

P. Sorensen

hi-fi

www.hi-fiworld.co.uk

SEPTEMBER 2003 UK £3.20

WORLD



WORLD MUSIC
12-PAGE MUSIC SUPPLEMENT

GOING LIVE

**ORIGIN LIVE'S
SUPERB NEW
RESOLUTION
TURNTABLE!**



BRITISH STEEL

NEW ARCAM FMJ CD33

VINYL SPECIAL:

- setting up your turntable
- tube and transistor phono stages
- six top cartridges compared
- the truth about DJ decks
- the Garrard story



SEPTEMBER 2003



**MONRIO MC207 AMPLIFIER * PURE DIGITAL RADIO
* REVOLVER R45 'SPEAKERS * WORLD STANDARDS GUIDE**

COMPUTER AUDIO WORLD ARCHIVE YOUR ANALOGUE

COMPETITION - WIN A SUPERB CYRUS 6 AMPLIFIER!

amazon
amphion
apollo furniture
argento
audible illusions
audio physic
breuer dynamic
brinkmann
carfrae
cartridge man
cawsey
chord electronics
clearaudio
decca london
dnm
duevel
dynavector
ear yoshino
ecs
es lab
final lab
gamut
graham slee
hadcock
incognito
infinity
jbl k2
klimo
korato

Digital has truly come of age

Our old first generation friend, CD, is already looking decidedly like Old Hat. Super Audio CD and DVD Audio are with us, assuming you can find the titles you want (rather than the titles they want you to have) at a record shop near you, or indeed in a record shop anywhere. Music (and gadget) lovers can revel in the multitude of ways to store and play their (compressed) music, from home or portable hard disk players, hand-held memory card players, or the humble home computer itself.

So why do we fill our adverts (and our shop) with obsolete mechanical machines from a bygone age to spin huge discs at 33.3 and 45rpm with a sharp diamond on the end of a moving arm to read tiny squiggles in the vinyl? How quaint!



Amazon Model 3 inc
RB250 arm - £995.00

Brinkmann La Grange inc 10.5
Tonearm (cart extra) - £6995.00



Origin Live Aurora (arm & cart extra) - £997.00



Michell Orbe SE (arm & cart extra) £1916.00



Michell Gyro SE (arm & cart extra) - £870.00

We have the largest selection of vinyl players anywhere in the UK (and possibly further afield too) - just a small selection on this page



More importantly, nobody assembles and tunes turntables like we do - to perfection!



Nottingham Analogue Horizon inc
RB250 arm - £528.75



Nottingham Analogue Spacedeck
(arm & cart extra) - £889.75



Origin Live Resolution (arm & cart extra) - £1979.00

lavardin
loricraft
lyra
michell engineering
morch
musical fidelity
nordost
nottingham analogue
origin live
ortofon
papworth
pink triangle
pluto
rega turntables
ringmat
rose
shun mook
shanling
shelter
sme
sonneteer
spendor
stax
sugden
sumiko
tci cables
tivoli audio
tom evans
townshend audio
transfiguration
trichord
van den hul

Warning!

We have a huge selection of accessories for the vinyl enthusiast which can be purchased either by personal callers to our shop, or by mail order world-wide.

Please consult our web site for product details, and how to order.

Latest!

- * The amazing state of the art JBL K2 speakers on demo now
- * Shanling CDT-100 CD player on demo
- * Naim Aro tonearm and Armageddon PSU on demo
- * Rose and Korato preamps on demo
- * At last - the new Michell Engineering Tecnodec - on demo



For info on these, and much more, including our numerous second-hand items, please visit our popular website: www.walrus.co.uk

** interest free credit available on most items, subject to status **

tel: 020 7724 7224

fax: 020 7724 4347

email: mail@walrus.co.uk

web: www.walrus.co.uk

Welcome!

CONTACTS: Mon-Fri 9am-5pm

EDITOR

David Price
tel/fax +44 (0) 0117 968 8264
e-mail: editorial@hi-fiworld.co.uk

DESIGN EDITOR

Faiza Chunara
tel: +44 (020) 7625 3129
fax: +44 (020) 7328 1844
e-mail: adproduction@hi-fiworld.co.uk

PRODUCTION EDITOR

David Noble
tel: +44 (020) 7625 3134
fax: +44 (020) 7328 1844
e-mail: classifieds@hi-fiworld.co.uk

WRITERS

Dominic Todd
LJK Setright
Haden Boardman
Albert Lee
Chris Parker
Paul Messenger

ADVERTISING

Amanda Sweeney
tel/fax +44 (020) 8864 4760
e-mail: advertising@hi-fiworld.co.uk

ACCOUNTS

Sharon Mehlhom
tel: +44 (0) 20 8841 8892
fax: +44 (0) 20 8841 9144
e-mail: accounts@hi-fiworld.co.uk

CREDIT CONTROL

Louise Palfrey
tel: +44 (0) 1923 270 833
fax: +44 (0) 1923 260 588
e-mail: creditcontrol@hi-fiworld.co.uk

WORLD AUDIO DESIGN

Technical Manager - Nick Lucas
www.worldaudiodesign.co.uk

tel/fax: +44 (0) 1908 218 836
e-mail: nick@worldaudiodesign.co.uk

PUBLISHER

Noel Keywood
e-mail: publisher@hi-fiworld.co.uk

PRIVATE & TRADE CLASSIFIEDS

tel: +44 (020) 7625 3134
fax: +44 (020) 7328 1844
e-mail: classifieds@hi-fiworld.co.uk

SUBSCRIPTIONS & BACK ISSUES

9:30am - 12:00 noon
tel: +44 (0) 1923 270 833
fax: +44 (0) 1923 260 588
e-mail: subscriptions@hi-fiworld.co.uk

Distributed by

Comag Magazine Marketing,
Tavistock Road, West Drayton,
Middlesex UB7 7QE
Tel: +44 (0) 1895 444 055

Printed by

Southern Print, Dorset
Tel: +44 (0) 1202 628 300

Our Agents in Malaysia

Millennium Hi-Fi & AV
Simon Chang
Showroom & office, 500-1-3 First Floor
Wisma Indah (Shen Court), Jalan Tun Razak
50400 Kuala Lumpur, Malaysia
Tel: 603 9283 8171 Fax: 603 9281 3762
e-mail: info@millennium-audio.com

All unsolicited submissions and goods are at the owner's risk. We accept no responsibility for such submissions, nor do we undertake to return them.

No material may be reproduced from this magazine without the publisher's written permission.
© Audio Publishing Ltd



david price

In this brave new world of genetically-modified digital audio, you'd think that plain old black vinyl would be taking something of a back seat. Surely, with none of the high tech appeal of DVD-A and SACD, analogue discs simply can't compete?

Wrong - despite the high tech trickery of DVD-A and SACD, the

bumpy old vinyl groove is still the most satisfying way to carry music. Which is why we've devoted this issue to LP, testing all the latest 'toys for the black stuff'!

Maybe it's a sad indictment of digital-obsessed modern life, but if a turntable like Origin Live's Resolution had come out twenty years ago, the whole hi-fi world would have gone bananas. Here's a brilliantly designed, thoroughly modern way to play music - offering higher fidelity than any DVD-Audio spinner, and tremendous 'legacy audio' compatibility too!

Fit a decent tonearm - such as OL's own modded Rega RB250 - and you've a recipe for vinyl heaven, but you'll need a decent cartridge too. In this month's supertest, we've tried six from £350 to £2,000. Then, when you've got your top turntable, arm and cartridge, there's the small problem of setting it up - so our very own 'King of the Cantilever', Noel Keywood, reveals the secrets. And, as even the best record player is nothing without a phonostage, we've put the latest and greatest solid-staters from Creek and Trichord against an old tubular belle from EAR. Finally, want to archive your prized long players in DVD-A quality? This month's *Computer Audio World* special shows you how!

For diehard digi-philes, we've got Arcam's superb new FMJ CD33. The Huntingdon company has made several tasty digital disc spinners in its time, and this is the latest. Then we have Monrio's MC207 integrated amplifier - a brilliant mix of Sugden sweetness and Cyrus crispness, in a svelte Italian body.

And finally, a music special with a difference - twelve pages of essential listening, spanning classical, jazz, funk, rock and pop. While many titles are brilliantly recorded, some are poor yet the music is great enough to shine through regardless!

David Price

how we test the products

- Hi-Fi World has its own advanced test laboratory and acoustically treated listening room.
- Hi-Fi World has a dedicated in-house team of experienced listeners. We review thoroughly by extensive auditioning, rather than by quick-fire group listening tests.
- Hi-Fi World's engineering team designs a wide range of products in-house. No other hi-fi magazine is so expert and dedicated.

WORLD VERDICTS: Because we only review products we find interesting, don't expect too many low scores. Likewise, five globe awards will be few and far between because there's only one superlative product of its type. The £ sign remains, as we often come across flawed gems that are great value for money.

	OUTSTANDING	- Simply the best.
	EXCELLENT	- Extremely capable.
	GOOD	- Worth auditioning.
	MEDIOCRE	- Unremarkable.
	POOR	- Seriously flawed.
	VALUE	- Keenly priced.

www.hi-fiworld.co.uk

HI-FI WORLD

SUITE G4, ARGO HOUSE
KILBURN PARK ROAD
LONDON, NW6 5LF

contents

reviews

digital players

ARCAM FMJ CD33 51

Chris Parker tries out Arcam's latest thousand pound bruiser, the FMJ CD33.

amplifiers

MONRIO MC207 40

Here's an exotic Italian alternative to Cyrus's CD8 and Sugden's A21a integrations, says Dominic Todd.

tuners

PURE EVOKE 1 VS. TIVOLI MODEL ONE 54

LJK Setright compares two very different takes on the traditional 'table radio' theme...

loudspeakers

REVOLVER R45 62

When he's not driving Jags, Mike Jewitt is a gifted loudspeaker engineer. Noel Keywood purrs at his latest creation, the Revolver R45 floorstander.

vinyl

ORIGIN LIVE RESOLUTION 56

Haden Boardman finds this new £2,000 turntable to be a worthy rival to Michell's Orbe – yes, it really is that good!

GROUP TEST 10

Five top notch moving coil cartridges, from £350 to £2,000, get the treatment from David Price and Paul Messenger – and we've thrown in the best ever moving magnet for good measure, too!

SONY PS-DJ9000 38

As Sony's PS-J9000 shows, not all DJ decks are made the same – Albert Lee says that if you want serious sound from vinyl, then buy hi-fi turntable!

accessories

CABLES 80

David Price tries out two simple ways to enrich your musical experience...

features

GET THE BALANCE RIGHT 20

Noel Keywood tells you precisely how to set-up your turntable for the best possible sound...

GET SET 23

...then turns his attention to tonearms and cartridges. Your vinyl will never sound the same again!

THREE STATE SOLUTION 34

David Price puts the brand new Creek OBH-15 and Trichord Delphini NC solid-state phono stages against and one favourite in the shape of EAR's tubed 834P.

THE NEW TRADITION 59

David Price goes west to meet Garrard's Terry O'Sullivan and Nigel Pearson, and finds 'traditional values in a modern setting'.

PAGE 12



PAGE 40

PAGE 56

PAGE 51



computer audio

SOUNDBYTES 71

The latest tantalising tidbits from the world of computer audio.

ARCHIVING ANALOGUE 72

Noel Keywood shows you how you use your computer to archive your prized vinyl to DVD...

DISCWELDER STEEL 74

...and then takes an in-depth look at Minnetonka Audio's discWelder STEEL DVD authoring software.

BUYING GUIDE

www.hi-fiworld.co.uk

visit our website for a comprehensive list of all the products we have reviewed over the past 11 years

SUBSCRIPTIONS HOTLINE

01923 270833

MON - FRI 9.30AM - 12.00 NOON
FAX: +44 01923 260 588

regulars

WORLD NEWS 7

NEXT ISSUE 9

READERS LETTERS 42

Hi-Fi World's wise men will reply to your letters and e-mails and put you back on the right course. And don't forget, every letter or e-mail we print wins a superb prize.

HI-FI WORLD KITS 64

Solder in one hand, glue in the other, satisfy your creative urges with a World kit.

HI-FI WORLD LIBRARY 68

A comprehensive selection of titles covering audio, valve amplifiers, loudspeakers, solid state electronics and more.

SUBSCRIPTIONS 70

Spare yourself the frenzied riot as you struggle with the hordes to claim the last copy of Hi-Fi World in the newsagent - Subscribe today!

COLUMNS 77,79,81

The World team get to grips with issues facing both the industry and hi-fi alike.

DIAL-A-DEALER 82

Look before you leap, or alternatively listen before you buy. These are the people to talk to.

MEET YOUR MAKER 84

Not a call to the spiritual, but a list of manufacturers detailing who makes what, and how to get in touch.

SPECIALIST HI-FI DEALERS 85

The perfect mix - excellent coffee, a comfortable sofa, and someone who really knows how to guide you through the world of hi-fi.

WORLD CLASSICS 87

Our list of products that have stood the test of time.

WORLD STANDARDS 92

Thinking of an upgrade or even a new system? Here's where to find our recommendations from the mass of hi-fi we've reviewed.

MARKETPLACE 107

READERS CLASSIFIEDS 123

The definitive place to find classic audio components.

ADVERTISERS INDEX 129

OLDE WORLDE 130

Haden Boardman remembers Marantz's inspired CD12 two box CD spinner

world music supplement

WORLD MUSIC 95

Here's a music special with a difference - twelve pages of essential listening, spanning classical, jazz, funk, rock and pop. While many titles are brilliantly recorded, some are poor yet the music is great enough to shine through regardless. Enjoy!

competition

A brilliant Cyrus 6 integrated amplifier will go to one lucky winner in this month's great give-away.



PAGE 26

PAGE 72

PAGE 23

Put The Needle



On The Record



And The Drum Beat



Goes Like This



Pro-ject,
stunning record playing systems from £115

Distributors: **Henley Designs Ltd, 01235 511166**
www.henleydesigns.co.uk, e-mail info@henleydesigns.co.uk

WorldRadioHistory

Centres of Excellence

The following dealers have been chosen for their exceptionally high standards in customer service, staff training and demonstration facilities.

We recommend them wholeheartedly

Scotland / Ireland / Wales

Glasgow - Glasgow Audio 0141 332 4707
Edinburgh - HIFI Corner 0131 554790
Edinburgh - Rust Audio 0131 557 1872
Aberdeen - Severnside HIFI 01224 587000
N Ireland - Kinnaird HIFI (Bangor) 02887 71360
Cardiff - Severnside HIFI 0292 0472899
Swansea - Severnside HIFI 01792 463777

North East

Hull - Severnside HIFI 01482 387171
Newcastle - Linnam Audio 0191 850 0999
Newcastle - Global HIFI 0191 230 3600

North West

Derlington - HIFI Experience 01425 481418
Doncaster - The HIFI Studio 01302 327274
Epsom - Severnside HIFI 01773 02577
Manchester - Severnside HIFI 0161 821 7768
Manchester - Precision HIFI 0161 829 8869
Sheffield - Moorpark Acoustics 0114 375 6048
Cardiff - Eric Wiley 01970 554774
Leeds - Severnside HIFI 0113 245 2725
Maidenhead - HIFIcentral HIFI 01494 344688
Chester - Audio Excellence 01244 345376
Warrington - Doug Brady HIFI 01925 838009
Creche - Audio Works 0161 428 7887

Midlands

Bedford - Acoustic AM 01334 345165
Dramatic - Technosound 01583 463297
Polebridge - Severnside HIFI 01731 897697
Cambridge - The Audiofile 01223 368105
Leicester - Leicester HIFI 0116 2539753
Nottingham - Severnside HIFI 0115 911 2121
Aylesbury - Zovex Audio 01295 819128
Leicestershire - Severnside HIFI 01532 537197
Leamington Spa - Acoustic HIFI 01926 888844
Widley - Sound Centre 01922 457326
Solihull - Music Matters 0121 742 0254
Birmingham - Music Matters 0121 428 2811
Kidderminster - Musical Audio 01562 822226

London

Essex - Karis electronics 0203 223 2247
Hullam - Severnside HIFI 0207 837 2540
Swiss Cottage - Severnside HIFI 0207 722 9777
Harrow - Harrow Audio 0208 863 0838
New Malden - Under 0208 942 9167
East Sheen - Choice HIFI 0208 393 1855

South West

Northampton - Audio Visual 01628 633925
Reading - Audio T 0118 958 5463
Reading - B & B HIFI 0118 958 2730
Newbury - B & B HIFI 01335 42614
Cornwall - Sounds Perfection 01326 231372
Exeter - Severnside HIFI 01392 218895
Oxford - Oxford Audio 01865 790879
Bristol - Audio Excellence 0117 926 4975
Bristol - Richard HIFI 0117 924 0878
Yovil - Mike Manning 01925 479361
Trenton - Audio Dimensions 01884 243384
Southampton - Phase Three 0238 022 8434
Salisbury - Salisbury HIFI 01722 322189
Basingstoke - Audio T 01256 324311

South East

Colchester - Graysco 1 & V 01206 577682
Brighton - Audio T 01273 264700
Hitchin - David Dymov AV 01462 452248
Rushmore - Kent Progressive Audio 01634 388004
Ipswich - Severnside HIFI 01473 284977
Norwich - Severnside HIFI 01603 767601
Worthing - Phase Three 01253 245377

email:news@hi-fiworld.co.uk

news

MU-FI TO THE MAX!

The ever-prolific Musical Fidelity has a raft of new products, appealing to a wide range of potential purchasers. At the top of the tree is the new Tri-Vista kW Laboratory Reference Pre and Power amps (below), costing £7,500 and £15,000 respectively. Only seventy five will be made. The company's founder, Anthony Michaelson says these are ultimate statement products, capable of outperforming



all rivals at a fraction of the price. The Preamp's output stage is "actually a small power amp", with a maximum output voltage of over 55v and 0.1ohm output impedance, making it able to deliver 10W RMS into a loudspeaker loud! The Power amp is a three box design, with two monoblock power amp sections (weighing 60kg apiece) and a one-box power supply, weighing 40kg! Musical Fidelity say it will get the best from any loudspeaker regardless of its load characteristics, essentially making the amplification 'disappear' into the system. Also new is the TriVista 21 DAC (below), £1,195 design offering the same analogue output stage as the superb TriVista SACD player, and a new BurrBrown DSD1792 DAC with upsampling, among many other features.



On a less esoteric level, we hear news of the new X-CANS v3 valve headphones, with a more upmarket casing (unfortunately the famous tubular design is gone), better componentry, an ALPS volume pot and a split rail transformer, the v3 promises an even better sound than the widely acclaimed predecessor. A £249 price tag makes this one for those who can't quite stretch to the kW pre. Also arriving is a new X-LP phono stage, in a new case to match the X-CANS v3. Finally, we can reveal the tantalising promise of a new Musical Fidelity turntable. Out this autumn, it should retail for around £1,300 and features a bespoke version of the forthcoming new SME arm, set to replace the 3009S2. Supplied complete with a good Grado cartridge, it will be an integrated package that buyers can 'plug and play'. Michaelson, with his characteristic bravado, told Hi-Fi World, "yes, it will be better than a Linn"! More information can be obtained from www.musicalfidelity.com, or by phoning 020 8900 2866.



THE PUSH CONTINUES...

As Sony and Philips continue with SACD, the rest of the music industry is continuing its push for DVD-Audio. Warner Music Group, Silverline Records, BMG, EMI Recorded Music, 5.1 Entertainment Group, Meridian Audio, Dolby Laboratories and Panasonic (MEI) have announced the formation of the DVD-Audio Marketing Council, which will serve as "a complete resource for all technical, press and marketing information related to the DVD-Audio format in the United States and Europe". The council will also function to educate hardware and software retailers to the benefits and features of DVD-Audio while simultaneously promoting consumer awareness of the new format. Admirable words, but whether this will translate into consumers being able to finally buy them in shops is anyone's guess...



CELESTIAL MUSIC?

The Celeste mkII is a new stereo portable digital radio that receives programmes from the WorldSpace satellite system, plus AM/FM terrestrial radio. WorldSpace programmes are broadcast from a network of satellites 34,000km out in space, and reception is possible almost anywhere in the UK, Europe, Africa, the Middle East and Asia. There are over forty stations broadcasting 24 hours a day, including the BBC World Service, CNN News, International News, Bloomberg, multi-lingual, educational, sport, weather, plus specialist music stations such as 'the original' Radio



Caroline. The radio itself claims 70W of output power, and runs from internal batteries, an external 12 volt supply or AC mains. Price

is £129. For a list of stockists, call 023 92 313090 or click on www.worldspaceradios.co.uk.

RATA ONLINE

Russ Andrews Accessories has launched a new website designed to make ordering its hi-fi and home cinema products easier. Secure online ordering is available for the full product range, and the site offers advice and tips on system set-up, and includes Russ's information booklets as free downloads. Click on www.russandrews.com to experience it firsthand!



COME TOGETHER

TEAC new high-end DV-50 offers SACD, DVD-Audio and CD playback, formats. As well as DSD, it plays 24/192 discs and even upconverts CDs. Three digital filter modes are offered, a VCXO circuit claims to eliminate jitter, there's a Video Off function, Component video output, Balanced XLR outputs and the usual Japanese battleship 'Ultra-high density chassis' for increased stability. A hefty beast, its vital statistics are 443x157x354mm and 21.2 kg. Price is £4,500. Call TEAC on 01923 819630 or click on www.teac.co.uk for more details.



SPOTTED

Garrard's Terry O'Sullivan talks to donkey - note the lack of hind legs visible...

COME TOGETHER

Clearaudio's new Unify is a versatile unipivot tonearm built around a single point sapphire bearing that sits upon a precision hardened steel spike. The combination of aluminium bearing housing, woven carbon fibre arm tube and stainless steel base effectively damp

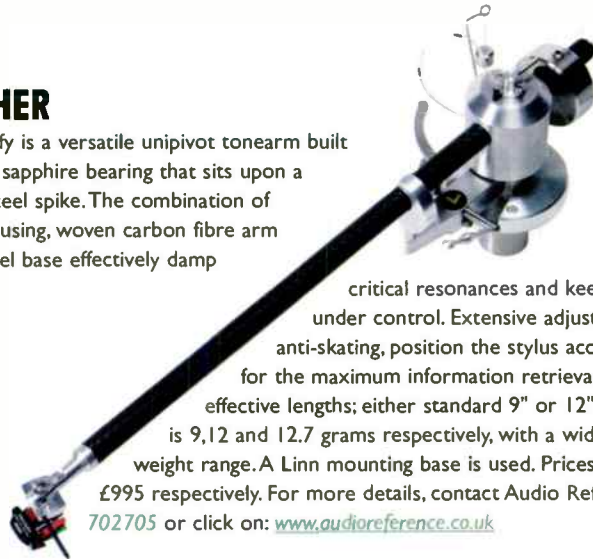

critical resonances and keep energy transmission firmly under control. Extensive adjustments including VTA, azimuth and anti-skating, position the stylus accurately within the record groove for the maximum information retrieval. The Unify is available in three effective lengths; either standard 9" or 12" and 14" versions. Effective mass is 9, 12 and 12.7 grams respectively, with a wide 2.5 – 17g cartridge weight range. A Linn mounting base is used. Prices are £690, £885 and £995 respectively. For more details, contact Audio Reference on 01252 702705 or click on: www.audioreference.co.uk

UP FOR A HYBRID?

Sony is briefing against the possibility of a DVD-Audio/CD hybrid disc. One of SACD's obvious strengths is its backwards compatibility with CD players (SACD discs will play in conventional CD players, but in only in two-channel CD resolution), but the company believes 'patent hurdles' make the DVD-A hybrid equivalent unlikely. Sources say that attempts to commercialise one thus far have 'flopped' in DVD Forum evaluations, owing to inconsistent operation in legacy DVD players, but this is not the main hurdle. Rather, a portfolio of Philips and Sony patents for hybrid Super Audio CD (SACD) filed by Philips in 1996 show how any plan to make hybrid DVD/CD would probably need licensing from Philips, says Sony.

Philips, Sony's SACD partner, holds various patents in hybrid and multilayer disc technology that are allegedly 'essential' for manufacturing of hybrid DVD/CD. Although the 1996 patent doesn't refer to SACD by name, it describes a disc hybrid with two recorded layers at different depths in a polycarbonate disc – which is how SACD works. A Philips spokesman said that if the proponents of DVD-Audio/CD hybrid discs can develop a workable standard, then they will find a "warm welcome in Philips' licensing department.". The question of whether the proponents of any such hybrid DVD-A/CD disc would be happy to join such a licensing program may ultimately determine the existence of any new disc...

CAMBRIDGE LINK UP

Cyrus Electronics and Imerge Ltd of Cambridge UK have announced that they are working together on a new generation of hard disk-based, Internet-enabled hi-fi products. Cyrus will produce a hard disk based home network audio system powered by XiVA, comprising a high specification HDD audio server with integrated Cyrus audio technology, network players and handheld wireless touch panel control. Called Cyrus Link, it will be launched in September 2003 to form the basis for an integrated multi-room audiophile solution. For more information on XiVA technology visit www.xiva.com and www.xiva-net.com.

NAKED VINYL

Tim O'Brien & Mike Savage
CHRYSLIS IMPACT ISBN 1-84411-005-2

From the founders of Bristol's Prime Cuts Music Exchange comes this light hearted romp through the spicier side of LP record cover art from the fifties, sixties and seventies. With no BlueNote-style examples of studied cool here, this is one for serious students of kitsch. One thing's for sure, all this would never have been possible on CD jewelcases!



ON AIR?

Even Digital Radio's strongest devotees cannot argue that it is not without reception problems. Unlike analogue, it either works or it doesn't, so if you've already got a decent, well set-up aerial and still can't get a signal, that's it. More worryingly, some users report that the maps showing which areas can (and can't) receive DAB are not completely accurate – sometimes, areas which show up as 'reception areas' can only receive just a few of the forty or so stations theoretically available – and not all. Good news, then, to hear that the BBC has confirmed that it is upgrading its digital radio transmitter network from 65% to 85% coverage of the UK population in 2004, bringing DAB broadcasts to new areas of Central England, East Anglia, the South and South East, the West and South West, the North, and Scotland. Work starts this summer on the expansion of the BBC's digital radio transmitter network. The BBC website will carry new maps of the planned expansion and, for the first time, BBC listeners will be able to check if their home will come into coverage in the next 12 months – a useful facility for those who can't yet receive BBC digital broadcasts. As transmitters are switched on, the postcode checker on the website will also be updated. For more information, click on www.bbc.co.uk/digitalradio or call 08700 100789.



next issue...

It's loudspeaker time! From Classique's Quad ESL remake and DynaVox's madcap UniQorn, to Naim's cutting-edge SL2 and a supertest of state-of-the-art stand-mounters, you'll find everything you wanted to know about 'speakers. We'll show you how they work - and how you can get them to work for you! And there's more:

AUDIO RESEARCH Vsi55
A stunning valve integrated from one of America's famous names.

DENON DV-2900
This Japanese giant is serious about DVD-A, as its new affordable player proves.

CREEK T50
From the acknowledged master of budget tuners comes the latest and greatest(?) hi-fi radio.

WINDOWS MEDIA AUDIO 9
So Microsoft's suddenly interested in sound quality, is it? We investigate...

next issue...



Vinyl Demand

Welcome to the world of advanced resolution analogue audio! With so much talk of high definition digital formats, it would be wrong to ignore what is very probably the most powerful and involving sound source currently available – ye olde black plastic! David Price explains why LP is the ultimate audiophile solution, then Paul Messenger and David Price listen to some of the best cartridges around...

Who'd have thought that in 2003, over half a century after the technology made its debut, the humble vinyl disc is still the best mass music carrier available? It may be a controversial assertion, but if you disagree then prepare to be surprised – and delighted. Analogue audio, courtesy of the LP record, is capable of sound that surpasses anything digital has to offer. The trouble is, as with anything analogue, is isn't always easy to coax serious sound from microgroove discs – and so in order to do it, you'll need the knowledge. In this month's issue of Hi-Fi World, we have it for you.

One of the biggest hi-fi myths that need to be debunked is that of 'progress'. Since the arrival of Compact Disc back in 1983, various factions from the both the hardware and software arms of the 'music

industry' have argued vociferously that digital is the solution to the problems of music replay. And in some ways, they're right. There's no doubt about it – digital discs (be it CD, SACD or DVD-A) offer genuine convenience allied to great sound – assuming you choose your equipment intelligently.

However, it's more than a little ironic that since the introduction of digital audio, analogue has enjoyed a new golden age. The sound quality possible from LP replay twenty years ago – already superb – has improved dramatically, making 'analogue' not just a serious alternative but, to many people's ears, far superior. If you haven't heard decent vinyl replay then you owe it to yourself to do so, and the good news is that brilliant, giant-killing decks, tonearms and cartridges are probably cheaper than ever in real terms.

How so? Well, while the bulk of

the sound squeezed out of digital discs is informed by the electronics, vinyl replay is a mechanical process pure and simple. The better and more intelligently that vinyl replay 'machines' are designed, the more the superb fidelity of this format becomes obvious – and of late, a wealth of design refinements and new technologies have come together to make stunning sound from analogue discs a reality.

TURNTABLES

Linn's Ivor Tiefenbrun was right when he said 'garbage in, garbage out' all those years ago – if you put a poor turntable into your system, you'll get rubbish out. The bad news is that, as record decks are essentially 'analogue measuring instruments', tracing a grooved disc as faithfully as is possible, the only way you'll get decent sound is by using one as cleverly designed and meticulously

set-up as possible. While electronic engineering solutions – via silicon chips – are cheap, mechanical engineering solutions require serious physical manufacturing to close tolerances to work well, and this costs money. The result is that the difference between the best and worst turntable is far greater than the best and worst digital disc player, because there's so much more to screw up. Put simply, you need to spend real sums of money on decent hardware or you're sunk before you've left harbour!

First and foremost, turntables need to revolve at a constant speed. Now, this may not seem too tall an order, but as the stylus traces a groove, it encounters resistance – especially on highly modulated, 'loud' passages. This is called dynamic wow, and it's a right pain to overcome. Even very high quality decks, such as Linn's LP12, for example, can suffer this. The solution is to use very powerful, torquey motors, but when you do this, you get motor noise feeding into the system and creating 'rumble'. As such, it's a balancing act – you need the most robust motor possible that doesn't ruin your noise floor.

There are several ways of achieving this compromise – belt drive, direct drive or idler drive. The first way is by far the most cost-effective solution, as the belt absorbs much of the motor noise. Direct drive is – in theory – better, because it doesn't rely on a complex system of motor, motor pulley, drive belt and inner/outer platter to transmit the speed, but small speed errors are also amplified – because they're driving the platter right from the very centre, which is called 'cogging'. Idler drives, such as Garrard's classic 301, have an even more torquey, direct drive to the platter via an 'idler wheel' driving the inner rim of the outer edge of the platter directly, but they can transmit rumble.

Secondly, turntables need good acoustic feedback resistance, meaning that they don't pick up air or ground borne interference. There are two ways of achieving this, either by a sprung, suspended subchassis design which damps the vibrations out between the plinth and the subchassis, which carries the bearing/platter/arm and cartridge, or by using a massive, non-suspended subchassis system that simply grounds out all the vibrations by virtue of its great weight. Either

system has its advocates, but it's fair to say that the former is cheaper to do properly. Massive non-suspended decks, such as the late seventies Japanese superdecks (Sony TT-S1000, Technics SP1000, Marantz TT1000) cost a bomb in their day – around four times more than a Linn LP12. However, the cheapest solution is to use a non-suspended deck with just rubber feet for isolation, a la Rega – this can work well if properly sited.

ARMS

Effectively, tonearms have to be mechanically and sonically neutral carriers for the cartridge. This means that – first and foremost – they have to have very low bearing friction in the horizontal plane, allowing the pick-up to trace the entirety of the record groove across the whole side untrammelled. They also have to be able to move up and down with ease, as the cartridge rides the (inevitable) warps of the record – meaning very low vertical friction is a necessity.

However, because there is a 'closed loop' between the vinyl record and the arm and cartridge bearings, there must be no play or 'slack' in the bearings. If there is, then the vital but minuscule mechanical vibrations introduced will colour the sound, and rob it of dynamics and grip. To wit, the bearing housing of any tonearm is pivotal ('scuse the pun) to the sound you'll get out.

It's not the whole story, however. A cartridge is a mechanical device that traces a groove, in much the same way that a motorcycle or car wheel traces the road. If it's overdamped or underdamped, it won't faithfully follow the contours resulting in the suspension grounding out or not rebounding properly. With records, this results in distortion as either the stylus doesn't sit in the groove properly at all times, or the cartridge suspension is overloaded. To wit, a tonearm must be able to offer an accurate range of adjustments for any cartridge. It should have tracking weight, anti-skate (i.e. bias) and VTA (vertical tracking angle) calibrations. All high quality arms, such as SMEs, have these, but unfortunately the best selling design – the Rega RB250 and RB300 do not. Fortunately, spacers

are available from companies such as Origin Live which facilitate this.

Arms also need to be of an appropriate effective mass. Essentially, the lower mass an arm is, the less mechanical 'character' it imposes on the cartridge as it attempts to trace the groove. However, most modern cartridges are of relatively low compliance, necessitating (for reasons of mechanical synergy) a higher mass arm. Fortunately, most arms and cartridges are reasonably well matched in terms of the weight-compliance equation, these days.

Another point is the arm's centre of gravity – just with a car or motorbike, the lower this is, the better the (cartridge) suspension is able to trace the groove. To wit, many arms have underslung counterweights, such as the SME Series V.

CARTRIDGES

If you think all this is complex, then cartridge design will give you a headache! Cartridges are transducers – you could think of them as essentially tiny loudspeakers in reverse. They take a mechanical movement (i.e. the stylus in the groove) and turn it into an electrical signal, fed into your phono stage, and then preamp and power amp. There are two types these days, moving magnets and moving coils. They work in a slightly different way, the former producing a far higher output than the other (around ten times as much). However, as with everything in life, there's always a trade-off, and MMs have a less precise, detailed and organic sound.

It's not always right to put it in such reductive terms but high end MCs invariably sound better than MMs – and they cost much, much more! By how much? Well, this month's group test should give you an idea.

Despite being seemingly very similar, the intricacies of micro-engineering means that cartridges often sound dramatically different. Here's where you can see how, and decide for yourself whether you think spending the extra is worthwhile...



CARTRIDGE SUPERTEST	p12
GET THE BALANCE RIGHT	p20
GET SET	p23
THREE STAGE SOLUTION	p34
CLUB CLASS?	p38
THE NEW TRADITION	p59
ORIGIN LIVE RESOLUTION	p56
THE VINYL CUT	p72

DYNAVECTOR DV20X-H £350

keeping with the big, bold and well lit midrange. In practice, I can see this cartridge working brilliantly with the Origin Live modded Rega RB250, which has an ever-so-slightly 'over smooth' treble and powerful, full bass response.

It is the dynamics and timing of this little pickup that truly impress. Dynavectors are often very musical sounding devices, which in conjunction with their traditionally warm tonality remind me of my late, lamented Supex SD900V. This cartridge has much of the magic of that old Japanese classic – it really gets into the groove and boogies. For example, Thomas Dolby's 'Fieldwork' came over with power and gusto – the DV20X-H is a truly gifted communicator on an emotional level. Transients aren't as stunning as, say, the (far more expensive) Ortofon Kontrapunkt B, yet it gives little away in terms of energy and impact. It's also great with the spaces between the notes, making for wonderfully foot-tapping rhythms – by contrast, all its price rivals sound stilted and mechanical.

I'd say the Dynavector is head and shoulders above all the oft-recommended 'affordable' cartridges – including the Goldring 1042 moving magnet and Sumiko BPS and Ortofon MC25FL moving coils. It manages to offer the best of all of these (very capable) designs in one package, and add some traditional Dynavector magic too. Both musical and neutral in equal measure, it is only when you reach the £400 price point of the Shure V15VxMR that it fails to dominate, and even up within the reaches of the Ortofon Kontrapunkt B it still impresses. Superb! **DP**

Series IV tonearm.

Dynavectors are traditionally unimpressive during the run in period, which often seems longer than others. The DV20X-H was no different, but when it did finally settle down, proved most impressive indeed. I can remember raising an eyebrow – Roger Moore style – when I first heard the '20, and this was no different. Essentially, it's far more neutral and self-effacing than any cartridge at this price point has a right to be, yet it is not clean to the point of blandness, as with – for example – Ortofon's MC25FL.

The great thing about its predecessor was its amazingly feisty, energetic and fast sound which made up with emotion what it lacked in analysis. The '20 adds a touch more midband incision, and sounds obviously more three dimensional, but retains almost all the older cartridge's passion. Bass is just a little on the light side, but it's more of a case of the tremendously articulate midband diverting attention away from the low frequencies. Treble is bright but by no means forward, and absolutely in

Remember the Ultimo 10X? This was one of the first moving coils I ever heard, back in the late 1970s. The DV20X-H is the dim, distant ancestor of this erstwhile budget blockbuster, and while technically very different (far more advanced), it sticks to its predecessor's value for money formula – to the letter.

It boasts the magnetic flux damping and softened magnetism of Dynavector's (hitherto) upper range designs, plus a powerful neodymium magnet. The head block is aluminium, making for a rigid platform for the cartridge motor assembly, and providing secure fixing to the headshell – this is one budget MC you can really clamp to your arm! As usual with Dynavector products, it is nicely finished, and well presented complete with a nice little bag of accessories. There's nothing particularly difficult about installing it – no odd geometry or awkward, alignment-unfriendly body shapes, and I found it easy enough to hand cue when I'd got it solidly bolted to my reference SME

MEASURED PERFORMANCE

Although the DV20X version is the 'low' output option, it still gives plenty of signal, producing 0.9mV at 5cm/s rms., a 6dB signal-to-noise advantage over its rivals in this group test.

Tracking performance was good, although the 20X could not track top level cuts at either 300Hz or 1kHz. It may mistrack on occasion. The vertical tracking angle was at high at 28degrees, so vertical distortion (left and right stereo images) was high, but being second harmonic the effect is difficult to detect.

The 20X has a nicely balanced frequency response characteristic, producing output within 1dB variation right up to 16kHz. On inner grooves tracing loss hardly affected this; the stylus is well profiled.

The DV20X measured well and should produce well balanced and impressive results in any set up. **NK**

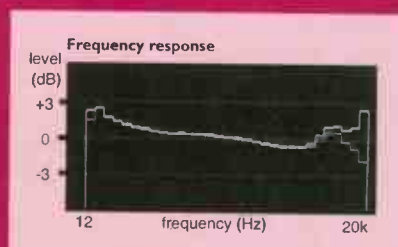

VERDICT ●●●●● £

Highly musical and engaging performer with a rich, smooth sound.

DYNAVECTOR DV20X H £350

Pear Audio

+44 (0)1665 830862

www.dynavector.co.uk

SHURE V15VxMR £400



This, the latest VxMR variant, has won many plaudits, and finds itself being the reference cartridge for Sony Music's archival operations. Its 6.6gm body boasts a die-cast aluminium mounting block, Shure's Dynamic Stabilizer damper, an ultra low mass Beryllium tubed cantilever and Micro-Ridge (hence MR) stylus claimed to track best at 1gm. At 15.87mm high, it's a fairly standard size and not too tricky to mount – even if the unconventionally shaped stylus assembly gives precious few reference points for alignment.

The beautiful claret red velvet box comes packed with accessories. There's an alignment protractor, turntable wedges, screwdriver, stylus cleaning brush, user and installation guides, (poor quality) mounting hardware and an excellent stylus guard which makes for angst-free installation. This also acts as a damper – Shure's exclusive viscous-damped 'Dynamic Stabilizer', as they call it, attempts to maintain a uniform distance

between the cartridge and the record under difficult playing conditions. When not required, it can be locked up into its detent position.

Although NK raved about this cartridge a few years back, this is the first time I'd heard it, and was duly enraptured. It is tonally far smoother and warmer than I'd expected from Shures of yore – indeed, it was one of the most fulsome cartridges in the test. Critically however, it still managed to be incredibly fast and incisive – this is the interesting point, because almost all cartridges are either warm or fast, but rarely both. This means that the Shure is both sensibly voiced (with a nicely smooth frequency balance) and superbly engineered, with an ultra-precise and responsive stylus, cantilever and generator assembly.

Cueing up Nick Lowe's 'So It Goes' revealed the essence of the latest V15. Bass guitars were full, but brilliantly taut and expressive. Midband was very detailed and open, with unusually strong depth

perspective and image articulation – the Shure managed to lock vocals in-between the speakers with unerring precision. Lowe's voice was very smooth, yet with oodles of timbral detailing – its grain was evident yet never coarse.

Moving up to the treble, the V15 provided a bold and brassy hi-hat sound. Although not quite as well resolved as the DV20X-H, it was altogether more rhythmically convincing (which is no small feat), making for truly engaging sound.

It's the rhythmic zip of this thing that really surprises. Put it against pick-ups that you'd previously thought of as being the most 'Decca-esque' available today (i.e. Ortofon's Kontrapunkt B) and the V15VxMR makes them sound positively pedestrian. Its attack transients are dizzying, and it invests a great sense of urgency into whatever it plays – you could say it's the cartridge equivalent of a Naim 250 power amp! Allied to its firecracker dynamics, which have you reaching for the volume control (when you're already cranked up close to the limit of your loudspeakers), you get one of the most characterful cartridges around at any price.

Of course, this cartridge has its drawbacks. It doesn't have the 'hear-through' clarity of the Kontrapunkt (but it is half the price), and lacks subtlety - albeit it less so than you'd expect. It is not a late night, dinner jazz tool – you might prefer to go back to your late eighties 16bit, 4 times oversampling CD player for a mellow moment of contemplative relaxation.

DP

VERDICT ●●●●●

Incredibly charismatic sound makes music a joy, but will not be to all tastes

SHURE V15VxMR £400

Howland West

+44 (0)20 8808 2222

www.hwinternational.co.uk

MEASURED PERFORMANCE

The V15VxMR is not like V15s of old. Tracking isn't as good as it once was, with a limited midband ability of 20cms/sec. Shure still quote very low tracking forces. The V15VxMR's upper limit is quoted as just 1.25gms. Under test I used 1.3gms in an SME312 12in arm.

The V15VxMR has an unusual frequency response, overdamped and possessing a slow roll down in output at high frequencies with no tip mass peak. It will sound smooth and warm as a result, but not dull. There was little loss on inner grooves, the stylus is a good one. The generator needs 250pF load for flattest response, then it produces a lovely square wave, free from ringing.

Vertical tracking angle was set high at 30degrees, resulting in high vertical mod. distortion. I suspect the

V15VxMR has been optimised for damping, square wave response and associated dynamic qualities. NK

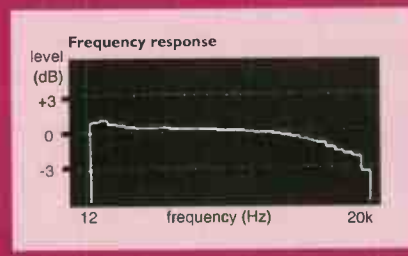

ORTOFON KONTRAPUNKT B £700



that midband. While many 'coils sacrifice detail for emotion, the Kontrapunkt really does let you have your cake and eat it. Rush's 'Subdivisions', for example, shows tremendous insight into the recording's most inner recesses, yet maintains a superbly engaging and propulsive sound. Depth perspective is superb at the price, and totally outclasses all the cheaper designs in this test. It imagines forward out of the 'speakers very confidently too – showing far tighter and better placed left-to-right image location.

No less impressive is this cartridge's dynamic prowess – it really loves to go loud-quiet-loud, finding the most subtle accents in a piece of music that any of the cheaper designs here would miss. It's far better at spotlighting the difference between a lightly struck and hard hit snare drums, for example.

Vocals, too, show its naturally expressive and emotive character – whilst remaining clean and smooth right up the frequency band; Randy Crawford's 'You Might Need Somebody' was awash with subtle phrasing inflections. To coin a well worn hi-fi phrase, this thing does 'microdynamics' superbly.

A superb cartridge, with few qualifications. Well above the cheaper members of the group, it really takes you into the realm of serious moving coils by doing everything extremely well. This very little to criticise here, save its subtle treble lift which could conceivably cause matching problems for a few analogue audiophiles.

DP

Said to commemorate the 250th anniversary of Johan Sebastian Bach, the Kontrapunkt comes in both 'A' and 'B' guises – the difference being the styli/ cantilever packages. The former has a Nude Fine Line stylus and an aluminium cantilever, the latter (tested here) a Nude FG80 tip with Ruby cantilever.

Its 10g stainless steel body is shaped in a way that makes installation and alignment a relatively straightforward process. It's quite tall, so those with Rega arm variants (with no VTA adjustment) may have to use spacers. I find it happiest in the SME Series IV at around 2.2g, but I don't spare the 'gees' in my reference Origin Live Illustrious, whereupon 2.5g complements the arm's 'lively' sound better.

At £700, the Kontrapunkt B is playing with the big boys (Lyra's Lydian Beta, for example, is no pushover), but it is more than at

home even when the stakes get high. It's a deeply engaging and musical performer, and one that I have to say doesn't strike one immediately as being 'an Ortofon' – anyone who's lived with this brand will know their characteristically clean, smooth and incisive nature, but may find them a tad unemotional. This one has a good deal of detail and atmosphere

Tonally, this cartridge errs gently to the bright side of neutral. Treble is certainly explicit, and with other designs this could be a problem, but so finessed and finely etched is this Ortofon's treble that it is not. Rather, you get a deliciously clean and smooth and open rendition of hi-hats, even if they're ever-so-slightly over-prominent in the mix. By contrast, the bass is just a touch light, but not obviously so. Indeed, so tight and tuneful is it that you soon find yourself tapping your feet and enjoying the music.

Best of all, by a country mile, is

MEASURED PERFORMANCE

The Kontrapunkt has a little generator loss above 1kHz but tip mass resonance brings output up at 6kHz and there's a treble peak of +2dB or so at 12kHz. It's all well controlled, and is likely to result in a full bodied sound with just a little top end brightness. Inner groove tracing losses were low, serving to reduce the peak usefully to give an approximately flat response.

The Kontrapunkt is very heavy, weighing 10gms – the upper limit of most arms. However, tracking force is high too, so if the counterweight applies this force it will bring it forward toward the pivot usefully. With an accurate vertical tracking angle and good tracking ability the cartridge will sound smooth and relaxed. It measures well. NK

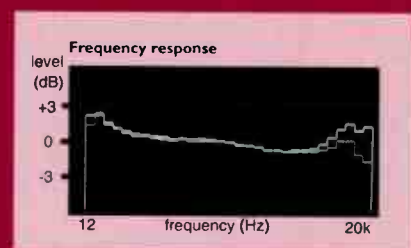

VERDICT ●●●●● £

Its exotic combination of excitement and finesse makes it the best value mid-price moving coil.

ORTOFON
KONTRAPUNKT B £700
Henley Designs
☎ +44 (0)1235 511166
www.henleydesigns.co.uk

DYNAVECTOR XX-2 £995

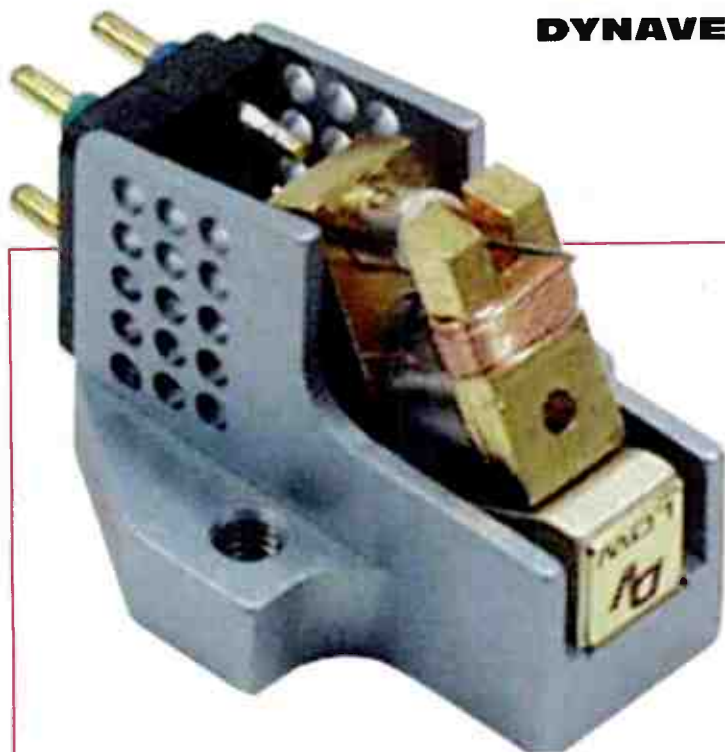

For many years, this Japanese specialist has been a leading practitioner of moving-coil cartridges, and is probably best known for its more affordable high output MC models, which have been market favourites for some twenty five years. But the company also has some classy upmarket models, incorporating its own proprietary technologies like magnetic flux damping, and employing unusual materials such as Alnico magnets.

The brand new £995 XX-2 retains the flux damping – a shorting coil wound around the polepieces to stabilise the magnetic field – that was first introduced in the XX-1 more than a decade ago. Those earlier examples could switch the damping on or off, but now it's a permanent feature.

A couple of years ago, Dynavector introduced a new 'flagship' DRT XV-1, whose prime feature was the use of Alnico

magnets, which combine high flux with low coercivity. This was very successful (I bought one, and love the gorgeous midband that always seems to go along with Alnico!), so Dynavector is now using it in the costly but rather more affordable XX-2.

Unlike its plastic predecessor, the XX-2 has solid alloy bodywork and a 'nude' front end, ensuring fine mechanical rigidity but leaving the solid boron cantilever looking very vulnerable to accidental damage. The tip has a Pathfinder line-contact stylus, and PCCOCC wire is used for the coils.

A sensibly chosen compliance places the fundamental resonance at an ideal 12-13Hz in a medium mass arm, with medium damping.

When it comes to the listening experience, the senior, older model still has it over the newcomer. The XX-2 needed a bit more running in when it arrived, so spent several days in regular use. It proved

beautifully neutral and delightfully even handed and vice-free, but never quite wowed me in the way that the DRT had.

It is, perhaps, a bit of a control freak, remaining unfailingly well behaved whatever is thrown at it. Images are broad and quite deep, with good resolution of fine, low level detail on even the densest material like orchestral and choral works. Indeed, it proved particularly good with high quality live recordings, such as Christy Moore's *Live at the Point*, a beautifully realistic recording with oodles of atmosphere and great musicianship. The XX-2 drew a big and convincing soundstage with oodles of realistic ambience, bringing fine tension to the whole proceedings.

At the same time, I didn't find the sort of toe-curling midband realism that I hear with others. There's a slight lack of vigour and excitement with this cartridge that leaves a bit more of a veil between music and listener than is found with more costly models. It's all just a little laid back, dynamically speaking, which just takes a little of the excitement and vigour out of the performance.

But one should make allowance for the fact that this is one of the less expensive examples in our exotic little grouping, and even at these extravagant sectors of the market, you do to some extent get what you pay for. At its price, the XX-2 gives a first class all round performance, with plenty of charm and delicacy. An extremely capable device at the price.

PM

VERDICT ●●●

Extremely competent and civilised performer, but lacks the edge to win in this ultra-capable group.

DYNAVECTOR XX 2 £995

Pear Audio

+44 (0)1665 830862

www.dynavector.co.uk

MEASURED PERFORMANCE

With tracking force set to 2gms, in the middle of the suggested range of 1.8-2.2gms, the DV XX-2 stayed in the groove at the highest levels, at 300Hz and 1kHz, but only just – there was some slight mistracking.

Dynavector have minimised distortion both laterally and vertically; this was a low distortion design with tracking angle spot on at 22degrees.

Output was low at 0.25mV at 5cms/sec rms; a quiet preamp is needed.

Output falls slowly across the midband, possibly giving a warm or full sound, rising back up to peak at +3dB at 18kHz. This will add a trace of top-end brightness. Tracking loss on inner grooves resulted in a flat response, so the DV XX-2 will never sound dull.

This cartridge measured well in all areas and has a well judged performance balance. It does need a good preamp though, since output is low. NK

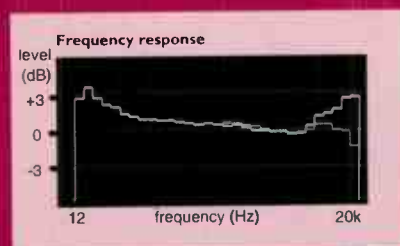

VERDICT ●●●●●£

Its canny mix of musicality and incision makes this a joy to listen to, and brilliant value to boot.

LINN AKIVA £1800

Linn Products Ltd.

+44 (0) 141 307 7777

www.linn.co.uk

Billed as a "super-precise, ultra-linear, direct coupled, moving coil cartridge", the Akiva incorporates a new magnet assembly for higher output than the previous Arkiv B. The medium mass (7.4g) cartridge body is, as is the vogue these days, machined from solid alloy for structural rigidity, with a ceramic 'front-piece'. Inside, a ceramic mounted rare-earth magnet creates the field in front of the hand-wound coils. Unlike the Arkiv B, a boron cantilever is used, with a Line Contact stylus tracking between 1.6 and 1.9g.

The cartridge is terminated with gold contact-tipped flying wires - being moulded to the cartridge body, it means there's one less set of contacts (i.e. between arm leads and cartridge pins) to oxidise, so it's a good idea in theory but will raise compatibility issues with tonearms with captive cartridge leads. The

body features Linn's clever three-point mounting system first seen on the Troika, which - in conjunction with a Linn Ekos makes for a brilliantly rigid fit with assured geometry. As always with Linn cartridges, a bag of top quality allen bolts, which can really be tightened up, are supplied.

The Akiva is very much in the mould of the previous Akiva B, inasmuch as it is a polished and refined performer but with an obvious rhythmic nature that makes listening to jazz, rock or pop music a joy. This is due in no small part to its obvious treble lift, which injects a degree of pep and vim to anything it plays, but mainly to the cartridge's inherent grip - which is positively tenacious. However, it does not sound overly bright, thanks to the sinuous bass that really pushes the music along. The overall effect is of a more incisive and open sound than its superb predecessor, which when

partnered with an Ekos makes for entrancingly musical sound.

Rush's 'Subdivisions' showed just how much a great high end coil like this can improve on an already excellent value mid-price design such as the Kontrapunkt B. There's a good deal more air and space in the upper midband and treble, yet greater finesse too (despite the slightly brighter tone). Imaging is wider and more accurately located, although it isn't quite up to the expansive VdH in this respect. Bass is tremendously grippy, yet satisfyingly tuneful - giving a real sense of the bass guitar's importance in the mix.

In just the same way as the Ekos is a punchy and engaging performer, so the Arkiv is voiced to provide a dynamic and insistently rhythmic sound - no matter what you feed it. With Thomas Dolby's 'Fieldwork', it was very much a case of 'senses working overtime' - the Akiva's glass-clear midband threw out masses of detail and lightening attack transients, making for a riveting listen, while its bass performance proved beyond reproach. Crisp, lithe and brilliantly articulated, I've heard few MCs sound so erudite.

If there's a criticism to be levelled, it's that it lacks the deliciously beguiling nature of the vdH, much in the same way that the Linn Ekos tonearm is more immediately impressive than the Naim ARO, yet ultimately less seductive. It isn't the world's most 'neutral' cartridge, but the one to go for if you - or your system - requires pace, power and punch above all else. **DP**

MEASURED PERFORMANCE

The Akiva was a reluctant tracker, skating right across the disc surface on high level test cuts, until its tracking force was set to maximum at 1.9gms. Then it performed reasonably well, staying in the groove, mistracking only highest levels. Output was reasonably high at 0.4mV at 5cms/sec. I suspect extra coil turns have boosted the latter at the expense of the former.

With vertical tracking angle is set at 26degrees distortion on vertical modulation was reasonably low at 3% second harmonic. Lateral distortion measured 0.7%, mainly second harmonic, from a 45um peak amplitude cut.

Output rises strongly to tip mass resonance, peaking by a large +6dB at 18kHz. Treble output starts to rise above 6kHz due to this effect. The Akiva will sound obviously bright as a result, even on inner grooves

where tracing loss only reduced the upper frequencies.

Measured performance of this cartridge was mediocre for a quality MC. NK

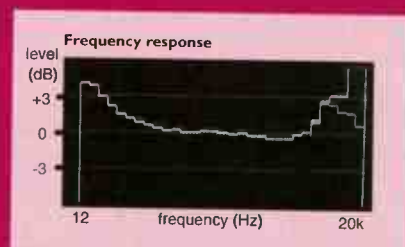

VAN DEN HUL GRASSHOPPER WHITE BEAUTY SPX £1,999



The Grasshopper range has been around since the mid-1980s, and has been through a series of upgrades since then. It was the first ever 'nude' cartridge, and while there might be sound sonic reasons for dispensing with cartridge bodywork (avoiding body resonances, for example), the approach does have lifestyle incompatibilities too, especially if there are children in the household! The lack of a stylus guard of any description also makes installation a particularly hazardous operation.

Having summoned up the courage, I actually found it straightforward enough to fit, helped by the extra local visibility provided through light reflecting from the all-white polycarbonate chassis. This also made cueing and stylus cleaning very easy, while the square shape further assists accurate alignment. Two sets of screw holes can be used, depending on the

particular headshell arrangements, to provide more secure mounting. Top vdH models like this White Beauty Special-X are actually built to order, and certain variations may be specified to suit individual preferences and system requirements.

The WB-SPX's spec naturally confirms the use of vdH's own stylus – a 2x85 micron type 1S – and talks of "matched crystal silver coils", but makes no mention of the cantilever material. The recommendation for this 8.5g cartridge is to use it in a tonearm with a sub-10g effective mass – a little lower than we had available. Nevertheless, in the Naim ARO the arm/cartridge resonance came in at a close-to-ideal 11Hz, with only light damping, which wouldn't seem a problem.

My only previous vdH experience was with a Frog, a few years back, and I hadn't been particularly enthusiastic. The same could be said

for my first impression here, though on this occasion first impressions proved misleading. Probably the cartridge needed a little running in, because its beautifully understated, wide-band neutrality quite quickly started to win me over. Indeed, the more time I spent with this cartridge, the more my respect for it grew, gradually turning into outright admiration.

Its ability to set up an enormously large and stable soundfield, with great width, depth and a wide dynamic range, was unequalled in this group. Ditto the exceptional neutrality and sonic purity, which seems to treat the whole spectrum with great even-handedness, showing no undue emphasis or favouritism to one particular zone, and with a lovely openness and unforced character through the broad midband. Unwanted vinyl artefacts are notably well suppressed, so the medium gets well out of the way of the message.

Leading edges and dynamics are very slightly muted. On Christy Moore's Live at the Point, for example, the applause was a little less distinct, the audience a little smaller, and Christy himself a little less dramatic that he might have been, though at the same time the fact that there's no tendency to force the issue.

An exceptionally neutral and capable cartridge, the White Beauty's nude construction and lack of stylus guard might not help the peace of mind, but the sounds it makes are unfailingly musical and easy on the ears. **PM**

VERDICT ●●●●£

Utterly self-effacing performer that charms and beguiles, this is one of the very best moving coils available.

**VAN DEN HUL GRASSHOPPER
WHITE BEAUTY SPX £1,999**

Van den Hul

☎ +44 (0)20 8997 4060

www.vandenhul.com

MEASURED PERFORMANCE

The Grasshopper White Beauty is under damped, having strongly rising treble our response analysis shows, and strong ringing down a square wave on both channels. It looked a bit messy, due to at least two resonant systems our response analysis suggests, at high frequencies. The cartridge will sound bright in balance and doubtless lively.

Low frequency tracking was good but not exceptional, the cartridge barely managing 63µm – not a torture track. It cleared 20cms/sec in the midband, which suggests it will hang on with strong female vocals and sibilance (spitch). Vertical tracking angle was a surprisingly low 20degrees, so vertical distortion was low too at 1%. Channel separation was unbalanced, suggesting generator misalignment, and output low at 0.44mV at 5cms/sec rms. The stylus traced inner

grooves well; tracing losses were low.

The Grasshopper didn't measure especially well. It's properties are not too tightly defined. **NK**

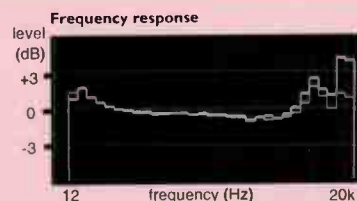

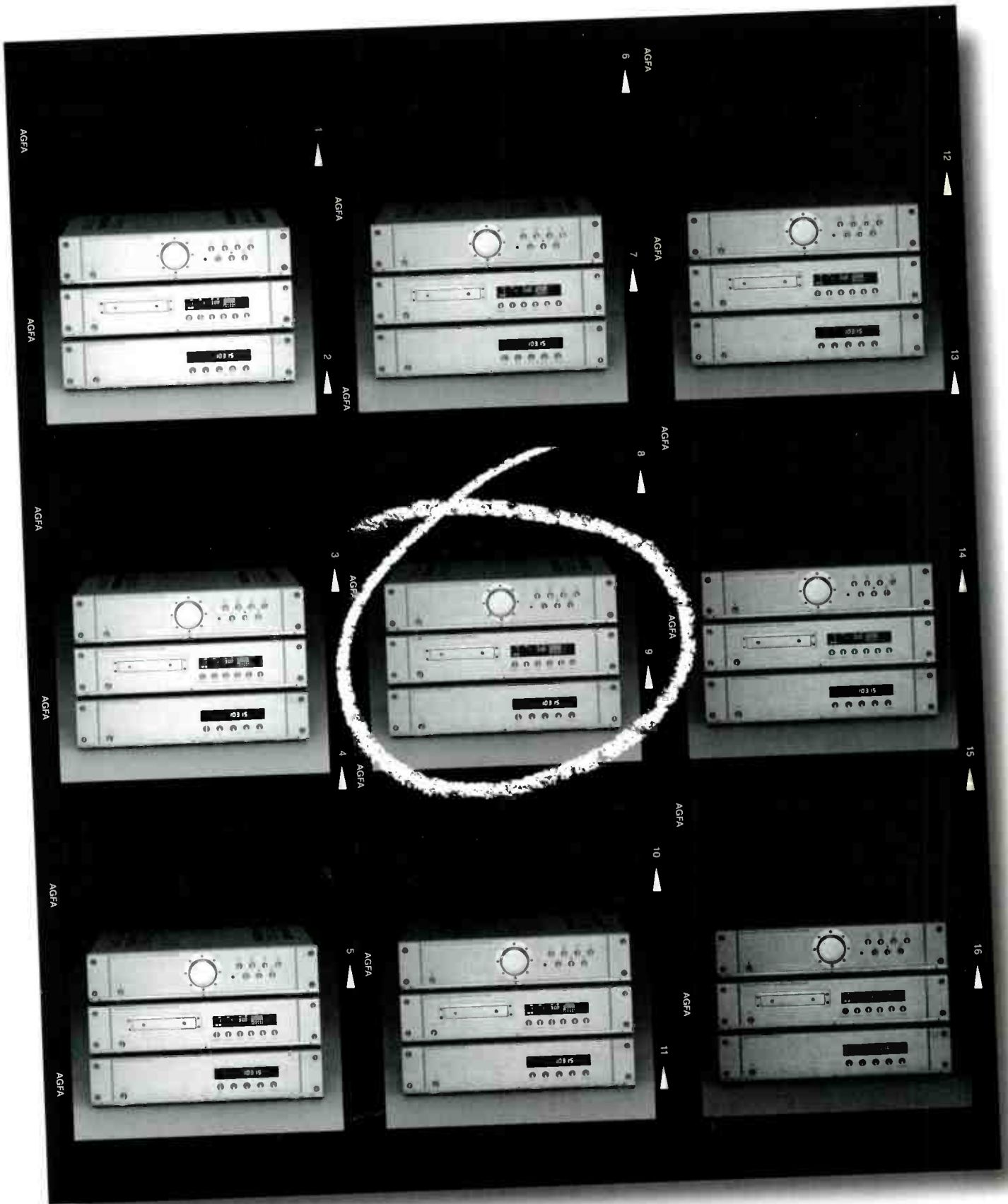

A3.2 SERIES.
MACHINED, MIL-SPEC ALUMINIUM FRONT PANEL.
PLATINUM PLATED FITTINGS. REMOTE CONTROLLED. PHONO STAGE.
POWERFUL, ROBUST, BUILT.

FOR DETAILS OF YOUR NEAREST STOCKIST RING 020 8900 2866. www.musical-fidelity.co.uk

conclusion

Before you get round to contemplating even the cheapest cartridge here, you'll need to have something of the calibre of the Michell TecnoDec /TecnoArm as a minimum, and preferably the likes of the Origin Live Resolution, Linn LPI2 Basik or Michell GyroDec SE. Then you can factor in a decent tonearm, of which the Origin Live modded RB250 would be the absolute minimum, or preferably at least an SME309, Origin Live Silver 250 or Naim ARO. This done, none of the cartridges here would disappoint. They're all really capable, and would paste some of the eighties 'fave raves', such as the ubiquitous Linn K9 or Audio Technica AT-OC9 comprehensively. The reason is that they're all well developed designs using modern practice and materials.

First, the Dynavec DV20X-H. The older version sounded less finessed and a tad more grainy, but was quite a bit cheaper when I reviewed it several years back. The new one is obviously superior, but lacks its value for money status – precisely because it now runs the Shure V15VxMR close on price. It's a brilliant "my first moving coil", easily bettering the likes of Goldring's G1042 in terms of clarity, dynamics, musicality and grip.

The Shure V15VxMR has the speed, grip and sheer emotive force of the long-lost Deccas, but without the tears (i.e. no re-cut record grooves!) It doesn't so much 'play' music as thrash it out with gob-smacking power and energy. This makes it a riot with many kinds of

music, yet I wouldn't like to use it for one of the roles that I think vinyl best performs - to provide a kind of 'musical meditation zone' at the end of the day. You know the thing – a Silk Cut, glass of Chardonnay and Miles playing 'Kind of Blue'. Buy this to thrill, not chill!

The Ortofon Kontrapunkt B has most of the Shure's emotion, with loads more finesse. This makes it a brilliantly judged 'jack of all trades and master of some'. If you're looking for an eminently capable and engaging performer that simply won't have you wishing you'd bought something else, then this is it. I think it's one of the best things Ortofon has ever done, in terms of the way it addresses the eternal price-performance dilemma.

The Dynavec XX-2 adds organic cohesion to the Ortofon's somewhat brusque sound, and starts to signal what is available to purchasers of seriously high end esoterica. It doesn't quite match the Linn or vdH, but offers a tantalising taste of the latter at half the price. Frankly, unless you're into Michell Orbe/SME V turntable/arm territory, you'd struggle to hear the difference. It is well rounded, well behaved and utterly unflappable. It might not have the terrier-like attributes of the Kontrapunkt, but boasts a sophisticated, refined and finessed view of the music that will suit

more mature listeners down to the ground.

Linn's Akiva follows the V15VxMR style of music making – which is to give a spirited, punchy and gripping sound - but adds more than a touch of Dynavec XX-2-like finesse. It's a brilliantly well-judged product from 'the Linn school' of music making. The great thing is that you can play music and not be too aware of any overt character in isolation – it's only when you put it against the likes of the vdH that it seems the flawed gem that it is.

Which brings us to van den Hul Grasshopper White Beauty SPX, which plays music with a cohesion and 'rightness' that makes all the others here seem wildly anachronistic. Utterly unflappable, deliciously uncoloured and sublimely unforced, it lets the recording's flavour flood out – with nothing added or taken away. Indeed, its problem is its lack of character, because at this price, folk like to buy characterful hi-fi and this is too self-effacing. Some may see this as a disadvantage, but for me – who prefers listening to the music rather than the cartridge, it is its most redeeming virtue.

THE TESTS

Countless different turntable/arm combinations were used, including Linn Ekos, Rega RB1000 and Naim ARO tonearms on an Armageddon-driven Linn Sondek LP12, and Origin Live Illustrious and SME Series IV tonearms on a Michell Orbe, with Naim and Trichord solid-state phonostages.

PRICES

- | | |
|---|--------|
| 1. Dynavec 20X-H | £350 |
| 2. Shure V15VxMR | £400 |
| 3. Ortofon Kontrapunkt B | £700 |
| 4. Dynavec XX2 | £995 |
| 5. Linn Akiva | £1,800 |
| 6. Van den Hul Grasshopper White Beauty SPX | £1,999 |



Get the balance right



Setting up a turntable is one of the most important things an analogue addict needs to know. Noel Keywood shows how...

The importance of setting up a record deck cannot be under stated. Turntables are essentially precision 'mechanical measuring instruments', and as such need to be as isolated from the outside world as much as is humanly possible. If not, ground and air born vibrations will intrude, and ruin the sound. The amazing thing is that even

relatively inexpensive decks will benefit from proper positioning, as – inevitably – they have poorer isolation from the outside world than their esoteric cousins!

Of most concern is floor bounce; suspended wooden floors move up and down at much the same frequency as arm/cartridge resonance, around 5Hz, making any turntable very sensitive to 'footfall'. A

firmly mounted wall shelf will avoid this, preferably on a brick wall rather than an internal stud wall (lath and plaster or plasterboard on wooden uprights). Stud walls usually sound hollow when you rap them with your knuckles. Make sure the shelf itself is solid; a thick piece of mahogany oiled and polished looks good or you can use MDF, 19mm minimum thickness. I once built a huge sand-filled shelf, but



A strong, dedicated turntable table from Mana.

these days use a large sheet of marble under a plinth of vast weight and proportions! You could always use builders' silver sand (dry it first!) between MDF sheets for a good, weighty, dead shelf.

If you cannot put up shelf, then use a table. Site it against a wall, where floor movement is at a minimum. The table should be low so the top doesn't sway too far. A high stand or table will amplify floor movement, so beware. To minimise acoustic pickup, especially bass, keep the turntable away from corners and distance it asymmetrically between walls, floor and ceiling if possible (i.e. not exactly half way along a wall, or up a wall). Window sills are firm sites, but a cold draught off the glass in winter will do the cartridge's tracking ability and sound no good at all. Heavy acrylic dust covers help reduce pickup, but the ideal solution is to remove your dustcover completely – if you usually play your deck with it in the 'up' position, that is.

Once you've positioned your deck properly, then you must ensure it is level. A spirit level is essential to ensure this, otherwise the bias force will be upset and the turntable's suspension will be impeded. That's assuming you've got suspension of course – decks like Regas or Japanese direct drives don't have this, meaning that a vibration-free location is even more critical! One great tip for these decks is to use a Townsend Seismic Sink, or if you can't afford this brilliant bit of hi-fi kit, then make one yourself [see DP's Top Tip]!

Independently sprung subchassis decks, such as Linn Sondeks, Michells, Thorens, etc. can't be set-up properly unless the deck itself is level.

Although suspension systems often offer height adjustment, this shouldn't be used ideally, as it varies the spring rate. If one (of the three or four) springs is more compressed than the others, then the system won't float as freely. So level the plinth using the deck's feet (if possible), or better still, using the isolation platform's levelling facility. For example, Audiophile Furniture's superb Base SP01 support has three legs which can level any deck perfectly, leaving the turntable's own suspension

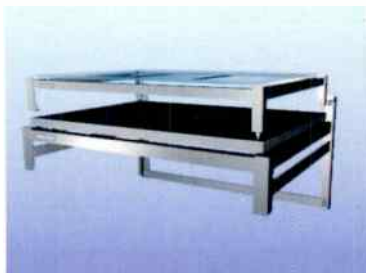

A spiked and isolated Mana turntable shelf - one for the dedicated.

adjusters unhindered!

Sprung decks need to be set so that the subchassis bounces up and down slowly and smoothly, without any untoward vibrating from side to side. With Linns and similar four-point systems, the best way to test this is to push down on the platter with your forefinger, one half of the distance between the spindle and the circumference of the platter, on the



Dedicated hi-fi stands like this are strong, well damped to resist vibration and - in this case - marble topped. Marble is a low vibration composite with plenty of mass. Ideal, but only on solid floors. Otherwise, use a shelf for the turntable.

plane from the spindle to the tonearm pivot. With three point systems, like Michells, just gently pushing down on the centre spindle gets it bouncing freely. When you've done this – you'll know how it bounces now, then you have to adjust the suspension (in the way

NON-COMPLIANCE

As far as the arm mass/cartridge compliance debate is concerned, few if any high compliance cartridges now exist; modern cartridges track superbly without using very high compliance. Arm design also moved away from 'ultra low mass' to 'sensibly low mass' coupled with extreme rigidity. Rega defined this approach with their superb RB300 that was both rigid but low mass too. As cartridges evolved SME moved away from the carbon fibre/titanium of their super low mass arm to the super rigid SME V.

THE FULL TWELVE INCHES
In our pictures you'll see the SME 312 that I use. This twelve inch arm is a cartridge test bed, its extra length minimising tracking error distortion to give more accurate intrinsic cartridge distortion figures. Twelve inch arms demand an inconveniently large plinth and they aren't as rigid - especially with a detachable headshell - as shorter nine inch jobbies. So stay with a niner for domestic hi-fi use. All the same, the 312 12inch SME is a lovely arm, both to look at and use.

particular to your deck) until it bounces as it should! Remember also that the tonearm lead, and the way it is 'dressed' (i.e. routed inside the plinth, and anchored to the plinth) has a great effect on the working of the suspension. Make sure it runs inside the plinth (if you deck has one!) without touching it anywhere except at the point it enters the plinth, and that there's a little free wire to let the arm bounce up and

NK'S TOP TIP:

If your ideal site is far from the hi-fi, consider using an external phono stage feeding the amplifier's Aux input through a length of good quality phono cable. I find this most convenient and practicable, especially nowadays when the hi-fi needs to be close to the TV. Make sure this phono stage uses valves if possible!

What you are doing here is creating an LP replay centre as it were, remote from the spaghetti and paraphernalia of the main system. It's then easy to have a small sub-shelf to carry all the gadgets and also have an LP rack nearby.

DP'S TOP TIP:

Make your own isolation platform by sandwiching a smallish, lightly inflated bicycle inner tube between two 300x300mm planes of glass or MDF. Alternatively, substitute the inner tube for two tennis balls, cut into four halves, one per corner.

Neither is an aesthetically pleasing solution, but you can bet your Boron cantilever that it will improve the sound dramatically!

down with the suspension smoothly.

If your turntable is placed properly, located dead level and tuned for a good, free suspension bounce, you'll find it sounds dramatically better than if it's simply dumped on a table. It's a right pain, but as soon as you've got it right, your ears will love you for it!

3 years of proven reliability.
2 years guarantee.

Shop prices are expensive because of rent, rates, wages, etc. Buy direct & save £££.

Price is not a guarantee of sound quality.

We have signed testimonials to prove that customers prefer our amplifiers to
£8,000 preamp + 320 watts power amplifier,
£4,000 pre/power amp & power supply,
£2,600 pre/power amp & power supply,
£1,400 well reviewed 150 watts amplifier.

Money back guarantee (less £30 UK or £100 overseas) that you prefer :-

£1,000 or £1,450 "KT88 Triode Connection" amplifiers to most transistor amplifiers, most transistor / valve hybrid amplifiers, most Single Ended valve amplifiers, most Ultra Linear valve amplifiers selling for £2,000 to £20,000

£2,500 or £1,800 "10 inch High End" speakers + our £1,450 amplifiers to overpriced pretentious £100,000 systems (at realistic life-size volume)

£700 EL34 valve amplifiers (40 watts + 40 watts) to most transistor amplifiers and transistor / valve hybrid amplifiers costing £1,000 to £2,000

£500 EL34 valve amplifiers (40 watts + 40 watts) to most £700 amplifiers.

£380 to £800 valve phono stages to most transistor phono stages.

Telephone 01634 268662 anytime or 01634 373410 for Mr Andrew Everard's review in Gramophone Magazine and Summary of 21 testimonials from satisfied customers.

www.affordablevalvecompany.com

Amplifier shown without CE safety cage, to prove that these are genuine valve amplifiers. Customers must not remove CE safety cage.

Free UK delivery.
Subsidised £50 UPS delivery to other countries.



definitive audio

Peddlers of fine wares, including:

Record players: SME models 10, 20 and 30; Kuzma Stabi, Stabi Reference; Nottingham Analogue Interspace, Space Deck, Hyperspace and Dais; Michell Orbe; VPI AriesScout; Avid Volvere, Sequel and Acutus.
Arms: Rega 300/600/900; SME Series IV and V; Kuzma Stogi; Triplanar.
Cartridges: VanDenHul Grasshopper and Colibri; Kuzma KC Ref; EMT; Reson Reca and Elite; Cartridge Man Musicmaker; Benz-Micro including Ruby Open Air; Kondo lo J.
Amplifiers: Border Patrol; Canary; Sugden; Art Audio; Monarchy; Western Electric; Icon; Tom Evans Audio Designs; SJS.
CD Players: Wadia; Sugden; Primare; Resolution.
Louspeakers: Living Voice; Vitavox; Lowther.
Cables and Tables by Living Voice.

Sale of part exchanged and ex-dem items	Sale	New
Clear Audio Solution - no arm SME cutout	£500	£900
Homing Agathon - 98dB 2 way horn - Mahogany - PM6A (alnico)	£1600	£3800
Living Voice Avatar - natural santos rosewood - ex-review bargain	£2200	£2900
Canary Audio CA 301 - 300B - 22 watts - juicy	£3400	£5400
Canary Audio CA 309 - 300B parallel p.p. - 45 watts - juicy and beefy	£9500	£13500
Canary Audio CA 300 - single ended monos - valve rect. - 8 watts	£2000	£3500
Jamo Concert 8 - loudspeakers - 2½ years old - maple - spotless	£700	£1365
Townsend Seismic - speaker stands - ugly and bouncy	£450	£695
Tube Technology MAC - mm and mc phono - nearly new - not bad	£600	£1400
Audio innovations Series 1000 - silver circuit - 50 watts class A	£1100	£2500
Alchemist Forsetti ADP 15A - integrated amp - broken and horrid	£100	£1400
AudioNote Soro - phono integrated - serviced/new valves - smooth & soft	£700	£1900
Clear Audio Master Reference - turntable - no arm		
2 years old - Perfect condition. Go on, be crazy, it's only...	£6000	£8500
Audio Research LS2 B - line pre - fine condition - giveaway	£1000	
Pink Triangle PT TOO Export - black - vgc - great sound	£300	
B&W DM603 S3 - black - good condition - dismal	£350	£600
Snell Type EII - walnut - industry classic - new bass-mid drivers		
high mass Pirate stands - lovely sound - 92 db per watt sensitivity	£700	
Snell Type JII - french polish walnut - industry classic - very nice sound	£400	
AudioNote ANJ-D - walnut - Huygens high mass stands	£600	£1400

Tel: 0115 973 3222 Fax: 0115 973 3666
internet: www.definitiveaudio.co.uk email: shout@definitiveaudio.co.uk

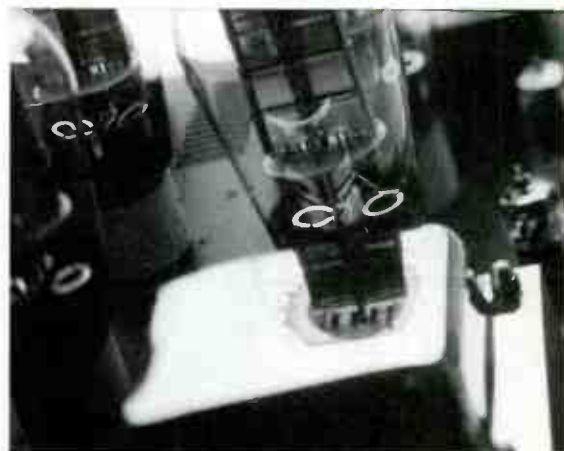

The BorderPatrol P20

'One of the best music appreciation devices available.'

Jason Kennedy Hi-Fi Choice Summer 2002.
EDITORS CHOICE

Full details on the P20 and other BorderPatrol amplifiers and power supplies can be found on line at www.borderpatrol.net

Tel/fax 00 44 (0) 1242 717171
e-mail bp@borderpatrol.net
www.borderpatrol.net



BorderPatrol

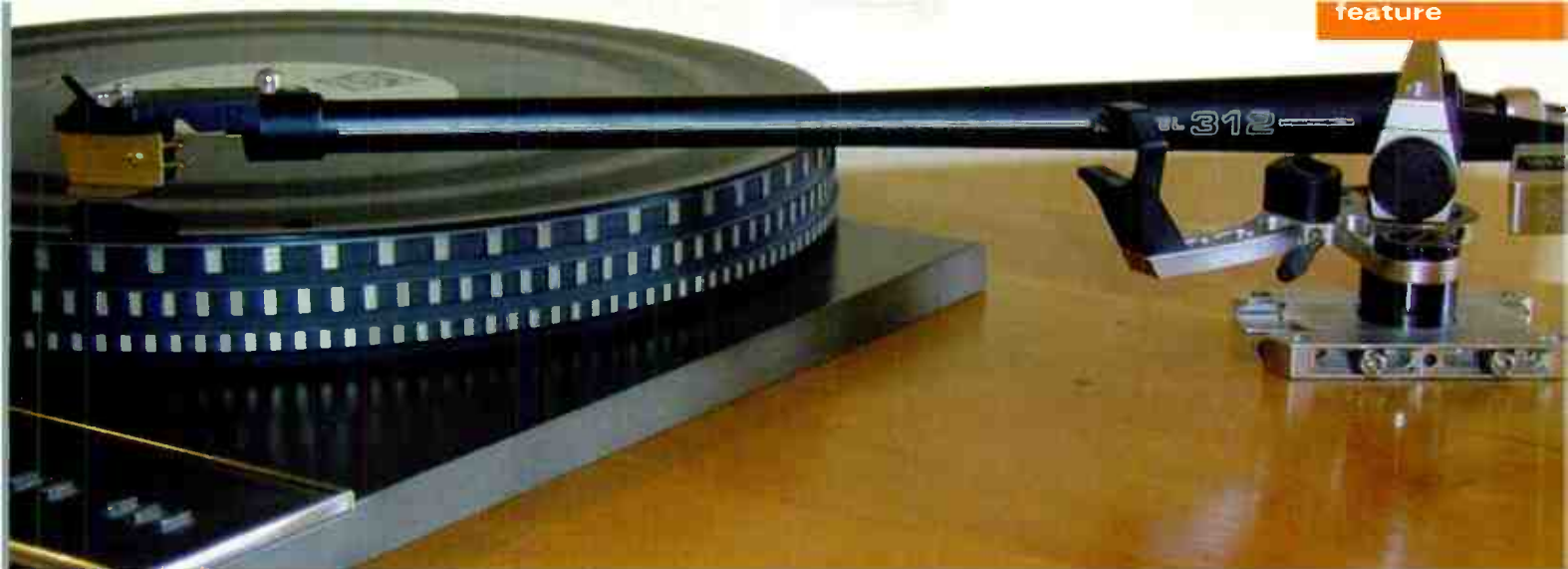

Get Set!

Noel Keywood talks you through one of the most sacred rites known to the analogue addict – the cartridge set-up ceremony...

Cartridge set-up is a ceremony – and if you've just spent more on a cartridge than most folk do on a CD player, it's one you'll enjoy no end in the certainty that your new pride and joy will deliver of its best. It's an intriguing pleasure, and a rewarding one too if you have a good modern cartridge and arm working through a decent phono stage, because vinyl will always deliver a beautiful sound.

A reality of cartridge reviewing is that when you are constantly

changing and setting up cartridges one is bound to go skyward some time or other, so I have evolved strategies for avoiding mishaps that you may find useful. As a matter of course I inspect the stylus cantilever with a large magnifying glass under a strong light, before removing the cartridge from its packing. In the past a small proportion of cartridges have arrived without a stylus. Or the stylus falls out after a short period of use, whereupon the arm sails right across the disc. In both cases this is due to a bonding problem between

stylus and cantilever and its best to quickly check everything is okay first.

Cartridges are usually well packaged, because they need plenty of protection. But manufacturers use different means of holding them in place, some of which are a little awkward. So keep the stylus guard on or – better – remove the stylus assembly altogether. With moving magnet cartridges like Shure's V15VxMR tested this month, I removed the stylus assembly before removing the cartridge, but with the moving coils you can't do this so the

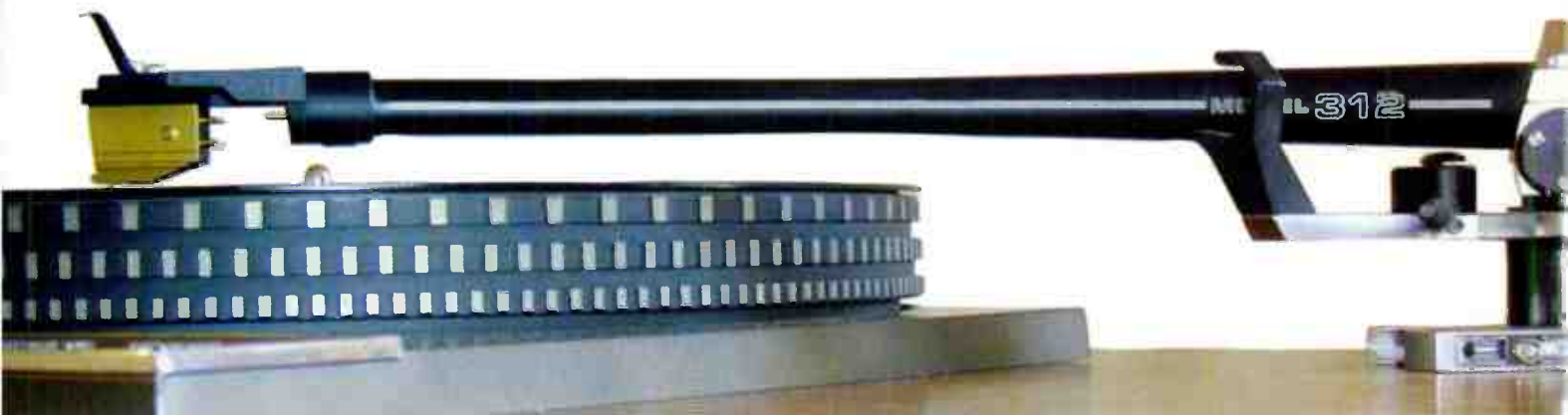

The horizontal white lines along the side of SME's arm tube aren't decorative, they're to aid alignment - in this case horizontal arm alignment. Those lines should be horizontal, not sloping down or up, in order for both vertical tracking angle and stylus rake angle of the cartridge to be 'correct' (well, as set by the manufacturer). With SME the arm pillar height is adjusted; Regas are not height adjustable, but spacers can be used.

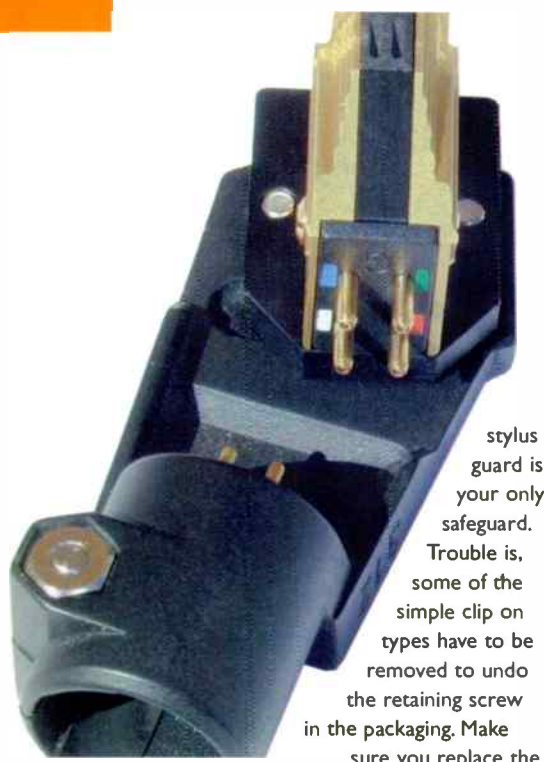

**The pins on this Ortofon are colour coded:
White - Left channel
Blue - Left earth return
Red - Right channel
Green - Right earth return**

stylus guard is your only safeguard. Trouble is, some of the simple clip on types have to be removed to undo the retaining screw in the packaging. Make sure you replace the stylus guard as soon as this screw is removed; if you were to drop the MC whilst lifting it out it would be a goner before you had even started!

Fitting an MM with its stylus removed is no problem of course, but fitting an expensive MC like Van den Hul's Grasshopper, which comes without a guard of any sort, is a nightmare. I clipped on a Dynavector guard. If you are faced with this situation I suggest you cobble something up to provide handling protection. I fit the cartridge close to the bench so it doesn't have far to fall!

Cartridge screws and set up bits

Ortofon make sure there are plenty of horizontal reference ridges on their cartridge body to aid alignment. The connecting wires have been left off for clarity; it's not the latest tweak.

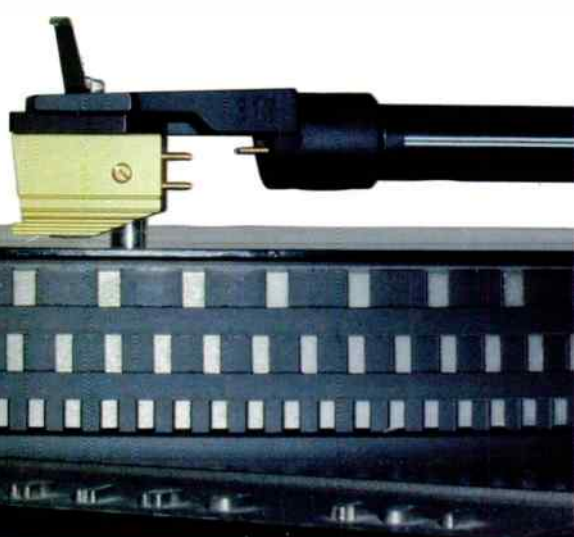

and pieces can be kept in a small 12in Stanley plastic toolbox from B&Q, or similar. You ideally need a range of gadgets, from pressure gauges to LP cleaning devices, screws, wires and allen keys in this great adventure in classic hi-fi.

In all my years of using LP I have never bent a stylus when playing a disc – and I always hand cue. The stylus is most at risk when fitting the cartridge or in arm handling accidents, where it slips from the fingers or gets knocked out of the arm rest. I use a tie wrap to hold my SME312 test arm in place whilst bolting on the headshell, because I know it is just waiting to jump out and send the cartridge skidding across the ribbed 401 mat the moment I forget! Remove the stylus guard only when the headshell is in place. If you have an arm with integral headshell, like the Rega RB250/300 designs, then remove the guard only after attaching the cartridge.

The cartridge pins and headshell leads are colour coded. Red is Right channel hot or +, and green its earth return. White is Left channel hot or +, and Blue its earth return. A small tab can sometimes be seen, as in Goldring's for example, connecting the metal screening can to one earth return pin. In the past, with metal bodied cartridges, this could cause an earth loop and hum. It was needed

for non-conductive arms/ headshells (e.g. plastic) and must be removed for metal arms. Only do this if hum occurs though. Do not remove the Goldring link because the Pocan mounting platform is non-conductive.

Fit the cartridge with the screws supplied, which will usually be lightweight aluminium. Use the smallest (lightest) screws possible. I use Rega stainless

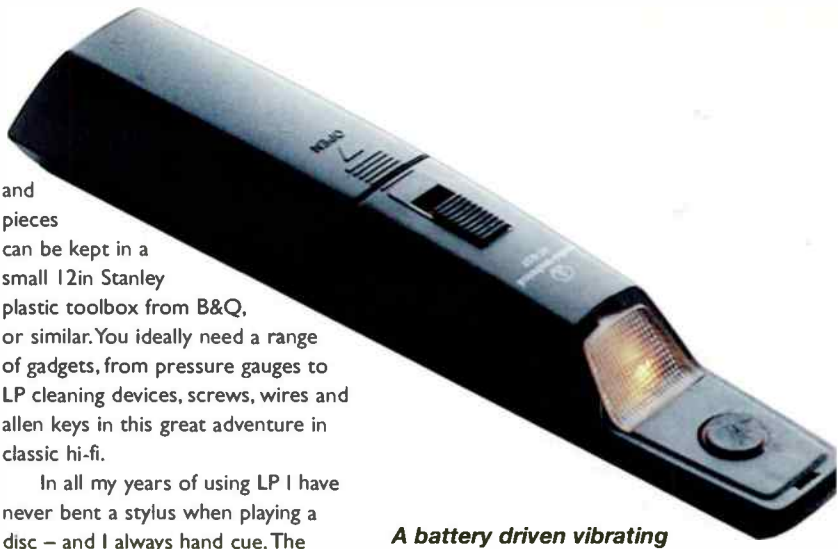

A battery driven vibrating brush is a good way to keep the stylus clean.

steel allen head bolts, because they are strong, non-magnetic and sonically neutral. Do not over tighten, as it can distort or damage the body; just make sure the screws are decently tight. When fitting, make sure the main front-back axis of the cartridge is parallel with the headshell axis. A small skew here results in quite a lot of tracking error and increased distortion, so take care. Some people leave off the fingerlift where this is possible, on the basis that it affects the sound. I prefer to hand cue with a finger lift, but this is only practicable with a solid plinth.

After fitting the cartridge, often – with a Rega for example - you must balance the arm. The tracking force gauge is first set to zero then the counterweight moved forward or backward until balance is achieved. This must be done with the stylus cover removed, so be careful. You then return the arm to its rest and set tracking and bias force.

On an SME like my 312, downforce is set by adjusting counterweight position. I use both a Shure SFG-2 cartridge balance (still available) and a much coveted Technics stylus pressure gauge, sadly unavailable. Follow the cartridge manufacturer's instructions about downforce. Most nowadays recommend a small range, typically 1.6gms-2gms with an optimum right in the middle of this range, or 1.8gms. Long contact styli generally are not operated much above 2.5gms. Moving coil cartridges usually require more downforce than moving magnet types. Only Shure still recommend low downforces it seems and even then the quoted range for the V15VxMR isn't quite right in my view; I use 1.3gms – slightly higher than their



In all modern arms the cartridge lies at an angle to the arm tube; this is its offset angle. Once face of the headshell at least, identified here by the orange line (left), acts as a reference face. When fitted the cartridge body must lie parallel to this face. Any skew here will raise tracking error distortion.

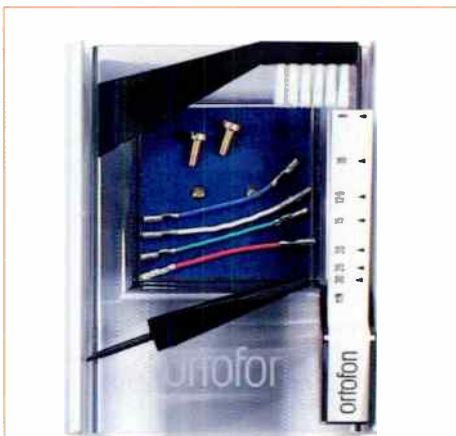

Here's a basic toolkit, as supplied by Ortofon with their MC cartridges. The small screwdriver is for the cartridge fixing screws, the brush for stylus cleaning and the balance for setting stylus downforce. Spare wires are provided in case of accidents.

Replace the screws with socket head stainless steel types if possible. Also useful, but not provided, are jewellers pliers for manipulating the tiddly bits.

recommended maximum. The idea is to minimise mistracking, which causes groove damage.

You will find cartridges need to be run in, to smooth the stylus wall and bed in the compliant cantilever hinge. Beware of windowsills; tracking might be degraded with a cold down-draught onto the cartridge in winter.

Once downforce and sideforce have been set, you have to move on to set arm height, cartridge verticality and then minimise lateral tracking error.

To set arm height place the arm on a disc and make sure the cartridge is parallel to the disc surface. You can experiment though. Lowering the arm pillar from this notionally correct position will decrease vertical tracking angle and in most cases decrease distortion too. Trouble is, with limited disc clearance the rear of the cartridge body may bottom out on warps. Also, this will alter stylus rake angle, possibly for the worse. If you are doing listening tests bear in mind that both rake angle and VTA are approximate, due to variability in cutting lathe settings and lacquer springback, so use a representative sample of LPs.

Next the arm's headshell needs to be rotated slightly to ensure the cartridge sits perfectly upright. In theory this balances channel separation, left-to-right and right-to-left. Again though, this is a little academic since in practice the good old LP is a little variable. The groove's modulation axes are tilted by dished records (and most are) and too

many cartridges have misaligned internal generator assemblies. You may like to try tilting the cartridge one way or another by just a few degrees to see if things sound better when it is not properly aligned! I quite often have to do this whilst testing.

Finally comes the need to minimise tracking error. What you are doing here is setting the cartridge at a perfect tangent to the groove at one of the arm's two zero points. One zero point is on the inner grooves, 60mm from the centre of the turntable centre spindle, whilst the second is at 120mm. Most tracking error alignment gauges use the latter position as the alignment point. With arms like the Rega you will need to loosen the cartridge bolts and slide the cartridge forward or backward in the headshell until the cartridge is in alignment. Then check that it is tangential 60mm out or thereabouts. Be absolutely sure when re-tightening that the cartridge hasn't been skewed by accident. Moving the cartridge in the headshell alters the arm's effective length and

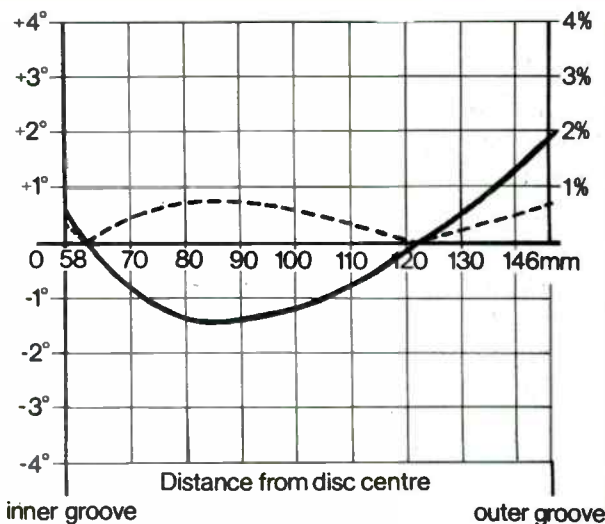

As arm tracks across a record the headshell and cartridge will reach a maximum of around 2degrees of error which produces up to 1% tracking error distortion. This graph shows both error across the disc surface and resultant distortion. Tracking error zeros (and distortion) typically at 120mm out from the centre spindle (its central axis) and 60mm out. The arm or cartridge is moved forward or backward until it is at a tangent to the groove at both points ideally.

The highly desirable SH-50P1 Technics Stylus pressure gauge, out of manufacture and only available second hand, for an arm and a leg. It gives a quick and clear readout, unlike balances.



its basic geometry so SME prefer to move the whole arm in its base.

The setup process is something of a revered procedure. It is worth doing properly and it may well be worth experimenting with settings afterward too, especially tracking force and bias, as pickup cartridges are incredibly sensitive and finely honed transducers. It's worth installing them carefully to make the most of what they can do.

Great HI-FI WORLD'S COMPETITION Giveaway

WIN A SUPERB **CYRUS 6 INTEGRATED AMPLIFIER** IN THIS MONTH'S GREAT COMPETITION!

Here's your chance to own one of our favourite mid-price integrated amplifiers – Cyrus's sexy new 6! The latest in a long line of electronics that can be

traced back to Mission's Cyrus 1 launched back in 1983, this is a brilliantly well conceived slice of 'affordable' esoterica. Indeed, when he reviewed it in Hi-Fi World's May 2003 issue, Noel Keywood raved about its superb sound, sleek looks and sensible facilities:

"It's compact, elegant and, with its diecast alloy casework, a lovely product to use... Modern Japanese amplifiers today have the same piecemeal construction, whereas the one-piece casting of the Cyrus 6 is anything but. It feels sturdy and all-of-

a-piece. Fit and finish are superb, and there are no gimmicky labels or logos. It's quietly modern yet elegant and superbly easy to use. But even though the Cyrus 6 induces no techno-fear, it actually packs a lot of technology into its compact casework.

Having used a Cyrus 7 as a reviewing tool for years, I can vouch for its reliability. Automatic protection circuits guard against catastrophe, and the Cyrus 6 is similarly equipped. It switches on with a flourish of lights as it self tests - the volume control is electronic, as are the other functions such as input selection and balance adjustment. There are five line inputs, a tape in/out and preamp outputs as well. Specified at 40W per channel, we measured 55watts (8ohms), so you get more... measurement showed (it was) producing uncomfortably high volumes, so there's power aplenty.

The Cyrus 6 sounds smooth, well integrated and clear, without the glassiness so common in modern Japanese amplifiers... there is absolutely no high frequency distortion, measurable or audible. The Cyrus has clean and delicate treble that gets quite busy with good recordings; there's plenty of resolution if it is required. At the

same time, it doesn't have the sort of pronounced top end that destroys the cohesiveness of so many modern solid-state amplifiers. Quite a few reviewers go for this sort of 'conspicuous treble', because it gives what appears to be strong detailing from an in-your-face sound. It isn't easy to live with though, especially with today's loudspeakers which seem to get ever brighter in themselves. Yes, the Cyrus 6 sits on my shelf nicely. This is the sort of amplifier I can recommend, safe in the knowledge that it's a superb design."

If you would like to win this superb bit of kit, then all you have to do is answer our four easy questions. Send your entries on a postcard to: September Competition, Hi-Fi World magazine, Unit G4, Argo House, The Park Business Centre, Kilburn Park Road, London NW6 5LF

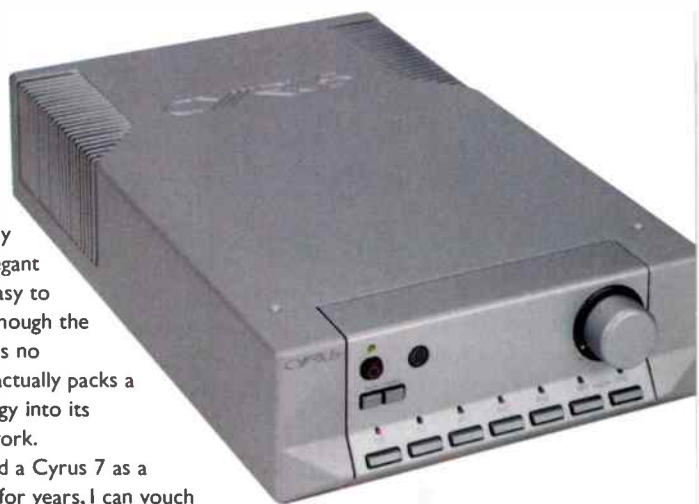

Competition Questions

[1] what was the original Cyrus amplifier called?

- [a] Cyrus
- [b] I
- [c] The First
- [d] Original Special Edition

[2] what is the casing made from?

- [a] monkey metal
- [b] copper
- [c] pressed steel
- [d] die cast alloy

[3] what did Noel measure its power at?

- [a] 1W
- [b] 5W
- [c] 55W
- [d] 1000W

[4] how did the Cyrus sit on Noel's shelf?

- [a] nicely
- [b] steadily
- [c] sensually
- [d] awkwardly

September Competition

Hi-Fi World Magazine
Unit G4 Argo House
The Park Business Centre
Kilburn Park Rd.
London NW6 5LF

Hi-Fi & Computer Audio World Competition rules and conditions of entry

1. Only one entry per house hold.
2. Multiple entries will be automatically disqualified.
3. Purchase of the magazine is not a pre-condition of entry.
4. No correspondence will be entered into.
5. The Editor's decision is final.
6. No employees of Audio Publishing Limited, or of any companies associated with the production or distribution of the prizes may enter.

CONGRATULATIONS

...to Ms Liz Griffiths of Coventry, Mr Peter Williams of S.Wales, Mr Mike Coldicott of Northampton, Mr R Jordan of Essex, and Mr Stephen Judge of Glastonbury the winners of our July 2003 competition. A Xitel Hi-Fi Link is on its way to you!

Sevenoaks SOUND & VISION



Sevenoaks Sound & Vision stocks a wide range of Hi-Fi separates, DVD players, amplifiers, speakers, plasma screens, LCD televisions and projection systems from all the leading manufacturers.

From starter systems to custom designed multi-room and home cinema installations, our friendly staff are available in all outlets to advise, demonstrate and guide you through the home entertainment jungle. If you're interested in home entertainment and want to avoid the confusion, contact your local Sevenoaks Sound & Vision outlet and **experience more.**

0% interest free option* is available on most products.

*Written details on request. Licensed credit brokers. Minimum balance £400. Subject to status.



Custom Installation

Are you looking to neatly and seamlessly integrate a Home Cinema or Hi-Fi System into your home? Our Custom Installation experts are fully trained in all areas and provide a prompt, reliable and professional service. Whether you're looking for lighting control systems, a dedicated home cinema installation with a retractable screen and built-in speakers or an integrated control system, Sevenoaks Sound & Vision has the solution.

www.sevenoakssoundandvision.co.uk



This system package, aimed at the digital technology enthusiast, includes the Award-winning 11L Speakers (What Hi-Fi? Sound and Vision - Awards 2003) combined with the exceptional 99 CD-P CD Player and 99 Power Amplifier.

The 99 CD-P CD player is equipped with a volume control and no less than six digital inputs. This is not a conventional CD preamp combination, as there are no analogue inputs. But the CD player allows free access to its high-quality internal 24-bit/192kHz DAC section which benefits most digital sources. The rest of the system is more conventional, and equally talented. The 99 power amp is Quad's entry-level powerhouse and, as with the CD player, the build quality and finish are first rate. The 11L standmounting speakers complete the package.

Ⓜ RADIUS



Introducing Radius from Monitor Audio - an exquisitely made and flexible speaker range.

Although seriously compact, the Radius is capable of delivering full-range, hi-fi sound whilst blending into any environment, without taking up valuable floor space. It is equally at home in a multichannel or traditional two channel system, as music reproduction is the first priority with all Monitor Audio speakers. Built to the same exacting standards as Monitor Audio's Reference range, the Radius uses advanced driver technology and is available in a variety of high quality finishes.

Ⓜ MONITOR AUDIO

World Radio History

BEDFORD
BIRMINGHAM
BRIGHTON
BRISTOL
BROMLEY
CAMBRIDGE
CARDIFF
CHELSEA
CHELTENHAM
CRAWLEY
CROYDON
EDINBURGH
EPSOM
EXETER
GLASGOW
GUILDFORD
HOLBORN
HULL
IPSWICH
KINGSTON
LEICESTER
LEEDS
LINCOLN
LIVERPOOL
MAIDSTONE
MANCHESTER
NEWCASTLE
NORWICH
NOTTINGHAM
OXFORD
PETERBOROUGH
PLYMOUTH
POOLE
PRESTON
READING
SEVENOAKS
SHEFFIELD
SOLIHULL
SOUTHAMPTON
SOUTHGATE
SWANSEA
SWINDON
SWISS COTTAGE
TUNBRIDGE WELLS
WATFORD
WITHAM (ESSEX)
WOLVERHAMPTON

**Please see Page 7
for address and telephone
number details**



FREE ortofon CARTRIDGE
With selected Turntables - Ask in-store for details

PRO-JECT

RPM4 Turntable £349.95

Turntables & Tuners

Arcam DIVA T61 Tuner	£249.95
Cyrus FM X Tuner	£499.95
Denon TU260L MKII Tuner.....	£119.95
Marantz ST4000 Tuner.....	£109.95
Michell Gyro SE/RB300 Turntable	£1049.95
Michell TecnoDec Turntable	£599.95
Project Debut Phono SB Turntable.....	£169.95
Project Debut II Turntable (Black).....	£119.95
Project Debut II Turntable (Colours).....	£134.95
Pure Evoke 1 DAB Radio.....	£99.95
Pure DRX-702ES Analogue/DAB Tuner.....	£329.95
Sony ST-D777ES FM/DAB Tuner.....	£549.95

a cut away look to the deck and while it looks a bit like a cakestand with the dustcover in place, in use the RPM4 looks much more the business.

The RPM4 soon impresses with the quality feel of its arm and the screw-down clamp to hold and flatten records, and as soon as the stylus settles into the groove it's clear this is a superior player. There's much less surface noise than with the Debut, and the music has much greater scale and power, allied to closer detailing. That lovely organic feel you only seem to get from great vinyl playback is apparent... This is a very grown-up record player for reasonable CD player money: it's well worth exploring."

WHAT HI-FI? August 2002

Selected outlets are Project Turntable Centres. Colour Options are available at additional cost



Michell Gyro SE/RB300
£1049.95

STARTER SYSTEM

marantz
CD4000 (Black) CD Player
PM4200 (Black) Amplifier

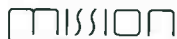

m71i Speakers

List Price £420

£299.95 • SAVE £120

Includes Speaker Cable Worth £20 FOC

PURE DIGITAL DRX-701ES Digital Tuner £229.95

"This new tuner from the recently renamed Pure is based on the 2001 Award winning Videologic DRX-601ES, but under the lid is an all-new third-generation digital radio engine, in the form of Frontier Silicon's Chorus FS1010.

The tuner uses 24-bit/192kHz conversion with 4x upsampling and data interpolation, and is

powered by a low-noise toroidal transformer - such attention to sonic detail pays off. Digital outputs are provided on electrical and optical feed, but most people will use the analogue out, and these sound very good indeed. As usual the tuner is subject to the signal quality off-air, but when it's fed from a high-quality outdoor aerial and a good signal it's capable of a crisp, powerful and detailed presentation. Even more populist music stations like Radio 6 benefit from the mix of a neutral balance and fine weight, while speech is also neutral and easy to follow. If you want a quality home tuner for digital radio, you need look no further."



WHAT HI-FI? Product of the year 2002
HIFI SOCIETY CINEMA AWARDS
PURE DRX-701ES

SAVE £20

Wharfedale Pacific Evo 30 Speakers £649.95

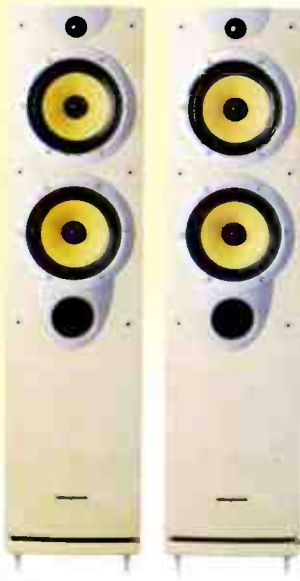

"Evolution? This is more like a revolution. Wharfedale's new range is more than just an upgrade of its Pacific series. The changes are radical, but the most obvious transformation is the removal of the original's unattractive tweeter module, which was situated on top of the speaker. The tweeter housing is now sunk into the Evo 30 cabinet, the intention being to improve dispersion and benefit from the improved rigidity of the strongest point of the cabinet.

Listen to the Evo 30s and the sonic changes leap out at you. Sitting on their chunky spikes and situated in free space, the speakers sound wonderful: low frequencies delve deep and delivery is punchy and fast...

You'll have gathered by now that we love the Evo 30s. They're beautifully made and are great all-rounders."

WHAT HI-FI? March 2003



Also Available
Monitor Audio
Silver S6 • £599.95

FREE
SPEAKER CABLE*
WORTH £65
WHEN YOU PURCHASE
WHARFEDALE
PACIFIC EVO 30 SPEAKERS

CD Players

Arcam DIVA CD62T.....	£369.95
Arcam DIVA CD72T.....	£449.95
Arcam DIVA CD82T.....	£599.95
Arcam DIVA CD93T.....	£949.95
Arcam FMJ CD33T.....	£1299.95
Cyrus CD6.....	£599.95
Cyrus CD8.....	£999.95
Denon DCD485.....	£129.95
Linn Genki.....	£994.95
Linn Ikemi.....	£1949.95
Marantz CD4000.....	£99.95
Marantz CD5400.....	£149.95
Marantz CD17/II M.....	£799.95
Meridian 507.....	£1194.95
Musical Fidelity A308 ".....	£1999.95
Musical Fidelity Tri-Vista SACD.....	£3994.95
Quad 99 CD-P.....	£999.95
Roksan Kandy KD1 MKIII.....	£544.95
Roksan Caspian.....	£994.95
Rotel RCD1072.....	£594.95
Sony CDPXE570.....	£99.95

PLEASE NOTE:

Some products may not be available at all outlets. Please call before travelling. *Not in conjunction with any other offer. Advertisement valid until at least 27th August 2003. E&OE



experience **more**

World Radio History



Amplifier Selection

Arcam DiVA A65 Plus Amplifier	£369.95
Arcam DiVA A80 Amplifier	£599.95
Arcam DiVA A85 Amplifier	£799.95
Arcam FMJ A32 Amplifier	£1149.95
Cyrus 6 Amplifier	£599.95
Cyrus 8 Amplifier	£799.95
Cyrus Pre X Pre Amplifier	£999.95
Cyrus Mono X Power Amplifier	(Each) £1199.95
Denon PMA355 Amplifier	£199.95
Harman Kardon HK670	£299.95
Linn Kolektor Pre Amplifier	£494.95
Linn LK85 Power Amplifier	£494.95
Marantz PM4200 Amplifier (Black)	£149.95
Marantz PM7200 Amplifier (Black)	£329.95
Musical Fidelity A3.2 Pre Amplifier	£999.95
Musical Fidelity A3.2 Power Amplifier	£999.95
Musical Fidelity A308 Amplifier	£1999.95
Musical Fidelity Tri-Vista 300 Amplifier	£3994.95
Quad 99 Power Amplifier	£549.95
Roksan Caspian Amplifier	£894.95
Rotel RA-01 Amplifier	£249.95



ARCAM
SOUND & VISION

FREE INTERCONNECT CABLE* WORTH £60
WHEN ANY DDD CD & AMPLIFIER PURCHASED TOGETHER

DiVA CD82T CD Player £599.95
DiVA A85 Integrated Amplifier £799.95

DiVA CD82T "Arcam's latest sounds like a more mature version of its little brother. On an initial listen the increased solidity and refinement are obvious, but over time the subtler dynamic shading and more assured handling of transients come to the fore... The Arcam CD82T is one of the best CD players available at this price point." **Hi-Fi Choice** ★★★★★ Sept 2002

DiVA A85 "You'll have realised by now that we rather like this amp. It took us completely by surprise, and further strengthens Arcam's already impressive product range... The A85 is superb, and we can't wait to put it up against its peer in a group test." **Hi-Fi Choice** ★★★★★ March 2001



B&W Bowers & Wilkins
DM602S3 Speakers £299.95

FREE SPEAKER CABLE* WORTH 10% OF THE
SPEAKER VALUE WITH ANY DDD S3 OR CDM NT SERIES SPEAKERS

"But the B&W 602 S3 are our winners. They're big and not particularly beautiful, yet if it were our money they're what we would buy. No rival can match the wide ranging dynamics or low frequency performance of these not so compact standmounters. Add all-round sonic excellence and the choice is easy. Give them sufficient space to breathe, then sit back and enjoy the music."

Hi-Fi Choice ★★★★★ Superst Winner August 2002

Also Available (Pictured Right)
B&W CDM NT Series • Prices start from £749.95



ROTEL **RCD-02 CD Player** £379.95
RA-02 Amplifier £349.95

FREE INTERCONNECT CABLE* WORTH £60
WHEN ANY ROTEL CD & AMPLIFIER PURCHASED TOGETHER

RCD-02 CD Player "Whether it's the raw, and sometimes just plain barking vocals of Tom Waits, or the stinging guitar stabs of Pete Townsend on some old Who tracks, the Rotel is one of those players that can't help but bring a smile to the face - it's a breath of fresh air." **Hi-Fi Choice** ★★★★★ Sept 2002

RA-02 Amplifier "The amp has a fast, detailed and yet satisfyingly full presentation. That allows it to make a fine job of the beats of Groove Armada's *Goodbye Century* set without losing sight of the fine details of the mix, and also husking out Marianne Faithfull's deliciously smutty vocals on *Kissing Time* with real relish. Add in decent levels of equipment - and the convenience of remote control, and we reckon Rotel has a winner on its hands." **Hi-Fi Choice** ★★★★★ August 2002





CYRUS

CD8 CD Player £999.95
8 Integrated Amplifier £799.95

Cyrus has been developing high performance hi-fi systems for nearly 20 years. Today their upgradeable, modular product range includes multi-room systems, home cinema and some of the world's finest hi-fi systems. Cyrus products are hand finished, half size die-cast enclosures and include a hidden digital command system that allows simple operation of any size system.

Joining the new Cyrus 8 amplifier is the stunning new high performance, upgradeable CD player, the CD8. Other new models in the 8 series include the AV8 digital AV processor and a new disc player, DVD8, featuring specially tuned video and audio circuitry.

Cyrus 8 Amplifier "The 8 is a large step forward from older generations of Cyrus amplifiers, and takes the company back into the leading pack in the sub-£1000 integrated amp sector... The Cyrus 8 is a must-audition product."

★★★★★ January 2003



ROKSAN

Kandy KA1 MKIII Amplifier £544.95

FREE INTERCONNECT CABLE* WORTH £60
 WHEN KANDY CD & AMPLIFIER PURCHASED TOGETHER

"When we last reviewed Roksan's Kandy integrated amp in February it fought off serious competition to come top in a *SOUND & VISION* test. This is its replacement the MkIII. Internal changes include an uprated power supply for the preamp section and identical mono modules for the left and right power amp sections. Roksan also claims 50 percent lower distortion on line-level inputs and a whopping 150 percent less on the phono input. The rated power output is an impressive 120 watts per channel into 8 ohms, and this amp has a confident, muscular way with music that bears this out. But don't be fooled into thinking this amp is raw but unrefined. With Van Morrison's *Down the Road* the Kandy has the guts to render the performance exciting and dynamic, but also the guile to deliver subtle details.



The upgraded Kandy MkIII is an excellent amp; the MkII version was impressive, but MkIII is a stunner. It betters all the amps here in the timing department, and has a wonderfully robust character that works well with all types of music. It manages to retain the good points of the MkII while adding extra resolution and subtlety. All the amps here have a place in the market. It's just that at £550 the Kandy really does set the pace."

★★★★★ October 2002

QUAD

11L Speakers £379.95

"Quad is best known for its superlative electrostatic designs, which start at £3500. So any £379 pair of speakers that carries the company's name has to be going some to avoid tarnishing the family reputation. The first surprise is that the 11Ls come in real-wood veneers covered with piano-gloss lacquer. This type of finish is almost unheard of at the £1000 mark, let alone at this price. Has anything been sacrificed for such a luxury finish? Here's the second surprise: apparently not.

The final surprise? Well, saving the best for the last, the sound quality of the 11Ls is phenomenally good. These are small speakers at just 33cm tall, but the scale and authority of their performance is terrific. The laws of physics dictate bass extension limitations, but thanks to a clever dual rear firing port arrangement the 11Ls plumb the depths with the determination of a rottweiler, even when placed in free space.



Also Available
Kef Q1 • £249.95

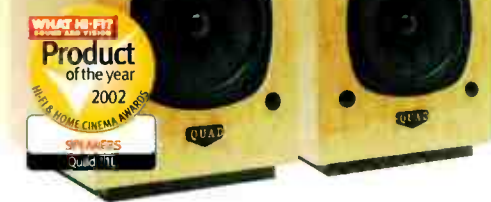

If you're in the market for a pair of top quality standmounters these Quads are a must listen. Quite simply, they're good enough to scare the competition big time."

★★★★★ August 2002

Speaker Selection

- Acoustic Energy** Aegis Evo One **£179.95**
- Acoustic Energy** Aegis Evo Three **£349.95**
- Acoustic Energy** AE1 MKIII (From) **£1699.95**
- B&W** CDM 1NT **£749.95**
- B&W** CDM 7NT **£1249.95**
- B&W** DM303 **£179.95**
- B&W** DM601 S3 **£249.95**
- B&W** DM602 S3 **£299.95**
- KEF** Q1 **£249.95**
- KEF** Q3 **£399.95**
- KEF** XQ1 **£999.95**
- Linn** Katan (Cherry/Maple) **£634.95**
- Linn** Ninka (Cherry/Maple) **£1044.95**
- Mission** 780SE **£349.95**
- Mission** 782SE **£899.95**
- Monitor Audio** Bronze B2 **£199.95**
- Monitor Audio** Silver S1 **£299.95**
- Monitor Audio** Gold Reference 10 **£799.95**
- Monitor Audio** Gold Reference 20 **£1499.95**
- Quad** 22L **£894.95**
- Quark** Epilogue II **£344.95**
- Wharfedale** Pacific EVO 30 **£649.95**

PLEASE NOTE:
 Some products may not be available at all outlets. Please call before travelling. *Not in conjunction with any other offer.
 Advertisement valid until at least 27th August 2003, E&OE.





MUSICAL FIDELITY A3.2 Series

A3.2 CD Player £999.95
A3.2 Amplifier £979.95

FREE INTERCONNECT CABLE* WORTH £100
WHEN ANY MF CD & AMPLIFIER PURCHASED TOGETHER

Replacing the **WHAT HI FI? SOUND AND VISION** Award Winning A3 CD and Amplifier, the new A3.2 models have been further refined and re-styled. The A3.2 CD Player now incorporates the same DAC, filter assembly and control mechanism as the highly-acclaimed Nu Vista CD Player. The A3.2 Amplifier draws on experience gained through the development of the Nu-Vista M3 amplifier and as such has inherited many of its qualities, producing a sense of ease and flexibility that is normally only associated with far more expensive designs.



Special Edition

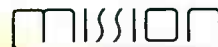

To celebrate twenty five years of high performance loudspeaker design and manufacture, Mission is proud to present special edition models of its highly acclaimed 780 and 782 loudspeakers. The 'SE' is more than just a 'go-faster' suffix. A selected version of Mission's unique microfibre treble unit is fitted and audiophile grade crossover components have been used. To reflect the special status of the 780se and 782se, these models in are finished in finely grained, Alder wood veneer.

782 SE Speakers (Pictured Left) £899.95

"Well, with the exception of the alderwood-veneer finish, these floorstanders look identical to the standard model, although there's a new tweeter and crossover design. One of the advantages of the three-way configuration is that each driver deals with only a narrow section of the frequency range, and the designers optimise each unit to perform its respective task. Mission's engineers have excelled in this area: these elegant floorstanders sound beautifully balanced and few rivals under £1000 can match their wonderful levels of clarity. The 'special edition' tag is overused but these talented floorstanders are bona fide sonic stars." **WHAT HI FI? ★★★★★ April 2003**

780 SE Speakers £349.95

"The revamped Mission 780s are hugely enjoyable: anyone with up to £400 to spend should consider these standmounters. Mission's clever move has paid off." **WHAT HI FI? ★★★★★ February 2003**



FREE SPEAKER CABLE* WORTH 10% OF THE SPEAKER VALUE WITH ANY MISSION SE SPEAKERS

Pioneer

PDR609 CD-RW Recorder £179.95



Also Available
Sony CDR-W3
CD-RW Recorder • **£219.95**

"While it looks simple, the Pioneer has an impressive array of features, including the handy double-speed disc finalization and CD-Text compatibility. Internally, the PDR609 is a big step up from the Award-winning PDR-509 it replaced: the DAC is now a 24-bit/96kHz number, aided and abetted by Pioneer's Legato Link conversion technology, and it has 24-bit A-to-D conversion which is ideal for copying your vinyl onto CD. If this is your plan, you'll appreciate that the Pioneer makes it easy to create first-rate copies from any source, helped by the manual recording-level controls. It was hard to tell our copy of Jim White's *No Such Place* from the original.

While the Pioneer's replay quality can't match the Marantz, it costs £120 less, which would buy you a lot of blank discs. If you've already got a dedicated CD player, we'd go with this recorder." **WHAT HI FI? ★★★★★ August 2001**

Recorder Selection

- Harman Kardon** CD-R30 CD-RW..... **£499.95**
- Sony** RCDW3 CD-RW..... **£219.95**
- Yamaha** KX393 Cassette Deck..... **£119.95**
- Yamaha** KX580SE Cassette Deck..... **£199.95**
- Yamaha** CDR-HD1300 CD-RW..... **£529.95**



pricing policy

We always try to ensure our prices are highly competitive. In the event you can find the same products and excellent service at a lower price, please bring it to our store managers' attention.

World Radio History

TAG McLaren



AV30R AV Processor £1799.95
100x5R Power Amplifier £2994.95

TAG McLaren's AV30R AV Processor is aimed at the home cinema enthusiast who is concerned with keeping up-to-date with the latest surround formats. When partnered with TAG's 100x5R Power Amplifier it makes an exceptional combination.

According to What Hi-Fi? Sound and Vision magazine in their October 2002 issue: "In use, the AV30R, connected to TAG's 100x5R power amp, is superb. True, it can't quite match the clarity and power of the latest-specification TAG flagship, the AV32Rbp-192, but by any AV standard this is a very high-end piece of kit, with excellent impact and fine detail across a range of movie soundtracks from Once Upon A Time In America to the explosive actionfests. Channel steering is immaculate, and the sense of a soundfield wrapped around you - even in 5.1-channel mode - entrancing, with spine-tingling rear-channel effects. The fine Pro Logic II implementation serves music as well as it does non-discrete AV soundtracks, and with



an SACD machine hooked up via the 5.1 channel inputs the lack of coloration and sheer bass oomph is extraordinary."

WORLD OF 212 ★★★★★ October 2002



XQ One Speakers £999.95



By combining technologies from its Reference and Q Series, KEF has introduced the new XQ speaker range.

Featuring KEF Uni-Q 'point source' arrays for unrivalled off-axis performance and 'super audio' Hypertweeters™, the XQ range fully exploits the wide bandwidth of digital formats like SACD and DVD-A. The range comprises the XQ One and Three stand mounters, the XQ Five floorstanders and XQ Two c centre speaker. All XQ models are available in a variety of finishes.

When tested in a group test, the **XQ Ones** received top honours - "KEF's new XQ Ones really are in a class of their own. With a depth of insight that is unmatched, plus a sense of cohesion that is rare - the XQ Ones are startling" concludes Hi-Fi World - April 2003.

Please Note Price Excludes Stands



19mm Titanium Dome Hypertweeter™

Developed directly from the Reference Series and time-aligned with the main array in its own low diffraction steel pod, KEF's new 19mm titanium dome Hypertweeter™ has the same wide dispersion characteristics at 'super audio' frequencies. With a flat response to 55kHz, it provides the high frequency extension needed to take full advantage of SACD and DVD Audio.

ACOUSTICS
REL

FREE INTERCONNECT CABLE* WORTH £100
WHEN YOU PURCHASE ANY REL SUBWOOFER OVER £700

Strata III Subwoofer (Wood) £699.95

REL is an audiophile company who take great pride in designing and building their highly acclaimed subwoofers. Because of their total commitment to performance, REL sometimes adopt unusual solutions to otherwise straight-forward problems.



Also Available
Q150E £499.95

"The aggression of Rage Against The Machine's Take The Power Back is near-tangible, the midrange a spitting, spiteful companion for the tight, deep, air-agitating bassline. As for the more deft creations of Chick Corea, the REL's articulate nature serves subtly to underpin basslines, rather than swamp them. The adaptability makes the Strata III a highly recommended subwoofer - it's a very versatile, musical piece of kit, and it doesn't cost the earth." WORLD OF 212 ★★★★★ July 1999

SAVE £100



PLEASE NOTE: Some products may not be available at all outlets. Please call before travelling.
 *Not in conjunction with any other offer. Advertisement valid until at least 27th August 2003, E&OE.

experience **more**

World Radio History





outlets nationwide

- Bedford** 29-31 St Peters Street **01234 272779**
- Birmingham** Arch 12, Livery Street **0121 233 2977**
- Brighton** 57 Western Road, Hove **01273 733338**
- Bristol** 92b White Ladies Road, Clifton **0117 974 3727**
- Cambridge** 17 Burleigh Street **01223 304770**
- Cardiff** 104-106 Albany Road **029 2047 2899**
- Cheltenham** 14 Pitville Street **01242 241171**
- Crawley** 32 The Boulevard **01293 510777**
- Edinburgh** 5 The Grassmarket **0131 229 7267**
- Exeter** 28 Cowick Street **01392 218895**
- Glasgow** 88 Great Western Road **0141 332 9655**
- Guildford** 73b North Street **01483 536666**
- Hull** 1 Savile Row, Savile Street **01482 587171**
- Ipswich** 12-14 Dogs Head Street **01473 286977**
- Leeds** 62 North Street **0113 245 2775**
- Leicester** 10 Loseby Lane **0116 253 6567**
- Lincoln** 20-22 Corporation Street (off High Street) **01522 527397**
- Liverpool** 16 Lord Street **0151 707 8417**
- Maidstone** 96 Week Street **01622 686366** Open Sunday
- Manchester** 69 High Street, City Centre **0161 831 7969**
- Newcastle** 19 Newgate Street **0191 221 2320**
- Norwich** 29-29a St Giles Street **01603 767605**
- Nottingham** 597-599 Mansfield Road **0115 911 2121**
- Oxford** 41 St Clements Street **01865 241773**
- Peterborough** 36-38 Park Road **01733 897697** Open Sunday
- Plymouth** 107 Cornwall Street **01752 226011**
- Poole** Latimer House, 44-46 High Street **01202 671677**
- Preston** 40-41 Lune Street **01772 825777** Open Sunday
- Reading** 3-4 Kings Walk Shopping Centre **0118 959 7768**
- Sevenoaks** 109-113 London Road **01732 459555**
- Sheffield** 635 Queens Road, Heeley **0114 255 5861** Open Sunday
- Solihull** 149-151 Stratford Road **0121 733 3727**
- Southampton** 33 London Road **023 8033 7770**
- Swansea** 24 Mansel Street **01792 465777** Open Sunday
- Swindon** 8-9 Commercial Road **01793 610992**
- Tunbridge Wells** 28-30 St Johns Road **01892 531543**
- Witham (Essex)** 1 The Grove Centre **01376 501733**
- Wolverhampton** Burdett House, 29-30 Cleveland St. **01902 312225**

within the M25

- Bromley** 39a East Street **020 8290 1988**
- Chelsea** 403 Kings Road **020 7352 9466**
- Croydon** 369-373 London Road **020 8665 1203** Open Sunday
- Epsom** 12 Upper High Street **01372 720720** Open Sunday
- Holborn** 144-148 Grays Inn Road **020 7837 7540**
- Kingston** 43 Fife Road **020 8547 0717** Open Sunday
- Southgate** 79-81 Chase Side **020 8886 2777**
- Swiss Cottage** 21 Northways Parade, Finchley Rd **020 7722 9777** Open Sunday
- Watford** 478 St Albans Road **01923 213533** Open Sunday

Please call to verify hours of business.
Contact our outlets via **E-Mail** outlet@sevenoakssoundandvision.co.uk

who are sevenoaks?

Founded in 1972, Sevenoaks Sound & Vision is one of the largest and most successful hi-fi and home cinema retailers in the country.

Each Sevenoaks Sound & Vision outlet stocks a wide range of quality products, covering all categories of specialist home entertainment, from Hi-Fi Separates to Widescreen Plasma Televisions and Projection Systems, all at highly competitive prices.

Friendly staff are available in all stores to advise, demonstrate and guide you through the home entertainment jungle.

opening soon

Subject to legal completion, we are opening new stores in the following locations: Ealing (North London), Staines (Middlesex), Weybridge (Surrey) & Wilmslow (Cheshire).

custom installation

Sevenoaks Sound & Vision's Custom Installation Service enables the integration of a home cinema or hi-fi system into your home as neatly and seamlessly as possible. All electronics can be hidden away, speakers discreetly mounted either in the wall or ceiling and the complete system operated via remote control.



Retractable Screen and In-wall Speakers

Our installation experts are fully trained to the highest standards in all areas and provide a prompt, reliable and professional service. Whether you're looking for a multi-room system, a dedicated home cinema installation with a retractable screen and built-in speakers or an integrated control or lighting system, Sevenoaks Sound & Vision has a diverse range of products available to cater for all your requirements.

sevenoaks online

The Sevenoaks Sound & Vision website has news and information on the Sevenoaks group and its outlets nationwide. The website is designed to provide you with answers to the questions you may have when buying new equipment.

For impartial advice and information, just click on sevenoakssoundandvision.co.uk

stock clearance

With 48 outlets nationwide, the Sevenoaks Sound & Vision group stock and display a wide range of products. As individual models and product ranges are changed or superseded, the preceding models are made available at a reduced price, for clearance. Visit our Website for an up-to-date list of the clearance stock, listed by outlet, within the Sevenoaks Sound and Vision group.

0% finance option†

Spread the cost of buying. 0% finance option is available on the vast majority of products we stock. †Written details on request. Licensed credit brokers. Minimum balance £400. Subject to status.

product range

An outstanding selection of products are on display and available for demonstration at all Sevenoaks Sound & Vision stores. However, some products may not be available in all outlets. Please call to check availability before travelling.

pricing policy

Whilst we do not claim always to be the cheapest, we try to ensure our prices are highly competitive. Take into account the expert advice, unrivalled product selection, demonstration facilities and excellent pre, during and after sales service and the lower price might not look such good value.

In the event you can find the same products and excellent service at a lower price, please bring it to our store managers' attention. We will always endeavour to offer you the best deal.

Three Stage Solutions

Phono stages were once a part of every preamp or integrated amplifier. These days, if you're serious about vinyl, you'll need an offboard solution. David Price tries out three of the best from Creek, EAR and Trichord, and finds that not all sound the same – far from it, in fact...

CREEK OBH-15

Thanks to the OBH-8SE and OBH-9, Creek have been a

powerful force in the budget phono stage market for years. Although it was by no means the best money can buy, their crisp and punchy sound made them superb value for money. The brand new £199 OBH-15 you see here combines the moving magnet stage of the '8 with the moving coil section of the '9, in one small 360g box.

It is superbly put together – there are individual pairs of phono inputs for both MM and MC, with a simple rear panel switch between the two. This is a great feature, because you effectively get 'two phono inputs', as you can hook two decks (one with an MM, the other with MC) up to one input at the same time. Shame the others lack this!

The OBH-15 works with MMs of 2.5-5.0mV output, and MCs of 0.5-1.0mV, meaning it is compatible with most MMs and mid-to-high output MCs. Its solid aluminium front panel contrasts with the black metal casing. Visually it's not striking, unlike the other two here, but if it did at this price point then I'd be worried the budget had been spent in the wrong place! It comes complete with Creek's OBH-2 'high grade power supply'. Switched on, the Creek is

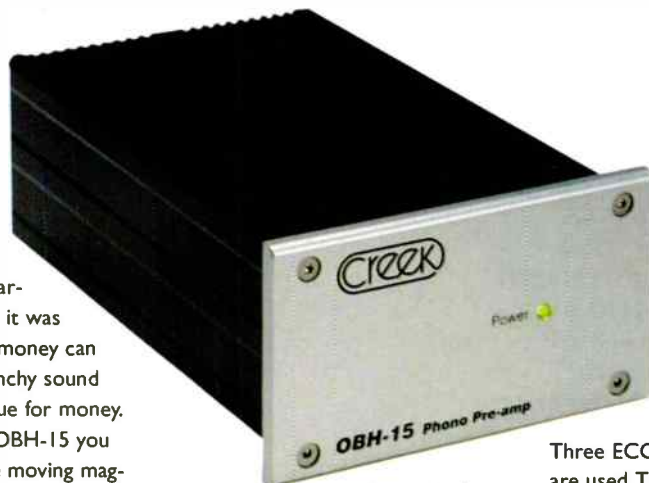

impressively quiet on either MM or MC – far more so than the EAR 834P – and very hum-resistant.

EAR 834P DELUXE

Tim de Paravicini should be well known to readers of this magazine, being responsible for a range of exquisite sounding tube amplifiers (of all shapes and sizes) under the EAR and Yoshino brands. What you see here is the most expensive 'Deluxe' incarnation of a design which has sold well for the best part of a decade. Where the standard 834P is finished in plain satin black paint, this £867.85 version gets an upmarket chrome front panel and 'luxury' finish, which really does lift it above the cooking black box.

Inside is an impressively large toroidal transformer, with a metal partition running the length of the case to screen the power supply

from the audio section.. As the unit is capable of 1V output from 2.2 mV moving-magnet or 220uV moving-coil input, it will easily drive most amplifiers without a line stage between.

Three ECC83 or 12AX7WB tubes are used. This deluxe version sports two small transformers, potted and screened in cans, acting as a step-up stage for moving-coil cartridges, invoked by a rear mounted MM/MC switch.

After a twist of the gold plated rotary on/off switch, the unit is ready to rock after about twenty seconds, although I'd suggest good half an hour of operation before serious listening starts. At high volumes, there's just the slightest amount of 'hiss' and hum audible – something with which valve users may be familiar!

TRICHORD DELPHINI2

The latest version of this popular product has the new 'Never Connected' power supply, which ensures the equipment is never directly connected to the mains, unlike conventional linear designs. It comprises two completely independent and isolated dc supply circuits, one for the positive voltage

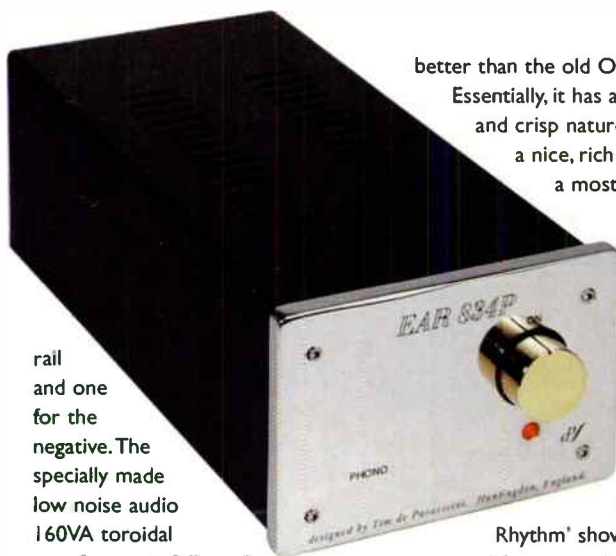

rail and one for the negative. The specially made low noise audio 160VA toroidal transformer is followed by the Never Connected circuitry and 3 pin voltage regulators. This level of filtering and regulation provides ultra low noise power supply lines before entering the main amplifier unit. A 4 way PTFE insulated silver plated copper lead squirts power into the main unit, which boasts two ultra low noise, wide bandwidth voltage regulation circuits - one positive and one negative rail, shared by both channels.

Finish is exquisite, bettering even the nicely screwed together EAR. This Class-A IC-based design uses 0.1% metal film resistors and selected 1% polystyrene and polypropylene capacitors. Its fully passive RIAA equalisation section, located between two active gain stages, uses high performance 'MCAP' film and foil polypropylene capacitors.

One of its charms is the wide range of user-selectable cartridge loading and gain options, via a set of four DIP switches inside. Cartridge loading of 33 ohms, 100 ohms, 1k ohms and 47K ohms is offered, along with gain presets for cartridges of 0.1-0.25mV, 0.25-0.4mV, 0.4-0.6mV, 2-3mV and 3-5mV. As with all solid-state designs, the Delphini benefits from being left on all the time, and really needs a good few weeks of running in from new.

SOUND QUALITY

At £199, the Creek OBH-15 is likely to be the choice of those with mid-price turntables, arms and cartridges - for example, a Rega P3 and Goldring G1042. The beauty of this wee thing is that it's more than capable of working with altogether more esoteric front ends, however - and well able to exploit any upgrades you may make on your way to vinyl Nirvana. Although not quite as keenly priced as the earlier Creek designs, it is more flexible and better presented. I'd say it sounds a little

better than the old OBH-8SE too.

Essentially, it has a super clean and crisp nature. Partnered to a nice, rich MM, it turns in a most engaging and musical sound, which is unfettered by the coarseness of cheaper phono stages such as NAD's PP2. Grace Jones' 'Slave to the

Rhythm' showed the Creek's strong, tight, expressive nature. There's lots of detail here, with fine left-to-right image placement. Bass is dry and on the light side, but very taut and grippy. Midband seems very open in isolation - it's only when you switch to the (six times more expensive) Trichord that you realise it's a tad veiled and spatially two-dimensional. Treble is crisp, with little harshness, although it's slightly vague in absolute terms.

The result is a superbly sharp and spry sound that works symbiotically with vinyl's over-smooth tendencies to give an extremely engaging and gripping sound. It gives little away in rhythms to either of the others here, although it could be accused of lacking the EAR's lilting, beguiling musicality. Herbie Hancock's 'I Have a Dream' shows it to be tonally a tad monochromatic, with less detailed information about the texture of acoustic instruments, and put on Kate Bush's 'Feel It' and a little of her rich, vibrant voice is lost. However, the Creek really romps through it, showing its truly musical nature. Not the ultimate, but you'll have to pay a good £100 to better it (in the shape of Trichord's Dino), which would buy you a smoother, richer tone and stronger bass - but little real improvement in musical enjoyment.

Akin to a small, light, highly tuned hot hatch, this disc preamp gives you a surprising amount of fun for relatively little outlay. Ultimately, it isn't in the same class as the others, but it can still teach them a thing or two about speed and immediacy, without sacrificing listening comfort.

Moving to the £867.85 EAR 834P, and you've suddenly spent a heck of a lot more money (which could easily be lavished on a better cartridge, for example). What then can you expect by way of reward? Well, if you've never heard a decent valve phono stage, then you owe it to yourself so to do. You may be

surprised, because the style of presentation is quite dramatically different to solid-state, and - critically - highly amenable in precisely the same way that analogue is more agreeable than digital. Put simply, it sounds more natural, yet those used to a fine solid-stater such as the Creek will also find some things about its sound wanting. It isn't, however, until you get into the yet more esoteric environs of the Trichord that this becomes explicit. Even then, compared to something within shouting distance of the best that solid-state has to offer, the EAR still whips it in several ways.

In a nutshell, the EAR 834P sounds like music, if that is not a contradictory statement. Obversely, it sounds less like a phono stage - or more precisely, a solid-state one! Cue up 'Slave to the Rhythm' and you find yourself listening in an entirely different way to the Creek. Gone is your concern for the precise dimensions of the recording studio in which Grace's voice was captured. Gone is your thoughts on the 'tightness' (or otherwise) of the bass.

THE GAIN QUESTION

Using a brace of different cartridges, the Creek seemed happiest on its MM setting, sacrificing a little punch and grip when used in MC mode. The EAR was again happiest with MM, its MC setting taking its performance down very slightly. The Trichord proved by far the most consistent - regardless of MM or MC it turned in a characteristically neutral and detailed sound, and was obviously utterly at home with low output MCs.

No longer do you think about the finely defined treble, or the strong image articulation. Indeed, all of these things are - in a sense - inferior to the Creek. However, suddenly all these don't really seem to matter any more. Suddenly you think, 'ahh - so that's what this song is about!'

The EAR communicates on a musical level better than either of the other two here. It takes you into the 'sensual world' of the music, where you find yourself connecting with the human creativity in the music, and not the technical peculiarities of the recording. First, you notice that the opening synth chords have hitherto unheard body, fullness and texture - but as soon as that thought has come, you're onto something altogether more profound. There's a sense of drama to those chords, of expectation. Then Grace's voice kicks in and again you're thinking about its depth and grain, but again this thought goes and suddenly you're hooked on the

A true 24bit/192kHz up-sampling digital/analogue converter that offers a major upgrade for one-box CD players and a sweet, natural CD sound

A digital bargain...

The Bel Canto DAC2 is one of those rare **AFFORDABLE** – £1295 – audio bargains that brings a real “smile-on-your-face” upgrade.

Your system can only be as good as the **SIGNAL SOURCE**. Wonderful amplifiers and speakers cannot add “quality” to a dubious source. In fact they are likely to emphasise its **INADEQUACIES** and sound worse!

We recommend a cost ratio of 5:2:1 in simpler systems – ie the source should cost 5 times more than the speakers. The DAC2 is a performance **BREAKTHROUGH**.

UPSAMPLING DONE WELL brings a more natural, spacious, easier sound to your whole CD collection, while “straight” CD can seem frenzied by comparison.

With digital in particular beware of sexy badges that promise the Earth. **“IT’S NOT WHAT YOU DO BUT HOW YOU DO IT”** applies in spades to DACs and CD players: chip accuracy, power supply regulation, internal layout and much more.

Allow time to hear the difference when you listen to the compact DAC2 – **10 SECONDS** should do.

Bel Canto **DIGITAL AMPLIFIERS** are also gaining a global reputation for performance against price. See WWW.BELCANTODESIGN.COM

Customers say we make some of the **BEST SOUNDS** they have ever heard, so you know we can do the same in your home. Our advice will take account of your best components and guide you where change is needed, in stages you can afford.

You **AVOID EXPENSIVE MISTAKES**, enjoy music along the way and save money in the long run.

JUST LISTEN AND YOU’LL KNOW

CD: ACCUPHASE, ACCUSTIC ARTS, AUDIO SYNTHESIS, Bel Canto, dCS (ELGAR, DELIUS, PURCELL, VERDI), MERACUS, SUGDEN, WADIA. **VINYL:** BASIS, CLEARAUDIO, CROWN JEWEL, DNM, GRAHAM, THE GROOVE, LEHMANN, MICHELL, SUMIKO BLUE POINT SPECIAL, TRANSGURATION. **AMPLIFIERS:** ACCUPHASE, ADVANTAGE, BEL CANTO, CAT, DNM, GAMUT, HOVLAND, NAGRA, SONNETEER, SPECTRAL, SUGDEN. **LOUDSPEAKERS:** AUDIO PHYSIC, BKS, ETHOS, NEAT, TOTEM, VERITY AUDIO. **TUNERS:** ACCUPHASE, MAGNUM DYNALAB. **CABLES:** ARGENTO, CHORD CO., DNM, NORDOST, SILTECH, YAMAMURA CHURCHILL ETC. **SUPPORTS:** ARCICI, KINABALU, STANDS UNIQUE

The Right Note

Music in the home

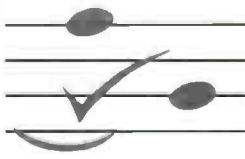

BATH

01225 874728

EXPERIENCE THE CHORD EFFECT!

The first time you hear your sound system with Chord interconnecting cables will be the first time you’ve **really heard it**.

Be warned – the effect can be shattering.

Your eyes and ears will be opened. Your music will never sound the same again.

Specify Chord cables – Hear the light!

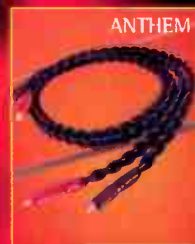

ANTHEM



RUMOUR 4

WHAT HI-FI? ★★★★★ July 01



CHAMELEON 2

WHAT HI-FI? ★★★★★

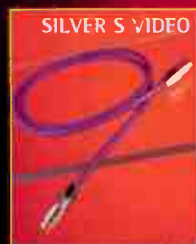

SILVER S VIDEO

FOR SALES AND INFORMATION
CALL: 01722 331674 FAX: 01722 411388
E-MAIL: CHORD@CHORD.CO.UK
OR VISIT US AT WWW.CHORD.CO.UK



phrasing, on the way she intones and pauses the words, and the way the synth backing hovers quietly yet menacingly behind. Then the drums kick in, and although there's less clout, somehow they seem more engaging. They suck you into the mix, and you're hooked until the end.

By contrast, neither the Creek or the Trichord do this trick as well. And time after time, this is what makes the EAR the most natural listen here. Ultimately, it's happiest with relatively simple acoustic music, where its compromises are least obvious – and boy, does it have compromises! Cue up Rush's 'Subdivisions', and you're struggling to get anywhere near as much atmospheric detail as from the Creek. It's as if the EAR lops off the whole, lowest layer of ambience. It's also loose in the bass, veiled in the treble, and can't really project images in space accurately. Funny then, that it still sounds a joy. Such fun is it that frankly, you don't notice the failings!

Moving from the EAR to the £1,265 Trichord is a different world – and one which so brutally reveals the failings of the EAR. However, I can't honestly put my hand on heart and say I preferred it outright. In a sense, the Delphini's biggest failing is its lack of character – which is on the face of it is absurd, because character is not what you want in a phono stage. But although the Trichord presses all the right buttons, it still doesn't engage the listener quite in the way the EAR does. Ultimately, I'd have to concede that for everyday listening, it is the better solution.

For example, 'Slave to the Rhythm' assumes dimensionality, space and accuracy that the EAR obfuscates. It builds on what the Creek does (so admirably for its price), by giving you a tremendously detailed insight into everything about the recording. Moving from a good CD player to a vinyl system with this at the helm shows you just what a fantastically high resolution medium

vinyl is. The same cannot be said for the EAR, which shows you – rather – what a fantastically musical medium vinyl is. A great showcase for this is Rush's 'Subdivisions'. Here we have an ultra-clean and detailed recording, beautifully produced and mixed but with not an ounce of warmth to be seen. The Creek has it sounding light and lithe, the EAR makes it sound soft and cohesive (more than is probably strictly true), but somewhat hazy and indistinct. The Trichord scythes through the mix, telling you all about the texture of the instruments, the tightness of the drum skins, the mixing of the vocals, the stunning speed of the percussion. It deconstructs this dense mix of music like peeling layers of skin from an onion.

The reason for this is grip. Where the EAR has some mysterious alchemic ability to make music despite a relatively casual interest in exactly how the notes start and stop (let's call it boogie, shall we?), the Trichord sounds riotously rhythmic because of its vice-like purchase on the attack, delay, sustain and reverb of everything that passes through. Bass notes start and stop like the aforementioned Honda sports car. Midband attack transients are lightning fast. Treble is superbly defined and utterly neutral – deliciously clean, it shows the EAR up as cloudy and the Creek tizzy. The Herbie Hancock track shows its imaging to be superb – it's all writ large in 3D. The soundstage isn't really any bigger than the EAR (which is most expansive already), but is far better delineated. There's more light to 'see your way around' in the recorded acoustic, more insight into the sounds of the instruments used, whereas the EAR focuses more on the way they're being played.

Tonally, the Trichord sounds like it has an extra octave of bass over the Creek. It is less 'warm' and full than the EAR – the latter seems to

give the upper bass a nice fillip – but loses the plot further down, where low bass just seems to fall away. The Trichord, by contrast, is strong and deep and even all the way down, with more muscular low bass than the EAR despite less weight further up the scale. Interestingly, although the Trichord is solid-state and the EAR tube, I'd say the former does tonal colouring better. By this, I do not mean that the Trichord is sweeter, richer and fuller – for it is quite the reverse, in fact. However, the EAR makes everything sound rich and sweet, no matter whether it was in the first place. The Trichord is far better able to signpost the difference between, say, Kate Bush's sumptuously 'analogue' 'The Kick Inside' or the very obviously digital 'Never Forever'.

CONCLUSION

The Creek is superb value for money, and will make any vinyl system sound immediate and engaging in a way that only analogue can. Brilliant value at under £200, and not that far behind the cooking Trichord Dino – only the latter's upgradeable PSU option really make its worth spending the extra, should you want an easy upgrade one rainy day. The EAR is supremely musical, yet at the price of £867.85 it has too many failings. However, if you go for the cooking version at just £399, this

REVIEW SYSTEM:
Michell GyroDec turntable
SME Series IV tonearm
Goldring G1042 moving magnet cartridge
Dynavector DV20X-H moving coil cartridge
Ortofon Kontrapunkt B moving coil cartridge
MF Audio Passive Pre
Pioneer SPEC2 power amplifier
Perigee Acoustics FK-1L loudspeakers

all changes. Suddenly, you've got a deeply impressive performer at the price, offering something that even the Trichord Delphini at three times the cost can't give – superb cohesion. If you're after an EAR, the entry level one is the bargain of the crop.

Finally, the Trichord. Although not the very best I've heard, it's the best all rounder at or near its £1,265 price. The new NC PSU really pushes into the top tier of phono stages, bringing superb grip and an utterly self-effacing nature. The only thing it misses is that last ounce of swing, which I suspect is a uniquely valve trait. So there you have it – at their respective price point, each design is the one to have. An embarrassment of riches, to be sure!

VERDICT ●●●●● £
CREEK OBH-15
Crisp, detailed and rhythmic sound make this a superb budget buy.

VERDICT ●●●●●
EAR 834P DELUXE
Deliciously lucid and beguiling sonics make this the most musical here.

VERDICT ●●●●●
TRICHORD DELPHINI
Tremendous all round ability gives great insight into any recording.

CREEK OBH-15 £199
Creek Audio Ltd.
☎ +44 01442 260146

EAR 834P DELUXE £867.85
EAR/Yoshino Ltd.
☎ +44 01223 208877

TRICHORD DELPHINI £1265
Trichord Research Ltd.
☎ +44 01684 292792

Club Class?



DJ decks are the most buoyant area of budget turntable sales right now. Over the past few years, a wealth of 'Technics clones' have appeared on the market, seemingly offering all the facilities of the classic SL1200 at under half the price. So are these a short cut to serious sound from vinyl, or just another pitfall to avoid on the analogue upgrade ladder? Albert Lee investigates, and tries Sony's popular PS-DJ9000 for size...

Until the nineteen nineties, vinyl was the world's major music carrier. If you wanted the new Beatles or Beethoven release, the chances are that you'd buy it on LP. As a result, most music fans invested modest sums of money in budget belt drive turntables from the likes of Garrard or BSR, and latterly Dual. These had a fair degree of automation, yet were simplicity itself to use - with little in the way of 'bells

and whistles'.

For the past decade however, new buyers coming to vinyl have been an altogether different breed. Casual music buyers have had Compact Discs to keep them happy, which leaves us with aspiring audiophiles and wannabee DJs. In the hi-fi market, the likes of NAD's 533 and Rega's P2 have sold steadily, but on the DJ side, there's been a veritable explosion, with vast numbers of budget decks hitting the

market. Technics direct-drive SL1200 has become an icon for this generation. Sony - one time purveyor of some of the best direct drive turntables - also has a popular seller in the PS-DJ9000. With all the style of Technics SL1200 at half the price, it promises much.

INTO THE GROOVE

On the rear of the unit there are a pair of phono sockets, a ground terminal and an IEC mains socket.

a strobe light to the left front of the unit.

The motor has the same short start up time as the Technics SL 1200, about half a platter rotation to full speed - however, braking was a little slower. With quartz lock selected the unit was rock-solid at the speed indicated. If the quartz lock was not in use and the pitch control in the centre detent, the stroboscope indicated speed fluctuation. These criticisms may seem irrelevant but in a mix it would appear that the vocalist was slurring. This is not a good thing!

How then did it sound? I'm afraid to report that it was dramatically poorer than a similarly priced hi-fi deck, such as NAD's 533 or Rega's P2. Bass was light with an extremely prominent upper midrange, along with a large amount of distortion. On investigation I discovered that the headshell was not sitting square in the arm. The cartridge was unable to be set at the correct VTA. This was due to a spacer weight under the cartridge in the headshell coupled with the slip mat thickness (4 or 5 mm). This would instantly catch out any newcomer to vinyl - and is something where the real hi-fi decks score over the Sony, along with the higher priced Technics.

Having access to an ADC LMG1 magnesium headshell - a very high quality aftermarket design for 'SME' arms and now no longer available - I installed the Stanton properly. Along with a felt slip mat, this solved the VTA problem, although the VTA control was still very coarse to use.

I then tried to align the

cartridge, only to find that pick up arm was not aligned to the protractor! As there was nothing I could do about this, the listening session carried on.

My next impressions were of a more tuneful bass and a much smoother mid to treble balance. The sound was still very wearing and shrill, doubtless due to poor manufacture of the pickup arm and also the loose pick up arm base that can be moved around! These are not good attributes. When compared with a SL 1200 the difference was staggering. The Technics was better in all aspects. This is all the more depressing, as the SL-1200's arm is a cheap generic S-shaped design that's miles behind the likes of the Rega RB250, as fitted the NAD 533 or Rega P2.

Another failing compared to a real hi-fi deck was the DJ-9000's isolation properties, both from the feedback loop and structure borne vibration. This, along with the poor pickup arm contributed to the shrill, bass light, truncated stereo image - unlike the SL 1200 which has a rich relatively wide image, although little depth or height in standard format (changing the SL 1200 to a Rega RB250, especially in Origin Live modded form, transforms this of course).

Overall then, the Sony proved deeply disappointing. In truth, it's pretty much par-for-the-course as far as budget DJ decks are concerned. It's certainly no shortcut to vinyl Nirvana - if you want decent sound then a pukka hi-fi design is your only option, or if you want a decent DJ tool, then the Technics SL1200 at twice the price is the real deal. Subjected to the rigours of life on the road showed just how far behind it - and, I suspect, its rivals - are compared to both the aforementioned Technics 'pro' deck and any of the entry-level hi-fi designs. It's a salutary lesson that, with analogue, you don't get something for nothing, and that if you're considering your first record player, then you need decide clearly whether you want to do mixing or not. If so, get an SL1200, if not you'll get far better sound with a decent 'budget audiophile' design.



The power switch is on the top plate on the left-hand side towards the rear. The start button is located at the left front. To the right of the pick up arm is the pitch control along with pitch bend controls and fine pitch adjusters. Directly under the arm are the speed control switch and a quartz lock loop switch. At the back of the arm lies the vertical tracking angle (height) adjuster. The arm is equipped with a finger lift plus adjustable bias, cueing lever and tracking force. The platter has stroboscopic marking around it with

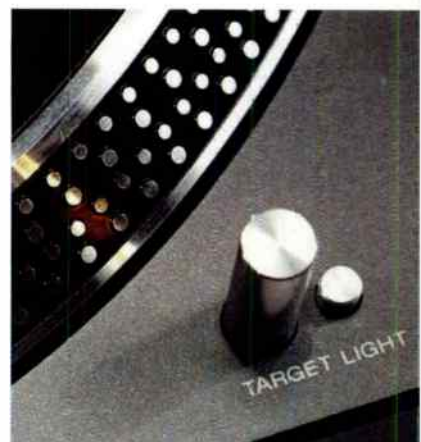
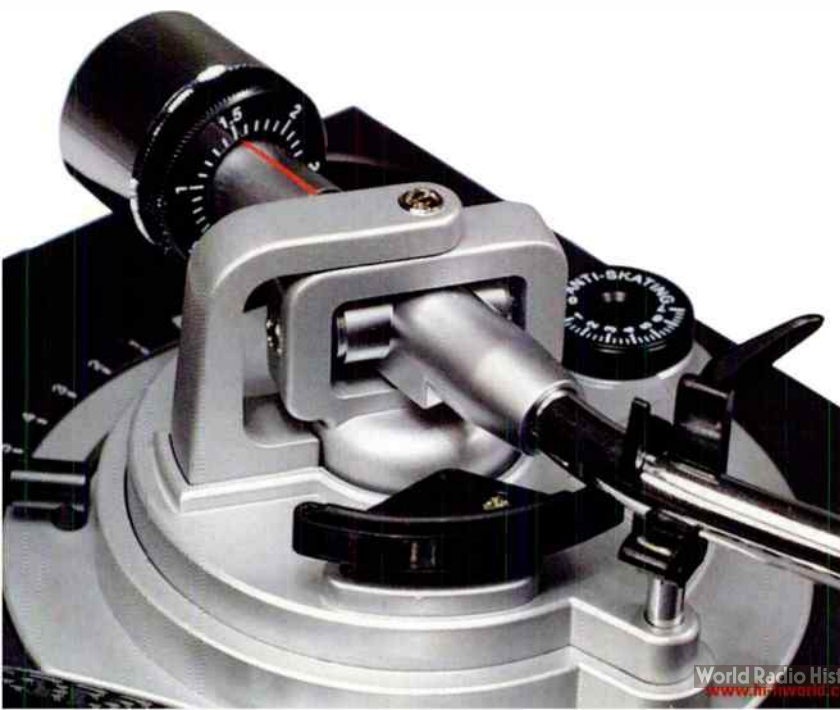

VERDICT ●●

A poor alternative to the Technics SL1200 for DJing and no rival to a Rega.

SONY PS-DJ9000 £300 NEW
(discontinued - now around £150)

Sony UK

+44 (0) 1932 816000

www.sony.co.uk

Ciao, Bella!



Dominic Todd enjoys meeting Monrio's pretty little MC 207 integrated amplifier.

Towards the end of the nineties, a small Italian company launched a series of amplifiers and CD players that, whilst not exactly rocking the establishment, earned a good deal of respect. Distributed in the UK by UKD, Monrio's Asty proved a sweet little thing with few sonic nasties. The MC207 looks set to continue the theme, but just a little more upmarket at £1,100.

Indeed, as soon as you pull this amp out of its box, it's not hard to tell that there's some serious componentry under the hood. The 130x80x310mm pressed steel casing is very solid, with a chunky 10mm anodised aluminium front panel, but this doesn't completely explain its considerable mass. Removing the lid shows exactly where the MC 207 gets its weight – it is a dual mono design with two 200VA power supply transformers, rather than just one feeding two mono circuits.

The NOR-SE toroidal transformer units look hefty enough to power the whole amp solo, so two of them should create quite some fireworks! Four 10,000uF capacitors are used for each channel – that's right, not four in total, but four per side!

Unsurprisingly, there's little room for the preamp amongst all this big-hitting electronic componentry, so its main board is mounted inside the

unit's front panel, with the ALPS Black volume control sandwiched between the two channels on the power board. Just for good measure, the pre-amp also has its own toroidal PSU about the size of one found in your average budget integrated amplifier!

The Monrio is definitely of the minimalist school when it comes to features, however. There's a standby function to keep the servo circuits warm, and four inputs plus a tape loop and an enigmatic 'direct' connection – this isn't actually a 'source direct' type input, but a direct input for using the MC 207 as a slave amplifier for multichannel applications.

SOUND QUALITY

With its thousand pound plus price tag, the MC 207 faces stiff opposition from the likes of Arcam's A85 (£800), Cyrus's 8/PSX-R (£1,150 all in), Roksan's Caspian (£895) and Sugden's A21a (£1,050). How then, does it sound? With the Monrio hooked up to my reference system, I kicked off my listening session with The Crash Test Dummies' 'In the Days of the Caveman'. The MC207 immediately lived up to expectations by offering a beautifully broad and deep soundstage, produced with the effortless ease associated with a decent dual mono design. Also typical of the best of the breed was an iron-fisted grip on the music, that

should keep even the 'loosest' of 'speakers in check.

Yet this bold 'wall of sound' didn't come at the expense of refinement, which is precisely the area in which a number of transistor power houses fall down. Whilst not exactly portraying a liquid, smooth valve-like quality in the treble, it was at least well integrated and free from glare. Cymbals, for example, didn't splash and fizz as they can do on inferior transistor amplifiers. The MC 207 offered a very engaging and energetic performance indeed.

Although different in design, construction and price, the huge soundstage and decent refinement couldn't help remind me of my old favourite, the NAD C370, but on a larger scale. The separation amongst the mix was good, although it couldn't quite offer the holographic insight of some of its rivals – the Cyrus 8/PSX-R, for example, defines each instrument just that little bit more precisely. Then again, even it couldn't approach the gutsy dynamic prowess of the Monrio.

Such a powerful sound is all well and good with certain types of music, but with something more sedate it can begin to grate. To see if this was the case here, I turned to Norah Jones' 'Don't Know Why'. Unsurprisingly, she fairly leapt from the 'speakers with great alacrity. It did, however, reveal the much-lauded artist as being a little too closely

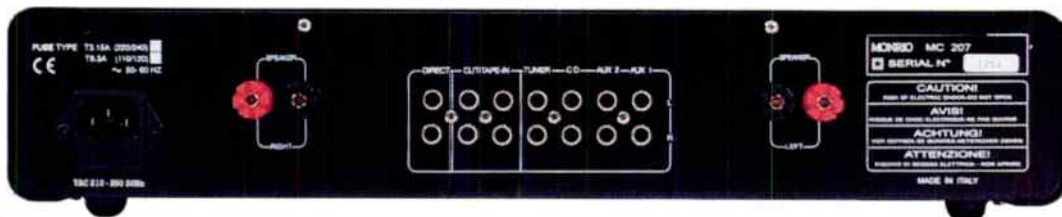

microphoned for my personal tastes – it's as though the recording engineers were determined to squeeze every last dB out of the signal until the sound teetered on distortion. Still, this is hardly the fault of the Monrio, which simply revealed the recording warts and all! As such, the resulting sound can be just a little too forward if you already have a bright pair of loudspeakers. With my current-hungry Celestions, the results were just about spot on however – a powerful vocal presence combined with good texture and timing made for another highly enjoyable listen!

The MC 207 was similarly revealing of The White Stripes' 'In The Cold, Cold Night'. It stripped away the recording, showing plenty of hiss, and kicked out the bass guitar track with sharp relief. Rather than spoiling the song, however, it simply added to the atmosphere of this rather eccentric, quirky recording, making for a nicely expansive sound. The whole piece was well balanced – bass didn't swamp proceedings on any of the tracks, and remained pleasingly solid and in tune with the rest of the mix. As with The Crash Test Dummies track, the Monrio was generally in its element here, even though it didn't offer the last word in detail retrieval. For example, the guitar timbre was fine, but not exceptionally well defined.

If the MC 207 does have a weakness, then I found it apparent with classical music. Listening to Prokofiev's Romeo and Juliet by The Berliner Philharmoniker, I found all the thunder and tension one could wish for in pieces such as 'The Montagues and Capulets'. Bass could have been a touch deeper, but this didn't distract from the impressive impact made. What was less pleasing was the slightly muddy string tone. I also found that when the pace died down, the Monrio became less engaging with average renditions of more delicate clarinet and horn solos. It seemed unable to get the best from the individual instrument, when it wasn't being played at full pelt. That having been said, the timing was good throughout and the brass sections generally showed no such

EDITOR SAYS

Here's an interesting one. For my money, the best amplifier at this price is Sugden's sublime A21a, but there's a problem. You see, this Class A delight simply doesn't have the motive force to work with any loudspeakers of average sensitivity or less - or even with sensitive speakers in loud rooms. The other obvious player at the price is Cyrus's 8/PSX-R, which has plenty of oomph, detail and clarity but lacks the Sugden's ultra-beguiling sound. This is where the Monrio comes in. Think of it as 'an Italian Meridian 551 - it's a great compromise between the two which offers real grunt and grip but a touch of finesse. Where the Meridian majors on style and connectivity options, the Monrio is more in the traditional mould of integrateds and thus less 'slick' to use, but ultimately has more vim and a broader tonal palette. A very capable new entrant to the mid-price amplifier fray, with its own distinctive Latin character.

weaknesses. In short, whilst the MC 207 was never less than pleasant to listen to, there were times when its ability to transfix the listener ebbed away somewhat.

I would be very surprised if any purchasers of Monrio's MC207 would be disappointed. Build quality and finish are top notch and it has all the features that most people need – namely a volume control and a handful of inputs. It generally delights and engages the listener with an exceptional vigour rarely found at this price. What it also successfully manages – which is far more difficult around this price – is to combine great vigour with decent refinement. If you've ever heard a NAD C370 then you'll know what I mean. If you

think of this amplifier, but with a still more polished presentation, then you'll get the idea.

What it can't quite do is strip away layers of music in the style of the Cyrus 8/PSX-R, or offer the first rate timbral definition of the Sugden A21a – for those wanting the last degree of insight, this is probably not the best amplifier at the price.

Think of this amplifier as treading a clever path between these two aforementioned class leaders, and you've got its measure. Although it can't beat either at their own particular games, it gives has a good go. Where the Monrio is weak, its faults are forgivable, where it is strong, it is sublime. Heartily recommended.

MEASURED PERFORMANCE

The Monrio MC207 has some clout, producing a hefty 84watts into 8ohms and 132watts into 4ohms. It will drive most loudspeakers well enough, getting good volume from them.

There was measurably more distortion at high frequencies than is common, with an extended harmonic structure and this may well colour treble slightly, possibly adding a little coarseness or edge. At 0.14% total harmonic distortion levels were low though – low enough to possibly pass unnoticed. I would guess Monrio choose to use as little feedback as possible.

With wide bandwidth and good channel separation the MC207 measures well enough in all areas. NK

Power	84watts
CD/tuner/aux.	
Frequency response	4Hz-70kHz
Separation	80dB
Noise	-92dB
Distortion	0.014%
Sensitivity	420mV
dc offset	10/3mV

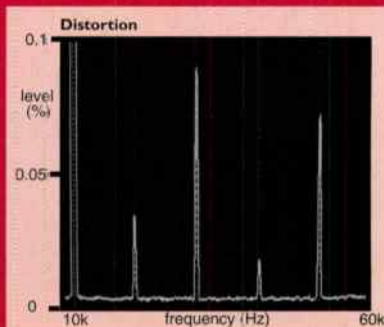

VERDICT

Powerful, muscular sound allied to real finesse makes this an essential audition.

MONRIO MC207 £1,100

UK Distribution

+44 01753 652669

www.ukd.co.uk

mail

Visit our website at www.hi-fiworld.co.uk or send your emails to letters@hi-fiworld.co.uk. Letter of the month wins a pair of precious Metals interconnects and one year FREE subscription to HI-FI World.



Letter of the Month

FROM CHRIST TO REVELATION

I was intrigued by the article that appeared in the July edition called 'A Kick up the 80s', which was your nostalgic trip back to the days of 'flat-earthers'. What you had to say certainly struck a chord. I had always been into hi-fi as a kid, but got into it big time in the mid-1980s when I indeed bought a LP12 and ImaTech Claymore. I was addicted to Hi-Fi Review, and even though I am embarrassed to say it now, thought Chris Frankland, as you alluded to from your little joke, was indeed the 'messiah'.

I was therefore devastated and (remember the day clearly back as I believe, about February, 1999), when I looked in my local WH Smith and couldn't find a copy of Hi-Fi Review. The company I subsequently found out were just. However, out of the ashes of Hi-Fi Review was born Hi-Fi World, which I thought was simply going to take off where the Review had left but this turned out not to be the case!

To tell you the truth I wasn't that impressed with Hi-Fi World, as it wasn't the 'flat-earther' mag I had hoped for. Even though some staff, including Noel, came over from Review, there was nowhere to be seen the scribbings of Chris 'Christ', Frankland. I think all of those who bought Linn/Naim systems wanted it reinforced that they had bought the very best and everything else was rubbish. Unfortunately for me I seemed to think this and fairly recently.

It was only 3 or 4 years ago that I decided to get rid of my high-end all-Linn system (except for the Sondek, which I think is absolutely brilliant). I now have a system which is far removed from what I had previously, just in case you are interested the Shunling tube CD player, Musical Fidelity A3 pre and power amps and Jansz concert Eleven speakers. To my mind this is a lot more musical than I have had in the past, and the only reason why I think I stuck with Linn, Naim, ImaTech equipment in the past was because I had not heard anything else and I only believed or wanted to believe what the 'flat-earthers' preached.

Thank goodness the scales had

been lifted from my eyes and, as first and foremost a lover of music, there are certain other brands that are more musical than the old Linn/Naim systems. They were great if you wanted music thrust before you — transients were brilliant and the music would be very much in your face, but ultimately would be tiring.

Having now bought a valve CD player there could be the possibility that I may end up buying valve amps. Having listened to the Shunling mono-blocks, I must say that I was most impressed. I think part of the reason I was able to open up my mind to other equipment was because of you (yes, that is you, David Price). It was then I started to listen to different pieces of equipment and this made me more open minded and drew me away from the 'flat earth' sect. I must admit to being nostalgic in missing the scribbings of Chris Frankland — I used to love the way he wrote and, in particular, I used to seem to buy almost every record (apart from only I listen to add) that he recommended.

All in all I think World is a great publication but I do miss being a member of the 'flat earth club' — it was like being a member of an exclusive group and those other people into hi-fi who don't have the obligatory Linn/Naim equipment were misguided souls who had woolly hearing! One thing you didn't mention in your article was that 'flat-earthers' systems of the 80s could not manage to image at all. I only found out what imaging was when I listened to a system that would have been frowned upon by 'flat-earthers' back in the late 1990s. On looking back at an old edition of Review, imaging was referred to as 'a hi-fi misconception'. Keep up the good work and may you long be editor, or all the other hi-fi mags around now are not for me.

Jonathan Diamond
Bishops Stortford,
Hertfordshire

Hi Jonathon — I wanted to write that eighties piece because I think it was a very interesting time for hi-fi, precisely because — as you say — there was a sort of 'alternative'

hi-fi scene going on, of which Chris Frankland was the cheerleader (or should that be 'ringleader'!) I too was a member of the 'fraternity' back then, and avidly read The Flat Response and Review, and also loved Chris's writing style — although I didn't necessarily agree with his conclusions. I also loved Malcolm Steward's stuff, and the way Noel provided a nice counterpoint with his far less tendentious, measurement-based pieces!

Of course, World was never a 'Hi-Fi Review part 2' — Noel's love for valves and classic vinyl saw to that. But I still think this mag has a similarly 'distinct' constituency of readers — what I'd call 'real world audiophiles' who are prepared to spend serious money on hi-fi if necessary, but who also like classic and DIY stuff where it is better. Interestingly, Linn, Naim, et al have moved on and shrugged off the 'flat earther' tag, which none of them ever liked anyway. Of all those names, Naim is probably closest to its 'punks' eighties credo — but all are doing some great and highly charismatic products nonetheless. So, don't dismiss those companies now simply because you grew out of their eighties designs — that would be just as doctrinaire as 'Christ' himself!

Incidentally, I contacted Christ last year with a view to doing a feature on him, from the Popular Hi-Fi (another mag I loved) days onwards, but he politely declined — I think he quite likes being out of the limelight these days. I've never met him, but all the hi-fi scribes who worked with him in the seventies and eighties, produced a wry smile upon my mention of his name. I

think most people in the biz respect him as a gifted writer, whatever their personal thoughts on his hi-fi politics may be! Thanks for your comments about World. DP

The Flat Response
— Christ, almighty?



AN EIGHTIES CHILD WRITES...

Thanks for a great magazine, the only hi-fi publication I can read without that slightly queasy sensation of being taken for a ride. You eclectic folks genuinely inform by playing to your individual strengths.

Being an 'eighties hi-fi child' myself, it's still the first experiences of hi-fi which stay with me. It's almost like we lost something - probably the ability to hear above 16kHz! Perhaps as we all look the big four-zero in-the-face there's a desire to signify our existence with greater things? Great events I remember began in the late seventies listening to a friend's dad's hi-fi, which was all Tannoy Lancaster, SME arms, head amps and other bits I didn't understand. The sound was incredible, mostly because it was effortless and unstoppably hi-fidelity!

I started to get the point playing my brother's first student system, a Technics belt-drive, Ortofon VMS20E, NAD 3030 and AR25 speakers - classic budget system! My own first system a few years later was a mixture of Unilet and Tottenham Court Road - an Ariston RD80 (Russ Andrews told me to ditch it and get a Linn!), Cyrus I and MS40 speakers. All this stuff I still have, though it's getting very long in the tooth and mostly modified out of existence. In addition I have two other Cyrus amps, half a dozen CD players, or more! The best of these is an ancient Denon (never did find a player to replace that first multibit Onkyo I had!).

Playing records on this system after fitting a new Akito arm and Denon cartridge took hi-fi to the point I never believed was possible from budget, the floor of the room disappeared, The Meat Puppets were obviously playing in some dusty recording studio in Arizona, some place! This lasted three days, and I've been chasing the sensation ever since, patiently awaiting its arrival. It's been quite close on occasion actually, but CD just doesn't do it at budget or any other levels I've heard. I gradually fell under the spell of the great guru Russ during his modding days. He knows how to cure you of all forms of ailments. His musical taste is appalling, by the way!

After all, tweaking was another great eighties thing along with all those little black boxes I still think of as ultimate hi-fi. Speaker cable made of ring mains (remember?), hours spent adjusting spring settings and bias on our decks. I completely ripped the guts out of mine and rebuilt it with Araldite and bitumen all over the place. Decent caps and resistors in the cheap motor. Internal speaker wire ditched for solid core or multistrand variable diameter. Russ took me to another level, his tweaks just made everything seem better.

After such training, if I buy a CD player these days, the first thing is to ditch the diodes for Schottkys, replace the main power caps for Os-cons, ditch the op-amps for Analog Devices or Burr-Browns, replug all the leads (I'm still waiting for someone to produce some half-decent ribbon cables for the inside of these things), clean-up the output RCAs, replace the mains cable with Russ Andrews earth wire, sit back and enjoy! It works, mostly!

Looking inside modern DVD spinners is a little more disheartening, however. It's like they moved on without telling me! There's really very little to get your mitts on. I just put the lid back on, what's the point! The one killer-tweak left is the power cable - how sad! Still, I reckon the greyness you rightly describe - something down to how low sound comes on the list of features on these things - is somewhat reduced. I'm continuing to collect eighties hi-fi. One day I'll get that magic-eye analogue sound back, The Meat Puppets await!

Yours in nostalgia,
Geoff Holmes

Hi Geoff - thanks for the kind words. My funniest memory of the eighties was to read in - I think - The Flat Response that Linn LPI2s sounded noticeably different depending on which side of the felt mat you used. My friends and I thought it was a wind-up, so we tried it on my LP12/Ittok/Supex SD900, Nytech CTA302 receiver and Linn Kans. And lo and behold - it did! Cool - or what? **DP**

NON COMPLIANCE WARNING?

I have noticed that in recent years, reviews of tonearms and cartridges tend not to discuss effective mass and compliance. Is that because there is more standardisation of mass and compliance these days? Back in the eighties, I remember everyone used to be careful to match their high compliance cartridges to low effective mass arms and vice versa, and charts would be published so you could work out the resonant frequency of the combination. My SME 3009 (non-detachable) is fairly low mass (9.5g) - do you have any suggestions for a suitable cartridge? I thought about a Shure V15VxMR or even a Cartridge Man Music Maker?

I was very impressed with SME's service in restoring a fairly scruffy 3009 arm to as-new condition. It works well with my Garrard 401, EAR 834 phono stage and World Audio K5881 through LS3/5as, playing my treasured classical LPs. Speaking of LPs, a suggestion for your classic cuts: Vladimir Spivakov plays Schubert, Paganini and Brahms on EMI

HQS 1413 (1979), which has one of the best sound qualities I have ever heard.

Paul Killick
Guernsey

Back in the seventies and eighties, vinyl was our main music carrier. As such, there were far more turntables, tonearms and cartridges around, and thus far more combinations thereof. It was, of course, very important for magazines to show readers how to match them - but now though, journalists are more focussed on showing readers how to match topky DVD-A players to loudspeakers, and the like. Of course, compliance is just as important as ever - and indeed in this month's vinyl special, Noel takes up the subject. Fortunately perhaps, whilst the seventies witnessed a move from high mass arms to ultra low mass (i.e. SME Series III, Audio Technica AT1120) and the eighties saw things swing right back to higher mass (Linn Ekos, Rega RB300, SME Series V), things have stayed pretty much the same for the past decade. Vinyl is now about partnering a relatively small number of arms (usually high-ish mass) with a lamentably narrow range of cartridges. As for your SME 3009, it's not really up to the latest tonearm technology, but it will work very well with the Shure V15VxMR, which many believe to be the finest MM currently available. **DP**

In a nutshell, cartridges these days do not have super low compliance, unlike ADCs and Empires (remember them?). Most now have medium compliance, track at 1.8gms and will suit the few tonearms around, which means mostly Regas and SMEs, both of which are low-ish mass. So by a degree of voluntary standardisation the matching problems have disappeared. **NK**



Low mass arms like this AT1120 were once all the rage, but now they're old hat.

TURNING THE TABLES

I am uncertain about the practicality of purchasing a Linn second hand - I have looked at the last forty sold on an online auction website, varying in age from 10 to 30 years. The number of upgrades and modifications these decks have gone through is mind-boggling. Buying one of these without first seeing its condition is too much of a gamble when anything from £500 to £1000 is changing hands.

Geoff Marson
Lutterworth, Leics

Firstly, I would NEVER buy a turntable unseen from internet auction sites, or anywhere else for that matter. In my experience, online auction sellers have a very elevated view of the quality, rarity and desirability of what they're selling, and a few nice digital pics of the outside does not tell you the full story – in fact, it can be misleading. Some readers may not be totally surprised to find that yours truly buys a lot of old kit (from all over the place) in order to keep Olde Worlde alive and kicking. I've practically given up buying stuff from online auctions, so bad has been the quality of the stuff – despite sellers' claims to the contrary. I find that dealers, Hi-Fi World classifieds and private sales (from local papers, etc.) are the best places – in all cases you can see (and hear) the things working. Don't accept anything less.

With this in mind, a Linn dealer would be a fine source of secondhand LPI2s – they'll have lots of 'part exchange' decks, as customers have bought brand new replacements. Personally, I'd aim for an old, mid-eighties LPI2 (with Valhalla and Nirvana kits), a mint plinth and cheapo tonearm such as an LVX+, for around £350. Get your dealer to fit a Cirkus upgrade kit (£300) – which will give you a new main bearing, motor, armboard and suspension – the best part of a new deck! You can later fit an Origin Live RB250, and then a Dynavector DV10x5 when funds permit. Remember you or your dealer will have to file a little niche into the rear right hand plinth crossbrace, to fit the Rega arm.

Alternatively you could go for any number of other decks. Essentially, you have to remember that the Linn is a very old design now, and is not the ultimate deck. A Michell GyroDec, for example, gives far greater incision and grip, with a much more even sound. The Linn sounds quite coloured and

constrained by comparison, but one respect it cannot be bettered in is musicality – it swings more than Austin Powers on his stag night! The result is a lovely, beguiling sound which contrasts to the sometimes unwanted clarity of the Gyro – the LPI2 is the vinyl equivalent of romantic candlelight, while the Michell is the proverbial bright, crisp spring morning. **DP**

ARMED FOR ACTION?

Recently I've inherited a Syrinx PU3B tonearm. Unfortunately in Italy nobody knows this arm very well, so please tell me your opinion of it. Furthermore, I've checked the bearings and anti-skating device by conventional tests. I've observed arm movements which I will now describe: the bearings are very tight and without play; the tonearm moves smoothly through its operating arc. Nevertheless, with zero tracking force, zero anti-skating force and the arm in the central balanced position, only at the end of the operating arc (before the last-inner grooves does the anti-skating begin to take effect, with a force of around 0.5g. Vertical movements don't convince me completely - there is slightly more friction in Syrinx vertical bearings compared with Ittok LVII Linn arm. Again with zero tracking force, zero anti-skating force and the arm in the central balanced position, when I down or lift the shell, it has difficulty returning to the initial balanced-horizontal position. Is this typical of the Syrinx PU3B arms?
Luco Berselli
Italy

Hi Luca – Syrinx Precision Instruments originally manufactured pregnancy scanners and ultrasonic measuring equipment in the mid-1970s, but its founder Scott Strachan came up with a winning tonearm design that reputedly outperformed the hitherto unassailable Linn Ittok in straight A-B dems. Thus was born the PU2. Frankly, build and finish wasn't anywhere near the Tik-Tok, but its next iteration, the PU3 was an altogether more robust affair. Some folk said it was sonically superior, but it was not to be – the company disappeared off the map.

Frankly, it's very hard to diagnose a tonearm problem via email! I wouldn't be too concerned about the bias compensation – even if it isn't working quite as efficiently as intended, it may not adversely affect the sound. In my opinion, only modest anti-skate is required and I routinely use half the suggested amount (i.e. 0.75g for a cartridge tracking at 1.5g). You also have to remember that it only really kicks in

towards the end of the disc anyway. The issue of vertical friction is more important, in my view. If the arm can't ride the disc surface, the cartridge's suspension can't work properly, making for obviously poor sonics. Frankly, if this is an issue, you'll be able to hear it! From what you say, I suspect your arm is indeed damaged, in this respect.

Twenty year old tonearms are all well and good – and it's nice to use something different to the ubiquitous Rega RB300, but frankly I'd junk it and go for an OL RB250. I know this is really boring for you to hear me say again and again, but it's the best vinyl value around – believe me, I've tried everything! Classic tonearms have great charm, but you have to remember they are mechanical devices which damage easily and invariably wear. Just as any twenty year old car – from Ford to Ferrari – on its original suspension bushes, dampers and springs will handle like a bowl of porridge, so old arms cannot trace grooves properly unless they've been meticulously preserved. Now we're back onto the second-hand theme – don't expect arms you've picked up for a few Euros to work as new! With classic hi-fi as with classic cars, unless you're going to strip and build everything yourself, then provenance is everything! **DP**

IN DEFENCE OF DL4S!

I like to come to the defence of Celestion DL4s. DP dismisses them as flaccid, but I've had a pair for nearly twenty years now and I still think they're wonderful. They are the last remaining survivors from my original budget system of a Rega 2, Cyrus One and DL4s. There are several good reasons for their longevity.

As the rest of my system has improved the little boxes have coped admirably with everything thrown at them. In fact, when I've wanted to show off my new record or CD player to non hi-fi friends they've all commented on how good the speakers were. I know their limitations: A DL4 is a pint pot - you can't squeeze a quart into it no matter how hard you try - but it's still one of the best pint pots going!

A couple of years ago, when the toddler problem arose I thought that perhaps a pair of floorstanders might be part of the solution. I went to audition some £500 'speakers at my local dealer - a pair of Rega something or others and a pair of something else that impressed me so much that I can't even remember what they were... Now, remember that my DL4s cost a hundred pounds twenty years ago. Given that all consumer electronics prices have

dropped considerably in real terms since then, these modern examples costing five times as much should have been quite outstanding. Nope. Not only was I not convinced that they were four hundred quid better, I wasn't even convinced that they were any better at all. So I've still got the DL4s thank you very much!

Guy Coulson
Via email

I pray for you in your darkness. **DP**

THE GREAT MD CONSPIRACY?

It almost seems like a conspiracy - it seems that all the magazines want to forget MD, as the latest craze of hard disk portables is obsessed over. Short sighted. I wouldn't be surprised that when Blue Ray technology comes on stream they will be quickly forgotten - dismissed as a technological oddity (like DAT or DCC) as being too complicated, expensive and requiring expensive batteries. My Sharp MT88 cost me less than £80 and will give me 16hrs playback from a 1800mah NiMH AA cell that cost me less than £1. Blanks cost me 60p. Truly a marvel!

Anon
Via email

I use my Sony MZE-E25 MD portable everyday - it's five years old and has been dropped countless times and lost and found, but has never once missed a beat. I've taken it to Japan, Spain, Greece, Tunisia, Germany, Portugal, Eire, France, Belgium, Holland - and played it in cars, trains, planes, buses and boats. It's brilliant, sounds good and I can slip in into my shirt pocket. I've yet to find any other audio portable that is such a good, versatile, reliable, all rounder! Don't dismiss MD! **DP**



Sony MD - one of the editor's fave music makers

TO CD OR NOT TO CD?

My system comprises a Philips CD50111 with Trichord Clock II mod, Pink Triangle Da Capo DAC with the latest filter, Creek P43R + 52SE amplification and

Epos E11 on dedicated stands. All cabling by Chord. Rel Strata II sub. All equipment on Torlyte platforms and all use Russ Andrews power cords.

I have been informed by a friend that my system would sound a lot better if I invested in a more modern CD player or a dedicated transport as the digital outputs are now a lot better than they were years ago. Would there be any truth in what I have been told, and if so, would you have any suggestions as to a few players or transports I should be looking to audition? I have up to £1500 to spend if necessary. My preference would lean towards a CD player, then I would still have music if the PT DAC had to go in for repair. I am thinking along the lines of a Meridian 507, Marantz CD17, Linn Genki or one of the Creeks. Am I thinking on the right lines or should I be considering something more expensive?

John Hamer
Isle of Man

Methinks your friend is wrong. Here's my advice - don't buy anything. Or if you must, then spend it on your amplification. Your transport isn't half bad - especially with the Trichord mod, and the PT DAC is superb. You'll really struggle to get better sound from any new CD player under £3,000 or so, I'd say. Ultimately, if you must upgrade your transport, then seek out a matching Pink Triangle Cardinal and fit the latest Clock 4 mod. Alternatively, spending £300-£400 on a used Audiolab 8000CDM or TEAC VRDS-T1 and having the same mod would give you an ever-so-slightly inferior sound with better durability. Personally, I'd save my pennies for something like the Musical Fidelity A308 integrated (£1,995), which is a

really big and powerful sounding amplifier with a nicely smooth sound - just what's needed to aspire your capable but fussy Epos ES11s. Another way round things would be

to sell the Eposes for Castle Conways, which would give you a less exact but larger and more physical sound. **DP**



MF A308 - forget CD spinners, this will really aspire your Eposes!

THE DARK SIDE OF SACD

After reading so much about the SACD release of the Dark Side of the Moon, I bought myself a copy as soon as it was available in Australia. Sadly I do not have a SACD player yet due to financial constraints. But as the new SACD disks are dual layer disks, I have been trying to build up some software for when I do have one. What a disappointment! The new disk did not sound any better through my CD player compared to the old CD, in fact I thought it sounded a bit more edgy. I found the answer while reading a review on this disk - apparently the CD layer had been subject to some peak compression / processing compared to the SACD layer. I suspect this was done to make SACD layer sound better than it really is. Result - one lost customer for SACD!

I do not want to spend my hard earned money on software the record company has made sound worse! (They already do that without even trying...) I have always been dissatisfied with the quality of most of the recordings on CDs (I mostly listen to 70s and 80s rock/pop). I used to think it was the fault of the medium itself but this is not the case. If you want to see what a difference a proper remastering can make, have a listen to Bee Gees' 'Their Greatest Hits THE RECORD' (Polydor HDCD) which sounds superb despite having some very old recordings and shows what the medium is capable of.

Can you please find out more about the CD layers of the SACD disks that are available? I suspect the Dark Side of the Moon is not an isolated case...

Dr. K Fonseka
Australia

Will do - meanwhile, any readers' experiences with the new DSOTM SACD will be most welcome. Unfortunately, I've just found that my original 1974 Japanese vinyl pressing

Sevenoaks SOUND & VISION



Spectacular Offers
Only On The
Sevenoaks Website
www.ssav.com

SAVE UP TO

50%

OFF ORIGINAL SELLING PRICE

Hundreds of Bargains

AVAILABLE FROM OUR 48 OUTLETS NATIONWIDE

Special Buys ✓ Overstocks ✓ Ex-Display ✓ End Of Line ✓ And Much More - All Fully Guaranteed

Log on to www.ssav.com and click on [Special Offers](#)

REAL STORES

REAL PEOPLE

REAL PRODUCTS

REAL SAVINGS

48 Outlets Nationwide

Bedford • Birmingham • Brighton • Bristol • Bromley • Cambridge • Cardiff • Chelsea
Cheltenham • Crawley • Croydon • Edinburgh • Epsom • Exeter • Glasgow • Guildford • Holborn
Hull • Ipswich • Kingston • Leicester • Leeds • Lincoln • Liverpool • Maidstone • Manchester
Newcastle • Norwich • Nottingham • Oxford • Peterborough • Plymouth • Poole • Preston • Reading
Sevenoaks • Sheffield • Solihull • Southampton • Southgate • Swansea • Swindon • Swiss Cottage
Tunbridge Wells • Watford • Witham (Essex) • Wolverhampton

New Outlets Now Open

We are delighted to announce that we have opened new stores in the following locations:
Poole 01202 671677 • Solihull 0121 733 3727 • Swindon 01793 610992
Wolverhampton 01902 312225.

Please Note: These stores are not currently available on our Freephone number.

Call Freephone 0800 587 9909



CD PLAYERS

AMPLIFIERS

SPEAKERS

TUNERS

DVD

RECEIVERS

RECORDERS

LCD TV

PLASMA

PROJECTORS

AND MORE

Why risk virtual shopping when there's a **REAL STORE** nearby?

of this great album, played on a Michell Orbe/OL Illustrious/Ortofon Kontrapunkt B and recorded into my PC via Cool Edit Pro then burned on to a 20p CD-R sounds better than both the CD and SACD layers of this new release... And my friend RJ – who knows nothing about hi-fi but loves the album – noticed too! Hmm.

Oh well, you mustn't be too cynical. I do actually think the Floyd SACD project is very commendable. In the absence of investing in any decent new bands, the music biz might as well do thoughtful re-releases such as this – instead of the cynical 'cash in' jobs they did first time around with CD. Enjoy this issue's World Music Supplement. **DP**

NAIMS TO CONJURE WITH

Several months ago you suggested that if you had the cash there was no point in "faffing about" with Naim's lesser amplifiers... Buy a NAP250 straight off. I would like to illustrate. Recently the bass drivers of my £2,000 thirteen year old loudspeakers gave up the ghost due to rubber suspension rot, so I was kindly loaned a pair of £200 speakers during the repair period. The move backwards was akin to swapping my Lingo mkII LP12 for a Rega 2 (as good as the 'speakers were, severe boredom soon set in).

In the meantime, instead of purchasing a Supercap as you suggested, I had the opportunity of getting a final production run olive green NAP250 at the sort of price you expect to pay for a seven or eight year old second-hand model. Well I have just put it – new and cold – into the system instead of my thoroughly warmed up and run in nine year old 180. The result? Bloody marvellous! More air, less grunge, better bass, better treble, even better timing and imaging well beyond the outer edges of those rather modest borrowed speakers. This leaves me with one major problem. Could I actually live with anything less than a set of 250s in a 5.1 system and will anything other than a NAV02 do?

Nigel Briggs

I think you've answered that one yourself, Nigel. I have to say that there's something about the NAP250 that really floats my boat. It's one of those transistor amps that – even if you don't like transistor amps – makes you get into the music with relish. It's a truly characterful classic.

DP

GENIUS MOVE?

If Sony used the Blu-Ray recording technology in a double-sided mini-disc-

sized product, they could get around 12GB on a single disk – meaning two-layer playback only discs could give around 24GB. Wouldn't this be great for a home audio/video recorder, giving around five hours of SACD stereo for archiving LPs., about 50 CDs (without lossy compression) for jukebox/SAMD portable use, over three hours of high resolution video recording and, of course, backwards compatibility with MiniDisc. After all, one the problems with CD/DVD, is that it's just not compact enough – especially for portable use – and it's not very robust, so a high capacity, MD-sized product that comes as standard in a caddy sounds ideal. But then this is too obvious a wishlist to come true, even if the technology's more or less in place for high-end consumer products at least. If Sony was hedging its bets, it could even make the audio/video recorder a universal SACD/DVDA product, and really worry a lot of the competitors ...

**James Morrow
Belfast**

Agreed. MD is an ideal sized format – compact yet far more robust than CD. If it was made 'high density' (MD HD?) using Blu-Ray, it would be mightily handy... Lets hope Sony Japan hasn't forgotten to renew its subscription to Hi-Fi World – otherwise they'll miss this great idea... **DP**

Philips designed CD from the outset to work with small 8cm discs as well as large 12cm discs. That's why all players have depressions in their disc trays. At last 8cm CDRs are appearing in UK stores, holding a useful 210MB. I love 'em; they are much easier to handle and store than ordinary CDs. We now need 8cm CD-RWs so data can be 'dragged and dropped' to formatted discs.

Philips are very aware 12cm CD lacked true portability and already have a small Blue Ray disc working, so we can expect mini-Blue Ray from the outset. The discs will be in caddies because the shorter wavelength laser light is upset by scratches. **NK**

TABLE TROUBLE

My turntable is playing slow and making a kind of scraping noise, as if the platter is fouling on something. A new belt has made no difference, so it seems that the reduced speed is directly due to the 'scraping'. I have sent queries out via email to people in Germany, Canada and the US and received various replies as to what to do. The guy in Germany wanted to send me a new DC motor, the guy in the States said it wouldn't be the motor and that a bearing fault

(which was my guess) was unlikely, while the guy in Canada said I just needed to play with some of the sub-assembly screws under the platter.

Having had the turntable to bits (not completely – just enough to try and see what's going on), I remain totally confused as to what is up with it. I'd like to get it serviced by someone who knows what they're doing, but the only person I've found locally wanted to do a complete strip down and rebuild (at a price higher than what I paid for the unit brand new!). I've tried in vain to find anybody in the UK who deals with or services Dual turntables, let alone in my area (Plymouth). Could you possibly help?

**Paul Slater
Devon**

The vital bit of information is missing here – the model number of your deck! If you are running a '505 type deck, to be truthful, it is simply time to buy something else. Both the bearing and motor can cause these problems. Do make sure the platter is correctly located on the bearing, because this can cause similar problems to what you describe. A new motor or bearing would make the deck uneconomical to fix. There is currently nobody in the UK offering a refurbishment service on Dual decks. As good as they are, they were budget items. **HB**

The only thing I can think of is that it's the speed change pulley guide rubbing on the belt, with the platter amplifying the rubbing noise – my Sansui SR222 is doing precisely this and it sounds much worse than it actually is. If not, then I agree with Haden – I'd just buy a Rega P3. **DP**



Dual turntables; great in their day, but not worth a rebuild.

SURROUNDED!

My system comprises a Tag McLaren AV32R processor, Marantz CD6000KI, Rotel pre-power, Audioquest Indigo+ cable, Profigold PGA301 interconnects, Castle Harlech main speakers and Mission centre and rears. Could you please advise me on a suitable subwoofer? I would also appreciate your advice on upgrading my system in general. The size of my listening area is 15x12ft, with curtains on rear wall with concrete flooring. I have a budget of 2500Euros to upgrade, but can go a bit higher if needed.

**Chris Murphy,
Eire**

Although you state your listening area, you do not state the full size of the room! If you have two free corners, I would recommend you go for two REL Q150 subwoofers. This is more effective than going for say a single Q400 - much better spread of bass. Do not forget to wire up both the high level and low level connections. At the moment you are using a mix of differing loudspeakers, this is not to be recommended, the next step would be to look at a Castle Keep centre speaker, and say a set of Castle Richmonds for rears... this would restore more synergy to your system. **HB**

OLD PROG AND THE NORTH

Do you know what happened to MVL Technology? I have recently bought an ex-demonstration MVL A2+ integral amplifier. It is wonderful, however I cannot seem to contact or find any information about the company. My suspicion is that they have gone into liquidation. I am a little concerned as to what I should do, should anything go wrong with it, as it is full of unique patented circuitry.

Secondly, could you suggest a pair of reasonably priced floorstanders to partner with my system? My present loudspeakers are unknown to all but those who used to frequent the shows in the late nineties - Acoustic Solutions Model Eights. They are great for jazz, folk, female vocals etc., and I want something that will handle my old prog rock albums too. The Model Eights lose out in the midrange when it comes to this genre. The rest of my gear is a Nottingham Analogue Spacedek and Musical Fidelity A3-2 CD player. Any help with these queries would be appreciated.

By the way David - it's really okay to like prog rock, you know... There's a lot of people who do. It would be nice to see you guys at World Towers put a system together to play it on.

**Steve Petch
The North**

If memory serves me correctly, the MVL A2+ turned in to the Aura range of amplifiers. I remember meeting the guy behind them at a show about fifteen years ago. It was a small MOSFET based design, and I do not think it would be a real challenge for someone to sort it out if it failed. However, it is not especially powerful, and I would suggest an easier, rather than harder load. Start with something like the Acoustic Energy EVO III speakers, they should suit it very well. As good and open as the little amp is, most modern speakers will cause it some difficulties, and I would not advise anything too demanding, so the EVO IIIs would be perfect. **HB**

Hi Steve - I know it's okay to like prog, it's just my strict 'new wave' upbringing that still gives me a subconscious and irrational(?) disdain for this worthy and creative avenue of musical and artistic expressionism. Let me share something with you - I too own vinyl copies of both 'A Trick of the Tail' and 'Going for the One'. Do you forgive me now? However, just the merest hint of ELP's 'Brain Salad Surgery' sends me into paroxysms of pain so intense that I'd rather listen to Vagon poetry - twice. Sure, we'll do a 'prog fi' feature for you, but give me a few months to psyche myself up to it first... **DP**

How about Flight of the Rat - or is that non-prog Rock? **NK**

THE MATRIX, DECODED...

I was intrigued to read your reports of your efforts to play quad LPs in the July issue, because, as a committed multichannel music fan, I have been conducting similar experiments myself. I have a quad cartridge (a Sontra Excel 500EX4 bought new from an item in Hi-Fi World a few years ago) but no quad decoder - they never seem to turn up second hand - so instead I have tried using my Dolby Surround analogue processor (Yamaha DSP-E492) with a number of quad-compatible albums yielded by a trawl through my LP collection.

One of the DSP modes, called "Concert Hall", seems to give the best results using EMI SQ discs. This mode has no centre channel and seems to sound better if the subwoofer is zeroed out. I have a number of classical LPs of which the jewels are some of the famous English-language Reginald Goodall recordings of Wagner's Ring Cycle. If I can enjoy without fatigue all five hours plus of the 6 LP set of "Twilight of the Gods" I think this setup must be doing something right!

Otherwise the results can be somewhat mixed but are always interesting.

However, further thought led me to consider another possibility, what about original soundtrack albums recorded in Dolby Surround? As far as I know virtually any OST CD from 1980 onwards is Dolby Surround encoded and so can be used as a source of multichannel sounds, so why not LPs? There should not be any compromise due to not having the correct decoder. My results seem to bear this out as for example "Siesta" by Miles Davis sounds terrific when the output from my EAR834P phono stage (fed this time by a stereo cartridge) is hooked up to the Dolby decoder (to give 5.1 rather than 4.0 channels). Now the sound surpasses anything I have been able to get from quad LPs. So, although quad might have gone down in history as the industry's greatest fiasco, the potential for genuine surround sound from vinyl lives on (provided you can find an OST LP recorded after the late 70s that is).

**Jim Taylor
London**

It is with no small degree of pride that I did my quadrasonic feature - and the response has been amazing. So many people are now telling me how they too have gone the way of The Matrix (surround, that is) and got into 4.0. I think there's an immutable logic to quad - after all, if two is 'twice as nice', then four is 'four real', is it not? I duly claim the mantle of 'the quadfather', and my place in history. Oh, and I'm probably the only hi-fi magazine editor who - after a spell living with 24/192 DVD - has actually gone back to 14bit 4times oversampling in the guise of Meridian's MCD Pro. Nurse!

DP

I use a Yamaha DSP-e492 - one of the back page £50 bargains! However I must say I am less impressed with the various surround modes compared to yourself - the Yamaha does actually use DSP rather than an analogue pro-logic decoder. Although this does back-up some work I have just been doing with a Marantz SR6300 with built-in circle surround decoder, as I have had some very impressive results! Like you say Jim, getting the vinyl will be the hard part! **HB**

You all might be interested in Denon's latest surround-sound receiver, the AVR-2803, which has an LP input (yes, onboard phono stage) and Dolby Pro Logic II as well as standard matrix decoding. Stereo converts to plausible surround-sound

through Pro Logic II and both QS and SQ matrix Quadraphonic discs should sound interesting too. I will be reviewing it soon. **NK**

THE RIGHT PROFILE?

I've been using my Ortofon Kontrapunkt B cartridge for the last 15 months fairly regularly (attached to a Project Perspective/Project 9 combination) and something I've noticed recently is that if I place the stylus in a 'non groove' area, it leaves a noticeable mark. These marks (or scratches) are quite distinctive. The cartridge is set at 2.2g, which is the minimum recommended weight. Is the stylus causing any damage in the grooves of my precious records? It doesn't sound worn.

Marky P.

It is true that every time you play a record there is some degradation of the surface. Luckily, what you are noticing is just the very fine tip which will leave a mark. If you work out just how small the profile is, even at 2 grams it is several tonnes per square inch! Rest assured I have LPs and singles from when I was now't but a lad, and they still play fine! **HB**

STRIKE UP THE BAND

After reading and trying to decipher Noel Keywood's comments, I still feel bemused that someone could be so inconsistent in a reply! Let me explain - no offence, Noel!

If we start at the beginning, with the original recording (before it gets into the electronics), we have instruments and voices that have specific harmonic spectrums. These harmonics provide the character of each instrument with differences between each type of instrument and variants of the same made in a different way. With CD, these harmonics are chopped off just outside the audio bandwidth, thereby (for most circumstances) changing the character of the original sound to something that is just perceivable, a violin for example when played through a CD source can sound brittle and hard. If you now change the source to DVD-A, the harmonic spectrum is increased from the improved bandwidth, thereby increasing the amount of harmonics. This improvement is relative (of course) to the level of sampling rate applied and thus you hear an improvement in the overall sound with an increase in the ability to hear the different instruments and variants thereof.

As with the measurements that NK does with his spectrum analyser, the harmonics can be clearly seen and verified. For example a 1kHz signal produces harmonics at 2k, 3k, 4k and so on, if we increase this by a factor of

10, then we get 10k, 20k, 30k, 40k. As you can see with this simple test, the 10k signal extends far beyond the capabilities of CD. It must be explained here, that these harmonics are not identical in level nor are they consistent with different instruments, as the levels of these harmonics dictate the instrument's character.

Now apart from the increase in bandwidth, we have to also consider the increase in accuracy. With CD the bit count is 16 bits, with DVD-A it is up to 24bits, when you put the both together you get a result from DVD-A that are greatly in excess of CD with all the benefits of a low noise background.

Theory aside, it must be also known that all DVD-As are not recorded the same, some vary this rate away from the ideal, currently we have 48k (24k bandwidth), 88k (44k bandwidth), 96k (48k bandwidth) and 192k (96k bandwidth).

With SACD, the bandwidth of the recording is not reliably known as we do not have any form of indication whether its playing a CD or SACD. This not only leads to further confusion but also a large cloud over the head of SACD of whether it really can deliver the goods. In my opinion, DVD-A rules having heard recordings from both sides of the fence.

Chris Found
"Design Consultant"
London.

I am not certain what 'inconsistency' you are alluding to. You appear to be saying that SACD is inferior to DVD, in measured and sonic terms and that it perhaps cannot sound good (as I have said). However, there's a little more to this argument than bandwidth extension and the reproduction of extended harmonics. SACD uses a more elegant digital conversion scheme than the PCM of DVD and it is certainly very linear. Even though SACD suffers out-of-band noise, which swamps harmonics above 20kHz, most listeners feel SACD has a lovely, full, mellow sound - and I share that view. Simple theory and measurement don't always give the answers expected, as we have found out with valves versus transistors. **NK**

MAD BUG STRIKES!

I have just been re-infected by the hi-fi upgrade bug after a ten year long spell of immunity! A couple of weeks ago I came across a bargain that I could not resist - I exchanged my Musical fidelity X-Ray (plus some money) for a Jadis JD3 Deluxe CD player. It was designed as a transport but it has an on board DAC plus

valves. This player is amazing compared to the X-Ray. The soundstage is more controlled and open plus with an added deep well-defined bass. Most of the instruments and vocals now seem to have fallen into their right positions. So as you can understand this player made a big impression on me. I am now interested to upgrade the rest of my system but there are so many choices out there in the jungle of hi-fi. I am therefore seeking some advice from your expertise.

So my current system consists of Jadis CD player, Musical Fidelity NuVista preamp plus matching X-A50 monoblocks, Silk interconnects, QED XT400 speaker cable and a pair of Snell Acoustics EII plus AVI Biggatron speakers. So at what end should I start to achieve further improvements? I would be very grateful for any advice that you can offer. I also have a query about valves. The Jadis is fitted with a pair of Golden Dragon 12AU7 (E8CC) valves. Will I achieve further improvements by changing them? If so, are there any that you can suggest? Or is this just a touch of madness?

Regards Andreas

Without doubt the weakest part of your system would be the little XA-50 monoblocks. As sweet as they are, they are clearly lacking compared to your source. No budget is given here, so again it is hard to be specific, but a decent valve power amplifier would really transform your system further. Why not try the Croft Twin Star reviewed in this issue, which would work superbly with any of your speakers. Upgrading valves can be a tricky business. All tubes do not sound the same, so try and find some new old stock European made ECC82 / 12AU7 valves. **HB**

A thermionic valve, yesterday...



"...the best tonearm I've heard to date..."

Hi-Fi World 2003 on Illustrious Tonearm

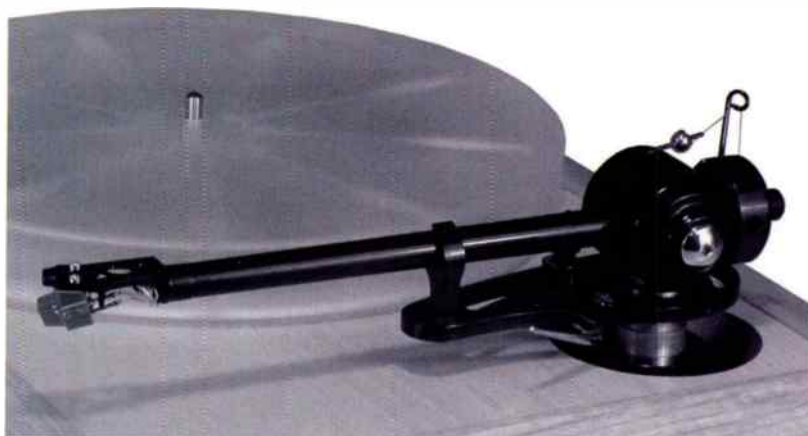

Origin Live Tonearms

"There may be better value propositions around to upgrade your system but if there is I haven't heard them....I fully anticipate this product remaining at the heart of my system for many years to come. A fantastic product then from Origin Live and this particular audiophiles dream review tool."

TNT Audio 2002 on Silver Tonearm

"The highest of recommendations for the Encounter tonearm: a new benchmark for musical communication, natural detail and timbral truth."

Paul Szabady, Stereo Times 2003 on Encounter Tonearm

"Brilliantly detailed yet utterly musical, this arm is set to join the all time greats. Wholeheartedly recommended."

Hi-Fi World 2003 on Illustrious Tonearm

Very occasionally new products appear that are so advanced as to render all previous benchmarks obsolete. People believe our new range of tonearms are just such products and we invite you to experience an unprecedented leap in your system performance - regardless of your tonearm. Arrange for an audition now.

Silver Tonearm £599

Encounter Tonearm £970

Illustrious Tonearm £1570

Illustrious Signature Tonearm £2500

All products carry a full no risk money back guarantee and are available via your nearest Origin Live dealer or by direct mail order.

Origin Live, Unit 5, 362b Spring Road, Sholing, Southampton, SO19 2PB
tel/fax: +44 (0) 2380 578877

www.originlive.com



the AUDIO.VISUAL Lounge

see hear believe.

STOCKISTS OF
AVID
ANATEK
ANTONY GALLO
B&W
CHORD ELECTRONICS
DALI
KEF
NORDOST
PRIMARE
REL
TANNOY
VDH

Specialist in audio and visual entertainment systems from the world's best manufacturer's

STOCKISTS OF
HARMON KARDON
MONITOR AUDIO
NAD
ORTOFON
PRIMARE
PRO-AC
PRO-JECT
ROKSAN
REGA
SME
VIENNA ACOUSTICS

Musical Fidelity Tri-Vista - full range in Stock



E: info@theavlounge.com T: 020 73753691 F: 020 73771756
Opening times: Mon-Fri 10.30 to 6.00 Sat-Sun 11.00 to 5.00
A: 135-137 Commercial Street, Spitalfields, London, E1 6BJ, UK

The Studio

Hi-Fi and Home Entertainment Consultants

"Music without the Madness"

Specialist in Naim, with complete Audio range on demonstration. We also can provide all other forms of Home Entertainment and welcome the opportunity to discuss all your Audio-Visual requirements

Contact: Peter or Ted

28 Aylmer Parade
Aylmer Road
Haringey
London
N2 0PE

Phone: 020 8348 0990
Fax: 020 8348 0990
Email: pwbc@dial.pipex.com
Website: thenaimshop.dsl.pipex.com



On the up?



Arcam's brand new CD33T is the first of its new generation of upsampling CD players. Chris Parker scales its dizzy heights...

Making high quality products in large quantities is a tricky road to tread, and few British brands do it as well as Arcam. The company produces a comprehensive range of affordable entry-level hi-fi, yet also manufactures some of the most highly respected and best sounding high-end AV equipment in the world. It's this that assures Arcam its position as one of Britain's foremost manufacturers.

The launch of the 'high end' FMJ range a couple of years ago pushed the brand upmarket, offering style and build quality hitherto unavailable from the more affordable Alpha range. No other product in the Arcam stable demonstrated this so well as the FMJ CD23 CD player. A genetic descendant of the hitherto top-of-the-range Alpha 9, here was a Compact Disc player that rivalled and often bettered the established reference products at the price. The FMJ CD33T you see before you is its replacement, seeking to better it by the introduction of a raft of new technology.

At £1,300, it's a little more expensive than the final derivative of the outgoing CD23, but first impressions are good. It's incredibly solid, without going down the Japanese battleship road which I regard as wilful overkill. What obviously sets it apart from the rest of the Arcam range and its

predecessor is the legend on the disc drawer, which reads '24 bit/192 kHz Upsampling Technology'.

The CD23 used 'Ring DAC' technology, passed on from the Alpha 9 player. A highly respected and advanced process, it was also very sophisticated for the time and sounded very fine indeed. However, five years down the road, Arcam claims to have found a superior technology that raises the sound stakes higher still. To wit, inside the box we have four examples of British-based Wolfson's finest. This company has made a good name for itself as a top class manufacturer of component chips and Arcam was one of the first to recognise this, featuring the 24/192 Wolfson multibit Delta Sigma DACs in its DV27 and DV88+ DVD players. Well, they're here too! No fewer than four WM8740 DACs per channel are used in the CD33T. Using them in this way is said to tighten tolerances by signal averaging throughout all four DACs.

Working in conjunction with multiDAC circuit is a digital upsampling stage, claimed to wring extra detail and depth from the old 16bit digital war horse! The 16bit/44.1kHz CD information is upsampled to 192kHz using a sophisticated filtering system and sampling device. Because the DACs are being used at full oversampling, a more relaxed (anti-aliasing) filter can be used, which aims for a smoother and

more natural sounding top end. Like all Arcam 'T' models, it uses a Sony transport (with CD text compatibility) and a high stability master clock oscillator claimed to deliver very low jitter, thus improving imaging and instrument placement.

In addition to the aforementioned Wolfson DACs and upsampling, Arcam has upgraded the analogue output stage. The CD33T has a DC coupled output with low offset servo control – this aims to improve the player's bass response. The operational amplifiers are made by Analog Devices and Burr-Brown and the decoupling capacitors are high grade audiophile models by Stargate and Oscon. There are two separate and individually regulated power supplies – one each for the analogue and digital sections and dual power transformers are employed. A full Acousteel tri-laminate chassis is used, also seen in that most smooth and quietest of drives, the Lexus! Its superb anti-resonance properties makes the CD33T as acoustically dead as a doornail, there's no Big Ben-type ringing here!

SOUND QUALITY

Within seconds of slipping a silver disc into a well run in and warmed through Arcam CD33T, it was clear that it not only retains but builds on the many impressive traits of its illustrious predecessor. Essentially, here's a tonally warm and smooth sounding performer, yet one which



has real rhythmic alacrity. It's very engaging and musical, yet also manages to sound quite seductive at the same time.

Detailing is a particular forte. Put on a specialist audiophile disc such as the Reference Recordings version of Copland's Third Symphony, and the clarity is superb. Strings have real body and realistic presence. Percussion is spookily realistic and perhaps most impressive of all, the dynamics are excellent. The difference between pianissimo and fortissimo is explicit, and makes listening to the CD33T an incredibly involving experience. This piece has a fantastically wide frequency range and the Arcam used it to full effect, the highest triangle 'ping' being as clean as the lowest thump of the bass drum. Arcam haven't always been renowned for the full palette of tonal colour but the CD33T puts this theory to the wall, there's a fantastic array of timbre and colour available from this machine with the

right recording and music. Jazz discs such as Miles Davis's 'Sketches Of Spain' and some good ol' big band Sinatra fared well too. Miles' solemn trumpet wailed effectively and Sinatra's ever-impressive phrasing and timing was a joy – but then it would be through a five quid transistor radio! The CD33T just added to the natural enjoyment and made it more involving.

Moving on to Radiohead's 'The Bends' and its much drier, studio style sound, the CD33T gave an appropriately crisp but highly detailed account of the disc. Imaging was pinpoint and the mix was projected out across the room with breadth and focus. Bass was taut and precise, while Thom Yorke's plaintive voice was very clean and detailed. The Arcam has a nicely forward way with vocals and midrange in general. It's not smacked straight into your face but is attention grabbing without being intrusive and aggressive. Sibilance is fairly low yet the player has a fast and rhythmic sound when necessary. Bass is very impressive – deep and tuneful. The faster and heavier tracks on the album

delivered a full sound with an especially impressive grip on the drums and bass, really driving the tracks along. This is another aspect of the sound that goes against most people's perceptions of Arcam. The CD33T can rock with the best of them.

My only reservation was that it lacks the last ounce of sweetness in the upper treble. There's certainly oodles of air and space, but it doesn't quite give the sense of effortless extension, to which some equivalently priced designs, such as Meridian's 507 can allude. Still, it's a most capable design in absolute terms. Put up against Marantz's £3,500 SA12 SACD (and DVD) player, the Arcam proved most impressive. Despite costing nearly three times the price, the Marantz only comprehensively beat the Arcam in terms of soundstaging and depth perspective. Facing off Sony's equivalently priced SCD-555ES SACD player, the new Arcam proved altogether more sophisticated sounding, albeit just a tad slower and less propulsive.

Overall then, I'd say it's Arcam's very best CD spinner so far. If you are in the market for a player that will make the most of your existing CD collection and last you well into the twilight of that format's years, then this is an essential audition.



MEASURED PERFORMANCE

The CD33T turns in a clean set of results, very low distortion at all levels helping greatly toward a high EIAJ dynamic range value of -110dB. The player is linear and up with the best in this respect. Arcam have moved toward a slightly brighter sound balance by the look of things, frequency response running out flat to a high value of 20.7kHz before plunging steeply due to anti-alias filtering. This is unlike earlier Arcam filter responses, with rounded off upper treble that led to a soft-ish sound. With low noise, good channel separation and normal output at 2.2V the new CD33T turns in a clean set of figures. NK

Frequency response	4Hz-20.7kHz	
Distortion	left	right
-6dB	0.005	0.006
-30dB	0.006	0.006
-60dB	0.33	0.32
-90dB dithered	1.38	1.36

Separation	left	right
1kHz	112	114
20kHz	96	102
Noise (IEC A)	-115dB	
Dynamic range	110dB	
Output	2.2V	

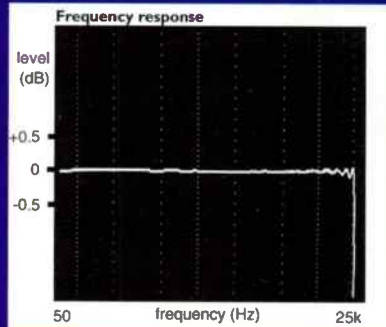

CAMBRIDGE - THE RIVALS

The Arcam CD33T's two closest rivals are all made within a few miles of one another, in Cambridge's hi-fi 'Silicon Valley' of Huntingdon. So how does it compare to the best of the rest?

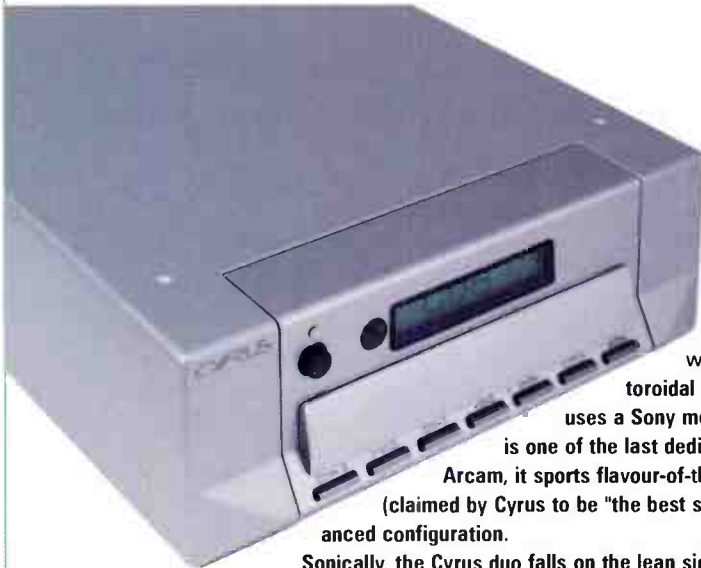

CYRUS CD8/PSX-R £1,350

This brand new two box Cyrus player is essentially the basic £1,000 CD8 upgraded by the addition of a £350 PSX-R.

Meticulous attention is paid to power supplies, with twin low noise toroidal transformers squeezed into the CD8's case, working in conjunction with the massive toroidal inside the PSX-R.

Unlike the Arcam, which uses a Sony mech, the CD8's triple beam laser mechanism is one of the last dedicated Philips CD player transports. Like the Arcam, it sports flavour-of-the-month Wolfson digital convertors (claimed by Cyrus to be "the best sounding 24-bit ICs available"), in dual balanced configuration.

Sonically, the Cyrus duo falls on the lean side of the Arcam. It has a rising high treble, which can add quite a lot of incision to discs with a lot of high frequency content – such as ride cymbals. This, allied to its brilliantly detailed and grippy bass and midband, makes for an 'electric' listening experience. You'll find yourself on the edge of your seat, locked into the rhythms of the music, amazed at just how much detail a humble old 16bit CD can throw out. It's a truly gifted CD spinner, but definitely something of an acquired taste. It's not quite into Naim CD5 territory, but it's getting that way. By contrast, the Arcam is an altogether more relaxed and sumptuous listen.

MERIDIAN 507

£1,195

This has been on sale for the best part of the year, and is a quintessential Meridian product. Whereas Arcam has changed its look several times in the past decade, the 507 looks like the previous model, which looked like the one before that, and so on. This manufacturer is not prone to sudden change for change's sake, and has a very strong brand identity. The 507 is superbly made, and although it looks 'different' to your average Japanese black (nee silver) box, it's not quite as dashing as the Cyrus's two box package, or the Arcam's clean modern lines. Once again, the obligatory 24bit, 192kHz DACs are featured, but here a CD-ROM drive is featured - carefully tweaked to keep jitter to very low levels using double buffering found in the more high end Meridian designs. Considering its diminutive dimensions, it's a heavy bit of kit and beautifully finished - bar the flimsy, plasticky computer CD drive type disc tray.

It sounds smoother and more beguiling than even the already well mannered Arcam CD33T. As such, the Arcam sits firmly in the middle of this Huntingdon threesome, with the Meridian sweet and the Cyrus bright. A deliciously beguiling midband with expansive soundstaging, great sense of perspective and wide, boldly carried left-to-right imaging characterises this player. It's sweeter up top than the Arcam, and looser and warmer down in the bass. Midband is less explicitly detailed, yet no less enjoyable. Even in Huntingdon you pays your money and takes your choice!



VERDICT ●●●●● £

Superbly detailed midband allied to excellent bass extension makes this a powerfully musical machine.

ARCAM CD33T £1,300

ARCAM LTD

+44 (0)1223 203203

Table Talk



L.J.K. Setright debates two portable radio propositions, Tivoli Audio's analogue Model One and Pure's digital Evoke-1.

Decisions! Are we doomed never to be free from them? Here are two radios. Here, to be fair to them, are two little radios: they are not tuners such as you should incorporate into the magnificent array of musical instruments which fills the end wall of your sumptuous drawing-room with apparatus and fills the air with music. These are radios which are destined to be parked on your desk, on a kitchen worktop, on a passing whim.

In many respects they are very similar. Each has a single little speaker, about three inches in diameter. Each is housed in a stylish little wooden box, coloured or veneered according to taste. Each reminds me of that lovely Arabic proverb 'If thy wife be small, stoop down that she may whisper into your ear': neither of them would

make enough noise to alarm a dog on a quiet night. Each provides a headphone socket for those of us not blest with sumptuous drawing rooms but anxious to savour the true delights of radio. Each of them costs more than one might expect, but less than might be paid for anything better.

The similarities present no problems: they declare where we stand. The differences are fundamental: each is a manifesto, a statement of ambition, to be regarded as warily as anything that might be uttered by a politician or a painter. Even in their marketing these two differ: the Tivoli comes in a box bearing a couple of pictures of bespectacled men, middle-aged intellectuals, relieved (out of perceived necessity, one suspects, rather than real conviction) by a couple of pictures of ladies who look unlikely to be attracted to either of

the gentlemen. The Pure Evoke-1 (hereinafter the Evoke) box is all bold bright colours and crowded type, with a picture of the radio set against a hazy background of toast and kitchen glassware.

The styling of these radios is similarly polarised. There is a severe and sober elegance about the Tivoli, a vaunting of its supposed purity implied in the visual impact of that one large low-geared and precisely calibrated tuning knob. Should you care for this primness, little could be more shocking than the pert vernacular of the Evoke, which takes the blond-wood-and-brushed-aluminium style of current domestic fashion and somehow makes it all look like polystyrene, with an electric-blue display of flickering electronic digits and a host of buttons to suggest that its soul is compounded entirely of binary codes. The Evoke is for those who

want to be, or at least to be seen as, devoted to modernity.

This is where we have to start making choices. The Tivoli is calculated to appeal to our sense of the proprieties: we are invited to recall and to relish the simple unadulterated truths of analogue radio, shorn of all the complexities and razzmatazz that have been superimposed on those basic truths for so long that most of us have forgotten what bliss it was in that dawn to be alive. There are, as the brochure inside the box urges us, alternative versions with stereo circuitry and a separate additional stereo speaker, even an infant subwoofer, and a CD player for those who like that sort of things. Nevertheless, it is clear that the makers would have us believe in the religious purity of radio that is not only strictly analogue but also puritanically mono, would have us present ourselves to our visitors as people of pinnickety rectitude and perspicacious discernment.

The Evoke, as it stands, only makes mono sound, but its circuitry processes stereo signals, available forthwith through the headphone socket (if you have and will use good headphones, the Evoke is the better bet) or, by extension of purchase, through a little matching stereo speaker similarly ported through the bottom of its housing. It is a cooler sound than that of the slightly warm-toned Tivoli, but does not improve with use; the Tivoli was biscuit-tin horrid out of the box, but needed only a couple of hours to reach what seems to be its optimum.

The supreme difference, it would seem, is that the Evoke is a digital radio, and therefore a DAB hand at doing what the young and forward-thinking would have us believe should be done. People with strong convictions, either way, might be forgiven for hesitating no further.

What, though, is the real issue here? Is it the validity of mono sound? Is it the fatuity of baby-voiced radios? Is it the tastefulness of appearances, remembering that there is no argument about taste since people of taste are agreed about what is distasteful? Is it perhaps a deep-seated social confrontation between Biedermayer isolation and street-creed vulgarity? Or is it just an argument about analogue or digital processing?

There is a valid case to be made, on behalf of those whose real interest is in music, for mono sound. There is also a case to be made, by those whose interest is in the sound

of music, for stereo. I find it hard to agree that there can be more than two or three exceptions to the general rule that more than two channels must be deplorable, but only when I have a couple of pages to spare will I venture deeper into that argument.

As to the fatuity of baby radios, such as these really are, let us not fool ourselves that baby radios are for serious concentrated listening, or that we never listen to the radio except seriously and in utter concentration. There is a place in almost every home, office, shop, building site, hospital or penitentiary, for radios such as these, and we should rejoice that we can fill that place with radios as good as these.

Appearances? By all means look at what you like to see, and avert your gaze from that which offends it; but what the devil does it matter otherwise? A radio is for hearing, not for seeing; the fact that style matters does not deny the underlying fact that styling is here irrelevant. Personally (and particularly with stereo equipment) I find it instinctive to sit with my back to the apparatus.

The clash between propriety and vulgarity is something that educationists and psychologists can debate until the cows come home. The cows nearest to me are fully two miles away, and would not find my premises at all homely, so I can confidently assert that there are very few exceptions to my general impression that all radio is vulgar. The supreme exception must be BBC Radio 3, a fainting echo of its glorious past and still being viciously dumbed-down by the politically

motivated, but still comfortingly elitist until about 9pm and still a paragon of signal-processing purity. Radio 4 is currently improving, and both of these channels are available in analogue and digital form. There is something to be said for Oneworld, which is exclusively digital, but the rest are sadly and commercially trashy; nor would I much fancy trawling through the murk of AM transmissions, though the Tivoli brings them in with surprising ease.

The final issue is like income tax: it cannot be rightly evaded, nor easily avoided. How do we choose between digital and analogue systems? The question has been aired enough, you think? While microphones and loudspeakers remain stubbornly analogue, digital processing makes everything between them easier for sound engineers and supposedly for us; if it cannot add anything, neither does it take away anything of value – except for that precious and enormously informative attack to each note, so that every semiquaver gives us a taste of the unreality of arriving without having travelled.

Maybe in the CD context digital processing cannot add anything; but that is not true of broadcasting. It enables the unscrupulous to do something theoretically illegal, which is to insert subliminal propaganda. So why does the government, which directly or indirectly controls all the broadcasting media, so busily and actively promote digital broadcasting? There must be a hidden agenda – and that, after all, is probably the real issue.



High Resolution



After numerous winning tonearms, Origin Live has now come up with something serious in the turntable department. The Resolution Modern is an unashamedly high-end design, brimming with trick technology and serious tweakery. Haden Boardman reports...

O rigin Live has been crafting serious vinyl-related products for many years now, and has achieved notable success with its Rega-based arms and modifications. Latterly, the Illustrious – which shares nothing with the famed RB300 – has proved a big hit with *Hi-Fi World*, and we believe it to be one of the very best tonearms currently available.

The man behind the company is Mark Baker, who also does all the design work. He clearly has strong views in his engineering philosophy – he isn't a fan of the high mass approach, nor the ultra low mass! Rather, he deliberately sails straight down the middle. Mark seems to understand that there is no "true"

way to turntable design, correctly pointing out that good design should be a balance between several needs and wants, and that by championing just one area of performance, another area will undoubtedly be compromised.

This range-topping combo of Illustrious arm and Resolution turntable is the pinnacle of his work. The deck itself is superbly finished, a gloss black base complete with dinky chrome feet and contrasting nicely with the chrome and black sub chassis, and the acrylic platter. I love the shape of the thing, to me it looks very 1950s!

It comes complete with onboard power supply, to drive the Resolution's formidable DC motor, which sits through the base and

straight on to your turntable shelf or support. The sub chassis sits on the base via three springs, although the majority of the weight is supported by just one spring. Each spring sits in its own little adjustable cup, and each spring is of a different strength. Set up was pretty straightforward, but it took a couple of attempts to get the subchassis sat level and square (do not dress the arm cable until you are happy the chassis is level), but it was not as hard as this had been suggested! The subchassis itself is an interesting device, it is actually designed to "flex" ever so slightly, and is carefully adjusted at the factory, with big warnings not to further tighten any of the screws! (Linn tight anyone?)

The small sub platter fits in to a

The powerful DC motor is mounted in its own housing, decoupled from the subchassis for superior sound...



very high quality bearing - a lot of effort has gone in to this vital area of the deck's performance. The belt fits around this and the motor. In use one does have to be careful about getting the belt tension correct, but more about that later. The main acrylic platter sits decoupled from this, and is quite light in weight. Most of the underside has been precision machined away, leaving a ring of mass towards the platter's perimeter.

The illustrious tonearm again breaks from the recent "norm" of one piece design. Mark Baker rightly points out this approach can actually cause as many problems as it cures, and by "breaking up" the arm, you also can control its resonant behaviour, and therefore the amount of sound colorations, in a much better manner. One thing that strikes you immediately is the size of the over sized bearing housing in which the arm sits - it is enormous! As in the case of the deck, fit and finish are very high. A very neat trick engineered in to the Resolution's arm base is a unique VTA (vertical tracking angle) adjustment. The arm sits in a perfectly machined collar, allowing it to slide up and down the deck arm mounting; it works a treat and is very neat. Normally "shims" would be used to adjust arm height, which is frankly a pain, and a waste of time. This is a very elegant solution, and made set up of the deck, so much easier.

It took a few attempts to get the deck set up so I was completely happy, but this was not difficult, and it really took no time at all. I fitted an Ortofon Kontrapunkt A cartridge (I know the B is a lot better, but none were available!) and was delighted to note the excellent setting of the arm's geometry. It took me less than five minutes to set up the cartridge; this was down to the excellent

accuracy between arm pivot point and spindle. With the user friendly VTA adjustment, final set up was an absolute doddle.

Final details concerned the location of the motor, and checking the speed with the supplied stroboscopic "photocopy"! Adjustment is via two small presets under the power supply case, easily done. The power supply itself is small, neat, and selects between 33 and 45 rpm. Despite me leaving the deck on, the case remained stone cold. The mains transformer is located in a separate enclosure, which is best positioned as far away as you can get it. Origin Live supplies a decent length of cable, and I found it possible to locate the thing in another room; it did hum just a wee bit! The deck was supplied with comprehensive instructions, which are a total necessity to set the deck up correctly. I did feel them a little lightweight and a little under nourished; more work needed here!

Setting the belt tension is perhaps the biggest gripe I have about the entire deck. It seemed to have more than a reasonable affect upon performance, and thus could not be ignored. Very simply, the motor moving independently from the deck can easily be set too far, or too close to the platter, with some slightly strange results. This was not helped by the Resolution's slippery feet; every time I cued a record, I ended up moving the deck in relation to the motor. In the end, I cheated, and used small amounts of Blu-tak to stop the thing from sliding about.

Overall, however, I was very impressed with the level of detail and expertise contained in both the arm and deck. Precision engineered, and beautifully executed; but as they say, the proof of the pudding is in the eating; at this kind of price point there is some pretty stiff

competition, like Michell's Orbe SE to name but one. Origin Live claims the combo to be an "ultimate" so just how does the sound stack up?

SOUND QUALITY

I still listen to around half my music on vinyl, and am a compulsive buyer of the black stuff. Popping the Origin Live combo in to my normal set up, replacing my Nottingham Analogue Hyperspace/ Space Arm (which have gone back to their maker for an update!) and Denon DL304 cartridge. The Nottingham Analogue deck offers a completely different philosophy on the turntable design; the top platter weighs more than the entire Origin Live deck, no DC motor, instead Tom Fletcher's "inertia drive" system (the motor simply tops up lost "inertia" from the platter) drives the deck, requiring the operator to literally push start it. The good thing about analogue, as was said before, there are no wrongs or rights, everything has an effect, a counter effect; it is like trying to square a circle, there are no absolutes.

From the instant it played the first track, it was clear the Origin Live was a completely different animal from the Nottingham offering. First album to hit the deck was Grace Jones' 'Island Life' - well you either love her or you hate her! 'La Vie en Rose' is one of those tracks that builds and builds, and on the wrong system, it can truly grate. It also happens to be one of my favourite tracks, and I am happy to report the Resolution/ Illustrious/ Kontrapunkt A did an amazing job. The presentation was different to what I was used to. On the positive side, it was much more laid back, the sound stage presented cleanly between the loudspeakers. A track

Origin Live Illustrious tonearm is a superb partner, both sonically and aesthetically, for this beautiful deck...



THE EDITOR SAYS:

It's become rather tiresome recommending Michell turntables of late – they've been head and shoulders above everything else, in my experience, and so I've had no option but to. It's great, then, when something like this comes along. I do not think it is better than its immediate price rival, the Orbe, but it is certainly different and not – on the whole – obviously inferior. Essentially, the Resolution has a smoother, sweeter, more beguiling and cohesive sound than the Orbe, which can justifiably be accused of sounding ever-so-slightly mechanical. By contrast, the Michell has altogether greater incision and grip, and a sense of unflappability, no matter what is thrown at it, that the OL lacks. However, the OL reminds me of a modern day LP12 without tears. It has few of that venerable deck's many weak points, and nearly all of its pluses. The Orbe pushes away by completely eliminating the LP12's bugbears, but does lose some of the Linn's innate musicality – the Resolution, however, does not. As such, it's a deliciously 'analogue' sounding tool that I'll be (happily) able to recommend to anyone striving for 'the magic of vinyl'.

DESIGN MATTERS

- piano black subchassis
- profiled acrylic platter
- platter de-coupled with an inert sub-platter
- highly specified bearing with military specification Arctic oil
- rigid sub-chassis with centre point support arrangement and damping devices
- high quality ironless DC motor with no cogging effect
- load compensating regulated power supply
- electronically switched speed control
- dimensions: 490x400x160mm
- weight: 9kg including arm

that can quite easily take your head off was almost easy listening. This was not to say there was any loss of detail, there was not, if anything the deck's ability to resolve those fine little details, was incredibly impressive. Flipping the album over to 'Private Life' on Side Two further reinforced this almost laid back character of the deck. Where on the previous track I had felt the Origin Live had bettered my Hyperspace, on this track, the NA offered the better deal. It was almost too laid back compared to what I was used to. Not by a massive margin you understand - we are talking degrees here, splitting hairs, but none the less it was 1:1 so far!

Changing beat, and another fave album, Massive Attack's 'Unfinished Sympathy' just shone on the Origin deck. Detailed, explicit, solid bass. One casual listener was simply amazed at this track. Again, comparing to the more expensive Nottingham deck, I found the bass if anything a trifle "warm" - almost caramel coated - but again I feel I am being somewhat unfair, as the deck

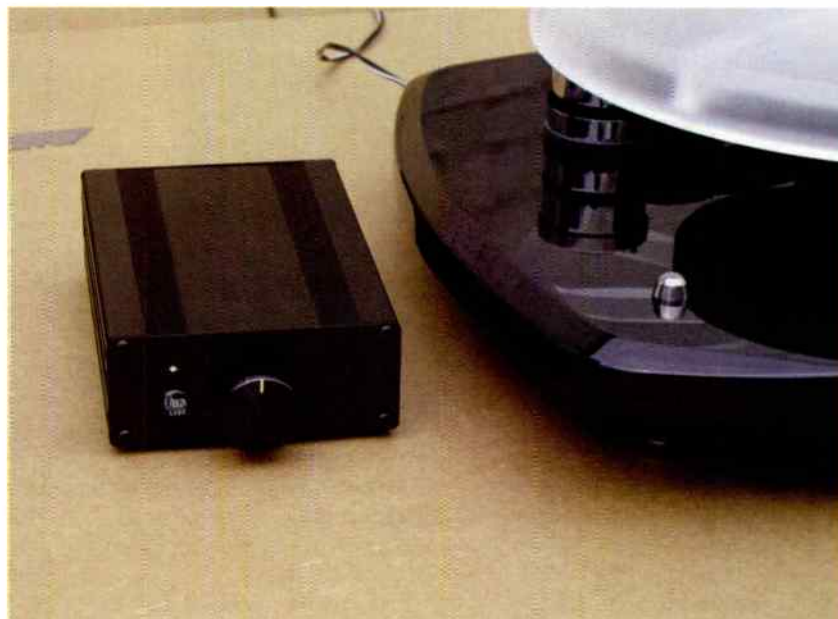

Offboard power supply can be kept a good distance away from the cartridge, and offers electronic speed change - no eighties-style 45RPM adaptors here!

sounded incredibly good, far better than its modest price tag would suggest. It was duly time for 'the Jimmy Smith torture track'... Plumbing straight in with 'Walk on the Wild Side', an

incredibly aggressive, almost over produced track with a massive orchestral intro before the Hammond and drums kick in, was an absolute show-stopper. On lesser designs, this track can simply take your head off, but not here. It was open, expansive and again easy listening. This deck seemed to have a way of softening aggressive tracks, without sacrificing detail. Some tracks which could grate like hell on my Notts deck, where more than listenable on here.

On the negative side, there were times when I felt the deck was too soft almost, and too warm. Lee Morgan's absolute classic 'Sidewinder' did not come across well. The double bass almost appeared smeared, and the high frequencies too repressed, almost as if held back and lacking in that last ounce of air. The deck's entire presentation was somewhat darker than what I was used to. Again, we are talking about degrees here, and not in absolute terms.

My other main criticism was background noise, which was higher than what I was used to. This was

not a major issue, but it was clearly coming from the motor and belt. I found the motor position almost hyper critical to getting the best from the deck. Too much belt tension resulted in a high level of background noise; too little resulted in smeared dynamics and a rather soft edge to the sonics.

In all fairness to the deck, I do feel like I am being somewhat over critical; this thing sells for the same kind of money as an LP12 or Michell Orbe. Frankly, it walks all over the LP12, and on balance, I much prefer the warmer presentation and outright listenability of the Origin Live deck over the Michell. Without doubt, the Resolution does have a slightly warm balance, but it is a very pleasant one. It is not bass heavy, or muddy sounding, and may even be bass light in the wrong system. The gilding of the lily is the illustrious arm. This I thought a wonderful piece of kit, detailed, smooth, and lacking in any kind of edge or drama.

As a combo the two work well. My only very minor gripes are those shiny feet, and the slightly high background noise. I was frankly surprised by the deck's performance; I truly enjoyed playing my records. It looks good, and it sounds good. Highly recommended as a first rate player of vinyl at the price point. I was impressed.

VERDICT ●●●●●

A beautifully crafted, superb sounding turntable that's a smoother and more beguiling alternative to the best of the rest.

ORIGIN LIVE RESOLUTION MODERN £1979
 ☎ +44 (0)2380 578877
 www.originlive.com

Garrard

A new tradition

David Price traces the history of Garrard turntables, and talks to Loricraft's Terry O'Sullivan about its future...

Analogue addicts have watched with interest of late, as Garrard - one of the most famous names in turntables - has been resurrected. Unlike the car industry however, where German giants have been buying up great British names at a pace, the marque has been taken over by a small specialist company that has built its business around servicing and maintaining these great decks - Loricraft Audio.



Early Garrard autochanger - rare!

Since acquiring the license to use the Garrard name, Terry O' Sullivan and Nigel Pearson have launched a brand new turntable - the 501 - and have just completed work on a second. Both are very much true to the spirit of the 'original' 301 and 401. They are manufactured in Lambourn, Wiltshire, which is very close to the original Garrard factory in Swindon.

The Garrard name can be traced back as far as 1721, when Garrard and Company was made responsible for the maintenance of the British Crown Jewels. It wasn't until 1914, however, that it was asked by the British government to manufacture precision range finders for the British Artillery. Thus was formed The

301 in superb Loricraft plinth.



Garrard Engineering and Manufacturing Company Ltd, of Willesden, London.

After the Great War had finished, Garrard reconfigured itself for peacetime production, and duly looked for new consumer manufacturing opportunities. They started making spring wound motors for the

emerging gramophone industry. Thus was born the first Garrard turntable part, the Number 1 Spring Wound Gramophone Motor.

In 1919, the company moved to Swindon, where there were

plenty of skilled engineering apprentices from the Great Western Railway Company. The motor found itself into turntables by Columbia, Decca, His Masters Voice, Lugton, Selecta, Coppock, Itonia and Thompson. The company soon went public to finance the expansion needed to meet the demand for spring motors, and in 1928 development started on electrical motors for gramophones, resulting in the belt drive motor called the Model E.

The very first Garrard gramophone was born in 1930, the Model 201. Used by the BBC amongst others, it also became very popular with hi-fi enthusiasts. Although originally designed just for 78rpm records, it was later modified to play the 33 1/3rpm, 16 inch records used in cinemas. The first record changer, the RC1, found its way into radiograms and Garrard started producing pickup arms for its decks.

After spending the war years producing clock mechanisms for military equipment, all links with Garrard and Company the Crown

Jewellers were severed, and The Garrard Engineering and Manufacturing Company Ltd. became a separate entity. A new record changer was rapidly developed - the Model TC30 of 1946. Two years later, the RC70 record changer was introduced to play the new ten and twelve inch 33 1/3rpm and seven inch 45rpm vinyl records, and the 'modern age' of Garrard turntables began.

The Garrard 301 turntable was launched in 1954, with a grease bearing and enamelled silver finish. The deck was soon relaunched with an oil bearing and an ivory white finish, and Garrard finally stopped its clock making. One of the first stereo pickups, the Model GCS10, was introduced, and the TPA twelve inch transcription pickup arm was launched in 1958, complete with



Birth of a legend - Garrard 201B.

height and stylus pressure adjustment, and a plug-in pick-up head.

In the same year, a serious factory fire occurred and production was restored with help from a local company, the Plessey Company Ltd., which loaned factory space. In 1960, Garrard finally became part of the Plessey Group of Companies as Garrard Engineering Ltd., and another factory was acquired in Swindon.

1965 was a big year for the company, with the launch of the Garrard 401 transcription turntable, which went on to achieve critical acclaim. Perhaps its most famous



Garrard 401 in latest Loricraft skeletal plinth...

product outside specialist hi-fi circles, the SP25, was also launched around this time. The Zero 100 automatic transcription table soon followed, with its revolutionary tangential tracking arm which won the company The Queen's Award.

By the mid-seventies, the SP25 was in its final Mark V incarnation, and the deck was practically ubiquitous in budget hi-fi systems, radiograms, music centres and 'record players'. A disco version, the Disco 80 was also produced. In 1975, Garrard's first direct drive player, the DD75, began production. The GT20, GT25 and GT35 mid-price



The mother of all motors... why Garrards have brilliant bass!

deck range was introduced, and soon after the 401 was discontinued, having sold over 50,000 units. A range of affordable direct drives using Garrard's own DD motor followed, comprising the DD 130, DD 131, and DD 132. In



Terry and Nigel's factory-fit sound system.

1979, Plessey sold Garrard to Gradiente Electronica of Brazil. A small development team led by the managing director, remained in Swindon until 1995, by which time the brand name had become largely moribund. In

Garrard Schroeder Reference Arm.



1997, Loricraft's Terry O'Sullivan opened discussions with Gradiente,

and obtained the licence to use the Garrard brand name. The new 501 turntable was launched in 2001, and promptly voted 'Best Classic Turntable' at the CES show in Las Vegas 2002. Although made by hand in far lower volumes, the 501 uses a similar design philosophy to the 301, but implemented in a far more modern way. A number of former Garrard employees were consulted during the design stage of the 501, in particular Brian Mortimer, the former head of Quality Control at the Swindon factory. Brian's father, the late Edmund (Monty) Mortimer was the head of research at Garrard, and so there is an unbroken link with Garrard's tradition of engineering and innovation.

The 501 uses a new bearing developed from (and interchangeable with) the original 301/401, and Garrard's own Aeroflux motor featuring a unique flying thrust bearing, its balanced rotor floating on air. This novel, patent pending design gives variable speed from 30-100rpm via Garrard's bespoke PSU2 power supply. A Loricraft plinth, which is widely acknowledged to be an effective 301/401 upgrade, completes the picture. A variety of finishes are offered, to customer order. The new 601 which recently won the

turntable of the year award in Germany in 2002, is described as "a logical alternative" to the 501 - with which it shares many parts.

Essentially replinthead version of the existing deck, it features fixed speeds of 33 1/3 and 45rpm, but full variable speed (including 66-92rpm) is available as an optional extra. It will be available for all SME arms including 10 and 12 inch types, and the Naim ARO.

This deck is also configurable for the Schroeder Garrard Reference Arm, which is the latest feather in the Garrard cap. Sourced, as its name suggests, from Frank Schroeder in Berlin, it sports a wooden arm tube. More than just homage to the long, lost Garrard Lab 80 turntable (which



Original Garrard rumble meter - 301 owners look away now!



Garrard Display Turntable - makes hens' teeth look plentiful...

also sported a similarly hewn arm), wood is used for its superb acoustic properties. Some types of wood, points out Nigel, approach carbon fibre in terms of lightness and stiffness, and have better natural damping properties.

GARRARD FACT FILE

- Because there were few electrical supply standards back in 1929, the Garrard Model E turntable could be used with AC and DC, 25-100Hz, and 50-250 Volts
- In 1961, Garrard developed a novel Magazine Tape Deck, but it failed as it was more cumbersome than the Philips Compact Cassette launched in 1963.
- The Lab 80 was launched in 1964 as the first 'transcription record changer' It had many unique adjustment features including a wooden arm.
- Terry O'Sullivan's engineer father was behind the Festival of Britain, Heathrow airport, Harold Wilson's attempt at the channel tunnel and the M4 motorway. Due to his cost-cutting when buying the road surfacing aggregate, he caused many cracked car windscreens, but - says Tel - famously 'didn't contradict' a then popular story that they were due to children shooting air pistols at passing cars...!

DAVID PRICE SPEAKS TO TERRY O'SULLIVAN

DP: WHAT'S YOUR BACKGROUND?

TS: "After leaving school, I went to the Brixton school of Building where I studied civil engineering, following in my father's footsteps. I first got into hi-fi in the late 1950s as a Saturday boy at Surbiton Park Radio, where I installed 301s in plinths using a padsaw to make the hole. I dreamed of one day owning a 301. In 1958 my parents bought me a Bush RP21 record player with a Garrard RC121 record changer, which I converted to stereo played through a Cossor stereo valve amp kit. I continued to lust after 301s, cycling to Stern Radio in Fleet Street just to look at them! In 1966, I bought a DT150 from Surbiton Park Radio on tick, followed by a Leak Stereo 30 and Wharfedale Super RS DD 10" making my own cabinets. I got fed up with the TD150 and bought a 401 direct from the factory in 1977, which I still have including an SME 3009 arm and Shure V15 cartridge.

HOW DID YOU GET THE GARRARD LICENCE?

In the nineteen eighties and nineties I worked for Tek Power Tools. As Tek was obviously in trouble, I used to visit Garrard engineering (experimental department) to sell them some power tools. Naturally, there wasn't so much business there, but I bought spare parts and got advice and gradually got their approval to approach Gradiante for the Garrard Licence. In doing this Garrard had ceased to exist in the UK. I think more than anything my insistence that Garrard shouldn't disappear got me the licence. I vowed to bring this company back. Loricraft was, and is,

superb level of craftsmanship explains those high prices...



Terry O'Sullivan.

my wife Lorraine's lace bobbin business, I started Loricraft Audio as we could use the same name which got it off the ground quicker.

WHY DO YOU THINK GARRARD'S SOUND SO GOOD?

They have more torque than other turntables they do not slow down or speed up due to stylus loading. They are direct drive turntables with the gear in between going from 1300rpm to 33 1/3rpm. The idler is very stiff compared to a belt, similar in function but not the same. Essentially, they are direct drives but do not have the cogging phenomenon of the typical DC direct drives.

Belt drive was conceived as a cheaper way of making respectable turntables, and even the best belt drives are, if nothing else,

respectable – but they're also much like the cheap ones! In a word, the 301 and 401 sound powerful. I'd argue that a 301 with a 10 watt tube amp sounds more gutsy than many hundreds of ordinary hi-fi watts! The 301 was a mono turntable, which although splendid on stereo has a rumble figure of -35dB – which wasn't apparent in mono.

The 401 was Garrard's answer and does have much lower rumble. The debate continues, though, as many prefer the 301 as it is more gutsy.

WHAT OF THE NEW DECKS?

The 501 is a development of the 301. Nearly all parts can be interchanged not least to make spare parts available. The 501 retains the grunt of the 301 (and arguably has more), but has a rumble figure of -69dB which is about 20dB greater than thought possible. The Aeroflux motor is vital in achieving this, its air suspension thrust pad bearing transmits very little of the high frequency noise associated with normal thrust type bearings. The stainless steel chassis is also of great importance. The greatest



Garrard is back - and beeswax will never be the same again!



Garrard gets on the road again.

improvement is the 501's AC power supply (available as PSU 45 and 85 for the 301 and 401) – it's very stable and of very low distortion.

The 601 was us trying to produce a near identical product to the 501 with the target price of £4,000 including arm and cartridge. We are still working to arrive at this price and not with the greatest of success! The 601 allows us to show off Gareth's ability as a designer. The 601 was inspired by listening to one of our 501s in the entry level skeleton plinth we make for 301s, 401s. The sound was incredible and if anybody is brave enough to opt for this it would carry our full recommendation to have a 501 skeletal. The plywood is marine ply which rightly is part of the folklore of 301s and 401s.



The finished product - Garrard's new 501 is an exquisite bit of kit.



When he's not machining bits for Garrard turntables, Nigel Pearson loves discussing the merits of Rover V8 engines, with which his decks share a design philosophy!



Four on the floor

Revolver line up no fewer than four drive units in their R45 floorstander. Does putting four on the floor like this make a difference? Noel Keywood finds out...

With all the floorstanders available these days, you'd think there was precious little room left for yet another like the Revolver R45, but that's not the case. Too many are flawed. Revolver's R33 loudspeaker, reviewed by Dominic Todd in our February 2003 issue, was, "in terms of, transparency, separation and staging amongst the best in the class" and the R45s I lived with recently are their floor standing cousins. From past experience I expected them to be better than a lot and I wasn't disappointed. Here's a large floorstander that offers a great performance all round – including plenty of bass.

There are still many disturbing idiosyncrasies - as I'll politely call them - in modern loudspeakers, where performance can veer right off course. I'm thinking here of peaky metal dome tweeters, or miserably low sensitivity. We can avoid such problems nowadays, yet still they appear. Peaky tweeters stand out in the showroom but are tiring to listen to over any period in the home – and low sensitivity demands use of a high power amplifier, which is likely to sound strained in its efforts to stir tardy drivers or a hungry crossover into action. So after being impressed by the nicely wrought balance of the R33s, I was happy enough to get these for review, only hoping for less peakiness!

The R45 is a big floorstander with an array of drivers that make no secret of its forte - to provide plenty of bass. There's nothing wrong with this if quality can be maintained. What Revolver has produced here is

a three-way loudspeaker with twin bass drivers for extra bottom-end oomph. A metal dome tweeter works with a large 165mm glass fibre cone midrange unit, below which sit two 165mm cone glass fibre bass units. The midrange sits in a sealed chamber (infinite baffle loading) whilst the two bass drivers are reflex loaded by a chamber fitted with a rear mounted port. Twin bass units accept more power and move air more easily than a single driver of the same dimensions. With less bass distortion this sort of arrangement should make for more relaxed sounding bass with greater impact – that's the general idea at least.

The R45s are fairly big, standing 930mm high, 250mm wide and 318mm deep. The lower plinth is solid but can be spiked for better stability on uneven wooden floors. The rear connection panel has removable links to allow biwiring. At 17kilos, the R45s are hefty but the light pearlescent Maple veneer and silver grey cloth on the side panels make them look modern and sleek. However, there is no grille to hide those drivers - and they are visually imposing.

It seems a contradiction, but the bigger a loudspeaker gets, the less power it needs. At least, this is the case if efficient drive units are used. Tests showed the R45s fit this category neatly. They need little power: one watt gave a massive 90dB sound pressure level - about right for a well designed modern loudspeaker using good synthetic cone drivers. This suggested the speakers would work well with my venerable 300B push-pull valve amplifier with its gentle 28watts. And so it turned out.



With four 300B triodes glowing brightly, the R45s fairly hammered me with just 10watts or so, a small monitoring 'scope showed. The valve amp was idling yet with their big bass the R45s were shaking the room on peaks. At normal listening levels I was using just a few watts; a 3watt amplifier would have been enough!

The two were a good combination in many ways. The vivid midrange clarity of the valve amp and its natural smoothness were both well conveyed by the R45s. I've been struggling of late to get female vocals sounding right through a variety of solid-state amplifiers and hearing the 300B well partnered like this reminded me why. No conventional amplifier can match its ability to

render vocals with such a natural smoothness, textural richness or a sense of dimensionality – and the R45s conveyed all these properties well. From the warm, husky tones of Toni Braxton through to Renee Fleming's operatic flights, the R45s showed they were able to resolve the properties of a first class amplifier and deliver fine vocals. In line with most glass fibre cones they display a crisp clarity and were forthright and a little unforgiving. The tweeter has a trace of prominence in the scheme of things that adds a little top-end sheen, even from the unparalleled neutrality of feedbackless triodes. In basic balance then, these loudspeakers are unarguably modern and I would suggest they were partnered with care by, perhaps, an Arcam amplifier.

It won't come as a surprise that the R45s have big bass. They go low but there is some prominence and fatness that rather draws attention to their activities further up the band, in the upper bass region around 100Hz. Some softness and bloat here fills out the sound and gives it heft, at the expense of definition and control. The R45s have plenty of low frequency output and it helps them deliver such a high sensitivity figure, since bass frequencies contribute much to what the microphone measures.

My 300B amplifier is a little large sounding at low frequencies, so I judged it time to switch to an Arcam FMJ A32 in case relief was to be had from the superior damping afforded by transistors. But Laurie Fincham of KEF pointed out to me many moons ago that acoustic damping contributes far more than electrical damping, so if a loudspeaker is underdamped acoustically then the amplifier is unlikely to make much of a difference. All of which is to explain that swapping from a high output impedance, zero feedback valve amp to a modern solid-state made little difference to bass quality. Most surprising was that the Arcam sounded a little softer in its treble than the triodes, partly I suspect because recent Arcam amps have a surprisingly sweet, gentle treble in any case, as if someone had tipped a pot of honey over the output transistors. Otherwise the FMJ A32 propelled the R45s well enough, but it didn't pull the R45s bass drivers into line; they are what they are.

All the same, by looking at the fine detail I am ignoring the bigger picture here – and it is a big picture! The R45s give a broad, well balanced and crisply clean sound that comes

over as well integrated and accurate. With heavy rock from the likes of Steve Earle they have all the power and range you need to bring thundering bass lines into the room, whilst chords from the steel strings of Earle's guitar have vibrancy and incision. The stabbing bass of Christina Aguilera's rap inspired 'Can't Hold Us Down' thundered from the R45s, with a good enough sense of menace to put some real weight behind the performance. With modern recordings like this the bass end sounded big and well enough controlled – and it went very low too. There was a trace of box overhang ('boing'), but yet again you tend to get this when you emphasise low frequencies using an underdamped cabinet. It was minimal in the overall scheme of things though and didn't colour what was a particularly clear, low colouration sound.

Brass rasped strongly and violin sections were vividly lit in the overture from Wagner's *Rienzi*. I realised here that these 'speakers well resolve micro-dynamics; violins possessed a vibrancy that was engaging and were well separated one from another. Plucked basses grumbled nicely and crescendos had a power that was enjoyable. Again, these are clean, modern sounding loudspeakers - not bright, but certainly forward and projective. If you're running old plastic cone jobbies they may come as a surprise! And an (old) amp with coarse treble

may not be the best choice either. But since I could barely get more than 10watts into them and a 30watter will have you pinned to the wall there's plenty of choice. Arcam's FMJ A32 was a sweet enough choice.

These speakers image cleanly. I ran them alongside KEF's Q7s for a short period and although KEF's Uni-Q unit can't be beaten for focus, the R45s came close, putting them up amongst the best in the field.

Which brings me to much the same conclusion Dominic Todd reached with the similar, but less bassy R33s. Here's a loudspeaker that does everything well. It may not be quite the most refined, but it has few rivals all the same. Turning 10watts into 100watts, or so it seemed, is one of those tricks only a well designed loudspeaker with good drive units can do. The R45 give a big, clean and accurate sound with the very latest standards of clarity and resolution from any amplifier they are paired with. If you want high quality floorstanders that can blow you across the room, give them a try. Or if you just want to hear the full might of an orchestra vividly conveyed, again give them a try. The market may be crowded with floorstanders, but there's plenty of room for one as good as this.

VERDICT ●●●●

Clean and powerful sound from a big floorstander that needs little power makes this a great loudspeaker buy.

REVOLVER R45 £899
 Revolver Audio
 ☎ +44 (0)870 0470047
 www.revolveraudio.com

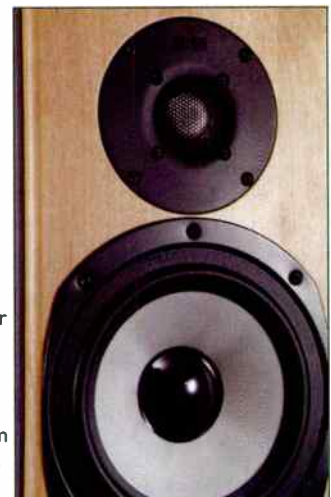

MEASURED PERFORMANCE

Frequency response was nicely flat, typical of good modern, synthetic cone drivers, but there's just a small lift up at 20kHz, suggesting output well above this frequency – useful for DVD and SACD. The bass/mid and tweeter were well integrated so the 'speaker will give good detail and will also be brightly lit, but not sharp. Bass output is raised and the port in particular is well damped and goes very low, all of which suggest the Revolver will have hefty bass that goes really deep if called for.

Sensitivity was very high at 90dB for one watt of input so amplifiers of 20watts will go loud and 40-60watts should be ample in most situations. At bass frequencies the 'speaker is really 4ohms, but above 20Hz it is higher than 8ohms so as a load it is reasonable. Reactance is low.

The Revolver is a very well engineered modern loudspeaker that will sound clean and detailed, but also deliver plenty of bass. It

measures very well and is nicely thought through. NK

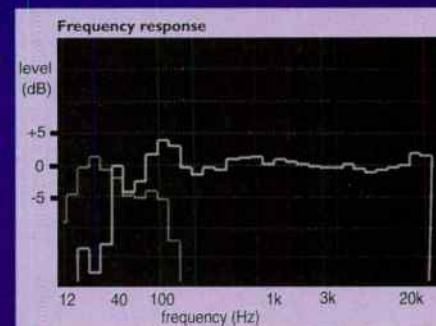
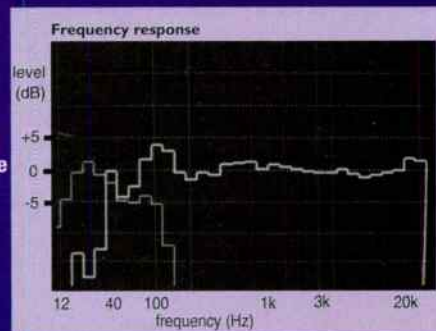

**DEMONSTRATION ROOM AT 12A SPRING GARDENS, NEWPORT PAGNELL, MILTON KEYNES,
BUCKS MK16 0EE BY APPOINTMENT ONLY - CALL FOR DETAILS ON 01908 218836**

The Kecl82 is our latest introduction for the true beginner and designed by Andy Grove. A simple and elegant design based on the classic ECL82 valve, a triode and power pentode sharing the same glass envelope. The amplifier consists of two ECL82s per channel, the triode sections work as the input/phase splitter and the pentode sections work in push-pull for the output stage. The amplifier offers 8 watts into an 8 ohm load, the hum level is extremely low, comparison to solid state standards. The chassis is constructed of 1.6mm mild steel with a black powder coat finish, there is only one signal input pair controlled at the front by a volume control for that simple touch. The speaker connects are the standard 4mm banana type, positioned at the rear, as are the mains input which is received through an IEC lead, mains switch and earth post. We have made the construction as simple as is humanly possible with comprehensive instructions. The circuitry is based on a single printed circuit board. Ultimately this kit is for the guy who has always fancied a go at building a kit, but never dared. Simon Pope says, "It's a great introduction to the valve sound. For its humble price it delivers a full and rich sound with great detail and good depth." Kecl82 weighs 9kg. External dimensions are 30cm(w)x23.5cm(d)x11cm(h)

NEW KIT**KECL82 VALVE AMPLIFIER KIT****£195**

These are our new 6550 series amplifiers. A pure class A design providing 40 watts into a 8 ohm load. (available in a 4 ohm version if required) A truly high end design by Andy Grove, using Svetlana 6550Cs in push-pull (any 6550 or KT88 tube can be used with this amp). It features valve rectification (5U4) a choke pi filter power supply and is hard wired. Weighs 19kg with dimensions



390mm(w) x 330mm(d) x 190mm(h) with valves or 220mm(h) with cage. Simon Pope says - "If you favour attack and rhythmic grip, together with a smoothness of sound that's incredibly easy to live with, the KIT6550 could well be the kit amp for you. The 6550 is one for those who like a valve sound married to the attack and clout of a good quality solid state design".

KIT6550 VALVE INTEGRATED AMPLIFIER KIT**£615****KAT6550 VALVE POWER AMPLIFIER KIT****£580**

The Kel84 features a pair of EL84 valves per channel in push-pull configuration. They give 15 watts into an 8 ohm load. The output transformers are Ultra Linear. Up front the ECF80 input/phase splitter valve has an extremely smooth sound. The Kel84 has very low hum, for simplicity the kit is built on a printed circuit board. A strong steel chassis is fronted by a 3mm anodised front panel and attractive chromed custom made knobs. There are five line level inputs, plus one monitor input, with a tape output included, all controlled from the front panel. At the rear is a mains switch/IEC power input, earth post, phonos, and 4mm banana sockets. Simon Pope says, "The quality that can be gleaned from this amp is a fine introduction to the joys of the valve sound. The Kel84 will highlight all the intricacies and depth of detail in your favourite recordings whilst retaining a warmth and fullness that is almost exclusive to pure valve amps and is rare at this price point." Kel84 weighs 10kg. External dimensions with valves are 300mm(w) x 270mm(d) x 150mm(h).

**KEL84 VALVE INTEGRATED AMPLIFIER KIT****£298**

The 2A3 PSE integrated amplifier offers a seriously hi-end sound, but without the cost usually associated with single-ended amplifiers. The stereo chassis houses, on the output, 2 x 2A3 in parallel single ended configuration and a single 6SN7 as the driver tube per channel. The valve rectified power supply consists of a 5U4 and a 10h choke. This feedbackless design provides 8.5watts into an 8 ohm load, so a good sensitivity speaker is required above 90dB. It can accept 6 line-level inputs fully controllable from the front panel. We provide the excellent Alps Blue potentiometer as standard. The amplifier is hard wired so plenty of scope for tweaking in the future. Simon Pope says, "The 2A3 PSE is extremely impressive piece of kit, good imaging, wide sound stage, nicely extended on the high frequency and tremendous bass thump. Weight - 20kg, external dimensions with valves fitted - 390mm(w) x 360mm(d) x 220mm(h)

**2A3 PSE INTEGRATED AMPLIFIER KIT****£570**

PROBABLY THE BEST DIY KITS IN THE WORLD



World Audio
design

The PRE-II is a valve pre-amplifier with six inputs, tape monitor and two sets of output sockets. It utilises a high quality line driver transformer and x5 gain. The PHONO-II is a dedicated valve phono stage that incorporates a step-up transformer for MC users. Finally, PSU-II is a power supply unit that feeds both the PRE-II and PHONO-II.

Power Supply Unit (PSU-II)	£205.00
Pre-amplifier (PRE-II)	£215.00
Phono Stage (PHONO-II)	£110.00
Moving coil step-up transformer	£77.00
Passive pre-amplifier (PAS-II)	£235.00



SERIES II MODULAR PRE-AMP KIT



KIT34 is a 32 watt stereo valve integrated amplifier, featuring a pair of EL34s, in push-pull mode, per channel, plus an ECF80 pentode/triode as input/phase splitter. The power supply is valve rectified (2 x 5U4), using a heavy duty choke to achieve exceptional smoothing. The output transformers are 14% Ultra Linear tapped to keep distortion down to its lowest level and the kit is totally hard wired utilising three tag boards. It has five line level inputs, plus a tape-in and



tape out, all controllable from the front. Simon Pope says, "This integrated brings together the best sonic virtues of our Kit88, kel34 and top of the range 300B PSE in an affordable package. The highlights of the sound are a deep and taut bass response, together with an open and highly detailed mid and high frequency response that only the best valve designs can achieve... a true valve classic." Weight 22kg, External dimensions with valves fitted - 390mm(w) x 360mm(d) x 210mm(h)

KAT34 VALVE POWER AMPLIFIER KIT

£480

KIT34 VALVE INTEGRATED AMPLIFIER KIT

£515

Our Parallel Single Ended amplifiers offer ultimate sound quality. Each monobloc has two of the beautifully linear 300B directly heated triode in its output stage, producing 20 watts into an 8 ohm load. At the front we have a 6AU6 pentode and an ECC82 as the driver valve. This design utilises a 5U4 rectifier valve in the power supply, in combination with a 10H choke, giving an extremely quiet supply. Both mains and output transformers use E/I pattern.

For purists, feedback is switchable and the kit is totally hard-wired. For those that require valves we provide the superb Tesla 300Bs, Russian 5U4s and European 6AU6s & ECC82. Simon Pope says, "Not to put too fine a point on it, the sound these monoblocs create is among the finest that can be encountered in hi-fi." Our 300B PSE kit bears an affordable price of £895.00 (UK price) excluding valves. Each



monobloc weighs 23kgs., external dimensions with valves: 25cm(w) x 38cm(d) x 22cm(h) per monobloc.

The 300B PP monobloc shares the same look and chassis as the 300B PSE monobloc.

The 300B PP kit has been created for those who prefer a bit more dynamics and drive to their valve sound. With a pair of 300Bs in push-pull configuration providing 26 watts output, these beauties will drive most modern loudspeakers to perfection. Andy Grove's design is totally feedbackless, using a 6AU6 pentode as the input valve and a 5687 as the phase splitter, the power supply uses

a Russian 5U4 for rectification. The kit is constructed by point to point wiring so some experience is required. 300B PSE owners do have the option to buy the conversion kit for £250.00 to turn their monoblocs to push-pull status. Each monobloc weighs 23kg.

300B PSE MONOBLOC KIT

£895

300B PP MONOBLOC KIT NEW

£895

The HD83 headphone amplifier is a beautifully simple design using Mullard ECL83 valves, a triode and power pentode housed in the same envelope. It works directly from any source, be it CD, tape, tuner etc., or from an amplifier's tape out or pre-amp out sockets. The circuit uses high specification E/I output transformers that will drive any headphone load from 16 ohms to over 300 ohms depending on how the secondaries are wired up. The HD83 is a single-ended design with the power pentode wired up in triode configuration for added sonic purity, and it is as quiet as a mouse. For sound quality Jon Marks says, "The bass is punchy and controlled without becoming artificial, while treble has the crispness of the best solid-state, with the tonal purity, delicacy and speed associated with valves." External dimensions 18cm(w) x 30cm(l) x 8cm (h) weight 4kg.



HD83 VALVE HEADPHONE AMPLIFIER KIT

£195

**DEMONSTRATION ROOM AT 12A SPRING GARDENS, NEWPORT PAGNELL, MILTON KEYNES,
BUCKS MK16 0EE BY APPOINTMENT ONLY - CALL FOR DETAILS ON 01908 218836**

Kel84 Upgrade kit

1 x 100K Alps blue Potentiometer
2 x 1000uF, 16V Black Gate
4 x 100uF, 50V Black Gate
4 x 0.22uF, 400V Jensen paper
in oil

£100**KiT6550 Upgrade kit**

1 x 100K Alps blue Potentiometer
2 x 2200uF, 16V Black Gate
4 x 100uF, 100V Black Gate
4 x 0.22uF, 630V Jensen paper
in oil

£130**KaT6550 Upgrade kit**

2 x 2200uF, 16V Black Gate
4 x 100uF, 100V Black Gate
4 x 0.22uF, 630V Jensen paper
in oil

£120**KiT34 Upgrade kit**

1 x 100K Alps blue Potentiometer
2 x 1000uF, 16V Black Gate
4 x 100uF, 50V Black Gate
4 x 0.22uF, 630V Jensen paper
in oil

£130**KaT34 Upgrade kit**

2 x 1000uF, 16V Black Gate
4 x 100uF, 50V Black Gate
4 x 0.22uF, 630V Jensen paper
in oil

£120**300B PSE Upgrade kit**

2 x 470uF, 16V Black Gate
4 x 100uF, 100V Black Gate
2 x 0.22uF, 630V Jensen paper in oil
2 x 0.47uF, 630V Jensen paper in oil
4 x 35A Bridge Rectifier KBPC3502
4 x 4700uF, 16V

£150**"KIT34 Upgrade Kit"****BARGAIN BASEMENT**

2A3 PSE chassis and base plate (without face plate), slight flaw on paint work, can hold 1 x 120 lam, 2 x 78 lam E/I transformer, 3 x octals and 4 x UX4s, hardwired. **Price - £50.00**

Kel84 chassis and base plate (Without face plate), slight flaw on paint work, can hold 1 x 78 lam, 2 x 29 lam E/I transformers and 6 x B9A. **Price - £40.00**

Audax drive unit, HMI30Z0, aerogel, 5 inch mid/base unit
UK price £35.00 each

5687 valves, double triode
UK price £7.00 each

Kit34 chassis - **UK price £50.00 each**

Pls fax/tel
00 44 (0) 1908 218836
to order

Mains transformers & Chokes**KIT6550/KAT6550 mains transformers**

2 inch stack, 130mm(h)x120mm(w)x135mm(l) drop through fitting with zinc cap. Secondaries: 0V-240V 300mA, 3.15V-0V-3.15V-0V-3.15V, 9A, suitable for 120V & 240Vac operation

KEL84 mains transformer

1.5 inch stack, 90mm(h)x 80mm(w)x 95mm(d) drop through fitting with zinc cap. Secondaries: 0V-240V 300mA, 3.15V-0V-3.15V, 5.5A, suitable for 120/240V operation

KIT88/KAT88 mains toroidal transformer

120mm dia. x 60mm(h). Secondaries: 195V-0V-95V, 450mA/0V-27V, 100mA/3.15V-0V-3.15V, 9A, suitable for 120/240V operation

KIT34/KAT34/KIT6550/KAT6550 choke

1.25 inch stack, 65mm(h)x105mm(w) with fitting holes x 60mm(d), clamp fitting, 2.5 H, 350mA

300B PSE mains E/I transformer

130mm(h) x 95mm(w) x 115mm(d), drop through fitting with zinc cap. Secondaries: 380V-0V-380V, 180mA/150-0V-150V, 25mA/0V-5V, 1.2A/0V-5V, 1.2A/0V-5V, 3A/3.15V-0V-3.15V, 0.4A suitable for 120/240V operation

KEL80 mains toroidal transformer (encapsulated)

130mm dia. x 65mm(h). Secondaries: 195V-0V-195V, 390mA/0V-27V, 100mA/3.15V-0V-3.15V, 7.5A, suitable for 120/240V operation

HD83 mains toroidal transformer

80mm dia. x 35mm(h). Secondaries: 0V-165V, 75mA/3.15V-0V-3.15V, 1A, suitable for 120/240V operation

PSU-II mains toroidal transformer

80mm dia. x 35mm(h). Secondaries: 0V-270V, 60mA/0V-10V, 2A, suitable for 120/240V operation

TRANS1 mains toroidal transformer

95mm dia. x 50mm(h). Secondaries: 0V-370V, 150mA/0V-6.3V, 3.5A 300B E/I choke 65mm(h) x 70mm(d) x 80mm(w) open frame fitting, 10H, 180mA.

KEL84 E/I choke

0.5 inch stack, 40mm(h)x 35mm(d)x 70mm(w) clamp fitting, 1H, 250mA

PSU-II E/I

40mm(h) x 35mm(d) x 70mm (w) clamp fitting, 15H, 20mA

KIT34/KAT34 mains transformer

2.5 inch stack, 120mm(h)x115mm(w)x95mm(d), drop through fitting with zinc cap. Secondaries: 365V - 0V - 365V, 300mA/0V - 5V, 6A/3.15V - 0V - 3.15V, 7.5A, suitable for 120/240V operation.

Output transformers

KIT6550/KAT6550 E/I 16% TAPPED UL push-pull output transformer 2 inch stack, 80mm (w) x 95mm(l) x 100mm(h), drop through fitting with zinc cap. Primary-secondary 4.5K, 16% UL tapped. Secondary 4 or 8 ohms, pls specify on order; max output 45 watts, max current 180mA, valves, KT88, 6550 etc

KEL84 E/I Ultra Linear push-pull output transformer

1.25 inch stack, 76mm(h)x 65mm(w)x 76mm(d) Primary - secondary, 8K with 12.5% UL tap - 8ohms, max o/p-15watts, max current 150mA valves EL84 etc

KIT88/KAT88 E/I push-pull output transformer

80mm(w)x95mm(l)x100mm(h). Primary-secondary 10K - 8ohms, max o/p-40watts, max current-160mA valves-KT88, 6550, EL34

KIT34/KAT34 E/I 14% tapped Ultra Linear push-pull output transformer

2 inch stack, 80mm(w)x95mm(l)x100mm(h), drop through fitting with zinc cap. Primary-secondary 6.4K, 14% UL taps, Secondary 8ohm, max output 34watts, max current 150mA, valves EL34, 6L6, 6CA7

HD83 E/I single ended output transformer

40mm(w)x50mm(l) x 55mm(h) Primary-secondary 4K - 4 x 64ohms windings, max o/p-1watts, max current-25mA valves-ECL83 etc

Pre-II E/I driver transformer

80mm(w)x60mm(l) x 65mm(h). 6:1 step down transformer, max current-10mA valves-6922 etc pre-amp stage

300B PSE E/I parallel single ended output transformer

130mm(h) x 95mm(w) x 115mm(d), drop through fitting with zinc cap. Primary 1K5 Secondary 8R, output .

Printed circuit boards

Kel84 Printed Circuit Board 280mm(w) x 135mm(l) x 1.6mm(d).

Kit34 PSE Printed Circuit Board 140mm(w) x 310mm(l) x 1.6mm(d).

Kel34 Printed Circuit Board 140mm(w) x 310mm(l) x 2.4mm(d).

HD83 Printed Circuit Board (a pair) 120mm(w) x 215mm(l) x 1.6mm(d).

HD83 Printed Circuit Board 140mm(w) x 160mm(l) x 1.6mm(d).

Pre-II Printed Circuit Board 105mm(w) x 130mm(l) x 1.6mm(d).

PSU-II Printed Circuit Board 105mm(w) x 130mm(l) x 1.6mm(d).

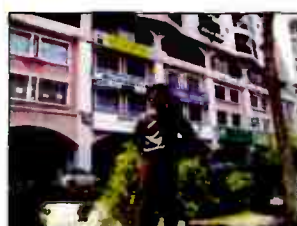
**Hi-Fi World in Malaysia at Millennium Hi-Fi & Av, Kuala Lumpur, Malaysia**

Hi-Fi World is now distributed through good bookshops and newstands in Malaysia. For back issues, general enquiries and advertising, contact Simon Chang at Millennium Hi-Fi & Av.

Also available are products by World Audio Design, Michell, Trichord, Lowther and ReThm loudspeakers.

Millennium Hi-Fi & Av
500-1-3 First Floor, Wisma Indah (Shen Court),
Jalan Tun Razak 50400 K.L.

tel: 603 9283 8171 fax: 603 9281 3762

137 Jalan Pendekar 2, Taman Skudai Baru, 81300 Skudai, Johor DT
tel: 607 554 5171 fax: 607 554 7645

e-mail: info@millennium-audio.com



WE HAVE OVER 30 TITLES ON OFFER!!!

AUDIO ELECTRONIC THEORY BOOKS



Electronics made Simple
by Ian Sinclair
This book covers the basic theory and principles of electronics. A good read for the beginner.
Code No 1420
£12.99 + £2.50 P&P (UK)

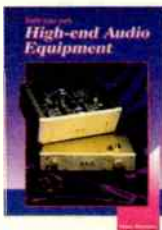

Build your own High-End Audio Equipment
by Elektor
Build your own High-End Audio equipment contains construction projects for solid state preamplifiers and power amplifiers, active cross-over filters, an active subwoofer, a mono/stereo compressor and a headphone amplifier.
Code No. 1390
£14.95 + £2.50 P&P (UK)



Audio/Radio Handbook
By National Semiconductor
National Semiconductor's manual is an essential aid to engineers and experienced hobbyists in the application of National's line of consumer audio and radio ICs. Not only does it hold comprehensive data of their ICs but discusses theory aspects of amplifiers and pre-amps and covers electronic principals.
paperback 200pp, Code No. 1810
£13.95 + £2.00 P&P (UK)



Build your own Electronic Test Instruments
by Elektor
This book contains designs for 17 measuring instruments, seven generators and analysers, ten miscellaneous instruments and a number of test ancillaries and auxiliaries. The designs range from a simple multicores cable designs contain a special printed circuit, drawing of which are given in an appendix.
Code No. 1400
£15.95 + £3.25 P&P (UK)



The LP is back
by Audio Amateurs
Your complete guide to LP care and maintenance designed to offer you everything useful for those who love and enjoy this older music medium. This covers the theory and care of LPs and the electronics and mechanics of its players.
154pp Paperback, Code No.1620
£8.00 + £2.00 P&P (UK)



The Joy of Audio Electronics
by Charles Hansen
This is a fail-safe guide to the pleasures of hands-on electronic construction. This book covers test and measurement projects, how to build simple kits, safety issues, the workplace, theory and resources. A must for the beginner who plans to build more advanced electronic projects in the future.
124pp Paperback, Code No.1650
£10.50 + £2.50 P&P (UK)

VALVE BOOKS



Audio Measurements
by Norman Crowhurst
Famous compendium of measurement and test techniques for audio reproduction equipment of the tube era includes discussion of all instruments needed. Covers amps, transformers, preamps, turntables, changers, tonearms, cartridges, tape recorders.
Code No.1830
£13.95 + £2.00 P&P(UK)

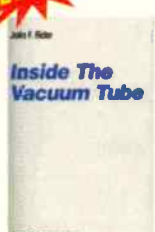

Inside the Vacuum Tube
by John F Rider
One of the most thorough (and funny) books ever written on the way vacuum tubes function. Rider's mastery of analogies common to most of us makes the book especially useful to those who want to learn about vacuum tubes.
Code No. 1840
£24.00 + £2.50 P&P (UK)



GEC Audio Tube Data
Full of data and circuits concerning the three most well known MO Valve power tetrodes, the KT66, KT77 and KT88, the (KT77 was GEC's answer to Mullard's EL34) and some data on the PX4 and PX25 triodes. The first section concerns preamplifiers of various types, with information regarding equalisation, tone controls, filters and suchlike. An excellent book for all valve heads.
Paperback Code No. 1780
£14.95 + £2.00 (UK)



Understanding Hi-Fi Circuits
by N. H. Crowhurst
Originally published in 1957. Discusses all aspects of amplifiers, pre-amplifiers and equalisation circuitry, well written, easy to understand. The author does concentrate on valve circuits, so no transistors here.
Paperback, 224pp Code No.1820
Price £13.95 + £2.00 UK p&p



Glass Audio Projects - 17 Vacuum Tube Designs
This book features 17 valve project, designed, tried and tested by some of the best authors state side. Designs such as a 300B push-pull amp, a 33 power amp a 6528 single ended, a 300B parallel single-ended amp, a 6C33C-B single ended amp, a 70W KT88 push-pull amp, a 2A3 single ended amp to name a few. All information is provided so most projects can be built from scratch.
Paperback 73pp, Code 1790,
£8.00 + £1.50 P&P (UK)



An Approach to Audio Electronic Valves in Audio Frequency Amplifiers
by E. Rodenhuis
Discussing the use of valve data, the function of different amplifier stages and includes detailed descriptions of eight designs. A wealth of practical data, measurements and interesting features will be found. A very good read.
Paperback 147pp, Code No. 1520
Price £12.95 + £2.00 P&P (UK)



The Best of Audion editorial projects
by Luciano Marci
This book contains six excellent audio projects - a high sensitivity speaker, a superb tube pre-amp, a 2A3 amplifier design, a project using the Russian 6C33CB and two projects using 300Bs as output valves. Overall the book is a fabulous read.
62pp, paperback book code 1750
£12.00 + £2.00 UK p+p



Vacuum Tube Amplifiers
by Valley & Wallman
This book is a well known reference valve text book and is assembled from pieces by ten knowledgeable authors. An absolute bible when it comes to valve electronics.
734pp, Paperback, Code 1770
£29.95 + £ 4.30 P&P (UK)

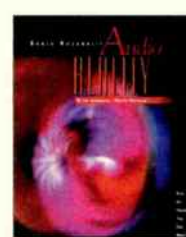

Audio Reality
by Bruce Rozenblitz
Investigates conductors, skin effect, impedance, interconnects, speaker cables, balanced lines, transmission lines, isolation transformers, tubes, acoustics and much more. Also, includes 6 excellent detailed valve design projects, 80watt OTL, 25watt OTL, grounded grid pre-amp, 150watt amp., 6550 SE amp. and a grounded grid cascode phono preamp.
Paperback 128pp, Code No. 1640
Price 21.50 + 2.50 P&P (UK)

ntals

Fundamentals of Radio-Valve Technique
J. Delach
This is part of the Philips technical series written in 1947 it was one of the most authoritative and comprehensive treatments of the nature and function of the vacuum tube.
534pp, Paper back
Code No. 1630
£15.50 + £2.50 P&P (UK)

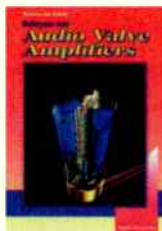

Build your own Audio Valve Amplifiers
by Rainer Zur Linde
This book covers construction projects for preamplifiers, power amplifiers and two amplifiers for musical instruments aimed at the practical audio/hi-fi enthusiast. It offers much information on the operation of electron tubes, while the first chapter gives a short history of the thermionic valve.
paperback, 251pp, Code No.1320
£14.95 + 2.50 P&P (UK)



Mullard Tube Circuits for Audio Amplifiers
Includes full designs for eleven power and control amps, including 5-20, using valves. Begins with a four chapter tutorial on getting the best sound from valve amplifiers.
142pp 8" x 10" Paperback Code 1030
£13.95 + £2.00 P&P (UK)



68 HI-FI W



RCA Receiving Tube Manual
Technical Series RC-14
This book presents RCA's commercial valve line-up as it was in 1940. The manual covers valve terminology, Technology and application, valve testing and then a larger section giving some circuit ideas and plenty of data on numerous valves e.g. 6L6, 6N7, 6SN7.
255pp Paperback, Code No. 1800
£13.95 + £2.00 p&p (UK)

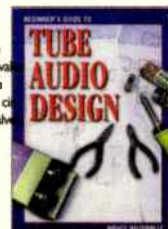

The Beginner's Guide to Tube Design
by Bruce Rozenblitz
This book takes a comprehensive look at tube audio design. It explains how vacuum tubes work and how to design with them. Rozenblitz covers stabilisation and testing, a description of 13 famous and classic amps and preamps and how to work effectively as a designer. A hands-on guide to construction techniques, tools and choosing components and tubes is provided. 1997.
132pp Paper back Code No. 1340
£15.50 + £2.50 P&P (UK)

computer audio world

advertising@computeraudio.co.uk
editorial@computeraudio.co.uk
news@computeraudio.co.uk

www.computeraudio.co.uk

MINI PORT

Xitel's new MD-Port I/O has been totally redesigned to complement the fast transfer methods of today's NetMD MiniDisc portables. Users can now record from MiniDisc back into their PCs, and an optical digital output lets them record the other way, so they can get music onto MD that SonicStage and OpenMG don't support. They can record MP3s, streaming audio and all other PC music digitally to MiniDisc with excellent sound quality, or record anything on MiniDisc to PC hard drive as a high quality .WAV file, or even turn it into an MP3 so you can keep it on your hard drive. It hooks up via USB, and runs with all Windows compatible media players and including Windows Media Player, Winamp, RealAudio Player, MusicMatch and many others. For details, see www.xitel.com.



REVOLUTION NO.9?

Microsoft is claiming great things for its new Windows Media Audio and Video 9, which is said to offer "unmatched audio and video quality at any bitrate". Compression improvements of 20% for audio are claimed, with optimisations for dial-up systems. Discrete digital surround sound with 5.1 channels and above, for streaming or download-and-play, at bitrates as low as 128 kbps, is also provided. WMA 9 Pro also supports full resolution audio, with 24 bit sampling resolution and 96 kHz sampling rates. There's also WMA 9 Lossless, a new mathematically lossless audio codec for "the ultimate audiophile performance", which can losslessly compress CD audio into one-half to one-third its original size. Go to www.microsoft.com/windows/windowsmedia/ for a free download.



SUPER DISK STORAGE

Optical storage specialist Imation has written a handy guide on how to best store CD and DVD media:

- [1] never touch a disc on its blank side - the disc should always be handled by the outer or inner edges.
- [2] store discs in dark, cool and dry conditions. Avoid the aggressive UV-radiation of sunlight. Moisture may impact data integrity as well. Those wishing to keep media for decades should archive them in protective cases, away from direct UV-radiation, at a temperature range from minus five to plus thirty degrees centigrade, in air humidity of around fifty percent.
- [3] keep them clean - remove fingerprints with water and a soft lint-free cloth. Avoid solvents or aggressive cleaning products.
- [4] place labels accurately - more important than the chemical construction of a label is the way it is applied to the disc. The electric motor within a high-speed drive operates at several thousand RPM and may start to wobble or oscillate, which affects read/write integrity.

LUCKY STAR?

The Magic Star is an MP3 Player, USB Flash Drive, and mobile e-mail client all in one. It can download and store any file-type on the drive, so users can take them anywhere. The MP3 player scans the drive and plays any MP3 files stored on the drive. This drive also has a mobile e-mail client, which means any e-mail client can be installed on the drive - allowing the user to check and download POP3 e-mails on any PC. It does not leave any files on the PC, so this is a safe way to check e-mail on the go. It comes in 64MB, 128MB or 256MB versions, and connects to PCs by USB 1.1, allowing for a 12Mbit per second data transfer rate. A 3.5mm earphone jack is fitted, and the internal battery gives twenty hours playback time - after which it is simply plugged into any USB port to recharge. Expect to pay £75 for the 64MB version. Point your browser at www.pc-memory-upgrade.co.uk/



TOOLED UP

Audiotools v4.5 for Windows, by Unrelated Inventions, lets you record audio and then process it, then save it in various formats including the much respected Fraunhofer MP3 codec, OGG, VQF and WMA. A shareware version, limited to ten minutes encoding is available for free, otherwise you'll have to buy online for \$20 (£12). Click on www.unrelatedinventions.com.

M-POWER

M Audio's Sonica Theatre is one of the smallest and neatest external, USB soundcards around. It draws its power from the USB port itself, so there's no need for fiddly external power supplies. Despite the diminutive dimensions, there's a wealth of features including 7.1 channel decoding, a coaxial digital output and line input, plus the latest 24bit digital to analogue converters. For those of a more specialist persuasion, the Audiophile USB is a USB audio and MIDI interface for Mac and PC. Its 24bit, 96kHz DACs uses AC-power for better fidelity than bus-powered circuitry. Two pairs of analogue line-level audio inputs and outputs (via quarter inch jack sockets or unbalanced RCAs) are provided, along with digital coaxial in and outs. Click on www.midiman.co.uk for more details.



Archiving Analogue

No sooner has the novelty of CD burning worn off, than the technology to author high quality audio DVDs becomes affordable. Noel Keywood takes up the story.

Recordable Compact Disc offered the ability to record music using a nineteen seventies coding scheme, one that I was vigorously criticising for its distortion way back in the 1980s. Eventually, as analogue-to-digital convertors improved and higher resolution 24/96 chips hit the market, the almost universal belief that CD was "perfect" – always palpable nonsense – started to change in the light of experience. Nowadays it's widely appreciated that 16bit quantisation does not offer enough resolution to satisfy the human ear's vast pressure level range, spanning from the movement of a hydrogen atom Yost tells us, to Concorde taking off - nor its frequency range, we suspect. Hi-fi demands better, and now you can get it!

There are plenty of 24/96 soundcards, like Creative Labs' Audigy 2 or M-Audio's Revolution, available for just £100 or so. These cards offer two-channel (stereo) recording at better than CD quality - but at present you can't do much with it. The industry has hit a bit of a conceptual dead end here, for the time being, but recordable DVD-Audio

may change that. Now you can record super high quality stereo or surround-sound recordings and replay them through your hi-fi. Well – sort of. And that's why I'm writing this article.

The subject is a minefield. Recording to DVD-A can be simple or horrendously complex. So here's how to record LP to DVD Audio in 24bit, 192kHz stereo as an example of what's involved, with a look at creating a surround-sound mix too. This would, for example, allow you to archive your LPs with minimal degradation (when affordable 24/192 convertors arrive) or change them to surround-sound, or edit out ticks and pops, rebalance the sound and then commit to DVD. What you can do to LP you can do to (unprotected) CD, so I will be covering CD too.

GETTING STARTED

This is going to be a simple run through how to copy analogue to digital, not digital copying which raises a whole slew of copyright issues. From a pickup cartridge you get a tiny signal of a few thousandths of a volt (millivolts or mV) that must first be equalised before it can be used, and amplified too. Disc phono stages either within amplifiers or external to them carry out this task. Equalisation boosts bass and cuts treble to compensate for bass cut/treble boost that occurs in the disc cutting process. If you don't equalise LP, it gives you a thin,

scratchy sound!

If you have an amplifier with a phono input then it has an on-board phono stage and its output is available from the Tape Out sockets, or from Preamp Out sockets, if fitted. Headphone out and loudspeaker terminals could be used, but they are way down the signal chain, so it isn't the best idea. An amplifier's Tape Out sockets usually give a few hundred millivolts and this fine for most computer line inputs. You will need a phono-to-3.5mm jack lead in most circumstances, available from Maplins for £2 or so, or at much higher cost of you want a high quality cable.

External disc stages can give a lot of output, especially if you use a high output moving coil on a high gain setting. This may overload soundcard or AC97 chip computer audio inputs, so beware. CD players potentially suffer a similar problem: they all give 2V out. Connect a CD up to a computer and your computer's input gain controls will have to be pulled right back, and even then you may hear distortion.

Most phono stages give x100 gain with moving magnet cartridges, so you'll get 500mV out from them on peaks, and occasionally a little more. This should be okay for a majority of computer inputs, but only



Start with a good quality turntable and decent phono stage...





: ...feed the signal into a 24/96 capable soundcard

just. If you have to make an attenuator, a 10k resistor in series and a 10k after it to ground will give a useful -6dB gain reduction (x0.5), or you could try 47k-100k in series. Alternatively (and better), use a passive pre-amp (variable attenuator) like the QED MA34. Many CD players have on-board control of output (volume) and this is the best way to reduce output level to get a match to the computer. Or again you could use a passive pre-amp.

Numerous external phono stages are available, from the diminutive battery driven QED Discsaver, the popular NAD PP-2 right up to valve preamps like World Audio Design's PRE II and the EAR834P.

Having got a line level analogue signal from your vinyl, it must now be turned into digital - a job for the computer soundcard's analogue-to-digital convertor. Computers have had on-board ADCs for a long time, but they are low quality. Most PCs nowadays have little 3.5mm jack Line Input at front or rear and these will go through a cheap stereo ADC on the soundcard. For hi-fi work you need a decent ADC, which means using a proper hi-fi soundcard, such as Creative Labs' SoundBlaster Audigy II or M-Audio's Revolution, which both give stereo in through a 24/96 convertor for less than £100. Therefore, both can record LP using higher resolution coding than that of CD!

However, companies like Cirrus Logic, Wolfson, Burr Brown and Analogue Devices have had 24/192 audio ADCs on their books for some years now so 24/192 consumer soundcards should be with us soon. Beware that soundcard bump talk about "7.1 channels" and "24/192" but they are talking Replay here, not recording. Most seem to try and avoid mentioning the fact that their soundcards have 'old fashioned' stereo inputs, albeit at good 24/96 quality. The ESI Waveterminal 192X

offers 24/192 ADC recording capability for \$300 (www.esi-pro.com), and is an interesting item for serious recording. As with all things computer related, what you buy today will be obsolete tomorrow so it's best to grab a card and get on with it!

IN THE MIX

Using a sound editing package such as Syntrillium's Cool Edit Pro, or Steinberg's Wavelab, you need to record your prized vinyl, telling your computer where the start and stop points are, or you can get it to decide automatically, according to audio level/time, etc. With LP you will likely want to start at the beginning of a track and stop at the end of it. You could, alternatively, start at the start of the LP and stop at the end of it, but at CD quality of 1.4Mbps (2ch, 16bit, 44.1kHz) you would end up with a large file of 210MB or thereabouts. Coding to 24/96 will increase data rate to 4.6Mbps, giving a 690MB file from one LP side, whilst 24/192 coding results in a data rate of 9.2Mbps and a file of nearly 1.4GB. Whilst these (wave or .wav) files are not large by raw video standards, they are still very large; it is easier to work with one track at a time.

Once you have your wave file, you're home and dry! DiscWelder Steel or any other burning program will recognise it and work with it. You can now burn to DVD - or CD if you so wish. Note that many editing packages can upsample audio from 16/44.1 to 24/96 or 24/192, but this will not give you the same quality as using the latest and very best high resolution ADCs on a good soundcard.

How about multichannel? By passing stereo from LP or CD through a Dolby Pro Logic II processor, you can generate surround-sound and often results are impressive. Ideally, this requires a software Dolby Pro Logic II processor. It is possible to generate six surround-sound channels from stereo via the preamp outputs of an A/V receiver fitted with Dolby Pro Logic, but then you would need a 6 channel card (M-Audio) to turn it to digital. There's arguably little point in this with CDs, but with LP it would mean you did not have to play the LP to get surround sound. You can pass the output from a stereo mic through Pro Logic (matrix decoding) and get interesting results.

I have recorded various situations at airshows, for example, in stereo and found Pro Logic II will

CLICK ON THIS!

<http://sounden.terratec.net>
Here's an interesting LP/cassette-to-computer USB external soundcard, and a neat external phono stage with adjustable output level. They even provide clean-up software!

place aircraft at centre, crowd left and right, and wind noise behind giving plausible surround-sound. Otherwise, you need a Soundfield mic (www.soundfield.com). If you want to record at home, then you can use individual mics on each channel, but again will need a soundcard with six input channels like the M-Audio Delta series. A card like this will also allow you to capture any surround-sound analogue signal and turn it back into digital of course, should you want to produce copies for your own use, or edited to change the sound.

At present it's early days for DIY surround-sound on DVD-A. Pinnacle, et al, are busy chasing camcorder users for their custom. But the release of discWelder may not pass unnoticed. With it you can copy LP to DVD Audio, at any quality level right up to the highest possible, without too much difficulty and at reasonable cost. With a bit more effort you can even produce 'better than CD quality' surround-sound audio DVDs - from LP! Recordable DVD has a lot more to offer audio enthusiasts than recordable CD ever did. And it has just begun...



Terratec's dedicated phono pre-amp for computers.

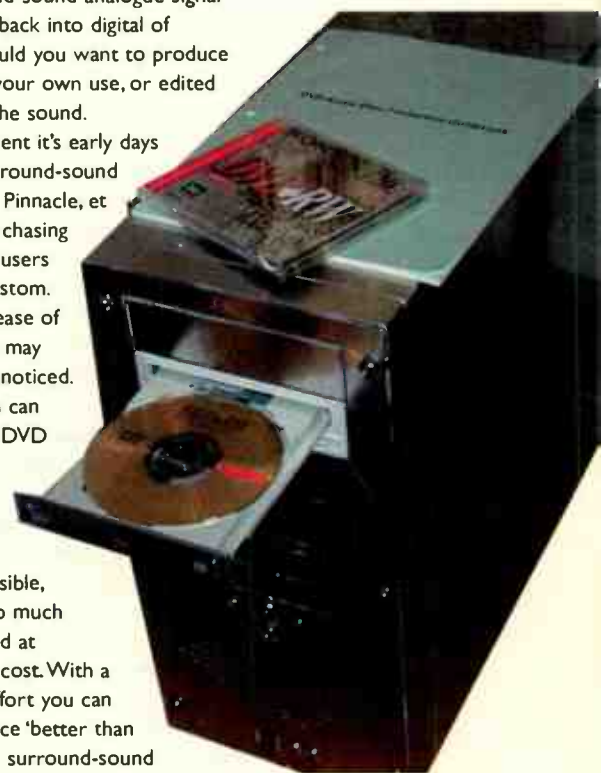

record it in .WAV format to your hard drive...



...and burn to DVD for your very own audiophile disc!

The Cutting issue

Want to burn your own high resolution DVD-Audio discs on your PC? Noel Keywood tries out Minnetonka Audio's discWelder Steel DVD-A authoring software...

Such are the exigencies of the computer market these days that, way before DVD-A had a chance to become a mature technology, someone put out a DVD-A authoring package! It's an idea that has intrigued me ever since I spotted a US magazine announce the arrival of Minnetonka Audio's discWelder some months ago. So when a review copy appeared in the mail, all the way from Minnesota, USA, I was keen to see what it could do. Being able to burn high quality DVD-Audio discs opens up a myriad of possibilities – from multichannel to high quality vinyl archiving at 24bit, 192kHz resolution!

DiscWelder Steel is the simple version priced at \$495, or around £350 according to the exchange rate. There's also discWelder Chrome for \$2495 which is for professional use. As the home studio market goes, £350 is quite expensive, but at present Minnetonka Audio seem to be out on their own. Software companies like Pinnacle are pretty much wrapped up with DVD video at present; the potential delights – and horrors – of multi-channel audio have yet to be taken onboard.

So why would you want to record to DVD-Audio? One reason is that it's a lot more flexible in what it can do than CD. You can record normal 16bit/44.1kHz CD quality stereo if you like, or stereo at super high quality 24/192. If you are a

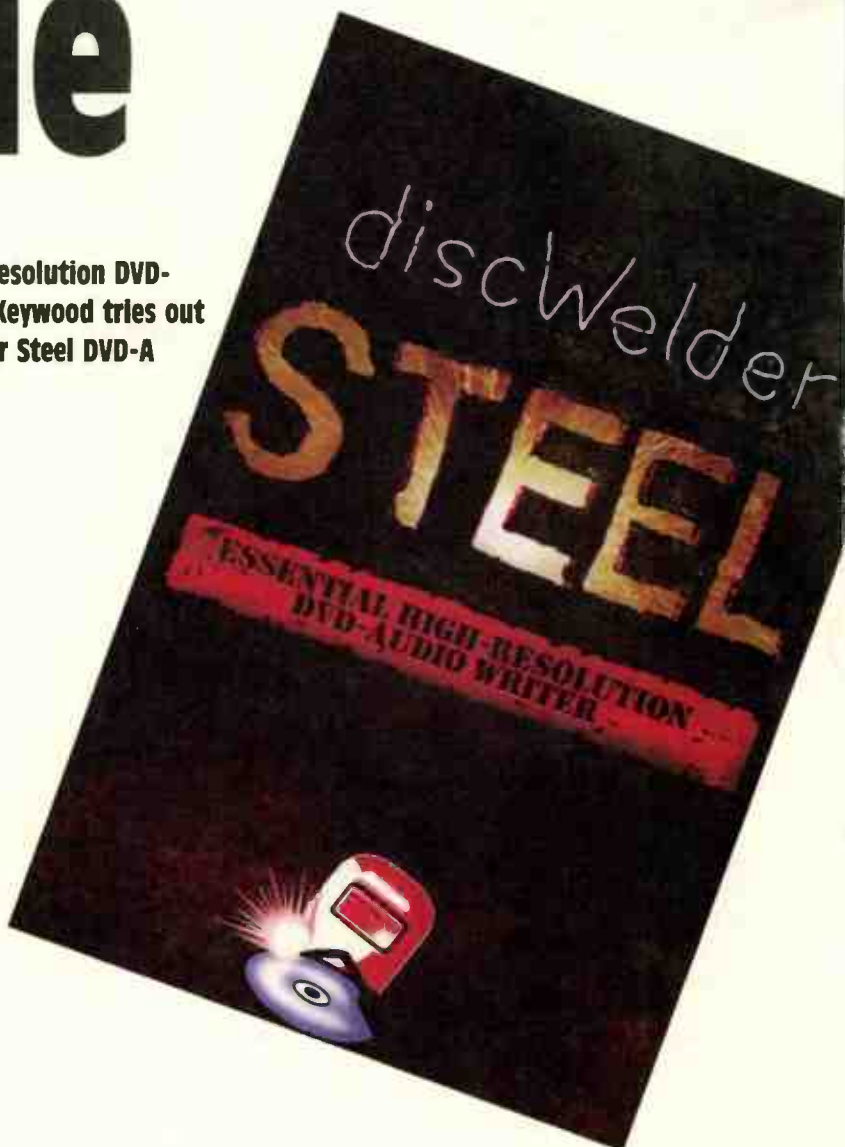

stereo fan who doesn't want a roomful of loudspeakers, burning LP to DVD-A at 24/192 may be the way to go. Then you can play your 24/192 coded LPs through your DVD-A player, alongside lesser quality digital 24/96 DVD-A discs (!) and DVD Videos of course. If your mates think you are living in the past with vinyl, just hand them a 24/192 DVD-A burnt from LP and see what they think! You will of course need a 24/192 sound card and an editing package, both of which will set you back a few hundred apiece, minimum.

If you have a surround-sound system with DVD-A player, like the inexpensive Pioneer DV-656 I used for this test, discWelder Steel allows

you to record to all six DVD-A channels in 24/48 quality, which equals surround-sound at better than CD quality (less distortion and smoother sound). But I bumped into an unexpected and disappointing limit here; you cannot get six channels of 24/96 onto a DVD-A without exceeding its maximum data rate of 9.6Mbps with discWelder Steel, since one channel of 24/96 gives a data rate of 2.3Mbps and six of them no less than 13.8Mbps. Normally Meridian Lossless Packing is used to halve this but Steel doesn't have MLP; you have to pay \$2495 for chrome if you want MLP.

So Steel cannot mimic a 24/96 commercial surround-sound disc.

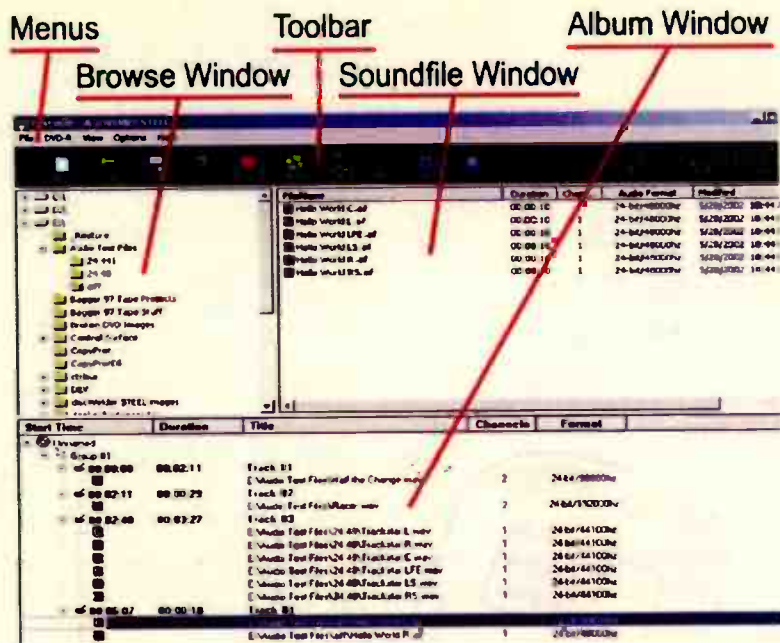
**VERDICT** ●●●●

Basic DVD Audio burner that's simple and stable. Expensive, but it works. A powerful tool.

DISCWELDER STEEL \$495

Minnetonka Audio
Software, U.S.A.
www.discwelder.com

However, you can burn in three channels, left, centre and right, of 24/96 to give three-speaker frontal stereo of high quality, something I tried with some success. Lacking Dolby or DTS compression, it will not encode to normal 5.1 (AC3) either; it handles only uncompressed PCM, but that's no bad thing.

In itself, discWelder Steel is a fairly simple package - in fact surprisingly so. It transfers .wav or .aiff files to DVD-R/RW - it does not prepare the files in any way. For this you need a multi-channel music editor to generate the six channels of information, such as Cool Edit Pro, Sonic Foundry Acid Pr0 4 or Cubase. Steinberg's Nuendo is another example (see www.steinberg.net, Professional Section). I used Steinberg's Wavelab 4.0 to prepare mono and stereo tracks as .wav files, right up to 24/192 resolution and Cool Edit Pro for surround-sound.

Steel recognises .wav tracks only in its Browse window, which had me fooled for a short time, expecting to be able to Open or Import them. After that it follows the normal routine of transferring wanted tracks to a library (Soundfile) window, from where they are compiled to disc in a third Album window that runs across the lower portion of the screen. Dragging a track across opens the disc, revealing the six channels: Left front, Right front, Centre front, LFE (Low Frequency Effect or subwoofer), Left Surround (Ls), Right Surround (Rs), the Surrounds being the rear channels. You cannot, I found, send a signal to a surround channel alone. The front channels must have .wav files in them, but they could be

inaudibly low level signals if you really had a need to do this.

DiscWelder has a simple, fixed on-screen graphic with Track Listing that can be configured for US (525/60) or European TV systems (625/50) and the disc can be named. Tracks of differing formats can be burnt to disc. I simply dragged files to the various channels then pressed Record. DiscWelder got to work, burnt the disc and in all cases it played perfectly. However, the Sony DRU-500 burner is a recent universal drive that supports +R/RW and -R/RW; Minnetonka recommend -R/RW drives as most compatible. They license their DVD burner from www.gearsoftware.com and suggest visiting their Support page for supported DVD drives.

The length of time taken to burn a disc depends upon DVD write speed and amount of data written, but with a 15 minute closing time (maximum) you can reckon on sizeable discs taking a good 45 minutes. Having said that, I burnt single test tracks in just minutes.

One of the reasons discWelder is quick and easy to use is that it is solely a disc burner. Preparatory work must be done beforehand using a music editing package and this is where things can get complicated and difficult, especially with surround-sound. Six synchronised tracks must be available to burn to DVD if you want to produce your own surround-sound discs and these cannot simply be lifted from a commercial DVD without bumping into copy protection. You'd need typically an M-Audio Delta 66 soundcard which has six analogue channels in of 24/96 to

import analogue, or a 24/192 consumer sound-card with stereo (two channels) in.

Computer requirements are a PC running Windows 98, 2000, NT or XP, with 10GB of unused disc space. Macs are not supported. You will also need a DVD burner. Minnetonka make it a precondition of use that you register the software with them. They then send an activation key.

I encountered no problems with discWelder Steel. It installed perfectly and ran without a hitch. It does have limitations, and it isn't cheap. At the same time, there's nothing else like it and burning to DVD-A gives you a lot more flexibility than burning to CD, with its two tracks of 16/44.1. Of course you do need a DVD-A player to play the discs, but not necessarily a surround-sound system. In fact, at present, it's easier to work in high quality stereo; most consumer soundcards offer two inputs at up to 24/192 and sound editors commonly work in this format. I hope more basic editing packages appear to support it, as they have done for transferring camcorder footage to DVD Video.

DiscWelder has appeared on the market so quickly the computer business has yet to contemplate its implications it seems to me, let alone react to them with hardware and software for consumer use. As it stands though this package opens up DVD-A to the man on the street, albeit with a few bob to spare, and in doing so extends the range of opportunity available to audio enthusiasts. It's much more flexible and powerful than a CD burner.

Tube Shop

.com

a lot easier!

'My tubes are impossible to get hold of'

Visit The Tube Shop
www.tube-shop.com



You can even telephone your order
0870 9220404

Why choose Tube-Shop.Com

- Over 2,500 different tube types in stock at all times
- We offer you the best prices around, Guaranteed
- UK's first fully online tube ordering system
- Expert matching service by PM Valve Labs
- We sell only the world's BEST brands
- Next day delivery (if ordered before 3pm)
- Free delivery (on all orders over £50)
- MONEY BACK GUARANTEE
- Trade enquires welcome

beyer dynamic



AURAL STIMULATION

Distributed by: Henley Designs
01235 511166 www.henleydesigns.co.uk
e-mail: info@henleydesigns.co.uk

MANTRA AUDIO

Specialist Suppliers of Audio Accessories
www.mantra-audio.co.uk

CARTRIDGE SELECTION		STYLUS	REPLACEMENT STYLUS
Goldring 006	£76	£62 GEX	Best Quality Diamond Stylus
1012 GX	£95	£76 GEX	402 SLN Mk II
1022 GX	£124	£100 GEX	AM 5 AN 60
1042	£143	£114 GEX	AN2 AN 70
Erica LX/H	£133	£109 GEX	DN 145 E DN 165 E
Elite	£232	£190 GEX	G800

GEX - Exchange price for a Goldring Any make/model of cartridge accepted

Audio Technica AT 95 E	£23	£15	DT 55 DT 80
AT 110 E	£28	£16	DT 55 DT 80
AT OC 9 ML	£330	£280 EX	DT 55 DT 80
Denon DL 110	£79		DT 55 DT 80
DL 160	£95		DT 55 DT 80
Grado Prestige Black	£40		DT 55 DT 80
Prestige Gold	£110	£73	DT 55 DT 80
Ortofon S10 Mk II	£34	£22	DT 55 DT 80
MC 15 Super II	£130	£110 EX	DT 55 DT 80
MC 25 FL	£227	£193 EX	DT 55 DT 80
MC 10 Supreme	£304	£258 EX	DT 55 DT 80
MC 20 Supreme	£382	£323 EX	DT 55 DT 80
MC 30 Supreme	£452	£385 EX	DT 55 DT 80
Kontrapunkt B	£643	£548 EX	DT 55 DT 80
Rohmann	£837	£742 EX	DT 55 DT 80
Shure M 97 XE	£98	£58	DT 55 DT 80
V 15 V XMR	£304	£204	DT 55 DT 80
Sumiko Blue Point Special	£265	£237 EX	DT 55 DT 80

*** Over 500 Stylus Types Stocked ***

HEADPHONE SELECTION	
GRADO	
Prestige Series	SR-60 £85
	SR-80 £104
	SR-125 £152
	SR-225 £199
	SR-325 £294
Reference Series	RS-1 £641
	RS-2 (new) £495

All items guaranteed authentic new originals
see our website for full selection of accessories
order direct from our secure online catalogue

MAIL ORDER (1-10 DAYS) PRICES (INC P&P) + INSURANCE FOR UK DELIVERY - £5 FOR EUROPE DELIVERY & £12 FOR US/WORLDWIDE DELIVERY TO COVER INSURANCE ON ORDERS OVER £50 VALUE

Tel/Fax (01757) 288652 e-mail: enquiry@mantra-audio.co.uk
MANTRA AUDIO (MFW), 22 GARTH AVENUE, NORTH OUFFIELD, SELBY, NORTH YORKS YO8 5RP

noel keyword



Done properly, vinyl can make Compact Disc quake in the light of its laser! Spin a 45rpm single and you'll wonder how we ever could have got rid of the LP - it's a devastating sound. But it's very sensitive to the components you use with it, and most certainly not the same as a 'plug and play' CD player. A quality turntable, arm and moving coil cartridge combination makes it sound fabulously open and dynamic, but it's downright mediocre - or worse - with a cheap deck and poor ancillaries. So, if you're wondering whether it's worth getting a record deck to play LPs, or more likely whether it is worth upgrading to hear what's possible from this superb format, here are a few personal views.

Whilst I have always had reservations about belt drive - and this country's obsession with it - I have no reservations at all about British pickup arms. Led by SME, they are the best! If you can't afford one of these, then I am going to recommend you buy Rega! It was Roy Gandy who had the courage and determination to design and manufacture what I believe is the first one-piece cast alloy tone arm, and sell it at an affordable price. It's tapered tube is a strong, consistent and well damped structure without mechanical couplings like a detachable headshell. When the Rega appeared we all learnt what a properly designed pickup arm could do, and even SME relegated detachable headshell models after this! Rega built its business on that one product, which has been exported in quantity around the world. If you want to begin to hear LP properly, get it! This arm is a

great starting point, responds brilliantly to tweaks and provides a useful anchor for my next recommendation.

The least expensive cartridge you can buy that gives good results is a Goldring 1042. Don't get anything cheaper! I've heard all the budget cartridges and in my view

„ A quality turntable arm and moving coil cartridge combination makes it sound fabulously open and dynamic, but it's downright mediocre - or worse - with a cheap deck and poor ancillaries.

they do LP no favours at all, making it sound leaden, dull, flat or just nasty. If you want something better, then Shure's V15VxMR is a great option - but Shure needs to package it better. The bodywork is a disgrace compared to, say, Ortofon's beautifully built Supremes. It needs a solid, resonant free body that is easy to fit, with pre-threaded fixing holes, and one that's easier to align too. A 1gm tracking force is also outdated and unnecessary; fine line styli will work much higher without exceeding the plastic limit of vinyl and 1gm in a bouncy suspended sub-chassis turntable is asking for trouble! All the same, this - or the cheaper 1042 - is your starting point for serious LP reproduction.

After using a swathe of turntables, including the intriguing Lux PD131 vacuum deck, I am at present wedded to a Garrard 401 for its rock-solid timing and explosive bass. The Japanese know a

thing or two about real hi-fi and Direct Drive has always been a part of that country's hi-fi scene, unlike Britain. The Garrard is a feedbackless rim drive, where there's even less leverage against the motor, so Direct Drive isn't there yet, but it's got its strengths which you can certainly hear in the bass. Suspended belt drive turntables are generally clean, clear and 'easy' sounding, and are also very practical to make inexpensively. Keep an open mind about turntables - there are many ways to spin an LP and some of those overlooked by the UK hi-fi scene can work well when engineered and set up properly!

My final recommendation is the most difficult for me to make, but a column is a personal view and here I have one. Solid-state isn't 'ideal' in the phono stage. I've heard all the solid-state phono stages, including the best and nothing ever came close to the remarkable all-valve Audio Innovations P2. These days, I now use our own KLPP1 preamp. Solid-state sounds clean and tidy, but it wrings the life and soul from LP. You get a flat, dry but mechanical rendition without any sense of insight. Detailing, if there, seems contrived. It is in the phono stage that the delicate analogue signal can be made or broken, so beware! If price is at a premium then the new Creek OBH-15 is a great introduction to the black art of black plastic, but hear a good valve phono stage and you'll realise what an incredibly big, wide, open and expansive sound vinyl is capable of. By contrast, digital - even in its new, 'advanced resolution' guises, sounds closed in and mechanical. If you love music, you owe it to yourself not to miss out on analogue! ●

H I - F I

HOME CINEMA

MULTIROOM INSTALL

BUY / SELL

Quarterly Sale items

	Our Price	Original Retail Price
Exposure VII pre + XII psu	£450.00	£1,200.00
Magnum Dynalab P 200 Pre	£695.00	£1,900.00
dpa Enlightenment DAC	£295.00	£
Kenwood L1000C Pre	£295.00	£895.00
Kenwood L1000M Power	£395.00	£1,295.00
Michaelson Audio Odysseus	£495.00	£1,500.00
Sunfire 300 Power Amp (110 volts)	£695.00	£2,400.00
Arcam Delta 110 pre amp	£295.00	£750.00
McCormack Line Drive	£395.00	£995.00
Thule 5 Spirit CD	£495.00	£900.00
Audio Refinement Pre 5 "new"	£395.00	£895.00

New this month

POWER AMPLIFIERS

Krell KAV 250A	£1,795.00	£3,650.00
Cello Performance 2 Monoblocks	£7,995.00	£20,000.00
Krell K5A 250	£2,750.00	£6,000.00
Bel Canto Evo 4	£On Dem	£3,895.00
Krell K5A 80B	£1,395.00	£3,600.00
Roksan Caspian Integrated	£On Dem	£895.00
Roksan Caspian Power	£On Dem	£645.00
Quad 33/ 303	£295.00	-

PRE AMPLIFIERS

Meridian 201 Pre	£195.00	£900.00
Audio Research LS25 mk II	£4,250.00	£5,995.00
YBA 2a Line	£1,295.00	£1,995.00

LOUDSPEAKERS

Martin Logan SL3	£1,795.00	£3,400.00
JM Lab Mini Utopia + Stds Rosewood	£2,495.00	£4,899.00
Dynaudio Audience 50	£395.00	£577.00
JM Lab Nova Utopia	£On Dem	£19,999.00
Heybrook Sextet (new drivers)	£495.00	£1,200.00
Revel Ultima Studio	£7,495.00	£13,000.00
ATC SCM 10 Passive Black	£495.00	£1,100.00

CD PLAYERS & DACS

Chord 5PM 1600E Dac/ Pre	£3,250.00	£6,500.00
Krell KPS 253c 24/96	£11,995.00	£23,498.00
Roksan Caspian CD	£On Dem	£995.00

TURNTABLES, ANALOGUE, VARIOUS

Project RPM 6 "new"	£On Dem	£500.00
Musical Fidelity XLP Phono Stage	£75.00	£150.00
Project RPM9/ arm/ 25FL (Ex Dem)	£895.00	£1,350.00
VPI TINT mk IV/ Rockport 6000/ Flywheel/ VPI Stand/ Clearaudio Accurate/ Pump etc. "new"	£8,500.00	£16,000.00
Roksan Radius (Acrylic) "new"	£On Dem	£850.00
Roksan Caspian Phono se	£On Dem	£950.00
Ortofon Rohman (2 hrs)	£850.00	£1,050.00

AV COMPONENTS

Lexicon MC8 Processor	£On Dem	£5,000.00
Lexicon RT10 DVD Player	£On Dem	£2,300.00

Power amplifiers

Krell FPB 600c	£6,500.00	£14,000.00
Krell FPB 700cx	£11,995.00	£15,000.00
Krell FPB 400 cx	£9,600.00	£12,000.00
Naim Nait 3	£475.00	£608.00
Rowland Model 12 (4 chassis)	£8,995.00	£14,500.00
Michell Alecto Monoblocks	£995.00	£2,000.00
Cary 805 C Monoblocks "new"	£4995.00	£8,250.00
E.S. Lab DX-58	£On Dem	£2,000.00
Plinius SA50	£1,795.00	£2,700.00
Plinius 8200P	£On Dem	£1,550.00
Krell FPB 200	£3,995.00	£8,000.00
Krell FPB 600	£5,995.00	£12,998.00
Plinius 5A 102 "new"	£On Dem	£3,750.00
Musical Fidelity P180	£395.00	£900.00
Musical Fidelity CRPS	£395.00	£900.00
Bryston 4 B5ST	£On Dem	£2,350.00
Jadis Deyf 7 mk III	£2,750.00	£6,000.00
Mark Levinson No 27	£1,750.00	£6,000.00
Linn Bass Active Card	£69.00	£120.00
Gamut D200 "new"	£2,250.00	£3,250.00
Musical Fidelity F15	£95.00	£250.00
Audio Innovations S1000 mk III monos	£995.00	£3,000.00
Krell MDA 300	£4,995.00	£12,000.00
Cary SLA 70 mk II Silver	£1,295.00	£2,250.00
Boulder 500 AE	£3,495.00	£5,500.00
Linn Klassik CD/Amp silver	£895.00	£1,030.00
Boulder 1060 Power "new"	£On Dem	£16,500.00
Primare 30.1 mk II Integrated	£1,350.00	£1,500.00
YBA Passion Stereo "new"	£3,995.00	£5,995.00
Plinius 250 mk IV "new"	£On Dem	£6,350.00

AV components

AV COMPONENTS

Lexicon DC2	£1,995.00	£3,500.00
SIM 2 HT 300	£7,500.00	£9,000.00
Primare P30 Processor	£1,295.00	£2,000.00
Linn Klassik DVD	£On Dem	£2,000.00
Lexicon MC1 "new"	£3,000.00	£5,500.00
Lexicon MC12 / MC12B	£On Dem	£8100.00/ £8900.00
Loewe Xemix DVD "new"	£On Dem	£495.00

PLASMAS/LCD/PROJECTORS

From NEC/ Panasonic/Pioneer/Sharp from	£4000.00	POA
Electrograph Delphi/Selec/Sony/Sanyo	£4,995.00	POA
Panasonic TH-42 PWD5 "new"		

Pre amplifiers

DNM 3c Primus Pre (3c psu)	£1,195.00	£2,000.00
Tom Evans The Vibe Pre	£On Dem	£2,700.00
Krell KRC	£2,495.00	£6,949.00
Graff 13.5 Pre	£1,495.00	£3,000.00

Chord D5C 1500E (dac/pre)	£3750.00	£6,500.00
Audio Research LS7	£895.00	£1,800.00
Audio Research LS1	£795.00	£2,000.00
Audio Research LS3	£895.00	£1,997.00
Musical Fidelity F22	£695.00	£1,500.00
AVI S2000 MP remote pre	£395.00	£800.00
Cary 5LP98L Remote Pre x-dem	£1495.00	£2,794.00
Boulder 1012 (pre amp/ 24.96 dac/ Phono)	£On Dem	£13,000.00
YBA Passion Pre (inc Phono)	£3,995.00	£5,595.00
Boulder 2010 Pre	£POA	£30,000.00
Plinius 16L "new"	£On Dem	£3,200.00
C.A.T. ultimate reference Pre Amp Inc/Phono "new"	£On Dem	£5,750.00

Quality speakers

JM Lab Alto Utopia BE	£On Dem	£9,999.00
Wilson Witt mk I	£3,750.00	£9,000.00
Avante Garde Duo (White)	£4450.00	£8,000.00
JM Lab Utopia	£8995.00	£18,000.00
JM Lab Mini Utopia + Stand	£2,495.00	£4,700.00
B&W Matrix 805 (Walnut)	£295.00	£650.00
ClaraVox Magnifica	£5,495.00	£14,500.00
JM Lab Micro Utopia + Stand	£2,195.00	£4,349.00
Wilson 5.1	£7,995.00	£19,600.00
Reference 3A	£1,750.00	£2,250.00
Audio Physic Spark	£1,150.00	£1,795.00
Talon Kite Centre & Bracket	£795.00	£1,750.00
Ensemble PAI	£895.00	£2,000.00
Audio Physic Caldera	£4,995.00	£10,000.00
Aerial Acoustic 5W12 Sub Woofer, Maple/remote	£2,995.00	£5,200.00
Mirage M3 si	£1295.00	£4,100.00
Linn Kabers (Active)	£995.00	£2,500.00
Rel Q 200 E	£On Dem	£650.00
Rel Q 150 E	£On Dem	£500.00
Audio Physic Luna Sub (wood)	£On Dem	£1,799.00
Audio Physic Yara	£On Dem	£999.00
Vienna Acoustics Mahler	£On Dem	£6,000.00
Vienna Acoustics Mozart	£On Dem	£1,700.00
Vienna Acoustics 5.1	£On Dem	£3,500.00
Cabasse io 5.1	£On Dem	£2,170.00
JM Lab Sib & Cub (5.1 spk sys)	£On Dem	£859.00
Blue Room Minipod (White)	£225.00	£298.99
Blue Room Minipod + Sub (Blue)	£625.00	£749.00
Blue Room Minipod Sub	£415.00	£468.99
SD Acoustics 5D1	£595.00	£1,650.00
Genelec 205 Active Monitors	£On Dem	£750.00
Audio Physic Virgo III "new"	£On Dem	£4,000.00
Audio Plan Contrast 3	£995.00	£3,200.00
Audio Physic Tempo III "new"	£On Dem	£2,000.00
Naim SBL's	£995.00	£2,225.00
Rogers L555 "new"	£260.00	£430.00

CD players DACS

Musical Fidelity NuVista cd	£2,495.00	£3,000.00
Sony SCD1 SACD	£2,495.00	£4,000.00
Theta Data Pro Basic IIIa	£1,795.00	£3,495.00
Bow Wizzard 24/96	£995.00	£4,000.00
Theta D5 Pro Prime II a	£995.00	£1,800.00
Mark Levinson M1 31	£3,750.00	£9,000.00
Trichord PD-S 503	£295.00	£500.00
Pink Triangle Ordinal	£295.00	£600.00
YBA CD I Delta (Twin psu)	£3,995.00	£5,500.00
Audio Synthesis DAX	£1,995.00	£4,000.00
Krell KPS 20i	£3,795.00	£9,900.00
Linn Karik Numerik	£1,595.00	£3,300.00
Mark Levinson 39	£2,995.00	£5,000.00
Marantz 17 Ki Sig (Black & Gold)	£695.00	£1,200.00
Myriad MDV 200 DVD	£750.00	£995.00
YBA CD 3 Delta	£On Dem	£2,200.00
Audiomeca Damnation CD Transport	£750.00	£1,600.00
Primare V20 DVD/CD	£750.00	£1,000.00
Audio Aero 32/192 Capitole CD (Ver. 4)	£On Dem	£4,500.00
Primare V25 CD/DVD	£On Dem	£1,000.00
Theta Pro Geny	£595.00	£1,295.00
Boulder 2020 dac	£POA	£24,000.00
Theta Data II Transport AT + link	£1,995.00	£4,000.00
YBA CD Integre "new"	£On Dem	£1,195.00

Turntables & analogue

Tara Lab Decade 8ft pair	£895.00	£2,000.00
Transparent Ref 20c Spk	£3,295.00	£5,000.00
Loricraft record cleaning machine	£On Dem	£1,100.00
Lyra Beta	£525.00	£595.00
Tara Labs The One Balanced Im	£999.00	£2,250.00
Earmax Pro	£On Dem	£425.00
Revox B160 Tuner	£450.00	£995.00
Decca London Gold (original Garrott Brothers)	£495.00	£ Priceless
5ME 30/2 A "new"	£10,495.00	£12,289.00
Moth Record Cleaning m/c	£395.00	£
Project RPM4/ Ortofon 510 "new"	£On Dem	£325.00
Ortofon Rohman	£On Dem	£1,050.00
Ortofon Kontrapunkt a/b "new"	£On Dem	£500.00/ £750.00
Michell Gyro SE/ RB300 "new"	£On Dem	£1,100.00
Michell Orbe/QC	£1,495.00	£2,200.00
Audio Synthesis Phono Eq mm/mc	£795.00	£
Gryphon Phono Pre-Amp (dual mono) Head Amp	£795.00	£1,600.00
SME Series V Arm "new"	£1,350.00	£1,650.00
Pink Triangle PT Ext psu	£495.00	£
Plinius 14 Phono "new"	£On Dem	£2,750.00
Nackamichi DR 3	£195.00	£400.00
Tom Evans - The Groove "new"	£On Dem	£1,795.00
Clear Audio Reference Mc phono stage X-demo	£1,695.00	£2,065.00
Rega Planer 3 + Hi Fi News Out Board Power Supply	£320.00	£423.00
Clear Audio Symphono phono stage X-demo MM/MC	£640.00	£740.00
Lavardin Reference Phono "new"	£On Dem	£2,500.00

* Reduced this month

Choice hi-fi

you choose

Choice hi-fi make it easy for you to fulfill your sonic dreams. Quality hi-fi is not just about expensive brandnames. It's about aspiring to the very best sound, about choosing your ideal system from the widest selection in the country, in a unique no-pressure environment.

your choice

- Acoustic Energy
- Advantage
- ATC
- Audible Illusions
- Audio Physic
- B.A.T
- Boulder
- Bryston
- Cary
- C.A.T.
- Chord
- Clear Audio
- Denon
- DNM
- Egglaston Works
- Electrograph Delphi
- Genelec
- Gryphon
- Graham
- Imerge
- J M Lab
- Krell
- Lexicon
- Linn
- Loewe
- Lutron
- Lyra
- Mark Levinson
- Michell Eng.
- Musical Fidelity
- Naim
- NEC
- Nordost
- Oracle
- Ortofon
- Plinius
- P.M.C.
- Primare
- Project
- Quadraspire
- REL
- Rockport
- Roksan
- Rotel
- Ruark
- Seleco
- SME
- Straight Wire
- Sugden
- Tara Labs
- Teac
- Totem
- Transfiguration
- Trichord
- Trilog
- Van den Hul
- VPI
- Wilson Audio
- Wilson Research
- YBA

tel: 020 8392 1959 & 020 8392 1963
fax: 020 8392 1994 info@choice-hifi.com

Open from 10am to 6pm Mon-Sat and other times by appointment.
Buy, sell, exchange quality hi-fi equipment.

We accept all major credit cards. Finance available subject to status

dominic todd



SACD is Sony's next MiniDisc. The two formats may not have a great deal in common, of course, yet there's more that links these two than first meets the eye. Both are, or were, new technologies pretty much developed solely by Sony. One only needs to take a look at the Patent register to see evidence of this. Sony has invested a great deal of time and money in both formats. SACD, rather like MiniDisc is a technology it simply can't afford to let slip. Rather like MiniDisc, SACD has been slow to capture the public's attention. Slow, at least in DVD terms, which changed the whole meaning of a "fast growing new technology". It also appears blighted by the near simultaneous launch of what appears a superior rival. In this case it's DVD-A; with MD it was the domestic availability of affordable CD-R.

A year ago or so it appeared that SACD really was up against it. Most of the DVD manufacturers were choosing DVD-A for their new mid-range machines. Toshiba, JVC and Panasonic all chose DVD-A, with only long-term ally, Philips, joining Sony in the SACD cause. Pioneer, of course, played it safe by offering both on their highly rated DV-656 machine, but they were alone on this, at least at this price level. More recently, budget machines from Limit and Cambridge have been launched with DVD-A now being available from £150. Yet Sony doesn't seem in the least perturbed, and may well be about to turn the tide, and replicate the fortunes of MiniDisc, through a combination of clever marketing and, unlike MD, massive software back up.

After patchy success with marketing SACD with conventional CD players Sony have taken the initiative and placed SACD chipsets in their hugely popular DVD lifestyle

"DAV-S" systems. Usually a manufacturer will filter a new technology down from the highest models, with the lifestyle system being the last to benefit, if at all. How many such systems ever featured HDCD for example? So it's a bold move for Sony to present a brand new technology to a mass market in such a short period of time. Bold, yet also particularly shrewd. This is a new

” Usually a manufacturer will filter a new technology down from the highest models, with the lifestyle system being the last to benefit, if at all.

technology being showcased to customers without them even being aware of it. I'd wager that very few customers cite SACD compatibility as a reason for buying a Sony DAV-S system. Yet, as the new range of discs become more readily available there is already a target audience waiting without them even realising it!

Of course, unlike MiniDisc, the crucial aspect of SACD is the software. Yet it's here, rather than the hardware, that we've seen the greatest advances of late. Universal Music International (UMI) has joined forces with Sony and Philips to promote the new format. UMI and Sony Music combined should do much to drive volume and competitive pricing. Then there's also EMI, Virgin, Zonda and a number of smaller independents all with current SACD catalogues and looking to expand. There are already over 650 SACD titles available in Europe and clever hybrid marketing allows for sales to be boosted by many who don't even have SACD players. By hybrid I mean discs which feature

both a conventional CD layer and an SACD one, allowing the disc to play back on a conventional player. Provided the disc is already available on CD this is hardly a strategy that will bring the punters flocking, yet when a release is on hybrid only, then the format can hardly fail to gain sales. Take a look at the huge sales success of Pink Floyd's, "Dark Side Of The Moon", recently re-launched in hybrid only, to see such an example.

Fortunately it's not only the old rock stalwarts that are being dusted down and split into multi-channel. Current doyen of the vocal world, Norah Jones, has just released her latest album in the new format.

So far so good, then. From unpromising beginnings, Sony has managed to infiltrate the mass market with its own

products, and the signs look promising for SACD from the music producers too. The next few weeks will be the real test though, for it's this time of year when the manufacturers launch their new ranges. It will be interesting to see just how many other manufacturers are prepared to nail their colours to the SACD mast as they did to DVD-A last year. A further fly in the ointment is that it's becoming apparent that certain DVD players simply refuse to replay some of the hybrid discs, Cambridge's DVDS7 (DVD-A equipped remember) being one of them. If Sony really want to win over the public, they're going to have to work on these compatibility issues, because this is just the sort of thing that most annoys the consumer. If they manage to sort out these teething problems and the record companies really do come up with the goods, then it may be the case that DVD-A will really have a fight on it's hands. That's something that many wouldn't have thought possible just a few short months ago. ●

Totally Wired

David Price tries out two simple ways to enrich your musical experience...

IXOS XHT611 £49.99
WWW.IXOSCABLE.COM

The one over-riding advantage that SACD has over DVD-A is that you don't need a monitor to use it. Sure, DVD-A's advocates have been claiming for years that if you drop a disc into the open tray and press play, it will play at maximum resolution without you having to scroll through an onscreen menu. While this happens sometimes, it doesn't work all the time - the result is that you need a video display if you're going to use DVD-A seriously. As such, you can either buy a dedicated mini LCD monitor, to stand on top of your system, or plug your DVD-A spinner into your plasma or TV.

Either way, you're going to need a SCART. Of course, most TVs come with them bundled, but they're invariably of the 'get you going' type. This IXOS is a different breed. Flat and flexible, you can run it under your carpet or mat to your TV. Result - an elegantly inconspicuous solution to the problem of getting your DVD-A and TV to work with one another harmoniously.

A fully wired 21 pin SCART to SCART cable, it boasts Twin Screen technology to reduce RF (radio frequency) interference, a rigid alloy SCART plug, high tensile 24kt hard gold plated signal connector pins and IXOS 'High Grade PC OFC' cable. This is a low loss design using Aluminium-Mylar foil wrap and Oxygen Free Copper braids. The rear entry design lets the cable drop immediately behind a piece of equipment, giving a neat space-saving install. As well as the long 3m version for £49.99, it's available in 1.5m

(£44.99) and 0.75m (£39.99).

The XHT611 gives superb pictures. While there are undoubtedly better designs available, you'll have to pay far much more for the privilege. This turns in deeply impressive colours, with fine contrast and image definition. There's a dramatic difference compared to bundled types - even the audio, through the TV's own speaker, sounds cleaner! Recommended for those grappling with the thorny issue of incorporating video into their audio systems.

SUPRA LO-RAD £49.99
WWW.JENNING.SE

In the great pantheon of hi-fi 'tweaking', mains cables are hardly the most exciting. While some can easily get inspired by exotic formulations of audio wiring with brightly coloured dielectrics and swish gold phono terminations, few find thick cables with moulded IEC plugs particularly sexy. Mains is vitally important to the correct functioning of your system however, and once you've got a clean electricity supply (preferably with a separate spur taken from your house's main fuse box), you'd be a fool to throw it away by using the thin, black spindly mains leads supplied by manufacturers.

Supra's LoRad is one such example. A CE-approved mains cable, (unlike many rivals), it is suitable for home DIY'ers to terminate with their own choice of mains connectors such as MK Toughplug, Schuko and IEC320 connectors. Our review cable came with a tough 13A 3-pin plug on one end and a rigidly moulded IEC on the other. In

between the braids are three mm cores of tin-plated OFC cable (with Brown (Live), Blue (Neutral) and Green/Yellow (Earth) coloured insulation jackets), semi-conductive earth insulation and a 99.99% coverage foil screen. The outer insulation is highly flexible (unlike some I could mention) - Supra say it easily passed the CE-regulation '20,000 bends' test! It is rated at 20A.

Sound is superb - it's a major advance over bundled IEC wires, providing you clean the 13A plug pins with isopropyl alcohol first. Preferably you should actually polish them with T-Cut or Brasso beforehand too, although some might find this a little excessive. Essentially, the LoRad brings smoothness, depth and detail. It removes the tinny, clangy, hard midband of the standard offerings, and takes you deeper into the music - letting your system really do its stuff. Despite its modest price, you might be surprised how much difference this can make - more than many 'snazzy' interconnects, for example. This, of course, depends on your system being good enough to exploit it, but I'd say it's worthwhile with any CD player or amplifier from around £300 upwards. Recommended.

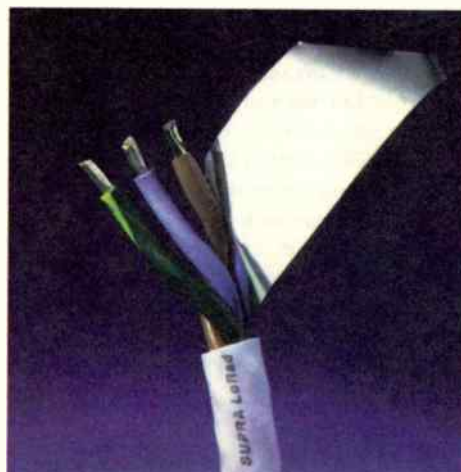

David Price



However interesting the likes of upsampling and re-clocking may be, I'm afraid the latest developments in digital technology simply can't compare with the theory and practice of analogue audio – and specifically, turntables.

In essence, the problematic of vinyl replay is a simple one. A stylus traces a groove as faithfully as possible, which itself rotates at a constant speed. Practically speaking however, there's a dizzying amount of mechanical processes at work which conspire to make this nigh-on impossible. Trying to engineer the perfect turntable is like chasing rainbows.

Countless compromises have to be arrived at, from the type of stylus profile and cartridge suspension to the pivot design of the tonearm and even its basic geometry. These aforementioned points are hard enough to crack, but when you get right back to basics – to the design of the deck itself – is when things start getting seriously tricky. By comparison, the theory of pulse code modulated digital audio seems like a walk in the park!

Along with the need to resist ground and air born vibration and possess a high quality main bearing (if these two weren't hard enough), turntables have to spin at a constant speed. This is where things get truly tricky, because the stylus tracing the groove actually effects the speed of the record's rotation. On louder, more heavily modulated peaks, the mechanical resistance provided by the groove causes the platter to slow down ever-so slightly. This is called 'dynamic wow', and when you get to the realms of high end analogue audio, it's a terribly tough nut to crack, because so many of

the other problems (feedback resistance, arm bearing quality, etc) have been dealt with.

Dynamic wow manifests itself in a very subtle way. For the benefit of our digital friends, think of it as a kind of jitter. It softens the sound, giving it a vague and unrhythmic nature – whereas a little bit of 'warmth' doesn't go amiss with

” **The theory of pulse code modulated digital audio seems like a walk in the park!**

digital, it's precisely what you don't want from analogue.

How then to deal with it? This takes us to one of my favourite hi-fi 'great debates' – belt drive vs. direct drive. The former is by far the most cost-effective solution, as the belt absorbs much of the motor noise. However, unless a seriously heavy platter is used, it can't stop this 'slowing effect' of the stylus when it hits loud passages. Recently, many manufacturers have moved from the once-obligatory Philips (nee 'Impex') 24-pole AC synchronous motor – as found on Linns, Regas, Aristons, etc. – to DC designs. These tend to be more speed stable, and throw less 'mush' into the system from the mains. And some decks, such as Origin Live and Michell for example, drive their platters from the periphery via a long thin rubber belt. In theory at least, this is better, because – just as with the gears on a bicycle's back wheel – driving from the inner platter simply amplifies any speed variations the motor may possess.

Still, my belief is that belt drives, no matter how well done, cannot completely eliminate dynamic wow.

Direct drives – when properly implemented – stand a better chance because they don't rely on a complex (and compliant) system of motor, motor pulley, drive belt and inner/outer platter to transmit the speed. Rather, the motor drives the platter directly. However, its small speed errors are also amplified – because they're driving the platter right from the very centre, so a feedback loop is used. Some manufacturers, such as Sony and Denon, use a magnetic strip imprinted on the inside of the platter's outer rim, in conjunction with a magnetic pick-up much like a 'tape head', to report back to the motor's speed governor on how fast

or slow the system is going. The motor can then correct its speed by providing more or less power.

To my ears, a well implemented DD with seriously accurate quartz crystal referencing and a substantial platter is capable of a tightness and a rightness that belt drive decks rarely attain – the trouble is, there aren't many such designs around, especially not affordable ones, as the likes of Sony's PS-DJ9000 proves!

Idler drives are an older variant of direct drive, and in a sense, purer. Here, a torque motor drives the inner rim of the outer platter directly via an 'idler wheel'. The trouble with these is that they were discontinued long before serious speed compensation systems (such as Quartz Lock) were devised, so they rely instead on an altogether more 'Neanderthal' approach of a massive, torque motor driving the rim, and to hell with noise considerations. The result is – as my visit to Garrard reminded me – a brilliantly powerful, tight and engaging sound. The downside is cost – the Garrard 501 is utterly exquisite, but very pricey. You pay your money and take your choice. ●

dial a dealer

This is a comprehensive directory of Hi-Fi Dealers throughout the UK and Ireland.

BEDFORDSHIRE

RICHARD'S AUDIO VISUAL 4 Greyfriars Bedford. Tel: 01234 365165. Stockists of: Arcam, Audioquest, Beyer, B&W, Bose, Cable Talk, Cyrus Denon, Marantz, Mission, Moth, Ortofon, Pioneer, Pro-Ject, Quad, REL, Rotel, Ruark, Sennheiser, Sound Style, Stands, Unique, Teac, van den Hul & more! Expert friendly service - Listening room. Pioneer Reference Point. Visa / Access.

BRISTOL & BATH

THE RIGHT NOTE Tel: (01225) 874728. Just think: most audiophiles listen for most of the time to systems that are 'not quite right'. Are you happy with yours? Forget the reviews and trying to put together a system like a patchwork quilt with the 'best' bits around. Its our job to do the assessing, you judge our results. We'll help you to plan a system for the future, even if you spread the purchases. Leave the 'up-grade-itis' behind, save money and enjoy music all the time. Just listen, and you'll know. CD: Acuras, Audio Synthesis, Classe, DCS, Enlightened Audio Design, Meracus, Orelle, Wadia, XTC. Vinyl: Basis, Crown, Jewel, Graham, Michell, Sumiko, Transfiguration. Amps: Acuras, Audio Sculpture & more. Speakers: Audio Artistry, Audio Physics & more. Tuners: Fanfare, Magnum Dynalab & many more. Cables: Chord, DNM, Silver Signals & more. (Credit Cards Accepted).

VAUDIO HiFi Consultants: 36 Druid Hill, Stoke Bishop, Bristol BS9 1EJ. Tel: 0117 968 6005. ATC, AVI, Alon, Audio Analogue, Audiomeca, Cadence Valve, Chord Amps, Electrocompaniet, Harman Kardon, Heybrook, Jamo, LFD, Lyra, Opera, Ortofon, Pink Triangle, Ruark, Mark Levinson, Michell, REL, SME, Shearman, Sonic Link, Sugden, Townshend, Triangle, Unison Research Valve Amps. Home Cinema demonstrated including, A/V Amps, DVD Players, Video Projectors and Screens. Demos by appointment only. Home trial facilities. Free installations. We are not a shop.

BUCKINGHAMSHIRE

NORTHWOOD AUDIO 98 Cambridge St, Aylesbury, Tel: 01296 428790. Established since 1992. Independent specialist retailer. Extensive Hi-Fi, A/V and Multiroom experience catering to your needs. From Vinyl to SACD, Valve to Solid State, from LCD to Plasma, Audiomeca, Audio Note, Cable Talk, Castle, Chord, The Chord Company, Cura, Denon, Elac, Epos, Exposure, Heart, JM Labs, KEF, Linn, Marantz, Michell, Micromega, Monitor Audio, NAD, Nakamichi, PMC, ProAc, Quadraspire, Rega, REL, Revox, Roksan, Rose, Rotel, Ruark, Sony, Sennheiser, Sonus, Talk Electronics, Tannoy, Teac, Tube Technology, Videologic, Vienna Acoustic. Export orders welcome. 2 demo rooms. Credit facilities available. Website: www.northwoodaudio.co.uk Email: info@northwoodaudio.co.uk

TECHNOSOUND 8 Granville Square, Willen, Milton Keynes, MK15 9JL. Tel: (01908) 604949. Fax: (01908) 202166. Audiophile Hi-Fi and Home Cinema specialists. All major brands stocked from Arcam to Yamaha. Meridian Digital Home Theatre dealer. Video projection, Plasma screens. Custom installation. 2 dem rooms and expert advice. Email: hifi@technosound.co.uk www.technosound.co.uk

CAMBRIDGESHIRE

THE AUDIO FILE 41 Victoria Road, Cambridge. Tel: 01223 368305. For the best in British Hi-Fi and Home Cinema entertainment. Visit or call to arrange a dem with products from: Arcam, Linn, Naim, Rega, Cyrus, Absolute Sounds, Kef, Sony, Yamaha, Rel, Ruark, Denon.

CHESHIRE

ACOUSTICA 17 Hoole Rd, Chester CH2 3NH. www.acoustica.co.uk Tel 01244 344227. All the best in HiFi & Home Cinema from Naim, Rega, Rotel, Sugden, Tube Technology, Primare, Isotek, Harman Kardon, Teac, Acoustic Energy, JM Lab, B&W, Sendor, Royd, REL, Quadraspire, SIM2 & Sanyo projectors and much more. We offer full demonstration facilities. Interest free credit and delivery & install systems throughout Cheshire, Merseyside & North Wales. Opening hours are Tuesday to Saturday 10.00 to 5.30.

ACTON GATE AUDIO 4 Ruabon Road, Wrexham, North Wales. Tel: 01978 364500. Audio Visual Specialists. Arcam, Audio Analogue, Bose, B&W, Celestion, Castle, Denon, Harmon Kardon, Jamo, Marantz, Michell, Mission, Onkyo, Pro-Ject, Musical Fidelity, NAD, Micromega, Myrad, QUAD, Radford, Rotel, Ruark, Tannoy, TDL, Teac, Thorens, UKD, Unison Research, Yamaha, DSP Club Member, Demo Room, installation service. Easy Parking and Motorway access. All major credit cards accepted. 9.30 - 5.30 daily. Closed Sunday & Monday.

DOUG BRADY HI-FI Kingsway Studios, Kingsway North, Warrington, WA1 3NU Tel 01925 828009 Fax 01925 825773. Visa, Mastercard. Lombard Tricity, 2 dem rooms, home trial; Agencies include: Arcam, Tag McLaren, AVI, B&W, Castle, Caspian, Chord Electronics, Exposure, Harbeth, Heybrook, Krell, LFD, Michell, Meridian, Musical Fidelity, Monitor Audio, Naim, Nautilus 800 series, Pink Triangle, ProAc, Roksan, SME, Wilson Benesch, XTC and many more.

CORNWALL

SOUNDS PERFECTION Cornwall's most exclusive Audio retailer. Agencies include: Audio Analogue, Audio Design, Audio Note, AudioQuest, Audio Spectrum, AR, Avid, Border Patrol, Boston, Dynavector, Electrocompaniet, Graaf, Henley, JM Labs, Lexicon, Michell, Monitor Audio, Musical Fidelity, Ortofon, Parasound, Primare, Project, NAD, Nakamichi, Nordost, Philoshophy, REL, Roksan, Ruark, Rotel, Totem, Tom Evans, Tsunami, S.M.E., Sugden, Stands Unique, Unison Research, Teac, Vienna Acoustics, Triangle, Trichords, VVB, Sonic Link. Home Demonstrations by Appointment. Tel/Fax: 01326 221372 Mobile 07798 554357 email nigel@soundsperfection.co.uk website www.soundsperfection.co.uk

DEVON

AUDIO DESTINATION Hi-Fi/Home Cinema specialists. 2 demonstration rooms, child's play area. Interest free credit. Relaxed friendly service. Systems/components to suit all budgets. Musical fidelity, Ruark, Monitor Audio, Nad, Roksan, Project, Primare, Nordost, Chord plus many more tel 01884 243584. fax 01884 258887, email: audiodestination@btconnect.com

DORSET

MOVEMENT AUDIO 588 Ashley Road, Poole, Parkstone, Dorset BH14 0AQ. Tel: (01202) 730865/380018. Arcam, B&W, Castle, Chord Electronics, Cyrus, Denon, Marantz, Michell, Mission, Pioneer, Tannoy Dimension, Yamaha. 2 Dem rooms. Listen to the available choice and decide at your leisure - no pressure, no obligation. Our staff enjoy music, with our choice of products, you can too! Service Department. Free installation. Home trial facilities. Access, Visa, Amex, Diners Card. Credit facilities available. Open Tuesday-Saturday 10-5.30. www.movement-audio.co.uk

MOVEMENT AUDIO 926 Wimborne Road, Winton, Bournemouth, Dorset, BH9 4DH. Tel: (01202) 529988/520066. Arcam, B&W, Denon, KEF, Marantz, Mission, Musical Fidelity, Opera, Pioneer, Quad, Roksan, Ruark, Yamaha. Full dem facilities available, also home dem. Friendly expert advice. Service Department. Free installation. Home trial facilities. Access, Visa, Amex. Open Tuesday-Saturday 9.30-5.30

DAWSONS OF WESTBOURNE Home Cinema Specialists. Main agents for Bang & Olufsen, Harman Kardon, JBL, REL, Mordaunt Short, Sony, Technics and TDL. Demonstration facilities include our unique Dolby pro-logic system comparator for the ultimate way to choose the perfect system. Also on demonstration large screen televisions from Thomson, Sony and Ferguson with video projectors from Sharp and Selec. Dawsons, 23 Seamoor Road, Westbourne, Bournemouth 01202 764965

WEYMOUTH HI-FI 33-35 Maiden Street, Weymouth, Dorset DT4 8BA. Tel (01305) 785729/766345. Arcam, B&W, Denon, KEF, Marantz, Mission, Musical Fidelity, Panasonic, Pioneer, Quad, Sony, Tannoy, Yamaha. Dem room. Friendly professional advice. Only quality hi-fi dealer in Weymouth area. Service Department. Free installation. Home trial facilities. Access, Visa, Amex, Switch, Delta Mastercard. Interest free credit. Instant credit. Open Mon-Sat 9.30-5.30

ESSEX

GRAYSTON SOUND & VISION 33 Sir Isaac's Walk, Colchester. (01206) 577682. Alchemist, Arcam, B&W, Boston Acoustics, Castle, Denon, Harman Kardon, KEF, Linn, Loewe Opta, Meridian, Michell, Musical Fidelity, Philips, Pioneer, Project, Rotel, Sennheiser. Superb demo rooms, free regional delivery and installation. Regular musical and surround evenings, home demonstrations. Excellent credit facilities.

GLOUCESTERSHIRE

THE RIGHT NOTE - Bath. For specialist advice and home demonstrations. See [BATH & BATH](#).

HEREFORDSHIRE

ENGLISH AUDIO 37 Whitecross Road, Hereford, HR4 0DE. (01432) 355081. Arcam, A.T.C., B&W, Castle, Cura, Cyrus Centre, Elac, Denon, JM Lab, KEF,

Loewe, Marantz, Mission, Musical Fidelity, NAD, Naim, Pink Triangle, Pioneer, Project, QED Systemline, REL, Rotel, Ruark, John Shearman, Stax, System Audio, Teac, Vienna Acoustics, Wadia, and Yamaha. Single speaker dem room, home trial facilities, free installation, service dept, Access/Visa, Credit arranged. Open Mon-Sat, 9.30-5.30pm. BADA members.

HERTFORDSHIRE

AUDIO FILE (THE) 27 Hockerill Street, Bishops Stortford, Herts. Tel: (01279) 506576.

DARBY'S OF ST. ALBANS, 6 Market Place, St Albans, Herts. Tel: (01727) 851596. Fax: (01727 812217) Email: sales@darbystvhi.co.uk Hertfordshire's premier Hi-Fi/Audio Visual specialists established 1946. Full Home Cinema demonstration suite. Whether your needs are large or small, we stock it all: Arcam, Cyrus, JVC, Yamaha, Quad, Denon, Sony, Bang & Olufsen, Pioneer, REL, KEF, Mission, Ruark, Celestion and many more. Free planning service. Free Delivery and basic installation. Full workshop facilities. Open 9-6 Mon-Sat.

LANCASHIRE

ADVENTURES IN HI-FI 5, Bishopgate, off Hallgate, Wigan, WN1 1NL. Tel 01942 234202. For the best hi-fi and home cinema products from quality manufacturers including Naim, Rega, Cyrus, NAD, KEF, Denon, Dynavector, Rotel, Shahinian, JM Lab, PMC, Project, Quadraspire, Selec and Sanyo projectors. We offer friendly advice, excellent demonstration facilities, 0% finance, free delivery and installation throughout the North West. Opening hours 10.00 - 5.30pm Tuesday to Saturday evenings by appointment.

LEICESTERSHIRE

LEICESTER HI-FI 6 Silver Walk, St Martins Square, Leicester LE1 5EY. Tel: (0116) 2539753. Email: info@leicesterhifi.co.uk www.leicesterhifi.co.uk Arcam, B&W, Chord Electronics, Copland, Cyrus, Denon, Greig Loudspeakers, KEF, Marantz, Michell, Miller & Kreisel, Musical Fidelity, NAD, Nakamichi, Naudilus, Mission, Project, Rotel, Sanyo Projection, Talk Electronics, Teac, Technics, Yamaha, and many more. 4 Listening areas over 3 floors. We can demonstrate, deliver and install. Including A.V. and Multiroom. Credit Facilities. All cards taken, open 6 days 9.30-5.30.

LONDON

BABBER ELECTRONICS SERVICE CENTRE 158 Uxbridge Road, West Ealing, London, W13 8SB. Tel: 020 8579 6315. Akai, Aiwa, A&R, Celestion, Dual, Goodmans, Harman Kardon, JBL, JVC, Kenwood, Marantz, Panasonic, Sennheiser, Sony, ES range, Tannoy, Technics, Wharfedale, Yamaha and many more. Auth. Service Dept. Credit Facilities. Open 10.30 - 5.30 Mon-Sat.

INFIDELITY 9 High Street, Hampton Wick, Kingston-upon-Thames. Tel: (020) 8943 3530. for full details see entry under [SURREY](#)

HIFI EXPERIENCE 227 Tottenham Court Road, London W1. 020 7580 3535. Arcam, Cyrus, Denon Gold, Quad, Kef, Meridian, Yamaha, Marantz, McCormack, Mirage, Nakamichi, Musical Fidelity, PAFF and many more. Open 10.00-7.00 Mon-Fri, 9-6 on Sat. Service dept, Credit facilities, delivery and free installation.

THE LISTENING ROOMS 161 Old Brompton Road, London SW5 0LJ. (020) 7244 7750/59. Fax (020) 7370 0192. Linn, Quad, Meridian, Nakamichi, Arcam, Audiolab, Acoustic Energy, SME, Audio Research, Krell, Wadia, Theta, Apogee, Martin Logan, Pioneer, Tannoy, Systemdek, Stax, Pink Triangle, Michell, Monitor Audio, Yamaha, Marantz, KEF, Bose, Celestion, Epos, Mission, Denon, Neat Petite. Mon-Sat 10-6pm.

THOMAS HEINITZ LTD 35 Moscow Road, Bayswater, London, W2 4AH. Tel: 020 7229 2077. Fax: 020 7727 9348. Email: info@thomasheinitz.com. Web site: www.thomasheinitz.com. Established in 1952, Thomas Heinitz has a long history of providing the best music and AV systems available. We continue to offer the highest standard of service in the most relaxed atmosphere. Whatever your needs, from multiroom and home cinema to a high quality stereo system, we offer consultation, design specification, architect liaison and installation in order to ensure your system is tailored to your exact requirements. For quotes contact our manager Johnny Drum.

GREATER MANCHESTER

ADVENTURES IN HI-FI 5, Bishopgate, off Hallgate, Wigan, WN1 1NL. Tel 01942 234202. See our main entry under [LANCASHIRE](#)

MANCHESTER

REPLAY AUDIO 64 Flixton Road, Urmston, Manchester. M41 5AB Tel 0161 202 9922. Audio Analogue, Bryston, Creek, DNM, Exposure, LFD, Michell, Myrrad, NAD, Onkyo, Ortofon, Pink Triangle, Project, Sonneteer, Sugden, Trichord, Unison Research, Teac, Loudspeakers from Acoustic Energy, A.R.T. Audio Physic, AVI, Blue Room, Epos, Harbeth, Living Voice, Monitor Audio, Neat, PMC, Royd. Lots of cables and accessories available. We are just off Junction 10 of the Manchester Ring Road (M160), five minutes from The Trafford Centre. Our demonstrations are relaxed and informal and help and advice is free! Phone or visit our web site www.replaydial.pixep.com or email replay@dial.pixep.com

MERSEYSIDE

ACOUSTICA 17 Hoole Rd, Chester CH2 3NH. Tel 01244 344227. See our main entry under "Cheshire".

MIDDLESEX

RIVERSIDE HI-FI 422 Richmond Road, East Twickenham, Middlesex, TW1 2EB. Tel: 020 8892 7613 Fax: 020 8892 7749. www.riversidehifi.co.uk Arcam, Bose, B&O, Castle, Copland, Denon, Krell, Marantz, Martin Logan, Michell, Monitor Audio, Musical Fidelity, NAD, Pioneer, Project, Rel, Sonus Faber, Sony, Tag McLaren Audio, Tannoy, Teac, Theta, Wilson. Finance available. Subject to status. Written details available on request. Export orders welcome. UK mail order available. 3 demonstration rooms. All major credit cards. Open 10am-5.30pm Mon-Sat.

NORFOLK

BASICALLY SOUND The Old School, School Road, Bracon Ash (Nr Norwich), Norfolk, NR14 8HG. Tel: (01508) 570 829. Stockists of the following leading Hi-Fi: Audio Analogue, Beyer, Bryston, Denon, Dynavector, Epos, Grado, Naim, PMC, ProAc, Rega, Royd, Sennheiser, Talk Electronics, Teac and more. Bada members. 2 comprehensive demo rooms.

NORTHAMPTON

CLASSIC HI-FI At Classic Hi-Fi we cover the best in quality sounds. Be it a question of taste, a question of balance or a question of price, we're the ones to help. We stock: Marantz, Nad, Pioneer, Roksan, Yamaha, Heybrook, LFD, Sugden, Rotel, Kenwood, B & W, Kef, Rogers, Monitor Audio, Musical Fidelity, Tannoy, Shearman Audio, Royd, Audio Alchemy, Teac and many more. For more details call: 01536 310855

LISTEN INN 32 Gold Street, Northampton, NN1 1RS. Tel: 01604 637 871. The World's Finest Hi-Fi from Arcam, Audio Analogue, Chord Company, Copland, Denon, FMJ, Fujitsu, Kef, Krell, Linn, Loewe, Martin Logan, Meridian, Miller & Kreisell, Mission, NAD, Naim, Proac, Rega, Rotel, Sennheiser, Sonus Faber, Wilson Benesch, Yamaha. Dedicated Viewing & Listening Rooms. Friendly Staff, Fresh Coffee, 2 Full Years Warranty, Part Exchange Welcome, Free Car Parking, Interest Free Credit, Members of BADA. Open 10am-5.30pm (Closed Thursday).

NOTTINGHAMSHIRE

NOTTINGHAM HI-FI CENTRE 120-122 Alfreton Road, Nottingham. Tel: 0115 9786919. Multi-room specialists. Hi-Fi, Home cinema. All leading brands stocked. Three superb demonstration areas. Two year parts and labour guarantee. Home trials. On site service facility. Full delivery and installation service. Easy free parking. BADA Dealer. Established 1968. Mon-Sat 9.00-5.30

OXFORDSHIRE

OVERTURE HI-FI 3 Church Lane, Banbury, Oxon OX16 9LR. Tel (01295) 272158. Email sales@overture.co.uk Website: www.overture.co.uk Arcam, Bose, Cura, Denon, Kef, Linn Products, Miller and Kreisell, Mission, NAD, Naim Audio, Yamaha. For sensible unbiased advice, call Oxfordshire's audio experts. Superb demo facilities. No appts. necessary. Home Cinema, Plasma TV, Projectors, Lutron Lighting, MultiRoom and Commercial Installations. Access/Visa, instant credit. Mon-Fri 10-6, Sat 9.30-5.30.

SHROPSHIRE

ADAMS & JARRETT Hi-Fi and Home Cinema Specialist. Phone or visit us at 6-18, Norman Road, St. Leonards-on-Sea, E Sussex. (01424) 437165/432398. Stockist of quality equipment including: Audio Innovations, Meridian, Kef, Ruark, Marantz, NAD, JBL, Royd, Dali, Jamo, Onkyo, Rel, Traget, Cable Talk, Technics, TDC, Yamaha, Kenwood. Air conditioned listening rooms, on site service and repair facilities

STAFFORDSHIRE

ACOUSTICA 114 Wolverhampton Rd, Stafford ST17 4AH. www.acoustica.co.uk Tel 01785 258216. All the best in HiFi & Home Cinema from Naim Audio, Rega, Arcam, Rotel, Sugden, Tube Technology, Primare, Isotek, Harman Kardon, Onkyo, Teac, Acoustic Energy, JM Lab, B&W, Spondor, Kef, Royd, REL, Quadraspire, SIM2 & Sanyo projectors and much more. We offer full demonstration facilities, interest free credit and delivery & install systems

throughout Staffordshire & the Midlands. Opening hours are Tuesday to Friday 10.00 to 5.30, Saturday 10.00 until 5.00.

SUFFOLK

ANGLIA AUDIO The Street, Hesselst, Bury St Edmonds, Suffolk, IP30 9AZ. Tel. 01359 270212. "Hi-Fi and speaker centre dedicated to quality hi-fi since 1971. Open 10-6. Closed Weds and Sundays. Evening and Sunday Demos by appointment.

AUDIO IMAGES 128 London Road North, Lowestoft, Suffolk, NR32 1HB. Tel: 01502 582853. Arcam, Acurus, Castle, Rotel, Moth, Triangle, QTA, Sugden, Denon, Yamaha, Mirage, M & K, Definitive, Musical Fidelity, plus the Incredible Rothwell range. Refreshingly different selection. Dem Room, Professional AV Installer's from budget to high end. Full credit facilities. 9.30 to 5.30 Mon & Sat ~ 9.30 to 6.00 Tues to Fri.

EASTERN AUDIO 41 Bramford Road, Ipswich, Tel. 01473 217 217. Fax 01473. 215705. Quad, Arcam, Audiolab, Meridian, Mission, Denon, Rotel, Marantz, NAD, Sony, Rogers, Nakamichi, Systemdek, Technics, Celestion, B&W, Tannoy, Morel Thorens and Top Tape. Also stock a wide range of accessories. usual credit facilities. A BADA dealer.

SURREY

INFIDELITY 9 High Street, Hampton Wick, Kingston upon Thames, Surrey, KT1 4DA. Tel. 020 943 3530. Email: infidelity@compuserve.com - Web Address: infidelity.co.uk Stockists of: Linn, Naim, Arcam, Meridian, Rega, B&W Naudius, Neat, Proceed, Royd, M&K, Rotel, Stax, Shahinian, Dynavector. Open 10.30 - 7.00 Tues - Fri, 10.00 - 6 Sat.

SUSSEX (EAST)

ADAMS & JARRETT For the best Audio Visual Specialist with friendly helpful staff phone or visit us at 6-18 Norman Road St. Leonards-On-Sea, East Sussex. Tel. 01424 437165/432398. Copland, Castle, Denon, Densen, Dynaudio, Jamo, Kef, Kenwood, Marantz, Meridian, Musical Fidelity, NAD, Onkyo, Primare, Rel, Rotel, Ruark, Tannoy, Technics, Yamaha. Interest free credit available subject to status. Visa, Mastercard.

WEST MIDLANDS

ACOUSTICA 114 Wolverhampton Rd, Stafford ST17 4AH. See our main entry under "STAFFORDSHIRE".

MUSIC MATTERS

Birmingham - 363, Hagley Road, Edgbaston, B17 8DL. Tel: 0121 429 2811. Solihull - 93-95, Hobs Moat Road, B92 8JL. Tel: 0121 342 0254. Stourbridge - 9, Market Street D48 1AB. Tel: 01384 444184.

Sutton Coldfield - 10, Boldmere Road, B73 5TD. Tel: 0121 354 2311. Arcam, Alchemist, Apollo, Audioquest, Audio Research, B&W, Cable Talk, Castle, Celestion, Chord, Copland, Cyrus, Denon, DPA, JBL, Kef, Krell, Marantz, Martin Logan, Meridian, Musical Fidelity, Panasonic, Pioneer, REL, Rotel, Ruark, SME, Sennheiser, Sonus Faber, Tag McLaren, Teac, Theta, Yamaha etc. Classical CD's available at Birmingham only. Demonstration rooms, service and installation. BADA member. VISA / MASTERCARD / AMEX / SWITCH. Open: 10-5.30 Tuesday to Saturday. Late night Thursday till 7.00 (not Stourbridge).

SOUND ACADEMY For the Midlands. The Parade, Sutton Coldfield, Tel. 0121 321 2445 & High Street, Bloxwich, Nr Walsall, (sharing the ASDA shopping centre) Tel 01922 493499. Hosts 4 private studios plus a Home Theatre Cinema with Tube & LCD Projectors. The best in hi-fi from Naim, Arcam, Audiolab, Chord, Meridian, Monitor Audio and many more. So... if you've taken time to read this, please let us make you welcome. Phone 0121 321 2445 for Sutton or 01922 493499 for Walsall. Call in and to browse our exciting display of hi-fi and home cinema equipment. Mail order available. Interest free credit S.T. Status. Open 6 days, 9am to 5.30pm. Please call for late night. Expert Advice, Cable Dressing and Installation.

WILTSHIRE

SALISBURY HI-FI LTD 15 Catherine Street, Salisbury, Wiltshire SP1 2DF. Tel (01722) 322169/330841. Arcam, B&W, Celestion, Denon, Kef, Marantz, Meridian, Mission, Musical Fidelity, NAD, Opera, Pioneer, Ruark, Tannoy, Yamaha, 2 Dem rooms. Friendly, relaxed atmosphere. Professional advice. Home dem available. Service department. Free Installation. Home trial facilities. Access, Visa, Amex. Interest free credit. Instant credit. Open Mon-Sat 9-5.30.

THE RIGHT NOTE - See under **BATH & BRISTOL** heading.

YORKSHIRE (NORTH)

SOUND ORGANISATION YORK, 2 Gillygate, York YO31 7EQ. Tel (01904) 627108. Carefully chosen Hi-Fi and AV equipment includes Arcam, B&W, Naudius, Denon, Linn, Naim, Rega, Rotel, Stax etc 3 dem rooms incl. Home Cinema and Linn connect. Service Department. Home Installations. Instant Credit and major credit cards. Closed Mondays. Phone for chat and more details. www.soundorg.co.uk

YORKSHIRE (EAST)

THE AUDIO ROOM 2 George Street, Hedon, Hull, HU12 8JH. tel 01482 891375. www.theaudiroom.co.uk

The North East's premier hi fi dealer, stunning showrooms and dedicated listening rooms, authorised agents for, Proac, JM Labs, Naim, Linn, Cyrus, Mark Levinson, Sugden, Pathos, Onson Research, Audio Analogue, Graaf, Rega, Rotel, B&W, Spondor, Revel, Sonus Faber, Wilson Benesch. Home demonstrations and credit facilities available. Open Mon-Sat, 9am-6pm. The North East's friendliest hi fi dealer.

ZEN AUDIO 35 George Street, Hull Tel. 01482 587397. "Comfortable listening rooms; Home dems; Personal, friendly service; Free installations. Agencies Include: Arcam, Audiolab, Atacama, Audio Innovations, Audio Note, Audion, Alchemist, B&W, Cable Talk, Chord CO, DPA, Densen, Denon, DNM, EAR, Exposure, Fi-Rax, Harbeth, Heybrook, Impulse, KAR, KEF, Michell, Micromega, Monitor Audio, Musical Technology, Myrrad, NAD, NAIM, Pioneer, REL, Rehdeko, Rotel, Royd, Ruark, Shearman Audio, Stands Unique, Sugden, Spondor, Sonic Link TEAC, TDL, Tube Technology, Vivanco and many others.

YORKSHIRE (SOUTH)

THE HI-FI STUDIOS

Hi-Fi - Home Cinema - Custom Installation
Tel: Doncaster 01302 727274 or 01302 725550.
E-Mail: info@thehifistudios.freeserve.co.uk
Web Site: www.thehifistudios.co.uk
Musical Fidelity, Electrocompaniet, ProAc, PMC, JM Lab, Ruark, Castle, TEAC, Unison Research, Monitor Audio, Impulse, Primare, Harbeth, NAD, Michell Turntables, Nottingham Analogue Studios, Audio Analogue, Living Voice, Densen, Celestion, KEF, Opera, Trichord Research, Nordost, Stands Unique, Ortofon, Project, Goldring, REL, Denon, TAG McLaren, Rotel, Yamaha, Proceed - plus many more. Viewing & Demonstration by appointment in a unique setting. Home trials and installation. Card facilities and 0% available. Please phone for more information. BADA. CEDIA.

YORKSHIRE (WEST)

Huddersfield Hi-Fi Centre

Hi-Fi • A/V • Widescreen
Plasma • Installation Service
4 Cross Church St, Huddersfield, 01484 544668.
Brands Inc. Arcam, B&W, Castle, Cyrus, Denon, KEF, Marantz, Mission, Musical Fidelity, NAD, Project, Sony etc. 3 Dem Rooms, Mon-Sat 9-5.30, Thurs 9-8, Closed Wed.

Huddersfield Hi-Fi Centre Halifax

3-5 King Cross St, Halifax. 01422 366832. Brands Inc. Arcam, B&W, Castle, KEF, Marantz, Mission, Musical Fidelity, NAD, PRO-AC, Project, Sugden etc. 2 Dem Rooms, Mon-Sat 9-5.30, Closed Thursday.

PREMIER AUDIO - now demonstrating - Room 1: DCS Elgar, Purcell & Verdi Transport, Plinius CD Lad & 250 Power, Verity Fidelo & Sonus Faber Speakers, Siltech Cables, Isotek Sub Station, BDA Equipment Stands Room 2: Audio Aero, Audio Synthesis, Kora Pre & Power, Pink Triangle CD/Amp, Martin Logan / Audio Physics Speakers, Arcici Equipment Stand, Isotek Sub Station P/S Audio Synthesis, Audio Physics, Audio Aero, Absolute Sounds, DCS, Kora, Plinius, Siltech, Arcici, BDA, Pink Triangle, Avid Turntables, Project, Ortofon, Van den Hul, Mirage, PIX welcome Home demonstration good selection of S/Hand. We are 10mins J39 - M1 10mins J30 M62. Tel: Wakefield 01924 255045 - Colin Grundy.

AUDIO REPUBLIC, 78 Otley Road, Leeds O11 3 2177294, www.audio-republic.co.uk for the very best in quality hi fi in West Yorkshire and beyond, our relaxed and professional approach stems from over 10 years experience in designing and installing high quality music systems. We believe the following offer outstanding results: Naim Audio, Rega Research, Dynavector Systems (amplifiers and cartridges) Totem Acoustic, Roksan Engineering, Beyer, Ortofon, Creek Audio, Shahinian, JM Lab, Epos, TEAC, PMC, Bryston, Quadraspire, Chord Cables, Custom Design, Alphason Designs. Choice of shop or home demonstrations, open Tues - Sat 9.30am to 5.30 pm, most credit cards welcome. Please phone for a chat and directions.

WALES

NORTH WALES

ACOUSTICA 17 Hoole Rd, Chester CH2 3NH. Tel 01244 344227. See our main entry under "Cheshire".

ACTON GATE AUDIO 4 Ruabon Road, Wrexham, North Wales, Tel. 01978 364500. See our main ad under Cheshire.

VINYL RECORD MAIL ORDER

DIVERSE VINYL 10 Charles Street, Newport, NP20 1JU. Tel/Fax: 01633 259661/256261. Email: sales@diverse-music.co.uk Probably the most varied and impressive selection of brand new LPs you'll find anywhere: international new releases, reissues and audiophile products. Also UK distributor of the Disco Anti Stat LP Cleaning Device. Call for a free catalogue, or visit www.diverse-music.co.uk

meet your maker

A reference guide to Britain's manufacturers and distributors

AUDIO SYNTHESIS Manufacturers of the outstanding DAX digital to analogue converter, comes DAX-2, a new Hi-End reference converter able to dig deeper into the digital source than ever before! A new addition to the superb PASSION series of all Vishay controllers has just been introduced in the form of PASSION 8, a fully remote controlled uniquely transparent passive preamplifier, the perfect match for DESIRE. By word of mouth our DESIRE power amplifier is rapidly convincing listeners, whether passive or active! New for 1997 is TRANSCEND a state of art CD transport with AES, coaxial, AT&T glass and Toslink outputs. Audio Synthesis, PO BOX 50, Nottingham, NG9 1DZ. Tel: (+44) (0)115 922 4138. Fax: (+44) (0)115 922 9701.

BORDER PATROL 63 Berriedale Avenue Hove BN3 4JD Tel/Fax 01273 276716. Manufacturers of Power Supply Units for valve amplifiers, Single-Ended Power Amplifiers and high quality Transformers. The Border Patrol PSU: valve-rectified choke input filter power supply units which dramatically improves the sound of valve amplifiers: models available to suit Audionote, Audio Innovations, Audion, Art Audio, Cary, Unison Research, World Audio Designs. The Border Patrol 300B SE single-ended valve amplifier featuring interstage driver transformers and valve rectified choke input filter power supplies. Border Patrol transformers: high quality output (PP and SE), interstage and pre-amp output transformers and high value inductors.

CREEK AUDIO LTD 12 Avebury Court, Mark Road, Hemel Hempstead, Herts, HP2 7TA. Tel. 01442 260146 E-mail: info@creekaudio.co.uk Internet: www.creekaudio.co.uk - Creek Audio build stylish Hi-Fi products in the UK, combining state of the art electronic design, with full bodied, accurate and musically rewarding sound. Our standard size products come in two award-winning ranges, the entry level 43 series and higher priced 53 series. These include: CD43 Mk2 - CD player with 24 bit resolution DAC, T43 AM/FM Tuner, Integrated Amps - 5350, 5350SE and 4330 Mk2 (described by Stereophile Magazine as the best amp under \$1000). Our A43 Mk2 and A53 Power Amps range from 50 to 250 Watts and both P43 and P53 Pre-Amps offer passive and active operation with remote control. In addition we have an award winning OBH range of small products: OBH-8/8SE MM and OBH-9 MC Phono Pre-Amplifiers, OBH-11 and 11 SE Headphone Amplifiers, OBH-10 and 12 Remote Control Passive Pre-Amps and OBH-14 - 24 bit DAC. See our home page for further details or call us for leaflets.

DBS AUDIO. PO BOX 91, Bury St Edmunds, Suffolk, IP32 7JU. Phone: 01284 723933 Fax: 01284 723933. Suppliers of Electro-Acoustic measuring equipment and CAD software to the audio industry. NEW: Clio win and Clio win Lite, the latest Windows versions of the Globally-established Clio Electro-Acoustic measuring system, used for loudspeaker design, Quality Control and electronics testing by many major audio companies. Clio win is the full (lab) system and Clio win Lite a lower-cost version for smaller companies and serious hobbyists. Both use the same purpose-built Clio HR200 ISA card, with its in-built mic. preamp and phantom powering. The matching Mic 01 (or Mic Lite) plugs straight in to make a complete system. Both versions offer the same high accuracy and ease of use: Clio win Lite simply has fewer functions. Common features include MLS testing (to eliminate sound reflections), sine and third-octave analysis, impedance, Thiele Small Parameters, LC

meter, software and manual on CD ROM -- plus much more. Measurements may be exported to our Netcalc software for accurate and easy crossover design. Also available: Boxcalc and Boxdraw bass optimisation packages and Outline speaker measuring turntable. Write or E mail and we will send fuller information and prices. Also, visit Audiomatica's new Website at: www.audiomatica.com

EPOS ACOUSTICS 2 Avebury Court, Mark Road, Hemel Hempstead, Herts, HP2 7TA. Tel. 01442 260146. Email: info@epos-acoustics.com Website: www.epos-acoustics.com Innovative design and superior sound distinguish EPOS speakers from other brands in a similar price category. Adhering to the EPOS tradition of musicality and communication, the new M12 follows closely the style of the successful ES12, and was awarded five gold stars in the March 2001 edition of *What Hi-Fi?* For more information about the M12 or the new M15 please see our home page or call us for leaflets.

FALCON ACOUSTICS LTD Tabor House, Norwich Road, Mulbarton, Norwich, Norfolk, NR14 8JT. Tel. (01508) 578272. U.K. distributors of FOCAL drive units and SOLEN (Chateauroux) polypropylene capacitors and the largest inductor manufacturer in the U.K. Comprehensive range of DIY Speaker Parts and Kits, Sub-Bass and Electronic Filters. "Everything but the wood" Enquiries should be accompanied by a 44p stamped addressed envelope.

LANGREX SUPPLIES LTD 1 Mayo Road, Croydon, Surrey, CR0 2QP. Tel: 020 8684 1166. Fax: 020 8684 3056. One of the largest distributors of electronic valves, tubes and semi-conductors in the UK and USA manufacturers. stock. We specialise in obsolete types including original UK and USA made audio valves. Telephone or fax for an immediate quotation.

NORTON TECHNOLOGIES LTD Manufacturers of the acclaimed AirPower LP12 Power Supply. 14 Rothesay Avenue, Chelmsford CM2 9BU. (01245) 283125

PLATFORM 7 High density marble ISOLATION PLATFORMS for all makes of equipment RACKS/STANDS. An elegant way to UPGRADE. Improves clarity: better BASS control. 3 Abbots Drive, North Wembley, Middlesex HA0 3SB. Tel: 020 8904 2646. Also NEALGAR DISTRIBUTION Tel/Fax 01296 24756.

PMC/BRYSTON Emmy award winning manufacturers of the highest quality loudspeakers and amplification. Industry standard in Mastering, Film Scoring, Broadcast and Post Productions. (5.1 & Stereo) PMC Products: Compacts, Floorstanders, and Large passive & active monitors. Prices range from £500 to £32,000. Finished in a large selection of exquisite real wood veneers, all PMC loudspeakers are available in horizontal mirrored pairs, centre channels and complementary subs for 5.1 surround systems. Bryston's balanced range of products include R/C Preamps, Integrated, Amp modules for all the PMC range, Mono, Stereo 150W to 800w per ch, 3 Ch, 4 ch and 5 channel THX amplifiers, Surround processors, all with distortion figures and build quality to die for. Every product is available in silver or black backed by a 20 year warranty. PMC Ltd 43-45 Crawley Green Road, Luton, LU2 0AA. Tel: 08704 441044 Fax: 08704 441045 Email: sales@promonitor.co.uk Web: www.pmc-speakers.com

REL ACOUSTICS North Road, Bridgend Ind Est. Bridgend, Mid Glamorgan, CF31 3TP. UK. Tel. 01656 768 777, international +44 656 768 777. Fax. 01656 766 093, international. +44 656 766 093. Email: contact@rel.net Web: http://rel.net The UK's only specialist sub-bass speaker manufacturer. "The only one that works". Get your dealer to give you a home demo and find out what the fuss is all about.

RDE TANDBERG HI-FI SERVICES Holly Tree House, The Green, Full Sutton, YORK YO4 1HW. Tel: 01759 372795. The service, overhaul and reconditioning of all Tandberg hi-fi products regardless of age.

SOUND IMAGE UK LTD. 52 Milton Road, London SW14 8JR. Tel: 020 -8255-6868. Importers and distributors of the finest audio equipment, featuring the stunning Boulder 2,000 series and the complete range from Norwegian manufacturer Electrocompaniet.

SUGDEN AUDIO PRODUCTS Designed and manufactured in the UK each Sugden product is hand-built by one highly skilled technician. A full range of pure class A amplifiers are available including integrated, stereo power and the incredible Masterclass balanced monoblocks. Our stunning Bijou system now comes with a single-ended pure class A power Amplifier with optional integral stand. Two analogue tuners have joined the range matching our A21 and Bijou series, offering a digital user interface with excellent facilities. Each amplifier series has a matching CD player with a class A output stage and heavily modified transport. The class A HeadMaster offers a pre-amp with three inputs a fixed and variable output with remote control. The HeadMaster can be used as a control unit in a high quality audio system and excels with headphones. Please contact us for product information, dealer list and brochures. 01924 404088 email info@jesugden.co.uk.

TALK ELECTRONICS Unit 12, Farnborough Business Centre, Eelmoor Road, Farnborough, Hampshire, GU14 7XA. Tel: 01252 378383. Please ring for details

TAG McLAREN AUDIO - The Summit, 11 Latham Road, Huntingdon, Cambs, PE18 6ZU. Tel +44 (0) 1480 415600 Fax +44 (0) 1480 52159. Combining science and technology with distinct style, TAG McLaren Audio's complete range of audio and audio-visula products are designed to bring maximum pleasure to the discerning listener. To find out more visit our website at www.tagmclarenaudio.com, email us on HelpDesk@tagmclarenaudio.com or contact our helpdesk on freephone 0800 783 8007.

tech+link distributes some of the best performing hi-fi and a/v accessories currently available in the U.K. These include: Puresonic, best known for its range of high performance interconnects and connectors, and cable adapters for a wide variety of hi-fi and a/v applications in its range; tech+link's own brand of high quality interconnects and connectors - digital compatible, 24k gold plated metal connectors; and hi-fi furniture - a selection of high quality speaker floor stands, surround sound stands and hi-fi racks. For more information, contact: tech+link International, Unit 8, Bat and Ball Enterprise Centre, Bat and Ball Road, Sevenoaks, Kent, TN14 5LJ. Tel: +44 (0) 1732 779400 Fax: +44 (0) 1732 449344

To advertise in Meet Your Maker please call
Amanda Sweeney on
020 8864 4760

specialist hi-fi dealers

LONDON



THE INNOVATIVE HI-FI, HOME CINEMA AND MULTI ROOM RETAILER/INSTALLER

SERVING LONDON FROM BATTERSEA

ORANGES & LEMONS

Friendly and efficient service
0% finance

JUICY FRUIT FROM LONDON'S FRESHEST RETAILER

ARCAM B&W CABLE TALK CASTLE CHORD CREEK DENON EPOS LINN MARANTZ NAIM NAD NEAT PMC QED REGA ROKSAN ROTEL RUARK STANDS UNIQUE SOUNDSTYLE YAMAHA XANTECH and many others

020-7924 2040
61/63 WEBBS ROAD, SW11
website: oandlhifi.co.uk

We aim to provide a well chosen selection of quality hi-fi and accessories including FMJ, ARCAM, B&W, NAUTILUS, DYNAVECTOR, LINN, LOEWE, MERIDIAN, M&K, NAIM, PIONEER, PROCEED, NEAT, REGA, ROTEL, SHAHINIAN, YAMAHA + more

www.infidelity.co.uk

Open: Tues-Fri 10.30am-7pm, Saturday 10am-6pm

Infidelity

INDECENTLY GOOD HI-FI

9 High Street, Hampton Wick, Kingston upon Thames, Surrey KT1 4DA
Tel: 020 8943 3530

~~AUDIO CONSULTANTS~~

27 BOND STREET, EALING
LONDON W5 5AS
TEL. 081 - 567 8703

Audio Analogue, Art Glass, Ash Designs, Avik, B&O, B&W, Cabietalk, Chord Company, Creek, Denon, Epos, Harman Kardon, Infinity, KEF, Linn, Marantz, Musical Fidelity, NAD, Nakamichi, Nordost, Oreille, Onkyo, Primare, Quad, Roksan, Rotel, Ruark, Sennheiser, SonicLink, Sound Style, Stands Unique, Straightwire, Supra, Tag McLaren, Target, Teac, Thorens, van den Hul.

10 - 6 pm Mon., Tues., Friday, & Sat.
Late night Thur., closed Wed.

Two demonstration rooms.
Free local delivery and installation.
Repairs and Services

SOUTH

WORTHING AUDIO

20 Treville Gate W Sussex BN11 1UA
(01903) 212133

The friendly shop with the best sound system in the South.
Talk Electronics - Friendly Advice - 3 Year Guarantee
Easy Parking - Open Mon-Sat. 10am-6pm
Late Night Wed 7.30pm.

Agencies include: Dynaudio, Ruark, Gradient, Roksan, Naim, Oreille, Sonneteer, Kora, Cymbol, Talk Electronics, and many more.....

SOUTH WEST

SOUTH WEST ANALOGUE

SME - MICHELL - NOTTINGHAM ANALOGUE - LORICRAFT GARRARD - PROJECT - ORTOFON - TUBE TECHNOLOGY 64bit Valve CD Player, Remote Control Hybrid Integrated Valve Amplifier CROFT VOODOO Isolation platforms/Loudspeakers, Equipment Stands and T/Turntable lift off Perapex Covers. Record cleaning service - Secondhand equipment

01643 851 351
graham@southwestanalogue.fsnet.co.uk

NORTH

Basically Sound

NORWICH ● NORFOLK

Audio Analogue, Bryston, Chord Co., Denon, Epos, Naim Audio, PMC, Pro Talk Electronics, Teac, Audio Note and more

The Old School
School Road, Braco
Nr Norwich, Norfolk
Tel (01508) 5...

EAST

STOWSOUNDS

audio consultants

These And More Available From:

Creek	JM Labs
Epos	Living Voice
Exposure	Neat Acoustics

For A Demonstration & Expert Advice Call
Stowmarket (01449) 675060
Stone Farm, Borough Lane, Gt. Finborough, Stowmarket

VALVES & TUBES

CVC Chelmer Valve Company

Buy CVC PREMIUM HI FI valves direct from us. All valves processed for improved performance. We also have stock of MAJOR BRAND types inc. MULLARD, GEC, BRIMAR, RCA, GE, PHILIPS, etc.

The Stables, Biddow Park, Great Baddow, Chelmsford, Essex, CM2 7SY
Tel: 01245 241301 Fax: 01245 241309
Email: sales@chelmervalue.com

SERVICES & CONSULTANTS

Front End Problem?

contact

The Cartridge Man

It doesn't have to cost an arm and a leg to get the best - listen to my Koetsu - and Decca - eater.

Also agents for Croft, Haddock, E.A.R, Michell & Moth.

plus cartridge re-tipping service
020 8688 6565
Website: www.thecartridgeman.com

MAIL ORDER

Now you can hear the full potential of your equipment!

YellIO Power Only £29.95 for 1m cable

Upgrade your mains cable to YellIO Power

Remove degrading radio frequency interference (RFI) to release the true potential of your CD or DVD. Made with KIMBER KABLE, YellIO Power uses eight high-purity copper conductors woven to silver RFI already on the mains and reject airborne RFI. The result? Play at higher volume with less distortion, hear previously unnoticed detail and deeper, tighter bass and less DVD see better picture definition and colour saturation. At only £29.95 you just have to give it a try!

Request your FREE copy on UK Freephone
0800 373467
quoting AH93

FREE UK MAINLAND DELIVERY

Cable Upgrade Scheme	60 Day Home Trial	FREE Delivery (UK Mainland)	Expert Advice
----------------------	-------------------	-----------------------------	---------------

Quality Cables & Accessories for Hi-Fi & Home Cinema Mail Order Direct

Buy online at www.russandrews.com

Russ Andrews Accessories Ltd.
FREEPOST NWW881A, KENDAL LA8 9ZA
Tel: 0044 1539 825500 Fax: 0044 1539 825540
E-mail: AH93@russandrews.com

atv

ATV SERVICES LEATHERHEAD 01372 456921

- Service & Repairs
- Valve & transistor amplifiers
- Vintage valve Radios
- Hi-Fi VCR's
- Valves Tested

VINYL

THE DIRECT DISC

VINYL VINYL VINYL

Thousands of records always in stock. + a full range of sought after compact discs. Extensive search service for wanted albums. Comprehensive 96 page full catalogue available at £1.50

Telephone / Fax 01992 447764
Or visit our web site on www.directdisc.demon.co.uk



Choice hi-fi

you choose

Choice hi-fi make it easy for you to fulfill your sonic dreams. Quality hi-fi is not just about expensive brandnames.

It's about aspiring to the very best sound, about choosing your ideal system from the widest selection in the country, in a unique no-pressure environment.

your choice

- Acoustic Energy
- Advantage
- ATC
- Audible Illusions
- Audio Physic
- B.A.T
- Boulder
- Bryston
- Cary
- C.A.T.
- Chord
- Clear Audio
- Denon
- DNM
- Egglaston Works
- Electrograph Delphi
- Genelec
- Gryphon
- Graham
- Imerge
- J M Lab
- Krell
- Lexicon
- Linn
- Loewe
- Lutron
- Lyra
- Mark Levinson
- Michell Eng.
- Musical Fidelity
- Naim
- NEC
- Nordost
- Oracle
- Ortofon
- Plinius
- P.M.C.
- Primare
- Project
- Quadraspire
- REL
- Rockport
- Roksan
- Rotel
- Ruark
- Seleco
- SME
- Straight Wire
- Sugden
- Tara Labs
- Teac
- Totem
- Transfiguration
- Trichord
- Trilogy
- Van den Hul
- VPI
- Wilon Audio
- Wilson Research
- YBA

H I - F I

HOME CINEMA

MULTIROOM INSTALL

BUY / SELL

Quarterly Sale items

	Our Price	Original Retail Price
Exposure VII pre + XII psu	£450.00*	£1,200.00
Magnum Dynalab P 200 Pre	£695.00	£1,900.00
dpa Enlightenment DAC	£295.00*	£ -
Kenwood LI1000C Pre	£295.00	£895.00
Kenwood LI1000M Power	£395.00	£1,295.00
Michaelson Audio Odyssey	£495.00*	£1,500.00
Sunfire 300 Power Amp (110 volts)	£695.00*	£2,400.00
Arcam Delta 110 pre amp	£295.00	£750.00
McCormack Line Drive	£395.00	£995.00
Thule Spirit CD	£495.00	£900.00
Audio Refinement Pre 5 "new"	£395.00*	£895.00

New this month

	Our Price	Original Retail Price
POWER AMPLIFIERS		
Krell KAV 250A	£1,795.00	£3,650.00
Cello Performance 2 Monoblocks	£7,995.00	£20,000.00
Krell KSA 250	£2,750.00	£6,000.00
Bel Canto Evo 4	£On Dem	£3,895.00
Krell KSA 80B	£1,395.00	£3,600.00
Roksan Caspian Integrated	£On Dem	£895.00
Roksan Caspian Power	£On Dem	£645.00
Quad 33/ 303	£295.00	-
PRE AMPLIFIERS		
Meridian 201 Pre	£195.00	£900.00
Audio Research LS25 mk II	£4,250.00	£5,995.00
YBA 2a Line	£1,295.00	£1,995.00
LOUDSPEAKERS		
Martin Logan SL3	£1,795.00	£3,400.00
JM Lab Mini Utopia + Stds Rosewood	£2,495.00	£4,899.00
Dynaudio Audience 50	£395.00	£577.00
JM Lab Nova Utopia	£On Dem	£19,999.00
Heybrook Sextet (new drivers)	£495.00	£1,200.00
Revel Ultima Studio	£7,495.00	£13,000.00
ATC SCM 10 Passive Black	£495.00	£1,100.00
CD PLAYERS & DACS		
Chord SPM 1600E Dac/ Pre	£3,250.00	£6,500.00
Krell KPS 25sc 24/96	£11,995.00	£23,498.00
Roksan Caspian CD	£On Dem	£995.00
TURNTABLES, ANALOGUE, VARIOUS		
Project RPM 6 "new"	£On Dem	£500.00
Musical Fidelity XLP Phono Stage	£75.00	£150.00
Project RPM9/ arm/ 25FL (Ex Dem)	£895.00	£1,350.00
VPI TNT mk IV/ Rockport 6000/ Flywheel/ VPI Stand/ Clearaudio	£8,500.00	£16,000.00
Accurate/ Pump etc. "new"	£On Dem	£850.00
Roksan Radius (Acrylic) "new"	£On Dem	£950.00
Roksan Caspian Phono se	£On Dem	£850.00
Ortofon Rohman (2 hrs)	£850.00	£1,050.00
AV COMPONENTS		
Lexicon MC8 Processor	£On Dem	£5,000.00
Lexicon RT10 DVD Player	£On Dem	£2,300.00
Power amplifiers		
Krell FPB 600c	£6,500.00	£14,000.00
Krell FPB 700cx	£11,995.00	£15,000.00
Krell FPB 400 cx	£9,600.00	£12,000.00
Naim Nait 3	£475.00	£608.00
Rowland Model 12 (4 chassis)	£8,995.00	£14,500.00
Michell Alecto Monoblocks	£995.00*	£2,000.00
Cary 805 C Monoblocks "new"	£4995.00*	£8,250.00
E.S. Lab DX-58	£On Dem	£2,995.00
Plinius SA50	£1,795.00	£2,700.00
Plinius 8200P	£On Dem	£1,550.00
Krell FPB 200	£3,995.00	£8,000.00
Krell FPB 600	£5,995.00	£12,998.00
Plinius SA 102 "new"	£On Dem	£3,750.00
Musical Fidelity P180	£395.00	£900.00
Musical Fidelity CRPS	£395.00	£900.00
Bryston 4 BSST	£On Dem	£2,350.00
Jadis Defy 7 mk III	£2,750.00	£6,000.00
Mark Levinson No 27	£1,750.00	£6,000.00
Linn Bass Active Card	£69.00	£120.00
Gamut D200 "new"	£2,250.00	£3,250.00
Musical Fidelity F15	£995.00*	£2,500.00
Audio Innovations S1000 mk III monos	£995.00*	£3,000.00
Krell MDA 300	£4,995.00	£12,000.00
Cary SLA 70 mk II Silver	£1,295.00	£2,250.00
Boulder 500 AE	£3,495.00	£5,500.00
Linn Klassik CD/Amp silver	£895.00	£1,030.00
Boulder 1060 Power "new"	£On Dem	£16,500.00
Primare 30.1 mk II Integrated	£1,350.00	£1,500.00
YBA Passion Stereo "new"	£3,995.00	£5,995.00
Plinius 250 mk IV "new"	£On Dem	£6,350.00
AV components		
AV COMPONENTS		
Lexicon DC2	£1,995.00	£3,500.00
SIM 2 HT 300	£7,500.00	£9,000.00
Primare P30 Processor	£1,295.00	£2,000.00
Linn Klassik DVD	£On Dem	£2,000.00
Lexicon MCI "new"	£3,000.00	£5,500.00
Lexicon MC12 / MC12B	£On Dem	£810.00/ £890.00
Loewe Xemix DVD "new"	£On Dem	£495.00
PLASMAS/LCD/PROJECTORS		
From NEC/ Panasonic/Pioneer/Sharp from Electrograph Delphi/Seleco/Sony/Sanyo Panasonic TH-42 PVWDS "new"	£4000.00	POA
	£4,995.00	POA
Pre amplifiers		
DNM 3c Primus Pre (3c psu)	£1,195.00	£2,000.00
Tom Evans The Vibe Pre	£On Dem	£2,700.00
Krell KRC	£2,495.00	£6,949.00
Graff 13.5 Pre	£1,495.00	£3,000.00

Chord DSC 1500E (dac/pre)	£3750.00*	£6,500.00
Audio Research LS7	£895.00*	£1,800.00
Audio Research LS1	£795.00	£2,000.00
Audio Research LS3	£895.00	£1,997.00
Musical Fidelity F22	£695.00	£1,500.00
AVI S2000 MP remote pre	£395.00	£800.00
Cary SLP98L Remote Pre x-dem	£1495.00*	£2,794.00
Boulder 1012 (pre amp/ 24.96 dac/ Phono)	£On Dem	£13,000.00
YBA Passion Pre (inc Phono)	£3,995.00	£5,995.00
Blunder 2010 Pre	P.O.A.	£30,000.00
Plinius 161 "new"	£On Dem	£3,200.00
C.A.T. ultimate reference Pre Amp Inc/Phono "new"	£On Dem	£5,750.00

Quality speakers

JM Lab Alto Utopia BE	£On Dem	£9,999.00
Wilson Witt mk I	£3,750.00	£9,000.00
Avante Garde Duo (White)	£4450.00*	£8,000.00
JM Lab Utopia	£8995.00*	£18,000.00
JM Lab Mini Utopia + Stand	£2,495.00	£4,700.00
B&W Matrix 805 (Walnut)	£2,995.00	£650.00
ClaraVox Magnifica	£5,495.00	£14,500.00
JM Lab Micro Utopia + Stand	£2,195.00	£4,349.00
Wilson 5.1	£7,995.00	£19,600.00
Reference 3A	£1,750.00	£2,250.00
Audio Physic Spark	£1,150.00	£1,795.00
Talon Kite Centre & Bracket	£795.00	£1,750.00
Ensemble PA1	£895.00	£2,000.00
Audio Physic Caldera	£4,995.00	£10,000.00
Aerial Acoustic SV12 Sub Woofer, Maple/remote	£2,995.00	£5,200.00
Mirage M3 si	£1295.00*	£4,100.00
Linn Kabers (Active)	£995.00	£2,500.00
Rel Q 200 E	£On Dem	£650.00
Rel Q 150 E	£On Dem	£500.00
Audio Physic Luna Sub (wood)	£On Dem	£1,799.00
Audio Physic Yara	£On Dem	£999.00
Vienna Acoustics Mahler	£On Dem	£6,000.00
Vienna Acoustics Mozart	£On Dem	£1,700.00
Vienna Acoustics 5.1	£On Dem	£3,500.00
Cabasse io 5.1	£On Dem	£2,170.00
JM Lab Sib & Cub (5.1 spk sys)	£On Dem	£859.00
Blue Room Minipod (White)	£225.00	£298.99
Blue Room Minipod + Sub (Blue)	£625.00	£749.00
Blue Room Minipod Sub	£415.00	£468.99
SD Acoustics SD1	£595.00	£1,650.00
Genelec 205 Active Monitors	£On Dem	£750.00
Audio Physic Virgo III "new"	£On Dem	£4,000.00
Audio Plan Contrast 3	£995.00	£3,200.00
Audio Physic Tempo III "new"	£On Dem	£2,000.00
Naim SBL's	£995.00	£2,225.00
Rogers LS55 "new"	£260.00*	£430.00

CDplayers DACS

Musical Fidelity NuVista cd	£2,495.00	£3,000.00
Sony SCD1 SADC	£2,495.00	£4,000.00
Theta Data Pro Basic IIIa	£1,795.00	£3,495.00
Bow Wizzard 24/96	£2,795.00	£4,000.00
Theta DS Pro Prime II a	£995.00	£1,800.00
Mark Levinson ML 31	£3,750.00	£9,000.00
Trichord PD-S 503	£295.00	£500.00
Pink Triangle Ordinal	£295.00	£600.00
YBA CD1 Delta (Twin psu)	£3,995.00	£5,500.00
Audio Synthesis DAX	£1,995.00	£4,000.00
Krell KPS 20i	£3795.00*	£9,900.00
Linn Karik Numerik	£1,595.00	£3,300.00
Mark Levinson 39	£2,995.00	£5,000.00
Marantz 17 Ki Sig (Black & Gold)	£695.00	£1,200.00
Myryad MDV 200 DVD	£750.00	£995.00
YBA CD 3 Delta	£On Dem	£2,200.00
Audiomeca Damnation CD Transport	£750.00	£1,600.00
Primare V20 DVD/CD	£750.00	£1,000.00
Audio Aero 32/192 Capitole CD (Ver. 4)	£On Dem	£4,500.00
Primare V25 CD/DVD	£On Dem	£1,000.00
Theta Pro Geny	£595.00	£1,295.00
Boulder 2020 dac	P.O.A.	£24,000.00
Theta Data II Transport AT + link	£1,995.00	£4,000.00
YBA CD Integre "new"	£On Dem	£1,195.00

Turntables & analogue

Tara Lab Decade 8ft pair	£895.00	£2,000.00
Transparent Ref 20ft Spk	£3,295.00	£5,000.00
Loricraft record cleaning machine	£On Dem	£1,100.00
Lyra Beta	£525.00	£595.00
Tara Labs The One Balanced 1m	£999.00	£2,250.00
Earmax Pro	£On Dem	£425.00
Revox B160 Tuner	£450.00	£995.00
Decca London Gold (original Garrott Brothers)	£1,495.00	£ Priceless
SME 30/2 A "new"	£10,495.00	£12,289.00
Moth Record Cleaning m/c	£395.00	£ -
Project RPM4/ Ortofon 510 "new"	£On Dem	£325.00
Ortofon Rohmann	£On Dem	£1,050.00
Ortofon Kontrapunkt a/b "new"	£On Dem	£500.00/ £750.00
Michell Gyro SE/ RB300 "new"	£On Dem	£1,100.00
Michell Orbe/QC	£1,495.00	£2,200.00
Audio Synthesis Phono Eq mm/mc	£795.00	£ -
Gryphon Phono Pre-Amp (dual mono) Head Amp	£1,695.00	£1,600.00
SME Series V Arm "new"	£1,350.00	£1,650.00
Pink Triangle PT Ext psu	£495.00	£ -
Plinius 14 Phono "new"	£On Dem	£2,750.00
Nackamichi DR 3	£195.00	£400.00
Tom Evans - The Groove "new"	£On Dem	£1,795.00
Clear Audio Reference Mc phono stage X-demo	£1,695.00	£2,065.00
Rega Planer 3 + Hi Fi News Out Board Power Supply	£320.00	£423.00
Clear Audio Symphono phono stage X-demo MM/MC	£640.00	£740.00
Lavardin Reference Phono "new"	£On Dem	£2,500.00

* Reduced this month

tel: 020 8392 1959 & 020 8392 1963
 fax: 020 8392 1994 info@choice-hifi.com

Open from 10am to 6pm Mon-Sat and other times by appointment.
 Buy, sell, exchange quality hi-fi equipment.
 We accept all major credit cards. Finance available subject to status

world classics

In this heavily revised section, you'll find the great and the good from audio's glorious past. Most are seminal designs which have earned their place in hi-fi history, but you'll also see some oddities which aren't classic as such, but are great used buys. The year of introduction is given, alongside the original UK launch price. Think we've overlooked something? Then write in and let us know!

DIGITAL

CAMBRIDGE AUDIO CD11986 [£1500]
Inspired Stan Curtis redesign of Philips CD104, complete with switchable digital filter. Lean but tight and musical performer.

CAMBRIDGE AUDIO CD 4SE 1998 [£200]
A touch soft in the treble and tonally light, but outstanding in every other respect.

LINN KARIK III 1995 [£1775]
The final Karik was a gem. Superb transport gives a brilliantly tight, grippy dynamic sound, albeit tonally dry.

MARANTZ CD73 1983 [£700]
A riot of gold brushed aluminium and LEDs, this distinctive machine squeezed every last ounce from its 14x4 DAC -super musical

MARANTZ SA-1 2000 [£5,000]
The greatest argument for SACD. This sublime Ken Ishiwata design is utterly musically convincing with both CD and SACD, beating most audiophile CD spinners hands down.



MERIDIAN MCD 1984 [£600]
The first British 'audiophile' machine was a sweeter, more detailed Philips CD100. 14x4 never sounded so good, until the MCD Pro arrived a year later.



MERIDIAN 207 1988 [£995]
Beautifully-built two-box with pre-amp stage. Very musical although not as refined as modern Bltstream gear. No digital output.

NAIM CDS 1990 [£ N/A]
Classic Philips 16x4 chipset with serious attention to power supplies equals grin-inducing sonics.

SONY CDP-101 1982 [£800]
The first Japanese CD spinner was powerful and involving. Brilliant transport more than compensated for 16x2 DAC, and you even got remote control!

SONY CDP-R1/DAS-R1 1987 [£3,000]
Sony's first two boxer was right first time. Tonally lean, but probably the most detailed and architectural sounding machine of the eighties.

COMPACT DISC TRANSPORTS

ESOTERIC P0 1997 [£8,000]
The best CD drive bar none; TEAC's Tokyo boys pushed the boat out in style. Brilliantly incisive, ridiculously over engineered.

KENWOOD 9010 1986 [£600]
The first discrete Jap transport was beautifully done and responds well to re-clocking even today.

TEAC VRDS-T1 1994 [£600]
Warm and expansive sound made this a mid price hit. Well built, with a slick mech.

DACs

CAMBRIDGE AUDIO DACMAGIC 1995 [£99]
Good value upgrade for budget CD players with extensive facilities and detailed sonics.

DCS ELGAR 1997 [£8500]
Extremely open and natural performer, albeit extremely pricey - superb.

DPA LITTLE BIT 3 1996 [£299]
Rich, clean, rhythmic and punchy sound transforms budget CD players.

PINK TRIANGLE DACAPO 1993 [£ N/A]
Exquisite; the warmest and most lyrical 16bit digital audio we have ever heard. Clever plug-in digital filter modules really worked!

QED DIGIT 1991 [£90]
Budget bitstream performer with tweaks aplenty. Positron PSU upgrade makes it smooth, but now past it.

TURNTABLES

ARISTON RD11S 1972 [£94]
Modern evolution of Thorens' original belt drive paradigm, Scotland's original super-deck was warm and musical, albeit soft. Still capable of fine results today.

DUAL CS505 1982 [£75]
Simple high quality engineering and a respectable low mass tonearm made for a brilliant budget buy. Polished, smooth and slightly bland sound.

GARRARD 301/401 1953 [£19]
Heavy metal - tremendously strong and articulate with only a veiled treble to let it down. In many respects, better than the seventies 'superdecks' that succeeded it.

GOLDRING LENCO 88/89 1963 [£15.65]
Simple, well engineered middleweight with soft, sweet sound and reasonable tonearms. Good spares and servicing support even today from specialists.

LINN AXIS 1987 [£253]
Simplified cut-price version of the Sondek complete with LVX arm. Elegant and decently performing mid-price package. Later version with Akito tonearm better.

LINN SONDEK LP12 1973 [£86]
For many, the Brit superdeck; constant mods meant that early ones sound warmer and more lyrical than modern versions. Beguilingly musical but now off the pace.



MARANTZ TT1000 1978 [£ N/A]
Beautiful seventies high end belt drive with sweet and clean sound. Rare in Europe, but big in Japan.

MICHELL GYRODEC 1981 [£599]
Thanks to its stunning visuals, this bold design wasn't accorded the respect it deserved until recently. Early examples sound cold and mechanical, but now right on the pace. Clean, solid and architectural sound.

REGA PLANAR 3 1978 [£79]
Brilliantly simple but clean and musical performer, complete with Acos-derived S-shape tonearm. 1983 saw the arrival of the RB300, which added detail at the expense of warmth. Superb budget buy.

ROKSAN XERXES 1984 [£550]
Supposedly the first to 'better' the LP12. Super tight and clean sound, with excellent transients. Less musical than the Sondek, but more neutral. Sagging plinth top-plates make them a dubious used buy.

TECHNICS SP10 1973 [£400]
Seminal Japanese engineering. Sonics depend on plinths, but a well mounted SP10II will give any modern a hard time, especially in respect of bass power and midband accuracy.

THORENSTD124 1959 [£ N/A]
The template for virtually every 1970s 'superdeck', this iconic design was the only real competition for Garrard's 301. It was sweeter and more lyrical, yet lighter and less impactful in the bass.

TOWNSHEND ROCK1979 [£ N/A]
The product of academic research by the Cranfield Institute, this novel machine has an extremely clean and fluid sound. Substantially modified through the years, and capable of superb results even today.

TRIO LO-7D 1978 [£600]
The best 'all-in-one' turntable package ever made, Trio/Kenwood threw their 'engineering best practice' book at this one with startling results. Clean, powerful and three-dimensional sound, ultimately limited by the tonearm.

BARGAIN BULBS

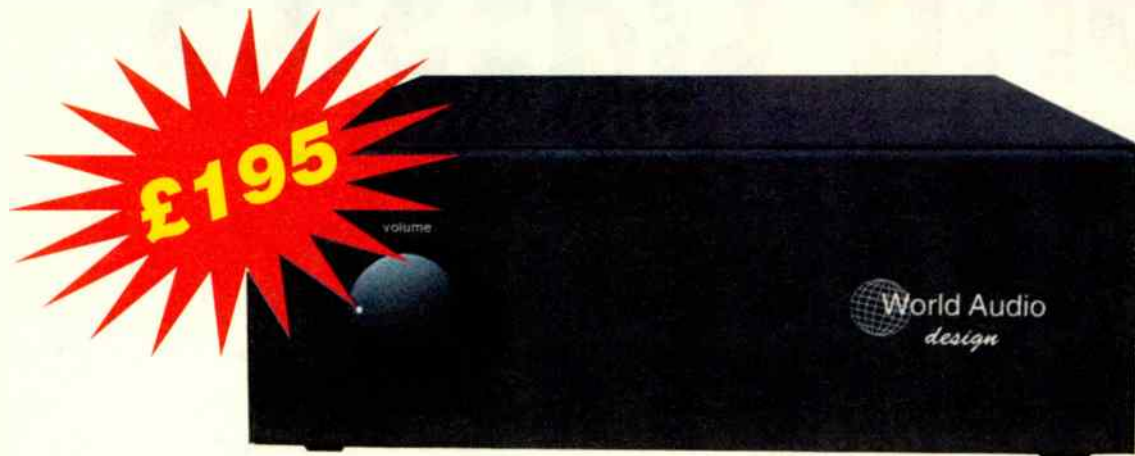

If you've always thought of valve amps as temperamental and expensive beasts, think again. World Audio Design's latest kit is designed with the budget conscious beginner in mind.

The Keci82 was created from a brief that demanded simplicity, ease of build and a super low cost. In order to achieve a reasonable power output we went for a push-pull amplifier.

We chose the ECL82, a triode/output pentode. This tube is readily available and has a good sound. In push-pull mode it delivers 8Watts. Realistically you need a speaker of around 89dB or above. This is possible at a budget price - try the smaller Triangle models, or a Tannoy mX3 or even one of the older Missions like the 773e, or if you like building your own speakers, try the Adire Audio HE10.1, as reviewed in HFW October 2002 issue.

You will see that the front has only a volume control, and it is fed by one pair of phono sockets. A selector and tape/source switch were not used in this amplifier as they are tricky to wire up, and the aim was to make it easy to build. In fact, in many ways the Keci82 would be great powering a second system, using a CD player as a source, and will definitely give you a taster of what valves can offer. Measuring 30cm wide, 23.5cm deep and 11cm height with feet, it is entirely self-enclosed. The valves are visible through the four upper circular vent holes (one directly above each valve). We have kept the look simple with the minimalist front panel holding the volume potentiometer. The two-part chassis is constructed from 1.6mm mild steel with a durable black powder-coat finish. The whole unit is very sturdy, weighing in at 9kgs.

The signal input is in the form of a pair of gold plated RCA phono sockets that sit at the rear of the chassis. The speaker sockets accept 4mm banana plugs as well as bare wire. The mains switch is positioned at the rear of the amplifier, on the right hand corner for easy access. Mains power is received via an IEC lead. The Keci82 is based on a printed circuit board (PCB). The PCB is easy to follow with all component names, locations and orientations shown clearly. The amplifier requires no set up, you just turn it on. The kit will come with comprehensive instructions taking you through the build step-b-step.

SOUND QUALITY BY SIMON POPE

Purity is the key to this amplifier's design and sound. Because there's very little to get in the way of the signal what you get is an exceptionally sweet and simple sound that also has a superbly wholesome roundness to it. A high quality recording of Mahler's Das Lied Von Der Erde on Reference Recordings showed that the Keci82 faithfully reproduced all the depth and space of a full symphonic orchestra without any problems. Violins were smooth and sweet, as was percussion (which virtually sparkled) and the woodwind section was especially impressive, with a spacious and airy sound.

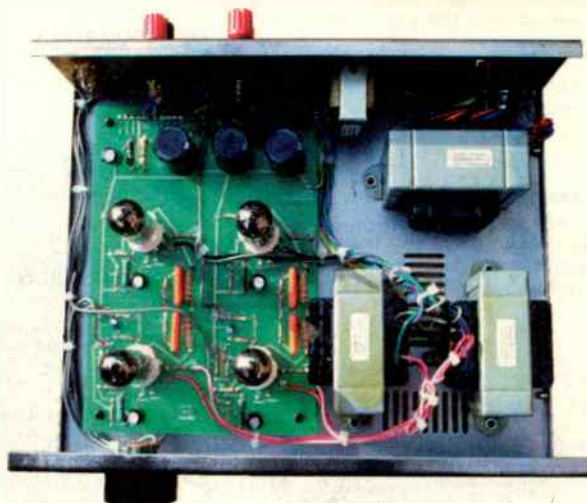

A run through Miles Davis's Kind Of Blue saw the little integrated delivering a detailed and precise sound that highlighted the warmth of Coltrane's tenor sax and the rich, deep sound of the upright bass. Rock and Pop records such as Radiohead's 'Lucky' demonstrated that the valves inside the amp, whilst small, are quite robust sounding, with commendable clout and bass depth for a humble budget 8W valve amp. This is a great introduction to the sonic art of the valve amp and a big upgrade for anybody with a mid-price solid-state amp that wishes to swap over to something more musically engaging, for a price that's virtually as cheap as chips!

MEASURED PERFORMANCE

Frequency response	+/-3dB 15Hz - 75kHz
power output	8 watts into an 8 ohm load
sensitivity	850mV (suitable for CD)
hum	0.5mV

**The Keci82 amplifier kit is available from World Audio Design
Tel/fax: 00 44 (0) 1908 218836 or order on-line at
www.worldaudiodesign.co.uk**

**Keci82 amplifier kit (UK price) £195.00
(inc. vat & carriage)**

**Keci82 amplifier kit (EU price) £195.00
(inc. vat, exc. carriage)**

**Keci82 amplifier kit (Overseas price) £170.00
(exc. carriage)**

TONEARMS**ACOS LUSTRE GST-1 1975 [£46]**

The archetypal S-shaped seventies arm; good, propulsive and involving sound in its day, but ragged and undynamic now.

AUDIOTECHNICA AT1120 1978 [£75]

Fine finish can't compensate for this ultra low mass arm's limited sonics - a good starter arm if you've only got a few quid to spend.

ALPHASON HR100S 1981 [£150]

First class arm, practically up to present-day standards. Buy carefully, though, as there is no service available now. Totally under priced when new, exceptional.

GRACE G707 1974 [£58]

This early Japanese example of the tonearm art has a smooth, lyrical sound. Imported by Linn, fitted to early LP12s. Sonically way off the pace now, though.

HADCOCK GH228 1976 [£46]

Evergreen unipivot with lovely sweet, fluid sound - although bass and dynamics are limited. Excellent service backup.

LINN ITTOK LVII 1978 [£253]

Arguably the first 'superarm'; Japanese design to Linn specs made for a muscular, rhythmic sound with real dynamics. Now off the pace, but the final LVIII version worth seeking out.

NAIM ARO 1986 [£875]

Truly endearing and charismatic performer - wonderfully engaging mid-band makes up for softened frequency extremes.

REGA RB300 1983 [£88]

Inspired budget esoterica. Detailed, tight, neutral sound but tonally grey sounding in absolute terms. Responds well to tweaking, and its cheaper RB250 brother better still.

SME 3009 1959 [£18]

Once state of the art, but long since bettered. Musical enough, but weak at frequency extremes and veiled in the midband. Legendary serviceability has made it a cult, used prices unjustifiably high.

SME SERIES III 1979 [£113]

Clever variable mass design complete with Titanium Nitride tube tried to be all things to all men, and failed. Charming nonetheless, with a warm and inoffensive sound.

TECHNICS EPA-501 1979 [£ N/A]

Popular partner for late seventies Technics motor units. Nice build and Titanium Nitride tube can't compensate for middling sound.

INTEGRATED AMPLIFIERS**A&R A60 1977 [£115]**

Sweet and musical feature-packed integrated; the Audiolab 8000A used its blueprint to great effect.

AUDIOLAB 8000A 1985 [£495]

Smooth integrated with clean MM/MC phono stage and huge feature count. Extremely reliable, too. Post '93 versions a top used buy.

CREEK CAS4040 1983 [£150]

More musical than any budget amp before it; CAS4140 loses tone controls, gains grip.

MCINTOSH MA6800 1995 [£3735]

Effortlessly sweet, strong and powerful with seminal styling to match.

MISSION CYRUS 2 1984 [£299]

Classic eighties minimalism combines arresting styling with clean, open, lively sound. Further upgradeable with PSX power supply.

MUSICAL FIDELITY A1 1985 [£350]

Beguiling Class A integrated with exquisite styling. Questionable reliability.

MYST TMA3 1983 [£300]

Madcap eighties minimalism, but a strong and tight performer all the same.

NAD 3020 1979 [£69]

Brilliantly smooth, sweet and punchy at the price and even has a better phono stage than you'd expect. The archetypal budget super-amp.

**NAIM NAIT 1984 [£350]**

Superb rhythms and dynamics make it truly musical, but tonally monochromatic. Fine

phono stage, very low power.

ROGERS CADET III 1965 [£34]

Sweet sounding valve integrated, uses ECL86 output valves, even has a half useable phono stage, sweet, warm a good introduction to valves

ROTEL RA-820BX 1983 [£139]

Lively and clean budget integrated that arguably started the move to minimalism.

SUGDEN A21 1969 [£ N/A]

Class A transistor integrated with an eminently likeable smoothness and musicality. Limited inputs via DIN sockets.

PREAMPLIFIERS**AUDIOLAB 8000C 1991 [£499]**

Tonally grey but fine phono input and great facilities make it an excellent general purpose tool.

CROFT MICRO 1986 [£150]

Budget valve pre-amp with exceptionally transparent performance.

LEAK POINT ONE STEREO 1958 [£ N/A]

Good for their time, but way off the pace these days. Use of EF86 pentode valve for high gain rules out ultra performance. Not the highest-fit!

LECSO AC-1 1973 [£ N/A]

Amazing styling courtesy of Allan Boothroyd can't disguise its rather cloudy sound, but a design classic nonetheless.

**LINN LK-1 1986 [£499]**

A brave attempt by the Glasgow boys to bring remote controlled user-friendliness to hair-shirt audiophile hi-fi. Didn't quite work, but not half bad for under £100.

Billy Vee

SOUND SYSTEMS

248 Lee High Rd, London SE13 5PL (10am to 6.30pm Closed Thurs & Sun)

Linn Summer Promotion!

Call (020) 8318 5755 or 8852 1321

Web: www.billyvee.co.uk email: sales@billyvee.co.uk E&OE

The Linn Annual summer promotion offers existing customers who own selected Linn source and control products, generous trade-in allowances against the new UNIDISK 1.1 and KISTO



Now is a great time to upgrade your system! From now until September we are offering a special trade-in value for: Mimik, Genki, Karik, Ikemi and AV5103 owners.



We have added extra value to the Linn guaranteed trade in making this a very special summer promotion indeed. Call sales to find out more and book your audition now!

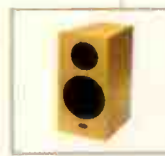

Also this summer, we are offering the CLASSIK Movie Di as part of a complete A/V package promotion. For further information on this fantastic offer please contact Ian Ridge on either of the above sales numbers.

NAIM NAC32.5 1978 [£ N/A]
The Salisbury company came of age with this, their classic high end pre. Brilliantly fast and incisive sound that's a joy with vinyl but a tad forward for digital.

QUAD 22 1958 [£25]
The partner to the much vaunted Quad II monoblocs - cloudy and vague sound means it's for anacrophiles only.

QUAD 33 1968 [£43]
Better than the 22, but Quad's first tranny pre isn't outstanding. Responds well to tweaking/ rebuilding though...

POWER AMPLIFIERS

LEAK POINT ONE, TL10, TL12.1 1949 [£28]



Early classics that are getting expensive. Overhauling is de rigeur before use, using original parts if possible. Surprisingly crisp and musical sound, that's far more modern than Quad IIs. Deeply impressive when in fine fettle.

LEAK STEREO 20 1958 [£31]
Excellent workaday classic valve amplifier with decent power and drive. Surprisingly modern sounding if rebuilt sympathetically. Irrepressibly musical and fluid.

LECSON API 1973 [£ N/A]
Madcap cylindrical styling alluded to its 'tower of power' pretensions, but it wasn't. Poor build, but decently clean sounding when working.

MARANTZ MODEL 9 1997 [£8000]
Authentic reproduction monoblocs still more than cut the sonic mustard. Highly expensive and highly sought after.

MICHELL ALECTO 1997 [£1989]
Crisp, clean and beautifully controlled with gorgeous styling. Partnered with the £1650 Orca this sounds delicious!

MUSICAL FIDELITY XA200 1996 [£1000PR]
200W of sweet smooth transistor stomp in a grooved tube! Under-rated oddity.

QUAD II 1952 [£22]
The all-time classic valve amplifier, with a deliciously fluid and lyrical voice. In other respects though, it sounds hopelessly dated. Low power and hard to partner properly.

QUAD 303 1968 [£55]
Bullet proof build, but woolly sound. Off the pace, but endearing nonetheless. Some pipe smoking slipper wearers swear by them!

QUAD 405 1978 [£115]
The first of the current dumpers is a capable design with smooth, effortless power and a decently musical sound. 606 and 707 continue the theme with greater detail and incision.

PHONO STAGES

CREEK OBH-8 SE 1996 [£180]
Punchy, rhythmic character with oodles of detail makes this a great budget audiophile classic. Partner with a Goldring G1042 for an unbeatable budget combination.

LINN LINNK 1984 [£149]
Naim-designed MC phono stage built to partner the original Naim NAIT - yes, really! Fine sound, although off the pace these days.

MICHELL ISO 1988 [£ N/A]
This Tom Evans-designed black box started the trend for high performance offboard phono stages. Charismatic, musical and punchy - if lacking in finesse.

TUNERS

CREEK CAS3140 1985 [£199]
Excellent detail, separation and dynamics - brilliantly musical at the price. T40 continued the theme...



MARANTZ ST-8 1978 [£353]
Marantz's finest radio moment. Warm, organic sound plus an oscilloscope for checking the signal strength and multipath.

NAD 4040 1979 [£79]
Tremendously smooth and natural sound allied to low prices and good availability make this budget analogue esoterica. Needs a good antenna to work properly, however.

LEAK TROUGHLINE 1956 [£25]
Series I an interesting ornament but limited to 88-100MHz only. II and III are arguably the best-sounding tuners ever. Adaptation for stereo easy via phono multiplex socket. Fed by a modern outboard decoder they're deliciously lucid with true dimensionality.



NAD 4140 1995 [£199]
Brilliant affordable digital tuner has a smooth, detailed musical sound plus sensible real-world facilities.

NAIM NAT03 1993 [£595]
The warm, atmospheric sound is further proof of Naim's proficiency with tuners.

PIONEER TX-9500 1976 [£295]
Another of the serious classic solid-staters. Boasts the usual high end Jap package of fine sound, brilliant sensitivity and superb build.

YAMAHA CT7000 1977 [£444]
Reputedly the best of the classic Jap analogues, this combines sleek ergonomics, high sensitivity and an explicit, detailed sound.

ANALOGUE RECORDERS

AIWA XD-009 1989 [£600]
Aiwa's Nak beater didn't, but it wasn't half bad nonetheless. Massive spec even included a 16x4 DAC!

NAKAMICHI CR-7E 1987 [£800]
The very best sounding Nakamichi ever - but lacks the visual drama of a Dragon.

REVOX A77 1968 [£145]
The first domestic open reel that the pros used at home. Superbly made, but sonically off the pace these days. B77 better, but couldn't match the Japanese.

SONY WM-D6C 1985 [£290]
Single capstan transport on a par with a Swiss watch, single rec/replay head better than most Naks. Result: sublime.

Billy Vee
SOUND SYSTEMS

EXCELLENT VALUE PRE - OWNED BARGAINS

SECONDHAND UNITS WITH WARRANTY. 24HR DEL ONLY £5. CHECK AVAILABILITY BEFORE ORDERING
CALL SALES:(020) 8318 5755 or 8852 1321 - 248 Lee High Road, London, SE13 5PL
0% APR is available on purchases of more than £660. Please call for details. Prices set at time of press. E&OE

Arcam FMJ CD23 Player (1Yr G/tee)	(1199.00)	£699.00	Linn Kaim Phono Preamp (1Yr G/tee)	(1700.00)	£799.00
Arcam FMJ DV27 Player (12Mth G/tee)	(1599.00)	£1199.00	Linn LK100 Power Amp (1Yr G/tee)	(695.00)	£349.00
Arcam A85 Amplifier (1Yr G/tee)	(799.00)	£599.00	Marantz DV890 DVD Player (1Yr G/tee)	(399.00)	£149.00
Arcam A22/P75 Dave AV Amp (1Yr G/tee) (2849.00)		£1495.00	Naim NAC72 Preamp (6Mth G/tee)	(745.00)	£245.00
Arcam Alpha 7 Tuner (6Mth G/tee)	(279.00)	£149.00	Naim NAT02 Tuner (1Yr G/tee)	(1029.00)	£799.00
B&W CDMC Centre Speaker (6Mth G/tee)	(299.00)	£175.00	Naim NAP 150 Power Amp (6Mth G/tee)	(799.00)	£525.00
Denon TU260L Tuner (6Mth G/tee)	(139.00)	£95.00	Naim CDX CD Player (1Yr G/tee)	(2470.00)	£1750.00
Linn Karik 2 C D Player (6Mth G/tee)	(1850.00)	£625.00	Naim CDS Head Unit (1Yr G/tee)	(4165.00)	£3295.00
Linn Numerik D A Converter (6Mth G/tee)	(1100.00)	£529.00	Naim PSX Power Supply-CDX (1Yr G/tee)	(2100.00)	£1695.00
Linn Majik Amplifier - Phono (6Mth G/tee)	(849.00)	£449.00	Quad FM4 Tuner - Grey (6Mth G/tee)	(299.00)	£175.00
Linn Kolektor Preamp (1Yr G/tee)	(495.00)	£369.00	Pioneer DV909 DVD/Laser Sil (6Mth G/tee)	(899.00)	£249.00
Linn Wakonda Preamp (1Yr G/tee)	(845.00)	£489.00	Ruark Talisman Speakers (6Mth G/tee)	(499.00)	£199.00
Linn Kaim Pro Preamp (1Yr G/tee)	(1400.00)	£599.00	Spendor S3 Speakers (1Yr G/tee)	(600.00)	£449.00

PIONEER CTF-950 1978 [£400]
Not up to modern standards sonically, but a great symbol of the cassette deck art nonetheless.



YAMAHA TC-800GL 1977 [£179]
Early classic with ski-slope styling courtesy of Mario Bellini. Middling sonics by modern standards, but cool nonetheless!



DIGITAL RECORDERS

KENWOOD DM-9090 1997 [£500]
Serious and sophisticated sound thanks to well implemented ATRAC 4.5; surprisingly musical MD recorder.

MARANTZ DR-17 1999 [£1100]
Probably the best sounding CD recorder made; built like a brick outhouse with a true audiophile sound and HDCD compatibility.

PIONEER PDR-555RW 1999 [£480]
For a moment, this was the CD recorder to have. Clean and detailed.

SONY TCD-8 DATMAN 1996 [£599]
Super clean sound makes this an amazing portable, but fragile.

SONY MDS-JE555ES 2000 [£900]
The best sounding MD deck ever, thanks to awesome build and heroic ATRAC-DSP Type R coding.

LOUDSPEAKERS

JR 149 1977 [£120]
Infamous cylindrical speaker that was ignored for decades but now back in fashion! Based on classic KEF T27 / B110 combo as seen in the BBC LS3/5a. Doesn't play loud, needs a powerful transistor amplifier, but rewards with fine clarity in imaging.

LEAK SANDWICH 1961 [£39 EACH]
Warm sounding infinite baffle that, with a reasonably powerful amplifier can sound quite satisfying.

LOWTHER PM6A 1957 [£18 EACH]
This seminal full-range driver is still manufactured. High sensitivity, as fitted to many classic horn designs.

MAGNEPLANAR SMGA198X [£800]
Technological loudspeaker with genuinely musical abilities; fast, smooth, open, dry.

MISSION 752 1995 [£495]
Cracking Henry Azima-designed floor-standers combined HDA drive units and metal dome tweeters with surprisingly warm results. Benign load characteristics makes them great for valves.



MISSION 770 1980 [£375]
Back in its day, it was an innovative product and one of the first of the polypropylene designs. Warm, smooth, clean and powerful sound.

MISSION X-SPACE 1999 [£499]
The first mass production sub and sat system using NXT panels is a sure-fire future classic - not flawless, but a tantalisingly unboxy sound nevertheless!

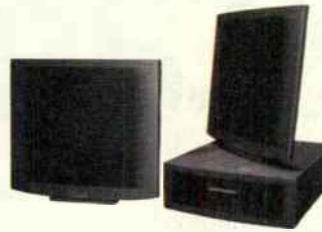

QUAD ESL57 1956 [£45 EACH]
Wonderfully open and neutral sound puts box loudspeakers to shame. Properly serviced they give superb midband performance, although frequency extremes less impressive. Ideally, use in stacked pairs or with sub-woofers and supertweeters.

QUAD ESL63 1980 [£1200]
An update of the ESL57, with stiffer cabinets. Until the 989, the best of the Quad electrostatics.

YAMAHA NS1000 1977 [£532]
High tech Beryllium midband and tweeter domes and brutish 12" woofers in massive sealed mirror image cabs equals stunning transients, speed and wallop allied to superb transparency and ultra low distortion. Partner carefully!



TANNOY WESTMINSTER 1985 [£4500]
Folded horn monsters which certainly sound good if you have the space. Not the last word in tautness but can drive large rooms and image like few others.

Billy Vee
SOUND SYSTEMS

SAVE UP TO 50% ON EX-DISPLAY BARGAINS

SOME AS NEW WITH 2 YR WARRANTY. 24HR DEL ONLY £5. CHECK AVAILABILITY BEFORE ORDERING
CALL SALES: (020) 8318 5755 or 8852 1321 - 248 Lee High Road, London, SE13 5PL
0% APR is available on purchases of more than £660. Please call for details. Prices set at time of press. E&OE

Arcam A85 Amplifier (1Yr G/tee)	(799.00)	£549.00	Marantz RC5000 Prog remote (1Yr G/tee) 60%	(299.00)	£135.00
Arcam A22/P75 Dave A.V. Amplifier S/H	(2849.00)	£1395.00	Marantz DV7000 DVD Player (1Yr Gtee) 60%	(599.00)	£199.00
Arcam DT26 DAB Tuner (2Yr G/tee)	(999.00)	£649.00	Naim CD5 CD Player (2Yr G/tee)	(1195.00)	£895.00
Arcam FMJ CD23 CD Player (1Yr G/tee)	(1199.00)	£779.00	Naim NAP 150 Power Amplifier (2Yr G/tee)	(795.00)	£595.00
Arcam FMJ DV27 DVD Player (2Yr/Gtee)	(1599.00)	£1259.00	Naim CDS/2 Player (2Yr G/tee)	(6256.00)	£4595.00
Celestion Compact A Spkrs R/nut (1Yr G/tee)	(600.00)	£269.00	Naim 52 Preamplifier (2Yr G/tee)	(3850.00)	£2795.00
K.E.F. Q5 Speakers-Cherry (2Yr G/tee) 60%	(599.00)	£299.00	Naim Credo Speakers (2Yr G/tee)	(1350.00)	£875.00
K.E.F. PSW 3000 SubWoofer (2Yr G/tee)	(599.00)	£399.00	Rega Planet 2000 CD Silver (1Yr G/tee)	(498.00)	£369.00
Linn Classik Movie System (2Yr G/tee)	(1995.00)	£1195.00	Rega Mira 2000 Amp Silver (1Yr G/tee)	(498.00)	£365.00
Linn AV 5103 Control Processor (1Yr G/tee)	(3250.00)	£1150.00	Sugden Bijou Ampmaster (2Yr G/tee)	(689.00)	£495.00
Lexicon MC1 Processor (2Yr G/tee) 50%	(5500.00)	£2595.00	Sugden MasterClass Integrated Amp	(2200.00)	£1590.00
Mission M51 Speakers - Rosenut (2Yr G/tee)	(299.00)	£209.00	Spendor S3 Speakers Maple (2Yr G/tee)	(600.00)	£399.00
Mission M53 Speakers - Beech (2Yr G/tee)	(549.00)	£369.00	TAG AV30 A.V. Proc - Silver (2Yr G/tee)	(2000.00)	£1395.00



world standards

These are the best products we've heard that are currently on sale in the UK, complete with the date they were originally launched and their current retail prices. Watch out for regular updates...!

TURNTABLES

ANTTI/ARM ONE/IQ1 1998 £725
Redesigned Systemdek IIX now off the pace, but the arm and cartridge are both star performers.

LINN LP12/ LINGO 1973 £2100
The quintessential belt drive superdeck offers a beguilingly musical midband at the expense of lumpy bass and nebulous imaging. Latest Lingo brings a new lease of life, with even more punch and polish.

MICHELL TECNODEC 2003 £575
Superb introduction to Michell turntables on a budget. Top quality build and elegant design make it the class of the mid-price field right now.

MICHELL GYRODEC SE 2002 £870
Its beauty is more than skin deep - superbly build and finish allied to clever design equals class leading performance. Latest DC motor with 'Never Connected' PSU make it all the more unassailable.

MICHELL ORBE SE 2002 £1916
Cost-no-object evolution of the Gyro adds massy acrylic platter and two-stage isolation. Fantastically capable all rounder with commanding, powerful, detailed sound that gets the best from almost any arm and cartridge.



PRO-JECT DEBUT II PHONO SB 2002 £170
Fuss-free all in one starter turntable, complete with built in phono stage. Not a star performer, but a fine midi system upgrade all the same.

REGA P3 2000 £298
Great entry level audiophile deck with fine bundled tonearm. Tweakable, and responds well to careful siting on a Base platform.

REGA P25 2001 £619
Until the TecnoDec, the best mid-price turntable package. Fine build and elegant styling. Clean, open sound but limited at frequency extremes in absolute terms.

SME MODEL 10A 1995 £3333
Exquisitely engineered deck and arm combo, but dry and clinical sounding compared to rivals. Accomplished performer with classical music, nonetheless.

TECHNICS SL1200/III 1973 £395

Slick build makes it a respectable performer, although the cheapo arm limits it - fit a Rega RB250 and it's suddenly a serious mid-price machine.

TO NEARMS

HADCOCK 242 SE 2000 £649
Latest of a long line of unipivots, with added mass, revised geometry and better finish. Musical like few others at or near the price, but poor frequency extremes.

LINN EKOS 1987 £1700
Subtle mods over the years, including revised bearings and the recent new wiring has kept it a serious contender in the superarm stakes. Lacks the SME's slam, the OL's clarity or the ARO's emotion, but has a feisty musicality all of its own.

MICHELL TECNOARM 2003 £346
John Michell's brilliant reworking of Rega's classic adds a classy counterweight and end stub, plus Cardas cable. The result is a near transparent sound with plenty of power and poise.

NAIM ARO 1987 £1425
Charismatic unipivot is poor at frequency extremes but sublime in the midband; truly emotive and insightful.

ORIGIN LIVE SILVER 2502001 £625
This fully developed and expertly fettled Rega boasts a superbly even, transparent and tuneful sound. Gives away only a small degree of finesse and dimensionality to top arms.

ORIGIN LIVE ILLUSTRIOUS 2002 £1570
A modern superarm with battleship build. Extremely strong, even and open sound in the mould of the late, lamented Zeta, plus fine tonal colouring. Exquisite.

REGA RB250 1984 £112
Sold through Moth Marketing, this is capable far beyond its price point, with a tight, lean and detailed sound. Responds brilliantly to Origin Live counterweight modification, and well to rewiring.

SME 309 1989 £767
Entry level SME complete with cost-cut aluminium armtube and detachable headshell. Tight, neutral sound with good tonality, but lacks the IV's pace and precision.

SME SERIES IV 1988 £1127
Offers nine tenths of the SMEV's magic at just over half price. Exquisitely built and finished, and a design classic. Faces stiff competition these days, but lovely nevertheless.

SME SERIES V 1987 £1614
The so-called Best Pickup Arm in the World isn't, but comes close. Vice-like bass with incredible weight, ultra clear midband and treble. Does everything except beguile the listener.

CARTRIDGES

AUDIO TECHNICA AT110 1984 £29
Great starter cartridge that's refined, detailed and musical beyond its price.

DYNAVECTOR DV10X5 2003 £250
A distant descendent of the classic Ultimo 10X, this has warmth and sweetness in spades, allied to a punchy bass. Beats G1042 comfortably.

DYNAVECTOR DV20X-H 2003 £299
The best modern budget MC combines deliciously sweet sound with fantastic get-up-and-go. High output version works a treat with valve phono stages too.

GOLDRING G1042 1994 £135
One of the best MMs going, with sweet and extended treble and punchy, muscular bass.

LYRIA LYDIAN BETA 1998 £600
An altogether more beguiling listen than the MC30S, although not quite as incisive. Superb all rounder, nonetheless.

LYRA PARNASSUS DCT 1997 £1895
Jonathan Carr's masterpiece is a brilliantly lyrical and fluid performer, with a deliciously sweet tone and immense subtlety and polish.

ORTOFON MC25FL 1994 £285
Strong budget MC with a cleaner and more detailed sound than the Dynavector; more sterile and less emotive, however.

ORTOFON MC30 SUPR' 1995 £550
Beautifully clean and detailed device with real finesse, albeit a tad mechanical sounding.

ORTOFON KONTRA' B 1999 £720
Surprisingly articulate performer by Ortofon standards. All the brand's usual polish and detail allied to real vim. Loves making music!



SHURE V15XMR 1994 £350
The most musical MM yet made - brilliantly dynamic and punchy in the classic Shure mould, yet refined and tidy too.

SUMIKO BPS 1995 £250
Charismatic performer with rhythm aplenty, but in other respects way off the pace - lacks smoothness and sophistication of the DV10X5.

DIGITAL DISC PLAYERS

ARCAM DIVA CD82T 2002 £600
Oodles of finesse, but not the most gripping performer at the price. A fine all rounder in the classic Arcam mould.

CAMBRIDGE AUDIO DVD57 2003 £200
Crisp, lively DVD-A sound makes this superb value for money, but 16bit playback is way behind similarly priced CD spinners.

CREEK CD50 2003 £699
Lyrical and musically engaging mid-price machine, but lacks its Marantz rival's tonal exuberance

CYRUS CD8 2003 £1000
Highly incisive, engaging, grippy and dynamic sound, but needs careful matching to smooth ancillaries. Optional PSX-R adds bass and dimensionality.

DENON DVD-A1 2002 £2500
Middling CD performance, but a genuinely strong DVD-A sound with masses of space and detail. Excellent pictures, too!



LINN GENKI 1999 £995
Undeniably fast, lithe, musical and fun - but some won't take to its dry, wry character. Works best in all-Linn systems, where it really rises to the challenge!

LINN IKEMI 1999 £1950
Has the brilliant focus and clarity of the previous Karik III with a dose more tonal richness and polish. More grip and poise than most at any price - still superb!

MARANTZ CD6000KI 2001 £500
Brilliantly warm and voluptuous sound will endear it to vinylphiles and tube lovers alike. Musical, colourful, polished and powerful like none others at or near its price.

MARANTZ CD17 II 2002 £800
Oft-overlooked middleweight boasts a truly beguiling sound with lots of tonal flavour. Sits awkwardly between the £600 and £1000 price points, where some brilliant value buys reside, though.

MARANTZ DV8300 2002 £1500
An extremely well designed universal player, offering a beguilingly natural sound whatever you feed it.

MERIDIAN 507 2003 £1195
Quintessentially Meridian mid-price machine; smooth, warm, expansive and seductively musical. The best all rounder at this competitive price point.

MUSICAL FIDELITY TRIVISTA 2002 £4000
When playing SACDs, the sweetest, most lucid and lyrical digital disc spinner we've heard. Old school stereo, pure DSD design. CD sound is up in the £1000 class, too! Future classic.

NAD C541I 2002 £330
Highly musical and articulate budget machine in the classic NAD mould. Second only to Cambridge's CD500SE in the value stakes.

NAIM CDS 2001 £1195
Taut and grippy like no others at the price, but lacks the warmth of the Marantz CD6000KI at half the price. To wit, it's a very focussed product, best used in Naim systems.

NAIM CDX2-XPS2 2003 £4950
A fine high end machine, but add an XPS2 and it becomes one of the most characteristically engaging 16bit machines we've ever heard. Plays music with such passion!

NAIM CDS3 2003 £7050
The most polished Naim CD to date; tremendously capable and musical, but lacks the Rotweiler quality of the cheaper CDX2-XPS2.

PHILIPS DVD963SA 2003 £400
Creamy CD sound allied to superb SACD and DVD video playback makes this brilliant value for money.

REGA PLANET 2002 £498
Rhythmic and beguiling performer, although lacks the warmth of tone needed to better its Marantz rival. Superb ergonomics and design, nonetheless.

REGA JUPITER 2002 £1000
A Planet on steroids, this machine adds depth and breadth to its baby brothers already impressive sound. Good, but facing stiff competition.

DIGITAL RECORDERS

PIONEER PDR-609 2001 £200
Brilliant value CD recorder that makes excellent recordings from its digital inputs. Half decent digital converters, too.

PHILIPS DVDR880 2003 £370
Poor CD audio playback, but makes great DVD video recordings and boasts fine ergonomics. Top AV value.

SONY RCD-W3 2002 £250
Usual superb Sony ergonomics make for nonsense budget buy. Fine direct digital copies, but analogue input poor. Middling sonics, but there's a digital output!

YAMAHA CDR-HD1300E 2002 £600
HD means MD-style ease of editing, but compromises recording quality ever-so slightly. Add decent CD replay and it's a fine all rounder nonetheless - top value.



ONKYO MB-S1 2001 £1100
An interesting machine complete with MP3 functionality, but high price, fussy ergonomics and over-smooth sound make it mediocre value against the Yamaha.

PHONO STAGES

CREEK OBH-2ISE 2003 £250
Musically enjoyable yet highly refined for the price - a superb buy. Gives the Dino a real hard time.

EAR 834P 1993 £400
Classic tube design with a deliciously warm and expansive sound - shame about the loose bass and veiled treble!

LINN LINTO 2000 £900
A musical and incisive performer, with more speed than the Delphini at the expense of detail and tonal colour.

MUSICAL FIDELITY X-LP 1999 £149
Clarity and detail allied to decent smoothness make it a solid first phonostage. MM/MC.

QED DISCSAVER 1995 £35
Rhythmic, bouncy sound via battery, although it's bright and forward. Great value, but £100 more on the X-LP is well worth it!

TRICHORD DINO 2002 £299
Great all rounder with switchable MM/MC. Fast, fluid and smooth like no others at the price.

TRICHORD DELPHINI 2003 £995
The very latest 'Never Connected' variant is easily the best, bringing velvety smoothness to an already refined and engaging performer. Neutral to a fault - some will mourn the passing of the charismatic ISO.

AMPLIFIERS

ARCAM DIVA A65 PLUS 2002 £370
Classic budget Arcam fare - decently sweet and open with sensible facilities and plenty of power.

ARCAM FMJ A32 2001 £1150
For those who value serious power and labyrinthine facilities over outright clarity or grip. A very impressive all rounder with an unusually muscular power amp at this price.

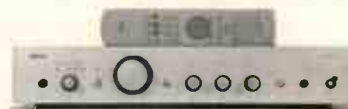

AUDIO ANALOGUE PUCINI 1999 £495
Brilliant value mid-pricer is a real step up from budget designs. Smooth, fluid, natural sound with adequate power and no nasties. Fine phono stage too!

AUDIO NOTE OTO SE 2000 £1199
This baby tuber is beautifully sweet and creamy, but lacks solid-state's clarity, detail and inclusion. Low, low power means speaker choice critical.

AUDIO NOTE SORO SE 2000 £1699
Wonderfully out-of-the-box sounding tube middleweight is all about sweetness and fluidity. Limited power and loose bass, but little the worse for it.

CYRUS 6 2003 £600
Cracking do-it-all mid price design, bringing svelte sound, good connectivity and upgradeability and stunning style and build.

CYRUS 8 2003 £800
Unusually warm and lyrical for a solid-stater, with decent power and punch. PSX-R adds dynamics, detail and dimensionality.



MERIDIAN 551 1994 £895
Evergreen middleweight is a serious performer even now. Tonally a tad dry, it's still very smooth and svelte with bags of power, detail and grip. Class act.

MUSICAL FIDELITY A308 2002 £2400
Impressive monster integrated. Vast power delivered with clarity, even-handedness and finesse. Musical, with real tonal colour. Separate pre-power version better still, but less good value.

NAD C320 2002 £220
Not the giant killer that the 3020 once was, but a very strong budget design. A great starting point; forms a fine system with NAD's partnering C541i CD player.

NAIM NAIT 5 2001 £845

A fast and thrilling listen, thanks to taut and articulate bass and midband. Surprisingly polished for a budget Naim amp, both sonically and ergonomically.

**SUGDEN A21A** 1993 £1020

The most musical amplifier at the price, bar none. Delicious Class A sound is smooth, sweet and wonderfully transparent with true tonal colour. Low power, so match carefully.

PREAMPLIFIERS**CREEK OBH-12** 2000 £220

Brilliant value budget passive, giving little away in sonics to far more expensive designs. Connectivity and build aren't great, but what do you expect at this price?

**MF AUDIO PASSIVE PRE** 2003 £1010

Novel and effective pre with switchable gain via a transformer, and balanced operation. Open and incisive sound, yet makes most active rivals sound edgy by comparison.

NAIM NAC112 2002 £660

Affordable admission ticket to the Salisbury high end experience. Detailed and dynamic, if tonally rather lacklustre.

POWER AMPLIFIERS**LINN LK140** 2000 £800

Dry and grey sounding, but decently dynamic and musically engaging all the same. A worthy worker in a budget Linn system.

NAIM NAP150 2002 £795

Driven by a decent source and a NAC112, this gives highly enjoyable results - providing you like the Naim sound! Taut, fast and feisty despite its relative lack of power.

MARANTZ SM-17 2001 £700

Useful budget power amp with plenty of clean transistor power. Not the most transparent, but sweet and clean all the same. Fine build completes a great value package.

MUSICAL FIDELITY**A308 CR** 2003 £2400

Superb transistor behemoth, worth partnering with any high end CD player or preamp. Oodles of grunt served up with poise and purpose.

QUAD 909 2001 £900

The latest current-dumper has a smooth and expansive character with enough wallop to drive most loads. Not the most musical, but super value all the same. Lovely build, finish and Quad's legendary service are nice.

LOUDSPEAKERS**B&W CDM1 NT** 2002 £750

Fine clarity and imaging allied to pleasing warmth and great rhythmic cohesion make these standmounters an essential audition.

CASTLE CONWAY 3 2003 £930

Superbly smooth and crisp performers, with a big hearted musical sound. Ultimately coloured though, with a slow, plummy bass.

CYRUS CLS70 2001 £800

Charismatic performer with a fast, tight and open midband, but lacks cohesion and scale..

EPOS ELS-3 2003 £200

Plenty of brio and a decent degree of refinement makes this budget baby a fine value contender.

**KEF Q1** 2003 £250

Highly polished and articulate standmounters at the price, but demand good ancillaries for best results.

KLIPSCH HERESY II 1997 £1100

An outstanding high sensitivity loudspeaker with midrange and treble horns coupled with infinite baffle 12" bass driver. Effortless, fast and accurate.

LINN NINKA 2001 £995

Major on rhythms and dynamics, making them an involving listen. Reasonably refined, too - but tonally disappointing.

MISSION 782SE 2003 £900

Bright and tight design capable of brilliant speed and grip, at the expense of warmth. Demands high quality, high powered ancillaries.

MONITOR AUDIO B4 2003 £350

An unusually smooth and lucid performer at the price, and its 3-way design means it drives rooms well. Fine engineering, but build and finish so-so.

MORDAUNT SHORT 914 2002 £300

Warm, detailed and articulate performer, but a touch loose in the bass and veiled up top. Fine partner for budget valve amps.

NAIM ALLAE 2002 £1990

Taut and grippy like few others, this speaker majors on transient speed. Surprisingly smooth for a Naim box, with nicely etched treble. As always, tonally dry.

TDK S-80 2002 £90

Ingenious NXT multimedia sub/sat system has a wonderfully even and open sound - like baby electrostatics.

**QUAD ESL-988** 2001 £3400

Wonderfully neutral and self-effacing with sublime imaging and projection. Treble lacks extension, bass lacks weight - although the pricier 989 answers the latter resoundingly.

PERIGEE FK-1L 2002 £5000

Charismatic Aussie ribbon design with deliciously open mid and treble, allied to fine bass weight. The right room and ancillaries essential. Engaging, musical and powerful sound. Superb.

W'DALE DIAMOND 8.1 2001 £120

Still the best baby budget standmounters around. Tight and grippy thanks to Kevlar drivers, but invariably limited in the frequency extremes.

**HEADPHONES****JECKLIN FLOAT TWO** 1998 £99

Wonderful panel-like sound from these esoteric-looking headclamps.

SENNHEISER MX-500 1999 £19

Our unqualified recommendation for those seeking a serious sounding pair of in-ear phones. Smooth, detailed and musical.

SENNHEISER PX-100 2002 £29

Cracking pair of lightweight open back cans ideal for personals, but good enough for real hi-fi use. Superb build allied to a smooth and engaging performance make them the spiritual successor to the HD-400s.

SENNHEISER HD-590 1998 £199

The company's best real-world cans to date. Open and smooth with plenty of detail. Brightly lit midband makes them an ideal partner for a valve headphone amp.

**INTERCONNECTS****CHORD CO. CHAMELEON 2** £90/M

One of our favourites, these are musical performers with a smooth yet open sound.

DNM RESON £40/M

Neutral and transparent - a steal!

NORDOST BLUE HEAVEN £150/M

Some of the fastest and most transparent cable around.

VDH ULTIMATE THE FIRST £260/0.6M

Carbon interconnects that help you forget the electronics and concentrate on the music. Miraculous transparency. Tight and tenuous bass mixed with air and space results in a cracking cable for the money.

World Music

Here's a music special with a difference - twelve pages of essential listening, spanning classical, jazz, funk, rock and pop. While many titles are brilliantly recorded, some are poor yet the music is great enough to shine through regardless. Enjoy!

the crusaders

STREET LIFE

1979

MCA 3008 LP

By the time of this album's release at the end of the seventies, disco music was fast becoming an artistically spent force. There were exceptions of course. An example was The Crusaders. They were a prime example of a long-established soul/funk band using disco as shortcut to commercial success.

Formed in Houston, Texas, as the Swingsters in the nineteen fifties, the band comprised Wilton Felder, Wayne Henderson (trombone), Joe Sample (keyboards) and Nesbert 'Stix' Hooper (drums). After forging a reputation as The Jazz Crusaders, they were signed by the Pacific label for whom they recorded a series of melodious albums. In 1970 the quartet became simply The Crusaders. In 1972, their hit, 'Put It Where You Want It', established them. It was later recorded by the Average White Band, finally conferring upon them real credibility. Henderson left the group in 1975, and several session musicians including master guitarist Larry Carlton, augmented the threesome on their subsequent recordings.

Randy Crawford, a hitherto largely unknown soul singer, provided the vocals to the title track of this, their 1979 release. Written by Joe Sample and Will Jennings, it's an eleven minute epic that showcased both Crawford's vocals

and the band's brilliant musicianship. Although brilliantly tight, Joe Sample's louche Fender Rhodes work is a brilliant accompaniment to Crawford's uniquely deep, powerful and breathy vocals.

In the best traditions of serious nineteen seventies soul bands, there's a vast array of musicians playing on 'Street Life'. Instruments include a number of saxophones, guitars, trumpets, trombones and basses, not to mention the occasional lush string parts. Rather than overwhelming, they merely accent and give flavour to what is a deliciously sweet, smooth and beguiling album.

The title track featured Wilton Felder on tenor, soprano and electric bass, Joe Sample on keyboards and Stix Hooper on drums, along with guitarist Barry Finnerty. Although it's the obvious stand-out single, the whole album is a great listen. 'My Lady', 'Rodeo Drive (High Steppin)', 'Carnival Of The Night', 'The Hustler' and 'Night Faces' are all highly seductive examples of a band whose members know one another inside out, making for a most charming album which gets better the more you play it.

'Street Life' was the last hurrah for The Crusaders. After the tremendous commercial success of the title track and single release, their subsequent recordings lacked the artistry of this superb album.

Undoubtedly, what made the title track was the sublime vocal strains of Randy Crawford, who subsequently went on to achieve great commercial success with her brilliant treatment a host of standards, such as 'Rainy Night in Georgia', and 'One Day I'll Fly Away'. Although Hooper left the line-up in 1983 (to be replaced by Leon Ndugu Chanler), Sample and Felder resolutely continued the group, but the magic ingredients had gone. 'The Good And Bad Times', released in 1986, celebrated the band's thirtieth anniversary, featuring several special guests including jazz singer Nancy Wilson.

'Street Life' was an exceptional album, boasting brilliant musicianship and a wonderfully cohesive, all-of-a-piece feel. It's largely instrumental, but needs few lyrics to communicate its glamorous but slightly seedy ambience. A fleeting but brilliant moment in disco's pantheon - very soon after, synthesisers and electronics would arrive and things would never sound the same again.

DAVID PRICE

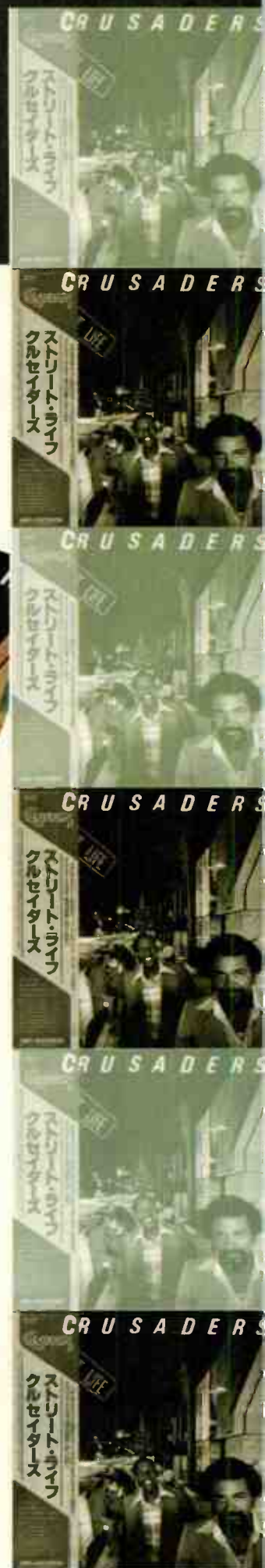
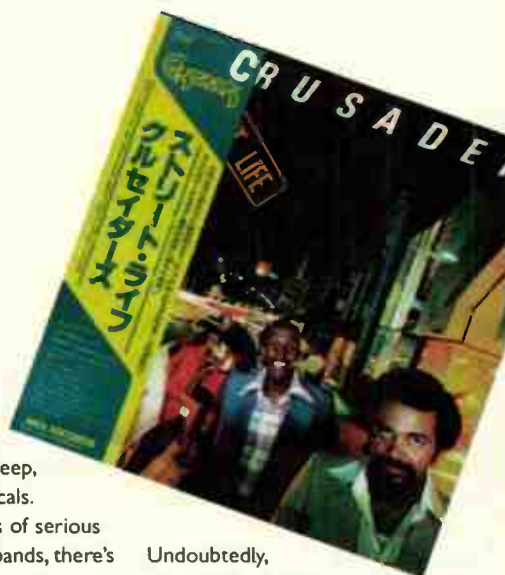

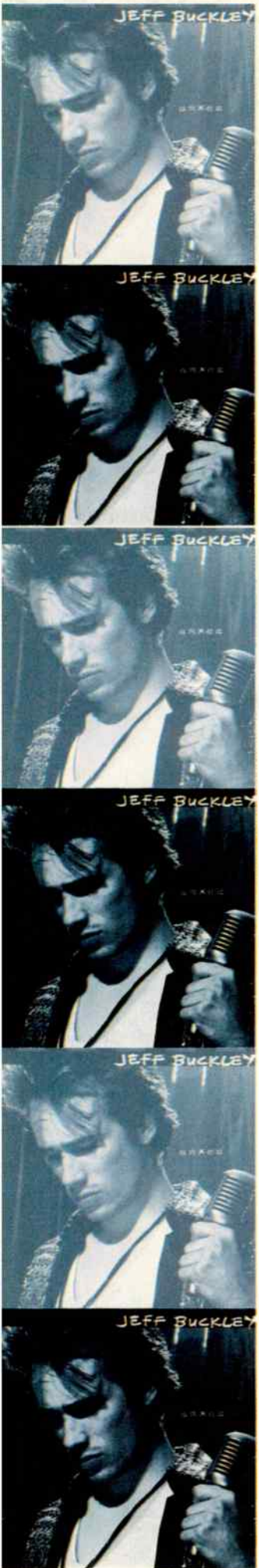

jeff buckley

GRACE

1994

COLUMBIA RECORDS 475928

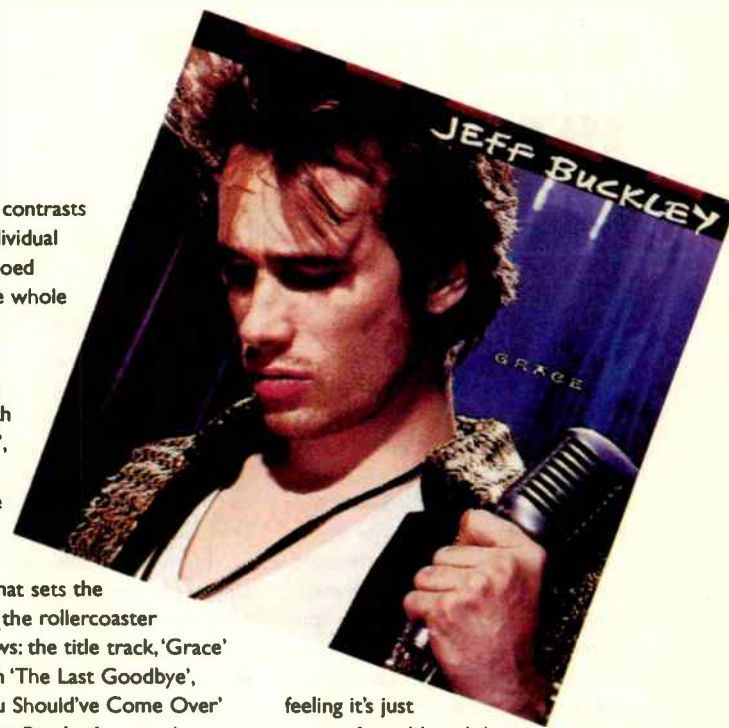

Related in August 1994 on Columbia, 'Grace' was the only studio album to be completed during Jeff Buckley's short lifetime. Son of nineteen sixties folk legend Tim Buckley, Jeff was desperate to make it on his own considerable merits, as he hardly ever saw his absent father. Such a terrible shame then that not only Tim should die so young but perhaps worse, his son Jeff should follow him to an untimely end, tragically drowning in Memphis harbour in May 1998.

Guitarist Michael Tighe, bassist Mick Grondahl and drummer Matt Johnson make up the band that recorded 'Grace', and so very successfully toured with Jeff on subsequent 1995 and 1996 world tours. Often overlooked due to the outstanding quality of Jeff's vocals, they formed an impressively tight ensemble, which became a key element in the lavish innovation that was to become 'Grace'.

An undeniably polished album, it is made so by the energy and subtlety of Jeff's multi-octave range voice, which eclipses just about any singer on the planet. So it was always going to be difficult not making this disc a mere showcase for his vocal genius, were it not for his often overlooked guitar artistry. Often playing his Fender Telecaster or his Rickenbacker 12-string at lightning speeds that would impress any metal-head, he always manages to inject a subtle beauty into even the most energetic rhythm. The band had a Led Zeppelin-like range of shades between light and dark with

the lavish contrasts within individual songs echoed across the whole album.

The recording opens with 'Mojo Pin', an innovative bluesy rock number that sets the scene for the rollercoaster that follows: the title track, 'Grace' along with 'The Last Goodbye', 'Lover, You Should've Come Over' and 'Dream Brother' are each so beautiful they could definitely be contenders for my favourite track of all time. The combination of magnificently executed innovative, lavish arrangements and angelic vocals produce in each case, an inspired and painfully beautiful piece of music. By way of contrast, these are interspersed with his well-known cover of Leonard Cohen's 'Hallelujah', an arrangement of the carol 'Corpus Christi' an intensely moving cover of the Elkie Brooks classic, 'Lilac Wine'.

Jeff, as if this wasn't varied enough, slips in a few real rough edged all out rockers: 'So Real' and 'Eternal Life' completing this incredible journey through his music. I've met people who don't like the heavier tracks, some who don't like the quieter tracks but never anyone who didn't like something about 'Grace'. One guitarist acquaintance of mine doesn't much like 'Grace'

feeling it's just too perfect, although he admits it did introduce him to Jeff's live material which he reveres.

If you don't already have 'Grace', you should buy it now - it's readily available on CD, usually for less than £10. If, however, you already have it, then go and hunt out some of his live material. 'Grace' has two roles; one is to present this polished slice of Jeff Buckley to us, the mere mortals for whom he played, and the other is to introduce us to his less well known live work. The best of this is the DVD 'Live in Chicago' (Sony Music Video 50216 9) and the 'Live from the Bataclan' EP (Columbia 662155 2), which is also available as part of the excellent boxed set 'The Grace EPs' (Columbia 501178 2). There has been so much written about Jeff Buckley and 'Grace' - justifiably so, in my opinion, as it is an awe-inspiring masterpiece.

DAVID DENYER

the byrds

YOUNGER THAN YESTERDAY

1967

COLUMBIA SBPG 62988

(stereo)/ BPG 62988 (mono)

The Byrds' earlier material was such a successful fusion of UK-influenced beat pop and West Coast folk that during the mid-sixties they were billed as the American Beatles. However, before recording their third album, '5th Dimension', lead singer and songwriter Gene Clarke left the band, leading to a highly experimental period as the fledgling songwriters took over. That album is good - very good - but it is their fourth album, 'Younger Than Yesterday' that converted this cynic to the wonders of The Byrds.

Chris Hillman, a Blue Grass mandolin player, had blossomed into a master of the bass guitar and gained even more inspiration after working with jazz legend Hugh Masekela, who in turn guests with tremendous effect on 'Younger Than Yesterday'. Hillman's song writing kicked into gear on this album, his inclusion of country musicians and rhythms into their rock and folk based frameworks lead the way not only for the next few Byrds albums, but also for the whole country rock movement that followed. You can hear his influence not only in later Byrds works but also in Manassas, The Grateful Dead and Jefferson Airplane to name but a few.

Recorded in late 1966 in Columbia's Hollywood Studios by ex-Beach Boy collaborator Gary Usher, 'Younger than Yesterday' initially fools the listener into thinking they'd put on a cheerful slice of Californian pop. The satirical 'So You Wanna Be A Rock 'n' Roll Star' opens this album at breakneck speed and launches the listener on into the depths of the album. The first Hillman penned tune follows:

'Have You Seen Her Face' providing a beautifully melodic contrast, to the all-out ballsy opener.

Half way through the first side stranger things start to happen: 'CTA-102', co-written by 12-string Rickenbacker virtuoso, Roger McGuinn, and his friend, sci-fi writer Carl Sagan, takes a beat pop rhythm and subsequently adds layer upon layer of effects to reaching a tripped out climax complete with 'alien-esque' voices.

The beautiful, folksy 'Renaissance Fair' brings us back to Earth with a showcase for McGuinn's sublime 12-string guitar work, and angel-voiced master of harmonies, David Crosby provides yet more contrast with his tripped-out lyrics. A Byrds' milestone follows this - the Hillman composition 'Time Between' introduces two of his fellow country musicians, Vern Gosden on acoustic guitar and Clarence White on 'Pull String' guitar. White's own development adds the steel guitar sound and country feel that was to become the future direction of the Byrds.

Besides Hillman, Crosby's inspired writing shaped this album. 'Everybody's Been Burned' despite being written back in 1962 provides the highlight of the album, the crystalline-layered guitars creating hypnotic rhythms beneath his dark yet beautiful vocals.

The ping-pong style of 'Younger Than Yesterday' continues with 'Thoughts and Words', further



extending the beat-pop-on-acid theme first encountered on 'CTA-102'

with the many layers of tape loops and backwards guitars adding a sitar-like feel to this individual acid-tinged groove. 'Mind Gardens' finds Crosby at his most tripped-out with a searching chaos of folk tunes, highly expressive vocalisation and recording effects whilst Dylan's 'My Back Pages'; a swansong to his acoustic years, perfectly echoes the passage of the Byrds from Sun-drenched Californian folk-pop into psychedelic country rock.

Another beautiful Hillman composition 'The Girl With No Name' takes us back in the folksy direction, before the finale of 'Why' which perhaps most seamlessly fuses the incendiary rhythms of the beat pop with the many-layered guitars of folk bluegrass, and drug-induced psychedelia laced with a heavy dose of West Coast sunshine.

One of the great albums of its decade, 'Younger Than Yesterday' is clearly inspired by its peers, yet it takes and develops these ideas creating a masterpiece that in turn went on to shape so much of the next thirty years of rock and roll.

DAVID DENYER





kate bush

THE KICK INSIDE

1978

EMI EMS630-026 LP

Hard as it may be to believe now, many viewed Kate Bush's first single ('Wuthering Heights') as a kind of novelty record. Her striking and distinctive vocal style was nothing like anyone else had heard at the time, making it easy pickings for satirists and cynics alike. Sadly, this rather detracted from what makes this song (and the album on which it was featured – 'The Kick Inside') so special, which is both the words and the music.

Back in 1978, Kate's studiously soprano tones weren't so much distinct as unique. Her Banshee-like wailing sounded nothing like classic female folk singer/songwriters (Joni Mitchell, Joan Baez, Laura Nyro), yet nor did her style sit comfortably outside the genre – a soul or disco diva Kate most assuredly was not!

Some critics cast her as a kind of new-wave siren, probably because of the shock of her voice which subsequent stylists like Hazel O'Connor were to later adopt. Yet she shared precious little in form or content with the likes of Blondie, either. In truth, she was a rock artist in the classic mould, but where she differed from the likes of male rock stars Peter Gabriel were those arresting lyrics from a distinctly female perspective.

'The Kick Inside' is surely one of the best rock debuts ever. It includes her earliest compositions, some of which she wrote in 1975 when she'd barely reached her teens, such as 'The Man With The Child In His Eyes' and 'The Saxophone Song'. It's packed with disarmingly personal and romantic compositions, such as 'Moving' and 'L'amour Looks Something Like You', which could

almost not have come from one much older. 'Feel It' shocks simply to hear such sentiments come from one so young!

The lyrics are remarkable inasmuch as they're both dark, cynical and world-weary, yet incredibly naïve and appreciative of life in its myriad (and often strange) forms. They alternate between the extremely private and personal, or dazzlingly imaginative projections of the subject in her song. The way in which she suffuses a sense of romantic dreaminess with knowing, worldly wit surely wouldn't disgrace John Keats. Hearing them via her unorthodox, almost theatrical singing voice – one which spans an eight octave range - is all the more arresting and unexpected. The result is that even sometimes quite pithy words such as, "oh to be in love, and never get out again, never get out again", can sound quite affecting.

Musically extremely polished, 'The Kick Inside' is a work of stunning maturity for a girl of just seventeen summers. Although it relies heavily on traditional verse-chorus song structures, it succeeds thanks to that amazing vocal style, which instantly makes this infectious quirky and unusual, and the brilliant playing of the backing musicians. The album's superbly accomplished musicianship – which sticks to standard rock practice but does it oh-so-successfully – allied to a

sympathetically economical production from Andrew Powell, makes for a sublime listen.

'The Kick Inside' is also fascinating inasmuch as it's a fixed point in time in her development. Listening to 1985's 'The Hounds of Love', for example, shows greater maturity on the part of the artist, but the former's immediacy still wins the day. The songs, about broken hearts and basic instincts, aren't conceptual, abstract or clever in the way that her later work is, and are all the better for it. We have Pink Floyd's Dave Gilmour to thank for getting this record out – without him – it wouldn't have happened like it did. It's a debut of both cringing naivety and breathtaking maturity, one which puts that of other female greats like Tori Amos or Sarah McLachlan to shame. As such, it's an essential listen, and as good an introduction to the rest of Kate Bush's work as you could ever want.

DAVID PRICE



thomas dolby

THE GOLDEN AGE OF WIRELESS

1982

VENICE IN PERIL LP VIP1001

In an era famed for its one-fingered synthesists and dodgy haircuts, Thomas Morgan Dolby Robertson was exceptional. A virtuoso who played as well as he programmed, he sported a floppy haircut of which his scientist father would have been proud.

Released in 1982, Dolby funded his debut long player by playing session keyboards for Foreigner. Luckily, producer Mutt Lange (of Shania Twaine fame) took his time, and the \$500-per-day fees that racked up bought him lots of quality time at high end studios like Tapestry and Playground.

His equipment list was minimal compared to some of his contemporaries; alongside his two analogue synths (a Micromoog and a Roland Jupiter 4) was a computer called Henry (a PPG 340/380) that had previously triggered Tangerine Dream's lighting show! Dolby pressed Henry into service to power Simmons electronic drums, and also got it generating immense, thundering bass sounds and glassy bell-like keyboard stabs. A rhythm section borrowed from Lene Lovich's band, and renowned guitarist Kevin Armstrong completed the line up.

The whole album was recorded without any sequencing for the keyboard parts, although the band would play along to pulses from the synths and drums over patterns from Henry the computer. Although spurned by some nineteen eighties electronic purists, fans of Radiohead will need no convincing that a live band playing alongside electronica can be both hypnotic and expressive.

The album kicks off with Flying North, showcasing Dolby's piano, backed by the full band and Henry the computer on drums. Analogue synthesiser lines don't come thicker than the drifting Jupiter 4 solo on

the outro. The lyrics conjure up dramatic scenes of derring do, of travelling and traversing continents – popular themes with that time's 'new pop' purveyors.

'Commercial Breakup' hints at Dolby's funk-ed-up future as Justin Hildrith knocks out what guitarist Armstrong memorably called, "the sort of beat that drummers don't like to play". Whilst heavy processing tries to choke the life out of Kevin's choppy guitar, double-barrelled bassist Mark Heyward-Chaplin plays his part so straight that it's almost punky. If you've ever wondered what Kraftwerk would sound like if they'd smoked 'vibes' with Herbie Hancock, stay with it till the synth solo on the breakdown.

An early Dolby composition, 'Europa and the Pirate Twins' has an element of the autobiographical. Born in Cairo, the young Tom followed his archaeologist dad around the globe, and these travels may have lent an outsider's perspective to his songwriting. Listen out for the best harmonica solo since Andy Partridge on XTC's 'Peter Pumpkinhead' – one of Dolby's heroes who had produced the tracks 'Lepzig' and 'Urges', which feature on the American version of this album.

'Windpower' runs a brilliant bass line courtesy of Henry the PPG computer, which swings as low as anything registered before or since. Add the best chorus Kraftwerk never wrote, and you've got the track that gave Dolby his only Top of the Pops appearance. The BBC's John Marsh reads the shipping forecast in a fade out that the BBC Radiophonic

Workshop would doubtless approve of!

'Airwaves' is the pick of a brilliant album, featuring synth parts that sound sequenced but aren't, delicate cocktail piano and electronic percussion sounds had never been heard before in 1982 – a metallic snare thwacks in just as Dolby sings the line, "Electric fences line our new freeways".

On later pressings of this LP, 'Cloudburst at Shingle Street' was dropped in favour of 'She Blinded Me With Science', a ballistic hit Stateside. The other track to be axed was 'The Wreck of the Fairchild', which was switched for the brilliant 'One of Our Submarines'. Although this Venice in Peril pressing is the one for vinyl collectors, these two replacement tracks are undoubtedly the stronger.

With the proceeds from 'She Blinded Me with Science', Thomas Dolby spent \$140,000 on one of the world's first digital samplers – the Fairlight CMI. In doing so he moved out of the analogue landscape of 'The Golden Age of Wireless'. Although his funkier follow up album, *The Flat Earth*, reached a wider audience, somehow it was less interesting and colder than this golden debut. Genius.

JONATHON CLEMENCE

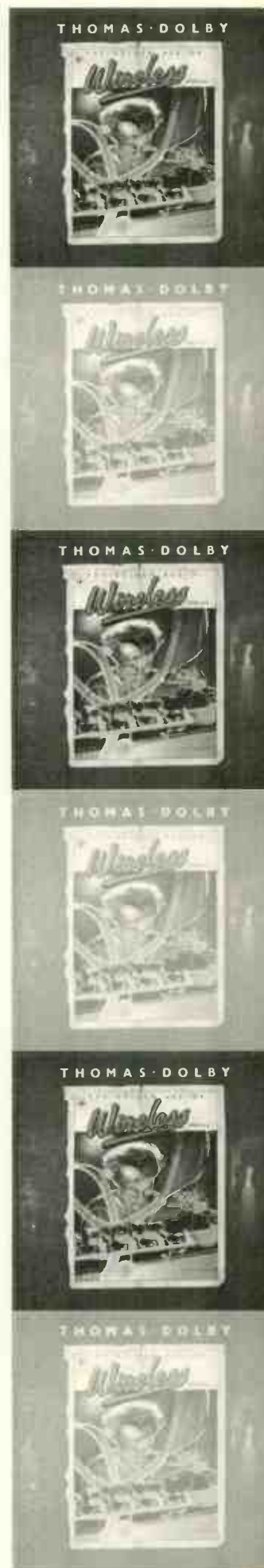
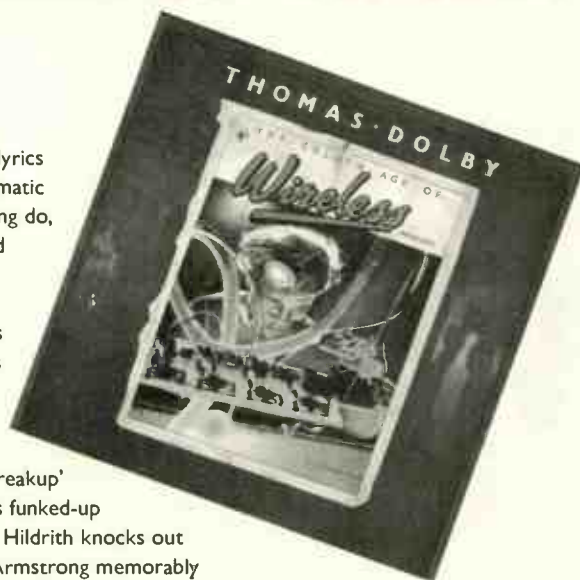

bach

DOUBLE VIOLIN CONCERTO, FRITZ KREISLER AND EFREM ZIMBALIST

1915 PEARL CD

What kind of noise annoys? Applause at the end of a live concert angers me no end, and so does tape pre-echo; but I am not one of those who grow tetchy when a member of the audience coughs or a second fiddle has the sniffles. The world is a noisy place, and we ought by now to have learned to tolerate its little foibles. Any gentleman with a half-decent brain should be able to filter out whatever is irrelevant when listening to music.

It is more difficult for a lady, whose need to hear her own particular baby crying from half-way across Grand Central Station apparently endows her with great acuity of hearing but poor ability to shut anything out. I recall a session when the male conductor, who could discern the faintest error in performance, was quite oblivious to a telephone ringing in the next room, though two ladies in the chorus were thoroughly disturbed by it.

Maybe I am lucky, or cloth-eared, or irredeemably selfish, but when I am listening to good music performed well I do not give a damn for passing aircraft, partying neighbours, or parlous reproduction. My ears may hear everything, but the brain screens out the rubbish; I listen just to what I want to hear.

My favourite version of the Purcell Birthday Ode that we know as Come Ye Sons of Art is half a century old, a French recording featuring Alfred Deller: in the first ritornello there is an eldritch screech from a rogue reed in one of the oboes, but it simply does not

matter. What does matter is Deller's supreme ability to bend a phrase, inflect a word, grace a step or ease a leap. Listen to him sing Strike the viol or, in duet with his son, what some of us Spoonerise as Pound the strumpet: here is vocal artistry almost incomparable, and only Barbara Streisand and perhaps Josh White justify that word 'almost'. Somebody recently said that there were now better counter-tenors than Alfred Deller; better businessmen, I dare say, but none so musical.

Nothing so unmusical as surface noise or any other mechanical crack and popple dating from pre-CD days need be a problem, any more than an errant oboe. My most compulsive proof of this is a 1915 recording (available on CD as a Pearl transcript) of Fritz Kreisler and Efrem Zimbalist (not the TV actor but his father, a pupil of Auer) playing the Bach double violin concerto. The recording quality is as shocking as might be expected, though the accompaniment (a string quartet rather than a full string orchestra, which is not a bad idea) suffers more than the soloists. It does not matter: the music matters so much that everything else can be dismissed.

I think I may never have heard a more moving performance of anything (not even Kreisler's later renderings, in 1926 with Blech and in

1936 with Barbirolli, of the Beethoven and Brahms concerti) than this, especially the largo movement. Elegant bowing, flawless portamenti, gracefully subtle rubato, and all the beautiful things that resentful post-1945 fashion has grimly expunged from performance practice, are here to be enjoyed with a gratitude as deep as the evident commitment of the players. There is something else, too, not to be sensed in those who have come later: an unforced natural dignity, which links the person of the performer with the essence of the music so that each illumines the other.

Many are the further examples I could quote, but there should be no need. Noise that cannot be erased should be ignored. Let us by all means select and perfect our apparatus so that we may benefit from the highest fidelity of reproduction; but let us not lose our sense of priorities. Admittedly we want to hear as well as possible, but what is it that we want to hear?

LJK SETRIGHT

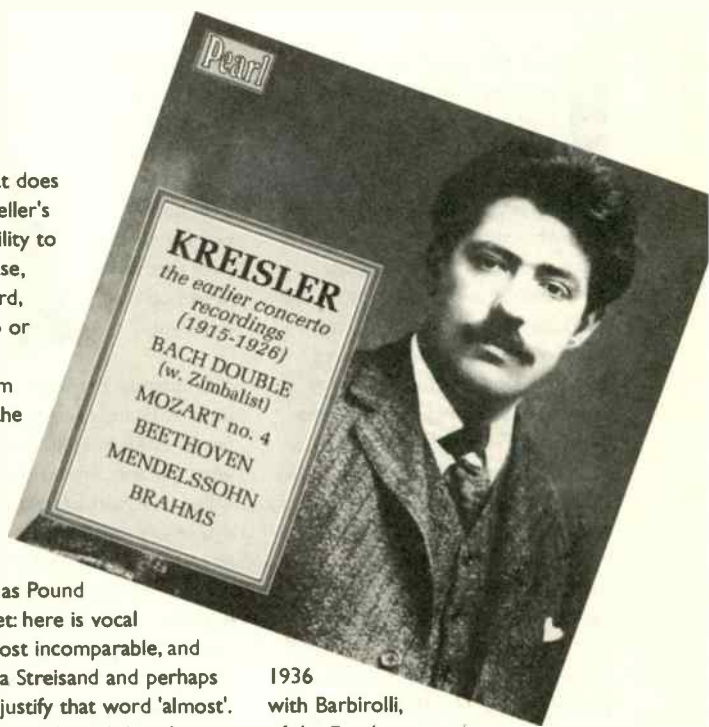
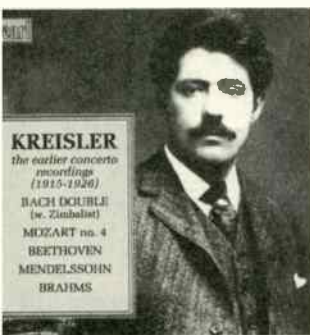

freeze

SOUTHERN FREEEZ

1980

BEGGAR'S BANQUET BEGA

22 LP

Back in the early nineteen eighties, Beggar's Banquet was a staging house for a brace of dark, dour 'electro' acts like Bauhaus, Gary Numan and Tubeway Army. With this in mind, it is hard to imagine a band less appropriate to its label than Freeez.

Released on January 1st, 1981 – appropriately enough amidst one of the coldest winters of the decade – the band's first Long Player, 'Southern Freeez' carried just one single (of the same name), which made it to number nine in the second week of March that year.

Freeez stood in absolute opposition to the artsy, fey, synth pop bands that dominated the charts of the day. Whereas the likes of Spandau Ballet, Orchestral Manoeuvres in the Dark and The Human League basked in the reflected glory of London's Blitz club, The Face magazine and the nascent 'new romantic' scene, Freeez was about funk, dance music and their own peculiarly British reading of the seventies disco. While the darlings of the 'synth pop' scene invariably boasted (real or imagined) art school backgrounds, this band's founder was an ex-van salesman from East London. Back in 1978, music-mad John Rocca had been working for dance music specialists Disc Empire, where he'd met up with musicians Peter Maas (bass guitar), Andy Stennet (keyboards) and Paul Morgan (drums), to form Freeez.

Their first single 'Keep In Touch' was released – highly unusually back then – on their own Pink Rythm (sic) label, and narrowly missed the UK Top 40 in 1980 when it had been picked up by Calibre. After moving to Beggars Banquet, 'Southern

Freeez' was released as a 45RPM single, featuring vocals by Ingrid Mansfield-Allman.

While the single is undoubtedly one of the high points of the long player, it is by no means the only. Rather, it sets the stage for one of the most original, offbeat and arresting soul records of the eighties, and also one of its rarest and least well known. 'Southern Freeez' boasts some of the tightest and most engaging 'Brit-funk' playing committed to vinyl, and a host of tunes to die for. The song names, such as 'Mariposa', 'Caribbean Winter', 'Sunset', 'Flying High', 'First Love', allude to the album's naively upbeat feel. But don't confuse Freeez with 'Brit funk' contemporaries like Shakatak and Lynx, purveyors of an altogether meeker and more inane mix of music.

Unlike the saccharine-drenched night-club fodder of its rivals, 'Southern Freeez' is an innovative and challenging listen. The bright, breezy feel of the album, which is infused with a mix of Flamenco guitar, Latin rhythms, brass stabs and disco beats, never completely dominates. Rather, some seriously plaintive, melancholic moments ensure that the album has a blue side. Despite being infectiously rhythmic, things never get too celebratory – it is one of those rare beasts, dance music you can really listen to time after time.

Although 'Southern Freeez' still sounds fresh and engaging today, back in 1981 it was positively prescient. Many of its key character-

istics later became staples for subsequent bands. For example, Peter Maas's ultra tight,

funky and percussive bass guitar style would later be used by Mark King in Level 42 to great commercial effect. More significantly however, John Rocca's trancey song structures with extended runs, short breaks and bridges, plus heavy reliance on percussive fills, proved an early blueprint for House music.

Legendary New York producer Arthur Baker thought so too, and in 1983 a newly downsized Freeez, featuring just Rocca and Maas, flew Stateside to record 'I.O.U.', written and produced by Baker with mixing courtesy of John 'Jellybean' Benitez. The single made it to number one in the UK, and the album, 'Gonna Get You' proved to be one of the formative influences on Detroit techno and House music that emerged from it. Brilliant and innovative as this album is – with its heavy use of early drum machines, sequencing and Roland SH-101 synthesisers – it lacked the outstanding musicianship of 'Southern Freeez' and its carefree charm. Where 'Gonna Get You' is sometimes too clever for its own good, 'Southern Freeez' oozes simple passion and naive charm, as evinced by the sleeve notes which read, "NEW WAVE JAZZ FUNK, PLAY LOUD." **DAVID DENYER**



propoganda

A SECRET WISH

1985

ZTT CD 4509 94749-2

By 1984, Trevor Horn's production work on Frankie Goes to Hollywood's 'Welcome to the Pleasuredome' had made him legendary. The obvious choice for his next project would have been its sequel, 'Liverpool', but instead he chose to work with five obscure Dusseldorf musicians; Ralf Dorper (keyboards), Andreas Thein (programming), Suzanne Freytag and Claudia Brücken (vocals) and Michael Mertens (percussion) - Propaganda.

Yet 'A Secret Wish' would not have been complete without the 'conceptualisation' of ex-New Musical Express scribe Paul Morley. Obsessed with French post-modern cultural theorists Roland Barthes and Jacques Derrida, Morley found this band an ideal vehicle for his sense of the dramatic. Together with Horn, the other co-founder of ZTT Records, he was able to conceive a brilliant mid eighties electronic pop record, with a vast, expansive and dramatic sound courtesy of producer Stephen Lipson and suitably dark and medieval video imagery courtesy of ex-NME photographer Anton Corbijn

'Dr Mabuse' was the group's first hit, a brilliant mix of Brücken's icy vocals and Mertens' epic synthesisers - complete with countless tempo changes, crashing crescendos and glides, plus jungle noises courtesy of a Fairlight CMI. Dorper's appropriately melodramatic lyrics sign, seal and deliver it superbly; "The man without shadow, he promises you the world, tell him your dreams and fanatical needs... he's buying them all - with cash".

Despite the album's musical and lyrical propensity for the overblown

- which at times approaches high camp - there are some truly affecting moments. 'Duel' is a sugary, uptempo romp with Brücken and Freytag almost sounding ebullient, yet the words - which explore the inherent contradiction between fidelity and deceit in loving relations - are invariably harsh. "The first cut won't hurt at all, the second only makes you wonder. The third will have you on your knees, you start leaving, I start screaming..."

'P-Machinery' explores that classic eighties zeitgeist - big brother. Mertens' pounding, propulsive rhythms - programmed into early, pre-MIDI PPG sequencers - allied to big, fat, brassy synth stabs, form an epic musical backdrop for Brücken's steely intonations, "Machines call out for followers, far out into the night." Even Orwell himself would have enjoyed the lyric's parting shot, "...another truth - installed by the machine".

Yet 'A Secret Wish' is so much more than three stellar singles. 'Sorry for Laughing' is a brilliantly reconstructed cover of Josef K's classic 1980 Postcard release, 'Dream Within a Dream' is Edgar Allan Poe set to a trancey synthesised backdrop and 'The Chase' is a dark, melancholic run of descending piano cadences and spacey synthesiser pads. 'Strength to Dream' - with its crashing power chords, strings and Fairlight storm sounds is a soundtrack looking for a film. Throughout, you can hear the voices and/or playing of Steve Howe (Yes), David Sylvian (Japan) and Glenn Gregory (Heaven 17).

This record's brilliance is its utter consistency; from conceptualisation, lyrics and music to the production and recording, it has an

utterly cohesive, all-of-a-piece feel. It hailed from a time when electronic music technology was advancing apace, and the brave new world of digital synthesisers was becoming a reality. Its use of Linn drum machines, Fairlight CMI, DMX and DSX and Roland M5 synthesisers, gives it a sound very much of its time, while the Sony PCM161Q digital recorder (16bit, 44.056kHz) lends it a chilly, greyish patina that suits the music perfectly.

The band split a proper in 1985 and a middling remix album, 'Wishful Thinking', was released soon after. Brücken recorded a duo with Glenn Gregory 'When Your Heart Runs Out of Time', for Nicolas Roeg's film, 'Insignificance', and went on to enjoy an artistically productive partnership with Thomas Lang as ACT. Indeed 1987's 'Snobbery And Decay' should be regarded as this album's real sequel, and not Mertens' 1990 project, '1234' with American singer Betsi Miller and two ex-Simple Minds men, Derek Forbes and Brian McGee - which also used the name Propaganda. It is but a pale echo of the vast, audacious ambition of 'A Secret Wish'.

DAVID PRICE

led zepppelin

HOW THE WEST WAS WON

2003

ATLANTIC 7567-83587-2

How the Best Was Done. It has been said that there are lesser university degree subjects than that of Led Zeppelin – and it's true. I have children who can verify this. Millions of words have been written about their undisputed grandeur, the groupies, the posturing, the witchcraft, and the symbols – even the music is worthy of comment. And what music!

In nine studio albums and the (justly) much maligned 'Song Remains the Same' live set, Led Zeppelin managed to squeeze more styles and skills into their songs than most bands would dare to dream of. But, without doubt, as powerful and as stimulating as Zeppelin's recorded output clearly was, it was the stage performances that put them into the realm of untouchables. And for the first time (for we will discount the unfortunate 'Song Remains the Same') those who never heard them live can sup from the chalice of Gods and gain a sip of the elixir that was Zeppelin live. 'How The West Was Won', an all-new triple CD set of Zeppelin in concert, is a triumph – let me say that from the outset. Even the most half-hearted ZepHead cannot fail to be absorbed. It comprises recordings made at LA Forum and Long Beach Arena during the tour of June 1972. Jimmy Page writes 'This is Led Zeppelin at its best and an illustration of How The West Was Won.' Difficult to argue with that.

A decent live album from Zeppelin is long overdue and it's amazing it took so long. Apparently Led Zeppelin are the most bootlegged band of all time, with some 384 'official' ones you can actually buy – in some safety now that the irascible Zeppelin Manager

Peter Grant has gone to his grave, for he was given to thwacking people found to be in possession of a Zeppelin scam-disc. Zeppelin never released a UK single, hardly ever made TV appearances and went to extraordinary lengths to shun the press. From the beginning in 1968 – right up to Knebworth in 1979, the studio albums were secondary to live concerts. Zeppelin flourished through relentless touring and naturally sharpened their act to the levels of majestic, unassailable quality. These three discs manifest that with alacrity.

As both concerts were recorded following the release of the band's classic fourth album few favourites are omitted. From the opening 'Immigrant Song', which is introduced by the 14 second 'LA Drone' you know you're in at the sharp end of Rock. The discs are crammed with moments of sheer joy, emotion, passion and, above all, magnificence. There are priceless performances of 'Heartbreaker', 'Dazed and Confused', 'Rock and Roll' and 'Whole Lotta Love'. There are peerless performances of 'Black Dog', 'Going to California' and 'That's The Way'. But, pleasingly, the evergreen 'Stairway to Heaven', often unfairly mocked (one assumes for its ubiquity) receives one of its best ever presentations. Recorded during the Long Beach concert, Robert Plant is unnervingly accurate in his delivery, delightfully strident in his

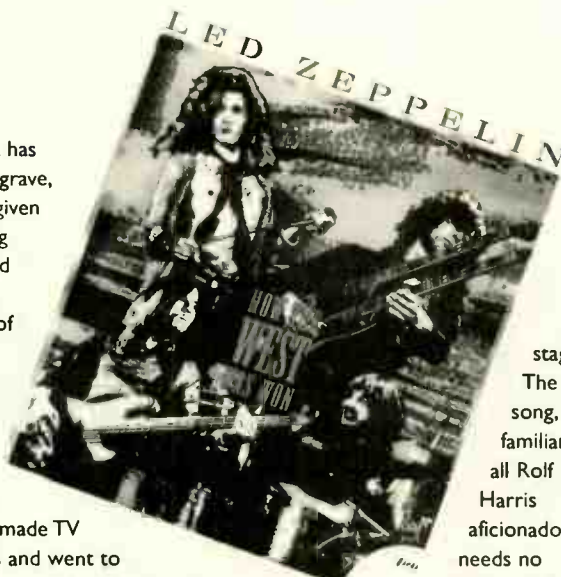

staging. The song, familiar to all Rolf Harris aficionados, needs no describing, but the build-up from

ballad to ballast is quite exhilarating – the best version you'll ever hear.

Not everyone will like this entire offering. Some may fine Plant's twittering and squealing (once capable of inducing audience orgasms – and we're not just talking girls here) a trifle tiring – they're certainly dated. And, although the blistering performance of John Bonham's sticks and skins on the mighty drum-roll 'Moby Dick' is one of his finest, quite simply not everybody likes twenty-minute drum solos. But these are preferences rather than performance faults.

I was lucky enough to have seen Zeppelin live from very privileged positions from 1968 until the end. This honour – for it is, indeed just that, will not be bestowed ever again (I hope). For many Zeppelin admirers since 1980 this is the only way to hear Led Zeppelin at their peak. 'How The West Was Won' is an absolutely perfect example of unfettered raw brilliance. It firmly demonstrates why Led Zeppelin were, and still are, the greatest rock group ever. Buy it - because you know there will never be another band like them. **ANDY GILES**



new order

RETRO

2003

London 0927 49499 2



RETRO New Order

New Order was formed from the wreckage of Joy Division, after the suicide of singer and lyricist Ian Curtis. The three remaining members of the band hired Gillian Gilbert on keyboards and continued to plough the furrow that Joy Division had started with a few essential differences. The voice of Bernard Sumner was less emotional and traumatic (more like an extra electronic instrument), the songs became more instrumental and less strict in form and synthesisers became more prevalent. Oh, and Peter Hook became the world's first-ever lead bassist, virtually taking over the main guitar tunes from his trusty Yamaha.

All this was central to New Order developing from a rock-based song band to the hitherto uncharted waters of the dance-influenced creations such as 'Blue Monday' and 'Confusion'. The band became the first such outfit with a solid rock

background to frequent the house clubs of New York City in the early to mid nineteen eighties, and hook up with legendary dance producer Arthur Baker.

At this time, Britain's youth was far more musically segregated than nowadays. Suddenly, introspective kids that were fans of the 'indie' New Order were faced with the 'long-mac-on-the-dancefloor' dilemma. It's arguably New Order that were pivotal in breaking down the barriers that existed in music at the time and are now non-existent. Factory records opened the Hacienda club in Manchester and the rest is pop-culture history.

New Order went from performing with their backs to the audience in a variety of odd venues to playing American stadium gigs in front of 20,000 or more in a very short period of time. Along came the Happy Mondays, Stone Roses, Inspiral Carpets and all the rest of the Madchester scene. This was followed

by the big beat dance/rock combinations of Chemical Brothers and The Prodigy, much of which is good quality in music today owes at least a small nod to New Order. New Order were, throughout all this, spearheading everything without actually realising it by creating some of the most tuneful, melancholy and up to date, yet also strangely timeless, music around.

'Blue Monday' became the best-selling 12" of all time – it was only available in this format but each disc famously lost money due to the as-always superior packaging of the record. It's this kind of attitude that makes New Order eternally cool by my standards. In the end the band finally made some of the money they were morally due thanks to the sale of Factory to London Records and a legal loophole. After the album 'Republic' and 1998's headline spot at the Reading Festival, they "walked off, went to bed and didn't speak to each other for five years", as Bernard

Sumner memorably put it. They reformed to give a supremely confident headlining performance at the same festival in 1999. Now they're gigging, and even doing Joy Division songs, and making records again - big, fun, rocky ones such as '60mph' and 'Crystal'. They are still as cool as ever, and with age they actually seem to be enjoying themselves. Not that the humour hasn't always been there - simply check out any of the videos!

'Retro' is a superbly crafted four-disc compilation that breaks the mould of previous compilations in a number of ways. The project was initiated by Rob Gretton, manager of the band throughout their career (including the Joy Division years) who died before the release of their latest studio album, 'Get Ready', which was swiftly followed by this collection. Firstly, each disc is themed and named: Pop, Fan, Club and Live. Secondly, the selection on each disc is chosen by an admirer. Journalist Miranda Sawyer for Pop, old band acquaintance John McCready for Fan, Mike Pickering (the 'M' of M People and one-time Factory A&R man) for Club and Bobby Gillespie of cutting-edge rockers Primal Scream (along with a bit of New Order input) for Live. As always, the packing and design of über style guru and long-standing Joy Division/ New Order collaborator Peter Saville is magnificent and minimal. It comes

with a beautiful booklet featuring comments from the band about their songs ("I fucking hate it" - Bernard on Blue Monday!) and some great pictures.

The Pop disc spans the history of New Order, from the early Joy Division composed first single, 'Ceremony', to the latest single (at the time of release) 'Crystal'. It's perhaps here that you realise just how many cracking tunes New Order have written: 'Bizarre Love Triangle', 'Temptation', 'Regret', and perhaps their best pop tune of all, 'True Faith'. Perhaps most interesting to long time aficionados such as myself is the Fan disc. Here are the more downbeat and melancholy sounds that make New Order what they are, the solemn 'In a Lonely Place', the timeless instrumental 'Elegia' and a few 'grey' gems from the earlier days such as 'Cries and Whispers' and 'Dreams Never End'.

The Club disc pays homage to the influence that the band have had on the world's dance scene with released remixes of New Order tracks from the likes of Arthur Baker and a great mix of three classics ('Touched By The Hand Of God', 'Everything's Gone Green' and 'Blue Monday') from Jam & Spoon. Finally the Live disc is a great example of the way in which the band have developed on stage. In the earlier days, the band weren't exactly keen to play live. They often stood facing

the other way to the audience, equipment would break down and cues would often be missed. They'd sometimes play five songs and piss off home. This all added to the mystique an attraction, of course. But they can also sound one of the tightest live acts you'll come across. There are good examples of both categories included here (a great bum note in the bass line of 'Ceremony' being one example worthy of the former) and a superb little interjection from a certain Alan Wise during a fairly recent French show (you'll have to buy it to find out!) makes it a brilliant contribution to this collection. It's not left an area within two feet of my CD player since it arrived (in perfect nick) from good old Amazon, where it's available at a very decent price.

It's an overused word, but New Order are genuinely unique. They changed the face and direction of British contemporary music like no others have since four blokes started jamming in a Liverpool basement. This collection is not only a wonderful thing to have on the shelf it also demonstrates the real worth of New Order in the bigger scheme of things. They matter. Absolutely no-one else sounds like them or has the knack of making something that sounds so complex also so simple (with the exception, perhaps, of J. S. Bach)!

SIMON POPE



NEW ORDER TECHNIQUE

1989

FACTORY 25CY-3083

By the time this album arrived, most thought New Order to have peaked. From the brilliant innovation of 'Blue Monday' to the sophisticated lyricism of 'True Faith', it was hard to see how the band could better themselves. But 'Technique', although perhaps not their best long player, could be argued to be their most significant. The reason for this is the explicit connection it makes with dance music. Eight years into their career, indie gods New Order - bearers of the mantle of Joy Division and the engine behind Factory Records - stumbled upon the Balearic zeitgeist, threw it into the mix and came up with the prototypical 'indie-dance' record. Without this, the Stone Roses, Happy Mondays, Charlatans, James - even - would may well have taken different trajectories and Madchester would quite possibly have never raved on. Bathed in the afterglow of the 'second summer of love', this is the band as upbeat and funky as they'd get - with the exception, possibly, of the sublime 'World in Motion' which followed immediately after. Big, house-style keyboard breaks, uptempo beats, bouncy basslines and hypnotic grooves truly embrace the dancefloor - and counterpoint the often edgy lyrics. It was a great listen, and very much the shape of things to come.



beethoven

SYMPHONY NO.5 IN C MINOR
Vienna Philharmonic Orchestra,
Carlos Kleiber (cond.)
DG The Originals 447 400-2

How does one introduce this recording to the uninitiated? Well, it would be best to start with Kleiber himself. Son of the legendary conductor Erich Kleiber, born in 1930 in Berlin but raised in Buenos Aires (where his father worked at the Teatro Colon), this international music man of mystery is one of the most rarely seen and heard conductors alive today. He is also arguably the finest. Picking and choosing concerts as and when, he ventures onto the podium very rarely. He is a renowned 'difficult' character.

Like the equally difficult but gifted Sergiu Celibidache, Kleiber doesn't 'believe' in recordings, but dabbles when he thinks it appropriate. The number of studio recordings he has made can be counted on two hands. All are firmly in the Austro-Germanic tradition and are 'landmark' pieces of musical importance and stature. All of these recordings are also superlative.

There are many reasons for this. He insists on extensive and painstaking rehearsal time (he can easily spend one three hour session on a five minute overture), he devotes equally intensive study time to the score and knows each instrument's capability, and each orchestra's capability, as well as the music, inside out. Not only is he musically communicative to near-genius level, he is also technically aware of an instrument's requirements and limits. This is what gains him an orchestra's respect. And an orchestra's respect is at least 50% of a great performance.

For this awesome talent, he can demand hefty fees (he once took a top range BMW as a concert fee in Munich!) Yet promoters and orchestras pay top dollar for him and the players will happily spend

hours rehearsing a few bars. Why? Listen to the first movement of this recording of Beethoven's mighty fifth and you'll know why. Herbert von von who?

Never, in my view, has so much sheer power, energy, intensity and drive been documented as well as in these seven minutes and twenty-two seconds of the first movement. It is focussed and relentless. After listening to the movement you literally have to stop the disc, take that breath you've been holding for the whole time and play it again to check that what you thought you heard was indeed correct. You feel like you've played it with them.

From the first opening 'fate knocking at the door' triplets, you know that this journey is to be thrilling, and indeed it is. Just when you think there's no more to give at climax, Kleiber and the VPO will deliver it with an intensity and rhythmic drive that is breathtaking. This Deutsche Grammophon recording was made at the perhaps the height of the classical recording age (as far as output is concerned), in March and April of 1974 at the VPO's Musikvereinsaal. At the time of its release time there were already countless Beethoven Fives available and there were (and are) plenty more to come. This one right away put everything else in the shade – and this included very fine readings by Toscanini and Klemperer.

The Vienna Philharmonic by nature never puts a foot wrong and with Kleiber's direction and coaxing they together reach the heights very rarely found in today's classical recordings and concerts. The second

movement string playing has a luminosity and depth that is simply stunning. Phrasing is just where it should be, as are subtle inflections and dynamics. Everything is simply 'right' about it, and what is telling is that you don't have to be a record collector or musician to feel this. When the third movement breaks into the last, it's like a vast door opening, heralding sunlight. It's not overblown or false, it's effective. The rest of the symphony is bathed in this sunlight as it roars and dances towards its inevitable conclusion.

If music matters in your life, you owe it to yourself to own this recording, whether you're a classical music lover or not. It turns what can be a tired war-horse of a piece into a something that deals with matters of the deepest profundity and joy. It sounds as fresh and groundbreaking as it must have done at the first performance. Listening to this recording and acknowledging the commitment and communication present, it's easy to understand why Kleiber is the conductor's conductor and the musician's musician. At its release, Kleiber's version was in a class of its own. And there it will, I'm sure, remain. **SIMON POPE**

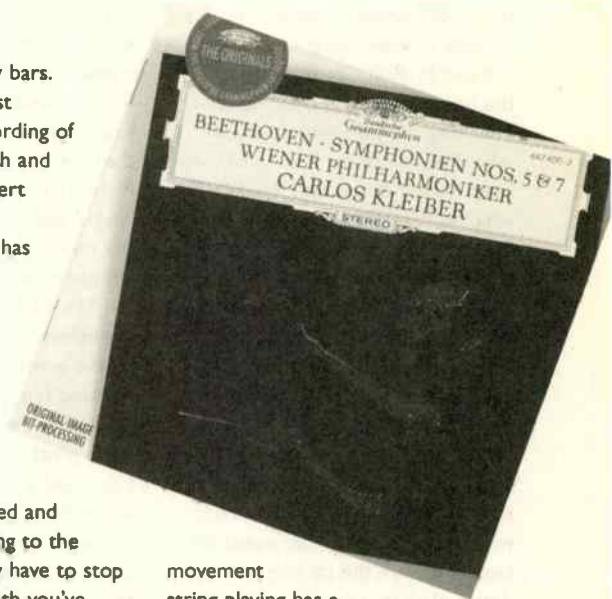

WELCOME TO OUR MARKET PLACE

Here are a wide variety of specialist hi-fi products and services.
 Keep an eye open for regular advertisers, who know the market and serve their customers in a friendly and reliable manner.

Sound Investment

If you have invested expertise and money in building up a sound system to your own unique specifications, then why compromise with indifferent housing units?

Fi-Rax offers a new dimension in audio visual racking - from a range of standard designs to the flexibility to custom create a unit to suit your particular sound system and lifestyle.

- *High quality aluminium construction.
- *Finishes available to your choice.
- *Fully adjustable 6mm glass shelving.
- *Sound isolation on shelving/feet.
- *Custom created to suit your system.
- *Free delivery throughout the UK.

Fi-Rax - a sound investment for those who want the best from their equipment.

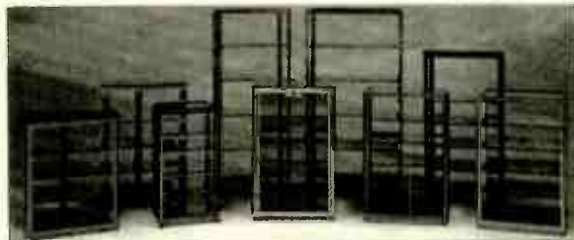

Audio Visual Furniture

For further information or a free brochure contact: JEM Distribution, Springfield Mills, Spa Street, Ossett Wakefield WF5 0HW. Tel: 01924 277626 Fax: 01924 270759

RETRO Reproduction

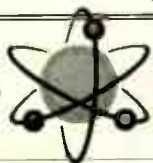

New web address: www.retroreproduction.com

28a Haddington Place Edinburgh EH7 4AF Phone/Fax 0131 558 9989

Open 11.00am - 5.30pm - closed Monday & Sunday

Used equipment for sale

Amplifiers
 Arcam 1U Power Amp £395
 Audionote M1 Valve Pre Amp with Phono Stage £395
 Audio Research VT100 MkII £2,300
 Audio Innovations 1000 monobloc hard wired with Jensen caps £995
 Beard BB3050 stereo integrated amp the last amp released new £1400 £795
 Conrad Johnson PF1 pre amplifier new £1200
 excellent phono stage
 EAR 834F Valve Phono Amp £495
 EAR 834L Valve Line Stage £275
 Exposure pre/power anniversary 8 model £495
 Heart 300b monoblocs as reviewed in July 03 issue of Hi-Fi World superb sounding new £2000
 Hafler 101k pre amp with MC facility boxed £995
 Linn Kloud power amplifier £35
 Linn remote processor pre amplifier new £3600 £995
 Marantz PM 66 K1 Sig Int Amp £245
 Meridian 103D pre power combination £225
 Meridian 104 FM Tuner boxed £150
 Meridian 505M MonoblocksMint £1,095
 MicroMega Tempo 1 Integrated Amp remote control with great phono stage new £800 £395
 Moth 100W Monoblocks with Passive Pre new £1400 £895
 Naim Nait 3 integrated Amp £375
 Naim NAP90 Power Amp £295
 Nakamichi CASE pre amp excellent phono stage new £400 £175
 Pass Alpha 3 Power Amp mint boxed one of the finest design ever Class A single ended £1095
 Pioneer A400 Integrated Amp £175
 Pioneer A400X Int Amp £195
 Premier A20 Integrated Amp boxed mint £350
 Quad 903 Power Amp £195
 Quad 306 Power Amp £250
 Quad 34 Pre Amp mint boxed £195
 Quad 405 Power Amp boxed £225
 Rega EK5 Power Amp £295
 Rotel 6 Channel Power Amp £195
 Rothwell Indus stepped attenuation passive pre amplifier 2mths old new £600 £350
 Sony TAVE930F Integrated Amp with remote Sugen A45 integrated Amp £95

Turntables
 Forns CO30 78rpm facility £125
 Mission 775 SM with 774 tonearm £295
 Michell Orbe turntable £1295
 Originlive classic turntable acrylic platter SME V Tonearm boxed £395
 System Deck IIX turntable ..UPGRADE £995
 YOUR REGA from £150
 STD with Mission 774 tonearm £195
 Thorens TD125 £175
 Thorens TD125 with SME plinth mint £290
 Townsend Rock Elite with optional extras plinth & lid £595
 Various Thorens TD150s ...from £50
 Various Rega turntable's phone for details

Speakers

ATC Active 100 custom piano black finish 3 mths old new £10000 £8995
 Audiophisic Spark MK3 latest edition new £1850 £995
 B&W Rosewood finish £295
 Epos ES11 with matching stands £275
 Epos ES14 mint with stands £350
 Gale 301 speakers £125
 Gale 401 chrome ended speakers £95
 JBL T1 2k boxed £795
 Lenpek S4 loudspeakers boxed £150
 Linn Isobark prices £495
 Meridian D600 Digital Active Speakers from £795
 Mission 780 Speakers £695
 Mission 751 Bookshelf Speakers £175
 Musical Fidelity M22 Bookshelf Speakers £195
 ProAc Tablette 2000 Signature yew finish mint boxed £995
 QLN Splitfield Signatures £895
 Quad ESL24 refurbished £995
 Rogers LS33 with AB 33 new £600 £275
 Royd Abbot floorstanding Speakers ideal for valve amp £395
 Ruark Equinox american walnut last edition boxed new £2000 £795
 Snell Type K Speakers - Kimber Silver Triangle Zays floorstanding Speakers new £1600 £795
 Tannoy GRF Memory 15" drive units walnut cabinet AWESOME PRESENCE new £5500 mint Wired (boxed Mint) £2950
 Tannoy C10T Speakers £175
 Tannoy D100 Bookshelf Speakers £375

CD Players, DACs

Audio Research CD2 CD Player £1,600
 Audio Research CDT1 Transport (new £3000) £1,995
 Arcam Alpha 5 £250
 Arcam Alpha 6 new £600 £225
 Arcam Alpha 7 SE £495
 Lowe Legro CD player built by Linn on Mimick rank board 2 years old new £1100 £95
 Marantz CD63 top loading CD Player £295
 Micromega CD Player Stage 3 (new £900) £395
 Meridian 208 CD Player + Pre Amp £395
 RCI RCD 965BX CD Player (Fitted with Black Gate Caps as standard) £175
 Revox B225 £375
 Sony CDIFX 3000 ES £595
 Sony 555 champagne finish battleship build quality Teac VRDS10 £450

Turners, Reel to Reel, Cassette Deck, misc

Meridian 204 Tuner £375
 Quad FM3 Tuner (boxed mint) £145
 Quad FM3 Tuner £95
 Quad FM4 Tuner old style £225
 Quad FM4 Tuner new style £285
 Quad 66 FM Tuner £95
 Rotel RT930 AX Tuner £95
 Revox G36 Open Reel Mint £395
 Sony DTG/ET100 dac machine £195
 Tascam 222 Open Reel £395
 Leak Troughline Tuner 3 various ...from £150

Due In
 Kimber cable various £175
 Moogers LS33/5 Speakers 15 Ohm £290
 Quad Wooden sieve for 33 and FM3 £50

NOW DEMONSTRATING

ATC SCM 7, 12, & 35 SPEAKERS PROBABLY THE FINEST SPEAKERS AVAILABLE - PRICES START FROM £480

Now stocking Sonneteer's new Bronte product range including digital amp from £800 and matching CD player



Ear 869 single ended triode integrated amplifier Improved version of the classic 859 with revised output transformers modified input stage with the addition of an extra signal valve which has allowed an increase to 15watt of single ended power, also the 869 can be used as a power amp. Don't be fooled by its modest power output this amp drives real world speakers. price £2498.00

Ultimate Ear Phono Stage

This is the ultimate esoteric Phono Stage as used in the world wide acclaimed Ear 312 Control Centre - Pre Amp. This has to be the ultimate Vinyl Replay purchase. price £2095

** FOR A LIMITED PERIOD ONLY **

Full value Trade in on Ear Phono Stages and other selected models.

WE ARE PROUD TO ANNOUNCE THE NEW BEAUHORN B2 HORN LOUDSPEAKERS IDEAL FOR LOW POWERED SINGLE ENDED VALVE AMPS

ALSO DEMONSTRATING THE NEW GRAHAM SLEE PROJECTS RANGE OF AFFORDABLE PHONOSTAGES

HARMONIC TECHNOLOGY SINGLE CRYSTAL CABLE

NOW IN STOCK - AT LAST I HAVE A CABLE TO DO ALL THE THINGS THE MANUFACTURE CLAIMS AND AT A RIDICULOUS LOW PRICE - PHONE FOR MORE DETAILS



There are now four models in the EAR lineup.

The classic 834P uses the same circuit architecture as its more expensive brothers, and shares the same high quality sound through MM type cartridges, it is enclosed in a tough, rigid metal case and is fully "CE" type approved. price £495.00

The signature builds on the Classic 834P specification by adding a superb moving coil (MC) input stage, as well as the no-extra-price option of a high quality volume control. price £590.00

Top to the range, the Deluxe 834P comes in stunning chrome and gold cabinet, and has extra attention and quality control. With different moving coil input options, this unit will fit: the most demanding of audiophile systems. For the true vinyl enthusiast. price £895.00

MC3 - The ultimate stage for MC matching with 3 fixed transformer taps to cover all types of moving coil cartridges, and separate left/right grounding. MC3 in used in the new £10,000 312 pre. price £630.00

Selected products from: ATC, Audio Physic, EAR Yoshino, Nottingham Analogue, Dynavector.



WE HAVE OVER 30 TITLES ON OFFER!!!

AUDIO ELECTRONIC THEORY BOOKS



Electronics made Simple
by Ian Sinclair
This book covers the basic theory and principles of electronics. A good read for the beginner.
Code No. 1420
£12.99 + £2.50 P&P (UK)



Build your own High-End Audio Equipment
by Elektor
Build your own High-End Audio equipment contains construction projects for solid state preamplifiers and power amplifiers, active cross-over filters, an active subwoofer, a mono/stereo compressor and a headphone amplifier.
Code No. 1390
£14.95 + £2.50 P&P (UK)



Audio/Radio Handbook
By National Semiconductor
National Semiconductor's manual is an essential aid to engineers and experienced hobbyists in the application of National's line of consumer audio and radio ICs. Not only does it hold comprehensive data of their ICs but discusses theory aspects of amplifiers and pre-amps and covers electronic principals.

paperback 200pp, Code No. 1810
£13.95 + £2.00 P&P (UK)



Build your own Electronic Test Instruments
by Elektor
This book contains designs for 17 measuring instruments, seven generators and analysers, ten miscellaneous instruments and a number of test ancillaries and auxiliaries. The designs range from a simple multicore cable designs contain a special printed circuit, drawing of which are given in an appendix.
Code No. 1400
£15.95 + £3.25 P&P (UK)



The LP is Back
by Audio Amateurs
Your complete guide to LP care and maintenance designed to offer you everything useful for those who love and enjoy this older music medium. This covers the theory and care of LPs and the electronics and mechanics of its players.
154pp Paperback, Code No. 1620
£8.00 + £2.00 P&P (UK)



The Joy of Audio Electronics
by Charles Hansen
This is a fall-safe guide to the pleasures of hands-on electronic construction. This book covers test and measurement projects, how to build simple kits, safety issues, the workplace, theory and resources. A must for the beginner who plans to build more advanced electronic projects in the future.
124pp Paperback, Code No. 1650
£10.50 + £2.50 P&P (UK)

VALVE BOOKS



Audio Measurements
by Norman Crowhurst
Famous compendium of measurement and test techniques for audio reproduction equipment of the tube era. Includes discussion of all instruments needed. Covers amps, transformers, preamps, turntables, changers, tonearms, cartridges, tape recorders.
Code No. 1830
£13.95 + £2.00 P&P (UK)

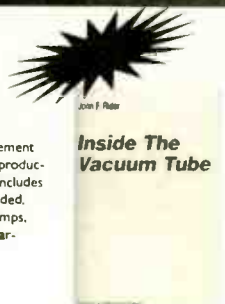

Inside the Vacuum Tube
by John F Rider
One of the most thorough (and funny) books ever written on the way vacuum tubes function. Rider's mastery of analogies common to most of us makes the book especially useful to those who want to learn about vacuum tubes.
Code No. 1840
£24.00 + £2.50 P&P (UK)



GEC Audio Tube Data
Full of data and circuits concerning the three most well known MO Valve power tetrodes, the KT66, KT77 and KT88, (the KT77 was GEC's answer to Mullard's EL34) and some data on the PX4 and PX25 triodes. The first section concerns preamplifiers of various types, with information regarding equalisation, tone controls, filters and suchlike. An excellent book for all valve heads.
Paperback Code No. 1780
£14.95 + £2.00 (UK)



Understanding Hi-Fi Circuits
by N. H. Crowhurst
Originally published in 1957. Discusses all aspects of amplifiers, pre-amplifiers and equalisation circuitry, well written, easy to understand. The author does concentrate on valve circuits, so no transistors here.
Paperback, 224pp Code No. 1820
Price £13.95 + £2.00 UK p&p



Glass Audio Projects - 17 Vacuum Tube Designs
This book features 17 valve project, designed, tried and tested by some of the best authors state side. Designs such as a 300B push-pull amp, a 33 power amp, a 6528 single ended, a 300B parallel single-ended amp, a 6C33C-B single ended amp, a 70W KT88 push-pull amp, a 2A3 single ended amp to name a few. All information is provided so most projects can be built from scratch.
Paperback 73pp, Code 1790,
£8.00 + £1.50 P&P (UK)



An Approach to Audio Electronic Valves
by E. Rodenhuis
Discussing the use of valve data, the function of different amplifier stages and includes detailed descriptions of eight designs. A wealth of practical data, measurements and interesting features will be found. A very good read.
Paperback 147pp, Code No. 1520
Price £12.95 + £2.00 P&P (UK)



The Best of Audion editorial projects
by Luciano Marci
This book contains six excellent audio projects - a high sensitivity speaker, a superb tube pre-amp, a 2A3 amplifier design, a project using the Russian 6C33CB and two projects using 300Bs as output valves. Overall the book is a fabulous read.
62pp, paperback book code 1750
£12.00 + £2.00 UK p+p



Vacuum Tube Amplifiers
by Valley & Walkman
This book is a well known reference valve text book and is assembled from pieces by ten knowledgeable authors. An absolute bible when it comes to valve electronics.
734pp, Paperback, Code 1770
£29.95 + £ 4.30 P&P (UK)



Audio Reality
by Bruce Rozenblitz
Investigates conductors, skin effect, impedance, interconnections, speaker cables, balanced lines, transmission lines, isolation transformers, tubes, acoustics and much more. Also, includes 6 excellent detailed valve design projects. 80watt OTL, 25watt OTL, grounded grid pre-amp, 150watt amp., 6550 SE amp. and a grounded grid cascode phono preamp.
Paperback 128pp, Code No. 1640
Price 21.50 + 2.50 P&P (UK)

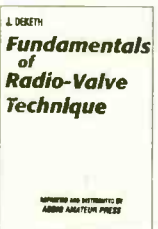

Fundamentals of Radio-Valve Technique
by J. Deketh
This is part of the Philips technical series written in 1947 it was one of the most authoritative and comprehensive treatments of the nature and function of the vacuum tube.
534pp, Paper back
Code No. 1630
£21.50 + £2.50 P&P (UK)



Build your own Audio Valve Amplifiers
by Rainer Zur Linde
This book covers construction projects for preamplifiers, power amplifiers and two amplifiers for musical instruments aimed at the practical audio/hifi enthusiast; it offers much information on the operation of electron tubes, while the first chapter gives a short history of the thermionic valve.
paperback, 251pp, Code No. 1320
£14.95 + 2.50 P&P (UK)



Mullard Tube Circuits for Audio Amplifiers
Includes full designs for eleven power and control amps, including 5-20, using valves. Begins with a four chapter tutorial on getting the best sound from valve amplifiers.
142pp 8" x 10" Paperback Code 1030
£13.95 + £2.00 P&P (UK)



The Williamson Amplifier
by D.T.N. Williamson.
Offers practical advice on how to build and set up the amplifier for best results.
40pp Paper back
Code No. 1040
£9.95 + £1.50 P&P (UK)



RCA Receiving Tube Manual
Technical Series RC-14
This book presents RCA's commercial valve line-up as it was in 1940. The manual covers valve terminology, Technology and application, valve testing and then a larger section giving some circuit ideas and plenty of data on numerous valves e.g. 6L6, 6N7, 6SN7.

255pp Paperback, Code No. 1800
£13.95 + £2.00 p&p (UK)



The Beginner's Guide to Tube Design
by Bruce Rozenblitz
This book takes a comprehensive look at tube audio design. It explains how vacuum tubes work and how to design with them. Rozenblitz covers stabilisation and testing, a description of 13 famous and classic amps and preamps and how to work effectively as a designer. A hands-on guide to construction techniques, tools and choosing components and tubes is provided. 1997.
132pp Paper back Code No. 1340
£15.50 + £2.50 P&P (UK)



S/hand and ex-demo clearance items - SEPTEMBER 2003

	Was	Now			
CD players DACs & Transports					
Pink Triangle DaCapo DAC 24 Bit S/H	1800	799	Opera Lux 3 Tier Table Clear/Stainless x-Demo	950	499
Pink Triangle Cardinal Transport S/H	1499	599	Partington Dreadnaught 24" Stands S/H	250	149
Pink Triangle Ordinal 1307 DAC S/H	749	399	Roksan HAO1D 0.5m Digital Interconnect S/H	49	25
Primare D30.2 CD Player S/H	1500	899	Tara labs Prime 1800 Bi-wire 5m S/H	1599	695
Wadia 830CD Player S/H	3295	1899	Tara Labs The One Balanced 1m x-demo	3000	1500
Turntables Tonearms & Cartridges					
Air Tangent 1C with Wisa Pump X-demo	5800	3999	Tara labs Floating Ground Station x-demo	899	450
Benz Micro LP New& Boxed	2200	1799	Target HR60 Silver Stands S/H	199	109
Kuzma Stabi/Stogi S Turntable New& Boxed	1295	1099	Target R1 Stands S/H	299	175
Lehmann Audio Black Cube SE New& Boxed	650	449	Transparent Music Link RCA -RCA 2m S/H	299	149
Lyra Lydian Beta New& Boxed	599	499	Transparent Music Link Balanced 2m S/H	499	249
Michell ISO Phono Stage S/H	549	250	Transparent Music Link Ultra Balanced 7.26m S/H	2349	1499
McCormack Phono Stage New and Boxed	650	399	Wilson Benesch Aside Carbon/Kevlar 4 tier stand S/H	960	499
Rega RB300 Tone arm S/H	188	119			

Tuners & Tape Decks, Power Supplies					
Tuners & Tape Decks, Power Supplies					
AKG C1000 Condenser Mic S/H				241	120
Magnum Dynalab FT-R Remote Switcher for FT101					
A/Etude (New&Boxed)				450	299

Bargains under a £100					
Bargains under a £100					
Sony TCK-461s 2 head cassette decks new&boxed				199	99

Midland Audio X-change are looking Audio Research, Krell, Mark Levinson, Naim Audio, Dcs, Wadia, cash paid call John Roberts

Amplifiers					
Amplifiers					
47 Labs Gain Card 25w / Humpty S/H	3250	1899			
Audio Analogue Maestro Integrated x-demo	2700	1899			
Electrocompaniet AW120Dmb S/H	2395	1599			
Gamut D200 Blk with Handles S/H	3295	1795			
Krell FPB600c Power Amplifier S/H	14000	8500			
Krell KSA 150 Power Amplifier S/H	6898	2199			
Unison Research S2K Remote x-demo	1295	995			
Rea Elicit Integrated with Phono Stage S/H	698	275			

Loudspeakers					
Loudspeakers					
Avalon Eclipse Maple x-demo	9800	7249			
ATC Model10 R/W Xdemo	1200	749			
Indigo Model Two Centre Channel Cherry S/H	199	129			
Living Voice Auditoriums Cherry x-demo	1600	1199			
Living Voice Avatars Maple x-demo	2700	1995			
Living Voice Avatars OBX-R Ebony x-demo	4000	2999			
Martin Logan Quest Hybrid Electrostatics Oak S/H	5940	1899			
Rega Xel Rose wood Floorstanders S/H	1295	399			

Cables & Accessories					
Cables & Accessories					
Air Pod size 1 x3 S/H	210	99			
Audi Note AN-V 2m Silver Interconnect S/H	450	199			
Acoustic Zen Silver Signature Balanced 12ft	2700	1499			
Cogan Hall EM-D 0.6m S/H	199	99			

Midland Audio X-change is looking for good used British & American Hi-Fi cash paid call John Roberts on 01562 822236

- Suppliers and installers of High Quality Audio Systems :
- 47 Laboratory
 - Accuphase
 - Audio Note
 - Audio Research
 - Avid
 - Basis
 - Cabasse
 - Cardas
 - Clearaudio
 - Conrad Johnston
 - Copland
 - Dcs
 - DNM / Reson
 - Einstein
 - Electrocompaniet
 - Final
 - Finite Elemente
 - Graff
 - Gryphon
 - Lavardin
 - Mark Levinson
 - Martin Logan
 - Michell
 - Nagra
 - Primare
 - ProAc
 - Rega
 - Resolution Audio
 - Sonus Faber
 - Spectral
 - SPM
 - Sugden
 - UKD

WE HAVE MOVED

New address:-

www.midlandaudiox-change.co.uk
 call John Roberts Tel: 01562 731100
 or fax on: 01562 730228
 The Old Chapel, Forge Lane, Belbroughton
 Worcestershire, DY9 9TD
 e-mail sales@midlandaudiox-change.co.uk
 Mobile 07721 605966

www.midlandaudiox-change.co.uk

Sound Stage

2nd User Hi-Fi & audio

01376 521132
07802 483698
CHELMSFORD, ESSEX
E-MAIL: soundstage@netlineuk.net
BY APPOINTMENT ONLY

PRE-OWNED EQUIPMENT

ARCAM ALPHA 10 AMP BOXED AND IMMACULATE	£499
ARCAM ALPHA 7 TUNER BOXED AND IMMACULATE-2 YEARS OLD	£179
AUDIOLAB 8000A-BLACK-PHONO 'E' SERIAL NUMBER	£299
CYRUS FM7 TUNER BOXED AND IMMACULATE	£299
CYRUS SMART POWER BOXED AND IMMACULATE	£449
DEFINITIVE TECHNOLOGY PRO SUBWOOFER 80 BOXED AND SUPERB	£279
DENON AVP A1 GOLD BOXED AND IMMACULATE (£3000 NEW)	£995
DENON AVC-A1SE BLACK BOXED AND SUPERB 7.1 DTS ES AC3-RF	£1795
KRELL KSA80B POWER AMP SUPERB CONDITION	£1595
LINN KAIRN PHONO PRE AMP	£695
MARANTZ CD63 SE KI SIGNATURE	£299
MERIDIAN 606 DAC BOXED AND IMMACULATE	£595
MICROMEGA DRIVE 2 CD TRANSPORT	£395
MICROMEGA STAGE 5 IMMACULATE AND BOXED	£429
MICROMEGA DRIVE 3/DAC BOXED AND IMMACULATE	£995
MISSION DADS/DACS TWO BOX CD PLAYER NO REMOTE SUPERB CONDITION	£249
MONITOR AUDIO SILVER 9i CHERRY BOXED AND SUPERB	£595
MONITOR AUDIO MA1800 REFERENCE GOLD LOUDSPEAKERS-BOXED	£595
MUSE MODEL 3 PRE-AMP REMOTE BLACK BOXED AND IMMACULATE	£995
MUSICAL FIDELITY HTP/HT600 AV SILVER 3 MONTHS OLD AS NEW (WERE £4K)	£2995
MUSICAL FIDELITY A220 INT AMP PIANO BLACK BOXED AND SUPERB	£499
NAIM CREDO BEECH 1998 BOXED AND IMMACULATE	£895
NAIM NAC 82 GREEN FRONT INC NAPSC 3 YEARS OLD SUPERB CONDITION	£1695
NAIM NAP140 NEW STYLE BOXED SUPERB CONDITION	£449
NAIM NAC 102 BOXED AND IMMACULATE 2001 MODEL	£795
NAIM NAC 92 PRE AMP BOXED AND IMMACULATE	£279
NAIM NAIT3/PRE OUT MODIFICATION BOXED AND IMMACULATE(1999 MODEL)	£399
NAIM DKO 2-WAY ACTIVE X-OVER WITH VARIABLE FREQUENCY	£299
NAIM NA CD-X CD PLAYER SUPERB	£1795
NAKAMICHI OMISSE/1 CD PLAYER WITH £1500 NEW-LOVELY CONDITION	£399
NAKAMICHI CASSETTE DECK 2	£179
PIONEER CLD 925 DOLBY DIGITAL LASER DISC PLAYER	£299
PRIMARE A30.1 INTEGRATED AMPLIFIER BOXED-SLIGHT MARK HENCE	£995
PRO-AC TABLETTE 50 CHERRY-IMMACULATE	£395
PROCEED PCD SERIES 3 CD PLAYER (£3500 NEW)	£1495
QED A240CD INTEGRATED AMPLIFIER	£99
RUARK EPILOGUE REFERENCE ROSEWOOD SUPERB AND BOXED	£299
RUARK CL20 BEECH VERY GOOD CONDITION	£895
SONY JAZ2 ES MINI DISC RECORDER BLACK WITH MANUAL LOVELY	£299
VIENNA ACOUSTICS MOZART BEECH WOOD GOOD CONDITION BOXED	£995

PROFESSIONAL RECORD CLEANING SERVICE - KEITH MONKS MACHINE - PLEASE RING FOR FURTHER DETAILS AND PRICES.

THREE MONTH WARRANTY ON ALL ITEMS
www.sound-stage.co.uk

WILLIAMS HART ELECTRONICS

HART ELECTRONIC KITS TRADED FOR OVER 30 YEARS



Mofet Monoblock Power Amp Kits
ONE OF THE BEST AMPLIFIERS YOU WILL HEAR! Regardless of price
REVIEWED IN HI-FI NEWS AS '...EXCEPTIONAL...
SELF EVIDENTLY CORRECT'



Single Ended Class A Valve Sound
13Watt Power Amp modules
FOR THOSE WHO WANT THAT VALVE
MIDBAND BUT BASS AND TREBLE TO MATCH



ACTIVE R/Control SUBWOOFER MODULE £177.30



Speakers Designed & Built to Order

Advertise your Hi-Fi on my website (FREE)

Also: Award Winning Phono Stage Kit, Active Crossover Modules, Speaker Drive Units, M Cap Capacitors, Caddock Resistors, Remote Control Volume and much more.

WEB SITE: www.williamshart.com e-mail: sales@williamshart.com

Tyn-Y-Coed, Lliidiardau, Bala, Gwynedd, LL23 7SG Tel/Fax for catalogue 01678 520757.

PERSONAL VISITORS SHOULD PHONE FIRST TO AVOID DISAPPOINTMENT

Run by former Technical Director of Wilsimow Audio



MUSICAL IMAGES

PRODUCT		LIST	NOW
ARCAM A75PLUS Silver AMP	NEW	£470	£350
ARCAM ALPHA5CD CD Player	SH	£450	£150
ARCAM ALPHA6AMP AMP	SH	£300	£150
ARCAM ALPHA9AMP AMP	SH	£500	£275
ARCAM ALPHA9POWER Power Amp	SH	£400	£250
ARCAM CD62 CD Player with TEXT	EX/DEMO	£370	£300
ARCAM CD72 Silver CD Player	EX/DEMO	£450	£280
ARCAM CD92 CD Player	EX/DEMO	£900	£530
ARCAM T61 Silver Tuner	NEW	£250	£180
DENON AVC-A1SE Black AV Amp, THX	EX/DEMO	£2,500	£1,500
DENON AVR1602 Black AV Receiver	EX/DEMO	£350	£280
DENON AVR2802 Gold AV Receiver	EX/DEMO	£650	£550
DENON AVR3802 AV Receiver	EX/DEMO	£850	£600
DENON DVD2800 DVD Player	EX/DEMO	£750	£600
DENON DVD2800 DVD Player	S/H	£750	£450
HARMON KARDON AVR4500 AV Receiver	NEW	£650	£375
HARMON KARDON AVR5500 AV Receiver	NEW	£750	£450
HARMON KARDON AVR8500 AV Receiver	NEW	£1,800	£1,200
HARMON KARDON CDR30 CD Recorder	EX/DEMO	£500	£400
HARMON KARDON DVD10 DVD Player	EX/DEMO	£200	£100
HARMON KARDON TU940RDS Tuner	NEW	£180	£135
KEF 200CENTRE Centre Speakers	EX/DEMO	£700	£550
KEF CRESTA 1 Speakers	EX/DEMO	£100	£80
KEF KHT2005 5 Speakers & SUB	EX/DEMO	£800	£600
LINN AKTIVMOD Aktiv Modules	EX/DEMO	£125	£50
MARANTZ ECLIPSE 70 DVD Combi System	EX/DEMO	£1,500	£750
MARANTZ LC1700 17" LCD 16:9 TV	EX/DEMO	£1,500	£1,000
MERIDIAN 558 Multi-channel Amp	EX/DEMO	£3,395	£2,000
MERIDIAN DSP33 DSP Active Speaker	EX/DEMO	£2,595	£1,500
MERIDIAN DSP5000 Cherry Speakers	EX/DEMO	£3,885	£2,500
MERIDIAN M33 Speakers	EX/DEMO	£1,560	£750
MISSION 78C Centre Speaker	EX/DEMO	£300	£150
MISSION 78DS Speakers	EX/DEMO	£300	£150
MUSICAL FIDELITY A3CR Pre Amp	EX/DEMO	£1,000	£800
MUSICAL FIDELITY HTP AV Pre Amp	EX/DEMO	£2,000	£1,000
NAIM INTRO Black Speakers	EX/DEMO	£790	£395
PANASONIC DMRE30EBS Recordable DVD Player	EX/DEMO	£550	£475
PANASONIC NVFJ630BS Silver VCR	NEW	£150	£120
PIONEER NS DV1000 Home Cinema System	NEW	£1,300	£1,000
ROTEL RB951 Power Amp	EX/DEMO	£300	£200
ROTEL RB985 Power Amp, 5 Channel, THX	EX/DEMO	£625	£450
SELECO HT300DG Projector	EX/DEMO	£9,000	£6,750
SONY DVPS 900 Silver DVD Player	NEW	£450	£225
SONY STRDB1070 Black A/V Receiver	EX/DEMO	£600	£375
SONY STRVA555ESN AV Receiver	EX/DEMO	£1,000	£750
SONY STSE370 Tuner	NEW	£110	£80
SONY VPLVW11HT Projector	EX/DEMO	£5,300	£3,300
YAMAHA DPX-1 Projector	EX/DEMO	£6,500	£4,500
YAMAHA DVD S520	EX/DEMO	£200	£165
YAMAHA RXV620RDS AV Receiver	EX/DEMO	£450	£300

**PLEASE VISIT OUR SHOWROOMS
OR CALL OUR HOTLINE
NUMBER FOR DETAILS.
MANY ARE ONE-OFF ITEMS!!**

HOTLINE 020 7497 1346

Convent Garden
18 Monmouth Street
Convent Garden
London WC2H 9HB
Tel: 020 7497 1346

E-Mail: sales@musical-images.co.uk

NOT VALID WITH ANY OTHER OFFERS OR PROMOTIONS E&OE



Connoisseur Audio



Ex = EX-Dem

Autumn Bargains !

P =Pre-owned

Look At These Prices - Ex-Dem And Pre- Owned Stock !! Call or Email Now For Details and Part Exchange Deals

Tel/Fax : 01436-670-928 Email : connoisseuraudio@btopenworld.com

Amps	Price	Amps	Price	Speakers	Price
New Logos	£2189Ex	EAR 861 Power	£899Ex	Triangle Celeus 202 120w	£ 899Ex
TT-RR Integ.	£2899Ex	EAR V20 Integrated	£2499Ex	Opera SP3	£1499Ex
Croft Twinstar Power	£999Ex	EAR 864 Pre	£1199Ex	Aurum Cantus Bookshelf	£975Ex
Croft Twinstar Power	£999Ex	Unison Research Unico I	£750	Bluenote A6 Piano Lacquer Black	£750Ex
Croft Epoch Elite Pre	£875Ex	Plinius SA102	£3495	Diapason Adamantes LE & Stands	£3300Ex
Audio A/log Donizetti Mono	£389Ex	Plinius 8200 Integrated	£1699P	Triangle Lyr 222 150w	£1299
Pink Tri-Angle Integral	£2999P				
Cartridges	Price	Tonearms/TTables	Price	CD/DAC	Price
Dynavecor DV20H	£325P	Bluenote U3 Unipivot Arm	£229	Audio Analogue Maestro CD	£1395Ex
Sumiko Blue Point Spec.	£259	Origin Live Aurora TT	£997	Unico CD	£995
Lyra Argo MC	£795	Origin Live Resolution	£1979	Audio Analogue Paganini	£699
Benz LP	£1599	Record Cleaners etc	Price	Monrio ASTY Player	£599
Mains Power	Price	Loricraft PRC 3	£699P	Misc	Price
PS Audio P300	£1399P	Racks		Power Leads KE/Audusa	Various ExDem
PS Audio P500	£2100	Clight Aspekt 4 Shelf Black	£499Ex	T/T Motor Kit Ultra DC	£725
PS Multiwave II	£220	Clight Aspekt 3 Shelf Black	£429Ex	Advanced VTA	£48
Isotek Qube 2Kva	£1295			New Valves Svetlana etc	Various

INCREDIBLE PERPETUAL TECHNOLOGIES PACKAGES - FULL SIGNATURE VERSION - £1995
Comprises Full Sig. P3A DAC, Full Sig Monolithic PSU & P1A Digital Correction Engine

www.connoisseuraudio.co.uk

Q.T.A. SYSTEMS - KITS -

DESIGNS ENGINEERED FOR EXCELLENCE WITH:-

- POLYPROP CAPS
- AIR CORED COILS
- HI-TEC DRIVERS
- TOP GRADE COMPONENTS

CABINETS INCLUDED WITH OPTIONS ON FINISH NOTES AND SPECIFICATIONS

- COMPREHENSIVE INSTRUCTIONS
- AVAILABLE AS COMPLETED UNITS WITH STANDARD OR EXOTIC VENEERS
- DISCRETE COMPONENTS
- CUSTOM MACHINING SMALL PANELS, JOINTS & CUT-OUTS

FOR FURTHER DETAILS:-

Q.T.A. Systems

2 Wheatsheaf Way
Linton - Cambs CB1 6XB
Tel: 01223 891091

www.qtasystems.co.uk

MIDLAND HI-FI STUDIO

HI-FI CONSULTANTS.
FAX/TEL: (01902) 380083 V.A.T.
Registration No. 333 9324 60

9 FINCHFIELD ROAD WEST,
FINCHFIELD, WOLVERHAMPTON,
WEST MIDLANDS, WV3 8AY

PRE SEASON CLEARANCE

AMPLIFICATION

S/H ARC LS2 LINE PRE (BLACK)	£1395
S/H ARC LS1 LINE PRE (SILVER)	£550
S/H ARC D200 POWER (BLACK)	£1595
S/H ARC D115 POWER (SILVER)	£1450
S/H ARC VT100 MK1 POWER (SILVER)	£2900
S/H AVI S2000 MP Revised PREAMP (complete with PHONO STAGE)	£450
S/H SANSUI S2000 PREAMP (extensive facilities)	£195
S/H METAXAS MARQUIS PREAMP in flight case (was £2250)	£950
S/H LUMLEY REFERENCE line stage PREAMP (was £1000)	£475
EX DEM PS 6.0 LINE PREAMP WAS £695 SAVE £400	£295
EX DEM KRELL KRC PREAMP £3495 SAVE £1000	£2495
EX DEM OCM55 PREAMP plus OCM 500 (200watt) POWER WAS £4600	£2295
EX DEM OCM55 PREAMP plus OCM 200 (100watt) POWER WAS £3400	£1695

SPEAKERS

S/H APOGEE CENTAUR MAJOR (MAHOGANY) (were £5000 PLUS)	£1750
S/H ATC SCM7 ROSEWOOD	£350
S/H KEF Q3 BEECH	£200
S/H BOSE LIFESTYLE 12 SURROUND SYSTEM/CD/RADIO (was £2500)	£575

DIGITAL

S/H COUNTERPOINT DA11 TRANSPORT (BLACK) (was £1500)	£595
S/H AVI S2000 MC CD reference	£300
EX DEM THETA CHROME HD CD DAC HALF PRICE from £950 to £475 ONE ONLY	
NEW TEAC RW280 TWIN CD/CDR	£379
NEW MARANTZ CDR631 PROFESSIONAL CD RECORDER	£495

COLLECTABLES

LEAK STEREO 70 plus STEREOFETIC TUNER (in TEAK sleeve)	£100
THORENS 125 TURNTABLE in SME PLINTH SYSTEM	£175 ono
MUSICAL FIDELITY MVT preamp plus STUDIO T power	£595

NEW PRODUCTS FROM:-

QUAD MYRIAD ROXSAN PERPETUAL TECHNOLOGIES TIVOLI PURE
PROJECT MARTIN LOGAN AUDIO RESEARCH

BARGAIN BULBS

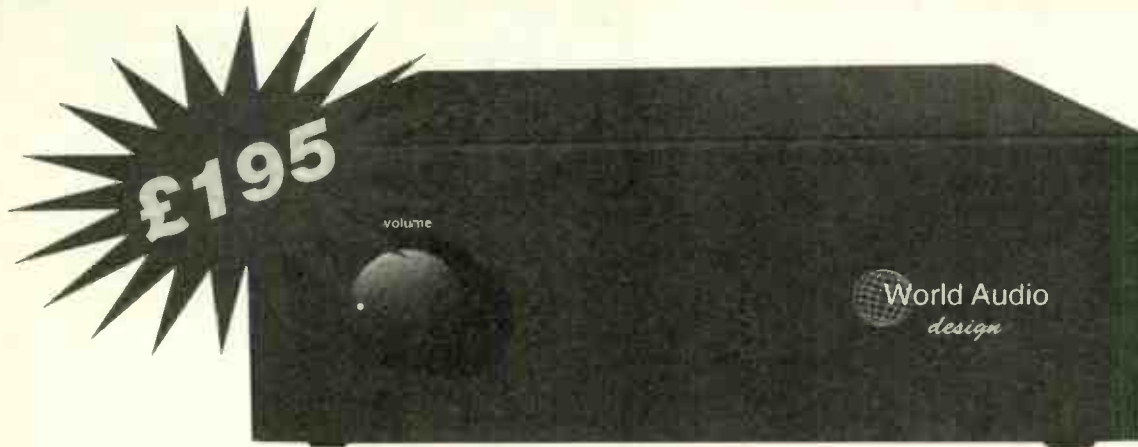

If you've always thought of valve amps as temperamental and expensive beasts, think again. World Audio Design's latest kit is designed with the budget conscious beginner in mind.

The Kec182 was created from a brief that demanded simplicity, ease of build and a super low cost. In order to achieve a reasonable power output we went for a push-pull amplifier.

We chose the ECL82, a triode/output pentode. This tube is readily available and has a good sound. In push-pull mode it delivers 8Watts. Realistically you need a speaker of around 89dB or above. This is possible at a budget price - try the smaller Triangle models, or a Tannoy mX3 or even one of the older Missions like the 773e, or if you like building your own speakers, try the Adire Audio HE10.1, as reviewed in HFW October 2002 issue.

You will see that the front has only a volume control, and it is fed by one pair of phono sockets. A selector and tape/source switch were not used in this amplifier as they are tricky to wire up, and the aim was to make it easy to build. In fact, in many ways the Kec182 would be great powering a second system, using a CD player as a source, and will definitely give you a taster of what valves can offer. Measuring 30cm wide, 23.5cm deep and 11cm height with feet, it is entirely self-enclosed. The valves are visible through the four upper circular vent holes (one directly above each valve). We have kept the look simple with the minimalist front panel holding the volume potentiometer. The two-part chassis is constructed from 1.6mm mild steel with a durable black powder-coat finish. The whole unit is very sturdy, weighing in at 9kgs.

The signal input is in the form of a pair of gold plated RCA phono sockets that sit at the rear of the chassis. The speaker sockets accept 4mm banana plugs as well as bare wire. The mains switch is positioned at the rear of the amplifier, on the right hand corner for easy access. Mains power is received via an IEC lead. The Kec182 is based on a printed circuit board (PCB). The PCB is easy to follow with all component names, locations and orientations shown clearly. The amplifier requires no set up, you just turn it on. The kit will come with comprehensive instructions taking you through the build step-by-step.

SOUND QUALITY BY SIMON POPE

Purity is the key to this amplifier's design and sound. Because there's very little to get in the way of the signal what you get is an exceptionally sweet and simple sound that also has a superbly wholesome roundness to it. A high quality recording of Mahler's Das Lied Von Der Erde on Reference Recordings showed that the Kec182 faithfully reproduced all the depth and space of a full symphonic orchestra without any problems. Violins were smooth and sweet, as was percussion (which virtually sparkled) and the woodwind section was especially impressive, with a spacious and airy sound.

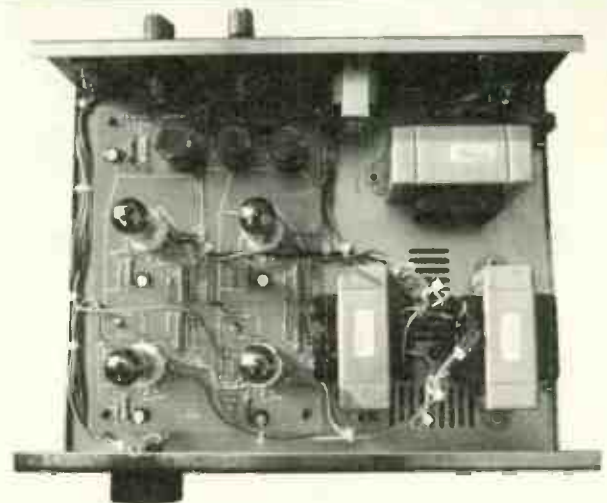

A run through Miles Davis's Kind Of Blue saw the little integrated delivering a detailed and precise sound that highlighted the warmth of Coltrane's tenor sax and the rich, deep sound of the upright bass. Rock and Pop records such as Radiohead's 'Lucky' demonstrated that the valves inside the amp, whilst small, are quite robust sounding, with commendable clout and bass depth for a humble budget 8W valve amp. This is a great introduction to the sonic art of the valve amp and a big upgrade for anybody with a mid-price solid-state amp that wishes to swap over to something more musically engaging, for a price that's virtually as cheap as chips!

MEASURED PERFORMANCE

Frequency response	+/-3dB 15Hz - 75kHz
power output	8 watts into an 8 ohm load
sensitivity	850mV (suitable for CD)
hum	0.5mV

**The Kec182 amplifier kit is available from World Audio Design
Tel/fax: 00 44 (0) 1908 218836 or order on-line at
www.worldaudiodesign.co.uk**

**Kec182 amplifier kit (UK price) £195.00
(inc. vat & carriage)**

**Kec182 amplifier kit (EU price) £195.00
(inc. vat, exc. carriage)**

**Kec182 amplifier kit (Overseas price) £170.00
(exc. carriage)**

Oxford Audio Consultants Ltd.

OUR SUPERB SERVICE IS THE SAME REGARDLESS OF PRICE



Now Demonstrating



Ex-Demonstration & Previously Owned Equipment

SALE LIST

Goertz Speaker cables	P.O.A.	SH
Denon DV5000 DVD Player	P.O.A.	SH
Onkyo TX DS 989 AV amplifier	P.O.A.	SH
Michell Orbe SE	£1195	SH
Audio Research LS25	£2995	SH
Krell FPB700cx	P.O.A.	
Wilson System 6.1 Ferrari Grey NEW PRICE	£10995	SH
Musical Fidelity F15 Power Amplifier	£695	SH
Musical Fidelity F22 preamp	£595	SH
Musical Fidelity FCD CD Player	£595	SH
Martin Logan Ascents ex dem light oak	£3495	XD
Exposure phono stage XIII MM	£495	SH
Krell 250p preamplifier	£1295	SH
Meridian 500 CD Transport	£795	SH
Musical Fidelity A3.2CD CD Player	£695	SH
dCS Delius	£2995	SH
Lexicon MC1	£1995	SH
Martin Logan Aeon ex dem	£2295	XD
Graaf 13.5 preamplifier	£1795	SH
Theta Dreadnaught 5 channel	£4995	XD
Onkyo Integra system - our dem models	£6995	XD
Veritas P400 Power Amplifier as new	£2495	XD
Theta Carmen DVD/CD Player silver ex dem	£2495	XD
Audio Research VT60 Power Amp	£ 795	SH

SH - Second Hand XD - EX Demonstration

0% interest free credit

Licensed Credit Broker

REFER TO OUR WEBSITE FOR THE LATEST UPDATED SALE LIST.

Agencies include: Acoustic Energy, Alphason, Atacama, Audio Analogue, Research, Beyer, BOSE, Castle, Chord Company, Copland, Creston, Canon, Dapason, Dwn Electronics, Fidelity, Giffing, G-saf, Integra Systems, IXOS, Jada, Jamo, Kel, Koetsu, Krell, Lesicon, Living Control, Loewe TV/Video, Linn Classic, Lyra, Marantz, Martin Logan, Michael, Musical Fidelity, NAD, Naim, NEC Gas Plasma Screens, Nakamichi, Nordost, Onkyo, Opera, Ortofon, Parasound, Pioneer, ProAc, Project, Tumbables, QED, Murkroom, Quad, Quadrapex, REL, Subwoofers, Sennheiser, Sharp LCD TVs, SME, Sonus Faber, Sonus Systems, Soundstyle, Stands Unique, Star, Stewart Screens, Tag McLaren, Tannoy, Teac, Theta, Translucent Ultron Research, Van den Hul, Vibe Acoustics subwoofers, Videologic, Vienna Acoustics, Wilson, Yamaha.

TAX-FREE EXPORT SERVICE
MAIL-ORDER AVAILABLE ON MANY ITEMS

Cantay House, Park End Street
Oxford OX1 1JD

Telephone: Oxford (01865) 790879

Facsimile: Oxford (01865) 791665

E-MAIL: oxford.audio@btinternet.com

WEBSITE: www.oxfordaudio.co.uk



V.A.T. No.
729580013



QUALITY USED
EQUIPMENT,
BOUGHT, SOLD,
PART EXCHANGE

TEL/FAX
0121 747 4246



URGENTLY REQUIRED
LINN, NAIM,
MERIDIAN, QUAD,
CASH WAITING

	RRP	NOW £
ACOUSTIC ZEN SILVER REFERENCE XLR I MTR EX DEM	815	595
ADVANTAGE A300 POWERAMP	2600	995
ADVANTAGE S2 PREAMP	2750	1495
AUDIO RESEARCH SP16	2500	1695
AUDIO RESEARCH VS55	2700	1795
AUDIO RESEARCH CLASSIC 60 GROOVE TUBED FULL SERVICE	3500	1695
AUDIO RESEARCH VT50 BALANCED	3500	1895
AUDIO RESEARCH D130	2000	995
AVANTGARDE UNO	7200	3495
BALANCED AUDIO TECHNOLOGIES VK51SE	7950	5795
BALANCED AUDIO TECHNOLOGIES VKD5SE CD	5450	2795
BALANCED AUDIO TECHNOLOGIES 6200/5 CHANNEL EX DEM	8275	5795
BALANCED AUDIO TECHNOLOGIES VK75SE	7950	5795
BALANCED AUDIO TECHNOLOGIES 300X	4000	2495
BOW WIZARD CD	3500	1695
CHORD CPA 3200 E	4800	2995
CLASSE CDT1 CD TRANSPORT	2700	1395
EAR 534 POWER BALANCED	2200	1395
EAR 899 INTEGRATED	2950	1895
EAR THE HEAD PHONO TRANSFORMER	N/A	295
HOVLAND HP-100 + MC PHONO	5750	3995
HOVLAND HP-100 LINE ONLY	4750	3295
HOVLAND SAPHIRE POWER AMP	7000	4495
JAMO CONCERT 11 CHERRY	2300	1095
KRELL KAV 280 CD	4000	2595
KRELL KAV 300IL	3700	2495
LAVARDIN IT 3 MTHS OLD	3400	2495
LUXMAN K-351 CASSETTE DECK	N/A	195
LINN BASIK PLUS	N/A	75
MAGNUM DYNALAB FT11	500	295
MARANTZ CD7	3500	2595
MARANTZ 63K1 SIG MK2	500	250
MERIDIAN 551	800	450
MERIDIAN 555	850	395
MERIDIAN 518	900	495
MERIDIAN 561	3200	1695
MERIDIAN 500 TRANSPORT	1400	695
MERIDIAN 505 MONO	900	550
MUSE MODEL 8 CD/DVD TRANSPORT	3500	995
MUSE MODEL 296 24/96 DAC	3500	995
MUSICAL FIDELITY F25	1500	595
MUSICAL FIDELITY NUVISTA CD	3000	2295
NAIM HICAP OLD STYLE	N/A	350
NORDOST BLUE HEAVEN 0.6 MTR XLR	180	95
NORDOST BLUE HEAVEN 1 MTR XLR	200	110
NORDOST BLUE HEAVEN 3 MTR BIAMP BANANA'S	570	350
NBS SIGNATURE SPEAKER CABLE 2 X 6 FT	2600	695
NVA THE INTEGRATED STATEMENT	1300	395
ORACLE CD TRANSPORT SPECIAL EDITION	9500	3995
PROAC FUTURE 0.5 MAHOGANY	3500	1995
PROAC RESPONSE 2.5 CHERRY	2500	1795
QUAD QC 24 / 11 FORTY	4000	2795
QUAD 988 1 WEEK OLD	3500	2195
RED ROSE ROSEBUD	3000	1695
SONUS FABER EXTREMA WITH STANDS	N/A	2995
SOUND LAB MILLENIUM 3	8295	4995
SUGDEN SAU51 PRE	N/A	495
TAG MCLAREN 60I INTEGRATED	600	295
TANNOY DIMENSION 8	4000	2495
THE TA PRO GENY	1100	495
VAN DEN HUL INTEGRATION HYBRID 0.6 MTR	160	95
VERITAS P400	3000	1495
WADIA 6	4500	1495

OPEN MON-SUN 10.00 TO 8.00
Website: www.centralaudio.co.uk
E-mail: tony@centralaudio.co.uk

ALSO AGENTS FOR

Advantage, Balanced audio technologies, Boulder, Burmester, Eggleston, Hovland, Kharma, Lumley, Pass labs, Sound lab, VTL.

HEATHERDALE PRE-OWNED GUARANTEED EQUIPMENT EXPORT FACILITIES AVAILABLE

- SPEAKERS**
- Orchid LMO Speakers Ex Demo £2495
 - Epos ES12 Speakers £375
 - B+W CDM1 Speakers £295
 - Pro AC Studio 1 Speakers Mk 2 £395
 - Thiel Cs.5 (New) £995
 - B+W Cdm1 Speakers £295
 - Mirage M3 Sl Speakers £1495
 - Thiel SCS 2 Speakers (Walnut Finish) (Brand New) Normal Price £2395
 - Mission 782 (Stand Mount Model) (Black Ash) Just Reduced From £250
 - Audio Physics tempo speaker £995
 - Revel Ultima sub 15 with LE1 sub amp £150
 - Etchx Symphony floor standing speakers £995
 - Pro Ac studio towers (etc drive) speakers £995
 - Orchid PL11 Speakers x demo £3745
- PRE AMPS**
- Naim nac 82 pre amp £1495
 - Mark Levinson reference 32 pre amp £904
 - Burmester 785 pre amp £395
 - Kirshaw perception pre amp with bal output and phono stage, with psu Exposure 11 & 12 Pre Amp & Power Supply Just Reduced from £500
 - Toft Pre Amp (fully balanced) £395
 - Adcom GTP 450 Tuner/Pre-Amp £350
 - Exposure 21 Pre-Amp (Remote) (Ex Stock) Just Reduced From £390

- AMPLIFIERS**
- Proced BPA2 Dual Mono Power Amp Ex Demo £2495
 - Musical Fidelity P100 Power Amps With MF3a Pre Amp & Psu £375
 - Naim NAP 180 power amp £295
 - Mark Levinson 333 power amp £395
 - Mark Levinson m133 reference mono's £995
 - Naim NAP 90/3 power amp £295
 - Cyrus two integrated amp with cyrus psx power supply £1495
 - Arcam Alpha 9 pre amp £1595
 - Revel Ultima sub 15 with LE1 sub amp £150
 - Audionote Neuro Nlono amps £995
 - Arcam Delta 290 integrated amp £150
 - Kreb KST 100 Power Amp £995
 - Nakamichi PA 5 Status Power Amp Cost New £1150
 - Adcom GFA S300 Power Amp £395
 - AVI 2000MI integrated amp £3745
- CD PLAYERS & TRANSPORT**
- Mark Levinson Reference 31.5 transport with ML30.6 DAC mm1 condition, boxed, £1495
 - Marantz CD 63 SE CD Player £904
 - Pioneer DV55 DVD Player Multi Region £395
 - Mark Levinson ML39 CD Player £395
- MISCELLANEOUS**
- Transparent Bi Wire Premium Adapters £125
 - Transparent Speaker Cables XL Ref 15R pair £2750
 - Siltech mains cable (boxed) £150
 - Soundstyle 5 Tier Equipment Stand £100

- Sansui TU-D99X Tuner £55
 - Kudos 5 Tier Equipment Stand (originally £200) £275
 - Revox B760 Tuner £325
 - Transparent Premium Digital Interconnect _ mtr £135
 - Madrigal C2 Gel 1mtr Balanced Interconnect £275
 - EPDA Stax 4040 Headphones £850
 - 1mtr Kondo KSL LP Interconnect (Normal Price £2000) £995
 - Mit Balanced 2 Mtr Reference Interconnect (Was £3495) £1195
 - Mit Shot Gun 750 8 Foot Bi-Wire Speaker Cable £795
 - Target Stands R2 £150
 - Yamaha Ct-810 Am/Fm Tuner £125
 - Nakamichi bx2 cassette deck £195
 - 5 mtr howland bi-wire speaker cable £600
 - Synergistic Research Coax Resolution Reference digital (with active shielding) £250
 - Stax SR007 omega ref (SR117 head phone & SRM007 dual triode) Normal Retail £2995 £1995
 - Audio Note ANS7 MC Transformer with Phono Stage £2495
 - Audio Note (kondo) KSL-AC2 mains cable (new and boxed) £650
 - Audionote (kondo) 3mtr pair SPZ speaker cable £2500
 - Audio Note (kondo) kSL-LP Silver litz interconnect 1 mtr pair £995
- P.O.A.**
- £195
 - £350
 - £3495
- TURNTABLES, CARTRIDGES & TONEARMS**
- Rega Planar 2 Turntable £95
 - Michell gyrodeck with gc power supply £995
 - Lumley stroosphere turntable (gold plated) with dedicated stand & large power supply £2995
 - Eminent Technology air bearing arm with magnesium wand c/w pump £1695
 - Verder Ebony Wood arm board Normal Retail £300 £225
 - Ortofon Jubilee Cartridge £95
- Other services available. See in store 0% Finance. Conditions Apply. See in store

ALL USED CARTRIDGES ARE CHECKED UNDER A MICROSCOPE BEFORE BEING OFFERED FOR SALE.

VISA - SWITCH - MASTER CARD - AMEX - DINERS CLUB WELCOME.
WE TAKE PART EXCHANGE ON NEW & USED STOCK and buy in for cash



Soundcraft HiFi.com

40 High Street, Ashford, Kent. TN24 8TE

Tel: 01233 624441

Check our web site: soundcraft.hifi.com

Manufacturer	Product name	Product type	New/used	Price	Manufacturer	Product name	Product type	New/used	Price
Arcam	A75 (black)	Integrated amplifier	Ex-demo	£399.00	Marantz	04A100 (tone free)	DVD	Ex-demo	£199.00
Arcam	DIVA CD93 Silver	CD	Ex-demo	£650.00	Marantz	SA-72100	Home Cinema	Ex-demo	£549.00
Arcam	FH1 CD131 Silver	CD	Ex-demo	£895.00	Marantz	SA-43010	Home Cinema	Ex-demo	£450.00
Arcam	DIVA (black)	DVD	Ex-demo	£495.00	Marantz	DV4100 (tone free)	DVD	Ex-demo	£199.00
Arcam	DIVA CD73 (Silver)	CD	Ex-demo	£449.00	Marantz	SR8300	Home Cinema	Ex-demo	£199.00
Arcam	CD-42	CD	Ex-demo	£299.00	Marantz	CD60000 (Gold)	CD	Used	£199.00
Arcam	FW 822	Amplifier	Ex-demo	£299.00	Marantz	725's Rosewood Black	Speaker	Used	£199.00
Arcam	Opal x3 (RCA)	Cables	Ex-demo	£85.00	Marantz	XLPS	Turntable	Used	£199.00
B&W	CDM 7M1 (cherry) slight cab damage	Speaker	Used	£799.00	Marantz	WT 600 5 Channel Power Amp	Power amp	Ex-demo	£1,295.00
B&W	Nashua 902 (Cherry)	Speaker	Ex-demo	£2,350.00	Marantz	HTP (Processor)	Home Cinema	Ex-demo	£1,295.00
B&W	Nashua 905.1 (Red Cherry)	Speaker	Ex-demo	£1,250.00	Marantz	NAP 238 Pre Amp	Power amp	Used	£1,495.00
Decca	DPD 2800 Mail (tone free)	DVD	Ex-demo	£499.00	Marantz	NAP 90.3	Power amp	Used	£299.00
Decca	DVD-800 (tone free)	DVD	Ex-demo	£199.00	Marantz	CD5+PSU (serviced)	CD	Used	£2,495.00
Decca	AVR 3003	Home Cinema	Ex-demo	£649.00	Marantz	AV-1 processor	Pre/power	Used	£495.00
Decca	AVC-415A	Home Cinema	Ex-demo	£1,995.00	Marantz	NAC 92R Phono/Pre Amp	Pre/power	Used	£199.00
Decca	DVD 3000 (black)	DVD	Ex-demo	£599.00	Marantz	32.5	Pre amp	Used	£199.00
Decca	DVD-4.1	DVD	Ex-demo	£1,495.00	Marantz	DVD 18.5 tone free	DVD	Ex-demo	£299.00
Decca	AVR 3002 (gold)	Home Cinema	Ex-demo	£549.00	Marantz	AI-300 (3 shelf rack)	Furniture	Used	£199.00
Decca	SOS (low car)	Turntable	Ex-demo	£199.00	Marantz	POS-707 CD Player	Tuner	Ex-demo	£150.00
Decca	4 shelf Hi-Fi rack	Turntable	Ex-demo	£229.00	Marantz	DXR-7025	CD	Used	£150.00
Decca	AVR 4500	Home Cinema	Ex-demo	£499.00	Marantz	Silver Special (lim)	CD	Used	£399.00
Decca	AVR-5500	Home Cinema	Ex-demo	£699.00	Marantz	ESP-964	Home Cinema	Ex-demo	£499.00
Decca	Centre	Speaker	Ex-demo	£149.99	Marantz	RSL-965BDS	Home Cinema	Ex-demo	£499.00
Decca	Sub Woofer	Sub woofer	Ex-demo	£249.00	Marantz	RSL-965BDS	Home Cinema	Ex-demo	£499.00
Decca	MCI 2 Processor	Amplifier	Ex-demo	£595.00	Marantz	RDV-995 (tone free)	DVD	Ex-demo	£349.00
Decca	MJM 1 Phono	CD	Ex-demo	£499.00	Marantz	Sobase (active) (used, Rosewood)	Speaker	Used	£1,995.00
Decca	CD-12	CD	Ex-demo	£749.00	Marantz	NT200 GC (DSP Processor)	Home Cinema	Ex-demo	£2,995.00
Decca	index 2	Speaker	Used	£149.00	Marantz	45" x 90" (18.9") was £450	Home Cinema	New	£799.00
Decca	Mark CD (lim serviced)	CD	Used	£599.00	Marantz	DSP-ARJ200	Home Cinema	New	£799.00
Decca	Labers (black)	Speaker	Used	£995.00	Marantz	DVD-5520 (region free)	Home Cinema	Ex-demo	£199.00
Decca	Classik Home (silver)	Home Cinema	Ex-demo	£199.99	Marantz	SLP-470105	Home Cinema	New	£650.00
Decca	DSP-1 Pro-Linc Processor	Television	Ex-demo	£249.99	Marantz	RXY-1200 KDS	Home Cinema	Ex-demo	£499.00
Decca	R 4 43104H	Television	Ex-demo	£249.99	Marantz	CDR-8D1	CD (H/Disc recorder)	Ex-demo	£499.00

MUSONIC STYLIS

SPECIALIST MANUFACTURER & SUPPLIER FOR MORE THAN 40 YEARS

REPLACEMENTS & ORIGINALS

MANY OBSOLETE/78 VERSIONS

PICK-UP CARTRIDGES

RECORD/TAPE/CD ACCESSORIES

WHY NOT TRY US AND HEAR THE DIFFERENCE !!

NAGAOKA CARTRIDGES NOW IN STOCK

For further information tel/fax/e-mail to:-

MUSONIC (UK) LIMITED
Unit 13 Wenta Business Centre Colne Way
Watford Hertfordshire WD24 7ND

Tel: 01923 213344 Fax: 01923 213355
E-mail:sales@musonic.co.uk

VISIT OUR UPDATED WEBSITE
www.musonic.co.uk

Trade and Export enquiries welcome

IAN HARRISON HI-FI TEL: 01283 702875

HI-FI AT DISCOUNT PRICES. FREE NATIONWIDE DELIVERY

SALE NOW ON!

9am-9pm INCLUDING SUNDAYS

TRADE IN YOUR OLD MOVING COIL CARTRIDGE & SAVE UP TO 60% OFF THE RRP.

CARTRIDGES & STYLUS	HI-FI FURNITURE	HEADPHONES	DVD
DENON	OPTIMUM	STAX	SONY
SHURE	ASH DESIGN	SENNHEISER	DENON
AUDIO TECHNICA	APOLLO	SONY	PHONO STAGES
GOLDRING	SOUND STYLE	AKG	TRICHORD
SUMIKO	SOUND	GRADO	MOTH
TRANS-	ORGANISATION	AUDIO-TECHNICA	CREEK
FIGURATION	ALPHASON	DAT	NAD
LONDON (DECCA)	CABLES	TASCAM	EAR
GRADO	BLACK RHODIUM	SONY	ROKSAN
ROKSAN	TRANSPARENT	PANASONIC	TOM EVANS
ORTOFON	QED	CASSETTE DECKS	LOUDSPEAKERS
RESON	ORTOFON	PIONEER	SONY
CLEAR AUDIO	NORDOST	TEAC	HARBETH
KOETSU	ARGENTO	SONY	CHABASSE
	AUDIO	DENON	SHUN MOOK
			EPOS
TONEARMS	TURNTABLES	MINI DISCS	AMPLIFIERS
SOUTHER	MICHELL	SONY	DENON
GRAHAM	CLEAR AUDIO	DENON	HALCRO
MOTH	AUDIO NOTE		MOTH
CLEAR AUDIO	CD PLAYERS	TUNERS	C.A.T.
HADCOCK	SONY	SONY	GAMUT
	DENON	DENON	ALOIA
			EAR
ACCESSORIES			
Hifi News Cartridge Alignment Gauge	£5	Audio Technica Stylus	
Hifi News Test Record & Alignment Gauge	£15	Cleaning Fluid	£5
Shure SFG/2 Tracking Force Gauge	£25	Clearaudio Carbon Fibre Record	
		Cleaning Brush	£14

PLEASE PHONE TO CONFIRM PRICE & AVAILABILITY PRIOR TO ORDERING
ALL GOODS ARE BRAND NEW & BOXED WITH FULL U.K. GUARANTEE
NO EX DEMO OR EX DISPLAY GOODS NO GREY IMPORTS. GOODS ARE NOT
SUPPLIED ON APPROVAL. SORRY, NO GENERAL CATALOGUES. PLEASE PHONE
OR WRITE FOR SPECIFIC REVIEWS, BROCHURES OR PRICES.

MAIL ORDER ONLY FROM: IAN HARRISON, 7 MILL HILL, REPTON,
DERBY, DE65 6GQ. TEL: 01283 702875. 9am - 9pm INCLUDING SUNDAYS.

Sound Music

93-95 Nantwich Rd., Crewe, Cheshire.
Telephone : 01270 214143

- Arcam CD72 - CD Player (SH) - £300
- Audiolab 8000 S - Integrated Amplifier (SH) - £450
- Audiolab 8000 M - Monoblock Power Amplifiers (SH) - £750 Pair
- B&W P5 - Speakers (SH) - £550
- Castle Pembroke - Speakers (Walnut/XD) - £300
- Castle Howard - Speakers (Oak/XD) - £950
- Epos ES14 - Speakers & Stands (SH) - £275
- Harman Kardon 4500 - AV Receiver (XD) - £450
- Infinity Kappa 400 - Speakers (XD) - £500
- JBL TIK 6 - Speakers (Beech/XD) - £1200
- Linn Klassik Movie System (XD) - £1500
- Linn Mimik - CD Player (SH) - £275
- Linn Kalrn Pro - Preamp (XD) - £600
- Linn Kollector - Preamp (XD) - £275
- Linn 5125 - 5 Channel Power Amplifier (XD) - £1350
- Linn 2250 - Power Amplifiers (XD) 2 For Sale At £1650 Each
- Linn Ninka - Speakers (Maple/SH) - £650
- Linn Keleldh - Speakers (Black/SH) - £300
- Linn Trikan - Centre Speaker (XD) - £350
- Linn Sizmik Maple - Sub (XD) - £650
- Meridian M33 - Active Speakers (XD) - £1100 Pair
- Meridian 505 - Mono Power Amplifiers (XD) - £650 Each
- Meridian D2500 - Digital Subwoofer (XD) - £1500
- Monitor Audio GR20 - Speakers (Beech/XD) - £1200
- Musical Fidelity "The Preamp" (SH) - £350
- Musical Fidelity Typhoon - Power Amplifier (SH) - £250
- Musical Fidelity XP100 - Pre-Amplifier (SH) - £400
- NAD T752 - Receiver (XD) - £475
- Onkyo DR90 - DVD Receiver (XD) - £250
- Quad 21L - Speakers (Maple/XD)
- Roksan Casplan - Four Channel Amplifier (XD) - £650
- Rotel RB 985 - Five Channel Amplifier (SH) - £450
- Tannoy Eyril 3 - Speakers (Maple/XD) - £650
- Tannoy Eyril 1 - Speakers (Rosewood/XD) - £300
- Wharfedale EVO 10 Speakers (Maple/XD) - £250

Agencies include : Linn, Musical Fidelity, S.M.E., Origin Live, Monitor Audio, Castle, Quad, Wharfedale, Harman Kardon, Creek, Meridian, Tannoy, Infinity, Loewe, Sanyo, Ortofon, VDH, JBL, Project, Roksan, QED, Cable Talk, Michell, Arcam, Trichord, PMC,

X electrical

We buy, sell & part exchange quality Hi-fi

AMPLIFIERS / RECEIVERS	CD PLAYERS	Logic turntable with Linn basic . . . £145
Sony STD8930 Dolby Digital amp . . . £265	TRANSPORTS & DACS	Rotel RQ970 BX Phono equaliser . . . £120
Marantz PM 7200 Champagne . . . £275	Mission DADS/DACS . . . £145	SPEAKERS
Audio Research D70 Valve Monster . . . £1095	Micromega Stage 1 . . . £175	Acoustical Alliance . . . £395
Haller 220 MonoPower amp*2 . . . £295	Sony CDPXB920E as new . . . £145	Acoustic Energy AE2 stands . . . £495
Musical Fidelity E10 . . . £135	Linn Mimik / Numerik CD/DAC . . . £895	Technics SBM300 . . . £175
Linn Nebula New Zealand's finest ! . . . £175	Pioneer PD580X . . . £125	Stirling LS3/5a mint . . . £445
Technics SUHA10 . . . £375	Rotel RCD965BX . . . £75	Linn Ninka . . . £545
Revox B740 Power amp . . . £495	Marantz CD6000 0 SE . . . £170	Musical Technology Harriers . . . £195
ElectroCompanion 1980's power amp . . . £475	Aura AVCSO piano black . . . £145	Linn Keleldh(passive) . . . £495
Musical Fidelity JA1 . . . £325	Marantz CD67 mk2 SE . . . £185	Monitor Audio monitors 3 gold . . . £245
Denon AVR 1601 . . . £175	Musical Fidelity CD2 . . . £145	Epos ES22 . . . £545
Quad 33/303 pre/power amp . . . £195	Pioneer PD5901 . . . £145	Kef RDMS Cherry . . . £875
Pioneer 8100 great 1970s amp . . . £145	Aura AVCSO . . . £125	Rogers LS2 and LS4 . . . £95/165
Alchemint Axion amp . . . £220	Sony SCD-XB940 SACD as new . . . £245	Mission 753s black . . . £295
Mode Audio M100B monoblocks . . . £245	Technics SLPG999 . . . £195	Monitor Audio MA14 black . . . £195
Cyrus straight line . . . £165	TUNERS	Rogers DB101 blue . . . £145
Rotel RC970BX/RB981BX/Pre/Power . . . £345	Musical Fidelity T1 . . . £125	Acoustic Energy AE109 . . . £275
NAD C270 power amp . . . £325	Denon TU240LM2 . . . £80	CASSETTES
Cyrus 3 plus NYC . . . £245	Sony STS SE570 Tuner . . . £75	Nakamichi 582 . . . £175
Arcam Alpha 7 Integrated . . . £175	Quad FM2 Valve . . . £145	Tascam 238 reel to reel . . . £275
Audiolab 8000C preamp . . . £275	Rotel NT1024 Silver classic . . . £245	Nakamichi BX300 . . . £250
Merwood RA3020 . . . £95	Rogers T75 English classic . . . £75	SYSTEMS
Audiolab 8000 P black . . . £445	TURNTABLES	Yamaha Q2031 2*31 band EQ . . . £195
Technics SV855big Integrated amp . . . £175	Systemdek IIA . . . £225	Technics SH8050 . . . £95
NAD 3030 1970s Silver . . . £115	AR EB101 black . . . £125	SYSTEMS/MISCELLANEOUS
Nakamichi 630 Preceiver . . . £155	Thorens TD160 Super /Mission774 . . . £195	Technics SCCHD550 . . . £315
Beard P35 Power Amp . . . £545	Rega Planar 2 . . . £125	Bose Lifestyle 30 . . . £1095
Quad 405 and 405-2 . . . £195/225		Bang & Olufsen One . . . £575

Please call us if you have any equipment to sell or are looking for anything in particular. New stock daily
All equipment is fully tested and guaranteed

Also: Music CDs, Games, Musical Equipment, Computers, TV, VCR & Photographic
Web page: www.xelectrical.com email: x@xelectrical.com
125 King Street Hammersmith 020 - 8563 7383
4 Station Bldgs Fife Road Kingston 020 - 8546 1233
Games & CDs upstairs at Kingston 020 - 8546 4442
43 Church Street Croydon 020 - 8680 0007

CLASSIQUE SOUNDS.(LEICESTER) INC ONE THING.

VINTAGE HIFI & VALVE SPECIALIST - TEL.0845 123 5137 (local rate UK only)

WANTED Vintage and modern hifi eqpt. Part exchange welcome

FOR SALE. PRE/POWER AMPLIFIERS

Tube Technology Seer valve line preamp. Mint. Bxd. £495	Croft super Micro 2 valve pre amplifier. £295
Union Research Unico 1 amplifier. 3 months old. £650	Marantz PM66SE K1 signature integrated amplifier £199
Pair Leak TL12 + valve amps Grey. Rebuilt by me. £599	Crimson Elektrik 5105/20 pre/power amplifier. Bxd. £249
Audio Innovations L1 valve pre amplifier. Bosed. £200	Sugden AU51 power amplifier. Bosed. £650
Tube Technology Unisis valve pwr amp. Mint bxd. £995	Heathkit MA12 Mono valve power amplifier. £150
Magnum A.100 2 X huge mono power amplifiers. 350 watts output. Excellent condition. Cost around £2000	£799
CR Developments Carmenta Line valve pre-amp. £450	Harmon Kardon HK1400 line amplifier. Mint/boxed £199
Hart 1100RSA integrated amplifier. 80W. Superb. £375	Keswood KA6600 integrated amplifier. Black. £60
Sugden A25 amplifier. Excellent condition & instr. £200	Naim NAC 92 pre amp. S/NO 161840. Mint. Bosed £299
Meridian Modular pre/power amplifier. Ex cond. £249	Magnum MP125 pre amplifier with MM/MC. £250
Quad 77 integrated amplifier. Mint. Bosed. Instr. £399	Quad 77 remote control for amplifier etc. Cost £300 £149
Musical Fidelity B1 integrated amplifier. Good cond. £125	Naim Nait 3R integrated amp & remote. Mint. Bxd. £495
Linn LK1 pre-amp and remote. Good condition. £249	Linn LK2 power amplifier. Good condition. £299
Copland CTA501 power amplifier. Valve. £1800	£799
Quad 11s in various condition and prices	EPOA Pioneer A400 integrated amplifier. Good cond £125
Leak Stereo 20 valve power amplifiers from . . . £POA	Harmon Kardon integrated valve amp. 110V. V rare £299
Quad 303 power amplifiers from . . . £125	Arcam Alpha 2 amplifier. Mint. Bosed/Instr £650
Nakamichi CA5 pre-amplifier. Ex cond. Cost £750. £375	Nakamichi PA5 100W/CH power amp. Cost £1300 £195
NVA A80 mono power amplifiers X 2. Good cond. £799	NVA A60 stereo power amplifier. Good condition. £295
AVI S2000 MI int amp & remote. Cost 1999. Mint £549	Linn LK100 power amplifier. Excellent condition. £395
Musical Fidelity Pre-8 pre-amplifier. Mint. Bosed £150	Arcam Alpha 3 amplifier. Mint. Bosed/ Instructions £100
Arcam Zeta 1 Pro logic Cinema amp. Cost £999. £450	Quad 33 pre amplifiers. From . . . £75

TURNTABLES

Garrard 401 with SME 3009 arm. £295	Thorens TD125 with thorens tone arm. £125
Transcriptors Hydraulic reference/Decca arm. Mint £800	Project 1 record deck. Excellent condition. Bosed £95
Dual CS05-2 turntable. Mint condition. Bosed £89	Garrard 301/401 chassis in various condition from £125
Dual 5054 record deck. Good condition/Instr £100	Trio KD550. Direct drive turntable. £95

SPEAKERS

Quad ESL57 speakers. All fully serviced with full 3 months warranty. Hear what ESL57s should sound like From £900 pr	Quad ESL57. Bronze pair. £550
Tannoy Lancaster corner units. 12 in Monitor goods. EPOA	Rolsan ROK-ONE speakers. Black. Mint. Bosed. £295
JPW active subwoofer. Mint. boxed. Instructions £160	Mission 773 floor standers. Mint/boxed. Half price £199
SD Acoustics SD3 loudspeakers. Piano finish £275	Rogers LS55 speakers. Rosewood. Bosed. Ex cond £399
Heybrook Heyhls. Black. Bosed. Ex condition £199	Celesion SL600 speakers. Good condition. Bi wire £175
Rega EL8 floorstanding speakers. black ash. Bosed £149	Proac 3 loudspeakers. Ex cond. Rosewood. Bosed £450
Tannoy Chatsworth with 12 inch monitor goods. £POA	Mordaunt Short MS201 pearl. Brand new. Black £169
Castle Kendall speakers. Good condition. £69	B&W DM4 speakers. Black finish £85
Pair Quad ESL57 spkrs. Fully rebuilt. le 4 Recon bass & 2 recon treble units. All new electronics. 12m warranty £1199	Kef C20 Bookshelf monitor speakers in black £60
Magneplaner MG 1.4. Bosed with £400 oak stands £999	

OTHER ITEMS

Musical Fidelity X-Flora FM tuner. Bosed/remote £350	Marantz CD50 Cd player. Ex condition. £79
Restek Concrete CD player. Top Loader. Mint. boxed. £995	Decca London international tone arm. New. Bosed. £175
Arcam Delta 1703 CD Transport. Mint. Bosed. £800	£399
Leak Troughline 3 stereo valve tuner. Fully serviced	£195
SME 3009 tonearms from . . . £125	Rotel 950 CD player. Ex cond. Bosed. £100
Syrinx PU2 tone arm in gold finish. £199	GEC PX4 valve. Brand new. £100
Quad 77 RDS FM tuner. Mint. Bosed. Instructions £399	Nakamichi CDP 2E CD player. Ex condition. £250
Sugden R21 tuner. Wooden case. Beautiful. £95	Cogan Hall loudspeaker cable 1.5 metre pair. £150
Naim 42.5 pre amp. MM boards fitted. £125	Phillips 101 top loading cd player. Collectable. £125
Marantz SD275 twin cassette deck. Dolby B/C £49	Technics SL-PG440A Mash CD player/remote. £75
Aiwa AD-5750 Dolby B-C-SHX pro cassette deck £75	Technics SL-PS620A CD player/remote. £75
Linn Tuner. Mint. Bosed. Very unusual. Cost £549	£249
Quad FM3 tuner in excellent condition. £195	Marantz CD63 top loader cd player. Collectable. £125
Arcam Alpha 5 cd player. Mint. Bosed/remote £195	KT880L synthesiser tuner. AM/FM. Black. £75

QUAD ESL57 & ELS63 PANELS / SERVICING ETC

NEW- B&W DM70 Electrostatic panels now undertaken. Price for one panel is £150.00
Reconditioned Quad ESL57 speakers from only £800.00 pr. Why spend £4000+? Have your
ESL57 SPEAKERS STANDARD SERVICE £375.PR. Ring for info.

Exchange/recon ESL57 bass panel £130. Treble £109. ESL63 panels £100 refurbished.
EL563/ESL57 speaker stands, available in black or woodgrain @ £175.00 a pair.
New socks for ELS63s £38 pr. Many other spare parts available. Please ring.
"Classique Sounds servicing restores the Quads to a position where they can hold their head high", Jon Marks. HIFI WORLD. April 1999. Full servicing facilities available.

Troughline 3 tuner service & realignment £200.00. (excludes valves. Rarely needed).
One thing stereo decoder (back in stock) £175.00 Ex review Hifi world.

TRANSLUCENT. (somewhat of a bargain) Hifi World. Jan 1999
PURE SILVER INTERCONNECT CABLE

99.99% pure silver conductors. Quality gold plated RCA phono plugs.
Half Metre terminated £70.00 One metre terminated £90.00. Available with Eichmann plugs + £30
New Translucent ULTRA + Heavy duty. 99.99% pure silver (4N). Eichmann Solid silver plugs
£249.M Or £199.00 per half metre. 7 day money back guarantee if not better than existing cable

NEW 1.0MM 99.99% Pure silver wire @£15m. 0.5mm pure silver wire @ £6.00m
Translucent pure silver mains cable. 3 amp. £129.00 13 amp £249
One Thing Mains cables. Class 1 RFI suppressed. Silver plated conductors.
Voltage spike protection. only...£70.00.

NEW EAR/YOSIMINO EQUIPMENT

Ear 834P MM/MC phono stage with/without volume. Brand new. Bosed at only £615	
Ear 834P MM1 phono stage. No volume control. Brand new. Bosed at only £489	
Ear 834L Line only valve pre-amplifier. Amazing. Brand new. Bosed at only £549	

TEL. 0845 123 5137 (Calls charged at local rate anywhere in the UK)
Tel 0116 2835821 or 07802 213740 (Mobile). Callers by appt only.
Opening times 10.00am-6.00pm Mon-Friday. 10.00am-2.00pm Saturday.
61 Aylestone drive. Aylestone. Leicester. LE2 8QE. Email
classique_sounds@yahoo.co.uk

HEATHCOTE AUDIO

TEL: 01992 653999 MOBILE: 07860 511111 E-MAIL ADDRESS: HeathcoteAudio@aol.com

VALVE AMPS

MICHAELSON AUDIO CHRONOS 4 BOX. PRE AMP/PSU/2 MONOS.(VERY RARE WASE10K) MINT £4000
 AUDIO RESEARCH VT-50 POWER AMP BAL/SE EX DIS. AS NEW/BOXED £2750
 AUDIO RESEARCH V-70 POWER AMP BALANCED (£4500) MINT £1950
 AUDIO RESEARCH LS-22 PRE WITH REMOTE UPGRADE & RE-VALVE MINT/BOXED £2950
 AUDIO RESEARCH SP-14 PRE C/W PHONO STAGE (£4000) MINT £2295
 AUDIO RESEARCH LS-2 PRE AMP (MULLARD REVALVE) MINT/BOXED £1395
 CONRAD JOHNSON PREMIER 14 REMOTE CONTROL PRE AMP EXCLT. £1995
 QUAD QC.24 PRE & QUAD H40 MONOBLOCKS (RETAIL £4000 SUPERB) BOXED/AS NEW £2750
 LUMLEY REFERENCE PP-40 PRE & ST-40 POWER AMPS (CHROME) MINT/BOXED £995
 UNISON RESEARCH SMART 845 MONOBLOCKS MINT/BOXED £2350
 UNISON RESEARCH S-6 REMOTE INTEGRATED EX DEM MINT/BOXED £1275
 ART AUDIO QUINTET POWER AMP MINT £850
 VINTAGE RADIO RESTORATION ADUR MONOBLOCKS VGC £895
 GRANT G200 AMS LTD.EDITION 200 WATT MONOBLOCKS & G100P PRE AMP EXCLT. £2250
 LUMLEY REFERENCE LR-120 MONOBLOCKS (TRIODE SWITCHABLE) REVALVED MINT/BOXED £1650
 UNISON RESEARCH CSP PRE AMP WITH PHONO STAGE MINT £695
 MONRID ASTY VALVE PRE-AMP (VERY PRETTY) 3 MONTHS OLD MINT/BOXED £375
 EAR 834P PHONO STAGE EX DEM/BOXED £350

SOLID STATE

AUDIO SYNTHESIS PASSION 8M BALANCED/SE/REMOTE MINT £995
 CONRAD JOHNSON EF-1 PRE AMP (GOLD) MINT/BOXED £895
 MARANTZ SC-22 PRE & MA-22 MONOBLOCKS MINT/BOXED £1250
 PINK TRIANGLE INTEGRAL (NEW PRICE £3995) AS NEW/BOXED £2995
 COPLAND CSA-28 REMOTE INTEGRATED C/W PHONO STAGE & REMOTE MINT £795
 CAIRN 4808 REMOTE INTEGRATED MINT £375
 TALK CYCLONE-1 REMOTE INTEGRATED EX DIS/PAI EXCLT. £1375
 TOCA SECA 20 WATT CLASS A AMP MARBLE FRONT VERY RARE /GOOD AS NEW £375
 REGA CURA REMOTE PRE AMP MINT £550
 PIONEER M-90 POWER AMP WITH VOLUME CONTROL/3 INPUTS MINT £695
 PIONEER ELITE VSX-95 AUDIO/VIDEO RECEIVER PIANO BLACK/SIDE CHECKS MINT £695

CD

TECHNICS SL-Z1000/SH-X1000 FLAGSHIP TRANSPORT & DAC (GOLD/WALNUT) BDXED £2450
 THETA PEARL TRANSPORT/DS PRO BASIC-11 DAC MINT/BOXED £2250
 THETA PEARL TRANSPORT/DS PRO PROGENY DAC MINT/BOXED £1250
 PINK TRIANGLE CARDINAL/ORDINAL 22 BIT/RELOCKING CABLES ETC. MINT/BOXED £1175
 ACCUPHASE DP-80 TRANSPORT EXCLT/BOXED £1750
 ESOTERIC TEAC P-1 TRANSPORT EXCLT/BOXED £995
 ROKSAN ROK-1 TRANSPORT WITH POWER SUPPLY UPGRADE MINT/BOXED £650
 DPA T-1 TRANSPORT (WITH DELTRAN) MINT/BOXED £495
 ORELLE CD107 TRANSPORT MINT/BOXED £395
 COUNTERPOINT DA-11E TRANSPORT EXCLT £595
 THETA DS PRO GEN III (AT&T, COAX, ETC.) WAS £6000 APPROX EXCLT/BOXED £2395
 THETA DSPr GEN III (PRE-AMP/DAC) EXCLT/BOXED £2295
 OPA PDM-1 MKIII 2 BOX DAC (WITH DELTRAN) MINT/BOXED £595
 OPA ENLIGHTENMENT DAC (WITH DELTRAN) MINT/BOXED £350
 AUDIONOTE DAC-1X SIGNATURE AS NEW/BOXED £650
 MONRID 18B DAC & SEPERATE PSU MINT £675
 TECHNICS SL-P 2000 REF.CO PLAYER MINT £795
 TEAC VRDS 25 MINT/BOXED £650
 SONY XA-50ES CHAMPAYNE GOLD MINT/BOXED £495
 PIONEER PD-91 AS NEW/BOXED £375
 TALK THUNDER-1 EX DISPLAY/NEW EXCLT £175
 TECHNICS SL9 900 NEW/BOXED £145
 AMC CD6A(BALANCED&PHONO OUTPUTS)

VINYL

NOTTINGHAM ANALOGUE STUDIO MENTOR REFERENCE & MATCHING ARM MINT £3250
 DRACLE DELPHI (BONDED PLATTER ETC) MINT £995
 REGA PLANNER-3/ARM/BIAS CARTRIDGE EX DEM BOXED £195
 SYSTEMDECK BDXED/VGC £195
 ARISTON Q DECK-11 MINT/BOXED £149
 GRAHAM 1.5 TONEARM GOLD VERSION WITH SIL WIRED EXT BOX AS NEW/BOXED £250
 DECCA LONDON INTERNATIONAL ARM (NEW UNUSED BOXED) BRAND NEW/BOXED £450
 SME 3009 UPGRADED AND OVERHAULLED BY SME UNUSED SINCE BRAND NEW BDXED £450
 LEHMAN BLACK CUBE SE EX DIS/BOXED £550
 HEED AUDIO QUAZAR PHONO STAGE & SEPERATE PSU MINT/BOXED £350
 McCORMACK PHONO STAGE MINT/BOXED £250
 EAR 834P PHONO STAGE NEW £25
 TALK BREEZE PHONO STAGE MM/MC EX DISPLAY
 NAO PP-1 PHONO STAGE

LOUDSPEAKERS

WILSON SYSTEM 5.1 PAWS/TAILS ETC PIANO BLACK MINT/CRATED £7500
 KLIPSCHORN CORNER K-HORNS BIRDS EYE MAPLE FABULOUS 104 OB MINT £4250
 B & W SILVER SIGNATURE, EXT X-OVER & SLATE STANDS/CABLES (£4500+) MINT £2350
 B&W 801 MATRIX LOUDSPEAKERS SOUND ANCHOR STANDS / EO.BOXES (COST £7000+) MINT/BOXES £2750
 SONUS FABER ELECTA S EXCLT £995
 BKS 107 MK11 SUPREME EX.DEM MINT/BOXED £1375
 AUDIONOTE ANK/SPX SILVER WIRED MINT/BOXED £575
 INFINITY KAPPA-8 REFERENCE MINT £1450
 SNELL C MK-IV AMERICAN OAK VERY RARE/GOOD EXCLT £1500
 PRODAC STUDIO 150 FLOORSTANDERS (CHERRY) SUPERB MINT £1050
 ALR JORDAN NOTE-5 SPECIAL BOBINGA WOOD FINISH EX DISPLAY/AS NEW BDXED £1195
 ROGERS STUDIO-7 EXCLT/BOXED £395
 EPDS ES-11 MINT/BOXED £375
 DYNAUDIO AUDIENCE 80 (CHERRYWOOD FINISH) AS/NEW £1000
 ROKSAN OJAN 3X & OJAN 3S SUBWOOFER SYSTEM (ROSEWOOD) RARE/SUPERB MINT/BOXED £1350
 IMF PROFESSIONAL MONITOR VII RING RING £1500
 CELESTION A-2 HUGELY CAPABLE (ROSEWOOD VENEER) BRAND NEW/BOXED £1250
 TANNY ARUNDEL 15"3839 HIGH POWER DRIVERS 95 DB SENSITIVE VERY RARE MINT £250
 SD DBS FLOORSTANDERS(OPEN BAFFLE) SMALLER BROTHER TO SD1 MINT £1500
 CASTLE HOWARD-2 PREMIUM BEECH FINISH BDXED £495
 CASTLE AVON FLOORSTANDERS MINT £795
 MINT £450

IPL ACOUSTICS TRANSMISSION LINE VGC £350
 MORBANT SHORT 902S SIGNATURE BRAND NEW/BOXED £295
 B&W 601 SERIES-2 £125
 CELESTION DITTON 25 VERY NICE ONE OWNER PAIR £150
 REL STORM ACTIVE SUBWOOFER EXCLT £550
 BOSE 901 MKIV (RECENT £700 SERVICE) BOXED £695

TUNERS /TAPE/DAT/MINIOISC/MISC

NAKAMICHI DRAGON JUST SERVICED MINT RING £250
 NAKAMICHI DR-3 (VERY LITTLE USE) MINT/BOXED £250
 PIONEER CT-91 REFERENCE CASSETTE DECK VGC £250
 SONY JA-30ES MINIOISC (CHAMPAYNE GOLD) MINT £375
 AUDIO RESEARCH BAL-1 BALANCED/PHONO CONVERTER MINT £375
 TALK LIGHTNING 1.1 TUNER EX DIS. AS NEW/BOXED TBA

RACKS/STANDS

SOUNDSTYLE ST-105/AQUA GLASS (NEW MODEL £3997) EX DIS/BOXED/AS NEW £275
 SOUNDSTYLE XS 105 5 SHELF BLACK OR SILVER (£320) EX DIS. £195
 SOUNDSTYLE XS 310 AV TABLE (£320) EX.DIS £195
 SOUNDSTYLE XS 105 5 SHELF CANCELLED ORDER 1 OFF BRAND NEW BOXED £245
 SOUNDSTYLE XS 100 4 SHELF CANCELLED ORDER 2 OFF BRAND NEW BOXED £195
 SOUNDSTYLE XS 250 CD STORAGE RACK CANCELLED ORDER 2 OFF BRAND NEW BOXED £150
 ATTACAMA R724/ATTABITE (WAS £250) VGC £95
 B&W STANDS FOR CD-INT SILVER/BLACK MINT £75
 TARGET 24 INCH STANDS EX DIS/AS NEW £250
 TARGET R-2

SPECIAL OFFER

BLACK RHODIUM S-130X2 BI-WIRE LOUDSPEAKER CABLE BRAND NEW LTD QUANTITY £10 PER METRE
BLACK RHODIUM S-300 BI WIRE LOUDSPEAKER CABLE BRAND NEW LTD QUANTITY £25 PER METRE

MAINS CABLES/BLOCKS/CONDITIONERS ETC

BLACK RHODIUM 8 WAY MAINS BLOCKS (CANCELLED ORDER) BRAND NEW £225
 BLACK RHODIUM 25 MAINS CABLE (BLACK CLOTH BRAID) BRAND NEW £65
 DPA 'THE POWER' MAINS FILTERS £75

CABLES

LOUDSPEAKER CABLE
 NORDOST SPM REFERENCE 2.5 METRE PAIR TERMINATED (AS NEW BOXED) £1450
 VAN DEN HUL REVELATION 2 METRE STEREO PAIR TERMINATED £600
 VAN DEN HUL REVELATION 1.5 METRE STEREO PAIR TERMINATED £375
 MIT MH-750 12 FT PAIR £850
 MIT MH-750 8 FT PAIR £650
 MIT TERMINATOR 6 3.3 METRE PAIR (NEW) £225
 NIRVANA AUDIO SL-SERIES 2.5 METRE PAIR EX DEM. FACTORY TERMINATED £75
 TRANSPARENT WAVE 200 2 METRE PAIR £175
 CARDAS HEXLINK 2 METRE PAIR (FACTORY TERMINATED) £275
 AUDIONOTE AN-L 4 METRE PAIR (FACTORY TERMINATED) £375
 DED GENESIS SILVER SPIRAL 4 X 1.5 METRE TERMINATED £225
 VANDEN HUL MC CS 122 2 X 3 METRE PAIR (EACH) £75
 AUDIOQUEST CRYSTAL HYPERLITZ 2 METRE BI-WIRE TERMINATED £75
 AUDIOQUEST INDIGO 3 METRE PAIR £50
 AUDIOQUEST TYPE 4 CABLE 4 METRE PAIR £25
 VAN DEN HUL TEATRACK BI-WIRE 5 METRE PAIR (TERMINATED) EX DIS £150
 CABLE TALK CONCERT BI-WIRE 5 METRE PAIR (TERMINATED) NEW £100

INTERCONNECT

ACOUSTIC ZEN SILVER REFERENCE 1.5 METRE PHONO EX DEM £795
 ACOUSTIC ZEN SILVER REFERENCE 0.5 METRE PHONO EX DEM £350
 ACOUSTIC ZEN SILVER REFERENCE 11 0.5 METRE £375
 HARMONIC TECH MAGIC LINK ONE 1 METRE EX DEM £650
 ACOUSTIC ZEN MATRIX REFERENCE 1METRE PHONO EX DIS. £350
 BLACK RHODIUM REQUIEM-2 NORMALLY £1750/METRE LTD QUANTITY BRAND NEW BOXED RING £400
 BLACK RHODIUM DRATORIA 1 METRE BRAND NEW PACKAGED £275
 BLACK RHODIUM DRATORIA 0.5 METRE BRAND NEW PACKAGED £275
 BLACK RHODIUM SYMPHONY 1 METRE (SEVERAL) CANCELLED ORDER BRAND NEW PACKAGED £65
 BLACK RHODIUM SYMPHONY 0.5 METRE (3 OFF) BRAND NEW PACKAGED £100/150
 VAN DEN HUL INTEGRATION 0.6/0.8 METRE (2 OFF) BOXED £300
 VAN DEN HUL SECOND 2 METRE BALANCED BOXED £350
 VAN DEN HUL SECOND 2.5 METRE BALANCED BOXED £350
 SONIC LINK VOICES 1 METRE EX DEM £75
 AUDIOQUEST DIAMOND 2 X 2 METRE PAIRS (MINT) EACH £550
 AUDIOQUEST LAPIS 5 METRE PAIR £650
 AUDIOQUEST TURQUOISE 2 X 2 METRE PAIRS (MINT) EACH £35
 YFERA 1.5 METRE PAIR £60
 NORDOST BLUE ANGEL 1.5 METRE PAIR BRAND NEW PACKAGED £100
 NORDOST BLUE ANGEL 0.5 METRE PAIR £65
 NORDOST BLUE ANGEL 1.0 METRE 5 PIN DIN TO PHONO'S £75
 LFD.4 FEET PAIR £50

DIGITAL

MADRIGAL AES/EBU 0.5 METRE £150
 NIRVANA DIGITAL COAX LEAD 4 FT. £200
 VAN DEN HUL FIRST 0.8 METRE BRAND NEW PACKAGED £100
 VAN DEN HUL D-102 MK.111 HB. 4 FEET EX DISPLAY/NEW £40
 CABLE TALK DIGITAL -3 (BRAND NEW PACKAGED) £50
 REGA DIGITAL INTERCONNECT 1 METRE (NEUTRIK PHONO'S) £30
 VAN DEN HUL AES/EBU £40
 AUDIOQUEST OPTLINK X TOSLINK £40

MOST EQUIPMENT STOCKED IS ONE OWNER MINT/BOXED, SIMILAR QUALITY VINTAGE AND MODERN EQUIPMENT REQUIRED FOR IMMEDIATE CASH PURCHASE. PLEASE PHONE GEORGE 10-6PM

Are you making the right connections?

Send for Britain's biggest catalogue of specialist cable and connections.

All available by mail order.

Phone 020-8942 9124 or clip the coupon for your Free copy
www.custom-cable.co.uk

CUSTOM CABLE SERVICE

PO Box 4007, London SW17 8XG

Please send me your FREE Custom Cable Catalogue

Name _____

Address _____

Postcode _____

NO FURTHER INFORMATION REQUIRED

Send to: Custom Cable Service
 PO Box 4007
 London SW17 8XG

HFV 09/03



5 MINS FROM M25

MATRIX HI-FI

VALVE AMP
REPAIRS

RECORD DECKS

LINN SONDEK BASIC PLUS MAHOGANY
VPI JUNIOR+ RB300
ROKSAN XLRXES, SME CUT
AUDIONOTE TT1, ORIGIN LIVE RB300
THORENS TD160 no arm
THORENS TD150
PIONEER PL-A35
GARRAD 401, SME PLINTH + SME 3009

PRE-AMPS

FINISTRA TOM EVANS
BURMISTER GERMAN QUALITY BOXED
MERIDIAN MODULAR
RAPPAPOET
BALANCED AUDIO TECHNOLOGY VK31
GATE VALVE PRE NEW
HAFLER PRE
BEARD VALVE PRE P300A
DNM 2 BOX

POWER AMPLIFIERS

ROGERS CADET II CHASSIS WITH PRE
ROGERS CADET III No1
ROGERS CADET III No2
AUDIO NOTE CONQUEROR 300B STEREO
AUDION STERLING EL34 STEREO CHROME
AUDION GOLDEN KNIGHT MONO BLOCS
EARLY BOXED, MINT IN SILVER
ROGERS HGG 88MK III
ROGERS CADET III VGC
ROGERS CADET III CHASSIS PRE + POWER
ROGERS RAVENSBROOK
ROGERS CADET II CHASSIS WITH PRE
ROGERS CADET III No1
ROGERS CADET III No2

EPHONE
ROGERS JUNIOR EL84 1X0 PUT X1MR SWAP
ROGERS MASTER EXCELLENT
ROGERS MASTER WORKS FINE
LEAK STEREO 20 VGC
LEAK STEREO 50
QUAD 303
GATES 300B PUSH PULL SILE WEB
EL34 AMP CHROME UNUSUAL (BEARD)
UNISON RESEARCH S6 IMMACULATE
VECTEUR CLASS A
ARION ELECTRA
SHANGLING POWER AMPS (SEE WEB SITE)

TUNERS, CASSETTE DECKS ETC.

YAMAHA KX480 CASSETTE DECK £80.00
YAMAHA KX500 CASSETTE DECK £85.00
YAMAHA CT710 TUNER £45.00
MISSION CYRUS FM7 TUNER £175.00

CD/HDCD/SACD/DVD PLAYERS

MARK LEVINSON DIGITAL PROCESSOR No. 35 WITH HDCD UPGRADE AWESOME £1,799.00
HILIOS CD2 £699.00
MARANTZ CD94 £349.00
CALIFORNIA AUDIO LABS TUBE ANALOGUE PROCESSOR DAC £450.00
SHANGLING CD T100 HDCD (SEE WEB SITE) £1,650.00
SHANGLING SCD T200 SACD (SEE WEB SITE) £2,150.00
PHILIPS DVD 6125 NEW £115.00

SPEAKERS

AUDIO NOTE ANK B MAHOGANY £399.00
AUDIO NOTE ANJ TEAK £599.00
LINN KANN'S NEW CHERRY £299.00
LINN KANN STANDS BLACK £85.00
SNELL JS III MAHOGANY £530.00
CELESTION A1 BLACK ASH £399.00
REGA ELA BLACK £299.00



NEW HIGH QUALITY HIFI ● VINTAGE HIFI FOR SALE AND WANTED

● DEM ROOM AVAILABLE THREE MONTHS WARRANTY ON ALL USED HIFI *

SEE OUR WEB SITE FOR THE LATEST STOCK

SHOWROOM

SHANGLING, MICHELLE, CELESTION, QED, AUDIOQUEST, SOUNDSTYLE, ETC...

65 DARENTH ROAD

NEW AND VINTAGE VALVES - INTERCONNECTS & SPEAKER - OFC & SILVER

DARTFORD

PHONE : (01322) 281700/292391 FAX: (01322) 229908

E-MAIL: info@matrixhi-fi.co.uk WEB: www.matrixhifi.co.uk

FREE EASY PARKING

KENT DA1 1LU

Origin Live Recreating the Original Sound

www.originlive.com



KIT TURNTABLES

"...this vinyl front end had my jaw heading towards the floor with the solidity and transparency of the music it was making...Overall a deeply impressive deck...brilliant value for money... component quality is superb and the build process is a doodle."

"One of the most enjoyable and musically involving turntables I have ever heard regardless of make or reputation."

Now you can own a professionally built, high performance turntable at a fraction of the normal cost. All OL turntable kits are supplied in various forms:

-A Standard Kit of Parts to enable you to build your own plinth at **£282**

-The Complete Non-suspended Standard Kit offered with a pre-drilled & finished plinth at **£349**

-The Complete Ultra Kit comes in two options. The Ultra Kit Classic offering a truly high end suspended sub-chassis turntable with beautifully finished solid wood plinth.

The Ultra Kit Modern offers the performance of the Ultra Kit Classic combined with the modern day skeletal styling.

Both options available at **£538**



TURBOCHARGING YOUR REGA ARM

"Nothing less than total dynamite"

If you are the proud owner of any Rega tonearm, you are now in the enviable position to transform its performance into the league of super arms with our modifications. The OL structural modification at £75 will enable your Rega to perform at a level exceeding that of arms costing over £1500!! High performance rewiring with high grade litz wire is also offered at an additional £70 and external rewiring is also £70 further increasing the performance.

"I have to say the Rega modifications turn this humble arm into a real giant killer. Gone is the rather grey, sterile sound of the cooking Rega. Instead, tonal colour is fresh, dynamics have great speed and impact, and the sound stage is huge."

Structural Modification - **£75**
Internal Rewiring - **£70**
External Rewiring - **£70**

For arm modifications we normally return your arm within 2 - 3 days



UNIVERSAL TURNTABLE MOTOR KIT

"It's value is nothing short of tremendous."

"The single most important upgrade you can ever make to any record deck concerns the motor drive...nothing can prepare you for the shock of going DC. In a word, gobsmacking."

"...if you are thinking of upgrading your system... the OL DC Motor Kit should be high on your list for consideration."

Whatever your current turntable, the results in upgrading to our DC motor & PS unit are simply astounding. Designed as a drop in replacement for almost all turntables, the OL upgrade kit offers vast improvements to all versions of Linn, as well as: Rega, Systemdeck, Roksan, Rock, Oracle, Michelle, VPI, Clearaudio, Acoustic Signature, etc. The kit consists of a high grade DC motor, aluminium electronic control box and offboard power supply. All this provides an extremely cost effective route to truly high-end audio and is significantly superior in performance to PS upgrades at three times the price.

OL Power Supply & Motor Kit - **£299**

Origin Live, Unit 5, 362b Spring Road, Sholing, Southampton, SO19 2PB, UK
Tel/Fax: +44 02380 57887 www.originlive.com email: originlive@originlive.com

Sound & Music

93-95 Nantwich Rd., Crewe, Cheshire.
Telephone : 01270 214143

- Arcam CD72 - CD Player (SH) - £300
- Audiolab 8000 S - Integrated Amplifier (SH) - £450
- Audiolab 8000 M - Monoblock Power Amplifiers (SH) - £750 Pair
- B&W P5 - Speakers (SH) - £550
- Castle Pembroke - Speakers (Walnut/XD) - £300
- Castle Howard - Speakers (Oak/XD) - £950
- Epos ES14 - Speakers & Stands (SH) - £275
- Harman Kardon 4500 - AV Receiver (XD) - £450
- Infinity Kappa 400 - Speakers (XD) - £500
- JBL TIK 6 - Speakers (Beech/XD) - £1200
- Linn Classik Movie System (XD) - £1500
- Linn Mimik - CD Player (SH) - £275
- Linn Kairn Pro - Preamp/Amplifier (XD) - £600
- Linn Collector - Preamp/Amplifier (XD) - £275
- Linn 5125 - 5 Channel Power Amplifier (XD) - £1350
- Linn 2250 - Power Amplifiers (XD) 2 For Sale At £1650 Each
- Linn Ninka - Speakers (Maple/SH) - £650
- Linn Keleith - Speakers (Black/SH) - £300
- Linn Trikan - Centre Speaker (XD) - £350
- Linn Sizmik Maple - Sub (XD) - £650
- Meridian M33 - Active Speakers (XD) - £1100 Pair
- Meridian 505 - Mono Power Amplifiers (XD) - £650 Each
- Meridian D2500 - Digital Subwoofer (XD) - £1500
- Monitor Audio GR20 - Speakers (Beech/XD) - £1200
- Musical Fidelity "The Preamp" (SH) - £350
- Musical Fidelity Typhoon - Power Amplifier (SH) - £250
- Musical Fidelity XP100 - Pre-Amplifier (SH) - £400
- NAD T752 - Receiver (XD) - £475
- Onkyo DR90 - DVD Receiver (XD) - £250
- Quad 21L - Speakers (Maple/XD)
- Roksan Casplan - Four Channel Amplifier (XD) - £650
- Rotel RB 985 - Five Channel Amplifier (SH) - £450
- Tannoy Eyril 3 - Speakers (Maple/XD) - £650
- Tannoy Eyril 1 - Speakers (Rosewood/XD) - £300
- Wharfedale EVO 10 Speakers (Maple/XD) - £250

Agencies Include : Linn, Musical Fidelity, S.M.E., Origin Live, Monitor Audio, Castle, Quad, Wharfedale, Harman Kardon, Creek, Meridian, Tannoy, Infinity, Loewe, Sanyo, Ortofon, VDH, JBL, Pro-ject, Roksan, QED, Cable Talk, Michell, Arcam, Trichord, PMC,



We buy, sell & part exchange quality Hi-fi

- | | | |
|--|--|---|
| <p>AMPLIFIERS / RECEIVERS</p> <ul style="list-style-type: none"> Sony STRDB930 Dolby Digital amp .£265 Marantz PM 7200 Champagne .£275 Audio Research D70 Valve Monster .£1095 Hafter 220 MonoPower amp*2 .£295 Musical Fidelity E10 .£135 Linn Nebula New Zealand's finest ! .£175 Technics SUMA10 .£375 Revox B740 Power amp .£495 ElectroCompanion 1980's power amp .£475 Musical Fidelity XA1 .£325 Denon AVR 1601 .£175 Quad 33/303 pre/power amp .£195 Pioneer 8100 great 1970's amp .£145 Alchemint Axion amp .£220 Mode Audio M100B monoblocks .£245 Cyrus straight line .£165 Rotel RC970BX/RB981BX Pre/Power .£345 NAD C270 power amp .£325 Cyrus 3 plus RVC .£245 Arcam Alpha 7 integrated .£175 Audiolab 8000C preamp .£275 Renwood KA3020 .£95 Audiolab 8000 P black .£445 Technics SUW85big integrated amp .£175 NAD 3030 1970s Silver .£115 Makamichi 630 Preceiver .£155 Beard P35 Power Amp .£545 Quad 405 and 405-2 .£195/225 | <p>CD PLAYERS</p> <p>TRANSPORTS & DACS</p> <ul style="list-style-type: none"> Mission DA05/DACS .£145 Micromega Stage 1 .£175 Sony CDPXB930E as new .£145 Linn Mimik / Numerik CD/DAC .£895 Pioneer PD5801 .£125 Rotel RCD965BX .£375 Marantz CD6000 0 SE .£170 Aura AYC50 piano black .£145 Marantz CD067 mk2 SE .£185 Musical Fidelity CD2 .£145 Pioneer PDS901 .£145 Aura AYC50 .£125 Sony SCD-BB940 SACD as new .£245 Technics SLPG999 .£195 <p>TUNERS</p> <ul style="list-style-type: none"> Musical Fidelity T1 .£125 Denon TU260L/MK2 .£80 Sony STS SE570 Tuner .£75 Quad FH2 Valve .£145 Rotel RT1024 Silver classic .£245 Rogers 175 English classic .£75 <p>TURNTABLES</p> <ul style="list-style-type: none"> Systemdek IIX .£225 AR EB101 black .£125 Thorens TD160 Super / Mission 774 .£195 Rega Planar 2 .£125 | <p>Logic turntable with Linn baikk .£145</p> <p>Rotel RQ970 BX Phono equaliser .£120</p> <p>SPEAKERS</p> <ul style="list-style-type: none"> Acoustical Alliance .£395 Acoustic Energy AE2 8stands .£495 Technics SBH300 .£175 Stirling LS375a mint .£445 Linn Ninka .£545 Musical Technology Harriers .£195 Linn Kelfidh(pastive) .£495 Monitor Audio monitor3 gold .£245 Epos ES22 .£545 Ref RDM3 Cherry .£875 Rogers LS2 and LS4 .£95/165 Mission 753c black .£295 Monitor Audio MA14 black .£195 Rogers DB101 blue .£145 Acoustic Energy AE109 .£275 <p>CASSETTES</p> <ul style="list-style-type: none"> Nakamichi S82 .£175 Tascam 238 reel to reel .£275 Nakamichi 8X300 .£250 <p>SYSTEMS</p> <ul style="list-style-type: none"> Yamaha O2031 2*31 band EQ .£195 Technics SH8058 .£95 <p>SYSTEMS/MISCELLANEOUS</p> <ul style="list-style-type: none"> Technics SCCHD550 .£315 Bose Lifestyle 30 .£1095 Bang & Olufsen Beo .£575 Toshiba TLPS60LCD projector .£1045 |
|--|--|---|

Please call us if you have any equipment to sell or are looking for anything in particular. New stock daily
All equipment is fully tested and guaranteed

Also: Music CDs, Games, Musical Equipment, Computers, TV, VCR & Photographic

Web page: www.xelectrical.com email: x@xelectrical.com
125 King Street Hammersmith 020 - 8563 7383
4 Station Bldgs Fife Road Kingston 020 - 8546 1233
Games & CDs upstairs at Kingston 020 - 8546 4442
43 Church Street Croydon 020 - 8680 0007

CLASSIQUE SOUNDS.(LEICESTER) INC ONE THING.

VINTAGE HIFI & VALVE SPECIALIST TEL 0845 123 5137 (local rate)(UK Only)

WANTED Vintage and modern hifi eqp Part exchange welcome.

FOR SALE PRE/POWER AMPLIFIERS

- | | |
|---|--|
| Tube Technology Seer valve line preamp. Mint. Bxd. £495 | Croft super Micro 2 valve pre amplifier. £295 |
| Unison Research Unico i amplifier. 3 months old. £650 | Marantz PM66SE K1 signature integrated amplifier £199 |
| Pair Leak TL12 + valve amps Grey. Rebuilt by me. £599 | Crimson Elektrik 510/520 pre/power amplifier. Bxd. £249 |
| Audio Innovations L1 valve pre amplifier. Boxed. £200 | Sugden AU51 power amplifier. Boxed. £650 |
| Tube Technology Unisis valve pwr amp. Mint bxd £995 | Heathkit MA12 Mono valve power amplifier. £150 |
| Magnum A.100 2 X huge mono power amplifiers. 350 watts output. Excellent condition. Cost around £2000 | CR Developments Carmenta Line valve pre-amp. £450 |
| Hart 1100RSA integrated amplifier. 80W Superb. £375 | Harmon Kardon HK1400 line amplifier. Mint/boxed £199 |
| Sugden A25 amplifier. Excellent condition & instr £200 | Naim NAC 92 pre amp. SNO 161840. Mint. Boxed £299 |
| Meridian Modular pre/power amplifier. Ex cond. £249 | Magnum MP.125 pre amplifier with MM/MC. £250 |
| Quad 77 integrated amplifier. Mint. Boxed. Instr. £399 | Quad 77 remote control for amplifier etc. Cost £300 £149 |
| Musical Fidelity B1 integrated amplifier. Good cond £125 | Naim Nait 3R integrated amp & remote. Mint. Bxd £495 |
| Linn LK1 pre-amp and remote. Good condition. £249 | Linn LK2 power amplifier. Good condition. £299 |
| Copland CTAS01 power amplifier. Valve. £1800 | £799 |
| Quad 11s in various condition and prices | EPOA Pioneer A400 integrated amplifier. Good cond. £125 |
| Leak Stereo 20 valve power amplifiers from..... £125 | Arcam Alpha 2 amplifier. Mint. Boxed/instr £95 |
| Quad 303 power amplifiers from..... £125 | Arcam Alpha 3 amplifier. Mint. Boxed/ Instructions £100 |
| Nakamichi CA5 pre-amplifier. Ex cond. Cost £750 £375 | Nakamichi PA5 100W/CH power amp. Cost £1300 £650 |
| NVA A80 mono power amplifiers X 2. Good cond £799 | NVA A60 stereo power amplifier. Good condition. £295 |
| AVI S2000 MI int amp & remote. Cost £999. Mint £549 | Linn LK100 power amplifier. Excellent condition. £395 |
| Musical Fidelity Pre-8 pre-amplifier. Mint. Boxed £150 | Arcam Alpha 3 amplifier. Mint. Boxed/ Instructions £100 |
| Arcam Zeta 1 Pro logic Cinema amp. Cost £999.00 £450 | Quad 33 pre amplifiers. From..... £75 |

TURNTABLES

- | | |
|--|--|
| Garrard 401 with SME 3009 arm. £295 | Thorens TD125 with thorens tone arm. £125 |
| Transcriptors Hydraulic reference/Decca arm. Mint £800 | Project 1 record deck. Excellent condition. Boxed £95 |
| Dual CS05-2 turntable. Mint condition. Boxed £89 | Garrard 301/401 chassis in various condition from £125 |
| Dual 505/4 record deck. Good condition/instr £100 | Trio KD550. Direct drive turntable. £95 |

SPEAKERS

- | | |
|---|---|
| Quad ESL57 speakers. All fully serviced with full 3 months warranty. Hear what ESL57s should sound like From £900 pr | Quad ESL57. Bronze pair. £550 |
| Tannoy Lancaster corner units. 12 in Monitor golds. EPOA | Roksan ROK-ONE speakers. Black. Mint. Boxed. £295 |
| Roksan ROK-ONE speakers. Black. Mint. Boxed. £295 | Mission 773 floor standers. Mint/boxed. Half price £199 |
| JPW active subwoofer. Mint/boxed/instructions £160 | SD Acoustics SD3 loudspeakers. Piano finish £275 |
| Heybrook Heyloins. Black. Boxed. Ex condition £199 | Celestion SL600 speakers. Good condition. Bi wire £375 |
| Rega EL8 floorstanding speakers. black ash. Boxed £149 | Quad 3 loudspeakers. Ex cond. Rosewood. Boxed £450 |
| Tannoy Chatsworth with 12 inch monitor golds. £169 | Mordant Short MS201 pearl. Brand new. Black £85 |
| Castle Kendall speakers. Good condition. £69 | B&W DM4 speakers. Black finish £85 |
| Pair Quad ESL57 spkrs. Fully rebuilt. le 4 Recon bass & 2 recon treble units. All new electronics. 12m warranty £1199 | Kef C20 Bookshelf monitor speakers in black £60 |
| Magneplaner MG 1.4 . Boxed with £400 oak stands £999 | |

OTHER ITEMS

- | | |
|--|---|
| Musical Fidelity X-Flora FM tuner. Boxed/ remote £350 | Marantz CD50 Cd player. Ex condition. £79 |
| Restek Concrete CD player. Top Loader. Mint. Boxed. £995 | Decca London international tone arm. New. Boxed. £175 |
| Arcam Delta 1703 CD Transport. Mint. Boxed. £800 | £399 |
| SME 3009 tonearms from..... £125 | Rotel 950 CD player. Ex cond. Boxed. £100 |
| Syrinx PU2 tone arm in gold finish. £199 | GEC PX4 valve. Brand new. £100 |
| Quad 77 RDS FM tuner. Mint. Boxed. Instructions £399 | Nakamichi CDP 2E CD player. Ex condition. £250 |
| Electri21 tuner. Wooden case. Beautiful. £95 | Cogan Hall loudspeaker cable. 1.5 metre pair. £150 |
| Naim 42.5 pre amp. MM boards fitted. £125 | Phillips 101 top loading cd player. Collectable. £125 |
| Marantz SD275 twin cassette deck. Dolby B/C £49 | Technics SL-PG40A Mash CD player/remote. £75 |
| Aiwa AD-S750 Dolby B-C-SHX pro cassette deck £75 | Technics SL-PS620A CD player/remote. £75 |
| Linn Tuner. Mint. Boxed. Very unusual. Cost £549 | £249 |
| Arcam Alpha 5 cd player. Mint. Boxed/remote £195 | Marantz CD63 top loader cd player. Collectable. £125 |
| Avantic Beam Echo valve tuner. BM611. AM/FM £149 | Trio KT8801. synthesiser tuner. AM/FM. Black. £75 |

QUAD ESL57 & ELS63 PANELS/ SERVICING ETC

NEW- B&W DM70 Electrostatic panels now undertaken. Price for one panel is £150.00
Reconditioned Quad ESL57 speakers from only £800.00. pr. Why spend £4000+? Have your ESL57 SPEAKERS STANDARD SERVICE £375.PR. Ring for info.

Exchange/ recon ESL57 bass panel £130. Treble £109. ESL63 panels £100 refurbished. ELS63/ESL57 speaker stands, available in black or woodgrain @ £175.00 a pair.

New socks for ELS63s £38 pr. Many other spare parts available. Please ring.

"Classique Sounds servicing restores the Quads to a position where they can hold their head high", Jon Marks. HIFI WORLD. April 1999. Full servicing facilities available.

Troughline 3 tuner service & realignment £200.00. (excludes valves. Rarely needed). One thing stereo decoder (back in stock) £175.00 Ex review Hifi world.

TRANSLUCENT. (somewhat of a bargain) Hifi World. Jan 1999

PURE SILVER INTERCONNECT CABLE
99.99% pure silver conductors. Quality gold plated RCA phono plugs.
Half Metre terminated £70.00 One metre terminated £90.00. Available with Eichmann plugs + £30
New. Translucent ULTRA + Heavy duty. 99.99% pure silver (4N). Fichmann Solid silver plugs £249.M Or £199.00 per half metre. 7 day money back guarantee if not better than existing cable

NEW 1.0MM 99.99% Pure silver wire @£15m 0.5mm pure silver wire @ £6.00m
Translucent pure silver mains cables. 3 amp. £129.00 13 amp £249
One Thing Mains cables. Class 1 RFI suppressed. Silver plated conductors.
Voltage spike protection. only...£70.00.

NEW EAR/YOSHINO EQUIPMENT

- | | |
|--|---|
| Ear 834P MM/MC phono stage with/without volume. Brand new. Boxed at only £615 | Ear 834P MM phono stage. No volume control. Brand new. Boxed at only £489 |
| Ear 834L Line only valve pre-amplifier. Amazing. Brand new. Boxed at only £549 | |

TEL. 0845 123 5137 (Calls charged at local rate anywhere in the UK)
Tel 0116 2835821 or 07802 213740 (Mobile). Callers by appt only.
Opening times 10.00am-6.00pm Mon-Friday. 10.00am-2.00pm Saturday.
61 Aylestone drive. Aylestone. Leicester. LE2 8QE. Email classique_sounds@yahoo.co.uk

THE EMPORIUM

Tel/Fax 01379 870873 email: emporium@despammed.com www.emporium.dicon.co.uk

"SEE WEBSITE FOR FULL LISTING"

CD & SACD & DACS

AUDIOMECA DAMNATION transport 450
 AUDIO NOTE DAC 2 black front 650
 AUDIO SYNTHESIS DAX 800
 AM 20 bit dac boxed 375
 COUNTERPOINT CD 11/10 transport/dac 20 BIT 1250
 CYRUS OAD 30 , new laser just fitted boxed 500
 DENISEN CD PLAYER beat 400 with gerno remote 900
 KRELL KPS20T transport 3000
 KRELL STUDIO DAC, boxed, good full sound 1000
 LECTOR CD PLAYER italian valve job, paper in oib etc 850
 LINN KABIR 3 825
 LINN KARU/NUMERIX old but nice & boxed 100
 MARANTZ CDA 94 dac excellent 350
 MERIDIAN 203 dac 150
 MERIDIAN 500 transport mk2, boxed 750
 MERIDIAN 200/263 TRANSPORT/DAC COMBO 1850
 MONARCHY 33da dac and pre in one, mint boxed 550
 NAIM CD3 3000
 NAKAMICHI DRAGON CD AND DAC3 box player, boxed 3400
 ORACLE CD transport 4500
 PINK TRIANGLE ORDINAL dac with 18 bit filter 4500
 PRIMAIRE 30.2 CD 1000
 PS AUDIO LAMBDA transport, with trichord dock 3, boxed 1000
 SHANLING CD T100 wonderful valv cd player, IN STOCK 1650
 SHANLING CD T200 as above but SACD player ex dem 1850
 SONY SCD 777s 2 channel 1250
 SUGDEN AUSTI DAC 375
 TEAC VRD510 cd player excellent 3000
 TEAC T117-D1 transport (dock 2) and dac 2750
 THETA GEN VA 2000
 THETA GEN V 2000
 TRICHORD PULSAR OME DAC hdcd & oscons 3000
 TUBE TECHNOLOGY FUSION VALVE CD PLAYER 700
 WADIA 12 DAC, balanced 600
 z-systems rdq-1, DIGITAL EQ, USE FOR SYSTEM CORRECTION, 2-systems rdq-1 digital eq and remote preamp 1650
VALVE AMPS
 AIR TIGHT ATK2 80 watt power amp 3000
 AUDIO INNOVATIONS 300 integrated mk1 BOXED 750
 AUDIO NOTE OTO SE with phono 250
 AUDIO RESEARCH CLASSIC 30 1050
 AUDIO RESEARCH CLASSIC 60 1500
 AUDIO RESEARCH Y160 1200
 AUDIO RESEARCH LS1 pre line level valve pre 600
 AUDIO RESEARCH LS7 boxed line level pre 700
 AUDIO RESEARCH LS8 mk1 line pre black front boxed 850
 AUDIO RESEARCH LS8 mk2 line pre black front boxed 1000
 AUDIO RESEARCH LS15 line pre with remote , silver front 1650
 AUDIO RESEARCH REFERENCE PHONO, black front, mint boxed, 2800
 AUDION STIRLING phono stage 350
 AUDION APOLLONIS, single ended lid edition 2800
 AUDION SILVER NIGHTS 1100
 BEARD p35 mk2 POWER AMP 450
 BEARD c35/p35 pre/poweramp combo 800
 BORDER PATROL 300B amp/mk1 1250
 CARY SLA70 power amp 700
 CONCORDANT EXCELSIOR pre with phono and valve psu 600
 CONCORDANT QUAD II MONOBLOCKS 500
 CONCORDANT EXULTANT PRE with phono and psu 550
 CONRAD JOHNSON PMA10AL boxed 450
 CONRAD JOHNSON PREMIER 7 pre, 2 box 2000
 CROFT EPOCH ELITE mahogany front, boxed 600
 CROFT SUPERMICO black, upgraded with stepped attenuator volume control 325
 CROFT SERIES N5 POWER AMP, JUST SERVICED , 650
 EAR V20 line level integrated 1400
 EAR 509 monoblocks mk1, just serviced excellent 1200
 GAMMA SPACE REFERENCE, 300B integrated amp, 1500
 GAMMA ENA REFERENCE special tweaked version 1500
 GAMMA AEDMS built, single ended 211 valves 17w boxed 2000
 HEART 300B stereo power amp 500
 LEAK STEREO 20 serviced 350
 LEAK TL121 pair POA 1600
 LUMLEY 120 MONOBLOCKS BLACK, BOXED AND BEAUTIFUL

PRICE
 LUXMAN amp much modified, 6550 output 800
 MELOS 333 two box pre line great dynamics,boxed 1000
 QUAD IS excellent resprayed pair with k666 VALVES 700
 QUAD IS special anniversary edition gold orig boxes etc 3250
 ROTHWELL power amp 450
 SHANLING MONOBLOCKS remote control volume, 50 watts 2000
 SONIC FRONTIERS SFH160 monoblocks 2500
 SONIC FRONTIERS SFS 40, power amp 800
 TRILOGY 901 preamp with phono, 375
 UMISON SIMPLY 4 integrated amp, boxed 800
 UMISON RESEARCH FEATHER ONE/POWER 35 pre/power, 1250
 VTL TINY TRIOE monoblocks, switchable between triode and untrilinear , lid edition, mint boxed 900 pair

LOUDSPEAKERS

ACOUSTIC ENERGY AE2 pair in textured black 500
 ALIANTE LINEA speakers, superb solid walnut standmounters 900
 ALTEC Voice of the Theatre ring for details 150
 ARCADIS speakers ak3 rosewood boxed, 750
 AUDIO CLASSICS type c excellent with valves 550
 AUDIO NOTE AM-1sp light oak, boxed 900
 AUDIO PHYSICS TEMPO orig version,black, with Essex dex 3400
 AYL pro 9 cherry , boxed 4500
 BMS 1076a MK2, granite ribbon hybrids, 1200
 CADENCE DS nice and efficient 600
 CARPRAE HORN, bag horns with latest eaf 8000
 CASTLE HARLECHS, near floorstanders 800
 CELLO SERAPHIMS active speakers, 4000
 DALI GRAND COUPE, rosewood 1000
 DALI GRAND DNYA floorstanders 1350
 DIAPASON ADAMANTIS mk2 with stands 1400
 DIAPASON KARIS boxed with stands 350
 EPOS ES11 black 900
 EPOS ES14 boxed with stands silver wired, 2000
 HALES COMCEPT S boxed, 600
 HEBBROOK QUARTETS with stands, 700
 INFINITY KAPPA 9i serious 1650
 JR 149 boxed with new loams excellent 2400
 REF q1 BOXED MINT with q30 subwoofer 1650
 REF REF 102 black, boxed 3000
 REF REF 2 m2a2 burr 250
 REF REF 2.2 black, boxed 750
 REF 105.4 pair 1050
 LINN KARBERS black passive with ku-stone stands 1500
 LINN KANS mk1 1200
 LINN KELLEDS, with ku-stone 800
 LUTHERY MAJAHORN , black, with pm6a 600
 MISSION 755 MINT BOXED 700
 NAIM CREDOS boxed CHERRY 850
 NAIM INTROS boxed, BLACK 390
 PROAC RESPONSE 1 Ext Moves 400
 PROAC RESPONSE 2 , 700
 QUAD ESL63 serviced by quad in 1200
 ROGERS STUDIO 1i 250 PAIR
 ROKSAN OJANS plain black finish 400
 RUARK CRUSADERS walnut boxed, 600
 RUARK ACCOLADES, walnut, boxed triwirable 1200
 SNELL E mk3 walnut boxed, the deans 550
 SONUS FABER ironwood stands adjustable 350
 TANNY SUPER RED MONITORS 600
 TANNY ARDENS reconed hpd 900
 TANNY c225, DUAL CONCENTRIC 10" AND ABR, glass tops nice 250
 TANNY cheviots MK1, Good pair serviced 450
 TANNY GRF cabinets repro pair in walnut with 15" golds 4000
 TDL studio 2 upgraded tweeters, rewired 350
 VIENNA ACOUSTICS BACH, beech 500

TUNERS, CASSETTE DECKS, REEL-TO-REEL

AMN GRS2 cassette 80
 ARCAM TS1 tuner black boxed 150
 AURA tuner TU-50, black 100
 CREEK T40 MK3 tuner boxed 120
 CYRUS FM7 250
 DEMON DMS 810 cassette 125
 LEAK THROUGHLINE III STEREO legendary tuner, serviced 120
 LEAK THROUGHLINE III with whistley valve decoder 300
 MERIDIAN 204 tuner 250
 NAIM NAT 03 tuner 400

NAKAMICHI BR125e cassette deck 800
 NAKAMICHI BR2 cassette deck, just serviced 1000
 NAKAMICHI DR2 cassette deck, mint boxed 700
 NAKAMICHI SR2 dual capstan 3 head nice machine 3250
 NAKAMICHI CDE with remote 450
 PIONEER F91 REFERENCE tuner 2000
 PIONEER CT91 REFERENCE cassette deck 2500
 PIONEER CT1000 cassette deck 375
 QUAD FM4 excellent 800
 QUAD FM4 brown with din socket 1250
 RATA PIONEER 900
 SENNHEISER HD590 headphones as new boxed 900
 SENNHEISER HD600 boxed 250
 SOUND DESIGN 5 shell stand black and cherry, 18 months old 500
 SUGDEN P51 silver tin tuner matches C51 pre-amp 900
 STAX LAMDA MOVA SIG/ SRM-T15 valve energizerboxed 900
 TEAC 6030 cassette dolby-S etc 350
 TECHNICS 9600 tuner, serious lamp 350
 z-systems rdq-1, DIGITAL EQ, 900

TRANSISTOR AMPS

ALCHEMIST GENESIS monoblocks, 700
 ARCAM ALPHA 10 integrated amp ,remote, boxed 400
 ARCAM RC pre/9p power remote control, 1200
 ARCAM ALPHA 9 integrated amp, 600
 AUDIO ANALOGUE DONIZETTI power amp 8000
 AUDIOLAB 8000A black 4000
 AUDIOLAB 8000M monoblocks, boxed 4000
 AUDIOLAB 8000M monoblocks upgraded to mx, boxed 900 pair
 AUDIOLAB 8000Q pre 1350
 AUDION platinum hybrid , valve/mosfet hybrid 1400
 AUDIO RESEARCH D130 transistor power amp, 900
 BOSE power amp, 250 watts mega lamp 350
 CARIN ARJA HE integrated with remote, boxed 300
 CARIN FAS NORD 100 watt remote integrated, boxed 2000
 CAMBRIDGE C200/S200 pre power 400
 COUNTERPOINT SA100 100 watt valve/mosfet hybrid 1500
 CREEK pre-p33 REMOTE boxed 375
 CRUSON 630 stereo power amp, 225
 CYRUS TWO scruffy 900
 CYRUS PSX, to go with TWO, with lever style on/off switch, 1100
 CYRUS STRAIGHTLINE WITH XPA power amp, boxed 450 pair
 CYRUS PRE/POWER & PSX-R with master controller 750
 DENON PDA 4400A monoblocks 400
 DMH 2 preamp, metal case but 3 boards, primus line level only 300
 DOLAN PM1 champagne fronted pre, adjustable phonostage 700
 EC AUDIO FINESTRA preamp, TOM EVANS, mm/mc 500
 GRYPHON KT 2 box pre with mm & new mc 2500
 HAFNER DH110/220 pre-POWER 600
 KRELL KPB 250MC mint monoblocks 390
 KRELL KPB 300B integrated amp 400
 KRELL KPB 300 stereo, gun metal finish 700
 KRELL KSA100 original giant sandline can 1200
 LECSON PRE AND POWER AP1 250 PAIR
 LFD L51 line preamp, 400
 LFD P40 power amp 600
 LHM LK100 1200
 LHM INTER integrated amp boxed 550
 LHM L1/R2 pre power, no remote, upgraded with ll280 boards 350
 LHM KARN PRO (line level) boxed 300
 LHM KARN with phono, boxed 600
 MARANTZ MA24 monoblocks, class A boxed 250
 MARANTZ PM17 MK2 class A integrated amp 4000
 MARANTZ SM 17 power amp, mint boxed 2 available 350
 MERIDIAN 201 with 60S monoblocks 500
 METANAS CHARISMA PREAMP, chrome finish 80
 MICHEL ALECTO STEREO, latest version boxed 150
 MOTH 100 WATT MONOBLOCKS, average condition only 150
 MUSICAL FIDELITY F22 preamp 100
 MUSICAL FIDELITY X-R2 integrated amp, mint boxed 100
 MUSICAL FIDELITY A100 50 watts sweet class A 120
 NAIM MAC 62/NAP 140 old style v good with cables 250
 NAIM 12 pre/nap 160 very old style 125
 PASS LABS 0 monoblocks class A single ended 75 watts 120
 PINK TRIANGLE PIP oak pre amp boxed 300
 PINK TRIANGLE PIP TWO pre mm and mc, one box , black 250
 PLUS18 8100 integrated amp line level 400

QUAD 33/303 boxed pair with manuals 200
 quad 33/m3 405 1 all nice with leads 330
 QUAD 34/306 with manual excellent 425
 QUAD 77 amp & cd player carbon, remote 800
 QUAD 33/405 MK1 100 watts of power 240
 REGA BR80 250
 REGA BR80 175
 ROWLAND CONSONANCE pre with mc boards and remote, black 1500
 SHI AUDIO CELESTE integrated amp, with phono 800
 TALX ELECTRONICS HURRICANE 2 power amp 300
 THRESHOLD GAS 2 100 watt power amp, boxed 500
 YAMAHA FZ200 professional 200 watts 350

TURNABLES, ARMS, CARTRIDGES

ARISTON RD80 with adc arm 200
 CLEARAUDIO REFERENCE turntable with tq1 ARM 2500
 CLEARAUDIO SIGNATURE moving coil cartridge 700
 CLEARAUDIO GAMMA mc cartridge 200
 CONRAD JOHNSON premier six MC HEAD AMP (novistor) 400
 DECCA LONDON BLUE excellent boxed 125
 100
 DYNATECTOR X00L moving coil, boxed 1750
 GARRARD 401 in APHELION PLINTH cherry 450
 GARRARD 301 in horcraft plinth with sme 3009 improved, clear cover 650
 GRAHAM SLEE PHONOSTAGES IN STOCK & AVAILABLE FOR HME DEMO 2500
 GROLBUG MR BARBAR just rebuilt by Ian den Hull,boxed 400
 GRYPHON PHONOSTAGE & HEAD AMP(6 boxes) 1750
 JBE SLATE DECK with infinity black window 2 arm 450
 KIMBER PBJ ARM LEAD TO FIT LHM/SME- suitable mc cartridges 75
 KRETTZ ARM,black, sa1100s mk2 new unused, boxed 700
 LFD MC2 phonostage 2000 700
 LHM LP12 valhalla with mission 774 and dynavector 400
 LHM LP12 valhalla/ MODIFIED REGA ARM 400
 LHM LP12 abromosa with valhalla, and akito 500
 LHM LP12 lingo/ took, troika 1150
 LHM TROKA decent condition 300 boxed
 LUXMAN pd131 direct drive/sme 3009 imp damaged lid but nice 200
 MICHEL GYRO SE & TECHNO available new decent trade in given 250
 ORIGIN LINE ARMS IN STOCK decent trade ins given 600
 ORIGIN LINE AURORA deck on dem 1450 with silver arm 200
 ORIGIN LINE RESOLUTION now on dem 350/500
 ORIGIN LINE MOTOR UPGRADES now in stock 150
 ORTFON KONTRAPUNKT A/B new boxed 150
 ORTFON MC300 MC2 j last rebuilt by V eddy 450 pair
 ORTFON T20 transformer 750
 PIERRE LUNIE J1 WITH SLS excellent 1400
 PIERRE LUNIE J1 WITH LST ARM 1800
 PROJECT R4M 4 with arm and cartridge, mint boxed 250
 REGA PLANAR 2 with rega cartridge 150
 REGA COUNTERWEIGHT MODIFICATION KIT in brass 50
 REGA ARM WITH full of docs, structural, int & ext wiring 275
 ROCK burntable, first Townsend version with rega arm 400
 ROCKPORT SIRIUS 2 with upgraded by Rockport arm 17000
 ROKSAN KEKRES, black, xps2 pm & ORIGIN LINE 4000
 SILVER ARM, ORTFON MC15 1000
 SME we 407 bearings, knife edge bearings, detach headshell, boxed 600
 SHURE V15 mtr in stock 300 new
 SONY HEAD AMP HASS de luxe job 200
 TRANSCRIPTOR SKELETON with vestigial arm 1000
 TRANSCRIPTOR HYDRAULIC REFERENCE, with sme 3009, 600
 VAN DEN HULL MC2 high output (2.5mV) very light hours 600
 VAN DEN HULL GRASSHOPPER GLA III, just serviced by V eddy 1000
 VAN DEN HULL GRASSHOPPER GHN III 11m output rebuilt by V eddy 1000
 VOYD the voyd, rosewood/ref bearing/platter, split phase audionote arm, boxed 1800
 WPI HW16S RECORD cleaning machine new/ex dem 450/420
 WPI JMW 9" arm special rega mount version 575

CABLES

AUDIOTECH ANVZ 1.5m interconnect 900
 CARDAS QUADLINK SC 1m pair phono 150
 CYRUS INTERCONNECT boxed 2 available 50
 JPS LABS CAPTIVATOR 2m power cord 600
 VAN DEN HULL Clearwater 3M power cables 80
 VAN DEN HULL MAGNUM 2.5M PAIR bananas 120
 VAN DEN HULL Clearwater 3M power bananas 80
 VAN DEN HULL MAGNUM 2.5M PAIR bananas 120
 EMPORNIUM our own cable, silver plated interconnects with gold phono plugs 35 pair
 EMPORNIUM also din to phono 35
 EMPORNIUM 4 PIN DIN TO 4 PIN DIN for quad 35
 EMPORNIUM ARM cable to fit sme/ron 1.6m 75

www.soundexpensive.com

Hi-Fi & Audio Consultants, Sales and Service

Buy What Hi Fi's Award winners at the cheapest prices!

cartridges

denon
dnm
goldring
lyra
ortofon
sumiko

cables

chord company
dnm
lfd
nardost
qed
trichord
van den hul

headphones

beyer
ergo
grado
sennheiser
stax

stands

frameworks
sound org'n
something solid
soundstyle
stands unique

accessories

creek

densen demagic
goldring
kontak
michell
milty
moth
nardost
pixall
qed
rms
shure
trichord
zerosfat

hardware

atc
audio physic
densen
epos
harbeth
in focus
lexicon
michell
naim
nardost
primare
red rose
sme
sugden
trichord

Second hand & ex dem deals



QLN Signature loudspeakers. New old stock. The boxes have been opened simply to check the contents. High quality, chunky, Scandinavian stand-mounts in unusual asymmetrical cabinets finished in maple veneer. Originally £1200 ish **£695**

Bow Wazoo XL amplifier. One of the most stylish integrated amps out there. Boxed, mint. S/H (**£2600**) **£995**



Densen B200 preamplifier. Black anodised aluminium case with chrome controls. Remote controllable with Densen "Gizmo" handset (not included). S/H, boxed, unmarked (**£1000**) **£600**



Primare A30.1 integrated amplifier. S/H a few weeks old, exchanged due to a compatibility issue with a REL sub. (**£1500**) **£1150**

Primare V20 DVD player. Latest spec of the V20 (before being replaced by the V25). Cost £995. Most video formats are catered for including component. Excellent condition, boxed. Set to multi region. Boxed S/H **£550**

Primare V25 DVD player. Most video formats are catered for including component. PAL progressive scan capable. Multi Region, boxed, fully warranted **£675**



Toshlba 9000E DVD player. Months old , boxed. (£1000 ish). Multi Region. S/H One owner **£650**



Toshlba 9000 DVD player. Must be an older model than above. Good but not unmarked condition. No box or manual (but it has the handset) . Region 1 only. Offers?

And the DVD machine generating these traded -in DVD players?



Lexicon RT10. All Formats (SACD, DVDA, DVD and CD). The best picture that I have seen and excellent Audio performance too. 5:1 output includes DTS. Priced at **£2500** it is on demonstration now.

Nordost cables

Red Dawn Rev1 loudspeaker cable 4m pair single wire. Used, in good condition (**£969**). **£500**

Red Dawn balanced interconnect 3m pair ditto (**£724**) . **£435**

Superflat (gold) bi-wire 2.5m pair. New. (**£180.95**) . . . **£135**

Superflat (gold) bi-wire 7m pair. Used. (**£369.95**) . . . **£220**

1 x 2m pair SPM loudspeaker cables bi-wire (**£2250**) **£1250**

1 x 3m pair SPM cables bi-amp (boxed) (**£2970**) **£1750**



hi-fi for grown-ups



ipswich(01473)655171
signals bucklesham
ipswich suffolk IP10 0DY
fax (01473) 655172
email: enq@signals.uk.com
www.signals.uk.com

diverse vinyl

10 charles st newport south wales np20 1ju
01633 259661/256261 sales@diversevinyl.com

NEW TITLES ON DIVERSE RECORDS:

RICHARD THOMPSON – THE OLD KIT BAG £21.90
RON SEXMITH – COBBLESTONE RUNWAY - £16.90
OTHER NEW ARRIVALS FOR JUNE/JULY:

Audio Bulls	Ego War	£15.90
British Saa Power	The Decline Of	£12.90
Canyon	Empty Rooms	£12.90
Cinematic Orchestra	Man With A Movie Camera	£13.90
Dave Gahan	Paper Monsters	£12.90
Deftones	Deftones	£19.90
Donnas	Spend The Night	£11.90
Eels	Shootenany	£12.90
Grandaddy	Sumday	£14.90
Kosheen	Kokopelli	£TBC
Lou Reed	NYC Man (Ultimate Collection)	£TBC
Marilyn Manson	Golden Age Of Grotesque	£13.90
McKay	McKay	£12.90
Metallica	St Anger	£TBC
Micheal Franti/Spearhead	Everyone Deserves Music	£15.90
Mogwai	Happy Songs For Happy People	£13.90
New Po-nographers	Electric Version	£13.90
Radiohead	Hail To The Theif 2LP	£18.90
Songs:Ohio	Magnolia Electric Company	£12.90
Sparklehorse	It's A Wonderful Life	£14.90
Stereophonics	You Gotta Get There To Come	£15.90
The Thorns	The Thorns	£11.90
The Thrills	So Much For The City	£TBC
The Tyde	Twice	£12.90
Tindersticks	Waiting For The Moon	£13.90
Various	Madlib Invades Blue Note	£15.90

ALBUM OF THE MONTH:

STEELY DAN "EVERYTHING MUST GO" £16.90

REISSUES:

Grandmaster Flash	The Message	£14.90
Lambrettas	Beat Boys In A Jet Age	£14.90
Leadbelly	Good Morning Blues 1936-40	£14.90
Led Zeppelin	1,2,3 & 4 (Classic Records 200g)	£26.90
Peter Gabriel	Peter Gabel 4	£26.90
Peter Green Tribute	Man Of The World (audiophile)	£26.90
Sonny Clark	Cool Struttin	£26.90
The Who	Who's Next 3LP set	£17.90
The Wicker Man	Full Soundtrack in Stereo	£16.90

LED ZEPPELIN "HOW THE WEST WAS WON" Live California 1972
LP Box Set from Classic Records - Released in September

DISCO ANTI STAT LP CLEANER

Probably the most economical LP cleaning device on the market

Only £41.95

Call for details

Call for a catalogue of over 3500

brand new LPs, or visit



www.diversevinyl.com



PHONE FOR LATEST LIST

NEW, EX-DEM AND CLEARANCE ITEMS

	RRP	SALE	
Acoustic Energy AE1 MKII	£995.00	£499.00	D
Arcam Alpha 10	£799.00	£519.00	D
Arcam FMJ P25 power amp	£750.00	£489.00	N
Arcam FMJ CD23 Cd player	£1099.00	£699.00	N
Arcam FMJ A22/Dave AC3 - DTS amp	£1849.00	£1,199.00	N
Arcam FMJ A22	£1,100.00	£769.00	D
Arcam FMJ P35 power amp	£830.00	£539.00	N
Cyrus SL Amp	£400.00	£199.00	D
Cyrus AV Master Processor	—	£195.00	D
Krell KAV 500i Int. Amp.	£5,498.00	£2,495.00	D
Linn Kaber	£1,995.00	£695.00	D
Meridian M33 Active speakers	£1,495.00	£995.00	N+D
Neate Mystique	£735.00	£499.00	D
Neate Elite	£1,200.00	£779.00	D
ProAc 3.8	£3,990.00	£2,299.00	D
Rotel RX965RDS A/V receiver	£950.00	£595.00	D
Mission 781	£399.00	£219.00	D
Mission 773 SE	£399.00	£239.00	N+D
Mission 78AS subwoofer	£699.00	£449.00	N
Mission 783	£995.00	£649.00	D
Vienna Acoustics Beethoven	£2,500.00	£1,795.00	D
Vienna Acoustics Mozart	£1,500.00	£1,195.00	D
Vienna Acoustics Hayden rosewood	£750.00	£569.00	D
Vienna Acoustics Mahler	£6,000	£4495.00	D

MUSICAL FIDELITY SPECIAL OFFERS

A3 CD	£799.00	£499.00	D+N
A3 pre amp	£999.00	£559.00	D+N
Musical Fidelity XP100 BARGAIN!!!!	£799.00	£549.00	N

D = EX DEMONSTRATION, N = NEW, S/H = SECOND HAND

Hi-Fi Multiroom and home cinema

ACOUSTIC ENERGY ARCAM ASH DESIGN AUDIO
 RESEARCH CELESTION COPELAND CYRUS
 DENON KEF KRELL LINN TAG MCLAREN MARTIN
 LOGAN MERIDIAN MICHELL MISSION MONITOR
 AUDIO MUSICAL FIDELITY NEAT ACOUSTICS
 PIONEER PROAC QED QUADRASPIRE REL SONUS
 FABER SME STANDS UNIQUE STAX THETA
 WILSON AUDIO ETC...

THE LISTENING ROOMS LTD

161 OLD BROMPTON ROAD LONDON SW5 0LJ
 TEL: 020- 7244 7750/59 FAX: 020 - 7370 0192
 www.listeningrooms.com E-mail: tlr@dial.pipex.com
 Mon-Sat 10-6pm

RESERVE YOUR COPY TODAY!

Complete this form and hand to your local newsagent

Please reserve/deliver*(delete as appropriate) Hi-Fi & Computer Audio World on a regular basis, commencing with the next issue, until further notice.

Name _____

Address _____

Signed _____

Date _____



Distributed to the newstrade by

COMAG
 MAGAZINE MARKETING

private ads

Dealers must not advertise in the Private Classified section. Monthly consecutive insertions will be considered Trade advertising. The Publisher reserves the right to judge submissions.

hi-fi
WORLD
& computer audio

Special Internet offer see page 129 for details

FOR SALE Pair of ATC-SCM50ASL (Black), <30hrs play, excellent condition, will deliver in UK, £4000. Tel: 07974 330242 or Email: jknapper@cityairexpress.com (Sep(I))

MUSICAL FIDELITY P270 power amp mint £525 ono. Sony MDS-JB930 MiniDisc £75, mint, boxed, Meridian 101 pre with pair 105 amps black rare £275. Sony ELS Elcasete £100 Tel: 07764 960127 (Sep(I))

KRELL KSA MkII £1050. Meridian 601 £500. 602 £450. 606 £400. 209 £50. Tag McLaren Gallipoli speakers with stands slightly marked hence £800 (£2600). Naim 101 tuner £400. Tel: 01279 724804 (Herts) (Sep(I))

MICROMEGA T-DRIVE, T-DAC, hi-end performance. AES/EBU, 2x coaxial optical, mint (£2000) £900 ono. Arcam Alpha 6 Trichord output board, mint (£850+), £380 ono. Trichord Pulsar Series I, HDCD, Oscon/, op-amp upgrades, AES/EBU coaxial, external PS.U. (£2200) £1000 ono. Audio Alchemy V.I.T.B. phono stage, MM/MC Power Station 3 (£550) £250 ono. Pioneer PD-S707, stable platter, hi-bit Legatto, great build (£300) £150 ono. Moving abroad! Tel: 0118 9312307 or 07740 866218 (Berkshire) (Sept)

MICHELL ELECTO monoblock power amps (pair). Michell Orca pre-amp with large power supply. Excellent condition £1900. Proac Studio 100 speakers walnut with Target T2 high mass stands £350. Tel: 01296 420792 or Email: john@walker9962.freeserve.co.uk (Sept(I))

ATC SCM10 speakers, boxed £399. Nakamichi BX125 cassette £109, HiFi Plus magazines 23 issues in binders £25. Stereophile magazines 28 issues £20 ono. Tel: 01942 891741 (Atherton)(Sept(I))

AUDIO ANALOGUE Puccini SE, latest model, silver finish, mint condition, boxed, £500 ono. REL original Q bass, mint condition £75. Can demonstrate. Tel: 01732 461561 (Sevenoaks) (Sept(I))

PIONEER F-93 Reference tuner £275. Albarry M-408 monoblocs with matching AP4 pre-amp £395. All items excellent re-advertised due to time wasters Tel: 01904 763157 or Mobile: 07960 615375 anytime (York) (Sept(I))

MARK LEVINSON 380 pre, 331 pwr amps with box, manual, 1/2mm M.L. balanced cable, just about run in, getting married why selling (new £8880) £4500 may split. Tel: 020 8357 1264 work 07971 708041 mobile (Oct(I))

DENON POA4400A monoblocs, pristine, boxed 160wpc Class A, five star rated. Effortless fluid sound, high end demonstration £360. Tel: 07770 936915 or 020 8304 6309 (South East London) (Sept(I))

LINN KLIMAX twin stereo power amp 250 watts as new (8 months old) awesome sound retail £6000, would accept £4500 ono. Tel: Shaun 07887 943103 (Sept(I))

ARCAM 290P power amplifier Xeta style £160 (£400). Arcam Alpha 6+ integrated with pre-out upgrade by Arcam £120 (£300). Tel: 01924 210397 or Email: christopherallan@blueyonder.co.uk (Sept(I))

LINN KREMLIN tuner 1991 £950. Linn Kairn preamplifier line level 1995 £650. Tel: 01763 262493 (Sept(I))

ONIX OA215 Soap P/S £300 ono. Yamaha DSPE492 processor £95. 2 tier rack £25. 3 tier rack £35. 5 tier rack £40. Tel: 01905 764145 (Worcs.) (Sept(I))

DPA PDM 2 two box DAC, little use, mint, boxed, stunning sound £600. Alphason Xenon arm excellent £120 Tel: 0121 779 3959 (Sept(I))

B+W CDMNTI (loudspeakers) brand new and boxed with dedicated stands £725. Exposure 17 preamp £350. Exposure 18 poweramp £350. DPA Renaissance CD player £450. All items in mint condition including interconnects. Tel: Andrew 01727 852215 or 07714 013571 (Sept(I))

MUSICAL FIDELITY Tri-Vista 300 integrated Ltd Edition amplifier mint, boxed, etc £3000 Tel: 020 8531 5979 or 07903 265205 (Oct(I))

STEREO FOR sale TDL floor speakers, Marantz CD, Music Fidelity amp, Nakamichi tape deck, Harman Kardon tuner, total set up cost £1700 sell £650. All like new, for details, phone 07977 095170 (Sept(I))

AUDIO AERO Capitole II CD player. Balanced/single ended, awesome sound. Runs directly into a poweramp. One owner, under one year old. New £4500 asking £3200. Tel: 01296 437314 (Aylesbury, Bucks) (Sept(I))

GAMUT D200 poweramp, 200 W.P.C. black fascia, transparent and neutral, incredibly detailed, with exceptional timing. One owner, less than one year old. New £3250, asking £2400. Tel: 01296 437314 (Aylesbury, Bucks) (Sept(I))

SONIC LINK DM20 dual mono amplifier £50. QED T260FM tuner £50. Technics RS-B608R auto reverse cassette £50. Teac CD-PI800 CD player £50. Mission M71 speakers £60, together £249. Tel: 01842 813193 or Email: patstw@hotmail.com (Sept(I))

AVI POSITRON floorstanding speakers finished in black ash hardly used hence sale £400. Tel: 020 8870 3630 or 07790 909728 (Sept(I))

CYRUS 8 amplifier with PSX-R power supply new and unused unwanted competition prize, silver, boxed, highly reviewed What HiFi 5 star rating, first offer £965 secures. Tel: 01224 322644 (anytime) (Sept(I))

THORENSTD124 granite effect heavy plinth SME 3012 arm superb £500. Incatec Claymore amp £150. Quad 303/33/FM II valve tuner £200. Tjoeb valve CD player £200. Tel: 01827 261082 (Tamworth) (Sept(I))

FOR SALE Primare pre 30 and A30.2 pre and power amplifier combination £1500. Sony SCD 555 ES Gold Super Audio CD player £700. Tannoy Revolution 2 speakers cherry £180. All mint condition Tel: 0771 325 8836 (Sept(I))

ANALYSIS EPSILON ribbon panel speaker good condition boxed £800 ono. Trichord Pulsar DAC and power supply £350. Teac D700 DAC £180 ono. Tel: 01634 323683 or 07901 893982 (Sept(I))

MARK LEVINSON 390 S CD processor. ATC speakers SCM-100A-SL piano black latest spec. Revel B-15 sub-woofer. Harmonic Tech cables. All components boxed, unused from new 5 - 2 months old, perfect bargain. Cost 21K. Sell 11K. Tel: Jeff for enquiries anytime on Aberdeen 01224 637044 or mobile 07779 567477 (Sept(I))

FOR SALE - Audionote ANJ/SP black ash speakers £650 (£1800) Romulus valve integrated amplifier can also act as pre/power £600 (£1800) Boxed perfect condition Tel: Bill 01993 851508 (Sept(I))

THIEL CS3.6 floorstanding loudspeakers, excellent condition £5495 brand new, absolute bargain at £1995. Tel: 01508 499586 after 6.30 or leave message on answer machine. Oct(I)

MERIDIAN 501.2 preamp boxed, mint condition £420. Boston URSPRO rear speakers £150. Arcam Delta 290P power amp £150. Pioneer SPD07 d/digital processor £200. Tel: 01206 542578 or 07787 533170 (Colchester) (Sept/1)

NAKAMICHI A82Z discrete 3-head cassette, manual, as new condition £200 ono. Tel: 023 80869042 or Email: davidk44@aol.com (Sept/1)

NAIM CDI £700, NAC82 £1250, Hi-cap (new style) £375. Linn AV5140 £1100, Keilidh (c/w plinths) £350. All boxed, c/w manuals, leads, remotes. Could deliver. Call Mark: 07770 667037 (Sept/1)

THORENSTDI160 MkII Hadcock (?) arm £195. Lyra Parnassus Van Den Hull modified top MC cartridge £360. Tel or Text: 07743 704479 (London) (Sept/1)

MERIDIAN 500 transport Meridian 566 20-bit DAC immaculate £1000. Linn Waconda pre-amp, mint, £300. Linn Lingo power supply £250. All boxed. Tel: 01206 503603 or mobile 07876 744343 (Sept/1)

FOR SALE: Paradigm PS1000 subwoofer 120 watt active level control crossover frequency variable phase 0-180degrees black ash finish excellent condition £100. Tel: John 07961 800162 (Bath) (Sept)

KIMBER HIGHCURRENT mains cable 3 feet x 2 £50 each. Fidelity Research 64 FX tonearm headshell £25. Records for sale, ring for list. Williams Hart mono block poweramps recent service Blackgate caps fitted £500. Tel: 01457 834465 (Sept/1)

ROKSAN ROK L2.5 Pre-amp. Artaxerxes Phono Stage and DS1.5 power supply. Five-star reviews - 'sounds as good as it looks'. Excellent condition. £1200. Tel: 07970 798099 or Email: mark@pearsem.freemove.co.uk (Sept/1)

FOR SALE: Mullard G234, EL34, EL37, some N.O.S. some second hand but tested good. Tel: John 07946 302815 or Email: chairman@sdrs.org.uk (Sept/1)

QUAD SPEAKERS Electrostatic, one not working. Offers. Tel: 01642 651 226 (Sep)

KESWICK BLUEPRINT - Point 1 speakers. Black and cherry, mint condition with boxes and manual £700 (£1000 new). Tel: 01782 633284 or Email: coat@btopen-world.com (Sept/1)

MONITOR AUDIO Studio 50's in cherry, one owner as new comes with H.N.E. granite plinths. All original packaging and accessories. Originally £4000. What HiFi reference speakers, £1400 ono. Tel: 01772 861507 (Sept/1)

TARGET SPEAKER stands Type R1 as new £125. Totom Model 1 speaker stands as new £125. Russ Andrews 6 way distribution power block £70. Tel: 01628 626085 (Sept/1)

CHORD CPA 2200 pre amp plus Chord SPM 600 power and silver (cost £4075) £2000. Chord LS 5/12A qualified monitor loudspeakers piano black & stand (cost £1935) £800. Pioneer PD 95 CD player silver (cost £2500) £800. Rotel Meichi RHT10 tuner silver cost (£1000) £500. KEF Reference speakers Series LS 3/5A speakers piano black & stands. All boxed and superb condition Tel: 01924 259603 (West Yorks) (Sept/1)

ARCAM FMJ 22 amp silver six months boxed mint (£1000) £599; Marantz CD6000K1 black 20 months £225; Teac MD100 2 months £100 Tel: 0115 960 3934 (Nottingham) (Sept/1)

WILSON BENESCH Circle turntable with ATCO.5 Tonearm (Full Circle without Ply Cartridge). Excellent condition. Great looking and sounding deck. £1200. Tel: 07970 798099 or Email: mark@pearsem.freemove.co.uk (Sept/1)

REVOX SYSTEM. Never used. 3 pieces. Top-rated. S26 FM tuner, S25 stereo amp. S22 CD deck. Still in sealed factory crates. 10 days old. Cost £1550. Best offer takes it period. Call 07810 284 943 or preferably message gordack7@yahoo.com (Sept/1)

J M LABS Micro Utopia, brand new, ex-dem, list £4600, accept £3750 including stands. Tel: 01922 477682 (Walsall) (Oct/1) LEAK STEREO 20, grey, £340. Quad ESL 57s bronze £395. Tel: 01744 755 434 (Sept/1)

RADFORD STA25 amplifier with control unit and tuner. All working ok and good order for £650. Tel: 01732 850 574 (Evenings) (Sep)

THETA MILES CD (balanced) £1300. Primare A30.1 amp £825. ATC SIA2 150 amp £1125. Dynaudio Contour 1.3 Mk2 speakers + Atacama stands £600. Pioneer F91 tuner £200. Tel: 0121 246 0486 (Sept/1)

KRELL KAV 300r integrated £1450 (£3500 receiver version of KAV 300i) Krell KAV 150a power £1350 (£2600). Both brilliant, perfect. Offers considered. Upgrading. Tel: Bill 01993 851508 (Sept/1)

HI-FI CLEARANCE (purchased December 1993) Townsend Rock turntable, Acrylic platter, SME 309 Silver tonearm, Goldring C4TE stylus, Transformer 800MCT (£1953) £1200. Audio Innovations P2 phono amp (£500) £300. Audio Innovations S700 valve amp (£1000) £600. Tel: 01270 766919 (Sept/1)

WANTED: NAKAMICHI PA7 ST7E DM10. Must be exceptional or mint condition. Also RM7CA and any sales literature from the era of Dragon CR7E etc. Tel: 07798 737274 (w), 020 8397 7274 (h) (Sept/1)

LINN ISOBARIK PMS. Teak + stands + in stand passive crossovers. Can dem. £595. Tel: 01702 527115 (Essex) (Sept/1)

MUSICAL FIDELITY A3 integrated amp £400 (£900). A3 CD £400 (£900). Monitor Audio Gold Reference 10 stand mount speakers £300 (£700). All excellent condition. Tel: Phil 01942 680010 evenings or 07881 784560 (Sept/1)

ARCAM DELTA 70.2 CD player v.g.c. £150. Linn Karma MC cartridge, approx 200hrs since rebuild, v.g.c. £150. Tel: Mel 01442 344362 daytime (Hertfordshire) (Sept/1)

REL STADIUM 2 Subwoofer, rosenut, mint condition £800. Tel: 07939 472073 or Email: mark-grant@spamcop.net (Yorkshire) (Sept/1)

C&R DEVELOPEMENTS Amphion single ended monoblock power amps. Based on 6C33C tubes. Beautifully crafted stainless steel, black cabinets. Blissfull sound, mint, boxed £1100 (£2000 new). Tel: 0115 937 3783 (Nottingham) (Sept/1)

DNM 2A/PA1 pre-power w/PSU's, £800 (£2450). Audio Magic ST-1's, awesome Danish speaker, stands, very like Wilson Watts, £1200 (£3800). QLN Signature speakers, crossover, stands, Nordost modified, magically communicative, £850 (£2200). Tel: Zeb 0131 6610126 or 07811 335060 or Email: zeb@relax.uk.com (Sept/1)

NORDOST INTERCONNECTS: Valhalla £850 (£2100), SPM £325 (£800), Red Dawn RCA-DIN £150 (£330), Valhalla Digital £500. Wanted: CA-50, E.A.R. 869 or similar sweet, dynamic, musical amp. Tel: Zeb 0131 6610126 or 07811 335060 or Email: zeb@relax.uk.com (Sept/1)

MUSICAL FIDELITY A300CR £1150 (£2200). Arcam Alfa 9, £395. B&W Matrix 804, £350. Quad FM4 405 30S Pre £600. Tel: Mark 01258 817 669 (Sept/1)

NAIM NA CDX CD Player, mint condition, boxed, £1500. Tel: 01246 232 085. (Sept/1)

ELAC SPEAKERS. One pair CL-310i. Top-rated. Ten days old. Still in sealed factory crate. Cost £850. Best offer takes it period. Call 07810 284 943 or preferably message gordack7@yahoo.com (Sept/1)

QUAD 34 preamp bronze DIN good condition boxed £130. Nordost Solar Wind interconnects 1 mtr, pair boxed £45. DNM Reson Bullet plugs 1/2 mtr pair £30. Tel: Mike 01758 613790 (Sept/1)

LOWTHER FIDELIO speakers, piano black finish fitted with PM5A drive units. Factory made £2000. Tel: 01293 824 667 after 6pm (Sept/1)

KEF 105 Reference Dalek type speakers £350. Large Kef CS7 kit speakers £250. Single Tannoy T.185 incorporating 10" dual concentric driver £65. Unused AR EB101 turntable as new £150. Tel: 01362 687 615 (Sept/1)

FOR SALE Pair of ATC-SCM50ASL (Black), <30hrs play, excellent condition, will deliver in UK, £4000. Tel: 07974 330242 or Email: jknapper@cityairexpress.com (Sept/1)

QUAD SPEAKERS Electrostatic, one not working. Offers. Tel: 01642 651 226 (Sep)

BARGAIN BULBS

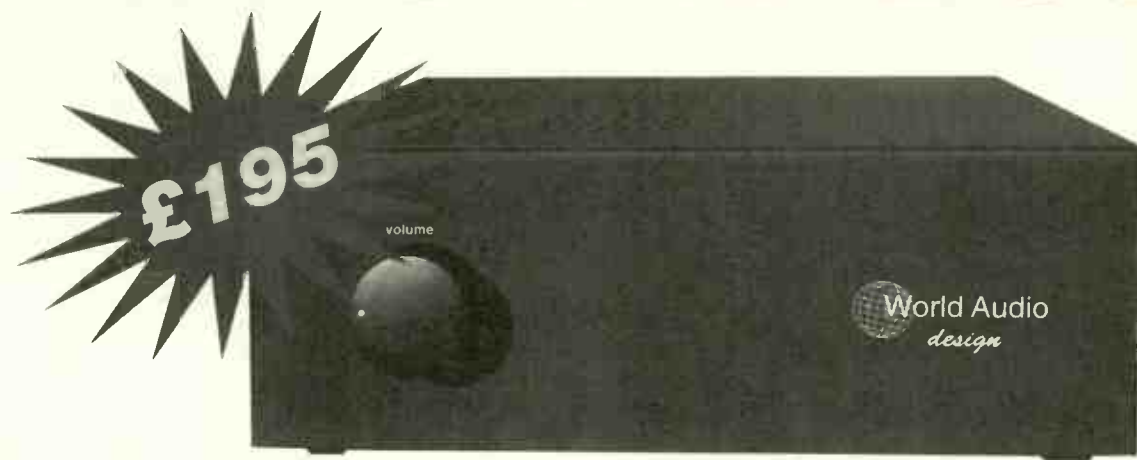

If you've always thought of valve amps as temperamental and expensive beasts, think again. World Audio Design's latest kit is designed with the budget conscious beginner in mind.

The Kecl82 was created from a brief that demanded simplicity, ease of build and a super low cost. In order to achieve a reasonable power output we went for a push-pull amplifier.

We chose the ECL82, a triode/output pentode. This tube is readily available and has a good sound. In push-pull mode it delivers 8Watts. Realistically you need a speaker of around 89dB or above. This is possible at a budget price - try the smaller Triangle models, or a Tannoy mX3 or even one of the older Missions like the 773e, or if you like building your own speakers, try the Adire Audio HE10.1, as reviewed in HFW October 2002 issue.

You will see that the front has only a volume control, and it is fed by one pair of phono sockets. A selector and tape/source switch were not used in this amplifier as they are tricky to wire up, and the aim was to make it easy to build. In fact, in many ways the Kecl82 would be great powering a second system, using a CD player as a source, and will definitely give you a taster of what valves can offer. Measuring 30cm wide, 23.5cm deep and 11cm height with feet, it is entirely self-enclosed. The valves are visible through the four upper circular vent holes (one directly above each valve). We have kept the look simple with the minimalist front panel holding the volume potentiometer. The two-part chassis is constructed from 1.6mm mild steel with a durable black powder-coat finish. The whole unit is very sturdy, weighing in at 9kgs.

The signal input is in the form of a pair of gold plated RCA phono sockets that sit at the rear of the chassis. The speaker sockets accept 4mm banana plugs as well as bare wire. The mains switch is positioned at the rear of the amplifier, on the right hand corner for easy access. Mains power is received via an IEC lead. The Kecl82 is based on a printed circuit board (PCB). The PCB is easy to follow with all component names, locations and orientations shown clearly. The amplifier requires no set up, you just turn it on. The kit will come with comprehensive instructions taking you through the build step-by-step.

SOUND QUALITY BY SIMON POPE

Purity is the key to this amplifier's design and sound. Because there's very little to get in the way of the signal what you get is an exceptionally sweet and simple sound that also has a superbly wholesome roundness to it. A high quality recording of Mahler's Das Lied Von Der Erde on Reference Recordings showed that the Kecl82 faithfully reproduced all the depth and space of a full symphonic orchestra without any problems. Violins were smooth and sweet, as was percussion (which virtually sparkled) and the woodwind section was especially impressive, with a spacious and airy sound.

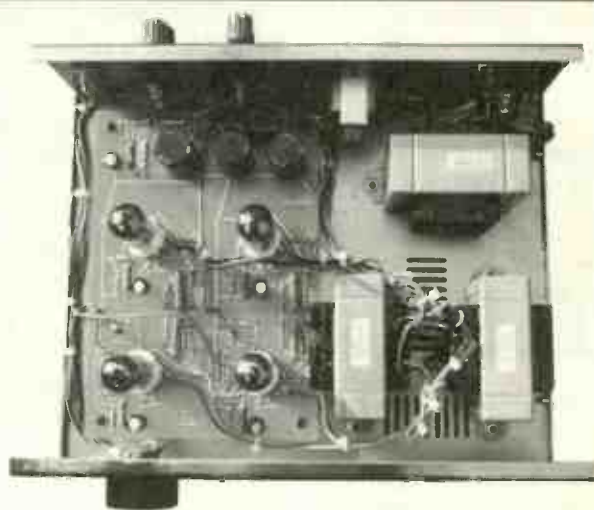

A run through Miles Davis's Kind Of Blue saw the little integrated delivering a detailed and precise sound that highlighted the warmth of Coltrane's tenor sax and the rich, deep sound of the upright bass. Rock and Pop records such as Radiohead's 'Lucky' demonstrated that the valves inside the amp, whilst small, are quite robust sounding, with commendable clout and bass depth for a humble budget 8W valve amp. This is a great introduction to the sonic art of the valve amp and a big upgrade for anybody with a mid-price solid-state amp that wishes to swap over to something more musically engaging, for a price that's virtually as cheap as chips!

MEASURED PERFORMANCE

Frequency response	+/-3dB 15Hz - 75kHz
power output	8 watts into an 8 ohm load
sensitivity	850mV (suitable for CD)
hum	0.5mV

**The Kecl82 amplifier kit is available from World Audio Design
Tel/fax: 00 44 (0) 1908 218836 or order on-line at
www.worldaudiodesign.co.uk**

**Kecl82 amplifier kit (UK price) £195.00
(inc. vat & carriage)**

**Kecl82 amplifier kit (EU price) £195.00
(inc. vat, exc. carriage)**

**Kecl82 amplifier kit (Overseas price) £170.00
(exc. carriage)**

trade ads

www.hi-fiworld.co.uk
hi-fi
 WORLD
 & computer audio

Dealers must not advertise in the Private Classified section. Monthly consecutive insertions will be considered Trade advertising. The Publisher reserves the right to judge submissions.

Special Internet offer see page 129 for details

AMAZING CABLES! Silver hybrid and solid silver interconnects from £85, with world class plugs. Solid silver speaker cables from £220. Fantastic performance, refund guarantee. Details: 0115 982 5772 after 7pm, or E-mail Bob@skydivers.co.uk (Dec/1)

LONDON TAPE RECORDERS. Open reel to reel specialists, established 30 years, machines bought, sold and exchanged. Akai, Sony, Pioneer, Teac, Tascam, Revox, Technics. Servicing on selected machines. Tel: 020 7603 0303 or 07950 400 005 (Oct/1)

HERTFORDSHIRE/NORTH LONDON Audio/Record Fair. Sunday 10th August 2003. 11.00 to 4.00. 9.30am early entry £10. At Cuffley Hall, Maynard Place, Cuffley, Herts. 5 minutes from M25 Junction 25. Tel: 07944 909 209 for details (Sep/1)

AUDIOPUBLIC, 78 Otley Road, Headingley, Leeds, 0113 217 7294. Yorkshire's newest Hi-Fi retailer, representing Naim, Rega, Creek, Totem, Quadraspire, Dynavector, Roksan, Teac and more. Used LP12's, Lingo's, Linto's stocked. Call for advice. Tel: 0113 217 7294 (Sep/1)

HIFI HUT in Harrogate offer the following quality brands: Bryston, Creek, Custom Design, Harman Kardon, Neat, PMC, Quad, REL, Wharfedale. Phone for details, directions, 01423 810 990 or 07736 392 852. www.hi-fihut.com (Sep/1)

EX DEMONSTRATION Klipsch speaker systems, KSB 2.1 £200, KG 3.5 £350, KG 4.5 £450, KG 5.5 £550. Heresy £650, all tested. Tel: Midland Radio Supplies on 0121 430 7817 or Email: guy-holdsworth@onetel.net.uk (Oct/1)

"AMPS" QUALITY Valve Amplifiers: Repaired, restored, upgraded. Custom designs commissioned. Kits assembled. Experienced Engineer. Free estimates and fair prices. Tel: 01525 756 935 <http://www.dhaen.co.uk/amps> Email: amps@dhaen.co.uk (Oct/1)

VINTAGE WIRELESS COMPANY LONDON
 Website: www.vintagewirelesslondon.co.uk
 Buy-Sell-Exchange. Vintage wireless and classical audio. Repairs, spares, restoration, modification to all valve equipment. Quad II, Leaks etc, shipped worldwide, best prices, call us at 17 Bell Street, London, NW1 5BY. Tel: 020 7258 3448 Fax 020 7258 3449 Email: vwirelesslondon@aol.com (Oct/1)

TOM TOM Audio - Specialists in Naim Audio, supply top condition pre-loved and ex-demo Naim equipment with full 12 month money back guarantee. Demonstration facilities. Can deliver stock list at: www.tomtomaudio.com Call 07971 202 742 or 01727 893 928 or Email: tunes@tomtomaudio.com with requirements. Wanted: mint Naim gear, cash waiting, will collect (Sep/1)

EMT 948 £600, 950 £1200, Nagra 4 stereo £1500, Revox B760 £750, B77 Mk I £450, A77 MkII £300, A700 £450, Studer A725 CD £550, A810 £600, A807 £450, A80 RC VU £650, B67 VU £700. Tel: 01246 275479 or Email: j.i.tipping@amserv.net (Sept/1)

WOODSIDE ELECTRONICS LTD. offer a repair service for Radford, Woodside and Quad II valve amplification. Transformers manufactured to original specification for the above plus bespoke designs. Tel: 01758 741 026 or Email: m.davis@virgin.net Web: <http://freespace.virgin.net/m.davis> (Sep/1)

SAVE MONEY with direct sale ceramic cabinet speakers from Faraday Sound. High end sound for half the money. Also pair used Focal TC90K tweeters £40. Wilmslow subwoofer £50. www.faradaysound.co.uk (Nov/1)

AUDIO ANALOGUE Maestro CD £1125. Sugden Masterclass Int. Amp. £2250. Copland CDA 266 CD £700. Chord Co. Signature Interconnects £375. More bargains on www.apexacoustics.co.uk Phone Steve 01527 450500. Mob. 07773 198336. (Sep/1)

WORTHING AUDIO True Sound Series Crossoverless monitors 96dB efficiency, single 8" driver, perfect for low powered tube (S.E.T.) and solid state Dynaudio Crafts, immaculate, boxed, with Dynaudio stands £1250. Amphion Argon loudspeakers £599. Musica Collins loudspeakers by Bernard Thiel & Partners (German) £1000. Audionote AN-ESEC lacquered finish + stands £5000. (RRP £13,600). Tel: Worthing Audio 01903 212 133 or 07900 918 882 (Sep/1)

EAR PRODUCTS on permanent demonstration, from the wonderful 869 to the rest of the range. Kora Explora 60 watt hybrid £450. Dynaudio Contours 1.3's Mk2 £699. Restek Consens fully remote and balanced £1100. Restek Chalanger £600. Omega speaker systems TSR1R £1199. H-Cat P12 £2499. Kora Equinox pre-amplifier MM £995. Kora Herries 96-192 valve DAC £1199. Tel: Worthing Audio 01903 212 133 or 07900 918 882 (Sep/1)

SILVER ARROW 4N-Pure flat silver foil air interconnects and speaker cables with Bocchino phono plugs. H-CAT P12 Zero distortion pre amplifier from America on permanent dem. Tel: Worthing Audio 01903 212 133 or 07900 918 882 (Sep/1)

NAIM NAC 32.5 pre, with phono stage, mint condition £275. Linn Karik, mint, (£1850) £650. Rotel RT 830 AL tuner £60. Telephone Jules on 01792 280061, Email info@sounddrjuleshifi.co.uk Web: www.sounddrjuleshifi.co.uk (Sep/1)

WADIA 21, inc manual, remote and feet, (£5250.00) £2200 WADIA 16, 4yrs (£7450) £3500. Basis Debut Gold Standard Turntable, inc custom dust cover, (£8,500) £4k £1400 Koetsu Red SIGNATURE *, 20hrs, (£2200) £1300. All mint, boxed. Telephone Jules on 01792 280061, Email: info@sounddrjuleshifi.co.uk Web: www.sounddrjuleshifi.co.uk (Sep/1)

AUDIO RESEARCH LS25 Mk1, 4yrs, (£5000) £3500 Audio Research M300 Mono Blocks MkII status [£12000] £4300 Tom Evans the Groove, phono stage, 2yrs, (£1800) £1400. Sonus Faber Extrema's on stands (£7800) £3900 All mint, boxed. Telephone Jules on 01792 280061, Email: info@sounddrjuleshifi.co.uk Web: www.sounddrjuleshifi.co.uk (Sep/1)

TRANSPARENT ULTRA Bi Wire 12ft, WBT Bananas (£3440) £2200 Mandrake 1mtr, RCA-RCA (£600) £300 Siltec Arm cable, Icheman bullets RCA's 1.5mts (£400) £260 Siltec 1.0 mtr RCA-RCA (£300) £180 Telephone Jules on 01792 280061, Email: info@sounddrjuleshifi.co.uk Web: www.sounddrjuleshifi.co.uk (Sep/1)

LINN KEILIDH'S, black ash, active cards, passive (£1000) £450 Audiolab Transport and DAC, Mint condition C/W manual and box £900 ono. AudioTechnica OC9 cartridge brand new £270. Telephone Jules on 01792 280061, Email: info@sounddrjuleshifi.co.uk Web: www.sounddrjuleshifi.co.uk (Sep/1)

MUSIC LINK Ultra WBT's, RCA's interconnect, 2.0mtr (£900) £600 LFD Mistral CD player, stainless steel & gold livery, boxed. Mint (£1050) £450 Telephone Jules on 01792 280061, Email: info@sounddrjuleshifi.co.uk Web: www.sounddrjuleshifi.co.uk (Sep/1)

NEW VALVE Amps; powers £260; matching preamp £190; other valve related goodies at www.audioclassics.co.uk or telephone 01942 257525 for more information. Dealer enquiries welcome. (Oct/1)

VINTAGE WIRELESS COMPANY LONDON
 Website: www.vintagewirelesslondon.co.uk
 Buy-Sell-Exchange. Vintage wireless and classical audio. Repairs, spares, restoration, modification to all valve equipment. Quad II, Leaks etc, shipped worldwide, best prices, call us at 17 Bell Street, London, NW1 5BY. Tel: 020 7258 3448 Fax 020 7258 3449 Email: vwirelesslondon@aol.com (Oct/1)

S/hand and ex-demo clearance items - SEPTEMBER 2003

	Was	Now			
CD players DACs & Transports					
Pink Triangle DaCapo DAC 24 Bit S/H	1800	799	Opera Lux 3 Tier Table Clear/Stainless x-Demo	950	499
Pink Triangle Cardinal Transport S/H	1499	599	Partington Dreadnaught 24" Stands S/H	250	149
Pink Triangle Ordinal 1307 DAC S/H	749	399	Roksan HAO1D 0.5m Digital Interconnect S/H	49	25
Primare D30.2 CD Player S/H	1500	899	Tara labs Prime1800 Bi-wire5m S/H	1599	695
Wadia 830CD Player S/H	3295	1899	Tara Labs The One Balanced 1m x-demo	3000	1500
Turntables Tonearms & Cartridges					
Air Tangent 1C with Wisa Pump X-demo	5800	3999	Tara labs Floating Ground Station x-demo	899	450
Benz Micro LP New& Boxed	2200	1799	Target HR60 Silver Stands S/H	199	109
Kuzma Stabi/Stogi S Turntable New& Boxed	1295	1099	Target R1 Stands S/H	299	175
Lehmann Audio Black Cube SE New& Boxed	650	449	Transparent Music Link RCA -RCA 2m S/H	299	149
Lyra Lydian Beta New& Boxed	599	499	Transparent Music Link Balanced 2m S/H	499	249
Michell ISO Phono Stage S/H	549	250	Transparent Music Link Ultra Balanced 7.26m S/H	2349	1499
McCormack Phono Stage New and Boxed	650	399	Wilson Benesch Aside Carbon/Kevlar 4 tier stand S/H	960	499
Rega RB300 Tone arm S/H	188	119	Tuners & Tape Decks, Power Supplies		
Preamplifiers					
Einstein "The Tube" Preamplifier x-Demo	6000	3999	AKG C1000 Condenser Mic S/H	241	120
Musical Fidelity A3 Preamplifier S/H	899	499	Magnum Dynalab FT-R Remote Switcher for FT101		
Graaf GM13.5BII Valve Preamplifier x-demo S/H	4000	2999	A/Etude (New&Boxed)	450	299
Krell KSL 2 Signature Analog Series with KPE Phono Board Fitted S/H	5800	1850	Bargains under a £100		
Krell KAV-S Processor/Preamplifier DTS/AC3/Pro Logic S/H14989	2999		Sony TCK-461s 2 head cassette decks new&boxed	199	99
Roksan L2 preamplifier S/H	1295	399	Midland Audio X-change are looking Audio Research, Krell, Mark Levinson, Naim Audio, Dcs, Wadia, cash paid call John Roberts		
Spectral DMC12 s Phono x-demo	4750	3299		
Spectral DMC30 Remote x-demo	8500	6500			

Amplifiers

47 Labs Gain Card 25w / Humpty S/H	3250	1899
Audio Analogue Maestro Integrated x-demo	2700	1899
Electrocompaniet AW120Dmb S/H	2395	1599
Gamut D200 Blk with Handles S/H	3295	1795
Krell FPB600c Power Amplifier S/H	14000	8500
Krell KSA 150 Power Amplifier S/H	6898	2199
Unison Research S2K Remote x-demo	1295	995
Rea Elicit Integrated with Phono Stage S/H	698	275

Loudspeakers

Avalon Eclipse Maple x-demo	9800	7249
ATC Model10 R/W Xdemo	1200	749
Indigo Model Two Centre Channel Cherry S/H	199	129
Living Voice Auditoriums Cherry x-demo	1600	1199
Living Voice Avatars Maple x-demo	2700	1995
Living Voice Avatars OBX-R Ebony x-demo	4000	2999
Martin Logan Quest Hybrid Electrostatics Oak S/H	5940	1899
Rega Xel Rose wood Floorstanders S/H	1295	399

Cables & Accessories

Air Pod size 1 x3 S/H	210	99
Audi Note AN-V 2m Silver Interconnect S/H	450	199
Acoustic Zen Silver Signature Balanced 12ft	2700	1499
Cogan Hall EM-D 0.6m S/H	199	99

Midland Audio X-change is looking for good used British & American Hi-Fi

cash paid call John Roberts on 01562 822236

Suppliers and installers of High Quality Audio Systems

47 Laboratory	Graff
Accuphase	Gryphon
Audio Note	Lavardin
Audio Research	Mark Levinson
Avid	Martin Logan
Basis	Michell
Cabasse	Nagra
Cardas	Primare
Clearaudio	ProAc
Conrad Johnston	Rega
Copland	Resolution Audio
Dcs	Sonus Faber
DNM / Reson	Spectral
Einstein	SPM
Electrocompaniet	Sugden
Final	UKD
Finite Elements	

WE HAVE MOVED

New address:-

www.midlandaudiox-change.co.uk

call John Roberts Tel: 01562 731100

or fax on: 01562 730228

The Old Chapel, Forge Lane, Belbroughton
Worcestershire, DY9 9TD

e-mail sales@midlandaudiox-change.co.uk

Mobile 07721 605966

classifieds ads order form

RATES - ALL ADVERTS MUST BE PRE-PAID

Maximum length per advert is 30 words, each additional word is 50p extra. Telephone numbers and E-mail addresses are treated as one word. Model numbers are treated as one word i.e. Quad 303 = two words. Please tick the box for the advert required

In a rush to get your advert published? Why not use our Instant Internet Advert to get on our website immediately. Only £15 per week (7 days)

Dealers must not advertise in the Private Classified section. Monthly consecutive insertions will be considered Trade advertising. The Publisher reserves the right to judge submissions

SPECIAL OFFER

Book a private or trade classified advert, and get one months *FREE internet advert

*FREE internet adverts are published three weeks AFTER the magazine has been published

Instant Internet Only Advert Private or Trade published immediately	£15 per week	<input type="checkbox"/>
Private magazine advert plus *FREE internet advert	£10 per month	<input type="checkbox"/>
Private magazine advert display black box plus *FREE internet advert	£15 per month	<input type="checkbox"/>
Trade magazine advert plus *FREE internet advert	£10 per month	<input type="checkbox"/>
Trade magazine advert display black box plus *FREE internet advert	£15 per month	<input type="checkbox"/>
Please tick here if you DO NOT WANT your FREE internet advert		<input type="checkbox"/>

Please write or type your advertisement copy in block capitals with one word per box.

Please continue on a separate sheet if necessary.

WE WILL ACCEPT PHOTOCOPIES OF THIS FORM

1	2
3	4
5	6
7	8
9	10
11	12
13	14
15	16
17	18
19	20
21	22
23	24
25	26
27	28
29	30

Name _____
 Address _____
 Post Code _____
 Daytime Tel: _____

Please debit my VISA/MASTER/SWITCH Card No.(Switch card issue No _____)

Expiry Date: _____ Cardholder Signature: _____

I enclose a cheque/postal order for £ _____ Made payable to: Audio Publishing Ltd.

Send in your private classified ads with our NEW Freepost service. No need for a stamp!

Send this form together with your payment in an envelope marked:

Hi-Fi World, FREEPOST LON3478, LONDON NW6 6YR



ADVERTISERS INDEX

Affordable Valve	22
AV Lounge	50
Billy Vee	89,90,91
Central Audio	114
Choice Hi-Fi	86
Classique Sounds	119
Connoisseur Audio	112
Custom Cable	117
Definitive Audio (Brighton)	22
DefinitiveAudio (Notts.)	22
Diverse Vinyl	121
Emporium (The)	120
Heathcote Audio	117
Heatherdale Audio	115
Henley Designs	6,76
Ian Harrison	115
Jem Distribution	107
Mantra Audio	76
Matrix	118
Midland Audio Exchange	110
Midland Hi-Fi Studio	112
Mission	BC
Musical Fidelity	18
Musical Images	111
Musonic	115
Origin Live	50,118
Oxford Audio	114
Q.T.A.	112
Retro Reproduction	107
Sevenoaks	27,28,29,30,31,32,33,46
Signals	121
Sound of Music (Crewe)	119
Soundcraft	115
Sounds Expensive	120
Soundstage	111
The Listening Rooms	122
The Right Note	36
The Studio	50
Tube Shop	76
Walrus Systems	IFC
Williams Hart	111
X-Electrical	119

PRIVATE & TRADE CLASSIFIED ADVERTS COPY DEADLINES

OCTOBER 2003 ISSUE - WEDNESDAY 6TH AUGUST 2003

NOVEMBER 2003 ISSUE - FRIDAY 5TH SEPTEMBER 2003



TWO BY FOUR

Haden Boardman remembers Marantz's classic twin box, four times oversampling CD12 CD player as a real big hitter...

Nineteen eighty eight was a good year for CD players. Five years after the dawn of this new digital format, some serious machines were finally appearing from the likes of Cambridge Audio, Meridian, and of course the audiophile wing of Philips; Marantz. Launched as a limited edition of just two hundred pieces, the CD12 is directly derived from the cheaper, but still very capable CD94 and DA94.

The CD12 transport contains no analogue section at all, just three digital outputs; an optical and three coaxial. The matching DA12 DAC has no less than three optical and three coaxial inputs, and includes a "tape monitor" loop for the rare off-tape monitoring DAT machines out there! It can sample at either CD's standard 44.1kHz or DAT's standard 48kHz. In common with all the lesser Philips-based machines of the day, the DA12 was based around the classic 16bit, 4x oversampled TDA 1541, but in this case it was the TDA 5141ASI, the most select "Crown" chip Philips made.

The entire CD12 is full of sweet little tweaks, courtesy of our friend Ken Ishiwata, who oversaw the entire project. Where the CD94 had a detachable figure of eight mains lead, the CD12 has extra high

quality oxygen free copper fixed mains leads on both transport and DAC. Inside, the entire electronics are fully encased in copper shrouds, to minimise RFI and other interference. All components are selected, and audio output is fixed via phono or balanced XLR connections.

This combo sounds exquisite. It has analogue-like tendencies, especially in the bass; this is one of the few CD players I know that can rival the bottom end of a good high end turntable, and get close to master tape quality. Most impressive is the sheer detail the combo gets from CD. Recordings that sound synthetic and processed on some CD players have new life here, a testament to how fine the original 16x4 chipsets are. Plugging in the latest up-sampling Musical Fidelity A3.2 CD player shows the old Marantz really can hold its own. There are areas in which the MF was softer and more smooth sounding, especially the very high treble, but it could not retrieve as much info off the disc as the Marantz. The Marantz was more listenable, having superior weight, bass extension and overall fidelity. Well, it did cost £2,500 back in 1988!

Like any vintage machine, getting parts can be a problem. The state of the art CDM9 swing arm mech is

used, and it is pretty bullet proof. The draw loading mechanism uses three drive belts and they wear out, causing very jittery draw movements. These are easy to sort out, but if a laser fails, it is time to find another CD 94 as a donor!

The machine came complete with a sophisticated RC12 remote control unit. The size of a paperback, and even heavier, this early learning remote control will be happy to learn all the functions of the rest of your hi-fi, but for some reason will not let you directly skip tracks on the '12! Actually it looks great, but is pretty darn useless, a real coffee table piece!

The other thing that is now getting useless are the original supplied interconnects. Balanced XLR one end, phono the other. The phono plugs go microphonic with age, and the copper is getting past its sell by date. In addition, the balanced output does not sound as good as the single ended output on this machine; the TD1541s are single ended devices, so I presume some kind of chip creates a balanced output. Don't bother.

Second hand, the CD12 still fetches around the £1000 mark. There are only two hundred of them, and I am not selling mine just yet! Fifteen years old and counting - and still superb!



A3.2 SERIES.

MACHINED, MIL-SPEC ALUMINIUM FRONT PANEL.
PLATINUM PLATED FITTINGS. REMOTE CONTROLLED. PHONO STAGE.
POWERFUL, ROBUST, BUILT.

FOR DETAILS OF YOUR NEAREST STOCKIST RING 020 8900 2866. www.musical-fidelity.co.uk

Delight your aural senses



Simple Perfect Sound

volare

MISSION

Tel: +44 (0) 1480 423700
www.mission.co.uk

Speaker stands not supplied with floorstanding speakers