

# Hi-Fi WORLD SUPPLEMENT

No. 19 DECEMBER 1995

**BOXMODEL -  
LOUDSPEAKER  
CABINET DESIGN  
ON THE PC**

## **DIPOLE BASS FOR THE QUAD ESL-63 ELECTROSTATIC**

**BOOK REVIEWS -**

**ELECTROSTATIC LOUDSPEAKER  
DESIGN COOKBOOK**

**THE LOUDSPEAKER DESIGN  
COOKBOOK - 5TH EDITION**

**WE VISIT THE  
EGHAM AUDIO FAIR**



**FREE D.I.Y. SUPPLEMENT No. 19**

NOVEMBER 1995

# NEW SENSOR CORPORATION

20 COOPER SQUARE • NEW YORK, NY 10003  
 (212) 529-0466 • (800) 633-5477 • FAX (212) 529-0486

USA MILITARY JAN TUBES *NEW, ORIGINALLY BOXED, AVAILABLE IMMEDIATELY*

TUBE NUMBER	1 PC.	10 PCS.	25 PCS.	50 PCS.	100 PCS.	500 PCS.	1000 PCS.
0A3 JAN	1.15	.90	.75	.65	.55	.45	.40
0C3W JAN RAYTHEON	3.65	2.90	2.30	1.90	1.60	1.30	1.20
5Y3WGTA JAN PHILIPS	4.90	3.90	3.40	2.90	2.60		
6AN8a JAN PHILIPS	5.90	4.70	4.20	3.80	3.15	2.60	2.30
6AS7GA GE	6.15	4.90	3.50	2.90	2.55	2.20	1.90
6BJ7 JAN GE	2.00	1.60	1.40	1.20	1.00	.90	.80
6BL8 JAN SYLV	1.65	1.30	1.10	.80	.65	.50	.45
6BQ7a JAN GE	2.00	1.60	1.35	1.15	.95	.80	.70
6C4WA JAN PHILIPS	4.70	3.75	2.90	2.30	1.80	1.65	1.55
6DJ8 JAN PHILIPS	3.65	2.90	2.30	1.60	1.40	1.15	.95
6EA8 JAN PHILIPS	2.00	1.60	1.35	1.15	.95	.80	.70
6H6 JAN GE	.65	.50	.40	.30	.25	.20	.15
6J5WGT JAN PHILIPS	4.40	3.50	2.60	2.10	1.80	1.65	1.55
6L6GC PHILIPS	21.50	16.90	16.20	15.40	14.90	14.40	13.90
6L6WGB JAN PHILIPS	19.90	15.90	14.90	13.90	12.90	12.20	11.80
6SJ7 JAN GE METAL	1.15	.90	.80	.70	.60	.55	.50
6SL7WGT JAN PHILIPS	7.40	5.90	4.90	4.40	3.90	3.60	3.30
6SN7WGTA JAN PHIL	7.40	5.90	4.90	4.40	3.90	3.60	3.30
6SQ7 JAN GE	3.15	2.50	2.00	1.50	1.20	1.15	1.10
6U8a JAN	2.00	1.60	1.35	1.15	.95	.80	.70
6V6GT GE ( GLASS)	12.40	9.90	9.50	8.80	8.40	7.60	6.90
6X5WGT JAN PHILIPS	1.90	1.50	1.35	1.20	1.05	1.00	.95
12AT7WC JAN GE	6.15	4.90	4.40	3.90	3.25	2.90	2.70
12AU6 JAN PHILIPS	1.90	1.50	1.25	1.00	.90	.80	.70
12AX7WA JAN GE	9.65	7.70	6.50	5.90	5.40	4.90	4.50
12AX7WA JAN PHILIPS	9.65	7.70	6.50	5.90	5.40	4.90	4.50
12SG7 JAN RCA	1.00	.80	.70	.60	.50	.40	.35
12SH7 JAN	1.00	.80	.70	.60	.50	.40	.35
12SL7 JAN GE	1.25	1.00	.90	.80	.70	.60	.55
83 JAN GTE	8.75	7.00	6.40	5.80	5.50	4.90	4.65
829B CETRON	8.55	6.85	6.25	5.65	5.35	4.75	4.50
5656 JAN RAYTHEON	7.50	6.00	5.00	4.20	3.30	2.50	2.20
5750 JAN GE	1.00	.80	.70	.60	.50	.40	.35
5751 JAN GE	6.15	4.90	4.30	3.90	3.20	2.70	2.30
5814a JAN PHILIPS	3.75	3.00	2.75	2.50	2.20	2.00	1.90
6080WC JAN GE	6.15	4.90	4.40	3.90	3.40	2.90	2.60
6188 = MIL 6SL7	11.15	8.90	7.90	6.40	5.90	5.60	5.30
6189W JAN PHILIPS	3.75	3.00	2.75	2.50	2.20	2.00	1.90
6922 JAN PHILIPS	4.25	3.40	2.80	2.10	1.90	1.65	1.45
7581a JAN PHILIPS	19.50	18.00	17.25	16.50	15.75		

MASTER CARD/ VISA ACCEPTED • MIN. ORDER \$100.00 • ALL ORDERS SHIPPED F.O.B. N.Y.C.

# D.I.Y. Supplement

## Contents

All rights to the designs are reserved by World Audio Design Ltd. They are published for single use by private individuals. They are not to be used for commercial gain without prior permission from World Audio Design Ltd.  
Audio Publishing Ltd and World Audio Design Ltd accept no responsibility for accident or injury arising from the construction or use of any of the designs published. All of the projects in this supplement have gone through rigorous listening and test procedures. The performance and specification of these projects can only be guaranteed on kits bought directly from World Audio Design Ltd.

### KIT NEWS

If there's a new component or service out there of interest to the DIY hi-fi enthusiast, we'll have tracked it down to bring you the details here.

5

### BETTER BASS FOR THE QUAD ESL-63

Noel Keywood describes a special active crossover he developed to smoothly integrate Quad ESL-63 electrostatics with Celestion's open dipole SL-6000 subwoofer system.

7

### BOXMODEL

One of the best known loudspeaker enclosure design packages around. We take a look at the latest version - also watch out for Transmission Line BoxModel which we hope to review in the next DIY Supplement.

19

### AUDIO FAIR

We visited the Egham Audio Fair on the 1st October. Here's what we found and what we thought of the event.

21

### LOUDSPEAKER DESIGN COOKBOOK

Newly updated and now on its 5th Edition, is Vance Dickerson's Loudspeaker Design Cookbook. Is it still the best book for budding DIY 'speaker builders?

23

### ELECTROSTATIC LOUDSPEAKER DESIGN COOKBOOK

If you've always wanted to build your own electrostatic loudspeaker, this could be the book for you. Author Roger R. Sanders discusses the practical aspects of design and construction.

25

### DIY LETTERS

Tell us about your designs, theories or just write in for advice. Our team of experts are more than willing to comment and offer help.

27



# BILLINGTON GOLD VALVES/TUBES

Long known as specialists in rare tube brands, Billington Export provides a line of premium-grade valves to fill the increasing demand for hard-to-find tubes! BILLINGTON GOLD features specially tested valves selected for long life, low microphony and low noise. Versions with gold plated pins are available. BILLINGTON GOLD brand comes from a variety of countries around the world. We have carefully chosen the best manufacturer for each type, with an emphasis on the highest audio quality and product reliability. We stock one million valves including: BRIMAR, GE USA, GEC UK, MAZDA, MULLARD, RCA, RUSSIAN/SOVTEK, SYLVANIA, TESLA, TUNGSRAM and other rare brands, as well as sockets and CRTs.

## BILLINGTON GOLD

2A3	15.50
6L6GC	6.45
12AX7	5.25
300B	60.00
811A	12.00
845	33.00
6550A	11.50
E81CC	5.25
E81CC-01	9.50
E82CC	4.50
E82CC-01	8.50
E83CC-01	8.50
E88CC	7.50
ECC81	5.25
ECC82	4.50
ECC83	5.25
ECC88	6.90
EL34	9.95
EL84	3.60
KT66	9.50
KT88	18.50

## SOVTEK

5U4G	3.60	ECC83/12AX7WB	3.50
6L6WGC	6.00	EF86	POA
6SL7GT	2.50	EL34G	6.20
6SN7GT	4.95	EL84	1.99
12AX7WA	3.50	GZ34	5.40
12AX7WB	3.50	GZ34/5Y3GT	2.90
5881/6L6WGC	6.00		

## RUSSIAN

6AS7G	4.50
6B4G	27.00
ECL82	2.25

Try us for ALL Russian Valves

## CHINESE

300B Silvertone	60.00
ECC88	3.90
EL34	7.00

## OTHERS

6CG7 Yugoslavian	6.75	6336A Penta USA	58.50
6X4W Raytheon USA	3.60	ECC85 Tungstram	3.30
5751 (USE ECC83)		ECL86 Tungstram	3.45

## RARE BRANDS

3AMP1A Tungstram Hungary	32.40
5C-450A STC UK	259.35
5R4GY USA	POA
5Y3GT RCA	3.90
6BH6 RCA	2.48
6L6WGB Sylvania	15.00
6V6GT STC UK	POA
12BH7A GE	11.40
12E1 STC/ITT UK	POA
13E1 STC UK	135.00
85A2 Mullard	5.93
807 USA	POA
5687WA RCA	6.45
6550A GE USA	33.00
CV4003 Mullard UK	POA
CV4004 Brimar UK	POA
CV4024 Mullard UK	POA
DG7-32 Tungstram Hungary	32.48
ECC81 Mullard UK (CV4024)	POA
ECC82 Mullard UK (CV4003)	POA
ECC83/ECC803S Tesla	13.13
EF86 GEC UK (CV4085)	POA
GZ32 Mazda	8.00
GZ37/CV378 Mullard UK	POA
KT90 Yugoslavian	45.00
PL519 ECG Philips	5.95

## SOCKETS

Jumbo 4-Pin for 211, 845, etc.	11.50
Jumbo 4-Pin, Gold Plated, for 211	24.00
UX4 for 2A3, 300B, 811A, etc.	2.25
UX4 Large Locking Type for 300B	6.00
B5 UK	POA
UX5 McMurdo UK for 807	3.60
B7A for 6C33CB	3.23
B7G McMurdo UK, chassis, skirted	0.72
813 Ceramic	15.00
Octal McMurdo UK	1.20
Octal PCB, nylon	2.70
Octal PCB, foreign	1.20
B9A for ECC83, EL34, EF86, etc, suitable for pre-amps: - - Ceramic, skirted, chassis, screening can;	
Chinese	1.20
Russian	0.90
- PCB, gold pins	2.40
B9D Magnoval, chassis, for PL519	2.25

We supply sockets for all valves listed in this advertisement

## TOPCAPS

For 2C34, 807, etc	1.20
For 12E1, 5B-254M, PL519	3.60

## MATCHED TESTING

£2.00 Per Valve (£4.00 per pair)

All items in stock at time of going to press. Prices in GB Pounds and subject to fluctuation: please check before placing your order. We stock over 3000 valve types and 400 types of CRT. Please ask for our free 50 page catalogue of valves and/or our CRT catalogue.

Payment is accepted by:

ACCESS, AMERICAN EXPRESS, DEBIT CARD, JCB, MASTERCARD, VISA, Bankers Draft, Bank Telex, Eurocheque and Cheque (UK only)  
MINIMUM ORDER: UK £50.00 + VAT & Carriage. Export £100.00 (US \$150.00) + Carriage



1E GILLMANS TRADING ESTATE  
BILLINGSHURST  
WEST SUSSEX RH14 9EZ UK  
TEL: (0)1403 784961 FAX: (0)1403 783519  
VISITORS STRICTLY BY APPOINTMENT PLEASE

# KIT NEWS

## NEW MAPLIN CATALOGUE

The new Sept '95 - Aug '96 Maplin catalogue is now available. It is the biggest ever, containing over 1000 pages, and has several new sections. Of most interest will be the new Hi-Fi, TV & Video section, which includes several new drive units, two loudspeaker kits, new interconnect cables and more.

Maplin Electronics  
P. O. Box 3, Rayleigh,  
Essex. SS6 8LR  
☎ 01702 554161

## NEW SOLDER

A new solder has been developed allowing connections or parts to be soldered to existing joints without disturbing the solder underneath. The MCP137 solder melts at 137°C, lower than the normal 180°C of tin-lead, and is made from an alloy of bismuth and tin.

Mining and Chemical Products Ltd  
Rosemont Works,  
Alperton, Wembley,  
Middlesex.  
☎ 0181 902 1191

## AUDIO-LINKS COMPONENTS CATALOGUE

Audio-Links have just finished assembling their Autumn '95 catalogue. Packed full of components for the DIY audiophile, products include 10k-250kΩ Alps potentiometers, Ansar polypropylene capacitors, 99.99% silver wire, Elma rotary switches for stepped attenuators and input switching, custom wound transformers for valve or solid state designs and bulk foil resistors.

The catalogue is available for just £2 which includes p&p.

Audio-Links,  
7 Fairmont Crescent,  
Scunthorpe,  
N. Lincs. DN16 1EL  
☎ 01724 870432

## BURR-BROWN DIGITAL AUDIO DEVELOPMENTS

Burr-Brown have for a long time been very active in the field of digital audio. The current Burr-Brown flagship audio DAC is the PCM1702, intended for top end and professional audio systems. New activity is centred around the PCM171x Sound Plus range of low cost Delta-Sigma audio DACs intended for cost sensitive market areas. The core member of the range is the PCM1710 and all family members are based on this part. The PCM1710 accepts either 16 or 20 bit data and offers a typical dynamic range of 98dB and a THD+N of -92 dB. The PCM1712 is offered as a lower cost alternative to the PCM1710. The PCM1712 accepts 16 bit data and has a typical dynamic range of 94 dB and a THD+N of -87dB. The PCM1712 is packaged in a 28 pin SOIC and operates from a 5v supply.

Burr Brown,  
1 Millfield House, Woodshots Meadow,  
Croxley Centre, Watford,  
Herts. WD1 8YX  
☎ 01923-233837

All Burr-Brown products may be obtained from their distributor, Abacus Electronics on Tel: 01635 36222



# HART

## Hart Audio Kits - Your Value for Money Route to Better Sound

2 Penylan Mill, Oswestry, Shropshire, UK. SY 10 9AF  
Phone 01691 652894 Fax. 01691 662864

Hart Audio Kits and factory assembled units use the very best audiophile components in circuit designs by the renowned John Linsley Hood to give you unbeatable performance and unbelievable value for money.

We have always led the field for easy home construction to professional standards, even in the studios we were using easily assembled printed circuits when HART kits in America were still using breadboards! Many years of experience and innovation going back to the early Ormsdale and Bovey classics gives us incomparable design expertise in the needs of the home constructor. The current range of Hart kits is designed to give you all the components for a matching ensemble of audio excellence.



### K1100 AUDIO DESIGN 80 WATT POWER AMPLIFIER.

This fantastic John Linsley Hood designed amplifier is the flagship of our range and the ideal powerhouse for your ultimate hi-fi system. This kit is your way to get EX performance at bargain basement prices. Unique design features such as fully FET stabilised power supplies give this amplifier World Class performance with startling clarity and transparency of sound, allied to the famous HART quality of components and ease of construction.

Useful options are a stereo LED power meter and a versatile passive front end giving switched inputs, with ALPS precision Blue Velvet low-noise volume and balance controls. Construction is very simple and enjoyable with all the difficult work done for you, even the wiring is pre-terminated, ready for instant use. All versions are available with Standard components or specially selected Super Audiophile components at £25.00 extra per channel, plus £2.40 if you want to include Gold Plated speaker terminals.

K1100B Complete STANDARD Amplifier Kit	£395.21
A1100B Factory Assembled	£499.21
K1100SC Complete SLAVE Amplifier Kit, £	£333.62
A1100SC Factory Assembled	£422.62
K1100M Complete MONOBLOC Amplifier Kit	£261.20
A1100M Factory Assembled	£329.20
RLH10 Reprints of latest Amplifier articles	£4.50
K1100CM Construction Manual with full parts lists	£5.50

### K1400 AUDIOPHILE PREAMPLIFIER. A versatile ultra high quality preamp with no less than seven inputs, all switched by sealed high quality relays. Separate tape output selection Class "A" headphone output for two phones. Lo-Z long line drive facility.

Standard Kit	£343.49
K1400M Kit with Tri-range tone controls	£398.41



### "CHIARA" SINGLE ENDED CLASS "A" HEADPHONE AMPLIFIER.

First Module to appear in our new "2000 Range" of kits. This unit provides a high quality "phone output" for those many amplifiers that do not have one. Easily installed with optional link-through facility the unit draws its power from our new Andante Ultra High Quality linear toroidal supply. Housed in the neat, black finished, Hart minibox it features the wide frequency response, low-distortion and musicality that one associates with designs from the renowned John Linsley Hood. Pre-terminated interconnecting leads and PCB mounted sockets prevent supply polarity reversal and on-board diagnostics provide visual indication of supply line integrity. Volume and balance controls are Alps "Blue Velvet" components. Very easily built, even by beginners, since all components fit directly on the single printed circuit board and there is no conventional wiring whatsoever. The kit has very detailed instructions and even comes with a full set of Hart audiograde silver solder. It can also be supplied factory assembled and tested. Selling for less than the total cost of all the components, if they were bought separately, this unit represents incredible value for money and makes an attractive and harmonious addition to any hi-fi system.

K2100 Complete Kit	£109.50
K2100SA Series Audiophile version with selected audiophile components	£112.46
A2100SA Factory Assembled and Tested "Chiara"	£149.46

K3565 "Andante" Audiophile Power Supply Kit to suit	£65.42
A3565 Factory Assembled and Tested "Andante"	£128.41
Special Offer: Both Units in Kit Form together with SA version "Chiara" with mains and DC Supply lead	ONLY £184.91
Factory Assembled and Tested	ONLY £267.88

**K1450 MAGNETIC PICKUP PREAMPLIFIER KIT** - A totally discrete component implementation with the superior sound of the Short Feedback concept. High quality components fitting to an advanced double sided printed circuit board make this a product of the leading edge of technology that you will be proud to own. New boards will be using step by step instructions it is very easy and enjoyable to assemble. The higher current consumption of this unit means that it is best powered by our new Andante Ultra Power Supply, but an idealised piece of technology in a matching case. This requires the specially assembled and stabilised supply bank needed by any sensitive preamp and includes fully protected Hi grade toroidal transformer along with a special limited life electrolytic capacitor for best free operation. The K1450 is suitable for all moving coil and moving magnet transducers this unit is especially recommended for, and will extract the very best from the modern generation of low output high quality moving coil transducers. This microcircuit kit comes complete with all parts ready to assemble inside the fully finished 278 x 134 x 62mm case. Comes with full set of link instructions as well as the Hart Guide to PCB Construction, we even show in enough full Audiograde Silver Solder to construct your kit!

K1450 Complete Kit	£111.56
K1450SA Audiophile Kit	£133.94

Why not buy the reprints and construction manual for the kit you are interested in to see how easy it is to build your own equipment the HART way. The FULL cost can be credited against your subsequent kit purchases.



### ALPS "Blue Velvet" PRECISION AUDIO CONTROLS.

Now you can throw out those noisy ill-matched carbon pots and replace with the best hi-fi components only used selectively in the very top flight of World class amplifiers. The improvement in track accuracy and consistency is astounding, giving better tone balance between channels and rock solid linear stability.

### MANUAL POTENTIOMETERS

2-Gang 100K Lin	£15.67
2-Gang 10K 50K or 100K Log	£16.80
2-Gang 10K Special Balance, zero cross and zero centre bias	£17.46

### MOTORISED POTENTIOMETERS

2-Gang 20K Log Volume Control	£26.70
2-Gang 10K RD Special Balance, zero cross and less than 10% loss in centre position	£26.91

### SOLOERING

The size of modern components makes the right soldering equipment essential for good results. Everything we offer will allow you to do your own soloering. See our Lists for the full range.

845-820 XS240 ANTEX 240v 25w Soldering Iron. This is the ideal Hi-Fi people iron as the bit is designed to follow around the element giving the best heat transfer. This excellent design also means that although it is small and handy enough for modern components its heating capacity is better than larger ones of conventional construction.	£9.95
Excellent Value	£9.95
845-080 ST4 Lightweight Soldering Iron Stand. This has provisions for the ideal 40g sponge for bit wiping.	£3.95

### HART SUPER AUDIOGRADE SILVER SOLDER

Hart Super Audiograde Silver Solder has been specially formulated for the serious audiophile. Not only does it give beautiful easy to make joints but it is designed to melt at normal soldering temperatures avoiding the possibility of thermal damage to components or the need for special high temperature tools. It is very low residue so makes production easy but elements that need to be soldered together after assembly.

845-007 3mtrs 22SWG in Hart Mini Tube	£3.90
845-008 100g Reel Special Valve Grade 20SWG	£12.00
845-009 100g Precision PCB Grade 22SWG	£14.75
845-110 100g Reel Superfine 24SWG for ultra precise control and easy working	£11.45

### PRINTED CIRCUIT BOARD SOLOERING PRACTICE KIT.

Whether you are constructing a HART kit? This is your chance to try! Your HART Printed Circuit Board Soldering Practice Kit comes with a range of modern components a typical Hart quality PCB, a set of the correct grade of solder and full instructions. It enables the constructor who is uncertain of his or her soldering ability to put together and solder a printed circuit board that is held in movement. The instructions require the right technique and guide you to an absolute beginner through the soldering, desoldering, but in fact very simple, and testing a good soldered joint.

Excellent value for money at only	£4.99
Super value with full Silver Solder	£6.95

### TECHNICAL BOOKSHELF

**NEW "AUDIO ELECTRONICS"** - And now, not in the press, but another classic from the pen of John Linsley Hood following his enormous success as his "Art of Linear Electronics" the latest edition of the all new edition of "Audio Electronics", now entirely rewritten by the master himself!

Containing details of design and equipment in a world of electronics that demanded the quality of sound for which Linsley Hood is famous. It includes a complete amplifier, audio equipment understanding electronics both in its greater context over the important areas.

The subject covered includes audio, hearing, hearing, power output, signal, digital audio, and microprocessors and high speed analogue systems. John's lifetime of experience and personal involvement in this field show how to apply his gift of knowing to his subject that he can write about. And it makes it both interesting and comprehensible to the reader. Contains 140 pages and over 200 line drawings. The new book is a superb value for money at only

	£18.99
--	--------

### "THE ART OF LINEAR ELECTRONICS."

The definitive linear electronics and audio book by the renowned John Linsley Hood. This 300+ page book will give you an unparalleled insight into the workings of all types of audio circuits. Learn how to read circuit diagrams and understand amplifiers and how they are designed to give the best sound. The various and ways of passive and active components are explained and there are complete sections covering power supplies and the selection of noise and hum. An old world respect from this writer the history and evolution of audio amplifiers is covered in the chapters on direct and indirect coupled amplifiers.

Completely illustrated this book is a valuable reference for the amount of information it contains on the most neglected field of linear, as opposed to digital, electronics. Indeed it must be destined to become the standard reference for all who work in or are interested in this field. Cannot be read without with immediate effect.

1994 344 Pages 747 x 190 1Kg 0 7536 888 4	£16.95
---	--------

### DIGITAL AUDIO AND COMPACT DISC TECHNOLOGY

0 7536 0614 2	£17.95
---------------	--------

### INTRODUCING DIGITAL AUDIO CO. DATA SAMPLING

ISBN 167675 2 6	£7.95
-----------------	-------

### "THE ART OF SOLDERING" 0 8472 314 3 0

	£3.95
--	-------

### TOWERS INTERNATIONAL TRANSISTOR SELECTOR

0 572 0146 1	£19.95
--------------	--------

### "AUDIO F.A.H." BP111

	£3.95
--	-------

### "HOW TO USE OSCILLOSCOPES & OTHER TEST EQUIPMENT" R A Perrett BP267

£3.50	
-------	--

### "THE LOUSPEAKER DESIGN COOKBOOK" Steve Dackman 14m Exr 10-9624 191 7-6

£22.95	
--------	--

### ELECTROSTATIC LOUSPEAKER DESIGN AND CONSTRUCTION Ruediger Wagner BK16

£18.95	
--------	--

### "THE INTRODUCTION TO LOUSPEAKERS & ENCLOSURES DESIGN"

V. Owen BP266	£2.95
---------------	-------

### "LOUSPEAKERS FOR MUSICIANS" BP257

	£3.95
--	-------

### "THE HART PRINTED CIRCUIT BOARD CONSTRUCTION GUIDE" This is included FREE with all complete kits but available separately

	£2.50
--	-------

### VALVE & EARLY CLASSIC BOOKS

THE WTL BOOK David Money BRV11	£17.95
--------------------------------	--------

LOUSPEAKERS: THE WHY AND HOW OF GOOD REPRODUCTION G Briggs 1949 0	£8.95
---	-------

8574 1913 II	£8.95
--------------	-------

### MULLARD TUBE CIRCUITS FOR AUDIO AMPLIFIERS

BR4427	£13.95
--------	--------

### "THE WILLIAMSON AMPLIFIER" 0 9424 1916 4

	£6.95
--	-------

### AN APPROACH TO AUDIO FREQUENCY AMPLIFIER DESIGN GEC 195 1-802-09 05 2

	£18.95
--	--------

### AUDIO ATHOLOGIES includes three Audio Engineering Six volumes covering the days when audio was young and things were wild. BR444 1 to 6 All £13.95 each

A SIMPLE CLASS AMPLIFIER J.L.L. using M.M.I.E. 1969 RH12	£2.50
--	-------

Postage on all books unless stated is only £1.50 per book, maximum £4.50 for any number of books. Standard rates for heavy books including £2.50 for a small

No waiting! All HART books are normally in stock!

Ordering your HART kit is easy, simply post, telephone or fax your order anytime. Let us know what you require, with your name, address, cheque or credit card number and expiry date. Your daytime phone number is useful in case we need to get back to you. If you need further information on our kits just ask our FREE lists. Overseas order are welcome and we can send anywhere in the World. **Post on UK orders up to £20 is £1.50, over £20 - £3.50. Express Courier £10.**

QUALITY  
AUDIO KITS

24hrs AUDIO LINE  
01691 652894

ALL PRICES  
INCLUDE  
UK/EU VAT

# HART

# A SUBWOOFER FOR QUAD

**Prodded by yet another reader's request, Noel Keywood describes his adaption of the Celestion SL-6000 dipole subwoofer to match the Quad ESL-63 electrostatic loudspeaker.**

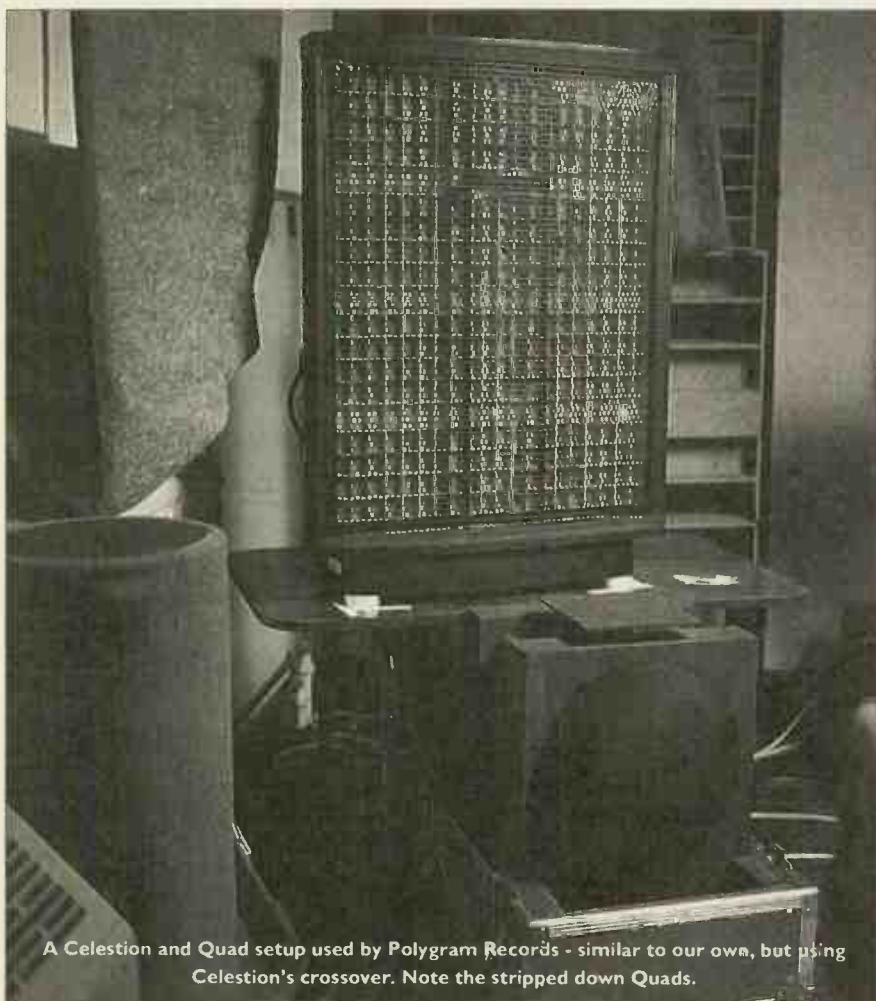

A Celestion and Quad setup used by Polygram Records - similar to our own, but using Celestion's crossover. Note the stripped down Quads.

**Q** I am a relatively new reader of 'World'. However, I have purchased some back copies from the 1991 era, including Issue No.1.

It is clear from the 1991 issues that a combination of the Quad ESL-63 and Celestion SL6000 was one for which you personally had a great affinity. The most interesting articles and correspondence in the March,

September and November 1991 issues are illuminating as to the potential of the SL6000 and convinced me that they would be worth enduring some pain in setting up in a listening room.

Theoretically speaking, the benefits of avoiding boxes for any speaker has to be a majorly positive factor in the quality of reproduction. The two speakers can apparently independently give outstanding mid and treble quality and

transparency (ESL) and bass depth (SL6000) unapproached by boxed subs. You do however point out eloquently in the November 1991 issue that there is a dropout zone between the two units (100Hz to 270Hz). You opined that you would be marketing a dedicated surface mounted electronic crossover to get over this problem.

My system comprises Micromega Stage I, Michell Argo/Hera, Quad 606/II and Celestion Ditton 44s, with my own constructed external crossovers (Solen caps & RATA inductors).

I have the following questions, to which I would be grateful for your answers:

Did you progress with the design and marketing of the crossover? Are there any other articles from past issues that comment on the above pairing? You write currently that you use modified ESL-63s in your listening tests. What modifications have you made? What differences in sound quality would I experience between ELS and ESL-63 speakers? Do you have any articles/reviews on the Gradient sub for Quad ELS?

**Jonathan Ling  
Blackheath,  
London.**

Since you want to "endure pain" I'm sure we can oblige! This project is painful, expensive, and frustrating in its obscure complexities. Anyone that makes it past the finishing post will reap rich rewards. What it gives you, I've confirmed by measurement, is a loudspeaker that runs from 5Hz smoothly up to 20kHz.



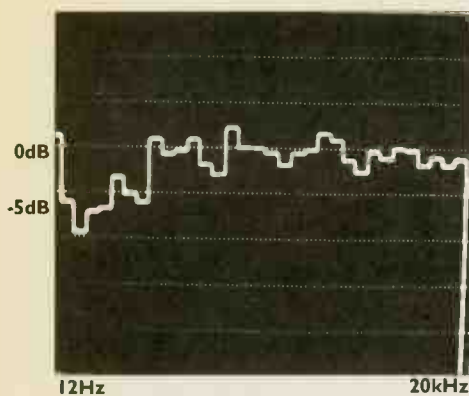

Frequency response of the Quad and Celestion together reaches down below the 12Hz of this analysis.

Better still, it isn't a barrenly theoretical achievement. The combination is truly awesome to hear; it really does offer a sound that is quite extraordinary, not just a different type of squeak.

We're talking about getting the best from the Quad ESL-63 electrostatic which, as enthusiasts will know, has one of the smoothest and most natural

difficulties remain. This project fell by the wayside originally when Celestion stopped making the SL6000 open dipole subwoofers. They were heavy and cumbersome (barely liftable), had a poor electronic crossover/EQ box and were expensive, so commercial success was eluded. In my view they are an interesting idea with loads of potential, but Celestion's iteration was compromised, if fantastic in basic performance.

Anyone wanting to assemble this hybrid all-dipole / no-box system will either have to find a pair of second hand SL-6000s or build their own equivalent. Since a simple bass dipole comprises a bass unit on a baffle, it isn't difficult, but experiment will be needed to tailor my crossover circuit to it. I believe there's enough information here to get you acquainted with the problems and the advantages of bass dipoles, a very rare and peculiar form of subwoofer with great strengths.

Electrostatics and open-dipole bass

pass) of the crossover has a lot of equalisation built in, so test equipment to measure frequency response is essential - not expensive these days.

Bought new this set up is costly. But there are a lot of Quad owners around who already have half of it. And there are enough Quads about for them to be available second-hand too. Although the bass section will need experimenting with, there are hours of fun here, plus a potentially great end result. All that's needed are a pair of hefty bass drivers if you build your own bass baffles - nothing too expensive. So overall cost depends very much upon circumstance. I shouldn't forget to point out that Celestion designed the SL-6000s to go with their SL600 monitors. Similarly, the bass section here could be used with dynamic speakers other than Quad's.

I found satisfaction in running a loudspeaker that achieved so much without a cabinet in sight. This radical proposition offers an appropriately different result, one that showed me just

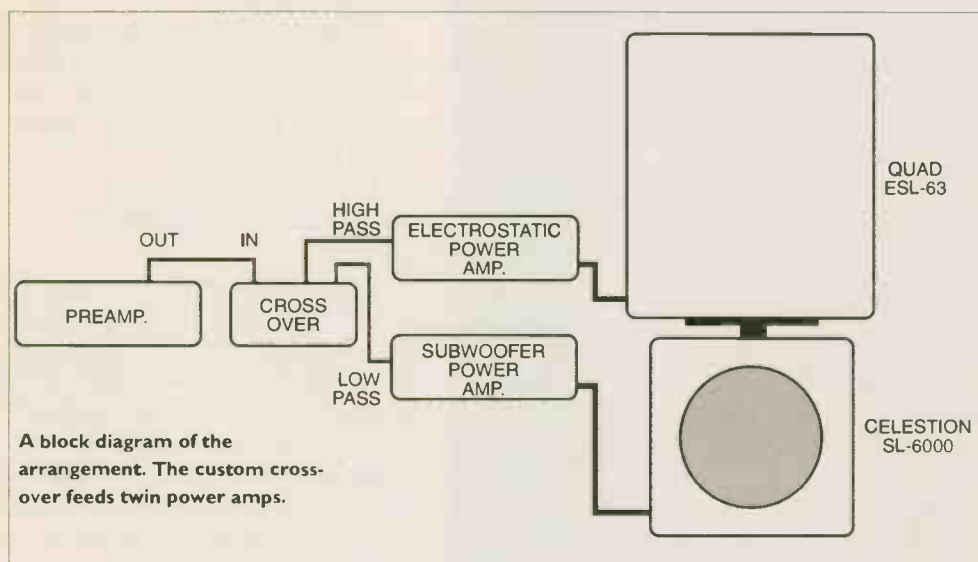

A block diagram of the arrangement. The custom crossover feeds twin power amps.

how many preconceptions characterise speaker design. Endless research has been carried out on enclosures of all sorts; that enclosures aren't necessary never gets consideration. It's quite an important realisation, one with some interesting commercial implications too. What if the Japanese developed and commercialised a speaker with no cabinet, using just a rigid plastic front instead? It would devastate the speaker market. I strongly suspect that the equalised dipole (open baffle) loudspeaker, with development, could be turned

into a commercially viable loudspeaker. The open-dipole subwoofer is a most peculiar beast. I know of very few manufacturers who've ever built or considered building such a speaker - and most that have walked away in the end! All credit to Celestion for trying. Here's a simple description of the operating principle and main features.

In principle the open dipole is just a bass driver mounted on a small baffle. There is no cabinet whatsoever. Below a frequency where the front-to-back distance of the driver, around the baffle

presentations of any loudspeaker, plus unmatched imaging. The subwoofer adds much needed bass, in this case including sub-bass down to the seismic movement zone. Furthermore, I carefully ensured bass signals were not handled by the Quad, allowing it to go louder without strain. The whole caboodle is larger than life in every sense.

Although the circuit published here took months of acoustics measurements and listening tests to develop (carried out back in 1991), some practical

units definitely have a future in our view. Although the subwoofer (low pass) section of my crossover is very specifically tailored for the Celestions, it could be modified for an open baffle subwoofer. However, this is entirely down to the home constructor.

To tackle this project you will need some knowledge of electronics and, probably, Don Lancaster's Active Filter Cookbook (contact Modern Book Co., Praed St., Paddington, London W2. Tel: 0171-402-9176). The bass section (low



## CELESTION SL-6000 DIPOLE SUBWOOFER

Specifications	
Type:	Double dipole low frequency array.
Drive units:	Two 12" dia. long throw ultra linear units.
Sensitivity:	Matched to SL600, adjustment available.
Dimensions:	Height (inc. SL600) 825 mm Height to stand top 455 mm Depth 536 mm Width 380 mm Base 310 x 380 mm
Weight:	Unpacked 76lbs 34.5kg Packed 86lbs 39kg

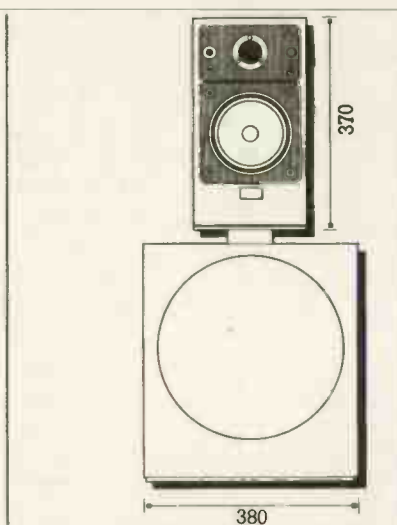

(twice baffle radius, or baffle diameter) is half the wavelength of the signal reproduced, cancellation between the forward and rear radiation (they are out of phase) starts to occur, causing output to drop by -6dB per octave. Since to hit 40Hz, the lower limit of most box speakers, would mean building a baffle 28ft in diameter, it's not surprising that most people opt for a closed box.

An alternative is to use a small baffle and apply compensatory +6dB/octave gain in the amplifier, to cancel out the acoustic cancellation. That's what Celestion did with the SL-6000, albeit using twin drivers and some unspecified (but patented) modification to improve performance.

The potential benefits of this system are fascinating. There's no tuned cabinet to impose its own sound and lower frequency limit. So bass output is even and reaches down low. In fact, the lower limit is set by the free air resonance of the driver. The SL-6000 did, as I've already explained, actually go down too low - to 5Hz! The only other unit to get close is the big REL Stadium subwoofer, by the way. So open dipole subwoofers are effective in this respect, ignoring other matters such as power handling, cone travel, etc.

The SL-6000 subwoofers came with their own crossover and equalisation box, which I found unsatisfactory. It was necessary to re-equalise the SL-6000 subwoofers to overcome certain problems; my crossover replaces

Celestion's. It's rather unusual, being a fourth-order section 'tuned' to meet various criteria, but it is reasonably simple electronically.

I investigated three main areas for this project:

- 1) SUBWOOFER-TO-QUAD MATCHING
- 2) OPEN BAFFLE SUBWOOFER EQUALISATION
- 3) OPEN BAFFLE SUBWOOFER ROOM ALIGNMENT.

### 1) MATCHING

#### Quad ESL-63

The Quad ESL-63 and the first ESL (57) have light bass because cancellation of forward radiation against backward radiation starts to occur at 260Hz, a frequency determined by the smallest panel dimension of 66cms (width). The rate of roll off depends upon positioning within a room, least loss occurring when placed on the floor and against a side wall, both of which can be thought of as panel extensions. On stands, however, the Quad's roll off in the bass is marked. There is some lift at around 90Hz where resonance of the driver/dust cover film

occurs. This augments what is otherwise a lean sound, adding a little extra weight.

I've drawn the ESL-63's low frequency response in outline (see diagram). It is a classic electrostatic response, by the way, not peculiar to the Quads. You can see from this that it is impossible to perfectly integrate a subwoofer. There'll always be lumpy bass and a very obvious mismatch between bass unit and Quad - that's one major reason why commercial subwoofers never blend in with ESL-63s. I tackled this problem by designing a second-order high pass filter with a little response peaking. This equalises the Quad's response, making it flat. The filter also acts to remove low bass which in turn improves the ESL-63's power handling. It keeps the internal audio step-up transformer away from core saturation, a mechanism Quad use to limit low frequency power to the

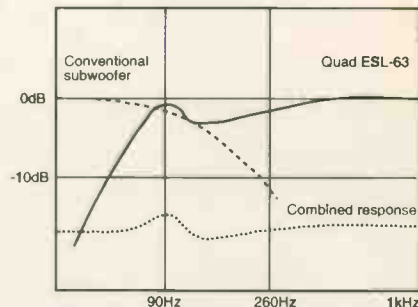

Quad ESL63 low frequency response and conventional subwoofer response (dotted line). They are impossible to combine perfectly.

speaker. The effect of the filter is, as the response shows, to give the ESL-63 a flat frequency response down to 180Hz or so, below which a -12dB/octave attenuation of low frequencies comes into play.

Rolling off the Quad at 180Hz prevents it from trying to handle low bass, which is a good thing. However, male vocals contain strong energy down to 80Hz, So any subwoofer used will, on occasion, have to handle vocal information - a potential problem. The Celestions did occasionally add a little colouration to deep male vocals. One way of minimising this effect is to use a subwoofer drive unit that is inherently

## IMPROVED STEREO DECODER FOR MONO VALVE TUNERS

Now with revised impedance matching, for wider separation, fuller bass and extended treble.

Experience REAL stereo from your Troughline, Quad, RCA, Rogers, etc. Just connect this great sounding decoder to the multiplex output from your mono tuner. Available as a mains powered boxed unit, or an easily assembled kit of parts, or a fully aligned module only. No special tuner alignment needed.

**Complete unit £48.50. Kit £28.50.  
Assembled module £12.50. (Inc. P&P)**

**STUDIO 12** Nanjivey Terrace, St Ives, Cornwall,  
TR26 1BQ. Tel: (01736) 798393

## Falcon Acoustics Ltd

incorporating Falcon Electronics Falcon Components

Send for our FREE price list PL24: Just send a large S.A.E. (36p stamp) or \$2 bill (air) overseas. Europe - \$1 bill or 3 International Reply Coupons (IRC)

New and updated FOCAL 'State of the Art' Kits  
FOCAL 'In-car' & JMLab Speaker Systems.

Increased range of SOLEN 400 & 630V Polypropylene capacitors.

DRIVE UNITS: by FOCAL, and a pick of the best from other manufacturers.

CROSSOVER NETWORKS - Active & Passive Components, Accessories, Large range of Capacitors + Falcon Custom-wound Inductors.

AUDIO AMATEUR PUBLICATIONS

Loudspeaker Design Cookbook, Recipes' Book, Mullard Valve Circuit, and many more - list in P/L. Back year sets of Speaker Builder, Audio Amateur & Glass Audio, plus the Audio Anthology Set.

COMPUTER PROGRAMS

Large selection of Programs available from the very comprehensive Liberty AudioSuite test program via AIRR and LoudSpeaker Ver.6, to the basic Bullock/White Boxresponse.

Also the IMP FFT Test Kit and the Mitley Mic Kit

Full details from

(Dept HFW) Tabor House, Norwich Road, Mulbarton, Norwich,  
Norfolk. NR14 8JT. Tel. (01508) 578272

the new

## CRICKLEWOOD ELECTRONICS

Very Interesting CATALOGUE

### ASTRONOMICAL RANGE AT DOWN TO EARTH PRICES

- TRANSISTORS + ICs + SEMICONDUCTORS
  - RESISTORS + CAPACITORS + INDUCTORS
  - SURVEILLANCE + SECRECY + SECURITY
  - PLUGS + SOCKETS + LEADS + CONNECTS
  - TV & VIDEO SPARES (inc Video Heads)
  - HIFI + DISCO + HIFI GADGETS + SPEAKERS
  - AUDIOPHILE COMPONENTS (inc Capacitors)
  - IN CAR AUDIO + SPEAKERS (inc Bass tubes)
  - COMPUTER ACCESSORIES + BOARDS
  - TOOLS + TEST EQUIPMENT + BENCHMARK
- & much much much more (over 10,000 lines).

SEND TODAY FOR THE VERY INTERESTING CATALOGUE

Pay by PO, Cheque, Credit Card or tape Coin to Paper

Please send me ..... copies of the 1995 Cricklewood Catalogue.  
I enclose £2.50 per copy (UK & Europe). £5.00 overseas

Name: .....

Address: .....

.....

.....

.....

Please Charge my Credit Card No. ....

Expiry Date ..... Tel No. .... HFW

**Cricklewood Electronics Ltd, 40-42 Cricklewood Broadway  
Lindon NW2 3ET Tel 0181 450 0995 Fax 0181 208 1441**

## AUDIO ENGINEERING

Our "type 15" is a medium-priced high performance 6 kilo single-ended output transformer, as used on our "musician" amplifier.

But with a series /parallel primary section, user set for a 300B or EL34/KT88/6550 output valve to match a 8 ohm load at 2500/3000 ohm to 8 ohm. With 130 milliamps DC. flowing through the primary the frequency response is level from well below 15 hz. to above 40 khz., with or without feedback. Thus allowing the accurate reproduction of large scale orchestral works with a large dynamic range.

The "type 15" has been used successfully as a replacement upgrade for various commercial amplifiers, and is now available for home constructors wishing to build their own amplifiers.

They are handwound in matched pairs, tested and guaranteed for one year. Priced at £180.00 per pair including carriage, insurance and VAT.

Also available are 2300/8 ohm, 2500/8 ohm, 3200/8 ohm, 3500/8 ohm, and 4000/8 ohm, 6 kilo dedicated single-ended output transformers priced at £170.00 per pair.

And of course our fully welded 1.5mm. mild steel blank chassis, the most popular sizes being ...

400mm. x 300mm. x 65mm, @ £30.00 each.

and

400mm. x 230mm. x 50mm. @ £50.00 per pair.

For more details on these and other items please send sae to P.J. Perry

**AUDIO ENGINEERING**

**57 Lyndhurst Drive, Leyton, London E10 6JB**

**Tel: 0181 558 4266**

### Get on our list - to get closer to this list.

- MIT MultiCap • Wonder Cap • Kimber Kap • Solo • Hovland MusiCap • Solen • Siemens
- Wima • Holco • Rel-Cap • Draloric • IRC • Allen-Bradley • Jensen • Resista • Vishay • Mills
- Caddock • Matsushita • TKD • Noble • Cardas • Kimber Kable • van den Hul • Discovery
- Audioquest • MIT • Alps • Bourns • Shalco • Elma • Electroschick • Nichicon • Gold Aero
- RAM • Mallory • Panasonic HFQ • Nichicon • Elna • N.O.S. • Ruby Tubes • UltraAnalog
- Burr-Brown • Crystal • Linear Technology • Analog Devices • Edison Price • Motorola • UCC
- International Rectifier • Hitachi • MagneQuest • Sonic Frontiers • Pearl • Tube Sockets
- WBT • Neutrik • Sound Coat • Curcio Audio Engineering • Assemblage and other kits

And it's growing and growing. To order The Parts Connection 1995 Catalog & Resource Guide, send £7 and mailing information. You'll also receive a Discount Coupon worth \$10 off a purchase over \$100 or \$25 off a purchase over \$250\* as well as *The Breadboard* bulletin to keep you updated on our latest news, information and growth spurts.

\*or \$10 US, or credit card information  
\*catalogue discounts are in US Dollars

### THE PARTS CONNECTION

A DIVISION OF SONIC FRONTIERS INC

2790 Brighton Road, Oakville  
Ontario, Canada L6H 5T4

Toll Free Order Line 1-800-769-0747  
(U.S. & Canada only)

Tel (905) 829-5858 Fax (905) 829-5388

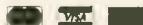



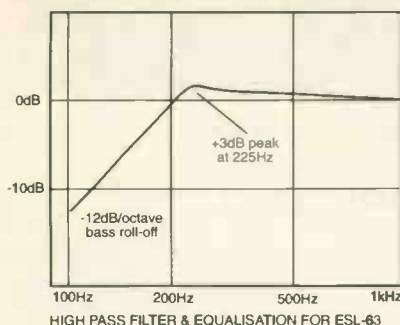

less coloured, always bearing in mind that the cone must be heavy if it is to have the low free air resonance needed for open-baffle working.

In the overall scheme of things, I didn't feel that occasional "chestiness" was anything more than a minor blemish in this set-up. But I've always accepted that the SL-6000s were far from perfect and needed development. Their prime role here is to demonstrate and confirm the merits of the open baffle dipole subwoofer.

**Celestion SL-6000**

Matching the Celestions to the Quads was even more problematical. Talking about colouration, Celestion would surely point out that the SL-6000s were not designed to work up to 180Hz, so what could I expect? Like most subwoofers, their own low pass crossover limits them to 100Hz, a sensible upper limit where true bass gives way to low-midrange, but not one that suits the ESL-63s, for reasons explained. This was less of a concern to me, however, than the complex matter of subjective "speed". Necessarily, to obtain a low free air resonance, the SL-6000s have heavy cones. I believe they were designed as guitar speakers, with heavy paper cones, a long throw and high power handling. Matching them in to the gossamer film of an electrostatic seemed as likely to work as perpetual motion.

Initially, I reasoned that these speakers could best be controlled by the use of motional feedback. Hah! That was false confidence. It took little more than a busy Saturday to find that a simple set-up is inherently unstable and liable to violent antics. Motional feedback senses cone movement and applies correction in a similar fashion to negative feedback. I wound a sensing coil onto the exposed front of an SL-6000's driver voice coil

former to derive a motion related signal.

This experiment was instructive, as well as dramatic. Instability was caused, Graham Bank of Celestion told me, by lack of a position reference. The result was an enormous crack from the cone as it attempted to leave the chassis on music peaks. Each time it did this the connecting braids carrying the signal from frame to voice coil broke, even though they were long enough to cope with the movement. It appeared they fractured under the enormous acceleration involved. Both Graham Bank at Celestion and Paul Mills at Tannoy have worked on motional feedback and between them convinced me that there were some deep seated difficulties in its application, explaining Philips' rapid withdrawal from the field back in the Seventies.

I noted then, in a demonstration at their headquarters in Eindhoven, Holland, that motional feedback gave the sort of fast, tight and even bass most enthusiasts dream about. That's just what I heard too from my own basic version: fantastic bass quality, provided I kept volume down, otherwise, the driver instantly destroyed itself!

However, my interest was, literally, academic. Analysing the (output) cone velocity signal against electrical input I found, not unexpectedly, that a lot of correction was being applied above 100Hz.

**2) SUBWOOFER EQUALISATION**

Similar correction could be applied passively by the use of equalisation in the low pass crossover network feeding the subwoofer and this is the reason for the peculiarly sharp response peaking above 100Hz you can see in the low-pass subwoofer feed. It injects high frequency energy (as far as bass frequencies go, that is) into the driver to add subjective "speed". Bear in mind that you don't hear this peak as such, because the drive unit cannot accurately reproduce it. It simply injects a little more energy where it is needed and is adjusted subjectively. I found +2dB or so about right for the Celestion drive units, but others may need more or less, according to their

abilities.

Another "speed" injection came from cutting out really low sub-bass frequencies. They contain a lot of energy and decay slowly in the room. This

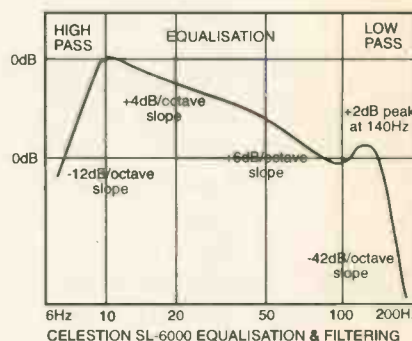

serves to give an impressive amount of physical presence to sound, but subjectively it weighs it down with lingering room boom. Believe it or not, the Celestion's go too low with the crossover supplied, which has no useful lower limit. My crossover applies tailored bass correction, with less emphasis on lower frequencies (i.e. around 40Hz), which compensates for room gain. It also incorporates a second-order (-12dB/octave) high pass filter at 10Hz to prevent record warps in particular overworking the system.

What you have to bear in mind is that the woofer cones are acoustically undamped and will flap around like crazy if given a chance. The high pass filter acts to limit cone excursion, necessary with this sort of sub-woofer. I managed to get adequately high sound pressure levels out of the SL-6000s though, although they will bottom if pushed too hard when strong subsonics are present.

Bass quality from these speakers varied considerably according to the power amplifier used to drive them; the SL-6000s were quite obviously a severe load. Trying to steady them by hand whilst working was impossible. They draw and reproduce quite staggering amounts of bass energy, shuddering in use, even though heavy and spiked to the floor. This vividly demonstrates just how much acoustic energy an open dipole subwoofer dissipates, although much of it is lost through cancellation.

The 120Hz peak equalisation applied to the SL-6000s is unique to them.

# LANGREX SUPPLIES LTD

DISTRIBUTORS OF ELECTRONIC VALVES, TUBES AND SEMI-CONDUCTORS AND I.C.S.

1 MAYO ROAD • CROYDON • SURREY CR0 2QP

24 HOURS EXPRESS MAIL ORDER SERVICE ON STOCK ITEMS

PHONE  
0181 684 1166

FAX  
0181 684 3056

A selection of our stocks of New Original Mullard - Brimar audio types made in UK.

STANDARD TYPES		SPECIAL QUALITY TYPES				
ECC81	MULLARD	6.00	A2900/CV 6091 GEC	17.50		
ECC82	MULLARD	6.00	E88CC - GOLD PIN MULLARD	8.50		
ECC88	MULLARD	6.00	E88CC SIEMENS GOLD PIN	8.50		
ECH81	MULLARD	3.00	E188CC - GOLD PIN MULLARD	8.50		
ECL82	MULLARD	3.50	ECC81 - M8162 / CV4024 MULLARD	6.50		
EF86	MULLARD	10.00	ECC81 - 6201 / GOLD PIN MULLARD	8.50		
EL33	MULLARD	10.00	ECC82 - M8136 / CV4003 MULLARD	6.50		
EL84	MULLARD	6.00	ECC83 - M8137 / CV4004 BRIMAR	6.50		
GZ32	MULLARD	8.50	EF86 - CV 4085 GEC	12.00		
GZ33	MULLARD	6.00	<b>AMERICAN TYPES</b>			
GZ34	MULLARD	15.00	5 R4GY RCA	6.00	12BY7A GE	7.00
6SL7GT	BRIMAR	4.50	6 FQ7/6CG7 SYL	7.50	6146B GE	15.00
6SN7GT	BRIMAR	4.50	6L6GC GE	12.50	6550A GE	20.00
6V6GT	BRIMAR	4.25	6L6WGB SYL	10.00	7027A GE	20.00
			12AX7A GE	7.00	7581A SYL	15.00

MANY OTHER BRANDS AVAILABLE

THESE ARE A SELECTION FROM OUR STOCK OF OVER 6000 TYPES. PLEASE CALL OR FAX FOR AN IMMEDIATE QUOTATION ON ANY TYPES NOT LISTED. WE ARE ONE OF THE LARGEST DISTRIBUTORS OF VALVES IN THE UK. SAME DAY DESPATCH VISA/ACCESS ACCEPTABLE. OBSOLETE TYPE A SPECIALITY.

OPEN TO CALLERS MON.-FRI. 9AM - 4PM. CLOSED SATURDAY

P&P 1-3 VALVES £2.00, 4-6 VALVES £3.00 ADD 17.5% VAT TO TOTAL INC P+P

VISA

Access

## The AP ELECTRONICS Route to Musical Happiness

### EXPERIMENT

With different interconnecting and loudspeaker cables

With SonicLink custom designed mains cables

By changing resistors and capacitors

With large power supplies

By applying simple modifications to improve your circuits

By bypassing high value capacitors with higher quality lower values

With mechanical damping of mechanical parts and electrical circuits

### LEARN

From your experiments

The features which give the best sound quality.

From knowledge gained through reading AP PERFORMANCE AUDIO

### MODIFY

Use the knowledge gained from experimentation

And from tips published in AP PERFORMANCE AUDIO

To rebuild your own amplifiers

To improve the sound quality of your system

To get greater enjoyment from your favourite music.

### BUILD

Build your own hi-fi equipment

From the excellent range of AP ELECTRONIC kits

### DESIGN

Design the equipment of your dreams

Make your dream come true with parts purchased from AP ELECTRONICS

## AP ELECTRONICS

Audiophile Parts at Affordable Price

1995 CATALOGUE now available - £4.95

(or FREE with your next £40 + order)

## AP PERFORMANCE AUDIO

The Journal of High Performance Audio Construction.

1995 Subscription (4 issues) - £5 (overseas £10)

Please make cheque payable to "AUDIOKITS"



CREDIT CARD TELEPHONE ORDER HOTLINE 01332-674929

(messages recorded when unattended - please give full details)

HOTLINE FOR FREE TECHNICAL ADVICE - TEL: 01332-674929

9-10am Mondays-Sundays

Derwent Business Centre, Clarke Street, Derby DE1 2BU

Tel: +44-1332-674929

Fax: +44-1332-298836

## TECHNICAL & GENERAL

Some Necessities - From the Original Classic Turntable Specialists

		P&P	
Connoisseur	BD1/2 Drive Belt	9.85	1.85
	BD1/2 Motor Suspension kit	13.75	2.25
	SAU.2 Headshell	16.75	2.55
	SAU.2 Connecting lead	15.95	3.55
	Standard Models		
Garrard	Wired arm tubes	from 12.75	2.55
	Cartridge camers (sliders)	9.25	1.85
	Idle Wheels	9.85	2.25
	301/401 Transcription Models		
	Original Thrust pad assembly	9.80	2.25
	Original Idler tension spring	2.95	1.85
	Original Speed control disc - 401	13.75	2.20
	Xeroxcopy Owners Manual 301 incl. full size mounting template	7.35	1.85
	Xeroxcopy Owners Manual 401 incl. full size mounting template	5.20	1.85
	Replacement intermediate drive wheel	19.95	2.85
	Replacement 301 control knobs On-Off/Speed select	pair 20.25	2.55
	Replacement 301 suppressor unit	5.65	2.25
	Replacement 301 motor pulley (-2%), (-1%), (Std), (+1%)	each 12.65	2.25
	Replacement 301 Chrome plated mounting bolts	set 3.70	1.85
	Recommended Lubrication set - early 301 or 301/401 (specify)	5.20	1.85
Goldring/Lenco	Idler wheel (lock-nut or clip fixing)	19.95	2.85
	Arm Pivot bearings with instructions	7.85	1.85
	Spindle/Main bearing assembly complete	22.85	3.85
	Headshells	from 21.95	2.55
	Instruction books	from 4.20	1.85
Thorens	TD.124 series		
	Idler wheel	19.95	2.85
	Drive belt	9.85	1.85
	Chassis spring suspension (replaces 'mushrooms')	13.85	2.55
	150/160 series		
	Drive belt	9.85	1.85
	Suspension springs (-1%), (Std), (+1%)	set 10.85	2.55
	Suspension bushes	set 12.50	2.25
	Armboards for most models	from 16.90	2.55
	Cecil Watts Dustbugs/Parastats/ (spares incl. Preener wicks)		

Cartridges and styli for 78s & Mono LPs in addition to current Stereo LP

TECHNICAL & GENERAL PO Box 53. Crowborough, E.Sussex. TN6 2BY Tel:- 01892 654534



Experimenters interested in this subject could use any large bass unit on an open baffle, or two in parallel to handle the power, and tune out the peak. Just bear in mind that the drivers must be big enough to move a lot of air. A fair amount of experiment will probably be necessary to get the bass sounding right, but a delight of the system is that it's amenable to tweaking. There's no driver/cabinet interaction to contend with, an overriding influence upon the sound of conventional cabinet loudspeakers. This makes the open-dipole subwoofer something of an experimenter's dream, but by now you may well be realising that they also have their problems and peculiarities - and in this section I haven't even talked about the need to tune them into a room. That's even more fun!

### 3) ROOM ALIGNMENT

There's one other big, big consideration which rarely gets talked about: tuning into the room. This is a peculiar process unique to the open baffle when it is used to deliver bass. It must be positioned and aligned correctly if it is to produce smooth bass, otherwise it will boom. In the few dipole speakers we have come across, including the Quad ESL-63, this subject is not even raised, let alone discussed, possibly because it is difficult to understand and resolve at a practical level.

Celestion decided to run room analyses on a computer for their customers to solve the problem. We tried to reach an empirical

understanding with our SL-6000s, finding only that in all the rooms in which we tried them they had to face outward for best results. The same should apply to Quads, by the way; they should give smoothest bass when facing outward, although I've never tried this. I suspect part of the reason why Quads give peculiar bass is because they are a non-optimally aligned dipole, facing inward to fire high frequencies toward a listener. Experimenters can, of course, easily move an open baffle for best results. Just bear in mind that this is a necessary part of running a dipole bass unit.

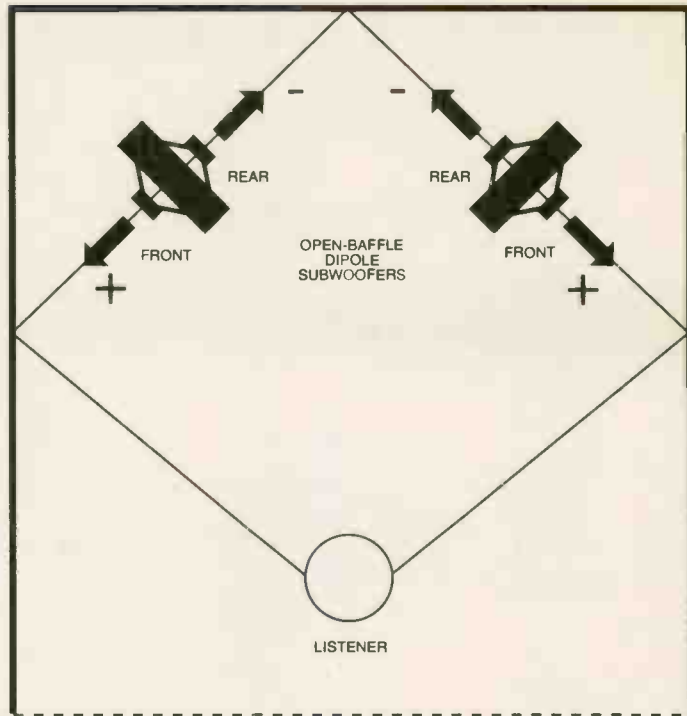

Within all the rooms in which we have used the Celestion SL-6000 subwoofers, best results were achieved with this orientation. We believe the rear wave reverses in phase and cancels at the opposing loudspeaker. While the front wave is heard by the listener the cancellation zones suppress diagonal room modes.

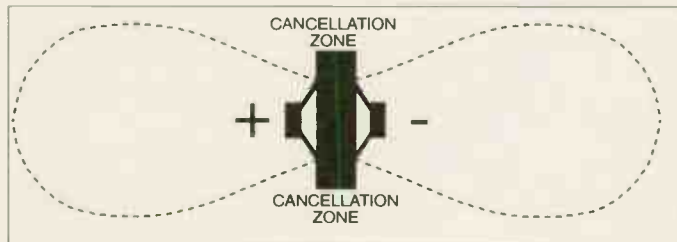

▲ A dipole radiates sound equally from front and rear, but 180 degrees out of phase. Where front and rear wave meet they cancel. This produces a 'dead' zone either side of the speaker. Both Quad and Celestion loudspeakers exhibit this characteristic.

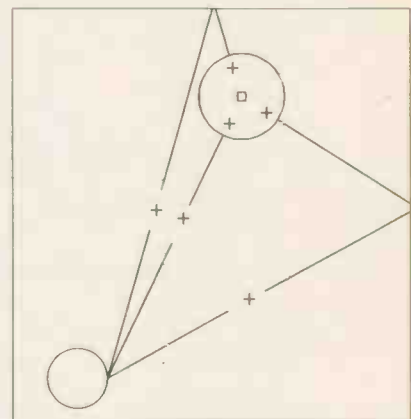

▲ A conventional monopole generates additive reflections off all walls. Their strength and phase depends upon speaker position. The result is unpredictable emphasis.

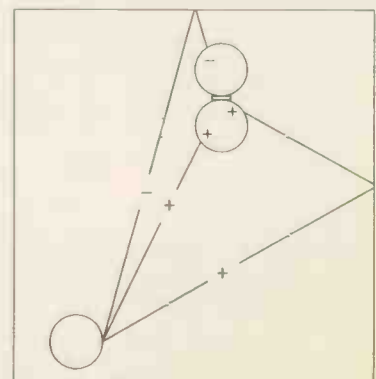

▶ A dipole can provide negative reflections and, properly arranged, this can be used to give a more balanced overall result in a reflective field like a room.

# CROSSOVER CIRCUITS

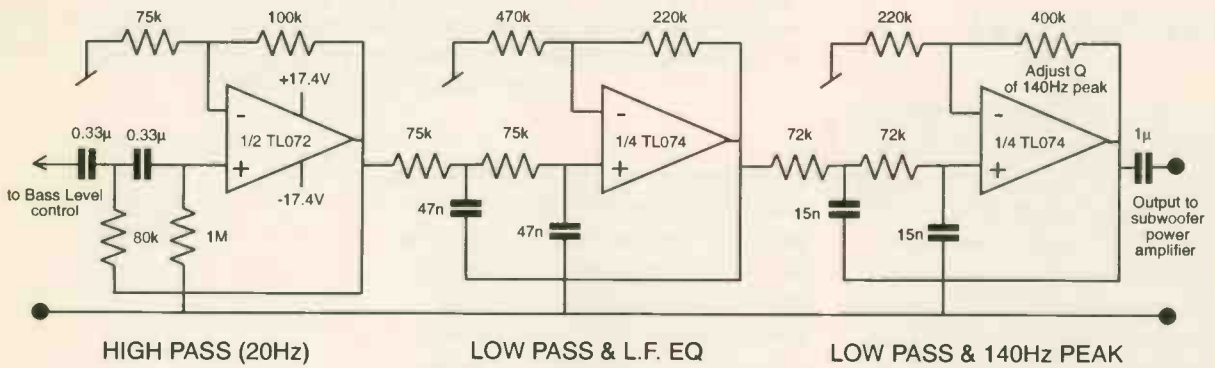
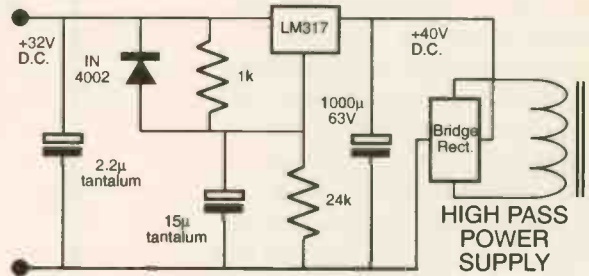
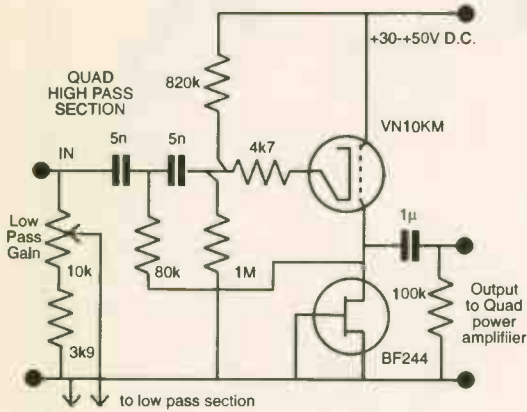

CELESTION SUBWOOFER LOW PASS SECTION

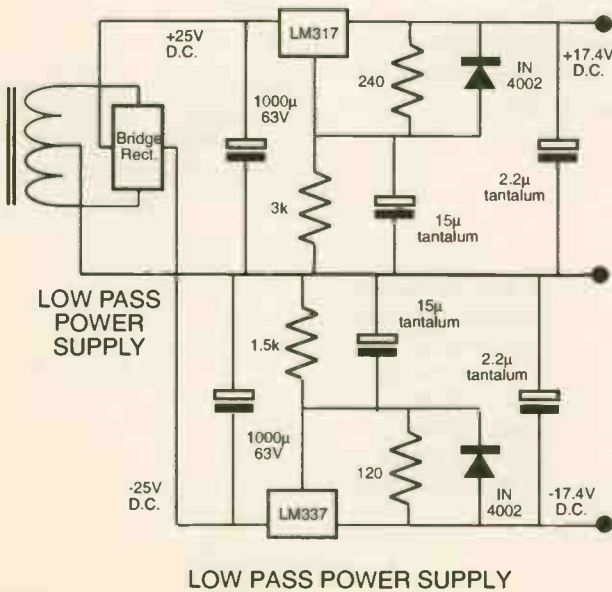

LOW PASS POWER SUPPLY





## QUAD HIGH PASS SECTION

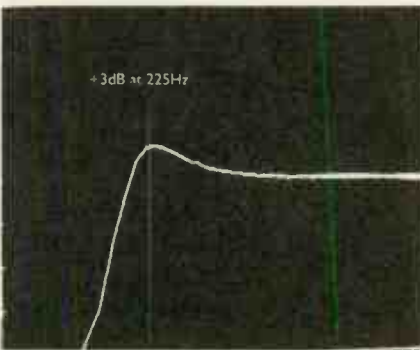

Most filters these days are, knocked up around a silicon chip. It's a fast and easy way of doing things, but not necessarily a satisfactory one. Cheap chips invariably have a sonic signature, something I wanted to avoid in the critical high pass section feeding the Quad. There are innumerable ways of designing such a circuit, but my notional ideal was to use just one high quality amplifying device.

I found that a remarkably high transconductance MOSFET, the VN10KM, offered what I wanted. This thing is a bit of a wonder for audio work, even if it is a pig to use, being almost 'naturally' unstable because of the gain available; a grid stopper must always be used if it is not to oscillate.

In the configuration used here as an active filter, the circuit has an overall gain of one, minimal noise, a very high

overload ceiling and negligible distortion at all frequencies and levels. It also has a high input impedance and a reasonably low output impedance, able to drive down to a  $4k\Omega$  load with  $1000pF$  in parallel. I measured a 124dB dynamic range. Quad enthusiasts can rest assured that this device is as transparent as one might hope, unlike chip-based filters.

Frequency response can be seen in our explanatory diagram and as an analysis from our spectrum analyser. A -12dB/octave high pass attenuation characteristic serves to prevent bass reaching the Quad, whilst the gentle lift that reaches +3dB maximum at 225Hz equalises the Quad's natural roll-off, giving it a fuller, richer and more balanced sound.

## CELESTION LOW PASS SECTION

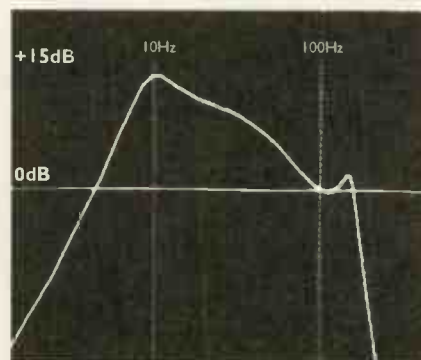

Because of the amount of filtering involved here, and the fact that a high level of transparency is not required for heavy bass cones, I used a set of TL072/4 silicon chips for the low pass section.

The circuit is a pretty straightforward arrangement with a second-order high-pass at 10Hz, followed by two cascaded second-order sections that combine to give equalisation and a fast, fourth-order, low-pass roll-off at 150Hz that can be tweaked to yield that vital 140Hz peak. Our diagram and spectrum analysis clearly show what this circuit provides.

Basically, an open baffle needs +6dB /octave bass lift to correct acoustic cancellation. However, room gain due to resonances, usually around the 40Hz-70Hz, must be taken into account, or over-heavy bass results I found. This is a benefit, because low frequency gain can be lessened. It needs to be kept in check if power handling is to be acceptable, and that's why I also included a second-order high pass filter.

I'd suggest you don't get too involved in the filter electronics, as so many engineers do. It is not necessary to use Butterworth responses, for example, in the face of massive imperfections elsewhere. This whole speaker is in fact a struggle to understand and tame various acoustic phenomena of some magnitude; pedantic electronic details are a distraction.

The bass low pass section feeds a power amplifier that in turn drives the SL-6000 subwoofers (or equivalent). This needs to be able to deliver a good 100watts. There are plenty of solid-state amps available second-hand for this purpose, or you could buy an NAD power amp new. They are very good value.

Remember that an open-baffle dipole subwoofer can produce enough bass to shake a building - but cones and power amps are put under severe strain if asked to do so.

In the next DIY Supplement we hope to have our own replacement for the SL6000s up and running, as well as a circuit board for active the crossover ●

Our thanks to Hi-Fi Experience Tel: 0171 580 3535, for the loan of Quad ESL-63s featured in the front cover photograph (ours don't look so smart without their grilles etc.)







# SERVICE MANUALS

We have what is probably the largest range of Service Information available anywhere. From the Earliest Valve Wireless to the Latest Video Recorders Colour Televisions, Test Gear, Audio, Computers, Amateur Radio in fact practically anything. Write Fax or Phone for immediate Quote.

Originals or Photostats as available

Also available. Our FREE catalogue detailing Hundreds of Technical Books and Repair Guides available.

**STOP PRESS**

Now Available. Our Service Manuals Index on P.C. Disc (3.5") for use on your Computer. Just £3.50 with FREE everlasting Updates. Order MP-285.

**MAURITRON TECHNICAL SERVICES (HFW),**  
8 Cherry Tree Road, Chinnor, Oxon, OX9 4QY.  
Tel: 01844-351694. Fax: 01844 352554.

Please forward your latest catalogue for which I enclose 2 x 1st Class Stamps or £3.50 for the Technical Books Catalogue plus Manuals Index on PC Disc(s)

NAME \_\_\_\_\_

ADDRESS \_\_\_\_\_

POSTCODE \_\_\_\_\_

If you do not wish to cut your magazine photocopy this coupon or use a separate sheet

## KEF CONSTRUCTOR SERIES

**Wilmslow**  
▼ Audio ▲

KEF Uni-Q Technology, the unique KEF driver design that delivers a sharply focused sound stage throughout a room, is now available to the home constructor.

KEF's Constructor Series of loudspeaker drive units and dividing networks, may be used in systems of your own design, or by following the KEF kit plans below:

**KEF Kit 60** - A two-way bookshelf/stand-mounted loudspeaker using a single 8" Uni-Q drive unit in a compact 18 litre reflex loaded enclosure. The DN60 dividing network allows bi-wiring/bi-amping.

**KEF Kit 80** - An 8" Auxiliary Bass Radiator augments the output of the main 8" Uni-Q driver used with a DN80 bi-wireable dividing network. This is a floorstanding loudspeaker with exceptional bass response.

**KEF Kit 90** - An 8" dedicated bass unit, 8" Uni-Q and DN90 bi-wireable dividing network give this three way floorstander extended bass output down to 35 Hz (-6dB).

KEF have designed a range of drive units and dividing networks which, with simple D.I.Y skills, can be transformed into State-of-the-Art loudspeakers capable of giving years of truly high-fidelity performance.

Kit	60	70	80
Boxed	£215	280	370
Total	£290	370	460

Free DIY speaker catalogue export £3.50



**KEF Kit 60**  
2-way bookshelf/  
stand-mounted



**KEF Kit 80**  
2-way floorstanding



**KEF Kit 90**  
3-way floorstanding

Dept. HFW  
Wellington Close, Parkgate Industrial Estate,  
Knutsford, Cheshire WA16 8XL  
Tel: 01565 650605  
Fax: 01565 650080

Open Tuesdays to Saturdays  
4 demonstration rooms

ACCESS VISA  
AMEX

# SPEAKER KITS FROM IPL ACOUSTICS

Over a 8 year period I.P.L. ACOUSTICS have developed a range of high quality speaker kits, using the best units from SEAS, MOREL, AUDAX, and I.P.L. and have produced a comprehensive range of speakers which will compete with the most expensive of commercial designs.

All speakers have biwired crossover kits containing high quality components and terminals.

**S5TL**  
TRANSMISSION LINE



PLUS KIT .....£331.00  
TOTAL KIT .....£446.00

**FIVE**  
TRANSMISSION  
LINE KITS

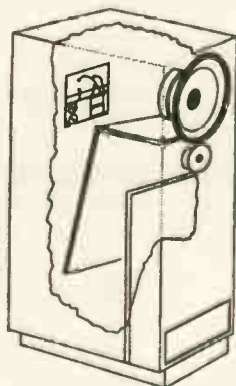

TRANSMISSION LINE  
PLUS KITS .....£166.00 -  
.....£331

**M3TL**  
TRANSMISSION LINE



PLUS KITS .....£166.00  
TOTAL KIT .....£225.00

**A2 H.D.A.**  
AEROGEL KIT



PLUS KIT .....£185.00  
TOTAL KIT .....£250.00

**S3TLM METAL**  
TRANSMISSION LINE



PLUS KIT .....£216.50  
TOTAL KIT .....£289.50

PRE-VENEERED CABINET KITS NOW AVAILABLE. Carriage charge extra on all kits.

If you would like further details please send large SAE with 36p stamp for PAGE SPEAKER BUILDING CATALOGUE, comprising VALUABLE ADVICE on DESIGNING, BUILDING, and TESTING speakers and full technical specifications including response curves of eight kits, drive units, and details of SPECIALIST CABLES and ACCESSORIES. KITS FOR A.V. USE NOW AVAILABLE.

**I.P.L. Acoustics, 2 Laverton Road, Westbury, Wiltshire, BA13 3RS. Tel: 01373 823333**



# BOXMODEL

## Dominic Baker tests Robert Bullock's computer program for loudspeaker design.

There is little to choose between most computer aided box design packages for loudspeakers. All use the tried and trusted Thiele-Small driver parameters and equations that predict the response of a driver in a given box. Some offer a more user friendly interface and better graphics, but all of them should give you the same results, if used with care.

So, you may ask "why another review of a loudspeaker CAD package?" Well the reasons are two-fold. The package covered here, BoxModel, written by Bob Bullock, is one of the most comprehensive I've come across at a reasonable price. It includes many extra facilities, such as being able to model active equalisation, but more of these later.

Also, there is another version of BoxModel, TL BoxModel, for transmission line loudspeaker box design, which we intend to review in the next DIY Supplement. The package reviewed here is an ideal grounding.

First things first: what's BoxModel like to use? Well, once you've used one of these packages, they're easy to pick up; I quickly had a response up and running on screen. Straight away, though, I found one little annoyance. To clear the drop down menus and move on to another section (i.e. once you have selected a driver to use and want to go on to decide whether to use a vented or sealed cabinet) you use the ESC key. Not a problem in itself, but if you touch the ESC key once too much, the program quits. Normally most packages prompt with 'are you sure. . . Y/N', which prevents such unintentional shut downs.

Apart from this inconvenience though, BoxModel is simple enough to use and has a good, logically laid out tree structure of menus. The instructions for BoxModel are all enclosed in README files on the program disk, so you'll need a printer to make a hard copy. The

HOWTO file gives four examples of complete system optimisations, each in 10 steps, which is extremely useful for first time users.

Now on to those features that make BoxModel one of the best at the price. It comes complete with specs. for 1074 drive units which have been pre-programmed in, including drivers from Audax, ScanSpeak, KEF, Focal, etc. This is great, saving a lot of monotonous data entry. When you have decided exactly which driver you want to use though, it is well worth checking the Thiele-Small

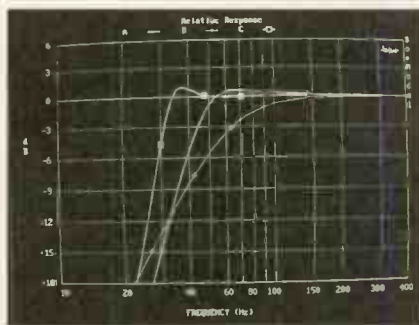

Typical low frequency response curves.

parameters. Errors on manufacturer's data sheets are fairly common. For those with reasonable maths skills and something like Bullock's own book, *Bullock on Boxes*, the parameters can be cross checked through the Thiele-Small equations.

Once you have selected the driver you want, it is a very quick process to get to a predicted response. For example, tell BoxModel that you want to use a single driver in a closed box with no equalisation, set the losses (default parameters are given in the HOWTO file) set input power, select Align (a useful command which optimises the cabinet for you to give the flattest response) and plot the response. The screen will show the predicted response for the data you have supplied.

But, along the way you are given

many more options which make BoxModel more comprehensive than most at this price level. Rather than using just a single driver, it is possible to model a pair of bass drivers wired in series or parallel and in a normal (vented or sealed) enclosure or isobaric type.

As well as sealed or vented boxes, it is also possible to model passive radiators (ABRs). You can also simulate 1st, 2nd or 3rd order active equalisation, something that is rarely used in domestic audio, but may be of interest to more ambitious experimenters.

BoxModel allows you to toggle between the Imperial system still in use in the U.S. and the European Metric system.

The losses within a vented system can be entered individually, QL - Leakage losses, QA - absorption from cabinet damping, and QP - port losses, which is really something for more advanced designs and designers. Normally, because QA and QP are low enough to be deemed insignificant (assuming that the port can vent freely and cabinet damping is thin), most packages rely on a 'typical' overall loss figure of 0.7 which gives accurate enough results. Here, default values for each of the losses in a vented system are given which yield this 'typical' value.

There are a few other facilities that BoxModel offers, such as modelling of a high pass warp filter, but most are going to be of little practical relevance to the home constructor.

BoxModel offers an affordable and comprehensive package that the user can learn and grow with. Some of the simpler packages around, although adequate, are easily surpassed when you get more experienced and adventurous. BoxModel should serve you through a wide range of designs at all levels, and as such is fine value.

Available from Marton Music,  
Masterson Ave,  
Read,  
Burnley,  
Lancs. BB12 7PL  
☎ 01282 773198



# Connect the dots.



Introducing The Parts Connection's first complete DIY kit: the Assemblage DAC-1 Digital Processor.

It comes in a small package (24cm x 5cm x 18cm chassis), but packs a big punch and a very musical sound. Designed for the rookie or first time kit builder, the only tools required are a pencil tip soldering iron, a screw driver, a wrench, a pair of electronics pliers, and a wire stripper or hobby knife. With only 21 solder joints and a handful of nuts and bolts, this kit goes together in one evening (typically about an hour). It's as easy as connecting the dots.

The parts quality is top notch. The board comes assembled and tested, implementing the Burr Brown 1702 DAC, a Crystal 8412 input receiver, an NPC 5813 digital filter, Analog Device's AD844 and 847 op amps and a custom potted toroidal power transformer.

At \$449 US, the Assemblage DAC-1 offers an outstanding value in digital conversion and comes with a *Satisfaction Guarantee* (return it with-

in 30 days of purchase for a full refund) and an *Assembly Guarantee* (if you can't get it running, we will!). We challenge you to find a DAC anywhere near this price with better measured performance, component quality, and most importantly, sound quality. Call us for more specific information on the performance or construction features.

To order the DAC-1 kit or to order The Parts Connection 1994 Catalog (for £3), full of a lot of other exciting stuff (including a \$10 US discount coupon good on your first order over \$100 US), send us your request and mailing address - or call with credit card information.

A S S E M B L A G E

**THE PARTS CONNECTION**  
A DIVISION OF SONIC FRONTIERS INC

2790 Brighton Road, Oakville, Ontario, Canada L6H 5T4  
Telephone 0101-905-829-5858 Facsimile 0101-905-829-5388

Toll Free Order Line 1-800-769-0747 (U.S. & Canada only)

## Vintage Audio

### Valve Data Book

FED UP WITH TRYING TO FIND THOSE ELUSIVE VALVE DATA BOOKS? THE SIMPLE FACT IS THEY DON'T EXIST ANYMORE!

THAT'S WHY WE ARE PRINTING OUR OWN. WE HAVE SPENT 3 YEARS COMPILING THE MOST INFORMATIVE AND COMPREHENSIVE DATA BOOK EVER.

THE **Vintage Audio** RECEIVING TUBE MANUAL IS 500 PAGES OF DATA ON OVER 18,000 VALVES, INCLUDING SCHEMATIC DIAGRAMS ON AMPLIFIERS FROM 3 WATTS TO 250 WATTS, PUSH PULL TO SINGLE ENDED, POWER SUPPLIES FROM 150 VOLT TO 1500 VOLTS STABILISED. DATA ON POWER TETRODES, PENTODES, TRIODES, DIODES RECTIFIERS ALL THE DATA YOU WILL EVER NEED IS IN THIS BOOK!  
TO ORDER YOUR COPY

PLEASE CALL - or - FAX US ON  
TEL & FAX

**(01239) 891448**

**Vintage Audio**  
BRYNHLYGEN

EGLWYSRW, CRYMYCH,  
DYFED, WALES. SA41 3UJ

OVERSEAS DISTRIBUTORS SOUGHT PLEASE CALL  
(PRINTED TO ORDER ONLY)

**Vintage  
Audio**



Amplifier Tube Manual



Sowter Transformers have been used by the Professional Audio Market throughout the world for at least the last twenty - five years.

Using modern technology and Computer Aided Design we are now able to offer a complete design and manufacture service.

Our current lists show a range of over 50 output, 70 power transformers and nearly 30 chokes.

**E.A. SOWTER LTD**  
P.O. BOX 36, Ipswich IP1 2EL  
SEND S.A.E. FOR DETAILS  
Tel: 0473 252794. Fax: 0473 236188

# THE 1ST EGHAM AUDIO FAIR

visited by Noel and Dominic - who describes the event.



**H**eld at Egham Youth & Community Centre on the 1st October and arranged by Graham Tricker of GT Audio, the Egham Audio Fair was an event worth attending, especially if you're into valves and vintage audio. I got a fantastic looking Nitrogen filled analogue voltage meter, reading up to 500V for a project I'm working on and a handful of vintage books, one on radio techniques by Scroggie, who was a great Wireless World writer in the 1950s, and a valve data book compiled by A. M. Ball, all at bargain prices.

Here are some of the other interesting items we spotted.

► Based on the Audionote Ongaku circuit, this home built single-ended 211 amplifier using Audionote transformers attracted a crowd. No one dared ask the price though!

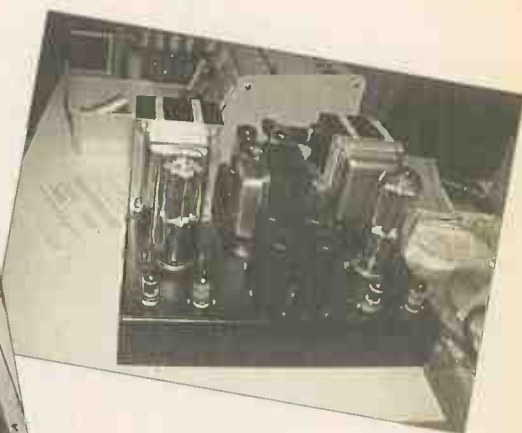

▼ A mixture of old and new here. This amplifier was home designed with modern transformers and components, but uses vintage PX25s in fixed-bias, single-ended working. This must be one of very few amplifiers in use using these extremely rare, but gorgeous looking PX25s.

▲ If you want to re-create a vintage circuit, Audio Fairs like this are the place for original components. Here's a box of unused and original transformers including those from Parmeko, offered by Sussex Surplus. And below a selection of original valves, including GEC KT66s, Mullard GZ32s and the increasingly scarce GZ34s. ▼



▲ A Mullard 5-10, probably built in the 60s. Mullard published their designs (we sell the re-printed book today) so many transformer manufacturers of the time wound to Mullard's specification so that DIYers could build their own.



► Even if you can't afford a complete amplifier using these rare and sought after valves, for between £5 and £15 you could take home one mounted to a wooden plinth. And don't worry, the valves used for these ornaments have all served their useful electronic life span ●



◀ Scott's stereo decoder is regarded by many as one of the best vintage designs around. This Type 335 decoder in absolutely superb condition was going for £175.





# Musical Oasis Co

An Oasis for the home constructor

- > Pair matched valves at low prices.
- > Quality loudspeaker drive units from top manufacturers like:- Morel, Seas & Kar.
- > Exclusive distributor for Keswick Audio magnesium alloy bass, midrange units.
- > Custom wound & standard range of high quality inductors.
- > Passive crossover components.
- > High performance loudspeaker cables & interconnects from major brands.
- > Loudspeaker up-grade components and helpful hints.
- > Treat your system to some real kick ass bass! Now available our new active sub bass kits for Hifi or Home cinema use.

Everything you need to build your own high quality Hifi, A.V, Home Studio or P.A loudspeaker system.

Please call to order your 1996 catalogue.  
Tel/ Fax (01977) 671823  
Mobile (0421) 507842

## HOVLAND • MUSICAP®

new distribution for Europe

### Coupling Caps

value uF	voltage	1 to 9 uk retail inc vat	10+ uk retail inc vat
0.010	1600	£8.34	£7.09
0.022	1000	£8.24	£7.00
0.033	600	£6.75	£5.74
0.047	1000	£9.76	£8.29
0.10	400	£7.15	£6.08
0.10	600	£9.54	£8.11
0.15	400	£9.22	£7.84
0.22	400	£9.69	£8.24
0.22	600	£12.01	£10.21
0.33	600	£15.29	£13.00
0.47	400	£10.32	£8.77
0.47	600	£17.71	£15.05
0.68	400	£14.28	£12.13
1.0	400	£18.45	£15.68
1.5	100	£12.82	£10.90
2.0	400	£23.15	£19.68
2.2	100	£15.94	£13.55
2.2	200	£19.40	£16.49
3.0	200	£22.93	£19.49
4.7	100	£23.15	£19.68

### Speaker Caps

value uF	voltage	uk retail inc vat	uk retail 10+ inc vat
1.0	100	£13.93	£11.84
1.5	100	£16.63	£14.13
1.8	100	£17.03	£14.47
2.0	100	£18.93	£16.09
2.2	100	£19.63	£16.68
2.7	100	£20.13	£17.11
2.7	200	£25.93	£22.04
3.0	100	£26.33	£22.38
3.0	200	£20.73	£17.62
3.3	100	£23.10	£19.63
4.0	100	£25.50	£21.67
5.0	100	£28.54	£24.25
6.0	100	£32.20	£27.37
7.0	100	£34.07	£28.96
8.0	100	£36.89	£31.36
9.0	100	£39.74	£33.78
10.0	100	£39.74	£33.78

OEM, TRADE AND RETAIL ENQUIRIES WELCOME

Ben-Dor, Lumb Carr Rd, Holcombe, Bury, Lancs, BL8 4MN, England.

Tel/Fax: +44 (0)1706 823025

SJS Electroacoustics

HAND WOUND INTERSTAGE, OUTPUT AND MAINS TRANSFORMERS FOR VALVE AMPS



Renhold  
cures  
his  
jitters!

...thanks to  
the Audio  
Technology  
'Sorcerer  
DAC'



20 Bit Colinear DAC • 24 Bit Floating Point Digital Filtering Full Kits • Sync-Lock for Zero Jitter • Precision Case Modular • Silver Wired/Soldered • Audiophile Components

For details of this and other kit/built products, send A4 SAE to:  
AUDIO TECHNOLOGY LTD, PO Box 147, BEDFORD, MK41 8PR

## DIGITAL STORAGE OSCILLOSCOPE

**\$230.**

The O-SCOPE is a pocket size module that plugs into a PC's printer port and turns it into a DSO, Spectrum Analyzer, Freq. Counter, DVM and Data Logger. Accepts standard probes.

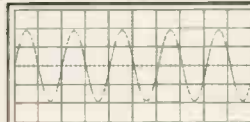

SINE WAVE

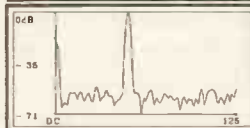

SPECTRUM

Operating parameters easily adjustable and continuously displayed. Bandwidths to 22 KHz for the O-Scope I and to 250 KHz for the O-Scope II which also features phase measurement and external trigger capabilities. DOS print screen or log to disk.

O-Scope I, Single Trace \$230.  
O-Scope II, Dual Trace 390.  
Probe, x1, x10 30.  
Sound Level Meter 55.

Prices include software, cables, power supply, instructions and U.S. Airmail shipping cost.

ALLISON TECHNOLOGY CORP.  
8343 Carvel Houston, TX. 77036 U.S.A.  
Tel: 713-777-0401  
Fax: 713-777-4746  
BBS: 713-777-4753

Pay by VISA, MasterCard, American Express or Bank Wire Transfer.  
Satisfaction Guaranteed.



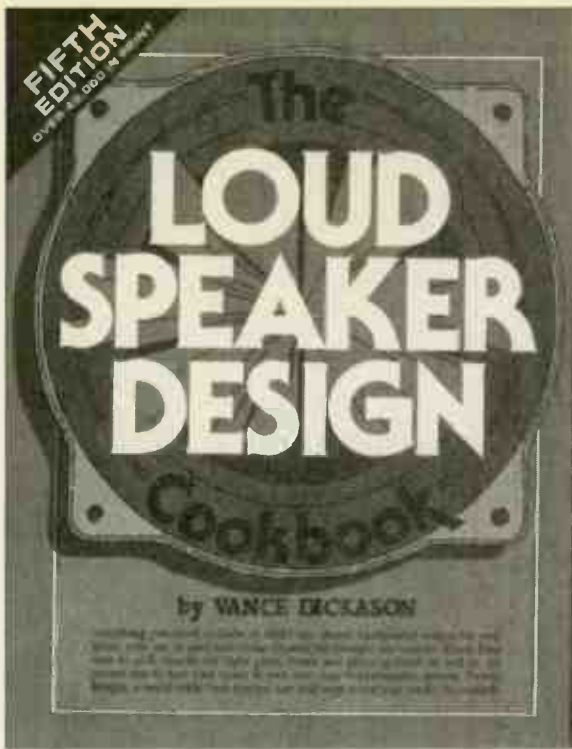

# THE LOUDSPEAKER DESIGN COOKBOOK

5th Edition, by Vance Dickason

Reviewed by Dominic Baker

**T**he Loudspeaker Design Cookbook has long been popular amongst DIY loudspeaker builders. It is written, like many American publications, in a chatty style that is easy to understand and digest, and is certainly better geared towards readers who actually want to build something, unlike more theoretical publications.

The new 5th edition, reviewed here, includes two new chapters, on Home Theatre and Car Audio Sound. These are as well covered as any I've seen, especially on Home Theatre which carries some very useful information for those that are interested.

We are more interested in the main body of The Loudspeaker Design Cookbook though, which covers a wide range of loudspeaker design and construction problems. The introductory chapter covers the basic drive unit and how it works. Unfortunately, for beginners to completely understand this short chapter they will need to be familiar with principles of electricity and magnetism - an A-level physics text book should give you the grounding needed. However, a lot of this first chapter will be irrelevant to practical DIYers; for example, fringe field effects for different pole geometries and different shorted-turn configurations, which are more to do with driver design than loudspeaker system design.

The next three chapters concentrate on the classic areas of sealed, vented and passive radiator systems, giving tables for

various alignments. If you have the basic Thiele-Small data provided by the driver manufacturer, it is relatively straightforward to plug the figures into these design tables. Even if you don't have the Thiele-Small data for a driver, a chapter later on is dedicated to measurement techniques used to extract them.

It always surprises me to see such attention devoted to Passive Radiator systems, since there are few commercial designs and only a handful of ABRs available to the home constructor. It seems especially odd when transmission lines (far more interesting as a design and popular amongst commercial manufacturers and home constructors alike) are skated over in four pages and some of the rarer, but more intriguing concepts such as isobaric, horn and open baffle are nowhere to be found. I suspect this is because the mathematical treatment of passive radiators is very similar to that of vented systems, so it is easy to generate such information.

Nowadays there are some very cheap computer packages that will model your design for you, saving you lengthy maths and use of tables, as well as being faster and more flexible. "What if I don't have a computer?" I hear you say. Well, if you simply want to optimise your driver to a cabinet, the book *Bullock on Boxes* is a better bet. But if you want to design your own crossover too, this is where The Loudspeaker Design Cookbook has the edge.

Chapter 7 deals comprehensively

with passive crossover theory. This will give the hobbyist a good insight into how to manipulate crossovers to give the effect they desire. But beware! Without some form of test equipment this is not a simple task. It is hard to know where to aim if you don't know where you're starting from, and all too often subjective tests can be misleading due to amplifier/loudspeaker interaction and lack of prior experience.

The Loudspeaker Design Cookbook covers many aspects of loudspeaker design and construction and as such is a valuable reference book to have on your shelves. For more involved design work though, aiming towards a practical design, I feel that home constructors would be advised to take a look at some of the more dedicated works around or some of the superb CAD packages available.

*Bullock on Boxes* is a better read if you want to design your own cabinet, and practical circuits for active crossovers can be found in far more useful depth in The Active Filter Cookbook. And Liberty's IMP test system is simple, cheap and the measurements it's capable of generating will get you far closer to your ideal loudspeaker than any number of books.

However, the Loudspeaker Design Cookbook will give you a good insight into what is involved in designing a loudspeaker, and if carefully digested will guide the reader towards selecting good drive units that will match the system you intend to build, which can be half the battle ●

# AUDIO LINKS

**SUPPLIERS OF HIGHEST  
QUALITY COMPONENTS**

## NEW PRODUCTS

### CUSTOM WOUND TRANSFORMERS & CHOKES

- Exceptionally high quality items for valve and solid-state designs at realistic prices.

### AUDIO - LINKS, "THE GREEN" INTERCONNECT CABLE

- Now available in kit form. All the parts you need to make your own reference interconnects at a fraction of the cost.

**TEL: 01724 870432/764804**

Mon. to Sat. 10am - 7pm

**AUDIO LINKS**

**7 Fairmont Crescent, Scunthorpe  
North Lincolnshire, DN16 1EL**

## BD ELECTRONICS

9 SCRIPSTON GILL, BRANDON, DURHAM, DH7 8BQ

TEL/FAX: 0191 3780193

### TANGO OUTPUT TRANSFORMERS

(THE HEART OF THE WORLDS BEST AMPLIFIERS) SECONDARY IMP 4,8,16 OHMS

MODEL NO.	WATTS	P.IMP	FREQ. RESPONSE	APPLICATION	PRICE
X-10S SE	40W	10K/70mA	20Hz - 55KHz -2dB	211, 845, VT4C	713.00
X-2.7S SE	40W	2.7K/100mA	15Hz - 80KHz -2dB	300B, 2A3	678.00
XE60-2.5 SE	30W	2.5K/90mA	20Hz - 100KHz -2dB	300B, 2A3	455.00
X-3.5P PP	120W	3.5K	4Hz - 100KHz -1dB	300B, KT88,	678.00
XE 60-5 PP	60W	5K	4Hz - 80KHz -1dB	6L6GC, KT88,	480.00
XE 60 3.5 PP	60W	3.5K	4Hz - 100KHz -1dB	EL 34, 6550A	455.00

OTHER TYPES AVAILABLE ON REQUEST

### TAMURA TRANSFORMERS

SECONDARY IMP. ALL 16, 8 & 4 OHMS EXCEPT F2004 16, 8 OHMS

MODEL NO.	WATTS	P.IMP	FREQ. RESPONSE	APPLICATION	PRICE
F2004 SE	8W	5K/100mA	30Hz - 80KHz -2dB	PX25, PX25A, DA-30, 50	340.00
F2007 SE	10W	3K/100mA	10Hz - 60KHz -2dB	300B, 2A3	340.00
F2020 PP	50W	3.5K	10Hz - 100KHz -2dB	300B, EL34, KT66	385.00
F2021 PP	50W	5K	10Hz - 80KHz -2dB	KT88, 6L6GC, 6550A	385.00

### MAGNEQUEST TRANSFORMERS

MAGNEQUEST TRANSFORMERS (HAND WOUND WITH OXYGEN FREE COPPER)

SECONDARY IMP. ALL 16, 8 & 4 OHMS EXCEPT F2004 16, 8 OHMS

MODEL NO.	WATTS	P.IMP	FREQ. RESPONSE	APPLICATION	PRICE
DS025 SE	25W	2K5/60mA	30Hz - 20KHz -1dB	300B, 2A3	215.00
DS050 SE	25W	5K/40mA	30Hz - 20KHz -1dB	PX25, PX25A, DA-30	215.00
DS 025 SE	25W	2K5/60mA	30Hz - 20KHz -1dB	300B, 2A3	755.00
DS025 HAS UPGRATED CORE AND WOUND WITH HIGH PURITY SILVER WIRE AND KIMBER SILVER LEADOUTS					
FS030 SE	40W	3K5/60mA	30Hz - 20KHz -1dB	300B	340.00
FS045 SE	50W	3K/60mA	30Hz - 20KHz -1dB	300B, 2A3	465.00
FS006 PSE	40W	1K25/120mA	30Hz - 20Hz -1dB	300B, 2A3 (PARALLEL SE)	340.00

### BLACKGATE CAPACITORS OTHER VALUES AVAILABLE

VALUE	SERIES	APPLICATION	PRICE	
47uF x 2	500V	SIKZ	VALVE PSU	52.50
100uF x 2	500V	SIKZ	VALVE PSU	82.00
2200uF	100V	BG N	VERY LOW ESR, NON POLARISED, USE IN	230.00
4700uF	35V	BG N	PAIRS IN L-CANCEL PAIR CONFIGURATION	110.00
1000uF	25V	BG NX	FOR VERY LOW NOISE	22.50
680uF	35V	BG NX	POWER SUPPLIES	24.50

### MISCELLANEOUS

VV - 388 POWER TRIODE (NEW 388B)	High Vacuum, Ua max 550v, Ia max 100mA, Guarantee 2K Hrs/1 yr	264.00
20W TO220 Metal Film Non Inductive Resistors	DR22, DR47, 1R, 2R2, 3R3, 4R7, 10R, 22R, 33R, 47R	3.45
	100R, 220R, 330R, 470R, 1K, 2K2, 4K7, 10K, 15K	3.45

ADD £2.50 DELIVERY AND THEN VAT TO ORDERS

RING FOR FULL CATALOGUE OF HIGH GRADE AUDIO COMPONENTS, NEUTRIK, DELTRON, LARGE SELECTION OF GOLD PLATED CONNECTORS XLR, PHONO, 4mm, MULTICONTACT. SEMICONDUCTORS, SOLDER, ETC.

# 'A CLASSIC ON A CLASSIC'

Well made aluminium chassis at less cost than a good set of valves!

Why not treat your valves to a sound base?

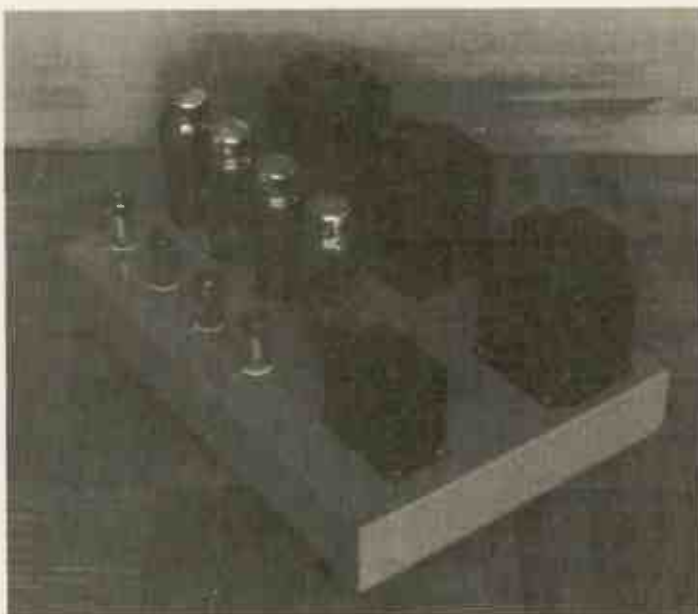

CHASSIS  
COMPANY

Please Send  
38p A4 SAE  
for details to:  
VCC, P.O BOX 36,  
LETCHWORTH,  
HERTS. SG6 2UR

by Roger R. Sanders.

# THE ELECTROSTATIC LOUDSPEAKER DESIGN COOKBOOK

Reviewed by Noel Keywood

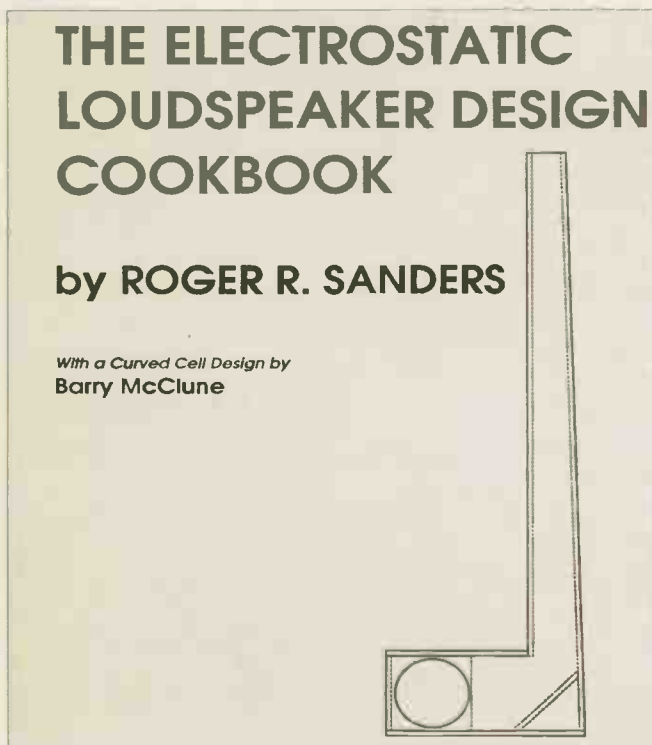

far enough to get some acoustic action - or a blinding flashover.

This is one of the world's most obscure and arcane hobbies; it is also one of the most complex - and a little dangerous too. The audio drive, when stepped up to a few kVs, as it must be, has enough punch to kill, even if the polarising potential doesn't.

I have to admire a book like this, for the subject is a notoriously

difficult one. All through, author Roger R. Sanders, whilst chivying the reader on, discusses all the compromises that have to be considered. With a background that, he claims, includes working on "thousands" of 'speakers for customers of the ESL Clearinghouse (his own U.S. enterprise, it seems) it's obvious he has broad experience of the practical problems.

This Cookbook attempts to provide a comprehensive grounding in electronics theory, but skates through the entire field at an alarming pace. It does the same for conventional subwoofers, which appear in this book because the author is firmly of the conclusion that they must be used with electrostatics. I tend to agree. Happily, the rapid fire nature of these chapters is

balanced by the rare value of the book's core content.

And this is where the Cookbook scores. Down-to-earth practical in a way that only American authors can be - but which others should take more note of (especially Brits) - this book tells you in "screw this to that, and glue that to the other" terms just how to build an electrostatic loudspeaker. It's 100% a hands-on enthusiasts book, rather than a theoretical tome, which means just about anybody will get the drift of the discussion.

Brits may run into supply problems with raw materials, but you can always contact the author by writing or phoning him at the ESL Clearinghouse in Oregon (USA), since he bravely provides contact details in the book. I could find no mention of all-American wonders like Uncle Elmer's Hickory Glue, but you are asked to find Du Pont Mylar, Lincaine, Glyptol, Krazy Glue and Hot Stuff. I started to smile when I saw that you also need Popsicle Sticks - getting those could be embarrassing.

It's rare to find so much practical information and experience in one book. I was fascinated to see confirmation of something I have discovered by measurement, that open-panel ESL response falls off below 280Hz (according to panel size) then peaks back up at 90Hz. The author suggests use of equalisation as one solution to this problem, which was my conclusion, as I explain in our DIY Supplement this month. The need for subwoofering is also discussed, because of the extreme difficulties of making electrostatics that will work at low frequencies.

I was disappointed to see absolutely no round-up of electrostatic theory at all; one chapter hidden away at the end of the book would have been better than none. But the author does say specifically that his book is theory and maths free, so the omission is intentional.

The Electrostatic Loudspeaker Design Cookbook has to be great value for anyone interested in building such a loudspeaker. It contains an enormous amount of information for the enthusiast and is as easy to read as could be possible. Since much information is just about unavailable elsewhere it's excellent value. A wacky book, but a must ●

**O**f all the obscure and wacky things to do, building your own electrostatic loudspeaker must be one of the most far out.

Electrostatics represent the outer limits of hi-fi, although they've always been revered for their promise of near perfect reproduction. It's a promise rather than a reality though, which simply serves to keep ever-hopefuls trying (I've started building one too). For that ardent band of experimenters, mostly American it seems, here's yet more help on what sort of Clingfilm to use (sorry, Du Pont Mylar type S), how many kilovolts are needed to polarise it (10kVs is adequate, 20 will have you cookin' - literally), and what sort of transformer will give you a 50:1 step-up so you can swing the polarising potential



# KIT & COMPONENT SUPPLIERS

## LOUDSPEAKER KIT SUPPLIERS

### Falcon DIY Speakers

Falcon Acoustics Ltd. Tabor House, Norwich Road, Mulbarton, Norfolk NR14 8JT. Tel. 01508 578272  
UK distributors of FOCAL drive units, Kits, In Car and JMLab speaker systems plus SOLEN (SCR - Chateauroux) polypropylene capacitors and the largest audio inductor manufacturer in the UK. Stocking Audio Amateur Publications and Computer software. Comprehensive range of D.I.Y Speaker kits, Parts, Accessories and Books.  
Please send large SAE (36p) for free price list "Everything but the wood"

### Audiocab

9 Skew Bridge Close, Wootton Bassett, Swindon, Wilts. SN4 7DW. Tel: 0793 848437.  
Loudspeaker cabinet kits are the speciality of "AUDIOCAB". Whether you are prototyping your own loudspeakers or working to a design published in Hi-Fi World, including the KLS3, "AUDIOCAB" will produce a bespoke kit to your specification. "Biscuit jointing" is used to ensure perfect alignment of adjacent panels and cabinets are dry assembled and sanded before dispatch. David Barfield, proprietor, says "no prior experience of woodworking will be required to build our kits and achieve a professional finish". Kits will normally be supplied in 25mm unfinished MDF but any finish is available and designs are usually enhanced by the use of mouldings to escape from the normal "square box". Ready built cabinets can also be specified. Professional, trade and retail enquiries are invited.

### Wilmslow Audio

Wellington Close, Parkgate Trading Estate, Knutsford, Cheshire WA16 8DX  
Tel. 0565 650605 Fax. 0565 650080  
Extensive range of drive units and over 30 different designs of self-assembly kit. Two 'ATC' kits now available. Drive units include those from KEF, Dynaudio, Audax, SEAS, Peerless, Scanspeak and Morel. Everything required for the loudspeaker builder and four dem rooms to listen to the kits in built-up form. Two new kits from Morel - one 3 litre, magnetically shielded, one 11 litre book shelf.

### IPL Acoustics

2 Laverton Road, Westbury, Wilts BA13 3RS. Tel. 0373 823333  
IPL supply a range of eight speaker kits using drive units from SEAS, Morel, Audax, Visaton etc. including four transmission lines to suit all room sizes. We also supply a full range of drive units, capacitors, and cabinet accessories as well as silver plated P.T.F.E. insulated cables.

### UPLIFTING SOUNDS - Tel: 0121 777 4196

Offers assistance in the design and construction of loudspeakers and audio furniture. From innovative to stylistic talk through your ideas with an enthusiast and choose your own level of involvement.

## VALVE AND OUTPUT TRANSFORMER SUPPLIERS

### P.V. Tubes

104 Abbey Street, Accrington, Lancs. BB5 1EE  
Tel. 0254 236521/232611 24 hrs a/p. Fax. 0254395361

For all your electronic components. Valves are new in branded boxes and matched pairs are available. Pls call for types and prices. We are closed all day Wednesday.

### Vintage Valves,

PO Box 147, Station A, Vancouver B.C. Canada, U6C 2M3. Fax (604) 876 5876.  
Dynaco, Sherwood, Scott, The Fisher, McIntosh, Eico, Harmon Kardon, Heath, Altec, Stromberg- Carbon. Many vintage parts and equipment available on request.  
Wilson Valves  
28 Banks Ave., Golcar, Huddersfield, West Yorks HD7 4LZ.  
Tel. 0484 654650/420774. Fax. 0484 655699.  
Mail order. Call us to find out more about our extensive range of valves. Over 1,000 different types stocked. S.A.E. for list. (Please mark for Dept. HFW).

Langrex Supplies Ltd  
1 Mayo Road, Croydon,

### Surrey CRO 2QP

Tel. 081 684 1166 or fax. 081 684 3056  
One of the largest distributors of electronic valves, tubes and semi-conductors in the UK by original UK and USA manufacturers. Obsolete types are a speciality. Telephone or fax for an immediate quotation.

### Billington Export Ltd.

IE Gillmans Trading Est., Billingshurst West Sussex RH14 9EZ  
Tel. 01403 784961 or Fax. 01403 783519  
Billington Export Ltd. holds large stocks of audio valves including many obsolete brands such as Mullard, GEC, Bnmar etc. as well as Sovtek, Thermanic Gold Brand and the recently introduced Billington Gold range. Also Cathode Ray Tubes (eg. used in Marantz tuner 10B). 50 page catalogue available. Tel or fax for a quotation. Minimum order £50.00 UK. £100 export.

### PM Components

Springhead Enterprise Park Springhead Road, Gravesend, Kent DA11 3HD. Tel. 0474 560521  
P.M. Components Ltd are the specialist component company for High End Audio enthusiasts. We have a design and manufacturing base for audio valves and associated products and have a capability to produce custom tubes for major manufacturers. Our 70 page catalogue is available at £2.50 including UK postage. P.M. Components are major stockists for Golden Dragon, Mullard, GEC and Teonex valves and have a vast archive of vintage tubes gathered from every manufacturer in the world.

### Chelmer Valve Company

130 New London Road, Chelmsford, Essex CM2 0RG. Tel 0245 265865 Fax. 0245 490064.  
Supplier of premium range of audio valves, other valves and components also available. (Please see our ad on outside back cover of this supplement)

## RESTORATION

GT Audio 5 Upper Road, Higher Denham, Bucks UB9 5EJ. Tel. 0895 833099  
Professional repair/restoration of all hi-fi including classic and vintage equipment. Supplier of very high quality electronic components, in particular types which are difficult to source. Original valves available, i.e. Mullard, Brimar, GEC, GE, RCA, Sylvania etc.

## COMPONENT SUPPLIERS

Hart Electronic Kits Ltd Penylan Mill, Oswestry, Shropshire SY10 9AF  
24 Hr sales/enquiries. Tel. 0691 652894  
A range of Audiophile kits for 80 watt Power Amplifiers, Tuners, Pre-Amps and Moving Coil/Moving Magnet RIAA Pickup Preamps. All kits are fully engineered, with our thirty years design experience for easy constructions from circuits by John Lindsey Hood, the most respected designer in the field. Send for lists.

### V.R.R.

30 Melbourne Ave, Worthing, BN12 4RT. Tel: 01903 501158  
Vintage Radio Restoration  
We can provide mains transformers, chokes and single-ended or push/pull output transformers as well as silver cable, paper-in-oil capacitors and other goodies all at reasonable prices. Our 30w monoblock short kit is only £299!

### AP Electronics

20 Derwent Centre, Clarke Street, Derby, DE1 2BUT  
Check out the AP ELECTRONICS 1994 catalogue. It's free with every order of over £40.00 or can be purchased for a £4.95 cheque payable to 'AUDIOKITS'. Over 80 pages include pre and power amplifier kits, high grade audiophile resistors, capacitors and semiconductors, audio and main cables, gold and rhodium plated connectors and COMPONENT NOTES on using high grade parts. A quarterly newsletter 'AP PERFORMANCE AUDIO' has been recently launched and your first issue is free.

### RushAudio

126 Station Rd., Tempsford, Sandy SG19 2AY. Tel. 01767 640779 Fax. 01767 640617  
RushAudio stock high quality British made

polypropylene capacitors (630V dc) ideal for PSU applications. 30uF (100mm x 50mm dia.) £22; 40uF (100 x 63) £27, 50uF (100 x 63) £32; 100uF (125 x 76) £55. Cabbage. 1 capacitor £2, 2 - £4; 3 or more - £6. Unfortunately VAT is extra on total of goods plus carriage. Cheque with order appreciated for prompt delivery.

## Audio Synthesis have in stock the following audiophile components:

A large selection of Vishay Bulk Foil Resistors, WBT audio connectors for pre and power amplifiers, Teflon insulated high purity SilverWire in various diameters, pure silver interconnects and speaker cables. Kits are available for the original PASSION and ProPASSION passive controllers and attenuators. For 1996 brochures and full details please contact: Audio Synthesis  
PO Box 100, Ilkley, West Yorkshire LS29 9XW  
Tel: 01943 600404 Fax: 01943 600383

## Audio-Links

7 Fairmont Crescent, Scunthorpe, North Lincolnshire DN16 1EL.  
Tel. 01724 870432 / 764804  
CUSTOM WOUND TRANSFORMERS & CHOKES  
- Exceptionally high quality items for valve and solid state designs at realistic prices.  
AUDIO LINKS "THE GREEN" INTERCONNECT CABLE  
- Now available in kit form. All the parts you need to make your own reference interconnects at a fraction of the cost.  
Vast range of highest quality electronic components and accessories for the D.I.Y. enthusiast. VAT incl. prices, mail order and a friendly service. Open Monday to Saturday 10am - 7pm

## Chassis Company

PO Box 36, Letchworth Hertfordshire SG6 2UR  
Tel/Fax: 01462 671594  
Suppliers of high quality classic style welded Aluminium chassis, designed for DIY Audiophile constructors. Our modular chassis is also very suited to semiconductor pre/power amplifier applications. Check out our PTFE sheet at £24 inc per sheet 150x30x5mm. Please send 38p A4 SAE for details.

## Russ Andrews Audiophile Components

Edge Bank House, Skelmersgh, Kendal, Westmorland. LA8 9AS  
Tel. 01539 823247 Fax. 01539 823317  
World leading supplier of the highest quality premium grade components. If you want the very best sounding resistors, capacitors, inductors, volume controls, wire etc. send for our 1994/95 catalogue. We also have a range of our own design of amplifiers, pre-amps, speakers and CD players built with our components. To receive your copy of our 1994/95 catalogue just mail, phone or fax the address above.

## VINTAGE DIY

Loricraft Audio  
4 Big Lane, Goose Green, Lambourn, Berks RG16 7SQ. Tel. 0488 72267  
Specialist restoration of 301's and 401's using genuine spares and re-manufactured parts to original pristine standards in our newly built workshops designed primarily for these purposes.

## CLASSIC TURNTABLES

Technical & General  
P.O. Box 53, Crowthorpe, East Sussex TN6 2BY. Tel. 0892 654534.  
The original specialist source of spares, restorations and overhauls for the classic turntables. Years of actual experience and comprehensive range of parts (originals and re-manufactured), manuals, ancillaries. No dubious 'improvements' - no harmful 'modifications'. Our specialities: Connoisseur; Garrard; Goldring; Lenco, S.M.E. Thorens; Watts; Ortofon; Shure; Cartridges and stylus for 78s, Mono LPs, Stereo LPs.

**YOU CAN ADVERTISE IN THIS SECTION FROM AS LITTLE AS £30 A MONTH**  
**CALL 0171 289 3533**  
**OR**  
**01245 443555**

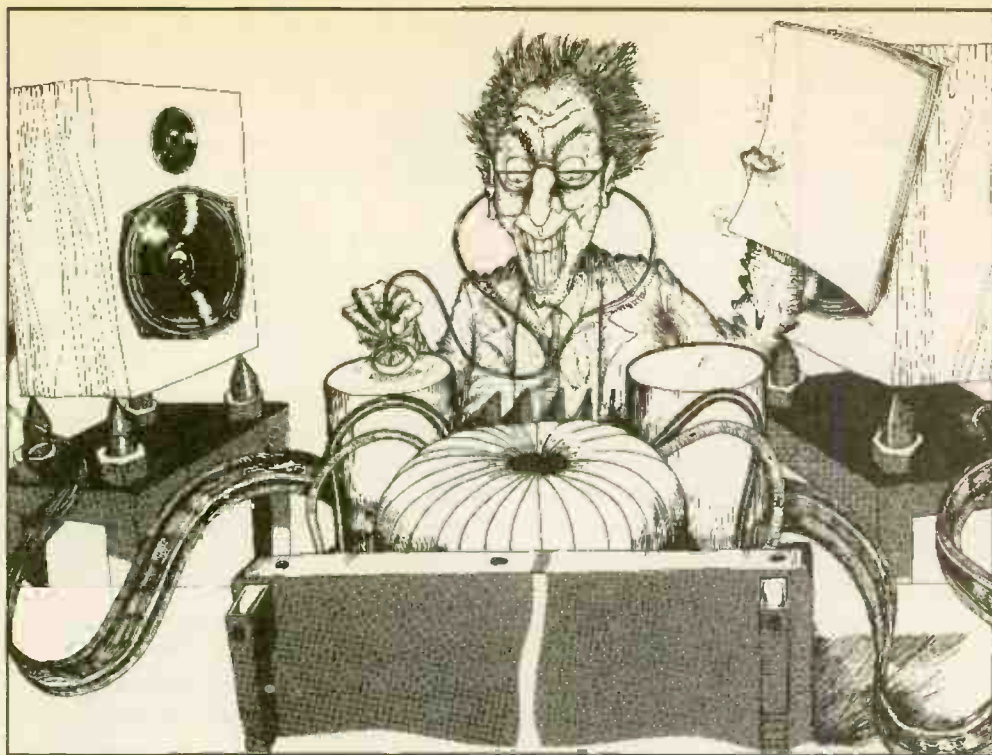

Keep up the good work.  
**Per Karlsson**  
**DSS-Audio,**  
**Borlange, Sweden.**

*One of the things we look for in all of our kit designs is high sensitivity. We use modern, light cone materials - carbon fibre and High Definition Aerogel, and simple crossovers so that as much of the power at the 'speaker terminals as possible is turned into sound. The 100µF capacitor is there as a safety precaution, acting as a D.C blocker, rather than as a actually acting as a filter.*

*The output from the midrange driver, being on an open baffle, self cancels and rolls off where the dimensions of the baffle allow the wave from the front of the cone to cancel with the rear. This happens around 400Hz. The 100µF capacitor is to prevent this midrange driver being overdriven by subsonics, such as record warps from LP where there is no LF filter.*

*However, your use of an LCR trap is useful. It adds more components to the signal path, which we try to avoid, but as you suggest power handling will be improved and impedance smoothed. This difference in approach to 'speaker design is common, for example Epos prefer minimalist crossovers at the cost of some response flatness, and KEF take an opposite*

# D.I.Y. Letters

## TRAPPED

For anyone thinking about building the open back HDA-driver DIY (KLS6) speaker from Hi Fi World, here's some tweaking advice. The 3inch mid-driver has got a resonance frequency of 220Hz and the 100µF high pass filter is not working as it should. Around the resonant frequency the filter function is virtually zero; I have measured 1 volt in and 1 volt out.

To get around this problem you should construct a LCR trap centred around 200-250Hz. It consists of a 4mH inductor, 100µF capacitor and a 5.6Ω resistor across the terminals of the mid-driver to give you a 6Ω +/- 1Ω impedance from 100Hz to 600Hz, instead of 37Ω at the resonance frequency without the trap. You should also lower the value of the high-pass capacitor to around 68µF(47µF+20µF

Solen polypropylene) to get the -3 point centred at 400Hz, as the 100µF did without the LCR trap. With this little tweak the filter function will work as planned and the driver will withstand probably twice or three times the power it did before, with less distortion as a result.

For anyone thinking about building this speaker, but can't afford the superb but terribly expensive Audax piezo tweeter, you can substitute a ribbon tweeter (Tonigen or ACR Fostex

makes good ribbons for around £50). This is the closest you can get to the piezo driver. Don't put a dome tweeter in it's place because they don't even come close! A third order T-filter consisting of a series 2.2µF / 0.15mH to ground / series 6µF, centred at 6kHz should do the trick. You also have to bring the ribbon down about -3 dB to match the midrange and bass. This is the solution for a budget HDA open-back speaker if you can't stand the huge cost of the Audax tweeter.

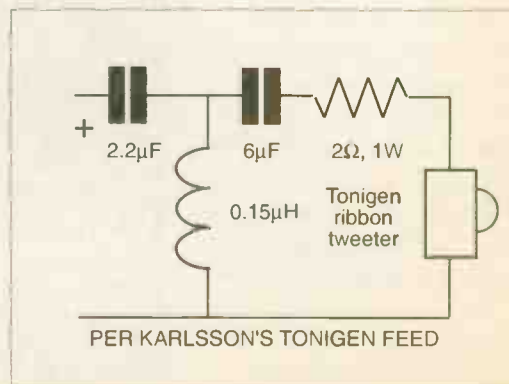
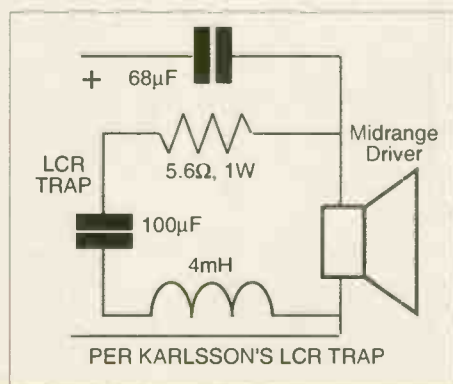



view, creating a super smooth response using a complex crossover network at the cost of some sensitivity.

On the subject of KLS6

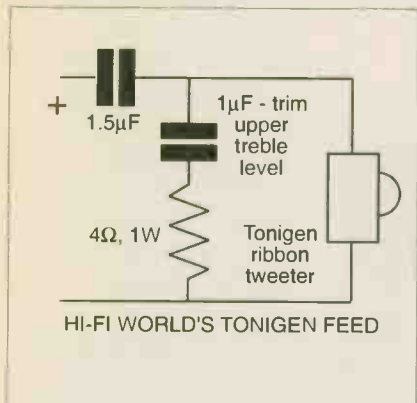

we have made a few subtle tweaks recently which may be of interest to builders. I was keen to exploit the clarity of the HD-3P tweeter, but without making it too obvious, as the Tonigen in the old Heybrook Sextets could be. However, it has been suggested that they are a little too soft in the treble, and, like the Tonigen, once you get used to its super-clean and fast character, you want more. We have tweaked our pair by reducing the series resistor R2 from 3.3Ω to 2.2Ω.

Another thing we noticed was that KLS6 could become a little thick and full in the upper bass in smaller rooms. The midrange and bass overlap deliberately, the lower midrange cancelling in the far field to give a flat response. Closer to the speakers this overlap causes a lift around 400Hz. To counter this and give a dryer, better balance sound, we have increased C3 from 50µF to 120µF. These tweaks have already been implemented for anyone who has ordered the KLS6 kit. DB

We have not tested and validated Per Karlsson's

notch filter, but it is pretty standard and should work. However, a third-order high pass for the Tonigen is unnecessary and is unlikely to give a net flat response. A simple 1.5µF series capacitor combines with the tweeter's innate frequency response characteristic (which is not flat) to give a sharp roll-in curve and a ruler flat pass band from 6kHz to 21kHz - see circuit. This is a tested and

validated circuit. NK

## VALVES & TRANSISTORS

Observing the growing interest in valve audio amplifiers and comments about them sounding more natural than transistor amplifiers, we have started a project to compare the two.

Although many interesting subjective comments and technical discussions have been printed in various magazines, it has been difficult to access literature in scientific journals. Could you or any of your readers point us to any past or recent literature on this subject?

M J Ruttar  
Y N Tsakiris,  
Edinburgh

I searched through my reference books but could find no useful scientific comparison between valves and solid-state devices. In many electronics books which were published during the transition from vacuum to crystal, superficial comparisons were made to assist engineers in understanding the new fangled three-legged devices, but that is as far as it seems to go. I think yours may be the first real comparison on audio grounds.

Although valves and transistors (bipolar and FETs) do much the same job in an amplifier circuit

# Letter of

## HOOKED ON DIY HI-FI

I recently purchased your magazine at a speciality book store and found it to be possibly the best Hi-Fi magazine I have ever encountered, because of the inclusion of construction and electronic theory related articles. Earlier this year, I designed and built a pair of 6V6 push-pull tube amplifiers, and this hooked me on their warm sound. I am writing to request your technical advice on the following matter. I have purchased a pair of high quality output transformers with the following specifications; 4300ohm, centre tapped ultra linear primaries, and 4/8/16 ohm secondaries.

These transformers have a power rating of 60W. At our local surplus store I bought a power transformer with two 408-0-408V secondaries at 232mA each. I am planning to construct a single chassis

stereo amplifier with these components using 6550 output tubes and a power rating of 40-60 watts per channel. I have enclosed the best design that I could come up with and am wondering if you could comment on it and tell me ways to improve it, or if you find it unacceptable, please provide me with a better design using the same basic components (output tubes, power and output transformers).

The preamp section of my amp is using a separate (on same chassis) 300Vdc regulated power supply featuring another surplus transformer. I am planning to use this for both sides of the amplifier for all tubes but the output tubes. Your advice on these matters would be greatly appreciated. I would also like your opinion on the Chinese made 6550 output tubes, as these are all I can afford for the time being, but do you think it would

be worth the expense to retube with Tung-sol, GE or GEC output tubes when possible? I am 16, and have taught myself everything I know about electronics, therefore your advice is very important to me. Keep up the great work with your magazine and I eagerly await the issue with your response to my questions in it.

Max Holubitsky  
Edmonton,  
Alta. Canada.

It is not realistic to design an amplifier "from a distance" like this, because there are so many variables. For example, you say your output transformers are "high quality", but what is their phase shift at 20kHz? Is this phase shift caused by leakage inductance or interwinding capacitance, or both? Also, the HT voltage provided by your mains

and look similar on paper they are very different in the physics of their operation. Also, a typical valve amplifier is different in it's topology to a typical transistor amp. This must also affect the sound quality of each. It is possible to build valve and transistor amplifiers which have very similar measured performances but which sound completely different. This leads me to think that there must be other more subtle differences which elude standard tests, or our interpretation of them.

I think you are going to have to search through the reference books on

each type and draw your own conclusions, but here are some areas which aren't usually covered.

It would be useful to start at the most basic level and analyse the fundamental differences between valves and solid-state devices. In a valve any particular electron (strictly speaking the electron's wave function) travels through free space, influenced only by the electric fields caused by the various electrodes in its path. The control grid's field holds back a proportion of the total electrons emitted by the cathode, a change in the grid voltage changes it's

field and thereby varies the total amount of electrons reaching the anode and hence the anode current.

The velocity of an electron by the time it reaches the anode after being accelerated by the anode's field is truly mind boggling. For example, in a valve with a fairly typical anode voltage of 450V the electrons will hit the anode at approximately 12 million metres per second (28million m.p.h. - no wonder it gets hot!). The electrons which make it past the grid are the same ones which, a tiny fraction of a second later,

appear at the anode and cause the signal in the load.

In a solid - state device the electrons have a very hard time of it. They have to fight their way through millions of random fields caused by the atoms in the substrate material. Solid-state (and that includes wire) electrons move at only a fraction of a metre per second, crashing and bouncing all the way, rather like a Christmas shopping trip on Oxford Street. It is not the actual electrons which carry the signal but the influence of one electron on it's neighbours, the message gets carried as a Chinese Whisper" only with less corruption of the signal (?).

In a bipolar transistor the flow of electrons is impeded by the base junction. Forward biasing the junction allows electrons to pass. Similarly, in an enhancement mode FET the gate has to be forward biased to allow the electrons through. Junction FETs, which were gate first type available, are normally reverse biased like valves. No bias on the gate allows the full saturation current to flow; reverse biasing reduces the current.

Comparisons were made between JFETs and pentode valves in the early texts because their characteristic curves look similar. That is, the current through the device is dependant more or less solely on the grid/gate voltage, but their method of operation is very different indeed, we we have seen.

Another point is that the current densities in valve and solid-state devices are completely different. In a valve a small current (milliamps rather than amps) flows

# The Month

transformer may not tally up with the operating conditions of the valve/ output transformer combination.

I suggest you seek out old valve manufacturer's data books and any other source of information you can for a circuit which is close to what you are after. The Groove Tubes "Tube Amp Book" has loads of commercial amplifier circuits in it, and companies like Angela Instruments have circuits of many of the more obscure amps, as well as those for Conrad Johnson and Audio Research etc. By studying other amplifiers you will get a feel for the different possible topologies used and can experiment to find which suits your ear.

Regulated supplies are a good idea but commercial constraints usually restrict their use to the more exotic amplifiers. You may

want to experiment with regulating the output valve screen grid supplies as well; improved clarity and bass definition usually results.

We have had experience with the Chinese KT88 valve(which is similar to the 6550) and found it to give good power output and sound quality, but you should get them from a reputable supplier, such as Billington or P.M. Components, in case of problems. Svetlana have released the 6550B-3 just recently and they will be worth a look at. The Tung-Sol 6550 is supposed to be the best of it's type, only beaten by the G.E.C. KT88. Both of these are extremely rare and expensive. There are some G.E.s and RCAs around, but they are pricey. Of course, the extended life and reliability, together with improved sound quality,

may justify the price for you. AG



## WIN A MAPLIN SOLDERING IRON KIT COMPLETE WITH A LENGTH OF SILVER SOLDER

The writer of the most interesting DIY letter each month will receive a superb Maplin soldering iron, stand, booklet on good soldering practice and a length of high quality silver solder. Write in to: Hi-Fi World DIY letters, 64 Castellain Rd, Maida Vale, London W9 1EX.



through a comparatively large area, while in any form of transistor the currents are much larger but the area through which that current flows is very much smaller. In other words, valves operate at low current densities while transistors operate at high current densities. Whether this, or the resultant magnetic fields generated (which could cause hysteresis distortion if the transistor has a ferromagnetic body) have any effect on the operation of the device is open to question.

At the macro level the topology of typical valve and transistor amplifiers bear very little similarity to each other. This is due in part to the nonexistence of a "PNP" valve. Early transistor amplifiers relied heavily on the germanium PNP transistor because NPN types were difficult to make before silicon appeared. These amplifiers looked quite like the valve amplifiers of the time, but offered very poor performance compared to valves. Cheapness and small size were the main driving force behind the popularity of transistor amps (and they still are).

Nearly all modern transistor amplifiers use what is known as the Linn topology (see the circuit to our solid-state monoblocks for an example), having a long tailed pair input stage, a single-ended voltage amplifier and a push-pull emitter follower buffer output stage all enclosed in a feedback loop. Both NPN and PNP transistors are needed for the Linn type of amplifier.

Maybe because valve designers only have one polarity of valve to play with they seem to have shown a little more creativeness and there are

all sorts of different possible configurations, although most commercially available amps seem to be developed from one of two generic types, the Mull 5.20 or the GEC 50W.

One fundamental difference between push-pull valve amplifiers and their solid-state counterparts is the output stage. Valve amplifiers use two identical devices and their outputs are summed in the output transformer (except OTL amplifiers, which still use identical devices but no transformer). The transistor amplifier uses two different but complementary devices and their signals are summed at the output node.

Distortion, frequency response and most of the standard tests applied to amplifiers have not so far explained the perceived differences in sound quality between different amplifier types. I hope that by detailed analysis



your study may bring you closer to understanding the hows and whys of amplifier sound quality and that my observations may help. A.G.

#### **A QUALITY BUILD**

Please find enclosed photographs of the super

sounding KLS3 loudspeakers. I enjoyed building them. I found the construction basically straight forward. As you can see from the photographs they are not like the house that Jack built! I have been building speakers for 27years - from KEF etc. I have also built the KLS4s (see photos), again straight forward.

I would appreciate your comments on the finished products. My kit consists of Arcam 5 CD player with DacMagic 1, Audiolab 8000C preamplifier and two 8000P power amplifiers, Yamaha KX580 cassette deck and Sony STS-311 tuner. I am using good quality interconnects and Cable Talk 3. Listening room size 18' long x 12' wide x 8' high.

**P. McCartney  
Nottingham.**

You've certainly made a super job of the cabinets, every bit as good as any commercial design. Perhaps you could make us a few pairs? I'm glad you found the cabinets easy, but with 27years of experience you will have become quite a master at this by now. For less experienced readers it is useful to know that any good timber merchant is capable of preparing the wood panels to a close tolerance. Once glued together only a little light



sanding should be necessary to give a smooth finish.

As for your system, it seems very nicely balanced. I suspect that you would hear a worthwhile improvement by upgrading your front end though, perhaps updating your CD player to Arcam 6 status which can be carried out for £150, would be the

most economical. Contact Arcam on 01223 861550. DB  
otographs of the super sounding KLS3 loudspeakers. I enjoyed building them. I found the construction basically straight forward. As you can see from the photographs they are not like the house that Jack built! I have been building speakers for 27years - from KEF etc. I have also built the KLS4s (see photos), again straight forward.

I would appreciate your comments on the finished products. My kit consists of Arcam 5 CD player with DacMagic 1, Audiolab 8000C preamplifier and two 8000P power amplifiers, Yamaha KX580 cassette deck and Sony STS-311 tuner. I am using good quality interconnects and Cable Talk 3. Listening room size 18' long x 12' wide x 8' high.

**P. McCartney  
Nottingham.**

*You've certainly made a super job of the cabinets, every bit as good as any commercial design. Perhaps you could make us a few pairs? I'm glad you found the cabinets easy, but with 27years of experience you will have become quite a master at this by now. For less experienced readers it is useful to know that any good timber merchant is capable of preparing the wood panels to a close tolerance. Once glued together only a little light sanding should be necessary to give a smooth finish.*

*As for your system, it seems very nicely balanced. I suspect that you would hear a worthwhile improvement by upgrading your front end though, perhaps updating your CD player to Arcam 6 status which can be carried out for £150, would be the most economical. Contact Arcam on 01223 861550. DB*







## THE HI-FI LAW OF DIMINISHING RETURNS

Ask a Hi-Fi dealer to upgrade your system, and he'll sell you ever more expensive bits of hardware, giving you a constantly changing sound, new solutions producing more problems which can only be solved with more expensive equipment. The harder you try, the more it costs and the less satisfying the results. This is the well known Hi-Fi law of diminishing returns. We have an alternative:

## THE RATA LAW OF INCREASING RETURNS

Why buy new equipment when it makes more sense to realise the full potential of your existing equipment. Don't replace it, upgrade it; it's cheaper. Most equipment can be transformed by us for the cost of a dozen CDs. Magic? No - logic! To find out how we do it, ask for our 1995/96 Catalogue; it provides discussion, analysis and a definitive resource of audiophile components and advice on the art of recreating music in the home.

# Russ Andrews Audiophile Catalogue

Includes :

- CD Players, Preamplifiers, Disc Preamplifiers, Power Amplifiers
- Loudspeakers
- Kimber Kable
- Upgrading Services and Guides
- Audiophile Kits and Components
- Accessories
- Reviews

# 1995/96 CATALOGUE

### **Russ Andrews**

Edge Bank House, Skelsmergh, Kendal  
Westmorland. LA8 9AS  
England

**Tel: 01539 823247**

Fax: 01539 823317

To receive your copy of our 1995/96 catalogue just mail, phone or fax the address above.