

Still  
£2.00

# Hi-Fi WORLD

OCTOBER 1994 £2.00

PHONO HEAD AMPS FROM  
AUDIOLAB, OPA, EAR,  
KINSHAW AND MICHELL

SCOOP!

## TDL REFERENCE TRANSMISSION LINE LOUDSPEAKER

DIY SUPPLEMENT No. 10  
banded to this issue

GRUNGE AUDIO -  
HI-FI ON THE  
CHEAP

BUDGET AUDIOPHILE CD  
PLAYERS FROM DENON  
AND ROTEL

DRIVING THE TDLs  
POWER AMPS FROM  
LINN, NAIM, SHEARNE &  
ALCHEMIST

## COMPETITION - MISSION CYRUS SYSTEM WORTH OVER £3000

SEE US AT  
LIVE 1994  
THE CONSUMER ELECTRONICS SHOW  
EARLS COURT  
E LONDON  
20-25 SEPT  
1994



# The most complex DAC in the World



*The PDM ten twenty-four - packed full of dpa innovations that redefine CD performance.*

## is also the simplest.

It has long been held as a tenet of audiophile wisdom that the simpler the analogue circuitry, the better the sound quality. We have spent many years developing our own DAC technology that results in an order of magnitude improvement in analogue simplicity. This is achieved by the use of our patent pending DX processor DAC that employs up to 128 times digital filtering. This gives a very simple analogue topology - just our op-amp and four passive components in the direct signal path.

This is some ten times simpler than conventional DAC's - and the sonic result it gives is extraordinary. Words cannot convey the sense of excitement when listening to music through it. Instruments sound much more tangible with better focus and separation. Sound stage and detail resolution are remarkable. Indeed, we are convinced our DX DAC technology completely redefines the capability of digital music.

However, this performance comes at a price - one being the complexity of the digital domain. An amazing one billion single bit additions are performed each second. The PDM ten twenty-four also features nearly 2,000 discrete components, 4,000 gates, 8 noiseshapers, 8 digital filters, 8 programmable dither sources and gold plated solid copper construction throughout - to name but some of the features. It is modular in construction, thus allowing future upgrades.

Moreover, the DX processor technology can be applied to more affordable DAC's. The PDM two fifty-six (our replacement for the highly regarded PDM two) is available. We are currently developing the PDM sixty-four that features a scaled down version of this technology for only £1250. For more information please telephone or write to:

dpa Digital Ltd.,  
7&8 Willowbrook Lab Units,  
Crickhowell Rd., St Mellons,  
Cardiff, Wales CF3 0EF  
Tel: (0222) 795621  
Fax: (0222) 794267

The logo for dpa Digital Ltd., consisting of the lowercase letters 'dpa' in a stylized, white, sans-serif font.

A logo for the 'dx 128 processor'. The text 'dx 128 processor' is written in a white, sans-serif font inside a white oval shape with horizontal lines.



# EXPERIENCE MUSICAL TRUTH

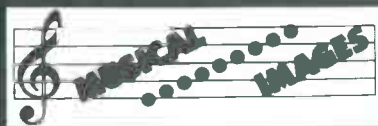

45 High Street, Hounslow, Middx.  
TW3 1RH  
Tel: 081 569 5802  
(Also at Edgware, Middx,  
Tel. 081 952 5535)



34, Buckingham palace  
Road, London SW1W 0RE  
Tel: 071 - 233 0774  
Fax: 071 - 233 7226

## audible difference

Scale, Diss, Norfolk.  
IP21 4DX  
Tel: 0379 740227

## Doug Brady Hi-Fi

Kingsway Studios,  
Kingsway North,  
Warrington.  
Tel: 0925 828009  
(Also at Liverpool, London  
and Otley, Nr Leeds)



Tel/Fax: 0252 377952

## Oxford Audio Consultants

Cantay House,  
Park End Street,  
Oxford OX1 1JE  
Tel: 0865 790879  
Fax: 0865 791665



Chantry Walk,  
16/18A Eldon Street,  
Tuxford, Nr Newark,  
Notts NG22 0JH.  
Tel: 0777 870372

## Audio Suite

42 St. Andrews Street,  
Aberdeen AB1 1JA.  
Tel: 0224 625 635



152A High Street,  
Bloxwich,  
West Midlands.  
Tel: 0922 493499



3 Bridge Street  
Guildford,  
Surrey  
Tel: 0483 504801

## SHROPSHIRE HI-FI

St. Michael's Street,  
Shrewsbury,  
Shropshire SY1 2ES.  
Tel: 0743 232317



41 Victoria Road,  
Cambridge.  
CB4 3BW.  
Tel: 0223 68305

## ZEUS AUDIO

2/4 Great Victoria Street,  
Belfast BT2 7BA.  
Northern Ireland.  
Tel: 0232 332522



## KJ WEST ONE

26 New Cavendish  
Street,  
London W1M 7LH.  
Tel: 071 486 8262



## NEW 200S PRE POWER £1250



93 Hobs Moat Road,  
Solihull,  
W. Midlands  
Tel: 021 742 0254

## Zen Audio

35 George Street,  
Hull HU1 3RE  
Tel: 0482 587397

# AT OUR KEY DEALERS

## dpa digital ltd

Unit 7, Willowbrook Technical Units,  
Crickhowell Road, St. Mellons, Cardiff CF3 0EF, Wales, UK  
Phone: 0222 795621 Fax: 0222 794267



Cover Photograph by  
Paul Hartley Studio 071- 482 3768

# THIS MONTH'S REVIEWS

## AMPLIFIERS

**AURA VA-80** 19  
The Aura VA-50 was much liked by us at Hi-Fi World, but now Aura have replaced it with the VA-80, a more powerful version that promises improved sound.

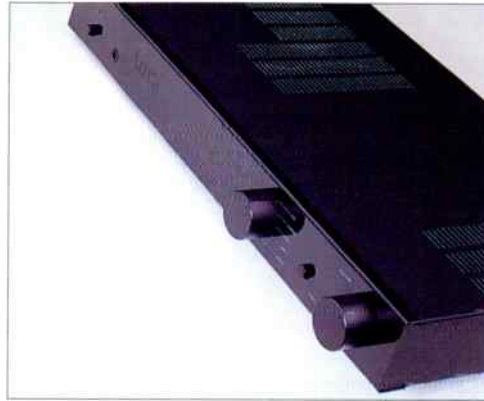

**HIGH-END AMPLIFIERS** 31  
We find four of the best pre/power amplifiers money can buy and put them through their paces with the TDL Reference Standard transmission line loudspeakers.

**LINN KAIRN/KLOUT**  
**NAIM NAC72/NAP250**  
**JOHN SHEARNE PHASE I**  
**ALCHEMIST FREYA/GENESIS**

## COMPACT DISC

**TWO AFFORDABLE 'AUDIOPHILE' CD PLAYERS**  
Two new CD players recently launched with the audiophile in mind. With both of them priced around the £250 mark, who has the sonic edge?

**ROTEL RCD940BX** 50  
**DENON DCD-825** 51



## LOUDSPEAKERS

**TDL REFERENCE STANDARD** 14  
A massive Transmission Line Reference loudspeaker from TDL. This £6000 beast can really shake the earth.

**MISSION 752** 41  
Using latest technology High Definition Aerogel drive units in an elegant floorstander, the 752s are Mission's latest pièce de résistance.

## TURNTABLES

**HEAD AMPLIFIERS** 57  
Following our group test of £400 turntables last month, we follow with some of the best phono head amplifiers around.

**EAR 834P**  
**DPA DIGITAL DSP 200SD**  
**MICHELL ISO**  
**AUDIOLAB 8000PPA**  
**KINSHAW PERCEPTION**

## CASSETTE

**ONKYO TA250** 48  
A £350 three-head cassette deck from Onkyo. Dominic Todd asks whether it can compete against its Nakamichi rival.

## TUNERS

**PIONEER F-303RDS** 29  
From Pioneer's new range comes the F-303 RDS equipped tuner. We take a close listen to assess its abilities

## REGULARS

**NEWS** 8  
Read all about it - new products, technologies, shows.

**LETTERS** 38  
Your news, views and musings.



**AMERICAN**  
and  
**CANADIAN**  
**SUBSCRIPTIONS**  
- see page 68

Editor  
**Noel Keywood**  
Assistant Editor  
**Dominic Baker**  
Production Editor  
**Ferewin T. Michael**  
General Manager  
**Mark Winfield**  
Marketing Manager  
**Richard Johnson**  
Advertising Director  
**Caroline Knott**  
Advertising Tel: 071-266 0969  
Advertising Executive  
**Amanda Sweeney**  
Design Engineer  
**Andy Grove**  
Technical Assistant  
**Nick Lucas**  
Contributors  
**Eric Braithwaite**  
**Richard Brice**  
**Giovanni Dadomo**  
**Peter Herring**  
**Simon Hopkins**  
**Dominic Todd**

Cartoonist  
**Freddy Ahmet**

Distributed by:  
COMAG, Tavistock Road, West  
Drayton, Middlesex, UB7 7JF  
Tel: 0895 444055

Origination by:  
Aclford Scanning  
7 Northolt Drive,  
Fairwood Industrial Park,  
Asford, Kent, T1423 1PA  
Tel: 0233 624042

Printed by:  
Southernprint, Poole, Dorset.  
Tel: 0202 622226

**AUDIO PUBLISHING LTD.,**  
64 Castellain Road, Maids Vale,  
London W9 1EX,  
Tel: 071-289 3533  
10 am - 6pm  
Fax: 071-289 5620  
Queries cannot be answered  
by telephone.

**MAIL ORDER**  
Tel: 071-266 0461 (24 hours)

**Subscription Rates:**  
UK: £22  
Overseas Surface: £29, Airmail:  
£42 (Europe) £52 (USA, Middle  
East), £62 (Australia, Japan)

No material may be reproduced  
from this magazine without  
the publisher's written  
permission.  
© Audio Publishing Ltd

**Q&A** 115  
Looking for the best upgrade, need a pair of 'speakers to match your valve amp., a cartridge for your turntable - we have the answers.

**COLUMNS** 61,63,69,71  
Meanderings from our team of hi-fi hounds.

**NEXT ISSUE** 60  
Don't miss our November issue, complete with another Free Supplement.

**SUBSCRIPTIONS** 68  
You don't even have to go outside to get your copy of Hi-Fi World, subscribe and you need never leave your listening room.

**ACCESSORIES** 97  
Mail order accessories for system tuning.

**HI-FI WORLD LIBRARY** 101  
Teach yourself about hi-fi with this wonderful range of books for the enthusiast.

**DIAL-A-DEALER** 89  
Who sells what and how to get in touch.

**WORLD AUDIO DESIGN** 81  
Kits for the enthusiast. Build your own amplifiers and loudspeakers from our professionally designed kits.

**MEET YOUR MAKER** 84  
The manufacturers' directory.

**WORLD FAVOURITES** 110  
Our pick of the best equipment reviewed in Hi-Fi World.

**CLASSIFIEDS** 123  
Browse the ever expanding range of quality second hand and vintage equipment for sale in our classified section.

**SPECIALIST HI-FI DEALERS** 77  
Need a specialist? - look no further.

**ADVERTISERS' INDEX** 130

## FEATURES

**GRUNGE AUDIO** 23  
Quality separates hi-fi on a shoe-string. We check out the bargains and bring you a taste of real Grunge Audio.

**RESTORE OR RENOVATE?** 64  
Hayden Boardman of Audio Classics explains whether you should restore your vintage hi-fi to its original glory, or modify and update as you rebuild.

## DIY SUPPLEMENT

In this month's FREE Supplement: we design a pure Class A monoblock power amplifier using special new output devices and delivering 36watts; build the SPL-1 loudspeaker kits from Wilmslow Audio; show you how to build your own interconnects and review a Hart kit designed to teach the art of soldering. Of course, there's also the usual Kit News, Book reviews, DIY letters etc.

## MUSIC

We select the best Rock, Classical and Jazz releases of the past twelve months. Hi-Fi World's essential guide to music everyone should hear.

**ROCK AND POP** 73

**CLASSICAL** 85

**JAZZ** 93

## COMPETITION

Win a £3000 Mission Cyrus system. Discmaster transport, Dacmaster CD convertor, Cyrus FM7 tuner, Cyrus III amplifier and High Definition Aerogel 752 loudspeakers. 66



# CONTENTS

GET YOUR FINGER ON THE PULSE



# THE LIVE AUDIO



**Take** your senses for a trip to LIVE '94, the UK's most exciting consumer electronics event.



**See** the latest hi-fi. TV. Video. Computers. Games. Camcorders. In-car. Musical instruments. Cameras. Telecoms. Satellite. Home automation.



**Experience** Capital Radio Live at LIVE. TV Times Live Television Studio. Dolby Home Cinema Promenade. BPIA Future of Photography. Real Hi-Fi Village. Young Newspaper Feature. Yamaha/TES National Youth Rock & Pop Awards. Computer Shopper PC Village. Focus on Multimedia. Games Arena.



**Get** your hands on a ticket. Phone the LIVE hotline or return the coupon now.

**LIVE '94**  
**THE CONSUMER ELECTRONICS SHOW**  
**EARLS COURT • LONDON**  
**20-25 SEPTEMBER 1994**

**LIVE HOTLINE:**  
**0 8 9 1 5 0 0 1 0 3**

Calls cost 39p per minute cheap rate and 49p per minute at all other times.

Please tell me more about LIVE '94 and how I can get a ticket to the UK's most electrifying event.

Name.....

Address.....

..... Postcode.....

HFW Please return this coupon to:  
LIVE '94, News International Exhibitions Ltd.  
Europe House, World Trade Centre,  
St Katharine-by-the-Tower, London E1 9AT.

## PROAC IMPROVE TABLETTE IIIS

The Tablette III is now available in Signature form, enhanced by distinctive real wood veneers.

This model has additionally been given a new bass drive unit which uses copper in the magnet assembly. Proac say heavy copper rings mounted above and below the T-shaped pole-piece reduce non linear and modulation distortion and increase overload margin. Further improvements have been made with the use of an open, equalised reflex port and crossover modifications.

The Tablette III Signature is available in real wood veneers such as Burr Oak, Ebony and Birds Eye Maple for £849 and also in Rosewood and Yew for £779.

**ProAc**  
**130-132 Thirsk Road**  
**Borehamwood**  
**Herts. WD6 5BA**  
**Tel: (081) 207 1150**



## ROTEL LAUNCH NEW AMPLIFIERS

Three new integrated amplifiers, the RA930AX MkII (£149.95), RA930BX (£199.95) and the RA935BX MkII (£249.95), as well as a RQ970BX phono equaliser (£129.95) should soon be available from Rotel dealers.

All three amplifiers are the result of development initiated in the UK and they use high performance components new to Rotel.

The entry level RA930AX MkII is a development of the RA930AX in which higher quality components have been introduced in key areas to increase performance and enhance value.

Rotel hope that the RA930BX, which uses audiophile components throughout and specialist integrated circuits in the line stage, will be a serious contender in a competitive area of the market.

The RA935BX MkII amplifier reflects Rotel's approach to audiophile design by using a toroidal power transformer and slit foil capacitors in the power supply and a symmetrical PCB with mirror image layout and star earth grounding techniques to maximise stereo imagery. It is also available with an integral high quality phono stage at a cost of £299.95.

The RQ970BX phono equaliser was built primarily to partner 'line only' amplifiers, although Rotel claim it can produce a marked improvement in performance when used in place of the integral phono stages of integrated amplifiers. This unit also uses audiophile components throughout and features switched MM/MC with fixed loads and gold plated input and output terminals.

For further information on Rotel's latest products contact the Marketing Department of Rotel UK.



**Gamepath Ltd.**  
**25 Heathfield**  
**Stacey Bushes**  
**Milton Keynes MK12 6HR**  
**Tel: (0908) 317707**



## SUB-£300 CD PLAYER FROM ARCAM

The new Alpha One CD player is the first machine from Arcam to enter the market below £300. Designed and built in the UK, it comes equipped with a Sony three-beam transport and Burr Brown's new PCM1710 multi-level delta-sigma DAC with fourth order noise shaping to reduce sensitivity to jitter and increase stability.

Arcam have also brought out a new top-of-the-range Delta Black Box 500 which will retail for £749.90, bringing their range up to six models. This is a DACC (a new acronym to us), or Digital Audio Control Centre. It offers digital-to-analogue conversion for up to seven digital sources, including laser disc, DAT and DAB (digital audio broadcast) and of course CD.

First class sound quality is promised from the Arcam, designed 1-bit DAC, built with discrete surface mount components. Arcam claim that new standards of jitter-free CD sound reproduction are set when the '500 is 'Sync Locked' to their Delta 250 CD transport, at a total package price below £1500. The Delta Black Box 500 can also be used as a digital pre-amplifier via the use of remotely controlled input selection and output levels.



**A&R Cambridge Ltd**  
**Pembroke Avenue**  
**Denny Industrial Centre**  
**Waterbeach**  
**Cambridge CB5 9PB**  
**Tel: (0223) 861550**

## ROOM DESIGNED LOUSPEAKERS

Roy Allison formed the new American Company RDL Acoustics (Room Designed Loudspeakers) last year with Edgar Villchur, the founder of Acoustic Research and inventor of acoustic

suspension and the dome tweeter. Two lines of product should be made available in the UK during September.

One is the RDL line which comprises several models of the same loudspeaker, each one individually optimised for a different room placement. There's the RDL FS-1 floor stander for use away from a wall, and the RDL F-1 for use against a wall. The B-1 operates on bookshelves, but away from a wall, whilst the smaller S-



It is designed to sit on a shelf, but against a wall.

The second range is the RA Labs (Black Gold) series, intended to offer great value. There are three stand-mount and two floorstanding speakers, ranging from £80 to £400 per pair.

RDL sell direct to the public only, offering their customers what they believe to be a unique '30 days, no-quibble, no-strings attached' returns policy, allowing potential buyers to try the speakers at home for up to 30 days before making a final decision, only having to pay for the return postage if not entirely happy with the product.

**RDL Acoustics**  
**20 Cleveland Way**  
**Shelley**  
**Huddersfield HD8 8NQ**  
**Tel: (0484) 603333**

## ELECTROFLUIDICS' LOUSPEAKERS GROW

The Sonolith 1 loudspeaker has recently been refined and is now the Sonolith 1.1xr. A larger model, the Sonolith 2.2xi, has been introduced to the company's range. After a lot of research into cabinet materials Electrofluidics eventually

developed vibro-cast, inert mineral-polymer enclosures for their speakers, which they claim minimise sound transmission, structural resonances, internal standing waves and external diffraction. Electrofluidics' founder Patrick Handscombe claims: "Removing most of the limitations inherent in normal cabinets allowed us to realise the full potential of our controlled-flexure alloy-cone drive units." The speakers

also have an aerodynamic port system to prevent air movement noise and optimize tuning. Computer-aided design followed by a large amount of testing has ensured that the high quality components used in the crossovers reach their full potential.

The speakers come in two standard finishes - Anthracite Nextel and Instrument Black Monitor, but almost any applied finish and colour is available to order. The recommended retail prices for July 1994 are £1995 for the Sonolith 1.1xr and £2695 for the 2.2xi.



**Electrofluidics**  
**27 Fournier Street**  
**London E1 6QE**  
**Tel: (071) 247 0813**

D E S E R V E S  
C L O S E R I N S P E C T I O N



## NAD 302. European Amplifier of the Year '93-'94

“An amazing design which can bring true Hi-Fi performance to those unable, or unwilling, to spend a fortune.”



BRITISH BY DESIGN

NAD MARKETING LTD. NAD BUILDING, 401-405 NETHER STREET, LONDON N3 1QG. TELEPHONE 081-343 3240



## BRIO HORN LOUSPEAKER

Two years of research and development have gone into the Brio corner horn loudspeaker, claim Thomas Transducers. Intended to complement valve amplifiers, an efficiency of at least 98dB SPL for 1 watt at 1 metre is claimed. Standing 51 inches high, it has an effective horn length of 15 feet and uses a single Lowther PM6A Hi-Feric drive unit as standard. The Brio should be available in September and will retail from £4750 per pair, depending on finish and drive unit specified.

**Bravura**  
**Thomas Transducers**  
**White House Hall**  
**Hadlow Road**  
**Tonbridge**  
**Kent TN11 0AJ**  
**Tel: (0732) 851408**

## ADVANCED COMPOSITE TECHNOLOGY LOUSPEAKERS

Wilson Benesch have overcome the difficulties encountered in producing the curved enclosure panels in the world's first Advanced Composite Technology (A.C.T.) loudspeakers. A 10mm thick aluminium baffle holds the custom-built three-way driver array, and sculpted hardwood forms are used to contrast with the black anodised surfaces and carbon fibre panels. The production prototype made its debut appearance at the Frankfurt Hi-End Show in August. Despite the advanced materials used their price is expected to be similar to that of floorstanding speakers made of MDF. They should be available in England from November 1994.

**Wilson Benesch**  
**Unit Two**  
**Fall Bank Industrial Estate**  
**Barnsley S70 3LS**  
**Tel: (0226) 770199**

## YORKSHIRE HI-FI & HOME CINEMA SHOW

Specialist retailer Sound with Style have arranged this popular show for the third time at the Doncaster Moat House in South Yorkshire. Taking place between 10am-5pm over the weekend of 15th and 16th October some 5000 people or more are expected to attend. The organisers claim that "most major British manufacturers will be there, including Linn, Naim, Arcam and KEF".

For further information contact -

**Sound with Style**  
**Tel: (0742) 737893**

## NEW PATH PLUGS

Path Group have improved and added to the Ixos range of plugs.

Whilst retaining the original side-entry banana plug (204) and the crimp fit screw terminal at £9.95 for a pack of four, new models for loudspeaker cable connection are a locking banana plug with an expanding centre pin (211) and a sleeved pin banana plug (212), both at £19.95 for four. The 212 features an insulated sprung sheath that covers the entire length of the pin to eliminate the possibility of shorting out the amplifier outputs by accidentally touching pins when connecting/disconnecting the speaker leads.

Two new phono plugs are also available, the 209 at £12.95 for four and the 210 at £9.95 for four. All plugs in the Ixos range have 24 carat hard-gold plating on their contact surfaces.



**Path Group PLC**  
**Unit 2**  
**Desborough Industrial Park**  
**Desborough Park Road**  
**High Wycombe**  
**Bucks. HP12 3BG**  
**Tel: (0494) 441736**  
**Fax: (0494) 461209.**

## NAD CHANGES CDS

NAD claim that their new model 513 CD changer has '...the performance and price of a single disc player'. Using MASH technology for digital to analogue conversion and costing £269.95 the 513 will handle up to three discs at once, rather than the usual five. This has come about after careful market research; apparently most people do not need or even want to play more than two or three CDs, one after another. With a full remote control it is possible to program up to 32 tracks from any of the three discs in any sequence. With the 513 NAD hope to offer a combination of performance, reliability and convenience at an affordable price. The player should be available at most NAD dealers from the end of August.

**NAD**  
**401-405 Nether Street**  
**London N3 1QG**  
**Tel: (081) 343 3240**



# PHILIPS INVENTS

## The Digital Compact Cassette When it comes to

sound quality, for Sting "good" just isn't good enough. He demands that his music is reproduced perfectly. That's why he is so impressed with Philips latest invention. DCC.



A digital cassette with the pure sound quality of a compact disc and the convenience of a compact cassette. There's a complete range of equipment, so you can play your DCC anywhere, in the home, in the car or on the street. And don't worry

about your collection of ordinary compact cassettes, the beauty of the DCC system is that it will play them too. DCC is already a big hit with the major record companies with hundreds of titles already available. So don't make a mistake, choose DCC. For details of stockists and further information telephone 081-665 6350.

**DIGITAL**  
**dcc**  
COMPACT CASSETTE



DCC 600 Player/Recorder



FW 91 DCC System



DCC 130 Portable



DCC 811 In-car

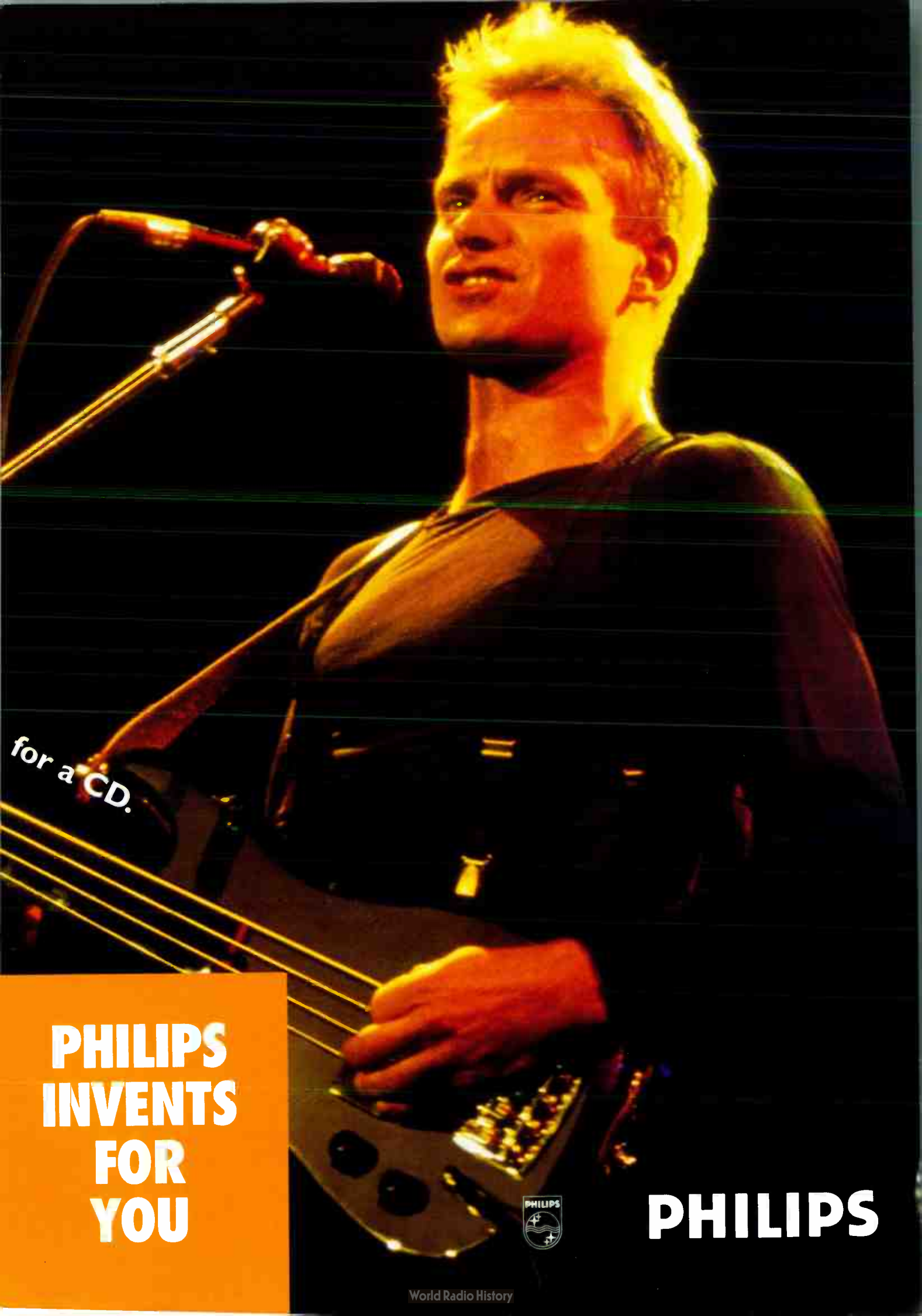

for a CD.

**PHILIPS  
INVENTS  
FOR  
YOU**



**PHILIPS**

# TRANSMISSION TOWER

Next time you go to grip with some of the deepest bass around, remember to try TDL's new Reference Standard transmission line loudspeakers.

The customer gawped: "Wow, there must be some big speakers in there" he said, as three people struggled past with a cardboard box large enough to double as a potting shed. We corrected him: "No, there's just one speaker in here". The TDL Reference Standard transmission lines (RSTLS - 'M') take their place in the Pantheon of ginormous loudspeakers alongside Tannoy GRFs, at 70kgs apiece (154lbs) needing at least two people to get just one off the ground.



These monsters are for those in love with transmission lines; each one has no fewer than three. There are two bass lines, tuned differently to give smoother bass, and a midrange line. Each bass line has its own bass unit, whilst two midrange units feed one midrange line. There are two tweeters and one super tweeter, making a total of seven drive units per cabinet.

Distributing power amongst so many drivers has the benefit of giving very good power handling. TDL have worked to eliminate the incohesiveness that multi-unit designs can suffer by setting them symmetrically around the super tweeter, to give a virtual point source of sound, they claim. To do this, the drivers are clustered together so that distances between them are less than half a wavelength of the lowest frequency they handle, to prevent cancellation effects.

But why use so many transmission lines in the first place? These long, tapered lines absorb the rear wave from a loudspeaker drive unit, reducing its low frequency limit, giving deeper bass or a wider operating range, in the case of the midrange drivers. Transmission line bass is also known for sounding smoother and more even than the resonant bass from tuned boxes, be they sealed or ported. Twin bass lines, stagger tuned, also distribute bass energy and give these speakers the ability to produce enormous bass power at low frequencies. Although an ideal transmission line is very long and tapers down to nothing, in practice it is impossible to build a line long enough to absorb all energy, so the end is ported on this speaker, providing further output at very low frequencies.

The midrange line, TDL say, extends the lowest operating frequency of the two midrange drivers down low enough to make the crossover point to the deep-bass units inaudible.

In a nutshell then, these speakers have been designed to produce very deep bass of enormous power. They have high power handling and can generate massive volumes too. Yet the drivers have been arranged to provide a cohesive sound with good stereo imaging.

I know from experience that big TDLs need a very large room to show what they can do. Small rooms make a speaker like this sound bloated and overpowering in the bass. We needed a large room with good acoustics, plus a number of power amplifiers to find a good match, preferably a few muscular Naims. Son et Lumiere at

67 Tottenham Court Road, London's premiere hi-fi street, provided us with a fine listening room, plus a brace of Naim amplifiers and CD players and equivalent models from Linn. Few dealers stock both Linn and Naim these days, yet that's what we wanted, since both manufacturers make big speakers, as well as amplifiers capable of driving them.

### SOUND QUALITY

There was an initial defining moment for bass performance from the TDLs: it was a single deep drum strike at the start of Agolo. From the References this was a major event, one that I felt in my stomach, one that shook the room. Other loudspeakers would attempt to cope manfully with the bass lines and percussion on Angelique Kidjo's Aye, but

able to reach down to 5Hz, unrestricted by any cabinet.

The TDL Reference similarly played fundamentals cleanly and with huge power, although they softened out upper bass detail a little; Billy Idol's weighty bass intro on Prodigal Blues didn't so much step down in pitch, but change weight, but then other speakers commonly don't convey much of the power behind this intro., so the TDLs were giving an alternative view of the performance, with emphasis on sheer bass power.

But I found this aspect of their performance was also very power amplifier dependent. To my surprise and consternation, the Naim NAP250 put too much power behind the low bass of these speakers; it became overwhelming. Linn's Klout pushed the bass forward and, inexplicably, gave the References a boxy, hollow sound at low frequencies, causing them to boom. Higher up though, the Klout showed it was a smooth and detailed performer, knitting together the multiple drivers well, to give a detailed and relatively cohesive sound. The Alchemist Genesis power amplifiers sounded more balanced through their lighter bass, but the John Shearne Phase 2 came out best here in terms of balance, displaying tight if strong bass in reasonable balance with the rest of the spectrum.

So bass performance proved very amplifier dependent with this speaker, more so than I am used to. This is as much a reflection upon the speaker as a load as it is upon the qualities of the amplifier driving it. Although bass proved excessive with Naim's NAP250 this is almost certainly because it can swing huge current at very low frequencies into low loads; it's normally a benefit, only in this case was it a drawback.

Big speakers mean big panels, which commonly resonate and colour vocals. Even the resonant tones of Billy Idol's crooning on Charmed Life failed to excite the TDLs in this way though. They projected his voice well, giving much the same interpretation as any good loudspeaker, indicating good basic fidelity in this area. The metronomic drum beat behind Grace Jones on Fame is another nasty one that tends to get cabinets going badly, but not this time. The force of the beat was huge, but Jones' voice was unaffected by it, being set up well at centre stage, seemingly out of the speakers.

I heard reasonably strong lower-treble



A cut-away view showing the impressive internal construction of the RSTLS - 'M'

they bypassed this event altogether. There was a closing finale too, which I'll describe later.

The References not only go down very, very low, finding instruments and sounds other speakers - even big ones - miss completely, but they also put enormous power into drums and low bass fundamentals. I've heard just one loudspeaker able to put more power into bass fundamentals than higher frequency harmonics, emphasising power over pace, taking some emphasis from pitch changes. That was the unique Celestion SL6000 open dipole subwoofer, a loudspeaker

# Don't trip up on your speaker cable!



When you invest in good quality hi-fi equipment, why skimp on the cable?

Especially now that Ortofon can offer 3 types of top-quality cable for under £10.

Each cable is made up of very fine core copper strands rated at 6-Nines (that's a copper purity of 99.9999% - it doesn't come much better), is flat and flexible for easy installation and features a 'tack-rack' for panel-pin fixing.

Cable Type	Description
SPK 100	Twin-core white cable, each core with 130 copper strands (total 260 strands).
SPK 200	Triple-core grey cable for bi-wiring with twin-core treble (260 strands) and 3-core bass (390 strands).
SPK 300	7-core blue cable having 13 strands per core (each strand laminated). Requires soldering.

You'd better hound us for the name of your nearest stockist.

## ortofon

Ortofon (UK) Limited, Chiltern Hill, Chalfont St Peter, Bucks SL9 9UG. Tel: 0753 889949.



## Studio One

117-119 HAMMERSMITH ROAD  
LONDON, W14 0QH.

Tel: 071 371 3037

Fax: 071 371 1790

We are Mon-Sat 9.30 -6.30



*Audio Specialists  
Classical and Jazz  
Vinyl on Sale*



*We offer home demos on  
Hi-Fi equipment and  
cables.*

*So you can make  
your choice.*

Agents for:- Alchemist, Audio Innovations, Aura, Alphason, Atacama, Audio Technica, Boston, B&W, Chord Company, Castle, Denon, Dynavector, Harmon-Kardon, JBL, Jecklin, Jamo Oriel, Kinshaw, Michell, Moth, Musical Fidelity, Nakamichi, Ortofon, Pro-ject, S.M.E., Sequence, Teac, Thorens, Totem, Tannoy, Townshend, Van - Den - Hul, and many more.

\* Home Installations\*

\* Free Local Deliveries\*

*"Call Joseph or Ossie now for Free advice"*

*"Unique Offer" - The Last Musical Fidelity A1 F.E.*

*"Final Edition" Hurry Now!!*

*"Records cleaned and sleeved on Nagaoka antistatic for £1.50 per album"*

*Pay us a visit, we are near Olympia*



energy that gave a curiously but pleasantly rich quality to steel strings of Steve Earl's guitar on *Someday*, but also I noticed a small sting in the treble, probably from the super-tweeter. This carried through to violins in Tchaikovsky's *Symphony No.6*, which sounded a little forward, if not edgy because of the sweet nature of Tring's SBM recordings of the Royal Philharmonic.

It was when making these comparisons that differences between the Linn Klout and Naim NAP250 again became obvious. This time, however, it was the Klout that prevailed, sounding smooth, cohesive and finely detailed in conjunction with the TDLs. For classical listeners in particular, I felt the NAP250 was less appropriate because of its tendency to sound a little bright.

Exactly how the TDLs sounded really did come down to amplifier matching. Generally, they're a speaker with massive bass power and extension. They need a big room, preferably with one dimension of at least 20ft, as well as a high ceiling. They handle vocalists well, projecting

*“ The References not only go down very, very low, finding instruments and sounds other speakers - even big ones - miss completely, but they also put enormous power into drums and low bass fundamentals. ”*

them out of the cabinets into firm and realistic images, set between the speakers rather than forward of them. Neither peaks nor suckouts colour the sound; these speakers are tonally smooth and even, which made them sound fine reproducing violins. But perhaps surprisingly, they are more dynamically restrained than many Rock listeners might like, being developed primarily to suit classical music, where smoothness of tone and neutrality are regarded more highly than speed and punch.

It was when the violins of the Royal Philharmonic gave way to canon in the 1812 that the TDLs gave a fitting finale. Listening on lesser speakers, I thought the orchestra had timidly used a kettle drum to simulate canon fire. Ha! Tring's beautifully recorded version of the 1812 sent the roar of a real canon into the room with a power from the TDLs that shook the sofa, rattled windows and

rocked the building. It was so awesomely powerful, it was a little frightening. This underlined differences between the References and other loudspeakers; they can produce a seismic event like no other ●

**Our thanks to Colin Welford and Alester Kells at Son Et Lumiere, 67 Tottenham Court Road, London W1 (Tel: 071-580-9059) for their excellent listening room, Linn & Naim amplifiers, records and participation.**

### MEASURED PERFORMANCE

Measured on the axis of the super tweeter, the TDL Reference Standard Transmission Line loudspeakers look reasonably flat in their frequency response, as our analysis shows. However, the super tweeter pencil-beamed; moving off axis by a few degrees when measuring caused treble above 10kHz to fall significantly. The drive units also interfere with each other, causing large phase suckouts in the speaker's frequency response when slightly off axis. The argument for accepting this is that the sound integrates in the far field, or in lay terms, the speaker should sound tonally flat and even at a distance, but this is serendipity. Multi-driver loudspeakers - each TDL has seven - commonly suffer this problem and it does give them a somewhat variable character, according to seating position and room behaviour. They do, however, have the advantage of enormous power handling, so it's a trade off.

After having heard disturbingly large differences between the bass performance of power amplifiers attempting to drive the TDLs I was surprised to find that they are a relatively light electrical load, having an overall impedance of exactly 8ohms, dipping to 5ohms at 100Hz and at 2kHz, but only over a narrow band. Yet in spite of this, the speakers are sensitive at 89dB, another surprise, because they look as if they need a lot of power, yet they do not. So TDL's engineering in these areas is pretty effective, yet listening tests showed the speakers were unduly power amp dependent and in this I can only assume that back-emf was playing a part, although the many slopes of the numerous bumps in the impedance plot all indicate reactance (energy storage), so this speaker is reactive, except below 10Hz and above 4kHz.

The speakers are meant to be angled inward quite heavily and kept away from rear walls, and the listening position should be greater than x1.4 the distance between the speakers, conditions we adhered to in our listening tests.

The twin bass lines can be separated from the other drivers and fed by a separate amplifier, since these speakers are bi-wirable. The circuit diagram shows the pi-filter network used to feed the bass units, which work in parallel. It seemed to me that this would be the best way to impose one set of conditions upon the bass units and another upon the midband/treble. Bass drive needs to come from a piledriving amplifier, whilst the rest of the speaker should be fed by something detailed and subtle, the Linn Klout

sounding ideal. This method of operation would allow bass level to be independently adjusted too.

The TDLs are surprisingly easy as a load in some ways, being unusually sensitive for a speaker of their size, so they don't demand the use of overly powerful amplifiers. With a lumpy but flat frequency response that extends down to very low frequencies, room size preventing us from measuring the low limit meaningfully I'm afraid, these speakers measure well, even if they do have some of the foibles common to large multi-driver designs. **NK**

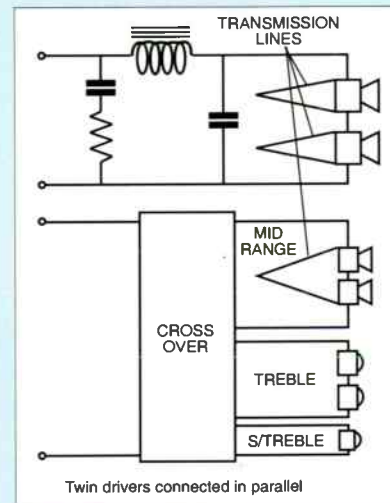

### Frequency Response



### Impedance

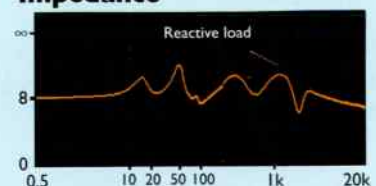

# Great tracking

Ortofon is famed the world over for the tracking capability of its cartridges. Cartridges which will breathe new life into a cherished LP collection, divulging detail as never before.

The cartridge is always the key factor in the reproduction of music from records and Ortofon has dedicated nearly 50 years to the manufacture of the finest pick-ups possible. Enjoying constant critical acclaim along the way.

So if you want to bring more out of your records than ever imagined, an Ortofon Cartridge will have you hot on the scent.



**500 Series**  
Moving magnet  
cartridges from £30-£100



**MC Series**  
Moving coil cartridges  
from £80-£110



**Q Series**  
Moving coil cartridges  
from £140-£300



**1000 Series**  
Moving coil cartridges  
from £600-£1500

## ortofon

Ortofon (UK) Limited, Chiltern Hill, Chalfont St Peter, Bucks SL9 9UG.  
Tel: 0753 889949.



TEL (0227) 742566

K.A.L UK LTD.

FAX (0227) 742270

AUDIO SPECIALIST

### K.A.L HIGH CLASS TRIODE AMPLIFIER



WE300B, single ended (WE91 specification)  
WE300B, single ended, K.A.L specification  
EL156 (German Triode) single ended  
AD1 (German Triode) single ended  
DA100 (large British Triode), Mono-Amp's, single ended  
DA30 (British Triode) stereo, single ended  
EMPORESS, preamp with MM/MC input  
MAGICIAN, line preamp with Telefunken MIL-valves  
HARLEQUIN, phono-preamp with Telefunken MIL-valves

### K.A.L HIGH CLASS LOUDSPEAKER



**Voice of TANNOY**  
**Voice of LOWTHER**  
**Voice of K.A.L**

HI-FI SHOW 1994, RAMADA HEATHROW, ROOM 1022

# AURAL INVESTIGATION

**David Harris listens to Aura's replacement for the VA-50. Can the new VA-80 amplifier improve on its predecessor?**

Replacing the popular VA-50, the Aura VA-80 is an attractive line level integrated amplifier possessing a 'mirror black' finish. A small on/off switch, volume control, input selector and a tiny tape monitor button decorate its front, although a headphone socket and a single green 'power on' LED complete the 'facia'. Like other Aura products, the VA-80 has a low profile, measuring just 65mm high. It's reasonably

compact too, and should fit into almost any shelf space.

Four MOSFETs have been used in the power stage, giving it a manufacturer's rating of 45 watts rms per channel. There are six line-level only inputs, so an additional phono amplifier would be required in order to use a turntable.

Four substantial binding posts are located on the rear panel of the amplifier alongside the row of phono inputs, those

for CD being gold plated.

This amplifier looks and feels well finished. It has a 'state of the art' appearance that would not go unnoticed in the most modern of homes.

## **SOUND QUALITY**

The most striking characteristic of this amplifier, which stood out immediately, was the warmth it gave to the lower registers. Bass lines were pronounced and

# NAIM

At  
Westwood & Mason in Oxford



NAC 52		
NAC 82	CDS	
NAC 92	CDi	NAP 250
	CD3	NAP 180
		NAP 90.3
NAIT 3		
NATO 3		

We stock:- Arcam, Aura, Creek, Denon, Epos, Kef, Klipsch, Marantz, Mission, Nakamichi, Neat, Quad, TDL, Tannoy Definition, Yamaha.

**WESTWOOD & MASON (OXFORD) LTD**  
46 GEORGE STREET, OXFORD (0865) 247783

Closed Thursdays  
Demonstrations by appointment



**ORANGES & LEMONS**  
THE INNOVATIVE  
AUDIO/VISUAL RETAILER



SERVING LONDON FROM BATTERSEA  
071-924 2040/3665  
61/63 WEBBS ROAD, SW11

"AN OUTSTANDING PERFORMANCE"



**Keswick Audio Research**

write or call for details on our full product range and your nearest stockist.  
Unit 8 Ferrybridge Workspace, Pontefract Road, Ferrybridge,  
West Yorkshire WF11 8PL  
Tel/Fax: (0977) 671823 or (0924) 870606

V o i a n t e



**Lumley ST70 power amp**  
"In many ways the ST70 is a quite remarkable amplifier"  
Hi-Fi News June '94

**BRENTWOOD HI FIDELITY**

Aura • Audio Innovation • Castle • Chord • Crimson •  
Denon • DNM • E.A.R. • Impulse • Lumley • Marantz • Mission •  
Micromega • Musical Fidelity • NAD • Pink Triangle • Project •  
Quad • Ruark • Rehdeko • Shearne Audio • Systemdek • Tannoy •  
TDL • Thule Audio

**Tel: 0277 221 210**

**2 INGRAVE ROAD, BRENTWOOD**  
Near corner of Brentwood High St.

very rounded, but not particularly slow and lingering, although they did lack the control and detail that is present with some more expensive integrated

*“I liked the midrange - vocalists were allowed to breathe, performing with space around them, a quality that often eludes amplifiers at this level.”*

amplifiers. Receiving its signal from an Audiolab 8000CDM transport linked into a Pink Triangle DaCapo DAC, the Aura VA-80 produced a quality of bass that was definitely over-warm and detached from the remaining music. Aura would not expect such an expensive front-end to be used in practice, however, so this warmth could be beneficial in certain circumstances, with a budget or mid-price CD player possessing a drier, coarser sounding bass, for example.

I liked the midrange - vocalists were allowed to breathe, performing with space around them, a quality that often eludes amplifiers at this level. Generally, the midband was smooth and polite, giving a pretty detailed insight into the music without throwing it out - with the occasional exception: Randy Brecker's trumpet was particularly impressive - it had real power.

Although this amplifier is quite explicit in the midrange and capable of revealing most shortcomings in recordings or the preceding equipment, its treble quality is not in quite the same league. Although sounding smooth and fairly free of grain, it masked the finer detail that more revealing amplifiers can resolve. Still, we're not exactly dealing with high-end equipment at this price and realistically, considering the level of front-end that it is likely to be partnered with the amplifier, its ability to smooth things out a little may be an advantage. The refinement in the higher end of the sound spectrum that 'affordable' CD players commonly lack could be hidden by the Aura to some extent, or at least calmed.

The guitars in Guns and Roses' Patience sounded a little confused - not completely mixed together but blended a little, compromising their individuality. This impression is based upon comparison with our KLPI valve pre-amplifier driving

our Class A solid-state mono-block power amplifiers, so it's really a small criticism for such a reasonably priced amplifier.

As well as the midrange, the other main strengths of the VA-80 lie in its ability to open up a big, wide soundstage which seemed to fill the room. This, along with good imaging ability, ensured that a life like illusion was created, seemingly revealing the positions the musicians within a band, or sections within an orchestra.

Another quality of the Aura that captured my attention was its ability to lay bare the rhythm behind the music. You simply couldn't fail to be aware of it - almost everything I listened to had a tight, flowing rhythm, driving pieces along. This is probably more attributable to the Audiolab/Pink combination, but nevertheless it reveals the accuracy present with this amplifier in terms of

conveying timing.

In the VA-80 Aura appear to have tailored an amplifier to suit this particular sector of the hi-fi market - and why not. For those people who want an affordable amplifier to complement affordable equipment, the Aura should not escape an audition. The VA-50 was unusual in its sound and much appreciated because of it; the VA-80 should find equal success ●

**Aura VA-80 £279.95 (black mirror)  
£329.95 (chrome)**

**Aura Designs Ltd.,  
Marlborough Road,  
Lancing,  
West Sussex, BN15 8TR.  
Tel: (0903) 750750  
Fax: (0903) 750694**

### MEASURED PERFORMANCE

The Aura produced a healthy 50watts into 8ohms, a standard loudspeaker load. Into 4ohms, a low load, it was less impressive. Ideally, there should be a substantial increase in power, up to double, but the Aura's small toroidal mains transformer wilted, causing the amp to give just 56watts. This is likely to soften out bass drive a little. However, Aura have now given this amp the ability to swing current without thermal limiting in the output MOSFETs and, in any case, this is essentially a budget design that aims to combine modest performance with good sound quality, so these deficiencies have to be seen in the context of price.

I was surprised to measure a very low channel separation figure of 36dB, even though the amplifier has no balance control across which crosstalk can occur. Low separation actually enhances the sound, strengthening centre images, usually vocalists, giving them stronger embodiment.

There was little noise, no hum and acceptably low d.c. offset. Bandwidth was a surprisingly wide 12Hz-50kHz. In the past Aura have rolled off treble response very early, to give a warm sound. Perhaps this was accidental, due to impedance mismatching around the volume control, or perhaps it was policy that Aura have decided to revise. Whatever, the new VA-80 moves away from band limiting just as other amps, like the Linn Majik-I, take it up with relish. Its effect is best judged by listening tests.

Distortion levels were low at all powers, right across the audio band. At high frequencies the distortion component was predominantly second harmonic, except at high output, when higher orders started to appear. I'd expect there to be little sign of distortion in the sound, since this is a very respectable performance.

Whilst there are distinct signs of cost

consciousness in the VA-80, that's only to be expected. The art, in a budget design, is to make savings in the right places and measurement suggests Aura have been judicious in this process, since this amplifier measures well enough. **NK**

### TEST RESULTS

Power	50watts
CD/tuner/aux.	
Frequency response	12Hz-50kHz
Separation	-36dB
Noise	-98dB
Distortion	0.004%
Sensitivity	200mV
dc offset	9/10mV

### Distortion

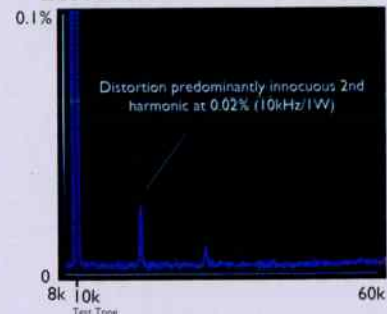

# S H E A R N E A U D I O

PO BOX 22 STEVENAGE HERTFORDSHIRE SG2 8HF TELEPHONE 0464 724337

DEMONSTRATIONS AVAILABLE AT:  
AUDIO SUITE (ABERDEEN) 0244-825331  
BRENTWOOD FIDELITY (BRENTWOOD) 0377-221210  
BURY AUDIO (BURY St. EDMUNDS) 0284-724337  
CLASSIC HI-FI (KETTERING) 0536-515766  
CITY SOUND (HASTINGS) 0424-429991  
HI-FI EXPERIENCE (DARLINGTON) 0325-481418  
(LONDON) 071-5803535



HI-FI CORNER (GLASGOW) 041-2482840  
MJS HI-FI (LEICESTER) 0455-846977  
NORTHWOOD AUDIO (NORTHWOOD) 0923-830877  
(AYLESBURY) 0296-28790  
PHASE III (WORTHING) 0903-245577  
SEVEN OAKS HI-FI (SELECTED BRANCHES ONLY)  
ZEN AUDIO (HULL) 0482-587397  
ZEUS AUDIO (BELFAST) 0232-332522

# ASL

Acoustic Solutions

# Jade



Acoustic Solution introduce Jade, a new reference in quality budget interconnects.

Jade offers outstanding transparency and accurate reproduction at an remarkably low cost

...from only £34.95 for a 1/3m pair... audition a pair soon.

## Acoustic Solutions

46a Market Street,  
Longton,  
Staffordshire,  
ST3 1BS  
Telephone (0782) 595330  
Fax (0782) 593187

'Sound Engineering For The Future'



# GRUNGE AUDIO!



The shelves inside Audio Gold hold reams of affordable Grunge hi-fi.

**Dominic Baker visits Audio Gold in Finchley, North London, to speak to Richard Goldsmith about Grunge audio - second hand gear that's too old to be valuable and too new to be vintage.**

**G**runge Audio is a valuable way for the budding or impecunious audiophile to get on the road to better sound quality. It's a product of car boot sales, swapmeets, audio jumbles and suburban shops like Audio Gold, stocked to bursting point

with second-hand goods. "I stock affordable hi-fi, but I also like to have some unusual things in the shop, things that are rare and interesting that people enjoy", Richard Goldsmith told us.

Question enthusiasts and you'll

often find that this is how they started out. "My customers are in their twenties and thirties, have often just moved into the area and want music in a flat or bedsit. They like the build quality of the earlier hi-fi, the solidness of it, and the fact that each item is



**Marantz and Trio are familiar names in Grunge Audio.**

individual rather than a series of black boxes without character; character or quirkiness comes from age."

Grunge Audio falls between the vintage/collectors market, which is for specialists who know what to buy and are prepared to spend and then restore, and modern second-hand that fetches reasonably high re-sale prices. A typical Grunge system might comprise a Pioneer PL12D/Thorens or similar record deck with SME 3009 'S'



**A fantastic GEC cabinet system - they don't make 'em like this anymore.**



**A pair of heavy duty Celestion 25s sit below a Transcripator turntable.**

shaped tone-arm and Shure cartridge, a large, silver fronted, receiver complete with sturdy controls from JVC, Technics, Rotel, Pioneer or Marantz and a pair of floorstanding Celestion Dittons, KEF Codas or even JBLs.

the cheapest midi-system, possessing a weak and crude solid-state amplifier driving the simplest of loudspeakers, comprising one drive unit in a small box.

In contrast, Grunge products are usually large, heavy and surprisingly well built. They're usually from the East, mainly Japan, being built in the days when labour costs and exchange rates were favourable enough to yield products of a quality the West could barely match. Most of them, like the big receivers for example, are cumbersome but they were in most ways built to last: heavy switches, cast sub-chassis and platters, large, high quality drive units, sturdy metal casework.

A whole system might cost between £150 and £300 and it will be a bargain in comparison with modern day price equivalents, such as there are. "They know that separates will give them better sound than an all-in-one system, yet will cost less and can be upgraded easily". This sort of money would otherwise only buy

The conservative design of these items means that at heart they have life in them. However, minor problems can lurk and may be the reason such goods were sold off by their owners in the first place. Quite often, switches and the like become intermittent due to oxidation of silver contacts. This imposed a strict working life of a few years. But faults like this can be easily cleared and the equipment should then last for many more years. "We give three months guarantee on all items



**A Marantz cassette deck just in and awaiting service. This SD3020 must be one of earliest decks to have a double speed transport.**



with the exception of speakers, but we still like to help. A lot of the time the faults are minor and we repair free of charge. I have a couple of engineers who check for safety and wear, so everything has life in it". This kind of equipment wasn't budget hi-fi. A lot of it was near top of the range and engineered to a very high standard in most respects.

Not only can Grunge Audio provide a way into separates for the budding audiophile, but it's also great fuel for the enthusiast tweeker. Take Grunge speakers for example. The boxes are large and heavy and the drive units normally sturdy KEFs, Celestions, Tannoys or JBLs. However,



**My favourite, the Marantz 4240 Quadrophonic receiver. The styling is outrageous, and how did they get all of those controls on one front panel?**



**KEF 102s - the drive units alone would cost a small fortune these days.**

the components used in the crossovers can be easily improved upon by substituting modern audio grade (Solen or Ansar) polypropylenes and such like. The internal damping can be replaced and re-tuned to give more or less bass and new internal wiring fitted. Anyone who has tried these modifications will vouch for their effectiveness - and it doesn't cost more than a few pints down at the local. "A lot of people who come in here find high-end shops

and prices intimidating. Grunge audio gets them on the way to separates hi-fi at a price they can afford".

### **WHERE TO FIND GRUNGE AUDIO AND WHAT TO LOOK OUT FOR.**

Apart from Audio Gold in London, where else can you

spot Grunge Audio? There are a number of places that Grunge hi-fi is likely to turn up: jumble sales, junk shops, hi-fi dealers that sell second-hand equipment, market stalls, etc.

The problem with Grunge hi-fi is that in most cases it won't have been checked out by an engineer. This isn't so bad if you're looking for speakers or a turntable, where if it can be demonstrated as working there is normally little that can go wrong. But amplifiers, tuners and cassette decks in particular need servicing and checking thoroughly if you are to be sure of a useful lifespan.



**The first personal stereo?**



**For less than £80 you could own one of these beasts - complete with analogue power meters.**

If something is not working, there is little point paying to have it repaired. Most engineers will charge around £20-30 an hour these days, and as anyone who has worked on this kind of hi-fi knows, it can take an hour just to get into the case and find the faulty component, let alone order a replacement and fit it. But if the equipment has been checked it is normally so well constructed that it should keep going for many years ●

# Pure and Precise

**In sound and design**

In 1994 Jamo celebrates its 25th Anniversary and to celebrate we bring you leading edge technology combined with an exceptional loudspeaker design synonymous with Danish styling and excellence. The 07 series combines fascinating design with transparent and authentic sounds meeting all the demands of the eyes and ears.

The 07 series - The Total Listening Experience



**Jamo**

**"The Sound of Excellence"**

## Pure and Precise

### Dealer

Barretts of Canterbury  
Bowers & Wilkins  
Canterbury HiFi  
Churchers  
Churchers  
Collingwood Radio  
Dawson's  
Hamiltons Electronics  
Howes of South Borough  
Kimberleys HiFi  
Sunderland Electronics  
Taylor & Roberts  
The Horsham Sony Centre  
VJ HiFi  
VJ HiFi  
Weybridge Audio  
Alphabec  
Analog Audio  
Collingwood Radio  
Kama  
Laysyl Ltd  
Musical Images  
Musical Images  
Nicholls HiFi  
Rightway  
Selfridges  
Sona Electronics  
Cashes of Cork  
LRG (Sound & Vision)  
Todds of Limerick  
Zeus Audio  
Cryers  
Manders HiFi  
Derann Audio Visual  
Forum HiFi & Video Centre  
Living Design  
The Stereo Shack  
H G Rapkin  
P Dogra & Son  
P.J's HiFi & Video Centre  
Pounds Ltd  
R Lewis & Co  
Roystons  
Select TV  
The Videofactor  
VAudio  
Wentworth Audio  
Plymouth Audio Visual  
**Excel Venture Trad. Co.**  
**Jamo HiFi USA Inc.**  
**Pan International Company**  
**Scan Audio**  
**Taiwan Audio Trad. Co.**  
**Jamo UK Ltd**

### Town

Canterbury  
Worthing  
Canterbury  
Hove  
Worthing  
Banstead  
Bournemouth  
Southampton  
Tunbridge Wells  
Bexleyheath  
Brighton  
Haslemere  
Horsham  
Folkstone  
Margate  
Weybridge  
London NW2  
London N12  
Ewell  
London W1  
London SW14  
Edgeware  
Hounslow  
London SE12  
London W2  
London W1  
London W8  
Cork (Eire)  
Bellast  
Limerick (Eire)  
Bellast  
Blackburn  
Grimby  
Dudley  
Nottingham  
Stoke on Trent  
Leicester  
Northampton  
Slough  
Banbury  
Hoddesdon  
Stroud  
Nuneaton  
Bristol  
Gerrards Cross  
Bristol  
Dunstable  
Plymouth  
**Singapore**  
**USA**  
**Hong Kong**  
**Australia**  
**Taiwan**  
**Daventry**

### Telephone

0227 767576  
0903 264141  
0227 765315  
0273 324616  
0903 305558  
0737 351365  
0202 764965  
0703 228622  
0892 28662  
081 304 3272  
0273 774113  
0428 643286  
040325432  
0303 258860  
0843 226977  
0932 851121  
071 431 9133  
081 445 1443  
081 393 2252  
071 323 2747  
081 876 7632  
081 952 5535  
081 569 5802  
081 852 5780  
071 723 7565  
071 629 1234  
071 938 4811  
021 276771  
0232 451381  
061 417222  
0232 332522  
0254 51842  
0472 351391  
0384 233191  
0602 622150  
0782 336233  
0533 530330  
0604 37515  
0753 521706  
0295 263222  
0992 465531  
0453 762485  
0203 385489  
0275 833135  
0753 884552  
0272 686005  
0582 663383  
0752262976  
**65-3832200**  
**1-7084984648**  
**852-8891989**  
**61-38195352**  
**886-42237609**  
**0327 301300**

**Jamo**  
The Sound of Excellence

campaign audio design  
**LOVE HERTZ**



Getting a better, more involving, sound often means spending a lot of hard earned money. It's such a waste, because every system can benefit from our cables and accessories, at a fraction of the cost of some new "black box". Here are some of the ways we can help.

We have Oxygen Free Copper interconnects (£12.48) up to Pure Silver cables (£120.00) and high definition loudspeaker cables in Silver plated Copper or Pure Silver. Our main cables add weight, power and scale. Non inductive RF filtering (£10.00) and over voltage protection (£3.00) enhance performance still further. Gold plated AV cables, both RF (£19.95) and Scart (£23.52), help bring picture quality in line with NICAM sound resolution.

Valves, capacitors and transistors are all microphonic, they cannot perform optimally if vibrated. Our set of three Brass Isolation cones (£6.50) are worth their weight in gold - revealing low level resolution and dynamics hitherto hidden beneath electronic noise. We also have a cure for your noisy fridge or central heating motor (£3.50), enabling you to throw away your big mains noise suppressor, which has been giving you that "sat upon sound" for years.

There's lots we can do to bring you closer to the emotion and energy of the performance. So confident are we, that we offer a 14 day money back guarantee.

Ring or write for details:-

**CAMPAIGN AUDIO DESIGN**  
**Llandudno Road (HW)**  
**Cardiff CF3 8PG**  
**Tel:- 0222 779401**

Trade and International Enquiries Welcome.

# People like us, like **Hi-Fi.**

**FOR THE BEST ADVICE ON THE LATEST MODELS**

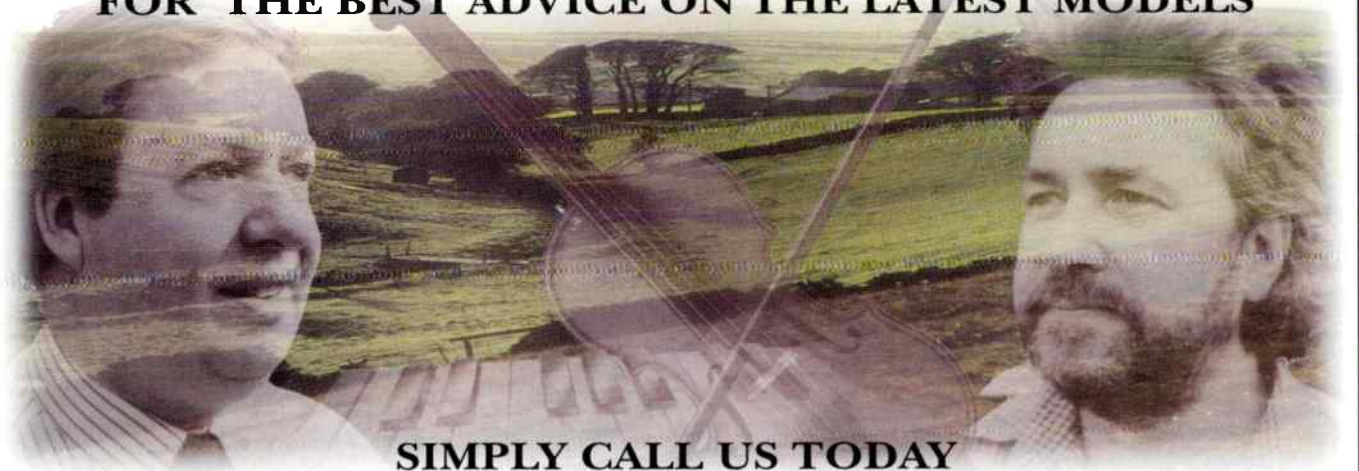

**SIMPLY CALL US TODAY**

- **THREE DEMONSTRATION ROOMS**
- **FREE INSTALLATIONS**
- **INTEREST FREE CREDIT**

**Steve**  
**Boxshall**

**AUDIO**  
**CAMBRIDGE**

**41 VICTORIA ROAD CAMBRIDGE (0223)68305**

PIONEER

BEST PRICES GUARANTEED

KENWOOD

TANNOY

MISSION

PANASONIC

TEAC

AKAI

PHILIPS

DENON

YAMAHA

MARANTZ

JVC

SONY

TECHNIGS



ALL BILL HUTCHINSON HI-FI SHOPS ARE DEDICATED AUDIO VISUAL CENTRES

ALL BRANCHES ARE MAJOR LASER DISC STOCKISTS

PIONEER

REFERENCE POINT

# Bill Hutchinson

Hi-Fi · CD · Audio Visual Centre

THE PROFESSIONALS

When you purchase from Bill Hutchinson you're buying the best names in Hi-Fi from the best name for Hi-Fi.

Our Product Guarantee and Pricing Policy ensure you obtain an excellent deal.

My staff and I look forward to being of service to you. *Bill*



HEAR KENWOOD'S INNOVATION WINNING AV AMPLIFIER



- YAMAHA DSP-2070 - AV AMPLIFIER - INNOVATION WINNER '94
- KENWOOD KRV 6060 - AV RECEIVER - INNOVATION WINNER '94
- PIONEER PDS-703 - CD PLAYER - INNOVATION WINNER '94
- MARANTZ 1020 - LYFE STYLE SYSTEM - INNOVATION WINNER '94
- AIWA AD-450 - CASSETTE DECK - INNOVATION WINNER '94
- KEF 100 - CENTRE SPEAKERS - INNOVATION WINNER '94
- JVC UX-C7 - AV AMPLIFIER - INNOVATION WINNER '94

## PRICE PLEDGE

Should you find any local dealer offering a better price for goods currently in stock at Bill Hutchinson and the alternative quoting retailer, we will better that deal.

LICENSED CREDIT BROKERS ASK FOR DETAILS

## THE LARGEST SELECTION OF QUALITY HI-FI AND AUDIO VISUAL SYSTEMS

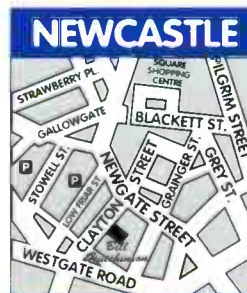
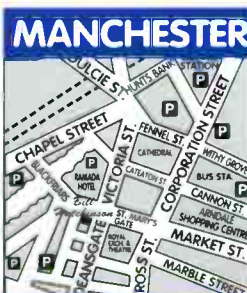
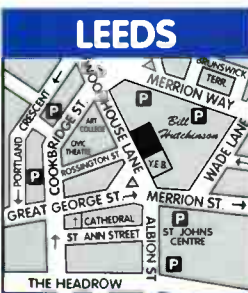

26-28 WOODHOUSE LANE  
0532-427777

50-52 DEANSGATE  
061-832 1600

87A CLAYTON STREET  
091-230 3600

43 HOPE STREET  
041-248 2857

43 SOUTH CLERK STREET  
031-667 2877

OPEN MONDAY SATURDAY  
9.30AM - 6.00PM  
THURSDAY LATE OPENING

OPEN MONDAY SATURDAY  
9.30AM - 6.00PM  
THURSDAY LATE OPENING

OPEN MONDAY SATURDAY  
9.30AM - 5.30PM  
THURSDAY LATE OPENING

OPEN MONDAY - SATURDAY  
9.30AM - 6.00PM  
THURSDAY LATE OPENING

MON SAT 9.30AM 6.00PM  
SUNDAY 11.00AM - 5.00PM  
THURSDAY LATE OPENING

ROTEL

ALL WITH 2 YEAR GUARANTEE

AIWA

World Radio History

# AIR DISPLAY

review

Pioneer's new F-303RDS tuner gives a useful display of what's on the airwaves.

Eric Braithwaite finds it sounds good too.



**P**ioneer's F-303RDS tuner is £179.95, a one of the new breed of Radio Data System tuners which gives listeners access to the full range of RDS services - all very readable price. The tuner automatically tunes to the strongest FM transmission in any area through the Programme Identification, or PI mode of RDS, something the Pioneer did without hitch. It displays the station name as well as its frequency and the type of broadcast ('Rock', 'News' and so on) and it allows you to search for a station that is currently broadcasting 'Sport' or 'Classical' or whatever, without the pain of tuning into the twenty-odd FM stations one by one. It also strobe test messages across the tuning window.

...and even, from a 100% level, the 100% of the tuner's display, which is a...  
...the tuner's display, which is a...  
...the tuner's display, which is a...

...the tuner's display, which is a...  
...the tuner's display, which is a...  
...the tuner's display, which is a...

...the tuner's display, which is a...  
...the tuner's display, which is a...  
...the tuner's display, which is a...

...the tuner's display, which is a...  
...the tuner's display, which is a...

When the Beatles' 'Here Comes the Sun' came in on R2, so did a sparkle. Distinctly brighter than the Quad FME, it went with a pleasing zing. No bad thing, in some ways, though any added sparkle couldn't really make Kiss FM's compression bearable, despite what was a reasonably solid bass issuing from the tuner. The only spoiling element was a degree of hollowness in the mid-band, more

...the tuner's display, which is a...  
...the tuner's display, which is a...  
...the tuner's display, which is a...

**Pioneer F-303RDS tuner** £179.95  
**Pioneer UK**  
**Hollybush Hill,**  
**Stoke Poges,**  
**Slough SL2 4QP.**  
**Tel :0753-789789**

## MEASURED PERFORMANCE

The F-303RDS has a small rise in its treble output that will add some brightness or just better detailing. Above 16kHz an mpX filter rolls down pilot tone and sub-carrier output enough for them not to be a nuisance when recording.

Distortion was respectably low at around 0.15% and, given 1.25mV or more from an aerial, hiss sinks to -73dB - inaudible even during the silences of Radio 3.

Selectivity in Wide mode was a sensible 66dB (adjacent channel); narrow mode takes the figure up to a healthy 83dB, easily enough to prevent powerful stations breaking through to weak ones even when close by.

Sensitivity was a little low, measuring 40mV on stereo and 4mV on mono., half that commonly achieved nowadays. This won't be so obvious except in marginal reception areas or with poor indoor wire aerials.

Pioneer fit a fairly good six-sector signal strength meter that works from 16µV of aerial signal through to 630µV, the last sector representing a usefully high level in terms of fidelity and, therefore, aerial effectiveness.

The F-303RDS measures well all

round, offering a lot of performance for the price. **NK**

## TUNER TEST RESULTS

Frequency response	13Hz-16kHz
Stereo separation	42dB
Distortion (50% mod.)	0.15%
Hiss (CCIR)	-73dB
Signal for minimum hiss	1.25mV
Selectivity (at 0.4MHz)	66/83dB
Sensitivity	
mono	4µV
stereo	40µV
signal strength meter	
Sector	1 2 3 4 5 6
Level (µV) -	16, 32, 63, 160, 320, 630

## Frequency Response

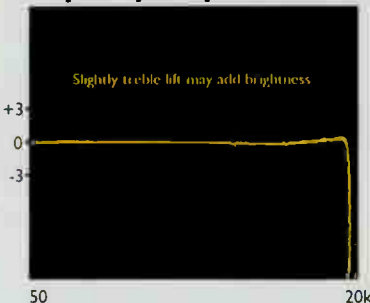



# Experience live music

*in your home.*

Experience a personal service second to none.

At Sound Gallery we will help you tailor a hi-fi system that sounds exactly the way you want it, not the way you've been told it should sound.

Experience the options in the neutral conditions of our demonstration room, and the professional home installation of your desired system.

**FOR A SOUND EXPERIENCE  
AND SOUND ADVICE, CALL**

**THE SOUND  
GALLERY**

**0494 531682**

65 CASTLE STREET • HIGH WYCOMBE • BUCKS HP13 6RN

World Radio History

# POWER STRUGGLE

**Noel Keywood listens to four power amplifiers as they struggle to drive the big TDL Reference Standard transmission line loudspeakers.**

**NAIM NAC72-NAP250**

A good number of readers ask about choosing a big power amplifier, and Linn and Naim rank highly as a potential choice. With the enormous TDL Reference loudspeakers looming into view on our calendar, we decided this would be a fine opportunity to get to grips with the Linn Klout power amplifier as well as its rival from Naim, the NAP250. To assess their relative merit, we pulled in the John Sheane Phase I power amplifier and the Alchemist Genesis monoblocks.

Normally, you'd choose a power amplifier on the basis of power output and the way in which its own innate sound quality complemented your speakers and appealed to your tastes. In this case, the speakers proved to exert such an influence upon the amplifiers that the two couldn't be so conveniently separated. I strongly suspect that what we heard in listening tests at Son et Lumiere wasn't just the simple combination of the two, but a fairly strong interactional process. Consequently, to try and more clearly distil the

metre from an 87dB sensitive speaker like the TDL Reference, then I need 13dB more power than 1watt, or 20watts. If I want 110dB peaks I need 23dB more, or 200watts. Since 100dB peaks give an average music level of around 93dB SPL or so this is playing softly; hitting 110dB peaks is playing loud, tests with our B&K 2230 Precision Integrating SPL meter show. That gives you some idea of just how much power requirement changes according to volume. Someone who plays loud or very loud, especially in a big room, needs hundreds of watts; someone who plays at restrained levels in a small-to-medium room needs no more than 50watts.

This example is sufficient for everyday guidance, even though it's at one metre in front of one speaker when in practice listening four metres in front of two speakers is usual, a situation that demands even more power, making the above figures minimums. It's really the ratio jump between normal and high volume listening that matters though; when you wick it, the power you need leaps upward. But before you decide that only a 200watt amplifier will do, bear in mind a few other points.

Big power amps have traditionally been more about power engineering than high fidelity; not all of them sound that good. The reputation Linn and Naim have for sound quality has probably helped their credibility in this field. So beware - 200watts can be 200watts of pain. Choose amplifiers for their sound quality in conjunction with the speakers you use; don't go for power just for the sake of it.

All loudspeakers, with the exception of horns, are inefficient; a lot of the musical signal just goes to heat up the drive unit voice coils. If you have a large room, want high volumes and intend to use a big 200watt amplifier to full capacity then the speaker will have to be able to take it. One way of ensuring it can is to distribute the power amongst multiple drive units - each TDL Reference has seven. High powers stress loudspeakers; make sure they can take it or you'll suffer horrible muddle and distortion, followed by failure when the voice coils start to rattle

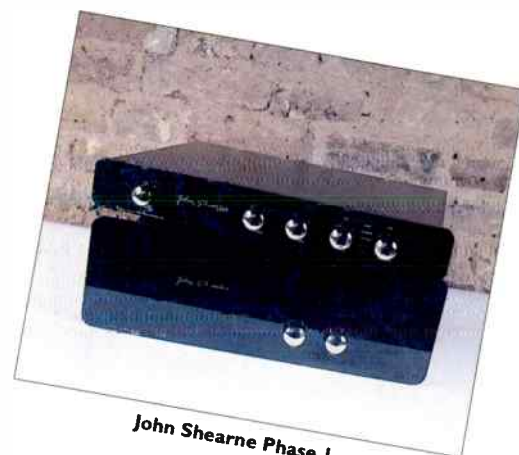

**John Sheane Phase I**

or when they burn out altogether.

Finally, our listening tests underlined again the occasionally strange and unpredictable way in which hi-fi products interface with each other, making performance predictions hazardous and possibly misleading. The only speakers I have encountered that upset amplifiers as much as the big TDLs were the Celestion SL6000 sub-woofers. They have much in common: big heavy cones - two per speaker - moving a lot of air. Since cone and air load mass in combination are reactive, meaning they store and release energy, these speakers return more energy to the driving amplifier than usual - and it showed. Yet again this highlights the importance of getting a demonstration before buying, since generalities about sound quality aren't necessarily enough ●

**Linn Kairn-Klout**

innate sound of the amplifiers we also used them on other speakers, our own KLS3s and Linn Kabers.

How much power do you need? I'm afraid there's no easy way to assess this down to the last watt, simply because it depends mainly upon room size and, especially, volume levels. Look at this example. If I want 100dB peaks at one



**Alchemist Freya-Genesis**

# NAIM NAC72-NAP 250

The 250 underscores Naim's reputation for producing power amplifiers of ultimate drive and pace. Big Naims maintain astonishing grip at low frequencies, coupling it with brutish power and drive. Surprisingly, although the NAP250 gave the best bass quality of all the power amplifiers, it injected too much power. Bass from the speakers became overwhelming. To use Naims for their grip and control, the TDLs would have to be bi-amped, the bass amplifier having its gain reduced slightly by an attenuator on the input. Less expensive, but less satisfactory too, a high power series resistor could be used to attenuate the bass line. This wouldn't affect electrical damping much, because a series inductor, which has an appreciable d.c. resistance, is used in the crossover.

The 250 has insight and delivers detail, but at the same time it has its own distinctive character in the lower treble region, sounding a little forward and bright, if clean. Since most loudspeakers possess a suckout in the 3-7kHz region, since few bass/midrange and dedicated midrange units reach smoothly up to 7kHz, this forwardness can usefully balance out the sound. Partnered with a loudspeaker that covers this region well, the 250 will come over as a little less than refined when

reproducing violins in particular, which are unusually strong in the energy they project across the upper midband.

With the big TDLs the 250 laid emphasis on the lower treble unit, pushing the prominent strings of Steve Earle's Gibson guitar forward with real bite and presence. It was good, visceral stuff and any Earle fan would love it, but at the same time it threw a spotlight onto the T62 treble unit, robbing the speaker of cohesiveness.

It was the absence of this glare that made the Klout sound smoother, more composed and refined, yet that wouldn't appeal to a Naim fan, since it gives a performance that's less dynamically challenging. But that's hi-fi. The big Naim amps have a grip of steel, allowing them to control the TDLs, teasing out firm yet deeply expressive bass lines and perfectly controlled yet clearly delineated percussion and rhythms ●

**NAP 250** £1486.38  
**NAC 72** £683.03  
**HI-CAP** £599.25  
**Naim Audio,**  
**Southampton Road,**  
**Salisbury,**  
**Wilts. SP1 2LN**  
**Tel: 0722 332266**

## MEASURED PERFORMANCE

Power output of the Naim NAP250 power amplifier was identical to that of the Linn Klout: it produces 78watts into 8ohms and exactly double, 156watts, into 4ohms. Naims always were about good power supply regulation and the NAP250 demonstrates it well by doubling its power in this manner.

The NAP250 produced second harmonic distortion in the mid-band and at high frequencies with low level signals. Higher order harmonics up to 5th appeared at high powers though. Since level reached 0.1% maximum, commonly considered to be a safe upper limit, it is questionable whether these distortions are audible. **NK**

## TEST RESULTS

Power	78watts
Frequency response	11Hz-22kHz
Separation	70dB
Noise	-90dB
Distortion	0.005%
Sensitivity	90mV
dc offset	8/12mV

# LINN KAIRN-KLOUT

I was struck by the smooth and finely detailed delivery of the Klout. This power amplifier has real insight; it reminded me of a DPA amplifier and, indeed, there is a similarity: both use surface mount components. The percussion, vocals and cross rhythms of Angelique Kidjo's Aye album were handled beautifully by the Klout; they were entrancing in their sense of life and complexity. Equally, the Klout showed itself at home reproducing a large orchestra: strings came over sounding sweet, smooth and well separated. I found the Klout both intriguing and satisfying in this respect: it delivered music with a degree of smoothness and finesse that isn't so common from big power amplifiers.

Another valuable and much appreciated property of the Kairn preamp and Klout power amplifier in this particular instance was its cohesiveness. I suspect this elusive factor is determined by component colourations. Poor components, like non-audio grade metal film resistors and polypropylene capacitors, can introduce quite a shriek into an amplifier, we've found during listening tests on components for our own designs. Eliminate such colourations and an amplifier becomes smooth and

cohesive in its sound. This is an area where the Klout excelled. It would be easy to say the resulting smoothness suits classical music particularly well, but I think not. There's a need in Rock music for neutrality too and the Klout has it.

It was only in the bass region that the Klout seemed a little chameleon like and, on occasion, open to criticism. It couldn't get a hold of the TDLs; they boomed quite strongly. Yet with the Kabers the Klout sounded quite restrained at low frequencies - a bit on the light side in fact. The Klout didn't live up to its name; it has more finesse than clout and this, I felt, was its forte. The Kabers held together nicely under its influence, coming across as well integrated, smooth and fundamentally right, apart from spitty treble caused by the ceramic dome tweeter. But unfortunately the Klout was not a partner for the TDLs at low frequencies - they were quite obviously mismatched ●

**Klout** £1895.00  
**Kairn** £1398.00  
**Linn Products Ltd.,**  
**Floor Road,**  
**Waterfoot,**  
**Eaglesham,**  
**Glasgow G765 0EP**  
**Tel: 041 644 5111**

## MEASURED PERFORMANCE

The Klout, like the NAP250, produced 78watts into 8ohms and 156watts into 4ohms. There's plenty of grunt here, except for very large rooms, or very insensitive loudspeakers. The power supply is well regulated, meaning the Klout is likely to have controlled bass. In this, Linn join Naim and DPA.

Distortion measured a low 0.005% in the midband, rising to 0.01% close to full output (-1dB). The components were solely odd order, which is unusual. At high frequencies this rare pattern was repeated, reminding me of Pioneer's A-400. The Klout may well have a bright-ish or perhaps sweet (like Pioneer) treble as a result of its basic transfer characteristic. Only listening tests can tell. **NK**

## TEST RESULTS

Power	78watts
Frequency response	12Hz-28kHz
Separation	100dB
Noise	-92dB
Distortion	0.005%
Sensitivity	230mV
dc offset	0.3/0.3mV



# ALCHEMIST FREYA-GENESIS

**H**aving wrestled with the big Naim and Linn power amplifiers, with no outstanding success I felt, the Alchemist Freya preamp and Genesis monoblocks were lined up with some trepidation. In the event they managed well, certainly better than I had expected.

Having considerably less bass drive than the NAP250 they suited the TDLs by removing emphasis of the deep bass region. The initial strike on the bass drum at the start of Angelique Kidjo's Agolo was softened out and muted. It seemed, subjectively, to have about half the power behind it provided by the NAP250 and whilst, in other circumstances this might well be categorised as a minus point, in this case it was definitely a plus point; reduced output from the deep-bass transmission lines brought them more into line with the rest of the performance, making the strong, but rich bass rhythms on Aye stay in touch with the rest of the performance. With the NAP250 they could swamp the vocalists; with the Alchemist bass lines remained powerful, if sounding a little soft and ill defined. All the same, the Alchemists stayed clean sounding and

didn't make the TDLs boom, as did the Klout.

Across the vital midband and treble regions the Alchemists showed they were lucid and smooth - even a little polite in the upper treble. Whilst not possessing the detailing and finesse of the Klout, the Alchemists did meld the drive units into a fairly cohesive source, from which violin, vocals and steel stringed guitar sounded natural enough. The dynamics were gentle rather than gripping, but these speakers do have a smoothness that tilts them toward classical useage rather than heavy, punchy Rock, in spite of their bass performance. Here, the Alchemist suited their outlook nicely, giving a smooth and gentle rendition of music, yet one that still had plenty of scale and, of course, fearful deep bass ●

**Freya Preamp**  
**Genesis Power**  
**Alchemist Products,**  
**4 Rosebery Mews,**  
**Muswell Hill,**  
**London N10 2LG**  
**Tel: 081 883 3008**

**£1020.00**  
**£1525.00/pr.**

## MEASURED PERFORMANCE

The Genesis power amplifier has plenty of power - it develops no less than 110watts per channel into 8ohms and 196watts into 4ohms, so it can drive big speakers to high levels quite easily and it has good power supply regulation too, almost doubling output when load halves.

An unfortunate feature of the Genesis was its distortion. At 1watt output at 10kHz it measured an acceptable 0.036%, primarily second harmonic, as shown in our analysis. As output increased though, the level rose steadily to reach no less than 0.5% at -1dB below full output. This is none too impressive, around 0.2% being about the maximum tolerable before audibility. **NK**

## TEST RESULTS

Power	110watts
Frequency response	16Hz-40kHz
Separation	102dB
Noise	-77dB
Distortion	0.004%
Sensitivity	400mV
dc offset	44/37mV

# JOHN SHEARNE PHASE 1

**T**he mysteries of amplifier-speaker matching, especially in an acute case such as this, were highlighted when I connected up the John Shearne Phase 1. Hoping for the best, but fearing the worst, I was surprised to hear a good, tight drum strike at the start of Agolo and firm, clear bass lines, strong but not excessive in level. Unexpectedly, the John Shearne amplifier struck the best compromise between bass power, control and the rest of the performance.

The full expressive range of Angelique Kidjo's voice came over without hindrance from the potentially thunderous transmission lines, yet as always there was plenty of bass of a sort that just doesn't exist with lesser speakers. I was never left wondering whether the big TDLs had gone weak kneed with the John Shearne, the finale of the 1812 showing clearly that it pays not to underestimate the speakers. Canons roared, the room shook and I was left a little awe struck. Few speakers can pummel you so hard physically; this is one of hi-fis most visceral experiences, nicely held together by the Phase 1 power amplifier.

Providing well etched vocals and clear cut cymbals, the Phase 1 also

showed itself to possess a good sense of clarity, reinforced by reasonably strong treble. A slight spitch to sibilance became apparent and again, as with the big Naims, I noticed that there were individual drive units at work in these speakers, loosely knitted together to form a whole. In possessing some treble character, at least with these speakers, the Phase 1 joined the big Naim amps in drawing attention to the individual properties of the drive units, at the expense of cohesiveness. This was a small minus point. Steel guitar on Steve Earle's Someday had real bite; the track kicked off with force, as it's meant to. The Phase 1 wasn't without kick, but it also made massed strings sound a little harder and less delicate than I might have wished. On balance though, I felt the Phase 1 offered the best all-round results with the TDLs, an unexpected outcome ●

**Phase 1 Power** **£1999.00**  
**Phase 1 Preamp** **£1099.00**  
**Shearne Audio,**  
**PO Box 22,**  
**Stevenage,**  
**Hertfordshire SG2 8HF**  
**Tel: 0438 740953**

Continued on page 37 ...

## MEASURED PERFORMANCE

The Phase 1 power amplifier produces 78watts per channel into 8ohms, dropping substantially to 56watts into 4ohms. Usually, power increases into low loads, but the Shearne was unhappy with them; it also produced more distortion into 4ohms.

Distortion rose at high frequencies, hitting 0.12%, with a spectrum of high order harmonics. Different results between the channels suggested it was crossover, determined by individual output transistor characteristics.

The John Shearne Phase 1 has been designed to deliver some of the character of a valve amplifier from solid-state. It has an unusual performance, at least in terms of solid state behaviour. It is best judged in terms in sound quality. **NK**

## TEST RESULTS

Power	78watts
Frequency response	4Hz-32kHz
Separation	72dB
Noise	dB
Distortion	0.01%
Sensitivity CD/Tuner	650/140mV
dc offset	20/3mV

# BUYING A PRE-AMPLIFIER AND POWER AMPLIFIER

**Integrated amplifiers these days deliver a lot of power, so why buy a pre-amplifier and power amplifier combination? Here are some of the subtle reasons for doing so.**

**I**t doesn't make sense, but it does seem to work in practice. Integrated amps should work every bit as well as separate pre/powers, yet ultimately dedicated preamplifiers and power amplifiers still offer the best results.

Separate pre/powers are a historical hangover from the days of valves, when power amplifiers were massive and generated so much heat they had to be found their own place in the home - definitely not on a shelf, usually down on the floor. To prevent owners getting 'scrubbers knee' from repeatedly switching the power amps on and off, the preamp invariably controlled the power amplifier through a large umbilical cable. Leak and Quad used such an arrangement and only by the mid-seventies was it being discarded.

Nowadays, separate preamplifiers and power amplifiers exist for different reasons. Massive power supplies are needed if high power is to be delivered into esoteric loudspeakers that plunge down to an impedance of a few ohms. This makes for a heavy and bulky amplifier, as do large heatsinks which are also a feature of high power designs.

For reasons of convenience and appearance then, it makes sense to split the preamplifier away from this mass of metalwork, since preamps can be neat and small. The preamp is sited conveniently on a shelf; the power amplifier can be placed either on display, or out of sight. Also, from the designer's viewpoint, especially when sensitive high impedance stages exist in the preamp, splitting the two also makes it easier to avoid hum

induction from the mains transformer.

A modern power amplifier is a chunky beast whose role is, or should be, to drive all loudspeakers - even the most difficult like electrostatics - well. Integrated amplifiers may offer the same level of performance on paper, but are rarely as sophisticated in other ways. Class A working, where enormous amounts of heat must be dissipated, or Class A/B with a heavy bias toward Class A, again where a lot of heat is produced and must be lost both demand a large case. Massive heatsinks also allow a dedicated power amplifier to run at a reasonable temperature when delivering very high power continuously. With the Klout, Linn use a single alloy extrusion to form the sides, front and rear of the case. As well as providing impressive structural rigidity this expanse of metal also acts as a heatsink to keep temperature down. So size offers performance advantages; it is most easily coped with in the home by keeping preamplifier and power amplifier separate.

Other more subtle features of independent power amps should not be ignored. A good example lies in the use by DPA and, now, Linn of surface mount components. These are micro-miniature components, little larger than a pinhead, that offer better sound quality than standard 'leaded' components. At present specialised items like this tend to be found in top quality power amps and preamps only, not in mass market integrated amplifiers.

Similarly, enthusiasts can expect to be confronted with some perplexing choices of sound quality with separate pre/powers, but then this is also a potential advantage, since it gives greater freedom of choice. Naim power amplifiers are known for their superb grip, pace and dynamics. Naim integrated amplifiers do not seem to be able to provide these properties in such strong and aurally distinctive form. DPA power amplifiers rely on

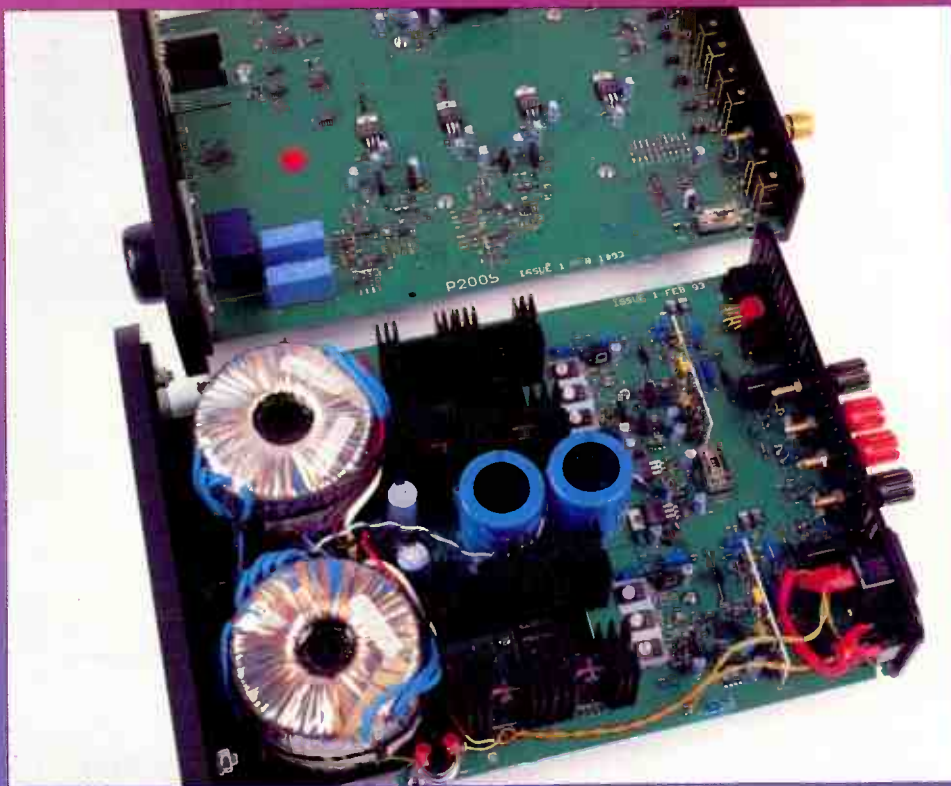

**DPA Digital were one of the first to use surface mount components, this is their latest pre/power, the 200S.**

surface mount technology, a novel form of output stage and, unusually, massive amounts of feedback (90dB) and they too have quite a distinctive signature. Chord power amplifiers use a switched-mode power supply and output MOSFETs to give a clear, precise sound with unusually deep, yet dry sounding bass. Then there are valve power amplifiers of course, like our own 300B design which can be operated with no feedback at all; this gives a free flowing and expansive performance.

Clearly then, apart from basic specified performance, independent power amplifiers are also about distinctive sound quality and in this our experience is that the good ones do truly have something special to offer.

There is a flip side to this though: many power amps of yore were simply audio generating stations as much suited to high frequency welding as anything else. Much a product of the late seventies, these have largely slid out of favour, being replaced by more sophisticated packages from those manufacturers mentioned above, plus many others. Generally, be wary of anything styled heavily to make a power statement, massive illuminated output power meters being one warning sign.

## PREAMPLIFIERS

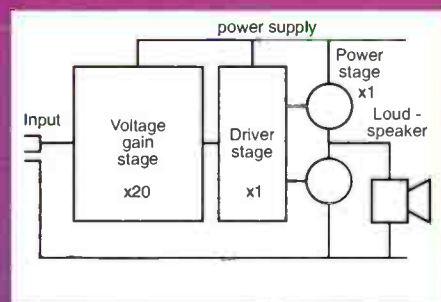

**In outline, power amplifiers have a voltage gain of around x20, typically needing 1V in to deliver full output of 20V (50W). The output stage has to deliver high current - up to 10A or more.**

Preamplifiers commonly have a peculiarly subtle yet influential affect upon overall sound quality in any pre/power combination and, even though they seem so intrinsically innocent, are often responsible for significant - even major - sound quality problems. Where power amplifiers often stamp their mark out with big boots - what they do is obvious and you like it or leave it - preamplifiers are altogether a more complex sonic proposition. Poor ones, often those which are fearfully complex in terms of their inputs and facilities, tend to erase detail from a performance, flatten perspectives, contract the

sound stage and add grit to the treble. Preamplifiers have the ability to make a system sound lifeless, cardboard cut-out and boring. Their degradations can have more impact in the long term than those of most power amplifiers.

Good stand alone preamplifiers are difficult to find, we feel. Michell, DPA and Rose (hybrid valve/solid state) all find favour with us, as do Audio Innovations with their valve L2 line stage. Linn and Naim also know that a preamp is a delicate device, rather than just a signal switching unit. Be very careful when auditioning any preamp.

This issue sees a group test of head amplifiers for phono cartridges (p57). Head amps are a specialised form of preamplifier, needed to amplify the minuscule signal from a moving coil or moving magnet pickup cartridge up to a level where it can be fed into a line input (i.e. tuner/aux/tape). Head amps like these underline how much of an influence preamplifiers can have.

There's more variety in preamps nowadays with the appearance of good valve designs which generally have a more fluid and relaxed sound than solid state types. However, do be very careful about these since low level valve stages are extremely sensitive and there's greater latitude for poor design to ruin the final product. Good valve

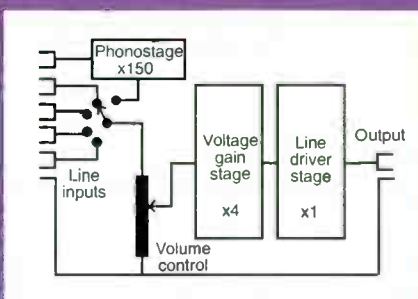

**Pre-amplifiers most commonly have all line inputs run direct into the volume control track via the input selector switch. Phono runs into a separate preamplifier/equalisation stage.**

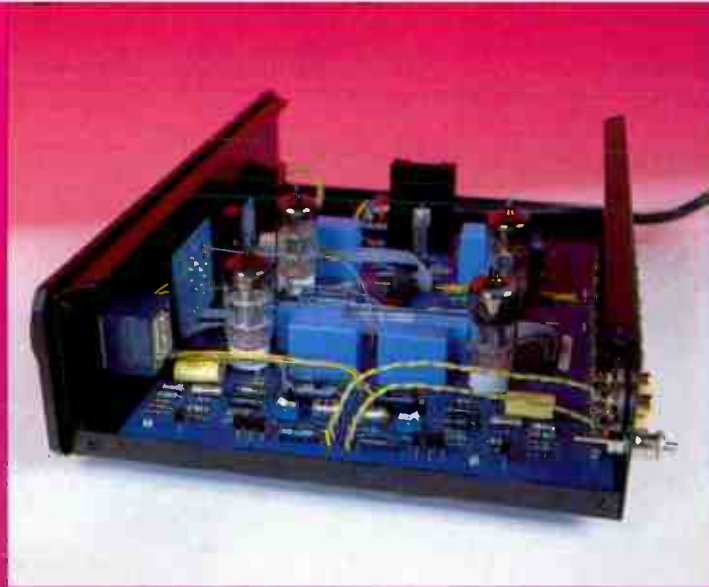

**The Rose RV-23S valve/solid state preamplifier has an open and sweet sound.**

preamps are beguiling to listen to; poor ones may sound bland and suffer both hiss and hum.

There's a good argument for using

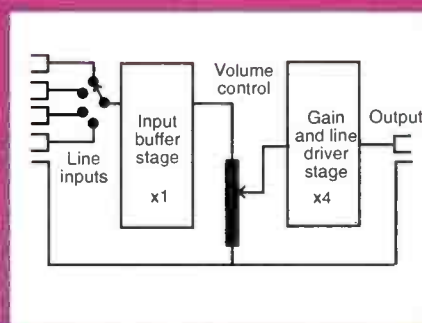

**Some manufacturers, like Quad and Naim, prefer to use an input buffer to give better defined input conditions. Input overload is a potential drawback with this system.**

a valve preamplifier with a solid state power amplifier. It's a combination that provides some of the openness, sweetness and fluidity of valves, with the practical strengths of solid state power amplifiers, namely good load tolerance, small size and high power output. There's less practical benefit in combining a solid state preamp with a valve power amp, although even this can in some cases be successful. However, a good valve power amplifier is very loud and can be seriously compromised by a solid state preamplifier of mediocre ability.

Independent preamplifiers and power amplifiers like those reviewed for this issue may offer little more power than an integrated one, say, the Denon PMA-350II. Good ones, these days, have a lot more to offer in terms of fidelity, however. That's the main reason for buying a quality pre/power combination. ●



**SPECTRA**  
*Dynamics*

# DEFLEX® PRODUCTS

For further details and a **FREE** comprehensive information pack  
Tel. (0745) 571600 Fax (0745) 570194

(We also have a range of specialist damping pads for In-Car Hi-Fi - **POWERPADS** - Phone for details)

## DEFLEX® acoustic PANELS

The simplest and most cost effective way to upgrade your existing system

Buy at least 2 Deflex panels specially designed and patented by Spectra Dynamics



Remove foam and/or wool damping from the inside of your speaker (if fitted)

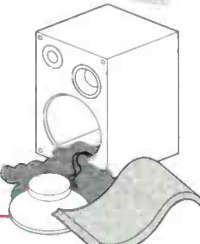

Place the flexible Deflex panel thru' the speaker cut-out and stick to the inside of the cabinet

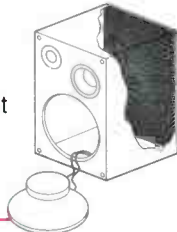

Sit back and listen to extra detail in sound, and far less distortion when played loud



### What the experts have to say...

"...a marked improvement was obvious from the first few bars of REM's Automatic for the people album..."  
*Hi-Fi News & Record Review - March 1994*

"...the result was sharper imaging, wider dynamics and a more natural sound..."  
*Hi-Fi Choice - January 1994*

"...Deflex panels seemed to give greater tightness and control, improved internal clarity, and pitch definition - all without deadening the sound in any way..."  
*Audiophile - January 1994*

**Standard Panel £7.95 (280 x 210mm)**  
**Sub Woofer £11.95 (340mm dia)**  
**Adhesive £3.50 (200ml)**

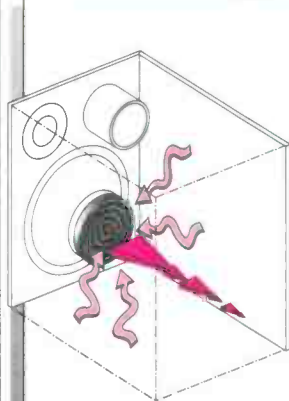

## MAGNAPAD GOLD

Used in professional stage monitors where the bass resolution is significantly improved

MAGNAPADS INCORPORATE THE SAME ADVANCED TECHNOLOGY ALREADY SUCCESSFULLY PROVEN IN SPECTRA DYNAMICS' DEFLEX PANEL

PRIMARILY DESIGNED TO ABSORB UNWANTED VIBRATIONS DIRECTED AT SPEAKER COILS AND MAGNETS, AND TO PREVENT FURTHER SOUND REFLECTIONS OFF THE FLAT SURFACES

SIMPLE TO FIT - APPLY A FEW SPOTS OF "SUPER GLUE" TO THE MAGNET AND PLACE THE MAGNAPAD IN POSITION.

Available in four sizes: 75mm, 125mm, 175mm & 225mm diameter

Prices from £7.95 per pack of 2



## FOCULPODS

Foculpods are high performance vibration absorbing supports designed to be placed under Compact Disc Players, Turntables, Amplifiers, Loudspeakers and all other Audio, Video and Computer equipment.

The material is a specially formulated low resilience polymer with excellent shock absorbing properties.

At nearly half the price of similar products, Foculpods not only save you money, but are equal, if not better in performance.

Available from most good Hi-Fi shops.

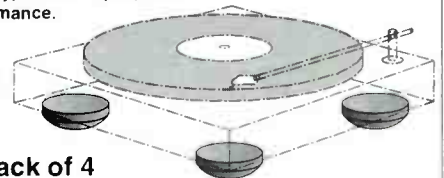

£19.95 per pack of 4

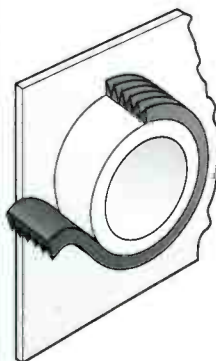

## DEFLEX® "WRAP"

This Deflex material is supplied in sheet form with a parallel "rib" running down its length. It can be used in a number of applications,

e.g. it can be cut to fit as a wrap around ports on reflex designs (see inset)

or on the flat panels inside transmission line or horn loaded speakers.

Deflex Wrap £14.95 (280 x 210mm)

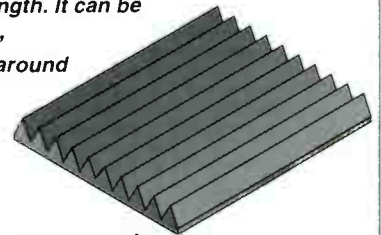

### DISTRIBUTORS WORLDWIDE

U.K. Tel. (0625) 500507 - Fax. (0625) 500508

Australia Tel. 3 429 2199

Canada Tel. 514-691-2584 - Fax. 514-692-9980

France Tel. 1 48 76 34 74 - Fax. 1 48 77 08 98

France Tel. 78 95 04 82 - Fax. 78 60 76 35

Germany Tel. 2961 / 51211 - Fax. 2961 / 51640

Germany Tel. 0208 / 35977 - Fax. 0208 / 381370

Greece Tel. 01 8028406 - Fax. 01 8064802

Holland Tel. 076-715010 - Fax. 076-714773

Indonesia Tel./ Fax. 31 311 598

Israel Tel. 3 5407279 - Fax. 3 5407418

Norway Tel./ Fax. 755 25335

Russia Tel./ Fax. 095 179 3753

South Africa Tel. 021 439 8450 - Fax. 021 439 8451

Spain Tel. 34 63 33 11 56 - Fax. 34 63 74 43 01

Switzerland Tel./ Fax. 61 361 64 66

Switzerland Tel./ Fax. 21 824 1175

U.S.A. Tel. 415-669-7181 Fax. 415-669-7558

U.S.A. Tel. 608-831-3433 Fax. 608-831-3771

# POWER AMPLIFIERS

## CONCLUSION

... Continued from page 33

It seemed to me that the tail was wagging the dog. We set out expecting to hear the innate differences in sound quality between power amplifiers and describe them in relation to the speakers. In the event, we heard some fairly radical effects of a magnitude beyond anything I am used to when changing amps around. Were the amps driving the big TDLs, or were they driving the amps? Sometimes, it seemed like the latter.

The tail can wag the dog. All loudspeakers generate a back-emf that opposes the amplifier and the bigger the cones, cabinet and air load, the greater this will be. I got the feeling that it was at times so great with these speakers that they were - electrically - shaking the amplifiers around a bit. The Linn Klout seemed most disturbed by the TDLs, producing peculiarly boomy bass. The big Naim got into a power struggle, whilst the Alchemist and John Sheame Phase 1s managed to keep a respectful distance and do their best, such as it was.

We weren't expecting this; but that's hi-fi for you - unpredictable. Basic differences between the NAP250 and the Klout were maintained and they were quite obvious, it's just that bass drive problems were so intrusive they became overwhelming.

Firstly, let me deal with the Naim NAP250. Known to deliver tight, deep and superbly controlled bass, giving Rock in particular great drive and superb timing, they understandably have a enthusiastic following. However, the NAP250 also has sharper treble with more bite than is to everyone's taste; the bigger, more expensive NAPI35 monoblocks have a smoother presentation. At low frequencies, the 250 in fact did the best job of all with the big TDLs, but in this case it was too much - there's just no justice! The twin bass lines delivered colossal bass, so much so that it overwhelmed everything. The best way to resolve this, using Naims, would be to bi-amp and reduce gain to the bass amplifier. This would pull bass level down, bringing it into line with the rest of the performance. But the NAP250 also made the TDLs sound less cohesive than the

other amps, due to their brightness, which wasn't so good. Ideally, with the TDLs the Naim would be best as a bass amp in a bi-amp system. It wasn't the best match otherwise, partly because the TDLs don't complement their speedy, dynamic nature. Bass apart, I felt the speakers sounded best with a smoother and more cohesive amplifier, a category into which Linn's Klout slips supremely well.

The Klout was, surprisingly, the most inept of all four amplifiers in terms of bass drive. It sounded weak with Kabers in contrast to the NAP250, and it became curiously overblown and boomy with the big TDLs. Yet, bass apart (again!) the Klout struck me as a beautifully detailed

Whatever, the name Klout struck me as inappropriate for a design whose strengths lie elsewhere. Don't let my criticism of the Klout's somewhat variable bass deter you from listening to this amplifier, since it has a beautiful presentation, one that I personally took to immediately. Being a bit of a valve head, the qualities of smoothness, ease of delivery and cohesiveness are ones I very much appreciate, substituting short term drama for relaxed and enjoyable long term listening. The Klout has refinement. Bass performance can be judged in a shop demo, but it must be with the speakers you intend to use.

The Alchemist Genesis monoblocks, like the John Sheame Phase 1, came over as mercifully detached from the TDLs in the bass department. They appeared to make little attempt at forcing the speakers to perform to the full extent of their abilities, unlike the Naim. It was just as well, since by backing off a little the Genesis produced a reasonably balanced result, albeit one of no outstanding merit. I found them gentle sounding, smooth and cohesive, but of limited low frequency drive in conjunction with the big TDLs. There was still plenty of bass, but it was somewhat soft and unengaging in nature. A pleasant performance then, not an inspiring one.

With the big TDLs the John Sheame Phase 1 came over as most balanced sounding of the four amplifiers. It too couldn't or wouldn't push the TDLs hard, bringing a welcome and needed reduction in deep bass output. Yet their bass sounded tight and articulate with this amplifier. Further up the audio band, the Phase 1 came over as a little bright in the upper midband, but detailed and insightful all the same; it was a good all-round performance I felt.

Given that the TDL Reference Standard loudspeakers don't sound sprightly enough for those wanting supreme speed, dynamics and timing for Rock music, and given that they have multiple drivers, they are best paired with a deeply smooth and cohesive amplifier like the Linn Klout, or a DPA 50S. Being bi-wireable, the bass lines are, ideally, best disconnected from the rest of the speaker and driven independently. In this role the colossal power and grip afforded by Naim amps seems ideal ●



**This cut-away of TDL's Reference Standard transmission line speaker shows the task a power amplifier faces when asked to drive a high power monitor. A large bass unit on either side, each rear-loaded by its own transmission line, must be driven and kept under control. At each end of the central drive unit array lies a midrange driver, both back-loaded by another transmission line. Two tweeters and one central super-tweeter complete the line-up of seven drive units.**

and cohesive sounding amplifier that delivered more of the music than the other three models. I was reminded very much of the DPA sound and wonder whether Linn's use of surface mount components had something to do with the qualities of the Klout.



# World



## CALLING ALL HI-FI ENTHUSIASTS

I thought I would put pen to paper after reading Dominic Todd's earthy and practical views in your July edition. I found myself in agreement with everything that he said in his Fair Views article about musical evenings, technical knowledge and hi-fi enthusiasts, despite being the owner of an olive green anorak (for hiking purposes only).

Manufacturer's and dealers that want more turnover from customers buying Lifestyle systems and Home Cinema should be very careful indeed about neglecting real enthusiasts who want more from their hi-fi systems. But enthusiasts themselves could do more also. I decided to start up a hi-fi enthusiasts group arranging musical evenings and trips to shows etc. At my own cost I typed up and copied letters, sending them to selected dealers and manufacturers, as well as enthusiasts. I was very disappointed with the response. Out of eight dealers, only two afforded me a reply. Out of twelve manufacturers I received only three replies. What I found worse than this is that subsequently the people that appeared initially to be most interested in the project let me down.

A year on I have grown content with not having the number of people involved that I would have liked, though I feel very proud of the few people that have remained staunch hi-fi junkies and have since become friends. I would like to thank all of the people who have formed the nucleus of the project, for keeping it alive and to the two dealers in our area for caring.

I am pleased that Dominic's view of the musical evening has been changed and hope that dealers and manufacturers will take notice of the message he included in his article.

My message is a simple one to all the above mentioned people 'WAKE UP'. Do not let our pastime get replaced with Sonic the Hedgehog and computer-generated recreation.

There's a lot more pleasure to be had listening to music and tinkering around with hi-fi equipment than many people think. So come on dealers, manufacturers, hi-fi enthusiasts and the hi-fi press, promote and encourage such clubs and musical evenings. It is our hobby - your future.

If you live in the North East and you wish to contact me, please do so.

**Steve Petch**  
**Hi-Fi Heretics**  
**7 Rillston Close,**  
**Deer Park,**  
**Hartlepool,**  
**Cleveland.**  
**Tel: 0429 867432**

## REPLACING NEW FOR OLD

As my amplifier and speakers are now about twenty-five years old, I have recently been looking around for replacements. With the current interest in valves I have been trying to remember back to valve amplifiers that I have owned and wondering whether I should go back to the old technology.

Many modern sound systems, although having very low distortion, excellent signal to noise ratio etc., sound rather bland and unexciting. This makes me wonder whether the system that I

have now is as enjoyable as some that I have owned in the past. There have been certain milestones in my musical enjoyment that I can remember clearly.

The first was when I built a 10watt amplifier from a circuit in a magazine using a pair of 6V6s in push-pull. Previously I had simply plugged the turntable into the radio and this amplifier was my first step towards High Fidelity.

The next step was mounting the speaker on a tapered board that fitted in the corner of the room to form a kind of horn. With the 10watt amplifier I thought this sounded great. The 10watt amplifier had been built from well used parts and failed after a few years, so I built a Mullard 3-3 to replace it. Although far less powerful, the Mullard

## Letter of

### THE TIDE IS TURNING

It seems that the tide is turning, the 'new is best' orthodoxy of the 1980s being gradually jettisoned in favour of a more commonsense approach to assessing equipment - that of its actual quality, rather than its newness.

In the 1970s problems were solved by new technology. We had wow and flutter 'solved' by Direct Drive and then solved again (?) by Quartz Lock. We had the problem of tonearm geometry which was duly 'solved' by S-Shaped, Straight and finally Linear Tracking arms. Digital Synthesized Tuning 'solved' the problem of drift on FM. This was partly marketing driven, but there was nevertheless a climate of science that hovered over the hi-fi world, promising solutions.

This all faded when the

'80s arrived and brought with it an approach heavily influenced by a somewhat metaphysical notion of musicality. In the now defunct Flat Response, then Hi-Fi Review people would write in with all manner of exotica (Oracles, JBLs, Systemdeks, etc.) and request advice on cartridges or record clamps and the like and be told to flog the lot and start again with an LP12, NAD and a pair of KEF Codas.

Both wisdoms espoused one thing: they celebrated the new and ignored the old.

With digital audio this has reached new heights. I own a Marantz CD52IISE and am very happy with it. I came across a Sony CDP101 last week in a junk shop for £45. This is the very first Sony player ever made. I bought it for a bedroom system. After cleaning the laser lens with

Send your letters to Hi-Fi World Letter Page,

# writes

sounded even better than its predecessor.

By this time stereo was becoming more common and I soon built a pair of Mullard 5-10 amplifiers to replace the 3-3. I used ultra linear output transformers which it was claimed would reduce distortion to 0.1%. For some reason the 5-10s never seemed to sound quite as

good as the 3-3.

I used a number of early transistor amplifiers, some of which sounded awful, before settling on my present 30watt. This was built from a circuit published in a magazine and was considered to be somewhere near the ultimate at the time.

It is clearly impossible to remember exactly the sounds of old amplifiers, but the one that I remember with the

most affection is, without doubt, the Mullard 3-3. I thought at the time that this was the most enjoyable amplifier that I had ever heard. On paper its performance was quite modest, but it sounded absolutely marvellous. Perhaps the sheer simplicity of the design and the small number of components had something to do with it. Some people also claim that a single-ended output stage sounds better than push-pull.

I wonder if it would be possible to build a Mullard 3-3 today using modern components and use it with good quality interconnect cables, and how its sound would compare with a modern design? Although 3watts seems ridiculously low powered by modern standards this was quite sufficient with the higher efficiency speakers of the fifties and sixties. Perhaps someone knows of a modern speaker that would go well with this amplifier.

What really matters is not

the measured performance of a component, but how enjoyable it is to listen to. Many modern amplifiers and other components are capable of reproducing the sound accurately, but sound cold and clinical. I shall be doing a lot of listening before deciding on replacements. The days of making decisions on measured performance have gone for good as far as I am concerned.

**Brian Darling**  
London

The only problem with building the Mullard 3watt amplifier, which I also built many moons ago, is finding an output transformer. You may well find that F&S Trading or Sowter can supply one. Alternatively, there's our 4watt single-ended amplifier kit, which comes complete with chassis, transformers, valves and all components for £385 and will save you a lot of hassle. Its output

continued on page 45...

## the Month

a paintbrush and isopropyl alcohol, Duraglitting the phono sockets and mains plug and fuse (a tweak that invariably works sonic wonders, incidentally!) imagine my surprise when I heard deeper, stronger, more tuneful bass and a midrange with superb front to back imaging and a real tuneful, listenable, (dare I say it?) almost valve like quality - from the Sony! The Marantz is much better in 'hi-fi' terms; frequency extremes, left-to-right imaging and low level treble detail, but aside from a slight tizziness on naturally tizzy digital cymbals, the Sony cleans up.

Don't dismiss 'old' hi-fi. If it weren't for the running costs, I'd be behind the wheel of a Jensen Interceptor FF instead of my Peugeot 205. Fortunately for hi-fi enthusiasts, we are largely exempted from the bottomless pit of expense that can go with old cars

and thus have little excuse not to investigate classic hi-fi.  
**Julian Price**  
East Sussex.

Magazines were certainly partly to blame for the way things went, with their sweeping statements about what is right and what is wrong and no room for manoeuvre in between. Any self respecting audio enthusiast knows that the sound they like may well differ from that of others.

As the larger manufacturers have charged off on the trail of AV and Home Cinema, hi-fi has become less pressurised and freer, with less of the push-and-shove of the 'heavy sell' mentality and more concern about finding a true way ahead, be it by valve, transistor, digital or analogue. Less hype and more genuine improvement is what we all want. **DB**

64, Castellain Road, Maida Vale, London W9 1EX.

### WIN HI-FI WORLD INTERCONNECT CABLES

### OR PERFECT PITCH'S FRANCINSTIEN CD

### ENHANCER

The writer of the most interesting or funniest letter will receive a choice of either: a free set of Hi-Fi World's silver plated copper interconnect cables, worth £69.95, or a Francinstien CD convertor enhancer worth £150.



# AMADEUS SOUND & VISION

Aura, Audio Innovations,  
Bang & Olufsen, Castle  
Acoustics, Micromega,  
Musical Fidelity, Nakamichi,  
NAD, Pioneer, Quad, Royd,  
Spendor, Technics.

10 BOLDMERE ROAD  
SUTTON COLDFIELD  
WEST MIDLANDS  
Tel: 021 - 354 2311



Interest Free Credit Facilities



Demo room with A/V system set-up.

# SINGLE ENDED

Single ended valve mono block power amplifiers

KT66 .....£350.00/pair  
KT88 .....£528.75/pair

Valve phono stage MM .....£142.00  
- variable output -

MC step up transformers.....£42.00

*The Garrard 301/401 power supply*  
*100/130 volt setting* .....£64.45

All units are fully assembled and tested.  
Prices include Delivery and VAT  
2 week money back guarantee

SAE for data sheet

**F&S Trading**  
31 brooks Road, Sutton Coldfield  
West Midlands B72 1HP  
Tel: 021 321 3357



## The Audio Room

&

## Pure Sound



For High End Hi-Fi

### Show Special!

If you are reading this at the Hi-Fi show at Heathrow, or planning to attend, just think! Pure Sound and The Audio Room are within 15 minutes drive from Heathrow. So if you want to listen to something you have found, but in quieter and less crowded conditions, give us a call. We'll even come and get you if you haven't got transport.

### Wide Range!

Our selected range of top quality brand names is listed here, and is always expanding, so if your preferred choice is not shown, please call us to discuss your needs.

### Demonstrations

To arrange a demo, to discuss what you need, or just for a hi-fi chat, call us and ask for Paul or Mark:

081 893 4485 / 0784 458176

### Stands

Appollo  
Base  
Frameworks

### Cartridges

Credo  
Transfiguration  
Ortofon

### Speakers

Audio Note  
Impulse (We have the new H1s)

Lumley Monitor  
Townshend  
Triangle

### Amplifiers

Arion Acoustics  
Audio Innovations  
Audio Note  
C.A.T.  
Credo  
Lumley Reference  
Triangle  
YBA

### CD Players

Consequence  
Counterpoint  
Kreatura  
Mephisto  
Micromega

### Turntables

Basis  
Graham  
Pro-Ject  
Townshend  
Wilson/Benesch

### Cables

Audio Note  
Cogan Hall  
Goertz  
Isolda  
Lieder  
Silver Sounds  
XLO

Pure Sound + The Audio Room, Whitton, Twickenham and Staines. Personal service, home demonstration, excellent hi-fi



# MISSION FLY WITH AEROGEL

**Using a special new cone material, High Definition Aerogel, Mission launch their new 752 loudspeaker. Dominic Baker enjoys the flight.**

The slow bluesy beat, lightly brushed cymbals, tight snappy drums and deep free flowing bass line of Counting Crows' Perfect Blue Buildings was my first introduction to Mission's new Cyrus 752 loudspeakers. Straight away it was clear that these were something different, the crisp, detailed and agile manner with which they handled the music making them one of a currently-rare new breed offering a level of quality that normally demands a higher sacrifice than £500.

Mission are the first manufacturer to introduce a loudspeaker using the advanced High Definition Aerogel (HDA) cone material developed by Audax in France. This is quite a step forwards for Mission, the majority of their standard range using either Plastiflexed paper drivers or a form of polypropylene.

The 6.5inch HDA bass/midrange driver used in the slim and elegant 752s is the most expensive unit Mission have ever used in a production loudspeaker. But their designer Henry Azima believes that the qualities of HDA more than deserve the extra outlay, and from my experience of this cone material I would wholeheartedly agree.

Mission don't take the same care with their 6.5inch HDA tweeter drivers from Audax as they do with the



# There is an Academy Award for Best Home Cinema Specialist, we are prepared for it...

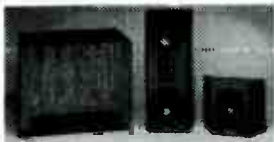

KEF THX™ SPEAKER SYSTEM



YAMAHA DSP-A2070



NOKIA SFN 9294 WIDESCREEN

Our In-Store Demonstration Theatre is here to let you experience the latest in Home Cinema Equipment

KEF THX™ Appointed dealer  
 Stockists of top brand name equipment including THX™  
 Free impartial advice on equipment to suit you  
 Free home surveys available



...Award winning equipment from Award worthy people



TEL: 0922 493499/473499

SOUND ACADEMY: SHARING THE ASDA CARPARK WITH AMPLE FREE PARKING  
 OFF HIGH STREET, BLOXWICH, NR. WALSALL, WEST MIDLANDS. FIVE MINS FROM M6 JNCS 10 & 11



KEF LEXICON THX™ APPOINTED DEALER.....CELESTION B&W KENWOOD ROTEL MARANTZ CHORD YAMAHA  
 MOROAUNT SHORT MONITOR AUDIO BOSE MISSION INFINITY JAMO SONY AND MANY MORE  
 TV & VCR FROM PANASONIC TOSHIBA NOKIA-WIDESCREEN LASER DISC AND PLAYERS



*You should be looking for only one kind of Hi-Fi.*

***The Best!***

*Call me, it's the only kind I deal with.*

For the Best...

*Apogee, Audio Research, Classé, Copland, Linaeum,  
 Magnepan, Martin Logan, PS Audio, Sonus Faber,  
 Theta, Van den hul*

And the Best of British...

*DPA, LFD, Michell, Orelle, Pink Triangle*

'Phone or fax me anytime, 9am - 10pm, any day including weekends on:

**0252 - 377952**

**0385 - 317952**

Mike Harvey's

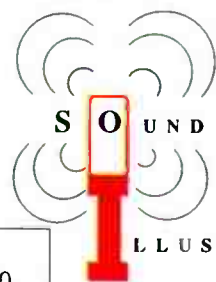

**Secondhand/Ex Demo equipment:**

Acoustat Mod 3 electrostatics £1500, Croft Super Micro-A £350, Musical Fid. A370 £1000  
 Oracle Delphi + Linn Ittok £600, Sonus Faber Electa £1300

*Anywhere in the South.*

make a few subtle modifications of their own, the only visible one being the black crackle cone finish, instead of the usual battleship grey/blue of HDA. This driver is mounted on a slanted baffle to time align its acoustic centre to that of the 25mm metal dome tweeter, and just beneath it lie three reflex ports which provide the bass tuning.

The midrange of the 752s wasn't quite as forward as I'd expected, as if Mission were trying to hide the fabulous qualities of HDA and keep the secret to themselves. I suspect that the slightly more restrained character of the 752s was chosen for its softer, less brutally revealing nature, which may offend listeners used to less a less intense sound. However, even though a little restrained, the superior quality of the HDA material makes itself known. The 752s have a crispness, a grasp on the focus of a piece of music and an

devoid of character, and I normally regard this as one of the better recordings available on CD. But on the same note, the Missions have the ability to show just how incredibly clean a good player can sound. A heavy polypropylene or even paper cone seems to mask this, putting some of the character back into CD; the 752s reveal it for what it is.

Mission have chosen to combine their special HDA bass driver with a metal dome tweeter, something which is normally frowned upon at Hi-Fi World. However, in the 752s it proves to be a wise choice, the use of a smooth metal dome tweeter with its bright character suits the HDA material especially well, allowing the units to integrate in an almost seamless manner. Cymbals and metal stringed instruments were given a pleasant sparkle, the upper harmonic structure preserved to create an open and natural atmosphere.

The bass of the 752s wasn't especially deep. In fact, on some tracks the deeper fundamentals were missed altogether; on others they were there but lessened in impact. But what is there seemed concentrated in its energy, waiting to explode in an instant. This gives the 752s terrific punch, driving tracks forwards and underpinning Rock to give a firm and well timed foundation. Higher sensitivity drivers do tend to have a leaner bass quality, their resonant frequency being raised by lighter cone materials, but what you get instead is improved bass articulation, where notes are played rather than lazily pondered over.

The most spectacular ability the 752s was the extra degree of intelligibility they imparted to apparently muddled or confused recordings. L7's *Stuck Here Again* with its solid kick bass and heavy rock attitude is a nasty, grungy recording, but was great fun on the Missions. They have the control to turn this kind of recording into a listenable and enjoyable experience. I can't think of a better way of inflicting brain damage!

The 752s are, in my opinion, by far the best loudspeakers Mission have ever designed. I'm sure that they will quickly assume cult status alongside the likes of Epos ES11s and Quad ESL63s, where a display of quality engineering combined with innovative high performance materials produces something far greater than the sum of the parts. Mission have something special in the 752s, something unique - at least for the time being - that once again pushes them out in front of the crowd ●

**Mission 752** £500  
**Mission Electronics,**  
**Stonehill,**  
**Huntingdon,**  
**Cambs. PE18 6ED.**  
**Tel: 0480 451777**

**MEASURED PERFORMANCE**

Mission's use of a High Definition Aerogel bass/midrange unit has provided a loudspeaker that combines good bass power with high sensitivity.

Using a nominal watt of pink noise (2.83V true rms) and measuring at a distance of 1m, I recorded a healthy 88dB from the 752s. This means that they will go a fair bit louder than most speakers at any particular volume setting. Their high overall impedance of 8.9Ω also indicates easy drive characteristics; they will not draw much current. The impedance curve stays high over most of the audio band, another good sign, but there is a dip in the treble down to 4Ω where the 752s will draw more current.

The frequency response of the 752s is very smooth, with no real peaks breaking the overall trend. The response does have a shallow dip through the mid-band though, which I suspect will soften vocals and lessen projection into the room. But as long as the box is good and solid this shouldn't reveal itself as a box bound colouration.

Overall the 752s are an interesting piece of engineering. They combine a flat response with good driver characteristics which should ensure consistent results with a wide range of partnering equipment. They're easy to drive and likely to be highly compatible.

**DB**

**Frequency Response**

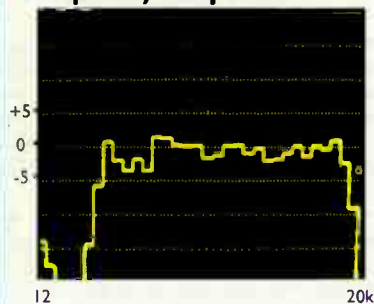

Essentially flat response, but shallow dip through mid-range

**Impedance**

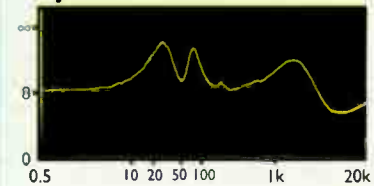

Treble impedance dives to 4Ω

*“The 752s have a crispness, a grasp on the focus of a piece of music and an effortless ability to produce detail and energy that places them far ahead of similar paper or plastic cone drivers.”*

effortless ability to produce detail and energy that places them far ahead of similar paper or plastic cone drivers.

Like the DPA 1024 and DaCapo CD convertors, as soon as the 752s are played you can hear that they're significantly different - and something special. There are a lot of loudspeakers out there, but the 752s are clearly distinguishable from them. They make the jump: they are not only different, but better. Vocals sound so lucid and transparent that it gives the 752s a cold and dry sound. This isn't an inaccurate character bestowed on the music by the cone material, more an absence of the colouration usually present.

It's quite surprising what the 752s can do to CDs and CD players. We all know that CD has its faults, but the 752s quite brutally reveal the hard, processed sound of lesser players. On several machines, some costing three or four times more than the 752s, Michael Stipe's voice on REM's *Everybody Hurts* became squeaky clean - too clean, too

# MICHELL GYRODEC AND QC POWER SUPPLY

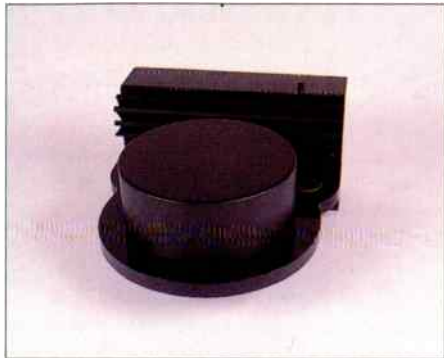

A SYMBOL OF PRECISION



**"THE MOST DESIRABLE DECK BELOW £1500"**  
Ken Kessler - Hi-Fi News & Record Review August '94

**Michell Engineering, 2 Theobald Street, Borehamwood, Herts WD6 4SE**  
Tel:- 081 953 0771

# Connect the dots.



Introducing The Parts Connection's first complete DIY kit: the Assemblage DAC-1 Digital Processor.

It comes in a small package (24cm x 5cm x 18cm chassis), but packs a big punch and a very musical sound. Designed for the rookie or first time kit builder, the only tools required are a pencil tip soldering iron, a screw driver, a wrench, a pair of electronics pliers, and a wire stripper or hobby knife. With only 21 solder joints and a handful of nuts and bolts, this kit goes together in one evening (typically about an hour). It's as easy as connecting the dots.

The parts quality is top notch. The board comes assembled and tested, implementing the Burr Brown 1702 DAC, a Crystal 8412 input receiver, an NPC 5813 digital filter, Analog Device's AD844 and 847 op amps and a custom potted toroidal power transformer.

At \$449 US, the Assemblage DAC-1 offers an outstanding value in digital conversion and comes with a *Satisfaction Guarantee* (return it with-

in 30 days of purchase for a full refund) and an *Assembly Guarantee* (if you can't get it running, we will!). We challenge you to find a DAC anywhere near this price with better measured performance, component quality, and most importantly, sound quality. Call us for more specific information on the performance or construction features.

To order the DAC-1 kit or to order The Parts Connection 1994 Catalog (for £3), full of a lot of other exciting stuff (including a \$10 US discount coupon good on your first order over \$100 US), send us your request and mailing address - or call with credit card information.

2790 Brighton Road, Oakville, Ontario, Canada L6H 5T4  
Telephone 0101-905- 829-5858 Facsimile 0101-905-829-5388

A S S E M B L A G E

**THE PARTS  
CONNECTION**  
A DIVISION OF SONIC FRONTIERS INC

Toll Free Order Line 1-800-769-0747 (U.S. & Canada only)

.... continued from page 39

transformers are larger, in order to give better bass drive.

There are some loudspeakers around that will go loud enough with 3-4 watts. If you want to build your own our KLS-2 has a sensitivity of 94dB, plus a flat impedance curve, being specifically designed for low output/low-feedback amplifiers like the Mullard. Otherwise most horn

already large record collections. We now offer hundreds of records (LPs & 78s) by mail order, with a full money back guarantee. Since we have minimal overheads, we can keep our prices at a reasonable levels and are usually able to get most items if we don't stock it ourselves. We will also grade all items aurally before despatch.

A catalogue is available by writing to the above address. Keep vinyl alive! (what a rotten trick discontinuing the Xerxes!)

were more interesting than they knew and say a lot about the current state of hi-fi in this country. What was so fascinating was that they gave two rankings for every machine: the order of preference and the average estimated cost for each. Their results showed -

- 1) People either have no idea about the law of diminishing returns, or cannot imagine how expensive good CD players can be.
- 2) People seem pretty good at

people can't recognise an expensive player when they hear one, they just don't like them. Why?

One might need to be educated into good hi-fi, the same way as one learns to taste wine. However, if this is true, then there are two unwelcome implications. Either high-end hi-fi sounds less like live music than 'ordinary' hi-fi, or people have forgotten what live music sounds like. I suspect the latter; most of the music that people hear has been electronically processed.

So, the manufacturers of high-end hi-fi may need to start encouraging people to get away from the technology, go out, and hear sound waves created by musicians. If they cannot do this, then the hi-fi future could belong to Home Cinema.

**Dr David Foreman Staffordshire.**

Differences in sound quality can be surprisingly

inconsequential to many people and for

them there is probably little difference between a good mid-priced player, costing say £400, and a high end machine costing several times the price. Much depends upon the perceptions and sensitivities of the listener and with a large, unselected group, the 'median' listener may well not be very discriminating.

Differences can be subtle too and require a long period of careful listening even on a revealing system before becoming obvious. Sometimes a new product

continued on page 47 ....

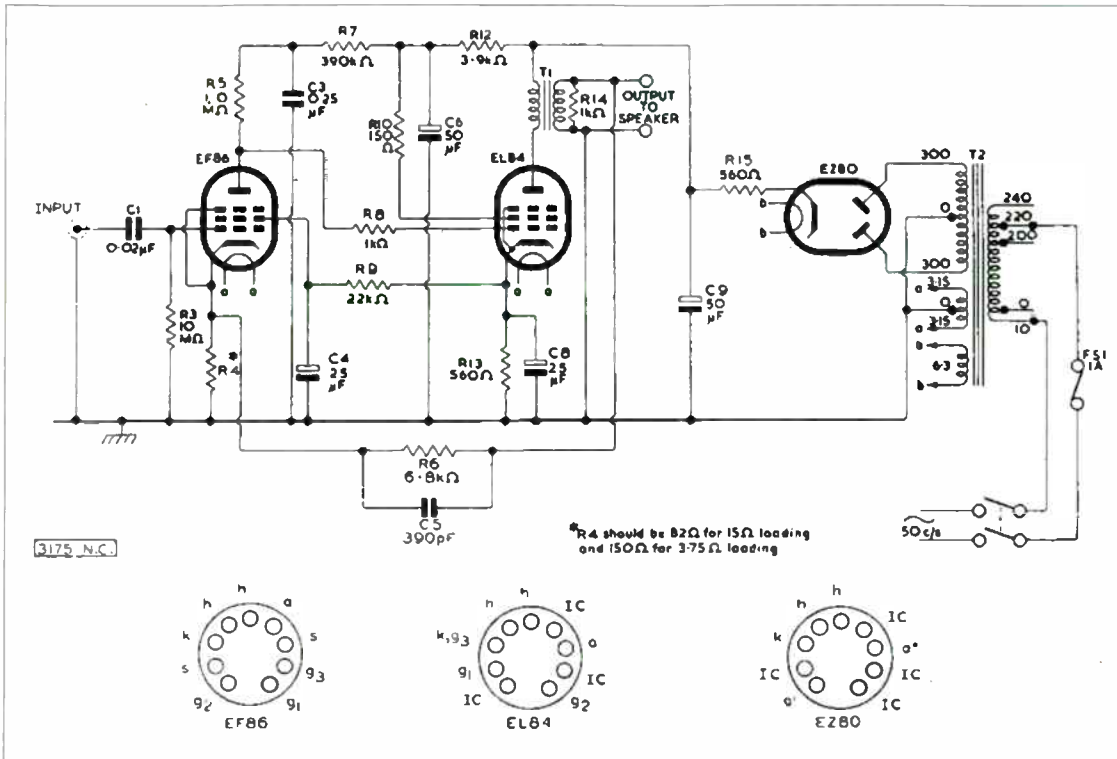

The Mullard 3w, 3 valve single-ended amplifier.

loudspeakers are plenty sensitive enough to pin you to the wall with a few watts. I'd go no lower than 94dB sensitivity though, otherwise you may be listening to the amplifier while it is clipping. **DB**

**ROLL UP - GET YOUR VINYL HERE**

In response to the letter from L.W. Perkins in the July issue, and in view of your response, I would appreciate your magazine informing its readership of a terrific source of quality used vinyl - me!

My associate and I formed Sunset primarily to expand our

**Steve Lawrence  
Sunset Records  
P.O. Box 3711,  
Stratford,  
London.**

**CD - THE PRICE OF PLEASURE**

One of your rivals recently published what they claimed was the largest blind test of CD players ever undertaken. Three hundred people listened to seven machines, with prices ranging from £250 to £1300. The CD players were from reputable manufacturers and most had received good reviews.

The results they printed

telling more expensive from cheaper CD players, as plotting the actual cost of the CD players against their estimated cost gives a convincingly straight line.

3) People do prefer mid-priced players to budget players. However, even budget players are preferred to high-end designs. Here, plotting preference against estimated price gives a U-shaped graph, with the cheapest players at the bottom of the 'U'.

If high-end CD players represent the cutting edge of advancement, then it is hardly clear that the advance is going in the right direction. It's not (as your rival suggested) that

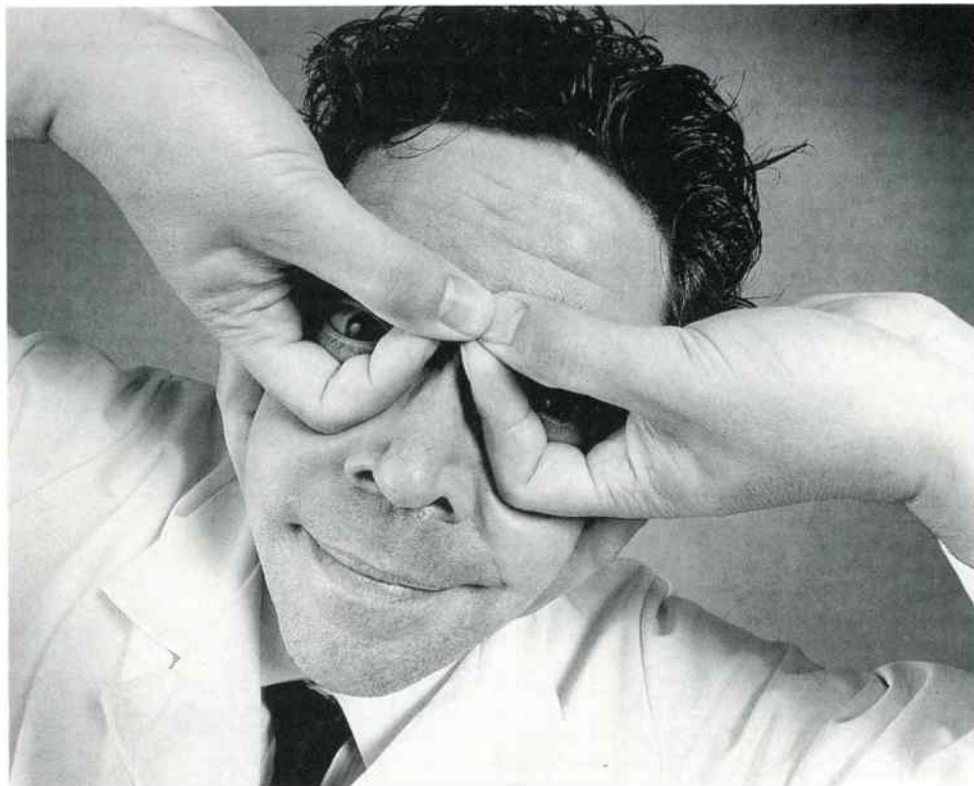

## Meet Mike Martindell. The man who broke the sound barrier.

In the world of hi-fi there are those who have it and those who have not. And Arcam's Mike Martindell has it in spades.

This is a man who did more for the anorak than Chuck Yeager did for the flight jacket. A man with only three things on his mind. Your left ear, your right ear and the final frontier... your wallet.

It took plenty of the right stuff (what Chuck would drawl 'moxie') to even dream of producing a CD player with Arcam's standards of sound quality for under £300. But if anyone could do it, Mike could. Our chief engineer and his team of self-confessed audiophiles have a rather compulsive habit. They like to break old records (of which Arcam has a rather inelegant sufficiency).

Combining a liberal dose of obsession (and we're not talking

after-shave) with the same principles and techniques that produced the first complete UK manufactured CD player, they created the new Alpha One.

The British-built A1, as it is affectionately nick-named (for reasons you will fully understand when you check it out at your Arcam dealer), has all the hallmarks of Arcam's legendary quality. Best sound performance in its class? Check! Elegant appearance?

Check! Future proof digital output? Check! Remote control? Check! Unique Arcam Fibreglass printed circuit board? Check! Military specification flow soldering? Check!

In fact the only thing that has been scaled down in this single-minded pursuit of glorious sonic performance...is the size of your cheque. Check!



**The Alpha One CD Player. Around £299\***

# ARCAM

*For more information about the Arcam Alpha One CD player and the name of your nearest dealer, please complete and return this coupon to us. In addition, if you would like independent reviews of any of our hi-fi equipment, please state which products and we'll be happy to send you the relevant material. Arcam, Pembroke Avenue, Waterbeach, Cambridge CB5 9PB. Or telephone: (0223) 440964 (24 hours). Fax: (0223) 863384.*

I am interested in reviews on (please state product(s)): .....

Title..... First Name(s)..... Surname.....

Address..... Postcode.....

In Canada: Avalon Audio Ltd. 101 Hanlan Rd., Woodbridge, Ontario L4L 3P5 Tel: (905) 850 7511 In New Zealand: Avalon Audio, 587 Mount Eden Road., Auckland Tel: (09) 638 9000 In the USA: Audio Influx Corporation, PO Box 381, Highland Lakes, New Jersey 07422-0381 Tel: (201) 764 8958.

\* Recommended UK manufacturer's retail price £299.90.

.... continued from page 45

can sound good at first, but after a few weeks of use its sound and its foibles begin to dominate. A quick blind listen with an unknown room, system and music is not enough for serious conclusions to be drawn. In such tests most people distinguish only the different sound balance between players - is it bright, dull, forward, bassy, bass light etc. It can take several minutes and several different tracks to be sure of even this, before you start to be able to listen for stage depth, height, width, detail, separation, image quality and focus, tonal colour, distortion and what have you.

At the budget end players commonly have gritty treble and weak bass. By the time you get up to £300 or so, most are sounding a lot smoother and more balanced, and from here onwards there is little that can be improved upon in terms of tonal balance. So it is easy to separate the cheapest from the mid-priced players, but the changes from there on upwards are less obvious in a short demonstration.

The system that is used will also have a great effect on the results. If, say, a Pioneer A400 was used for amplification, with its bass warmth and bloom, it would suit the weaker bass of budget machines better than high-end players which may sound overblown in comparison.

Sadly, there are so many variables that such tests can't be seen or taken as definitive even if, superficially, they look attractive. At best they form an interesting experiment.

**DB**

**I MISSED**

I feel rather like Baggio having missed a penalty in the recent World Cup Final shoot-out; he missed the goal, I missed the

301.

Six months ago, in an unknowledgable desperation, I bought an Akai tuner from a bootsale for £5.00 just to listen to Jazz FM and a few other broadcasts. The cold, compressed sound began to drive me crazy - really. So having browsed through your magazine (not as thoroughly as I should have, as you will see) and reading about the warmth of valve I thought it might be an idea to buy an old valve tuner - audiophile or not the warmth would do for me. A few weeks ago I saw an old valve tuner and though I initially didn't like the look of it, it was valve and for £1.50 I thought what the heck! I also relented and bought the valve amp for £1.50 which was being sold along with it.

I got the tuner home and well, it didn't work. A fuse change and hey presto! Reading through your magazine recently I read that the Leak Troughline was superb but needed realignment and 5mV aerial strength for best results, so I was delighted with my purchase. The amp is a Leak Varislope 2.

So I went on to read about Garrard decks. The 401 I thought - that's what I must look out for. So last week I passed up a 301 at a bootsale thinking it inferior. Every time I think about it I feel as sick as poor Baggio must do.

But before you go thinking, "There's an ungrateful soul" I must say that if it came to a choice I would have picked the Troughline Stereo FM3 over the 301 as I love listening to Jazz FM in the evenings and the Troughline delivers it in dazzling style. I hope whoever got the 301 loves it as much as I do the Troughline.

**Gilbert Akinyele  
Benhillwood Road,  
Sutton.  
Surrey SMI 3SS**

P.S. Please help! When I got the Troughline home the string came off the tuning pulley. Some repair shops say

they can help but they need the diagram to show which way the string goes - how many turns this way and so on. Having got a manual from T.I.S. there is no indication of this. Or would this come under the term 'realignment'? If so is there a place where I can have this done which isn't too far from me? If it doesn't come under the term 'realignment' please advise me of the configuration so that I can listen to GLR once in a while. (I've manually tuned it in to JFM).

**Try speaking to Graham Tricker at G.T. Audio on 0895-833099, who specialises in restoration of tuners, including Troughlines. Situated in Higher Denham, like you he's close to the M25 construction site - not so far away in terms of**

behalf as the magazine is exactly to my liking. My newsagent has been instructed to supply me with future editions. The second issue I bought came with Supplement No.8, again, an excellent read!

I have two questions I hope you can answer satisfactorily, these are:-  
1) Are issues 1 - 7 of the Supplement still available? If they are I am willing to pay for any cost/postage that may be involved.

2) As I am a complete tyro in such matters can you recommend any book(s) that will educate me in matters electronic? Ideally, something that will take me from the simplest (e.g. what a capacitor is, where it goes, and why does it go there) through to more advanced knowledge, practical and theoretical.

I look forward to further



**Anyone know how to put the string back on the tuning wheel of a Leak Troughline?**

distance, if not time with traffic speed being about that of a bulldozer. **NK**

**AN INTEREST REKINDLED**

I have recently re-acquired my taste for listening to music, live and recorded.

As a consequence of this interest I again started to look at the current range of 'hi-fi' magazines and because it cost less than the others I bought your May edition of 'Hi-Fi World'. A wise choice on my

issues of Hi-Fi World, please do not drop your standards. Congratulations!  
**W.E. Bowman  
Newcastle-upon-Tyne.**

P.S. I prefer the 'sound' of analogue reproduction.

**We did not know how popular the DIY Supplements were going to be. Of the first seven supplements, Numbers 2 (April '93) and 6 (December '93) are not**

**continued on page 55 ....**

# TAPE CHALLENGER

Can Onkyo's new 3-head TA250 cassette deck take on the might of Nakamichi? Dominic

Todd listens closely.

Without beating about the bush, it's clear that Onkyo's most recent cassette deck entry is after Nakamichi's blood. Priced at £349.95 the Onkyo leaves a mere tenner change between itself and the highly rated (and aspired to) Nakamichi DR-3. Onkyo are by no means the first large Japanese company to attempt to do battle with the cassette deck kings. Sony, Technics and Aiwa, to name but three, all field decks to compete at this level and above.

What marks the Onkyo out as being special though, is that rather than taking the usual approach of trying to woo the customer with "bells and whistles", often to disguise less than top rate sound quality, they've opted for a sensible range of facilities and good quality engineering (rather like Nakamichi). Thus you'll find a good quality three head and three motor dual capstan transport and "clean"

sounding electronics. What you won't find are gimmicks such as powered doors, tape editing features and such like.

Onkyo haven't been too stingy, though. There's still an excellent track search device (that actually works), a multi-function counter and fine bias control, as well as the usual three-head ability to monitor recordings. Onkyo have also resisted the temptation to join the Dolby S bandwagon (so far). Otherwise, the actual finish of the machine is up to Onkyo's high standards, and is good enough to stand comparison with Nakamichi. Drawbacks were that the case was too wide to fit a standard 19in rack - and that's wide - and there's no tape type indicator, even though selection is automatic.

Being as well built as a Nak' is one thing, sounding as good is quite another. To see if the TA250 lives up to Onkyo's

aspirations, I put it along side a Nakamichi DR-3. Most striking was the stability with which images were portrayed. Vocals remained staunchly in the centre of the soundstage and the Onkyo's pitch stability was never in doubt. This comes as no surprise for a deck offering dual-capstans and three motors. What the transport can't make up for, though, is the quality of the electronics. Here the Onkyo was impressive, but by no means flawless.

Recordings generally had a slightly bloated, albeit solid, bass line. There was plenty of deep bass extension; subsonics from a closing door sound effect buried within Billy Idol's Pumping on Steel shook the room impressively. The bias control was a bit flaccid in comparison with most others, full rotation from minimum right around to maximum bias offering less change of sound quality than expected even with ferric and chrome tapes. This

## MEASURED PERFORMANCE

The Onkyo replay response had been very carefully adjusted, giving an especially flat frequency response maintained right up to 20kHz. The replay amplifiers were quiet, but the transport ran +1% fast, which may be noticeable as slightly raised pitch on pre-recorded tapes. Tapes recorded and played on the machine will run at the right speed.

Recording frequency response was good too, due to the use of a quality dual head. Unfortunately, I had to crank metal bias up to maximum to get treble flat - and then only just, as our response analysis shows. High performance metals like TDK MA-XG cannot be tuned in, since there isn't enough bias adjustment range. Cooking metals like TDK MA and Maxell MX match in at full bias.

As usual there was enough bias range for chromes and ferrics, all of which can be tuned in to yield a wide, flat frequency response, so the TA-250 will in practice suit a wide variety of tapes. However, metals these days really do give excellent results and, now, are relatively cheap, so it seems a pity that a recorder with pretensions to quality is barely able to cope with them. Onkyo need to ponder this one.

Distortion levels were low and head overload limits high in the midband (MOL315) and at high frequencies (SAT10k). With 0VU set at Dolby flux, metal recordings can be peaked at +6 or thereabouts on the Onkyo display.

Chromes and ferrics can be taken up high too, to around +4. These parameters are all primarily a function of head quality.

Hiss levels were low enough to be determined by the tape being used, Dolby B giving a full -10dB hiss suppression and C -20dB, a good result. Sensitivities (record gain) were correct too.

The transport possessed tight basic speed control, as the sharpness of the spike at right in the seed stability analysis shows. There was little capstan wow, but surprisingly a little flutter can be seen as a broad peak in the middle of the analysis. I wouldn't expect this to add much coarseness or papery colouration though.

NK

## TEST RESULTS

REPLAY (prerecorded tapes)  
 Frequency response (-2dB) 30Hz-20kHz  
 Speed accuracy +1%  
 Hiss (70uS, Dolby out) -60dB

RECORDING (blank tapes)  
 Frequency response (IEC Primary Refs.)  
 ferric (IECI) 12Hz-19kHz  
 chrome (IECII) 12Hz-18kHz  
 metal (IECIV) 12Hz-20kHz  
 Separation (1kHz) 55dB  
 Distortion (315Hz) 0.4%  
 Hiss (70uS, Dolby out) -56dB  
 Speed variations (DIN total) 0.1%

Flutter energy (3-3.13kHz)	-27dB
MOL/SAT (IEC Refs)	315/10k
IEC I (ferric)	+4.5dB/-5dB
IECII (chrome)	+4dB/-6dB
IECIV (metal)	+4.3dB/0dB

### Frequency Response

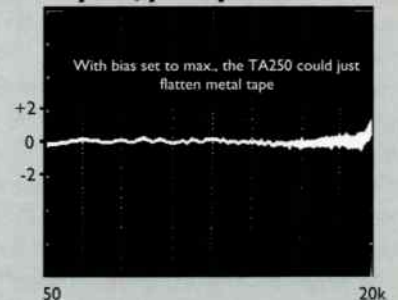

### Speed Stability

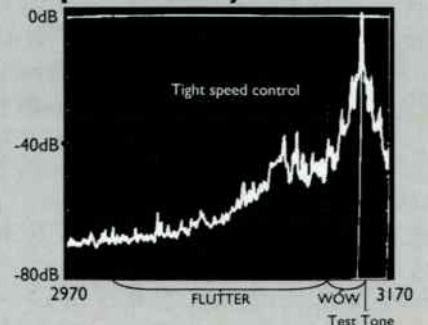





has a few consequences. TDK AR sounded dull and warm at normal bias, as it often does, being a low bias tape. However, swinging to minimum bias didn't clear the warmth and lead to convincingly natural tonal balance, which was a pity. Bass stayed a bit soggy too, whereas AR can give unusually clean sounding bass, since it can accept more bass level than metal tapes. Higher coercivity TDK AD immediately showed that it is the right sort of match for this deck, giving tighter, cleaner and punchier sound with stronger treble.

Chrome tapes came over as quieter than ferms (which they are!) but otherwise little different in their general presentational quality, exhibiting some general warmth and fluffiness, or shall we say a lack of definition and precision to the sound, even though basic tempo was held tightly by the transport. Again, bias variation didn't affect the situation much, offering some fine tuning with TDK SA-X but never quite making it sound right. However, the general level of quality was good; this deck possesses no nasties.

Metal tapes also came over as less pin-sharp and clearly defined than usual, even though they were clearly brighter than the original. This was a trifle odd, since metals commonly become a little

coarse as their treble rises, but not on the Onkyo. All the same, TDK MA gave a balanced sound with clean, inoffensive treble.

Whilst the 250's transport endows the deck with excellent pitch stability and dynamics, further comparisons with the source revealed the 250 to lack that final "edge" to the recording (something which plagues most cassette decks and distinguishes most Nakamichis). Also, the bass didn't quite reach the same quality as the source, yet it did at least remain composed and in tune with the rest of the mix, if a little bloated.

Pre-recorded tapes varied, and lacking any form of Play Trm, certain recordings could sound a little dull. However, the TA-250 managed well in this area and it is obvious that Onkyo have tried hard to adjust it carefully to do as good a job as possible - which is better than most, except of course a Nakamichi (again!).

Dolby B reduced what little background noise there was to virtual silence. Yet, typically, the other side of the coin was that treble detail became less precise, drum beats slightly veiled and the sense of space without Dolby was subtly replaced by a return to the sound becoming processed. Having said that, the end result was by no means poor and

would be quite suitable for those forced to listen with Dolby due to close speaker monitoring, or sensitive speakers.

Dolby C was far better implemented than is often the case with such circuits. It actually ran "B" quite close, with a scant softening of dynamics the only real clue. Neither circuit suffered "pumping", effects and were above average in their operation.

The Onkyo is effective, but it isn't a worthy alternative to a Nakamichi DR-2 (£500), although it does rival a DR-3 in some respects. The build quality, operational aspects and solid transport aren't in doubt. It's the electronics which don't quite pass muster in this company, yet at the same time the Onkyo was still in a better state of factory adjustment than most rivals and through this alone it manages to compete effectively. At the price, it's an effective machine, if not quite an inspiring one - yet few cassette decks are except, well, you know who ●

**Onkyo TA-250**  
**Onkyo UK,**  
**401 - 405 Nether Street,**  
**London, N3 1QG.**  
**Tel: 081 343 2082**

**£350**



# DIGITAL

**Dominic Baker auditions two new corporate representatives in the fiercely contested**  
**aimed at the**

## ROTEL RCD940BX - £229.95

The RCD940BX CD player replaces the highly acclaimed RCD945AX. But for this new model Rotel have moved away from the Philips transport and chipsets they normally use, and instead have gone to the East for these parts. It uses a multibit 18bit 8x oversampling digital to analogue convertor, but the circuit is tweaked by Gamepath, the UK importers of Rotel, for improved sound in the critical UK market.

### SOUND QUALITY

After reading mediocre reviews of Pink Floyd's new album, *The Division Bell*, I'd decided that it wasn't worth risking £14 for, but spotting it for £9.99 a couple of weeks ago, I couldn't resist. I'm glad I didn't too, I think *Division Bell* is one of the best Floyd albums since *The Wall*. *What Do You Want From Me* starts in classic Floyd style, a deep bass drum taps out the beat whilst soaring electric guitars wail away in the upper midband. The 940BX revelled in this, the clean and pure tone of the guitars given wonderful presence and a crystalline clarity.

The RCD940BX is remarkably free of the grittiness sometimes pronounced in the upper mid and lower treble of even some expensive two box players. Here it excels with its smooth and open projection of detail, engaging you in the performance and urging you to listen on.

If I was being especially critical, against more expensive machines it does thin out vocals just a touch, on this particular album making David Gilmour's already lean and dry voice more hollow that it really should be.

The rich and moody saxophone on *Wearing The Inside Out* had a lovely tone to it, natural and clear. The 940BX can be a bit clinical in its presentation though, dissecting the components of a performance and laying them bare. It's not clinical in an uninviting way though, managing to hold my attention well. It's just very ordered in the way it deals with a piece of music, a property which can break the flow, but I found it informative and interesting to listen to all the same.

The treble of the 940BX is bright, occasionally too bright, emphasising sibilance on Blur's *Parklife*, but most of the time has an engaging sparkle to it. Whether, like the Arcam Black Box 50, this 'sparkle' will become fatiguing over an extended listening period remains to be seen. I used the RCD940BX over a fortnight and didn't take offence at its presentation, which appears to be a good sign. But steer clear of peaky metal dome tweeters or amplifiers with high treble distortion, just to be on the safe side.

On albums like *The Division Bell* though, where Floyd's use of a sharply hit cymbal taps out the beat that keeps the rest of the track moving, and on most rock albums, this treble emphasis helps clarify the tempo of the track, keeping the listener abreast of the music.

One thing that was quite marked

with the 940BX, was its ability to separate the two stereo channels, but still hold an image in between. As Velvet Crush's #10 begins, you can quite clearly hear three footsteps forwards from the left hand side of the stage to a near centre position, followed by the damped sound of clothing brushing against the guitar as the performer sits down. A guitar a little further back on the right starts the track, and after two notes the sitting guitarist joins in with his first chord.

I wasn't expecting to be able to hear this level of detail and image clarity from a £230 player, so it came as a bit of a shock, but as it says on the disc cover 'custom engineered for a full range of audio experiences'. It's not just the recording that's good though, the music is superb. It's good rock and roll, with plenty of guitar, good drumming and vocal harmonizing along similar lines to the *Lemon Trees*. The Rotel made tidy work of this album, giving it the energy and drive it deserves.

The Rotel RCD940BX has many great qualities for a £230 CD player. The bass is firm and deep, if a touch dry, the midband is uncluttered and the treble sparkles, giving the whole a busy and active balance. It is capable of bringing order to music, sometimes in a slightly clinical manner, but it doesn't become overwhelmed as the music becomes more complex. A little more emotion at heart wouldn't go amiss, but the new Rotel still rates as one of the best players in its heavily contested class.



# DELEGATES

**budget CD player market - Denon's DCD-825 and Rotel's RCD940BX, both audiophile.**

## DENON DCD-825 - £219.99

The new Denon DCD-825 was designed and specified in the UK, in similar fashion to the Rotel, and purpose built for this market. It features high quality, audio grade Burr Brown op-amps and dual mono 18bit Burr Brown PCM61 convertor chips. Denon have put a lot of effort into the DCD-825, hoping that it will re-establish them as leaders in the budget audiophile CD player market.

### SOUND QUALITY

The Denon DCD-825 had a much firmer presentation than the Rotel RCD940BX. Whereas the Rotel had a light and airy sound, the Denon puts more weight behind individual notes; even its treble seemed more solid, losing the wispy airiness of the 940BX. Bass lines were given greater prominence, underpinning the music more firmly, but it did tend to get a little carried away at times, losing grip and giving a soft bloom to strong bass lines.

On Pink Floyd's *The Division Bell* album, the kick bass drum and guitar were given more power, their full impact being resolved more completely. And again this effect was noticeable with Blur's *Parklife*, where the strong, poppy beat gained an extra degree of impact and drive. The DCD-825 is a

really energetic little performer, squeezing the beat out of music, pushing it forwards.

The same soaring guitars on Floyd's *What Do You Want From Me* didn't have quite the same presence and clarity that the Rotel could manage though. Instead they took on a sharp, almost grating quality, showing a rougher sounding midrange on this player. In fact there was a fair amount of grain in the upper midband and treble which made itself known especially with female vocals and strings, imparting a coarseness to them.

The treble too, although less bright than that of the Rotel, was splashy and occasionally could become a touch fierce. Velvet Crush's #10, although much more immediate and forthright, lost some of its delicacy and light, open touch, the upper harmonics of the steel strings becoming brittle. Having said this though, it did have more warmth to its sound, giving a less clinical edge than the Rotel.

The Denon easily carried off the pace and rhythm of L7's latest album, *Hungry for Stink*, holding its own with the heavy, thunderous guitars and intermittent doses of clumsily applied feedback. Here the DCD-825 is able to contribute best, injecting some of its own might to force the music along and power it out of the loudspeakers.

Stuck Here Again - punchy bass line, grungy guitar and aggressive female vocals - gave the Denon something to really chew on. Where the Rotel took some impact and drama away, the

DCD-825 showed off its dynamic abilities. Sad thing is, you couldn't take too much of it with the Denon. The Rotel, although less impressive with rock, was easier to listen to for longer periods.

Denon's DCD-825 didn't share quite the same stereo separation and imaging abilities of the RCD940BX though. It was still possible to follow the three footsteps and movements of the guitarist on the *Velvet Crush* CD, but without quite the same precise focus. Central images became more diffuse too, spread out across the stage instead of being located in tightly defined areas. The upside of this though was a less mechanical presentation, performers seemed more closely linked in to what they were doing, not separated out as individuals as on the Rotel.

The Denon has a firm sound with impact and incisiveness that keeps the music flowing with a solid beat from below. It's a great machine for rock and pop, where its enthusiasm and exciting presentation add drive to the music, making it more involving for the listener. I feel its midrange is a bit coarse and the treble can become a little spitty at times, but the DCD-825 makes up for this with an engaging and enjoyable presentation.

Again, as with the Rotel, peaky metal dome tweeters and sharp sounding amplifiers are best avoided if you want it to stay on the right side of fatigue, but in a matched system the Denon is able to conjure up a dramatic and strong performance.

# The new Audiolab 8000CDM Compact Disc Transport



The Audiolab product range:  
8000A Integrated Amplifier  
8000C Pre-amplifier  
8000PPA Phono Pre-amplifier  
8000P Stereo Power Amplifier  
8000T FM/AM Tuner  
8000M Monobloc Power Amplifier  
8000DAC Digital-analogue Converter  
8000CDM Compact Disc Transport



## AUDIOLAB

Cambridge Systems Technology Limited, Spitfire Close, Ermine Business Park, Huntingdon, Cambs. PE18 6XY. Tel 0480 52521

## CONCLUSION

Both the DCD-825 and RCD940BX are good machines in their own right, the Denon for its powerful and solid performance and the Rotel for its more refined midband and top. For rock and pop listeners I suspect that the Denon will win the day, but for more refined classical and vocal work, the Rotel has the smoother presentation ●

**Rotel RCD940BX**  
**Gamepath Ltd.,**  
**25 Heathfields,**  
**Stacey Bushes,**  
**Milton Keynes,**  
**Bucks. MK12 6HR**  
**Tel: 0908 317707**

£229.95

**Denon DCD-825**  
**Hayden Laboratories Ltd.,**  
**Hayden House,**  
**Chiltern Hill,**  
**Chalfont St. Peter,**  
**Bucks. SL9 9UG**  
**Tel: 0753 888447**

£219.99

### DENON DCD-825 MEASURED PERFORMANCE

In its response balance, the Denon DCD-825 veers in the opposite direction to the Rotel, with a slight bass lift and treble fall. Even though these trends are only minor, from experience I would expect them to give the DCD-825 a good solid bass and gentler treble than that of the Rotel, since even small response differences are clearly perceptible with CD.

Again though, distortion is higher than I would expect from a Japanese player, and certainly a lot stronger than the older DCD-890 which has long been a favourite at Hi-Fi World. Like the Rotel it has strong low order distortion, which from experience I would almost certainly expect to have an influence on the sound.

The output of the Denon is high at 2.4V, similar to that of the Rotel, allowing extra headroom for passive preamps and possibly giving it an edge in A-B demonstration room comparisons against players adhering to the Philips 2V standard. Dynamic range is some 7.5dB greater than the Rotel thanks to lower overall distortion; separation is wide and noise low. **DB**

### TEST RESULTS

Frequency response	4Hz-21kHz	
Distortion %		
-6dB	0.006	0.006
-30dB	0.044	0.064
-60dB	0.53	0.51
-90	29.6	30.9
-90dB dithered	4.96	9.19
Separation dB	left	right
1kHz	98	99
20kHz	74	78
Noise	-110dB	
with emphasis	-110dB	
Dynamic range	105.5dB	
Output	2.4V	

### Frequency Response

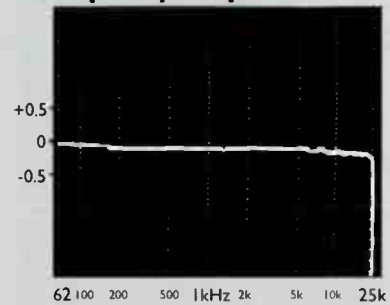

Bass lift and treble fall gives solid sound

### Distortion

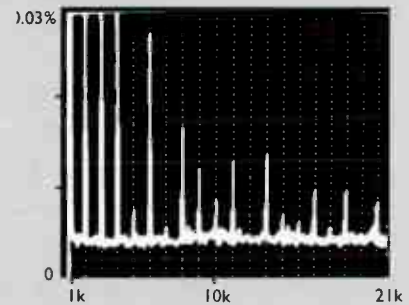

High distortion

### ROTEL RCD940BX MEASURED PERFORMANCE

Unusually for a Japanese CD player, the Rotel RCD940BX did not measure especially well. The frequency response is as flat as any up to 10kHz, but here the RCD940BX departs from the norm and heads upwards to a treble peak reaching +0.4dB at 20kHz.

This rise will almost certainly add a brightness or sparkle to the treble, although not necessarily a nasty one. However, distortion harmonics (see below) at -30dB, or typical music level, are high and wide ranging, which I would expect to add some form of sharpness to the sound, although to what degree can only be assessed subjectively.

Elsewhere, the Rotel RCD940BX measures well, with good separation and low noise, but dynamic range is limited to 98dB by high distortion.

Output is a little high at 2.35V giving the Rotel an advantage in the demonstration room. **DB**

### TEST RESULTS

Frequency response	4Hz-20.75kHz	
Distortion %		
-6dB	0.040	0.066
-30dB	0.093	0.191
-60dB	1.71	1.78
-90	36.5	36.7
-90dB dithered	11.9	12.8
Separation dB	left	right
1kHz	100	102
20kHz	74	75
Noise	-109dB	
with emphasis	-109dB	
Dynamic range	98dB	
Output	2.35V	

### Frequency Response

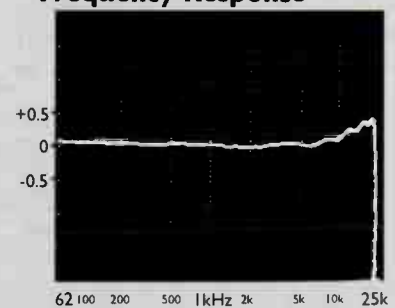

Treble peak adds some brightness

### Distortion

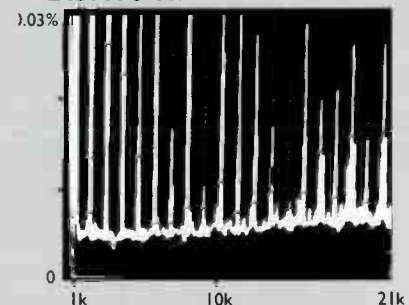

Strong and wide ranging distortion

Adagio cantabile

**VISIT US AT THE RAMADA HI-FI SHOW, Heathrow ORTOFON/KINSHAW/PROJECT - FRIENDSHIP ROOM**

- **STOP** - consider all the options
- **LOOK** - at all the alternatives available
- **LISTEN** - carefully to what is on offer

With British reviews consistently awarding \*\*\*\* and \*\*\*\*\* ratings to our equipment, you will not be disappointed.

**Overture Integrated Amplifier:** "... it offers a quality of sound comparable with models priced at least twice as much and will suit those looking for something that is vibrant and alive, yet tonally neutral and absolutely natural." ... **AUDIOPHILE June 1994.**

**Overture DAC:** "It's terrific value and a good upgrade if you think your CD player is a bit lethargic or not injecting enough verve into the music" ... **WHAT HI-FI August 1994**

New product launches every quarter. Ask your dealer for a demonstration of the Kinshaw range and redefine your reference.

Contact your nearest retailer for an audition or for more information ...



**Conceptual Design - Sound Engineering**

Overseas agent:  
Kinshaw Electronics Ltd.  
84 Pendarves Street  
Tuckingmill, Camborne  
Cornwall TR14 8RE  
Tel: +44 (0)209 715878  
Fax: +44 (0)209 711939

U.K. agent:  
Ortofon (UK) Ltd.  
Chiltern Hill  
Chalfont St. Peter  
Bucks. SL9 9UG  
Tel: 0753 889949  
Fax: 0753 889636



**Chord Electronics Ltd**  
3 Bower Mount Road  
Maidstone ME16 8AX  
Tel. 0622 764874/692000 Fax. 0622 764506  
Chord UK Dealers

Cottage Audio	0522 702834
KJ Leisuresound, London W1	071 486 8262
Acoustic Arts, Watford, Herts.	0923 245250
Brentwood Music Centre, Brentwood, Essex	0277 221210
Progressive Audio, Gillingham, Kent	0634 389004
Doug Brady Hi-Fi, London WC2	071 379 4010
Doug Brady Hi-Fi, Warrington, Cheshire	0925 828009
Doug Brady Hi-Fi, Liverpool, Merseyside	051 733 6859
Doug Brady Hi-Fi, Leeds, Yorkshire	094 346 7689
Photocraft Hi-Fi, Ashford, Kent	0233 624441
West Midlands Audio, Worcester, West Midlands	0905 58046
The Reference Studio, Heathfield, Sussex	0435 868004
Paul Green Hi-Fi, Bath, Avon	0225 316197
Eastbourne Audio, Eastbourne, Sussex	0323 25828
Surrey Hi-Fi, Godstone, Surrey	0883 744755
Sound Academy, Wallsall, West Midlands	0922 493499
English Audio, Hereford, HR4	0432 355081
Hi-Fi Experience, London W1	071 580 3535
London Hi-Fi Services, London	071 263 1015
Diva Audio Fidelity, London SW11	071 924 5286
Music Matters, Birmingham, West Midlands	021 429 2811
Music Matters, Dourbridge	0384 444184
Vaudio, Stoke Bishop, Bristol	0272 686005
In Hi-Fi	031 225 8854
Audio Reflections	0532 528850
Audible Difference	0379 740227

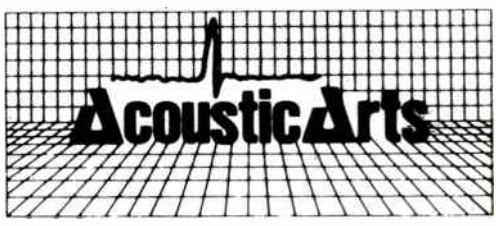

**Full range of Denon equipment on demonstration. Including the new Denon DCD 825**



**Come and experience Denon Audio Visual in our dedicated studio.**

**Stockists:-**

Adcom, Apogee, Audiolab, Audio Innovations, Audio Research, B&W, Castle, Celestion, Copland, Denon, Jadis, Koetsu, Kef, Krell, Magneplanar, Marantz, Martin Logan, Michell, Micromega, Orelle, Professional Monitor Co., PS Audio, Rel, Revox, Roksan, Sequence, SME, Sonic Link, Sonus Faber, Target, TDL, Theta, Thorens, UDH, Wilson Audio.

**Acoustic Arts Limited**  
101 St Albans Road, Watford, Herts. WD1 1RD  
Tel:- 0923 245250/233011 Fax:- 0923 230798  
Opening hours 10 am - 6 pm Tues to Sat

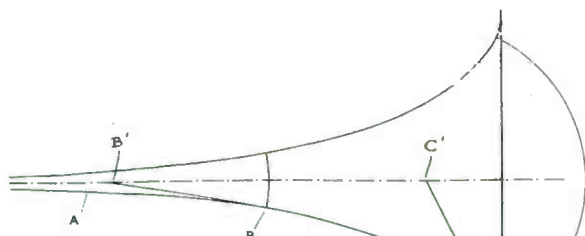

FIG 1.

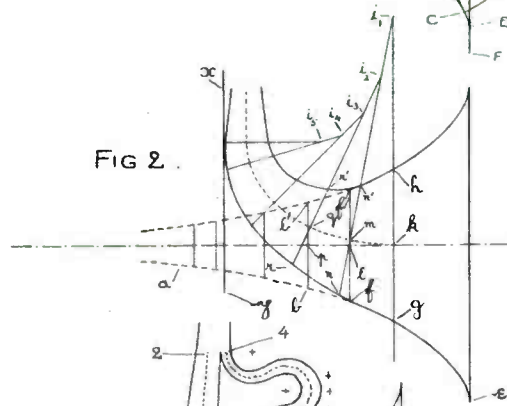

FIG 2.

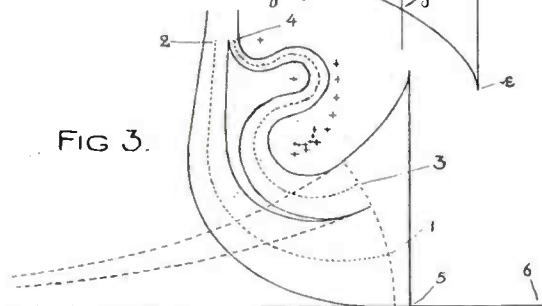

FIG 3.

[This Drawing is a reproduction of the Original on a reduced scale.]

Paul Voigt early Tractrix horn drawing, from his 1927 patent.

.... continued from page 47

available any more and the others are in very short supply.

A book that will take you from a beginner to advanced level between two covers is *The Art of Electronics* by Horowitz & Hill - it's superb. There's a chapter of basic theory which takes a look at individual components such as resistors, capacitors and inductors. The book then carries on to explain transistors, FETs, op-amps and so on. Each chapter starts at a basic level and at the end there are practical circuit suggestions which you could build to help get a feel for the components. This book is available through Hi-Fi World Mail Order, or from technical

book shops. **DB**

### TRACTRIX

It was most gratifying to read the article on Paul Voigt and his Tractrix horn loudspeaker in the June issue. Far from being a historical curiosity the Tractrix horn is alive and well today and for good reason too.

Bruce Edgar, long time horn experimenter in the US, produces a 'domestically sized' midrange horn using the tractrix contour mated to a Dynaudio D54 loudspeaker. He states that the tractrix contour assumes that the waves travelling down the horn take on a spherical shape instead of a flat shape assumed by the

exponential horn. In the tractrix horn the wavefront at the mouth couples better with the air and as a result sounds better than the exponential horn.

Articles on Bruce Edgar's tractrix horn designs and an interview he did with Paul Voigt have appeared in *Speaker Builder* and *Sound Practices*. For those who are interested in more information try contacting -

**1) Speaker Builder**  
**c/o Audio Amateur**  
**Publishing Group**  
**PO Box 576**  
**Peterborough**  
**NH 03458-0576**  
**USA**  
**Tel: 603 924 9464**  
**Fax: 603 924 9467**

**2) Sound Practices**  
**PO Box 180562**  
**Austin**  
**Texas 78718**  
**USA**  
**Phone/Fax: 512 339 6229**

**3) Bruce Edgar**  
**(Edgarhorn)**  
**Box 1515**  
**Redondo Beach CA**  
**90278**  
**USA**  
**Tel: 310 370 1302**

**Ian McPhail**  
**Australia.**

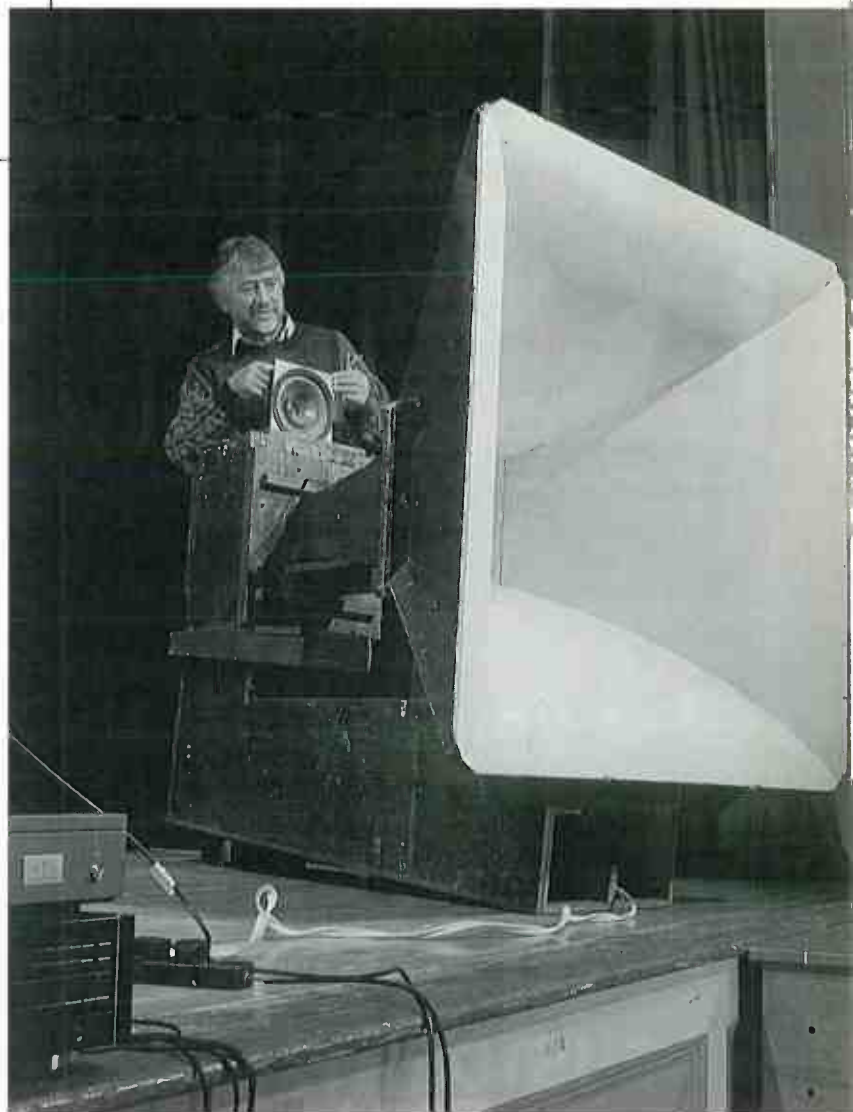

The Tractrix horn, built by Paul Voigt.

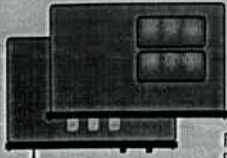
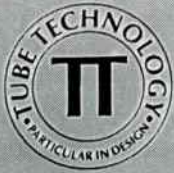

Prophet  
PreAmp



Genesis  
Monobloc



Unis  
Integrated



Synergy  
Pre/Power

*Explosive bass dynamics, a midrange  
clear as a bell & shimmering treble.....  
.....A tighter rendition of Music....*

*In a world of black boxes,  
valve amplifiers like this are  
scene stealers.....*

*Hi-Fi World, June 1994*

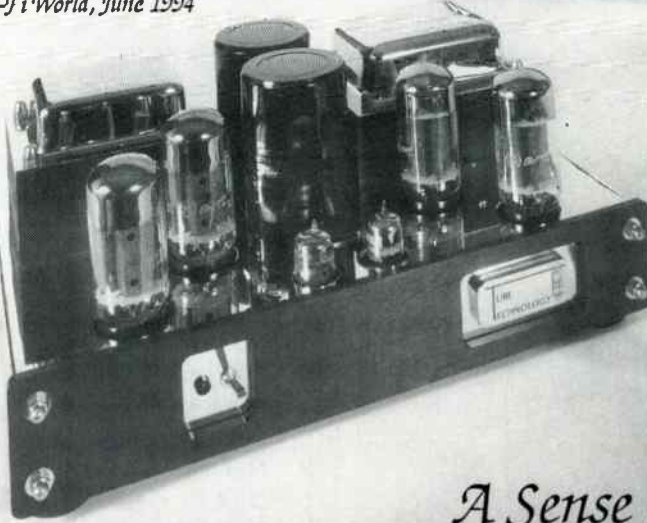

*A Sense of Rhythm*

Tube Technology, Design & Manufacturers of High Quality Tube Amplification  
and Distributors of Gold Aero Vacuum Tubes.

Please enquire for further information. Foxhills Farm, Longcross Road, Ottershaw, Surrey,  
KT16 0DN, England. Tel: 0932 873444 ~ Fax: 0932 873012

*Pictured:- The Genesis 100 watt All Tube Monoblocs.*

# **HORN LOUDSPEAKERS** **Klipsch**<sup>®</sup> **HIGH EFFICIENCY FOR FULL PERFORMANCE SOUND**

Hear KLIPSCH for yourself at - Acton Gate Audio 0978 364500. Audio Excellence 0272 264975. Audio T 071 794 7848. Doug Brady 071 379 4010. Chantry Audio 0777 870372. Clearsound 0745 343060. Diva 081 875 9593. Five Ways Hi-Fi 021 455 0667. KJ West One 071 486 8262. Listen Inn 0604 601430. Music Matters 021 429 2811/742 0254/0384 444184. Heatherdale Audio 0903 261213. Radlett Audio 0923 856497. Riverside Hi-Fi 081 892 7613. The Audio Galley 0730 895194. The Hi-Fi Studio 0302 781387. Westwood & Mason 0865 247783.

## Are you making the right connections?

Send for Britain's biggest catalogue of  
specialist cable and connections.  
All available by mail order.  
Phone 081-9429124 or clip  
the coupon for your Free copy.

**CUSTOM CABLE**  
**SERVICE**

PO Box 4007, London SW17 8XG

Please send me your FREE Custom Cable Catalogue

Name \_\_\_\_\_

Address \_\_\_\_\_

Postcode \_\_\_\_\_

NO FURTHER INFORMATION REQUIRED

Send to: Custom Cable Service  
PO Box 4007  
London SW17 8XG

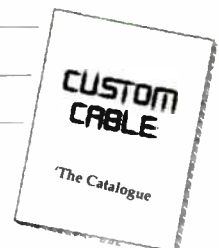

HPW7/94



# HEAD HUNTING

**Eric Braithwaite searches for the best phono head amplifier.**

**H**ead amps are great for serious vinyl lovers. They're super high quality amplifying stages for cartridges, both moving magnet (MM) and moving coil (MC). The pre-amplification and correction (RIAA equalisation) they apply used to be built into ordinary amplifiers, forming the 'phono stage'.

Because this function is quite difficult to engineer properly, cheap chip solutions were commonplace in integrated amplifiers, leading to a certain mediocrity of reproduction from LP. As CD has taken over from LP, manufacturers have happily abandoned the phono stage altogether, producing line-level only amplifiers. Trouble is, people have huge LP collections and still want to listen to them. The independent head amp is a superb way of doing so.

But what do you need to look for when buying a head amp? For ultimate quality you must consider using a moving coil cartridge, so an MC input is important; happily most stand-alone head amps have them. Moving coil cartridges generate minuscule outputs measured in millionths of a volt. This demands the use of an ultra low noise input stage if hiss is not to be a problem, at least with low output MCs like the Ortofon MC7500 (0.19mV) or Linn Klyde (0.25mV) for example. Hiss will be less audible from moving coil cartridges

having a high-ish output, like the new Ortofon Supremes, which give 0.7mV. That's no less than 11dB more than the MC7500 (and 9dB more than the Klyde), meaning that hiss will be equivalently lower. Subjectively, it's a huge difference. But don't confuse high output MCs like the Supremes with high output MCs designed to feed MM inputs; the latter give double the output or more (e.g. 2mV or so) and they do not give all the sonic benefits - they're a compromise.

Then there's the warp filter problem. Without a warp filter you can suffer from flapping loudspeaker cones, at least if you have a compliant MM cartridge in a heavy arm and you use ported (reflex) loudspeakers. The IEC insisted some time ago that disc stages be fitted with a filter that removes signals below 40Hz to eliminate this potential problem. Yet few of these dedicated disc stages have one, or at least, a good one. Audiolab are the exception, fitting a neat, switchable filter - a very unusual feature and one I've always recommended. Warps are less of a problem when an MC cartridge is used, because they have lower compliance, so not everyone will need such a filter and since they lighten bass and audibly remove subsonics, designers often avoid them.

If you're running Quad II power

amplifiers (like so many of our readers it seems), or any low sensitivity power amp that needs 1V input for full output, beware! Most of these head amps cannot satisfactorily drive such beasts direct, through either a volume control, a passive preamp or an active preamp like our own KLP1 which has line drivers but no gain. For example, with a very low MM gain of x77, the Audiolab will barely produce 0.5mV output on peaks, so even at full volume a Quad II would not deliver full output. These head amps have been designed to feed a line input with 200-300mV input sensitivity.

To retain good specified overload headroom for head amps, designers are forced to keep gain down when faced with an output swing of around 5-10V rms from today's silicon chips. A discrete high voltage output stage with a little gain would solve the problem, but only the inventive Tim de Paravicini has seen this solution and used it with the EAR834P, using valves to swing 20V of output, no less. As a result, the EAR834P is the only head amp that can drive a Quad II or any power amp direct, whilst also being able to work with any integrated amplifier too. Bear in mind that a gain of x160 minimum is needed if a head amp is to feed low sensitivity power amps direct. **NK**



## **AUDIOLAB 8000PPA £799.90**

The Audiolab offers two inputs and outputs, needing no internal re-configuration, so changing from MM to MC presents no practical difficulties. A muting circuit automatically operates when switching inputs or when choosing high or low gain for MC, or switching in the LF filter. This filter I couldn't entirely decide upon; on some recordings I felt leaving it switched out slowed things down; on others, particularly rock music, it added weight and gravitas. The apparent amount of filigree detail was remarkably impressive, with the elements of classical recordings particularly laid uncompromisingly bare. It was almost as

though a musical recording had been etched into Italian glassware instead of cut in vinyl. The position of every orchestral section was defined with unmistakable clarity, layers laid out like a skinned onion. Anyone who takes a connoisseur's interest in microphone positioning would be able to draw a map from the Audiolab without any assistance.

The amount of sheer space was startling and, at first, hearing an instrumental echo bounce off some part of the location was quite surprising. However, ultimately there was a lack of 'roundness' and body to the overall tone, producing a somewhat anaemic effect compared to the other phono stages. Instruments had a somewhat flat perspective.

On MM the same fine detail and delicacy was well in evidence on orchestral recordings and the sense was of through-going tonal colour and of a performance that was more cohesive. The elements of rhythm made up of lead guitar, bass and drums couldn't be faulted individually, but required more torque from the engine for unsticking a behind from the armchair and dancing.

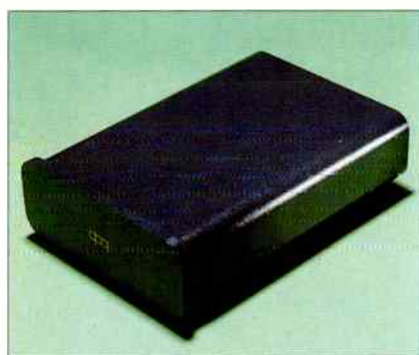

## **DPA DIGITAL DSP 200SD £495.00**

Lodged within the now-standard gunmetal grey, flat-fronted case, the DPA phono stage is configurable for moving-coil or moving magnet cartridges, switchable by two toggle switches at the rear. So far, so straightforward, but using a Morch da Capo with what should have been a sufficient 0.2mV output, there wasn't enough gain.

The DPA conformed more closely to what one would expect a piece of electronics from this stable to sound like with the Koetsu (with fifty per cent more output) than the da Capo. It was bright, forward, thrusting and lively, putting lead

guitarists and lead vocalists crisply in front of the plane of the speakers. While strings had a bright tone, but without taking on any feared steeliness, jazz piano fared less well, a grand ending up with more than a suspicion of honky-tonk in the upper notes. As with all these phono stages, detail in the mid-range was exemplary, the DPA pulling off that trick of differentiating between the sides of a percussionist's triangle, a rare subtlety. On orchestral music, imagery was well defined, fairly broad, but slightly compacted between the speakers.

While the bass was expected to be strong and deep - and it was - the crisper pace of the mid-range and speedy treble rather detracted from it. Bass rhythms - particularly in orchestral music - tended to sound somewhat slow by comparison, although rock and jazz was a little less foot-dragging.

Initially, with the Goldring MM the same traits were evident, though this time with the more up-front projection and tough bass than the Koetsu had produced and far more than the da Capo. Again, however, upper treble, in violins, guitars and piano developed a steelier quality than I would have liked. Detail was again very fine, and the bass really extremely powerful. All in all, it was very lively - if a little too forceful for some.

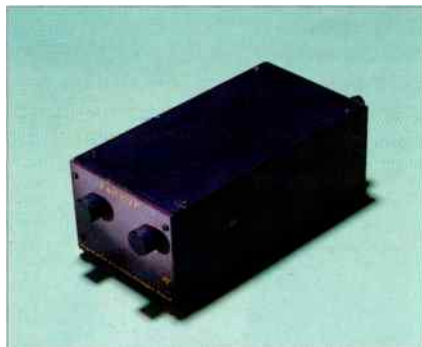

**EAR 834P £340**

Inevitably, perhaps, this is the only one to use valves, but despite a somewhat ordinary-looking rectangular box, produced a startlingly good sound which belied the fact it was the cheapest on test. Like the DPA, the 834P is switchable for either MM or MC via a small push-button at the back. If the DPA's gain was too low, then the EAR's was on the high side.

Most marked was the EAR's uncanny silence, both on MM and MC. Equally marked was the clarity of definition, the finest detail coming through the speakers untrammelled. The 834P performed with some of the anticipated Paravicini hallmarks. It was the only phono stage of this group, except for the Iso, to transmit those delicate nuances of voice which on a recording often apparently disappear, but through equipment like this are revealed as a singer's breath control. It gives vocalists and soloists a real third dimension between the speakers.

Splendidly, the EAR reproduced ambience quite proportionately to the

recorded voices and instruments, with no tonal emphasis or aberrations to destroy the illusion except for a somewhat over-crystalline quality to violins. It was by far the most seamless at reproducing some clever pan-potting across the soundstage.

Only one reservation regarded the bass. On piano, it was very strong and firm, giving an excellent impression of the scale of piano sound, but double basses and cellos had rather too warm and less defined a bloom.

Imagery was extremely precise, with plenty of positional information, yet also a homogenous whole.

On moving magnet? Exactly the same, allowing for the inevitable disparity between the overall sound and tonal quality of both cartridges, though there was a little more treble brightness and sharpness from the Goldring.

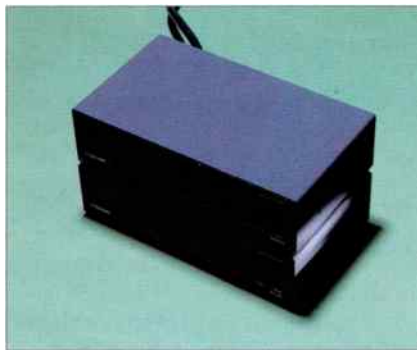

**KINSHAW PERCEPTION PHONO CENTRE £525**

Like the Iso, the Perception Phono Centre arrived with a dedicated power supply in a box similarly shaped, sized and Nextel-grey finished. While a variety of MC cartridge loadings can be catered for, puzzling out from the instructions precisely how the various bits and pieces fit on the circuit board is not entirely simple. I had severe attacks of doubt sorting it all out. But then, normal buyers would have a dealer to help.

The Perception certainly demonstrated plenty of it on MC, being on a par with the best of the rest. Allied to inner detail and subtlety, it produced a very tight soundstage, and a very 'big' and expansive sound which took little notice of the confines of the speakers. Orchestral sections and band members performed precisely in their allocated places, with a good deal of verve and fluidity.

The overall result was extremely impressive, with a strong and large bass underpinning everything and constantly present. Tonal quality was distinctly faithful, with first and second violins clearly differentiated and vocals and solo instruments full of nuance. These qualities made rock music extremely exciting, but on orchestral music a slight doubt crept in.

On moving magnet, the Perception really came to the fore, with a splendidly rich quality to orchestral woodwind and brass. Any reservations about its dynamics which surfaced during the Eighth on

moving coil were quickly dispelled as woodwind and brass burgeoned and swelled out over the whole orchestra as they should. Reproduction of ambience was also the near equal of the Iso and EAR, with depth almost as good. Rock came over with an excellent studio ambience, although double-tracked vocals for some reason were less clearly so than on MC, blurring into each other.



**MICHELL ISO/HERA £528**

As might be expected, the Iso is encased in a brown acrylic box, through which a red LED glows when it is powered up from the bulky optional Hera power supply. This one is unusual, in that of this group it is for moving coil cartridges only. I discovered that in fact, should customers insist, an MM Iso can be bought, but it cannot be converted to MC afterwards.

Like the Perception, the Iso can be configured for a variety of cartridge loadings, but unlike the Kinshaw, also for degrees of gain, though this is done at the factory rather than by the user. This does make the Iso extremely versatile.

In common with the others, the Iso reproduces about as much of the finest mid-band and treble detail anyone could wish for, overtaken on the extreme subtleties of instrumental and vocal nuance only by the EAR. Imagery was extremely well-defined, with rather more space and air than any of the others, with the exception of the Audiolab.

Where the Iso differs somewhat from the Kinshaw and EAR is in its presentation of bass. Always very tight and rhythmical, it needs a low D on an organ recording occasionally to convince a listener that it's there when required. It arrives when needed, but doesn't make itself felt in the background all the time, which may be disconcerting to some listeners.

By comparison with the DPA, Kinshaw and EAR, the treble is perhaps somewhat sweeter, though some of the sharper recordings still let rip with ear-piercing exactitude.

Like the EAR, the Michell Iso gives a thoroughly cohesive picture of a recording, with the ability to be surprisingly revealing. A plus (or a minus) for some is that the Iso, like the EAR and Audiolab can be ruthless about recording quality, though the natural flow of music means that this aspect is unintrusive until you start listening for it.

## CONCLUSION

In vinyl replay, there is often so much variation between cartridge, turntable and arm performance that it must seem that a totally pure, entirely neutral replay system might be beyond the power of mankind to invent. In the end, the judgement has to be almost exclusively subjective.

I spent some time carefully comparing original vinyl with CD re-issues and remasterings through a very wide variety of equipment. Despite some prejudices to the contrary, many producers and engineers do treat the master tapes with great respect. Some don't, but I don't use their results for reviews like this. Replaying vinyl, the essential balance to be struck is between a natural impression in the living room and an accurate reproduction of what was on the record. Between both ideals lies a wide no-man's land.

Most natural, with a high score on grounds of accurately fishing detail out of the groove as well, were the Iso on MC and the Perception on MM. Close on their heels followed the EAR, much the best in terms of equal performance on both MM and MC, my reservations about its 'valve-like' bass bloom compared to the tighter transistor quality of the others failing to put it at the top of the pile. On price, it represents an absolute bargain.

On MC, gain certainly appeared to present a problem. The DPA, Kinshaw and Audiolab were more dynamic with the Koetsu, with its 0.36mV output and more restricted with the da Capo's 0.2mV. For midband clarity, the DPA was downright astonishing, being extremely impressive in this area, albeit with a sheen to the treble which I found a little exaggerated. The Iso, Perception and EAR were distinctly sweeter and smoother, with the Perception always sounding exciting. The Audiolab, as it happened, was sweet to the point of being a little too laid-back by comparison.

Audiolab's 8000PPA is rather unnerving. On both MM and MC it is supreme at undoing the stitching in any recording and laying it out for forensic inspection. Academically, it is exceptional; but the result remained stubbornly clinical. Going back to Klemperer, the Audiolab would fail to convince anyone already prejudiced that he had any 'get up and go' at all. Yet the evidence of other vinyl replay systems and some highly rated CD transports and DACs does belie that belief. Beethoven's Eighth here remained a late 50's quality recording, with only passing acknowledgement of its being a wonderful performance, something which the EAR and Iso grasped firmly.

Auditioning phono stages may be an arcane pursuit, but when one is on the shopping list, it is about to become another essential hi-fi chore. Pick your phono personality, then go and do some matchmaking with your cartridge to see if you can live together. My ideal mate from the disc dating agency would be either the Iso or EAR, but I wouldn't necessarily turn down an offer from the others ●

## AUDIOLAB 8000PPA

The Audiolab 8000PPA has three switched gain settings. MM switches in a 47k $\Omega$  input load and x77 gain, whilst the two MC settings switch in 100 $\Omega$  and x720 or x2250 gain. The 8000PPA is best feeding a preamplifier possessing gain. It is not really meant for a passive preamp feeding a low sensitivity power amp like the Quad II, for example, which needs 1V in.

The input noise levels were extremely low for both MM and MC, being right at the lower limit of what is achievable. In this respect, the 8000PPA is a very good choice, being quieter than most.

The bandwidth was a wide 0.5Hz-80kHz, -1dB, the lower limit rising to 50Hz with the warp (LF) filter switched in. **NK**

Frequency response	0.5Hz-80kHz
Separation	90dB
Input noise (CCIR)	
MM	0.3 $\mu$ V
MC	0.06 / 0.05 $\mu$ V
Distortion	0.005%
Gain	x77, x772, x2250
Overload	12V rms out

## DPA DIGITAL DSP 200SD

This preamp sounds different because it uses DPA's own thick-film integrated circuit, the DH-OA32, a unit developed for audio work.

Frequency response was flat from 8Hz to 37kHz within 1dB limits on MM, but in fact high frequency gain doesn't fall fast enough above 20kHz, giving a net rise in treble response.

On MM this preamp was the quietest we've ever tested, managing just 0.15 $\mu$ V on input noise (CCIR). On MC however, it was noisier than most, giving 0.12 $\mu$ V of input noise. This is about double

that of other stages, meaning the DPA will give 6dB more hiss. **NK**

Frequency response	8Hz-37kHz
Separation	90dB
Input noise (CCIR)	
MM	0.15 $\mu$ V
MC	0.12 $\mu$ V
Distortion	0.01%
Gain	x135, x1550
Overload	5.5V rms out

## EAR 834P

The 834P uses input transformers for moving coil cartridges. Not relying exclusively on silicon chips, it can swing 20V rms output allowing it to drive even insensitive power amps like Quad IIs, direct.

Frequency response was wide and there's no warp filter in the 834P. Input noise levels were low at 0.55 $\mu$ V on MM and 0.06 $\mu$ V on MC. These figures are up amongst the best, making the 834P very quiet. The 834P offers a fine all-round performance.

**NK**

Frequency response	6Hz-87kHz
Separation	44dB
Input noise (CCIR)	
MM	0.55 $\mu$ V
MC	0.06 $\mu$ V
Distortion	0.01%
Gain	x290, x2750
Overload	20V rms out

## KINSHAW PERCEPTION

The Kinshaw Perception head amp has very low noise on MM, but is hissy on MC. It doesn't have enough gain to feed insensitive power amplifiers direct. With a maximum output of 10V rms, determined by the silicon chips used internally, the Kinshaw must feed a sensitive line input stage.

Bandwidth on both MM and MC was high, measuring 6Hz-120kHz. This version of the Perception headamp does not have a warp filter, which can be problematical, especially on MM when a compliant cartridge is used. Lack of such filtering

does, however, give stronger, deeper bass. **NK**

Frequency response	6Hz-120kHz
Separation	80dB
Input noise (CCIR)	
MM	0.17 $\mu$ V
MC	0.25 $\mu$ V
Distortion	0.002%
Gain	x100, x930
Overload	12V rms out

## MICHELL ISO/HERA

The Iso is for moving coil cartridges only. Like so many disc preamps, this one has no warp filter, maintaining gain down to 5Hz, so the Iso should possess a weighty deep bass and a more open quality.

The Iso has a gain of x1100 at 1kHz and a maximum output swing of 9.5V. This is just enough for low output moving coil cartridges, 0.2mV from a cartridge giving 220mV output from the Iso, so it is best best feeding a preamplifier possessing gain.

Input noise was low, measuring out at 0.09 $\mu$ V.

This is a straightforward moving coil stage of low noise and high gain that will suit most moving coil cartridges. **NK**

Frequency response	50Hz-16kHz
Separation	63dB
Input noise (CCIR)	
MC only	0.09 $\mu$ V
Distortion	0.003%
Gain	x1100
Overload	9.5V rms out

# IN THE NOVEMBER ISSUE

Don't miss the next colourful and exciting issue of Hi-Fi World, full of up to date reviews, features and everything hi-fi. Next month we'll be giving you another free DIY Supplement, a treat for you DIYers out there. Here's just some of the things we hope to bring you in November:

## MINI MONITOR LOUDSPEAKERS

Looking for super quality sound, but stuck for space? We test a group of miniatures, all offering quality sound from a compact enclosure.



## NAD 533

A budget turntable from NAD, built to their specifications by specialist turntable manufacturer Rega. At £200 it could be a bargain.

## ROTEL RQ970BX

Rotel's new phono head amplifier uses top quality audiophile components for an amazing £129. We listen closely and then show you some simple modifications that make it rival head amps costing several times the price.

## BURMESTER 931 TUNER

Listen to the radio in style with this high-end chrome plated tuner from Burmester in Germany. Could this be the best tuner we've ever heard?

## COMPETITION - WIN A COMPLETE AURA HI-FI SYSTEM WORTH OVER £1150

A complete Chrome finished system comprising CD-50 CD player, VA-80 amplifier and SP-50 loudspeakers.



Hi-Fi World is still only £2, but with more editorial than most rivals. With the most enthusiastic and expert editorial team in hi-fi journalism, can you afford to miss it? Make sure you don't by filling in this order form and handing it to your newsagent.

# Hi-Fi WORLD

Please reserve/deliver\* Hi-Fi World on a regular basis, commencing with the next issue, until further notice.

Name: \_\_\_\_\_

Address \_\_\_\_\_

Signed: \_\_\_\_\_ Date: \_\_\_\_\_

• Delete as appropriate

Distributed to the news  
trade by

**COMAG**  
MAGAZINE MARKETING

## DIY SUPPLEMENT No. 11

Just to keep all you DIY freaks happy, they'll be a free DIY Supplement with the November issue. Look out for our experiences with Maplin's Millennium 4-20 valve amplifier kit. Of course, they'll also be all the usual letters, news, book reviews etc. Don't miss it.

Colouration is the issue. It may be colouration that decides what a hi-fi system sounds like more than just about anything else. It seems to be everywhere and since it's the result of resonance, which, like feedback, surrounds us in everyday life in a myriad forms, perhaps this isn't surprising.

Colouration can't easily be detected by conventional measurement and it is stimulated by impulsive signals like music. This makes it a prime candidate for an effect that we can't easily measure yet seems pervasive, fitting the bill as the most likely source of the sonic signature of every little component in a hi-fi system. We know how strongly it affects loudspeakers, but we don't yet fully understand how it affects electronic components, although some plausible theories exist.

Colouration in its most blatant form is the wooden sound of a loudspeaker cabinet resonating, stimulated by music, especially deep male vocals. The chestiness and wooden thrum this produces taints speech and overhangs it too, dying away just after speech has stopped, just as you'd expect from a resonant system. Another property of colouration is that, like distortion, it has a Jekyll and Hyde nature: it can be annoying - and generally is - but it can also be euphonic. Wooden speaker colouration sounds out of place until the speaker is asked to reproduce cello, then suddenly it can add welcome warmth and woodiness.

Schoolbooks illustrate the basic principle of resonance with a weight on the end of a spring. This is an example most of us can understand from experience. We know the weight will hang motionless unless disturbed. Give it a jolt and the weight will start to bounce up and down on the spring. No matter how it is jolted, whenever the system settles down the weight ends up bouncing up and down at the same rate; it doesn't jitter up and down one minute then laze up and down the next.

We can often identify a material, like steel, from the sound it makes when struck, and humans are pretty adept at associating the particular sound of a resonant system with the material producing it. As far as hi-fi goes, this acuity is unfortunate. It means we are unduly sensitive to the way resonances colour sound and, indeed, we often use materials to describe the peculiar sound of resonance, describing something as "steely", "wooden" or "papery", for example.

It's this association that makes me suspect



components used inside, including the valves. This makes them pliable, as it were, in their sound quality, which is very good news.

Transistor amps seem less amenable to character change, possibly because transistors themselves are more consistent in the materials used for their construction and because more active components are needed, so statistically changing one component has proportionately less effect. That's not to say component changes don't have an effect though.

If manufacturers become

## Reflections from Noel Keywood

# kaleidoscope

colouration is the problem. Too often in hi-fi, the sonic properties we would ascribe to a component seem to describe the sound of its basic material.

I suspect the sound of cables may well be attributable significantly, if not fully, to the materials used. At least, the difference in sound between carbon, copper and silver cables seems to very closely mimic the respective resonant signatures of their base substances. Silver cables sound astonishingly bright, clear and detailed; I find them quite a revelation. Carbon in cables and resistors comes over as supremely neutral, a property I also rather like. Copper is a well damped metal and because it is what we use it is a de facto sound standard - more on this soon. The subject of the influence of copper, especially in chassis where steel is commonly used, is an interesting one that we spend a lot of time talking about here - I hope we can bring some more information on this fascinating subject (which the Japanese take very seriously by the way).

Experimenting with loudspeaker crossover capacitor types and the affect of damping them with Blu-Tack, Tannoy take the view that resonance is the most likely explanation for the effects they heard. Whilst external vibration can be cited here, it seems as likely that the currents flowing through components commonly set up weak electrostatic and magnetic forces that exert some mechanical influence, enough possibly to cause a characteristic signature to be developed by the substance concerned. In the same way that wood gives a wooden colouration, I suspect that other materials manage to impose their signatures also. Whether the inherent electrical resonances of capacitors, often well out of the audio band, are a part of this I don't know, but they could well be.

As far as constructors and manufacturers are concerned this is largely good news, but with a hint of bad. Our experiences suggest that a large proportion of the characteristic sound of a good valve amplifier is attributable to the

more aware of the differences audio grade components make, then the speciality and uniqueness of audio engineering - always close to an art form (a science with more than seven variables) - will also be enhanced. With so many more variables (the sound of components) and with a recognised need to balance them, the artistic side will come to the fore. Ever tried to balance the sound of paper-in-oils against polypropylenes? It's a fascinating experience and a instructive one too. I hope in future it becomes a more common one as audio engineering becomes less glib and more specialised. There are plenty of signs that things are going in this direction.

And the little bit of bad news? Well, the day we know all there is to know, the mystery in audio will vanish. If banishing colouration moves us much further ahead, then this day will approach; we'll certainly have systems that sound more alike. Colouration won't be an issue, but we'll have less colour in our lives!

aim your price!



The new **naim audio NA CD3**  
now on demonstration  
at

The  
**Hi-Fi**  
Showrooms

12a West Street, Congleton,  
Cheshire, CW12 1JR  
Telephone (0260) 280017.

## Sale Bargains

	SRP	SALE PRICE		SRP	SALE PRICE
<b>Speakers</b>			<b>Amplifiers (cont)</b>		
Apogee Stage	3000-D	1295	Sumo Athena preamp	S/H	200
KEF 105	2295-D	1795	Marantz SP50 Dolby		
KEF Q80	549-D	349	Surround amp	199.90	140
Linn Nexus (Black Ash)	459-D	299	Robertson Forty Ten P/amp	S/H	200
Linn Kan II	459-D	250	Linn LK280 P/amp	988-D	450
Aura SP50	399.95-D	319	Musical Fidelity F22	999	799
Magnepan MG1.4	S/H	499	Musical Fidelity F15	1899	1499
Arcam Delta 2	339.90-D	249	Musical Fidelity A470	S/H	1795
Rogers LS8	499.90-D	324	Quad system comprising:		
Quad ESL63 inc. stds.	S/H	795	Quad 44 preamp, Quad 405-2 Power amp,		
Tannoy 611 II	429.99-D+N	329.90	Quad FM4 tuner	S/H £500 inc Rack	
Tannoy 609 II	294.99-D+N	229.90	<b>CD Players</b>		
Tannoy 607 II	219.99-D+N	159.90	Drele CD10T transport	799-D	649
Tannoy 605 II	169.99-D+N	129.90	Orelle DA180 DAC	599-D	499
<b>Amplifiers</b>			Orelle CD480	399-D	329
Linn Pretek	378-D	245	Marantz CD10	1099.90-D	829
Linn Powertek	417-D	270	Wadia 6	3995-D	2595
Linn Intek	449 S/H	249	<b>Turntables</b>		
Arcam Delta 60	299.90-D	224	Linn LP12 (valhalla)		495
Pioneer A400	239-D	149	Zeta arm		
Musical Fidelity Pre3a	S/H	349	D = Ex Dem		
Musical Fidelity P150	S/H		S/H = Second-Hand		
Meridian 601 Digital	2750-D	1789	N = New		
Classe DR10	2299-D	1779			
Classe DR4	1735-D	1300			
Nakamichi PA7E	S/H	600			

 **THE listening rooms**

161 OLD BROMPTON ROAD, LONDON, SW5 0LJ  
TEL: 071-244 7750/59 FAX: 370 0192

# Recital

WHAT ARE YOU REALLY LOOKING FOR?

- \* A SYSTEM THAT WILL REALISTICALLY REPRODUCE ALL YOUR FAVOURITE RECORDINGS.
- \* COMPONENTS THAT ARE RELIABLE AND BEAUTIFULLY FINISHED
- \* RELAXED DEMONSTRATIONS THAT ALLOW YOU TO CHOOSE THE EQUIPMENT
- \* FRIENDLY EFFICIENT SERVICE THAT IS SECOND TO NONE
- \* EVENING, SUNDAY AND HOME AUDITIONS BY ARRANGEMENT

TELEPHONE REX ON: 071-731 0340  
10 TIL 6, MONDAY TO SATURDAY

**RECITAL**  
289 NEW KINGS ROAD  
FULHAM  
LONDON SW6 4RE

PRODUCTS STOCKED: MICROMEGA, MICHELL, DPA, CHORD CO, HARBETH, AUDIONOTE, CARY, TRILOGY AVI, TRIANGLE, PIERRE LURNE, NAD, AURA, CHARIOS, RUARK, PINK, C.R. DEVS, LUMLEY, PARASOUND, SUMIKO, SME, HEYBROOK, CAT, IMPULSE, JORDAN WATTS, NVA, DYNAVECTOR, ORELLE

## Tesseract Audio.

We make them  
the way they said  
you just can't make  
them anymore.

For full details of the Tesseract range of head amplifiers, pre-amplifiers, power amplifiers, turntable power supplies and dealer list contact: Tesseract Research Ltd, Sutton Business Centre, Restmor Way, Hackbridge Road, Wallington, Surrey, SM6 7AH Telephone: 081-669 0011 Fax: 081-773 0406



**TESSERAC AUDIO**  
The Best of British High End

When rock records are recorded, the instruments are recorded separately and combined and controlled, mixed and "panned" (steered into stereo position) electronically within the recording console.

Classical records are recorded differently. Although it's entirely possible to "mic-up" every instrument within an orchestra and then - with a combination of multitrack and electronic panning - create a stereo picture of the orchestra, this is usually not done for two reasons. Firstly, the technique would be very costly and complicated and secondly, this "multi-miked" technique has never found favour when it has been tried. Critics, musicians and audiophiles all agree that it fails to provide as faithful a representation of the real orchestral experience as more simple, or "purist" microphone techniques.

Oscar Wilde wrote in *The Importance of Being Earnest* that, "Truth is rarely pure and never simple", and it is certainly the truth that "purist" recordings are not as pure as all that! For, whilst I have heard many excellent recordings made with just a pair of microphones (and some passable ones of my own!), it is often the case that extra microphones must be employed to boost a particular instrument or group of instruments.

For instance, although a typical classical recording may be made with the major part of the signal derived from two or three microphones, these will often be supplemented with outrigger microphones to add ambience and spot microphones to bolster the horns and the oboes.

Furthermore, the strings may often be miked from above so as to control their level relative to the rest of the orchestra. When extra spot microphones are employed it is often necessary to add artificial reverberation because, being so close to the instrument they are picking up they often sound too "dry" in

comparison with the signals picked up from the main stereo pair.

Nevertheless, despite these extra complications, the fact remains that the majority of the signal that goes onto the master tape at a classical recording session is derived from just two or three microphones. Surprisingly there are no fixed rules as to how these main microphones should be arranged, although a number of popular deployments have evolved over the years. To some extent, the way microphones are arranged



# recorded message

Left by Richard Brice

achieves a certain character of sound. Often it betrays a "house style" as distinctive to a classical recording connoisseur as a Stock/Aitken/Waterman production to a pop critic.

Deutsche Grammophon currently use two Pressure Zone microphones taped to huge sheets of perspex, an arrangement which is essentially the same as wide-spaced omnidirectional microphones much beloved by American recording institutions.

British record companies have developed their own arrangements too, and hence their own house-styles. Decca pioneered the eponymous Decca Tree, whilst the BBC stuck almost exclusively to co-incident crossed pairs (sometimes referred to as Blumlein stereo) until relatively recently. Other companies, Philips for instance, use a combination of techniques.

The problem with all of these microphone arrangements is that each one fails (in different ways) to provide an absolutely satisfactory rendering of the sound field in which the microphones are immersed. Whilst the crossed pair technique probably produces the sharpest spatial picture,

many recording engineers prefer the less accurate - but often more natural - sound of spaced microphones. The reason for this probably lies in the coincident microphone technique's failure to capture the time difference cues we experience in real life due to the fact that our ears are on either side of our head - and therefore about eight inches apart.

Coincident microphones are so called because the microphones are, as far as is practically possible, coincident in space (in other words there is as little space between them as the recording engineer can contrive). Due to the way stereo works over loudspeakers, the relative amplitudes of the signals in the stereo channels are more important than their relative timings and coincident microphones have many advantages over a spaced pair because they "capture" only these direction dependent level differences.

Spaced microphones, on the other hand pick-up plenty of time differences, but generate insufficient level differences. Unfortunately a compromise seems inevitable. In the process of producing a

"sharp" and well defined stereo image, coincident microphones discard the time differences which do so much to convey to the listener the pleasant sensation of spaciousness that is apparent when spaced microphones are employed, even though spaced arrangements fail to produce a fully focused stereo image.

The really good news is that with modern signal processing, it may be possible to have one's cake and eat it too, so to speak. I recently did some experiments with a new

microphone technique which utilises spaced omnidirectional microphones either side of a baffle of wood. The dimensions of the microphone spacing and the size of the baffle are derived from the dimensions of the human head. In itself there's nothing new in this, the BBC have been experimenting with similar microphone arrangements for the last couple of seasons of the Proms.

The interesting aspect of this new technique is that the signals from the two microphones pass to two high quality analogue to digital converters and thence to a digital signal processing unit where the signals are analysed and modified. The new technique, dubbed TIHM (for Time-Intensity Hybrid Microphone) results in a particularly natural and accurate impression of sound in real space. So accurate, in fact, that in early trials I was able to walk in a one-hundred-and-eighty degree arc around the microphone array and this was accurately conveyed when replayed over just two loudspeakers. Further trials are planned for the system, including a series of orchestral and chamber recordings. Watch this space ●

# RESTORE OR RENOVATE?

**Should you wreck the nation's heritage by soldering new components into an old amp or become a museum by lovingly re-crafting a 1948 widget? Haden Boardman of Audio Classics discusses the complex ethical issues facing those who frequent car boot sales. And you thought life was easy!**

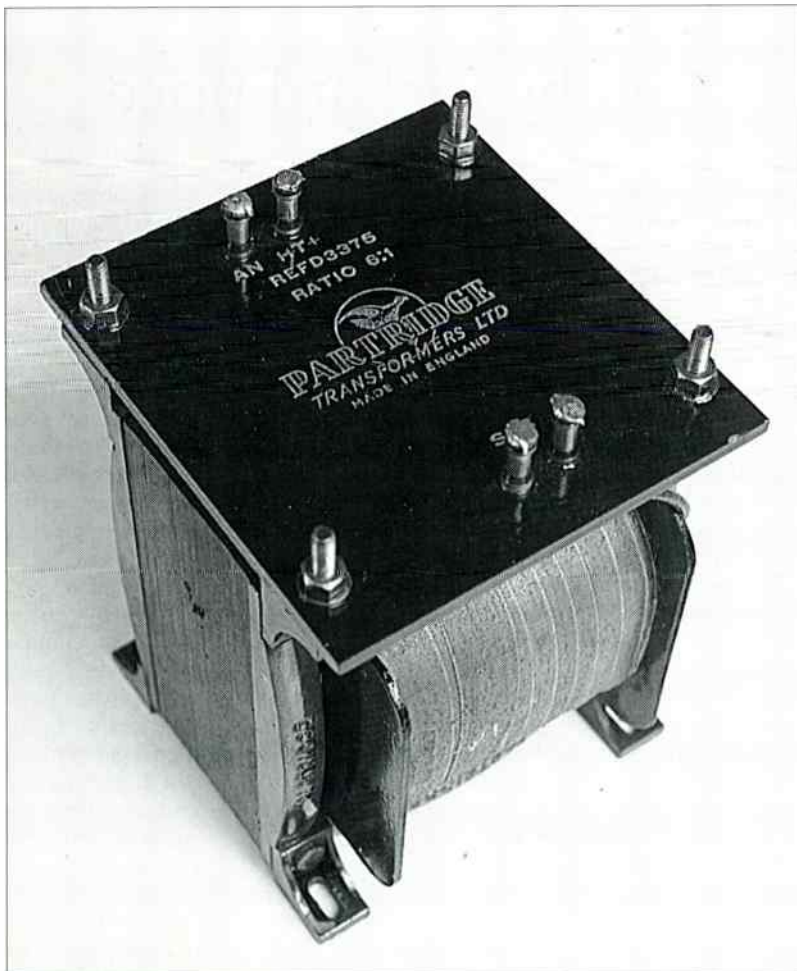

**An original Partridge driver transformer.**

**S**hould you put new components into old amplifiers when renovating them, or try to retain their originality by using old components? Whichever you choose to do, each has its own set of benefits and drawbacks, affecting both value and performance

At one extreme of the market

there's a band of engineers who take an original and rebuild it to a totally different circuit. These guys use a bare chassis and transformers - the bits that are difficult to have made in small volume for sensible cost - as the basis of their own design. Most of these 'rebuilt' are so drastic that none of the original character of the original

remains. My personal opinion about this is unprintable.

At the other end of the scale is the customer who wants to touch nothing. The kind of person who, if a capacitor or resistor fails, will only replace it with exactly the same type. This person believes the original engineer was 100% right in the first place with both choice of component and circuit. This is all well and good, but sometimes it is just impossible to track down brand new original 1950s components. I haunt Amateur Radio rallies and the like hunting down boxes of new/old stock components and it ain't as easy as popping down to your local electronic components supplier.

What you do with a dead amplifier which has leaky coupling capacitors, abnormally high value resistors, no valves and electrolytic capacitors that have exploded all over the inside of the chassis is a totally different argument. If its exterior is rusty, do you re-spray it in the original colour or do you chrome plate it and hand glue a couple of rosewood cheeks to each side?

It's a question of degree. Some vintage amplifiers seem to gel in original form. Any undue interference with a soldering iron worsens the sound. The Goodsell 'Williamson', H. J. Leak's original TL12 0.1 and W & N Electronics' Audiomaster 520 all used the best quality components available at the time, such as Hunts metallised polyester capacitors, Mullard and Marconi/Osram valves, which were state of the art. Early classics like these should be restored as near as possible to their original form.

My personal nightmare would be a chrome plated TL12 0.1 with all new 'designer' label components. The original designers got this one right. As there are so few of these beasts about, it should be a criminal offence to molest them. However the later Leak TL12+ with EL84s in ultra-linear configuration instead of KT66s triode connected (as in the TL12) is quite a different breed of animal.

All the Leak tube amps have a common theme running through their design. In the case of the later 'Plus' and 'Stereo' range, I don't think H.J. Leak & Co. got it 100% right. Since ECC81s and ECC83s do not work



well in this circuit, renovation and modification are the order of the day here; restoration back to original form is not imperative. I personally don't think that ultra-linear operation is at all successful, so I ditch it. The ECC81/83 phase splitter is changed for an ECC82 and the circuit to one that does a better job than the original devised by Leak. The EF86 at the front bites the dust, to be replaced with an ECC83. Different people do different things with totally different results. Russ Andrews, without changing the fundamental circuit, makes a Stereo 30 sound totally different. Better or worse, as is the case with my own rebuilds, is up to the end user.

A lot of the cheaper 1960s valve amps also benefit from renovation or improvement. Rogers Cadets can sound very good when re-built with better quality items. Later Radfords and early Quad IIs are another 'Holy Grail' that should only be touched with extreme caution, their designers being very crafty in the layout of the design. One disturbed wire on a Quad II can upset the stability margin and therefore the sonic purity. On the

wounds is extremely difficult. The variety of components offered by Audionote, GT Audio, Maplin, RATA and Sonic Frontiers is amazing. Audionote and GT Audio appear to follow the paper-in-oil/carbon film route, RATA and Sonic Frontiers the more modern polypropylene/metal film route. The others seem to offer a mixture, which is just what I recommend. Remember that more modern components will give you a different sound that may not fit in with what your idea of the amplifier in question should sound like.

In modified amplifiers I personally use metal film type resistors as grid leak and stoppers, carbon as anode load resistors and wire wounds in the power supply and as output valve cathode resistors. The capacitors I use are mainly metallised polyester layer (similar in sonic character to the original 'Hunts' type). I try not to use one capacitor

original animal will fetch. Remember, you might actually de-value some items by restoring or renovating!

There are a lot of cheap little valve amplifiers out there that sound poor. Changing some of the out-of-

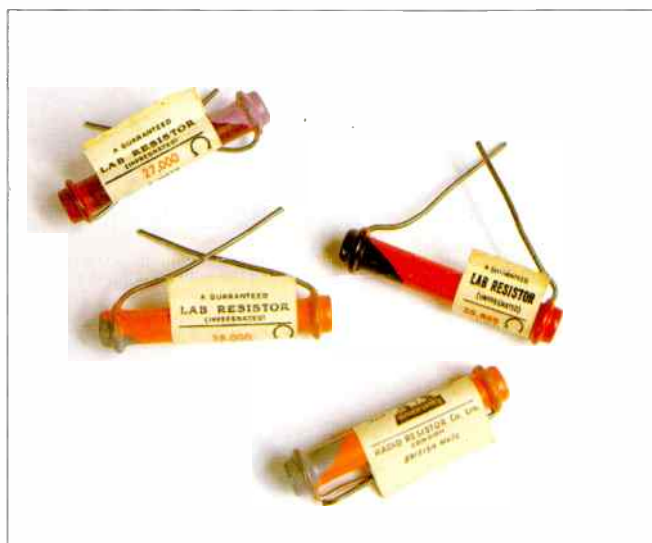

**Solid carbon rod resistors were the order of the day, these made by the Radio Resistor Co. of London.**



**Large oil filled paper capacitors for HT smoothing.**

other hand, a couple of mods can be performed to improve sensitivity and reliability without changing the sonics at all.

One problem with DIY mods is you can never be sure that you have actually made the thing you are working on better. Some times a sideways or even retrograde step can appear initially to be an improvement. It may well offer something sonically different and if you have done the work yourself it will be gratifying to hear, be it good or bad.

The choice of whether to fit new style Ansar Supersound or Kimber capacitors, Holco or Vishay resistors against old style metallised polyester or paper-in-oil, carbon film or wire

type more than once. Paper-in-oil coupling capacitors need to be watched. A new sample of these critters killed a brand new Marconi PX25A which put me in a grumpy mood for a week. Plain and simply, paper-in-oils are not as reliable as other types. Avoid their use when driving expensive, irreplaceable triodes. Making a decision whether to restore an amplifier to its original factory

condition, or renovate it by fitting more modern components to improve the circuit, is a matter of personal choice. If it's a rare bird, restoration to original form is a must, especially if you want to sell it later. If it's a cheap 'n' cheerful item, like a little Rogers Cadet (which used very poor original components), it's well worth the renovation/updating route. Just bear in mind that when you have finished it's worth no more than any other Rogers Cadet, even if you have fitted four Audionote silver foil signal capacitors at £120 each! Just apply a little common sense. I cannot sell a modified Leak TL12 0.1 for anywhere near the amount an

value components for new ones will not necessarily transform a £5 car boot sale special into the likes of a TL12 0.1, but for little cost it can provide hours of fun with a soldering iron and give you something that may well have a reasonable sound. And just think - you will be able to say you fixed it up yourself!

One final thing that may help your decision to restore, renovate or just plain tinker, a famous proverb; "if it ain't broke - don't fix it" Never a truer word spoken ●

\*\* ECC82s will not plug straight into A LEAK without modifications.



**TCC paper in oil signal capacitors; these are military surplus.**

# WIN A MISSION CYRUS HI-FI SYSTEM WORTH OVER £3000

This month we have a rather special competition for you, a complete Mission Cyrus system worth over £3000. This state of the art system comprises Mission Cyrus Discmaster transport and Dacmaster CD convertor, FM7 tuner, Cyrus III amplifier and a pair of the stunning new 752 floorstanding 'speakers using superb HDA drive units.

The electronics are all housed in Mission's custom die-cast magnesium alloy casework, giving them a smooth, solid, high quality feel. Ergonomically, they are a lesson in clarity, with neat

micro-processor controlled push buttons mounted on a 45° ledge at the bottom of the fascia.

The Cyrus Discmaster transport and Dacmaster CD convertor are at the leading edge of technology. The transport uses the specialised and rarely seen CDM-9 Pro mechanism and when used with the Dacmaster is linked by an AES/EBU balanced digital cable, a superior and more refined mode to optical or co-axial.

The Dacmaster CD convertor uses Analogue Devices' 1862, a very high quality device again rarely seen

elsewhere. When Eric Braithwaite listened to the combination he described the benefits of this device as allowing "a listener to discount vigour in favour of its marked strengths in portrayal of ambience, precision of focus and mostly spot-on tonal definition". Summing up the Discmaster and Dacmaster combination he wrote "It has been a long wait, but I feel it was definitely worth it".

The second source the lucky winner will receive is the Cyrus FM7 tuner. Complete with seven presets and a beautifully weighted rotary tuning knob, the FM7 is a delight to use. When we listened to the FM7 for the April '94 issue, we found it possessed a musical, communicative and incredibly detailed sound, with insight straight into the studio and its surroundings.

The Discmaster, Dacmaster and FM7 all feed the Cyrus III amplifier, long awaited successor to the Cyrus I and II. The Cyrus III has four line level inputs and provision for MM phono, and tape monitor. Pushing out a healthy 66watts from its compact cast casework, the Cyrus III is no slouch, capable of powering most loudspeakers with ease.

But this isn't really necessary with the fabulous 752s that form the final link in the system. Using High Definition Aerogel drive units they are sensitive, detailed and sweet on the ear with breathtaking clarity in the all important midrange. Bass is firm and deep, and highs open and natural, all in all, the perfect partner for the equipment that lies before.

To enter this fabulous competition for a complete Mission Cyrus system worth over £3000, simply complete the questions opposite.

Please send your entry on a POSTCARD, or the back of a SEALED ENVELOPE, and completed in block capitals, to arrive no later than Tuesday 4th October 1994 to:

**MISSION CYRUS Competition**  
**Hi-Fi World Magazine,**  
**64 Castellain Road,**  
**Maida Vale,**  
**London. W9 1EX.**

## COMPETITION ENTRY QUESTIONS

1) What is the casework of the Cyrus electronics constructed from?

- |                             |                  |
|-----------------------------|------------------|
| A. Sand-cast alloy          | B. Pressed Steel |
| C. Die-cast Magnesium alloy | D. Aluminium     |

2) What DAC chipset does the Cyrus Dacmaster CD convertor use?

- |                     |                          |
|---------------------|--------------------------|
| A. Philips DAC-7    | B. Analogue Devices 1862 |
| C. Burr Brown PCM63 | D. Crystal CS4328        |

3) How many preset stations can the Cyrus FM7 tuner hold?

- |      |      |
|------|------|
| A. 4 | B. 5 |
| C. 6 | D. 7 |

4) What is the power output of the Cyrus III amplifier?

- |            |            |
|------------|------------|
| A. 66watts | B. 55watts |
| C. 44watts | D. 33watts |

Don't forget to include your name, address and a telephone number so we can contact the winners promptly.

In the event of more than one entrant submitting all the correct answers, the winner will be decided by the tie breaker. We will endeavour to publish the results in the December 1994 issue. Purchase of the magazine is not a precondition to entry.

No correspondence about this competition will be entered into and the Editor's decision is final.

No employees of Audio Publishing Ltd. or any of the companies associated with production or distribution of the prizes may enter.

Your name and address may be added to our mailing list only. If you would prefer not to receive details of new products or special offers from us alone please state so on your competition reply form. Hi-Fi World magazine is published by Audio Publishing Ltd.



**AUGUST ISSUE  
COMPETITION - THREE  
ROTEL AMPLIFIERS  
WITH MATCHING TDL  
LOUDSPEAKERS**

First prize of a Rotel RC/RB-980BX pre/power amplifier and TDL RTL3 loudspeakers goes to: Richard Ward of Lewisham, London

Second prize of a Rotel RA-960BXII integrated amplifier and TDL RTL 2 loudspeakers goes to: R.J. Masterson of Whitley Bay, Tyne & Wear.

Third prize of a Rotel RA-935BX integrated amplifier and TDL RTL1 loudspeakers goes to: R. Keegan of Workington, Cumbria.

Congratulations to all of the winners.

# Subscriptions

**12 ISSUES FOR ONLY £22** (UK only)

## HI-FI WORLD SUBSCRIPTION FORM

Please send me the next 12 issues of Hi-Fi World, starting with the \_\_\_\_\_ issue.  
I enclose my cheque/postal order for £22 (UK only) made payable to **Audio Publishing Ltd.**

Name \_\_\_\_\_

Address \_\_\_\_\_

Daytime Tel No: \_\_\_\_\_

Please debit my VISA/ACCESS Card No:

--	--	--	--	--	--	--	--	--	--	--	--	--	--	--	--	--	--	--	--	--

Expiry Date: \_\_\_\_\_

Tel: 071-266 0461

Send to: **Audio Publishing Ltd.**, 64 Castellain Road, Maida Vale, London W9 1EX.

Overseas subscription rates.

Surface Mail: £29.

Airmail: £42 Europe, £52 Middle East, Hong Kong, Singapore & Malaysia, £62 Australia, Japan, Korea & China.

Airmail

Surface Mail (tick as appropriate)



8/94 E&OE

# U.S. & Canadian Subscriptions



**Hi-Fi World**  
U.S. & Canadian Subscriptions

P.O. Box 754, Manhasset, N.Y. 11030 - 0754  
Telephone: 516 627 3836 Fax: 516 627 1972

I wish to subscribe right now - and receive monthly copies of Hi-Fi World Air Speeded direct from the Publisher in London U.K. to the N.Y. Office

I enclose my payment to :- FRJ/Hi-Fi as checked below  
1 Year - 12 Issues \$66 (U.S.)

U.S. FUNDS ONLY PLEASE - Add \$10 U.S. for Canada.

OR

Please charge my Credit Card with the amount indicated.  
(All major Credit Cards accepted)

No: \_\_\_\_\_

Expiry Date: \_\_\_\_\_

Signature: \_\_\_\_\_ Name: \_\_\_\_\_

Address: \_\_\_\_\_

City: \_\_\_\_\_ State: \_\_\_\_\_ Zip: \_\_\_\_\_

Or Telephone:

**516 627 3836**

Or Fax:

**516 627 1972**

8/94

Unfortunately, all issues prior to December 1991 are completely sold out, but subsequent issues, as listed below are available for £2.00 excluding postage and packing.

# Back Issues

## HI-FI WORLD BACK ISSUES ORDER FORM

Please tick the box next to the issue(s) you wish to order

- |  |       |   |       |
|--|-------|---|-------|
| <input type="checkbox"/> December 1991 | £2.00 | <input type="checkbox"/> September 1993 | £2.00 |
| <input type="checkbox"/> January 1992  | £2.00 | <input type="checkbox"/> October 1993   | £2.00 |
| <input type="checkbox"/> October 1992  | £2.00 | <input type="checkbox"/> November 1993  | £2.00 |
| <input type="checkbox"/> January 1993  | £2.00 | <input type="checkbox"/> January 1994   | £2.00 |
| <input type="checkbox"/> February 1993 | £2.00 | <input type="checkbox"/> February 1994  | £2.00 |
| <input type="checkbox"/> March 1993    | £2.00 | <input type="checkbox"/> March 1994     | £2.00 |
| <input type="checkbox"/> May 1993      | £2.00 | <input type="checkbox"/> April 1994     | £2.00 |
| <input type="checkbox"/> June 1993     | £2.00 | <input type="checkbox"/> May 1994       | £2.00 |
| <input type="checkbox"/> July 1993     | £2.00 | <input type="checkbox"/> June 1994      | £2.00 |
| <input type="checkbox"/> August 1993   | £2.00 | <input type="checkbox"/> July 1994      | £2.00 |

Total no of issues ordered ..... Total price .....

(Overseas add £1.00 p+p for every issue UK p+p £0.50 inc)

I enclose cheque/PO for £ .....made payable to **Audio Publishing Ltd.**  
I wish to pay by Visa/Access (orders for 3 copies or more only), please debit my account no:

--	--	--	--	--	--	--	--	--	--	--	--	--	--	--	--	--	--	--	--	--

Expiry date: \_\_\_\_\_

Name .....

Address .....

Post Code .....Tel: .....

Please send completed order form together with your cheque/PO to:  
**HI-FI WORLD**, 64 Castellain Road, Maida Vale, London W9 1EX.

8/94

Please allow 28 days for delivery

**H**ang on a minute, first we have CD - perfect sound forever, then DAT - perfect sound and with the convenience of being recordable. But DAT fails on the domestic market, adopted only by recording studios and is replaced by the domestically aimed DCC and MD. But before they've even gained popularity, we're told that CD isn't as good as it should be and that three new systems are being developed to improve its performance. Does that mean that DCC and MD are dead before they even got going? Or will DCC become a more serious rival to CD, as it is developed and resolution improves, perhaps overtaking CD sometime in the future?

The PASC section of DCC has always been capable of 18bit resolution, and in theory 20bit is possible. We already know that there is a true 18bit version of DCC due for launch in December, the DCC730. You may ask what's the point if there are no 18bit sources available to take advantage of this, but Decca studios are already working on new 18bit DCC recordings. DCC will also gain a turbo drive, making tape spooling five times faster than existing machines, and track access times three times faster, bringing it closer still to CD, but with the advantage of being recordable.

So what future will CD have if two improvement systems for 16bit CD, developed by Sony (Super Bit Mapping) and Philips (Adaptive Noise Shaping) and the new HDCD recording system are, once again, to fight it out for popularity? Will anyone buy 'improved' CD, or will the masses give up and revert back to vinyl and analogue cassette? And if three new 'improved' CD systems are being developed, confirming that CD wasn't good enough in the first place, what if they fail like DAT? Who will want CD once it's been discredited? The marketing antics of the larger manufacturers could quite possibly spell the

death of digital all together.

Any manufacturer knows that for a product to have a long and fruitful lifespan, it has to be at the leading edge of technology when it is introduced. In fact, it has to be something special, something that will take years to improve upon. Take QUAD as an example, and their electrostatics. When introduced they were truly innovative, there was nothing like them. The complexity and level of engineering ensured that for anyone to improve on them would take years of



Dominic Baker

## dB on the level

research and development. And it worked, they still sell well today and compare with the best.

CD was behind even when first introduced. The first players sounded dreadful, vinyl was leaps and bounds ahead. DCC and MD just took another step backwards - MD especially because it doesn't appear to offer any route for improvement, looking more like a fashion accessory than anything else. Too much has been made of convenience and secondary factors such as surface noise, and not enough about quality. These systems were engineered to be adequate, nothing more. Their 16-bit coding system gives a reasonable sound, so that's what we got - something reasonable, nothing special. Higher bit systems were possible but not thought necessary - I bet they're kicking themselves now.

Vinyl is still the audiophiles' only medium engineered for sound quality first and foremost. Yes it's inconvenient, has

surface noise, is bulky to store, wears out etc, but at least it does the job intended. And what's a little surface noise compared to a harsh and gritty treble, or the sterile and emotionless sound of CD?

Perhaps I'm being a little too hard on CD - it's not that bad, it's just not as good as it should be. I started out with CD and have invested thousands of pounds in a collection of discs, at a far higher cost than vinyl, for a medium who's days now look numbered. I wouldn't have minded the extra cost so much if CD had been an improvement over LP, but it wasn't. I've moved backwards, as it were, in order to enjoy the quality vinyl offers, starting an LP collection quite recently.

So where does it all go from here? Well in my mind there is only one way forwards for CD that will prove successful. One system has to be adopted, one that is recordable, and one that is far superior to 16-bit CD. 20-bit isn't

enough, look at the plot in the September issue of a 20bit wave form (p51). If you saw that kind of waveform distortion come out of an amplifier you were developing, you'd throw it in the bin and start again. If 20bit systems are the next step, in ten years time we'll be faced with the same problem again. Amplifier and loudspeaker technology will have improved and the shortcomings of CD will once again be revealed.

A large step forwards needs to be made, maybe 24bit. I certainly don't want to be sold short again,

caught with thousands of pounds worth of out-of-date CDs, and I should think that the majority of music lovers agree. We've listened to SBM recordings, and good though they are, they're not the kind of step forwards that the audiophile wants. Anyway, this kind of system isn't really new technology, more a clever manipulation of an outdated one.

Before we rush once again into a new technology, a little thinking and future planning needs to be done. Any new system is going to have to be demonstrably better than any existing system available, and by such a margin that the buying public can be convinced that they should have it - then there will be a demand. When introduced, colour TVs had a clear advantage over black and white, something that was so obviously better, that you had to have it. CD or its successor desperately needs to make a similar kind of leap if it is to be unequivocally successful ●



Hi-fi systems can be built up from the humblest of beginnings, to a system worth thousands. There are people fortunate enough to go along to a hi-fi shop with a great wedge of cash and purchase a complete system in one fell swoop. For many of us, however, this is just not possible. Instead, finances dictate that the long and often turbulent path of "upgrading" is the only way to an audio heaven that lurks an impossible distance away.

I fall into this category, not having the finances to blow on a once-and-for-all system, or the contentment to just leave things alone. My own system started from as humble beginnings as any - an Arcam Alpha amplifier bought for £100 from a secondhand shop. For the first five months it was used with nothing more spectacular than an Aiwa "Walkman" and some Philips 'speakers from a 'tower' system.

Five months later, with my tolerant Arcam still in one piece, I put together my first proper system. A secondhand Aiwa AD-F270 (still a current model at the time) provided a cassette source for £50 and 'speakers, courtesy of Comet, in the form of the Sony APM 10ES. A brand new Denon TU-550 tuner was the next addition. Combined with a four-element outdoor aerial it provided excellent results that weren't too far behind the Revox tuner I use today.

Before I'd even contemplated a main source, I was already on the upgrade path. A secondhand pair of Celestion SL6s at £125 were too good a bargain to miss. These were the first speakers where I realised there was more to hi-fi than just deep bass and crisp treble. The SL6s showed me subtleties that existed in the mid-range too. Selling these later was to be a mistake.

My first mistake, however, was the purchase of my first main source: a Denon DCD-920. It wasn't so much that it was a bad CD player, merely average, doing little to encourage me to go out and try new artists on CD. Yet it did teach me a

lesson - and that was to always listen to a piece of hi-fi before buying it, no matter how cheap it may be.

The SL6s were sacrificed for a pair of Tannoy DC2000s. At the time I remember being immensely impressed by the presence of the Tannoys and their excellent imaging. It wasn't long though before I started realising something was "missing" in the mid-range. Vocals didn't seem to have the body that I'd taken for granted with the SL6s.

The upgrade bug had well and truly bitten. I sold



## Fair Views

- from Dominic Todd, our man in Scarborough

the Arcam to a friend, replacing it with one of the first Pioneer A-400s. I remember it not impressing me as much as I was expecting, but found it grew on me as time went by.

The Denon CD player made way for a Rotel RCD 865. Although this was more of a sideways move, it seemed to gel with the A-400, unlike the Denon

It was all change on the tape front too. My trusty AD-F270 was ousted in favour of an all-singing, all-dancing Sony TC-K520. As it happened, the TC-K520 featured in the first cassette deck group test that Hi-Fi World featured in May '91. Not that it scored particularly well, managing a resounding "average".

My next move was pretty radical. Having decided I greatly preferred the sound of vinyl to CD, I not only sold my Rotel, but all my CDs as well. A Manticore Mantra took over the reins as my main source and a record collection was quickly established. Sticking with the vinyl theme, I upgraded the Audio Technica AT95E (a stalwart

if ever there was one) for an AT OC5 and then later an OC7. Never quite content with the DC2000s, I traded them in for what I consider to be my first piece of semi-esoteric hi-fi. The Celestion SL600s, which I still have now, had identical drive units to my much missed SL6s, and with better cabinets to boot.

In a quest to upgrade my amplifier, I sold the A-400 and invested in a Cambridge C/A 100. That didn't last too long, neither did the Audiolab 8000A, Albarry PPI or an ancient Radford. I settled on a Meridian MCA-1, mainly due to its excellent phono stage.

All was well until I decided that I really needed CD to complement vinyl if I was to get all the new albums I wanted. The Meridian wasn't so hot on line level, so after listening to dozens of amplifiers, it was another A400. This time though, I adapted the Meridian's phono stage (powered by a separate transformer) to use with it. Again, I'm still using this today.

A Pioneer PD-S801 CD

player was sold to finance the CD player I have today - a Cambridge CD3M and DAC3. Even though Cambridge had disappeared, so I knew it was a bit of a gamble, it paid off, and has been totally reliable....so far!

The Revox B760 tuner was another opportunistic purchase which I have written about before in these pages. Needless to say it has been faultless operationally and encourages me to listen more to the radio than I would otherwise. What more could you want from a tuner?

A Sony Professional Walkman replaced the TC-K520 cassette recorder. It's a fantastic companion when on the move, and means I don't get withdrawal symptoms from my music when I'm on holiday. The recent addition of a Roksan Xerxes brings things up to date. Although even this hasn't escaped being upgraded. The Pickering 7500 cartridge was changed for an Ortofon MC20 II, and the Tabriz arm for an Artimiz.

Needless to say, I'm delighted with the results, although people keep asking me when "that" amp. is going to go. The answer is when one comes along that comprehensively outclasses the A-400, and doesn't break the bank. At the moment, though, it looks as though a bank job is going to be the only way of funding further upgrades (a perennial problem when one reaches a certain stage). Yet I'm enjoying my music more than ever and seem to be buying more records and CDs than ever too. Cloud Nine is now just that bit closer ●

# Bury Audio. Chosen by hand appreciated by ears.

For the best in Hi-End hi-fi Bury Audio is a must. All the names stocked are individually chosen to complement one another to give the best sound in their class. Whether you're after an upgrade or a full system, we can offer advice and experience together with full demonstration facilities to ensure you make the right choice. Naturally we offer a full installation and set-up service

<b>Analogue Replay.</b>	<b>CD Replay.</b>	<b>Amplification</b>	<b>Speakers.</b>
Denon, Goldring, Kinshaw, Lyra, Michell, Ortofon, Pink Triangle, Project, Rega, SME, Sumiko Tesseract.	Arcam, Audio Alchemy, Counterpoint, Marantz, Meridian, Musical Fidelity, Orelle, Pink Triangle, Quad, Rotel Teac.	Arcam, Albarray, Audio Innovations, Aura, Heybrook, Marantz, Meridian, Michell, Musical Fidelity, Quad, Rotel, Sheame, Tesseract Tube Technology.	Arcam, Castle, Heybrook, Keswick Audio, Monitor Audio, ProAc, Royd, Ruark Spendor.





**BURY AUDIO**  
47 CHURCHGATE STREET,  
BURY ST. EDMUNDS, SUFFOLK IP33 1RG.  
TEL/FAX: 0284 724337

Mon-Sat. 9.30am - 6.00pm. Closed Wed.  
Mail Order and Export enquires welcome.

# TREAT YOURSELF!

**DEM ROOMS AT BOTH BRANCHES  
INSTANT CREDIT AVAILABLE**

Selected sounds from Alchemist, Aura, Boston, B&W, Cabletalk, Castle, Celestion, Denon, Exposure, Gyrodek, Harman Kardon, Heybrook, KEF, Marantz, Micromega, Monitor Audio, Moth, NAD, Nakamichi, Rose, Rotel, Royd, Ruark, Systemdeck, Tannoy, TDL, Thorens, etc...

 *Export speciality*  
*all major credit cards accepted* 

## NORTHWOOD AUDIO HI-FI SPECIALISTS

126 Pinner Road  
Northwood  
Middx HA6 1BP  
Tel: (0923) 820877

98 Cambridge Street  
Aylesbury  
Bucks HP20 1BA  
Tel: (0296) 28790

# WOLLATON A•U•D•I•O

## The Monarchy



**DIP**



**Digital Interface Processor**

The DIP will improve your CD transport by removing jitter

At £245 + P&P it's the most cost effective upgrade you will ever make

*Phone for further information  
and copies of reviews*

All Wollaton Audio products  
Are Available on Home Trial

**Wollaton Audio**  
134 Parkside, Wollaton, Nottingham., NG8 2NP  
tel/fax: 0602 284147

# V' audio

Hi-Fi Consultants

## 'A Broadsword for the Back End'

At V'Audio we try to keep our feet firmly on the ground and don't go in for much of the hype in the Hi-Fi Trade, including that perpetuated by the press! Two in particular spring to mind during the 'silly season', as there's not much new to talk about. One is about 'front-ends', i.e. The Garbage In - Garbage out bit; not that there isn't much truth in this but it gets too dominant and it constantly amazes me how people will spend fortunes on front-ends and yet seem reluctant to change their speakers and yet in 90% of the cases that would gain them the greatest benefit! Most front-ends aren't that bad and amps are far more consistent than speakers; indeed there aren't that many really good speakers out there, which is why we only sell quality products such as ATC, RUARK, HEYBROOK, ALON, TRIANGLE: all of these have unique qualities but let's get back to the title 'BROADSWORD'. This stand mounting speaker was one of Ruark's first, hasn't been reviewed for ages and just tends to get forgotten with new units such as the TALLISAM, CRUSADER, TEMPLAR and EQUINOX coming out. It has been modified over the years and at £850 is still one of the finest we know at that price especially driven by AVI monoblocks. So if you want to improve your back-end at a realistic price ring for an audition. I'll consider 'Hype No.2' next time!

**Ian C. Vaudin**  
36 Druid Hill, Stock Bishop,  
Bristol BS9 1EJ.  
Tel. Bristol (0272) 686005 (+ Fax)



# The Music a Pages

Giovanni Dadomo

## INDEX

### RECORD REVIEWS - ALBUMS OF YEAR

**ROCK & POP** .....74  
Giovanni Dadomo

**CLASSICAL** .....85  
Peter Hornig

**JAZZ** .....93  
Simon Hopkin



### BLUR Parklife FOOD CD 8 29194 2 1

● Blur's Parklife is, quite simply (though it's anything but simple) the most focused, refreshing, totally damned inspired record in the whole year's heap. I've had it some twelve weeks now, even got a cassette so I could listen to it in the street as well as at home, and my partner reckon's I'll get my marching orders if I don't stop playing the damn thing.

Like Pulp's *His'n' Hers* this sounds like a ready-made Greatest Hits package, and singer/writer Damon Albarn has become a hero to rank with Ray Davies, Pete Townshend, Frank Black, Arthur Lee — or maybe twenty others at their peaks. Simply put, he writes great, catchy, funny, melodic little tales that are perfect slices of today: 'Bank Holiday', 'The Debt Collector', the one with Phil Daniels talking about feeding birds in the park — there's not a bad song on here and it *just* has to be one of the Great English Records of the Nineties.

I went on and on and on about this in the August issue, so check your back pages. And if you don't have it or knod the budget rise with it last week, no worries. More words never could do great music justice and this is — really, really is — great British pop at its best. If you never buy another pop record in 1994 so they say.

### P J HARVEY Rid of Me ISLAND CD 8002 514 616-2

● Twelve months can be a long time, but if anything in this collection stands the test of time it's the second album from Polly Harvey. Time and again her trio prove the old adage that it's not what you put in, but what's left out that matters. Led by PJ's deceptively simple, predominantly percussive guitar work and

ably abetted by Steven Vaughan (bass) and drummer Bob Fillis, this is some of the hardest, most potent music I've ever heard. I reckon Beethoven would've loved it — he could probably have even heard it!

Favoured mostly — that stuttering guitar re-emerges and again, but treats no criticism (listen to the early, classic Pink) for repetition as glibness. And if the music is sparse, sometimes to the point of brutality, then Harvey's voice and lines are anything but — the words are clipped, sparse, ironic, wise. It's no pretension to do, Sylvia Plath too would've loved PJ's beautifully condensed poetry, and no feminist in this politically correct age could possibly fail to respond to the splendid twirling of fractal imagery on songs like 'Man on a Hill' — 30-foot Queenie or, best of all, 'Me Jane' with its wondrously perverted arsenal of macho mythology it is entitled, 'Won't you move over Tigger/Banana you see I'm bleeding/Me I'm Jane and I'm transito make sense of your screaming.' The best thing to come out of the West Country since the Trojans (no joke, they made some brilliant discs too) and really my Woman Of The Year, this is a classic record from a true 30-foot woman. Do not miss on any account.

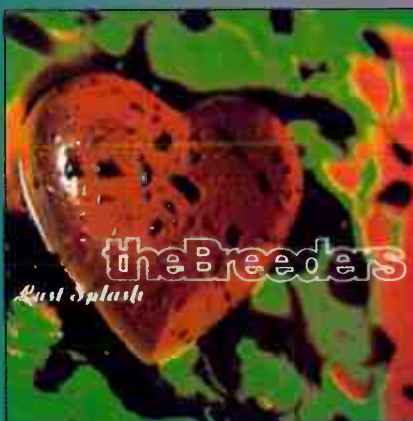

### THE BREEDERS Last Splash 4AD CAD 3014

● This is one music I'll take with me to my grave if only because it contained (did you spot it) the greatest error of fact that former member Tanya Donnelly had

gone off and wed Ken Coates (RIP). That was a serious case of jelly. Kate Bush or one of the Brontës above I think. But that's another, or all story.

Anyway this, the weird Brendon record proper (there were two EPs between) and what started out as a job project of the overtime Blue has, thankfully, turned into a proper career. That Mr Jim Dear is not was a best-seller may not now always seem obvious from her Pines (best, waiting at the bar alongside such major guests as that of Blind Faith and Joey Santiago, but it's a story for more. Shadows of the past, inevitably anger — Invisible Man or The Arch, say has them more to The Wicked than a few notions of past examples. The music is by turns tough melodic, gets the the usual Tommy Gentry tones of the early rock 'n' roll, which appears in two distinctly different (but equally inspired interpretations) while 'Big or Small' are hard and tough enough for the most committed rock listener — and I'm not talking about one of The Shadows now. A cracking good long player, I can't wait for him to have another baby. If you know what I mean.



**THE LEMONHEADS**  
Come On Feel The Lemonheads  
ATLANTIC 7567 82537-2

Former indie heroes The Lemonheads make their crossover breakthrough with this previous. It's A Shame About Ray and it was a sure bet that with Evan Dando and company becoming international heroes and Dando himself the inimitable face of '93 a few short notes would turn up their noses with the release of this inevitable. But before that in a month that found them competing with new releases from The Wonder Stuff, Teenage Fanclub and Tinderbox — pretty damn good records one and all — this remains the cream of the crop as far as this old fart's concerned.

There's the lovely Gram Parsons tribute 'Big Gay Heart' (the best of the 50s), and express train country law 'Down Again'. Dando can be big and bullish like John Wayne or Prospero Bon, or turn on the delicate pop charm and sit

back with an item like 'I'll Do It Anyway' — where he's more than ably assisted by Robyn's Carolee surprise surprise (well I was). But this time the guest appearances almost as surprising — Rick James for one, who might have been a prime inspiration for Lenny Henry's hillbilly song 'Mr. Widdowson'. All of this is speedily flushed out by a band who can handle everything from funk to punk to country without missing a note. A Major on my player.

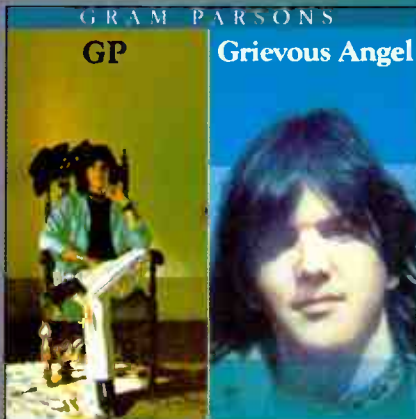

**GRAM PARSONS**  
GP/Grievous Angel  
REPRISE 7599 26108 2

● I shall make no apology for including a couple of twenty-year-old releases in this retrospective because, frankly, I couldn't do my mind be about when or where, but what's in the groove. And times, I don't want to take the edge off these two brilliant discs from the tragic Mr P, a man who can rightly be counted as a great rock innovator, all important in the way of Hendrix, Joplin, Lou Reed or Dylan. The topical sleeve notes to this two-record set will tell you how Gram just about invented Country Rock, first with the International Substandard Band, then as key member of his own flying, Barnets Brothers, not to mention having taught The Byrds a few dose-home cowboy licks along the way. Hell, he was almost a Rolling Stone, and Evan Dando (who once proudly sported a GP's shirt for many years) photo-shoot he seemed to do last summer.

When his own band split Gram teamed up with Eric Burdon and it was a marriage made in that same rock 'n' roll pantheon that put John and Paul, Mick and Keith on, even more aptly, Don and Phil every alongside one another. Parsons' croaky, husky voice, forever on the point of flatness, but miraculously forever keeping just this side of the edge was wonderfully paired with Eric's more than delicate tenors. And could the boy pen a tune — 'Well Sweep Out The Ashes', 'The Morning', 'Ste', 'The New Soft Shoe' — disarms every one. There's even an amazingly beautiful cover of Don and Phil's 'Love Part 2'. There's more to rock a swatch of Bud by,

but more than that it's a record no collection with heart should be without. I've been listening to the geezer for a good twenty years and he still touches me in places very few others reach. Some epitaph.



**THERAPY?**  
Troublegum  
A&M 540 196 2

● An Irish trio who went the usual indie route prior to moving to the inevitable major, the band's second A&M release more than underlines the fact that this really is a force to be reckoned with — forget U2, I still think they're the best thing to cross the water since Guinness or James Joyce. Andy Cairns (vocals, guitar), Fyfe Ewing (drums), and Mike McKeegan (bass) are as hard, fast, tough and mean as they come. Nobody this side of Shane McGowan could have come up with such classic lapsed Catholic lines as "Heaven fucked you or you weren't wearing a tie", or made songs about holy old clichés like religion, sexual guilt and all the rest of the old palaver sound as fresh and exciting or be seen with such inspired eyes.

But it's the music that'll grab you by the coat-tails and kick your bottom all the way down the street and back again. There's nothing harder, faster, punchier or more ear-wrenching this side of the classics — everyone from Led Zep to Joy Division and Husker Du spring to mind, but you can never forget this is Therapy? you're listening to. They'll give you an ear-bashing to be sure, but it'll be positively exalting as well as exhausting.

**TIM BUCKLEY**  
Live At The Troubadour 1969  
EDEL ED CD 400

● Unlike the Gram Parsons disc, this live set's not a reissue, but as the title explains it is a quarter of a century old. But then it's like they say about good wines or whiskeys — sometimes the old ones really are the best. Since his untimely death in 1975, the one time folkie's been discovered by at least one new generation, and it's unlikely that

things will change now. His songs, his extraordinarily gorgeous voice, the sheer wealth and range of the music he made, will doubtless be thrilling hearts in another quarter century or more. Hendrix, Charlie Parker, Miles Davis, even the aforementioned Parsons, these are the kind of god-given talents that make it all worthwhile, whose work helps to make this confusing mess we call life not meaningful at least tolerable.

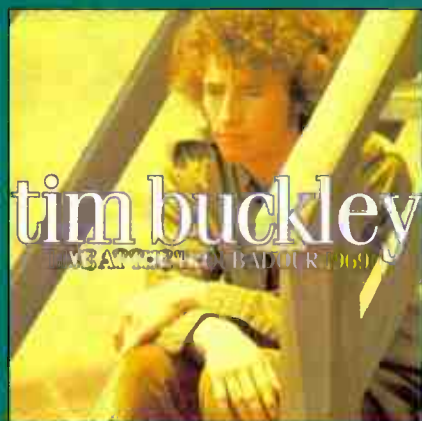

Buckley emerged as part of the post-Dylan folk scene, and he cut a mere nine studio discs in his too brief life, but in that time he managed to try everything from folk-rock, to wildly experimental dalliances with jazz that took in every one from Ornette Coleman to Sun Ra before dabbling in the nascent rock and funk coalition of his later years.

Having been a cult figure for so long, Buckley's attraction not to mention his very eclecticism means his fans really are fanatics, and being such are hotly opposed as to which was his best work. I've always loved the sweaty, pre-Springsteen funk of his later days, Greetings From L.A. in particular; other camps favour the wild experiments of Lorca or Starsailor. It's from the era of these last two that this live set comes, and the most surprising thing to me on first hearing was that the music was more fully formed, coherent, less rambling than on record. So now I love every record the man ever made and this one, so long available only a frequently iffy bootleg, is one of the best. A wizard.

**PULP**  
**His n' Hers**  
ISLAND CID 8025

● One way and another it's taken Jarvis Crocker and his band Pulp a decade to make this record. They've indie'd themselves to death, cut more Records Of The Week than God, and finally come up with a record as rich and invigorating as the flower that opened this very morning. Crocker's madly angular vocal deliveries go perfectly with his tales of suburban life at the end of the century, a world full of joy-riding, fast and vapid sex, all set against a very Ealing-style Brit background where a cup of tea is both the ultimate panacea as well as the



accompaniment to some curdless dinner, mid-afternoon Resident's Wives, naughtiness.

In Candida Doyle's superb and encyclopaedic keyboard work, from grand to Tri-Ang piano (even a Spooky saxophone, DJ wagon, Prussian Service and his guitar, all provided with a solid rhythmic skeleton thanks to Neil Birrell and Steve Huddy, percussionist and bass respectively). This sounds like it's Greatest Hits, because I've seen before, and I love every wild and crazy, impeccably catchy, totally delicious moment of it. It's like the best of the past thirty years of Britpop — from Kinks to Spinks (well, they made their best records here anyway) to Steve Hazy, I could go on and on and on — but mostly I still, I know, go on and on listening to and loving Pulp.



**PRIMAL SCREAM**  
**Give Out But Don't Give Up**  
CREATION CRE CD 146P

● Yes, yes, yes. Primal Scream owe a huge amount to the Stones, we all know that, for a fact after Screamadelia. Still, it was and remains a classic record as good as anything the older bellies did in their Sticky Fingers. Back On Main Street prime. Can you really expect them to have changed that much from one disc to the next? Of course not, and this is something of a Screamadelia revisited. So Bobby and the boys took themselves to Ancient Studios in Memphis (home of so many Stax-Walt classics etc, etc.) got in veteran producer Tom Dowd, pulled in some help from the utterly crucial

Memphis Horns (hell, they even dug up funk-wrangler George Clinton for the suitably named (if hardly original) so-funny-fun). The result is a record that it does by no means hurt to listen to, one that manages to span the four-form narrow gap between the late Sixties to current Dances-Club-feels.

And you know what? They pulled it off again. Big Ins Plane is a stone groover for Robert, yeah well it does, and 'City of Mystery' is one of the loveliest ballads made in a few dozen moons. And I don't care what anyone says, hell, not do I like this one a whole lot, it's appearance, and it's couple of months prior to the new Stones, cause makes for some real hard head scratching. You know, I was at a party the other night and this young woman — I think she was having a fluff, asked if I was Keith Richards. Did I really look that ragged? I thought! But it was the real RP, I think I might just damn Mick and Ronnie and the rest, and beg Bobby Gillespie for a gig.

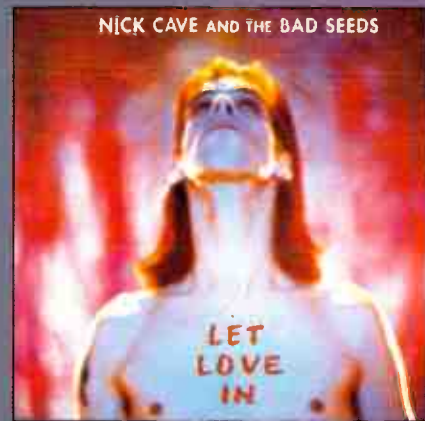

**NICK CAVE & THE BAD SEEDS**  
**Let Love In**  
MUTE CD STUMM123

● Confession: the first time someone lent me a Nick Cave album I figured myself silly. Here was some crazy, gothic Australian, yacking on in the most monotone drone this side of Ben Cooper and pretending he was Robert Plantum in that old picture where he plays the guitar with the 'love and hate' tattoo on his shoulder.

But I persevered and in the end I grew to love the guy. Australian or not he was, of course. Krig Gethin the days of Birthday Party, then went solo and peaked (or as I believe) with Tender Prey. Well, this is his best record since. Assisted by most of the quality guys, crew.

...Bibi Stangland and a host of guests, Cave turns in his best performance since the aforementioned Tender Prey (not that he didn't shine more than occasionally on the likes of The Good Son (or Henry's Dream) but it's a long time since Cave was a consistently inspired or empowered as on the likes of 'Thirsty Dog', the awesome 'Do You Love Me' or the totally off the top-out 'Cut out and keep



# Specialist Hi-Fi Dealers

## SOUTH



### BUCKINGHAMSHIRE'S PREMIER HI-FI DEALER

Arcam, Denon, Linn Products, Naim Audio, Meridian, Rotel, Yamaha, NAD, Quad, Tripod, Nakamichi, Rega, Creek, Epos, Mordaunt Short, Celestion, Marantz, Mission, Cyrus, etc. ...

65 Castle Street, High Wycombe, Buckinghamshire.  
Open Monday - Saturday  
0494 531682 / 464670



7 ST. PANCRAS,  
CHICHESTER,  
WEST SUSSEX  
CLOSED ALL DAY  
MONDAY  
Tel: (0243) 776402

Appointed stockists of: A+R Cambridge, Castle Acoustic, Creek, Dual, Goldring, Linn Products, Monitor Audio, Naim, Nakamichi, Quad, Rega, Rogers, Royd Audio, Spondor



### BRIGHTON'S LEADING HI-FI SHOP

Cyrus, Roksan, Micromega, Audionote, Audiolab, Rega, Arcam, Exposure, Aura, Epos, Thiel, Ruark, Rotel, Marantz and other fine equipment.

66 Upper North Street, Brighton  
Telephone 0273 775978

## WORTHING AUDIO

20 Treville Gate, W Sussex. BN11 1UA  
(0903) 212133

The friendly shop with the best sound system in the South. Friendly advice

• 3yr guarantees • easy parking

Open Mon - Sat. 10am-6pm Late night Wed. 7.30pm  
Agencies include: Arcam, Exposure, Kinshaw, Naim Audio, Marantz, Ruark, Audio Technica, Target, Tripod, JPW, TDL, Orelle, and many more ....

Stockists of: ARCAM • CREEK • EPOS  
HEYBROOK • MICROMEGA • NAIM AUDIO  
NEAT • REGA • ROKSAN • ROTEL • ROYD  
TEAC • YAMAHA

## Infidelity

indecently good hi-fi

9 High Street, Hampton Wick, Kingston upon Thames, Surrey KT1 4DA. Tel: 081-943 3530  
Open Tues - Sat 10.30am - 7.00pm.

### FRANKIE IS BACK!

Ex-Luxman, Carver & Hafler chief engineer with his own back up team can custom-modify, rebuild, up-grade or repair any high-end equipment. Japanese spares, speaker bi-wiring service. To restore the best sound for modern & old classics, call Francis Wong on-



Tel: (0582) 411480 or Fax (0582) 451957

## INHAUS AUDIO

Suppliers of the finest  
Hi-Fi equipment  
available

Tel. (0702) 465892 or Mobile (0831) 616426

Viewing & demonstrations strictly by appointment only

**PRO**  
ROKSAN J NAIM J REGA J MICROMEGA J ARCAM J CREEK  
J ROTEL J MARANTZ J DENON J RUARK J EPOS J  
SYSTEMDEK J AUDIOLAB J NEAT J SHAHINIEN J SOUND  
ORGANISATION J SOUND FACTORY J CHORD COMPANY J  
AUDIO TECHNICA J MANA ACOUSTICS J

Records also available  
**PRO MUSICA**  
6 Vineyard St., Colchester, Essex  
0206 577519

## LONDON & SOUTH EAST

"One of the 5  
best hi-fi shops  
in the world"

### GRAHAMS HI-FI

Canonbury Yard, 190A New North Road  
London N1 7BS, ☎ 071-226 5500  
Ring for a chat, an appointment and a map!



For the great sound of sound :

**The Comflake Shop**  
37 Windmill Street London W1P 1HH  
071 631 0472 Fax. 071 436 7165

We stock ATC, Arcam, Meridian, Naim, Rega, Royde, Roksan, AVI, Monitor Audio, DNM: as well as offering a marvellous mail-order worldwide service • Crunch •

## The Hi-Fi Shop

GUILFORD'S SPECIALIST SINCE 1950

We are at:  
3 BRIDGE STREET, GUILDFORD  
(By the traffic lights - next door to Alfred Marks)

0483 504801 • 0483 304756

Access • Visa • Switch

Open Monday-Saturday 9am-6pm (later by appointment)



SPECIALIST HI-FI OUTLET  
DEMONSTRATION ROOM - PARKING

- QUAD • AUDIOLAB • REL • TUBE TECHNOLOGY •
- TDL • TANNAY • KEF • DENON • NAKAMICHI • THORENS •
- TARGET • MAGNUM • ROTEL • MARANTZ • MICHELL •
- SENNHEISER • BEYER HEADPHONES • JPW •
- SOUND ORGANISATION • SOUNDSTYLE TRIPODS •
- VAN DEN HUL CABLES • BOSE • MUSICAL FIDELITY •
- SEISMIC SINK •

'HOME CINEMA NOW ON DEMONSTRATION'

Just 2 minutes off Junc. 6 M25, (A25)

**GODSTONE 0883 744755**  
45 High St., Godstone, Surrey RH9 8LS

**Spaldings**  
ESTABLISHED IN SOUND

☎ 081-654 1231/2040  
352/4 LOWER ADDISCOMBE RD.,  
CROYDON, SURREY

## AUDIO CONCEPT

27 BOND STREET, EALING  
LONDON W5 5AS  
TEL. 081 - 567 8703

AMC, Acoustic Energy, Aura, Audiolab, Audio Innovations, B&O, B&W, Cannon, Castle, Cyrus, Denon, Dual, Evolution, JPW, KEF, Marantz, Micromega, Mission, Monitor audio, Musical Fidelity, NAD, Nakamichi, Onix, Onkyo, Quad, REL, Rogers, Rotel, Systemdek, Target, Teac, Thorens, Van den Hul.

10 - 6 pm Mon., Tues., Friday, & Sat.  
Late night Thur., closed Wed.

Two demonstration rooms.  
Free local delivery and installation.  
Repairs and Services



79/81 Fairfax Road  
Swiss Cottage  
London NW6 4DY  
071 624 8855/6  
Mon-Fri 10-7-Sat 10-6

## EAST

alphason apollo audio innovations audion audio note audioquest dpa fuller helus heybrook impulse ixos kar lyra michell morel orlton pierre lurne project projekt qed royd sonic link sound organisation soundstyle sterling sugden sumiko townshend trichord van den hul voyd home demonstrations wide range audion audio note and kar lyra michell qed royd k... projekt qed royd sugden sumiko orlton pierre lurne project projekt morel orlton pierre lurne project projekt qed royd sterling sugden sumiko townshend trichord van den hul voyd home demonstrations wide range valve/transistor/analogue/digital, nice people, peculiar adverts .....

Signals hifi for grown-ups  
martlesham heath ipswich (0473) 622866

## The Audio File



27 HOCKERILL STREET, BISHOP'S STORTFORD, HERTS.  
TEL: 0279 50576

## EIRE

We Never Compromise On Quality



55 Mein St Blackrock Co Dublin  
Tel 2889449/2888477 Fax 2834887  
Open Tue/Sat 10AM-6PM. Thur/Fri 'till 9pm - Closed Monday

**Acoustic Dimension**

AVI • ATC • AUDIO INNOVATIONS • ACOUSTIC ENERGY • MICROMEGA • AUDIO NOTE • LFD • REF 3A • IMPULSE • JPW • TDL PROJECT • PRO AC • TRIANGLE • RUARK • ROTEL • MARANTZ • DPA • APOLLO •

Now ex demo equipment.  
Credit card accepted.

# Specialist Hi-Fi Dealers

## EIRE

### Peter Dand & Company Ltd Established 1963

Bang & Olufsen, Quad, KEF, Thorens, TEAC, and many more!  
2 Demonstration Rooms  
2 Year Guarantee  
111 Clonskeagh Road, Dublin 6  
Tel. 01035 31 269 4433

## MIDLANDS



You can come and visit us at:  
**25 HENLEY STREET,  
STRATFORD CV37 6QW**  
Contact Dirk or Jamie on:  
**Tel/fax No. 0789 414533**  
We are stockists of the leading Hi-Fi brands including:

**ARCAM, SONY, PANASONIC, NAKAMICHI, B&W, PIONEER, TECHNICS, DENON, NAD, KEF, MARANTZ, ROTEL, MUSICAL FIDELITY, MONITOR AUDIO, MISSION, TANNOY, QUAD, TDL & SENNHEISER, YAMAHA, CELESTION, ACOUSTIC RESEARCH, AUDIOQUEST, MONSTER, TARGET, BEYER, SYSTEMDEK.**

9% Finance is available on selected products and all major credit cards accepted. We also have a Demonstration Room and Service Facilities. Monday to Saturday 9.30-5.30. Late night Wednesday "WHERE FRIENDLY SERVICE STILL COUNTS!"

## W. OWEN EST 1901

### Audio/Video Specialists

Pioneer • Reference Point • Kenwood  
Sony • Akai • B&W

Free Installation and Home Delivery

58 Market Street, Oakengates 2A Stratford Street  
Telford, Shropshire Newport, Shropshire  
Tel: (0952) 613818 Telford Tel: (0952) 810876

## MUSIC MATTERS HI-FI

### THE AUDIO SPECIALISTS

for the most exciting range of equipment available in the Midlands which includes:

Arcam, Aiwa, Alchemist, Alphason, Apollo, Arcam, Audiolab, Audioquest, Audio Innovations, Audio-Technica, Aura, Beyer, Cambridge Audio, Canon, Celestion, Chord, Cyrus, Deltec, Denon, Dual, Epos, Exposure, Heybrook, Impulse, Infinity, KEF, Luxman, Marantz, Meridian, Michell, Micromega, Mission, B+W, Mordaunt-Short, Michaelson Audio, Monitor Audio, Monster, Musical Fidelity, Nakamichi, NVA, Panasonic, Pink Triangle, Pro-Ac, Revox, Rogers, Roksan, Rotel, Royd, Ruark, Sansui, Sennheiser, Straitwire, Systemdek, Target, Technics, Thorens, Wharfedale, Yamaha etc.

**OPENING TIMES:**  
Tues-Thurs 10.30-6.00  
Friday 10.30-8.00  
Saturday 10.00-5.00

Demonstration by Appointment

**351 HAGLEY ROAD, EGGBASTON,  
BIRMINGHAM B17 8OL**  
Tel: 021-429-2811

**156/7 LOWER HIGH STREET  
STOURBRIDGE, WEST MIDLANDS DY8 1TS**  
Tel: 0384 444 184

**INTEREST FREE**  
(for Ltd Period) APR 0%  
Written details on request.  
Licensed Credit Broker.  
Switch card accepted



## Moorgate Acoustics Hi-Fi



Frustrated and confused?

Call in and get some help and advice from a company that cares enough about its customers to put them first.  
**184 Fitzwilliam St., Sheffield. Tel: (0742) 756048**  
**8 Westgate Chambers, Rotherham. Tel: (0709) 370666**

## Peter Ellis Audio

A wide range of audio products always in stock including:-  
Quad, Denon, Stax, Marantz, Arcam, Creek, Sugden, QED, Castle, Rogers, Celestion, Tannoy, Nakamichi, Yamaha  
\* Home Cinema available \*  
\* Demonstration Room \*

29, Kirlgate, Newark,  
Nottinghamshire NG24 1AD  
0636 704571



Advent, Albarry, AKG, Alphason, AMC, AR, Arcam, Audioquest, Audio Technica, Beyer, Bose, Castle, Chord, Denon, Dual, Goldring, Meridian, Michell, Monitor Audio, Nagoka, Nakamichi, Ortofon, QED, Quad, Revox, Sennheiser, Sequence Design, Spondor, Target, TDK, TDL, Thorens, Wharfedale, K. Monks Record Cleaning Service.

**Five Ways Hi-Fidelity., (Est.1972)**  
12 Islington Row  
Edgbaston, Birmingham B15 1LD  
021-455 0667 (Closed Mondays)

## AUDIO EQUIPMENT FROM LEADING AND SPECIALIST BRANDS ON TWO FLOORS FOR YOU TO LISTEN AND CHOOSE FROM

- 3 Demonstration Rooms
- Home Trials
- Home Cinema - Instore Demonstration Theatre
- Audio Visual Equipment
- Evening Demonstrations by appointment
- Inhouse Service Department
- Mail Order Available
- Interest Free Credit on Selected Items (Apr. 0% - Written details on request)

Hi-Fi for the Beginner, the Enthusiast and the Audiophile Telephone (0922) 493499/473499

ACOUSTIC ENERGY • ARCAM • ALEMA • AUDIO LAB • APOLLO • A.T. • AUDIO ALCHEMY • AUDIO QUEST • B&W • BOSE • BEYER • CABLE TALK • CHORD COMPANY • CHORD • CYRUS • CELESTION • DPA • EPOS • EXPOSURE • INFINITY • JMW • KEF REFERENCE • KENWOOD • MARANTZ • MICHELL • MONITOR AUDIO • MONSTER • MORDAUNT SHORT • MERIDIAN • MICROMEGA • MISSION • MOTH • MUSICAL FIDELITY • NAKAMICHI • ORTOFON • PROJECT • QUAD • ROKSAN • ROGERS • ROTEL • SENNHEISER • SONY • SPENDOR • SUMIKO • SYSTEMDEK • TARGET • TDL • THORENS • TRIANGLE • TUBE TECHNOLOGY • VAN DEN HUL • VANDERSTEEN • YAMAHA • YBA



**Southfield ACADEMY**

CINEMA EXPERIENCE

Quality, Clarity, Expertise... and that's just the service!

Sharing the ASDA Carpark with ample free parking.  
Off High Street, Bloxwich, Nr. Walsall, West Midlands  
Near M6 Jnc. 10 & 11  
Open 6 Days, 9am - 6pm  
Late night Friday



## CREATIVE AUDIO

9 DOGPOLE, SHREWSBURY,  
SHROPSHIRE  
Tel: (0743) 241924  
Closed Mondays

- Comfortable listening rooms
- Home demonstrations available
- Part exchange welcome
- Free home installation
- Interest Free credit

Authorised retailer for:  
A & R ARCAM, AUDIOLAB,  
CELESTION, CYRUS, DENON, DUAL,  
MERIDIAN, MISSION, MONITOR,  
AUDIO, QUAD, REVOLVER, ROKSAN,  
ROTEL, YAMAHA, EPOS, NAIM, KEF,  
RUARK

## FRANK HARVEY Hi-Fi EXCELLENCE

163 Spas Street, Coventry, CV1 3BB Tel: 0203 525200.  
Mon to Sat 9.30 till 5.30. Closed Thursday

**MUCH MORE  
THAN HI-FI**

WE ARE A  
BADA DEALER

Audiolab • Audio Alchemy • Arcam • Alphason • Bose • Bang & Olufsen • Celestion • Cyrus • Denon • Dual • Foundation • Kef • Marantz • Monitor Audio • Mission • Musical Fidelity • Nakamichi • NAD • Quad • Rega • Rogers • Rotel • Target • Tannoy • Thorens • Van Den Hul • Yamaha

MAILORDER • EXPORT • HOME TRIALS

**3 Floors. 3 Dem rooms. 3000 sq feet in the pursuit of Hi-Fi Excellence**



TO FIND OUT HOW LITTLE  
IT CAN COST TO  
ADVERTISE IN THIS  
SECTION PLEASE CALL  
CAROLINE KNOTT ON  
071 266 0969

## THE STATE OF THE ART....

- EXPERT ADVICE
- CREDIT FACILITIES
- PART EXCHANGE WELCOME
- REPAIRS

Come and hear - NAD • B&W • NAKAMICHI • BOSE • QUAD • BEYER-DYNAMIC • SENNHEISER • AURA - and lots more in our listening room.



Tel. 0743 - 355186

**Hi-Fi Limited**  
12 Barker St. Shrewsbury

Plenty of parking - park and ride buses stop outside!

## MIDLAND STUDIO

PHONE/FAX OR WRITE FOR OUR LATEST LIST OF EXDEMONSTRATION OR SECOND HAND EQUIPMENT FROM LEADING ESOTERIC MANUFACTURERS



**MIDLANDS HI-FI STUDIO**  
WULFRUNA STREET  
WOLVERHAMPTON WV1 1LX

TELEPHONE  
0902 771774



FAX  
0902 380083

# Specialist Hi-Fi Dealers

## WEST & WALES

### ENGLISH

audio

3ADA

#### CYRUS CENTRE

PINK TRIANGLE, AUDION-SYSTEMDEK, HEYBROOK, MICHI-KEF, REFERENCE, MICROMEGA, NAKAMICHI, CHORD, ARCAM, MUSICAL, FIDELITY, ROGERS, NAD, ROTEL, DENON, TANNOY, MARANTZ, MISSION, STAX-DUAL, TDL, ALBARRY, JPW, CELESTION, IXOS, SME, RUARK, MOTH-AUDIO TECHNICA, EXPOSURE, AND OTHERS.

Free installations. Credit Facilities. Service Department

Mon - Sat 10 - 6

95 Whitescross Road, Hereford HR4 0DG 04325 358081

## NORLOSTONE

MARBLE - GRANITE - STONE SPECIALISTS

GRANITE AUDIO STANDS. The ultimate solution to problems of resonance and tonal accuracy. For 'bespoke' designs consult **NORLOSTONE**, West Dean Road, West Tytherley, Salisbury. SP5 1QG. Tel: 0980 862253

## NORTH WALES

### ACTON GATE AUDIO

THE HI-FI CENTRE IN WREXHAM

Aiwa, Albarry, Arcam, B&W, Canon, Celestion, Cyrus, Marantz, Michell, Micromega, Mission, Musical Fidelity, NAD, Nakamichi, Quad, Radford, Rega, Rogers, Rotel, Ruark, Spondor, Tannoy, Thorens, Wharfedale, Yamaha.

"Yamaha cinema DSP club authorised dealer"

4 RUABON ROAD, WREXHAM  
TEL. 0978 3645000

## NORTH

### ASTON AUDIO

ARCAM • MERIDIAN • MISSION • CYRUS • AUDIOCAB • B & W • NAKAMICHI • AURA • DENON • QUAD • YAMAHA • KEF • MARANTZ •

ROKSAN • NAD • MF • AJWA • DUAL • CELESTION • ROGERS • AUDIOQUEST • TECHNICS •

WEST STREET • ALDERLEY EDGE • PLUS HOME CINEMA • CHESHIRE • TEL. 0625 582704 • INTEREST FREE CREDIT • DISCOUNT CD & TAPE • BADA •

## AUDIO COUNSEL HI-FI SPECIALISTS

LINN, NAIM, REGA, ARCAM, ROTEL, ROYD, SHAHINIEN, DYNAVECTOR, EPOS, MARANTZ, NAKAMICHI, MICROMEGA and many more...  
"Time spent with staff may prove to be a particularly wise investment"

Audiophile

12/14 Shaw Road, Oldham OL1 3LO  
Tel. 061 633 2602



Near Norwich  
Norfolk  
Tel. (0508) 570829

Basically Sound of Norfolk

STOCKISTS OF LEADING HI-FI

Arcam, Naim, Audiolab, Epos, Denon, Nakamichi, Acoustic Energy, Heybrook, Micromega, Rotel, TDL, The Chord Company, Sound Style etc...

## REPAIRS/DIY



Chelmer Valve Company  
for  
Audio Valves

Buy CVC PREMIUM Hi-Fi valves direct from us. All valves processed for improved performance. We also have Stock of MAJOR BRAND types including: MULLARD, GEC, BRIMAR, RCA, GE, etc  
130, New London Road, Chelmsford, Essex, CM2 0RG  
Tel: 0245 265865 Fax: 0245 490064

## TECHNICAL & GENERAL

THE ORIGINAL TURNTABLE SPECIALISTS  
for the Great Classic Turntable, Arms, Cartridges, Styli.

CONNOISSEUR • GARRARD • GOLDRING • Lenco • ORTOFON • SHURE • S.M.E. • THORENS • WATTS

All available Genuine spares and our own re-manufacture of obsolete parts  
Servicing and Overhauls, to original technical specifications.

NO ILLUSORY 'IMPROVEMENTS' NO DUBIOUS OR HARMFUL 'MODIFICATIONS'  
Remedial Services available

Cartridges and styli, correct radius diamonds, for early recordings - 78s & LPs

TECHNICAL & GENERAL

P.O. Box 53 Crowborough, East Sussex TN6 2BY  
Tel: 08 32 65 45 34

## LOOKING FOR REAL HI-FI or HOME CINEMA IN SWINDON

Audio Technica, Acoustic Energy, Audio Innovations (valve Amp), Beard (Valve Amp), Cerwin Vega, Impulse, Red/Acoustics, and many more....

We also stock quality ex demonstration and secondhand hi-fi Quality car Audio, new, used and secondhand, also available Repair and refurbishment classic equipment

52 Audio Exchange 52

52 Morse St, Swindon Tel. 539008

(Off Commercial Road, Swindon) Open 10am - 6pm, Mon - sat



**BANDOR**  
MINIATURE LOUSPEAKERS  
DESIGN AND MANUFACTURE OF MINIATURE LOUSPEAKERS AND SYSTEMS

TRANSMISSION LINE KITS exploits the unique performance of BANDOR 150mm (8") & 50mm (2") drivers. Humidity proof. Ultra Linear Drivers (see Brochure for Xmas)

11 Penfold Cottages, Penfold Lane,  
Holmer Green, Buck. HP15 6XR  
(0494) 714058



## Lockwood Audio

Tel: 081-207 4472

Fax: 081-207 5283

WE BUY AND SELL  
NEW, USED AND VINTAGE  
SPEAKERS, DRIVERS, CABINETS, PARTS.

SPEAKER REPAIRS

THE

Authorised **TANNOY** Specialist

MAJOR CREDIT CARDS WELCOME

IMPERIAL STUDIOS,

MAXWELL ROAD,

BOREHAMWOOD, HERTS. WD6 1WE

## SOUNDS AROUND

Professional Service Repairs  
and Accessories  
Agent for Golden Dragon Valves

146 Clarendon Park Road, Leicester  
Telephone : 0533 702442

## SOVTEK VALVES

6550WA, 6L6WGC/5881, EL34G,

12AX7WB/7025, EF86/6267

Over 1000 different types of valves stocked S.A.F. for list

DEPT. HFV

Wilson Valves, 28 Banks Ave, Golcar,

Huddersfield, West Yorks, HD7 4LZ.

Tel: 0484 654650/420774 Fax: 0484 655699

Mail order only, Visa etc.

## GTAUDIO

Specialises in the repair of all types of audio equipment (including valve). All work is guaranteed and carried out to the highest standard.

Tel: 0895 833099

## CD SELECTIONS

The UK's leading suppliers of bargain CDs and music for your free catalogue contact

CD SELECTIONS

PO BOX 1011

DORCHESTER DORSET D12 7YG

Tel. 0305 848 725

## GOLDMINE RECORDS

(behind M & S)

8 Shambles Square, Manchester M3 1RE

Telephone 061 839 3616

The best Oldies Shop in the North!  
Fantastic Selection of 45s, from the 50's, 60's and 70's (US Re-issues) US and UK hits and Classic Rock 'n' Roll, R & B, Country, Doo-wop, etc. Plus superb range of re-issue CDs. Send large 42p S.A.E. for our brilliant 45's catalogue (over 5000 titles)

Downstairs in The Soul Cellar - Killer Selection of Soul Originals + Latin, Funk, Etc....  
Play a visit to the shop, open from 10am - 6pm - Mon - Sat  
Stay and find all the Tunes you've seen after for years. dept11FW

## SERVICES & CONSULTATIONS

**R. J. F.** 84 Pandarves Street, Tuckingmill,  
Cambourne, Cornwall TR14 8NJ

Tel: (0209) 710777

AUDIO-VISUAL

Dealers for Audio Technica, B & W, Beyer, Cerwin Vega, Denon, Dynavector, Foundation Audio, Goldring, Harman Kardon, JBL, Marantz, Michell, Micromega, Musical Fidelity, Nakamichi, Ortofon, Percepton, Pink Triangle, Project, GED, Sansui, SD Acoustics, Sharp, SME, Target, TDL, Townshend, Impulse, Audio Innovations, Audionote, Audiomack, New Form, Suggden, TEAC, Triangle plus more! Much second hand equipment available plus repairs to all brands



Retra

Retailers of Fine Audio Equipment

Congloton

- ▶▶ EPOS
- ▶▶ ONIX
- ▶▶ DENON
- ▶▶ LINN
- ▶▶ AUDIO ALCHEMY
- ▶▶ ARCAM
- ▶▶ B&W
- ▶▶ NAKAMICHI
- ▶▶ ROYD
- ▶▶ TARGET
- ▶▶ TRIPOD
- ▶▶ LOUSY COFFEE

▶▶ SUPERB DEMO FACILITIES

▶▶ FULL INSTALLATION & HOME DEMO SERVICE

OPEN 6 DAYS A WEEK  
OTHER TIMES BY  
APPOINTMENT

0260  
297544

17A Duke St Conglton Cheshire CW12 1AP

**Sowter Transformers**  
EA Sowters Ltd  
PO Box 36  
Ipswich IP1 2EL  
0473 219390/252794

Output and mains transformers for GEC KT88 circuits.  
Can also make any other transformer to order. Send SA for lists and data.

# Specialist Hi-Fi Dealers

## WHO SAYS YOU CAN TRUST A BADA DEALER?

### VOX MAGAZINE:

"You can be confident that BADA members are reputable, financially sound businesses which will sell your hi-fi in a professional manner."

### HOMES & GARDENS:

"A tried and tested way of finding trustworthy dealers . . . BADA whose members are specialist Hi-Fi Dealers."

### GRAMOPHONE:

"Over 100 member shops . . . from Aberdeen to Plymouth . . . Helping customers to identify, clarify and satisfy their needs through the demonstration of suitable hi-fi products."



## CHOOSE YOUR HI-FI FROM A DEALER YOU CAN TRUST

Write for a FREE Fact Sheet, BADA benefits and full members list to P.O. Box 229, London N1 7UU. Tel: 0171 226 4044 Fax: 0171 359 7620

### service and repairs

maintenance to almost all brands of hi-fi. in guarantee repairs to Kenwood, pioneer, Aiwa, Panasonic, Technics, Teac, Yamaha and others. All repairs guaranteed for 3 months.

mwes electronic services.

5, King St. Delph, Oldham. Tel/fax 0457 820862

**ANCRUM ELECTRONICS**  
YOUR LOCAL HI-FI SHOP  
PIONEER, TECHNICS, PROLOGIC AMPS + LASER DISC FOR HOME ENTERTAINMENT  
TEL: (0382) 480030  
39 GRAY ST., BROUGHTY FERRY DUNDEE  
Dedicated Dolby, Pro-logic listening rooms

### AERIALS

## ANDY'S AERIALS

- TV & FM AERIALS SUPPLIED & INSTALLED
- MULTIPOINT SYSTEMS REPAIRS
- DIY SALES FULLY INSURED COMPETITIVE PRICES
- ALL WORK GUARANTEED FREE SITE SURVEYS
- 7 DAY SERVICE Areas Covered

HARROW, BRUSLIP, NORTHWOOD, EALING, ACTON, HAYES, SOUTHWALL, HEATHROW etc

CALL US FOR A PROFESSIONAL & RELIABLE SERVICE

08184 4890 OR 0840 830233  
SHOWROOM AT: 345c NORTHOLT RD., (OPP SAINSBURY'S) SOUTH HARROW, MIDDX. OPEN 9am-5.30 MON-SAT

## L.G.S. AUDIO SERVICES.

Quality Audio Equipment and Hi-Fi Systems Repaired and Serviced at Reasonable Cost  
2nd Floor, Forest Mills, 133 Alfreton Road, Radford, Nottingham NG7 3JL  
Tel: 244443

Silver Sounds and Sonic Link cables tailor-made to your requirements.  
Check out the latest impedance matched Goertz cable from Townsend Audio. Cogan-Hall Cables.  
Contact Mike Gilmour for professional advice and friendly service.  
Lismore, Avonch, Ross-shire IV9 8RP  
TEL/FAX 0381 620655

### THE AERIAL SHOP

188 Halfway St, Sidcup, Kent. (London SE & Kent areas covered)  
Tel: 081 300 5588/8990/7454

GET THE BEST FROM YOUR HI-FI  
100's of Aerials, 100's of fittings for Hi-Fi Aerials, TV Aerials & Satellite Dishes DIY or fitted by our Engineers.  
Quality equipment stocked e.g. ANTIFERRENCE, TRIAX, LAB GEAR ETC.....

### REVOX SERVICE & REPAIRS

"Authorised agent for Revox Products"

- 17 Years experience, ex-Bauch
- All repairs carried out and guaranteed
- Fast turnaround

Tel: 0923 893711  
Suite 10, Smugoak Business Centre, Lye Lane, Bricketwood, Herts. AL 23UG

## OVERSEAS

### Sum of the parts.

ALPS NOBLE  
Volume and balance pots used by the best manufacturers.

KIMBER KABLE  
Precision crafted wire, connectors and caps.

VISHAY  
A resistor without equal.

GOLD AERO  
Selected, tested, guaranteed.

MIT MULTICAP  
World's finest film capacitor!

The very best in audio grade parts, upgrade/mod kits and complete kit products. Call, write or fax for our catalogue.

**SONIC FRONTIERS**  
INCORPORATED

2790 Brighton Road, Oakville, Ontario, Canada L6H 5T4  
Telephone (905) 847-3245 - Fax (905) 847-5471

MIT MultiCap • Wonder Cap • Kimber Kap • Solen • Siemens Hovland MusiCap • Wima • Holco • Draloric • Vishay • Caddock Mills • Matsushita • Noble • Kimber Kable • Cardas • Discovery Audioquest • Alps • Bourns • Shalco Attenuators • Electroswich Elma • CTS • Elna • Nichicon • Gold Aero • RAM • N.O.S. Tubes Linear Technology • Burr Brown • Analog Devices/PMI • Motorola Edison Price • Pearl • Tube Sockets • WBT • Neutrik • Kits

### T.V.M. Audio Visual

The Antenna Specialists  
52 St Andrews Street  
Northampton NN1 2HY  
Tel: (0604) 37769  
Fax: (0604) 601845

High quality FM Radio and T.V. Aerials. Mail Order  
Please phone for more details

## STAFFS & DERBY

HOW TO **SAVE £100 ON YOUR HI-FI**

Choosing the right Hi-fi and saving money is a difficult task, make it easy on yourself. To get your copy of "Guide to Buying Hi-fi" just telephone

**FREEPHONE 0800 373039**

We will send you one Free of Charge together with our Fact Pack and see how you can save £100 on recommended Hi-fi Systems.

### Active Audio

12 Osmaston Rd, 29 Market Street, 95 Stafford Street,  
The Spot, Tamworth, Hanley,  
Derby, Staffs, Stoke-on-Trent.  
Tel: 0332 390385 Tel: (0827) 53355 Tel: 0782 214994

## SCOTLAND

### RIVERSIDE AUDIO

South West Scotland Tel: 0475 631 066  
Argyll and Bute Tel: 0700 504845

The mystique of valve amplification demonstrated in the comfort of your own home. Art Audio, Concordant Valve Amplification, Atacama Audio Supports, J.P.W. Speaker Systems, Fullers Audio Loudspeakers.

## HI-FI WORLD SPECIALIST DEALER DIRECTORY ORDER

BOOK 12 MONTHS FOR A 30% DISCOUNT!!  
OR 6 MONTHS FOR A 20% DISCOUNT.

I wish to be included in Hi-Fi World's Specialist Dealer Directory starting the \_\_\_\_\_ issue for a total of \_\_\_\_\_ insertions.

Please find enclosed my artwork/copy details. I wish to book \_\_\_\_\_ column centimetres at £12.50 per col. Cm.

Name \_\_\_\_\_

Company \_\_\_\_\_

Address \_\_\_\_\_

\_\_\_\_\_

\_\_\_\_\_

\_\_\_\_\_

\_\_\_\_\_

\_\_\_\_\_

Postcode \_\_\_\_\_ Telephone No. \_\_\_\_\_

Please return to Caroline Knott,  
Hi-Fi World,  
64 Castellain Road,  
London W9 1EX





# WORLD DESIGNS

## by Mail Order

world audio design mail order

### K5881 KIT

£395 ▼



A superb, Class A, 20watt stereo power amplifier that uses the Russian 5881 output valve, a military version of the American 6L6, designed for low distortion audio work. It has super-quality output transformers (4/8/16Ω selected internally) to minimise distortion and the input stage uses triode working. A rugged, sixteen-gauge, all-welded steel chassis is provided, together with protective bottom plate for safety.

Designed for long life, low running costs and excellent sound quality, K5881 is sensitive enough to be used with a simple passive pre-amp. or our own line-drive pre-amp, and it matches modern loudspeakers well. There is a choke-regulated power supply and the channels can be paralleled to turn it into a 40W monoblock if desired.

#### SPECIFICATION

Power	20watts/ch.	Separation	60dB
Frequency resp.	16Hz-40kHz	Noise (CCIR)	-103dB
Distortion	0.02%	Sensitivity	240mV
		Weight	16kgs(34lbs)

### 300B VALVE AMP KIT

£850 ▼



This is a specialised amplifier based on the highly linear 300B triode valve. Our 300B runs in Class A, giving one of the most sweet, open and neutral sounds possible today. Matched with good loudspeakers, it is unsurpassed.

The kit comprises a strong 16-gauge mild steel chassis, fully punched, welded and ground smooth. Finish is a durable 'powder coat' black. A protective bottom plate is provided for safety. Output terminals (one pair) take 4mm plugs axially and radially for

bi-wiring, or heavy gauge bare cable. Output options of 4/8/16Ω are selected internally at the transformer. A small circuit board carries most of the components. Can be monoblocked for 60watts.

All parts are included in the kit, except valves since different 300B makes are available.

#### SPECIFICATION

Power	28watts	Separation	54dB
Frequency resp.	5-18k-nfb	Noise (hiss/hum)	-100dB/-72dB
	50k-fb	Sensitivity	240mV
Distortion	0.2%	Weight	20kgs(44lbs)

### 4W SINGLE-ENDED VALVE AMP KIT £385 ▼



The 4W Single-Ended amplifier kit is a line level integrated amplifier. It comes with three line level inputs and a tape output. High quality components are used throughout, including polypropylene signal capacitors, Alps volume control, custom C&K gold plated selector switch etc. Valves are included.

#### SPECIFICATION

Power	4watts	Noise (hiss)	-100dB
Freq. Response	9Hz-64kHz	(hum)	0.7mV
Distortion	1.3%	Sensitivity	180mV
Separation	74dB	Weight	10Kgs (22lbs)

#### DEMONSTRATIONS!!

Most of our products are on demonstration at Hi-Fi Confidential, 34 Buckingham Palace Road, Victoria, London. Phone the patient and understanding Luigi on 071-233-0774 to check availability. He's a valve afficianado, and stocks plenty of good products - including World Audio Design.

See page 83 for order form...

# WORLD DESIGNS

## by Mail Order

### VALVE LINE LEVEL PRE-AMPLIFIER

£295

Constructed from heavy gauge steel with an aluminium anodised and polished front panel. This new chassis comes with the complete kit of parts necessary to build the valve line level pre-amp.

The components are all high quality and include a special screened toroidal transformer, Military Spec. Russian valves, Alps potentiometer, polypropylene signal capacitors, silver plated



### HIGH DEFINITION LOUDSPEAKER

The High Definition loudspeaker is ideal for low power, high quality amplifiers, transistor or valve. It goes very loud with just 1-5watts, having an enormous sensitivity of 94dB - that's 8dB more than most other speakers. It is also a very easy load for valve amps (8ohms) and it gives a terrifically dynamic and fast sound. This speaker is also unusually suited to low powered vintage amplifiers, such as Quad IIs, Radfords, Pye Mozarts and such like.

The High Definition loudspeaker is available in two forms; as a drive unit pack containing two bass units and two tweeters modified and tested, or complete with all crossover components, gold plated bi-wire terminal dishes, silver plated copper wiring and long haired wool.

Drive Unit & Crossover kit etc £195  
Drive Unit Pack £145



NEW

### CLASS A 36W SOLID STATE MONOBLOCKS

£580/pr.

A pure Class A transistor design offering superb clarity and

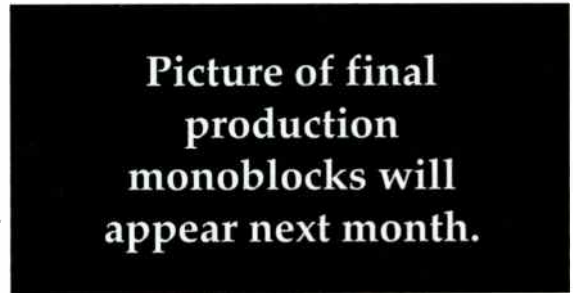

transparency. The kit comes complete with a heavy-gauge steel chassis chrome plated for an attractive and hard wearing finish. All components necessary to complete these super monoblock amplifiers are provided in the kit and it comes with clear, easy to understand instructions.

The Class A monoblocks use special new super grade audio transistors. They are extremely fast and linear, giving a super measured performance without the need for high levels for feedback.

### SPECIFICATION

Power (8Ω)	36watts	Distortion (%)		
Frequency Resp.	1Hz-50kHz	1W	Full	O/P
Noise	-104dB	1kHz	0.003	0.005
d.c. offset	3mV max	10kHz	0.008	0.04

NEW

### THREE WAY CARBON-FIBRE DRIVER LOUDSPEAKER

This is our third loudspeaker design and the most advanced to date. KLS3 uses extremely light and stiff carbon fibre cone drive units for a fast and accurate sound. A dedicated 4inch carbon fibre midrange drive unit provides the cleanest, smoothest and most detailed midrange characterised by superb projection. The treble is handled by a sweet sounding fabric dome tweeter and for real bass power and articulation a light and stiff 8inch carbon fibre bass driver is employed.

KLS3 has been engineered to get the best from your amplifier, be it valve, solid state, single-ended or zero feedback. Its High 90dB sensitivity and near flat 8Ω impedance make it one of the easiest loudspeakers to drive.

KLS3 is available in three forms: Drive unit pack £230; Drive units + crossover etc (just about everything but the wood) £350; fully built, tested and finished in high quality, real wood veneer for £1500.



NEW

### HIGH TECH AUDAX DRIVE UNITS

The 1994 range of Audax drive units sees many modern high tech materials and technologies that would normally be unavailable to the home constructor. We offer a small range of the highest quality drivers, including High Definition Aerogel (HDA) units, carbon fibre and three superb soft dome tweeters. Sadly there isn't enough room to print the specs, but if you are interested in any of the following drivers, please ask us for a detailed spec sheet.

#### Audax Drive Units:

##### CAST CHASSIS UNITS

	4 inch mid	6.5inch bass/mid	8inch bass
HDA.....	HM130Z0.....	HM170Z0.....	HM210Z0
CARBON FIBRE.....	HM130C0.....	HM170C0.....	HM210C0

##### FABRIC DOME TWEETERS

- TW025M0 (25mm 92dB suitable for 2-way systems)
- TW025M1 (25mm 92dB suitable for 3-way systems)
- TW034X0 (34mm 93dB a large dome with powerful sound)

**WARNING**

**THESE ARE EXPERT KITS, NOT FOR THE INEXPERIENCED. YOU MUST BE ABLE TO SOLDER AND READ A CIRCUIT DIAGRAM. THE VALVE KITS CONTAIN LETHAL VOLTAGES. WE CANNOT BE HELD RESPONSIBLE FOR ANY ERRORS ARISING FROM THE CONSTRUCTION OF THE KITS.**

**ORDER FORM**

Please send your completed order form to: **WORLD AUDIO DESIGNS, 64 Castellain Road, Maida Vale, London W9 1EX**  
Tel: 071 266 0461 Fax: 071 289 5620

240/120 option - delete the voltage NOT required.

Valves included except where stated.

'BUILT' - we can supply the amplifiers built up and tested by an approved service, for safety and guaranteed performance to specification.

DESCRIPTION	ORDER No.	QTY	PRICES	
			UK (inc VAT & carriage)	OVERSEAS. (net)
<b>4W single ended integrated</b>				
KIT	4WSE-K240/120	<input type="text"/>	£385	£330
transformer set	4WSE-TR240/120	<input type="text"/>	£190	£150
<b>K5881 20W budget valve amplifier</b>				
KIT	K5881-K240/120	<input type="text"/>	£395	£350
BUILT	K5881-B240/120	<input type="text"/>	£595	£550
transformer set	K5881-TR240/120	<input type="text"/>	£220	£180
<b>300B 28W specialised valve amplifier (prices do not include valves)</b>				
KIT	300B-K240/120	<input type="text"/>	£850	£725
BUILT	300B-B240/120	<input type="text"/>	£1150	£950
transformer set	300B-TR240/120	<input type="text"/>	£430	£370
<b>KLPI line level preamplifier</b>				
KIT	KLPI-K240/120	<input type="text"/>	£295	£250
BUILT	KLPI-E240/120	<input type="text"/>	£395	£335
<b>Phono Stage</b>				
PCB only	RIAA-PCB	<input type="text"/>	£35	£30
Full kit including casework	RIAA-K	<input type="text"/>	£249	£215
<b>KLS2 2-way, high definition, floorstanding speaker</b>				
Drive Units + Crossover kit etc	KLS2-C	<input type="text"/>	£195	£165
Drive units	KLS2-D	<input type="text"/>	£145	£120
<b>KLS3 3-way carbon fibre driver floorstanding loudspeaker</b>				
Drive Units + Crossover kit etc	KLS3-C	<input type="text"/>	£350	£300
Drive Units	KLS3-D	<input type="text"/>	£230	£200
<b>Class A 36w solid state monoblocks</b>				
KIT	CLAS-A	<input type="text"/>	£580	£495
<b>AUDAX DRIVE UNITS (P&amp;P Extra, please add £5.75 for individual units or tweeters, otherwise add £10)</b>				
<b>High Definition Aerogel</b>				
4inch midrange	HM130Z0	<input type="text"/>	£45	£40
6.5inch bass/mid	HM170Z0	<input type="text"/>	£50	£45
8inch bass	HM210Z0	<input type="text"/>	£60	£55
<b>Carbon Fibre</b>				
4inch midrange	HM130Z0	<input type="text"/>	£40	£35
6.5inch bass/mid	HM170Z0	<input type="text"/>	£45	£40
8inch bass	HM210Z0	<input type="text"/>	£55	£50
<b>Fabric Dome Tweeters</b>				
25mm 92dB for 2-way systems	TW025M0	<input type="text"/>	£15	£13
25mm 92dB for 3-way systems	TW025M1	<input type="text"/>	£16	£14
34mm 93dB - powerful sound	TW034X0	<input type="text"/>	£25	£22

I enclose cheque/postal order for £ \_\_\_\_\_  
made payable to **World Audio design Ltd.**

NAME:: \_\_\_\_\_

ADDRESS: \_\_\_\_\_

I wish to pay by Access/Visa. Debit my account no:

<input type="text"/>	<input type="text"/>	<input type="text"/>	<input type="text"/>	<input type="text"/>	<input type="text"/>	<input type="text"/>	<input type="text"/>	<input type="text"/>	<input type="text"/>	<input type="text"/>	<input type="text"/>	<input type="text"/>	<input type="text"/>
----------------------	----------------------	----------------------	----------------------	----------------------	----------------------	----------------------	----------------------	----------------------	----------------------	----------------------	----------------------	----------------------	----------------------

POST CODE: \_\_\_\_\_ TEL: \_\_\_\_\_

Expiry date:

**CREDIT CARD ORDERS TELEPHONE 071 - 266 0461 (24 HOURS)**

Signature .....

**OVERSEAS PRICES AND DETAILS**

All our kits can be supplied overseas excluding the European Community, free of UK tax (VAT). However, allow for your own local import taxes (customs duties) and for carriage charges, which must be added to our net price.  
Surface mail is slow (1-4 weeks) but inexpensive; airmail is fast (up to 7 days) but more expensive. We recommend couriers like Amtrak for speed and door-to-door service.  
We package overseas orders securely.

**METHODS OF PAYMENT**

International money order in Sterling, Visa, Mastercard/Access, Local Currency at agreed exchange rate by registered mail.  
Payment in advance. Contact us for details.  
**CONTACT: RICHARD JOHNSON** London, England.  
PHONE (9.30am-6pm) **071-289-3533**  
ANSWERPHONE (24hrs) **071-266-0461**  
FAX (24hrs) **071-289-5620**

# Meet-Your-Maker

A reference guide to Britain's Manufacturers and Distributors.

**ACOUSTIC ENERGY**, 3a Alexandra Road, London W13 ONP. Tel: 081 840 6305. Acoustic Energy manufacture the award winning Reference Series AE1 and AE2 loudspeakers and the new Aegis Series Model 1, all of which feature the unique AE metal cone drive units. The AE distribution division offers superb high end products from WADIA, GRYPHON, ENSEMBLE and TARA LABS.

**ACOUSTIC SOLUTIONS LTD** Present an innovative range of interconnect for the Audiophile. We specialise in bespoke manufacture to your exact requirements. Phone us for a chat on 0782 595330. ASL 46a Market Street, Longton, Staffs ST3 1BS

**ALCHEMIST PRODUCTS**, 4 Rosebury Mews, London N10 2LG. Call us for a list of our dealers in many areas including:- London, Kent, Hampshire, Wilts, Milton Keynes and N. Ireland and for product information on the Kraken, Freya, Bragi, Odin, Genesis and more. Tel: 081 883 3008

**ALEMA UK LTD.**, 25 Montifore Road, Hove, BN3 1RD. Tel: 0273 202637. Audion "Edison" "Andersson" (Trade enquiries welcome for our newly extended range).

**APPOLLO**. The UK based designers and manufacturers of high quality speaker stands and equipment racks have now added to their comprehensive range a modular system ideal for housing audio visual products and CD storage. Please send for our free brochure to Zenith Crown Ltd, Tipton Rd, Dudley, West Midlands, DY14 Tel. 021 520 5070. Fax: 021 522 2055. - All export trade enquiries welcome.

**ARCAM**, Pembroke Ave, Denny Industrial Centre, Waterbeach, Cambridge, CB5 9PB. Tel: 0223 440964 or Fax: 0223 863384. Manufacturers of the Delta 290 Amplifier and the Delta 280 Digital FM Tuner. The two together produce a sound that has been described as 'subtle and intriguing' and that provide 'real clout' - discover this for yourself. For information on not only these products but also the Arcam CD Players, Speakers, Cassette Decks etc., 'Phone or write in to request a brochure - The pleasure is all yours!

**ATACAMA AUDIO SUPPORTS** from Sambell Engineering Ltd. We are the sole manufacturers of the SE range of speaker stands, consisting of an 8", 12", 16", 20" and the award winning 24" high stand. Also three specialist models for the Tannoy sixes Loudspeakers.

**AUDIONOTE CO**, Unit 1, Block C, Hove Business Ctr, Fonthill Road, Hove BN3 6HA. Tel: 0273 220511. Audionote supply a range of very high quality and very expensive audiophile components including valve output transformers.

**AUDIO SYNTHESIS**, 99 Lapwing Lane, Manchester, M20 0UT. Tel: 061 434 0126. Audiophile design, development and distribution. Please contact us for details of: PASSION the passive controller everyone's talking about. SILVERBLUE pure silver interconnect cable and the ultra analog based dac - DSM.

**BANOO MINIATURE LOUSPEAKERS** Studio II, Penfold Cottages, Penfold Lane, Holmer Green, Bucks. HP5 6XR. Tel: 0494 714058. Aluminium anodised cone drivers with only 1.8 gm moving mass giving full detail to sound covering 2/3 of the frequency spectrum.

**BANDRIDGE LTD** are the premier suppliers of quality audio and video leads, connectors and speaker cables in the UK. In addition to probably the widest range available, including PROFI GOLD SUPER GOLD and SUPER +, offering a level of quality that meets the needs of the most exacting specification. Bandridge of London Ltd, Premier House, Deer Park Road, Wimbledon SW19 081 543 3633.

**CABLE TALK** PO Box 413, Woking, Surrey. GU22 8Y2 Telephone 0483 750667. Fax 0344 360866. Designers and manufacturers of British made high quality, value for money, interconnect and speaker cables. Phone or fax for a free full colour brochure on our What Hi-Fi? 5 star rated products.

**CAMPAIN AUDIO DESIGN** Llandudno Road Cardiff CF3 8PG. Tel: 0222 779 401. Supplies manufacturers mailorder, high purity silver interconnects, loudspeaker cables, internal wires and bespoke mains cables. Generous two week trial period.

**CHORO ELECTRONICS** 3 Boxer Mount Road, Maidstone, Kent. Tel: 0622 764874. Audition the Chord SPM 1200 at any of the following branches: Doug Brady Hifi - Liverpool. Leeds/London/Cheshire, Audio Reflections - Leeds, Music Matters - West Midlands and many others. Please call us for details.

**CREEK AUDIO LTD** 2 Bellevue Road, Friern Barnet, London N11 3ES. Tel: 081 361 4133. Fax: 081 361 4136. Manufacturers of the 4240 Integrated Amp, P42 and A42 Pre/Power Amps, CD42 CD Player. Please write for further details.

The Exultant Power Amp fitted to Quad II Hardware.  
**OBS AUDIO**, PO Box 91, Bury St Edmunds, Suffolk, IP3

DNF. Tel: 0284 828926. Fax: 0284 828026. The DBS5 loudspeaker kit, as designed by Dave Berriman and featured in Hi-Fi News Feb/Mar 92, is still available - only from DBS Audio. To find out what these comprise, cost and how to order plus any other information on DBS products please telephone, fax or write in to the above address and numbers.

**D H M DESIGN**, - BUNDEE CD REPAIR PROTECTION SYSTEM - Tried and tested on Tomorrow's World. Repairs and protects over 50 CD's, even those scrubbed with steel wool. Effective for all laserdisc formats including CD ROM, MiniDisc and CDI. RRP £14.95. Why buy a new one when you can clean, repair and protect fifty? Contact David Mather for details of your nearest stockist or distributor. Export enquiries welcome. DHM Design Ltd, Studio 6, Bentinck Court, Bentinck Road, West Drayton, Middlesex. UB7 7RG. Tel: 0895 449559 Fax: 0895 420540

**ECA DISTRIBUTION**: For the "naturally neutral" chain. Nothing added, nothing taken away. The VISTA line-amp; The LECTERN S power-amp and the SERVO A.2 speakers. Resulting from their own Research and Development, the ECA Design Team provides a "super-symmetry" circuit with the barest minimum of wiring in the amps vacuum impregnated air-coils in the custom-made midrange unit for the speakers. P.O.Box 3023 London NW2 7RW. Tel: 081 830 5128

**IAN EDWARDS**, The Old Chapel, 282 Skipton Road, Harrogate, Yorks. Tel: 0423 500442. Somebody Somewhere must make better storage units for CDs, Music, LPs, HiFi, Books, etc. than Ian Edwards. BUT until he appears, why not send for the brochure showing a selection of HAND MADE units. To do this please send 3 x 2nd class stamps.

**E J JORDAN DESIGNS**, The Oak, Manor Bier, nr Tenby, S Pembrokeshire, SA70 8QR. Tel: 0834 871 209, or Fax: 0834 871 770. Curvilinear metal cones loud speakers were first developed by Ted Jordan in 1963. EJ Jordan Designs are now World Leaders in foil cone technology. First and foremost.

**ELECTROMAIL**, PO Box 33, Corby, Northants, NN17 9EL. Tel: 0536 204 555. The branch of the well known R.S. Components trade mail-order business that deals with the public. They have a huge range of components - and catalogues to match.

**EMF**, 2a Bellevue Road, Friern, Barnet, N11 3ES. Tel: 081 361 6734. Manufacturer of Sequel 50w integrated amplifier and the Crystal O2a converter. Amplifier and DAC. Please write in for details.

**FALCON ACOUSTICS LTD.**, Tabor House, Norwich Road, Mulbarton, Norwich, Norfolk, NR14 8JT. Tel: (0508) 78272. U.K. distributors of FOCAL drive units and SOLEN (chateaux) polypropylene capacitors and the largest inductor manufacturer in the U.K. Comprehensive range of DIY Speaker Parts and Kits. Sub-Bass and Electronic Filters.

"Everything but the wood"

**FARADAY SOUND**, 248 Hall Road, Norwich, NR1 2PW. Tel: 0603 762967. Loudspeakers in CONCRETE: the ultimate enclosure. Now you can build your own low density concrete cabinet enclosure Faraday FS1, Siren, FS5, FS10 or a design of your own choice. Stunning sound and reviews. Simple DIY skills only! Full instruction guide including cabinet construction for only £3.95. Includes reviews, photos etc. and at least £5 discount off any further products purchased from us e.g. ready made cabinets. Also £25-£150 off any complete loudspeakers!!!

**FOUNDATION AUDIO**, 53 Beecroft Way, Dunstable, Beds. LU6 1EE. Tel: 0582 477550 or Fax: 0582 604001. We have long been acknowledged as the market leader in sonically superior stands and major in 'specials'. Send for our brochure and details of your nearest stockists.

**FULLERS AUDIO**, 20 Tunbridge Road, Southend on Sea. Essex SS2 6LT. Tel: 0702 612116. Fuller's audio produce a range of innovative products. Amplification - a10 a single ended class A semiconductor power amplifier - £1200. b70 a mostel power amplifier of high standard - £599. pre1 and pre2 matching pre-amplifiers - £599. £649. gen1 prono stage for mm and mc cartridges £299 Loudspeakers - Pharos system upgradeable from 1 pair of cabinets to 3 pairs for truly extended bass, passive/active options £649-£2499. Spmix a 3 way floor standing unit £849. Sultan H.E., 98dB sensitivity £439. matching Sub Woofer £559. Sultan 91 5dB sensitivity £309

**F & S TRADING LTD**, 31 Brooks Road, Siltton Coldfield, West Midlands B72 1HP. Tel: 021 321 3357. "Single-ended amplifiers"

**J E SUGDEN & CO LTD.**, Valley Works, Station Lane, Heckmondwike, West Yorkshire, WF16 0NF. Tel: 0924 404088. Manufacturers of hand crafted audio products

'A world of Music'. Call or write in for information on our SDA-1 Digital to Analogue Converter, SDT-1 CD Player, A21a Class 'A' Amplifier, A25B Intergrated Amplifier, A48 Intergrated Amplifier, Au5ic Pre Amplifier, Au5ip Power Amplifier and more.

**JORDAN WATTS ACOUSTICS LTD**, Cyntra Place, 201 Mare Street, Hackney, London E8 3QE. Tel: 081 985 1646. Jordan Watts Acoustics for Sight AND Sound.

**KESWICK AUDIO RESEARCH**, 54 Coach Road, Outwood, Wakefield, W Yorks, WF1 3EX. Tel/Fax 0924 870606. "I'd say that the Figaro is the best miniature speaker I have heard" Audiophile March 1993. Write in or call for details on our full product range and your nearest stockist.

**KRONOS DISTRIBUTION**, 35 Furlough Road, Dungannon, N. Ireland, BT17 4DU. Tel: 0868 748632. Fax: 0868 448281. Kronos is the UK distributor of some of the finest Hi Fi products in Europe. These include Audiomeca digital products and turntables; Lieder silver speaker and interconnect cables; Pro-Ject turn-tables and amplifiers; Triangle speisers and electronics; and YBA amplifiers. We also handle Frameworks equipment tables; Arnon valve amplifiers and mains filters and Essex Audio digital products from the UK. Please telephone or write for product details and dealer lists.

**LANGREX SUPPLIES LTD**, 1, Mayo Road, Croydon, Surrey, CR0 2QP. Tel: 081 684 1166. Fax: 081 684 3056. We are one of the largest stockists and distributors of electronic valves, tubes and semiconductor in the UK. Over 6,000 types in stock. We specialise in obsolete types including original UK and USA made audio valves. Telephone or fax for an immediate quotation.

**LECSON SYSTEMS LTD.**, Unit 19, Nuffield Rd. Ind. Est., St. Ives, Huntingdon, Cambs, PE17 4LD. Tel: 0480 498211. Call for info on our range of integrated and four channel integrated bi-amplifiers. Stereoplus, Quattra and Quattraplas analogue and digital interconnects and loudspeaker cables. As a compliment to the LFD range of accessories GOLD plated mains 13A plugs and sockets now available.

**LOCKWOOD AUDIO**, Imperial Studios, Maxwell Road, Borehamwood, Herts, W06 1WE. Tel: 081 207 4472/ 081 207 4473. A Big Lane, Goose Green, Lambourn, Berks. RG16 7SQ. Tel: 0488 72267.

Specialist restoration of 301's and 401's using genuine spares and re-manufactured parts to original pristine standards in our newly built work shops designed primarily for these purposes.

**LYNWOOD ELECTRONICS**, Coley Lane Farm, Wenlworth, Rotherham, S62 7SQ. Tel: 0709 873667. Jenkin Floor Headphones and quality recordings from Proprius. Phonophone, Opus. MAP and Swedish Society. A complete range is now available to suit every system and every pocket.

**MAY AUDIO MARKETING U.K. LTD.**, 83 Main Street, Buryton in Whatfield, North Yorkshire. LS21 7BU. Tel: 0943 864930. Distributors of High Quality audio products from Duson Electronics, Totem Loudspeakers, Jekkin Floot Headphones and quality recordings from Proprius. Phonophone, Opus. MAP and Swedish Society. IF YOUR MUSIC YOU LOVE, TELEPHONE OR WRITE FOR LITERATURE.

**MICHELL**, 2 Theobald Street, Boreham Wood, Herts, W06 4SE. For full information on our full range of excellent products including the Gyrodec, Alecto, Iso Argo and others please telephone us on 081 953 0771.

Michell - Symbol of Precision  
**QUANTUM AUDIO LTD**, PO Box 26, 1 Oliphant Drive, Kilmarnock KA3 7JA. Tel: 0563 71122 Fax 0563 61133.

Quantum's craftsmen produce the £899.99 MINTSTREL 30 Watt, Ultra Linear, zero feedback correction, integrated, line level, valve amplifier. Don't buy any old fashioned valve amplifier before hearing the unique improvements modern technology provides to valve sounds. An audition will immediately convince the listener of the Mintstrel's superiority.

**SELECT SYSTEMS (PERFECT PITCH MUSIC)**, Hanworth Trading Estate, Hampton Road West, Feltham, Middlesex. TW13 6DH. Tel: 081 893 8662. Fax: 081 893 4318. We manufacture the Franconstein CD enhancement system. The Oculia DAC and Perfect Digital and Analogue interconnects. Perfect Pitch also provide frequency design, manufacture, prototyping and test, also valve and solidstate specials. Trade enquiries welcome.

**REL ACOUSTICS**, Unit 2, New Street, Bridgend Ind Est, Bridgend, Mid Glamorgan, CF31 3UD. UK. Tel: 0656 768 777. International +44 656 768 777. Fax: 0656 766 093. International +44 656 766 093. The UK's only specialist sub-bass speaker manufacturer. The only one that works! Get your dealer to give you a home demo and

find out what the fuss is all about.

**REL. HARMAN AUDIO**, Unit 2, Borehamwood Ind. Park, Rowley Lane, Borehamwood, Herts, W06 5PZ. Tel: 081 207 5050. Fax: 081 207 4572. Sub Base Systems - Rel. Strata, Stadium, Stentor, Studio

**RICHARD ALLAN AUDIO**, Bradford Road, Gomersal, Cleckheaton, W Yorks. BD19 4AZ. Tel: 0274 872442. Fax: 0274 869935. Manufacturers of very high quality loudspeaker enclosures and drive units. Examples being the £270 RA8 series 2 as supplied to the BBC and the 5" reviewed Minette 2 at £120

**SAMBELL ENGINEERING LTD**, Winston Avenue, Croft, Leicestershire, LE9 6GQ. Tel: 0455 283251.

**SEQUENCE DESIGN LTD**, 83 Main Street, Burley-in-Warfedale, Yorkshire. LS29 7BU. Tel: 071 495 0775. Fax: 071 495 0281. Slim loudspeakers which stand close to a wall or hang like pictures. 'Likely to cause a glint in the audiophile's eye (Audiophile)'; 'the answer to a prayer... a bargain in the extreme' (HiFi News). Available with light or dark grilles and various solid wood finishes. From £199.95 a pair. Call or write in for an information kit and reviews re-prints.

**SHEARNE AUDIO**, PO Box 22, Stevinge, Herts, SG2 8HF. Tel: 04387 40953. Following the success of John Shearn's Phase 1 pre power combination, (reviewed in HWF), is the phase 2 reviewed earlier in HWF and listed as a world favourite. Having many of the design features of the phase 1 R.R.P. £549, 50 wpc and same finish as Phase 1 pre-power. Also, option of phono stage for phase 2 mm £65 mc £75

**SLATE AUDIO**, makers of 'THE FINEST SPEAKER SUPPORTS IN THE WORLD' have never had a bad review, our reputation is legendary. Contact us now for details on our CUSTOM STANDS, as well as our solid marble GARRARD 301/401 PLINTH SYSTEM (Hi-Fi World Dec 93) THE GLASSMAT platter mat and the very special SME GARRARD 301 or 401 CELEBRATION ARMS. 47 Gemini Close, Leighton Buzzard, Bedfordshire, LU7 8UD. Tel: 0525 384174.

**THE SPEAKER COMPANY**, Unit 9, Waterside Mill, Waterside, Macclesfield, Cheshire, SK11 7HG. Tel: 0625 500507. The Speaker Company are a new company offering a wide range of loud speaker units from Audax, Celestion, KEF, Morel SEAS and many more. Also a wide range of speaker accessories the keen builders.

**THE TDI GROUP**, Unit 1 Summerlea Court, Alton Road, Herriard, BASINGSTOKE, Hampshire. RG25 2PN. Tel: 0256 381 514. Fax: 0256 381 692. Electronic Components distributors specialising in; Mains Power Connectors, Jack Plugs and Sockets, 4mm Connectors, Din and Mini Din Connectors, Phono Connectors, DC Connectors, XLR Connectors, Rotary Potentiometers, D Type and IDC Type Connectors, Co Axial and BNC Connectors, Switches, LEDs, Diodes, Bridges and Rectifiers, Fuses and Thermal Tips. - Have you got one of our new 1994 General Product Catalogues?

**TARGET AUDIO PRODUCTS PLC**, Britannia House, Leagrave Road, Luton, LU3 1RJ. The Audio equipment, rack and speaker stand specialist. For information on our products please telephone or write.

**TRICHORD RESEARCH LIMITED** Following on from the highly acclaimed CD clock oscillator modifications the Pulsar Series One digital to analogue converter. This unique design is part multibit and part bitstream to give absolute linearity over an extremely wide dynamic range. Switchable between 18 or 20 bit resolution this converter will become the standard for CD replay. For details telephone (0684)573524

**WOLLANTON AUDIO**, 134 Parkside, Wollanton, Notts, NG8 2NP. Tel/Fax: 0602 284147. Imported high end at lower prices. XLO interconnects and loudspeaker cables - "The Best in the World" Ciements loudsprating ribbon and transmission line technology to reproduce the finest sounds. Monarchy digital - trant, DAC - DAC - pre and DIP anti jitter module. Matches the best at a fraction of the price. "NEW" Audio Valve aers - Simply gorgeous. Call us for details.

**WILMSLOW AUDIO LTD**, Wellington Close, Parkgate Trading Est, Knutsford, Cheshire WA16 8DX. Tel: 0565 650605. Extensive range of drive units and over 30 different designs of self-assembly kits. Everything required for the loudspeaker builder and four dem rooms to listen to the kits in built-up form.

To Advertise in this section,  
please contact  
Caroline Knott on:  
071 266 0969

# Classical

## Peter Herring

**I would imagine there must be as many 'nouveau classiques' each year as there are 'nouveau vins' and, like wines, there are many which will only ever qualify as 'vin de table', while a select few will acquire vintage status. And, to pursue the wine analogy, there are some which are fit only for flushing the drains.**

**Which of the 1994 will acquire that vintage status? I've a dozen-or-so nominations drawn from this year's reviews, ranging from the familiar made fresh by some inspired performances, to the kind of discoveries which can excite even the most jaded ear (and they don't come more jaded than those of a record reviewer).**

One of music's hoary platitudes is that Georg Philip Telemann was merely a journeyman composer providing lightweight entertainment for his patrons and of far inferior stature to his contemporary, Johann Sebastian Bach. This is ignorance masquerading as judgement and is perpetrated by those who believe Bach could do no wrong (as a clique, exceeded only by those who tell you that Mozart never put a foot – or a note – wrong). In his time, Telemann was regarded not just as Bach's equal but, his superior and if you explore his chamber music, you'll discover that those seventeenth century 'musos' were by no measure misguided fools.



Of course, Telemann's music – anyone's music – can sound dull if played by unresponsive and unsympathetic players. The Drottningholm Baroque Ensemble does not fall into that category. They play with an enthusiasm and relish that suggests they are discovering the pleasures of Telemann's music and they want to make sure that you, the listener, make the same discovery. The Ensemble is directed by Nils-Erik Sparf in a generous selection of Telemann's chamber music on the Swedish label BIS, which is imported into the UK by Conifer Records. The sound is as lively and engaging as the playing and the catalogue number is BIS CD-617.

The Drottningholm players also contribute to another of the year's finest recordings, this time on Decca's L'Oiseau-Lyre label. Here, it's not a case

of discovery, more a scrub-down for one of music's monuments, Mozart's Die Zauberflöte (The Magic Flute). Arnold Ostman directs a performance of wonderful freshness and clarity, one that while not eschewing the traditions of the work, is not weighed down by them. This, you feel, is how Mozart surely intended it to be conveyed; it is after all very much a bizarre pantomime graced by great music. Whether it does or doesn't have a hidden agenda comprehensible only to magicians and masons is irrelevant. Ostman, aided by a generally excellent team of soloists (with Sumi Jo as the Queen of the Night the pick of them) takes the opera at face value and produces a performance which is not only the best of the period instrument recordings, but one of the handful of great interpretations on record. You'll find the Drottningholm Zauberflöte on L'Oiseau-Lyre 440 085-2.

Just as there isn't one great Magic Flute, so there isn't one version of Mahler's Ninth Symphony which towers above the rest. I love this work – it would be with me on the proverbial desert island – and I enjoy having several recordings in my collection, all of which possess special qualities: Abbado,

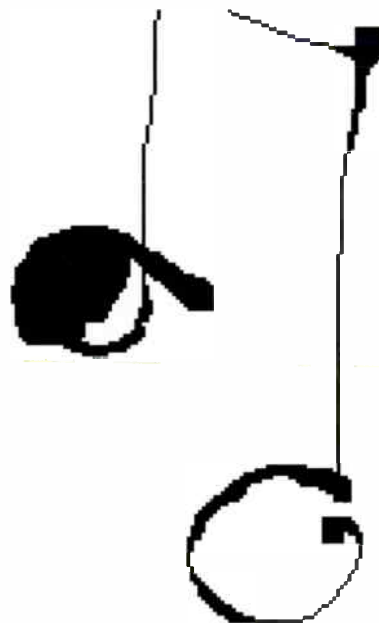

# Classical

Barbirolli, Kubelik, Walter among the conductors. It's also richly satisfying to be able to add to these personal favourites and the live recording by the Russian conductor Rudolck Barshai has slotted in without difficulty alongside the names above.



It is, as with all great interpretations of this score, an intensely personal view, conscious of the deliberate banalities of the work as well as its visionary beauty. If the acid test is, does it involve you, does it convince you, then Barshai scores on both counts. The recording is wholly acceptable and if the playing of the Moscow Radio Symphony Orchestra hasn't the polish of Abbado's Viennese or Barbirolli's Berliners, it lacks nothing in commitment. Rudolck Barshai conducts Mahler's Ninth Symphony on BIS CD-632.

Another fine Russian conductor whose recordings always merited considered evaluation was the late Kiril Kondrashin. It is a sad irony that, at a time when mediocre musicians in the west



were being given the freedom of the studio – and the budget – to chum out innumerable equally mediocre recordings, the opportunities for the like of Kondrashin were so cruelly limited by a political divide. However, enough survives to vouch for Kondrashin's undoubted qualities, including some tapes he made in The Netherlands towards the end of his career. These radio recordings have now been issued by Philips in what, according to the label's marketing-speak, is a strictly limited edition. For me, the plum is a coupling of two of the most elusive, multi-layered and even puzzling symphonies of this century, Shostakovich's Sixth and Nielsen's Fifth, both in performances which are nothing short of revelatory. These are concert recordings and some audience noise does intrude, but the performances are riveting and there are telling contributions from every department of the Royal

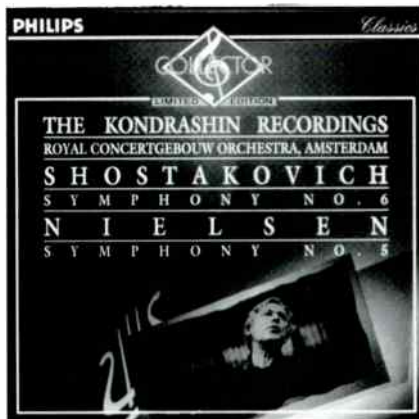

Concertgebouw orchestra of Amsterdam. Kiril Kondrashin conducts Nielsen and Shostakovich on Philips 438 283-2.

Staying with twentieth century symphonies, no lover of Vaughan William's music will want to be without a couple of vintage performances in Sony classical's British Pageant series. On an exceptionally well-filled CD, Dmitri Mitropoulos conducts an electrifying Fourth Symphony, one that brooks no compromise when it comes to harsh, even violent sonorities of this extraordinary work. "I don't know if I like it, but it's what I meant," remarked the composer, and here the listener can get some inkling of the impact the symphony must have had on the audience at the premiere in 1935.

It has been generally believed, certainly by me, that the first recording of Vaughan William's Sixth Symphony was



made by Sir Adrian Boult for HMV. Not so: Boult was pre-empted by Leopold Stokowski and this New York performance is coupled with Mitropoulos's Fourth. It isn't in quite the same league, both in the playing and the interpretation but remains a valuable – and historical – document. Vaughan William's Fourth and Sixth Symphonies are on Sony Classical SMK58933 and, sandwiched between the symphonies is a splendid performance of the Tallis Fantasia.

If this Vaughan Williams disc is a bargain, then so is George Hurst's memorable performance of Elgar's First Symphony on the budget Naxos label. This seems to have been one of those sessions when everything just came together: the BBC Philharmonic Orchestra plays out of its collective skin and the hugely underrated George Hurst appears determined to demonstrate his status as an Elgarian. The result is utterly compelling, and a reminder of how fine a work this symphony is, easily comparable to any written across the channel during the late nineteenth and early twentieth centuries. If you don't believe me, invest a fiver or so in Naxos 8.550634.

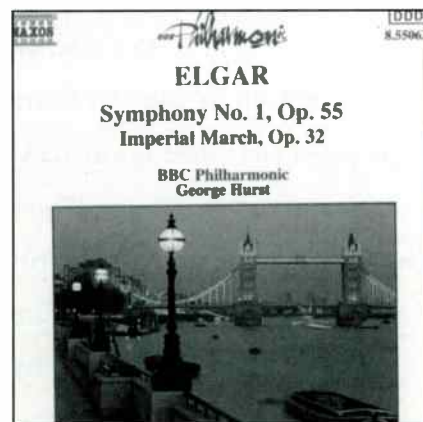

English music from a much earlier period is collected under the heading 'Elizabethan and Jacobean Consort Music' by the New London Consort under Philip Pickett on a Linn Records issue. Among the better-known of the composers features are William Byrd, Thomas Campion, Anthony Holborne, John Jenkins and Thomas Morley and, inevitably, there is a contribution from the



ubiquitous Anon.

It is fifty minutes or so of delightful music-making, with soloists Catherine Bott and Michael George in splendid voice. The textures are richly-coloured, the programme well-judged in terms of contrast and sonorities, and the recording is convincingly atmospheric; the sum of the parts exudes a soothingly hypnotic spell and you'll find it on Linn **CKD011**.

I found a similarly spell-binding quality to the sacred music of Nicholas Ludford, as indeed have many others to judge by the commercial and critical success of the series on ASV's Gaudeamus label. Ludford was born around 1485 and died circa 1557 and, for much of his life, was a member of St. Stephen's Chapel, Westminster. That is about as much as any musical dictionary will tell you, but reference to Frank Harrison's lucid evaluation of early English polyphony in volume three of the New Oxford History of Music will give an illuminating insight into Ludford's importance and his contribution.



What Frank Harrison says in words, ASV's recordings convey with equal eloquence in sound. Andrew Carwood directs The Cardinal's Musick and makes a very persuasive case for Ludford with each of his recordings. The Missa Benedicta et venerabilis and the Magnificat Benedicta, coupled together on ASV **Gaudeamus CDGAU132**, are outstanding settings in every respect.

How much more music awaits discovery among the archives of the British Museum, or those of our great cathedrals and universities? You would imagine that, of all Renaissance

composers, the music of the Italian, Giovanni Pierluigi da Palestrina – regarded by many as prince of polyphonists – would be amply represented in the catalogue. This is far from the case; indeed, surprisingly few of his Mass settings have been recorded outside the more famous works, the Missa Papae Marcelli and the Missa Brevis, for example.

Over recent years, recordings by the Tallis Scholars have introduced several important Mass settings to the catalogue for the first time and, to commemorate the four hundredth anniversary of Palestrina's death in 1594, these have all been brought together in a superb four-CD set (not fourteen-CD as somehow appeared in the original review!). The set is an incomparable introduction to Palestrina's music, with Peter Phillips directing performances of remarkable insight and scrupulous scholarship, but with no lack of fervour or colour. Given the time-span of the recordings, the sound quality is astonishingly consistent; and the qualities of clarity, line and purity of tone that Phillips has always sought from his choir are evident from first-to-last. The Tallis Scholars commemorate Palestrina on **Gimell CD GIMB400**.

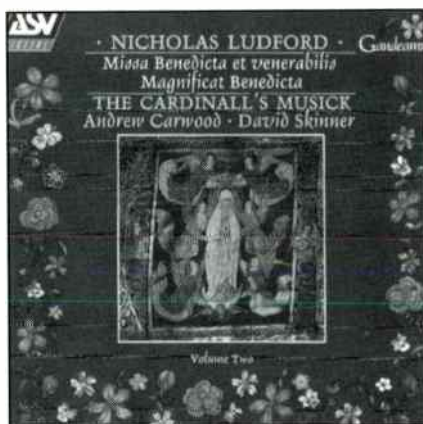

All the Tallis Scholars' recordings come into the category of a 'collectable series'. Another such series which was enhanced this year is the Lindsay Quartet's 'Bohemians' on ASV. As the name implies, this features Czech composers and has already brought first-class recordings of string quartets by Dvorak, Smetana and Janacek. In the newest addition to the series, the Lindsay Quartet is augmented by that fine pianist Peter Frank in Dvorak's Piano Quintet Op81 and the Piano Quintet No2 of

Bohuslav Martinu. The combination makes for thrilling music-making, superbly recorded on **ASV CD DCA889**.

And if you enjoy the thrill of first-class recording along with performances of stature, then Leonard Slatkin's Britten issue on RCA Victor will not disappoint. He offers the most famous of Britten's orchestral pieces – the Young Person's Guide to the Orchestra, the Sinfonia da Requiem, the Sea Interludes and Passacaglia for Peter Grimes and the Chacony and the London Philharmonic is in top form throughout. It's on **RCA Victor Red Seal 9026 61226 2**.

Herbert Blomstedt's San Francisco Symphony Orchestra comes into the same category with a CD which shows commendably imaginative programming in contrasting Richard Strauss's Ein Heldenleben (A hero's Life) with that most poignant and heartfelt work of his later years, Metamorphosen. Music which is worlds apart because the world in which they were created had changed so radically. It is sumptuously recorded on **Decca 436 596-2**.

My selection ends as it began, with a recording from Robert von Bahr's BIS label. Not only can you discover Telemann with BIS, but also the often extraordinary sonorities of the chamber music of Heinrich Ignaz Franz Biber, with



some dazzling violin playing by Maria Lindal. Biber, who died at the age of sixty in Salzburg in 1704, was himself a violin virtuoso whom the Concise Oxford Dictionary of Music succinctly describes as a "considerable composer for this instrument". They're right, as Maria Lindal and Ensemble Saga prove on **BIS CD-608**.

Classical

# THE RECORD SHOP

66 FIFE ROAD  
KINGSTON-UPON-  
THAMES  
SURREY  
KT1 1SP  
TEL: 081-546 3880  
FAX: 0372 360996  
EST. 1968

SPECIALIST IN NEW VINYL  
RECORDS

- CHESS BLUES ALBUMS (US VINYL) - £8.49 EACH  
MUDDY WATERS - 'ROLLING STONE'  
BUDDY GUY - 'CHESS MASTERS'  
MUDDY WATERS - 'RARE AND UNISSUED'  
JOHN LEE HOOKER - 'PLAYS & SINGS THE BLUES'  
SONNY BOY WILLIAMSON - 'DOWN & OUT BLUES'  
JOHN LEE HOOKER - 'REAL FOLK BLUES'  
LITTLE WALTER - 'HATE TO SEE YOU GO'  
AZYMUTH - 'LIGHT AS FEATHER' - £7.49  
JOHN COLTRANE - 'BLUE TRAIN' - £8.95  
KEITH JARRETT - 'ARBOUR ZENNA' - £3.99  
TONY REMY - 'BOOF!' - £10.49  
(1ST GRP VINYL IN 2 YEARS!)
- HERBIE HANCOCK - 'MANCHILD' - £7.49  
MILES DAVIS - 'DOO BOP' - £7.99  
ALAN PARSONS - 'TRY ANYTHING ONCE' - £9.99  
BONNIE RAITT - 'LONGING IN THEIR HEARTS' - £9.95  
DOORS - 'FULL CIRCLE', 'OTHER VOICES' - £7.99 EACH  
JOHN MARTYN - 'APPRENTICE', 'COOLTIDE' - £8.99  
BEATLES - ALL TITLES IN STOCK  
£9.95 EACH, EXCEPT:  
WHITE ALBUM - (2LP) - £11.95  
1962-66 (RED 2LP COMP) - £12.50  
1967-70 (BLUE 2LP COMP) - £12.50  
MAZZY STAR - (1ST ALBUM) - £8.99  
BARBARA STREISAND - 'BACK TO BROADWAY' - £9.99  
GRANT LEE BUFFALO - 'FUZZY' - £9.49  
BEACH BOYS - 'PET SOUNDS' - £5.99  
CROWDED HOUSE - 'WOODFACE' - £5.99  
DANIEL LANOIS - 'FOR THE BEAUTY OF WYNONA' - £12.95  
SANDY DENNY - 'WHO KNOWS WHERE THE TIME GOES'  
(4LP BOX SET +BOOK - £30.95)
- BOB DYLAN 'MORE GREATEST HITS' - £9.95  
(2LP, 2 UNRELEASED TRACKS - HAVEN'T SEEN THIS  
FOR TWO YEARS AT LEAST!)
- GILL SCOTT HERON'S AMNESIA EXPRESS  
'LIVE IN EUROPE' - 2LP - £8.95  
ANDY SHEPPARD - 'IN CO-MOTION' - £4.99  
BILL BRUFORD - 'MASTER STROKES 78-85' - £4.99  
(FEATURES ALLAN HOLDSWORTH & JEFF BERLIN)
- GEORGE BENSON - 'BEYOND THE BLUE HORIZON' - £5.99  
(US VINYL - CLASSIC CTI WITH RON CARTER &  
JACK DE JHONNETTE  
HINDU LOVE GODS - £4.99  
(WARRN ZEVON WITH BILL BERRY, PETER BUCK &  
MIKE MILLS OF R.E.M.  
ANGELIQUE KIDJO 'LOGO 30' - £6.95  
MARY COUGHLAN - 'SENTIMENTAL KILLER' - £4.99  
PAUL BRADY - 'TRICK OR TREAT' - £5.99  
ROBERT CRAY - 'I WAS WARNED' - £5.99  
IAN MCNABB - 'TRUTH & BEAUTY' - £6.49(2LP)  
HARRY CONNICK JNR - 'WHEN HARRY MET SALLY' - £6.49  
CHRIS REA - 'ON THE BEACH' - £5.95  
PACO DE LUCIA - 'ZYRYAB' - £6.49  
4 NON-BLONDES - 'BIGGER, BETTER, FASTER, MORE' - £9.95
- MAJOR STOCKIST OF ECM, LINN, ORIGINAL JAZZ CLASSICS, BLUE  
NOTE & ACID JAZZ. WE ARE NOT TIED TO ANY PARTICULAR TYPE OF  
MUSIC. WE LIKE EVERYTHING ON VINYL. HEAVY TO AMBIENT!
- POSTAGE & PACKAGING £2.00 +50P PER ALBUM  
THEREAFTER WE DON'T SKIMP ON THE PACKING - AND ALL LP'S  
ARE POSTED WITH POLY-LINED INNER SLEEVES
- SO PICK UP THE PHONE AND ASK FOR TIM OR MARTIN  
(SECOND HAND VINYL ALSO AVAILABLE)

ACCESS/VISA WELCOME

## TABULA RASA LOUDSPEAKERS



"It is a rare experience to play a track that you have known for the better part of, say, twenty years and suddenly, to hear new details and information."

(Hi-Fi World - Dec '93 on CT77 loudspeaker kit)

With the increased popularity of "do it yourself" hi-fi, Tabula Rasa are offering an extensive range of quality loudspeaker kits and car audio kits from top German manufacturer Mainhattan Akustik.

All loudspeakers kits are simple, fun to build, and at prices to suit

all pockets. Each kit comprises drivers, filters, connections, terminals, and all the necessary fittings needed to complete your chosen loudspeaker, and every kit is available with or without cabinets. Furthermore, each kit comes with a 10 year warranty as standard and will be delivered within 14 days of confirmation of your order. For a catalogue (including price lists and a brief guide to speaker construction) please send £2.00 (refunded after first kit purchased) and a self addressed A4 envelope to:

**Tabula Rasa, 136 Kilnwood, Walters Ash, High Wycombe,  
Buckinghamshire, HP14 4UR, Tel 0494 565116**

Cheques and postal orders should be made payable to Tabula Rasa.  
Trade prices available on request.  
30 days money back guarantee offered  
on all drivers & kits.

## Wilmslow Audio

### THE ULTIMATE HI-FI EXPERIENCE

Arcam Aiwa Audiolab B&W Castle  
Denon Dual Heybrook Kef Marantz  
Monitor Audio Mordaunt-Short  
Nakamichi Qed Revolver Rogers  
Tannoy Target Teac . . .  
*Britain's leading loudspeaker kit  
and drive unit suppliers*

Catalogue of our full range £2.00

*Four demonstration rooms*

Wellington Close, Parkgate Trading  
Estate, Knutsford, Cheshire WA16 8DX  
(Dpt HFW)

No appointment necessary Closed  
Monday

Telephone (0565) 650605

Fax (0565) 650080



# Hi-Fi World Dial-a-Dealer

**AUDIO EXCELLENCE** 'Where the music matters' 65 Park Street, Bristol BS1 5PB. Tel: 0272 264975 Fax: 0272 251327. Great Hi-Fi carefully selected and demonstrated by friendly enthusiastic staff. Home installations and check-ups. Two year warranty, from our own service department. Open 9.00-5.30 Tuesday - Saturday, closed Monday.

**PAUL GREEN HI-FI LTD.** Kensington Showrooms, London Road, Bath, Tel: (0225) 316197. Musical Fidelity, Krell, Creek Rogers, Quad, Cust. car park, Best collection in the West.

**VAUDIO**, 36 Druid Hill, Stoke Bishop, Bristol, BS9 1EJ. Tel: 0272 686005. ATC, Acoustic Energy, Ruark, AVI, Exposure, Pink Triangle, Wadia, Audio Innovations, SME (incl. 20A), Chord Amps, Mitchell, AMC, Analogue Electronics, Cadence Valve, Jarno LFD REL Sansui, Sonic Link, Stax, Townsend, Audio Technica, Goldring, LRS, Ortofon Sumiko Demos by appt only. Home trial facilities. Free install. service facilities.

## HEREFORDSHIRE

**WENTWORTH AUDIO** 83 High Street North, Dunstable Beds. NU6 1JJ. Tel: 0582 6633 83. Marantz, Pioneer, Rotel, Audioblab, Mission Cyrus, Moth Sony, HK, NAD, Pink Triangle, Yamaha, Systemdek, Albury etc. Free installation & delivery. Home demos. Part exchange. Interest free credit - 6-9-12-18 & 24 month terms. Free car parking at rear of shop. Free refreshments (alcoholic or otherwise) 11. Open 10-6pm Tues-Sat.

**TECHNOSOUND LTD.** 79 West Street, Dunstable, Beds. Tel: 0582 663297. See our main entry under Bucks.

## HEREFORDSHIRE

**NEWBURY AUDIO** 2 Weavers Walk, Northbrook Street, Newbury, Berks, RG13 1A1. Tel: 0635 33929. Linn, Creek, Epos, Denon, Nakamichi, Shihmian, Marantz, Microomega, JPW, Ruark, Single speaker dem room. Appt necessary. Home trial facilities. Free install. service dept. late appts. Access/Visa. Interest free credit subject to status. 6 days 9.30am - 6.00pm.

**ARC AUDIO**, 9 Dukas Ride, Crowthorne, Berks, RG1 16LZ (0344) 62201. Denon, Harman, Kardon, JPW, Marantz, Monitor Audio, Onyx, Rogers, Tannoy, Thorens, Yamaha. Demonstration facilities. No appointments necessary. Home trial facilities. Free installation. Access. Visa. Diners. Open Mon-Sat 9-6pm (closed Wed at 1pm).

**READING HI-FI CENTRE**, 4 Queen's Walk, Reading RG1 7DF. Tel: 0134 585463. The best equipment, advice and service from Berkshire's premier Hi-Fi emporium! Products include: Arcam, exposure, Audioblab, Meridian, Rotel, Sony, sennheiser, Top Tape Centre, and many more.

**ASTLEY AUDIO**, Watlington, 0491 839305. See our entry under OXFORDSHIRE.

## BUCKS

**D. L. CHITTENDEN LIMITED** 59-61 The Broadway, Chesham Bucks, HP5 1BX. (Opposite Boots). Tel: 0494 18444. Philips, Denon, Kenwood Canon Audio, Koss, Wharfedale, Mitsubishi, Target, Grundig, QED, Mordaunt-Short, Toshiba, Dolby Project Systems, Nicaam TV and Video, Surround Sound, AV Systems. Showroom. Demonstrations from expert and friendly staff. No appointments necessary. Service Department. Credit facilities available. Open 8.30 to 5.30 Mon-Sat.

**AUDIO INSIGHT** 53 Wolverton Rd, Stony Stratford, Milton Keynes, Bucks. 0908 561551. See our main entry under Technosound.

**DEJAC HI-FI Consultants**, 21 the Broadway, Old Amersham, Bucks, HP7 0XK. Tel: (01494) 433173. AMC, Arcam, Bose, Meridian, Quad, Denon, NAD, Tannoy, Mission, TDL, 2 dem rooms. Appts necessary. Free installation. Priority finance. Instant credit. Open 9.30-5.30 pm including Saturdays.

**NORTHWOOD AUDIO LTD** 1, 98 Cambridge St, Aylesbury, Bucks HP20 1BA. Tel: 0296 28790 (AP). Selected sounds from Alchemist, Anna, Biston, B & W, Cabletta, Castle, Celestion, Denon, Exposure, Gyrodec, Harman, Kardon, Heybrook, Marantz, Microomega, Monitor Audio, Moth, NAD, Nakamichi, Ross, Rotel, Royal Rhapsody, Systemdek, Tannoy, TD, Thorens etc. Expert orders welcome. 2 Dem. rooms. Credit facilities available.

**TECHNOSOUND LTD** 7 Granville Square, Wilton, Milton Keynes MK15 9UL. Tel: 0908 604949. Audiophile Hi-Fi Specialists. All major brands stocked from Arcam to Yamaha. Demonstration facilities and expert advice. Mon-Sat 9.30 - 5.30 late night Friday. Credit Cards accepted. Finance available.

## CAMBRIDGE

**CAMBRIDGE HI-FI** 1-3 Hawthorne Way, Chesterton, Cambs. CB4 1AT. Tel: 0223 67773. Kenwood, Pioneer, Arston, Kef, Technics, Yamaha, Marantz, B&W, AR, Mordaunt-Short, Bose.

Single speaker dem room. Tues-Sat 9.30-5.30pm. Closed Monday. Free install. service dept. Vis/Access credit facilities.

**STEVE BOXSHALL AUDIO**, 41 Victoria Road, Camb. CB4 3BW. Tel: 0223 68305. 10.00-6.00pm 6 days. 3 dem rooms. Denon, Rotel, Yamaha, Mission, Nakamichi, Wadiao, Audioblab, Marantz, Krell, Martin Logan, Magneplanar, Wadia. Home trial facilities. Appointments preferred. Free install. and service dept. Access/Visa.

**FENWAY**, 5 High St, Ely. Tel: 0353 664421. Contact Gary Holland For Sony, Technics, Rotel, Tannoy, Pioneer, QED, equipment and accessories. Demonstration facility. In-House Service Dept.

**SWIFT HI-FI**, St. Annes Parade, Wilmslow. 0625 526213. Aura B&W, Denon, Kenwood, Marantz, NAD, Pioneer, Rotel, Systemdek, Tannoy, Revolver, J.P.W., M. Short, Mission, Celestion, Technics, Audioblab, Castle. Open 9.30-6. Dem room. No pressure. BADA member.

**THE HI-FI SHOWROOMS** 12A West Str, Congleton, Cheshire (0260) 280017. 1 Stanley St, Leek (0533) 383780. Celestion, Creek, Exposure, Marantz, Musical Fidelity, Pink Triangle, Project Rotel, Ruark, Systemdek, Tannoy, Technics, 5 Dem Rooms. No appts. nec. Home trial. Free install. Service/Dept. Access/Visa. Lombard Tricity. Open 9-5.30, Closed Wed.

**HALE HI-FI**, 2 Bold St, Hale Road, Altrincham, Cheshire WA14 2ER. Tel: 061 929 0834. Open Mon - Sat 10am-6pm & later by appointment. Specialising in equipment by: Nam, Quad, Royd, Nad, Denon plus selected others. Large range of quality accessories. On site service department. Installation & delivery. Home demonstrations a pleasure.

**ASTON AUDIO** 4 West Street, Aldeney Edge, Cheshire. Tel: 0625 582704. Products include: Celestion, Creek, Yamaha, Monitor Audio, B&W, Awa, Aura, AKG, Musical Fidelity, Tannoy, Sennheiser, Marantz, Dual, Denon, Quad, Sansui, Technics, Spendor, Mission, SME, Nakamichi, Audioblab, Rogers, Audioquest, Mordaunt-Short, Meridian, Deltac, Roksan, Arcam, Kef, NAD, Cyrus and others. Discount CD and tape. Extended guarantee. Interest free credit and written details on request.

**CHRIS BROOKS AUDIO**, 29 Gaskell Street, Stockton Heath, Warrington, Cheshire WA4 2UL. Tel: (0925) 261212. Tues-Sat 10.00-6.00. 2 dem-rooms. credit facilities. All credit cards. Established 1978. Total absence of bulls!.

**CONGLTON HI-FI**, 11a Duke St, Congleton, Cheshire, CW12 1AP. (0260) 297544. Acoustic Energy, Arcam, B&W, Denon, Epos, Linn, NAD, Nakamichi, Onyx, Royd, Target etc. Superior appointed single speaker dem. facilities. No appointments necessary. Home trial facilities. Free installation. 2 year guarantee on all equipment. Access. Visa. Open Mon-Sat, closed Weds.

**DOUG BRADY HI-FI**, Kingsway Studios, Kingsway North, Warrington, Cheshire WA1 3NW. (0925) 820009. Largest choice of specialist hi-fi in NW. All credit cards. 3 dem rooms. Fair demonstrations and home trial facilities. Open 6 days.

**PRACTICAL HI-FI**, 88 Bridge Street, Warrington WA1 2RF. Tel: 0925 632179. See our main entry under Preston, Lancs.

## CLEVELAND

**GILSON AUDIO LTD**, 172 Borough Rd., Middlesbrough (0642) 246793. Linn, Exposure, Arcam, Mission, Cyrus, Denon, Marantz, Rotel, Pioneer, Audioblab, Tannoy. Demonstration facilities in estate shop and one demonstration room. Appointments necessary. Home trial facilities. Free installation on request. Service department. Access/Visa. H.P. 10-5-6 days.

**ACTION ACOUSTICS**, 155-157 High Street, Rodran, Cleveland TS10 3AN. 0642 480723. Audio Innovations, Denon, Harman, Kardon, JBL, Michel, Musical Fidelity, Pink Triangle, Relox, Rogers, Thorens, etc. Dem room. Appointments nec. Home trial facilities. Free installation. service dept. Access. Visa & HP. Open 9.15-5.30.

## CORNWALL

**RUF AUDIO VISUAL**, 84 Pendarves Street, Tucking Mill, Camborne, Cornwall TR14 8NJ. 0209 710777/612260. TDL, Michel, Musical Fidelity, NAD, Nakamichi, B&W, SME, Microomega, Pink Triangle, Project, Revelation, Harman, Kardon, Triangle, Hifonics, dem show room and trial rooms. Home demos. Appts nec. Home trial. Free install. service dept. All cards. Switch and Transax. Open Mon-Sat 9.30-5.30.

## CUMBRIA

**MISSIONS SOUND & VISION**, 11 Warwick Road, Carlisle CA1 1DH. Tel: (0228) 22620. Bang & Olufson B & W, Castle, Sonic Link, Quad, NAD, Yamaha, Sony, Rotel, Demo Suite. No appts nec. Home trial facilities. Free installation. Service Department 9-5.30 Mon-Fri, Thurs 9-1, Sat 9-5.

**PRACTICAL HI-FI**, 106 English Street, Carlisle, CA3 8ND. Tel: 0228 44792. See our main entry under Lancaster.

## DEVON

**THE HI-FI ATTIC**, 58 New George St, Plymouth Devon PL1 1RR. 0752 669511. We stock most leading brands including Linn, Arcam, Denon, Pioneer, Musical Fidelity amongst others, and have an expert enthusiastic staff. Premises include attractive hi-fi and home cinema demonstration rooms. We offer free installation and credit facilities (written details on request) also a fully equipped service department. We can also provide a mail order service for all your LaserDisc requirements. We accept Visa, Access, Amex.

**CELESTION LTD**, 33 Walnut Road, Chelston, Torquay, Devon TQ2 6HS. Tel: (0803) 606863. Denon, Marantz, Rotel, Musical Fidelity, Acoustic Energy, NAD, Castle, Heybrook, Celestion, JPW etc. Two dem rooms. Home trial. Free installation. Access. Visa, Amex, Diners, Hi-Fi Markets Chargecard. Credit facilities. 9.30-7.30 Mon-Fri, 9.30-6.00 Sat.

**UPTON ELECTRONICS** 31 Torquay Road, Paignton Devon TQ3 3DT. Tel: 0803 551329. Pioneer Reference Point Dealer. Denon, Sony, Technics, Harmon-Kardon, Orelle, Kinshaw, Creek, Quad, Audio-Innovations, Target, Tannoy, Mordaunt-Short, Castle TDL, Ruark, JPW, Royd, Project, Monitor-Audio, Microomega, Chord, van der Hul, Jomo. Full range of accessories etc. Demonstration room. Home demos. Free delivery and installation. own in-house service dept. Access/Visa, Amex, Diners, Hi-Fi Markets Chargecard. Credit facilities. 9.00 - 5.30, 9.00 - 1.00 Wed.

## DERBY

**STRAD TRADITIONAL AUDIO**, 29 Meadowfield, Whaleybridge nr Buxton, Derbyshire SK12 7AX. Tel: 0663 733383. We construct custom made reproductions of classic 1950's loudspeaker enclosure designs using authentic blueprints. These have never been bettered for valve amplification. Requests for specific designs considered and researched. Superb new speaker units from Richard Allan and Lowther are used.

**ACTIVE AUDIO**, 12 Osmaston Street, The Spot, Derby, Tel: 0332 380356. Fax: 0332 385185. We have three studios including a dedicated Audio Visual studio for the demonstration of quality equipment from the largest range in the Midlands. Open six days per week. Own service department. Free local delivery. Home trial facility. Current special offers and buyers fact pack and quotation on request.

## DEVON

**DAWSONS**, 23 Seamount Road, Westbourne, Bournemouth Dorset, 0202 764965. B&O, Castle, Canon, Jamo, JBL, Pioneer, Sony, Target, TDL, Technics. No appts necessary. Free installation. Service dept. Various credit facilities available. Open 9-5.30 6 days a week.

**SUTTONS HI-FI**, 18 Westover Road, Bournemouth, Hants. Tel: 0202555512. Linn, Arcam, Mission, Quad, Audioblab, Rotel, Yamaha, Denon etc. 2 single speaker listening rooms. Home demonstrations and free installation. Mon-Sat 9.00-5.30. Call for details.

## DEVON

**BRENTWOOD HI-FI FIDELITY**, 2 Ingave Road, Brentwood, Essex CM15 8AT. Tel: 0277 221210. Audio Innovations, Castle, Chord, Crimson, Denon, DNM, E.A.R., Impulse, Mission, Microomega, NAD, Pink Triangle, Project, QUAD, Ruark, Rehdero, Shear Audio, Systemdek, Tannoy, TDL, Thale Audio. Single speaker dem rooms. Home trials, demos and installations. Mon-Sat 9.30-5.30. Access/Visa. Home service facilities. Simply THE place to visit if you're serious about music.

**TWENTY 20 AUDIO VISUAL LTD**, Unit 205 Lakeside Shopping Centre, West Thurrock, Grays, Essex DM16. Tel: 0708 891818. Fax: 0708891300. For your total home entertainment requirements. From a 2' Cassio to a 50" Pioneer screen. Dolby surround specialists with three dem rooms dedicated to pro-logic, laser disc software in stock from Harman, Kardon. Pro Logic from Yamaha, Marantz, Pioneer, Technics, Kenwood and B&O.

**RAYLEIGH HI-FI**, Chelmsford, 216 Maulstram St. 0245 265245. **RAYLEIGH HI-FI**, Rayleigh 44a High Street. 0268 779762. **RAYLEIGH HI-FI**, Southend, 132/4 London Rd. 0702 435255. Over 21 years experience of supplying the best. "The best dealer in the best equipment, the best service" Carefully selected hi-fi from Arcam, Audioblab, Denon, Epos, Linn, Meridian, Mission, Nakamichi, Quad, Royal Roksan, etc. etc. 3 years guarantee on Hi-Fi systems. 0% credit facilities.

**AUDIO T**, 442-444 Cranbrook Road, Garis Hill, Ilford, Essex IG2 6LL. (081) 518 8915. Fax: (081) 554 8463. Great Hi-Fi from Arcam, Audioblab, B&O, Bose, Cyrus, Denon, KEF, Marantz, Meridian, Mission, Microomega, Nakamichi, Rotel, Sony, Yamaha & many more. Mon-Sat 10-6. 3 year guarantee on Hi-Fi. Free delivery & installation. 30 day free upgrade scheme. Home demonstrations. Part exchange. 2 listening rooms. Home Cinema specialists. BADA Bonded.

**AUDIO EXCELLENCE** 'WHERE THE MUSIC MATTERS'. 58 Bristol Road, Gloucester, GL1 5SD. Tel: 0452 300046. Fax: 0452 310680. Great Hi-Fi carefully selected and demonstrated by friendly enthusiastic staff. Home installations and check-ups. Two year warranty, from our own service department. Open 9.00-5.30 Tuesday - Saturday, closed Monday.

**AUDIO T**, 40-42 Albion Street, Cheltenham, Gloucestershire, GL52 2RQ. (0242) 583960. Fax: (0242) 226435. Great Hi-Fi from Arcam, Audioblab, Denon, Epos, Linn, Meridian, Mission, Quad, Rogers, Rotel, Yamaha & many more. Mon-Fri 10-6, Sat 9.30-5.30. 3 year guarantee on Hi-Fi. Free delivery & installation. 30 day free upgrade scheme. Home demonstrations. Part exchange. Single speaker listening room. BADA Bonded.

## HAMPSHIRE

**JOHN COLLIER**, Near Petersfield, Hampshire, Mana Castle, Alchemist, Albany, Audio Innovations, Wadia, Deltac, Tube Technology, Denon, Pioneer, Alphason, Tripod, Nad, Teac, Audio Alchemy, XIPSc, Aliv, C Proac, JPW, Moth, Pink Triangle. Mail order cabinets supplied to order in any size, wood & hand painted finishes, stone-granite-marble sheathing. For a demonstration with home comforts call us for an appointment on 0730 895194.

**HOPKINS HI-FI**, 'FOR THE BEST SEAT IN THE HOUSE' experience home cinema sound with Technics, Denon and Kenwood. Award winning products. Now on demo at HOPKINS HI-FI 38-40 Fratton Road, Portsmouth, Hants, PO1 5BX. Tel: 0705 822 155. Fax: 0705 830 753.

**HAMPSHIRE AUDIO LTD**, 2-12 Hursley Road, Chardlers Ford, Hants SO5 2FU. (0703) 252827/265232. 3 hi-fi and 2 home cinema surround sound dem studio's. Thurs, Sat evening closed Mondays (except in December). Service dept on site (2 yr guarantee). Large free car park - junctions 4 (M27/M3) 5 (M27) 12 (M31) and 13 (M3) at within 3 miles. est. 1969.

**AUDIO T**, 4 Feathers Lane, Basingstoke, Hampshire RG21 1AS. (0256) 24311. Fax: (0256) 24430. Great Hi-Fi from Arcam, Audioblab, Denon, Linn, Meridian, Mission, Naim, Rotel, Sony, Yamaha & many more. Mon-Sat 9.30-5.30. 3 year guarantee on Hi-Fi. Free delivery & installation. 30 day free upgrade scheme. Home demonstrations. Part exchange. Single speaker listening room. BADA Bonded.

## HEREFORDSHIRE

**ENGLISH AUDIO**, 95 Whitecross Road, Hereford, HR4 0DG (0432) 350281. Musical Fidelity, Arcam, Castle, Ruark, Rogers, JPW, Microomega, Chord, Audion, Systemdek, Heybrook, Kef, Stax, Pink Triangle, Denon, Marantz, Mission, Cyrus, A.I., Rotel, NAD, Nakamichi, TDL and others. Single speaker dem room. Home trial facilities. Free installation. service dept. Access/Visa. Credit arranged. Open Mon-Sat: 10-6pm. BADA members.

**DAVID ORTON AUDIO VISUAL**, 6-8 Bancroft, Hitchin, Herts. Tel: 0462 - 452248. Mission, Cyrus, Denon, Pioneer, Marantz, Aura, Kenwood, Royal, Ruark, Celestion, JVC, Polk and many more. Open Mon-Sat 9.30-5.30. All major credit cards accepted. Finance available. See our main advert pg 105.

**DYNAMICS**, - Welwyn, Herts - Europe's largest stockist of ex-dem and second hand equipment. High End Audio - Bought, Sold or Exchanged. Various items in stock. See our main advert pg 128. Phone service Dept. All items guaranteed. All major credit cards accepted. Please telephone 0462 - 714038 for appointment.

**GOSEPEL MUSIC AUDIO**, 32a High Street, Kington, Herefordshire HR5 3BJ. (0544) 230254. Alphason, Alisson, Revolver, Luxman, Yamaha, QED Audio Systemline.

**ACOUSTIC ARTS LTD**, 101 St Albans Rd, Watford, Herts. 0923 245250. Fax: 0923 230798. Absolute Sounds, Adcom, Acoustic Energy, Audioblab, Chord, Denon, Marantz, Meridian, Orelle, S.M.E., T.D.L. 3 dem rooms. multi-room & home theatre. Expert installation. Credit facilities available. Tues-Sat 10-6.

**STUDIO 82**, 82 High Street, Harpenden, Herts AL5 2SP. 0582 762426. Fax: 0582 467022. ATC/AVI, Arcam, Aura, Audioblab, B&O, Denon, Epos, Mission, Cyrus, Naim Audio, Nakamichi, Quad, NAD etc. Quiet single speaker dem room. Appts nec. Home trial. Free installation. Service dept. Vis. Access and finance terms. 9-5.30 (Mon-Sat) Closed Mends.

**THE AUDIO FILE**, 27 Hockerill St., Bishop's Stortford, Herts CM23 2DH. Tel: 0279 506676. Fax: 0279 506638. Linn, Naim, Roksan, Quad, Rega, Mission, Arcam, ProAc, Marantz, Sony etc. 4 dem rooms. Installation service. Min 3 year warranty. 0% BADA.

**HERTFORD MUSIC**. We want you to feel good when choosing your system in our 3 demonstration rooms (and bar!). System from budget to £15,000. Products include: CR Developments, Microomega, REL, Accoustics, Acoustic Energy, Michell, Magnum, Diamond Acoustics, Beard, Lumley, Renaissance, etc. Access, Visa, Mail Order. Please telephone: 0992 442425.

# Hi-Fi World Dial-a-Dealer

**RAO LETT AUDIO**, 141 Watling Street, Radlett, Herts, WD7 7NQ. Tel: 0923 856497. Mark Levinson, Proceed, Proac, Magnepan, Martin Logan Tube Technology, Teac, Roksan, Audiolab, Stax, Systemdek, Jards, Copland, ATC, Audio Alchemy, AVI, EAR, Sumiko, Quad, Sonus Faber. Home trial facilities, free installation. Service Dept. Visa/Access 9-5.30 Mon-Fri 10-5.30 Sat.

**REVOX Service & Repairs**, Suite 10, Smugock Business Centre, Lye Lane, Brickwood, Herts. AL2 3UG. Tel: 0923 893711. Seventeen years experience, ex-Bauch. Authorised agents for Revox products, sales and spares. All repairs carried out are guaranteed. Fast turnaround. Any enquiries telephone: 0923 893711.

**ZEN AUDIO** - George Street, Hull Tel: (0482) 587397 - Evening (0964) 670849. Audiolab, Audio Innovations, Aura B&W, Cabletalk, DPA, Heybrook, JPW, KAR, Micromega, Michell Harmon Kardon Impulse RuArk Rotel Sugden. Comfortable Listening Room. Home Trial facilities. free installations - personal friendly service

**PROGRESSIVE AUDIO**, 2 Maryland Court, Rainham, Nr Gillingham Kent ME8 8QY. Tel: 0534 389004 Agencies include Audio Innovations, Audionote, Audiomatic, Audiotecnic, Chord amps Cogan Hall, Conrad Johnson, Convergent, DALI, Decca, Eminent Technology, Goldring, Impulse, Koetsu, Levinson, L.F.D. Lyra, Lumley Reference, Meridian, Michell, Micromega, Moth, Dring Live, Pink Triangle, Proac, Proceed, Ruark, Silversounds, SME, Sugden, Sumiko Systemdek, Snell, Target, T D L Transfiguration, Townshend Tube Technology, Voyd, V P I etc etc. Demonstrations by appointment please

**JOHN MARLEY HI-FI CENTRES**, 2 Station Road, West Canterbury (0227) 769329. Also at Dover - 0304 207562 Arcam Aura B&W, Heybrook JPW, Proac, Pioneer, Rotel, Ruark, Tannoy, Technics. Dem rooms and home trial facilities. Mon-Sat 9-5.30 plus Thurs. Free install Credit to #1,000. Access. Visa and credit charge. Service Dept

**KIMBERLEY HIFI**, 193 Broadway, Bexleyheath, Kent. Tel: 081 3043272 Pioneer, Technics, Kenwood, Marantz, Denon NAD Aiwa, Tannoy, Mission, Rotel, Wharfedale, Castle Separate dem room, no appt necessary free installation. service dept instant credit facilities no early closing

**V. J. HIFI**, 29 Guildhall Street, Folkestone, Tel: 0303 256860 Mon-Sat 9-6. NAD, Yamaha, Marantz, Sony, Tannoy, Denon, Kenwood, Rogers, Musical Fidelity, Quad, Aiwa, Aura, Heybrook, Castle, Mission, Yamaha, REL, JBL, Polk Dem rooms in both stores free install. Credit facilities available. specialists in home theatre, Amex, Dinners. Visa Access. Service Dept. We are BADA dealers.

**THE WESTGATE HI-FI**, 2 Station Road West, Canterbury, Kent. 0227 769329. Suppliers of quality hi-fi equipment including Arcam, Akai, Aura B&W, Denon, Jamo JPW Mordaunt Short, NAD, Panasonic, ProAc, Quad, Rotel, RuArc, TDL Technics, Tannoy Part exchange Listening room. Service and repairs. Credit facilities. Access/Visa Open 6 days 9-5.30.

**DOVER HI-FI**, 43 High Street, Dover. Tel: Dover 207562. Suppliers of quality hi-fi equipment including: Arcam, Akai, Aura, B&W, Denon, Jamo, JPW, Mordaunt Short, NAD, Panasonic, ProAc, Quad, Rotel, RuArc, TDL Technics, Tannoy Part exchange. Listening room. Service and repairs. Credit facilities. Access/Visa Open 6 days 9-5.30

## LANCASHIRE

**AUDIO CLASSICS**, 8 Lowe Mill Lane, Hindley, Wigan, Lancs. WN2 3AF Sorry but we are unable to answer queries in writing. I buy, sell, modify and repair all vintage and valve hi-fi equipment. Advice is free. New equipment by EAR, croft, Ortofon and more soon. Phone if just for a chat. Credit cards accepted. Quick worldwide delivery, callers by appointment. Tel: 0942 57525 or Fax: 0942 525861 7 days a week

**PIONEERS HIFI CENTRE**, 94-96 High Street, Rishton, Blackburn, Lancs. Tel: 0254 887799. Stockists of: Sony Esprit HiFi, Technics, Marantz, Musical Fidelity, Pioneer, Kenwood, Rotel, Tannoy, Mission, Ruark, B&W and many others. Dem room, service dept. free delivery and installation (local area) Access/Visa and Switch

**PRACTICAL HI-FI** 43 Friargate, Preston. Tel: 0772 883958. The audio visual specialist, expert advice, instant demonstrations, best prices, instant free credit, part exchange welcome. Extended warranty. Stockists of: Yamaha, Kenwood, Denon, Sony, Technics, Onkyo, Marantz, Pioneer, Mission, Kef, Jamo, Celestion, B&W. Also stockists of LaserDiscs.

**PRACTICAL HI-FI**, 84 Penny Street, Lancaster, LA1 1XN Tel: 0524 39657 - See our main entry under Lancaster.

**PRACTICAL HI-FI**, 3335 Knowsley Street, Bolton, Lancs Tel: 0204 395789 - See our main entry under Lancaster.

**PRACTICAL HI-FI**, 10 Preston New Road, Blackburn, BB2 1AW Tel: 0254 691104. See our main entry under Lancaster

**PRACTICAL HI-FI**, 81 Whitgate Drive, Blackpool, FY3 9DA Tel: 0253 300599. See our main entry under Lancaster.

**LEICESTER HIFI COMPANY**, 6 Silver Walk, St Martin's Square Leics LE1 5EW Tel (0533) 539753 Fax (0533) 626097. Acoustic Energy, Arcam, Marantz, Micromega, Mission/Cyrus, Musical Fidelity, Nakamichi, Meridian, Rogers, Roksan and "oodles more" 2 dem rooms, home trial arranged, free install, service dept. Credit facilities. Access/Visa/Diners/Amex. 6 days. 9.30-5.30

**THE LISTENING ROOMS**, 6 Hotel Street, Leicester, Tel: 0533 623754 fax. 0533 623758. Linn, Audiolab, Arcam, Tannoy, Definition, Denon, Rotel, NAD, Heybrook, TDL etc. Open 10.00-5.30 (Six days)

**STEREO SHACK**, 1-3 Guildhall Lane, Leicester. Tel: 0533 530330 Aiwa A.R. Denon Kenwood Jamo Mission, NAD, Philips, Pioneer, Home Cinema specialists. Free installation. Open 9.30-5.30 6 days Credit available.

**65a Wide Bargate, John Adams Way Boston Lincs PE21 6SG Tel: 0205 365477** Quad, Nakamichi, Arcam, Marantz, NAD, Castle, Tannoy, Rogers etc. Separate demonstration studio incl home cinema. Free installation. Access. Visa. Tues-Sat 9-5 pm

**COTTAGE AUDIO**, 17 Bridge Street, Saxilby, Nr Lincoln. LN1 2PZ. Tel: (0522) 702834. Evenings (0522) 696708 ATC, AVI, Chord amplifiers, Harbeth LFD, Michell, Dring Live, Kinshaw, QED, Royd, Sansui, Sequence. Something solid, Sonic Link etc. Demonstration rooms. Home trial facilities. Free installations and above all a personal, friendly service.

**STAMFORD HIFI CENTRE** - 9 Red Lion Square, Stamford, Lincs. PE9 2AL (07081) 62128 Pioneer Technics, Cyrus-Mission, Rotel, NAD, Yamaha, Kenwood, Marantz, Quad plus all major speaker manufacturers. Expert Advice, Comparator demonstrations, part-exchange HiFi purchased for cash. No appts necessary. Home trial facility, free installation. Service Dept. Mastercard, Visa and credit charge. Mon-Sat 9.5-5.30 pm Closed Thursdays

**ANALOG AUDIO**, 849 High Road, Finchley, N12. (081) 445 3267. For friendly service and advice. AR, AKG, Allison, AT, Cerwin Vega, Denon, Dual, Harmon Kardon, Jamo, Infinity, Marantz, NAD, Pioneer, Rotel, Revolver, Sonab, Teac, Thorens, Tannoy, Wharfedale, Yamaha. Speaker cables and accessories. Free installation service.

**AUDIO CONCEPT**, 27 Bond Street, Ealing, W5 5AS. Tel: (081) 567 8703. Acoustic Energy, Audiolab, Aura, B&O, B&W, Boston Acoustics, Canon, Castle, Denon, Dual, Evolution, Infinity, JPW, Kef, Marantz, Mission, Monitor Audio, Musical Fidelity, NAD, Nakamichi, Dnix, Quad, Revox, Rogers, Rotel, Systemdek, Target, Teac, Thorens, Van den Hul, Two dem rooms. Interest free credit, free local delivery & installation, service department Hi-Fi Specialists without the attitude!

**BABBER ELECTRONICS**, 158 Uxbridge Road, West Ealing, London W13 8SB (081) 579 6315. Akai, Aiwa, A&R, Celestion, Dual, Goodmans, Harman Kardon, JBL, JVC, Kenwood, Marantz, Panasonic, Sennheiser, Sony ES range, Tannoy Technics, Wharfedale, Yamaha.

**THE CARTRIDGE MAN** - Front end problems? It doesn't have to cost an arm and a leg to get the best listen to my Koetsu - and - Decca - Eater. Also agents for Croft, Sugden, Thorens, Pentachord Speakers and Notts Analogue. (Plus a cartridge re-tipping service) Tel: 081 688 6565

**DIVA AUDIO FIDELITY**: For the finest in real HiFi, AV and Multiroom systems. Accuphase, Audio Innovations, Audio Note, Audiostatic, Aura, Chord, Conrad Johnson, Impulse, Klipschorn, Levinson, Lumley Lyra, Michell, Micromega, Monitor Audio, Primare, Rel, Rotel, S.M.E. Tnangre, Trifogy, XLO. Call us or pop in for a musical experience you'll never forget. Open 10-6, Mon-Sat at Workshop 30, Royal Victoria Patriotic Building, Fitzhugh Grove, Wandsworth Common, London SW18. Tel/Fax: (081) 875 9593. Also see our full page advertisement on page 18 of this issue.

**GOLF ELECTRONICS**, 311 Kenfish Town Road, NW5 2TJ Tel: 071 482 2518. Fax: 071 284 3381. Authorised dealers for: Sony, Panasonic, Aiwa, Akai, Mitsubishi, Philips, Grundig, Bose. We carry an extensive range of hardware from Walkmans to camcorders, including a wide range of TV and video equipment. Free local delivery & installation on selected items. Open 10-6 Mon-Sat. We regularly have

special offers on different products. A visit to GDLF ELECTRONICS could save you £££s

**HIFI & COMPONENTS**, 84 Battersea Rise, London, SW11 1EH. (071) 223 1110. Denon, Tannoy, NAD, Rotel, Bose, Dual, QED, Wharfedale, Jamo, Celestion, Kenwood, Ortofon Infinity, Shure. to name but a few! Established over 29 yrs. Appts necessary. Service dept 10-6 (closed Weds)

**HIFI EXPERIENCE**, 227 Tottenham Court Road, London W11, 071 580 3535. Arcam, Audiolab, Mission, Cyrus, Quad, Celestion, Kef, Meridian, Rogers, Tannoy, Yamaha, TDL, Thorens, Marantz, Nakamichi, Musical Fidelity and many more. Open 10.00-7.00 Mon-Fri 9-6 on Sat. Service dept, Credit facilities, delivery and free installation.

**THE HIFI SURPLUS STORE**, 62 Weymouth Street, W1 Tel: 071 486 9981/071 935 7582. Stock a full range of goods including: Aiwa, Akai, B&W, Bose, Dual, JVC, Jamo, Kenwood, Marantz, Mordaunt-Short, Mission, NAD, Pioneer, Rotel, Sony, Technics, Teac, Thorens, Tannoy, Wharfedale. Full range of "Target" speaker stands always on stock. All goods are brand new in sealed cartons with full 1 yr guarantee. We guarantee you can not buy cheaper elsewhere. Give us your genuine quote and we will beat that price by £10 (goods must be in stock). Access/Visa welcome. Open Mon-Sat 9.30-6pm. Late night 'till 6.30 Thurs

**KAMLA ELECTRONICS**, 251 Tottenham Court Road, London W1P 9AD Telephone 071 323 2747 Fax 071 637 2690. Acoustic Research, Aiwa, Akai, Albany Alchemist, Alphason, Audio Alchemy, Audio Innovations, Audio Technica, Audioquest, Aura, Audiostatic, B&W, Cerwin Vega, Conrad Johnson, Copenhagen, Furukawa, Goldring, Infinity IXDS, JPW, JVC, Kef, Kenwood, Kurza, Lynwood, Mavel, Micromega, Mitsubishi, Monster, Mordaunt Short, Moth, Nakamichi, Oracle, Ortofon, Panasonic, Pioneer, Proct, QED, Rotel, Ruark, Sansui, Stax, TDK and many more!!!!

**K J WEST ONE**, 26 New Cavendish St., London W1M 7LH. 071 486 8262/63 Fax 071 487 3452. Two hi-hi & dedicated home cinema dem studios. Appts pref. Home trial. Installation by arrangement. Service dept. Major credit cards. Interest free credit on selected items. Major brands stocked: Acoustic Energy, Arcam, Audio Innovations, Audion, Aura, Audiolab, Audio Research, B&W, Chord, DPA, Epos, Impulse, Krell, Martin Logan, Meridian, Michell, Musical Fidelity, Nakamichi, Nitfy Girty, Oreile, Pink, ProAc, Quad, Roksan, Sonus Faber, Stax, Tannoy, Thera. Open 6 days

**BILLY VEE SOUND SYSTEMS**, 248 Lee High Road, London SE13 (081) 318 5755. Arcam, Linn, Naim, Quad, Creek, Cryo, Marantz, NAD, Rotel, Rega, Denon, Yamaha, Tannoy, Mission, Micromega, Heybrook etc. 2 dem rooms, instant free credit. Access/Visa. Closed Thursdays

**CONNECTIONS**, 13 John Prince's Street, London W1M 9AH Tel: 081 348 5676. Dealers in: Absolute, Audio Note, Audioquest, Deltac, Harmonix, Kimber, Mandrake, MIT, Siletech, Symo, Van den Hul, WBT and others.

**THE LISTENING ROOMS**, 161 Old Brompton Road, London SW5 0LJ (071) 244 7750/59. Fax (071) 370 0192. Linn, Quad, Meridian, Nakamichi, Arcam, Audiolab, Acoustic Energy, SME, Audio Research, Krell, Wadia, Theta, Apogee.

Martin Logan, Pioneer, Tannoy, Systemdek, Stax, Pink Triangle, Michell, Monitor Audio, Yamaha, Marantz, Kef, Bose, Celestion, Epos, Mission, Denon, Neat Petite, Kel-Sat 10-6pm

**THE CORNFLAKE SHOP**, 37 Windmill Street, London W11 (071) 631 0472 (domestic). (071) 323 4554 (multiroom) Fax: (071) 436 7165. Tues-Sat 10-7 Rega, Roksan, Naim, Monitor Audio, Arcam, Nakamichi, Rotel, Epos etc. 3 dem rooms (incl. home cinema) Friendly professional service. Home trial facilities, appts preferred. Full delivery and repair service. Multiroom specialists. Access & Visa.

**MUSICAL IMAGES**, 173 Station Road, Edgeware, Middlesex. Tel: (081) 952 5535. See advert under Middlesex for more information.

**MUSICAL IMAGES**, 45 High Street, Hounslow, Middlesex. Tel: (081) 569 5802. See advert under Middlesex for more information.

**AUDIO T**, 190 West End Lane, West Hampstead, London, NW3 1SQ. (071) 794 7848. Fax: (071) 431 3570. Great Hi-Fi from Adcom, Arcam, Audiolab, B&W, Denon, Epos, Marantz, Meridian, Michell, Mission, Philips, Rotel, Proac, Micromega, Nakamichi, Yamaha, & many more. Mon-Sat 10-6 3 year guarantee on Hi-Fi. Free delivery & installation 30 day free upgrade scheme. Home demonstrations. Part exchange. 2 listening rooms. BADA Bonded

**ORANGES & LEMONS**, 61-63 Webbs Road, Battersea SW11. Tel: 071 - 924 2040/3665. Juicy fruit from London's newest, freshest Hi-Fi/Home Cinema retailer. Telephone demonstrations, or just pop in. All the usual ie. friendly and efficient service, free home installation, credit cards plus all the very best from Arcam, Chord Co, Meridian, Mission, NAD, NAIM, Roksan, Royst - with more to come. The innovative Audio/Visual retailer.

**ZEBRA**, 18-24 Brighton Road, South Croydon. Tel: 081-688 2093. The UK's first and finest Home Cinema Store. 3 Demonstration Rooms. Laser Disc CRT and Projection TV Centre. Many brands stocked including Arcam, Audiolab, Meridian, Lexicon, Kef, Pioneer, Rotel, Yamaha, REL and Panasonic. Mon-Sat 9.30-6.00pm. All major credit cards accepted. Finance available. Evening demonstrations by appointment.

## GREATER MANCHESTER

**THE AUDIO COUNSEL**, 12 Shaw Road, Oldham, Manchester OL1 3LQ. Tel: 061 633 2602. Linn, Arcam, Naim, Yamaha, Creek, Nakamichi, Denon, JPW, Marantz, Royd, Lexicon. 3 dem rooms, free install. Visa/Access. Licensed credit brokers up to £1,000 instant credit. Full multi-room & A.V. installation 10.00-5.30pm. Mon, Tues, Wed, Sat. 10.00-7.00pm Thurs & Fri

**CENTRAL RADIO (Manchester) Ltd**, 30-32 Shudehill, Manchester M4 1EZ. Tel: 061 834 6700. Est. 1946 we have a wide range of Hi-Fi separates, systems, Pro-logic, TV, Video, Portable Audio, Tape, Stylus and Accessories. In House Service Dept. Agents for Aiwa, Beyer, Bose, B&W, Cerwin-Vega, Canon, JBL, Kenwood, Marantz, Mission, Panasonic, Pioneer, Sennheiser, Sony, Technics, Thorens, Wharfedale, etc. We accept Access, Visa, AmEx, Switch

TO FIND YOUR AREA  
Use our  
COLOUR REFERENCE



To Advertise in this section, please contact Caroline Knott on:

071 266 0969

# Hi-Fi World Dial-a-Dealer

Cheques upto £1500 & Finance subject to status. Open 9.00am to 5.30pm Mon to Sat. Easy Parking. Call for directions.

**SPECIALISTS (HOME DEMONSTRATION SPECIALIST)**  
- for a 'Musical' system tailor-made (sonically and visually) to your Home requirements. Aricon Acoustics (Valves), Audiomeca, Audio Synthesis, Audio Valve Amplification, Kinshaw, Lieder, Ortofon, Project, Teac, Triangle, YBA, Orpheus Audio, please tel: 0257 426100 or Fax: 0257 473175 for appointment.

**HALE HI-FI**, Tel: 061 929 0834.  
See our main entry under Cheshire.

**BILL HUTCHINSON HI-FI**, 50-52 Deansgate, Manchester M3 2FE. (061) 8321600. For the largest selection of Hi-Fi and audio visual equipment in the North West. Specialist A.V. demonstrations of the highest quality. Best prices guaranteed. Minimum 2 year warranty and an optional 5 yr guarantee available. Instant credit and mail order service on offer throughout the U.K. Pioneer, Denon, Kenwood, Yamaha, Technics, Marantz, Mission, Tannoy plus many more.

**PRACTICAL HI-FI** 65 Bridge Street, Manchester M3 3BD. Tel.: 061 839 8869. See our main entry under Lancaster.

## MERSEYSIDE

**DOUG BRADY HI-FI**, 401, Smithdown Road, Liverpool, L13 3JL. (051) 733 6859. Fair demonstrations and home trial facilities. All credit cards. Largest choice of specialist hi-fi in N.W. Closed Wednesdays and lunch 1-2.15pm.

## MIDLANDS

**HARROW AUDIO**, 27 Springfield Rd., Harrow, Middlesex. Tel: 081 863 0938. Open Mon-Sat 9.30-5.30. Most brands available - see our regular advert for full range including Audioblab, Arcam, Audioquest, Apogee, Aura, B&W, Cyrus, Denon, Epos, Krell, Marantz, Mission, Nakamichi, Tannoy, Target, Yamaha etc. AV Specialist including installation. Interest Free Credit - ask for details. The largest range of accessories for miles around. 2 dem rooms. Plus Carriage Free. Mail Order.

**AUDIOCRAFT**, 18 Hillington Road, Uxbridge, Middlesex UB10 0AD. (0895) 253340. Unbelievable but true you can audition these brands here: Audion Proac, Michell, Ereffe, LFD, Lumley Levison, Lurie, Triangle, Semtec, Mag Audio, Teac, VHD, Silversounds, YBA, Stax, Theta, Monitor Audio, Fuller Audio, Trilogy, Lyra, Sumiko, Ortofon, Decca, Target, Project, Moth, Kelvin, Townsend, Edison, Audio Alchemy, Keski, Musical Fidelity.

**MUSICAL IMAGES**, 45 High Street, Hounslow, Middlesex. Tel: (081) 569 5802. Fax: (081) 569 6353.

**MUSICAL IMAGES**, 173 Station Road, Edgeware, Middlesex. Tel: (081) 952 5535. Fax: (081) 952 5535. Most brands available - see full page advert. Interest free credit, ask for details. Demo rooms. Repairs & Service. Sunday opening - Open all week. A Home Cinema Specialist. Mail order. Part exchange.

**AUDIO T**, 159a Chase Side, Enfield, Middlesex. EN2 DPW. (081) 367 3132. Fax: (081) 367 1638. Great Hi-Fi from Adcom, Arcam, Audioblab, Celestion, Denon, Marantz, Meridian, Micromega, Mission, Philips, Rotel, Yamaha, & many more. Mon-Fri 10-6 Sat 9.30-5.30. 3 year guarantee on Hi-Fi. Free delivery & installation. 30 day free upgrade scheme. Home demonstrations. Part exchange. 2 listening rooms. Home Cinema specialists. BADA Bonded.

## NORFOLK

**BASICALLY SOUND**, The Old School, School Road, Bracon Ash, Norwich, Norfolk, NR14 8HG. Tel: (0508) 957 70829. Arcam, Heybrook, Chord Co, Rotel, Semtec, Mag Audio, Teac, Tannoy, Denon, Naim, Spondor, Sound Organisation, Audio Technica, Creek, Epos etc. 2 comprehensive dem rooms, home trial facilities, free installations, Visa Access, HP facilities. Tues-Fri 9.30-1.00pm, 2.00-5.30pm. Saturday 9.30-5.30pm.

**PROTECT-A-DISC**, Unit 4, Elvin Way, Sweetbrair Industrial Estate, Norwich, NR3 2BB. Tel: 0603 482193. Producers and suppliers of finest quality card record and CD sleeves with taped edges, poly-lined or unlined, mailers and crumfoams etc. Please send SAE for full current price list. Trade enquiries welcomed. Tel: 0603 482193.

## NORTHAMPTON

**LISTEN INN**, 32 Gold Street, Northants NN1 1RS. Tel: 0604 37871. Fax: 0604 601430. Naim, Linn, Rega, Audioblab, Arcam, Cyrus, Royd, Nakamichi, Mission, Denon, Rotel, Naid, Heybrook, Marantz, Chord Co. etc. etc., Open 10.00-5.30 (Closed Thurs)

## NOTTINGHAMSHIRE

**DEFINITIVE AUDIO**, Tel: (0602) 813562. For a carefully considered approach to building a true high fidelity audio system with components derived from the following manufacturers: Audio innovations, Wadia, Micromega, Deltec, E.M.T. Horning, Voyd, Systemdek, SME, Revox, Impulse, Ortofon, Pioneer. Also the remarkable Living Voice Air Partner loud speaker system. Demos by appt. Please phone for further details. install. free of charge. Mon-Sat 10.00-7pm. Closed Wed a.m.

**PETER ELLIS AUDIO**, 29 Kirkgate Newark, Notts NG24 1AD. Tel: 0636 704571. QUAD Castle, Arcam, DEO, Sugden, Tannoy, Thorens, Marantz, Denon, Teac. Demo room. free install. Service dept. Access. Visa American Express. Mon-Sat 9-5.30. Closed Thursdays PM.

**CHANNY AUDIO**, 18-18a Eldon Street, Tuxford, Nr Newark, Notts. NG22 0LH. Tel: 0777 870372. Pink Triangle, OPA, Rotel/Michi, Micromega, NVA, Alchemist, Michell, Monitor Audio, Lumley, SME, Audion and much more. 3 dem rooms home trial free installation, service department. Access & Visa. credit facilities. Mail order. Mon-Sat 9.30-6.00. Sun and evenings home dem by appointment.

**NOTTINGHAM HI-FI CENTRE** 120-122 Alfreton Road, Nottingham. Tel: 0602 786919. Over 25 years experience. superb demo rooms. extensive range. free parking. Mon-Sat 9-5.30.

**JOHN KIRK SALES & SERVICE**, 70 Chilwell Road, Beestons Notts. NG9 1FQ. Tel: 0602 - 252986. Your specialist Hi-Fi Dealer for AKG, Alphason, ARcam, Aura, B&W, Bayer, Canon, Castle, Celestion, Denon, Quad, Hunt Eda, Marantz, Mordant-Short, Nakamichi, Panasonic, Philips, Pivotell, QED, Quad, Revox, Roberts, Rogers, Sennheiser, SME, Sugden, Tandberg (service) TDL, Technics, Telarc, Thorens, Powermid, XIOS. Come and see our range of quality Noka, Finlux, Panasonic TV and Video Recorders.

## OXFORDSHIRE

**AUDIO T**, 19 Old High Street, Headington, Oxford. DX3 9HS. (0865) 65961. Fax: (0865) 60415. Great Hi-Fi from Arcam, Audioblab, Cyrus, Denon, Epos, KEF, Marantz, Meridian, Musical Fidelity, Rotel, Sony, Yamaha & many more. Mon-Fri 10-6 Sat 9.30-5.30. 3 year guarantee on Hi-Fi. Free delivery & installation. 30 day upgrade scheme. Home demonstrations. Part exchange. 2 listening rooms. Home Cinema specialists. BADA Bonded.

**WESTWOOD & MASON**, 46 George Street, Oxford. Tel: 0865 247783. Creek, Marantz, Naim, Arcam, Rotel, Rega, Epos, Tannoy, Mission, Nakamichi, Denon, Aiwa, Quad, Yamaha, Monitor Audio. Open 9.30-5.00pm. Dem room. Closed Thursdays.

**ASTLEY AUDIO LTD.** 3 Marketplace, Wallingford (3 miles from Berkshire border) 0491 839305. Aura, B&W, Technics, Panasonic, Pioneer, Kenwood, Sony, Yamaha, Denon, Dual, Marantz, Mission, Tannoy. 1 listening room. Home trial, free installation, Service department, Access, Visa, Amex, Oiners. Instant credit. Tues-Fri 9-5.30. Sat 9-5. Records & CDs stocked.

## SHROPSHIRE

**AVON HI-FI**, 12 Barker Street, Shrewsbury, Shropshire. SY1 1DJ. Tel: 0743 355166. Aiwa, Beyer-Dynamic, NAD, Quad, B&W, Mordant-Short, Kenwood, Bose, Nakamichi, Onkyo, Teac, Sennheiser. Dem room. Home trial. Free install. Service dept. Access/Visa. £1,000 instant credit. Mon, Tues, Wed, Fri, Sat 9-5.30.

**SHROPSHIRE HI-FI**, St Michael Street, Shrewsbury, Shrops. SY1 2ES. Tel: 0743 232065. Stockists of Musical Fidelity, Mordant-Short, Sony, Kenwood, Pioneer, Rotel, Denon, B&W. Proac. Audio Visual Products available. Open 9.30 - 5.30pm Mon-Sat.

## SOMERSET

**MIKE MANNING AUDIO**, 110 Middle Street, Yeovil, Somerset, BA20 1HE. Tel: 0935 79361. Fax: 0935 32923. Mobile 0850 325965. Naim, Roksan, Pink Triangle, A&R (Arcam), ION, NAD, Pioneer, Rotel, Denon etc. Dedicated listening lounge, for relaxed and unpressured demos. Appts not necessary but best to telephone first. Home trial facilities on request, free installation and service dept, instant credit, Access/Visa etc. 9-5.30, closed Mondays.

## STAFFORDSHIRE

**ACTIVE AUDIO**, 95, Stafford Street, Hanley Stoke-on-Trent, Staffs. Tel: 0782 214994. Fax: 0782 283346. We have four studios including a dedicated Audio Visual studio for the demonstration of quality equipment from the largest range in the Midlands. Open six days per week. Own service department. Free local delivery, home trial facility. Current special offers and buyers fact pack and quotation service on request.

**MUSICAL APPROACH**, Unit 7, Woodings Yard, Bailey Street, Stafford, Tel: 0785 55154. Also branch at 37 High Street, Aldridge, nr Walsall. Tel: 0922 57926. Linn, Rega, Arcam, Rotel, Royd, Heybrook, Marantz, Teac, Celestion, Apollo, Target. Mon-Sat 9.30-5.30. Home cinema equipment stocked. 2 single speaker dem rooms. Service dept and free install. Credit facilities. We are now agents for Rega products. Stafford branch only.

**ACTIVE AUDIO**, 29, Market Street, Tamworth, Staffs. Tel: 0827 53355. Fax: 0827 59513. We have two studios including a dedicated Audio Visual studio for the demonstration of quality equipment from the largest range in the Midlands. Open six days per week. Own service department. Free local delivery, home trial facility. Current special offers and buyers fact pack and quotation service on request.

## SUFFOLK

**AUDIO IMAGES**, 7 All Saints Road, Pakefield, South Lowestoft, Suffolk. NR33 6JL. Tel/fax: 0502 582853. Quad, Triangle, Arcam, Castle, Rotel, Moth, JPW, Finlux, Audio Innovations, plus the amazing ROTHWELL range. Separate dem room. no appts nec. 10-6.30. Tues-Thurs. 7pm Fri 6pm Sat.

**SIGNALS** Martlesham Heath, Ipswich. Tel: (0473) 622865. display advertisement for brands: Turntables, high end CD drives/DAC's as well as integrated players, valve and solid state amplification, wide range of cables and loudspeakers. Home demonstrations/equipment trial service. Please telephone for directions and to book appointment.

**BURY AUDIO**, 47 Churchgate Street, Bury St Edmunds, Suffolk. IP33 1RG. Tel: 0284 724337. Arcam, Audio Alchemy, Heybrook, Marantz, Michell, Meridian, Nakamichi, Pink Triangle, Quad, Rotel, Sonus Faber, Stax, Tube Technology. Single speaker dem room. Free install. Credit facilities. Mon-Sat 9.30-6.00, closed Wed. Evening dems by appointment.

**EASTERN AUDIO**, 41 Bramford Road, Ipswich, Tel: 0473 217 217. Fax: 0473 215705. Quad, Arcam, Audioblab, Meridian, Mission, Denon, Rotel, Marantz, NAD, Sony, Rogers, Nakamichi, Systemdek, Technics, Celestion, B&W, Tannoy, Morel, Thorens and Top Tape. Also stock a wide range of accessories. usual credit facilities. A BADA dealer.

**FENWAY**, 71 The Rookery Centre, Newmarket, Tel: 0638 66166. Contact Mark Pearson. For Sony, Technics, Rotel, Tannoy, Pioneer, DEO, equipment and accessories. Demonstration facility. In-House Service Dept. "FREE INSTALLATION BY EXPERTS"

## SURREY

**STALLANES HI-FI**, 352-4 Lower Addiscombe Rd, Croydon, Surrey. 081 654 1231.2040. 3 dem rooms and home dem. Free installation/credit.

Linn, Naim, Quad, Arcam, Audioblab, Cyrus, Marantz, Denon, Ruark. Mon-Sat 9-6, Tues 9-8. Closed Wed. Service dept.

**PJ HI-FI, The HI-FI Shop**, 3 Bridge Street, Guildford, Surrey. GU1 4RY. Tel: (0483) 504801. 9-6 Mon-Sat. Linn, Meridian, Rega, Arcam, Quad, Revox, Musical Fidelity, Rotel, NAD, Nakamichi, Marantz, KEF. Reference etc.

**ROGERS HI-FI**, 13 Bridge Street, Guildford, Surrey. (0483) 61049. Aiwa, Creek, Denon, Qual, JPW, Marantz, Onix, Pioneer, Systemdek, Ruark, Tannoy, Teac. Dem facilities available, no appts necessary, free installation, service dept. Access/Visa. Instant credit upto £1,000 subject to status. Monday-Saturday, 9.30-6pm, later by appointment.

**SURBITON PARK RADIO**, 48 Surbiton Road, Kingston-upon-Thames, Surrey. (081) 546 5549. QUAD, Castle, Denon, Qual, Kenwood, Mordant-Short, JBL, Rotel, Pioneer, DEO, B&W and Tannoy. Demo facility. Access, Visa and Switch 9.30-5pm.

**SURREY HI-FI**, 45 High Street, Godstone, Surrey. RH9 8LS. (0883) 744755. Specialist Hi-Fi outlet, demonstration room and parking available. Quad, Audioblab, TOL, Tube Technology, Rel Acoustics, Nakamichi, Kef, Thorens, Musical Fidelity, Van Den Hul cables, Bose, Sennheiser, Beyer headphones, Marantz, Denon, Michell, Van den Hul, Musical Fidelity, Tannoy, Target, JPW. Single speaker dem rooms. Free installation service dept, Access/Visa/Mastercard. Open 9-6pm. Closed all day Wednesday.

## SUSSEX (EAST)

**THE POWERPLANT "Brighton's Leading Hi-Fi Shop"**, 66 North Street, Brighton. Tel: 0273 775978. Comfortable listening rooms. Knowledgeable and approachable staff. Roksan, Micromega, Exposure, Audioblab, Epos, Rotel, Marantz, Cyrus, Regal, Arcam, Mission and more.

**WORTHING AUDIO**, 20 Treville Gate, W Sussex, BN11 1VA. Tel: 0903 212133. "The friendly shop with the best sound

systems in the South" Friendly advice. 3 yr guarantees. easy parking. open Mon-Sat 9-6pm. Late night Wed. Arcam, Exposure, Naim, Audio, Marantz, Ruark, Restek, Clear Audio, Audio Technica, Target, Tripod, Sennheiser, AR and many more.

**CHURCHERS HI-FI**, 154 Montague St. Worthing, Sussex. BN11 3HH. Tel: 0903 821595. All major well know brands of Hi-Fi stocked. Please call for details.

**HEATHERDALE AUDIO LTD.** 202 Finton Road, Worthing, Sussex. Tel: 0903 872288 or 0860 660901. eves. Three comfortable demonstration lounges where you can audition, Audionote, Krell, Audio Research, Klipsch, Martin Logan, Apogee, Sonus Faber, Theta, S.M.E, Copland, Voyd, Magnephaner, E.M.F., Lumley, Reference, Creek, Rotel, Heybrook, Clearaudio. Phone for used stock list. We are the South Coast's Premier Hi-Fi Specialist.

**BOWERS & WILKINS Ltd.** (est. 1945) 1 Bicket Buildings, Little Hampton Road, Worthing. Tel: (0903) 2 64141. Top names in Hi-fi and audio visual including 88W, Nakamichi, Castle, Denon, Philips, Quad, Technics, Aura, Teac, Sugden, Mission, Thorens and many more. 4 dem rooms (budget - high end.) expert friendly advice, service dept. local installations free, one minute from A24 & A27, free local parking, Access/Visa. Instant Credit upto £1,000 subject to status. Open 6 days.

**CHICHESTER HI-FI**, 7 St Pancras, Chichester, W Sussex. PO19 1SJ. Tel: 0243 776402. Linn, Naim, Rega, Creek, Nakamichi, A&R, Denon, Roksa, Epos, JPW, Ruark, Rotel, Quad. Spondor. Evening appts available.

## TAYSIDE

**DEAR AUDIO**, 28-36 Castle Street, Dundee DD1 9WZ. Tel: (0382) 26591. Rotel, Denon, Pioneer, Technics, Aiwa, Mission, Castle, Mordant-Short, Monitor Audio, Bose, Infinity. All equipment ready for demonstration. No appt nec. free installation. service dept. Open 9.30-6pm six days a week. (close 5pm Sat).

## TYNE & WEAR

**BILL HUTCHINSON HI-FI**, 87a, Castle Street, Newcastle-upon-Tyne. (091) 230 3600. For the largest selection of Hi-Fi and audio visual equipment in the North East. Specialist A.V. demonstrations of the highest quality. Best prices guaranteed. Minimum 2 year warranty and an optional 5 yr guarantee available. instant credit and mail order service on offer throughout the U.K. Pioneer, Denon, Kenwood, Yamaha, Technics, Marantz, Mission, Tannoy plus many more.

## WARWICKSHIRE

**STRATFORD HI-FI**, 25 Henley Street, Stratford-upon-Avon, CV3 0W. Tel: 0789 414533. Pioneer, Technics, Denon, Marantz, NAD, Rotel, Musical Fidelity, Monitor Audio, Mission, Tannoy, Quad, TDL, Sennheiser. 0% finance is available on selected products and all major credit cards accepted. Dem Rooms. Service facilities. open 9.30-5.30pm. Late night Thursday until 8.00pm.

## WEST MIDLANDS

**FRANK HARVEY HI-FI EXCELLENCE**, 163, Spon Street, Coventry CV1 3BB. Tel: 0203 525200. The Midlands first choice for specialist Hi-Fi. Audioblab, Audio Alchemy, Arcam, Audio Quest, Alphason, Bose, Bang & Olufsen, Celestion, Cyrus, Denon, Qual Foundation, Kef, Reference, Marantz, Monitor, Audio Mission, Musical Fidelity, Nakamichi, Naid, Rega, Rogers, Rotel, Quad, Systemdek, Target, Tripod, Tannoy, Thorens, Van den Hul, Yamaha 3 floors. 3 demonstration rooms. Open 9.30 till 5.30. Closed Thursday. All credit cards incl. Amex & Oiners. instant credit and interest free facilities. Home trials. Free installation, home cinema AV floor. We are a BADA dealer.

**MIDLAND VALVE HI-FI**, Specialising in true fidelity systems built around valve amplification - Audion 3000 Silver lights, Audio Innovations, Impulse, Audio Note, KAL, Townsend Audio, Ortofon, Voyd, Micromega, Edison, Stax, Apollo, Dynavort, Seismic Sink, Valves. Home demonstrations and part exchange. Also vintage. Leak, Quad, Croft, Radford, etc. flexible opening 7 days. phone Gary 021 722 2317.

**MUSIC MATTERS**, 351 Hagley Road, Edgbaston, Birmingham. B17 8DL. Tel: 021 429 2811. Roksan, Nakamichi, Arcam, Audioblab, Kenwood, DPA, Tannoy, Royd, Heybrook, Michell, Panasonic, Aura, Celestion, Musical Fidelity, Mission/Cyrus, Meridian, Kef, Monitor Audio, Pink Triangle, Ruark, Epos, Exposure, Pioneer and many, many more! 2 single speaker dem rooms. Appts necessary. Home trial facilities and free install. Service dept. Access/Visa-instant credit upto £1,000, interest free credit available also. Tues - Thurs 10.30-6pm, Friday 10.30-8.00pm, Saturday 10.00-5.30pm. Check out the new branch in Solihull - Phil works there so it can't be bad! 021 724 0284.



# jazz

Simon Hopkins

methods and materials in an intelligent manner, and without entertainment as its prime function. Typically then, a handful of this year's best records

have seen musicians from an improvising background, if not always a specifically jazz one, tackling this whole area of ambient music-making, and coming up with at least as fine a music as the best coming from the post-rave arena, and very possibly a damn sight better. Chief example: Absinthe, one of two offerings during this year from New York altoist-collagist-composer John Zorn's occasional supergroup Naked City, a quintet of New York noise-makers comprising bop drummer from Hell Joey Baron, keyboardist Wayne Horvitz, Brit-guitar-improviser Fred Frith on bass, guitarist Bill Frisell and Zorn himself.

This column has blathered on endlessly about both Zorn and Naked City and with just cause: despite his pretty widely reviled approach to music, Zorn remains one of contemporary jazz's - indeed one of all contemporary music's - most creative, most persistently fertile imaginations. But nothing in the decade and a half of Zorn's music could really prepare the listener for Absinthe, for where the altoist's music has always been noted for its short attention span, for its schizophrenic genre-leaps, for its omnivorous consumption of hard bop and b-movie soundtracks and surf music and Free Jazz and thrash metal and punk rock and Christ-knows-what ever else came to hand, Absinthe - though unquestionably dense, bewilderingly multi-layered stuff - is yet the most motionless, static piece of music Zorn has produced to date, certainly the only one which could possibly approach description as ambient.

Yet while the form and overall sound of the piece distinguishes it from the bulk of Zorn's, its sound puts it emotional lightyears from the increasing vapidity of rave-orientated ambient. And its sound is born of its theme. A natural conceptualist, and surely this generation's most consistent successor to John Cage, Zorn has often inextricably bound his music up with some overarching story, image or theme. The music of Italian film

soundtrack composer Ennio Morricone in *The Big Gundown*, the rise of German fascism in *Kristallnacht* and so on. In Absinthe, it is the emotions and senses experienced under the influence of the narcotic liqueur loved by fin-de-siecle Parisian bohemians, and this music's uneasy, shifting, often barely audible, highly imitating version of stasis owes everything to these experiences.

This is uncomfortable stuff, and listeners looking for the womb-like slumber party soundtrack of rave-orientated ambient aren't going to go a bundle on this stuff, but it's encouraging that far from being a totally isolated piece (though it is, of course, highly unique in its realization), Absinthe unwittingly finds itself among a whole clutch of records aspiring to infuse the stasis of ambient with the psychotic unease of mid-20th century art music, records being made by musicians otherwise unconnected by background and genre. Check out Lull and Final and Main and Techno Animal and Thomas Koner and Seefeel and a whole host of others, and find disparate, perhaps even mutually hostile music-makers pulling ambient in broadly the same direction. Absinthe is a stand-out example of just this manipulation, and certainly the finest created by a group coming from an unquestionably jazz background.

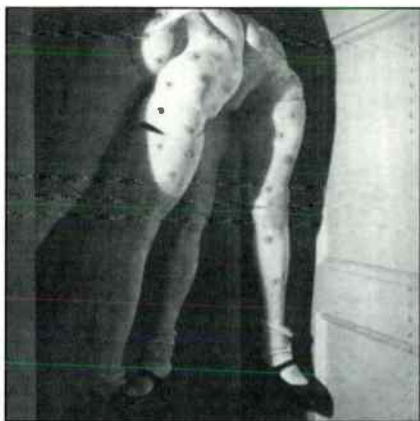

**NAKED CITY**  
**Absinthe**  
**AVANT**

● The buzz word - or one of the most used at any rate - in recent pop music has unquestionably been "ambient". A term first coined by early Roxy Music keyboardist-turned serious composer Brian Eno, it was intended to denote a functional mood music which at once drew on the bizarrely oxymoronic fields of American minimalist music - most especially that of La Monte Young and Terry Riley - and industrial/environmental background music, or muzak.

The current vogue for ambient kicked in at the end of the 80s as music for the chill-out room, where strung-out ravers could come down from their musically- and chemically - induced high. With these post-rave associations, ambient has been dragged into the nineties with most commercial succes by musicians coming from a dance background, with The Orb as both prime example and hugest stars.

Of all definitions of jazz it's always seemed to this writer that one of the most useful descriptions is that the music provides a platform for using pop music's

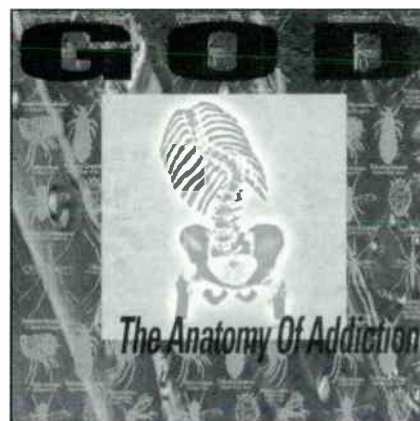

**GOD**  
**The Anatomy of Addiction**  
**BIG CAT**

● If Absinthe occupies so much time here, it's because it encapsulates in its outward simplicity so much of the best creative jazz of the last twelve months, and accurately describes its mood. Despite the TV ad-friendly nature of so much pre-1960 jazz, none of the music's leading edge has ever been anaesthetic; it's a music almost by definition agitating, unsettling, revolutionary. A billion miles from the stasis of Absinthe, British industrial-thrash-jazz collective God represent a similar dysfunctional approach to improvised music making.

This was the fourth time out for God, and saw the group at its barest, most stripped-down yet, though the line-up itself remained a big one: leader Kevin Martin and Tim Hodgkinson on



## JORDAN

We are the world leaders in Metal Cone Loudspeaker Technology and our experience and expertise extends back over 40 years.

Our precision tooled foil cones together with our unique Linear High Compliance Suspensions provide loudspeaker drive units of unrivalled performance.

Our approach permits the use of the most simple crossover and enclosure designs and opens the door to a virtually limitless range of performance options.

The newly developed Jordan JX Series of loudspeaker drive units represent the cutting edge of driver technology. Based on the wide bandwidth, foil cone principle, pioneered by Jordan over forty years ago, these latest drive units offer significant improvements in bandwidth, linearity, efficiency and power.

The Jordan JX Series comprises three drive units:

The Jordan JX51 is a foil cone mid-high frequency unit having a piston diameter of 51mm. It provides an exceptional bandwidth from 100Hz - 30kHz, with good efficiency and power handling. Used singly or in multiples it is intended for use in systems to provide the highest standards of sound quality.

The Jordan JX125 is the complementary bass unit to the Jordan JX51. The low mass foil cone has a piston diameter of 125mm which is suspended by the unique Jordan Linear High Compliance Suspension to achieve a fast and extended bass performance down to 25Hz (depending upon the loading conditions).

The Jordan JX92 is a new addition to the Jordan range. It embraces a 92mm foil cone and is intended for use as a full range driver in compact systems. The bandwidth extends from 45Hz - 17kHz with excellent efficiency and power handling. The unit offers significant advantages for a compact, low cost system, having the special qualities of sound achievable from a crossover-free design.

For further information, please contact:

### E.J. JORDAN DESIGNS

The dak, Manorbier, South Pembrokeshire, SA70 8QR  
Tel. 0834 871209 Fax. 0834 871770

Distributor clears stock, export-discount **50%** or more

# HIGH END SALE

## WELL TEMPERED



Record Player, Classic, Signature **£590**

## AUDIO RESEARCH

DAC1, SP9, SP15, D250 MkIIIS, M300 MkII, Classic150

**KOETSU** Black, Rosewood Signature, Onyx Signature

## MARK LEVINSON

MLC1, JC1, ML6, HQD-system (2xML6A, 2xLNC2, 6xML2, 2xHartley/Quad/Decca-array)

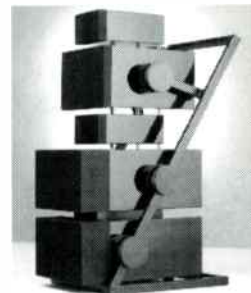

## GOLDMUND

Studietto, ST4, T5, Cartridge, Mimesis amplifier series, Super-Dialogue, Apologue (picture)

Also: **Berning, Breuer, Cotter, Eureka, Fidelity Research, Linn, Moersch...**

**Call for catalogue!**

Glotta AB, phone +46 8345251, fax +46 8346533

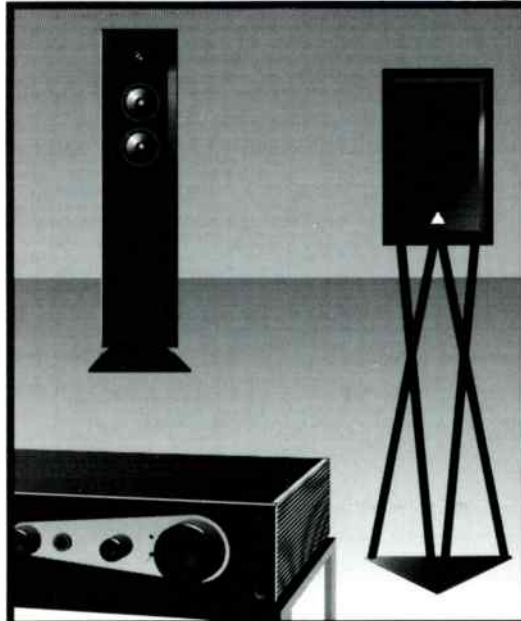

# TRIANGLE

ELECTROACOUSTIC

## FRENCH SPEAKERS

...as reviewed by English speakers...

"The Alicante's big, fluid, wide-ranging and open presentation lets the music speak for itself."

Jonathan Kettle, AUDIOPHILE, November 1993

"The Titus E has an absolutely riveting sound with openness and rhythmic drive."

WHAT HI-FI?, March 1993

"The Icares are fast and enthusiastic: there's nothing twee or laid-back about their presentation of music - whether reserved classical or high energy rock."

WHAT HI-FI, October 1992

## AND AS FOR THE AMPLIFIER...

"The Triangle TE60...has very clean treble...separation is first class...bass is outstanding...an excellent product. A super little amplifier, nicely styled and beautifully finished."

Jimmy Hughes, AUDIOPHILE, March 1994

## THE ROMANCE OF FRENCH HI-FI

Berks  
**THE AUDIO ROOM**  
3 Little brook Avenue  
Burnham, Slough, Berks  
0628 - 668112

Corwall  
**RJF AUDIOVISUAL**  
84 Pendarves Street  
Tuckingmill, Camborne  
0209-710777

Dublin  
**ACOUSTIC DIMENSION**  
16 Idrone Mews, Idrone Lane  
Black Rock, Co. Dublin  
0103531 - 2884612

Norwich  
**SOUND APPROACH**  
161 Unthank Road  
Norwich  
0603 - 622833

London  
**DOUG BRADY HI-FI**  
(See Dial-A-Dealer)  
071 - 379 4010

Liverpool  
**DOUG BRADY HI-FI**  
(See Dial-A-Dealer)  
051 - 7336859

Warrington  
**DOUG BRADY HI-FI**  
(See Dial-A-Dealer)  
0925 - 828009

London  
**DIVA**  
Workshop 30, Royal Victoria  
Patriotic Bdg., Wandsworth  
081-875 9593

Greater Manchester  
**ORPHEUS AUDIO**  
Wigan WN6 0PD  
0257 - 426100

Scotland  
**HI-FI EXCELLENCE**  
293 Union Grove  
Aberdeen  
0224-322520

Triangle loudspeakers cost from as little as £265. TE60 Integrated Amplifier £549 - for more details phone Ortofon UK (0753-889949) or Kronos (08687-48632)

saxophones, Godflesh's Justin Broadrick and Terminal Cheesecake's Russell Smith on guitars, Tom Prentice on viola, John Edwards on double bass, Dave Cochrane and Gary Jeff on electric basses, Scott Kiehl and Lou Ciccotelli on drums and Swiss reedsman and leader of 16-17 (of whom more later) Alex Buess guesting on bass clarinet.

On previous albums - the live *Loco and Consumed* and their studio debut *Possession - God* have shown a distinct taste for expansiveness with often long work-outs seeing huge swathes of saxophones, guitars, vocals and samples meshing over a dense backdrop of massive bass, driving drums and clattering percussion. On *Addiction*, these elements remain, naturally, but even with the often highly dubbed-out production, there is a focus here I've not previously heard them muster. Here tracks get stripped down to their bare bones, to massive HM riffs or dub reggae basslines or 70s Miles Davis grooves, over the top of which elements of the group's sound are brought in and out of the mix like so many fleeting fantoms; the massed ensemble sound that this band can summon up like no other is only sparingly brought to bear, but when it's there, it's breathtaking, pulverizing.

Still the finest band in Britain, still one of the most awe-inspiring groups working in (or at least somewhere near) contemporary jazz, *God* remain unparalleled, and *The Anatomy of Addiction* is their finest yet. Where to next?

## 16-17 'GYATSO



### 16-17 Gyatso PATHOLOGICAL

● A further crucial example of work happening along the God axis, noisy Swiss improvisers 16-17, led by the aforementioned Alex Buess, have been around for some years now, but *Gyatso* is a radical step forward and without question one of this hack's favourite records of the year. A trio of Buess on saxophones and bass clarinet, guitarist M Kneubuhler and drummer K Remond, 16-17 are augmented here with God-leader Kevin Martin on samples and GK Green from Birmingham's grindcore kings Godflesh on bass.

Like *Anatomy of Addiction*, Gyatso sees Martin in the producer's chair and the results again bear the fruits of a kind of Interactive Age approach to jazz; Martin has recorded hours of this group improvising and then done the ultimate cut-and-paste job on the lot, taking sections and spinning out tape loops from them, offsetting solos against each other, generally cannibalising the proceedings in a voracious way; only then has the bass been added with yet further saxophones plastered all over the proceedings. The results are mind-boggling: a relentless, inconceivably dense mass of stop-start rhythms and sprawling improvised sound. This is undeniably one of the toughest records of the year, a truly daunting listen (to listen to it end-to-end, non-stop is almost physically draining), yet one of the last twelve months' creative landmarks.



### DEATH CUBE K Dreamatorium STRATA

### KAZUYUKI K NULL & JAMES PLOTKIN Aurora SENTRAX

● Two more offerings from musicians from an improvising background, and hence one at least tangentially jazz, which offered a sort of anti-bliss take on ambient. *Aurora* saw Japanese monster thrash metal guitarist KK Null, leader of Zeni Geva as well as creator of a series of fantastic solo records (check every damn one out if you can find 'em), join forces with fellow guitarist Jim Plotkin from the American group OLD who themselves

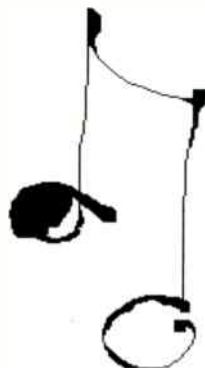

whip up a fine blend of thrash metal noise and psychedelic improvised sprawl. The results of their meeting are a genuinely beautiful record; *Aurora* is a series of exquisite, fragile sound sculptures shot through with an uneasy tone.

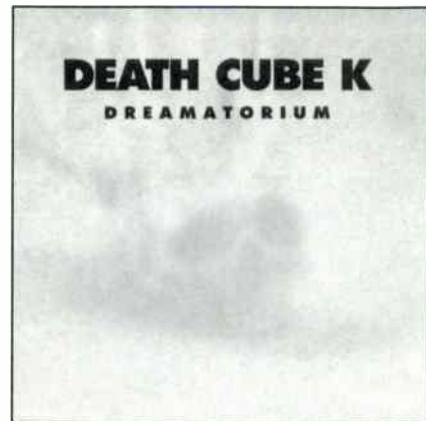

While *Dreamatorium* brought together two old friends in the shape of Death Cube K: producer-bassist-arranger Bill Laswell and San Franciscan avant-garde speed metal guitarist Buckethead. Again musicians noted for the outward freneticism of their output - a freneticism as often as not born of their restless hybridizing - they've turned out a collection of beautiful, but highly disturbing tone poems.

### MILES DAVIS What I Say? Volumes 1 & 2 JAZZ MUSIC YESTERDAY

● A grossly overlooked hybrid of jazz improvisation, funk and 20th century "art" music, the 70s output of Miles Davis remains a huge presence looming over so much of the music reviewed here. These two CDs feature two sets recorded by a stellar band in 1970 and are essential.

### PAT METHENY Zero Tolerance For Silence Geffen

● A glorious celebration of noise or a complete piss-take? Who cares? Just check out the generally anaesthetic guitar virtuoso in Sonic Youth-ish guitar-only freak-out. A total blast.

### JAN GARBAREK & ANOUAR BRAHEM Madar ECM

● The Norwegian saxophonist's finest outing for years, alongside oud virtuoso Brahem and tabla player Shaukat Hussain. Urgent, singing, plangent: essential.

### STEVE TIBBETTS The Fall of Us All ECM

● Tibbetts' often violent guitar meshes seamlessly with the pan-ethnic rhythms and textures of his eight-piece band.

# Lumley REFERENCE



**ST 70  
STEREO**

Anything else  
is a compromise

WITH THE SUPERB RANGE OF  
PRODUCTS NOW AVAILABLE FROM

*'Lumley Reference'*

YOU NEED COMPROMISE NO  
FURTHER

CALL OR WRITE FOR MORE  
DETAILS & DEALERS LIST:

**REFERENCE**  
*International*

**PINERIDGE SANDY CROSS,  
HEATHFIELD, EAST SUSSEX  
TELEPHONE (0435) 868004  
FACSIMILE (0435) 864481**

"Sweet is the sound of  
music to those who  
have experienced  
better hi-fi"

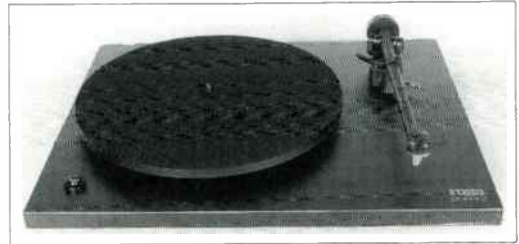

Linn Naim Rega Arcam Quad Audiolab  
Royd Kef Epos Mission Nakamichi Denon  
Rote Teac Micromega

Access & Visa  
% Finance  
BADA

**Real Hi Fi**

Hear the difference

Demonstration  
Installation  
Service

**BETTER HI-FI**

The Essence of Music .....   
16 COOK STREET, LIVERPOOL L2 9RF ☎ 051-227 5007

## TECHNICAL & GENERAL

Some Necessities - From the Original Classic Turntable Specialists

Connoisseur		P&P
BD1/2 Drive Belt	9.85	1.85
BD1/2 Motor Suspension kit	13.75	2.25
SAU.2 Headshell	16.75	2.55
SAU.2 Connecting lead	15.95	3.55
<b>Garrard</b>		
<u>Standard Models</u>		
Wired arm tubes	from 12.75	2.55
Cartridge carriers (sliders)	9.25	1.85
Idle Wheels	9.85	2.25
<u>301/401 Transcription Models</u>		
Original Thrust pad assembly	9.80	2.25
Original Idler tension spring	2.95	1.85
Original Speed control disc - 401	13.75	2.20
Xeroxcopy Owners Manual 301 incl. full size mounting template	7.35	1.85
Xeroxcopy Owners Manual 401 incl. full size mounting template	5.20	1.85
Replacement Intermediate drive wheel	19.95	2.85
Replacement 301 control knobs On-Off/Speed select	pair 20.25	2.55
Replacement 301 suppressor unit	5.65	2.25
Replacement 301 motor pulley (-2%), (-1%), (Std), (+1%)	each 12.65	2.25
Replacement 301 Chrome plated mounting bolts	set 3.70	1.85
Recommended Lubrication set - early 301 or 301/401 (specify)	5.20	1.85
<b>Goldring/Lenco</b>		
Idler wheel (lock-nut or clip fixing)	19.95	2.85
Arm Pivot bearings with instructions	7.85	1.85
Spindle/Main bearing assembly complete	22.85	3.85
Headshells	from 21.95	2.55
Instruction books	from 4.20	1.85
<b>Thorens</b>		
<u>TD.124 series</u>		
Idler wheel	19.95	2.85
Drive belt	9.85	1.85
Chassis spring suspension (replaces 'mushrooms')	13.85	2.55
<u>150/160 series</u>		
Drive belt	9.85	1.85
Suspension springs (-1%), (Std), (+1%)	set 10.85	2.55
Suspension bushes	set 12.50	2.25
Armboards for most models	from 16.90	2.55

Cecil Watts Dustbags/Parastats/ (spares incl. Preener wicks)  
Cartridges and styli for 78s & Mono LPs in addition to current Stereo LP

**TECHNICAL & GENERAL PO Box 53. Crowborough,  
E.Sussex. TN6 2BY Tel:- 0892 654534**



## AUDIO ACCESSORIES



### HI-FI WORLD SOLID SILVER INTERCONNECTS.

Constructed from solid strands of pure silver wire, and with a thick outer casing and screening braid, these interconnects offer the ultimate in transparency, openness and detail. Superb Neutrik Profi phono plugs are silver soldered to the cables in pseudo-balanced configuration for lowest noise/interference and extensive use of adhesive heat-shrink is used to strengthen the join between cable and plug for long life. Available exclusively through Hi-Fi World Mail Order.

.....£139.95/1M PAIR.

### HI-FI WORLD SILVER PLATED COPPER INTERCONNECTS.

A similar construction to our solid silver cables, but using silver plated copper and standard Gold Phono plugs. Because the majority of the audio signal passes through the skin of a cable these can approach the quality of silver, but at the cost of normal high quality copper cable.

.....£69.95/1M PAIR.

### HIGH QUALITY MAINS CABLES.

Supplied to Hi-Fi World by Campaign Audio Design these mains cables are screened to reduce Radio Frequency and Electromagnetic Noise. They also come

with a VDR fitted which protects equipment from mains spikes. The MK plugs have a silver plated fuse and holder for the cleanest supply. Available with IEC or Figure eight (Marantz/Philips CD players) equipment plugs or with a hard wired, soldered 4-way mains block.

**IM WITH IEC PLUG**.....£19.20  
**IM FIGURE 8 PLUG** .....£15.75  
**IM 4-WAY BLOCK**.....£31.95



### 4-WAY MAINS BLOCK WITH RF FILTER

Similar to the standard 4-way mains block featuring 2m screened mains cable, MK plug with silver plated fuse and holder and VDR to stop mains spikes reaching your equipment, A special RF filter has now been added which cuts out even more mains borne interference. Suitable for top-end systems

.....£45.50

### EQUIPMENT SPIKES

Machined from solid brass these equipment spikes can be placed under equipment to help ground harmful vibration and enhance the visual appearance of your equipment. The spikes come in sets of three and will

support equipment weighing up to 10kg. We hope to introduce a larger spike suitable for heavier equipment and loudspeakers within the coming months.

.....£6.50

### AFFORDABLE SILVER PLATED COPPER INTERCONNECT

A 'budget' interconnect featuring high quality silver plated copper co-axial cable and standard gold plated phono plugs is now available. The plugs are silver soldered to the cable for good electrical contact and high mechanical strength.

.....£28.00/1M PAIR



### HIGH QUALITY AERIAL LEADS

If you've just spent a lot of money on a good tuner and aerial, then you'll want to connect the two together with the best cable possible to ensure the signal is preserved. We now have a high quality copper co-axial cable furnished with gold plated connectors which does just that. Because the length of cable required for different circumstances will vary greatly, we are offering a custom termination service for this cable.

.....£19.95/1M +£2/EXTRA 1M



### GARRARD 401 CELEBRATION SME IV TONEARM

A special version of the SME IV cast magnesium alloy tonearm, dedicated to the Garrard 401. The SME IV is precision engineered to be fully adjustable, making set-up easy and precise. If you want to get the best from your Garrard 401, this is a fantastic tonearm, sympathetically styled to form a perfect combination.

GARRARD 401 CELEBRATION SME IV TONEARM .....£820

## AUDIO ACCESSORIES



LP together. Review in Hi-Fi World August 1994, these machines are a must for the dedicated Vinyl collector.

### BASIC RECORD CLEANING SYSTEM

.....  
**£199.90**

**RECORD MASTER RECORD CLEANING SYSTEM FOR ALL SIZES (7/10/12") WITHOUT ADAPTOR** .....

**£249.90**

**1.5 FI FULLY AUTOMATIC SINGLE SIDED RECORD CLEANING SYSTEM** .....

**£399.00**

**MINI-PRO I RECORD CLEANING SYSTEM BOTH SIDES CLEANED SIMULTANEOUSLY** .....

**£599.00**

For further details and cleaning fluid cost please contact the Mail Order Department on 071 - 266 0461

**NEW**

### NITTY GRITTY RECORD CLEANER

Bring a glossy shine to your LPs with the Nitty Gritty series of record cleaners. Several versions are available from the basic machine to the near fully-automated Mini-Pro (pictured) which cleans both sides of the

### BUG AUDIO

A fascinating little device no larger than a hand-held remote which allows the user to adjust bias on any cassette deck perfectly for any tape. You can check the state of your cables and connections with it, too! Supplied with a cassette test tape and full instructions. (See review, Nov. 1992 issue.)

**BUG AUDIO** .....**£59.99**



### MICHELL ENGINEERING PLUGS

Craftsmanship marks out Michell Engineering's range of gold and rhodium plated plugs from the competition.

**GOLD-PLATED SIDE ENTRY BANANA PLUGS (4)** .....**£10.00**  
**GOLD-PLATED SURE-LOC**



**BANANA PLUGS (4)** .....**£14.95**  
**RHODIUM-PLATED SURE-LOC BANANA PLUGS** .....**£18.95**  
**GOLD-PLATED SPEAKER CABLE CONNECTORS**...**£10.00**

### GOLD PLATED 4MM BANANA PLUGS

Heavy-duty, gold-plated banana plug with a unique type of axial solderless connection for loudspeaker cables. The cable is stripped back and pushed into a clamping collar which is then screwed down tight, accepting cable up to 6mm external diameter and 4mm core diameter. Supplied in sets of four.

**BANANA PLUGS (4)** .....**£8.00**

### RECORD STORAGE CUBE

Designed to hold about a hundred LPs, with an internal width of 37cm, height of 32.5cm and depth of 32cm. The cubes can be stacked or placed alongside each other - and are even strong enough to be used as seats! Made from 15mm MDF (Medium Density Fibreboard) with a smart durable black paint finish, the cube is supplied in flat-pack

form ready for home assembly.

**RECORD STORAGE CUBE** .....**£45 EACH**

**SIX CUBES FOR THE PRICE OF FIVE** ..... **£225.00**  
**EIGHT CUBES FOR THE PRICE OF SEVEN!**.....**£315.00**



### ANTI-STATIC RECORD SLEEVES

Translucent sleeves, treated to reduce static and dust attraction, supplied in packs of fifty.

They will fit inside ordinary printed inners.

**LP SLEEVES (50) PRICE £8.15**

### SOUND SWIVEL

A rotating, upright, double-sided, storage cabinet with space for up to 160 Compact Discs, including 8 double jewel-cases. Mounted on an all-steel turntable, it swivels smoothly through 360 degrees giving easy access to the storage compartments either side. Manufactured in durable MDF with a Black Ash effect finish, the Sound swivel comes packed for self assembly with full instructions.

**SOUND SWIVEL** .....**£49.95**



# Hi-Fi World

# AUDIO ACCESSORIES

## AUDIO-TECHNICA RECORD CLEANING SYSTEM

Removes both dirt and static; a tiny amount of cleaning agent in the handle removes fingerprints, oil and film, while a pad lifts off dust. Pad brush and fluid are supplied.

**AUDIO-TECHNICA RECORD CLEANING SYSTEM £10.50**



## AUDIO-TECHNICA COMPACT DISC LENS CLEANER

A disc the size of a CD, with fine brushes - one of which is dampened with cleaning fluid. As the disc spins in the player, the brushes clean the laser lens. It may not suit all machines.

**CD LENS CLEANER .....£16.25**



## KONTAK

An effective cleaning solution that removes contaminants from electrical connections. After application, a system regains its original life, sparkle and vigour.

**KONTAK .....£19.00**

## HI-FI WORLD DRY STYLUS CLEANER

Keep your stylus sharp and bright for perfect tracking without using fluid. Cut a strip about the size of a matchbox striker off this sheet of card and draw it gently under the stylus from back to front. One sheet of this card, with its aluminium-oxide micro-abrasive coating, should be enough to clean your stylus at least forty times.

**DRY STYLUS CLEANER...£1.95**

## EQUIPMENT SUPPORTS

FrameWorks is an innovative range of versatile hi-fi supports whose high standard of strength and rigidity results from their 'triangulate' design. The shelves are supported on struts of thin cross-section and four sturdy corner columns, to reduce resonances.

Versatility is guaranteed by two or three shelf options, an additional isolation shelf and a stacking unit to expand the system as the hi-fi grows. All you need to do is add components as and

when you feel the need.

FrameWorks stands come with attractive 10mm thick toughened smoked glass shelves, supported on rubber-damped spikes to reduce vibration and lessen the tendency for the glass to slide. Metal parts are finished in a hardwearing satin black powder coat.

FrameWorks stands will extract the best out of any equipment.

FrameWorks' excellent hi-fi equipment stands are now available through our Mail Order Department.

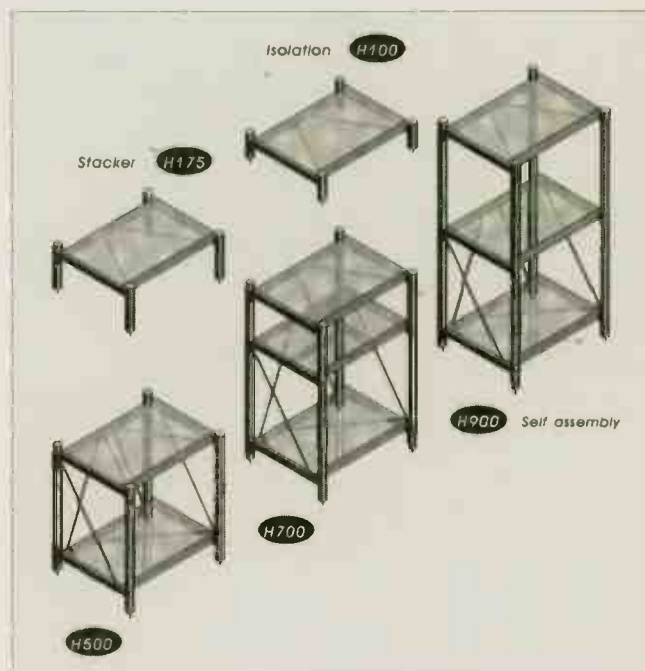

PRICES FOR FRAMEWORKS EQUIPMENT STANDS ARE AS FOLLOWS;

CODE	HEIGHT	PRICE
H100	100MM	£109
H175	175MM	£119
H500	500MM	£205
H700	700MM	£275
H900	900MM	£305

ALL FRAMEWORKS SHELVES ARE 550MM WIDE BY 450MM DEEP. All prices include VAT & p+p for UK only.



**H100 ISOLATION TABLE**

# AUDIO ACCESSORIES

## GOLDRING EXSTATIC MAT

For vinyl users, the Goldring Exstatic is a felt mat made with fine carbon fibre strands. This helps to reduce positively charged static electricity that builds up on the surface of records.

**GOLDRING EXSTATIC MAT** £7.50



## SUPER EXSTATIC CARBON FIBRE DISC CLEANER

Effectively removes dust and grime from record grooves, this cleaner is a combination of one million carbon fibre filaments and a soft velvet cleaning pad.

**EXSTATIC CARBON FIBRE CLEANER** £9.95



## MILTY TRIPLE A

Suitable for all types of cassette players including auto-reverse, the Milty Triple A wipes clean single/dual capstans and pinch rollers with a non-abrasive cleaning action.

**MILTY TRIPLE A** £6.50

## MILTY MAGNET IX

The Milty Magnet IX comes complete with battery. It requires approx one second to de-magnetise the heads removing magnetic charge build up. Recommended after every 30 hours of playing time.

**MILTY MAGNET IX** £10.50

## HI-FI WORLD SPECIAL AUDIO ACCESSORIES ORDER FORM

Please send me:

- Audio Technica CD Lens cleaner .....£16.25 each
- Audio Technica Green CD Ring Stabilizers .....£6.50 (Pack of 5)
- Audio Technica Record Cleaning System .....£10.50
- Basic Record Cleaning System .....£199.90
- Record Master Record Cleaning System (without adaptor).....£249.90
- 1.5 Fully Automatic Single Sided Record Cleaning System .....£399.00
- Mini-Pro Record Cleaning System .....£599.00
- Bug Audio Biasbug .....£59.99
- CD sound swivel .....£49.95
- Equipment Spikes .....£6.50
- Garrard 401 Celebration SME IV Tonearm .....£820.00
- Gold plated 4mm plugs .....£8.00 (4)
- Goldring Exstatic Mat .....£7.50
- Goldring Super Exstatic Carbon Fibre Disc Cleaner .....£9.95
- Standard Silver Plated Copper Interconnects (1m pair).....£28.00
- Hi-Fi World Silver Plated Copper Interconnects (1m pair) .....£69.95
- Hi-Fi World Solid Silver Interconnects (1m pair) .....£139.95
- Hi-Fi World Aerial Leads .....£19.95 per m + £2.00 per extra m
- Hi-Fi World Dry Stylus Cleaner .....£1.95 per sheet
- Kontak cleaning fluid .....£19.00each
- Michell Gold-Plated Side Entry Banana Plugs (4) .....£10.00
- Michell Gold-Plated Speaker Cable Connectors .....£10.00
- Michell Gold-Plated Sure-Loc Banana Plugs (4) .....£14.95
- Michell Rhodium-Plated Sure-Loc Banana Plugs (4) .....£18.95
- Milty Magnet IX .....£10.50
- Milty Triple A .....£6.50
- Nagaoka Anti-static record sleeves .....£8.15 (50)
- Pixall MkII Record Cleaner .....£10.75 each
- Pixall refill roller .....£2.75each
- Record storage cube .....£45.00 each
- Screened Mains Cable With 4-Way Block (1m) .....£31.95
- Screened Mains Cable With RF FILTER4-Way Block (2m).....£45.50
- Screened Mains Cable With Fig 8 Plug (1m) .....£15.75
- Screened Mains Cable With IEC Plug (1m) .....£19.20

Prices are exclusive of postage & packing, please add £1.00 for postage in the UK and £2.00 for postage overseas. With the exception of the Record Cleaning Systems which are £4.00 UK and £10.00 overseas.

- Your name and address may be added to our mailing list only. If you would prefer not to receive details of new products or special offers please tick box. Hi-Fi World magazine is published by Audio Publishing Ltd.

10/94

Please allow 28 days for delivery

### Books

- Electrostatic 'Speaker Design & Construction .....£19.95 + £2.00 p&p
- The Williamson Amplifier .....£9.95 + £1.00 p&p
- Mullard Circuits for Audio Amplifiers .....£13.95 + £2.00 p&p
- The Loudspeaker Design Cookbook .....£23.75 + £2.00 p&p
- The Art of Electronics .....£35.00 + £4.00 p&p
- The Art of Linear Electronics .....£16.95 + £2.00 p&p
- Audio & Hi-Fi Handbook .....£40.00 + £4.00 p&p
- Loudspeakers: The Why & How .....£10.95 + £1.00 p&p

All prices are exclusive of postage & packing. For U.K. and Europe please see above. For 10 or more books p&p is free. Outside Europe please contact us for rates.

I enclose cheque/PO for £ .....made payable to **World Audio Publishing Ltd.**

I wish to pay by Visa/Access, please debit my account no:

--	--	--	--	--	--	--	--	--	--	--	--	--	--	--	--	--	--	--	--

Expiry date: 

--	--	--	--

Signature: .....

Name .....

Delivery Address .....

N.B. If delivery address is different to the credit card holder's address please supply both.

Tel: .....

Please send completed order form together with your cheque/PO to:

**HI-FI WORLD,**  
64 Castellain Road,  
Maida Vale,  
London W9 1EX.



Credit Card Orders  
Telephone 071 - 266 0461  
24 hour Mail Order Answerphone

# Hi-Fi World WORLD LIBRARY

## **ELECTROSTATIC LOUDSPEAKER DESIGN AND CONSTRUCTION, by Ronald Wagner. £19.95**

This book takes you step by step through the design and construction of a full range electrostatic loudspeaker, including the basic operating principles behind electrostatics. Whether you intend to build your own electrostatic, repair and restore a vintage electrostatic or are just interested in the principles behind electrostatics, this book is a must.

The author takes you deep into his design decisions and offers practical advice on how to build the amplifier and set it up for best performance.

principles through to full design exercises and practical circuits.

## **LOUDSPEAKERS: THE WHY AND HOW OF GOOD REPRODUCTION, by G. A. Briggs. £10.95**

A popular and easy to understand book on building loudspeakers, using empirical techniques that pre-date computer analysis. A fine grounding, written by a manufacturer with first hand experience - recommended for beginners.

## **THE LOUDSPEAKER DESIGN COOKBOOK, by Vance Dickason. £23.75**

This best selling book in the field of loudspeakers offers good, up-to-date practical design information for the home constructor. Like today's manufacturers it uses modern Thiele Small theory and parameters.

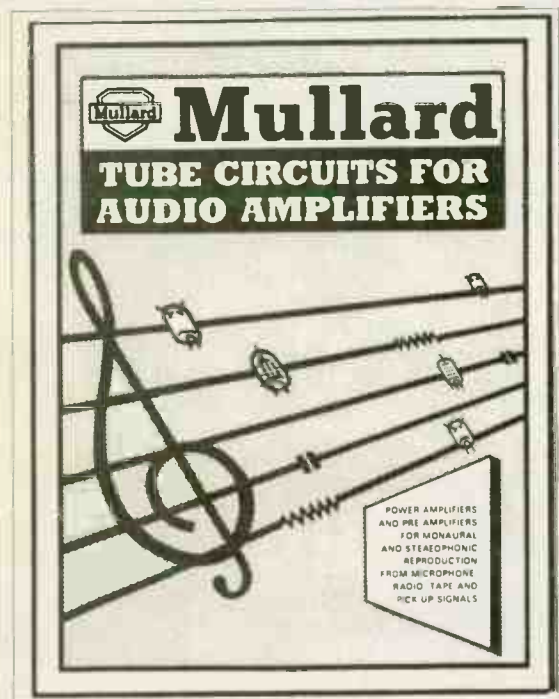
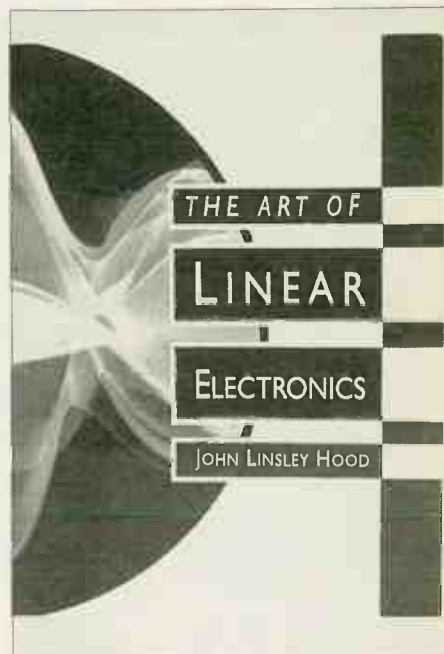

## **MULLARD TUBE CIRCUITS FOR AUDIO AMPLIFIERS. £13.95**

First published in 1959 by Mullard, this book includes full designs for eleven power and control amplifiers, including the 5-20, using valves. This book begins with a four-chapter tutorial on getting the best sound from valve amplifiers.

## **THE ART OF LINEAR ELECTRONICS, by J. Linsley- Hood. £16.95**

Concentrates specifically on analogue electronics for audio and goes into detail on obscure topics like the drawbacks of feedback, as well as its advantages. Covers mainly solid state but also includes valves. A must for serious enthusiasts and budding designers.

## **THE WILLIAMSON AMPLIFIER, by D. T. N. Williamson. £9.95**

In April 1947, Williamson's valve power amplifier became an overnight success.

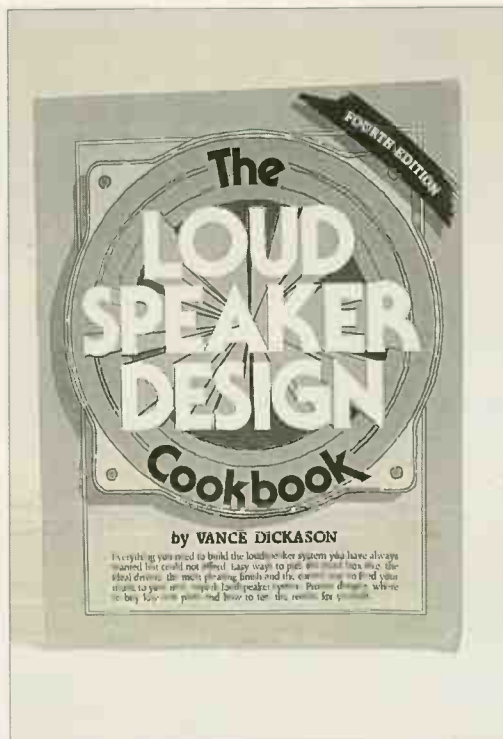

## **THE ART OF ELECTRONICS, by P. Horowitz and W. Hill. £35**

The definitive electronics book. The Art of Electronics is an ideal book for the beginner through to the engineer. Written in easy to understand English, each chapter takes you from basic first

## **AUDIO AND HI-FI HANDBOOK, edited by I. R. Sinclair. £40.00**

The Audio and Hi-Fi Handbook is written by some of the best known designers and spokespeople of the audio industry. It offers an insight into every area of audio, from sound waves and acoustics, through to car hi-fi.

## **AUDIO & HI-FI HANDBOOK**

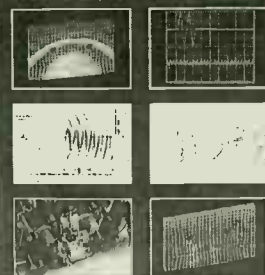

# **Try me & see** **For the very best** **DEALS for 1994!**

**on any current Hi-Fi, A/V,  
Home Cinema unit or VCR -  
AND all Award Winners**

**AMAZING PRICES GUARANTEED**

***PHONE NOW***—*you'll get first-class  
service, savings and support.*

- ▶ Budget, Regular and Esoteric Equipment.
- ▶ Insured Overnight Delivery, anywhere in the U.K.
- ▶ Major Credit Cards, Switch/Connect accepted.
- ▶ All goods carry comprehensive Warranty.
- ▶ Goods under Warranty collected and delivered FREE.
- ▶ Extended Warranties up to 5 years available.

*You can always buy from TMS with the complete confidence that we will never let you down.  
We ever put our customers first and constantly upgrade and update our systems in order to improve our service.*

**081-563 0003**  
**Fax 081-563 0300**

**Try Me & See Ltd,**  
**5 Rocks Lane, Barnes,**  
**London SW13 0DB**



Announcing . . . the  
Elektra Integrated &  
Eos Power Amplifiers

ELEKTRA INTEGRATED £999  
EOS POWER AMP £899  
TITAN MAINS FILTER £125  
SILVER INTERCONNECT AND DIGITAL  
CABLES FROM £75  
SILVER SPEAKER CABLES FROM £25 per m

Arion  
ACOUSTICS

MAKE THE LEAP  
FROM AUDIO TO  
. . . REALITY

Worldwide sales agents

**KRONOS DISTRIBUTION**

35 Farlough Road • Newmills

Dungannon • N. Ireland

Tel. 0868 748632

Fax. 0868 748281



**KRONOS**

*Extraordinary hi-fi for ordinary people.*

That would sum up our approach to how we choose the products that we import and distribute

*Pro-ject* turntables. *Audiomeca* analogue and digital disc players. *Triangle* amps and speakers. *Lieder* cables. *YBA* and *Arion* amplifiers.

Style, character, top class performance and value for money: another way to sum

**PUTTING THE GROOVE BACK INTO MUSIC**

For more information, contact

Kronos on: 08687-48632

# RINGMAT

## FOR RECORD LOVERS

First record support to be properly designed

### Hear what reviewers say:

"A carefully researched and innovative product which genuinely transforms analogue replay at nominal cost. The string bass was more dynamic, the separation cleaner and, more importantly, the phrasing of the music was more fluid - you heard the vocal line arch and fall." **Christopher Breunig (Hi-Fi News, September '93)**

"I found I preferred the RINGMAT and will carry on using it. The results were wholly positive..." **Jason Kennedy (Hi-Fi Choice, April '93)**

"RINGMAT gave a sharper, cleaner, more solid sound, with better fine detail and clarity. On complex material the improvement in stability and focus was remarkable; easily comparable to an expensive tonearm, cartridge or power supply upgrade... Any drawbacks? None I could detect..." **Jimmy Hughes (Audiophile, October '93)**

"I found the sound of my LPs improved significantly, reminding me of the experience of listening to records on a Goldmund Reference turntable with a van den Hul Grässhopper cartridge with its nude stylus. All of a sudden, much more of the music, and the space in which it was performed, was evident. I'm sure that the legions of Linn and Rega owners out there who still play their LPs will want to make the modest investment required for a major improvement in vinyl play."

**Andrew Marshall**  
(Audio Ideas Guide, Winter '94)

### Hear what your fellow music lovers say:

"I would agree with everything you claim for this product. The music is more natural, more musical, and with a loss of a certain rawness which persisted, no matter what, beforehand."

**Mr. C.R., Northants**

"RINGMAT goes on my very short list of things that make differences I care about." **Mr. P.F., Washington D.C.**

"This product must be one of the most cost-effective accessories ever to be offered to music lovers." **Mr. R.A., Norway**  
*Can RINGMAT really be that good?*

Yes, it is, but there is only one way for you to find out - try it yourself. But be warned; if you let your best friend borrow it, you will finish up buying another!

### Prices

Different versions to suit turntable or budget from **£25 for RINGMAT 200 to £45 for RINGMAT 330 MKII XLR**

They can be obtained through good Hi-Fi retailers or on mail order direct from:

**RINGMAT DEVELOPMENTS**  
**PO BOX 200 BRENTWOOD ESSEX CM15 8QG**  
**Tel.: 0277 200 210 Fax: 0277 201 225**

(p&p: additional £2.50 UK, £5.50 outside)

USA: Something Worth Hearing, Rochester, N.Y. tel.: 716 461 1295

TAIWAN: Taifu Electronics Corporation, Taipei, tel.: 8862 341 9137

GERMANY: Fortissimo, Düsseldorf, tel.: 211 482 372



# Dynamics

## HIGH END AUDIO BOUGHT/SOLD EXCHANGED

	PRICE	TYPE	PRICE
MARK LEVINGON ML7A PREAMP MINT	2895	S HAND	3800
MARK LEVINGON N026 N026 BAL MINT	435	EX DEMO	5000
SOTA COSMOS VACUUM PLATTER SME V MINT	13,750	S HAND	17,500
WELL TEMPERED WATT TURNTABLE 3 ARM MINT	11,495	EX DEMO	12,995
MERIDIAN 602 TRANSPORT B&G DAC 2 LATEST MINT	12,995	EX DEMO	15,495
CAMBRIDGE CD1 CD PLAYER 16 BIT MODIFIED WITH			
MAGNIVE POWER SUPPLY 1 SUPP FB	1,795	S HAND	PHONE
METAXIUS ICARUS INTEGRATED AMPLIFIER CHROME MINT	1,395	EX DEMO	2,995
AUDIO RESEARCH SP15 REVISION A PREAMP BLACK	1,345	S HAND	1,700
AUDIONOTE M1 SILVER PREAMP V G C	1,320	S HAND	1,500
PINK TRIANGLE PP2 MK2 YSHAY MODIFIED PREAMP MINT	1,295	S HAND	1,500
CARY CAD 105 PREAMP PHONO & PREAMP MINT	1,295	S HAND	1,500
QUONTERPOINT SHIL LINES TUBE & SA9 PHONO STAGE GO BLOW	1,295	EX DEMO	1,500
YOUR MIND & WALLET MEGA V G C	1,295	S HAND	1,500
QUINTESTER 000 1400 PREAMP BALANCED MINT	1,295	S HAND	1,500
AUDIO RESEARCH D70 MK2 POWER AMP MINT	1,295	S HAND	1,500
COUNTERPOINT SA4 OTL MONO AMPS V G C	1,295	S HAND	1,500
MARK LEVINGON ML2 REFERENCE MONO POWER AMPS			
BALANCED SUPERB V G C	1,295	S HAND	1,500
MARK LEVINGON ML3 POWER AMP MINT	1,295	S HAND	1,500
NRG A2015 POWER AMP BALANCED LATEST SPEC MINT	1,295	S HAND	1,500
NRG A 401 400 WATT CLASS A MONO POWER HOUSES			
BALANCED HIGH FIDELITY WITH SPECIFICATION V G C	1,295	S HAND	1,500
CONRAD JOHNSON PREMIER 3C VALVE PREAMP MINT	1,295	S HAND	1,500
ULI-VAE RESEARCH ORI POWER AMP MINT	1,295	S HAND	1,500
MERIDIAN D5000 DIGITAL ACTIVE SPEAKERS STUNNING			
LOOKS AND SOUND TO MATCH MINT	1,295	S HAND	1,500
ACOUSTIC ENERGY AEG SPEAKERS & STANDS MINT	1,295	S HAND	1,500
BATH TUB & SPINDLES SIMILAR WATTS & PUPPINS WALNUT			
VERY INTERESTING 980B V G C	1,295	S HAND	1,500
DELLO AMATI SIMILAR TWIN MOUNTED PAIR IN OAK ON			
GRANITE STANDS SUPERB V G C	1,295	S HAND	1,500
LANNUN L50 SPEAKERS & STANDS BLACK MINT	1,295	S HAND	1,500
DYNAUDIO FACETTE SPEAKERS BLACK OR CHERRYWOOD MINT	1,295	S HAND	1,500
DYNAUDIO CONSEQUENCE SPEAKERS FLAGSHIP MODEL IN			
CHERRYWOOD DYNAMIC DRAMA STUNNING MINT	1,295	S HAND	1,500
CALL 401 SPEAKERS & CHROME STANDS BLACK GOOD	1,295	S HAND	1,500
CENESIS 800 SPEAKERS & STANDS BLACK MINT	1,295	S HAND	1,500
MELAN ARGENT 1 SPEAKER PIANO BLACK MINT	1,295	S HAND	1,500
MELAN ARGENT 2 SPEAKER ROSEWOOD MINT	1,295	S HAND	1,500
MELAN ARGENT 3 SPEAKER ROSEWOOD MINT	1,295	S HAND	1,500
PROAC PROSTATIC ELECTROSTATIC SPEAKERS RARE V G C	1,295	S HAND	1,500
SNELL A3 SPEAKERS WALNUT MINT	1,295	S HAND	1,500
APOGEE DVA 8 DAX TAUFER SPEAKERS MINT	1,295	S HAND	1,500
MARTIN LOGAN MONOULTRASH SPEAKERS OAK MINT	1,295	S HAND	1,500
METAXIUS IRAKLIS MK2 POWER AMP CHROME MINT	1,295	S HAND	1,500
AUDIO RESEARCH C12 KT10 VALVES AMP MINT	1,295	S HAND	1,500
MUSICAL FIDELITY P270 MK2 POWER AMP MINT	1,295	S HAND	1,500
APOGEE CALIPER SIGNATURE SPEAKERS GREY MINT	1,295	S HAND	1,500
SYNTHESIS REFERENCE SPEAKER SYSTEM ASH MINT	1,295	S HAND	1,500
AUD OPLAN KOWTRAST 2 SPEAKERS ROSEWOOD MINT	1,295	S HAND	1,500
METAXIUS CHARISMA PREAMP CHROME MINT	1,295	S HAND	1,500
MARK LEVINGON ML7 PREAMP MINT	1,295	S HAND	1,500
PI HI 19 TURNTABLE TRI PLANAR MK3 ARM	1,295	S HAND	1,500
SME IV & V ARMS MINT FROM			
SONOGRAPHE AIRTIGHT ATMI AMPLIFIER MINT	1,295	S HAND	1,500
DUNTECH CROWN PRINCE SPEAKERS PIANO BLACK MINT	1,295	S HAND	1,500
EQUATION ZERO SPEAKERS PIANO BLACK MINT	1,295	S HAND	1,500
MERIDIAN 200 TRANSPORT 285 DELTA SIGMA MINT	1,295	S HAND	1,500
CRYSTAL REFERENCE MK2 WITH ARTANGENT MINT	1,295	S HAND	1,500
MARANTZ LE12 CD PLAYER LTD EDITION BALANCED	1,295	S HAND	1,500
APOGEE DAX CROSSOVER MINT	1,295	S HAND	1,500
SEITA STAR 34HIRE 3 E12 ARM MINT	1,295	S HAND	1,500
QUICKSILVER PRE AMP MINT	1,295	S HAND	1,500
MERIDIAN 601 DSP PRE AMP BALANCED MINT	1,295	S HAND	1,500
NESTROVIC NAI VALVE MONO POWER AMPS BALANCED	1,295	S HAND	1,500
CARY 2A3 VALVE POWER AMP 15 WATT TRIODE MINT	1,295	S HAND	1,500
CARY 300B VALVE MONO POWER AMPS 40 WATT TRIODE	1,295	S HAND	1,500
APOGEE SCINTILLA SPEAKERS GREY 10TH V G C	1,295	S HAND	1,500
SUMO ATIAS SPEAKERS OAK V G C	1,295	S HAND	1,500
SNELL A2 SPEAKERS WALNUT V G C	1,295	S HAND	1,500

"OODLES OF HIGH END CARTRIDGES AVAILABLE RING FOR DETAILS" MANY MORE ITEMS IN STOCK, EFFICIENT SERVICING DEPARTMENT. WE ARE LOCATED IN WELWYN, HERTS  
ALL ITEMS GUARANTEED - ALL MAJOR CREDIT CARDS ACCEPTED RING FOR DETAILS AND DEMONSTRATION 0438 714038  
10.00 AM - 7.00 PM MON - SAT 10.00 AM - 1.00 PM SUN



# WANTED

We wish to buy all kinds of secondhand Hi-Fi equipment from budget to exotic, old or new, working or not, odd items or complete systems.

- TURNTABLES - Japanese, Linn, Rega, Thorens, Lenco, Garrard, Dual, Michell etc.  
Belt Drive, Direct Drive, Idler Drive, plus Tonearms and Cartridges.
- AMPLIFIERS - Small ones, Large ones, Good ones, Bad ones, Valve ones, Transistor ones.  
Japanese, Armstrong, Rogers, Leak, Quad, Meridian, Pre-Amps, Power-Amps etc.
- RECEIVERS - Japanese, Goodmans, Leak, Armstrong etc.
- TUNERS - Analogue ones, Digital ones etc.
- CASSETTE DECKS - Single, Twins, Old Top Loaders etc.
- REEL - REEL - Revox, Aiwa, Philips, Ferrograph etc. Reels of Tape
- CD PLAYERS - Geriatric ones, Modern ones, Multibit ones, Singlebit ones.
- SPEAKERS - Big ones, Little ones, Famous ones, Forgotten ones, Brown ones, Black ones, inc. Diamonds, Goodmans, Maxims, Celestion, Dittons etc.  
Bookshelf ones, Floorstanding ones, Drive Units, Crossovers.

JOB LOTS OF ACCESSORIES, DEALERS TRADE INS., CLEAR-OUTS, DISCONTINUED MODELS, EQUIPMENT RACKS, CABLES, PLUGS, RECORD, TAPE, CD COLLECTIONS, GOOD, BAD, OLD, UGLY, BULKY, TINY, WORKING OR NOT.

# LOUGHBOROUGH

## HI-FI

38 BAXTER GATE, LOUGHBOROUGH, LEICS. LE11 1TQ  
TEL. 0509 - 239521/236113  
OPEN 9 - 5.30 6 DAYS.



**SPECTRA**  
*Dynamics*

**THE PAST &  
THE PRESENT**

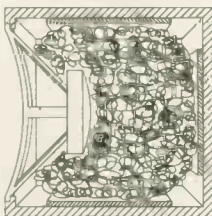

Inside a Typical Cabinet

**LISTEN TO  
THE FUTURE**

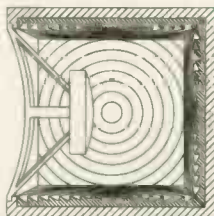

Deflex Panels Fitted

**GET THE MUSIC OUT OF YOUR SYSTEM, AND LET  
YOUR SPEAKERS BREATHE!**

## DEFLEX® A.P.T. ACOUSTIC PANEL TECHNOLOGY

PURPOSELY DESIGNED HI-TECH SPEAKER LININGS  
NOT BY-PRODUCTS FROM ANY OTHER INDUSTRY

**"NEW APPROACH STUNS THE EXPERTS  
"BIGGEST BREAK-THROUGH IN 20 YEARS"  
"RESULTS NEVER ACHIEVED BEFORE"  
"THE MUSIC IS FASTER, BRIGHTER,  
CLEANER, WITH DEEP, CONTROLLED BASS"**

Replaces the existing damping material inside your loudspeakers – quick and easy to fit. Available for any loudspeaker.

Deflex acoustic panels have excellent performance characteristics. The polymer is specially formulated to absorb shock and vibration, thus minimising cabinet resonances.

The surface emulation has been carefully designed to eliminate standing waves

The energy inside the enclosure is controlled – **NOT ABSORBED**, as in other cabinets.

Independent tests on MLSSA show energy gains over 50%.

**U.K. DISTRIBUTOR**

**The  
SPEAKER  
Company**

UNIT 9,  
WATERSIDE MILL,  
WATERSIDE,  
MACCLESFIELD, CHESHIRE  
SK11 7HG  
Phone 0625 500507

**CURRENT PRICES**

Standard Panels  
@ £7.95 each

Sub-woofer Panels  
@ £11.95 each

Adhesive from  
£3.50 (200ml)



**VISA**

Credit Cards



Open: 10 - 6pm Mon-Sat  
10 - 9pm Thursday  
World wide tax free export

Welcome  
24 hrs. delivery service

071 - 233 0774

# ENJOY THE MAGIC OF VALVES

## Pure Natural Sound

**0%**

**INTEREST FREE CREDIT  
ON SELECTED ITEMS**



*Audio Innovation, E.A.R.,  
Lumley Reference, Tube  
Technology, Conrad Johnson,  
D.D. Audio, Hi-Fi World Kit*

**We Offer**

- 24hrs. delivery services
- Part x-change
- Free three years warranty on selected product
- Home load
- Home installation
- Interest free credit
- We are located very new to Victoria main line underground station. One minute walk & open late 9pm (Thursday)

*We have in stock:  
Spendor • Quad • Royd • Triangle • KEF •  
Tannoy • Proac • Castle Speakers*

*Please ASK for our special offer list*

*CD Player From:- Quad • Micromega • Teac • Marantz • Rotel • AMC •  
Pioneer • Orelle Musical Fidelity*

*Cassette Decks from:- Aiwa • Denon • Sony • Nackamichi • Harman • Marantz*

*Amps From:- DPA • Orelle • Quad • Albery • Musical Fidelity • Alchemist  
• John Sheam • Aiwa • Pioneer*

*Turntables From:- Pink Triangle, Thoren, Alphason, Townsend Rock*

*DACS from  
Pink Triangle • DPA • Kinshaw  
Orell • Musical idelity • Teac*

### HI-FI CONFIDENTIAL LTD

34 Buckingham Palace Road, London SW1W 0RE (Victoria Station) Phone 071 - 233 0774 Fax. 071 - 233 7226

# DAVID ORTON AUDIO VISUAL



## Cyrus Centre

Marantz, Denon, Pioneer,  
Cyrus, Mission, Rotel, Ruark,  
B&W, Thorens, Oracle, Aura,  
Kenwood, Polk, Celestion,  
JVC, and many more!!



Dolby Prologic Dem. Room &  
Hi-Fi Listening Room

**6-8 BANCROFT, HITCHIN, HERTS**

**TEL: 0462 452248**

# THE MIDLANDS FIRST CHOICE FOR REAL HI-FI HI-FI EXCELLENCE

YOU ARE CORDIALLY INVITED TO OUR  
AUTUMN SEASON OF MUSICAL EVENINGS.



Oct 5th Arcam	Nov 2nd Bang & Olufsen
Oct 12th Meridian	Nov 9th Yamaha
Oct 19th Home Cinema	Nov 16th Rega
Denon-Pioneer-Canon	Nov 23rd Mission Cyrus
Oct 26th Audiolab	Nov 30th Quad

Refreshments and Wine Available. Evenings Start at 7.00pm.

Tickets are Limited. For Information on These Evenings Please Telephone

The Best Selection of Hi-Fi and Home Cinema from the Worlds Best Hi-Fi Manufacturers.

Audiolab-Audio Alchemy-Aura-Arcam-Audio Quest-Alphason-Apollo-Bang & Olufsen-Bose-Castle-Canon-Cable Talk-Celestion-Creek  
Chord-Cyrus-Denon-Dual-Foundation-Heybrook-Kef Reference-JPW-Jamo-Laser Disc-Marantz-Meridian-Monitor Audio-Mission  
Michell Gyrodek-Monster Cable-Musical Fidelity-Nakamichi-NAD-Panasonic-Pioneer-Polk Audio-Quad-REL-Rega-Rogers-Rotel  
Royd-Sennheiser-Systemdek-Target-Technics-Tripod-Tannoy-Thorens-TDL-Van Den Hul-Wessex-Yamaha and Home Theatre  
and Much Much More in Store on 3 Floors with 3 Dedicated Demonstration Rooms of the very Best Hi-Fi

FREE CARRIAGE.  
UK MAIL ORDER.  
EXPORT SERVICE AVAILABLE.  
PART EXCHANGE SERVICE.  
2 YEAR FULL GUARANTEES.  
FULLY EQUIPPED.  
SERVICE FACILITIES.  
5 YEAR EXTENDED GUARANTEES

BECAUSE PEOPLE LIKE MUSIC FROM.

**FRANK HARVEY.**

163 MEDIEVAL SPON STREET.  
COVENTRY CV1 3BB.  
TEL 0203 525200 FAX 0203 631403.

INTEREST FREE CREDIT ON  
SELECTED PRODUCTS.  
(DETAILS ON REQUEST).  
APR 0%.  
FREE INSTALLATION AND  
DELIVERY SERVICE.  
OPEN MONDAY TO SATURDAY.  
9.30 TILL 5.30.

FOR THE BEST | → ADVICE  
→ INSTALLATIONS  
→ DEMONSTRATIONS  
→ AFTER SALES SERVICE

# SPALDINGS

The South East's Leading Hi-Fi Specialists

352-354 Lower Addiscombe Road Croydon Surrey CR0 7AF

081 654 1231/2040

# TRUE MUSICAL

quality hi fi products with style and value for

sounds outstanding



**audiolab**

**8000cdm & 8000dac**

**Audiolab**

Never a company to do things by half measures, when Audiolab introduced a CD Transport to partner their Award-Winning DAC, their meticulous approach to CD reproduction resulted in a product of outstanding sound quality to match the rest of their range - 8000A, 8000C, 8000P, 8000M and 8000T.



**marantz**

**cd 63**

**Marantz**

Marantz are another of the audio pioneers with a passion for making recorded sound as enjoyable as the real thing. They call it a dedication to pure hi

fidelity and over the years it has led the audio press to bestow awards on numerous products in their extensive range.

Since its launch earlier this year the **CD 63** has been heralded as a player with outstanding performance and exceptional value for money.



**pioneer**

**pds 703**

**Pioneer**

It's here, the new star of the CD world at an outstanding price. With Pioneer's unique Stable Platter Mechanism and their revolutionary Legato Link DAC, is this one to judge the others by? Audition this exciting new player with front runners from Arcam, Marantz, Rotel and others today. Yet more reasons to check out this award winning range at Sevenoaks Superfi.

Oh, and by the way, Pioneer are offering a generous £ 50 allowance when you part-exchange any hi fi, for an **A300X, A400** or **A400X** amp at

any of our branches listed below.

Sevenoaks, Tunbridge Wells, Watford, Chelsea, Leicester, Guildford, Oxford, Croydon, Hanley, Nottingham, Leeds, Derby, Sheffield, Lincoln, Camden, Hull and Birmingham.

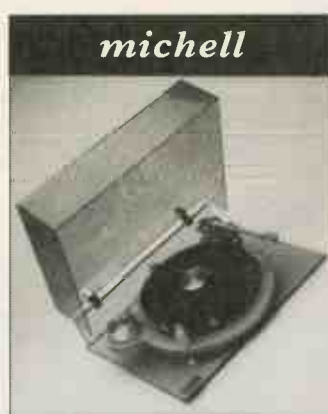

**michell**

**gyro dec**

**Michell**

The **Gyro Dec** has always been a class act. Beautifully styled, it looks like no other turntable and has the performance to match. After twenty years of success John Michell now complements it with products that are impossible not to recommend. At Sevenoaks Superfi you can audition the range including -

**Argo** (Preamp), **Iso** (Head amp) - **Alecto** (Power amps). The new **HR** (High Resolution) products are also available.

Our other turntables include the Pink Triangle **Export GTI** and **Anniversary**.



**ruark**

**equinox**

**Ruark**

Craftsmanship, style and refined musical presentation are the hallmarks of Ruark loudspeakers. With the addition of the **Equinox**, their reputation is enhanced. The outboard

## 26 BRANCHES THROUGHOUT

We are authorised dealers for most brands of quality Hi Fi. For a competitive quote please



**SEVENOAKS**  
109-113 London Road  
0732 459555  
Sevenoaks Hi Fi



**CHELSEA**  
403 Kings Road, SW10  
071 352 9466  
Sevenoaks Hi Fi



**ESSEX**  
1 The Grove Centre, Witham  
0376 501733  
Sevenoaks Hi Fi

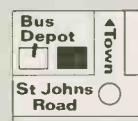

**TUNBRIDGE WELLS**  
28-30 St Johns Road  
0892 531543  
Sevenoaks Hi Fi



**BRIGHTON**  
55 Preston Street  
0273 733338  
Sevenoaks Hi Fi



**CHELTHENHAM**  
24 Pittville Street  
0242 241171  
Sevenoaks Hi Fi



**GUILDFORD**  
73b North Street  
0483 366666  
Sevenoaks Hi Fi

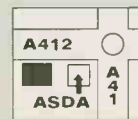

**WATFORD**  
478 St Albans Road  
0923 213533  
Open Sunday  
Sevenoaks Hi Fi



**CANTERBURY**  
20a Lower Bridge Street  
0227 462787  
Sevenoaks Hi Fi

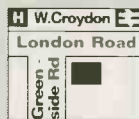

**CROYDON**  
373 London Road  
081 665 1203  
Sevenoaks Hi Fi



**LEICESTER**  
94 Granby Street  
0533 557518  
Sevenoaks Hi Fi



**WOOLWICH**  
162 Powis Street  
081 855 8016  
Sevenoaks Hi Fi



**CHATHAM**  
4 Railway Street  
0634 846859  
Sevenoaks Hi Fi



**ENFIELD**  
7 Genotin Road  
081 342 1973  
Sevenoaks Hi Fi



**OXFORD**  
41 St Clements  
0865 241773  
Sevenoaks Hi Fi

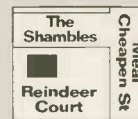

**WORCESTER**  
2 Reindeer Court  
0973 223362  
Sevenoaks Hi Fi

# EXPRESSION

*hi fi connoisseurs and music lovers*

crossover concealed within the stands bring 'high end' technology at affordable prices. You will find the Ruark range, including **Swordsman II**, **Sabre**, **Templar**, **Talisman II** and **Crusader II** at Sevenoaks Superfi.

There are many other quality loudspeakers including Kef Reference, Castle, ProAc, TDL, Mission and Monitor Audio

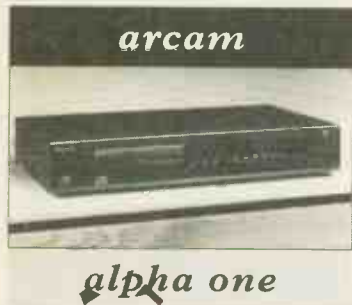

## Arcam

Talk to Arcam and they'll invite you to 'listen' to sound rather than just 'hear' it. It's a principle they adopt in their dedication to product design and manufacture, ensuring that the music you listen to is reproduced with breathtaking accuracy.

Their new **Alpha One** is yet another of their products to encompass these principles. A CD Player that has an ideal balance of performance and price.



*dcd 825*

## Denon

At the forefront of digital and analogue recording technology, Denon are arguably the leading Japanese hi fi brand available in the UK. Their products deliver a unique combination of design quality and audio performance right across the range.

The **DCD 825** is a player that will continue their reputation as a maker of truly great hi fi equipment.



*ordinal*

## Pink Triangle

Once again, this innovative British company has set new standards for digital reproduction with the

superb **Ordinal DAC**. Like the highly acclaimed **Da Capo**, you have a choice of filter sets, to attain the detail and imagery, all Pink Triangle products are renowned for.

To audition **Ordinal** and **Da Capo** or our other Audiophile CD players, Transports and DACs which include Roksan, Teac, Quad, Arcam and Cyrus, contact your local branch **Musical Fidelity**.



*e 100*

The **E100** integrated amplifier is just one model from Musical Fidelity's new **Elektra** series. Together with the **E200** (Preamp), **E300** (Poweramp), **E500** (CD player) and **E600** (Tuner), it forms an outstanding range that complements the **A1000** (Integrated amplifier) and **F Series** components superbly.

That's not all - we also have Top quality amplification from Exposure, John Shearman, Cryus and Quad for you to consider.

## WHO ARE WE?

Sevenoaks Superfi are at the forefront of Hi Fi retail in the UK. For over 21 years our companies have been selling quality Hi Fi products to discerning customers, and our enthusiasm is undiminished.

## AFTER SALES

All our products can be installed in your home. If you wish to use this service please ask your local branch for details.

## PEACE OF MIND

All the products we sell are brand new, fully guaranteed and maintained in our own service departments. We also offer our own 'no quibble' extended warranty. Ask for details.

## PRICE PROMISE

We always try to ensure our prices are competitive. In the unlikely event of an identical product being available from a local authorised dealer at a lower price, we will beat that price by up to £20. To qualify it must be a verifiable offer on product that is in stock, brand new and in a sealed box. No added value offers apply on price beat sales.

## PRICE BEAT VALUES:

£110 - £500 = £10

£501 - £1,000 = £15

£1,001+ = £20

## SOME USEFUL NUMBERS:

Sevenoaks Central Service Department  
0732 459105

Superfi Central Service Department  
0602 420414

Mail Order Hotline  
0732 458985

# THE COUNTRY...

*ring any one of our branches ~ we are always pleased to hear from you.*



**BIRMINGHAM**  
67 Smallbrook, Queensway  
021 631 2675  
Superfi

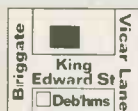

**LEEDS**  
7 King Edward Street  
0532 449075  
Superfi

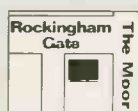

**SHEFFIELD**  
1 Rockingham Gate, The Moor  
0742 723768  
Superfi



**COVENTRY**  
16 Spon Street  
0203 223254  
Superfi



**LINCOLN**  
271a High Street  
0522 520265  
Superfi

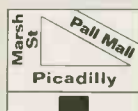

**STOKE ON TRENT**  
51 Picadilly, Hanley  
0782 265010  
Superfi



**DERBY**  
56 London Road  
0332 360303  
Superfi



**LONDON**  
2-4 Camden High Street  
071 388 1300  
Superfi

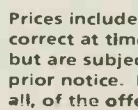

**NOTTINGHAM**  
15 Market Street  
0602 412137  
Superfi



**HULL**  
4 Dock Street  
0482 24051  
Superfi

Prices include VAT and were correct at time of going to press, but are subject to change without prior notice. E&OE. Most, but not all, of the offers displayed are also available from our associates Superfi, Sevenoaks Hi Fi and Superfi are not legally related and are separate commercial undertakings. All prices are valid until at least September 30th, 1994.

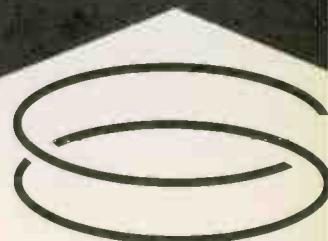

SEVENOAKS  
SUPERFI

# World favourites

## COMPACT DISC PLAYERS

NAD 501	£180	A break from the MASH tradition, the Philips powered 501 gives excellent results.	Apr'94
ROTEL RCD965 DIS	£350	A smooth and easy sound make this one of the best value players around.	Jan'94
QUAD 67	£790	A new breed of Quad. Lacking nothing in verve or excitement.	May'93
SUGDEN SDT 1	£850	Airy and spacious with a rare quality of ambience.	Mar'93
NAIM CDI	£1598	Single box, 16 bit player. Close to the two box CDS, has vital 'tingle factor'.	Apr'92

## COMPACT DISC TRANSPORTS

ARCAM DELTA 250	£750	Transport with sync-lock facility. Good partner to BB50	May'94
DPA DIGITAL T-1	£795	Superbly detailed sounding transport when sync-locked to DPA's converters.	Jan'93
ORELLE CD10-T	£799	Very involving, unforced and natural when used with Orelle's DA-180 DAC.	Feb'94
M'MEGA DUO CD.2	£1850	Seriously priced, serious CD using Philips' CDM-9 PRO mechanism. Exemplary.	Apr'93

## DIGITAL TO ANALOGUE CONVERTERS

DACULA	£376	This little devil from Select Systems really gets its fangs into the music.	Dec'93
ARCAM BB50	£450	Detailed and lively sound. Sync-lock to Delta 250 transport for best results.	May'94
DPA LITTLE BIT II	£450	Clean and confident sound with good resolution and focus.	May'94
ORELLE DA-180	£599	'Analogue' sounding converter, best with matching transport.	Feb'94
P. T. ORDINAL	£695	Pure sound, smooth and free from hardness. One of the best at any price.	Jul'93
P. T. DA CAPO	£1450+	Pink Triangle's own one bit DAC reaches new standards in digital. One of the very best.	Mar'94
		Even better with DC supply and new filter options.	July'94
DPA 1024	£6000	A reference for all other convertors. DPA's own discrete design.	

## TURNTABLES

SYSTEMDEK IIX900	£230	£330 with RB250 tonearm. A fine all-rounder and easy to upgrade. Neutral character.	Sep'94
PRO-JECT 6.1	£435	Complete with Ortofon MC15 Super and can even play 78s for an optional £10.	Sep'94
TOWNSHEND ROCK III	£799	The MkIII has a fabulously stable, solid image and terrific bass.	Feb'94
P. T. ANNIVERSARY	£1200	Very neutral turntable. Excellent imagery and detail.	May'92
SME MODEL 20	£2495	The last great turntable, bettered only by the £11,000 Model 30.	Oct'92

## TO NEARMS

REGA RB 300	£139	Simple and superb; dynamic with solid bass.	Various
SME 309	£568	Based on IV and V: Aluminium armtube and detachable headshell.	Jan'93
SME IV	£850	Loses little to the fabulous V, possibly the best value for money SME.	Dec'93
SME SERIES V	£1232	A masterpiece of precision engineering, with a cohesive sound.	May'92

## CARTRIDGES

GOLDRING 1012 GX	£60	Rounded bass, slightly forward midband, clean transients. A bargain.	Jul'93
GOLDRING 1022GX	£80	Extra degree of dynamic range and speed over the 1012GX	Jul'93
SUMIKO BLUE POINT	£100	The Blue Point casts a romantic charm over all types of music. Robust too.	Oct'92
ORTOFON MC15	£100	Moving coil cartridge at a moving magnet price. Has a tight grip on rhythm.	Jun'92
GOLDRING 1042	£100	A reference to all other MMs regardless of price	May'92
ORTOFON SUPREMES	£225-450	The MC10, 20, & 30 Supremes offer superb sound and value for money.	July'94
LINN KLYDE	£450	Soft treble, but a stonkingly good cartridge.	June'94
ORTOFON MC2000	£650	We came across this one by accident: used on a Garrard 401 with an SMEIV it gave one of the best results we've ever heard.	Dec'93
ORTOFON MC7500	£2000	The best MC available? Produces real-life scale of music.	May'94

## CASSETTE RECORDERS

AIWA AD-F850	£230	Fine recording quality and good playback. A real bargain.	July'94
NAKAMICHI DR2	£500	Worth every penny, pushes recordings to the limit and remains unflustered.	Feb'94
NAKAMICHI DR1	£780	Nakamichi sound quality, and manual head azimuth adjustment.	Jun'93
NAKAMICHI CR-7	£1500	No Dolby 'S', but auto tape tuning and motorised head. The Best!	Aug'92

## TUNERS

NAD 402	£160	Stunning budget tuner, with a warm and open sound. Can compete with the best.	Jan'94
AURA TU-50	£230	Superb FM-only tuner. Produces a delightful, three-dimensional sound. A cracker.	May'92

# World favourites

MISSION CYRUS FM7	£299	Clear and lucid sound. One of the best, regardless of price.	Apr'94
QUAD 66FM	£490	Among the very best in terms of tonal colour and imagery. Remote controllable.	Nov'92
NAIM NAT 03	£500	Warm and easy sound with a good sense of atmosphere. Good value.	Sep'93
NAIM NAT 01	£1377	The best solid state tuner currently available. For better radio, live in the studio!	Mar'92

## INTEGRATED AMPLIFIERS

NAD 302	£160	Lots of insight and detail, but could sound a little rough in the wrong system.	Jan 93
PIONEER A-300X	£200	Exceptionally sweet mid and treble, plus the superb dynamic range of the A400.	Dec'92
DENON PMA-350II	£220	Powerful and with deep rhythmic bass drive.	Sep'93
ARCAM ALPHA 5	£230	Lots of life and energy; a good phono stage too.	June'94
ROTEL RA960BXII	£325	Suits a wide range of music always sounding confident and open.	May'94
AURA VA50	£350	Powerful bottom end with detailed and spacious mid and treble.	June'94
AUDIOLAB 8000A	£430	Very neutral and superbly built. Good bass, great imagery, but can be sterile.	Apr'92
J.SHEARNE. Phase2	£495	Gorgeous looks, even better sound. Tight, quick bass and valve-like mid and treble	Dec'93
MISSION CYRUS III	£499	Superb engineering, a solid cast chassis and a clear and spacious sound.	Apr'94
STEMFOORT SF60	£549	Excellent bass drive and fine midband presence, powerful too.	Sep'94
SUGDEN A21a	£639	Class A transistor amp. Sharp, crisp, deep, tight, and it images well too.	Feb'94
EAR 834	£1295	Valve integrated amplifier with a sweet, open and detailed sound.	Feb'93
AUDIONOTE OTO SE	£1500	10watts of the sweetest sound around. Use sensitive speakers though	Aug'94

## PRE-AMPLIFIERS

EAR.834P	£290	MM/MC phono stage. Uses valves to create a rich sound with tremendous depth.	Jan'94
A. Innovations. LI	£299	Valve line level preamplifier. Outstanding results with vdH carbon interconnect.	Feb'94
A. SYNTH. PASSION	£475	Or £275 for the kit version. Unrivalled transparency from a passive pre-amp.	Aug 93
ROSE RV23-S	£495	Valve/Transistor hybrid. Smooth and clean, rich and spacious.	Nov'93
DPA DSP 200S	£495	Not quite the 50S, but there's still nothing to match it at the price.	Jun'93
MICHELL ISO HR	£850	Impossible not to recommend. What more does your vinyl want?	May'93
NAIM NAC82	£1945	Remote control preamp. The NAC82 thrusts detail forwards in true Naim fashion.	Apr'94

## POWER AMPLIFIERS

ROSE RP-190	£495	Used with the Rose pre-amp it gives 70 watts of smooth relaxing sound.	Nov'93
SUGDEN AU41P	£530	100 Watts of smooth, detailed, full bodied sound. And at a bargain price.	Apr'93
QUAD 606	£675	140W powerhouse. Smooth and civilized, with the legendary Quad back-up.	Aug'93
DPA DPA 200S	£750	Not as cold as the 50S. Better than anything else at the price.	July'93
NAIM NAP180	£898	Partner to NAC82. Has real drive and grip on loudspeakers.	Apr'94
MICHELL ALECTO (S)	£1300	Valve like transparency, big warm easy going sound.	Sep'93.
MICHELL ALECTOS	£1800	The Alectos have a lucidity and three dimensional realism that is rarely attained.	Dec'92
CHORD SPM 1200	£2995	Massively powerful, dynamic and detailed sound. Among the best of solid state.	Mar'93
E.A.R. YOSHINO	£25,000	Single-ended valve design. Noel is still suffering withdrawal from this product.	Jul'93

## LOUDSPEAKERS

GLL MAXIM	£120	Replacing the Maxim 3; not as tight in the bass but still one of the best at the price.	Aug'93
MISSION 760ISE	£150	One of the best miniatures around, very musically involving.	Jan'94
HARMAN LS 0300	£200	Glass fibre woofer gives a forward and open mid with good bass kick	Nov'93
TDL RTL 2	£250	Bass on a budget. Solid, vibrant and spacious sound.	Dec'93
SYSTEMDEK 931	£300	Poor man's LS3/5a? Coherent and involving, these little gems really sing.	Mar'94
HARBETH HL-P3	£400	There probably isn't a more neutral sounding design anywhere near the price.	Feb'93
ROGERS LS8a/2	£449	Big, enjoyable, room filling sound from this 2-way floorstander.	Feb'94
REL STRATA	£499	Rel's Strata offers excellent bass depth and power.	Mar'94
H'BROOK QUARTET	£555	Sensitive enough to work with low power valve amps. Fast and detailed sound.	Jul'93
CASTLE CHESTER	£600	Good solid sound and beautiful finish. 1/4 wave bass bading.	May'94
SYSTEMDEK 937	£600	Transmission line floorstander that won't offend.	May'94
TANNOY D100	£650	Believable 3D images produced by this small dual concentric speaker.	Jan'94
PROAC Studio 100	£699	Excellent monitors with detailed, natural sound and plenty of atmosphere	Feb'94
SPENDOR SP2/3	£769	Smooth sounding speaker with a superb mid-range. Very easy to listen to.	Feb'94
UKD CALLAS	£850	Powerful bass and high quality sound from a solid wood miniature.	Aug'94
TANNOY D700s	£1970	Dynamic and powerful. Needs a good clean power amplifier for best results.	Sep'93
QUAD ESL63	£3228	A reference to all others; superb imaging qualities and transparent sound.	Various

# Oxford Audio Consultants

## HI-FI SPECIALISTS



Our superb service is the same,  
regardless of price.

### AUDIO RESEARCH LS7/VT60

At last a combination at an affordable price. Quite  
sensational sound quality to boot!

### NOW DEMONSTRATING

AUDIO RESEARCH CD1/CDT 1  
AUDIO ALCHEMY DAC IN THE BOX - staggering sound for £199.95  
MICROMEGA STAGE - the new concept in upgradeability  
ORELLE CD480 - a serious British competitor to the ARCAM  
PINK TRIANGLE DA CAPO - NOW IN STOCK  
THETA DATA BASIC & GENERATION V - real high end  
TEAC VRDS 7/10/20 AND 700 2 BOX SYSTEM  
SME 20 - the finest engineering with superb sonics  
PROJECT TURNTABLES - value for money  
LYRA CLAVIS Mk 2 - even better and only £995  
KINSHAW PERCEPTION PHONO STAGE  
AUDIO INNOVATIONS ALTO - lovely sound and styling  
COPLAND CSA 14 - bargain of the century!!  
DPA 200 SERIES PRE/POWER  
KRELL KRC/KRC 2 preamps with the latest S SERIES power amps - seriously high end  
- wait till you see the new KPS digital series  
MUSICAL FIDELITY F SERIES - very, very good value  
HEYBROOK SEXTET/QUARTET - very room friendly  
MARTIN LOGAN AERIUS - magic looks and sound  
QUAD ESL 63 - we are now main agents for the complete range of QUAD  
REL STRATA AND STADIUM SUBWOOFERS  
RUARK EQUINOX - furniture for the living room  
SONUS FABER - no apologies!! these are our favourites  
DENON DF 10 - mini size components available separately  
BOSE LIFESTYLE SYSTEM - almost invisible hi-fi!

### EX DEM & P/EX BARGAINS

ALCHEMIST KRAKEN £250  
KRELL KRC2 £3195  
NAKAMICHI CR7 EX DEM £1395  
AUDIO RESEARCH DAC 1-18 £995  
AUDIO RESEARCH LS2 £1595  
AUDIO RESEARCH SP9 £895  
RUARK TALISMAN MK 2 EX DEM £550  
MUSICAL FIDELITY PRE3A PREAMP £195  
HEYBROOK HB2 SPEAKERS £150  
STAX QUATTRO CD PLAYER £1595  
AUDIO RESEARCH V70 EX DEM £2995  
KRELL CD DSP CD PLAYER EX DEM £2995  
THETA DS PRO PRIME £895



Please ask for details or our current list

Agencies include: Aura, Accuphase, Acoustic Energy, Air Tangent, Apogee, Audio Alchemy,  
Audio Research, Audio Technica, Basis, B&W, Castle, Classe, Copland, Denon, Denon  
Cartndges, DPA, Dual, Goldring, Harmonix, Heybrook, HPW, Kimber, Koetsu, Jadis,  
Krell, Lyra, Magneplanar, Magnum, Mandrake, Marantz, Martin Logan, Michell, Micromega,  
Music Fidelity, NAD, Nakamichi, Onix, Orelle, Ortofon, Pink Triangle, Pioneer, Polk, Proceed,  
PS Audio, QED, Quad, REL Subwoofer, Revox, Rogers, Roksan, Rotel, Ruark, SD  
Acoustics, Seismic Sink, Sennheiser, Sequence, Sequerra, State Audio, SME, Sonus Faber,  
Stax, Target, TDL, Teac, Theta, Thorens, Van den Hul, Wadia, Wharfedale, Wilson

TAX-FREE EXPORT SERVICE  
MAIL-ORDER AVAILABLE ON MANY ITEMS  
Open Mon-Sat 10am-6pm

# Oxford Audio Consultants

Oxford Audio Consultants, Cantay House, Park End Street OX1 1JE  
Telephone: Oxford (0865) 790879 Facsimile: Oxford (0865) 791665

## LEONARD BOOTH



WHY WAIT A LIFETIME  
BEFORE YOU SEE & HEAR  
..... AND BUY  
YOUR QUAD EQUIPMENT  
CALL IN NOW FOR YOUR  
IMMEDIATE DEMONSTRATION

35 SOUTH STREET  
EASTBOURNE  
0323 731755



Don't let your  
**LISTENING ROOM**  
spoil his performance.

With the help of

**Room Acoustics Services**  
you can achieve near concert hall realism,  
in harmony with your home decor.

Full details, reviews etc, of our computerised postal  
Hi-Fi room acoustics consultancy available from:-

### ROOM ACOUSTICS SERVICES

3, Queen Elizabeth Way, BARTON-upon-HUMBER,  
South Humberside, DN18 6AJ. Tel: (0652) 635523



**hi Best prices for new, xdem & s/h equipment fi**

NRG 401 S Stereo pwr	as new	£4500	WADIA 2000 tran/dac	mint s/h	£3750
Krell KSA 150	mint/s/h	£2995	Meridian 200/203	mint s/h	£695
Krell KSA 250	mint s/h	£3995	Meridian 602/606	mint s/h	£1795
Audio Research D240 mkII	mint s/h	£1595	DPA PDM 1 mkII	mint s/h	£250
Krell KSA 100 mkII	mint s/h	£1595	Micromega Duo BS	mint s/h	£250
Audio Research Classic 60	mint s/h	£1995	Roksan Rok DP1	as new	£695
Conrad Johnson MF200	mint s/h	£895	Wadia 7+9 tran/dac	mint s/h	£15995
Musical Fidelity P180	as new	£495	Mark Levinson 30/31 tran/dac	mint s/h	£15500
Nestrovic Labs NA1	mint s/h	£1995	Meridian 200/263	mint s/h	£895
VTL Manley 350	mint s/h	£2750	CAL Tempest mkII	mint s/h	£1395
Audio Innovations 2nd (2A3.82)	mint s/h	£1595	Magneplanar 1.4	as new	£750
Audio Innovations 1000 monoblocks	as new	£850	Audio Note ANK Sp + foundation	as new	£550
Audio Innovations 1st Audio	as new	£850	Snell type E's + Foundation	as new	£850
Naim NAP 135	mint s/h	£1800	Monitor Audio MA14		
Threshold S150	mint s/h	£795	Gold mkII	as new	£325
Roksan L1/S2 pre/pwr	as new	£1295	Meridian D600B	mint s/h	£1595
Cadence 2/MA2 pre/pwr	x-dem	£1995	JPW AP2's	as new	£95
Musical Fidelity MA100	mint s/h	£650	JPW Minims	as new	£60
NRG PA1 reference	mint s/h	£2500	Harmon Kardon LSO 500S	as new	£175
Linn Kairn Pro	x-dem	£750	Castle Acoustics York deluxe	as new	£250
Naim NAC 52	mint s/h	£2000	Apogee Diva + DAX	mint s/h	£3995
Counterpoint SA9/SA11	mint s/h	£5995	Infinity IRS BETA	mint s/h	£4995
Audio Innovations S1000 pre	x-dem	£795	Marlin Logan Quest	mint s/h	£2800
Trilogy 902 pre	as new	£795	Ruark Talisman II	mint s/h	£650
Audio Research SP15 mkII	mint s/h	£3500	TDL Reference Monitors	mint s/h	£1200
Audio Research SP14	mint s/h	£1595	Naim SBL's	mint s/h	£1100
LFD LS11	mint s/h	£495	Impulse H2's	vgc	£1595
Audio Research SP8 mkII	mint s/h	£795	Acoustic Energy AE1 + Stds	mint s/h	£695
Michell Argo/Itara	mint s/h	£550	ATC SCM 20	mint s/h	£850
Audio Innovations L2	as new	£450	TNT mkII/ETII/STD	mint s/h	£3995
Mark Levinson 26S/25S	mint s/h	£4995	Manticore Mantra/RB 300	mint s/h	£450
Audio Note OT0	as new	£650	Koetsu 80th anniversary	mint s/h	£1595
Audio Innovations S500	as new	£550	Koetsu Black	mint s/h	£350
Audio Innovations S300	as new	£350	Linn ARKIU	x-dem	£695
Beard BB100	as new	£595	Burmester 838 phono	mint s/h	£550
Albary PP1	mint s/h	£295	Tesseract TAADA phono mm/mc	as new	£995
Marantz CD10	mint s/h	£795	Beard P100 phono	mm/mc	£195

**Going to the Hi-Fi Show?**

**Take the opportunity to visit CHOICE we're only 15 minutes away.**

**Relax those weary legs, have a coffee and sample some great sounds.**

**Make an appointment now for Saturday or Sunday from 9am to 7pm.**

MINT S/H - Second hand as good an example as we've seen anywhere

AS NEW - Typically less than 4 months old in new condition

X-DEM - Typically 'as new' but may be older

G.C/V.G.C - In perfect working condition but may be marked

**hi CHOICE fi**  
**(081) 568 8808**

Equipment bought or part exchanged  
Full demonstration facility - by appointment  
Major credit cards accepted  
9.30am - 8.00pm 7days

**Inaccessible accessories by post.**

If you can't get to us, we'll get our accessories to you.

CARTRIDGES: Arcam, Audio Technica, Denon, Dynavector, Goldring, Lyra, Ortofon, Sumiko. CABLES: Audioquest, Cable Talk, Goertz, Heybrook, Ixos, Kimber, Kontak, LFD, Monster, Ortofon, Precious Metals, QED, Sonic Link, Van den Hull, XLO. STANDS: Alphason, Apollo, Atacama, Sound Organisation, Sounds Style, Stands Unique, Target. HEADPHONES: Beyer, Sennheiser, Stax. ACCESSORIES: Audio Technica, Audioquest, BIB, Discwasher, Goldring, Hunt, Ixos, Kontak, Last, Michell, Milty, Moth, Nagoaka, Pixall, QED, Shure, Townshend. Plus a full range of quality equipment available.

PLUS A FULL RANGE OF QUALITY EQUIPMENT AVAILABLE. SEE OUR MAIN ADVERTISEMENT.



**BURY AUDIO**  
TEL & FAX: 0284 724337  
MOBILE: 0850 565693

47 CHURCHGATE STREET,  
BURY ST. EDMUNDS,  
SUFFLOK IP33 1RG.

**THE AUDIO GALLERY**

For a Fine Selection of High Quality Audio Equipment

Tube Technology ~ Audio Innovations ~ Audio Note ~ Wadia  
Audio Alchemy ~ DPA ~ TEAC ~ Micromega ~ Alchemist  
Martin Logan ~ ProAc ~ Klipsch ~ Acoustic Energy ~ TDL  
Heybrook ~ JPW ~ Impulse ~ Pink Triangle ~ SME ~ Denon  
Moth ~ Audio Synthesis ~ NAD ~ Pioneer ~ Alphason ~ Tripod  
Sonic Frontiers ~ Counterpoint ~ Absolute Sounds  
Replacement Valves by Gold Aero

Demonstrations by Appointment Only  
Please call - 0730 895191 - Hampshire, Nr. Petersfield

RING FOR DETAILS



UXBRIDGE, MIDDLESEX  
**(0895) 253340**

**Unbelievable but true you can audition all these brands here. Audion, Proac, Michell, Lumley, Levison, Lurne, Triangle, Teac, VHD, Silversounds, Stax, Monitor Audio, Trilogy, Lyra, Sumiko, Ortofon, Decca, Target, Project Moth, Townshend, Edison, Chario, Trichord Research, Cadence, Kinshaw, SD Acoustics, Totem.**

7 days a week 10am - 7pm  
RING FOR DETAILS  
UXBRIDGE, MIDDLESEX  
**(0895) 253340**

## Audio Physics

### CLEANLINE - Modification for the Naim HICAP

Would you believe that the already excellent sound of your Naim equipment could be improved?

Replace the IC regulator in the HICAP with our easily fitted very low noise regulator module, built with selected discrete components. Like our many satisfied customers you too can gain a clearly demonstrable improvement in clarity and enjoyment.

The CleanLine module is £125 inc, with clear fitting instructions, a help line and a full refund if not completely satisfied.

Phone Geoff Mead on 0895 637846 for full details

## MANTRA AUDIO

- CARTRIDGES AND STYLUS
- MAIL ORDER DIRECT 1-10 DAYS
- COMPETITIVE PRICE (inc P&P)

MAKE	MODEL	CARTRIDGE	STYLUS	MAKE	MODEL	CARTRIDGE	STYLUS	
Arcam	C 77	£27.00	£15.00	Ortolan	OM10, OMP10 (T4P)	£25.00	£18.00	
	E 77	£45.00	£33.00		OM20, OMP20 (T4P)	£34.00	£31.50	
	P 77	£56.00	£45.00		OM30, OMP30 (T4P)	£72.00	£59.00	
Audio Technica	P 77MA	£66.00	£49.00	Ortolan	DM N CLUB S	£29.00	£15.00	
	AT 95 E	£21.00	£19.50		510	£20.00	£19.00	
	AT 110 E	£26.00	£16.00		520, 520P (T4P)	£49.50	£36.00	
	AT 450 E	£57.00	£33.00		530, 530P (T4P)	£76.00	£57.00	
	AT420 E	£36.00	£22.00		MC 1 TURBO	£54.00	£45.00*	
Denon	AT OC 3	£95.00	£84.00*	Shure	MC 3 TURBO	£99.00	£82.50*	
	AT OC 5	£110.00*	£90.00*		MC 10 Super	£76.00	£65.00*	
	DL 110 MC	£85.00	£52.00*		MC 15 Super	£99.00	£82.50*	
	DL 160 MC	£75.00*	£58.00*		VN 35 MR	(V 15 III)	£83.00	
Goldring	DL 304 MC	£180.00	£145.00*	Sontra	VN 45 MR	(V 15 IV)	£90.00	
	ELECTRA	£24.00	£16.00		V 15 VMR	£225.00	£130.00	
	1006	£44.00	£29.00		SWISS QUALITY DIAMOND STYLUS PRICE			
	1012 GX	£58.00	£38.00		ADC	R20 XE OLM 32/34/36 XLM III	£12.50	
	1022 GX	£76.00	£49.00		Dual	DN 145/155/165E DN 149S	£12.50	
Nagaoka	1042	£96.00	£61.00	Ortolan	FF 15/VMS 10/20 EII, OMP 10/20	£12.50		
	Erica (LX)(H)	£90.00	£55.00*	Shure	N75 ED/EJ T2, N95 ED/EJ	£12.50		
	MP 11	£25.00	£12.50	Sontra	Antistatic carbon fibre record cleaning brush	£9.00		
MP 11 Boron	N/A	£26.00						

\* Exchange any MC \*\*\* Other types available \*\*\* Tel (0757) 288652

• SPECIAL OFFER: All above UK Supplied UK Guarantee - No grey imports

Please state Stylus Idant necessary. Cartridges on all orders - enquire - No credit cards

MANTRA AUDIO (HFW), 22 GARTH AVENUE, NORTH DUFFIELD, SELBY, NORTH YORKS YO8 7RP

## Esoteric • Audio • Imports

Importers, Distributors and Purveyors of Fine Quality Audio Equipment

Are delighted and proud to reveal that an Electrocompaniet Retailer has been awarded our highest Accolade

V'AUDIO of BRISTOL is the U.K.'s first "GOLD MEDAL" RETAIL DEALER.

V'Audio are contactable on (0272) -686005

Esoteric Audio Imports also offer a FULL servicing and spare parts facility for:-

ELECTROCOMPANIET & TANDBERG Audio Products For further details please call or fax:-

TEL/FAX:- 0243 - 533030

## The NORFOLK/SUFFOLK High End Dealer

# audible difference

near DISS, NORFOLK

Audio Research	Audion (Alema)	ART Audio
ATC	Audio Innovations	Audio Note
AVI	CHORD	Copland
Croft	DAWN AUDIO	dpa
EAR	Impulse	Kinshaw Perception
Linaeum	Lyra	LFD Audio
Magnepan	Micromega	neat
Orelle	Pink Triangle	ROKSAN
Sumiko	SME	Sonus Faber
SUGDEN	Tube Technology	van den Hul

At this level of equipment we believe that the highest level of service should be offered.

We will book only three demonstrations a day to ensure that you have ample time to evaluate the option YOU choose,

DEMONSTRATIONS IN OUR LISTENING ROOM OR YOUR HOME

EQUIPMENT LOAN SERVICE AVAILABLE

Tuesday to Friday, 12 to 9 pm

Saturday 9 to 5 pm

PLEASE RING FOR AN APPOINTMENT

0379 740227 OR 0850 983233

# Audio Classic

## FOR SALE

CHAPMAN stereo Valve integrated, Parmenco, mint	£130	QUAD FMII tuner + stereo decoder	£75
Counterpoint SA5 / SA20, mint boxed, save £1000's	£2200	Radford FMT2 stereo tuner	£75
Elite Townsend 600, 85 wpc power amp	£250	Rogers stereo Valve tuner	£75
Heath S99 integrated valve amp	£100	Gale 401 loudspeakers, mint pair	£250
Goodmans 150 receiver	£75	Castle Conway II	£150
Leak TL12+, pair valve monoblocks, mint	£300	J.R. 149 round speakers	£75
Naim Nait	£150	Jordan Watts MODULE pair,	£50
Pioneer SX747 Quadrophonic receiver	£75	KEF Correlli, pair, good condition	£75
Radford STA25/III, SC22, FMT2 mint pre/power/tuner	£500	Leak LK18 sandwich speakers, pair, good condition	£35
Rogers JUNIOR Stereo valve power amp, vgc	£200	Pro Ac Super E.B.T. pair, small & mint	£150
Rogers CADET III stereo valve integrated	£100	Richard Allan 'Minette', pair, brand new to clear	£50
QUAD 303/33 pre/power	£185	Rogers LS7 loudspeakers, pair, mint £250	
Quad 33 preamp, mint	£75	Rotel RL850II, brand new boxed speakers	£75
QUAD 44 preamp, mint, boxed	£200	Vitavox 12" bass units, monster magnet, pair	£100
Haddock G220 arm, mint boxed	£75	Wharfedale Linton 3XP, brand new, boxed	£50
Decca FFSS arm & pick up	£60	Marconi 42 radio, c. 1930, v.g.c.	£200
S.M.E. 3009/II v.g.c	£60	GEC 'O' Phono radio, c. 1930 good condition	£100
Thorens TD135 turntable, c/w arm & cartridge	£40	Philips 830 radio, c. 1932, mint	£400
Revox G36 open reel recorder 1/4 track valve	£200	Rock-Ola 1448 Juke Box, 1954, 120 selections	£2500
Leak Troughline STEREO, aligned & serviced	£200	Sobell Table radio gram, c. 1948	£50
NAD 4020 tuner	£75	Winsor Valve tester, c/w book	£50

Mail Order - no problem. Next day delivery £15

Part exchange / swapsies welcomed

Access / Delta / Eurocard / Mastercard / Visa = + 5%

Haden Boardman, Audio Classics / Mellotone Acoustic Co.

Telephone 0942 57525

Fax 0942 525861



# readers' queries

## DRIVING APOGEES

In my search for a suitable amplifier to drive my Apogee Centaur Minor speakers, I have noted that amplifiers with a high (200-500+) damping factor produce, good, clean, well controlled bass. Valve amplifiers that I have listened to generally have a low damping factor and produce badly controlled bass at best. What relevance is the damping factor?

My system consists of the Apogees, Teac VRDS-7 CD and a B&W 250D Power amplifier (1980's - 100 wpc into 8ohms). No pre-amp, direct input from CD, volume control via gain controls on power amp. Interconnects are KLOTZ professional cable and speakers cable is from MAPLIN - 431 strand OFC.

The sound is flat/dull, compressed, poor in imaging and lacks integration and is not very loud at max. volume. The speakers are easy to drive - worked reasonably well with an Audio Innovations 300 (10 wpc) but appear to need a high current amplifier to get the best out of them. I have been recommended the likes of Krell but is outside my budget. What about the Crown (Amcron) Macro Reference (700+wpc)+ PSL-2 pre-amp (from Shuttle Sound), seems a real bargain(?) at £2300 + £569 +vat. Can you

**Write in with your problems to Hi-Fi World, 64 Castellain Road, Maida Vale London W9 1EX.**

**Our panel of experts will endeavour to solve them or at least offer some practical advice**

suggest alternatives that would not require a second mortgage?

Music:- Electronic Jazz Chic Corea and the likes of Joni Mitchell/Cohn. The wife listens to popular music. Should I try

adding a pre-amp to the system before spending money on a new pre-power combination or change the speakers for the Vandersteen 2 Ces? By the way, is the designer of the Vandersteen speakers the same Mr Steen who had a speaker company in the '80's operating out of Surbiton, Surrey?

My son's (16yrs) system consists of KEF 103.4s, Technics SLPG 620 CD, Audio Innovations 300 amplifier, Revox A77 MK II 15ips Reel to Reel tape deck, Tandy interconnects and 79 strand speaker cable. Sound is bright and lacks bass, the amp needs changing - help! The Technics SU900 and the Teac AX5030 amps are on the short list. Music - Nirvana etc. I have promised him either a

Teac VRDS-7 or a Micromega Stage as a replacement for the Technics CD player.

**Chulan Weeresinghe Kingston upon Thames, Surrey.**

Some of the properties of the Apogees are inherent to the speaker and some to the amplifier, no doubt. You'd be comparing them to your son's KEF 103.4s I imagine, which would make the Apogees sound a bit dynamically flat.

Damping factor, in the way it is traditionally talked about (ratio of amp output impedance to loudspeaker impedance), may be a bit of a red herring. What theorists overlook is the presence of a series inductor feeding the bass driver of nearly all commercial loudspeakers. With a DC resistance of 1Ω or thereabouts, this makes amplifier damping factors greater than 8 pure fantasy. Our diagram shows how an amplifier with 0.2Ω output impedance (Z out) appears to offer a damping factor of 40 (8/0.2) but in fact, as far as the bass unit is concerned, has a real output impedance of 1.2Ω (1+0.2), giving a true damping factor of 7.

In our experience increasing overall feedback

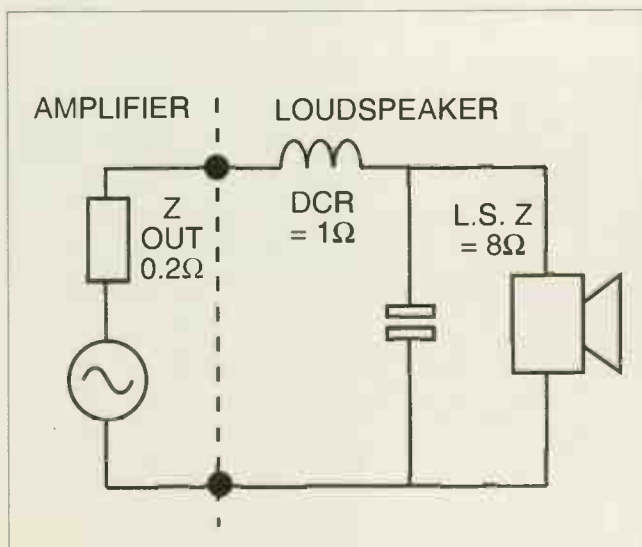

Continued on page 117...

# FREE Audio Catalogue

**That Will Change  
The Way You Buy Hifi**

**Inside the new RDL  
catalogue you'll discover:**

- The secret to picking the right speakers.
- Why your home is the only place to test audio equipment.
- How to get more audio for your money.
- How to buy home theatre systems.
- Why the reviewers say RDL offers superior audio equipment at unbelievably low prices.



Buying from RDL is easy and risk free with our **100%** "no strings attached" money back guarantee.

Roy Allison, President and Chief Designer of RDL Acoustics has put together two new, superb ranges of speakers to fit every situation at prices well below normal shop retails.

**FREE  
32 pg.  
AUDIO  
catalogue**

Order your free catalogue, call:

**0484 603333**

or fax on 0484 607774

**RDL**  
ACOUSTICS

20 Cleveland Way, Shelley  
Huddersfield, HD8 8NQ

*Can I try it at home?*

**YES!**

To arrange a home demonstration (with no obligation) or just for friendly chat ring  
0257-426100 anytime



ARION ACOUSTICS • AUDIOMECA  
(FRANCE) • AUDIO SYNTHESIS •  
AUDIO VALVE AMPLIFICATION  
(GERMANY) • KINSHAW • LIEDER •  
ORTOFON •  
PRO-JECT • TEAC • TRIANGLE •  
YBA (FRANCE)  
and other selected brands

## definitive audio nottingham

Tel/Fax (0602) 813562

Import/Export

LIVING VOICE HÖRNING WAQIA AUDIO INNOVATIONS MIRO IMPULSE SME  
TOWNSHENO VITAVOX EMT XLO GOLORING OALI VOYO SYSTEMOEK PIONEER  
REVOX LOWTHER MICROMECA

During the past few years there has been a significant increase in the availability of simple low power valve amplifiers - particularly in single ended configuration. This would have been a more valuable development if there had been a corresponding increase in availability of high sensitivity loudspeakers. A 5-9 watt valve amplifier needs to see a very even load and a sensitivity of 98 dB/w @ 1m. or more. Without this the full benefit of these simple amplifiers cannot be fully realised. In many ways the amplifier/loudspeaker relationship is so important that it should be considered as a single unit.

Definitive Audio represents a coherent hierarchy of such loudspeaker/amplifier combinations ranging from 3 to 50 watts, 94 to 108 dB/w and from £450 to £14,000.

USED ITEM FOR SALE					
*denotes full warranty				(4 months old)	300 750
Ortofon Quartz	100			* Sugden SDT 1 (as new)	500 960
Quazar	150			* Revox B215 S gold (black)	
*Audionote 1.0	700	1500		< 12 months old	900 1850
(10 hours use)				* Systemdek ixX 900 oak	100 220
Kesiki Purple Heart				Linn Axis Akito K9	330
Saphire (200 hours use)	400	850		*Voyd .5 Reference oak	2000 3600
				Helius Orion III	250 550
				Souther Linear Arm	550 1300
Audio Innovations:-				Lowther Accousta - Walnut	300
* 200 pre amp mm+mc	200/240	350/420		* Snell 'A' II Mahog.	2200 5000
* Second Audio 15 watt monos	1400	3000		* Linn Index +	
* P2 phono stage				KU Stone -12 months old	150 350
<12 months old	550	700		Pioneer PDS 901 new unboxed	300 500
NVA phono stage	150			Silver Sound i/c cables	100 140
* Snell AII mahogany	2000	5000		Audio Innovations Alto	
Meridian Argent II	300	800		3 months old	200 300
Lowther Accousta [pm 2c]	200			Snell J	400 700
* JPW AP2 walnu/vash	100	175		Linn KAN + KAN II stand	170
Linn Kan 1 + mk II stands	150			JPW AP2 Ash - perfect	110 175
Fullers Audio Sultan	190	400		Souther Linear Arm	250 1300
Tannoy 601 inc stands	100	200		Helius Orion III	220 550
* Audionote.J. [ANSP] oak	400	1000		Silver Sound Whisper S/C	175
* Pioneer PD 901S				Systemdek 11x900. Oak	100
< 8 months old	300	500		Linn Axis AKITO K9 perfect	280
*Micromega leader				KESIKI Purple Heart (200H.R.S)	390 850

CARRIAGE EXTRA  
PHONE OR FAX DIRECT (0602) 813562

.... Continued from page 115

tends to tighten and dry out the sound of an amplifier and since it also lowers output impedance it would seem from simple inspection that high damping factors give a tighter sound when in fact other factors are responsible. Our recommendation is not to worry about it too much. Simple correlations rarely hold up to critical analysis in audio, which is why it is a black art.

Absolute Sounds, importers of Apogee, told us the speakers need plenty of current and are insensitive. With a mismatched amp, they told us, the dynamic bass driver will not subjectively match the ribbon mid/treble unit. Depending upon room size, you need 50watts or more. We'd recommend you go for a super-quality hi-fi solid state rather than a part-time welding amplifier. Try a DPA50S or a Naim 82/180. A Chord SPM1200 would also make a good partner.

Valve amps are more load sensitive than solid-states and will react differently to the varying load of the Apogees. Absolute Sounds noted this, saying that some do work and some don't, which is what we would expect. You would need to audition a valve amplifier before making a choice.

Vandersteen Loudspeakers are imported by Arcam, and not from Surrey, but Canada. Stuart Perriam of Arcam Sales said the Mr Steen you refer to started S. D. Acoustics, of Surbiton, Surrey. Vandersteen loudspeakers can be auditioned by appointment at your nearest Arcam dealer. Phone Stuart at Arcam on 0223-440964.

You need something with a bit of wallop in it for KEF 103.4s, the Audio Innovations being unsuited (try our super-sensitive KLS2s for them). For the KEFs try a Pioneer A-400X, an Audiolab 8000A or a Sugden Stemfoort

SF60 which has really tight, dry but punchy bass. **NK**

### STOPPING THE MUDDLE

I am writing to give you some feedback about the magazine and ask for some advice.

The reason I subscribe to Hi-Fi World is because it usually contains the right mixture of articles. People do not change their kit every month so pieces about electronics and record reviews mean that there is always something to read when an issue contains reviews of things that are either too expensive or too cheap.

I own a Walker CJ 55 turntable, Mission arm and a Goldring 1012 cartridge, an A&R Cambridge A60 amp, Mission cable and 760i 'speakers on bookshelves out of reach of my daughter.

I am happy with the sound when I play string Quartets or Suzanne Vega, but full orchestras and Pearl Jam quickly sound muddled when they play forte/loudly. With a budget of £400-500 what should I do? I seek an overall improvement in clarity with better imaging. I am considering a basic Rotel or NAD pre-power combination as a path towards future upgrades. Is this the right step to take?

I would be grateful if you could send me Mr Walker's address to ask him how to set up the turntable correctly.

**Owen Palmer  
Valencia,  
Spain.**

The muddle at high levels is most likely to be due to your cartridge, especially if the deck is not set up properly. The Cambridge A&R (now Arcam) A60 is an old warhorse with a smooth sound and plenty of power and the Mission speakers are also very competent.

First, check that the arm is still moving freely by balancing it out (i.e. reduce the tracking weight to zero) and seeing whether it floats

laterally and vertically with reasonable freedom. Do this with the stylus guard on or, if you've lost it, with the stylus removed. If the arm is sticking, this will degrade tracking and introduce muddle on peaks; it will need servicing. Contact Mission on 0480-451777.

Alternatively, the arm may not be set up properly or the stylus may be worn or damaged. The 1022 should track at around 1.8gms, but try 2gms maximum. Ideally, you should buy a stylus gauge to check this. Ortofon and Goldring can help here.

Have a good look at the stylus cantilever to make sure it isn't bent. If the stylus is more than a year old and has been used a lot you should consider replacing it. The 1012 body will take a 1022 or 1042 stylus assembly, a cheap way of upgrading performance. But be sure that your arm is in good condition first and that you know how to set it up. I feel fairly certain that this is where your problem lies. **NK**

Though the A&R A60 is now on the elderly side, I would, as always, upgrade step-by-step to make the best use of resources. Bear in mind, however, that the final improvement on clarity and imagery will be brought about by putting the Missions on good stands rather than on bookshelves. However, until your daughter reaches an age of responsibility vis-a-vis speaker cones, consider acquiring a Rega RB300, or from the second-hand market, even an Alphason Xenon or SME309. Colin Walker's CJ55 shouldn't need much work, but the Mission arm could be worth replacing. This is a relatively simple matter, involving straightforward carpentry. The arm-board is a rectangle of 18mm MDF, so a piece can be cut to size and drilled for any arm. Originally it was drilled for a Linn-type mounting, so Linn or

Alphason arms will fit anyway. Pick your arm, then pick up your drill! Colin is now semi-retired, but can be contacted on 0928 733326. He will be able to supply a copy of the original instruction manual.

As to the next stage, pre-power combinations which include a disc stage are not easy to find at around £400. The A60 should be easily convertible to a pre-amplifier by your dealer, and a short-cut thus occurs to me. Temporarily, try out a Rotel or NAD power amplifier using the converted A60: you can then upgrade the pre-amplifier later when funds become available. Don't forget the little audiophile bargain from Crimson, the 620B, which has re-appeared again and is a very agile and inexpensive power amplifier. But also listen to Sugden's excellent integrated amplifiers if you can and even the JVC AX-A662BX. **EB**

### ONE BOX OR TWO?

I would very much value your advice on up-grading my front end. I'm looking to buy the most suitable CD player for my Pioneer A-400X and Richter Harlequin speakers (floor-standing, twin 125mm woofer design with 89dB/watt @ 1 metre sensitivity and tonally neutral balance - does this help?). CD is my only source and my current Sony CDP-211 is rather outclassed. My tastes range from Holst to Grace Jones, from the MJQ to the Stone Roses.

I had intended on getting a quality single-box player such as the Arcam Alpha 5, but I was extremely impressed listening to the QED Digit with the Marantz CD52 MkII as a transport. Hence my quandary: is it better to stick with a costlier single-box player, or a cheaper transport, but with the QED DAC? If the latter, are there better alternatives to the ever present Marantz, such as a

Continued on page 119... ▶▶



# Sussex Surplus

13 STATION ROAD, HORSHAM, WEST SUSSEX RH13 5EZ

Telephone: (0403) 251302 Fax: (0403) 270339

Test Equipment • Components • Accessories  
Electromechanical • Mechanical • Engineering

## Valves Mostly UK.

## Oil Filled Chokes

## Oil Filled Paper Capacitors

P.T.F.E. silver plated wire various colours and sizes 50p per mtr.

A.V.O CT160 Valve Tester EX M.O.D

tested and supplied with data book £99 + £20p+p Solartron varifible H.T power supplies with meter 0-500V+DC 100MA/3-15-0-3-15 3A tested very

good condition £75 + £20p+p

P+P add £5.00 +VAT per order UK only unless otherwise stated.

Overseas postage at cost

VAT at 17.5% to be added to all UK orders.

All items in this advert are made to mill spec

Type	Price
GZ34 MULL	£9.00
KT66 G.E.C.	£65.00
EF86 G.E.C.	£9.00
EF86 MULLARD	£6.00
ECC81 MULLARD	£5.00
ECC82 MULLARD	£5.00
ECC83 MULLARD	£10.00
12Ax7 MULLARD	£6.00
E88CC G.E.C	£8.00
5R4GY	£4.00
6080	£10.00
E810F MULLARD	£10.00
E180F MULLARD	£6.00
GZ37	£3.00
EL84 MAZDA	£4.00
6SN7GT	£4.00
DA42 G.E.C	£15.00
U19 RECT	£10.00
6x4 RECT	£3.00
4212E S.T.C	£100.00

Type	Price
10H 25MA	£8.00
2.5H 220MA	£10.00
5H 250MA	£12.00
5H 350MA	£18.00
5H 400MA	£20.00
20H 120MA	£15.00
15H 120MA	£15.00
2H 150MA	£10.00
1H 300MA	£10.00
10H 250MA	£20.00
4.5H 220MA	£10.00

Type	Price
2MFD 600V	£6.00
4MFD 600V	£6.00
8MFD 600V	£8.00
8MFD 800V	£10.00
8MFD 1000V	£12.00
1MFD 600V	£5.00
.5MFD 1000V	£5.00
.5MFD 5000V	£15.00
12MFD 350V	£8.00
1MFD 2500V	£15.00
.25MFD 1000V	£5.00

## Varnished Chokes

10H 75MA	£10.00
3H 40MA	£10.00

## Varnished H.T Transformers

Primary	Secondary
230/240V	612-0-612V
	430 MA £25.00
230V	275-0-275V
	6-3V 2-5A
	6-3V 1A £18.00
	5V 2-5A

## Oil Filled H.T Transformers

Primary	Secondary
115/230V	1250-0-1250V 230V
	310MA £35.00 725/700-0-725/700
	4.6V 100MA 385MA
	180-0-180 55MA
	6.3V 6A
115/230V	400-0-4-00 5V 6A £50.00
	250MA £18.00 6.3V1A
	30V 100MA
115/230V	350-0-350 150MA 115/230V
	6.3V 1A 300/250-0-250/300
	6.3V 2A £37.00 125MA
	6.3V 6A £20.00

## Oil Filled Heater Transformers

Primary	Secondary
115/230V	6.4V 3A x2
	2.5-5V-6.4x2 £15.00
115/230V	6.4V 10A
	10V 650MA
	26V 650MA £15.00
115/230V	2-5V-5V-6.4V
	2A x 4 £15.00
115/230V	6.4V 5A x 3 £20.00

## SOLARTRON BLOCK H.T. PSU.

250/300V 200MA
6.3V 6A
6.3V 6A
6.3V 2A £100+£20 P+P

## SOLARTRON BLOCK H.T. PSU.

200/300V 100MA
6.3V 1A
6.3V 2A
6.3V 4A £60+£10 P+P

## SOLARTRON SR5 152 VALVED H.T. PSU

0-500V 150 MA
6.3V 5A £175 + £20 P+P

## Parmeko Microphone Transformer

PRI 300 Ω - 300 Ω
SEC 300 Ω - 300 Ω
RATIO 1+1: 1+1 £10 EACH

## ROBAND BLOCK H.T. P.S.U.

350V 250 MA
6.3V-0-6.3V 3A £100+
6.3V-0-6.3V 3A £20 P+P

## FARNELL STABILISED H.T./L.T. PSU VARIABLE, WITH METERS

0 -350V 150MA
3.15V-0-3.15V 2A
0-2.5V-5V-6.3V 3A £130 + £20 P+P

## FARNELL STABILISED H.T./L.T. PSU. VARIABLES WITH METERS

0.350V 100 MA
3-15V-0-3.15V 2A
0-2.5V-5V - 6.3V 3A £100+£20 P+P

All items in this advert are made to mill spec.

CLEARAUDIO, S.M.E, AUDIO RESEARCH, CREEK, E.M.F., KLIPPSCH, APOGEE, COPLAND, SONUS FABER, AUDIOWARE

## HEATHERDALE AUDIO LTD.

202, Findon Road, Findon Valley, Worthing, West Sussex.  
Tel. 0903-872288. Fax 0903-872234

### CLEARAUDIO

And playing Oscar Peterson's Verve album, "We Get Requests", the signature brought an immediacy and intimacy to the performance, setting my feet tapping to the music and placing the musicians right there in my room . . . . .

Chris Beeching, Hi-Fi News & RR Aug. 94.

This months pre owned bargains;	
Magnum Reference 300 pre-amp	£325
Magnum Reference Int amp	£299
Audio Innovations 1st Audio	£995
Audio Innovations 100 pre-amp	£995
B&W P211 Speakers, (Ionafane Treble unit)	£400
Jadis 30watt stereo integrated amp	£1195
Audio Innovations 200 pre-amp	£295
Audio Innovations 200 power amp	£295
PS Audio 200 watt signature amp	£895
Audio research SP9 Pre (black)	£1895
Linn LP12	£395
Apogee centaurus speakers	£1595
Wadia Digimaster X32 DAC	£795
Pioneer PD 93 Reference CD player	£995
Sony 702 DAC	£795
Nakamichi Dragon	£995
Magneplanar Tympani IV speaker	£1995
Audio Innovations 500 int. amp.	£595
Audionote IO cartridge (low hours)	£795

THREE COMFORTABLE DEMONSTRATION LOUNGES.  
VISA WEL.COME.

MAGNEPLANAR, MARTIN LOGAN, ROTEL, THETA, JADIS, World Audio History

## EX-DEMONSTRATION & SECONDHAND SALE

QED disc saver phono stage	£25	Micell Gryodec power supply	£85
Quad 606 power amp	£450	Moth series 30 100wpc mono	£250
Quad FM4 tuner	£220	Quad 34 pre amp	£220
Quad FM3 tuner	£75	Chord SPM 800 power amp	£1399
Spendor S20 loudspeakers	£399	ATC SCM 10 loudspeakers	£795
LFD Integrated "0" (phono) int amp	£529	Magnum MC 250 pre amp	£149
Origin Live OL2 loudspeakers	£449	Magnum MF 250 power amp	£149
Acoustic Energy AE1 loudspeakers	£400	DNM 3A6 preamp	£650
Harbeth HL Compact Loudspeakers	£299	Arcam Alpha II int. amplifier	£100
Sony CDP 550 CD player	£60	Mordant Short NS50 bi-wired	£150
NAD 7240/PE tuner/amplifier	£100	Rogers LS7/t loudspeakers	£250
Celestion SL600si idspks inc. stands	£450	Sansui AV 7000 S/Sound amp	£499

For new equipment see us in Lincolnshire Dial-a-Dealer

## Cottage Audio

17 Bridge Street, Saxilby, Nr. Lincoln. LN1 2PZ  
Tel: (0522) 702834 eve: (0522) 696708

VOYD, HEYBROOK, LUMLEY REFERENCE, KRELL,

.... Continued from page 117

NAD 502? I'm looking for a front-end that combines the most superior amalgam of information retrieval, dynamics and atmosphere.

Hope you can help.

**Damien Hasan  
Perth,  
Western Australia.**

Which ever way you look at it, the route of separate transport and DAC is going to be the most costly. Even if you use the Marantz CD-52 as a transport with the Digit DAC it is going to cost you the best part of £500. What it does offer is great

the cheaper players around on sonic grounds. It also has a CDM-9 transport inside, so when the time comes it would survive an upgrade to an external DAC much better, and comes with the legendary Quad back-up and service. Have a listen to both and see what you think. **DB**

#### WHERE'S LOWTHER IN THE UK?

I have currently a more traditional hi-fi (high-end?) system: Linn LP12, Ittok. Asaka, Proceed Transport/DAC Mk 2, Linn Kaim and Klout. Audiostatic ES 100. In this system I very much prefer the LP section. From

valve amplifier (power requirements). Do you have an opinion on this comparison? Why is there no mentioning of Lowther or other horn designs in your magazine (especially in your interesting discussion on the need for more efficient speakers)?

**Uwe Steinmueller  
Deisenhofen,  
Germany.**

The Lowther and ES100 are at opposite ends of the speaker scale. It would be difficult to go easily from one to the other without becoming aware of some disturbing differences. Horns are dynamic; they have the unique ability amongst loudspeakers of driving the air load of a room properly; that's what the horn part is all about - it's an acoustic transformer, load matching drive unit to room. A good horn will move air like no other loudspeaker, giving apparently massive and effortless dynamics. Because of good acoustic matching, efficiency is very high too, little energy being wasted. So horns need just a few watts, as you've found out, meaning they can partner esoteric low power single-ended amplifiers, which helps improve overall sound quality. But they have some significant limitations too. Even a big horn has limited deep bass extension and the large, often wooden, throats can introduce boxy, wooden colourations. Few have a flat frequency response either, meaning there's usually a strong character to the sound. So horns are a trade-off; we suggest you listen carefully, at length and with a wide variety of material, from strings and solo violin though to Rock with clear vocals and deep bass lines. Lowther products are sold mainly overseas; they have no UK dealers, offering home demos only. Hørning Agathons use Lowther drivers and are also available in Austria and

Germany; you may like to locate the dealer and listen to them too.

Electrostatics are inefficient and can sound dynamically a little flat. They also sound, generally, very sweet and smooth, free of colouration and distortion. The use of a dynamic bass unit often results in a poorly integrated sound though, since most bass drivers differ significantly in character from the thin plastic film of an electrostatic. Inefficiency often means that a large solid state power amp must be used, which imposes its own limitations.

Whilst we greatly appreciate the distinctive properties of both horns and electrostatics, it is possible to advance the more domestically acceptable conventional loudspeaker toward them. Audax, the French drive unit manufacturer, keep us abreast of the latest developments in drive unit technology and from them we can get drive units that approach the efficiency of horns and the transparency of electrostatics, without the drawbacks of either. To prove the point, we designed and built KLS3 and find it's a fabulous speaker, to which we're becoming a bit addicted. It's almost spooky to see such a large floorstander delivering an impressive scale of sound from something like our 4watt single-ended amplifier. With a near-flat 8Ω impedance, near flat frequency response, 90dB sensitivity and simple crossover design this, surely, is the way ahead for conventional loudspeakers. **NK**

#### ECSTATIC STATICS

I thought I would write to express my gratitude for the advice you have given to other readers and to ask for some for myself. Yours was the first

Continued on page 121....



The Quad 67 CD player will survive upgrades well, thanks to its superb sound.

flexibility, and upgrading to a better DAC appears to be an easy option. But, bear in mind that if you do upgrade the DAC, its performance will almost certainly be limited by the transport, so pretty soon you'll want to be upgrading the transport as well.

Personally, I'd go for something like the £350 Rotel RCD965 Discrete. It has a smooth sound, but with plenty of detail and atmosphere. Another excellent one box player is the Quad 67. It is a lot more expensive at £790, but would probably far outlive any of

your magazine (and a few others) I got interested in tube amplifiers (do they make CD more enjoyable?). Last weekend I could hear a single-ended triode 2W amp (from Tube Amps in Germany) driving a Lowther Bicolor 200.

I am not in the situation to really say whether it sounded better than my system, but I am very sure that I have never heard such a dynamic and detailed imaging system. After this session it is clear for me that I need to decide whether I like the ES100 or the Bicolor more, because this decision is important for the choice of a

## RARE RECORDS BY MAIL

**JON TAYLOR**

29 A Lambs Conduit Street,  
Holborn, London WC1N 3NG  
Tel. & Fax: 071 831 9907; Mobile 0385 323393

**Specialising in rare 60s/70s/80s/90s  
Progressive, Psychedelic, Underground, Acid Rock,  
Rhythm & Blues, West Coast, Country Rock, Hard  
Rock, Thrash, New Wave, Punk, Rock & Pop  
Memorabilia.**

**Buy, Sell, Trade. Send your wants lists.**

Free lists available on all major artists including Abba, AC/DC, Adam & The Ants, Bryan Adams, Aerosmith, A-Ha, Tori Amos, Bangles, Beach Boys, Beatles, Black Sabbath, Blondie, Marc Bolan, Bon Jovi, David Bowie, Kate Bush, Byrds, Belinda Carlisle, Cher, Eric Clapton, Alice Cooper, Cult, Cure, Deep Purple, Def Leppard, Depeche Mode, Dire Straits, Doors, Duran Duran, Bob Dylan, ELO, Eurythmics, Fleetwood Mac, Free, Genesis, Grateful Dead, Guns 'N' Roses, Hawkwind, Jimi Hendrix, INXS, Iron Maiden, Michael Jackson, Jam, Jethro Tull, Elton John, Kinks, Kiss, KLF, Led Zeppelin, Level 42, L7, Madonna, Marillion, Metallica, Meatloaf, New Order, Nirvana, Pearl Jam, Pet Shop Boys, Pink Floyd, Pixies, Elvis Presley, Prince, Queen, R.E.M., Cliff Richard, Rolling Stones, Roxette, Rush, Sex Pistols, Simple Minds, Simply Red, Smiths, Bruce Springsteen, Status Quo, Rod Stewart, Sweet, Thin Lizzy, U2, Velvet Underground, Wham!, Who, Yardbirds, Yes, Neil Young, Frank Zappa.

Please include a SAE or IRC.

**Top prices paid for Records, CD's, Cassettes, Music  
Books, Videos, Pop Magazines and Music  
Memorabilia.**

**Whole Collections bought.**

AN EXCLUSIVE

HI-FI DEALER



**CAMBRIDGE HI-FI LTD**

FOR THE TOTAL EXPERIENCE IN HI-FI

**B&W, BOSE, KEF, KENWOOD,  
MARANTZ, TECHNICS,  
YAMAHA**

AND MANY OTHER QUALITY BRITISH &  
JAPANESE HI-FI PRODUCTS INC. TAPES  
AND ACCESSORIES

VISIT OUR SHOWROOM FOR ADVICE & A DEMONSTRATION IN OUR DEMO ROOM

1 -3 HAWTHORN WAY, CAMBRIDGE  
AMPLE CAR PARKING

**CAMBRIDGE (0223) 67773**



FAX NO. (0223) 353741

**VISA**

*o v e r t u r e*

## Tears for Fears ?

**Save the distress, visit the best !**

- ◆ Linn Products ◆ Arcam ◆
- ◆ Naim Audio ◆ Meridian ◆
- ◆ Quad ◆ Nakamichi ◆
- ◆ Denon ◆ Heybrook ◆
- ◆ Mission ◆ Epos ◆
- ◆ Audioquest cables ◆



" If only Mr Fears had  
discovered Overture  
earlier "

- ◆ Open 6 days ◆ 10.00 to 18.00 ◆ BADA ◆

**Overture HiFi Specialists**

**3 Church Lane**

**BANBURY**

**OXON**

**(0295) 272158**

## COMPACT DISCS

The Classical CD Specialist

**H & R CLOAKE LTD**

(Established 1946)

OVER 10,000 CD's IN STOCK  
3,000 Cassettes  
3,000 LP's (POP)  
and Laserdiscs to order (list available)

SPECIAL OFFERS  
each month

ALSO MAIL ORDER SERVICE AVAILABLE  
CD'S SENT POST FREE (UK)  
CASSETTES/LP'S AT COST

Access/Visa Accepted

29 High Street, Croydon CR0 1QB

081 - 681 - 3965 - Classical

081 - 686 - 1336 - Pop/Jazz

**COMPACT DISCS**

C  
L  
A  
S  
S  
I  
C  
A  
L

P  
O  
P  
U  
L  
A  
R



.... Continued from page 119

magazine that had consistently good things to say about Quad speakers and amps. My hi-fi (thanks to you) consists of 2 pairs of Quad ESL 'speakers driven by a pair of Quad IIs. The rest of the system is a Linn LP12 with Ittok arm and K9 cartridge, a Pioneer F90 tuner, a Teac A108 cassette deck, a Sony DTC690 (if you are thinking of buying one of these, buy it from an authorised dealer - take it from me!) a Denon DCD1420 CD player, and the original Musical Fidelity Preamp.

I well remember the first pair of ESL speakers (cost £200) I bought and my thinking that I shouldn't expect too much from them (I had been using Arcam 2+ speakers for several years previously). I was bowled over! The next step was the acquisition of a second pair, also for £200, just in case I was thrashing the single pair. I had them mounted one pair on top of the other for a while, but I had to take the top pair off because they blocked out the light from the patio doors. I have just converted the garage into a music room and I

expect I shall mount the second pair soon. I added the pair of Quad IIs a year ago - bliss. . . However, my query.

I have had the Musical Fidelity Preamp (bought second hand from Dave Berriman no less, for £100) for about about 12 years, but now it doesn't have enough inputs. Does anyone know if it is possible to have three extra inputs added to it and who might do it? Alternatively, can you suggest a pre-amp with six inputs, two of which must be tape inputs that sound as good or better than the Preamp. Is it true that line level pre-amps would not be suitable for the Quad IIs because of their low output?

Whilst I think of it, what about asking readers to send in funny stories about their experiences when buying equipment? Here's mine. I bought the Denon CD player from Absolute Sounds and Video, which is now Audio T in Basingstoke and the entire demonstration lasting one hour of various CD players was carried out by a salesman who played a guitar throughout! It was a bass guitar and although I could not recognise the make it

appeared to be of the fretless variety. He held the guitar when no music was played, but when the music played - wow - he really came to life, even at low volume! He played along to the music and discussed prices at the same time. The only thing he didn't do was take the guitar off and lean it against the wall. I was so impressed with his musicianship I had to buy something! The name on the receipt was Simon.

Many thanks once again for a great magazine.

**Lance Maleski  
Whitchurch,  
Hampshire.**

First of all, ask Quad to send you their information sheet No. 021 which explains exactly how to mount a pair of stacked Quads. There is also a protection circuit that can be fitted to the ESL to help prevent damage, so ask about this too. It really is worth stacking them, they can sound absolutely fantastic.

The problem of too few inputs is easily addressed. QED have been making switch boxes for years which give extra inputs to pre-amplifiers. They are simple and cheap, and available at nearly all hi-fi dealers.

I think you are getting in a bit of a muddle about which pre-amps would be suitable, should you wish to change. It is not the power output of the Quad IIs that causes the problem, it is the amount of signal needed at their input for full volume. The input sensitivity of the Quad IIs is around 1.4V, which means

that they need 1.4V of signal from the pre-amplifier for full output.

There are two basic sorts of pre-amplifier you could buy, those that can amplify (active) and those that do not (active and passive). An active pre-amplifier usually has gain, so if you plug in a tuner that can produce only 0.75V, the pre-amplifier will amplify this low signal up to the 1.4V required to get full power from the power amps. For the Quad IIs you need an active pre-amplifier with gain, because all items except CD do not produce enough signal.

A line level pre-amplifier is one which doesn't have a phono stage. Records do not give a flat frequency response, they have more treble than bass, so an equalisation circuit is needed, the equalisation being the RIAA curve. As you have a record deck you need a phono stage, so a line level pre-amplifier would not suit.

So what you are looking for is an active pre-amplifier, with a phono stage, six inputs and two tape monitors. It sounds more complicated than it really is, honest. If, after wading through all of this, you do decide to go for a new pre-amp, here's a short-list of suitable devices with inputs for CD, tuner, phono and two tape decks: Rose RV-23S at £495, a valve design with a sweet and clear sound; Rotel RC980BX at £350 which has a smooth and laid back sound and the long standing £450 Audiolab 8000C which is possibly a touch gritty for your system. Whatever you do, have a good listen first. The Quad IIs and stacked ESLs will produce a very revealing system that may highlight preceding equipment's shortcomings.

As to readers' funny stories about experiences when buying equipment, we already get a lot of them, but yours is one of the few that is printable. **DB**



The Rose RV-23S valve preamp has a sweet and clear sound.



Makers of Quality  
Amplifiers

Tel: (0255) 422533

## CABLE TALK

BRITISH  
MADE

★★★★★ Rated interconnects and speaker cables are available from your local specialist dealer.

.....STOP PRESS.....STOP PRESS .....STOP PRESS.

"Talk 3's great sound quality and value for money"  
(Dec '92 WHAT HI-FI?)

Can now be obtained in a convenient bi-wire format at £4.50 per metre.

Please telephone 0483-750667 Fax 0344-360866  
For Further Information

## KIMBERLEY HI-FI

*A Sound Investment*

• SEPARATE DEMONSTRATION ROOM •  
BRANDS STOCKED: DENON • TECHNICS • KENWOOD • AIWA  
• NAD • DUAL • CASTLE • GOODMAN'S • MARANTZ • MONITOR  
AUDIO • HECO • ROTEL • PIONEER •

SOUTH  
LONDON'S &  
NORTH KENT'S  
ONLY

0% FINANCE  
AVAILABLE ON  
SELECTED ITEMS



193 BROADWAY, BEXLEYHEATH, KENT

081 - 304 3272

## DAN DULEY HI-FI

15 St. Georges Square,  
Forest Gate,  
London E7 8HN  
Tel: 081 470 9795  
(after 2pm.)

THE NEGUS is a complete studio quality monitor system, with loudspeakers customised to suit your room. LONG demonstration sessions possible.



NEGUS  
Electronics:-

COMBINED  
PRE-AMP AND  
CROSSOVER

THREE  
MATCHED  
50W<sub>RMS</sub> PER  
CHANNEL  
AMPLIFIERS

POWER PAK:-  
SUPPLIES ALL  
UNITS

## HALE HI FI



We stock:-

ROYD, NAD, NAIM, LINN, CREEK, ARCAM,  
QUAD, YAMAHA.

A wide range of accessories always available.  
Full demonstration facilities - no appointment  
necessary - full service department.  
Free delivery and installation

2 Bold Street, Hale Road

Altrincham, Cheshire WA14 2ER

Telephone: (061) 929 0834

## PRIVATE

LINN KABERS, walnut, current spec.+ KuStone stands, immaculate. £700.  
Tel: (0342) 834364.

LINN KAIRN/LK100 PRE/POWER combination. Boxed with manuals etc. £1095.  
Tel: (0642) 542395 (day), (0429) 274638 (eve.)

HI-FI WORLD 5-20 Valve Monoblocks, 36 w.p.c. class A, wood side cheeks £400. Edison I2 class A valve power amp. 12 w.p.c. £250. Audio Innovations S200 MM pre-amp, £200. Arcam Delta Black Box 5 DAC, new 1/94, £250. Marantz CD63, new May/94, immaculate, £180 or swap for Rotel RCD965BXD.  
Tel: (0706) 345418.

SENSIBLE OFFERS FOR: Speakers; Quad Electrostatic Bronze, Wharfedale Linton, Leak Sandwich. Cassette Decks; National Panasonic RS2600S, Akai GX-R6, Pioneer CT-200. Aiwa F660 Turntables; Beogram 1200, Thorens TD124/11 SME 3008 Ortofon cartridge and pre-amp, Strathearn STM1, Garrard 80SB MkII. Tuners; Leak Troughline 3, Leak Fectic FM, Sugden RD51, Pioneer TX-940L, Quad FM4. Amplifiers; Leak Stereo 30, Leak Stereo 30 plus, Sugden stereo, Hart Lindsey Hood. CD player; Marantz CD63T.  
Tel: (0723) 372473.

LINN LP12 (black), Circus, Naim ARO, Troika (new), Exposure active power amplifier system, Naim SBL loudspeakers, Mana reference tables, all cables, £8000. All boxed and immaculate. Tel: (0934) 522635 (Answer phone).

LINN ITTOK pickup arm, as new, boxed with instructions, £200.  
Tel: Mike (0843) 592066 after 6pm.

FOR SALE. AIWA ADF-660 cassette deck 3 heads, Dolby B/C £65 o.n.o. Lynwood Advanced Mains Conditioner £95 o.n.o.  
Tel: (0642) 559078

NAIM ACTIVE SYSTEM. 72 pre-amp 2x140 power amps NAXO, dual power supply RATA Regs+caps etc. £1530. SNAPS, 2x140 power amp boards. £120.  
Tel: (0670) 354726.

LONDON JUBILEE (Decca) phono cartridge. As new £500 o.n.o.  
Tel: (0403) 733055.

WANTED Audio Innovations S700 or Beard BBI00 amplifier or other interesting line level valve amp around £500. For sale. Musical Fidelity A100, boxed £200  
Tel: (0480) 460502 (Cambridge Area).

WANTED: SONY TAE-1000 Dolby Pro-Logic pre-amplifier.  
Tel: (0272) 695936.

TWO QUAD 405IIs £120, £160. K9 pick-up £7.50. Lynwood mains filter £40. Tel: (081) 556 9102.

MAGNUM MF250 POWER AMP. 150Wrms, £295. Meridian M3s active 105Wrms speakers £395, 200/203 DAC7 £745. Albany AP4/1008II £795. Artemiz £295, Naim NAC42 £130, Nait I £165 p/exchange?  
Tel: (0206) 861457 (Jim).

AUDIOLAB 8000All latest spec, mint £295. Linn LP12 black/Akito/K5 £395. Wharfedale 507s + stands £100.  
Tel: (0474) 812753 (after 7pm + weekends)

GARRARD 401 £150. Lowther Acoustas £150 pair. Quad 100watt mono valve amp £50. Thorens TD125MkII, SME3009 and Shure V15 £85. Vortexion mono valve amp £20.  
Tel: Alan (0661) 852874.

GARRARD 301, v.g.c., original plinth, SME3009, Shure ME75 £150. Nitty Gritty record cleaning machine £100  
Tel: (0533) 553176.

NAIM NAP 140, six months old, as new £450. Epos ES11 mint condition with stands £295. NAC 42, MC boards, excellent performance for £75.  
Tel: (0734) 866616

MISSION 753 SPEAKERS. Immaculate condition and boxed. £475 ono. Sumo-Polaris power amp 250W.p.c. of American muscle. £250 ono. Mint  
Tel: (0480) 435930 eves. (Mission service engineer)

QUAD ESL63. Excellent condition £1150.00  
Tel: (0730) 817188.

TRIO TUNER KT615 Analogue. Smashing performance but needs alignment £40. Sansui AU217 amp in sound working order £35. SME 3009IIIS tonearm with Ortofon VMS30EII £35.  
Tel: Bob Parsons (0895) 674136 (day) (0628) 662135 (home).

REGA PLANAR 3 plus AT95E cartridge. A really great deck, little used. £175.  
Tel: (0532) 621130.

REGA PLANAR 3. RB200 arm. Arcam C77 cartridge (20+ hrs use) mint, boxed £125-00. Quad 33-303 pre/power amps. v.g.c. £150-00. Cyrus solid core speaker cable 4x3m £18-00.  
Tel: David (081) 348 0612 (home) (081) 741 3119 (days).

TANNOY CORNER LANCASTERS £450, Leak TL50+ £200 each, Stereo 20 £180, Troughline £50. Garrard 301 £150, Linn Akito arm £60, Decca Gold £50, Wharfedale SFB3s £200. Wanted good pre-amp (exchange?)  
Tel: (0709) 555403.

NAIM 72 PRE-AMP, current style, good condition. Variable and straight through boards. £400  
Tel: (0734) 731776.

VALVE GEAR: Avantic SPAII £120, tuner £30. Armstrong amp £60, receiver £60, Leak Troughline £50. Goldring GL75 Varispeed £45, Decca Gold £50, Lowther Accousta horns new Ticonal PM6s £350.  
Tel: (0709) 555403

AUDIO NOTE I.O. 50 hours use, made by Kondo in Japan, not British, £995. Koetsu Red £275, DN13 pre-amp six power supplies offers, wanted, Apogee Stage, KEF 105III, QED Digit  
Tel: (0642) 559543.

LOWTHER ACOUSTA HORNS, efficient, fast, dynamic £390, Fisher FM100B valve tuner £495, Kelly Ribbon tweeters £95, Garrard 301, Decca FFSS, MkIII head £195, Technics tuner ST-53 £39.  
Tel: (0642) 559543.

SWAP your Primare 928 remote pre-amplifier for my mint not remote Primare 928 with cash adjustment and it sounds better. For sale; Pink Triangle PIP11 pre-amplifier, new power supply, mint, boxed £1200 (£2670).  
Tel: (0943) 466381 (home).

QUICKSILVER VALVE PRE-AMP, pair 60w Quicksilver valve monoblocks, cost £4000, bargain £1695 only for this superb sounding high-end combo. Naim MC boards £40, adjustable CD boards £40.  
Tel: (0449) 676335.

GARRARD/DECCA AP76 Decca teak plinth with smoked perspex and teak cover £60. Garrard Synchro-Lab72B £30. Hi-Fi World first issue to 21, mint condition, offers please.  
Tel: (081) 391 5956.

FOR SALE: Ion Nexus amplifier system. SP-1 pre-amp (MC and MM), X-PAC 2 power supply, SAM 40 power amp. £450. 4x6m Kimber speaker cable £75. Target table. 2-tier, 4-shelf. Suit Ion/Naim amps. £40. All mint.  
Tel: (051) 342 8463.

TEAC VRDS-10, CyrusII and PSX, Mission 75 Is, Linn K400 bi-wire, Target HS24 stands, Audioquest Emerald interconnects. 10 months old, boxed, £1200 ono. 66cm Hitachi Nicaam TV and Hitachi Nicaam Videoplus video. Cost £1400. Sell £700.  
Tel: (0792) 298417.

SUGDEN SDTI CD PLAYER. 13 months old. Little use, excellent sound and excellent condition £500. Denon PMA 250II integrated amplifier, 2 years old, good condition £70. Musical Fidelity B200 amplifier £150.  
Tel: (0702) 618922 (Southend).

TECHNICS SU-A900 £280 - cost £400, Technics SH-GE90 £175 - cost £250, Philips CD692 - £50. Tannoy DC2000 £120 - cost £320. All only six months old.  
Tel: Marcus (0704) 573646.

TRANSMISSION LINE SPEAKERS professionally built to 'Wireless World' specification, KEF units £170. Leak solid state amp 80 w.p.c. 3900A in original box £50.  
Tel: (0922) 722486 (West Mids. Evenings)

THORENS TD124 TURNTABLE / w Fidelity Research FR64S arm with heavy counter weight and silver output cables, Garrott Brothers Micro Scanner Linn Asak cartridge. £250 ono. Genuine reason for sale.  
Tel: Mike (0934) 518072.

QUAD 606 POWER AMPLIFIER with QED passive pre-amplifier and good quality interconnects. All excellent. Boxed etc. £390.  
Tel: Plymouth (0752) 341719.

FOR SALE Quad power amps (re-valved), Quad 22 pre-amp, Quad FM2 (two available), Quad AM tuner (LW/MW/SW). All in very good condition. £350  
Tel: (0962) 861894 (Hampshire)

RUARK TALISMAN IIs. Black finish. Excellent condition. 15 months old, £400 ono.  
Tel: (081) 360 3799 (day/eves).

LINN LK280 POWER AMP, including interconnects, excellent condition, boxed £325-00 o.v.n.o.  
Tel: (0582) 592211 (evenings).

AUDIO SYNTHESIS Ultra Analogue DAC £595; Krell KSA50 MarkII £950; Krell KST100 £1395 (Balance of warranty); Sonus Faber Electa £950. All items mint and boxed.  
Tel: (0543) 274199.

NAIM NAP135 power amps, £1425 pair, NAC32.5 pre-amp, type 72 boards, £235, HI-CAP power supply £215. Linn Kaber speakers, latest specification, Linn tn-wire cables, £725. All as new, boxed.  
Tel: (0489) 798890.

PYE MOZART pre and power amps. Excellent condition and sound quality £300 ono. Mullard 510 power amp (one only) £25. Kenwood DPX9010 CD transport £275.  
Tel: (091) 487 7796 (Tyneside).

MUSICAL FIDELITY A1 class A amplifier £110. Technics SL-PS620A compact disc player £110. Both immaculate with original packaging.  
Tel: (0742) 746790 (7-9pm).

WANTED: Private Buyer wants Thorens 3001/Rega or TP90S, or Thorens 520/SME or TP90S, or Townsend Rock MkIII/Rega, or Voyd Helius. Must be in excellent condition.  
Tel: (0482) 842740 (evenings. Ask for Paul)

LINN SONDEK LP12, REGA RB300 ARM, REGA ELESA Cartridge. All just professionally overhauled and set up. For sale due to upgrade. Can be demonstrated. £400.00  
Tel: 0392 833611 (Devon)

# ZEN AUDIO

GEORGE STREET HULL. TEL 0482 587397

Comfortable listening room

Home demonstrations

Free home installations

AUDIOLAB, AUDIO INNOVATIONS, AURA, B&W, CABLETALK, DPA, HEYBROOK, JPW, KAR, MICROMEGA, MICHELL, HARMAN KARDON, IMPULSE, RUARK, ROTEL, SUGDEN,



CLEAN, REPAIR & PROTECT

OVER 50 CD's

## CD REPAIR

For details of your nearest stockist call 0895 449559

TRIED & TESTED ON TOMORROW'S WORLD - BBC1

- CD ROM
- CD GAMES
- AUDIO CDS



Please send me Bunde CD3 Disc Repair Protection System at £14.95 inc P&P each

Please send your cheque/postal order made payable to Axion (Europe) Ltd

NAME \_\_\_\_\_

Axion (Europe) Ltd. ADDRESS \_\_\_\_\_

6 Bentinck Court \_\_\_\_\_

Bentinck Road \_\_\_\_\_

West Drayton \_\_\_\_\_

Middx. UB7 7RG \_\_\_\_\_

POSTCODE \_\_\_\_\_

TEL (DAY) \_\_\_\_\_

ESSENTIAL FOR ALL CD USERS

£14.95 inc. P&P Please allow 14 days for delivery

## M.J.S. HI-FI

### Agencies Include:-

Audiophile Furniture, Basis, CAT, Cogan Hall, Concordant, Dynalab, Graham, John Shearne, Kinshaw, Sonic Link, L.F.D., Lumley Monitors, Lumley Reference, Magnum, Moth, Nottingham Analogue, Origin Live, Ortofon, S.D. Acoustics, Silver Sounds, S.M.E., Pearl, Townshend, Transfiguration, Triangle.



FOR MORE DETAILS PLEASE PHONE:

**M.J.S. HI-FI**  
80 Stapleton Lane, Barwell,  
Leicestershire LE9 8HE  
Telephone: (0455) 846977  
BY APPOINTMENT ONLY

## ABERDEEN



- \* Single Room Demonstrations available.
- \* Full Service Department
- \* Free Delivery and Installation anywhere in Scotland

Authorised dealer for:- Linn, Chord, Proac, Mordaunt Short, Audio Research, Sonus Faber



42 St Andrew Street, Aberdeen  
Tel/Fax 0224 - 625635

**AUDIO INNOVATIONS:**

First Audio amplifier (2A3/88) £865 (New £1550); Series 200 pre-amplifier - only three months use - £235 (£350); Series 1000 MC transformer £140 (£300). Standesign Penta 5 shelf equipment support £75 (£160+). All perfect, can demonstrate. Near offers invited. Tel: (0455) 636695 - Please leave contact number if unlucky.

MICHELL GYRODEC, Rega RB300, Audio Technica AT OC10 moving coil cartridge and Gyro PSU. 11 months old, mint condition, little use. Bargain at £850 ono. cost £1320. Tel: (0202) 482124 (Chrstchuch).

LARGE COLLECTION of early hi-fi for sale as one lot, including Leak TL50 plus amps, Leak Stereo 50 and 60 amps, pre-amps, Troughline mono and stereo tuners, Leak spares, (inc. transformers), new boxed valves. Garrard 301, 401 and Thorens TD124 turntables, Decca FFSS heads, SME arms, Tandberg tape decks. Write only please enclosing SAE for full list to Mr Snow, 7 Edith Avenue, Peacehaven, East Sussex, BN10 8LJ.

LEAK TROUGHLINE stereo tuner and Leak Stereo 70 amplifier in matching teak, want a good home, £160 ono. Will sell separately. Tel: (0604) 760804 (Northampton)

ONIX BWD I-FM Stereo tuner with power supply, boxed, mint condition £350. Tel: (021) 553 5759.

**FOR SALE**

- 1) Audio Alchemy DAC DDEv1.0 and 'Clearstream' interconnect. Boxed as new, cost £499-00, accept £245- ono.
- 2) Leak Troughline stereo FM3 tuner, mint condition £149- ovno.
- 3) Wanted- Class A headphone amp! Preferably valve design! Tel: (081) 347 6077.

MAGNEPLANAR MG1B panel loudspeakers. Excellent sound as usual, mint condition, oak/black, £495 o.n.o. Wanted: One Quad II power amp (original condition). Tel: (0734) 722880.

AUDIO TECHNICA AT1005II pick-up arm complete with hydraulic lift. Despite its age is still in excellent condition with box, instructions etc. Also Shure M75EDII cartridge. Good home needed - Yours for the price of the postage or free to anyone who can collect. Tel: Adnan Webber (0275) 393520 (Bnston)

CABLE CLEAROUT 50% OFF NEW PRICES? Interconnect: 1/2m Siltec MC4-24 £100 (2 pairs available) WBTC connectors. Speaker cable: 5m pair Van den Hul CS122 £50. 3m pair Vecteur CV30 £25. 2.3m pair Exposure £6. Tel: (021) 430 3416.

YOU WOULD BE WARMLY WELCOMED at 'Fasganeoin', a long established, well recommended quiet country house hotel set in lovely grounds in Pitlochry, the heart of the Scottish Highlands. Tel: (0796) 472387 Fax: (0796) 474285.

LINN KEILIDH loudspeakers, black finish with ceramic bases. 10 months old. Price new £690, will sell for £490. Tel: (0900) 85344 (after 6pm).

**ROKSAN TABRAZ Z1 tone arm + Isoda phono leads. 12 months old. RRP £330, will accept £135. Tel: Andy (081) 361 6050 (day) (0727) 834561 (eve).**

DELTEC LITTLE BIT DAC, plus DNM interconnects, boxed, excellent condition; £190. Tel: (031) 554 8883.

WANTED: DENON POA6600 monoblock power amplifiers for cash. No telephone, please write: D Webster, 111 Strathmore Road, Hinckley, Leics. LE10 0LP.

WANTED: AUTOCHANGE DECK capable of playing 45s and 78s. Garrard AT60MkIII or Thorens, or W.H.Y.? Tel: Peter (0202) 659714 (eves, Poole) (0202) 595488 (day).

QUAD FMII TUNER, 33 pre-amp, 303 amplifier (boxed, mint) £150. FM Tuner (early model) £35, 11 pre-amp and amplifier £115, 22 pre-amp & amplifier block £40. ESL Bronze speakers £250. 100+ Mullard valves various, unused, boxed £45. Audiomaster stereo valve pre-amp £35, Dulci monoblocks (need attention) £25. Tel: (0306) 743469.

REBUILT GARRARD 401 turntable (silver) £200 ono. Logic Tempo turntable with Datum arm (black) and cartridge £120 ono (MC). Triangle speakers (floor standing), various Deltec and LFD cables. Deltec mains filter. Several speaker stands (offer or exchange). Tel: (0292) 441544.

"LOWTHER" HORN LOADED mini-monitors with newly re-coned PM6 drivers £350. "Stax Lambda Professional" earspeaker plus "Stax SRD-X Professional" energiser. Hardly used, boxed, £400. "Audio Technica ATH70" electret headphone with energiser. Mint, boxed, £100. Tel: (051) 426 1600 (day) (051) 426 1352 (after 6pm).

AUDIO INNOVATIONS SERIES 500, excellent condition, boxed £495. Musical Fidelity CD2, excellent condition £160. DAT, Sony DTC690, excellent condition £295. NAD 5020 Monitor Series CD, brand new £150. Tel: (0332) 271088.

D.A.T. SONY Portable Recorder (Model TDC-T7). As new, only £265 o.n.o. (£450 new). Tel: 081 347 6077

A & R CAM A60 Integrated Amp. Excellent condition £110. Rogers LS7s Speakers. Original (& best) model VGC £220 including stands. superb combination. Will Dem. Telephone: Graham (0737) 223425 (Surrey).

REVOX B77 MR11 Two Track Recorder 7.5 & 15 IPS. 10.5" Tapes. Absolutely immaculate condition. £1,900 new only £700 ono. Telephone: (0344) 867 589 or (0374) 194 069.

MERIDIAN MCA 1 Amp with CD, tape, MC Modules also matching MFM Tuner great sound boxed bargain £200 or will swap for new style Naim Nait 2. Ring Tony (0742) 723138.

AUDIOPHILE SPEAKERS. US Imported Ryan Acoustic Speakers (£1,000+ new). Fantastic sound stage and imaging. £575, includes high quality target RI speaker stands. Telephone: (0276) 61350 evenings (after 7pm)/weekend.

ARCAM DELTA 170 CD Player with black box and Audioquest cables. Boxed. Perfect condition. Will gladly demonstrate. £350 ovno. (0977) 620558.

ARMSTRONG 626 RECEIVER boxed with manuals, £100, Armstrong 521 amplifier, £45, both in excellent condition. Goldring Lenco GL75 Transcription turntable, £65. Telephone: (0252) 622403 (NE Hants).

LINN LP12/LINGO/Cirkus/Aro/Klyde/Equinox Head Amplifier £1,700. Naim new style NAC72, old style Hi-Cap pair NAPI35s complete system £2,000. Audiovector F3/LYD speakers freestanding threeway floorstanding excellent imaging. £1,200 new. Only three months use £750. (Tilbury) 0375 843713.

MAGNUM MF250 Power-amp 125 WRMS £275 Mendian M3s Active + M30 Stands £395, 101 pre amp £130, 200/203 DAC7 £745. Albany M1008II/AP4 £795. Artimiz £295. Naim Nait £150, Marantz CD56 £100. (0206) 861457.

LINN LP12/Ittok/Asaka - £650; Linn LK280 - £400; Cambrdge P50II (1973, faulty, use case for DIY preamp?) - offers. Northampton (0604) 403947 after 7pm.

MANA ACOUSTICS Reference Table in immaculate condition, with box £250. Also two Cornflake Shop, single tier equipment tables £25 each. Telephone: (071) 239 0398 (Simon Bance) days.

CASTLE WINCHESTER Speakers, Yew Wood Veneered, CMW floor stabilisers, 3 years old. £850, less than half price. Reason for sale too large for new location. Buyer collects. Telephone: (0983) (I.O.W.) 565849.

REL STENTOR Sub-woofer costs new £1,500 accept £700. (0803) 297691 evenings (Torquay, Devon).

COPPER CHASSIS - non magnetic, high conductance material for the best sound. 2 sizes available: 405x305x75 mm stereo amp \$125.00 330x230x50 mm preamp or monoblock \$100. Bottom plates \$15.00 Tubes: WE275A, WE274, 6V6, 6550 etc. Oil Caps: over 3000 signal and reservoir in stock. Many other parts. Send for complete list. C.Phaneuf, 972 Guillaume Boisset, Cap-Rouge (Quebec) Canada G1Y 1Y9.

DPA 200S PRE and Monoblocks 200 WPC with 2 pairs white slink, 2 power filters, stunning sound cost over £2,400. 6 months old, absolutely as new accept £1,895 ono. Tel: 0454 201043

JPW RUBY 4 Floorstanders, stunning sound and looks in Santos Rosewood. Cost £1,500 in March accept £1,100 ono. DPA 200S Pre/monoblocks etc. cost £2,400 accept £1,895 ono. Tel: 0454 201043

MERIDIAN: 200 CD transport, 6 months old; 203 DAC7 converter. Both mint, boxed. Optical + coax cables. Genuine reason for sale £795. Ph. (0223) 69300 (Paul) evenings.

KENWOOD DP X9010 Transport, as new, boxed, half price £300 or exchange for Mendian 200 Transport. Telephone: Marc (0392) 422357 Exeter.

BARGAIN: One pair of KEF 105.III mint condition. Black Ash for quick sale £1,300 no offers. Will deliver within reasonable distance. Tel: 0522 693373

ALBARRY 1008, 100 watt Mono Block Amplifiers £650. Albany S508, 50 watt Stereo Power Amplifier £300. Audioquest Video-Z digital interconnect 0.5 metre £25. All mint condition, little used, will demonstrate. Telephone: (0277) 355769 (Essex).

KEF 104.2 Speakers £800, Akai CD A7 £100, Pioneer A88X Amplifier £200, Nakamichi BX125 Cassette Deck £150. All in Good Condition, all with receipts. Telephone: (0543) 256697 Lichfield.

REVOX A77 Reel-to-Reel tape deck. Factory fitted high speed and vanspeed plus TEAC AN-180 dedicated Dolby N/R system. Domestic use only. Full service history. £450. Telephone: Robert (0603) 222230 (Norwich).

KEF 107II, Rosewood, £1,400. Celestion SL600 £260. Audionote Ks £225. Sony 228ES CD Player £220. Rogers LS3/5A with active subwoofer £600. Inca Tech Claymore amp £110. Telephone: (0977) 643629.

# SLATE AUDIO

HI-FI Design & Cable Services



*Better than a . . .*

## SLATE AUDIO GARRARD 401

The Garrard is very musical and involving, and entices you to sit back and listen for hours. Bass lines roll along with poise; vocals float around your listening room with a haunting elegance. The 401 never draws undue attention to tiny detail. Instead it pulls the music together, producing a very tightly weaved musical fabric. Forward and assertive, it never sounds out of breath or muddled, it just continues to offer music as a total entity. The open qualities that it offers also bring out the best in your ancillaries, nothing sounds under strain or under pressure. Quiet operation is the final surprising feature. The rumble that once afflicted the 401 has been silenced once and for all. The build and performance of the Garrard 401 are really an audio equivalent of the E-type Jaguar, they're both fine examples of sixties British engineering.

**AUDIOPHILE**

The Slate deck defines what real instrument solidity should be. Bottom end delivery is also in a class of its own. The word controlled kept appearing on my notepad, the turntable giving a Rock-like performance, with stacks of detail.

**HI-FI CHOICE**

I have never used a turntable system like this one. It seems to get everything right. It relies on massive, yet clever and precise engineering to get the best from LP. With an Ortofon MC2000 cartridge fitted to the arm (SME IV), sound quality was unquestionably superior to CD. The Garrard seems free of what, in comparison, seems like sloppy timing on belt drives . . . it keeps a rigid control on tempo, making for a fast controlled delivery. Music blossoms out of the speakers and fills the room . . . the Garrard/SME/Ortofon/Slate combination teased so much out of the Vinyl groove, presenting it clearly, that CD was forced to take a back seat. Images on the stereo stage were strongly embodied. They had real substance and life.

**HI-FI WORLD**

47 GEMINI CLOSE, LEIGHTON BUZZARD, BEDS, LU7 8UD. TEL: 0525 384174

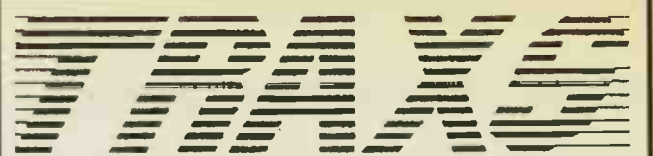

STANDARD CASE



FULL AND SEMI FLIGHT CASES

### THE ULTIMATE IN RECORD/COMPACT DISC/CASSETTE PROTECTION

Presenting a selection of cases carefully designed to meet the needs of Collectors, DJ's and all Buyers of Records, CD's, Cassettes

Introducing our new range of semi and full flight cases for '94

These Cases are constructed from Plywood/M.d.f. Full Flight finished in Stucco Alloy covering will all heavy duty Aluminium/Steel Corners, Catches, Lift-off Hinges and Angle Trim. Semi-Flight same as full Flight but Finished in Black Vynide Covering.

	Standard	Semi-Flight-	Full-Flight
A - holds 200 singles	£39.99	£59.99	£69.99
B - holds 400 singles	£45.99	£64.99	£75.99
C - holds 600 singles	£49.99	£69.99	£79.99
D - holds 50 albums	£45.99	£64.99	£75.99
E - holds 100 albums	£49.99	£69.99	£79.99
F - holds 100 CD's	£45.99	£59.99	£69.99
G - holds 200 CD's	£49.99	£69.99	£79.99
H - holds 100 cassettes	£45.99	£69.99	£79.99

All prices include Postage & Packaging in the UK. Overseas customers add £25 per case for delivery

Ring now and order by ACCESS/VISA 0803 855746

Standard cases are constructed from high density chipboard/Ply and finished with black vinyl cloth with protective aluminium trim, with lockable catches and lift-off hinges.

Please send cheque/PO made payable to TRAX, BODENA WORKSHOPS, HORSEPOOL ST., BRIXHAM, DEVON TQ5 9LD. Allow up to 21 days delivery.

# Francis of Streatham

Established 1913

Hi-Fi Video Specialists



Appointed Stockists for:-

Panasonic/Technics, Hi-Fi + Video, Dolby Prologic  
Come and listen to the new Technics SCCA1080  
Dolby Prologic mini system and the range of  
Technics separates

Large Stockists of Styli & Accessories

Own Service Department  
Part Exchange available

081 - 769 0466/0192

169 Streatham High Road, London SW16 6EG

# FI - RAX

ADJUSTABLE AUDIO FURNITURE

High quality  
Aluminium  
Construction  
Various Finishes  
available.



Adjustable  
Glass Shelves  
sitting on  
Isolating Rings.

Tel: 0924 277626

Any size or  
shape custom  
made on request.

FAX: 0924 270759

JEM DISTRIBUTION  
SPRINGFIELD MILLS SPA ST.,  
OSSETT, WAKEFIELD,  
WEST YORKS WF5 0HW

## PRIVATE

LINN SONDEK – Valhalla – Ekos – K18 – Ex Cond. new stylus. Plus Sound Organisation table. Can dem with your system. £925 ono call Steve on (0273) 679500.

NAIM NAP90 Power Amp brand new un-used with guarantee £285. Also Sound Organisation Z021 two tier equipment table £65. (0708) 470706.

LINN LP12 VALHALLA Akito £450 Linn Keilidh Speakers eight metres K400 £450 or will swap your newish Audiolab 8000A for either (021) 561 1889.

QUAD II/22 SET V.G.C. £350. FM1 Tuners, £20–£60. Multiplex Decoder £40. Troughline III's Mono, G.W.O. £80–£95. Lindley Troughline, Internal Decoder £250. Wanted. Single bronze TL12+. Swaps Possible. (0550) 4272.

LOOK!! Audiolab 8000All and Epos ESIs with Epos stands for sale. Superb sound quality. Still guaranteed. Condition as new. Demonstration welcome. £595 o.n.o. Call Adrian on Llandudno (0492) 879244 anytime!

ALBARRY M408 Mono-blocks, DMP1 active preamp, APS1 power supply £595. Concordant Quadll amps £275. Transcriptors Skeleton turntable, vestibule arm, A.T. cartridge, £135. Tannoy Cheviot speakers £265 (12" HPD). Telephone: (0604) 584630.

MISSION CYRUS II Amplifier, £125. Linn Kan Speakers with Kann II Stands, £175. Carefully and lovingly used. Telephone: (091) 273 6916 after 6pm and weekends.

LEAK TL150+ Amplifier with vari-slope three preamp, spare original output and mains transformers and spare set of valves. £275. No offers. Demo. (0386) 553942.

NAIM 82 preamp £1,300, Hi-Cap £425, 250 amp £1,000 Micromega CD3.1, Pro 2 Dac £2,000 5 months old. KEF 104/2 Ref Black £500. Or whole system for £5,000. (0235) 765986.

LINN SONDEK LP12 Turntable, Linn Ittok K9 arm & cartridge, Marantz CD52II SE CD Player, Audiolab 8000A amp, Monitor Audio R700 Gold Speakers and matching stands, 2 x 5 metres Monster bi-wire speaker cable. Complete system £850. Phone (0202) 570675.

LINN LP12, Ittok, new K18, Skyline Platform. All in perfect condition. £550. Beaconsfield (0494) 677628.

SME IV ARM £450, SOTA Sapphire plus SOTA clamp and custom power supply £500, RATA torlyte stand £50, Thorens TD150 in hardwood plinth plus Mayware arm £120, SME 3009 Series II arm £40. Tunbridge Wells (0892) 862302.

LINN ISOBARIKS, Rosewood, with stands and panels, immaculate condition, boxed, £950 (new £2,500). Telephone: (0204) 842367.

LINN KAN II Speakers. Bi-wired Walnut finish complete with Kan stands. Immaculate condition. All boxes. Also 13 metres of K400 bi-wired speaker cable. £485. Telephone: (0483) 37286. Surrey.

KEF B139 Elliptical/B110/T27/Coles 4001G Drive Units for sale, no data sheets, 1 pair of each, offers. Call Les (021) 777 5497, 6–9pm.

TESSERAC TALA, Line Level Pre-amp: silver wire, Alps Pots etc. (£1,500), £1,000 ono. Meridian 263 Dac, £300 ono. Both mint and less than 12 months old. Telephone Phil (0208) 75376.

RUARK TALISMANS Rosewood finish, modified, mint condition. £400 o.n.o. (0525) 382710.

NAIM CD1 3 months old, £1,400 Naim 72/140 £795, boxed including all appropriate leads. (0703) 738271.

NAIM NAIT2 £225. Rega RB300, Van den hul rewired £175, Goldring Eroica LX. £75. Lentek Step-up £25. Thorens TD150, re-plinthed, Valhalla P/supply. £75. Vvhafedale 505.2. £95. (0993) 811480 (Oxfordshire).

MICHELL ALECTO Monoblocks £1,150, Yamaha DSP-A2070 – £650, Panasonic NVFS88B SVHS – £550, Yamaha N5-C90 – £60, B+W Rock Solids – £150, Celestion 7000 Ribbon Speakers – £650. All mint condition. Phone Tobey (0244) 814666.

CONCORDANT EXCELSIOR Valve Amp £400, Exemplar Transistor Amp (class A) £400; Ear 834P Phono Amp (unused) £240 (with volume control). (0865) 63160.

LINN ISOBARIKS with stands and 2 x 8m NAC A4 cable. £650. (0728) 747 735.

QUAD 34/405 II both very light use, mint, boxed £375. Stax SR34 Pro, very little use, still under warranty £80. SME 1115 mint boxed, offers. Tel: 0296 826197

A & R A60 AMPLIFIER and MC60 moving coil board, good condition £50, Audio technica ATF5 moving coil cartndge, light use £15, Quart PMB 45II headphones, as new £15. Telephone: (0702) 711817.

TANNOY LANCASTERS 12" Golds Teak, exceptional condition £400 o.n.o. Can demonstrate. SME ARM 3009 S2 complete boxed £30. Telephone: (0453) 546191. Glos.

PIONEER PD-S901 CD Player with remote, £220 Mission 762 speakers with matching stands, £130. All as new, boxed. Glasgow (041) 248 2686, Pete. Wanted Teac P700.

ATTENTION WOMEN READERS. Female Hi-Fi enthusiast (25 years), keen on Pop and Classical music, wishes to meet like-minded FEMALE 18-35 years with a view to shanng all interests. Please phone Silvana on (0273) 206767. Evenings.

SONY PRO WALKMAN WMD6C Perfect £100. B & W DM2 MK2s Perfect matched units one corner of one cabinet chipped hence £75 pair. Cash only, buyer collects. Please phone (0273) 206 767. Evenings.

FOR SALE. Brand new boxed set of Bose 101 Monitor Speaker with 5 years warranty. Unwanted gift, bought 30.6.94. Only £165 for quick sale. Worth over £200. Terry (0753) 549642.

AVO VALVE tester type 160, recent service and calibration, supplied with hand book, valve data manual and calibration certificate £90. (0373) 463474.

LEAK STEREO Troughline £125 also Leak Venislope 2 pre-amp £40, both for £150, prefer buyer collects. M/CR area (061) 790 9059.

QUAD ELS Loudspeakers, Bronze, excellent £350. Sage Audio Supermos 2 250WPC Class A pre and power amplifier, better than A Krell? £400. Relive Hi Fi history, over 250 assorted Hi Fi Magazines 1972-1983, many more since! Offers: Glasgow (041) 776 3642.

P.T. ANNIVERSARY/SME IV/OC5, Deltac 50S pre+ power, Epos ES14, Rotel 965 BX CD, Hitachi FTMD5500 Akai GX6. Complete system with 2 x 50 tables + dedicated stands and cables. £4,500 o.n.o. (071) 277 6012.

SD ACOUSTICS 'OBS' Loud-speaker, truly seamless and transparent sound – Highly rated and reviewed – beautiful, deep walnut and black finish. Accept £330 o.n.o. (£860 list). Tel: 081 347 6077

QUAD 405, BOXED etc, mint, £150. Leak TL10/Point one, excellent, £150. Leak Stereo/20 Vari-slope, excellent, £200. Wharfedale Rosedale Speakers, produced early/mid '70's, beautiful cabinets, excellent, £200. Could securely pack and freight any of above if required. Wanted Sony EL – cassette player. (0886) 833655. Evenings.

QUAD ELS Black, overhauled, protection circuits fitted, excellent, boxed £400. Audio Innovations 5800 class A power amp. £325. Tel: 0883 349298 (Surrey)

LINN LP12 MOTOR UNIT (1993) £295. Kans & K2 stands £245. Std. motor unit £50. Sony SQ decoder £30. Sony TC399 £130. Pioneer RT707R £250. Sony CDP911E £160. Sony ES separates wanted. Tel: (0273) 846290.

STEREO DECODER MODULES, fully aligned with full info. Simple DIY project to convert your mono tuner. Limited supply, so order now. £12.50 inc. P&P. Tel: (0736) 798393.

RUARK ACCOLADE SPEAKERS, top of their range, floor standers, black veneered finish, crossover upgrade by Ruark, superb sound, vgc. Total new cost £2750, asking price £1600. Tel: (0474) 327286 (Kent).

KEF REF. 104aB Rosewood cabinets. Internally rewired. Excellent condition, collectable, 100w. Move forces sale. £350 ono. Tel: (0272) 559698 (Bristol) Buyer collects

ATC SCM20 SPEAKERS, rosewood, slightly marked, £750. Quad 66 pre-amp and remote control, one month, £750 ono. Technics SL110 D/D transcription turntable and SME 3009 series II imp. arm, £120 ono. Tel: (0892) 536919 (W. Kent).

GARRARD 301 with strobe platter, wooden plinth, connoisseur arm, very good condition. £180 ono. Garrard 401, wooden plinth, good condition, £120 ono. May consider exchange. Tel: (0382) 24681

## SITUATIONS WANTED

Ambitious, young branch manager in retail entertainment field looking for management job in Hi-Fi retail business anywhere in UK. Interest mainly in hi-end/valve equipment. Telephone Marc: Helliwell (0392) 422357.

QUALIFIED MANAGEMENT Accountant who loves Hi-Fi and music wants to contribute enthusiasm and financial management expertise to manufacturer or retailer within the industry. Greater London and South East. Jim (081) 889 2524.

HI-FI NUT SEEKS new opportunity. I would love to work in the Hi-Fi market. Can you find it in your heart to give this man a break? Telephone: Keith (061) 437 5819.

HI-FI ENTHUSIAST, 38, Ex D.J. and oil industry, seeks position in Hi-Fi industry on full / part-time or home consultancy basis (large lounge, great for home demos). Friendly, good communicator, open minded (i.e. valves / trannies / C.D. / L.P. can "all" sound good / bad!), vanced musical interests, Brighton based. Telephone: Chris (0273) 541462 (24 hour A/V).

MAKE ME HAPPY – give a job. Budding designer, completes 3D design degree at Sheffield Hallam, June 1995. Interested in Audio/ Visual industry. Hard worker, sense of humour. Home (0873) 811619. College (0742) 509337. Adam Norbury.

# Eyee

## ENTERTAINMENT UK LTD

**BUY AT A PRICE NOBODY CAN BEAT !!**

AVERAGE SAVINGS OF AT LEAST 25%

### CD'S TAPES VINYL AND IMPORTS

ALL AT TRADE PRICE - ABSOLUTELY NO MARK UP!!!

- \*No minimum purchase amount
- \*No club recommendations to buy
- \*No minimum membership period
- \*No restrictions on material

CHECK THESE PRICES FOR A REAL DEAL

ALL FULL PRICE CD'S ONLY £8.99 - TAPES & VINYL ONLY £6.49

WE SUPPLY EVERYTHING  
FREE SEARCH FACILITY INCLUDING TRACK LISTINGS AND PRICE

Membership is only £7.95 a year, which most people recover with their first order

Don't delay, JOIN NOW and save.

Freephone 0500 78 45 33 9.00am to 8.00 pm

**FREE CD OR TAPE WHEN YOU JOIN**

# CDs at Trade Prices!

## CD EXPRESS

Would you like to buy your CDs at the same price as the shops pay? Before they add their BIG profit margins?

Well now you can!

CD EXPRESS MUSIC CLUB is run by Musicians who care about the price of CDs. And our members buy ALL their CDs at TRADE PRICE!! This means full-price CDs for as little as £8.60, and budget titles for as little as £1.80 including VAT!

This is a genuine offer, with NO hidden catches. Our prices cannot be beaten!

**together we can cut the cost of music!!**

ring now for your **0532 351865** free info pack

**every UK release at trade price**

## Art Audio MAESTRO

"They are just so stunningly gorgeous and open to listen to, I can barely imagine anything more alluring"

NK Hi-Fi World, June '91

Valve amplifiers from £750 to £4150 Cables from £27 to £1700

Select Audio  
Glasgow (041) 226 4268

Audio Venture  
Banbury, Oxon (0295) 261863

K.A.I. (UK) Ltd  
Folkestone (0303) 245005

Doncaster Hi-Fi Studios  
Sunnyfields (0302) 781387

The Hi-Fi Consultants  
London (071) 380 0866  
Evenings (071) 482 0003

The Hi-Fi Consultants  
Nottingham (0602) 232450

Poul Green Hi-Fi  
Bath, Avon (0225) 316197

Audible Difference  
Diss, Norfolk (0850) 983233 or (0379) 740227

Impulse Audio Consultants  
Westcliff-on-sea, Essex (0831) 616426 or 0374 277736

Hazelmere Audio  
High Wycombe, Bucks (0494) 437892

Sound Academy  
Bloxwich, West Midlands (0922) 473499

New A4 brochure containing full details of our amplifier

and silver cable range contact  
**Art Audio (UK) Ltd., 130 Main Street, Calverton,  
Nottingham, NG14 6LU  
England UK  
Tel. 0602 - 653604  
Fax 0602 - 637795**

# LORICRAFT AUDIO

Turntable Repair and Record Cleaning Service

Sale and Repair of Classic Hi-Fi Specialising in Garrard and Thorens

Manufacturers of high quality plinth systems. Review (copy available)

Electronic low distortion power supply and active power supply for Garrard 301/401 Thorens TD124

Re-manufactured spindle bearing and correct lubrication kit. Specially designed for this type of bearing

Loricraft specialist services start at £5.00 for platter damper rings

**New Catalogue now available**

**Big Game**  
Lambourn, Berks. RG16  
&XQ. Tel. 0488 72267

**See us with Art Audio at Chesterfield**

## IAN HARRISON HIFI

7 MILL HILL REPTON, DERBY, DE65 6GG. \*MAIL ORDER ONLY  
Tel: 0283 702875 9am-9pm FOR LATEST PRICES

THE AMOUNTS SHOWN IN BRACKETS ARE WHAT YOU CAN SAVE (COMPARED WITH THE NORMAL SELLING PRICE. PLEASE PHONE OR WRITE FOR EXACT PRICES. THE EXACT PRICE WILL DEPEND ON HOW MANY WHAT TYPE OF CARTRIDGES YOU WISH TO TRADE IN. MOVING MAGNETS CANNOT BE TRADED IN)

CASSETTE DECKS		HEADPHONES	TUNER
NAKAMICHI DRAGON	SENNHEISER	QUAD: SONY	
NAKAMICHI CR7E	BEYER	MARANTZ	
NAKAMICHI DR1	AUDIO TECHNICA	PHILIPS	
NAKAMICHI DR2	KOSS	BLANK TAPES	
NAKAMICHI DR3	ROSS	YOK. MAXELL	
AIWA XKS8000	SDNY	SONY. BASF	
AIWA XKS7000	AKG	AMPEX. JVC.	
TEAC V8000S	SCOTCH		
TEAC V7010	HIFI FURNITURE		
TEAC R9000S	APOLLO. SOUND		
SONY TCX611S	ORGANISATION.		
GOLDRING			DAC PACK £169
DIGIT			DIGIT £109
DIGIFLEX £16			POSITION £69
OPT DIGIT £24			OPTIFLEX £30
DIGIT REF £250			ROOMLINK £POA
ACCESSORIES/EPQA			
GOLDRING, DEO			
CABLES			TEST TAPES/CD
AUDIOQUEST,			MARANTZ, PHILIPS
SONIC LINK,			QUAD, SONY,
GOLDRING, DEO			DENON
HARRISON MULTI			
PURPOSE TEST			
CASSETTE			
SPEAKERS			DENON AUDIO
QUAD, SPENDOR,			TECHNICAL TEST
WHARFE			CD
EROICA			£12.99

Part 1

## Gold Aero

"The Cream of the Crop"

Gold Aero USA was founded in 1973 by an audiophile, for audiophiles. The founding principle of the company was to provide the high end audio consumer with the highest quality vacuum tubes. This tradition continues into the nineties.

Our years of experience testing and listening to a variety of tubes has revealed that only a very small portion of tubes commercially available are suitable for the demanding audiophile. We are able to purchase large volumes of tubes from premium sources worldwide for our selection of the "Cream of the Crop". The remaining tubes which are unacceptable for Gold Aero are then assimilated into the industrial market.

For Further Details Contact; Tube Technology, Foxhills Farm, Ottershaw, Surrey, KT16 ODN, Tel: 0932 873444





## ORDER FORM

**SPECIAL OFFER!** Now you can advertise in the Classified Section for only £10 or £15 in a display black box (incl. VAT). Maximum length is thirty words, each additional word 50p extra. Telephone and model numbers are treated as one word. All advertisement copy should be typed or written in block capitals and accompanied by the form on this page.

### SPECIAL OFFER!

**BOOK 1 MONTH GET 1 MONTH FREE  
OFFER APPLIES TO PRIVATE ADVERTISERS ONLY.**

Cheques should be made payable to Audio Publishing Ltd. Please send your copy to: Hi-Fi World Classified Ads., Audio Publishing Ltd., 64 Castellain Road, London W9 1EX. Classifieds will be published in the first available issue after receipt.

### HI-FI WORLD CLASSIFIED ADS

Please write your advertisement copy on a separate sheet of paper and return with this completed form.

Name

Address

Post Code

Daytime Tel No:

Private Advertiser     Trader     Situations Wanted (Tick where applicable)  
 Display (boxed £15 inc. VAT.)

I enclose cheque/postal order for £  Made payable to **Audio Publishing Ltd.**

Please debit my VISA/ACCESS Card No.

<input type="text"/>	<input type="text"/>	<input type="text"/>	<input type="text"/>	<input type="text"/>	<input type="text"/>	<input type="text"/>	<input type="text"/>	<input type="text"/>	<input type="text"/>	<input type="text"/>	<input type="text"/>	<input type="text"/>	<input type="text"/>	<input type="text"/>	<input type="text"/>	<input type="text"/>	<input type="text"/>	<input type="text"/>	<input type="text"/>
----------------------	----------------------	----------------------	----------------------	----------------------	----------------------	----------------------	----------------------	----------------------	----------------------	----------------------	----------------------	----------------------	----------------------	----------------------	----------------------	----------------------	----------------------	----------------------	----------------------

Expiry Date:

Send to: **Hi-Fi World Classified Ads.,**  
Audio Publishing Ltd., 64 Castellain Road, London W9 1EX.



### UNIQUE OFFER!

Looking for a job in the hi-fi/audio market? Hi-Fi World can help you. Advertise yourself free for one month in these pages under the heading **SITUATIONS WANTED**. Maximum length 30 words.

### TRADE

### TRADE

### TRADE

### TRADE

QUAD valve system including Quad II power amps, 22 control unit, AM & FM Tuners, all in good condition. £400. Leak stereo 60, £350. Leak stereo 20, £200. Rogers Cadet Mk3, £85. Scott 200B, amplifier £175. All fully serviced. Garrard 401 + SME 3012 in SME plinth, £200. AVO VCM 160 Valve tester, £130. Siltech 4-56 pure silver interconnect £100/stereo metre. Telephone (0895) 833099.

#### PAY TOP PRICES FOR:

1. Old Valves: STC4300A, STC4274A, STC4242A, any PX4, PX25 or equivalent. DA30, DA60, DA100, DA250, Mullard's EL34, EL37, AC044, EL33, GEC KT66, KT77, KT88, A2900, Mazda P650, PPS-400, PP3-250, P625, PX650, CV25, CV1040, CV1168, CV1178, CV1679, CV444.  
2. VINTAGE AUDIO: Lowther, Tannoy, Garrard 301, Westrex, RCA, Quad, Leak, SME, EMT, ALTEC, JBL, Goodmans Axiom 80. Telephone: (0227) 742566, Fax: (0227) 742270.

EAR 834 INTEGRATED Ex Dem as new £950, 834P £200. Scott valve integrated £175, Musical Fidelity MVT Preamp £325, Mallory 40 MF x 40MF capacitors £15, Leak Stereo 20 £175, part exchange welcome. Wanted, top quality turntable. Tannoy DC 3000 loudspeakers. (021) 784 8765.

WANTED Tannoy Autograph, Decca-Decola, Vitavox Drivers, Garrard 301 (V.G.D.) Westrex Drivers 2080, 2090, Lowther PM-2, PM-3, PM-4, single TP-1, valves PX4/PP3-250, STC 4300, DA 30/60 STC 4274 ED/AD-1 EMT 927/R-80. Telephone: (0444) 881184 before 8.00 pm.

RESTORATION OF CLASSIC EQUIPMENT by electronics engineer, suitably qualified (degree/MAEs) and 40years of experience. Quad service agent and specialist knowledge of Radford, Leak, Rogers, Armstrong, etc. Extensive workshop enables original design standards, accompanied by detailed reports. 7 days. Woodford, Essex. Tel: 081-504 5467.

NAIM CDS £2,895, Naim CDI £1,675, Naim NAC82 £1,750; all new, surplus stock: DNM Senes 3B Six £2,995, Mendian 508 £1,145, Roksan LI £1,395, SI £995, M1s £1,995, Peter Sanhen SP 1.5 £995, Roksan Ojan 3 £675 Acoustic Energy AE 1s £595, Roksan Danus £1,200, Dynaudio Contour 1.3s £850, Tascam 34B 4-track £795, all ex-demo / s-hand, others available. The Comflake Shop (071) 631 0472.

ROGERS LS7/STANDS £239. LS4A £140. LS8a £279. Ruark Sabres £149. Proac Super Towers £699. Naim IBL £499. Heybrook Sextets Ex Dem £899. Quartets Ex Dem £479. MS Classic 40 £359. Gale GS301 MK II £175. Hi Fi purchased for cash. Objective Audio (0279) 426647 or (0850) 484464 or Fax: (0279) 860460.

TRIANGLE CALISTOS Ex Dem £1,350. Musical Fidelity Pre 3 + 2MA65 Blocks new £1,050. Pink Triangle LPT Rega RB300, Ortofon Quattro Cart Ex Dem £799. Systemdek 900 separate PSU. Acrylic Platter RB300, Conus Blue £295. Heybrook TT2 RB300, Goldring 1022 mint £295. Quad ESL's 63 £1,200. Two Audionote PISE Power Amps Ex Dem £725 each. Telephone: RJF Audio (0209) 612260.

FARADAY CONCRETE cabinet loudspeakers. Now you can build your own low density, concrete enclosure L/S as made by Faraday Sound, eg acclaimed SSI. See our main ad in Meet Your Maker section page 84

AUDIO INNOVATIONS 500 boxed £595 800MKII £450 800MKI £395 valve amps from £150 why build? Arun valve preamps line £245 Phono £295, Leak tuners also Quad. Station Sound's (0903) 239980 / 501158.

**ABSOLUTELY VINYL** For our latest free catalogue of used Rock/Jazz/Classical Vinyl LPs send 19p SAE to: P.O. Box 55, Reading, RG4 0UE.

KEF REFERENCE 102.2 £399. Proac Super Towers £699. Musical Fidelity 3A preamp/PI80 power amplifier (1200) £549. Rega Elex amplifier £225. Cyrus one amp £139. Micromega Leader £395. Mendian 200T Transport / Roksan DA1-4 DAC £749. Others available. Objective Audio. (0279) 426647 or Fax (0279) 860460. Hi Fi purchased for cash.

QUAD II valve amplifiers renovations with silver wire, gold plated speaker terminals and phono input, vishay resistors and quality capacitors, new valves. Phone for information sheet. Mid-Sussex Hi-Fi (0414) 459196.

INNOVATIONS ALTO INTEGRATED £200, LI Preamp £200, Edison Valve Power amp £200, Musical Fidelity Preamp MVT £200, Audio Research 60W Valve Power amp £695, Daystrom Valve monoblocks £150, Avantic Integrated £50, Armstrong £50, V.D.H. RB300 £70, Ariston Q deck £40, Voyd/Helius/Ortofon £1,550, Systemdek II x 900A/P £150. Speakers: floorstanding Kammerzeit (92 dB) £400, Castle Trent £90, Tnangle comete (92 dB) £250, Titus £100, Baby monitors £50, Hyugen Stands 150 LBS £150. Wanted Leak Stereo 60, TL25/50+/50+ O/P transformers, all valve hi-fi from past or present, also Camcorder! Telephone: (021) 722 2317.

### WANTED

SLATE AUDIO are looking for Garrard 301s and 401s. Fair prices paid for fair examples, better prices paid for fine examples. We can arrange collection if necessary. Telephone Peter Soper on 0525 384 174

# Advertisers Index

## MAIN ISSUE

ACOUSTIC ARTS	54
ACOUSTIC SOLUTIONS LTD	22
AMADEUS S & V	40
ARCAM	46
ARION ACOUSTICS	103
ART AUDIO	128
AUDIBLE DIFFERENCE	114
AUDIO GALLERY	113
AUDIO PHYSICS	114
AUDIO SUITE	124
AUDIOCRAFT	113
AUDIOLAB	52
BETTER HI-FI	96
BRENTWOOD MUSIC CENTRE	20
BURY AUDIO	72, 113
CUSTOM CABLES	56
C.A.D.	27
CABLE TALK	122
CAMBRIDGE HI-FI	120
CD EXPRESS	128
CHOICE HI-FI	113
CHORD ELECTRONICS	54
CLASSIC HI-FI	114
COTTAGE AUDIO	118
DAN DULEY	122
DAVID ORTON AUDIO VISUAL	106
DEFINITIVE AUDIO	116
DHM DESIGN	124
DIVA	28
D.P.A.	IFC, 3
DYMANICS	104
E.J. JORDAN	94
ESOTERIC AUDIO IMPORTS	114
EZEE ENTERTAINMENT	128
F & S TRADING	40
FRANCIS AUDIO	126
FRANK HARVEY HI-FI	107
FULLERS AUDIO	70
GLOTTA AB	94
H & R CLOAKE	20
HALE HIFI	122
HAMPSHIRE	76
HEATHERDALE AUDIO	118
HI-FI CONFIDENTIAL	106
HI-FI SHOWROOM	62
IAN EDWARDS	70
IAN HARRISON HI-FI	128
J.E. SUGDEN	IBC
JAMO	26, 27
JEM DISTRIBUTION	126
K.A.L.	18
KESWICK AUDIO	20
KIMBERLEY HI-FI	122
KINSHAW ELECTRONICS	54
KLIPSCH	56
KRONOS	03
L.F.D. AUDIO	122
LEONARD BOOTH	112
THE LISTENING ROOMS	62
LORICRAFT	128
MANTRA AUDIO	114
MICHELL ENGINEERING	44
M.J.S	124
NAD	10
NORTHWOOD AUDIO	72
ONKYO	BC
ORANGES & LEMONS	20
ORPHEUS	116
ORTOFON	16, 18
OVERTURE	120
OXFORD AUDIO CONSULTANTS	112
PHILIPS	12, 13
PLATFORM 7	76
PREMIER MARBLE	76
RARE RECORDS	120
RDL ACOUSTICS	116
RECITAL	62
REFERENCE IMPORTS	96
RINGMAT DEVELOPMENTS	104
ROOM ACOUSTIC SERVICES	112
SCARBOROUGH HI FI	105
SEVENOAKS	108, 109
SHEARNE AUDIO	22
SLATE AUDIO	126
SONIC FRONTIERS	44
SOUND ACADEMY	42
SOUND GALLERY	30
SOUND ILLUSION	42
SPALDINGS	107
SPEAKER CO.	105
SPECTRA DYNAMICS	36
STEVE BOXSHALL AUDIO	27

STUDIO ONE	16
SUSSEX SURPLUS	118
TECHNICAL & GENERAL	96
TABULA RASA	88
TESSERAC	62
THE AUDIO ROOM	40
THE RECORD SHOP	88
TOCA	70
TRAXS	126
TRIANGLE	94
TRY ME & SEE	02
TUBE TECHNOLOGY	56, 128
UKD CALLAS	76
V'AUDIO	72
WESTWOOD & MASON	20
WILMSLOW AUDIO	88
WOLLATON AUDIO	72
ZEN AUDIO	124

## SUPPLEMENT

BADGER BOARDS	12
BANDOR	4
BILLINGTON EXPORT	IFC
CHELMER VALVE CO.	16
CRICKLEWOOD ELECTRONICS	12
ELECTROMAIL	OBC
EUROSONICS	4
G.T. AUDIO	IFC
GLASS AUDIO	24
HALCYON	4
HART ELECTRONICS	20
I.P.L. ACOUSTICS	14
KIT SUPPLIERS	26
LANGREX SUPPLIES	14
LOCKWOOD	24
P.M. COMPONENTS	17
SEAS	IFC
SERIOUS KITS	IBC
SJS	24
SONIC FRONTIERS	12
SONIC LINK	24
SOWTER	12, 24
VINTAGE VALVES	IFC
WILMSLOW	12
WOLLATON	4



# SUGDEN

HAND CRAFTED ■ FAIT À LA MAIN

DESIGNERS & MANUFACTURERS OF HI-FI & AUDIO EQUIPMENT

J. E. SUGDEN & CO. LTD.

Valley Works,

Station Lane, Heckmondwike,

West Yorkshire WF16 0NF

Tel. Heckmondwike 0924 404088/9

Fax No. 0924 410069

World Radio History

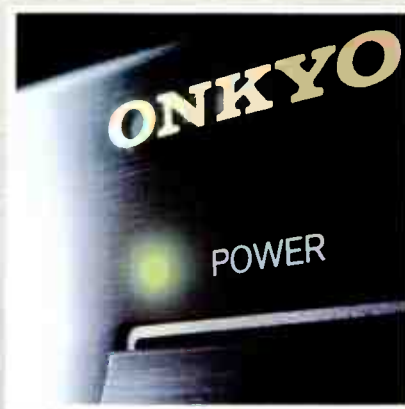

A RANGE OF HI-FI SEPARATES, MINI-AUDIO COMPONENTS AND HOME-THEATRE SYSTEMS  
COMBINING PURE, NATURAL REPRODUCTION WITH LEADING-EDGE TECHNOLOGY AND A BUILD QUALITY OF SUCH  
RELIABILITY THAT EVERY PRODUCT CARRIES A NO QUIBBLE 3 YEAR PARTS AND LABOUR GUARANTEE.

ONLY AVAILABLE THROUGH SPECIALIST INDEPENDENT DEALERS.

**ONKYO**  
**3** YEAR  
PARTS &  
LABOUR  
WARRANTY

**ONKYO**<sup>®</sup>  
**HIGH FIDELITY**

