

Only
£2.00 *Plus*

Hi-Fi WORLD

MAY 1994 £2.00

**AIWA'S DUAL-
CAPSTAN AD-F810
£200 BARGAIN**

**THE MIGHTY
TONE SCOUT**

**NEW HORN LOUDSPEAKER
FROM LIVING VOICE**

**SIX AFFORDABLE
CD CONVERTORS**

**NEW HEYBROOK
INTEGRA
AMPLIFIER**

**ORTOFON'S ANNIVERSARY
MC7500 CARTRIDGE**

**COMPETITION TUBE TECHNOLOGY VALVE-AMP
AND CASTLE HOWARD LOUDSPEAKERS**

SCOOP!

SCOOP!



The truth,
the whole truth,
and nothing but the truth . . .



. . . so help me DPA!

It is a truth universally acknowledged, that clarity of sound allows true involvement with music.

Recognised Hi-Fi critics throughout the world have consistently praised DPA's products for their unrivalled clarity and transparency of sound reproduction. This inevitably leads to more profound musical experiences.

After years of development, the 200S pre and power amplifiers have been perfected. The amplifiers share the technology that has so inspired reviewer's praise in the past. The 200S combination at £1,250 gives state of the art performance at a reasonable price.

If you crave musical truth, contact DPA so we can help.

dpa

DPA Digital Ltd., Unit 7, Willowbrook Tech. Units, Crickhowell Rd., St. Mellons, Cardiff CF3 0E1 Tel (0222) 795621 Fax (0222) 794267



EXPERIENCE MUSICAL TRUTH



45 High Street, Hounslow, Middx.
TW3 1RH
Tel: 081 569 5802
(Also at Edgware, Middx,
Tel. 081 952 5535)



93 Hobs Moat Road,
Solihull,
W. Midlands
Tel: 021 742 0254

NEW 200S PRE POWER £1250

audible difference
Scole, Diss, Norfolk.
IP21 4DX.
Tel : 0379 740227

Doug Brady Hi-Fi
Kingsway Studios,
Kingsway North,
Warrington.
Tel: 0925 828009
(Also at Liverpool, London
and Oiley, Nr Leeds)



Tel/Fax: 0252 377952



Royal London Buildings,
Wulfruna Street,
Wolverhampton.
WV1 1LY.
Tel/Fax: 0902 771774



Chantry Walk,
16/18A Eldon Street,
Tuxford, Nr Newark,
Notts NG22 OLH.
Tel: 0777 870372

Audio Suite
42 St. Andrews Street,
Aberdeen AB1 1JA.
Tel: 0224 625 635



152A High Street,
Bloxwich,
West Midlands.
Tel: 0922 493499



3 Bridge Street,
Guildford,
Surrey.
Tel: 0483 504801



St. Michael's Street,
Shrewsbury,
Shropshire SY1 2ES.
Tel: 0743 232317



41 Victoria Road,
Cambridge.
CB4 3BW.
Tel: 0223 68305



2/4 Great Victoria Street,
Belfast BT2 7BA.
Northern Ireland.
Tel: 0232 332522



KJ WEST ONE
26 New Cavendish
Street,
London W1M 7LH.
Tel: 071 486 8262

AT OUR KEY DEALERS

dpa digital ltd

Unit 7, Willowbrook Technical Units,
Crickhowell Road, St. Mellons, Cardiff CF3 0EF, Wales, UK
Phone: 0222 795621 Fax: 0222 794267

AMPLIFIERS

HEYBROOK INTEGRA 24
Can Heybrook produce an integrated amplifier worthy of their excellent loudspeakers? Eric Braithwaite has an exclusive listen.



ROTEL RA-960 BX2 58
Has a bit of tweaking put this amplifier in pole position? Dominic Todd takes it for a spin.

COMPACT DISC

MERIDIAN SYSTEM 19
It looks stunning, but how does it perform? Robert Wilson finds out if there's more to Meridian than just a pretty face.



BUDGET DACS 27
With CD now firmly entrenched in the market place we look at some interesting ways to get more music from your silver discs.

DPA Little Bit II
Select Systems Dacula
QED Digit Reference
EMF Crystal
Audio Alchemy DAC-in-the-box
Arcam Black Box 50

TEAC VRDS-7 66
Robert Wilson gets to grips with the new entry level model in Teac's heavyweight range.

LOUDSPEAKERS

LIVING VOICE TONE SCOUT 14
A massively engineered horn loudspeaker we just had to hear. Dominic Baker visits Definitive Audio and enjoys some time listening to the new Tone Scouts from Living Voice.

INFINITY KAPPA 6.1i 36
Dominic Baker spends some time with this high-tech Californian.

THREE AFFORDABLE FLOORSTANDERS

SYSTEMDEK 937 51
Having made pleasant sounds with their small monitor, can the turntable manufacturers go one better.

CASTLE CHESTER 52
Those nice gentlemen at Castle have sent us a slightly smaller speaker this month. That nice Mr Baker has had a listen.



KEF Q50 53
From KEF's new range, a floorstander using their unique Uni-Q point source drive units.

TURNTABLES

ORTOFON MC7500 34
Does the final word in analogue technology from Ortofon make Eric Braithwaite swoon?

TUNERS

ONKYO T-401 68
Onkyo are back on the scene. We take a first look at their budget T-401 tuner.

CASSETTE

AIWA AD-F810 42
Noel Keywood and Robert Wilson re-examine this cassette bargain, before it disappears.



Editor
Noel Keywood

Assistant Editor
Dominic Baker

Editorial Assistant
Robert Wilson

Production Editor
Ferewini T. Michael

General Manager
Mark Winfield

Marketing Manager
Richard Johnson

Advertising Director
Caroline Knott
Advertising Tel: 071-266 0969

Design Engineer
Andy Grove

Technical Assistant
Nick Lucas

Contributors
Eric Braithwaite
Richard Brice
Giovanni Dadomo
Peter Herring
Simon Hopkins
Dominic Todd

Cartoonist
Freddy Ahmet

Distributed by:
COMAG, Tavistock Road, West
Drayton, Middlesex, UB7 7QE
Tel: 0895 444055

Origination by:
Ashford Scanning
2 Norfolk Drive,
Fairwood Industrial Park,
Asford, Kent TN23 2FB
Tel: 0233 622042

Printed by:
Southernprint, Poole, Dorset.
Tel: 0202 622226

AUDIO PUBLISHING LTD.
64 Cassellin Road, Malva Vale,
London W9 1EK
Tel: 071-289 3533
Fax: 071-289 5620
Queries cannot be answered
by telephone.

MAIL ORDER
Tel: 071-266 0461 (24 hours)

Subscription Rates:
UK: £22
Overseas Surface: £29, Air-mail
£42 (Europe & Middle East),
£62 (Australia, Japan & China).

No material may be reproduced
from this magazine without
the publisher's written
permission.
© Audio Publishing Ltd



**AMERICAN
and
CANADIAN
SUBSCRIPTIONS**
- see page 60

REGULARS

NEWS 7, 9, 11, 69

All of the latest equipment and information from the trade.

LETTERS 44, 45, 47, 49, 54, 55

A broad selection from this month's massive postbag.

COLUMNS 39, 61, 63, 71

Varied comments about all things hi-fi by the World staff and contributions.

NEXT ISSUE 57

Here comes the sun. What delights await in our June issue?

SUBSCRIPTIONS 60

Avoid the hassle of visiting the newsagents, get your copy of Hi-Fi World fast.

ACCESSORIES 97

For all your tweaking requirements, products that work!

MEET YOUR MAKER 65

Listings of manufacturers details



DIAL-A-DEALER 89

Hi-Fi bliss may only be a 'phone call away.

WORLD AUDIO DESIGN 81

Wonderful products with lots of glowing glasswear.

WORLD FAVOURITES 128

Our guide to all that's best in hi-fi.

QUERIES 103

Another batch of problems solved by your favourite hi-fi gurus.

CLASSIFIEDS 141

Second hand bargains a plenty.

ADVERTISERS INDEX 146

FEATURES

BRISTOL SHOW 41

All the gossip from the trade's annual three days in the West Country.



MUSIC

Our guide to some of the best new releases.

ROCK RECORD OF THE MONTH:

Primal Scream : Give Out But Don't Give Up

CLASSICAL RECORD OF THE MONTH:

Georg Philipp Telemann : Complete Double Concertos With Recorder

ROCK AND POP 74

CLASSICAL 85

JAZZ 93

COMPETITION

COMPETITION 72

Always fancied some large loudspeakers with lots of bass? Why not try your luck in this month's competition? We've got a pair of Castle Howards and a Tube Technology Unisys integrated valve amplifier to drive them awaiting a lucky winner.



CONTENTS

SCALING NEW HEIGHTS.

There's a new tower on the block – the Studio 200.

And it's going to make you think again about how much loudspeaker you should get for your money.

Innovative cabinet construction, critical driver offset placement and state-of-the-art componentry combine to bring you a new sophistication in high-end listening experience.

The Studio 200 can now be auditioned at selected dealers. Contact us for details.

 **ProAc**
Perfectly Natural

130-132 THIRSK ROAD
BOREHAMWOOD
HERTS WD6 5BA
TEL: 081-207-1150
FAX: 081-953-8933

NAIM THAT TUNE

With the intention of making their highly desirable products available to a wider audience, Naim have introduced a new entry level CD player. This will sell alongside the recent Nait amplifier and NAT 03 tuner.

The £899 NA CD3 is presented in Naim's new slimline style and features a very novel, possibly unique, drawer mechanism which rotates through 90 degrees to permit disc changing.

Although the case is slim, Naim have still managed to find room for eleven regulated power supplies coupled to a large toroidal transformer. As with other Naim CD players, careful consideration has been given to the effects of vibration and microphony by isolating the transport section.

NAIM AUDIO
Southampton Road,
Salisbury,
Wilts, SP1 2LN.
Tel: 0722 332266.



VALVES GET A GRAMMY

Valves are slowly infiltrating the professional recording business. America's prestigious Grammy awards, presented in recognition of musical achievement by the National Academy of Recording Arts and Sciences, were announced in a gala ceremony at Radio City Hall, New York, on 1st March 1994. In the category Best World Music Album, the winner was Ry Cooder and V.M. Bhatt's 'A Meeting by the River' album.

In their acceptance speech Walter Lily Acoustics acknowledged the contribution made by the fine engineering that lies behind this album, for its support of the skills and efforts of the musicians. The microphone, preamplifier and 15ips tape recorder were all valve powered analogue units, designed by valve designer extraordinaire, Tim de Paravicini of EAR, Huntingdon, England. Tim was in the audience to view the ceremony, even though tickets for everyone, apart from the award winners themselves, cost a mere £300!

Few engineers in the world (if any) know how to re-engineer a 1960's Studer C37 open-reel professional studio recorder in the way Tim does it. His revitalised Studers come fitted with improved valve amplifiers, uprated tape guidance mechanics and new glass crystal ferrite heads (made in America) to Tim's specifications.

The Grammy award focuses attention on the fact that top professional musicians are nowadays recognising the superb sound available from modern valve recording equipment. Others to follow Ry Cooder and V.M. Bhatt are Inspiral Carpets and Erasure, with their latest singles; both used one of Tim's Studer C37s in the recording process.

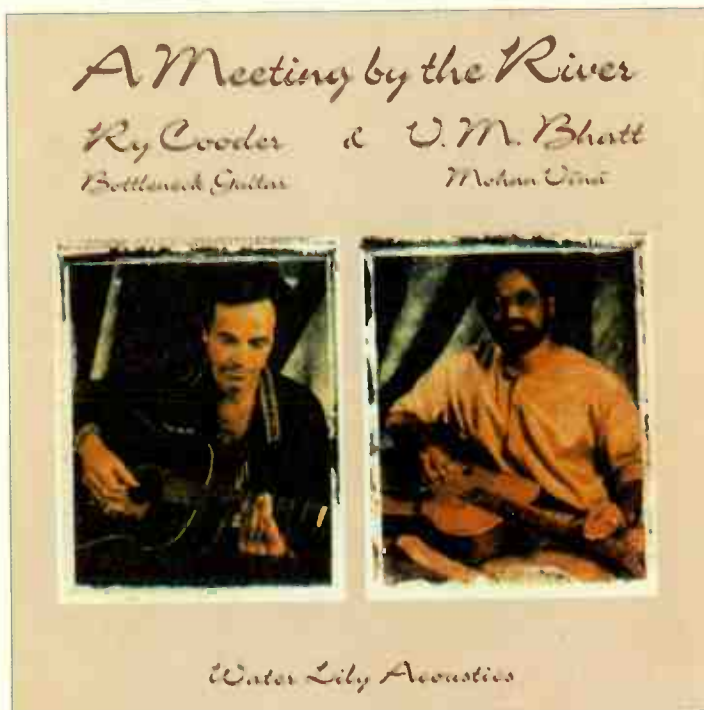



NOT JUST ANOTHER
DESIGNER LABEL



It had to happen...with such a pedigree in the natural reproduction of music,
it was only a matter of time before Naim took control of the actual music playing on Naim systems.
Inspiring the launch of the Naim record label. With Compact discs of outstanding quality,
mastered from the original tapes using a CD recorder specially modified by Naim engineers
- preserving the very essence of the music and its performance.



Naim makes music makes sense  naim audio

Naim Audio, Southampton Road, Salisbury SP1 2LN, England. Tel: (0722) 332266

- LONDON**
Billy Vee Sound Systems
 245 Lee High Rd. Letchworth, Essex. Tel: 081 316 5100
Doug Brady Hi-Fi
 18 Blenheim St. Coventry. WC2 Tel: 071 376 4010
The Cornflake Shop
 37 Windmill St. W1 Tel: 071 631 0472
Grahams Hi-Fi
 Cannonbury Yard 190a New North Rd. N1 Tel: 071 226 5500
Son et Lumiere
 67 Tottenham Court Rd. W1 Tel: 071 580 9059
The Sound Organisation London
 4 Popford Wharf, Climb St. SE1 Tel: 071 403 2255
Studio 98
 79-81 Fairfax Road. NW6 Tel: 071 624 8855
Uxbridge Audio
 109 Chiswick High Rd. W4 Tel: 061 742 3444
- NEAR LONDON**
Infidelity Hi-Fi
 9 High St. Hampton Wick. Kingston-upon-Thames. Surrey
 Tel: 081 943 3530
Radford Hi-Fi
 43 King Edward Court. Winkley. Rees. Tel: 0780 806801
The Sound Gallery
 65 Castle St. High Wycombe. Bucks. Tel: 0494 531662
Spaldings
 352-354 Lower Addiscombe Rd. Croydon, Surrey
 Tel: 081 654 1231
Studio 82
 82 High St. Harpenden. Hertfordshire. Tel: 0562 764246
Uxbridge Audio
 278 High St. Uxbridge. Middlesex. Tel: 0995 230424
- SOUTH**
Audio Designs
 26 High St. East Grinstead. W Sussex. Tel: 0342 314569
Audio T
 Four Feathers Lane. Basingstoke. Hampshire. Tel: 0256 24311
Chichester Hi-Fidelity
 7 St Pauls Church. Chichester. Sussex. Tel: 0743 776407
Jefferies Hi-Fi
 69 London Road. Brighton. E Sussex. Tel: 0273 609431
Jefferies Hi-Fi
 4 Albert Parade. Green St. Edgbourne. E Sussex
 Tel: 0223 31336
Jefferies Hi-Fi
 29 London Road. Portsmouth. Hampshire. Tel: 0705 663604
Mike Manning Audio
 128 Poole Road. Westbourne. Bournemouth. Dorset.
 Tel: 0202 751522
Soundzart
 40 High Street. Aylesford. Kent. Tel: 0233 824441
Sound FX
 207 Solent Business Centre. Milbrook Road West. Southampton.
 Tel: 0703 511030
Worthing Audio
 20 Telling Gate Precinct. Worthing. W Sussex. Tel: 0903 212100
- EAST**
The Audio File
 87 Nicolson St. Bishops Cleeve. Herts. Tel: 0279 508576
Basically Sound
 The Old School. School Rd. Bilcon Ash. Nr Norwich. Norfolk.
 Tel: 0508 70849
Pro-Musica
 6 Vineyard St. Colchester. Essex. Tel: 0206 577519
Rayleigh Hi-Fi
 216 Moulsham St. Chelmsford. Essex. Tel: 0245 265245
Rayleigh Hi-Fi
 119 41 London Rd. Southend-on-Sea. Essex. Tel: 0706 433258
Rayleigh Hi-Fi
 44A High St. Rayleigh. Essex. Tel: 0206 110182
- WEST**
Audio Excellence
 58 Bristol Rd. Gloucester. Tel: 0452 300046
Audio Excellence
 69 Park St. Bristol. Avon. Tel: 0272 264975
Audio T
 60 Fillet Street. Swindon. Wiltshire. Tel: 0793 538222
Mike Manning Audio
 110 Middle Street. Yeovil. Somerset. Tel: 0335 79381
Radford Hi-Fi
 6 Fore St. St Marychurch. Torquay. Devon. Tel: 0803 326723
Radford Hi-Fi
 78 Chesser St. St Thomas. Exeter. Devon. Tel: 0352 216925
Radford Hi-Fi
 12 James Street West. Bath. Avon. Tel: 0225 446 6245
Radford Hi-Fi
 101 Cornwall St. Plymouth. Devon. Tel: 0752 226011
Radford Hi-Fi
 52-54 Gloucester Road. Bristol. Avon. Tel: 0272 426248
- MIDLANDS**
Creative Audio
 9 Dunsoppe. Shrewsbury. Shropshire. Tel: 0743 241924
Griffin Audio
 94 Bristol St. Birmingham. Tel: 021 692 1359
Listen Inn
 32 Doris St. Northampton. Tel: 0604 37871
Sound Advice
 The Sound Factory. Duke St. Loughborough. Leicestershire.
 Tel: 0509 218254
West Midlands Audio
 158 Charnock Road. Worcester. Tel: 0905 458046
Overture
 3 Church Lane. Banbury. Oxfordshire. Tel: 0295 272158
Westwood & Mason (Oxford) Limited
 46 George Street. Oxford. Tel: 0865 247783
- NORTH**
Audio Counsel
 12 Shaw Road. Odham. Lancashire. Tel: 061 633 2602
Audio Projects
 45 Huddersley Lane. Leeds. West Yorkshire. Tel: 0532 304585
Better Hi-Fi
 16 Corn Street. Liverpool 2. Merseyside. Tel: 051 227 5007
Doug Brady Hi-Fi
 The Arcade. Crossgate. 19 Crossgate. Oley. Leeds. West Yorkshire.
 Tel: 0543 4677
Doug Brady Hi-Fi
 401 Smithdown Rd. Liverpool 15. Merseyside. Tel: 051 733 6859
Doug Brady Hi-Fi
 Kingwillow Studios. Kingwillow North. Warrington. Cheshire.
 Tel: 0925 829009
Hale Hi-Fi
 2 Bold Street. Hale Road. Altrincham. Cheshire. Tel: 061 929 0834
Lintone Audio
 8 The Arcade. Winton Centre. Gateshead. Tyne & Wear.
 Tel: 091 459 8929
Lintone Audio
 7-11 Park Lane. Gateshead 8. Tyne & Wear. Tel: 091 477 4167
Lintone Audio
 20-22 Birmingham Mall. Newcastle upon Tyne. Tyne & Wear.
 Tel: 091 232 2334
Lintone Audio
 242 Park View. Whitley Bay. Tyne & Wear. Tel: 091 252 4665
Peter Martin Hi-Fi Showrooms
 12A Wilest Street. Congleton. Cheshire. Tel: 0260 280017
Sound with Style
 81 Nether Hall Rd. Doncaster. S Yorkshire. Tel: 0302 321421
Sound with Style
 284 Gleadap Road. Sheffield. S Yorkshire. Tel: 0742 737893
The Sound Organisation
 26 Gillygate. York. Tel: 0904 627108
- WALES**
Audio Excellence
 134 Chryns Rd. Cardiff. South Glamorgan. Tel: 0222 226585
Audio Excellence
 8 High St. Swansea. West Glamorgan. Tel: 0792 474608
- SCOTLAND**
Russ Andrews High Fidelity Ltd
 34 Northumberland Street. Edinburgh. Tel: 031 557 1672
Stereo Stereo
 278 St. Vincent Street. Glasgow. Tel: 041 248 4079
Robert Ritchie
 102 Murray St. Montrose. Tayside. Tel: 0674 73765
- NORTHERN IRELAND**
Lyric Hi-Fi
 163 Stranmillis Road. Belfast. Tel: 0232 361296

may '94 trade winds

CASTLE'S 900th BIRTHDAY?

Designed to coincide with the 900th anniversary of the foundation of Durham cathedral, Castle's new Durham 900 loudspeaker has just been launched.

With a claimed sensitivity of 90dB, this compact, two-way reflex design utilises a new double ring magnet system to drive a 5inch polypropylene woofer.

Supplied in mirror-image pairs with the tweeter mounted below the bass driver to preserve optimum phase relationships, the Durham 900s are available in seven real wood veneer finishes, priced at £279 per pair.



CASTLE ACOUSTICS

LTD

Park Mill,
Shortbank Road,
Skipton,
North Yorkshire, BD23 2TT
Tel: 0756 795333

RIAA NEWS

Latest statistics from the Recording Industry Association of America show the music industry in the USA to be in a healthy state, unlike that in the UK.

Compiled by KPMG Peat Marwick, the accounting firm responsible for six major recording companies, figures show a 6.7% rise in the total number of units shipped, to 956 million, with CD accounting for nearly 500 million of the sales.

Unfortunately, British involvement in the US music scene appears to be at an all time low, unlike during those heady days of Beatlemania. Britain's once dominant role in producing 25% of the world's recorded music, has now dropped by nearly 50%. Record company executives, especially A&R personnel, must be getting very worried.

Finally, could Rock and Roll music have been killed off by CD? As the major record companies continue to pillage their back catalogues at the expense of promoting new talent,

the youth of the USA seem to be turning away, with a drop in total consumption by the 15-24 age group from 43% to 31%. No wonder Sega and Nintendo are laughing!

MORE DEFINITION FROM TANNOY

A small floorstanding loudspeaker has just been launched by Tannoy under the Definition banner. The D500 is a cut down version of the impressive D700, using the same complement of drive units, but in 8 inch form rather than the 10inch variety used by big brother.

Having a price of £1470, the D500 uses a complex cabinet construction employing the double-chamber reflex system in a multi-faceted cabinet made from 18mm MDF and finished in a selection of real wood veneers.



The drive units utilise Tannoy's Differential Material Technology and experience with dual-concentric designs to produce a phase coherent point source speaker.

Sensitivity is rated at 91dB, with a minimum impedance of 4 ohms, so suitably loud levels of sound should be easily produced.

TANNOY LTD
Rosehall Industrial Est,
Coatbridge,
Stathclyde, ML5 4TF.
Tel: 0236 420199

NEWS FROM NEWS

We couldn't resist including this little snippet. Spotted in Saturday's Guardian, 12th March 1994, was an advertisement by Hi-Fi News; they are looking for three editorial staff. But does its peculiar wording posses a hidden meaning we wondered?

Firstly, they want an Assistant Editor "to do the Editor's job when he's not there". They also want a Production Editor to "do some of the Editor's job even when he is there" and, finally, they also want an Art Editor with so much "commitment" that "the Editor doesn't even try to do his/her job" (the editor is a 'he' actually, but Link House Publishing probably haven't realised this yet).

Applicants should contact the Editor - if he's there!

AUDIOLAB TRANSPORT

At last, Audiolab have introduced their long awaited CD transport, which joins their 8000DAC to make a two box package costing £2000.

The £1250, 8000CDM features a great deal of Audiolab's own technology and custom manufactured parts, built around a computer grade CD ROM drive.

The transport also features a balanced AES/EBU digital output for connection to Audiolab's 8000DAC.



CAMBRIDGE SYSTEMS

TECHNOLOGY LTD

Spitfire Close,
Ermine Business Park,
Huntingdon,
Cambs, PE18 6XY.
Tel: 0480 52521

VALVES

If you are looking for new amplification why not come and audition our range of valve amplifiers



LUMLEY
AUDIO INNOVATIONS
E.A.R

Pink Triangle, EAR, Audio Innovation, DNM, Chord, John Shearne, Micromega, Quad, Marantz, Denon, Aura, Mission, Tannoy, Castle, TDL, Impulse, Ruark

BRENTWOOD HI FIDELITY

2 Ingrave Road, Brentwood, Essex, CM15 8AT

Tel: 0277 221 210

studio

82 The High Street
Harpenden
Herts AL5 2SP

82

HARPENDEN LTD

Telephone: 0582 764246
Facsimile: 0582 467022



naim audio



NAIM NAIT 3



NAIM CD 3



NAIM TUNER 03

REAL



HI FI

Agencies:

ARCAM ATC AUDIOLAB AURA AVI BANG &
OLUFSEN BLAUPUNKT B&W CASTLE
DENON EPOS HARBETH MARANTZ
MISSION NAD NAIM -AUDIO
NAKAMICHI
PANASONIC QED ROBERTS
RADIO TARGET TDL



Soundcraft Hi-Fi

Your Place or Ours?



Hear the difference whilst relaxing in our Traditional Kent Style Listening Room.....

.....or let us deliver and set up your chosen system in the comfort of your own home.

For your convenience we offer an appointment service, where you can hear the best equipment available to-day. You are welcome to bring your own records or CDs, and by arrangement, any part of your existing system for comparison.

We guarantee that you will be thrilled with your music, not just for the first few months but over many years of listening.

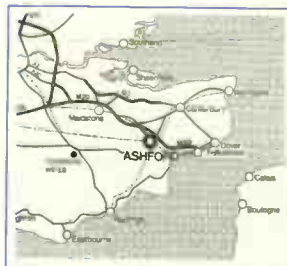

Delivery and installation service



Soundcraft Hi-Fi, The New Musical Experience
40 High Street Ashford Kent TN24 8TE
TEL:0233 624441 Fax:0233 640333



Listen Inn

HI-FI SPECIALISTS

Linn, Naim, Epos, Heybrook, Arcam, Mission, Royd, Audiolab, Creek, Cyrus, Quad, Denon, Rotel, NAD, Marantz, Kef, Chord Company (Naim and Epos Northampton only).

LISTEN INN Northampton
Appointed REGA Agent

32 GOLD STREET, NORTHAMPTON
TEL: 0604 37871
6 HOTEL STREET, LEICESTER
TEL: 0533 623754

MOREL'S SECOND SYMPHONY

Hot on the heels of the Music First 705 comes the second loudspeaker in the range, the new 704.

This is a smaller floorstanding speaker using four drive units. The 704 retails for £999 with integral stands. High quality, close tolerance componentry is used within the crossover and internal wiring is van den Hul silver plated copper.



MOREL UK LTD
11 Foxtail Road,
Nacton Industrial Est,
Ipswich, IP3 9RT.
Tel: 0473 719212

DENON CONTINUE TO DROP NAMES

Since January this year, the BBC has implemented radio text onto stations 2, 3, and 4. With this in mind the new TU-380 RD tuner from Denon will bring these enhanced RDS facilities to the listener at a competitive price of £189.99.

Radio text allows the listener to access useful information relating to the transmission to which they are tuned.

With AM and FM reception capabilities, RDS, Radio text and full RDS EON facilities, as well as 40 preset memories the Denon comes equipped to handle the ever more crowded airwaves.

HAYDEN LABORATORIES LTD
Chiltern Hill,
Chalfont St. Peter,
Gerrards Cross,
Bucks, SL9 9UG.
Tel: 0753 888447.

NATIONAL VINTAGE COMMUNICATIONS FAIR '94

Now into its third year, this event promises to offer a wide range of vintage audio and video collectables. Held at the Birmingham NEC on Sunday 15th May between 10.30am and 5pm there will be over 250 stands and plenty of experts on hand to value equipment or give advice, as well as clubs and societies. The admission fee is £3.

For further information, contact:

NVCF'94
2-4 Brook Street,
Bampton,
Devon,
EX16 9LY.
Tel: 0398 331532

PANASONIC SPONSORSHIP DEAL

Panasonic Europe has extended, by a further three years, its sponsorship of the European Community Baroque orchestra.

The deal, worth more than £335,000, will continue Panasonic's involvement with the orchestra which was founded in 1985, and uses a completely new line up of talented young musicians every year.

Since Panasonic began to sponsor the orchestra, over five years ago, nearly 500 musicians have had the opportunity to play in venues all over the world.

PANASONIC UK
Panasonic House,
Willoughby Road,
Bracknell,
Berks, RG12 8FP.
Tel: 0344 853157.

QED DIGIT UPGRADE

Having recently introduced the Digit Reference at £450, QED are now allowing a unique upgrade path for existing owners of the Digit and Positron.

This involves credit for the full retail price of the Digit (£139) and, if already purchased, a Positron (£85). If you already own these, then the conversion to a reference DAC in the full width case using the original boards plus the twin Positron operation, costs £226 inclusive of VAT.

QED Audio Products Ltd.
Ridgeway House,
Ridgeway Close,
Lightwater,
Surrey, GU18 5XU.
Tel: 0276 451166.

RIAA PHONO STAGE CORRECTION FROM THE APRIL SUPPLEMENT.

Oops! You were, once again, very quick to point out that we'd placed a resistor in the wrong place. Here's the final circuit, with R6 in the right place. Now you'll be able to get it to work.

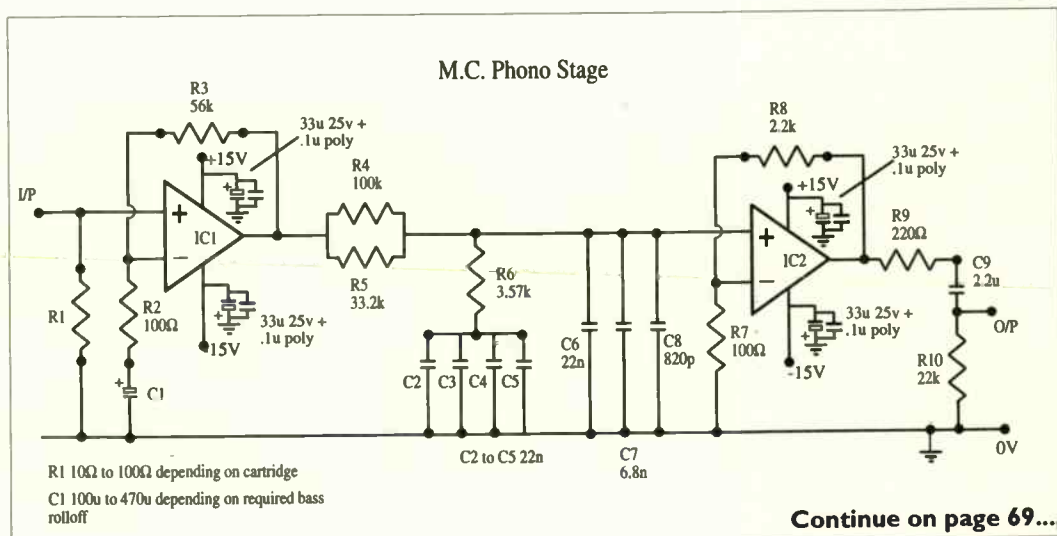

**PHILIPS
INVENTS**

The Digital Compact Cassette When it comes to

sound quality, for Sting "good" just isn't good enough. He demands that his music is reproduced perfectly. That's why he is so impressed with Philips latest invention. DCC.



A digital cassette with the pure sound quality of a compact disc and the convenience of a compact cassette. There's a complete range of equipment, so

you can play your DCC anywhere, in the home, in the car or on the street. And don't worry

about your collection of ordinary compact cassettes, the beauty of the DCC system is that it will play them too. DCC is already a big

hit with the major record companies with hundreds of titles already available. So don't make a mistake, choose DCC. For details of

stockists and further information telephone 081-665 6350.



DCC 600 Player/Recorder



FW 91 DCC System



DCC 130 Portable



DCC 811 In-car



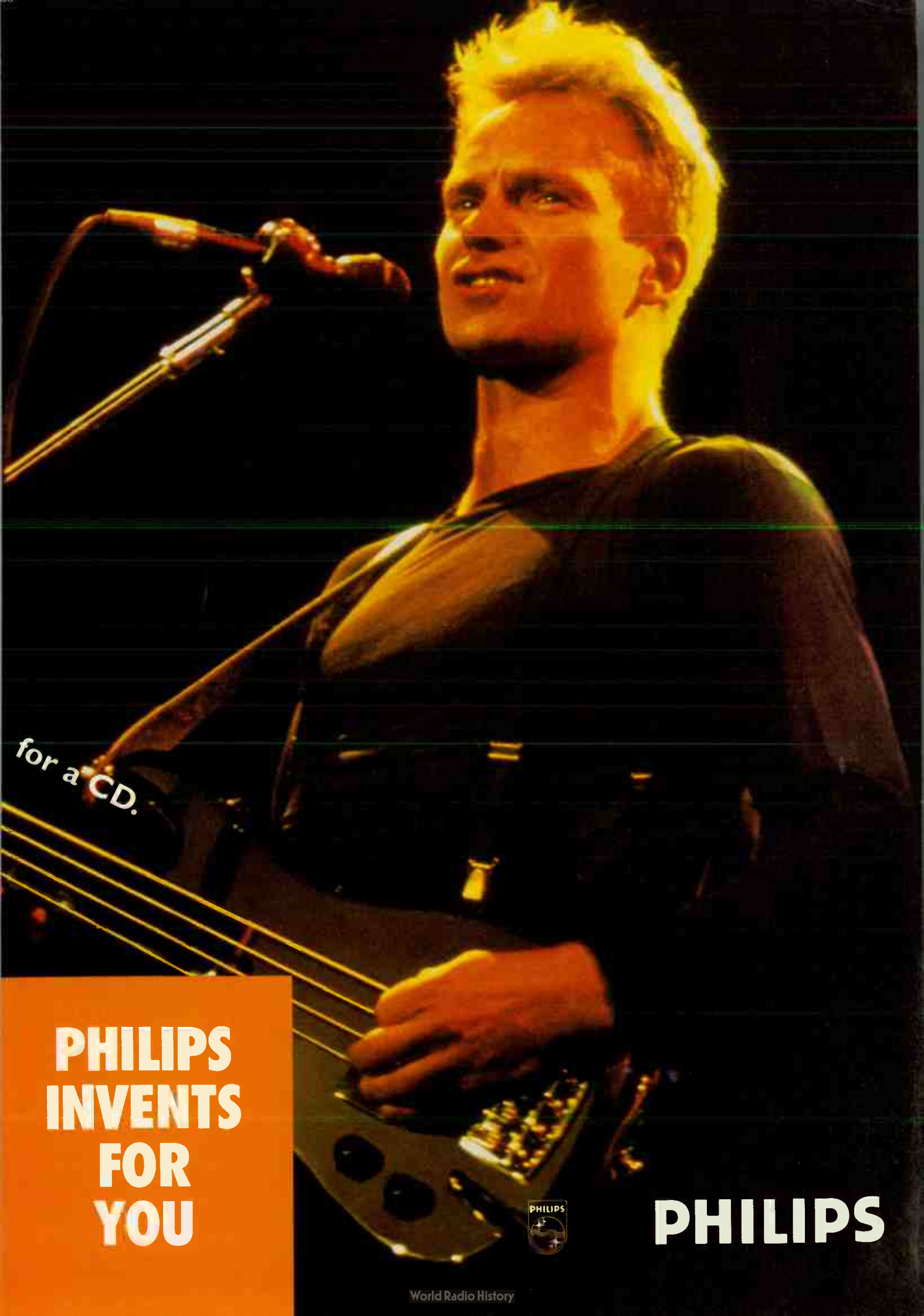

for a CD.

**PHILIPS
INVENTS
FOR
YOU**



PHILIPS

Scout Master

**Dominic Baker visits a pair of Horn loudspeakers in Nottingham -
the Living Voice Tone Scouts.**



"I had a customer drive down from Scotland last week. He'd arranged to borrow the Tone Scouts for a while and came down in a van - but we could only get one of them in! So it'd be best if you came up here to listen to them", said Kevin Scott on the telephone. I was angling to get a pair of Living Voice Tone Scout horn loudspeakers for review, but like all true horns, they are massive.

I arrived in Nottingham on a bright Tuesday morning and found Definitive Audio tucked away down a quiet residential street. Kevin runs his business from home, the front room set out like a normal living room, with the exception of 7ft high horn loudspeakers, and spare rooms used to hold stock. Kevin stocks a small range of high quality equipment from which he builds up systems for customers. This includes Pink Triangle and Voyd turntables, SME arms, Micromega and Wadia CD players, Audio Innovations valve amplifiers and loudspeakers from Høring. He's also one of the men behind Living Voice, whose first product was the £14,500 Air Partner horn loudspeakers. They've recently added a new, smaller model, the Tone Scout, domestically an easier proposition to accommodate than the Air Partners.

Kevin's approach to hi-fi retailing is quite different to that of a High Street shop. Demonstrations are by appointment only and the atmosphere is very relaxed. Kevin makes conversation while brewing some especially wicked fresh coffee - just what I needed after a hectic drive from London.

Sitting back in a high armed sofa with sunlight sprinkling through the window and silence all around, I started to remember what it's like outside of



Kevin's system sits at the back behind the 'speakers. Note the two massive Solartron SRS 152 power supplies used to supply the HT voltage to the First Audio power amplifiers.

London's bustle!

Kevin looked for a record to play whilst I quizzed him about Secomak-Vitavox, military equipment suppliers who manufacture the high quality drive units for Living Voice loudspeakers, including the Tone Scout.

Kevin Scott is the front man to Living Voice, but it is Vitavox who carry out design of the drive unit and the horn geometry. A cabinet maker in London builds the enclosures and an engineer in Birmingham tests and measures the final product. But Kevin co-ordinates the whole process, performs the listening and marketing, whilst also running Definitive Audio.

Kevin's system, as you'd expect, is a little out of the ordinary. His primary source is vinyl, and he has around 1000 albums to testify to his love of music. The CD collection is only just beginning, a few hundred or so played by a Wadia 6 which Kevin chose for its open and crisp sound. The vinyl is played by an EMT HST15 moving coil cartridge, with an exposed generator assembly. It is mounted in a silver wired SME V tonearm that sits on a Voyd 0.5 turntable. Kevin imports the EMT range of cartridges, but the one he uses has been modified.

The pre-amplifier is a standard Audio Innovations L2 with P2 phono stage, connected to a pair of First Audio power amplifiers. These take their HT supplies from two, not insubstantial, Solartron SRS 152 power supply units. These are about twice the size of the actual amplifiers, having brightly glowing neons and large voltage meters to reinforce their military appearance. Sitting to one side is a custom built 3.5W single-ended PX4 power amplifier, unfortunately not in operation whilst I was there.

The new Tone Scouts were set up and ready when I arrived, although they'd only been back from loan for a day, so Kevin was still adjusting the midrange and treble levels for the best balance. Towering behind them sat the Air Partners, "you must have a quick listen to those before you go", grinned Kevin "I keep forgetting how good they are myself."

The Tone Scouts are considerably smaller than the Air Partners, although still appreciably larger than most domestic floorstanders. Each one weighs around 20stone (127kgs), so moving them isn't particularly easy. This weight is a combination of two things, the massively built drive units, which can actually be disassembled for repair or cleaning, and the cabinet. This is made using 18mm thick, high density birch plywood, with 36mm sections for strengthening, and then veneered using top grade, real wood veneers. This gives them enormous



Kevin in front of the Tone Scouts. Although half his height, they're nearly twice his weight!

rigidity, which helps to produce a clean sound, free from colouration.

The Tone Scout is a three way system, using a 12 inch, un-doped paper unit for the bass. This is coupled to a compound horn which was initially designed using computer modelling and then fine tuned subjectively to give consistent results in a wide range of listening environments. The mid-range is handled by one of Vitavox's units, the S5 motor unit, nicknamed the 'Landmine' by Kevin (see picture). This unit uses a specially made 2inch aluminium dome diaphragm with a very compliant surround, all mounted within the casting to form the pressure chamber. This has a threaded hole in one end to allow it to be screwed into Vitavox's cast aluminium, four-cell mid range horn. Because of this, other units can be used by simply screwing them in. Kevin speaks highly of Beyma, a Spanish drive unit manufacturer. But, the Vitavox is the best; each one is tested for 100 hours with a 100watt programme to ensure quality and reliability.

As with the midrange, several different tweeters are available. These come principally from either JBL or Beyma. "It's quite difficult to find a good tweeter that can keep up with the 104dB sensitivity of the bass and midrange", says Kevin. The pair of Tone Scouts I listened to had a Beyma tweeter fitted, coming in at around 13kHz, so the tweeter is only handling a

small amount of the frequency range.

Because of the extremely high sensitivity of these horns, running the drive units in takes a considerable amount of time. Even 1 watt of input power is enough to pin you to the wall, and the drive units hardly move. Kevin reckons that they continue to improve in performance over a year or so, depending upon the amount of use they get. The pair I was to hear took around half

an hour to warm up and soften out, but this warm up period decreases as they get closer to being properly run in.

The first thing that struck me about the Tone Scouts was the way they coupled to the room, driving it effortlessly with a sound larger than life. The jazz

Continue on page 17

TURNTABLES tonearms & cartridges FOR THE LOVE of music

To hear the dynamics and explosive power of Tchaikovsky's 1812 Overture, your Hi-Fi system comes from Audiofreaks. For your final choice of analogue front end components we have selected a few of the very best.

VPI turntables and record cleaning machines, the unsurpassed WHEATON Tri-Planar IV tonearm, BENZ-MICRO state-of-the-art moving-coil cartridges and the latest wonder - EXPRESSIVE TECHNOLOGIES SU-1 step-up transformer with matching interconnect cables IC-1 and IC-2. The first and only MC transformer that works.

AUDIOFREAKS

15, Link Way, Ham, Surrey TW10 7QT.
Tel: 081. 948 4153 Fax: 081. 948 4250.



Tesserac Audio.
We make them
the way they said
you just can't make
them anymore.

For full details of the Tesserac range of head amplifiers, pre-amplifiers, power amplifiers, turntable power supplies and dealer list contact: Tesserac Research Ltd, Sutton Business Centre, Restmor Way, Hackbridge Road, Wallington, Surrey, SM6 7AH Telephone: 081-669 0011 Fax: 081-773 0406



TESSERAC AUDIO
The Best of British High End

Great tracking

Ortofon is famed the world over for the tracking capability of its cartridges. Cartridges which will breathe new life into a cherished LP collection, divulging detail as never before.

The cartridge is always the key factor in the reproduction of music from records and Ortofon has dedicated nearly 50 years to the manufacture of the finest pick-ups possible. Enjoying constant critical acclaim along the way.

So if you want to bring more out of your records than ever imagined, an Ortofon Cartridge will have you hot on the scent.



500 Series
Moving magnet
cartridges from £30-£100



MC Series
Moving coil cartridges
from £80-£110



Q Series
Moving coil cartridges
from £140-£500



1000 Series
Moving coil cartridges
from £800-£1500

ortofon

Ortofon (UK) Limited, Chiltern Hill, Chalfont St Peter, Bucks SL9 9UG.
Tel: 0753 889949.



... Continue from page 15

pianist was playing a piano with keys the size of shoe boxes, and the saxophone

in speed. It may not be especially deep, but the timing and power of what's there is spectacular. A fiercely played tabla proved a suitable test, showing the lightning fast response of the 12 inch bass unit. The bass does have quite a hard, dry quality to it, which seems to be a character of horn loudspeakers, but it gives a powerful and lively presentation.

One thing that we've noticed with efficient loudspeakers is the extra detail and excitement you get from lighter, faster drive units, and the Tone Scouts take this to the limit. Most at home with fast, light acoustic music and classical pieces, the Tone Scouts

produce music with breathtaking realism and drama. With rock, they quickly show up the shortcomings of a recording, but their bass isn't really rich enough, or deep enough to be convincing. The powerful slam is amazing though; they must be heard to be believed.

The Tone Scouts are fascinating and nearly unique loudspeakers. They demand to be assessed by demonstration, so different is their approach to music. But, for £6000, what you get is a loudspeaker

that will last a lifetime. And they don't demand Krell power to sound their best. Kevin has recently sold a pair to an enthusiast who uses Quad IIs. "He loves them. He was going to upgrade his amps, but the sound was so good he decided to have them serviced and continue to use them" ●

Living Voice Tone Scout £6000
Definitive Audio
Tel: 0602 813562

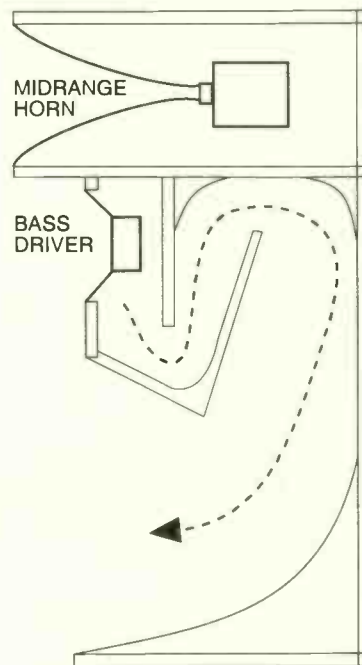

Cross section of the Tone Scout. A combination of 18mm and 36mm high density birch ply is used throughout the cabinet.



A selection of the drive units used by Living Voice. From left to right: 1. Vitavox S2 motor with a 2 inch aluminium diaphragm. 2. The Gauss tweeter used in the Air Partner. 3. Beyma CP21F slot tweeter. 4. The S5 motor unit used in the Tone Scout (nicknamed the "Landmine").

was powerful enough to hold you in your seat. Any conventional loudspeaker would sound Micky Mouse beside them, such was the scale of reproduction. The four-cell casting of the midrange certainly does its job well, throwing out a clear and spacious sound, with plenty of energy and detail. In some ways it's perhaps a little too good for the rest to keep up with, the tweeter just adds a little sparkle to the top and the bass wasn't especially deep.

Where the bass does score though, is

MEASURED PERFORMANCE

The Living Voice Tone Scouts were interesting to measure. It is very difficult to accurately measure a horn, so I used a number of different microphone positions to get an accurate idea of what each section was doing before completing an overall response.

The response is quite a lumpy one. The midrange output is formidable, but doesn't stretch quite high enough to reach the tweeter output and form a smooth response. I would expect the dip between mid and treble to constrain vocals, not allowing them to project as well as they should. But subjectively this is less noticeable than you'd expect, perhaps due to the wide dispersion of the four cell horn and the reflections it causes.

The lower midrange is raised by 3-4dB which produces a very forward balance, to piano and saxophone for example. The bass level is lower than the midrange, again preventing a flat response, but at the listening position, and with room reinforcement, bass level is probably slightly better aligned to the midband than

the plot shows.

Measurement started to get interesting when I tried to push 1 watt of pink noise through the Tone Scouts to get a sensitivity measurement. Luckily, the neighbours were understanding and I managed to bear the sound for long enough to measure 102dB at 1m. Even on transients, the Tone Scouts aren't going to need more than a couple of watts to drive them.

The Impedance curve also suggests that the Tone Scouts aren't going to be a problem to drive. The high overall impedance of 15.5Ω means that they need around two thirds of the current of a typical British loudspeaker. It's a smooth impedance curve as well, but the dive in the treble will effect feedbackless amplifiers, perhaps resulting in a duller sound.

Overall the Tone Scouts are a little odd, but that's what you'd expect from such a different and unique loudspeaker. At the end of the day it comes down to personal taste. For £6000 you will obviously listen very carefully before a decision is made. **DB**

Frequency Response

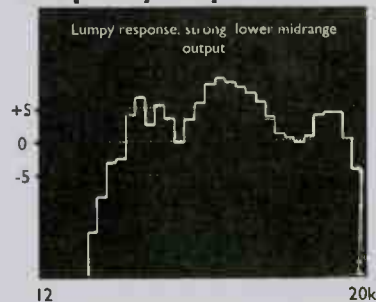

Impedance

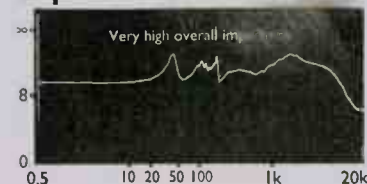

MADE TO

MEASURE

The new 500 Series from Meridian takes another step forwards in hi-fi style. Robert Wilson takes a listen to their latest CD player and pre/power amplifiers.

Can serious hi-fi be good looking? In certain respects I believe it can. Take, for instance, SME's stunning tonearms or the beautiful Michell Gyrodec. But these are examples of elegant, high precision mechanical engineering. What about the black box brigade? Can CD players, amps and the like, look good and be ergonomically correct, allowing form to compliment function?

Meridian believe that it can be, and have proved so with the attractive new 500 series components. A full system was supplied for review here, comprising an integrated CD player, a pre-amp, a stereo power amp and a system remote control.

All the products are beautifully finished, and are packaged in similar cases (321mm wide) finished in black textured enamel with a shiny glass top panel. The 506 CD player follows in the Meridian tradition: the disc drawer contains the entire disc

mechanism - platter, motor and swing-arm laser. You load a disc by placing it direct onto the motor hub. It's neat system that eliminates the usual wobbly drawer, for to carry the entire mechanism Meridian have had to engineer an

altogether more substantial instrument.

The function controls available on the player cover basic operations only. More complex ones are situated on the system remote controller.

Outputs are the



NEW PRODUCT



BASE

VIBRATION ISOLATION PLATFORMS

Realise the full undistorted potential and accuracy of your high fidelity audio components with the latest concept in platforms.

Available as individual platforms, modular racking systems or hardwood enclosures built by craftsmen to suit your requirements. Integral cable routing separates sensitive carriers from mains leads combining tidy appearance with elegant furniture design.



"THE REVIEWER'S CHOICE"

For your brochure & local dealers please 'phone the number below

Audiophile



Audiophile Furniture Limited Telephone: 0342 826262

KLIPSCH High efficiency Loudspeaker for

Full Performance Sound

FORTE 11 MODEL £1490 per pair (reviewed by M. Colloms C.Eng M.I.E.E)



UK Distributor - 021- 430 7817

HORN LOUDSPEAKERS

Klipsch[®]

MAYPOLE LANE, BIRMINGHAM, B14 4PE.

Doug Brady Hi-Fi

"You really must hear this"



Also available:

Arcam, Meridian, Naim, Pink Triangle, Exposure, Roksan, Audio Innovations, Tube Technology, Mission, Lyra Cartridges, Michel Engineering etc...

MAKE FRIENDS AT DOUG BRADY HI-FI

| | | | |
|--|---|---|---|
| Kingsway Studios, Kingsway North, Warrington, Cheshire (0925) 828009 Open six days. Fax: (0925) 825773 | 401 Smithdown Road, Liverpool L15 3JJ Merseyside (051) 733 6859 Closed on Wednesday. | 14/18 Monmouth Street, Covent Garden, London WC2H 9HB (071) 379 4010 (071) 497 1346 Open seven days Fax: (071) 497 9205 | The Forge Cottage, 19 Crossgate, Otley, Leeds, West Yorks LS21 1AA (0943) 467689 Closed Sunday & Monday. |
|--|---|---|---|

standard analogue stereo pair, with additionally an electrical and an optical digital output. Also present on the back panel are two 5 pin DIN sockets which facilitate the use of Meridian's Comms. Link. This allows the entire system to be controlled from one unit, designated the master, in a multi-room system.

Internally, the player uses the Crystal high definition Delta-Sigma convertor (also used by Quad and EMF), consistent with the latest Meridian practice, coupled to a discrete Class A output stage.

The 501 control unit (a pre-amp) has six inputs for analogue sources that can be adjusted for sensitivity and identified using the amp's four-character Alpha-numeric display. A high quality MM/MC phono board is available as an option for the dedicated LP input.

The display is useful when operating the system from the comfort of your favourite armchair. Adjusting volume switches the display automatically to identify the source component and attenuation in dBs. It allows level to be adjusted in single dB steps from 1 to 99. The balance control works in a similar fashion, a small arrow pointing either left or right and a number showing the alteration in signal level in dBs on that specific channel. True electrical balance occurs when a zero is displayed, flanked by both arrows. The control unit can be customised for use in specific systems; directions for this are provided in the comprehensive instruction booklet.

Although the basic controls for either component are present on their respective facias, the system really comes into its own when used with the full-function remote control. This looks stunning. It's shaped with a gentle curve that allows it to sit comfortably in your hand. Separate functions are laid out in a sensible manner and I soon became familiar with its operational procedures. Colour coding of the primary functions was a nice touch, allowing quick identification of primary and secondary functions.

Finally, we come to the 555 power amplifier. A brushed aluminium fascia and heat sinking fins of the same material let this little beauty run cool, showing off the piano-finish top plate to great effect. I think it's the most stylish component of all, looking like a junior Mark Levinson power amplifier. A solitary green diode, centre-front enhances the symmetry of the design, residing just below the manufacturer's logo. It indicates when 65 watts of power per channel is available.

Bi-wiring is aided by the inclusion of two sets of output terminals.

Did the system live up to its appearance, or was Meridian's pretty packaging and fancy remote control just for show, leaving the system without any musical get up and go?

The sound of this system was speaker dependant, which could be construed as saying that the Meridians are a neutral combination. When listening

through the Heybrook Sextets the system took on a lean, dry nature. Bass guitar and kick drum had a tight, punchy delivery which gave a homogeneous sound to rock rhythm sections. Complex multi-timbrel percussion which is present on numerous CDs of so called 'World Music' was well dissected, as the Meridians displayed the tonal variations teased out by different playing styles.

The amp's ability to respond to dynamic changes was quite effective, although when using recordings where the variation of level was especially intense the Meridians failed to encompass the entire spectrum of musical expression, causing the dynamic shading of a track to become slightly Spartan and in some examples a little emotionally bland.

With the bottom-end sounding dry and marginally laid back, the resultant diminished presence - due to a lack of bass richness - gave the mid-range frequencies a more prominent role in the overall sound. This aspect of the presentation endowed the system with a fair degree of communication, particularly with vocal and primary instrumental parts brought to the fore in a multitrack mixdown.

For example, Gerry Rafferty's voice was well presented, with a good delivery of the throaty tones that his vocals possess. A sibilant edge to some sharp vocal transients did become apparent

under close scrutiny, but this effect was marginal and not offensive to my aural sensibilities.

The reproduction of string arrangements again suffered slightly from the dry perspective that this system exhibited, resulting in a sound prominent in upper harmonics; it was pleasantly detailed and quite lively but could have benefited from the gentle warmth of a richer, more woody timbre, to inject a little more organic character.

With Rafferty's 'City to City' album the system proved adept at separating out various instruments, placing them into a well proportioned soundstage with a good degree of spatial precision. Towards the back of one track the Meridian highlighted some bongo playing which brought a strong sense of dimension to the image.

The latest Ry Cooder CD, 'A meeting by the river' on which he duets with V.M. Bhatt, has a gorgeous acoustic which, when played through an exceptional system, can sound breathtakingly solid. The Meridians made an honourable stab at this, managing good stage width and capturing a high percentage of the subtle

“Bass guitar and kick drum had a tight, punchy delivery which gave a homogeneous sound to rock rhythm sections.”

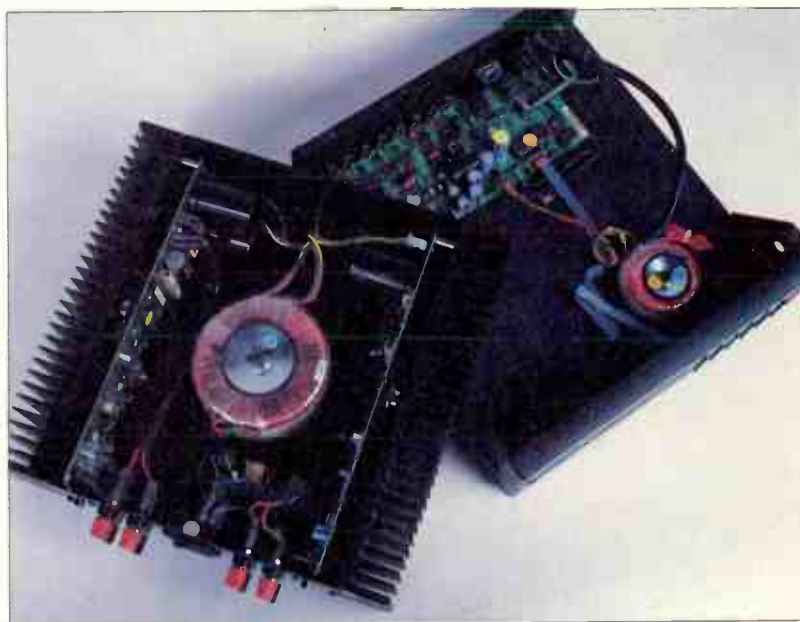

acoustic inflections that help to characterise the room acoustic. However, the system did diminish some of the huge stage depth by bringing the Tabla further forwards, compressing the depth perspectives of the recorded environment.

The analytical properties of the Heybrook's ribbon tweeters showed that the Meridians enjoy a refined treble, sounding particularly sweet with delicate percussion such as bells, triangles and tambourine. A slight haze could be detected, tempered with a light feathery wisp that sometimes prevailed when listening to 'brushed' cymbals. Having said that, the Meridians were able to show variations in the stroking of a hi-hat.

My final listening session with this system was used to assess the new Primal ►►



THE HI-FI LAW OF DIMINISHING RETURNS

Ask a Hi-Fi dealer to upgrade your system, and he'll sell you ever more expensive bits of hardware, giving you a constantly changing sound, new solutions producing more problems which can only be solved with more expensive equipment. The harder you try, the more it costs and the less satisfying the results. This is the well known Hi-Fi law of diminishing returns. We have an alternative:

THE RATA LAW OF INCREASING RETURNS

Why buy new equipment when it makes more sense to realise the full potential of your existing equipment. Don't replace it, upgrade it; it's cheaper. Most equipment can be transformed by us for the cost of a dozen CDs. Magic? No - logic! To find out how we do it, ask for our new free Catalogue; it provides discussion, analysis and a definitive resource of audiophile components and advice on the art of recreating music in the home.

Russ Andrews Audiophile Catalogue

Includes :-

- CD Players, Preamplifiers, Disc Preamplifiers, Power Amplifiers,
- Loudspeakers
- Kimber Kable
- Upgrading Services and Guides
- Audiophile Kits and Components
- Accessories
- Reviews

1993 Edition 2 Available Now



RATA

Edge Bank House,
Skelsmergh,
Kendal,
Westmorland, LA8 9AS

Tel: 0539 823247

Fax: 0539 823317

UK: Post Free,
Europe: 3 International Reply Coupons.
Overseas: Send US \$3 bill or four IRC

Scream album which had just arrived for review. This was a very enjoyable experience, as the music is very much influenced by the sounds of the sixties, which I adore. The up-beat rhythms used in some cuts were portrayed by the Meridians with a good measure of enthusiasm and verve, the use of various percussive elements was also captured well, highlighting even more my delight in the obvious Rolling Stones influences used in the album's concept.

Acoustic guitar had a nicely varied tonal quality, although again there was an over-exposure of upper harmonics which

could lead to a sound more akin to a National than a Martin. Some limitation of dynamic expression also slightly hampered the emotional content of some of the more descriptive tracks, where violent attacks on the strings were a little neutered. The rhythmic involvement of the music was carried off well, thanks to the cohesive, dry bottom-end producing a well defined kick on the bass drum which was easy to follow, although I would also have liked a bit more dynamic impact from the kit.

As a complete package, the Meridians work together well, both electronically

and sonically. They rank very highly as far as ease of use and ergonomic design are concerned. As ornamental hi-fi they don't disappoint, being well styled and bolted together. They will certainly provide their owners with lots of product satisfaction. This counts for a lot, especially in certain areas of the market, one where sound quality takes equal or - sometimes-second place. However, in going for the a part of the market that is likely to be concerned about appearance, Meridian haven't forgotten their audio pedigree either, managing to produce integrated hi-fi units that look good and can sing too ●

MEASURED PERFORMANCE

MERIDIAN 501/555 AMPLIFIER

Being a long established company founded and still run by an electronics engineer (Bob Stuart), Meridian can be relied upon to produce a technically faultless amplifier. The 501 preamp and 555 power amplifier measured extremely well in all respects, but I was surprised at one particular feature - the system is all direct coupled. So don't expect to connect up any source with d.c. offset; the amplifier's protection circuits will kick in smartly with a loud clunk. Whilst most sources are a.c. coupled, the odd one or two are not and do possess some offset, so beware of this. Obviously, Meridian's own tuner and CD player are acceptable, but I've come across the odd cassette deck that produced output offset, so beware. Get a demo first.

Why direct couple in the first place? All other things being equal, it can enhance sound quality by eliminating coupling capacitors; it also gives tight deep bass. All the same, few manufacturers are bold enough to practice this, since d.c. output offset on a power amp blows loudspeakers up, that's why the 555 has protection circuits.

Meridian strongly band-limit their amplifiers to suppress transient distortions; the 501/555 were -0.5dB at 20kHz and have a -1dB bandwidth limit of 35kHz, which is low. This is good practice, providing the resultant amp doesn't sound dull or warm, as some can. This one did not though.

Distortion was well suppressed at all frequencies and levels, but harmonics at high frequencies were odd-order only. A hint of hardness in the sound can be introduced by this.

The pre-amplifier was very sensitive, needing just 100mV (160mV via CD) to drive the power amp to full output that measured 78watts into 8ohms (120watts into 4ohms). This is a well engineered amplifier **NK**

AMPLIFIER TEST RESULTS

| | |
|--------------------|-----------------------|
| Power | 78watts |
| CD input | |
| Frequency response | 0Hz-35kHz |
| Separation | 81dB |
| Noise | -90dB |
| Distortion | 0.01% |
| Sensitivity | 100mV |
| dc offset | 68/72mV |
| Disc | optional (not tested) |

Distortion

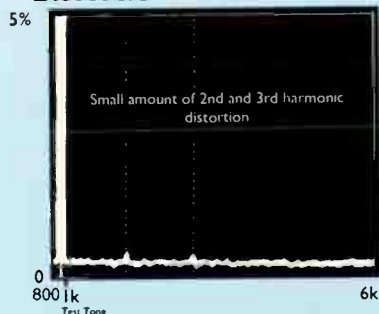

MERIDIAN 506 CD PLAYER

As you'd expect from a company like Meridian, the 506 CD player measured extremely well in all respects, showing good quality engineering. The response was very flat, showing just a slight roll off above 10kHz, which should ensure this player has an inoffensive treble.

The 506 is a very linear player, exhibiting low distortion at all levels. Distortion rises a little at -60dB, giving a dynamic range of 106.6dB, but at -30dB, normal music level, it's virtually undetectable (see plot). Even with a -90dB dithered signal distortion time-averaged out to a very low figure, 3-4%, or about as low as it goes.

Elsewhere, the 506 measured extremely competently, with good channel separation, healthy audio output level and low noise. Even spurious outputs were low.

The 506 is a very well engineered player. I'd expect a smooth and detailed sound, but only subjective tests can fully reveal this. **DB**

CD TEST RESULTS

| | | |
|--------------------|-------------|-------|
| Frequency response | 4Hz-21.2kHz | |
| Distortion % | | |
| -6dB | 0.004 | 0.005 |
| -30dB | 0.006 | 0.006 |
| -60dB | 0.65 | 0.64 |
| -90 | 35.3 | 34.7 |
| -90dB dithered | 4.1 | 3.1 |
| Separation dB | left | right |
| 1kHz | 106 | 100 |
| 20kHz | 88 | 76 |

| | |
|---------------|--------|
| Noise | -96dB |
| with emphasis | -101dB |

| | |
|---------------|---------|
| Dynamic range | 106.6dB |
| Output | 2.18V |

Distortion

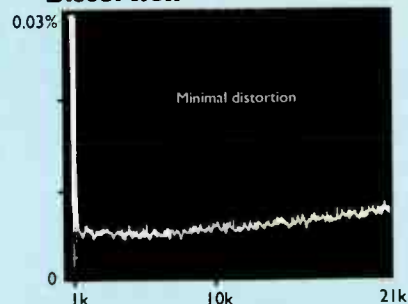

Frequency Response

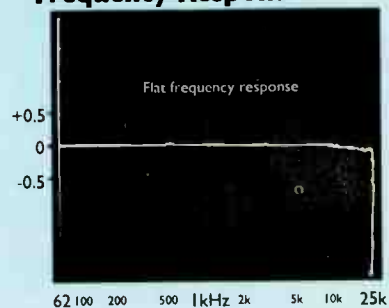

Best of Intentions



I wuz robbed! Well, not exactly, but I was wrong. On first hearing, I thought the Heybrook Integra was in for a slamming. But, hours after it had been switched on and after a night's sleep, I changed my mind. And, I'd better say, I did a bit of a U-turn without anyone threatening me with a going-over by any of Plymouth's stropplier marines.

What miffed me were two fundamental characteristics, one mechanical and one sonic, which coloured my judgement for a day. One was the simply horrible plastic control knobs, which are so poorly finished and so light to the feel they'd be sneered at by a manufacturer of clock radios sold off in the cheaper end of the market. Yet Heybrook have had the sense to put in two pairs of chunky binding posts for two pairs of speakers or bi-wiring, a sensible array of phono inputs, separate listen and record controls and a headphone socket - an endangered species these days. Heybrook, even though it doesn't make the TT2 turntable any more, has even put in a more-than-decent MM/MC disc stage.

If the controls are arrayed on a fascia that I feel looks a bit too early-eighties and is born out of primary school design, then my outraged aesthetic sensibilities are perhaps out of step. After all, they've been nurtured lately on some elegant expensive Counterpoint gear, or the smoother, curvier lines of Arcam and Orelle. Or maybe I was just expecting some polished wood at either end like the burr-walnut Heybrook adorn the Quartet speakers with. No matter. Every mother loves its young, so English audiophiles may worry less about the looks.

The Integra's single sonic fault, however, was hard to come to terms with, until I began to appreciate its other strengths. At first, a somewhat relentless, almost uncultured, treble drew my attention so much it subsumed all else. While it brought about a vividness to rock and jazz music, it made authentic violins distinctly screechy and scratchy and more abrasive than usual. Omette Colman on violin (no, that's not a mistake of mine - nor of his) is a bit hard to take anyway, but through the Integra it had a touch of the dentist's drill about it. A jazz trio, too, had a

new integrated amplifier's bass quality. It can be rhythmical, tuneful, sharply defined and yet with a warm enough quality to bring out real lower string and viola tone. At least when it had warmed through; in its first few hours it had seemed almost one-dimensional. Equally, the Integra could handle breadth and depth in recordings, even those studio ones where the ambient clues are usually, at best, dry and anaemic. It put body into a recording.

Now, why all this worked beautifully on something like Archy Shepp and John Coltrane live at Newport, with a

supremely enjoyable performance (hard-toned sax excepted), but not with opera or choral works, became as much of a mystery as the origin of the statues on Easter Island. There were absolutely no complaints regarding the breadth or depth of soundstage. All three of

Papageno's tormentors in *The Magic Flute* were located precisely where they ought to be. Characters moved across the stage with precision. But a full orchestra sounded dynamically flat by comparison with other designs. The larger the scale of the work, the 'flatter' the performance became.

This was a shame, because the adeptness of the Integra at conveying the range of instruments, their spatial location and subtleties of inflexion couldn't quite make up for the lack of dynamic expansiveness.

Or have I been too spoilt recently by Sugden's £100 more expensive A21a Class A amplifier? To put a better perspective on it, while noting the same lack of dynamic 'lift' on orchestral music, two friends rated the Integra's strengths as far more

"Kirstie McColl, too, though vocally a spot on the bright side, had a splendid array of realistic 'clubby sounding' backing instrumentalists"

hard-sounding flute.

Stop concentrating on that edge, though, and the Heybrook revealed real qualities which many amplifiers in this price bracket don't match. Woodwind, brass and double bass, for example, had a resolute, clear but warm and full tone. A couple of friends noted how the horns in a Haydn symphony rasped and roared over the strings with a sense of the sound of a live orchestra. Kirstie McColl, too, though vocally a spot on the bright side, had a splendid array of realistic 'clubby sounding' backing instrumentalists on 'Soho Square' and the Integra had resolution enough to separate artificially-induced drum sequences from real instruments where other more expensive amplifiers fail.

There's much to be said, too, for the

With the new Integra amplifier, Heybrook are intent on entering the amplifier market. Will they succeed? Eric Braithwaite listens; Noel Keywood measures.



should be bought 'sound unheard', nor partnered too exotically at either end, I suspect. But then, I drink coffee made from ground beans, not Gold Blend,

consequential than this weakness. In fact, they preferred its naturalness of tone to a thousand-pound integrated from overseas.

Heybrook have hit a difficult spot in the market. Although I find the Audiolab 8000A highly detailed, its restraint on occasion and seeming unwillingness to party gives the Integra an edge in that

respect. Heybrook's design also includes a phono stage that leaves very little to be desired against the line stages. In absolute terms, the company has engineered an integrated amplifier that has some of the best of the Audiolab blended with the best of the much-loved Creeks. It might be a winning combination, but it's not one that

and I have a taste for single malt. Who said 'Snob'?

**Heybrook
Heybrook Hi-Fi Ltd.,
Estover Ind. Est.,
Plymouth PL6 7PL
Tel: 0752 731313**

£550

MEASURED PERFORMANCE

The Integra started smoking with less than one second's full power delivery into a 4ohm load - it didn't want to know. We found the emitter resistors were responsible; they overheated instantly and need uprating. Amplifiers must be able to deliver current into a low load for at least some short period of time and a vast majority do. I suspect that in use, the Integra would burn out its emitter resistors if driven heavily into four ohm loudspeakers (some KEFs for example), although it is lightly fused to prevent this, so it may, alternatively, fuse-blow. It would be wise of Heybrook to make the Integra more robust before marketing it.

Power output was a healthy 84watts (8ohms), enough to drive any loudspeaker. The power amplifier is strongly band-limited, output falling to -0.5dB at 20kHz. The -1dB limit was 36kHz. This sort of roll-off is introduced to minimise transient distortion, but it often makes for a warm-ish or fulsome sound.

Sensitivity was unusually low at 400mV, for tuner, CD and tape. These days, 200mV is a normal value, since some budget cassette decks and tuners produce just 350mV or so. Similarly, the disc stages were insensitive at 6mV and 0.9mV for MM and MC respectively. The Integra ideally needs more overall gain.

Low frequency response rolls off below 18Hz on CD, a little high for this source. The bottom-end was band-limited to 44Hz with LP (MM and MC), to stop warps being amplified.

Distortion was low in the mid-band, measuring 0.03%. However, it rose at high frequencies to reach 0.15%, with extended harmonics, as our analysis shows. This is likely to be audible as a slight coarseness in the sound.

The disc stages were a little more noisy (equivalent input noise) than many these days. Hiss would be audible with low output moving coil cartridges, but less so with high output and moving magnet types.

Although the Integra works as it stands and has plenty of promise, it still needs some final tidying. **NK**

TEST RESULTS

| | |
|--------------------|------------|
| Power | 84watts |
| CD/tuner/aux. | |
| Frequency response | 18Hz-36kHz |
| Separation | 66dB |
| Noise | -97dB |
| Distortion | 0.03% |
| Sensitivity | 400mV |
| dc offset | 0/0mV |

| | |
|--------------------|------------|
| Disc (MM) | |
| Frequency response | 44Hz-30kHz |
| Separation | 67dB |
| Noise | -76dB |
| Distortion | 0.03% |
| Sensitivity | 6mV |
| Overload | 100mV |

| | |
|--------------------|------------|
| Disc (MC) | |
| Frequency response | 44Hz-30kHz |
| Separation | 67dB |
| Noise | -70dB |
| Distortion | 0.03% |
| Sensitivity | 0.9mV |
| Overload | 15mV |

Distortion

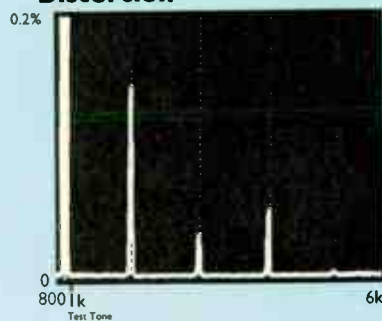



Experience live music

in your home.

Experience a personal service second to none.

At Sound Gallery we will help you tailor a hi-fi system that sounds exactly the way you want it, not the way you've been told it should sound.

Experience the options in the neutral conditions of our demonstration room, and the professional home installation of your desired system.

**FOR A SOUND EXPERIENCE
AND SOUND ADVICE, CALL**

▶▶ **THE SOUND
GALLERY** ■

0494 531682

65 CASTLE STREET • HIGH WYCOMBE • BUCKS HP13 6RN

World Radio History

DAC STACK

Once you've bought your Japanz CD 108SE turbo Mk II Limited Edition, offering high-end sound quality for £200, where do you look for a worthwhile upgrade?

We all agree that in the up-to-£300 CD player market the Japanese reign supreme, but above £300 things are slightly different. The problem is, ditching your £200 turbo for a completely new machine can be a costly business.

Fortunately, there's another option. Keep the player, but upgrade its electronics by buying an external convertor, or DAC (Digital to Analogue Convertor). This way, the player can be used to spin the disc, whilst the digital-to-analogue conversion process is carried out by an external processor of higher quality.

So here are six budget DACs, priced between £200 and £450, that offer a high performance and a cost effective upgrade for anyone who owns a CD player with a digital output. Most modern players have an optical output, but earlier ones commonly had an electrical output. All but one of the DACs tested here have input sockets for both; Dacula has just an electrical input, but then, its manufacturers will convert the optical output on your player to coax as they reckon it sounds better anyway. So these DACs can be added to nearly any existing stand alone CD player.

The advantage of a separate DAC? Well, that £500 player you were just about to buy more than likely uses the same transport mechanism (the bit that spins the disc and reads it) as your current £200 turbo player. So all you're really getting is a better DAC (or support electronics), and probably a few more flashing lights as well. Why throw away a transport that, in effect, you'll then buy again? Adding a separate DAC means that your funds are concentrated on the part that matters - the critical convertor electronics - so obviously this approach presents a much more cost effective upgrade path. Later, of course, you can get a genuinely better transport, especially if you buy a sync-locked DAC. With these, only made by Arcam and DPA at present, you have to buy their own transport later.

Robert Wilson
investigates six
budget CD
convertors that
promise to upgrade
the performance of
entry level CD players.

Dominic Baker applies the tests.

Stand alone DACs come from smallish, specialist companies whose main aim is to beat the competition in terms of sound quality alone. Major manufacturers get very tied up with 'perceived market value' and all sorts of other marketing concerns, which is why expensive CD players commonly come smothered in lights and what have you, all of which detract from the quality of their internal electronics.

In contrast to this approach all six of the DACs here are engineered for

sound first, making the combination of £200 CD player and £300 DAC the equivalent of any £1000 stand alone player. There might be another box and a few more wires, but there's also better sound and greater flexibility to upgrade.

So, if you're more interested in what it sounds like, than what features it offers - and you should be - read on. We've got six of the very DACs on test, all at affordable prices ●

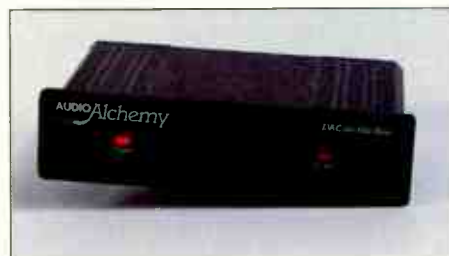
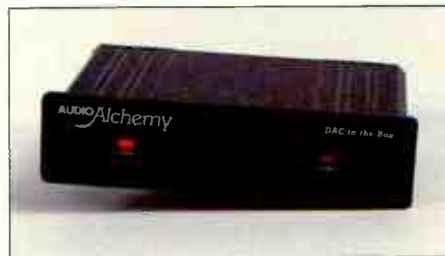

DPA Little Bit II

If, like me, you're one of those people who enjoys pieces of hi-fi that are aesthetically out of the ordinary, then the Little Bit II will be right up your street. Finished in slate grey with curved edges all around the half width case, and a front panel corrupted only by a lone green LED, the Little Bit looks decidedly purposeful. All the main switches occupy the rear panel, including one for power and another for the Deltran sync-lock facility. The DAC has two digital inputs, one optical (Toslink), one coaxial, as well as the optical slave for the Deltran.

Conversion technology is Philips' Bitstream, incorporated into a circuit board displaying the neat surface mount componentry that DPA favour.

Sound Quality

The Little Bit II is a very lively performer with a tight and cohesive musical presentation. With 'Aye', an album by African singer Angelique Kidjo, the DPA enjoyed the complex rhythmical arrangements, creating a sound with precise dynamics. Bass definition was

very good, being strong and quite deep with a rich tonal quality that is often lacking in this sterile digital world. You could criticise the bottom end for being just a tad slow compared to the more upbeat handling of higher percussion, but this is only a minor gripe.

Overall, the Little Bit expressed a very neutral character, enabling it to differentiate various instrumental timbres quite beautifully. When listening to "A meeting by the river" the subtle variations in playing techniques between Ry Cooder and V. M. Bhatt were crystal clear. This CD is a wonderful recording, produced using valve equipment and has a deep soundstage which was well exploited by the DPA, highlighting its ability to resolve intimate ambient and spatial information.

The DPA's excellent vocal definition and projection was admirably demonstrated by John Lee Hooker's 'Boom boom' where he positively

growled into a room bathed in reverb. With a Hammond organ punching through the mix, along with the kick drum and snare, the DPA put up a real performance. The treble resolution of the DPA is very explicit, if a little cold when compared to its bigger brother the PDM I/III. Hi-hat cymbals came across brightly with a sharp, incisive edge, but lacked the fullness of timbre that can be reproduced by the finest DACs available, but these cost between three and four times the Little Bit's £450 price ●

DPA Little Bit II **£450**
DPA Digital Ltd.
Unit 7, Willowbrook
Technical Units,
Crickhowell Road,
Cardiff CF3 0E1
Tel: 0222 795621



SELECT SYSTEMS Dacula

This small black box conjures up sinister images when placed in the presence of other DACs. The ribbed aluminium case produces a very workman like appearance which gives the impression that Dacula means business.

A sturdy power supply occupies a separate box attached to the DAC, that houses the crystal convertor chip, via a long lead and a 5 pin DIN plug. As with the DPA and QED, this convertor has all its operational niceties mounted on the rear panel. One coaxial digital input, a set of audio outputs and a toggle switch labelled stand-by/operate. There isn't a lot because there isn't any more room on the box measuring 45x110x165mm (hwd).

The front panel features an LED indicating the operating mode, red for stand-by, changing to orange and then green, traffic light style, when you play music.

Sound Quality

And the Dacula certainly does play music. It exudes a marvellous lucid quality with the treble in particular being sweet, very detailed and crisp. As with the Arcam, this DAC's balance also tends towards that expressed

by good analogue systems. The Angelique Kidjo album enabled Dacula to show its deft touch with intricate

percussion; triangle and bells sparkled, filling the soundstage with shimmering overtones.

The funky rhythm guitar was very lively and solid, especially considering its position at the edge of the soundstage, where the complement of backing vocals also helped to create the illusion of width. The overall picture was enthusiastically finished off with a fast, agile and warm bass.

The laid back assurance of the Dacula brought a gorgeous blend of steel and wood to the timbre of Ry Cooder's guitar, which, when mixed with the glass on steel harmonics of the bottleneck slide, was quite mesmerising. The natural acoustic of this fine recording was also expertly preserved, being punctuated by drum beats from behind the duetting guitars.

Dacula's presentation also suited John Lee Hooker, where he certainly came across as a laid back, cool cat with menace

in his voice during 'Bad like Jesse James'. The natural unforced inflections in his voice were complemented by the full tonal quality of the guitar and all its threatening dynamics which only slightly lagged behind the lightning fast Arcam and DPA.

In fact, this refined and tasteful character of the Dacula had me reaching for a copy of Gerry Rafferty's 'City to City', so I could settle down in a mellow mood with 'Baker Street'. The delicate hi-hat, vivid sax and shimmering upper harmonics on the string sections didn't disappoint ●

Select Systems DACULA **£399.00**
Select Systems Ltd.,
Hanworth Trading Estate,
Hampton Road West,
Hanworth,
Middx. TW13 6DH
Tel: 081 893 8662



QED Digit Reference

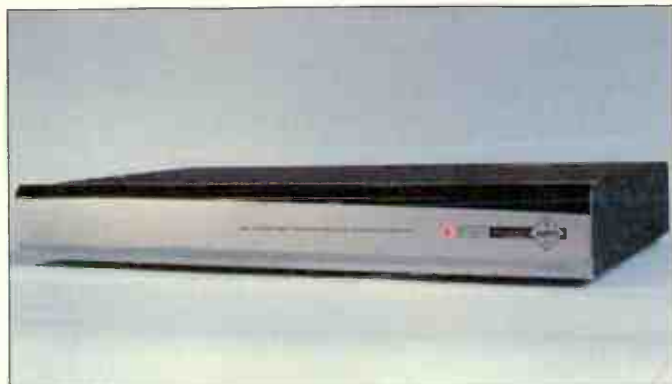

The £450 Digit reference mirrors a growing trend in the UK manufacturing industry, that being the use of mirror finish chrome on the facia of hi-fi products. Although this does look very snazzy, it also shows up grubby finger marks with alarming ease, however this isn't such a large problem as once installed there should be no need to touch. All the switching is on the rear, one for power and another for selecting either coaxial or optical digital inputs. These are grouped next to the audio outputs.

The slim, full width case houses two separate Positron power supplies, one each for the digital and analogue sections. Conversion is performed using a Philips 7323 bitstream chip and the output is based around a Signetics op-amp.

Sound Quality

With the red LED glowing brightly in the dazzling front panel I settled down and let the music play. The QED presents the listener with an exciting perspective of the material. The balance is slightly forward with a sharp, sometimes forceful,

character.

The bass on 'Aye' was quick and deep, but not quite as well rounded or defined as that produced by the DPA or Arcam DACs. Vocals were highlighted well, especially using this album with its explicit mic techniques. You could certainly notice the Paisley Park studio influences on some of the tracks. Other vocals that had been EQ'd to make them more prominent in the mix (an old trick) did however become a little too shouty with an emphasis on sibilant transients.

The Indian percussion on Ry Cooder's new album was also more forward in the mix, the QED not so good at revealing the complex reverb patterns which create the illusion of space in the reproduction. Having said that, the QED still gave a wide soundstage with precise instrument definition and wonderful variations of the different guitar tones and textures.

John Lee Hooker was in the listening

room, large as life with all the emotion present in that guttural growl of his, although the lack of differentiation between the main vocal and the artificial reverb did make him appear a little less solidly placed than some other DACs manage. The striking guitar attacks on 'Bad like Jesse James' didn't quite have the heart stopping drama and dynamics that can be recreated using this disc. But the QED still managed to communicate Mr Hookers musical intentions with a clear portrayal of his style ●

QED Digit Reference £450.00
QED Audio Product Ltd.,
Sr. Perters Road,
Huntingdon,
Cambs, PE18 7DE
Tel: 0480 52561

EMF Crystal



Another shiny one this, with a chrome mirror finish front panel measuring just 216mm wide and 72mm high. Chunky rotary controls are used to select the two coaxial and one optical input and to control the level of the variable output. Internally, the EMF uses, as its name suggests, a Crystal chip set with a low-jitter input interface, but cannot be sync-locked to a transport like the DPA or Arcam.

As mentioned earlier, the EMF features a variable output which allows the DAC to be connected directly to a power amp. It also has a set of output terminals fixed at the Philips standard 2 volts. Three LEDs on the EMF indicate the power status as well as showing when the muting and de-emphasis circuits are working.

Sound Quality

The EMF is a very refined machine which produces a detailed treble lacking the sibilant distortions inherent in some CD players. When listening to 'Aye' I noticed the delightfully deep ringing tones on some of the ride cymbal fills, giving a

more natural texture to the sound compared to the usual tizz you hear with lesser machines.

Overall, the EMF is a little drier than the Arcam, with a slightly shallower image which reduces the air and ambient presence of the track. However, this tighter sound does lead to a DAC that gives a very cohesive musical performance. Bass is particularly tight, and the dry nature also exploits the timbre of the drum skins that prevail in this rhythmical African music.

This enjoyable reproduction of percussion was highlighted again when listening to the Ry Cooder and V. M. Bhatt disc, where the tabla had such an incisive snap that it seemed to lift the tempo of the entire recording. Midrange detail was laid bare with exquisite steely textures to the guitar strings, recreating the metallic ringing of their harmonics. It's just unfortunate that the woody timbre of the instruments body was not quite as well rounded as I'd have liked.

The EMF does a superb job of focusing your attention on the prominent instruments in the mix. The Hammond organ in 'Boom, boom' was resolved well, giving insight into the lively style of playing used by Hooker to convey his interpretation of the arrangement. The hard edge to the attack on the acoustic guitar had an authority which gave body and strength to "Bad like Jesse James". This was also evident during Steve Winwood's 'Roll with it' where the EMF revelled in this excellent mix of piano, organ and brass ●

EMF Crystal £450.00
EMF Audio,
2A Bellevue Road,
Frien, Barnet,
London N11 3ES
Tel: 081 361 6734

AUDIO ALCHEMY

Dac-In-The Box

A little tongue in cheek, this product. Surely enough is enough, what with Dacula and Little Bit. Trust the Americans! However, not everything in the USA is bigger, I discovered, when picking up the Audio Alchemy DAC-in-the-box from Hi-Fi Experience on Tottenham Court Road. The DAC does come in a box, a very small box, most of it taken up by the power supply!

The actual converter comes in a very small metal case measuring 35x140x100mm (hwd) with two LEDs on the front panel, one for power and the other stating when the data-stream has been locked on. Data conversion is taken care of by a multi-bit Analog Devices 1860 chip with a Crystal input receiver. The rear panel houses the two digital inputs, optical and electrical, as well as audio outputs for the stereo channels and a small jack plug socket for connection to the outboard power supply.

Sound Quality

I must admit to being a little taken aback by the Audio Alchemy. With its toy shop name and Corgi size I was expecting a

Mickey Mouse sound, but this little gem told me otherwise.

The first instantly noticeable aspect of this DAC's sound was its dry, tight bass. Although being the lightest in the group it was still quick and lively, if a little lacking in the dynamic punch and transient definition of other DACs. This was at its most obvious with the Angelique Kidjo disc which displayed great integration of percussion, especially the up-beat tracks, but lacked the dynamic shading that is present in the recording, leaving it sounding a touch bland with the leading edges softened.

Image depth and stage width were magically captured in the 'Meeting by the river' CD (which makes it an excellent reviewing disc). The Audio Alchemy produced a slightly enclosed stage with a shallower depth and less explicitly detailed acoustic information. However, its portrayal of the guitars was seductively mellow and refined, if again lacking the

raw metallic glare which these instruments can produce.

The treble quality displayed by this DAC was very inoffensive; there was plenty of detail and musical insight, although it didn't shimmer in the way Dacula can.

The gentle character of the DAC-in-the-box was a little at odds with some of John Lee Hooker's material where the menace in his delivery was fractionally diluted. But the blend of instrumentation and the overall integration of the sound was very good ●

Audio Alchemy £199.00
Path Distribution,
Unit 15, Hayward Ind. Park,
Tameside Drive, Castle Bromwich,
Birmingham B35 7BR
Tel: 021 749 2240



ARCAM

Black Box 50

Internally, the new Black Box is very interesting, employing what Arcam refer to as a hybrid 18 bit conversion system, where multi-bit conversion is used for the upper bits and single-bit conversion for the lower ones. At £450 this technology comes resplendent in a full width case with elegantly curved front panel complemented by subtly rounded switches. These select the digital input (coax/optical), the sync-lock defeat, phase inversion and power status.

Arcam have fitted the Black Box with two sets of audio outputs as well as a monitor output for digital connection to a DAT or CD-R machine. Like DPA, Arcam have fitted a sync-lock, slaving the transport to the clocking mechanism in the DAC. However you must purchase Arcam's Delta 250 transport to use this feature; thankfully this was also supplied for review.

Sound Quality

The Black Box sounded very promising even when fresh out of the packing case, but I allowed it to 'burn-in' over the weekend of the Bristol show. What greeted me on Monday morning was a very good CD source indeed.

What immediately struck me about the Black Box sound was how much detail it resolved, and that it delivered music in such a seductive manner. This DAC manages to give a vinyl-like balance to the digital medium. The treble was sweet and lively, if a touch breathy at times and the bass warm and rich with excellent timing and rhythmic presence.

The image thrown out by the Black Box was both wide and deep, with the central vocals slightly laid back in respect to the plane of the speakers. Listening to the 'Aye' album I became very aware of the integration of Angelique Kidjo's voice into the mix; this led to a pleasing and harmonious musical presentation. With percussion the Black Box produced tight and cohesive transients that were very nearly equal to that of the DPA, however the Arcam did just edge ahead in the bass, being a bit fuller and quicker.

The gorgeous instrumental timbres present on the Ry Cooder CD, recorded

using valve gear, were enticingly exposed by the Black Box, giving an exemplary insight into the techniques of the performers. The depth of the recording, which is filled out by Indian percussion, in this case a tabla and a dumbek, was also well preserved giving a solid image with acres of space around the musicians.

Where the DPA dissected the mix with surgical precision, the Arcam manages to blend the various harmonic clues into a complete picture, yet still maintaining the intricate positional balance within the soundstage ●

ARCAM Black Box 50 £450.00
A&R Cambridge Ltd.,
Pembroke Avenue,
Denny Ind. Centre,
Waterbeach,
Cambridge CB5 9PB

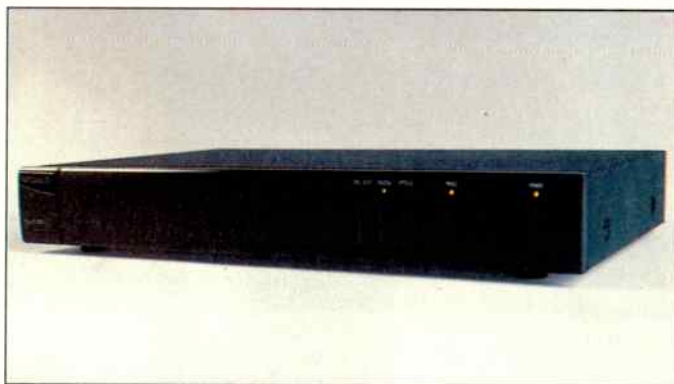

DPA LITTLE BIT II TEST RESULTS

| | | |
|--------------------|--------------|--------|
| Frequency response | 4Hz-21.25kHz | |
| Distortion % | | |
| -6dB | 0.0056 | 0.0054 |
| -30dB | 0.011 | 0.011 |
| -60dB | 0.77 | 0.72 |
| -90 | 37.7 | 35.1 |
| -90dB dithered | 13 | 12.5 |
| Separation | left | right |
| 1kHz | 110 | 110 |
| 20kHz | 99 | 94 |
| Noise | | -102dB |
| with emphasis | | -105dB |
| Dynamic range | | 105dB |
| Output | | 1.86V |

Frequency Response

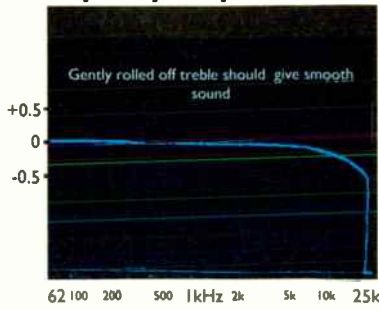

Distortion

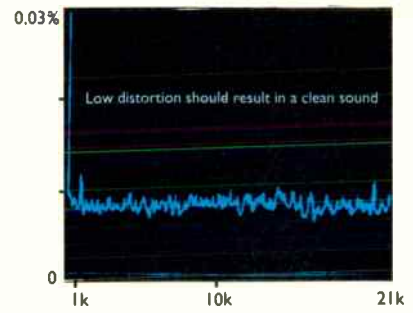

DACULA TEST RESULTS

| | | |
|--------------------|-------------|-------|
| Frequency response | 4Hz-21.2kHz | |
| Distortion % | | |
| -6dB | 0.006 | 0.006 |
| -30dB | 0.006 | 0.006 |
| -60dB | 0.75 | 0.73 |
| -90 | 33.4 | 32.3 |
| -90dB dithered | 5.26 | 3.5 |
| Separation | left | right |
| 1kHz | 104 | 109 |
| 20kHz | 89 | 86 |
| Noise | | -89dB |
| with emphasis | | -89dB |
| Dynamic range | | 104dB |
| Output | | 1.9V |

Frequency Response

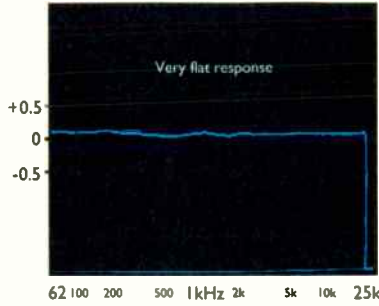

Distortion

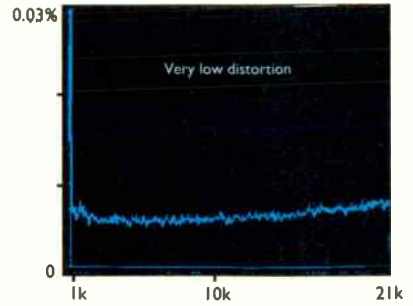

DIGIT REFERENCE TEST RESULTS

| | | |
|--------------------|-------------|--------|
| Frequency response | 4Hz-20.4kHz | |
| Distortion % | | |
| -6dB | 0.004 | 0.004 |
| -30dB | 0.02 | 0.02 |
| -60dB | 0.59 | 0.51 |
| -90 | 30.8 | 28.7 |
| -90dB dithered | 6.31 | 7.74 |
| Separation | left | right |
| 1kHz | 97 | 101 |
| 20kHz | 95 | 93 |
| Noise | | -100dB |
| with emphasis | | -101dB |
| Dynamic range | | 107dB |
| Output | | 2.38V |

Frequency Response

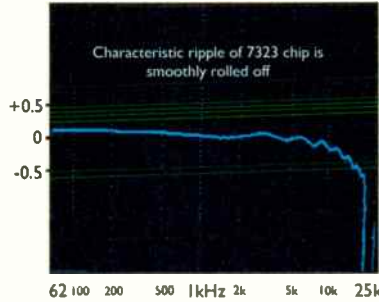

Distortion

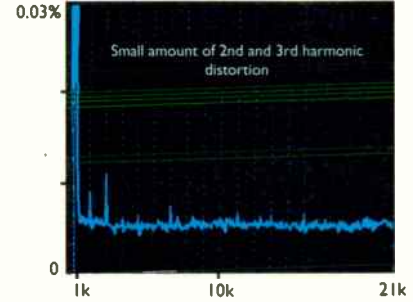

CRYSTAL TEST RESULTS

| | | |
|--------------------|-------------|--------|
| Frequency response | 3Hz-20.2kHz | |
| Distortion % | | |
| -6dB | 0.006 | 0.006 |
| -30dB | 0.012 | 0.008 |
| -60dB | 0.43 | 0.36 |
| -90 | 34 | 38 |
| -90dB dithered | 19 | 24 |
| Separation | left | right |
| 1kHz | 109 | 106 |
| 20kHz | 89 | 87 |
| Noise | | -120dB |
| with emphasis | | -120dB |
| Dynamic range | | 114dB |
| Output | | 2.02V |

Frequency Response

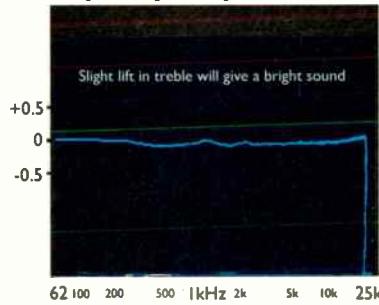

Distortion

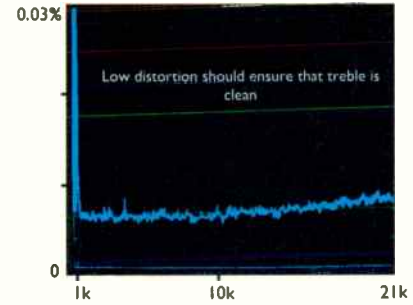

DAC-IN-THRE BOX TEST RESULTS

| | | |
|--------------------|-------------|--------|
| Frequency response | 4Hz-21.3kHz | |
| Distortion % | | |
| -6dB | 0.009 | 0.01 |
| -30dB | 0.03 | 0.03 |
| -60dB | 1.02 | 0.89 |
| -90 | 55.9 | 49 |
| -90dB dithered | 32.5 | 24.5 |
| Separation | left | right |
| 1kHz | 117 | 98 |
| 20kHz | 104 | 72 |
| Noise | | -106dB |
| with emphasis | | -109dB |
| Dynamic range | | 101dB |
| Output | | 2.55V |

Frequency Response

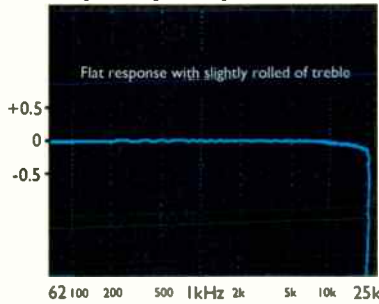

Distortion

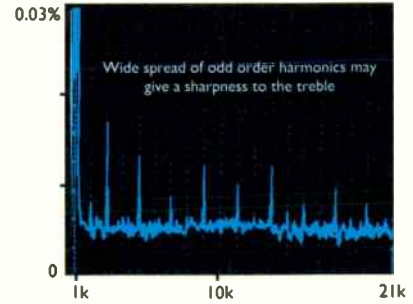

BLACK BOX 50 TEST RESULTS

| | | |
|--------------------|-------------|---------|
| Frequency response | 4Hz-21.4kHz | |
| Distortion % | | |
| -6dB | 0.014 | 0.017 |
| -30dB | 0.096 | 0.128 |
| -60dB | 1.34 | 2.62 |
| -90 | 39.9 | 78.9 |
| -90dB dithered | 12.7 | 6 |
| Separation | left | right |
| 1kHz | 101 | 90 |
| 20kHz | 92 | 68 |
| Noise | | -89.5dB |
| with emphasis | | -93dB |
| Dynamic range | | 98dB |
| Output | | 2.36V |

Frequency Response

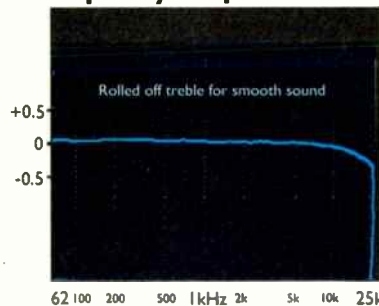

Distortion

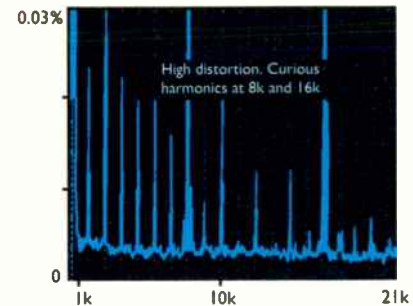

S Standens
 92A HIGH STREET
 TONBRIDGE 0732-353540

**ALL QUAD
 PRODUCTS STOCKED**

*Listen to some of QUAD'S finest
 hi-fi equipment in our two
 demonstration rooms*

**WE'VE BEEN GIVING
 SOUND ADVICE FOR
 OVER 50 YEARS**

DAVID NEWTON

'Return Journey'

for solo piano

'Beautifully judged playing'

David Newton is one of the rising stars of British Jazz. He is highly regarded throughout Europe as both soloist and accompanist, playing and recording with everyone from Buddy de Franco to Carol Kidd. His pedigree as a composer is equally impressive, from his early days as Musical Director to Alan Ayckbourn to more recent commissions from the BBC.

'Return Journey' is David Newton at the height of his powers, as pianist, composer and improviser. His playing has a power and immediacy which communicates like no other while his extraordinary sense of melody and formal control will delight and surprise at every turn.

*'Return Journey' is available on Linn Records
 AKD 025 (CD) AKH 025 (LP), AKC 025 (MC)
 Distributed in the UK by Polygram*

Infidelity

indecently good hi-fi



Buying hi-fi should be fun, we guarantee to make it so. Listen to a well chosen selection of quality hi-fi equipment in our comfortable and relaxed listening room. Bring along your own records or CDs, we'll provide the coffee, and hear the difference we can make to your enjoyment of music.

MICROMEGA's fantastic new STAGE CD players now on demonstration

ARCAM, EPOS, HEYBROOK, MICROMEGA, NAIM, NAKAMICHI, NEAT, REGA, ROKSAN, ROTEL, ROYD, TEAC and YAMAHA

9 High Street, Hampton Wick, Kingston upon Thames, Surrey KT1 4DA
 Telephone: 081-943 3530. Open: Tues - Fri 10.30am - 7pm, Saturday 10am - 6pm.

EXPENSIVE TUNER??

THEN HAVE THE AERIAL IT DESERVES

You spend many hours and quite a lot of money choosing that new tuner, so don't ruin the whole effect by fiddling with bits of wire or old aerials. Have the full benefit of the multipath-free, clean signal which only a well designed and properly installed unit can achieve. If D.X. is your scene, then go for the ultimate in rotating high gain narrow beam systems like our G.23 with 19dB Forward gain, 38dB F. to B. and Acc. Ang. down to 15 Degrees or have a "one off" special built, up to 32 elements.

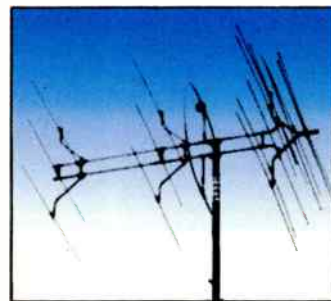

GALAXIE CIRCULAR 17-ELEMENT STEREO
 GAIN 15.9dB F. TO B.33.7dB. L.74"

WE DESIGN, MANUFACTURE, SUPPLY AND FIT

- ★ FM arrays from 4 to 23 Elements. TV from 10 to 92 Element.
- ★ British-built and designed to withstand our weather.
- ★ Interested D.I.Y. advice freely given, backed by our complete range of masts, brackets, rotors, cables and aerials. Systems available for chimney, loft, wall, or through roof mounting.
- ★ Professional installation service available within a nominal 200-mile radius of LUTON. Full details of this service available on receipt of a large S.A.E. which will bring you our complete "Aerial Guide" which is more than just a list of our products and prices, and carries details of all our services, including MAIL ORDER and site surveys.

**CONTACT US ON 0582 36561 or WRITE To:
 RON SMITH AERIALS**

98, ASH ROAD, LUTON, BEDS, LU4 8AQ

Personal Callers: Shop Hours Mon. Fri. Sat. 9.00 to 6.00. Lunch 12.30.1.00
 Tuesday & Thursday 9.00 to 10.30. Wednesday Closed

(On Tue/Wed/Thurs/ we are often available: Phone to check. Mon/Fri/Sat we are always open)

**NAIM AUDIO U.K. RECOMMEND OUR FM AERIALS AND THEIR DEALERS
 CAN OBTAIN YOUR CHOSEN MODEL WITHIN 48 HOURS, OR SUPPLY EX
 STOCK.**

CONCLUSION

All the DACs in this test were successful in that they provided a sufficiently high standard of sound quality to justify their purchase. This underlines the fact that CD replay has advanced considerably over the last couple of years or so. To be honest, if you own a good middle market CD player that's beginning to get a little sonically 'dog eared', then any of these convertors should bring about a sizeable improvement in sonic performance.

At £199.95 the DAC-in-the-box was

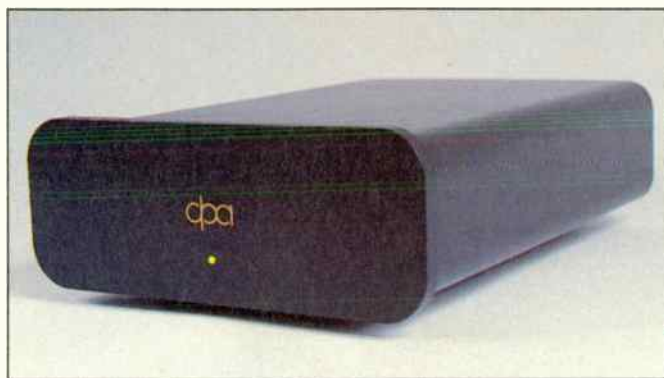

a little out of its depth in this group. Having said that, however, it didn't disgrace itself. In fact, since the other products all cost at least twice as much as this little wonder from Audio Alchemy, it was they who needed to prove their worth against it. DAC-in-a-box gives a disproportionately high quality of sound for such a miniscule outlay.

If you already own a QED Digit and Positron, the Reference is definitely a convertor to listen to, especially in view of the upgrade path that QED make available. It gives the Digit more dynamic presence, one which creates an exciting musical perspective that is slightly raw around the edges. Good for rock music maybe, but the QED lacks some of the refinement that makes the remaining DACs better all-rounders, I feel.

It was this refinement that marked out the EMF Crystal as a particularly impressive convertor. The treble could be singled out as being especially detailed, whilst at the same time retaining a cohesion that made listening very pleasurable. This DAC's ability to focus a listener's attention on the main elements of a mix, without compromising the detail present in the rest of the soundstage, made for a very informative sound which could be just a touch too dry in the bass, but never slow.

The Dacula was seductively subtle in

its presentation of a musical performance; this was its forte. This device gently creeps up on you with devilish intent, until it consumes you with its persuasive performance. Forget this unit's unorthodox looks and size, Dacula is a very desirable product. Music is recreated with a panache that belies its digital origins, the shimmering treble is an absolute delight, especially at this price. The cohesion of the sound across the entire frequency spectrum was also the main reason for the DAC's ability to

mimic a good vinyl system, along with tuneful bass. It's unfortunate that the Dacula didn't possess the feature that enabled our remaining two DACs to contest the final shoot-out.

Yes, you've guessed it, Sync-locking! OK, I can

hear the other manufacturers crying "foul", but I feel that it's unjust not to allow the DPA and the Arcam to benefit from their inclusion of this feature. However, even when used as ordinary stand-alone convertors these two still did enough to justify their place in the final battle.

The Little Bit is the most neutral performer here. Its ability to differentiate

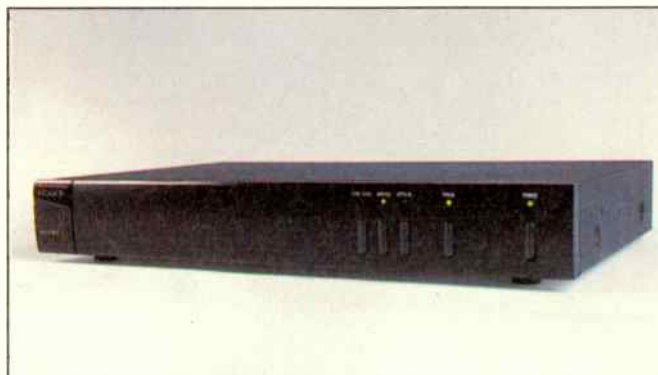

between instrumental timbres was most enjoyable as was the dynamic shading and resolution of transient information. Where the DPA did slip up, however, was in the bass. It was superbly defined and taut but I felt it lacked a little pace. Overall, the DPA did appeal more to one's cerebral facilities than to the heart.

Oh for a smidgen of the Dacula's soul!

So this leaves us with Arcam's Black Box 50. A controversial choice this one, but to my ears it was the convertor that sounded most impressive, more so when sync locked with the dedicated transport.

The bass was superb: tight, extended and very articulate. In the treble the Arcam displayed a sweet nature with the only major gripe being a slight breathy quality which was tidied up by the sync-lock, but what won the day was the portrayal of John Lee Hooker's voice - it was the most life-like of all I felt. Others (Eric Braithwaite, Dominic Baker and Noel Keywood, all of whom listened) had some reservations, acknowledging it as very impressive in timing, bass power and overall dimensionality, but feeling that there was some slight loss of body to vocalists. A certain degree of lower treble emphasis may have been responsible for this, but it also enhanced detail.

Whatever - and there were reservations about measured distortion colouring the sound slightly - the Arcam must be auditioned. Everyone found it impressive, although some preferred the DPA for truthfulness of balance. We were split on this one.

TRANSPORTS

When assessing these DACs, three of the manufacturers, Audio Alchemy, Arcam, and DPA expressed a preference for their own transport to be used. This was particularly relevant with the products from Arcam and DPA, because they use

an optical link between the DAC and the transport enabling the clock fitted to the convertor to control the data from the transport.

The use of sync-locking allowed the Arcam and DPA to take a step ahead of the competition, in both cases bringing about a cleaner,

more precise sound, tightening up the musical strands of a performance to produce a better defined structure.

The only drawback of this system is the expense (isn't it always!) which works out at £750 for the Arcam Delta 250 transport and £795 for the DPA TI transport ●



Musical Celebration

When I took Danish cartridge manufacturer Ortofon's new flagship, the MC7500, home with me, I promised not to make any bacon jokes. But it brought home to me how astonishingly good the sound from vinyl can be. (Oops. Near miss, there.) And that is having had a bevy of equally expensive digital replay gear around over the last few months. At £2000, I'll say unequivocally the 7500 moving coil cartridge is worth every penny.

I've always held that reproducing the real-life scale of music through hi-fi is an unattainable goal. Anyone who has sat next to a concert grand or even a flute-player will know the sheer dynamics are impossible to re-create. But the illusion is attainable and the Ortofon comes so close it's uncanny.

Take Mingus live at two different venues in New York. The atmosphere was tangible, the subtle differences of captured ambience quite distinctive, and the playing entrancing. There's something about the way the Ortofon reproduces

Ortofon celebrate their 75th anniversary with the MC7500

Moving Coil cartridge.

Eric Braithwaite celebrates its superb sound.

acoustic instruments that is exceptional in its stability, shades of tonal colour and convincing accuracy. Listen to an alto or soprano sax and each is absolutely spot-on, so real you can see the shape and the size.

As a window into recording quality, the Ortofon is almost frightening in its clarity. After the Mingus, after a whole bevy of Blue Notes, I turned to Gerry Mulligan on Castle. What a shock it was to hear the unmistakable sound of a DAT master tape copy rather than Blue Note's reel-to-reel. A friend thought it was a DAT machine I was playing it on.

This extraordinary insight and resolution brings with it some difficulties. Some of my favourite rock was

disappointing. There's little point in playing Dinosaur Junior; the whole damn thing was so electronic, so flat, un-dimensional and compressed and the Ortofon so unforgiving that it becomes depressing, no matter how good the music. The MC7500 is for serious collectors.

So, by and large, it was my 'serious' collection of recordings I turned to (that, by the way, didn't exclude rock, but it did mean picking early pressings like the first American one of LA Woman, rather than ones made from second or third generation tapes). Here, the Ortofon is supreme.

On opera, the nuances of vocal expression, the dynamics of the singers and orchestra, the staging, are captured

with vivid realism and great grace. Desdemona's scream at the end of Otello was spine-chilling; the great burgeoning of orchestral colour in the Overture to Tannhauser mouth gappingly dynamic.

So it is with concerti, whether they are Romantic or Baroque. C. P. E. Bach's concerto for two pianos was reproduced with the most accurate timbral differences and subtleties possible, each absolutely precise in scale and positioning vis à vis the rest of the instruments. Ricci's violin in the Decca SXL of the Tchaikovsky Violin Concerto was breathtaking in purity and quality of tone, as well as technique. That's not ignoring the emotional effect, either. As with all hi-fi to aspire to, the MC7500 conveys the full gamut of emotion from A-Z with the fervour of a live concert.

Curiously, it does all this without any of the distracting side-effects associated with vinyl replay. The Gyger Replicant stylus (sounds like a Schwarzanegger character) is so called because it's intended to replicate the shape of a cutting stylus. It does this to such effect that even my more worn, treasured, ASD and SXL recordings replayed with a remarkable lack of surface noise. What was more distracting, although it never detracted from the performance, was the amount of tape hiss behind the music, or on Decca's Kingsway Hall recordings the rumble of the tube trains below the hall. I have a strong suspicion that even the producers have seldom heard their pressings so well-reproduced.

There is one curiosity. While the Ortofon is exceptional in conveying scale, tonal colour, intimacy, breadth and depth, there are times when the bass appears to have a couple of anomalies, at least, when it's assessed against top-end digital, even if it's fully equivalent and often superior in other areas. There is a bloom to it which makes timpani and occasionally double-basses sound too fully and less sharply defined than, say, the beautifully rosinny tone of cellos and violas, or the unerring reedy tone of woodwind in all its variety (even when an oboe is buried in the depths of a score, its position and sound is unmistakable). This can be tightened up with care by adjusting the tracking weight and bias, but while the focus stays sharp, rhythm and beat on rock driving along like a TGV, bass tone is still less pure than one suspects really was recorded.

All the same, that is simply subsumed by all the other things the MC7500 does so well. Dynamically, Ortofon's new top-end model deals with changes in pace and volume with absolute aplomb. It's in the subtlety of it that it deserves acclaim: when a pianist holds one note back, slightly behind the beat, this is normally subjugated to the rhythm. With the 7500 in the arm, it's plain for all to hear, just as the player intended.

No snags? Well, apart from it costing the price of a second-hand car, its output is low. At 0.13mV it's not so near

inaudibility as previous Ortofon MCs, but I doubt if any normal MC stages would cope with it without hiss (but then, you wouldn't use it with a £250 integrated, would you. Would you?) A dedicated top-quality MC stage or transformer are essential. Ortofon also supply eight-nines copper headshell leads - use them, they sound better. Unfortunately, they also supply screws rather than allen-headed bolts, which are harder to tighten up.

But the plusses outweigh all this. The body is machined out of titanium, subtly shaped like a Saab Turbo and silkily finished even down to a laser-printed name and number on the front. Even without seeing the Bosboom miniature

leather Gladstone bag it arrived in, everyone was impressed. I don't want to return it; my friends don't want me to send it back. Alas, I've emptied my piggy bank and it just doesn't have a hundred thousand two-penny pieces in it. Now, where did I put that pools coupon . . . or that book about the Great Train Robbery?

Ortofon MC7500 £2000
Ortofon UK Ltd.,
Chiltern Hill,
Chalfont St. Peter,
Bucks. SL9 9UG.
Tel: 0753 889949

MEASURED PERFORMANCE

Frequency response of the MC7500 is shown at fairly high resolution in our third-octave analysis. Like that of most moving coils, the upper midband does not droop, since there are no generator losses. Ortofon have tamed the treble peak - a common problem with MCs - well, but I was surprised to see it centred at 10kHz, reminding me a little of the old SPU. By cartridge standards though, the 7500 has a commendably flat frequency response. In case you are wondering, the peak at the left (low frequency) end of the trace is caused by arm/cartridge resonance; it's not strictly a cartridge phenomenon.

Tracking performance was very good at low frequencies and exceptional in the midband. I was surprised to find the 7500 clear 25cms/sec rms, something few other cartridges can manage. This will give a very secure and confident sound, on vocals in particular.

Distortion from MC cartridges is always a little higher than that from a good MM. Ortofon's own VM Series used to turn in around 0.3% on lateral modulation. The 7500 produces 0.7% in contrast to this, primarily second harmonic in nature. Vertical tracking angle measured an accurate 23degrees, keeping vertical mod. distortion down to a low 1.5%. This is lower than that from most cartridges (3-5%).

Channel separation was a satisfactory 24dB overall. Output was very low at 0.19mV at 5cms/sec rms. Technically the best way of matching is via a step-up transformer, but to date I have found good preamps sound a little better. However, it would be impossible to produce a preamp for this cartridge that lacked audible, if slight, hiss, its output is so low.

The 7500 measures like a good MC should. However, measurement doesn't reveal much about tip geometry, nor a myriad other factors that affect sound quality, so listening tests must be, as always, the final arbiter of sound quality.

NK

TEST RESULTS

| | |
|--------------------------|------------|
| Tracking force | 2.5gms |
| Weight | 11gms |
| Vertical tracking angle | 23degrees |
| Frequency response (2dB) | 20-20k |
| Channel separation | 26dB |
| Tracking ability (300Hz) | |
| lateral | 90µm |
| vertical | 45µm |
| lateral (1kHz) | 25cms/sec. |
| Distortion (45µm) | |
| lateral | 0.7% |
| vertical | 1.5% |
| Output (5cms/sec rms) | 0.19mV |
| Channel imbalance | 0.6dB |

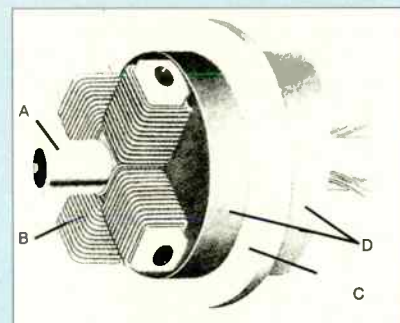

MC7500 Signal Coil assembly

- A - Cantilever holder
- B - Signal Coils
- C - Platinum washer
- D - Rubber Dampers

Frequency Response

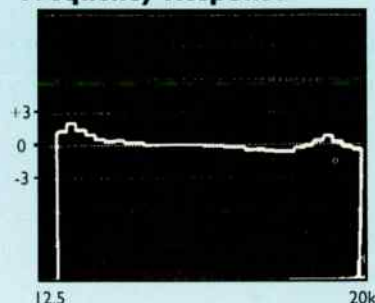

Three Ways Forward

Dominic Baker listens to the high technology, three-way Kappa 6.1i from Infinity.



A good three-way loudspeaker promises good bass, a clear and cohesive midrange plus sweet treble, thanks to dedicated drive units. With such potential in mind I looked

forward to getting Infinity's Kappa 6.1i speakers home. Having a price tag of £995, they sit at the bottom end of this U.S. manufacturer's range, one that stretches from £200 up to - well - infinity.

Pouring over the blurb I discovered that a lot of thought has gone into the drive units of this speaker. The bass unit has a large 8inch injection-moulded graphite cone. Injection moulding gives a

more consistent and controllable wall thickness than vacuum forming (the usual method) and the graphite used gives a strong, yet light cone that handles power well but can respond quickly to transients.

Moving upwards, the midrange driver is made from a soft, clear plastic which allows its 2inch dome and surround to be moulded from one sheet of material. The metal gauze behind this dome was not, as I first thought, to prevent little fingers pushing it in, but is there to break up standing waves in the cavity behind the surface of the dome.

At the top lies a circular ribbon tweeter using a lightweight Kapton diaphragm. In general, ribbon tweeters offer a sweet and unusually clean treble response.

So, the ingredients all seemed to be of high quality and my expectations, as I read the literature, were steadily rising. A couple of other points worth mentioning are the level controls for midband and treble (well, Infinity are American) and the use of wedge shaped cabinets to reduce standing waves.

So that my expectations weren't falsely shattered, I left the Kappas in a small room pumping music overnight to run them in properly. Ribbon tweeters especially tend to need this time to sweeten up and deliver their best.

Next morning, seeing that these speakers were rated as 6ohms impedance, and that the minimum recommended amplifier requirement was 30watts, I decided to remove the valve amplifier from my system and replace it with a DPA solid-state design, which seemed a safer bet to begin with.

I began listening with Texas and their new Ricks Road album. This is a good, full bodied recording that tends to bring the best out of most hi-fis - and it certainly worked well in this instance. The Kappas had a big, easy and relaxing sound that managed to engulf the room and the listener. Their bass was on the larger side, giving a heavy thud to bass lines, but it just managed to steer clear of sounding monotonous. It wasn't what I'd call particularly powerful or dynamic, though it was firm and there was plenty of it. The midband and treble regions were good quality too. The midband had the kind of focus and smoothness that only good three-way 'speakers have and the treble was as sweet and open, as you'd expect from a good ribbon.

It wasn't until track seven, 'You've got to give a little', that I started to doubt the 6.1is. This track is a real foot tapper if ever there was one, but something was missing that threatened to take away its appeal. The upper bass punch which forms the foundation and beat for this track failed to make it out of the cabinets, giving an almost reticent presentation, reducing their apparent 'speed'. This track also picked out a few other oddities that started to explain what the Kappas were up to. Although each individual drive unit is undoubtedly very good at its job, they

weren't integrating well enough to give a cohesive performance. Here was a case of plenty of individual talent, but an uncoordinated team effort.

Moving on to REM's Automatic for the People, the Kappas sounded a little more together. They are best suited to this kind of dry recording, but given anything a little rich they seemed stifled. The soundstage was quite wide and had some depth to it, which is a good thing, and they imaged well enough to place Stipe and the members of his band reasonably accurately. I did try experimenting with the midband and treble level controls during this album, but although the midband could be forced a little further forwards and the treble given a little extra crispness, they also became more obvious as individual drive units.

The Kappa 6.1is are a soft, relaxing loudspeaker to listen to. They don't offer much insight into music but they do give it a pleasantly warm character. I suspect that part of this softness was due to the midrange dome failing to match the bass unit or excellent tweeter. It sounds as if there was a gap either side in the

frequency spectrum, removing some crispness and punch. They don't suffer poor recordings well either; where other 'speakers push a recording at you, the Kappas refuse to let it out and if the recording is already a little recessed sounding in itself, the effect is cumulative, resulting in a muggy sound.

The Kappa 6.1is have many good things going for them: their treble is excellent, having a lovely, detailed and liquid quality that sets ribbons apart from the rest. The midband was good too: smooth and clear, if a little too far back to offer real projection. But as a package the Kappas fail to impress. They are polite and won't offend, but they we're just a little too laid back for my taste ●

Kappa 6.1i **£995**
Gamepath Ltd,
25 Heathfields,
Stacey Bushes,
Milton Keynes,
MK12 6HR.
Tel: 0908 317707

MEASURED PERFORMANCE

Infinity are one of America's biggest loudspeaker manufacturers, so I was expecting a well engineered and thought-out loudspeaker in the Kappa 6.1i. And indeed I found just that. Using impressive drive-unit technology, their frequency response was both even and within desirable tolerance limits, ensuring a balanced subjective performance.

There was a lift in the upper bass and again higher up in the midband, enough to add a little punch to the bass and help push vocals out of the 'speakers, avoiding boxy colouration. The dip higher up in the treble will remove some sparkle and energy, but the positive side is that the speakers won't exaggerate sibilance or harshness, so a smooth sound should result.

As is common with many U.S. loudspeakers, the Kappa 6.1is are of higher than average sensitivity. They produced 88dB of sound pressure level at 1m with a 2.83V pink noise signal, which is 2dB or so higher than average. This means that the Kappa 6.1is will go loud with relatively few volts.

However, the impedance curve gives more of the story. The Kappas are a low impedance load, which means that although they are sensitive, they aren't particularly efficient. They demand nearly twice the current from an amplifier that a typical high impedance British loudspeaker would for the same volume control position. Our analysis shows that this speaker's impedance sits just below 5Ω for much of the frequency range and has a measured overall value of 6Ω, which is low. This makes them a demanding load, one that is liable to highlight power supply

differences in solid state amplifiers and demand the use of a 4Ω output tap in a valve amplifier.

The Infinity's are also a highly reactive load, shown by the sharp dips and peaks in the impedance curve, but having said this, most modern transistor amplifiers will have no problem driving them.

The Kappa 6.1is are a well engineered loudspeaker. Their frequency response is smooth due to successful integration of the three drive units, at least in measured terms. They are a quite demanding load, but a quality transistor amplifier of around 50watts or so should drive them with ease. DB

Frequency Response



Impedance



SYSTEM LOUDSPEAKERS

"EVEN A SHORT LISTEN TO THESE WELL BUILT SPEAKERS FROM
THE SCOTTISH COMPANY BEST KNOWN FOR TURNTABLES
WILL TELL YOU THEY'RE SPECIAL"

WHAT HI-FI? February 1994

SYSTEMDEK LTD. IRVINE HA12 8LD SCOTLAND U.K. TEL 0294 271251 FAX 0294 277095

VDH Carbon *Cables*

'THE FIRST'

" These wires will make your
system sing. "

What Hi-Fi? Nov '93

Also in the Carbon series

THE SECOND

Balanced interconnect

REVELATION

Probably the world's finest speaker cable

REVOLUTION

Reference speaker cable

NEW 'STORM'

Classic interconnect from £24.99pr

'SNOWTRACK'

Superior bi-wire speaker cable £7.99/m

VAN DEN HUL UK
P.O. BOX 304, MAIDSTONE, KENT ME16 8TS TELEPHONE: (0622) 721636

van den Hul

Affordable Hi-End

CD Players
DAC
Amplifiers
Loudspeaker

" I also feel that the Orelle
CD-10T/DA-180 combination
sets a new reference in this
price category. "

Hi-Fi News & RR, Oct '93

NEW **CD-480** CD Player **£399**

VLS series interconnects

IC-1200

Silver plated OFC cable **£34.99pr**

D-LINK

Solid silver digital interlink **£49.99**

UNIT 12, I-MIX HOUSE, 6 WADSWORTH RD, PERVALE, MIDDX UB6 7JJ
TELEPHONE: 081-810 9388 FAX: 081-810 9365

Orelle
Hi-Fi

Recently we've measured - and rejected - a number of products that hadn't been properly tested during development. They behaved abysmally in objective terms and the problems were audible. I hope the fallacy that products can be developed satisfactorily without measurement isn't about to set sail once again.

It's a convenient idea for cash strapped small manufacturers, and it's convenient for non-technical journalists (and magazines) too, who would equally like to believe that testing can legitimately be avoided. It isn't very convenient for buyers though who, in the fullness of time, will too often find they bought a pup and won't wish to repeat the experience.

In the long run, duff niche products tar all small manufacturers with the same brush - one of incompetence - discouraging buyers and retailers alike from taking an interest in products occupying this part of the market.

At present, Britain's got a great indigenous hi-fi market. I'm surprised by the robust enthusiasm with which U.K. hi-fi enthusiasts pursue their hobby. They're prepared to risk spending thousands of pounds on specialist products of unproven reputation - but it's an act of faith that should not be abused. If it is, then slowly but inexorably the desire for such products will be overwhelmed by fear of unreliability and poor performance. Buyers will drift away and that'll be the end of that. The market for niche products will die as potential buyers feel they must, by all common sense, be forced to accept the poorer sound but greater reliability of mass produced equipment that comes from the better equipped major manufacturers.

If this happens, Britain will lose not only its present vigorous and, in places, inventive cottage hi-fi industry, but also the potential to support new company start-ups. Large oaks grow from small acorns;

most UK hi-fi manufacturers started up in a back room somewhere or other. Too many poorly developed products will kill this sort of entrepreneurial spirit, ultimately destroying a tenacious sector of British manufacturing that has existed from the very beginning of electronics as a technology, way back near the turn of the century.

The dangers of ignoring measurement are not obvious, but they can be severe. My favourite example, because it is so cogent, is that of the Decca London cartridge. Anyone



Reflections from Noel Keywood kaleidoscope

who's heard it admits to being mightily impressed - including me. It delivers hair-trigger transients and possesses the fastest, punchiest bass going. But often I hear this interesting tell-tale observation "If it's right, then all other cartridges are wrong".

Sadly, the Decca isn't right - it's massively wrong: measurement proves it. But this remark is fascinatingly true about many products that measure poorly - they may sound quite radically different, leaving listeners to decide whether they are very right, or very wrong.

This cuts right to the heart of the dilemma such products raise. It is possible to produce a hi-fi product that sounds different, even interesting in sonic character - but of poor basic performance. I'm not being academic here - having the ability to measure I've come across many in twenty five years of reviewing. That these products are wrong is not necessarily immediately obvious though, at least, in listening tests. I'll come onto the product that sparked off these musings in a minute. First let me give you another example of one of the most blatant and

accepted examples of acceptable wrongness - the Euro 'speaker.

This animal has boom and ting. It isn't, unfortunately, a figment of the imagination of Europhobic British journalists. Many European loudspeakers are still engineered knowingly with a sound tailored to appeal to what what European buyers find most desirable.

Does it matter if something is not right, so long as it's enjoyable? Perhaps not, but that's a personal decision that should be left to the individual listener. I suspect most people would at least like to know about this sort of thing beforehand, and it's essentially our job to provide such information in reviews of course, which is why we have an in-house laboratory and measure every item we review.

Finally, let me cover the situation that renewed my fears about the subjective-only assessment and development of hi-fi products. A valve amplifier arrived for review. One independent freelance had reputedly said it sounded awful and had refused to review it, yet another had

said it sounded really good. We measured it - awful!

We studied the circuit, looked at the components used and the quality of construction and then listened. The reasons for the ambivalence toward it became obvious. High quality components and the fact that, as in all valve amps, just a few thermionic amplifying devices were present, in this case with necessarily limited feedback, guaranteed a good degree of basic clarity and crispness to the sound. But the distortion we measured was also audible, colouring

the sound severely with coarseness if volume was turned up (this was a 70watt amp).

The first reviewer listened at high levels, the second at relatively low levels. Neither got all of the picture. One heard all that was wrong about the amplifier, the other all that was right. I sympathise with their plight more than I do with that of the manufacturer, who had commissioned the design from an engineer who knew it was wayward and yet had not thoroughly checked the outcome. I told him exactly what was wrong and who could put it right for him (we could, but it would compromise our impartiality). We will review the amplifier soon.

I hope you can see from these tales why measurement is essential. A good measured performance doesn't guarantee good sound quality, but it is an important prerequisite for it. Some people in the industry have conveniently convinced themselves that measurement isn't necessary. They are wrong - dangerously wrong. It's not in anyone's interest to produce duff products ●

"ASTOUNDING"

DIGIT THE DAC

QED'S Bitstream Digital to Analogue Converter

"... It really is the most cost effective upgrade ever... For twice its price it would be superb, at what it costs, it's outstanding." (Hi-Fi World May 1992)

Send a 1st Class Stamp for a copy of the full review and our NEW 32 PAGE AUDIO CATALOGUE.



QED

QED AUDIO PRODUCTS LTD, RIDGEWAY HOUSE, RIDGEWAY CLOSE,
LIGHTWATER, SURREY GU18 5JU, ENGLAND

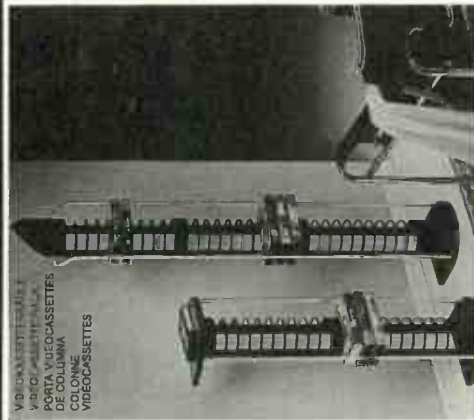

"The VIDEO-STAX, manufactured in high quality resin coated steel, is the ideal storage system for your video collection."
1. Small STAX, black, 20 VHS videos.....£43.00
2. Large STAX, black, 40 VHS videos.....£53.00

PIM Ltd, Unit D5, Road 7, Hortonwood, Telford TF1 4GP
Tel: 0952 608429 Fax: 0952 604211.
Prices include carriage + VAT.

NEW FROM PIM STEELSTAX CHECKS

"The CD-STAX, manufactured in high quality resin coated steel, is the ideal storage system for your CD collection."
1. Small STAX, black, 40 CDs + 5 doubles£28.00
2. Large STAX, black, 60 CDs + 5 doubles£38.00
3. Large STAX, silver, 60 CDs + 5 doubles£53.00
4. Table top rack, black, 20 CDs.....£12.00
5. Large STAX "Piano Man", 60 CDs + 5 doubles, £38.00

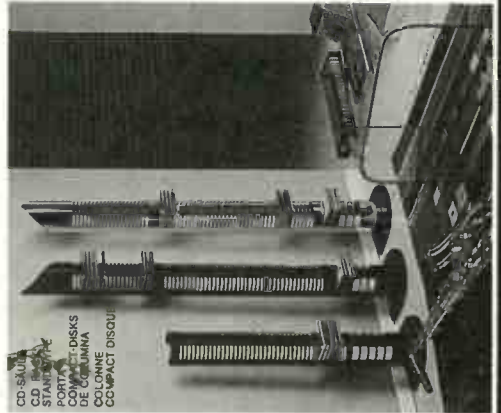

**WOLLATON
A•U•D•I•O**

**THE SHEFFIELD
LABS
XLO TEST AND
BURN-IN CD £29.95
AVAILABLE FROM
WOLLATON AUDIO
AND SELECTED
DEALERS**

WOLLATON AUDIO - TEL/FAX: 0602 284147



BRISTOL SHOW

Eric Braithwaite on the prowl, brings new products launched at this year's Bristol Hi-Fi Show.

Either the Bristol Marriott hotel was squirting essence of optimism through the air-conditioning or the Sound and Vision Show in February had hi-fi in their most bullish mood for a good while. Arcam's Rick Pullar was cracking jokes (that's what he called them) all the way through demonstrations. Hope he doesn't give up his day job . . .

Though Arcam had their new cheapish converter and Delta 250 transport, there were otherwise fewer niche products than usual. But then, the Japanese companies were waiting to launch their newest and brightest at the Brown Goods Shows in April. Sony were rumoured to have their new MiniDisc players (in-car, a Walkman-sized playback machine, a similarly pocketable record/playback device and the first hi-fi sized player) for private view, but the sound of Amie blazing away on the telly in one of Sony's rooms was too loud to find out. Speaking of which, Cerwin-Vega, exiled to the far end of a corridor, had something (a CV1515) with two 15in woofers in it that made a devil of a racket, but my ears couldn't take it.

Much more interesting were the first of Monitor Audio's 200 series loudspeakers, designed by ex-Epos luminary Robin Marshall. Judging by the sound, the 201 combines the best of the MA Studio designs with the best of the far-famed Epos ES1 I. Systemdek had their new range of Systym speakers, including an elegant slim floorstander which is due in about six months.

New company Questech popped up with a pyramid-shaped range using Bandor drive units, while Royd produced a good sound from the tiny £595 Sorcerer, spotted very briefly at Ramada last autumn. Like Pioneer, who had their 'UK' speaker in their room, Sony have produced a speaker for the UK too, with a 'biocellular' tweeter, made of fibres grown by bacteria. I'm sure that's what they said. Which reminds me, Canon added a sub-bass system and wedge-shaped speakers to their non-organically grown mushroom-shaped range.

In electronics, novel developments

appeared from Audiolab and Kinshaw. Audiolab have come up with an £800 phono stage, just to prove vinyl won't lie down. They also showed their new transport and mentioned (but didn't display) their forthcoming 'Zq' range of amplifiers, to include a line-level alternative to the now ageing 8000 series. Kinshaw were producing very wholesome sounds in the Kronos room (via Triangle speakers) with their new sub-£500 integrated in the Overture range. It includes a phono stage and DAC to complement the higher-end Perception series. Also spotted there was a £220 Pro-ject turntable and three (!) Ortofon MC7500 cartridges. a Pro-ject integrated amplifier is forthcoming.



Also on display in the Creek room (now divorced from Tannoy and in the hands of Mike Creek again) were the new 4240 integrated, P42 pre-amp and A42 power amp, all very affordable and newly cased at £250 each.

NAD played host to Onkyo, a once-widely known brand in the UK, but absent for some years, with a full range of electronics and the first A/V amplifier to use Sanyo's new THX chip.

Also making its first appearance was an elegant midi-system, the DF10, from Denon, which isn't. Each bit is available as separates, including a choice of RDS and non-RDS tuners. Rotel announced, still in the tuner kingdom, their RT990, based on Michi electronics, and Denon, again, had the first sample of their new TU-380 RDS tuner for under £200.

Linn assaulted neighbour Gramophone's ears with Reggae and Ragga, via Magik-I, Mimiks and Kelteks, then turned to Baroque, ironically, when they left. By association of ideas, Naim showed their new sub-£1000 NA CD3 CD player, which has a drawer that swivels out instead of sliding. Novel, eh?

Some manufacturers stayed away, Tannoy, B&W and Philips (and DCC, hmm) being notable absentees, but ProAc were represented in Michell's CD-free room (the only one, and pretty busy) with a brass-hatted Alecto taking pride of place.

Yamaha, KEF and JBL were giving various varieties of film and Surround-Sound a work-out as usual, though JBL cracked up towards the end of Sunday, put the blood-and-thunder films away and started playing Lemmings on their twenty-foot wide screen. Great fun, but the guy who walked in, said 'This is frivolous!' and stormed out would have been more welcome in the Meridian room, where Bob Stuart was demonstrating digital Surround Sound, but without pictures, just to prove you can have real audio as well as the Odeon in your living room. The sound was coming (mostly) from the new 565 Surround-Sound processor, 5000 digital and DSP 5000C centre-channel speakers, which had just been previewed in Las Vegas.

Bob made much play of many early recordings being three-track, left, right and centre. Though RCA and others did record three channels in the Fifties and Sixties (the Rubinstein Chopin recordings, for example) I don't think they meant us to hear three. Or did I misunderstand the purport of his introduction? However, real music did indeed sound more like real music and less like a soundtrack in the Meridian room.

A year ago, JBL's Lemmings might have been a metaphor for the industry, but it's good to see interest in hi-fi reviving again. Now we're all in a happier mood, have you heard Rick Pullar's joke about the . . . on second thoughts, maybe you don't want to ●



BUDGET BIAS

Nearing the end of its lifespan, Aiwa's AD-F810 three-head cassette deck can be found at bargain basement prices.

Noel Keywood and Robert Wilson report.

Here's a real bargain: a three-head, dual-capstan cassette deck with all the gizmos needed for high performance, but at a bargain basement price of £199.95. Nowadays, that'll normally get you a budget single-capstan machine with two heads - a basic specification. What's the catch? Simple, the Aiwa AD-F810 is being phased out, so it's become a "bin-end"

That might sound perjorative, but this is no ordinary bin-end, which is why I decided to devote a page or so to its passing. If you are in the market for a cassette deck, the Aiwa AD-F810 is an interesting bargain worth close consideration. It owes its peculiar price/performance ratio to outside events, the strengthening of the Yen being the most significant, bin-end status less so.

Nowadays, through rising domestic labour costs and the strong Yen - which if America gets its way will only continue

on its journey upward - Japan cannot offer such complex products for so little. Aiwa long ago started moving its manufacturing out of Japan to Singapore, to reduce labour costs. But sophisticated key components like the dual-capstan transport and siamesed record/replay heads are still made in Japan, so they remain expensive. As a result, the day of the £200 price tag on a deck of this specification has long since gone.

The AD-F810 will be replaced with a model of similar basic specification, Aiwa told me, but it will be more expensive. Based on current trends, it's unlikely that the fundamental performance of the new model will improve upon that of the '810; there'll probably be a re-arrangement of gizmos at most.

We've already tested the '810, during late 1991, and concluded that it "offers a fine blend of properties, resulting in excellent recording quality with ferrics, chromes and metals, plus fine replay of

pre-recorded tapes." For this revisit we re-tested another sample supplied by Richer Sounds, just to be doubly certain about its performance.

What is it that a deck of this apparent complexity offers? Being three-head it has separate record and replay heads (the third is the erase head). The theoretical benefits are higher recording levels, flatter frequency response and lower distortion. Separate record and replay heads also allow an owner to monitor a recording whilst it is being made, giving instant assessment of the impact of both bias and recording level adjustment.

A good dual-capstan transport cuts speed variations right down, giving a stable and clear sound, free from unsteady pitch or the coarseness and colouration caused by flutter.

The AD-F810 also has record gain adjustment to compensate for differing tape sensitivities. The Aiwa doesn't, at this price, have Dolby S of course, but it does possess Dolby B and C, as well as HX PRO headroom extension. So there's quite a line up of facilities on offer. Bear in mind too that because the head can record high levels onto tape, this helps make hiss less obvious, giving better dynamic range.

SOUND QUALITY

Starting with pre-recorded rock music the Aiwa sounded very promising. The ability of the bass to remain taut and solidly bolted down helped to produce music with a rhythmic coherence which made listening to cassette more enjoyable than it sometimes can be.

Treble content was also reasonable, the Aiwa managing to defer from the usual splashy mixture that is common to budget decks, offering instead good resolution of the leading edge of hi-hat cymbals.

A Chopin piano recording is always a tricky task, even for the finest cassette transports, laying bare the slightest deviation in pitch control. The Aiwa made a fair stab at this; the piano wasn't especially stable causing the image to waver at times, but stable enough to make the overall reproduction entertaining, which

made up for the odd variation in pitch.

When it came to recording however, the Aiwa really shone brightly. It has the ability to express quite noticeable differences in the standard of tape formulation.

Using a high quality metal tape showed that the Aiwa wasn't out of its

projection was already partially diminished. Bass also lacked presence when compared to the master, the authority and weight that could be heard in the original was slightly softened and lacked the punch and dynamics which give drive to a track. But we're talking about perfect cloning here and to damn

the Aiwa on these counts would be very harsh as it did a very fine job indeed. Treble definition was very good, the detail being presented in a very clear and concise manner, without sibilance or spit.

“The recreation of the stereo image, so explicit in the master, was again well recorded with very good depth and only a slight softening at the edges.”

depth, with Maxell's MX being particularly sweet. There was a slight veiling of main vocals in some complex rock mixes, leading to a reduction of presence in the track where vocal

The recreation of the stereo image, so explicit in the master, was again well recorded with very good depth and only a slight softening at the edges. The central focus of the track was solidly placed, and again only partially recessed with respect to the master.

When switching to chrome tape, in this case Maxell XL II-S, there was a distinct increase in musical involvement due to a tighter, punchier bottom end which contrasted well with a tonally balanced midrange. Nicely reproduced instrumental timbre also added to the overall picture painted around articulate vocals. The main reduction in recording clarity with the swap to chrome was in the treble, which became slightly more hissy with a loss of the crystalline detail that was prevalent with metal tape.

Finally, with ferric tape the sound quality became a little more limited. The treble was dull in nature, lacking the life and sparkle that was present in the previous recordings, even when the bias was optimally adjusted. The influx of raw edges in the treble also became very prominent on vocals adding a sibilant character to the dynamic transients. Although the midrange maintained a good degree of tonal neutrality it seemed to be a little slow, due to the underlying bass arrangements which lacked the integration shown with chrome tape.

The Aiwa is a very competent deck when used with pre-recorded material, especially rock music, however it really begins to shine when used as a recording tool, if care is taken with respect to the choice of a good quality chrome or metal tape ●

MEASURED PERFORMANCE

The AD-F810 showed itself to possess a bit more drift than the best, but it still managed well for the price. Drift can sometimes be heard when listening to forms of music that contain sustained notes, most commonly from piano. A sudden change in pitch is heard; it is slight but can be surprising because of its subjective incongruity.

Dual capstan transports are meant to lessen or eliminate flutter, something the Aiwa does well. You can see this as an absence of spikes or peaks across the central area of the speed stability analysis. It was successful in this respect, giving a purer sound in consequence.

The head and record E.Q. together deliver a very flat frequency response characteristic, shown for metal tape in the analysis. Identical results were produced for ferrics and chromes. Variable bias tuned in all three types effectively.

Head overload levels were good, but not exceptional. This again is down to cost, but it's certainly better than most at this level. That's MR-X PRO turned in creditable +5dB/+1dB mid-band/treble overload figures all the same.

Replay frequency response, which affects pre-recorded tapes, was flat to 18kHz. This is sufficient to ensure they do not sound muffled with Dolby B engaged.

| | |
|--|------------|
| REPLAY (pre-recorded tapes) | |
| Frequency response (-2dB)30Hz-20kHz | |
| Speed accuracy | +0.3% |
| Hiss (70uS, Dolby out) | -58dB |
| RECORDING (blank tapes) | |
| Frequency response (IEC Primary Refs.) | |
| ferric (IECI) | 12Hz-17kHz |
| chrome (IECII) | 12Hz-17kHz |

| | |
|------------------------------|---------------|
| metal (IECIV) | 12Hz-20kHz |
| Separation (1kHz) | -54dB |
| Distortion (315Hz) | 0.6% |
| Hiss (70uS, Dolby out) | -55dB |
| Speed variations (DIN total) | 0.05% |
| Flutter energy (3-3.13kHz) | -34dB |
| MOL/SAT (IEC Refs) | 315/10k |
| IECI (ferric) | +4.5dB/-5dB |
| IECII (chrome) | +4dB/-4dB |
| IECIV (metal) | +4.6dB/+0.5dB |

Frequency Response

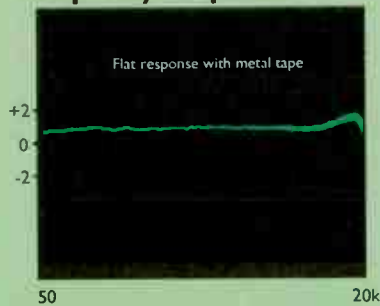

Speed Stability

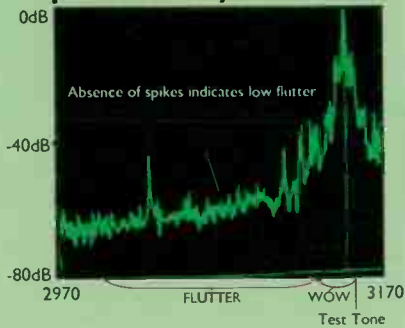

Available for £199.95 from Richer Sounds and other retailers.

AIWA AD-F810 £199.95
AIWA
5 Heathrow Summit Centre,
West Drayton,
Middlesex UB7 0LY.
Tel: 081 897 7000



World



WHEN WILL IT STOP?

Whilst I applaud your interest in DIY, I'm concerned about the way in which your new DIY projects are bought to reader's attention. If I were keen to build a valve amplifier, I would have been keenly interested in your kit for a Mullard 5-20. However, whilst waiting and making up my mind, I would have learnt of your future plans to produce a 300B amplifier, surely well worth the wait - a better amplifier.

Then, during the delay while you sorted out transformer difficulties with the 300B, I would discover that you had plans for a Single-Ended 300B, which is surely worth the wait, being a better amplifier.

If you carry on at this rate, constantly offering a better future, I don't think I would ever build my valve amplifier. When will this all end? I see myself in the year 2000 looking at your silver-wired and coiled single-ended amplifier using HFW triodes

thinking that it might be better to wait for the gold wired and coiled version!

**Andrew J. Blackburn
Sevenoaks,
Kent.**

Always assuming you have infinite amounts of wonga! The amplifiers are separated by quite wide price gaps.

Mullard 5-20 was fine in terms of its basic circuit, but simple in its chassis work. We replaced it with K5881 which fully meets, or surpasses, commercial products in build quality - cost, just £395.

In contrast, 300B (push-pull, 30watts) costs £750 at present, which is quite a lot more. It is proving to be a very difficult amplifier to get into production, mainly because it is so specialised and we are perhaps a little too dedicated to its perfection. Also, modern-day GZ-34 rectifier valves have proved to be hopelessly unreliable when operated within Mullard's original

550V max. specification, which has caused further delay. We've found a better alternative.

Single-Ended 300B, another design in prototype form only at present, produces 20watts and is, because of its highly unusual nature, an even more expensive amplifier, available - because of its necessarily massive transformers - only in monoblock form. So it does not overlap with 300B push-pull.

We've are now having special audio capacitors built to our specification - in addition to the transformers of course - and do hope, ultimately, to produce silver

wired transformers and, probably, all components to our own design spec. The improvements in sound quality such components provide are forcing us along this path. Conventional components were never designed exclusively for audio and when you study their construction, their limitations within this critical role become obvious.

It'll all end when you run out of money or we disappear in a puff of smoke when our latest 2kV wonder power supply throws a wobbly! **NK**

Letter of

LONG LIVE MUSIC REVIEWS

The comments made by Brian Cochrane (World Writes, March '94 issue) prompted these thoughts.

Long live the record review section of HFW. I have found it an invaluable guide to much interesting music. Through your reviews I have discovered some superb albums, many of which I have subsequently purchased. With CDs costing as much as they do, I like to limit the chance purchase. A hi-fi mag without record reviews is like a computer mag without program reviews. I mean, equipment is all very nice to look at, but it's albums that

we actually listen too. Isn't that what hi-fi is really all about - listening to music?

On the same theme - listening to music - let's consider the law of diminishing returns. There is a certain point in hi-fi where small gains in performance start to cost silly money. True, good performance isn't cheap, but in terms of the increased hours spent listening to music, it is value for money. To give an example: The Pink Triangle Da Capo: yes please, I would like one. Well worth the asking price and guaranteed to make you listen to more music, but £1500 for a d.c. battery supply! Would a d.c. battery supply make you

WIN HI-FI WORLD SILVER PLATED COPPER

INTERCONNECT CABLES

(1 metre pair)

The writer of the most interesting or funniest letter will receive a free set of Hi-Fi World's silver plated copper interconnect cables, worth £69.95.

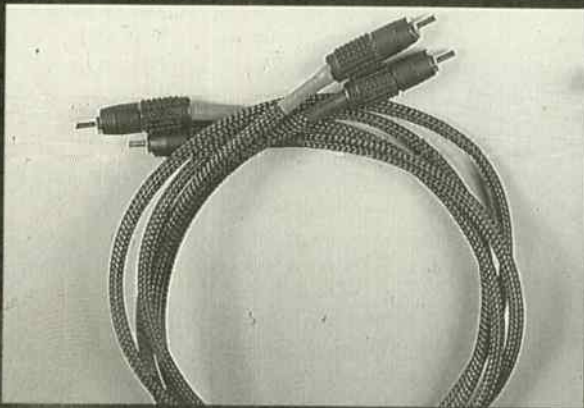

Send your letters to Hi-Fi World Letter Page,



writes

NOT ENOUGH LINN

We were pleased to read of Mr Hatton's delight with the Cirkus upgrade to the LP12.

Since the formation of Linn Products, we have been committed to easy-to-use, value for money products that offer both longevity and performance. The LP12 with its single button control expresses our view that hi-fi should be easy to use and enjoy, in addition to offering the best possible sound.

At Linn, because customers come first, we respond positively to magazine requests for products. You have recently

reviewed a Karik, Kaim, LK100 and Keilidhs in a system, and we currently have outstanding requests from you for the Arkiv and the Klyde moving coil cartridges in the pipeline.

We welcome criticism because we have confidence in our products and we trust our customers to establish the facts about value and performance for themselves and, indeed, as enthusiasts we see the diversity of view within the enthusiast sector as an essential element in developing our business.

Everyone is capable of appreciating fine music at home, so Linn does not qualify or limit customer, retailer or magazine access to

its products in an elitist or prejudiced way. All Linn customers are important to us and we wish to be able to address their investment in their music collections and their Linn hardware for as long as they wish to develop their systems. To this end, we continue to work with all our retailers, including Harrods, to set new and higher standards because we all care about music.

**Ivor S Tiefenbrun, MBE,
Linn Products Limited.**

"What's all this about?", you might ask yourself. It's Linn's diplomatic response to an observational reply I wrote to a reader's letter (penned by Richard Hatton of East Sussex in our April 1994 issue), where I claimed Linn had lost interest in the specialist market and in supplying us with products for review. "Not so", said Ivor Tiefenbrun, founder and managing director, when he ear-wigged me by telephone, claiming that my observations were inaccurate and misrepresented Linn's policy towards its customers. I was being biased by adverse publicity generated by rivals and a few disgruntled dealers, he said.

I have to contend that we've traditionally experienced unusual difficulty in getting Linn products for review, in spite of strenuous efforts on our part, prompted by persistent reader demand. Ivor says we haven't tried hard enough; I've promised to bombard Linn with fax requests to prove that we do try. Don't hold your breath, but do keep your fingers crossed!

NK

IMAGINARY IMAGE?

In the past I have, through your letters pages, criticised what I see as the arrogance of Linn products in making sweeping statements about sound quality. I have not however criticised the products themselves and in fact, after listening to numerous turntables, including Voyds, Roksans etc. and after the dismal failure of a bankrupt stock Ariston RD90S project, I have settled on a Linn LP12/Akito. This set up has effectively silenced my CD player and got me listening to the music again, instead of the system.

So what? I hear you cry. This is what. While in the process of buying the LP12 I had a long listen to the Keilidh speakers, finally rejecting them on the grounds that my beloved Rogers Studio 3s could 'out image' them with one tweeter tied behind their backs. The very next day I picked up your December issue and noted that Dominic Baker drew similar conclusions in the Linn system review. Still, speaker choice is very subjective. It's what happened next that intrigued me.

The chap from the dealer's, whilst installing the LP12, asked my opinion of the Keilidhs and then told me that imaging doesn't exist, but is just an idea generated by hi-fi mags!

It seems the Linn view is that the only thing we can be reasonably sure of is that what was recorded was music. We cannot know and therefore cannot pass judgement on the original positioning of individual instruments etc.

continued on page 47... ▶▶

the Month

listen to more music than at least 150 new CDs? Not in my view.

I have to say, I like the balance of HFWR. I can do without reviews of headphones, equipment supports, etc. If you fancy reviewing something different, how about a look at the many varied means of storing CDs?

**Simon Filmore
Edgeley,
Stockport**

"Long live the record review section", we certainly hope it will. However, the big record companies can be a little reluctant in supplying a specialist mag such as this with their latest mega releases. Vox, Q, etc get

precedence, even though our readers have massive record collections, our surveys show. I'm glad our reviews successfully guide you when purchasing.

As for diminishing returns, well, lets face it, reproduced sound is still light years away from being truly life-like, so every small advance helps, even when the costs involved are astronomical. RW

Yes, you're right, music is what hi-fi is, ultimately, all about. We'll never drop record reviews, we all enjoy music too much - and we know our readers do too. Thanks for your encouragement. **NK**

64, Castellain Road, Maida Vale, London W9 1EX.

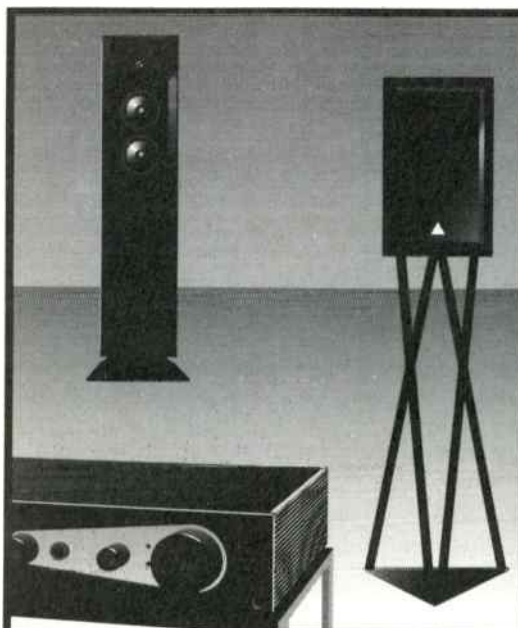

TRIANGLE

ELECTROACOUSTIC

FRENCH SPEAKERS

...as reviewed by English speakers...

"The Alicante's big, fluid, wide-ranging and open presentation lets the music speak for itself."

Jonathan Kettle, AUDIOPHILE, November 1993

"The Titus E has an absolutely riveting sound with openness and rhythmic drive."

WHAT HI-FI?, March 1993

"The Icares are fast and enthusiastic; there's nothing twee or laid-back about their presentation of music - whether reserved classical or high energy rock."

WHAT HI-FI, October 1992

AND AS FOR THE AMPLIFIER...

"The Triangle TE60...has very clean treble...separation is first class...bass is outstanding...an excellent product. A super little amplifier, nicely styled and beautifully finished."

Jimmy Hughes, AUDIOPHILE, March 1994

THE ROMANCE OF FRENCH HI-FI

Berks
THE AUDIO ROOM
3 Little brook Avenue
Burnham, Slough, Berks
0628 - 668112

Cornwall
RJF AUDIOVISUAL
84 Pendarves Street
Tuckingmill, Camborne
0209-710777

Dublin
ACOUSTIC DIMENSION
16 Idrone Mews, Idrone Lane
Black Rock, Co. Dublin
0103531 - 2884612

Norwich
SOUND APPROACH
161 Unthank Road
Norwich
0603 - 622833

London
DOUG BRADY HI-FI
(See Dial-A-Dealer)
071 - 379 4010

Liverpool
DOUG BRADY HI-FI
(See Dial-A-Dealer)
051 - 7336859

Warrington
DOUG BRADY HI-FI
(See Dial-A-Dealer)
0925 - 828009

London
DIVA
Workshop 30, Royal Victoria
Patriotic Bdg., Wandsworth
081-875 9593

Otley
DOUG BRADY HI-FI
(See Dial-A-Dealer)
0943 - 467689

Scotland
HI-FI EXCELLENCE
293 Union Grove
Aberdeen
0224-322520

Triangle loudspeakers cost from as little as £265; TE60 Integrated Amplifier £549 - for more details phone Ortofon UK (0753-999949) or Kronos (08687 48632)

LEONARD BOOTH

35 South Street
Eastbourne
Sussex
BN21 4UR

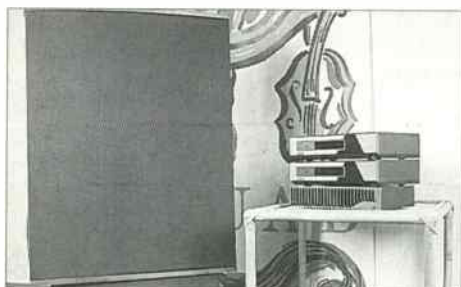

Complete range of
QUAD stocked

Tel. 0323 - 731755

The WIZARD



Hand made
Adjustable Shelf
Rotary Unit.

Can hold 1536 CDs
or 1440 Cassettes
or 384 Videotapes
or 575 Penguin
Books; or any
mixture. Books up
to 6 1/4" deep.

Revolves on Ball
Bearings in 30.4"
turning circle
21 1/2 x 21 1/2 x 75" high.

Teak, oak, pine
mahogany, ash,
£1550 inc.
VAT & Delivery.

FOR OUR BROCHURE
of
CD/Video Drawer Chests
CD racks
Bookshelves
LP, music · Hi-Fi
Cabinets &
the Budget Line
—Specials made to
order—

Please send 3 x 2nd
class stamps to:

Ian Edwards The Old Chapel
282 Skipton Road, Harrogate
HG1 3HB. Tel: 0423 500442

...continued from page 45

However, it seems to me that unless someone inadvertently mixes up the two stereo channels we can be very sure of what was left, right and centre. Imaging, in the three dimensional sense, then follows from the reproduction of ambient cues which I believe work on the ears in a similar fashion to that which produces stereoscopic vision. Therefore, to deny imaging is to deny stereo.

Of course if I'm wrong and the Linn installer is right then two questions arise.

1. What have numerous researchers been wasting their time for since the Columbia records experiments in 1931?

2. Why don't Linn sell Keilidhs singly?

Colin Berrisford
Billing,
Lancs,

I also wish people wouldn't make sweeping statements about imaging and such like without really knowing what they're talking about - especially when they're supposed to be knowledgeable in the field of hi-fi. The hi-fi installer may well have never heard a pair of loudspeakers that can image, but then he's probably got a midi-system at home. **DB**

Don't be fooled by salesmen: good loudspeakers most certainly do image.

As a recording engineer I spend a lot of time sitting at a mixing console creating this illusion. If the stereo image did not exist, then why do companies like SSL and Neve bother to fit pan pots to their £250,000 consoles? Why do the world's top recording studios, such as George Martin's superb new AIR complex, spend vast sums of money on 'state of the art' digital reverbs if the effects

produced by them cannot be heard in a stereo mix. Even listening to a basic recording made using a pair of 'crossed' mics you can determine whether it was produced in a small 'dead' room, or a large reverberant auditorium, showing that it is possible to capture an entire three-dimensional acoustic in stereo.

The layering of different instrumental parts from a multitrack to a stereo mix is easily achieved through clever use of the pan controls, fader position (separate track level), EQ, which enables certain parts to be made more prominent, and spatial information (reverb, mic positioning etc).

From a musician's point of view, open the gate-fold cover of Paul McCartney's "Press to Play" album and you will find colourful drawings by the 'Fab One' illustrating to the engineer/producer Hugh Padgham how he wants the 3D image of each track to be built.

To monitor the building of a stereo image requires very good speakers; ATCs and B&Ws are favoured by many engineers, for instance, and I'm not in the least bit surprised that the Rogers 'out imaged' the Linns, as they do make monitors that are used in the industry (e.g. the BBC).

And now we have the new and startling three-dimensional effects created by Sensaura and OM3D from just two loudspeakers, where people can actually walk around the listening room, helicopters can take off vertically and drums can appear to be coming from behind you! This is currently causing some consternation amongst even die-hard stereo engineers - at least, those who haven't come across the psycho-acoustic theory that has made such astonishing effects possible. Pity your poor salesman when he hears this! **RW**

QUAD MODS

I am so glad to have discovered your magazine over the last few months - we seem to be in tune. I have finally discovered some people who approve and applaud some of the kit I use: Quad ESL63, Troughline tuner, Garrard 401 - and not just dismiss this stuff as quirky or old fashioned.

Are there any mods I can make to my ESL63s without invalidating the guarantee? And can I find or make, or are there better kinds available than the little 'L' shaped bit that the shop screwed to the base with 2" long wood screws!!

Prompted by your magazine today I auditioned and purchased an EAR834P from Hi-Fi Confidential in London. Many thanks. Luigi at Hi-Fi Confidential was the most knowledgeable person in a hi-fi shop I have met! And your review very accurate, except that the 834P is not quite silent in my system. All the same, it is as you say "a piece of REAL Hi-Fi". It has made my records and Quads come to life!

Luigi demonstrated the 834P using the prototype of your kit pre-amplifier and 20W power amp - very impressive and I am told easy to build. Please send me some more details.

Thanks again for your positive approach and guiding me to a product that is all it purports to be.

Robert Keeling
Horsham.

We're glad you liked the 834P as much as we did; it's a gorgeous valve head-amp, of that there's no doubt.

There are an infinite number of mods you can make to Quad 63s, all of which will upset Quad, invalidate the guarantee, threaten your life and give you lots of enjoyment! With 2500volts on them, moding Quads is all about living dangerously. The single biggest improvement comes

from removing the protective aluminium louvred grill through which the sound struggles to escape. You must remove the fabric sock first, then the louvred panels can be popped out. The sock can then be replaced.

This mod. greatly improves clarity and fine, low level detailing; you'll feel you could hear a pin drop from a 100metres after this - it's how we use our Quad 63s. Bear in mind though that this mod. exposes dangerously high voltages, so it is not recommended for those with small children. Ideally, another grill with a more open mesh should be substituted. Garden centres have interesting plastic mesh for plants that I've mused upon as possibly suitable. The current grilles are designed to resist the attentions of children with metal knitting needles. **NK.**

FIRST TIME READER

I recently bought my first copy of HFW (the March issue) and felt a strange yearning for the days when I would buy SME headshells, remove playing weights etc. Tweaking. Now that's something you would never get in "What More Adverts", unless of course it involved the purchase of more expensive kit.

The strangest tweak I ever came across was when I auditioned a second hand pair of Celestion Ditton 44s. Removing the grille revealed tweeters that had been fitted with 'collars' made from sections of a washing up liquid bottle. They were held in place by Blue-Tack. Their owner, who had himself bought the speakers second hand, said that he had never had the grilles off and had no idea why the collars were there.

I have found that there are two tweaks that improve the sound of my system considerably. To improve the bass response - close the

continued on page 49... ►►

The Audiolab 8000A Integrated Amplifier



The Audiolab product range:
 8000A Integrated amplifier
 8000C Pre-amplifier
 8000P Stereo power amplifier
 8000T FM/AM tuner
 8000M Monobloc power amplifier
 8000DAC digital-analogue convertor

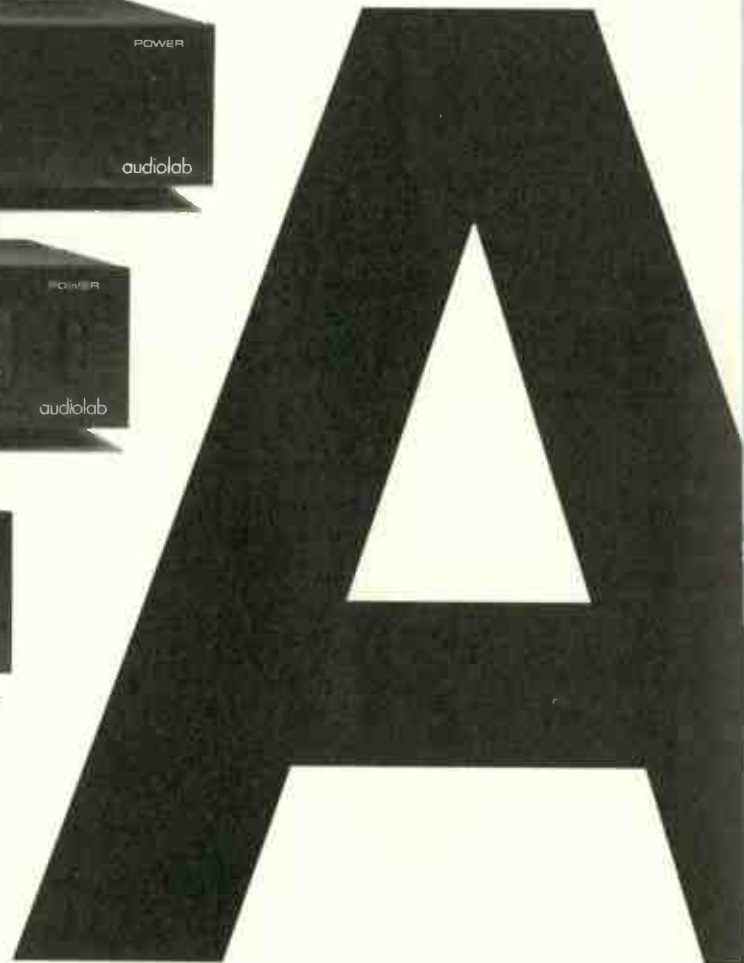

Winners
FBA AWARDS 1993
 Audiolab 8000A
 Best Integrated Amplifier
 Audiolab 8000T Best Tuner
 Audiolab 8000DAC
 Best Digital Component
 Audiolab 8000C & 8000P
 Best Hi-Fi Separates

AUDIOLAB

Cambridge Systems Technology Limited, Spitfire Close, Ermine Business Park, Huntingdon, Cambs. PE18 6XY. Tel 0480 52521

...continued from page 47

curtains, remove the arm chair and replace it with a dining table chair! To improve high/mid range - have my ears regularly syringed.

Seriously I have found that the listening environment can have a considerable impact on sound quality. Auditioning of equipment is valueless unless carried out in one's own listening environment and as part of your own system. I have found, to my regret, that speakers which sounded wonderful in the dealer's showroom sounded quite different when brought home.

Although there have been constant attempts to establish objective, scientifically measurable parameters to define high fidelity, in the final analysis subjective elements cannot be dismissed. For example, CD was claimed to have near-perfect audio quality: total channel separation, low signal-to-noise ratio etc. Yet there are now devices whose sole aim is to give CD a more 'vinyl-like' sound! How introducing spurious cross talk could add an essential vinyl ingredient, that is, static scratches, surface noise and the odd mistrack is beyond me.

In conclusion, I enjoyed your magazine immensely and found it a stimulating read. But there is a final tweak you could consider. Put on your favourite music and sit down, accompanied by your specific tittle. If the sound is not acceptable, imbibe. Continue until either the system sounds great or you no longer care!

Brian Neal
Bishops Stortford,
Herts.

3D SOUND ON VINYL?

Your article in the January issue of the Hi-Fi world about the new OM3D recording process so intrigued me that I decided to purchase one of the recording's recommended by you. I therefore went to

our local record shop armed with the necessary information and requested them to order initially either Ian Shaw's Ghostsong's or Keith Tippett's the Dartington Concert for me, both stated to be available on LP or cassette, as I still stick to my record player, anachronistic as it may be.

To my dismay they have now come back to say that only CD is available and that the LPs were withdrawn last Autumn.

Can you confirm this and/or tell me where I can get an LP, preferably, or a cassette which has been recorded on the OM3D system, and put me out of my misery.

F.J. Heath
Aldeburgh,
Suffolk.

It appears that LP has been deleted, but CDs and cassettes are currently available, we have been told. The Dartington Concert is from E.G. Records, cassette number EEG 2106-2. Ghostsong's is on Ronnie Scott's Jazz House label, cassette number JH MC025. We hope this helps you locate the recordings. NK

MAN WITH A MISSION

In the days before esoterica, ordinary people bought their 'stereo' a pieces of furniture. Ours was a good looking teak radiogram. We thought it sounded lovely, so did our friends, who eventually bought similar units.

Our high fidelity reading was a few half-understood articles in Everyday Electronics or Gramophone. After ten years of blissful ignorance, a breed of electronic virus emerged - the 'Hi Fi Reviewer'.

This deadly virus started to spread amongst us. It infected our Sixties values, disgorging strange new buzz words. We had suddenly become. . . electronically challenged.

I was seriously infected by this virus, and in a moment of high fever, sold my trusty radiogram and bought a Philips tuner/amp and a pair of Wharfedale speakers. Delicious. Turn it up. Let's hear the swish of the conductor's baton. Bang! Out popped the speaker cones. Not the amp or speakers fault. Too much broadcast mush. I wondered if I could make a sturdier pair of speakers.

A library search unearthed a book by G. Briggs, and one of his designs appealed to my new found purist strivings. It was a 40 litre monolithic box with one eight inch bass and one tweeter. I made two, not from the as-yet undiscovered MDF or even well known chipboard. No-one had told me about coloration and box resonance, so my speakers were made from furniture - quality oak veneered plywood - real wood from trees - 20mm thick.

They sounded fine with KEF units fitted, and as time passed were tweaked bit by bit. First a Coles super tweeter. Next some sticky felt lining - then solid wiring and a host of silly things, like polystyrene cup rims stuck on the tweeter; spikes, front baffle suspension, BAF wadding, no BAF wadding, Blue-Tack, Black-Tack, Green-Tack and on and on.

So here I am twenty years later, divorced, grey and middle aged - with the same speakers. Now though, the latest electronic wizardry feeds them; NAD amp, CD player, tuner, and a Rega deck. All are recommended by the "Hi Fi Reviewer of the Century". A touch of golden guidance in a maze of confusion.

It must be time to change the speakers, I think. They look a little bashed in and, well, sort of old-fashioned. But what should I buy? Technology must have roared ahead in the last twenty years. I will buy the "Audio Award

of the Year" and save all those baffling comparisons and pushy salesman. So I buy a pair of Mission 760i SE speakers and some Target stands - without even listening - the magazine will be right: it was before with the Rega and NAD equipment.

I carefully read the manual, set up the speakers, put on my most demanding CD sit down and. . . disaster. Sounds mushy and compressed. Fiddle around with the stands. Hammer in the spikes. Wiggle the connectors. No difference - still mushy. "Wait for a week and you will hear a difference", says the salesman. I wait. No difference. Rush outside to save the old speakers from the garage junk heap. Wire up. Sit down. Relief. All the familiar clarity and warmth. My old friends are back, warts an' all. Ready for another twenty years.

David Manser
Swindon.

Even modern high tech loudspeakers can be no match for a well engineered 'speaker of the past, especially if it cost 10 times or so more; Quad's electrostatics are the best demonstration of this point. The Missions are well ahead of most rival budget speakers around. They are recommended with similarly priced competition in mind, not something that costs several times the price, even if they are a few years old. DB

Also, when you make loudspeakers they are, naturally enough, tailored to the sound you prefer, be it right or wrong. Isn't this one of the wonders of DIY? Having become accustomed to that sound, a different one can be difficult to accept. I'm surprised you should find the Mission's "mushy", because they are known for their lucidity. NK

continued on page 54...

THREE OF A KIND



Dominic Baker and Noel Keywood investigate what three mid-priced floorstanding loudspeakers have to offer the audiophile.

Floorstanding loudspeakers promise deep bass, yet in our experience too few actually manage to deliver it. Additionally, they commonly don't possess the coherence of smaller loudspeakers that more closely mimic a point source. But perhaps things are changing. Let's hope so, because there's plenty of evidence that people would like better bass than that from a box on a stand. Floorstanders take up no more room, but they have more cabinet volume and that should mean deeper bass.

We've picked three floorstanders to test this month, all between £500-£600 -

an increasingly popular area of the market. These are the kind of loudspeakers that you'd typically use with a high quality specialist integrated amplifier, perhaps an Audiolab 8000A or a Sugden A21a.

The three we picked, hopefully, represent the state of the art in British loudspeaker design.

First of all, the Castle Chesters. These were chosen on the strengths of the more expensive Howards reviewed last issue. They come from one of the more traditional loudspeaker companies, Castle Acoustics, who seem to have taken on a new lease of life over the last year or so.

Next in line are the Systemdek System 937s. Systemdek have just entered the loudspeaker market and are already doing well, combining quality drive units with good engineering. They are also nicely styled, to give a modern, young, image.

KEF have been in loudspeaker design for nearly three decades now and the Q50s are plucked from their latest range. Using the well known Uni-Q point source drive unit they aim to bring point source imagery to a floorstander.

So, here are three floorstanders with plenty of potential. To see how we got on with them - read on ●



for consistency and quality. The tweeter is similar to the one used in Heybrook's Quartets, which we know to have a smooth and detailed sound and the bass unit is a heavily doped 6inch paper unit with a supple surround.

The Systym 937s took far less time to run in than the stiffer coned Chesters, but a good ten hours or so is still worthwhile. The light fabric dome tweeter becomes a lot smoother and sweeter after a few hours of use and the bass frees up a little. Another thing worth bearing in mind, especially if you have polished wooden floors, is that because the bass vents close to the floor, the 937s sound cleanest if the supplied spikes are used.

Unlike the Chesters, the 937s could be pushed right up close to a rear wall, which makes them very versatile in terms of positioning. However, although the bass didn't become overblown, it did show some slight flabbiness and a tendency to slow the music down. Pulling them out a little rectified this, but even right out in the room the bass wasn't as fast as that of the Chesters. Slow bass is a drawback of transmission line 'speakers, but the benefit of this form of loading is a full, warm and engulfing bass that is smooth, rich and deep.

The 937s are real smoothies, with an even balance that made them relaxing and easy to sit in front of day after day. They're not so impressive initially, but they grew on me. The 937s don't draw attention to themselves; there's plenty of detail to be heard, but it's not presented in a forthright fashion. You can press Play on the CD, sit in front of them and enjoy the music without being pinned to the wall.

Their gently detailed soft dome tweeter and doped paper bass unit are extremely well married together, making for a cohesive presentation. Music can rise seamlessly through the crossover point without suffering a change in character or tonal balance. This makes the 937s well suited to slower, more subtle rock tracks, jazz and classical than, say, dynamic pop. The latter benefits from a more forward mid and better bass attack.

The 937s displayed the American country rock character of Counting Crows' 'August and Everything After' album especially well. The dark atmosphere of the recording and damped acoustic were accurately relayed in an emotional and musically rewarding fashion. The strike of the drumstick on the snare and the rapid decay of the sprung wires resonating against the bottom skin could easily be picked out, with Hammond organ and the moody vocals of Matt Malley adding to the suppressed ambience of the recording.

Aimiee Mann's catchy pop lyrics were given a super smooth delivery by the Systemdeks. The acoustic bass on 'Jacob Marley's Chain' had a lovely rich bloom to it, punctuated by the squeak of the guitarists other hand sliding up and down the fret board, attempting to hit each note on time. Aimiee's vocals weren't pushed quite as far forward as they deserve to be, but were well focused and uncoloured all the same.

The Systym 937s are an easy and enjoyable loudspeaker to listen to. They aren't especially precise in their delivery and they don't image with great precision, but the soundstage they create is open and full. Having said this, these speakers are undemanding and easy to sit in front of, possessing a fluidity of presentation that makes almost any form of music sound pleasant. They don't shout or introduce coarseness, which should make them popular with many music lovers. Not as forthright as the Chesters, but a soothing remedy to a hard day's work ● DB

SYSTEMDEK SYSTYM 937

Systemdek have only recently entered the furiously competitive world of loudspeaker manufacture. However, they're already celebrating success with a well thought out range of competently engineered loudspeakers, the smallest of which, the Systym 931s, we enjoyed a couple of issues ago. The Systym 937s are the newest of the range, designed to offer good bass from a modest sized floorstanding enclosure.

This is achieved through transmission line loading, which in this case acts as a long reflex port venting low bass forwards at floor level through two thin slats in the front baffle. They are attractively styled, the textured grey front and rear baffles combined with wood veneered top and sides to give a modern image. Both drive units are supplied by SEAS, being chosen

MEASURED PERFORMANCE

Systemdek's Systym 937s are a transmission line loaded, two-way floorstander. Transmission line loading in this form promises good, deep bass; the low-bass output of the line is vented forwards to add to the upper bass directly radiated from the main unit. The output from the port in the analysis is a lower level to that of the main response, due to microphone position. In practice this output will be boosted by wall and floor reinforcement; we measure in free space.

The 937's frequency response measured reasonably flat and where it does deviate the effects will be helpful rather than detrimental. The peak at 2-3kHz will push the sound out of the box; the lift in the lower bass will add speed

and punch. Treble level is a little low compared to bass/midrange output but not by enough to make the 937s sound overtly dull so much as smooth.

The 937s are of average sensitivity at 85.5dB for a nominal watt (2.83V) pink noise input measured at 1 metre. But, like most British loudspeakers, they have a high overall impedance of 10.5Ω which means that they won't be too demanding on amplifiers. The single small hump at the bass end of the impedance curve shows that the line has been correctly proportioned and damped, so good quality bass should result.

Like Castle's Chesters, the 937's are well engineered to suit a wide range of amplifiers and give a smooth frequency response. DB

Frequency Response

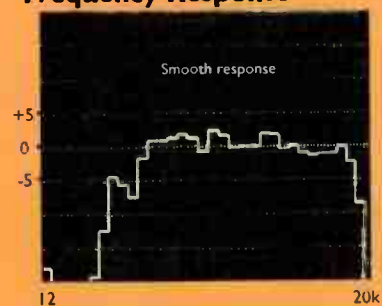

Impedance





CASTLE CHESTER

After enjoying the Castle Howards, reviewed in the last issue, I decided that it was likely to be worth taking a look at another 'speaker in Castle's range. Flicking through the file I came across the floorstanding Chesters. These are very similar in many respects to the Howards, using a 6.5inch doped paper bass unit, 25mm metal dome tweeter and 1/4 wave resistively terminated bass loading. But, unlike the Howards, they have no upward firing driver, which I found was responsible for slight midband confusion. Eagerly, I ordered a pair.

When they arrived I was even more eager to get them running. For £600 you get a pair of beautifully finished real wood veneered cabinets. They are not quite as elegantly styled as the Howards, but

possess high quality drive units and chunky gold plated bi-wire binding posts all the same. The Chesters were nicely proportioned too and should blend well into most living environments.

In my rush to listen to the Chesters though, I forgot one thing - and it's worth bearing in mind if you audition these 'speakers. As with other Castle loudspeakers that I've come across in the past, they take a good thirty hours to run in properly. Straight out of the box they can sound dry and constrained in the bass and a little sharp in the treble, which certainly isn't representative of what they can achieve in full song.

Returning to the Chesters a couple of days later I found the sound had improved quite considerably. They have real upper bass punch, which lends drive and enthusiasm to music, and their treble is sweet and open, but crisp, adding a pleasant sparkle to the balance. I quickly found that the tightest and most tuneful bass was to be had at a distance of around 2ft from the rear wall of my room. They are quite sensitive to placement so this will probably vary from room to room.

The Chesters have a very clear and communicative presentation, displayed well by the BMX Bandits with their forwardly placed jangly guitars, the dry thud of bass drum and cleanly recorded vocals, right through to the lighthearted and humorous 'Kylie's got a crush on us'. The Chesters do a superb job of allowing instruments and vocals to play freely without becoming blurred or smearing into each other. Individual melodies could be followed with ease, I found, making for

a very tidy and composed performance.

Next into the drawer of my CD player went Magnapop's Hot Boxing. Sadly not the best of recordings this one, but the Breeders/Pixies style tracks put this recently released album high up my list of new favourites. It's quite a complex album to deal with for lesser 'speakers, tending to push them into confusion, but the Chesters managed to make an excellent stab at it producing a powerful, gutsy performance. The 1/4 wave loaded bass gives speed and power to music such as this, in a way many reflex 'speakers cannot match. It also appears to provide a free and uncoloured midrange with good projection.

Given a recording with a little more richness than raw sounding indie rock and the Chesters can really charm. Sharleen Spiteri's lightly strummed guitar and polished vocals on Texas's Ricks Road album (this is as well recorded on vinyl as on CD, by the way) gave the Chesters something to really sing about. They related the width and depth of the soundstage well, providing enough focus to allow instruments and vocals to be placed precisely and with confidence. With some concentration, their was just enough cohesion to the sound to allow a good picture of the band to be formed.

The Chesters really are quite special in my opinion. They add little character of their own to the music, allowing it to communicate well with the listener. The treble is sweet and inoffensive with a crispness to it that gives the Chesters a fresh balance. The midrange isn't constrained by the box in any way and the bass combines good punch and drive with enough weight to create a large and realistic performance. I'm trying to think of a criticism, just to avoid being accused of sycophancy! For £600, I can't. Even the spikes in the base are larger than normal, well finished and screw in smoothly. A fine piece of engineering in every respect, the Chesters deserve recognition ● **DB**

MEASURED PERFORMANCE

The Castle Chesters use the same 1/4 wave bass loading as the Howards, reviewed in the last issue. However, with the Chesters there is no second bass unit to drive the line, just one firing forward. This gives the Chesters slightly lighter bass, but also avoids the problems of interaction between two units covering the same frequencies.

Our frequency response analysis shows an even and smooth characteristic. The crossover has been very well engineered: there's little real evidence of a dip, which should give them a truthful and clean sound. There is a little lift in the midband, but this will usefully serve to push vocals and detail forwards. The bass is even too, with good extension, given that we measure in free space conditions.

Castle claim 90dB sensitivity for 1 watt at 1 metre, but I could only squeeze 87dB - just above average - out of them using 2.83V of pink noise. But they are efficient, shown by the high impedance curve which gives an overall 10.5Ω. They will not demand much current from a partnering amplifier.

Castle have engineered the Chesters well. They have a flat and well controlled frequency response, good sensitivity and high overall impedance, making them suitable for most amplifiers. **DB**

Frequency Response

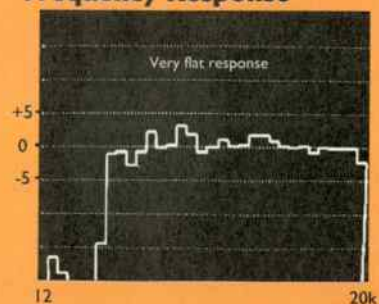

Impedance

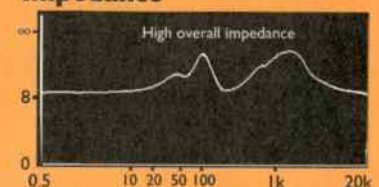



size with bass output. Initially, the Q50s appeared to have lots of grumbling, rolling bass that started from somewhere deep inside the cabinet, coursed its way around a bit then exited through one or other of the ports to continue its tortuous journey to my ears. Pity that all the other frequencies chose a more direct path, for the two apparently end up somewhat out of sync. I felt

This subjective phenomenon - out of sync bass - is a common price to pay for a speaker that is less damped than is good for it - and boomy. Some tracks, those that tuned into the cabinet's resonance, gave the Q50 a hard time. The metronomic drum beat in Do or Die, from Grace Jones'

Fame album, induced an embarrassingly box-bound "boof..boof" from the Q50; it sounded unhappy.

Curiously, the Q50s don't have the sheer bass depth of many other KEF speakers. I was surprised at the lack of rolling thunder from the opening of Steve Earl's 'Copperhead Road'; equally, but in another vein, the spectacularly explosive timpani in Carmina Burana made the cabinets boom, yet failed to really shake the room. Moving to the eternally difficult bass lead of Tina Turner's Break Every Rule showed clearly that the Q50s produce upper bass strongly, but curtail deep fundamental power. On balance, I would summarise the Q50s as having a balance that is subjectively bass prominent, under-damped and somewhat cabinet-resonant.

With the lower frequencies making themselves so well known it wasn't perhaps surprising that the midband should in contrast seem a little pushed back on the sound stage. Vocalists were quite clearly

reproduced. Angelique Kidjo's wonderfully characterful vocals swooped up and down in expression and power, but she had taken a few paces backward on the stage it seemed, the band's bassist apparently taking her usual place further forward. Hmmm.

Whilst KEF explain that the crossover point of their Uni-Q drive unit is aurally invisible - and technically they are right - subjectively the tweeter does have its own character, characterised by a slight low-treble prominence that adds a touch of occasional brightness into the sound with rock music, but occasionally had more impact with classical, I found. The violin of Hideko Udagawa was projected forward very strongly and came across as a little shrill and lacking in real detail. The vivid shimmer of the strings, their overtones and the instrument's rich woody resonances should all have been more explicit I feel. Whilst the Q50s threw the violin forward, plucked basses grumbled their way out of the cabinet ports. The Q50s worked well enough with rock, the tweeter livening up the speaker at high frequencies and giving it clarity, but with classical they were less successful.

The Q50s display less of KEF's traditional tonal levity than earlier models. Whilst they don't veer too far away from this particular ideal with rock, I have my reservations about their behaviour with classical recordings. Orchestral works and solo violin in particular suffered from colouration and distorted perspectives. Imaging was imprecise too.

KEF built their reputation not only by offering loudspeakers of great reliability and consistency through sheer weight of engineering, but also by making them appeal to a broad spectrum of musical tastes as well. In my experience, the Q50s take one step away from this ideal, offering a more coloured performance. It's good enough to find an appreciative audience, but by being what they are, the Q50s do demand to be auditioned carefully first - preferably in the home ● **NK**

KEF Q50

Floorstanders are enjoying something of a comeback these days. KEF's Q50s join the throng, coming in at £499. They are slim and unintrusive, possessed of a black ash veneer finish with gently curved black cloth grills and a discreet Q logo at the top of the cabinet. Floorstanding cabinets have plenty of room on their front panels for a drive unit or two - KEF chose two. There's a full range Uni-Q driver which has a tweeter positioned at the centre of its cone, taking the place of the usual dust cap.

Augmenting it is a bass driver which works up into the lower mid-range. Both work in ported reflex chambers, one port firing forward, the other backward. As KEF say "this arrangement gives the advantage of high power handling and efficiency". It also provides plenty of cone area for, potentially, strong bass.

Rightly or wrongly, most of us equate

MEASURED PERFORMANCE

The crossover between the mid-range driver and tweeter is smooth, but there is a steady lift upward in output above 4kHz, and above 8kHz output dies away, suppressing upper treble output. This will take away treble sparkle, but the lift will add lower treble forwardness.

Low bass falls away, but there is a peak in the upper bass at 250Hz which will add some upper-bass prominence. The wide shallow dip throughout the midrange is likely to constrain vocals to the box. It is well known that such trends are far more audible than deeper, narrower dips which the human ear can't detect so easily.

The low slung impedance curve results in an overall impedance of 7Ω-3Ω or so lower than most other British

loudspeakers. BUT NOT low enough to cause a problem to modern solid-state amplifiers. The curve itself has a sharp peak in the midband and impedance dives rapidly after this point - not a good loudspeaker for low feedback amplifiers.

The Q50s are of above average sensitivity, partly because of their low impedance. I measured 89.5dB at 1m using a nominal watt (2.83V) of pink noise input. This means that with a 30-40watt transistor amplifier they should go loud enough for all but the largest of parties.

The Q50s are reasonably well engineered. Their frequency response does not deviate too far from flatness and they offer a reasonable load. **DB**

Frequency Response



Impedance



J. E. Ellis,
Pinner,
Middx.

Hi-Fi World,
64 Castellain Road,
Maida Vale,
London W9 1EX

Ref: 300B AND 5881 VALVES

Dear Hi-Fi World,

Your 300B valve amplifier described in your August supplement is said not to be a re-run of an old design. If my memory serves me correctly, Partridge Transformers published very similar designs over fifty years ago for directly heated triodes PX25, DA30, DA60 and DA100. Admittedly, they did not have feedback windings on the driver transformer.

Distortion products of the 300B amplifier are said to be mainly second harmonic. One of the features of push-pull working is the balancing out of even harmonics so either the output stages of the prototype are out of balance or the fault lies in the driver stages.

Turning to the K5881 valve amplifier kit, the 6L6 is stated to have been designed by R.C.A., but this is not strictly accurate. The screen grid or tetrode has a kink in its characteristic, rendering it unsuitable as a power valve. Philips added another grid to make the pentode and patented it in 1933. C.S. Bull and S. Rodder of E.M.I. were given the task of circumventing the Philips patent, which they did by the invention of the beam tetrode. However, the Marconi Osram Valve Co. said that they could not mass produce it and the invention was passed on to R.C.A. The M.O.V. Co. did later make it in the form of the KT66, KT standing for Kinkless Tetrode (source: The Setmakers, published by BREMA).

J.E. Ellis



The 300B triode



The 5881 beam tetrode

Yes, I did not claim originality of the total design, but the driver stage and its methods are mine. One of the reasons for the driver transformer (my own winding method and propriety design) was to provide enhanced reliability to the output stage (why it enhances reliability I do not wish to divulge).

On the complete amplifier, the driver stage contributes about 50% and is mainly 2nd harmonic at about 0.4% with 70V rms (approx. 200V p-p) drive to each output tube due to it being a single-ended input and driver device.

Any absolutely balanced "push-pull" amp will still have even harmonic terms in its output. I have yet to see any amp, regardless of its technology, (i.e. transistor, FET, valve) having less 2nd than 3rd harmonic. The maths of this is due to odd orders being modulated by the fundamentals to produce even order by two non-linear terms.

The real purpose of the 300B was simplicity and consistency of performance, to encourage beginners into the world of hi-fi.

I know R.C.A. did not invent the tetrode but did

design the 6L6 and its derivatives, such as the 5881. There is a difference between inventing, designing and being an "applications note" engineer.

**Tim de Paravicini
Esoteric Audio Research**

**From the book
SETMAKERS**

"The first tetrode commercially available in Britain, designed by H.J. Round of the Marconi Company, was introduced by M-O V in 1926, and other manufacturers soon followed. However, it was not until

1928 that it was widely adopted by setmakers, prompting Wireless World to announce "Real H.F. amplification, formerly the privilege of the few, is now open to everyone". The applications of the screen grid valve were limited by an unfortunate 'kink' in its performance curve, and to suppress this Philips introduced a fifth electrode, between screen-grid and anode. The resulting 'pentode', eventually to become the most widely used of all receiving valves, found immediate application as the 'power' valve driving the loudspeaker, its high gain

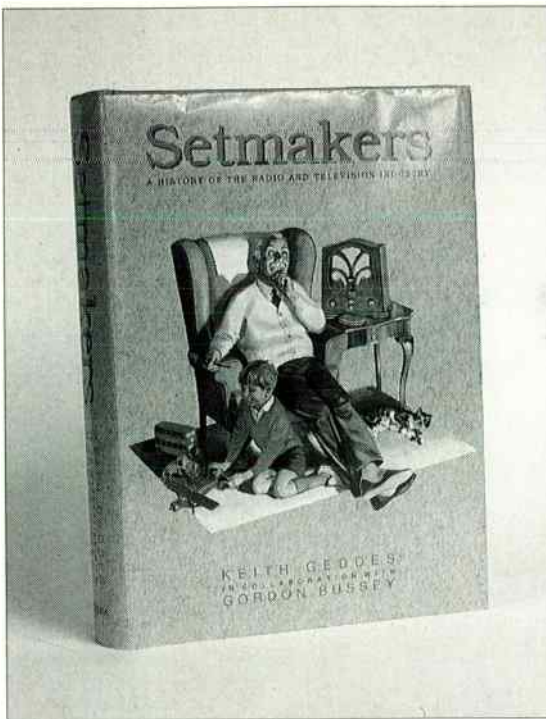

as welcome at that end of the receiver as the screen-grid valve's was at the other." (p68)

"In 1933, two members of the Department (EMI Research), C.S. Bull & S. Rodder were given the task of circumventing Philips' patent on the pentode valve. Within two days they had conceived the notion of the beam tetrode, in which the electron stream was brought to a focus between screen grid and anode, and was thereby made to perform the function of the 'suppressor-grid' that Philips' had added to the tetrode to create the pentode. The idea

was patented, and around 100 experimental valves were made in Research Department, but when manufacture was proposed to the M-O V they declared that it could not be mass produced. The patent was subsequently shown to RCA, who used it to produce the highly successful 6L6 valve, whereupon M-O V relented and belatedly developed its famous British counterpart, the KT66." (p147) (KT - Kinkless Tetrode)

Reprinted with kind permission from BREMA, the publishers, and Keith Geddes, the author.

TRIODES, TETRODES, AND ALL THAT

In the early days of radio there were only triodes and

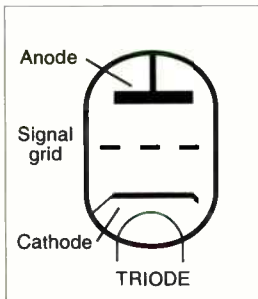

diodes. The diode was used for rectification and detection; it cannot amplify. The triode was used for amplification.

Triodes are not perfect, especially at high frequencies. They have limited gain, due to their comparatively low internal resistances, demanding a lot of preceding amplification, as well as a high drive voltage. This means using more valves, which is expensive, cumbersome and limited the amount of feedback that could be applied.

Triodes also suffer "Miller Effect" at high frequencies. The grid-to-anode capacitance causes

real problems, especially in high frequency amplifiers, but even in audio amplifiers too. Researchers found that putting an extra grid (screen grid) inside the valve between the input grid and the anode was the answer. It shielded the input grid from the anode giving rise to the Tetrode (four electrodes).

The tetrode revolutionised the radios of the day. Not only did it have the effect of reducing the input capacitance to a much more acceptable value, but it also greatly increased the valve's internal resistance, increasing gain so that wide-band, high gain stages could be designed easily. This cut down on the amount of valves needed to get good performance.

One problem remained. Inside a valve, negatively charged electrons emitted by the cathode smash into the anode at mind-boggling velocities. They cause more electrons to be emitted from the anode. In the triode

these "secondary electrons" cause no problems - they simply float around for a bit and then get attracted back to the positively charged anode. But in a tetrode some are attracted to the screen grid, reducing the anode current. This causes a "kink" in the valve's characteristics which can produce distortion.

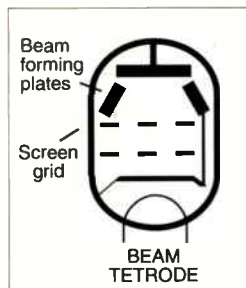

To overcome this problem, a third grid was introduced (by Philips), placed between the screen grid and the anode. It's called the "suppressor grid" and is held at ground

potential. It sends the secondary electrons back to the anode, eliminating the kink. This three-grid valve became known as a pentode and had both excellent high frequency performance and high gain.

Needing only a small input voltage to get large power output ,

pentodes appeared to be good output valves. Examples are Philips EL34 and EL84.

A later alternative to the screen grid was to squeeze the electrons from the cathode into a tight beam with earthed "beam guiding plates". This type of valve became known as the "beam tetrode", even though it had five electrodes inside. Such valves are used mainly for power stages because they give low distortion and are very efficient. Examples of this type are KT66, KT88 and the 5881 (KT = Kinkless Tetrode).

So we can see that the pentode and beam tetrode were the result of a lot of development to overcome the problems inherent in triodes. Yet even when they were introduced, some

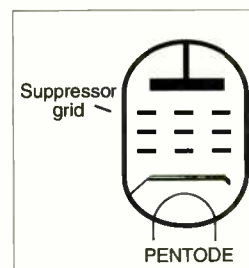

engineers continued to claim, for good reason, that triodes were superior. Today's view that this is so echoes an argument

from yesteryear.

Andy Groves

M.A.F

STANDS THAT DELIVER



Speaker Stands

MAF speaker stands have received critical acclaim since their recent launch. Trevor Butler said in Hi-Fi News (Feb'92) "Vocals were portrayed with superb realism and presence. Bass drums were reproduced with authority and orchestral bass was improved becoming smooth, deep and highly musical." These unique stands do deliver and are made in a variety of sizes and heights dedicated to specific speakers. These are not 'one size fits all' stands. Phone for details, or a copy of Trevor Butler's review.

Quad ELS Stands

these are the stands used by Chris Beeching in his feature on servicing and rebuilding the ELS (Hi-Fi News, Nov'93), and have elevated the performance of the ELS into another league.

Turntable Stand

This unique design will allow you to enjoy the ultimate performance possible from your turntable which will undoubtedly put a smile on your face. The unit is available with an additional shelf to accommodate a power supply if required. Please specify turntable type and size when ordering, as these superb stands are made to suit individual turntables.

NEW PRODUCT

System multi-shelf unit

This unit is made specifically to order, and with from two to five rubber-mounted 10mm thick smoked-glass shelves. The unit can be made to any height. This was the stand which took the Ramada show by storm, supporting Audion's magnificent '845' pre- and power amps. If you want to make a feature of your hi-fi, this is the shelf unit to have. It sounds great, too.

Unit 12b
Burton Business Park
Wellington Road Extension,
Burton on Trent,
Staffordshire
DE14 2AP
Telephone and fax No:
0283 30550

The thrill of hi-fi is often hearing the most delicate and subtle aspects in a recording. Today's CD technology can present an astonishing amount of information, but getting it all into your system is not quite that easy.



The more you put in
INPUT

It's here that Audio Technica's micro engineering skills can help, starting with the **AT6078 CD Lens Cleaner**. Deep inside your player the lens attracts dust, smoke and other debris, an industry acknowledged problem. A 10 second session with the unique eight brush disc safely returns optimum performance, greatly reducing tracking error for higher fidelity. **AT6078** contains CD control codes for fully automatic operation (in car **AT7121**). As an improvement to all machines but especially those 'budget' models **AT674 CD Stabiliser** is a carbon-fibre disc which helps reduce servo motor movement and aid error correction. Finally there's our magic green damping rings **AT6079** which fit to the edge of individual CD's to absorb stray laser light. The result is a smoother, more integrated sound and added disc edge handling protection.



&
The better it comes out
OUTPUT

From the wide A-T headphone range we can offer **ATH308** (and sister model 309), the perfect mid-size headphones. High sensitivity, low weight and extreme comfort make them stand out from the crowd. Our 900 Series offer a 'larger than life' sensation courtesy of large diameter drivers and copper clad aluminium voice coils. Top of this range **ATH911SV** is packed with sound enhancing features including 'High Energy' Neodymium magnets. For ultimate audiophile listening **ATH9000** is a very special headphone/transformer combo which sits in a direct line between your amplifier and loudspeakers. Its electret condenser system is at the leading edge of high fidelity to re-create the very sense of 'being there'.

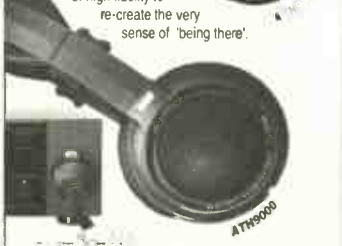

audio-technica
INNOVATION PRECISION INTEGRITY

Technica House, Royal London Industrial Estate
Old Lane, Leeds LS11 8AG
Tel: 0532 771441 Fax: 0532 704836

SEE THEM AT GOOD HI-FI STORES

Music Mill

At the Music Mill, we believe that buying hi-fi should be a pleasurable experience. We offer friendly professional service and advice in comfortable 'no rush' surroundings with the emphasis on your specific requirements. Excellence in hi-fi includes Nakamichi,

hear

Harman Kardon, DNM, Rehdeko, Audio Innovations, Nottingham Analogue, Pro-Ac, Systemdek, B&W, Cerwin Vega, Dal and Micromega.
The Music Mill - a fresh approach to hi-fi selection.

Access for people with special needs

Specialist hi-fi technical advice and service

here

The Music Mill (Scotland) Ltd
Bonnington Mill Business Centre
72 Newhaven Road
Edinburgh
EH6 5QG
Tel & Fax: 031-555 3963

Art Audio

MAESTRO

"They are just so stunningly gorgeous and open to listen to, I can barely imagine anything more alluring"

NK Hi-Fi World, June '91

Valve amplifiers from £750 to £4150.

Cables from £27 to £1700

Select Audio
Glasgow (041) 226 4268

Doncaster Hi-Fi Studios
Sunnyfields (0302) 731387

Paul Green Hi-Fi
Bath, Avon
(0225) 316197

Hazelmere Audio
High Wycombe, Bucks
(0494) 437892

Audio Venture
Banbury, Oxon (0295) 261863

The Hi-Fi Consultants
London (071) 380 0866
Evenings (071) 482 0003

Audible Difference
Diss, Norfolk
(0850) 983233 or
(0379) 740227

K.A.L. (UK) Ltd
Folkstone (0303) 245005

The Hi-Fi Consultants
Nottingham (0602) 232450

Impulse Audio Consultants
Westcliff-on-sea, Essex
(0831) 616426 or 0374 277736

Sound Academy
Bloxwich, West Midlands
(0922) 473499

New A4 brochure containing full details of our
amplifier and silver cable range contact
Art Audio (UK) Ltd.
130 Main Street, Calverton,
Nottingham, NG14 6LU
England
UK Tel. 0602 - 653604
Fax 0602 - 637795

Name:
Address:
.....
.....
Code:

IN THE JUNE ISSUE

What better way to pass those long hot summer evenings than listening to some good music and reading your favourite magazine, especially with the reviews and features we have lined up for the June issue. Here's a selection of what we hope to bring you next month -

DPA PDM Ten Twenty-Four

A stunning new digital CD convertor from innovative DPA. Designed mostly in-house to avoid the of mass-production chips, the new £6000 Ten Twenty-Four promises to be revolutionary. We'll have an exclusive review.

MISSION CD PLAYER

This stunning two box player looks set to cause another buzz around the office, especially since we'll also have two PSX power supplies to go with it.

TUBE TECHNOLOGY GENESIS VALVE AMPLIFIER

New monoblock flagship valve power amplifiers from a well established manufacturer.

BUDGET AMPLIFIER GROUP TEST

Can home grown budget integrated fight off the marauding hoards of tweaked-up Japanese 'super amps'?

ROGERS STUDIO 5

The latest mid-sized speaker from a respected manufacturer whose name is synonymous with the quintessential British sound.

AUDIOLAB CD TRANSPORT

The long awaited partner for the 8000DAC, will both combine to form something special from the digital medium?

SENTEC AURORA

Large floorstanding loudspeakers from Scandinavia, with a big sound.

RECORD CARE

With vinyl becoming very precious, we've decided to take a serious look at what's available for preserving our recorded heritage.

Hi-Fi World is still only £2, but with more editorial than most rivals. With the most enthusiastic and expert editorial team in hi-fi journalism, can you afford to miss it? Make sure you don't by filling in this order form and handing it to your newsagent.



Please reserve/deliver* Hi-Fi World on a regular basis, commencing with the next issue, until further notice.

Name:

Address:

.....

.....

.....

.....

.....

Signed: _____ Date: _____

- Delete as appropriate

Distributed to the news
trade by

COMAG
MAGAZINE MARKETING

TWEAKED UP

The RA-960 BXII is the latest of Rotel's products to receive special attention. Dominic Todd thinks it was worth the effort.



Rotel are mounting something of a come-back in the field of amplifiers. The old 8-series amps rarely failed to get glowing reports every time a new derivation was launched. However, the introduction of the 9-series, two and a half years ago, didn't receive such universal recognition. The budget 920 and 930 were well received, but Rotel's more expensive amps met with something of a luke warm reception.

I remember the RA960BX was a particularly slow seller, especially in comparison to the new breed of "superamps", such as the Pioneer A400 and Marantz PM 40SE, which simply left the Rotel floundering. Over-pricing didn't help the 960's cause either, being a good £100-£130 more expensive than rivals, right up until its demise.

Now, after the storming success of the year old RA935BX, comes a new

improved RA-960BX, imaginatively named the Rotel RA-960BXII. This time Rotel have got the price right too. Whilst most rivals have been creeping up in price, Rotel have held fire. A price of £325.00 is competitive against the Pioneer A400X (£299.95) and NAD 306 (£329.95). It's not a steal, though, with rivals from Denon and Marantz still undercutting the Rotel by £75 and £25 respectively.

In a break from my usual habit I'll mention what hasn't changed first of all. The casing, all controls and features are identical, making it indistinguishable from its predecessor. This is no bad thing, though, as Rotel products are one of the best finished in the business. A solid, compact casing is fronted by a smart, black brushed aluminium effect metal front panel. It also makes a refreshing change for an amp of this price not to suffer the usual bending rear panel, as one attempts to attach and disconnect phono plugs.

Features include, a headphone socket (don't laugh, it's something you'll no longer find on the A-400X), defeatable tone controls, separate record and listen

MEASURED PERFORMANCE

The RA-960BX worried me initially by running hot compared to most solid state amplifiers, then I saw a warning in the handbook where this was attributed to Class A working in the driver stage. Otherwise, the amplifier behaves conventionally, turning out 78watts into 8ohms and 121watts into 4ohms. Unaffected by reactive loads, it possesses plenty of power and will handle speakers that are a difficult load.

The main amplifier (i.e. CD/tuner/tape inputs, etc) reaches down to 16Hz (-1dB), low enough to give it bass power with some feeling of speed, for really deep bass can apparently slow things down. At the other end of the audio spectrum, treble

rolls off slowly above 25kHz, becoming -1dB at around 55kHz minimum, the precise frequency depending upon volume control position, as is so often the case. The RA-960BX is flat across the audio band though. It is also sensitive, needing just 200mV for full output, and noise free. Distortion levels were generally low, except as level went up at high frequencies. Then, it rose rapidly, reaching 0.17% just below (-1dB) full output. This may just be perceptible as a slight sharpness in the treble, since third harmonic and higher odd-order components took over from second above a few watts of output.

The disc stage has switchable MM/MC input options on the rear panel and the MC

input offers a 100Ω load, not 47k as in so many amps. It is also very sensitive, needing just 0.25mV for full output, enough for low output MCs. Hiss was quite low too, measuring 0.1μV equivalent input noise, so this stage puts up a good measured performance for MC cartridges. The same applied to MMs. However, Rotel have taken the low frequency response of MM and MC down to 20Hz before rolling it off, allowing some cone flap to occur with warps, at least in a system prone to it. The plus side is that deeper bass should be apparent.

The RA-960BX measures well and has well engineered disc stages, which is a bonus. **NK**

selectors and two sets of speaker outputs (one switched). The real changes have occurred internally, although the only technical specification to have increased is the damping factor. Power remains at 60 watts. The key changes have been to use polypropylene capacitors in the negative feedback area, and the output device. There has also been a change to the internal chip in the line amp, and the power supplies are now de-coupled via Rubycon smoothing capacitors.

This may not sound a lot, but every change of component was carefully listened to and evaluated before the final specification was decided. I've never been a fan of the original 960's sound quality; although it was free from any serious vices, I found it rather lacking in pace and involvement. So after burning in the test sample I was interested to see if Rotel had achieved their goal; superior timing, speed and articulation in the bass.

With Celestion SL6 speakers being one of the speakers used in the mark II's development, I hooked up my own similar SL600s, to see how it would cope with this often difficult load. Joe Jackson's, 'Nineteen Forever', got the Rotel off to a fine start. The extra drive was instantly noticeable, and much improved from the original 960. The bass guitar's prominence led the mix, and gave it the vital weight of sound needed for listener involvement. Vocalists don't usually present a problem for Rotel amps, and the 960 was true to form here. Jackson's vocals were presented with the

characteristic Rotel warmth and richness. Fortunately it avoided the syrupyness of some over-smooth amps, but at the same time failed to wring every last detail out of the music, as something like an A-400 would.

Jeff Healey's interpretation of Mark Knopfler's 'I Think I Love You Too Much', showed the 960 to have a more forward, and subsequently less recessed, balance than any previous Rotel amps (pre/powers included). It came as quite a surprise to find that Healey's vocals were

pushed well in front of the rest of the mix, and had real presence. This contributed to the sound stage's excellent depth and width, which rivals some of the best at this price range, and marks yet another break from Rotel's tradition of tending to sound occasionally shut in. This new found openness really does change the character

of the whole amplifier, allowing it to sound less constrained with complex music, and hence less fussy with varying types of music.

If there was a weakness to the 960's convincingly well rounded sound quality, it was shown up with a Capercaillie 'Crosswinds' album, and by comparing the amplifier to others directly afterwards. Instruments and vocals that crossed into the upper mid-range, such as violin and saxophone, could occasionally sound strangely out of tune, almost as though they weren't playing as a whole with the rest of the music. It's not a trait one really notices, though, until another amplifier is heard directly alongside. Also, it's not a problem that I see as serious; it doesn't affect the

listener's enjoyment of the music.

Classical music, a traditional Rotel forte, gave an all round competent performance. Large scale orchestras were free from dynamic compression, and the broad soundstage coped admirably with the instruments' separation. The Rotel also gave the listener the opportunity to follow particular instruments in movements of a dense structure. With quartets, it wasn't the last word in crystalline clarity, and wasn't quite as open sounding as some, but none the less represented a firm step in the right direction over previous Rotel products.

The Rotel RA960BXII is a likeable product. The build quality is first rate for the price, and inspires real confidence. All the features that should be included, are, and none that shouldn't be (such as loudness controls), aren't. What's more, there is a large dealer network, meaning that you don't have to travel miles for a dem, and servicing is a straightforward job. I can say from experience that Rotel amps are also superbly reliable. Yet the old RA960 amp had all of this, but I still wouldn't really have recommended it on the grounds of its rather drab sound quality. Here, the Mark II really excels, sounding confident and composed with a wide range of music, it's also pacy and reasonably articulate.

Despite the odd niggle, the Rotel RA-960BXII has matured into an amplifier which I can confidently recommend alongside the successful Pioneer A-400X and Denon PMA-350II. The modifications have transformed the 960 from a middling contender to one which is firmly entrenched in the top league ●

Rotel RA960BXII £325
Gamepath Ltd.,
25 Heathfield,
Stacey Bushes,
Milton Keynes,
Bucks. MK12 6HR.
Tel: 0908 317707

“The Mark II really excels, sounding confident and composed with a wide range of music”

TEST RESULTS

| | | | |
|--------------------|------------|--------------------|------------|
| Power | 78watts | Sensitivity | 2.8mV |
| CD/tuner/aux. | | Overload | 170mV |
| Frequency response | 16Hz-74kHz | Disc (MC) | |
| Separation | 78dB | Frequency response | 20Hz-60kHz |
| Noise | -95dB | Separation | 52dB |
| Distortion | 0.02% | Noise | -69dB |
| Sensitivity | 200mV | Distortion | 0.02% |
| dc offset | 8/14mV | Sensitivity | 0.25mV |
| | | Overload | 15mV |
| Disc (MM) | | | |
| Frequency response | 20Hz-52kHz | | |
| Separation | 59dB | | |
| Noise | -74dB | | |
| Distortion | 0.02% | | |

Distortion

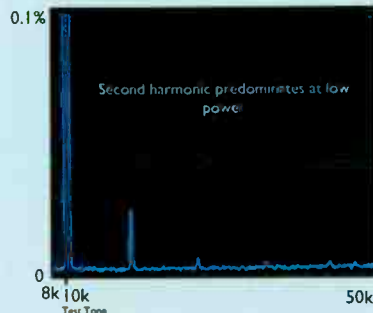

The domination of the chart scene by dance music has had one profound effect on popular music today, that is the death of the Lyric - indeed the threatened death of the popular song form itself. Put in this way, I believe we ought to regard dance as a "pure music" form - more akin to classical music than to the aural song tradition which has formed the basis of all folk, rock and pop music until now.

A very different kettle-of-fish it is to the tradition of the song, which reaches back to the pre-literate past. (Of course, rap music represents an important exception, but in rap, the message - albeit often distastefully xenophobic and misogynous - is of such overriding importance that this type of music is a form of poetry and not a musical form at all.)

To me, this emergence of a pure, popular musical form is both a good thing and a bad:

Good, because the exploration of pure sound is very far from the meretricious experimentation which it is sometimes accused of being (why shouldn't musicians blend sounds in a manner to delight our sense of hearing in the same way a cook might explore different ingredients to delight our sense of taste?)

Bad, because it cuts us off from the vital tradition of the finely crafted three minute song. Put another way; where are the "our songs" of the future?

I don't suppose anyone can know exactly when the song-form first developed, but it was an invention every bit as important as the wheel (although, come to think of it, where would Bruce Springsteen be without both inventions?).

The first songs I remember were folk-tunes which we learned at school. And it's odd, how thirty years later I discover that I learned highly sanitised versions of these most early songs. For instance

although I remember singing, She Moved Through the Fair, I don't remember singing the final verse:

*I dreamt it last night that my young love came in,
So softly she entered, her feet made no din,*

*She came close beside me, and this she did say,
"it will not be long, love, till our wedding day."*

With the inclusion of this last verse, the perfect blend of everything a good



recorded message

Left by Richard Brice

song should be, it becomes. It's delightful, humorous in a way that is delicately self-mocking, erotic, but not licentious. These attributes are what attracts me to what I consider to be the great period of song writing, the nineteen-twenties, thirties and forties. Whether it's Jerome Kern's and Dorothy Fields' A Fine Romance or Cole Porter's:

*There's no love song finer
But how strange, the change
From major to minor
Everytime we say goodbye.*

The delicate double rhymes and the musical prosody to mimic the words "major to minor" shows a creative deftness which is quite wonderful.

Which brings me to Gershwin and Gershwin, and my "desert island" lyric:

*In time the Rockies may crumble
Gibraltar may tumble,
They're only made of clay
But our love is here to stay.*

A characteristic of these lyrics, typical of the words of the popular song during the twenties, thirties and

forties, is their air of urbane detachment. I'm not for a minute suggesting that the art of great Lyric writing is dead - far from it. However, the modern songwriter just has to be so-o-o serious!

*The boy child is locked in the fisherman's yard
There's a bloodless moon
where the oceans die
A shoal of nightstars hang fire
in the nets
And the chaos of cages where
the crayfish lie.*

It's brilliant but, blimey Sting, it's grim stuff - Samuel Taylor Coleridge on 48 track digital. Neither is the eloquent romantic dead either, at least whilst we still have Annie Lennox:

*Stay by me
And make the moment last
Please take these lips
Even if I have been kissed
A million times
And I don't care if there is no tomorrow
When I could die here in your arms*

But it is very earnest. Of course, teeny-pop still provides a lightweight alternative. The New Kids

on the Block might have "acronymically" become the tough NKOTB, but the songs haven't.

And Take That, even the titles: Babe, A Million Love Songs. Let's face it, they don't auger well for the following Lyric. And when you listen to the Lyric, well your pessimism's not disappointed!

And a cab combs the snake trying to rake in that last night's fare and a solitary sailor who spends the facts of his life like small change on

strangers pauses inside peekhole park for a welcome 25 cents and the last bent buff from a package of Kent's as he dreams of the waitress with Maxwell House eyes and marmalade thighs with scrambled yellow hair and a rhinestone studded monarch he says "Irene" as she wipes a wisp of dishwater blonde from her eyes and the Texaco bacon burns on a steel belted attendant with a ringing valve special crying "fill her up and check that oil you know it could be the distributor and it could be your coil!"

Is it any wonder, when Lyrics have reached this sophisticated synthesis of James Joyce and Raymond Chandler, there's perhaps nowhere left to go.

Conceivably, that's why dance music has emerged as a strong force. Not so much a denial of the lyric as a reaction against a kind of brick wall brought about by the polarization of the contemporary lyric between the high-brow existentialist's creation of meaning and the puerile. Perhaps rock has finally hit the same crisis which has hit all the arts in the 20th century, the "Where do we go now?" crisis ●

TABULA RASA LOUDSPEAKERS



"It is a rare experience to play a track that you have known for the better part of, say, twenty years and suddenly, to hear new details and information."

(Hi-Fi World - Dec '93 on CT77 loudspeaker kit)

With the increased popularity of "do it yourself" hi-fi, Tabula Rasa are offering an extensive range of quality loudspeaker kits and car audio kits from top German manufacturer Mainhattan Akustik.

All loudspeakers kits are simple, fun to build, and at prices to suit all pockets. Each kit comprises

drivers, filters, connections, terminals, and all the necessary fittings needed to complete your chosen loudspeaker, and every kit is available with or without cabinets. Furthermore, each kit comes with a 10 year warranty as standard and will be delivered within 14 days of confirmation of your order. For a catalogue (including price lists and a brief guide to speaker construction) please send £2.00 (refunded after first kit purchased) and a self addressed A4 envelope to:

Tabula Rasa, 136 Kilnwood, Walters Ash, High Wycombe, Buckinghamshire, Hp14 4UR, Tel 0494 565116

Cheques and postal orders should be made payable to Tabula Rasa. Trade prices available on request.

30 days money back guarantee offered on all drivers & kits.



Hi-End Hi-Fi in the heart of East Anglia.

For the best in Hi-End hi-fi Bury Audio is a must. All the names stocked are individually chosen to complement one another to give the best sound in their class. To get the best from CD there are DAC's like **Pink Triangle - Da Capo or Ordinal**. Great sounds now can mean good looks too thanks to **Michell - Iso, Argo, Alecto**. Now, Gyrodec sounds better still with the **Tesseract - Tags psu**. Valves from **Tube Technology - Unisis**. For fanatics, **Musical Fidelity - F22 and F15**. Open natural sounds from **LFD - PAO, LSO, MMO**. Stunning to look at and to listen to the new **Ruark - Equinox**. These are just a selection of the impressive sounds on demonstration now. Why not come in and have a listen to the best sounds in East Anglia.



Bury Audio

47 Churchgate Street,
Bury St. Edmunds, Suffolk IP33 1RG
Tel or Fax : 0284 724337

D I V A

audio fidelity

Experience just how good your LPs and CDs really can sound by listening to them through one of our hifi systems.

analogue replay
Project
Michell
Townshend
Wilson Benesch
Basis
Kuzma
SME
Sumiko
Lyra
Transfiguration

digital replay
TEAC
Aura
Micromega
Counterpoint
Mark Levinson
Accuphase

valve amplification
Audio Innovations
Trilogy
Audionote
Tube Technology
Conrad Johnson
Lumley Reference
Counterpoint
Sonic Frontiers

*solid state
amplification*
Rotel
Aura
Adecom
John Shearne
Audiogram

Alchemist
LFD
Michell
Chord
Primare
Mark Levinson
Tesseract Audio

loudspeakers
JPW
Monitor Audio
Sequence
B&W
Triangle
Audionote
SD Acoustics
Impulse
REL
Audiostatic
Thiel
Klipschorn
Townsend

cables & accessories
XLO
Audioquest
Audionote
Cogan Hall
Silver Sounds
Seismic Sink
Tripod
Frameworks
Leider

audio-visual
Harman
Lexicon
JBL

From £50,000 to £500 we put together the finest hifi to suit every budget. Call us or pop in to arrange a musical experience you'll never forget.

Workshop 30, Royal Victoria
Patriotic Building, Fitzhugh Grove,
Wandsworth Common, London SW18
0 8 1 8 7 5 9 5 9 3

When the time came for me to set the Classified Ads section this month (see our last few pages, for those of you who never get that far!) I was reminded of my impoverished past. With Japanese equipment increasing in price all the time and well known British companies trying to move upmarket away from cut-throat Oriental midi-systems, it is becoming increasingly difficult to put together a really good system for little money. Here's where our Classifieds can help.

There's a wealth of high quality second-hand equipment around at the moment. The reason is perhaps that as signs of the recession lifting start to show, people are upgrading to newer, more expensive equipment. But whatever the reason, it will benefit those who have the time to read through the used equipment advertisements that appear within our pages, and those of other sources such as Exchange & Mart.

BEGINNING

At the beginning of my hi-fi enthusiast years I bought equipment almost exclusively from classified ads, as well as retailers who took equipment in as part exchange, selling it to less wealthy customers. I started out in my teens (and this is the first time I've admitted to owning any of this stuff!) picking up an old Thorens TD160 (£80), Helius Scorpio tonearm (£40), an AT-95E cartridge (£16.95 new), a wicked looking and heavily built Sugden A48a Class A 50 watt amplifier (an amazingly well spent £75) and a pair of what are now known as Ruark Sabres. The ones I had were pre-Ruark (called Diesis Solitaires, as far as I remember), but they sounded better than anything else I could afford at that time, so I took a risk and bought them for £90.

So for around £300 I got what I thought at the time to be an excellent system. It wasn't long before I'd modified, re-wired, bi-

wired everything to a point that made them pretty much worthless to anyone wanting a neat and tidy hi-fi system, but I enjoyed it and the whole exercise taught me a lot about how hi-fi works.

From there onwards I steadily upgraded my system through second-hand equipment. In the end I managed to amass an excellent system consisting entirely of used equipment: a Cambridge CD2, Rose RV23 valve pre-amplifier, Deltec 50S power amplifier (I still use this, one of my best-ever buys) and a pair



Dominic Baker

dB on the level

of Celestion SL600s. The whole system cost less than half of its original retail value, yet was in as-new condition.

Of course, not everyone has the time or inclination to buy second hand in this fashion, but it is an option worth considering; there are real bargains out there. Interestingly, keeping the second-hand market active supports the retail price of new products too. Both Jaguar and Mercedes have found in the past that it was in their interest to support the second-hand market for their cars in order to reassure new-product buyers that the price paid wouldn't plummet directly they handed over their wad. So healthy second-hand demand makes for a more active primary market.

I couldn't help noticing, whilst compiling this month's classifieds, the amount of excellent equipment that's up for sale at bargain prices. I reckon I could put together a superb system for under £1000, all esoteric gear and quality stuff, the kind that lasts. For example, a top flight vinyl system could be made up from: Elite Rock, Rega RB250, AT OC5 (a

little bright, but not bad for a first cartridge), the whole lot £335. An Audiolab 8000A would be an extra £295 and a pair of Epos ES14s complete with stands £350. The Elite Rock is a superb turntable complete with a unique damping trough that controls the arm, to the benefit of the cartridge, allowing it to perform at its best. The 8000A is an excellent and perennially popular amplifier and the ES14s are lucid, and very neutral in their sound.

This is a system of high quality items that are built to last. They should give a lifetime of pleasure - and all for the price of a top-of-the-range midi system. Record decks especially are good value at the moment, it seems.

There are other notable bargains to be had, the best of which must be the Pink Triangle PIP at £350! These were around £2000 new only a few years ago. It may be a mistake, but if it isn't, someone's going to get a real bargain here.

Looking for a decent phono head amp? How about a Michell Iso with Hera power supply for £275. Another Michell

bargain is the Gyropower power supply at £50! If our contributor Eric Braithwaite hears about this one it'll be gone before the magazine gets printed. There's a latest generation Mission Cyrus 1 for £175 and a QED Digit and Positron complete with Digiflex interconnect for £119, so good quality hi-fi is easy to find at reasonable prices.

Now, the tricky bit - the law. Unfortunately, as I mentioned in a column a year or so ago, the law basically goes as far as "let the buyer beware" and no

further. So it is your responsibility to make sure that everything's done properly when buying.

Don't get over excited about the bargain you're about to land, because if you rush into it, you're likely to get something you didn't want. A courier is the best means of transport as they will insure the parcel during transit and a record is kept of the equipment's movements between the two parties. Even though Amtrak have a so-so reputation with our American readers we find (they are America's equivalent to B.R.!) their service in the U.K. is excellent.

We are trying to set up a special courier service with Amtrak for readers at the moment, offering good rates and fast, safe carriage. Hopefully this will open up the masses of quality second hand equipment to a much wider audience. This should be in place in time for the June '94 issue. So if you've never flicked through the classifieds at the back of the magazine, have a look now. You might find that it opens up hi-fidelity to you in the way it did for me ●

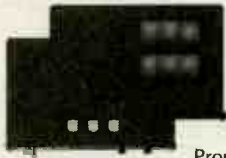
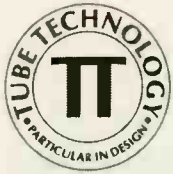

Prophet



Genesis



Unisis

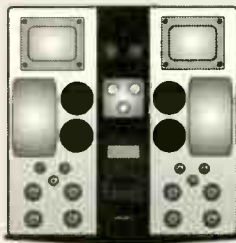

Synergy

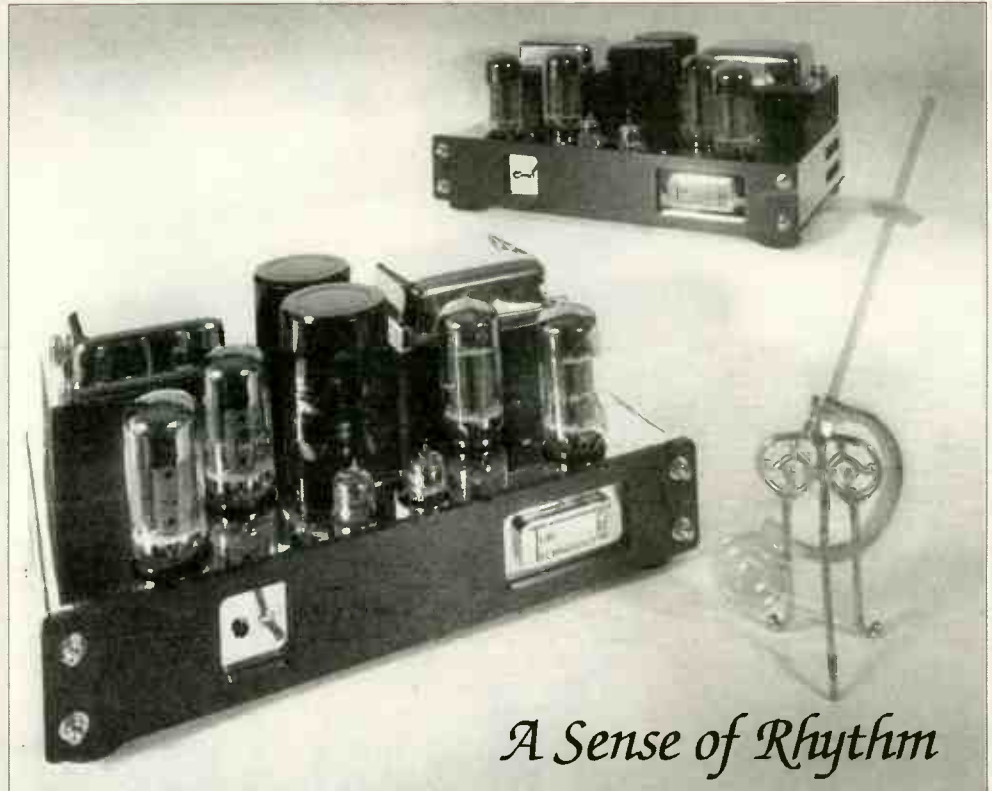

A Sense of Rhythm

Tube Technology, Design & Manufacturers of High Quality Tube Amplification & Distributors of Gold Aero Vacuum Tubes. Please enquire for further information on our range of amplifiers and Vacuum Tubes. ~ Hatch Farm, Chertsey Road, Addlestone, Surrey, KT15 2EH, England.
Tel: 0932 850361 Fax: 0932 850354 ~ Pictured; *The Genesis 100 watt All Tube Monoblocs.*

Wilmslow Audio



As any discerning sound engineer will tell you, the ATC SCM50 and 100 are the ultimate in accurate low distortion professional monitoring. But what they may not know is that self assembly versions based on these classic monitors are now available from the UK's leading speaker kit supplier, Wilmslow Audio, at a fraction of the ready built price. ATC and Wilmslow Audio have worked very closely on the cabinet and crossover design to ensure that the completed kit lives up to the very high standards associated with the ATC name. As with all Wilmslow products, the ATCK50 and K100 kits come complete with precision machined cabinet panels, crossovers, and all necessary hardware, including

factory matched ATC drivers. Cabinet parts are machined from high grade MDF for easy assembly and consistent acoustic performance. ATC's MK I Tri-Amp Pack systems are available as an option if required.

- The Result . . .**
- Stunning accuracy and clarity
 - Clean well damped bass
 - Smooth detailed treble
 - Totally transparent mid range
 - No overdraft!!!

If you aspire to the unrivalled quality of ATC monitoring, but are working to a tight budget, contact Stephen Leigh who will be pleased to tell you exactly how economical these kits are. ATCK50s and 100s are on demonstration by appointment.

Wilmslow Audio Limited, Wellington Close, Parkgate Trading Estate, Knutsford, Cheshire, WA16 8DX, England. Tel: (0565) 650605 Fax: (0565) 650080

Adagio cantabile

... "It ain't what they say, it's the way that you play it... That's what gets results....."

Upgrading? Building? Replacing? or just rediscovering music....

...the **overture** and **perception** ranges will redefine the reference.

Whether playing vinyl or CD, all Kinshaw products have been designed with purity, transparency, musicality and compatibility in mind.

Phono Centres, DAC's, Pre-Amps, Amplifiers and.....

To avoid disappointment from making the wrong choice, don't make your purchase before at least auditioning our products.

U.K. agent: Ortolon (UK) Ltd. Chiltern Hill Chalfont St. Peter Bucks. SL9 9UG Tel: 0753 889949 Fax: 0753 889636

Overseas agent: Kronos Distribution 35 Farlough Road Newmills, Dungannon N. Ireland BT71 4DU Tel: +44 (0)8687 48632 Fax: +44 (0)8587 48281

Contact your nearest retailer for an audition or for more information....



Conceptual Design - Sound Engineering

Kinshaw Electronics Ltd 84 Pendarves Street, Tuckingmill, Camborne, Cornwall TR14 8RE Fax: +44 (0)209 711939

Meet-Your-Maker

A reference guide to Britain's Manufacturers and Distributors.

ACOUSTIC ENERGY, 3a Alexandra Road, London W13 0NP. Tel: 081 840 6305. Acoustic Energy manufacture the award winning Reference Series AE1 and AE2 loudspeakers and the new Aegis Series Model 1, all of which feature the unique AE metal cone drive units. The AE distribution division offers superb high end products from WADIA, GRYPHON, ENSEMBLE and TARA LABS.

ALCHEMIST PRODUCTS, 4 Rosebury Mews, London N10 2LG. Call us for a list of our dealers in many areas including:- London, Kent, Hampshire, Wilts, Milton Keynes and N. Ireland and for product information on the Kraken, Freya, Bragi, Ddin, Genesis and more.

ALEMA UK LTD., 25 Montifore Road, Hove, BN3 1RD. Tel: 0273 202637. Audion 'Edison' 'Andersson' (Trade enquiries welcome for our newly extended range).

APPOLLO, The UK based designers and manufacturers of high quality speaker stands and equipment racks have now added to their comprehensive range a modular system ideal for housing audio visual products and CD storage. Please send for our free brochure to Zenith Crown Ltd. Tipton Rd, Dudley, West Midlands, DY14 Tel 021 520 5070. Fax: 021 522 2055. - All export trade enquiries welcome for our newly extended range).

ARCAM, Pembroke Ave, Denny Industrial Centre, Waterbeach, Cambridge, CB5 9PB. Tel: 0223 440964 or Fax: 0223 863384. Manufacturers of the Delta 290 Amplifier and the Delta 280 Digital FM Tuner. The two together produce a sound that has been described as 'subtle and intriguing' and that provide 'real clout' - discover this for yourself! For information on not only these products but also the Arcam CD Players, Speakers, Cassette Decks etc., Phone or write in to request a brochure - The pleasure is all yours!

AUDIODOTE CD, Unit 1, Block C, Hove Business Ctr. Fonthill Road, Hove BN3 6HA. Tel: 0273 220511. Audiophile supply a range of very high quality and very expensive audiophile components including valve output transformers.

AUDIO SYNTHESIS, 99 Lapwing Lane, Manchester, M20 0UT. Tel: 061 434 0126. Audiophile design, development and distribution. Please contact us for details of PASSION the passive controller everyone's talking about. SILVERBLUE pure silver interconnect cable and the ultra analog based dac - DSM.

AVONDALE AUDIO, Tel: 0246 200096. Exploit the full potential (and more) of the Linn LP12 Turntable for only \$568.00 inc. (Cost much less than a Lingo) with Avondale's very naughty but STUNNING converter. For a chat...the above number, please.

BANDOR, Studio II, Penfold Cottages, Penfold Lane, Hoimer Green, Bucks. HP5 6XR. Tel: 0494 714058. Aluminium anodised cone drivers with only 1.8 gm moving mass giving full detail to sound covering 2/3 of the frequency spectrum.

BANDRIDGE LTD are the premier suppliers of quality audio and video leads, connectors and speaker cables in the UK. In addition to probably the widest range available, including PRDFI GOLD, SUPER GOLD and SUPER +, offering a level of quality that meets the needs of the most exacting specification. Bandridge of London Ltd. Premier House, Deer Park Road, Wimbledon SW19 0B1 543 3633.

CABLE TALK PD Box 413, Woking, Surrey, GU22 8YZ. Telephone 0483 750667. Fax 0344 360866. Designers and manufacturers of British made high quality, value for money, interconnect and speaker cables. Phone or fax for a free full colour brochure on our What Hi-Fi? 5 star rated products.

CANFORD AUDIO PLC, Crowther Road, Washington, Tyne & Wear, NE38 0BW. UK Sales 091 415 0205. Admin 091 417 0057. Fax 091 416 0392. U.K.'s leading manufacturer and distributor of professional audio equipment. 6000+ products are detailed in a bi-annual catalogue which is available free of charge to professional users. Next day deliveries when possible.

CAMPAIGN AUDIO DESIGN, Llandudno Road, Cardiff CF3 8PG. Tel: 0222 779 401. Suppliers / manufacturers mailorder, high purity silver interconnects, loudspeaker cables, internal wires and bespoke mains cables. Generous two week trial period.

CHELMER VALVE COMPANY, For Audio Valves - 130 New London Road, Chelmsford, Essex. CM2 0RG. Tel: 0245 366206/366206. Fax 0245 490064. We manufacture the high quality alternatives to all those famous brand names of yesterday. Such as Mullard, MOV, GEC etc. With over 30 years experience in this field, we process valves from world wide sources using our specially developed factories. For CVC premium valves inclusive of pre-amp and power-amp, also rectifiers and sockets call Chelmer Valve Company.

CHORD ELECTRONICS, 3 Bower Mount Road, Maidstone, Kent. Tel: 0622 764874 Addition the Chord SPM 1200 at any of the following branches: Doug Brady HiFi - Liverpool /Leeds/London/Cheshire. Audio Reflections - Leeds, Music Matters - West Midlands and many others. Please call us for details.

CONCORDANT PREMIER TUBE, 14 Glyn Close, Barwell, Leicester, LE9 8GL. Tel: 0455 843752. The Excelsior - Designed for the analogue enthusiast. The Exhilarant - Designed for the line enthusiast. The Exquisite - Designed for the analogue and line enthusiast.

The Exhilarant Power Amp fitted to Quad II Hardware. **DBS AUDIO**, PD Box 91, Bury St. Edmunds, Suffolk, IP3 0NF. Tel: 0284 828926. Fax: 0284 828026. The DBS6 loudspeaker kit, as designed by Dave Berriman and featured in Hi-Fi News Feb/Mar 92, is still available - only from DBS Audio. To find out what these comprise, cost and how to order plus any other information on DBS products please telephone, fax or write in to the above address and numbers.

OPA DIGITAL, Unit 7, Willowbrook Technical Units, Crickhowell Road, St Mellons, Cardiff, CF3 5DF. Why do reviewers across the world rave about DPA products? Listen to DPA's DACs, transports, amplifiers and cables and discover for yourself.

IAN EDWARDS, The Old Chapel, 282 Skipton Road, Harrogate, Yorks. Tel: 0423 500442. Somebody Somewhere must make better storage units for CDs, Music, LPs, HiFi, Books, etc. than Ian Edwards BUT until he appears, why not send for the brochure showing a selection of HAND MADE units. To do this please send 3 x 2nd class stamps.

E J JORDAN DESIGNS, The Dak, Manor Bier, nr Tenby, S. Pembrokeshire, SA70 8OR. Tel: 0834 811 209. or Fax: 0834 871 770. Curvilinear metal cones loud speakers were first developed by Ted Jordan in 1963.

EJ Jordan Designs are now World leaders in foil cone technology First and foremost. **ELECTROMAL**, PD Box 33, Corby, Northants, NN17 9EL. Tel: 0536 204 555. The branch of the well known R.S. Components trade mail-order business that deals with the public. They have a huge range of components - and catalogues to match.

EMF, 2a Bellevue Road, Friern, Barnet, N11 3ES. Tel: 081 361 6734. Manufacturer of Sequel 50w integrated amplifier and the Crystal D2A converter. Please write in for details.

FALCON ACOUSTICS LTD., Tabor House, Norwich Road, Mulbarton, Norwich, Norfolk, NR14 8JT. Tel: (0508) 78272. U.K. distributors of FOCAL drive units and SOLEN (chateauroux) polypropylene capacitors and the largest inductor manufacturer in the U.K. Comprehensive range of DIY Speaker Parts and Kits, Sub-Bass and Electronic Filters.

'Everything but the wood' **FARADAY SOUND**, 248 Hall Road, Norwich, NR1 2PW. Tel: 0603 762967. Loudspeakers in CONCRETE: the ultimate enclosure. Now you can build your own low density concrete cabinet enclosure Faraday FS1, Siren, FSS, FS10 or a design of your own choice. Stunning sound and reviews. Simple DIY skills only. Full instructions including cabinet construction for only £10. Includes reviews, photos etc. and at least £10 discount off any further products purchased from us e.g. ready made cabinets. Also £25-£150 off any complete loudspeakers!!!

FOUNDATION AUDIO, 53 Beecroft Way, Dunstable, Beds. LU6 1EE. Tel: 0582 477550 or Fax: 0582 604001. We have long been acknowledged as the market leader in sonically superior stands and major in 'specials'. Send for our brochure and details of your nearest stockists.

FULLERS AUDIO, 20 Tunbridge Road, Southend on Sea, Essex SS2 6LT. Tel: 0702 612116. Fuller's Audio produce a range of loudspeakers priced from £329 to £2499 and a complimentary Pre and Power amp combination (electronic).

GRANITE AUDIO STANDS - The ultimate solution to problems of resonance and tonal accuracy. For 'bespoke' designs consult NDRLOSTONE, West Dean Road, West Tytherley, Salisbury. SP5 10G. Tel: 0980 862253.

J & H SUGDEN & CO LTD., Valley Works, Station Lane, Heckmondwike, West Yorkshire, WF16 0NF. Tel: 0924 404088. Manufacturers of hand crafted audio products. 'A world of Music'. Call or write in for information on our SDA-I Digital to Analogue Converter, SDT-I CD Player, A21a Class 'A' Amplifier, A25B Integrated Amplifier, A48 Integrated Amplifier, Au51c Pre Amplifier, Au51p Power Amplifier and more.

JORDAN WATTS ACOUSTICS LTD., Cyntra Place, 201 Mare Street, Hackney, London E8 3DE. Tel: 081 985 1646. Jordan Watts Acoustics for Sight AND Sound.

KEWICK AUDIO RESEARCH, 54 Coach Road, Outwood, Wakefield, W Yorks, WF1 3EX. Tel/Fax 0924 870606. 'I'd say that the Figaro is the best miniature speaker I have heard' Audiophile March 1993. Write in or call for details on our full product range and your nearest stockist.

KRONOS DISTRIBUTION, 35 Farlow Road, Dunganon, N. Ireland, BT714 DU. Tel: 0866 748632. Fax: 0868 448281. Kronos is the UK distributor of some of the finest Hi Fi products in Europe. These include Audiomeca digital products and turntables; Lieder silver speaker and interconnect cables; Pro-Ject turn-tables and amplifiers;

Triangle speakers and electronics; and YBA amplifiers. We also handle Frameworks equipment tables, Arion valve amplifiers and mains filters and Essex Audio digital products from the UK. Please telephone or write for product details and dealer lists.

LANGREX SUPPLIES LTD., 1, Mayo Road, Croyden, Surrey, CR0 2QP. Tel: 081 684 1166. Fax: 081 684 3056. We are one of the largest stockists and distributors of electronic valves, tubes and semiconductors in the UK. Over 6,000 types in stock. We specialise in obsolete types including original UK and USA made audio valves. Telephone or fax for an immediate quotation.

LECSON SYSTEMS LTD., Unit 19, Nuffield Rd. Ind. Est., St. Ives, Huntingdon, Cambs, PE17 4LD. Tel: 0480 498211. Call for info on our range of integrated and four channel integrated bi-amplifiers. Stereoplus, Quatra and Quattraplus analogue and digital interconnects and loudspeaker cables. As a compliment to the LFD range of accessories GDL plated mains 13A plugs and sockets now available.

LFD AUDIO, 110 Oxford Crescent, Clacton-on-Sea, Essex CD15 3PZ. Tel: 0255 422533. From the #479 integrated to our state of the art battery disc pre-amp, LFD Audio aim to offer top quality amplification at realistic prices. To get the best from your amps, why not try our value for money analogue and digital interconnects and loudspeaker cables. Gold plated mains 13A plugs and sockets also available.

LOCKWOOD AUDIO, Imperial Studios, Maxwell Road, Borehamwood, Herts, WD6 1WE. Tel: 081 207 4472/ **LORICRAFT AUDIO**, 4 Big Lane, Goose Green, Lambourn, Berks. RG16 7SU. Tel: 0488 72267.

Specialist restoration of 301 s and 401 s using genuine spares and re-manufactured parts to original pristine standards in our newly built work shops designed primarily for these purposes.

LYNWOLD ELECTRONICS, Coley Lane Farm, Wentworth, Rotherham, S62 7SU. Tel: 0709 873667. Lynwold Electronics is famous for manufacturing the only range of audio mains cleaners that really work. A complete range is now available to suit every system and every pocket.

MARANTZ HIFI UK LTD., Kingsbridge House, Padbury Daks, 575-583, Bath Road, Longford, Middlesex UB7 0EH. Tel: 0753 680868 or Fax: 0753 680428. Marantz is a manufacturer of Hi-Fi separate components, including CD, DCC, cassette decks, amplifiers, tuners, receivers and speakers. Also now active in Home Cinema with Pro-Logic amplifiers and receivers, plus Nicaam VCR and video processor.

MAY AUDIO MARKETING U.K. LTD., 83 Main Street, Burley in Wharfedale, North Yorkshire. LS21 7BU. Tel: 0943 864930. Distributors of High Quality audio products from Dusen Electronics, Totem Loudspeakers, Jeklin Float Headphones and quality recordings from Proprius, Prophone, Dpus, MAP and Swedish Society. IF ITS MUSIC YOU LOVE, TELEPHONE DR WRITE FOR LITERATURE.

MICHELL, 2 Theobald Street, Boreham Wood, Herts, WD6 4SE. For full information on our full range of excellent products including the Gyrodec, Alecto, Iso, Argo and others please telephone us on 081 953 0771. Michell - Symbol of Precision

PEAR AUDIO, 3 Northumberland Mews, Alnmouth, Northumberland, NE66 2RS. Tel: 0665 830862. A wide range of products including Shahinian Loud Speakers - Super elts, ARCS, Obelisks, Hawks and Diapasons. Dynavector amps and cartridges and Bedini amongst others.

PERFECT PITCH MUSIC, Hanworth Trading Estate, Hampton Road West, Feltham, Middlesex, TW13 6DH. Tel: 081 893 8662. Fax: 081 893 4318.

We manufacture the Francinstien CD enhancement system, The Dacula DAC and Perfect Digital and Analogue interconnects. Perfect Pitch also provide freelance design, manufacture, prototyping and test, also valve and solidstate specials. Trade enquiries welcome.

QUANTUM AUDIO LTD., PD Box 26, Kilmarnock, Ayrshire, Scotland, KA1 1BA. Tel: 0563 71122. Audiophile CD's & LP's. The UK's largest specialist:FDNE,REFERENCE RECORDINGS, SHEFFIELD LAB, WILSDON AUDIO, KLAVIER V.V.T.L. etc. Write or phone for full listings and prices.

REL ACOUSTICS Unit 2, New Street, Bridgend Ind Est. Bndgend, Mid Glamorgan, CF31 3UD. UK. Tel: 0656 768 777. international +44 656 768 777. Fax: 0656 766 093. international. +44 656 766 093. The UK's only specialist sub-bass speaker manufacturer. 'The only one that works'. Get your dealer to give you a home demo and find out what the fuss is all about.

RICHARD ALLAN AUDIO, Bradford Road, Gomersal, Cleckheaton, W Yorks. BD19 4AZ. Tel: 0274 872442. Fax: 0274 869935. Manufacturers of very high quality loudspeaker enclosures and drive units. Examples being the C270 RA8 series 2 as supplied to the BBC and the 6" reviewed Minette 2 at £120.

SAMBELL ENGINEERING LTD. Winston Avenue, Croft, Leicestershire. LE9 6GQ. Tel: 0455 283251.

ATACAMA AUDIO SUPPORTS from Sambell Engineering Ltd. We are the sole manufacturers of the 'SE' range of speaker stands, consisting of an 8", 12", 16", 20" and the award winning 24" high stand. Also three specialist models for the Tannoy 'sixes' Loudspeakers.

SEQUENCE DESIGN LTD., 24 Brook Street, Mayfair, London W1Y 1AE. Tel: 071 495 0775. Fax: 071 495 0281. Slim loudspeakers which stand close to a wall or hang like pictures. 'Likely to cause a glint in the audiophile's eye' (Audiophile); 'the answer to a prayer...a bargain in the extreme' (HiFi News). Available with light or dark grilles and various solid wood finishes. From £199.95 a pair. Call or write in for an information kit and reviews re-prints.

SHEARNE AUDIO, PD Box 22, Stevenage, Herts, SG2 8HF. Tel: 0438740953. Following the success of John Shearn's Phase 1 pre power combination, reviewed in an earlier issue of HFV, newly launched John Shearne's Phase 2 integrated amp with many of the design features of the Phase 1. R.R.P. £495, 50 wpc & same finish as Phase 1 pre power also option of phono stage for Phase 2 £95.

SLATE AUDIO, makers of 'THE FINEST SPEAKER SUPPORTS IN THE WORLD' have never had a bad review, our reputation is legendary. Contact us now for details on our CUSTDM STANDS, as well as our solid marble GARRARD 301/401 PLINTH SYSTEM (Hi-Fi World Dec 93) THE GLASSMAT plinth mat and the very special SME GARRARD 401 CELEBRATION ARMS. 47 Gemini Close, Leighton Buzzard, Bedfordshire. LU7 8UD. Tel: 0525 364174.

THE SPEAKER COMPANY, Unit 9, Waterside Mill, Waterside, Macclesfield, Cheshire, SK11 7HG. Tel: 0625 500507. The Speaker Company are a new company offering a wide range of loud speaker units from Audax, Celestion, KEF, Morel SEAS and many more. Also a wide range of speaker accessories the keen builders.

THE TOI GROUP Unit 1 Summerlea Court, Alton Road, Harnard, BASINGSTOKE, Hampshire. RG25 2PN. Tel: 0256 381 514. Fax: 0256 381 692. Electronic Components distributors specialising in: Mains Power Connectors, Jack Plugs and Sockets, 4mm Connectors, Din and Mini Din Connectors, Phono Connectors, DC Connectors, XLR Connectors, Rotary Potentiometers, D Type and IDC Type Connectors, Co Axial and BNC Connectors, Switches, LEDs, Diodes, Bridges and Rectifiers, Fuses and Thermal Tips. - Have you got one of our new 1994 General Product Catalogues?

TARGET AUDIO PRODUCTS PLC, Britannia House, Leagrave Road, Luton, LU3 1RJ. The Audio equipment, rack and speaker stand specialist. For information on our products please telephone or write.

TRICHORD RESEARCH LIMITED Following on from the highly acclaimed CD clock oscillator modifications the Pulsar Series One digital to analogue converter. This unique design is part multibit and part bitstream to give absolute linearity over an extremely wide dynamic range. Switchable between 18 or 20 bit resolution this converter will become the standard for CD replay. For details telephone (0689) 573524

WOLLATON AUDIO, 134 Parkside, Wollaton, Notts, NG8 2NP. Tel/Fax: 0602 284147. Trying to bring imported high end down in price with Wollaton is the UK distributor of the following products: XLD interconnects and loudspeaker cables - 'The best in the world'. Clements loudspeakers; ribbons and/or moving coil drive units in outstanding value loudspeaker systems. Monarchy Digital: transports and converters (including the model 33 D to A with built in high quality preamp) to match the best at a fraction of the price.

WILMSLOW AUDIO LTD. Wellington Close, Parkgate Trading Est. Knutsford, Cheshire, WA16 8DX. Tel: 0565 650605. Extensive range of drive units and over 30 different designs of self-assembly kits. Everything required for the loudspeaker builder and four dem rooms to listen to the kits in built-up form.

To Advertise in this section, please contact Caroline Knott on: 071 266 0969



READY FOR BATTLE

**With its thick front panel and heavyweight construction
TEAC's new £600 VRDS-7 CD player certainly looks ready
to fight it out in the middle ground.**

Robert Wilson lends an ear.

This TEAC player looks imposing, filling up a shelf on our equipment rack with consummate ease. By the sheer bulk of its presence you know it means business - or at least, you hope it does - so it ranks highly on any perceived value scale. For £599 you get a hefty, solid box (442x149x331mm) with a solid slab of a front panel made of brushed aluminium studded with chunky illuminated 'professional' push-button switches. It creates an impression of something built to withstand the rigours of professional life, rather than the quieter waters of home. This isn't particularly surprising, given that Tascam (Teac's parent company) is heavily involved in the broadcast and recording industry.

The main reason for the chassis' size

is to provide the space required for Teac's superbly engineered Vibration-free Rigid Disc-clamping System (VRDS). This is mounted in the middle section of the player and it takes up a lot of space vertically, making the VRDS-7 quite high, compared to more conventional machines. Any player using the VRDS unit will never be a slimline model.

So what makes VRDS so special that Teac are willing to resort to the tooling needed for such an expensive chassis layout? Well, conventional CD transports only clamp the disc in the centre which, according to Teac, allows it to vibrate when spinning, especially at the edges. This makes the task of reading the disc that much harder for the laser. These difficulties are compounded by discs failing to be flat. So, Teac devised a

system which supports the whole disc from above, using a platter with a precision-machined concave surface that allows disc warps to be 'ironed' out. Of course, these techniques have been employed for donkeys years by those chaps who build vinyl playing machines.

The D/A conversion technology used in this player employs Philips' bitstream system where two SAA7350 chips are used in differential operation to reduce common-mode distortions. Digital filtering is handled by a 20 bit, 8 times oversampling chip. With transport and power transformer mounted centrally, Teac have chosen to locate the digital and analogue circuit modules separately on either side of the chassis.

The player is blessed only with basic operational functions as far as switches are concerned. These are duplicated on the remote control, together with more specialised commands. A fluorescent orange display located centrally, below the disc tray, provides the operational information and can be dimmed via an on/off switch on the remote.

Initially, I was a bit shocked by the rather flimsy nature of the disc drawer, which appears ill at ease with the solid external construction. However, the loading mechanism was smooth, if a little slower than some other players due to the complex nature of the transport operation.

Once the disc had been loaded and I'd settled myself into the sofa along with a cup of coffee, all that was left to do was turn up the volume on the Cyrus III and press play.

As if to reinforce the solid appearance of the Teac the music was

given a firm and stable foundation. Bass from this player grabs you immediately, especially with a big, lively sounding disc like 'Aye' by Angelique Kidjo. The various strands of percussion combined to form an intricate image around the singer. The Teac allows the music to be easily dissected using a well spaced and proportioned soundstage, although with a little less ambient detail recovery than some, a property that resulted in a shallower image.

Dynamically, the Teac was slightly more up-front than a lot of bitstream machines. Its ability to convey the impact of drum beats and the percussive nature of some powerful bass guitar lines was certainly a pleasant change from the bland perspectives often found in players using this type of D/A conversion. Musically, the bottom end was very fluid, rolling along quite nicely, the timing being not outstandingly precise but still competent enough to maintain an interest in the complex rhythmic patterns and layering involved in this African music.

Listening to "The first of a million kisses" which has Fairground Attraction's extraordinarily diverse use of acoustic instrumentation, showed that although the Teac can go down quite deeply into the lower registers it can at times be caught out. This occurs during more complex melodic bass lines which

become muddled and balloon out into a 'one note' rendition, but at least the Teac attempts to do something with these tracks; other players don't even hint at the depth of bass present in the music.

With vocals, the Teac displayed a strange phenomenon, almost as if it has a dual personality. From a slightly warm and rounded bass character the Teac reverts to a colder, slightly harsher mid-range.

" Its ability to convey the impact of drum beats and the percussive nature of some powerful bass guitar lines was certainly a pleasant change. "

Simple acoustic arrangements begin to sound disjointed. Mid-range information comes that bit further forward in the mix, which sounds impressive and immediate with rock music, giving lead vocals an exciting edge, but when analysed using more subtle music the Teac tends to strip away some low level acoustic and harmonic clues which affect the way a piece of music forms into a whole composition.

The incisive playing of some musicians could be a bit fierce, accentuated by a hard grainy edge which complemented the expressive drive in fast rock, but could be a touch fatiguing when you're in the mood for something more soothing.

Things start to get really interesting

with this player when you decouple the transport section and feed the data stream into an external DAC. For this I used the DPA PDM I/III which is normally Deltran locked to a Teac P-500 transport. However, this is not a VRDS unit. Basically the VRDS-7 has a superb transport, the DPA convertor filled out, the mid producing a more lucid and timbrally purer sound with a sweeter treble, while retaining the solidity and strong architectural aspects of the Teac's sound. Considering that the VRDS didn't have the undoubted advantage of being sync-locked to the DAC the sound quality of the pairing wasn't that far behind that produced by our usual transport.

So there you have it. As a stand alone player the VRDS-7 is a very competent machine blessed with its fair share of virtues and vices. However, if you're looking for a well built player to use while saving up for a top quality DAC, to eventually mate with it as a transport, then the TEAC is worth auditioning. The transport section is a honey and will certainly do justice to a wide range of excellent convertors ●

TEAC VRDS-7
TEAC UK Ltd.,
5 Marlin House,
The Croxley Centre,
Watford,
Herts. WD1 8YA
Tel: 0923 225235

£599

MEASURED PERFORMANCE

The VRDS-7 displayed a peculiar trait: it threw up a spectrum of aliasing products at -30dB music level from disc. Our spectrum analysis clearly shows this as an apparent spread of distortion products (seen as spikes) but, being non-harmonically related, we had to sum them with a pencil and a piece of paper as it were - the analyser was flummoxed. The total amounted to 0.08% distortion, a relatively high level similar to that from old sixteen-bit machines. However, since this spectrum only appeared at one specific level, it may be of little consequence subjectively. At all other levels the Teac proved as linear as any multibit player, even if it was not quite up with the best.

The frequency response characteristic, seen in the analysis, measured flat up to 10kHz and rolls off above that frequency. From experience I know this ensures its sound will not be bright or spitty. The Teac had good channel separation, a normal output of 2volts and low spurious output levels above 21kHz. With a reasonably wide dynamic range of 106dB, it measured well in all respects, except for the peculiar aliasing problem. **NK**

TEST RESULTS

| | | |
|--------------------|-----------|-------|
| Frequency response | 3Hz-21kHz | |
| Distortion (%) | | |
| -6dB | 0.004 | 0.004 |
| -30dB | 0.08 | 0.08 |
| -60dB | 0.6 | 0.6 |
| -90 | 29 | 29 |
| -90dB dithered | 4 | 5 |
| Separation (dB) | left | right |
| 1kHz | 115 | 119 |
| 20kHz | 91 | 97 |
| Noise | -116dB | |
| with emphasis | -116dB | |
| Dynamic range | 106dB | |
| Output | 2.2V | |

Distortion

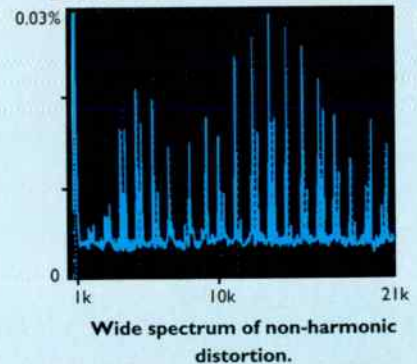

Frequency Response

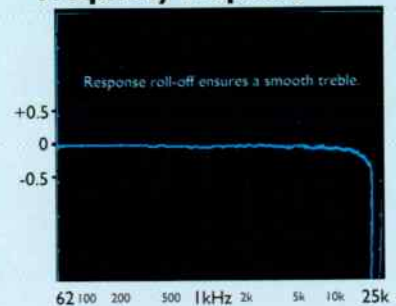

ONKYO IN-TUNE



Returning to the UK marketplace, are Onkyo in-tune with the budget T-401 tuner? Dominic Todd makes some comparisons.

Japanese manufacturer Onkyo had a good reputation for solid build quality and value; now they're back after an absence of three years. Here we look at what is essentially the successor to the T4120, the T-401 tuner.

Three years have certainly done little to alter the successful Onkyo formula. With a price of £159.95 it's good value alongside obvious rivals such as the Rotel RA 930AX (£175.00), Yamaha TX-470 (£159.95) and - the one to beat - the NAD 402 (£169.95). An unmatched 3-year warranty furthers the tuner's case in the value stakes. It includes a brand new replacement should the item show a fault within the first year of ownership.

Features include, 40 station random preset storage (split into six "classes"), a two mode front-end (local/DX), (auto/mono) and Medium Wave (for Virgin Radio, for example).

Features that you might be surprised to learn are absent include, Long Wave, remote control, direct access station search and RDS (now seen as near essential by most of the Japanese tuner manufacturers). If you seek this feature check out the T-450 RDS at £259.95.

A MOSFET front end, solid aluminium front panel and details such as the cork feet all add to the impression of the Onkyo being carefully and solidly built.

The T-401 replaced a Revox B760 in my system, although because this isn't exactly a fair comparison I had an NAD 402 on hand for comparison.

The B-52s on Radio 1 sounded slightly less compressed than this particular radio station can sound, and the T-401 sounded fairly dynamic as a result. However, a boxiness and nasal midrange were

apparent in comparison to the NAD.

Tuning into one of our local stations had the effect of broadening the soundstage, reducing some of the veiling that had affected Radio 1. Yet the vocals in particular still seemed to be somewhat trapped inside the speakers.

News and drama on Radio 4 didn't possess any particular sense of realism - of actually being there - that the best tuners can convey. There was a lack of sibilance on female vocals though, and good depth to the soundstage that gave plays

reasonable listener involvement. Yet again, the Onkyo had to assume second best to the NAD, which has the uncanny ability to really involve a listener, echoing more expensive tuners.

The Onkyo had quick and sensitive auto-tuning. The national BBC stations were picked up on three or even four different frequencies, although many were unlistenable (distant transmitters), even in mono, due to distortion.

Classical music proved the Onkyo's strong point, with a suitably light and breezy balance for quartets, and good weight to larger orchestral pieces. Once again, though, it couldn't overcome the NAD, which demonstrated less muddle between the instruments, and a greater sense of "air" around the individual players.

The Onkyo T-401 is a competent machine, but time appears to have taken its toll on this tuner somewhat. Tuner technology has advanced in leaps and bounds, as shown by machines like the NAD 402. Sound quality that was once first rate at the price is now simply competent, placing the T-401 amongst its competitors at best - not ahead. If sound quality is paramount, then I'd suggest you take a look at the Rotel RT 930 or acclaimed NAD 402 ●

MEASURED PERFORMANCE

The T-401 has a slight roll down in the upper audio band, our analysis shows, that will result in a little less of the subjective hardness that affects many mass-market tuners.

Distortion proved very low at 0.1% (stereo, 50% mod - see our spectrum analysis), on central and far left and right stereo images. Pilot and sub-carrier were well suppressed too.

With an aerial signal of 0.6mV or more, hiss dropped to a satisfactorily low -72dB. That makes the tuner quiet enough for critical Radio 3 listening. Selectivity was good too, at 85dB alternate channel rejection both above and below any wanted station. Audio output was a healthy 700mV, high enough for passive preamps.

A Distant/Local legend switches to Local at 630µV, showing whether the aerial being used is adequate for optimum sound quality. The Onkyo T-401 measured well in all areas. **NK**

TUNER TEST RESULTS

| | |
|-------------------------|---------------------|
| Frequency response | 4Hz-15.5kHz |
| Stereo separation | 33dB |
| Distortion (50% mod.) | 0.1% |
| Hiss (CCIR) | -72dB |
| Signal for minimum hiss | 0.63mV |
| Selectivity (at 0.4MHz) | 85dB |
| Sensitivity | |
| mono | 1.6µV |
| stereo | 25µV |
| signal strength | "Local" above 0.6mV |

Frequency Response

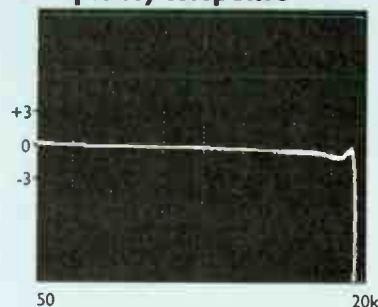

.... Continue from page 11

VDH ON A SHOE STRING

A new entry level interconnect cable has just been announced by van den Hul. The Storm is a coaxial cable using silver plated copper and is suggested for use between CD player (or DAC) and amplifier.

Terminated with high quality gold-plated phono plugs, the Storm is available in two lengths, costing £24.99 for a 0.8m stereo pair and £29.99 for 1.2 metres.

VAN DEN HUL (UK)

P.O. Box 304,
Maidstone,
Kent, ME16 8TS.
Tel: 0622 721636.

CABLE TALK

Another range of cables have been introduced by specialist manufacturer XLO. Dubbed the 'Standard' range, these are priced between the existing Pro and Reference ranges at £180 per metre pair of interconnect and £299 for a 9ft pair of speaker cables.

For those of us with more modest financial means, the new Pro 150 comes in at £55 for a 1.0 metre pair.

If, however, you are fortunate enough to own a seriously esoteric amp, then the Reference PL 10 powercord at £200 for a 6ft length may just prove to be the icing on the cake.

XLO have also produced a test/burn-in CD in collaboration with Sheffield Labs, which has special tracks for burning in cables. This hot stuff is available for £35.

WOLLATON AUDIO.

134 Parkside,
Wollaton,
Nottingham, NG8 2NP.
Tel: 0602 284147

ALPHASON IMPROVEMENTS

With the world still gripped solidly in the hands of a global recession, Alphason have managed to do the politically correct thing. They've not only improved their best selling speaker stands, but also reduced their price.

The 'A' range speaker stands now retail at £60, a saving of £10 over the previous model. Improvements include re-designed pressed steel top-plate, better rigidity, and a wide range of sizes.

PATH GROUP

Unit 2, Desborough Park Industrial Est,
Desborough Park Road,
High Wycombe,
Bucks, HP12 3BG.
Tel: 0494 441736.

SORRY!

Apologies to Michell Engineering. In the reply to Alain G Lefebure's letter last issue we said that the Alectos do not enjoy low impedance loads. The monoblocks are happy driving low



impedance loudspeakers, it's the stereo that is not

HISTORY OF VALVES - CONFERENCE UPDATE

Here's an update on a conference entitled The History of Thermionic Devices, to be held by the Newcomen Society, who are based in the Science Museum, London. We first ran a short news item on this conference in our March 1994 issue.

The one-day conference will be held on Saturday 23rd April 1994 at the Science Museum Annexe, Blythe House, Blythe Road, London (close to Olympia). The day's programme will be -

The Physical Background, by Dr M. C. Duffy, University of Sunderland.

Nineteenth and Early Twentieth Century Origins, by K. R. Thrower, OBE, Research Director, Racal Radio Group.

Growth of the Electron Tube Industry, by Dr T. Going, Senior Scientific Officer, London Hospital Medical College.

Applications and the Growth of New Industries, by Pat Leggat, formerly Chief Engineer, External Relations, BBC.

High Frequency and Microwave Tubes, by Dr J. R. Pierce, formerly Bell Telephone, Professor of Engineering at California Institute of Technology, Chief Technologist, Caltech Propulsion Labs.

Industrial and High Power Thermionic Devices, by M. Foley, formerly head of valve division, ASWE.

The Entertaining Electron, by E. Davies, Special Projects Group, The Science Museum.

Delegates will be provided with a buffet lunch, at which they can also see "relevant artefacts" (old valves!) from the Science Museum reserve collection. At 5.30 p.m., there'll be a light buffet accompanied by archive film and slides, before the final paper. The conference will end at 7.30 p.m. The fee will be £35 (inc VAT), which includes coffee, lunch, afternoon tea, finger buffet and proceedings. Please send your application, with the conference fee, to -

Executive Secretary
The Newcomen Society
The Science Museum
LONDON SW7 2DD.

Contacts -
Newcomen Society - 071-589-1793
Science Museum - 071-938-8000
or write for a programme to -
Keith Thrower, Old Cedar,
12 Wychcotes,
Caversham,
Reading RG4 7DA.

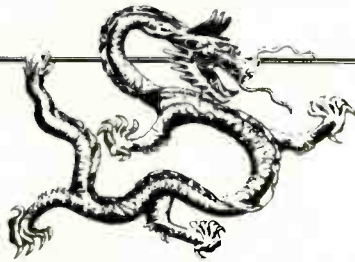

Golden Dragon

Precision Audio Tubes

Please enquire or any tube types not listed. We have an inventory of over 2,500 different types in stock.

RETAIL PRICE LIST

| Golden Dragon Pre-amplifier Tubes | | Golden Dragon Triodes | | | Golden Dragon Powder Tubes | | | | |
|---|--------|----------------------------|--------|---------|----------------------------|------------|--------|---------|---------|
| Singles | | Singles | Pairs | Quads | Pairs | Quads | Octets | | |
| 6AQ8/ECC85 | £6.50 | 2A3 4PIN | £22.50 | £47.50 | £95.00 | EL84/6BQ5 | £8.50 | £17.00 | £34.00 |
| 12AT7A/E81CC/ECC81 | £6.50 | 2A3 OCTAI | £22.50 | £47.50 | £95.00 | E841/7189a | £12.50 | £25.00 | £50.00 |
| 12AU7A/E82CC/ECC82 | £6.50 | 211 | £28.50 | £59.00 | £118.00 | KT66 | £25.00 | £50.00 | £100.00 |
| 12AX7A/E83CC/ECC83 | £6.50 | 300B | £69.00 | £140.00 | £280.00 | KT88 | £49.50 | £99.00 | £198.00 |
| 6DJ8/E88CC/ECC88 | £10.95 | 811A | £11.50 | £25.00 | £50.00 | KT88 SUPER | £59.00 | £118.00 | £236.00 |
| 6SL7GT/ECC35 | £7.50 | 845 | £36.50 | £75.00 | £150.00 | 6L6GC | £18.50 | £37.00 | £74.00 |
| 6SN7GT/ECC33 | £7.50 | 805 | £36.50 | £75.00 | £150.00 | 6550A | £39.50 | £79.00 | £158.00 |
| Special Quality Golden Dragon Pre-amplifier Tubes | | Golden Dragon Powder Tubes | | | NEW DESIGN | | | | |
| Singles | | Pairs | Quads | Octets | | | | | |
| E81CC-01 Gold Pins | £9.50 | EL34/6CA7 | £25.00 | £50.00 | £100.00 | 50CA10 | £75.00 | £150.00 | £300.00 |
| E82CC-01 Gold Pins | £9.50 | | | | 807 | £25.00 | £50.00 | £100.00 | £100.00 |
| E83CC-01 Gold Pins | £9.50 | | | | | | | | |
| E88CC-01 Gold Pins | £14.50 | | | | | | | | |

Gold Dragon Select Tubes

| | |
|------------|-------------|
| 5AR4/GZ34 | £8.50 |
| 5U4G | £8.50 |
| 85A2 | £6.50 |
| ECL82 | £4.50 |
| ECL86 | £4.50 |
| EL509 | £7.50 |
| PL509 | £7.50 |
| 12E1 | £25.00 |
| 6072A | £7.50 |
| 5687 | £8.50 |
| 6AS7G | £15.00 pair |
| 6C33C/B | £75.00 pair |
| 6550 Super | £75.00 pair |

Gold Plated Ceramic Valve Bases

| | |
|---|--------|
| 4 PIN UX4 | £3.50 |
| 4 PIN JUMBO GOLD PLATED | £25.00 |
| 7 PIN B7G CHASSIS | £3.50 |
| 8 PIN OCTAL PCB | £3.50 |
| 8 PIN OCTAL CHASSIS | £3.50 |
| 9 PIN B9A PCB | £2.50 |
| 9 PIN B9A CHASSIS | £2.50 |
| GOLD PLATED ECC83 SCREENING CAN & SKIRT | £8.50 |
| GOLD PLATED ECC83 DAMPING CAN | £4.50 |

Carriage charge: £2.50 on any order. All prices plus VAT @ 17.5% Payment: Cash with order or Visa - Mastercard - American Express. 23 Hour Answerphone Services

We also have available ceramic valve sockets and holders for the entire Golden Dragon range. For further details please contact:

A SELECTION FROM OUR VAST STOCK OF VINTAGE AND AUDIO QUALITY VALVES.

Please enquire for items not listed.

| | | | | | |
|--------|------------|-------|---------|--------------|--------|
| ECC81 | BRIMAR | 4.50 | UU5 | MAZDA | 5.50 |
| ECC82 | G.E. | 4.50 | UU6 | MAZDA | 6.50 |
| ECC82 | RFT | 4.50 | 2X2A | RCA | 5.00 |
| ECC83 | TEONEX | 3.50 | 3A/167M | ITT | 10.00 |
| ECC85 | TEONEX | 3.50 | 5Y3WGTA | SYLVANIA | 4.50 |
| ECC88 | G.E. | 5.50 | 5V4G | BRIMAR | 3.50 |
| ECC88 | BRIMAR | 4.50 | 6AG7 | RCA | 3.50 |
| ECC88 | TEONEX | 4.50 | 6A7G | RCA | 8.50 |
| ECH81 | MULLARD | 3.50 | GBH6 | BRIMAR | 3.50 |
| ECL82 | TEONEX | 3.50 | 6C8G | RCA | 3.50 |
| ECL86 | TEONEX | 3.50 | 6DQ6B | PHILIPS | 3.50 |
| EF86 | TEONEX | 4.50 | 6K7G | RCA | 3.50 |
| EF804S | TELEFUNKEN | 25.00 | 6SL7GT | BRIMAR | 4.50 |
| EL34 | TEONEX | 6.50 | 6SN7GT | TEONEX | 3.50 |
| EL85 | MULLARD | 4.50 | 6SN7GT | BRIMAR | 4.50 |
| EL86 | MULLARD | 4.50 | 6SQ7GT | TEONEX | 4.50 |
| EL504 | TEONEX | 4.50 | 6V6G | RCA | 5.50 |
| EL509 | TEONEX | 5.50 | 6V6GT | TEONEX | 4.50 |
| EL519 | TEONEX | 5.50 | 6X4 | TEONEX | 2.50 |
| EM84 | TEONEX | 3.50 | 12AT6 | BRIMAR | 2.50 |
| GZ32 | MULLARD | 8.50 | 12AV6 | RCA | 2.50 |
| GZ33 | MULLARD | 5.50 | 12BA6 | WESTINGHOUSE | 3.50 |
| GZ34 | TEONEX | 5.50 | 12J5GT | RCA | 3.95 |
| GZ34 | MULLARD | 16.50 | 12AX7WA | ECG | 10.50 |
| GZ37 | MULLARD | 4.50 | 12AY7 | RCA | 8.95 |
| KT66 | TEONEX | 6.00 | 12E1 | STC | 15.00 |
| KT66 | GE | 16.50 | 13E1 | STC | 140.00 |
| LS9B | COSSOR | 6.95 | 13D3 | BRIMAR | 6.50 |
| M8136 | MULLARD | 8.50 | 85A2 | MULLARD | 6.50 |
| M8162 | MULLARD | 8.50 | 1625 | RCA | 6.50 |
| M8137 | MULLARD | 15.00 | 5687WA | RCA | 6.50 |
| MHLD6 | MAZDA | 5.50 | 5751 | RCA | 6.50 |
| OA2WA | TEONEX | 3.50 | 5814A | GE | 5.50 |
| PCC88 | SIEMENS | 3.50 | 5881 | USSR | 4.95 |
| PL36 | MAZDA | 3.50 | 6146B | TEONEX | 8.50 |
| PL504 | MAZDA | 2.50 | 6158 | BRIMAR | 6.50 |
| PL509 | MAZDA | 5.50 | 6189 | SYLVANIA | 6.50 |
| PL519 | THORN | 5.95 | 6201 | GE | 6.50 |
| PY32 | MULLARD | 2.50 | 6463 | UNITED | 7.50 |
| TT100 | GEC | 65.00 | 6550A | TEONEX | 12.50 |
| U19 | GEC | 8.50 | 6870 | BRIMAR | 11.50 |
| UCC85 | MULLARD | 3.50 | 6072A | RAYTHEON | 6.50 |

P.M. COMPONENTS LTD., Springhead Enterprise Park, Springhead Road, Gravesend, Kent DA11 8HD, England

Tel: 0474 560521. Telex: 966371 TOS-PM-GM. Fax: 0474 333762

GOLDEN DRAGON MAIN DEALERSHIPS, available in selected areas. Please call Clive Norris for details

A good hi-fi system can be immensely entertaining and rewarding over a long period of time. However, as a retailer, demonstrating such equipment can be anything but.

Having attended many a demonstration myself, from both sides of the fence I can appreciate just how bewildering it can be. Here are seven golden rules to help make any demonstration less stressful - and perhaps even enjoyable!

1. Rule number one is: find a good dealer. They can make all the difference between walking away with a mediocre system, or owning something state-of-the-art. Questions to ask yourself are: has the dealer been established long? Do you feel you can trust and feel relaxed in conversation with him or her? These factors can matter more than choosing someone with the largest stock and the cheapest prices. Shopping by mail order may save you a few pounds - and there are certainly bargains to be had - but in the long run using a local dealer will give you access to expert knowledge as you upgrade, secure a decent demonstration, provide good service (and possibly a piece of loan equipment whilst yours is being repaired). Most dealers can also offer a good part-exchange deal when you upgrade, which goes some way toward offsetting the savings you might have gained by buying mail order.

2. The second rule is tied in with the first, being about the demonstration conditions a dealer can provide. Single 'speaker rooms are a must. Basically, they provide an environment where you can sit down with just one pair of loudspeakers and listen to all the equipment without being distracted by the workings of the rest of the shop.

Another option, which more and more dealers are picking up on, is home demonstration. This has the obvious advantage of putting the customer in the most familiar and relaxing environment, as well as yielding a sound that is in no way influenced, for better or

worse, by the acoustics or nearby bustle of a dealer's demonstration room. It's not uncommon to get a piece of hi-fi equipment home and be disappointed after listening to it at the dealer's - and vice versa.

Although a home demonstration can be a good bet, it's still not ideal. You may quickly grow to dislike a product that is superficially exciting but, for your tastes, fatiguing or apparently flawed in the longer term. A good dealer should understand and appreciate this and let you change the



Fair Views

- from Dominic Todd, our man in Scarborough

equipment after a day or so if it doesn't suit.

3. Third, always take along a couple of CDs or LPs that you're familiar with. If not, choose something that the dealer has that is familiar. You need to know how your prospective hi-fi will cope with the type of music you listen to. This is especially important, as different brands, and even models within those brands, can suit different types of music. An experienced dealer will know which brands to recommend, based upon your taste in music.

4. The next rule is to make sure you actually listen to the track(s) you want to listen to, or the entire track if necessary. Also ensure that the dealer changes over equipment without delay, as the human brain has a very short memory for retaining detail.

5. Fifth, have an idea of how much you can spend. This may sound obvious, but it's surprising how many customers wish they'd spent a little more, or could have got the sound they wanted for less. As with everything else in life, hi-fi is game to

the law of diminishing returns. This tends to set in at around £300 per separate item. Below this, compromises commonly become noticeable; above it the differences become smaller and harder to spot. What you have to keep asking yourself is: does one CD player actually sound X pounds better than another CD player. So be flexible with price and set yourself a price band. In this way you're more likely to get exactly what you want.

6. The sixth rule is to be flexible about the equipment itself. Magazines offer a useful guide as to what's available and, of that, what's worth auditioning. However, just because a piece of equipment hasn't been reviewed, or has, but received a luke warm review, should not necessarily rule it out. Hi-fi equipment can be fairly particular about what it's partnered with, and it's not unusual to find a trio of "Best Buys" that just do not gell together.

Again, this is something to trust to the dealer who should know from experience what works together and what doesn't. If you doubt him, ask for proof

via a demo. Be receptive to what the dealer may recommend, even if you'd not considered it before.

A word of caution though. Expensive separates can stand around in the shops for a while. There may be nothing wrong with such products and provided it's made clear that they are ex-demonstration or a discontinued line they may still make the best choice.

Try to be sure you know where a particular product is in its development history (some products are on their sixth variation for example).

Again this is something that magazines can assist with as they constantly review the latest "Mark IIs" or at least make mention of such changes, giving some idea of whether any improvement is significant or not

7. Finally, avoid Saturdays like the plague! Most hi-fi shops are about two-to-four times busier on a Saturday and trying to get a decent demonstration may be difficult. Demonstrations usually have to be shorter on a Saturday, and staff aren't usually at their most relaxed, which can rub off on you. A home demonstration could get round this if attendance during the rest of the week is a problem.

And finally don't panic - or be panicked! A perfect system doesn't exist yet. Even fabulously expensive ones can be idiosyncratic in their sound and not to everyone's liking. There are as many different sounds as there are paintings that please people. Choose the one you are happy with over a long period of time and let no one rush you, or force you to go along with their view. Remember, it's your choice ●

Win Tube Technology and a pair of Castle

Ever wondered about the magic of a valve amplifier coupled to a pair of high quality, efficient transmission line loudspeakers? Well, here's your chance to experience one of the very best sounds around for free, because this month we're giving away a superb Tube Technology Unisys integrated valve amplifier and a pair of the excellent Castle Howards, which feature 1/4 wave bass loading.

This truly is a match made in heaven, the Castles being efficient and easy to

drive, allowing the Unisys valve amplifier to give its very best. We're even throwing in a set of super high purity Ortofon SPK300 bi-wire loudspeaker cables to make sure that the system performs to the highest standards.

The Tube Technology Unisys is a minimalist integrated valve amplifier complete with phono stage, so you'll still be able to play your favourite records as well as CDs. It has a total of four line-level inputs, so a tuner, tape deck and one other line level source can also be

used. Twenty eight watts of sweet valve power comes from two pairs of EL84 pentodes per channel - more than enough for the easy-to-drive Howards. Finished in exquisite chrome and gold, with a charcoal-black front panel, the Unisys really is a head turner.

The Castle Howards are a hybrid design, using a conventionally mounted 6.5inch doped paper driver and metal dome tweeter, plus a second top mounted 6.5inch cone which is 1/4 wave loaded for good bass. They give a fabulously open and spacious sound, with a clean midband, sweet treble and fast, deep and musical bass.

This is one of the very best amplifier and loudspeaker combinations money can buy, and it could be yours for the price of a stamp.

To enter this fabulous competition for the Tube Technology valve amplifier and Castle Howard loudspeakers, just complete the questions opposite.

Please send your entry on a POSTCARD, or the back of a SEALED ENVELOPE, completed in block capitals, to arrive no later than Friday 6th May 1994 to:

**TUBE TECHNOLOGY/CASTLE
Competition
Hi-Fi World Magazine,
64 Castellain Road,
Maida Vale,
London. W9 1EX.**

Don't forget to include your name, address and a telephone number so we can contact the winners promptly.

In the event of more than one entrant submitting all the correct answers, the winner will be picked by the Editor from the tiebreaker. We will endeavour to publish the results in the JULY 1994 issue. Purchase of the magazine is not a precondition to entry.

No correspondence about this competition will be entered into and the Editor's decision is final.

No employees of Audio Publishing Ltd. or any of the companies associated with production or distribution of the prizes may enter ●

COMPETITION ENTRY QUESTIONS

1) What valves does the Unisys use to get its 28W power output?

- | | |
|---------|---------|
| A. EL37 | B. EL34 |
| C. EL84 | D. EL81 |

2) Including phono, how many inputs does the Unisys have?

- | | |
|------|------|
| A. 2 | B. 3 |
| C. 4 | D. 5 |

3) What kind of loading is used for the bass of the Howards?

- | | |
|--------------------|-------------|
| A. Reflex | B. 1/4 wave |
| C. Infinite baffle | D. Isobarik |

4) Who makes the Howards?

- | | |
|-----------|------------|
| A. Church | B. Castle |
| C. KEF | D. Chateau |

THE TIE BREAKER (OBLIGATORY)

Valves make music sound so sweet,
The Castle Howards are hard to beat,
Together they offer quite a treat,
Why do you think they sound so neat?
.....

We will endeavour to publish the results in the May 1994 issue. Purchase of the magazine is not a precondition to entry.

No correspondence about this competition will be entered into and the Editor's decision is final.

No employees of Audio Publishing Ltd. or any of the companies associated with production or distribution of the prizes may enter.

Unisys Valve Amplifier Howard Loudspeakers

competition



MARCH ISSUE COMPETITION - THREE SUGDEN A21a CLASS A AMPLIFIERS

We offered three chances to win one of the very best integrated amplifiers available, the Class A Sugden A21a - and you responded by filling our offices with more entries than we've ever had! Noel, our Editor, just managed to pick three winners before disappearing forever beneath the pile. Here are the lucky three:

- 1) Mr D. Kelly of East Barnet
- 2) Mrs C. P. Gibbs of Isleworth
- 3) Mr P. Skelton of Gateshead

Thank you for such a great response. Who ever would have guessed that such a specialised - but admittedly superb - amplifier would have generated such a response. What enthusiasm!





Giovanni Dadomo

INDEX

RECORD REVIEWS

ROCK & POP74
Giovanni Dadomo

CLASSICAL85
Peter Herring

JAZZ93
Simon Hopkins

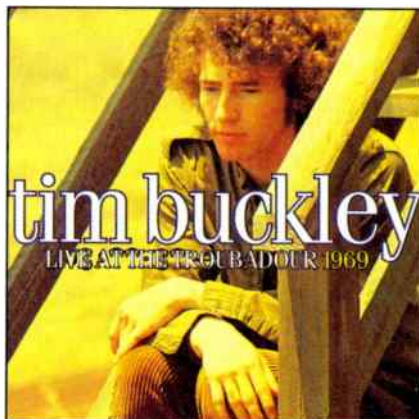

TIM BUCKLEY
Live at the Troubadour 1969
EDEL ED CD 400

● For someone who kicked the bucket in 1975, Tim Buckley's sure been productive of late. Edsel kicked things off with the brilliant two hour-plus live set 'Dream Letter' about three years past, then came the far briefer, but just as essential 'Peel Sessions' and now this.

At the risk of being tewwibly boring and/or repeating myself, I'll make the recap brief: Buckley came on the 'pop' scene in the late Sixties via a much-admired debut LP on the then hugely prestigious Elektra label (co-travellers including Love and The Doors). From a patently folksy start, he then proceeded, over a brief but busy nine-album career, to pick up on rock, jazz, soul, funk, and

sundry combinations of each before quitting this mortal coil at the unhealthily young age of 28. This new release catches Buckley during his jazzier, most experimental phase, ie. circa the studio albums 'Lorca' and 'Starsailor'. A lot of hardcore fans deem this to be among his best work - it's certainly Buckley at his most dangerous and border-crossing. For my part, I've found some of the studio stuff from this period a trifle vague and even self-indulgent, prey to the formlessness that then - as now - can so easily come about in the name of freedom.

If people meandered in the studio, you could be forgiven for thinking they'd ramble even more on a live stage. But - deliciously perverse to the last - the Tim Buckley heard here is anything but a wanderer. Even the long instrumental 'Venice Mating Call' (which Tim gives the tragically prophetic alternative title of 'Give Smack A Chance' - it was heroin that took his life before his twenties were out) is anything but a rambling mess, all sturdy rhythms and cogent warbling and with music to match. 'Strange Feelin' is just one instance where the man's breath-taking vocal range and melodic dexterity are allied to a tune to die for; 'Gypsy Woman' is heart churningly lovely ... I can't find a clinker here and it's nothing to do with nostalgia: the man was a genius and to hear him is to love him, to learn something new every time, to miss his magic prescience all the more. Diamond stuff.

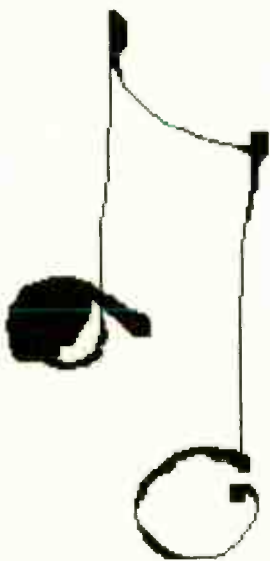

INSPIRAL CARPETS
Devil Hopping
 MUTE DUNG 25 CD

● Inspiral Carpets are one of those 'Are they still around?' sort of groups, if you know what I mean. Less notorious or high-profile chart - and publicity-wise than most of their Mancunian cohorts (what price Happy Mondays or those geezers who used to be Joy Division and went soft?) the Carpets can pull off the admirable trick of waiting until you think they'd gone away and then coming up with a stone killer single in the shape of 'I Want You', their brill collaboration with living legend Mark E. Smith, and a song graced with the best drum track this side of Love's '7 and 7 Is'. It also happens to be the opening cut on this sturdy and very admirable selection of songlets, and if there's nothing else as immediately collar-tugging as this mini-masterpiece, it's easy to see why the band, with their penchant for steady and thorough tour work, are still alive and kicking after all these years in the saddle. Check their other chart fave (albeit less so) 'Plutoman', the clever 'Uniform', or the deliciously formed 'Just Wednesday'. Not the wildest band in the world perhaps, or the most unpredictable, but they hit the bullseye plenty, ring many bells.



THE CHARLATANS
Up To Our Hips
 BEGGARS BANQUET BBQ 147

● Most reviews of the third LP by this amiably jingly-jangly-guitar combo focus on the fact that their keyboard player's doing a bit of 'Bird' (and I don't mean Charlie Parker) for armed robbery when all he really steals is a few Ray Manzarek riffs. There are catchy toons aplenty, but singer Tim Burgess could vary his tonsil-work a bit more. Nice enough, but there's still no real contest when placed alongside the epochal 'Some Friendly'.



TRUE BELIEVERS
Hard Road
 RYKO RCD 40287

Great Lost Band No. 29053. True Believer, out of class rock spawning ground Austin, Texas (remember Doug Sahm, Commander Cody etc. etc.?) this was a bunch of good time rockers who cut a cracking stomp 'n' booze debut, got applauded by all and sundry and then - inexplicably - were dropped before their second LP was even issued. Shame and a sin, 'cause both discs - packed in one box here - will repay anyone with trad, impeccably retro lugholes. Time marches backwards, hoo-ray!

SHORT CUTS

LISA GERMANO
Happiness
 4AD CAD 4005

● Hot on the heels of the much-loved 'Inconsiderate Bitch' EP (great title!) comes a bitter-sweet LP debut, the NYC girly-girl vox (move over Suzanne Vega) a perfect foil to those tart lyrics and wild, wild violin stuff - proving that good + unusual = unusually good.

MOTORHEAD
Live at Brixton Academy
 ROADRUNNER 1009 1/4/2

● Scrambled brains anyone? I emmy can arrange this for you. Out takes from the 1988 'No Sleep At All' disc, lost but now found. Thank Hell for that, eh, pop pickers?

JOHN TRUDELL
Johnny Damas and Me
 RYKODISC RCD 10286

● American Indian poet/singer Trudell bites the bullet - but hard. Sitting Bull's revenge and the red man's answer to Gil Scott-Heron. Great words, cool toons, big, big heart.

SAINT ETIENNE
Tiger Bay
 HEAVENLY HVN 8

● Does Sarah Cracknell have a glorious voice or what? Crit faves come up with a third album which - when they're not trying to be instrumentally clever clogsy - finally justifies (most of) the brouhaha. Pure-ish pop for tomorrow people

rock & pop record reviews

Rock + Pop

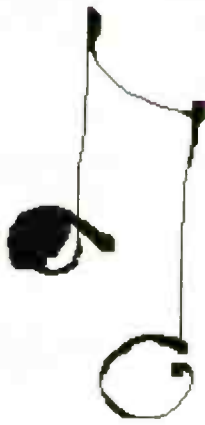

**PRIMAL SCREAM
Give Out But Don't Give Up
CREATION CRECD I46P**

● They say ignorance is bliss. A cliché, for sure, but have you ever really sat down and thought about what this tried and trusted favourite means? Me neither. That is until I sat down and listened to this latest Primal Scream opus and tried to make sense of my feelings about it.

Fact: Primal Scream are the most blatantly derivative rock'n'roll band in the world, shamelessly regurgitating every Rolling Stones cliché known to man. This was patently obvious a couple of years past when, after a couple of fairly mediocre, take-it-or-ignore-it LPs, they finally entered the premier league with the by now classic 'Screamadelica' album. Produced to a large extent by Jimmy Miller, who twiddled the knobs for the Glimmer Twins for the bulk of their Golden Years, i.e. circa 'Sticky Fingers', 'Exile on Main Street' and all points adjacent, the disc nonetheless seemed to hit the jugular with a generation who'd only experienced Jagger and Co as their mam and pa's music or something they heard occasionally popping up on Capital Gold. It was, unashamedly, a stroll through pastures old. And yet, for all that, the record won both critical and public acclaim, garnering rave reviews, hit singles and LP status. Even weirder, the band - and front man Bobby Gillespie in particular - managed to get through his (their) copious press interrogations - I recall one particular Gillespie piece that focused totally on his encyclopedic love of and interest in all things poppy -



her other copious talents - on hearing the new album for the first time, was heard to remark how, track by track, this was a 'Best Of ... the Rolling Stones' LP by another name. As in, "Yeah, Honky Tonk Women". and "Isn't that just like Wild Horses ... again?"

My darling was quite correct of course (as usual) but that's another 'Women - can't live with 'em, can't live without 'em' story. Still, there's just no way this record, this band, could possibly exist had there been no Rolling Stones. But then there have been legions of copycats trying to work the same furrow as old rubberlips and Co., so why should this particular aggregation get away with it while scores of others fell by the wayside? Well, for a start, not all the copyists of yore exactly crapped out. There's at least one instance here - the admirably plangent mid-tempo soul

slobber 'Cry Myself Blind' that carries equally strong echoes of prime-time Rod Stewart and The Faces as it does them other geezers. And what were The Faces except a good Stones rip-off with (maybe) a better singer?

And surely that's another reason why Primal Scream get away with it - in Bobby Gillespie they have one of the most odds-on powerfully charismatic front-men seen in yonks. The guy has it - class, style, front ... and a fair pair of tonsils, to boot.

Not to mention that the band's musical roots are, of course, nonpareil, witness only the presence here of the impeccable and solid gold Memphis Horns - on, er, horns, ditto the equally fabled Atlanta Rhythm Section. Plus the whole thing was mainly cut at the rightly legendary Ardent Studios in Memphis (where-at the entire Stax-Volt, Otis Redding, Booker T etc. etc. funky Southern soul shebang first exploded) and - crowing glory - the production is largely down to one Tom Dowd, a Soul vet with more credits than a Francis Ford Coppola movie, while latterday funk is represented by the far from grizzled and ever welcome George Clinton, who manages to elbow his vox on to the self-explanatory 'Funky Jam', for one.

Most importantly, and for all the salad dressing that is superficially regarded as style, this band write cracking tunes. 'Rocks' has done its bit already, chart-wise, but it's a sure bet that laff riots like 'Big Jet Plane', the sensuous 'Free' or the aforementioned 'Cry Myself Blind' - it hurts so good, as they used to say - will enrich airwaves and jukeboxes across our spotty little globe before too long. No big surprises then, but Primal Scream are still something to shout about.

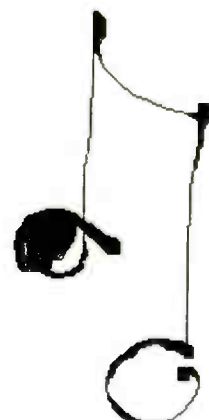

Specialist Hi-Fi Dealers

SOUTH

THE SOUND GALLERY

**BUCKINGHAMSHIRE'S
PREMIER HI-FI DEALER**

Arcam, Denon, Linn Products, Naim Audio, Meridian, Rotel, Yamaha, NAD, Quad, Tripod, Nakamichi, Rega, Creek, Epos, Mordaunt Short, Celestion, Marantz, Mission, Cyrus, etc. ...

65 Castle Street, High Wycombe, Buckinghamshire.
Open Monday - Saturday
0494 531682 / 464670

WORTHING AUDIO

20 Treville Gate, W Sussex. BN11 1UA
(0903) 212133

The friendly shop with the best sound system in the South, Friendly advice

• 3yr guarantees • easy parking

Open Mon.-Sat. 10am-6pm Late night Wed. 7.30pm

Agencies include: Arcam, Exposure, Kinshaw, Naim Audio, Marantz, Ruark, Audio Technica, Target, Tripod, IPW, TDL, Orelle, and many more.....

the powerplant

BRIGHTON'S LEADING HI-FI SHOP

Cyrus, Roksan, Micromega, Audionote, Audiolab, Rega, Arcam, Exposure, Aura, Epos, Thiel, Ruark, Rotel, Marantz and other fine equipment

66 Upper North Street, Brighton
Telephone 0273 775978

STATION SOUNDS

FOR A SELECTION OF VALVE AMPLIFIERS AND OTHER OLDER QUALITY EQUIPMENT

Valve amplifiers (combos and hi-fi) overhauled at sensible rates.

Audio Note speakers and used Audio Innovations amplifiers stocked.

Valve and other equipment always wanted.

Mike Pointer 0903 239980 (including Fax)

DOWN PLATFORM WORTHING STATION SUSSEX

Stockists of: ARCAM • CREEK • EPOS
HEYBROOK • MICROMEGA • NAIM AUDIO
NEAT • REGA • ROKSAN • ROTEL • ROYD
TEAC • YAMAHA

Infidelity

Indecently good hi-fi

9 High Street, Hampton Wick, Kingston upon Thames, Surrey KT1 4DA. Tel: 081-943 3530
Open Tues - Sat 10.30am - 7.00pm.

CHICHESTER HIGH FIDELITY

7 ST. PANCRAS,
CHICHESTER,
WEST SUSSEX
CLOSED ALL DAY
MONDAY
Tel: (0243) 776402

Appointed stockists of: A+R Cambridge, Castle Acoustic, Creek, Dual, Goldring, Linn Products, Monitor Audio, Naim, Nakamichi, Quad, Rega, Rogers, Royd Audio, Sendor

LONDON & SOUTH EAST

**"One of the 5
best hi-fi shops
in the world"**

GRAHAM'S HI-FI

Canonbury Yard, 190a New North Road
London N1 7BS. ☎ 071-226 5500
Ring for a chat, an appointment and a map!

BADA

For the great sound of sound :

The Comflake Shop
37 Windmill Street London W1P 1HH
071 631 0472 Fax. 071 436 7165

We stock ATC, Arcam, Meridian, Naim, Rega, Royde, Roksan, AVI, Monitor Audio, DNM; as well as offering a marvellous mail-order worldwide service • Crunch •

The Hi-Fi Shop

GUILDFORD'S SPECIALIST SINCE 1950

We are at:
3 BRIDGE STREET, GUILDFORD
(By the traffic lights - next door to Alfred Works)
0483 504801 • 0483 304756

Access • Visa • Switch

Open Monday-Saturday 9am-6pm (later by appointment)

Front End Problems?
contact-

The Cartridge Man

It doesn't have to cost an arm and a leg to get the best - listen to my Koetsu - and - Decca - eater.

Also agents for Croft, Sugden, Thorens, Pentachord Speakers & Nottingham Analogue.

plus cartridge re-tipping service

081-688 6565

volume one
Tel: 081 304 4622

Alchemist, Alphason, Arcam, Audioquest, Audio Technica, Beyer, B&W, Cabletalk, Canon, Celestion, Chord Co., Micromega, Michell, Moth, Musical Fidelity, Nakamichi, Neat, Ortofon, Pink Triangle, QED, Rotel, Royd, Ruark, Sennheiser, SMF, Sonic Link, Sony

41 UPPER WICKHAM LANE,
WELLING, KENT

AUDIO CONCEPTS

27 BOND STREET, EALING
LONDON W5 5AS
TEL. 081 - 567 8703

Acoustic Energy, Aura, Audiolab, Audio Innovations, B&O, B&W, Cannon, Castle, Cyrus, Denon, Daul, Evolution, JBW, Kef, Marantz, Micromega, Mission, Monitor audio, Musical Fidelity, NAD, Nakamichi, Onix, Quad, Rogers, Rotel, Systemdek, Target, Teac, Thorens, Van den Hul.

Two demonstration rooms.
Free local delivery and installation.
Repairs and Services

World Radio History



Spaldings

ESTABLISHED IN SOUND

☎ 081-654 1231/2040
352/4 LOWER ADDISCOMBE RD.,
CROYDON, SURREY

KIMBERLEY HI-FI

A Sound Investment
SEPARATE DEMONSTRATION ROOM •
BRANDS STOCKED: • DENON • TECHNICS •
• KENWOOD • AIWA • NAD • DUAL •
• CASTLE • GOODMANS • MARANTZ •
• MONITOR AUDIO • HECO • ROTEL •
• PIONEER • REFERENCE POINT •
SOUTH LONDON'S & NORTH KENT'S ONLY

LARGE RANGE OF ICE
INC PIONEER & KENWOOD

193 BROADWAY, BEXLEYHEATH, KENT
081 - 304 3272

studio 99

79/81 Fairfax Road
Swiss Cottage
London NW6 4DY
071 624 8855/6
Mon-Fri 10-7 SAT 10-6

SURREY HIFI

SPECIALIST HI-FI OUTLET
DEMONSTRATION ROOM - PARKING

• QUAD • AUDIOLAB • REL • TUBE TECHNOLOGY •
• TDL • TANNY • KEF • DENON • NAKAMICHI • THORENS •
• TARGET • MAGNUM • ROTEL • MARANTZ • MICHELL •
• SENNHEISER • BEYER HEADPHONES • JPW •
• SOUND ORGANISATION • SOUNDSTYLE TRIPODS •
• VAN DEN HUL CABLES • BOSE • MUSICAL FIDELITY
• SEISMIC SINK •

'HOME CINEMA NOW ON DEMONSTRATION'

Just 2 minutes off Junc. 6 M25, (A25)

GODSTONE 0883 744755
45 High St., Godstone, Surrey RH9 8LS

MIDLANDS

W.OWEN EST 1901

Audio/Video Specialists

Pioneer • Reference Point • Kenwood •
Sony • Akai • B&W
Free installation and home delivery

55 Market Street, Chichester
Tel: 01243 613315

75 Stratford Street,
Stratford, Warwickshire
Tel: 01827 841876

STRATFORD HI FI LTD

AV AND LASER DISC IN STOCK

You can come and visit us at:
**25 HENLEY STREET,
STRATFORD CV37 6QW**

Contact Dirk or Jamie on:
Tel/fax No. **0789 414533**
We are stockists of the leading
Hi-Fi brands including:

ARCAM, SONY, PANASONIC, NAKAMICHI, B&W, PIONEER, TECHNICS, DENON, NAD, KEF, MARANTZ, ROTEL, MUSICAL FIDELITY, MONITOR AUDIO, MISSION, TANNY, QUAD, TDL & SENNHEISER, YAMAHA, CELESTION, ACOUSTIC RESEARCH, AUDIOQUEST, MONSTER, TARGET, BEYER, SYSTEMDEK.

2% Finance is available on selected products and all major credit cards accepted. We also have a Demonstration Room and Service Facilities.
Monday to Saturday 9.30-5.30. Late night Wednesday
"WHERE FRIENDLY SERVICE STILL COUNTS!"

Specialist Hi-Fi Dealers

MIDLANDS

MUSIC MATTERS

THE AUDIO SPECIALISTS

for the most exciting range of equipment available in the Midlands which includes:

Arcam, Aiwa, Alchemist, Alphason, Apollo, Arcam, Audiolab, Audioquest, Audio Innovations, Audio-Technica, Aura, Beyer, Cambridge Audio, Canon, Celestion, Chord, Cyrus, Deltec, Denon, Dual, Epos, Exposure, Heybrook, Impulse, Infinity, KEF, Luxman, Marantz, Meridian, Michell, Micromega, Mission, B+W, Mordaunt-Short, Michaelson Audio, Monitor Audio, Monster, Musical Fidelity, Nakamichi, NVA, Panasonic, Pink Triangle, Pro-Ac, Revox, Rogers, Roksan, Rotel, Royd, Ruark, Sansui, Sennheiser, Straitwire, Systemdek, Target, Technics, Thorens, Wharfedale, Yamaha etc.

OPENING TIMES:
 Tues-Thurs 10.30-6.00
 Friday 10.30-8.00
 Saturday 10.00-5.00
 Demonstration by Appointment

351 HAGLEY ROAD, EDGBASTON, BIRMINGHAM B17 8DL
 Tel: 021-429-2811

156/7 LOWER HIGH STREET STOURBRIDGE, WEST MIDLANDS DY8 1TS
 Tel: 0384 444 184

INTEREST FREE
 (for Ltd Period) APR 0%.
 Written details on request.
 Licensed Credit Broker.
 Switch card accepted

ELECTRO CENTRE
 255 BRIDGE ROAD, HANWORTH, BIRMINGHAM

TEL 021 554 1878 & 523 2426

FULL RANGE OF H-FI.
 PIONEER, TECHNICS, KENWOOD,
 JVC, SONY, AIWA, AKAI

Guaranteed the lowest price in the UK.
 24 Hour Mail Order Facility Available

THE STATE OF THE ART....

- EXPERT ADVICE
 - CREDIT FACILITIES
 - PART EXCHANGE WELCOME
 - REPAIRS

Come and hear - NAD • B&W • NAKAMICHI • BOSE • QUAD • BEYER-DYNAMIC • SENNHEISER • AURA - and lots more in our listening room.

Tel. 0743 - 355166



AVON Hi-Fi Limited
 12 Barker St. Shewsbury
 Plenty of parking - park and ride buses stop outside!

Peter Ellis Audio

A wide range of audio products always in stock including:-
 Quad, Denon, Stax, Marantz, Arcam, Creek, Sugden, QED, Castle, Rogers, Celestion, Tannoy, Nakamichi, Yamaha

* Home Cinema available *
 * Demonstration Room *

29, Kirkgate, Newark,
 Nottinghamshire NG24 1AD
 0636 704571

SOUL ACADEMY

THE MOST EXCLUSIVE INDEPENDENT HI-FI STUDIO

The internal atmosphere and easy access make it so much more exciting choosing your hi-fi from the finest audio products available.

Just off the High Street, Bloxwich, nr. Walsall, West Midlands.
 (Ample free parking)
 (OFF M6 JUNCTION 10)

TEL: (0922) 493499 - 473499

Open 6 days a week. Mon - Sat
 All major Credit Cards accepted
 Part Exchange enquiries welcome

ALBARRY • ACOUSTIC ENERGY • ARCAM • ART AUDIO
 • AUDIOLAB • AUDIO QUEST • B&W • BOSE • CABLE TALK • CHORD • CYRUS • DPA • DYNAUDIO • ENSEMBLE • EPOS • EXPOSURE • JPW • KEF • REFERENCE • MARANTZ • MERIDIAN • MICROMEGA • MISSION • MOTH • MUSICAL FIDELITY • NAKAMICHI • ORTOFON • PROSPECT • PROJECT • QUAD • ROKSAN • ROGERS • ROTEL • SONICLINK • SYSTEM DEK • TDL • THORENS • TRIANGLE • TOWNSEND • TUBE TECHNOLOGY • VAN DEN HULL • YBA •

ARCAM, ROYDE, AUDIOTECH, CELESTION, APOLLO

MUSICAL APPROACH

Surround sound systems available for demonstration

STAFFORD WOODINGS YARD 0785 55154

ALDRIDGE 37 HIGH STREET 0922 57926

LINN, ROTEL, MARANTZ, HEYBROOK, TARGET

Single speaker demo rooms free expert installation

CREATIVE AUDIO

9 DOGPOLE, SHREWSBURY, SHROPSHIRE
 Tel: (0743) 241924
 Closed Mondays

- Comfortable listening rooms
- Home demonstrations available
- Part exchange welcome
- Free home installation
- Interest Free credit

Authorised retailer for:
 A & R ARCAM, AUDIOLAB, CELESTION, CYRUS, DENON, DUAL, MERIDIAN, MISSION, MONITOR AUDIO, QUAD, REVOLVER, ROKSAN, ROTEL, YAMAHA, EPOS, NAIM, KEF, RUARK

Advent, Albarry, AKG, Alphoson, AMC, AR, Arcam, Audioquest, Audio Technico, Beyer, Bose, Costle, Chord, Denon, Dual, Goldring, Meridian, Michell, Monitor Audio, Nagaoko, Nakamichi, Ortofon, QED, Quad, Revox, Sennheiser, Sequence Design, Spondor, Target, TDK, TDL, Thorens, Wharfedale, K. Monks Record Cleaning Service.

Five Ways Hi-Fidelity., (Est.1972)
 12 Islington Row
 Edgbaston, Birmingham B15 1LD
 021-455 0667 (Closed Mondays)

MIDLAND STUDIO

PHONE/FAX OR WRITE FOR OUR LATEST LIST OF EXDEMSTRATION OR SECOND HAND EQUIPMENT FROM LEADING ESOTERIC MANUFACTURERS

MIDLANDS HI-FI STUDIO
 WULFRUNA STREET
 WOLVERHAMPTON WV1 1LX

TELEPHONE 0902 771774 FAX 0902 380083

EAST

The Audio File

27 HOCKERILL STREET, BISHOP'S STORTFORD, HERTS.
 TEL: 0279 506576
 2 FOUNDRY WALK, MARKET HILL, ST. IVES, CAMBS.
 TEL: 0480 66123



signals

- audio innovation • fuller's audio • goldring • heybrook • impulse • ipw • lyra • michell • micromega • qed • soniclink • sumike • alphason • apollo • audioquest • ixos • projekt • soundstyle • sterling • townshend • trichard • sugden • and many more

Monday to Saturday 10-6

MARTLESHAM HEATH • IPSWICH
 (0473) 622 866

EIRE

Acoustic Dimension

AVI • ATC • AUDIO INNOVATIONS • ACOUSTIC ENERGY • MICROMEGA • AUDIO NOTE • LFD • REF 3A • IMPULSE • JPW • TDL PROJECT • PRO AC • TRIANGLE • RUARK • ROTEL • MARANTZ • DPA • APOLLO

Now ex demo equipment.
 Credit card accepted.

We Never Compromise On Quality

CLONEY AUDIO

55 Main St Blackrock Co Dublin
 Tel 2889449/2888477 Fax 2834887
 Open Tue/Sat 10AM-6PM. Thur/Fri 'till 9pm - Closed Monday

FRANK HARVEY

Hi-Fi EXCELLENCE

163 Spon Street. Coventry. CV1 3BB Tel : 0203 525200.
 Mon to Sat 9.30 AM 5.30. Closed Thursday

MUCH MORE THAN HI-FI
 WE ARE A BADA DEALER

Audiolab - Audio Alchemy - Arcam - Alphason - Bose - Bang & Olufsen - Celestion - Cyrus - Denon - Dual - Foundation - Kef - Marantz - Monitor Audio - Mission - Musical Fidelity - Nakamichi - Nad - Quad - Rega - Rogers - Rotel - Target - Tripod - Tannoy - Thorens - Van Den Hul - Yamaha

MAILORDER - EXPORT - HOME TRIALS

3 Floors, 3 Dem rooms, 3000 sq feet in the pursuit of Hi-Fi Excellence
 World Radio History



Peter Dand & Company Ltd
 Established 1963

Bang & Olufsen, Quad, KEF, Thorens, TEAC, and many more!
 2 Demonstration Rooms
 2 Year Guarantee

111 Clonskeagh Road, Dublin 6
 Tel. 01035 31 269 4433

Specialist Hi-Fi Dealers

TECHNICAL & GENERAL

THE ORIGINAL TURNTABLE SPECIALISTS for the Great Classic Turntable, Arms, Cartridges, Stylis.

CONNOISSEUR • GARRARD • GOLDRING • Lenco • ORTOFON • SHURE • S.M.E • THORENS • WATTS

All available Genuine spares and our own re-manufacture of obsolete parts Servicing and Overhauls, to original technical specifications.

NO ILLUSORY 'IMPROVEMENTS', NO DUBIOUS OR HARMFUL 'MODIFICATIONS'
Remedial Services available

Cartridges and stylis, correct radius diamonds, for early recordings - 78s & LPs

TECHNICAL & GENERAL
P.O.Box 53, Crowborough, East Sussex TN6 2BY.
Tel. 08 92 65 45 34

REVOX SERVICE & REPAIRS

"Authorised agent for Revox Products"

- 17 Years experience, ex-Bauch •
- All repairs carried out and guaranteed •
- Fast turnaround •

Tel: 0923 893711
Suite 10, Smugoak Business Centre,
Lye Lane, Bricketwood, Herts. AL 23UG

BANDOR

MINIATURE LOUSPEAKERS
DESIGNED AND MANUFACTURED BY MINIATURE LOUSPEAKERS AND SYSTEMS.



Drive Units - 2" module with 1.3gms. mms. + 6" 8" & 15" CLUMINIUM CONED DRIVERS. Flat pack TRANSMISSION LINE KIT and NEW BANDORA-MORA semi-active complete loudspeaker system.
Free technical sheets etc.
11 Penfold Cottages, Penfold Lane,
Holmer Green, Buck. HP15 6XR
(0494) 714058

LOOKING FOR REAL HI-FI or HOME CINEMA IN SWINDON

Audio Technica, Acoustic Energy, Audio Innovations (Valve Amp), Beard (Valve Amp), Cerwin Vega, Impulse, Red/Acoustics, and many more....
We also stock quality ex-demonstration and secondhand hi-fi Quality car Audio, new, used and secondhand, also available Repair and refurbishment class equipment

52 Audio Exchange 52

52 Morse St, Swindon Tel. 539908
(Off Commercial Road, Swindon) Open 10am - 6pm, Mon - sat

VINTAGE AND VALVE HI-FI

Haden Boardman buys, sells, modifies & repairs all vintage hi-fi equipment.
Always quality hi-fi available, new and secondhand. Advice is free, phone if just for a chat. Credit cards accepted. New equipment by Croft, E.A.R, Richard Allen + more coming soon!
Quick worldwide delivery, callers by appointment. Sorry but we are unable to answer queries in writing

GARRARD 301/401 **Audio Classics** 8 Lowe Mill Lane,
IN STOCK Tel (0642) 57525 Hindley,
7 days a week Fax (0642) 525851 Lancs WN2 3AF

mwes electronic services

Repair & services to almost all makes of Hi-Fi. In guarantee repairs to Denon, Kenwood & Pioneer. All repairs tested for electrical safety.

MWES ELECTRONIC SERVICES
5 KING STREET, DELPH
OLDHAM OL3 5DL
TEL/FAX. 0457 820862

Lockwood Audio

Tel: 081-207 4472 Fax: 081-207 5283

WE BUY AND SELL
NEW, USED AND VINTAGE
SPEAKERS, DRIVERS, CABINETS, PARTS.

SPEAKER REPAIRS
THE

Authorised **TANNOY** Specialist

MAJOR CREDIT CARDS WELCOME
IMPERIAL STUDIOS,
MAXWELL ROAD,
BOREHAMWOOD, HERTS. WD6 1WE



Cheshire Music

Hi-fi systems for music lovers.

ATC Loudspeakers AVI Electronics.
Clearly the best at any price.

For further details or a demonstration contact
Roy Parrish on 061-439 0082

Retailers of Fine Audio Equipment
Congleton

- ▶ EPOS
- ▶ ONIX
- ▶ DENON
- ▶ LINN
- ▶ AUDIO ALGHEMY
- ▶ ARCAM
- ▶ B&W
- ▶ NAKAMICHI
- ▶ ROYD
- ▶ TARGET
- ▶ TRIPOD
- ▶ LOUSY COFFEE

SUPERB DEMO FACILITIES

FULL INSTALLATION & HOME DEMO SERVICE

OPEN 6 DAYS A WEEK
OTHER TIMES BY APPOINTMENT

0260
297544

1/1A Duke St Congleton Cheshire CW12 1AP

Swift

THE HI-FI SPECIALISTS

ST ANN'S PARADE (ON A34) WILMSLOW CHESHIRE

0625 526213

- 2 YEAR GUARANTEE • EASY PARKING
- DEM ROOM • PART EXCHANGE

Aiva • Audio Lab • Aura
B & W • Castle • Denon • Cyrus
Celestion • J.P.W. • Kenwood
Marantz • Mission • NAD •
Pioneer • Rotel • Systemdek
Tannoy • Technics

REPAIRS/DIY

RATA
Edge Bank House, Skelmergh, Kendal,
Westmorland, LA8 9AS
Telephone : 0539 823247

If you like the Hi-Fi equipment you have but want a better performance, don't change it.

UPGRADE IT!

You can build better than you can buy and we offer kits, parts and instructions for anything from simple component upgrades to complete rebuilds, plus kits to build high end equipment from scratch.

New Upgrading Service.

If you are daunted at the prospect of taking the lid off your prized possession, send it to us and we can do the upgrade for you: We will advise on feasibility and cost before starting work and upgrade to the level of performance you require and can afford. We have a secure, low cost collection and delivery service within the UK.

Upgrades to: Audio Research, Celestion, KEF, Krell, Linn, Marantz, Meridian, Naim, Nyltech, Pioneer, Quad, Leak, Radford, Rotel etc....

Send now for full details and a copy of our 1993 Audiophile Components Catalogue No. 2.

To cover postage Europe 5 x IMCs, World 9 x IMCs, or quote your credit card number (Visa or Mastercard only). UK - free.

CVC Chelmer Valve Company
for Audio Valves

Buy CVC PREMIUM Hi-Fi valves direct from us. All valves processed for improved performance. We also have Stock of MAJOR BRAND types including :MULLARD, GEC, BRIMAR, RCA, GE, etc

130, New London Road, Chelmsford, Essex, CM2 0RG
Tel: 0245 265865 Fax: 0245 490064

World Radio History

WEST & WALES

ENGLISH
audio **3ADA**

CYRUS CENTRE

PINK TRIANGLE-AUDION-SYSTEMDEK-HEYBROOK-MICHI-KEF REFERENCE MICROMEGA-NAKAMICHI-CHORD-ARCAM-MUSICAL FIDELITY-ROGERS-NAD-ROTEL-DENON-TANNOY-MARANTZ-MISSION-STAX-DUAL-TDL-ALBARRY-JPW-CELESTION-IXOS-SME-RUARK-MOTH-AUDIO TECHNICA-AND OTHERS

Free installations: Credit Facilities: Service Department.

Mon - Sat 10 - 6
95 Whitcross Road, Hereford HR4 0BG (0432) 359081

audio excellence

WHERE THE MUSIC MATTERS

Bristol 65 Park Street
Bristol BS1 5PB (0272) 264975

Cardiff 134/6 crwys Road
Cardiff CF2 4NR (0222) 228565

Gloucester 58 Bristol Road
Gloucester GL1 5SD (0452) 300046

Swansea 9 High Street
Swansea SA1 1LE (0792) 474608

TUESDAY - SATURDAY 9.00 - 5.30
CLOSED MONDAY

NORTH WALES

ACTON GATE AUDIO

THE HI-FI CENTRE IN WREXHAM

Aiva, Albarry, Arcam, B&W, Canon, Celestion, Cyrus, Mastler, Marantz, Michel, Mission, NAD, Nakamichi, Quad, Radford, Rega, Rogers, Rotel, Ruark, Spendor, Teac, Tannoy, Thorens, Wharfedale, Yamaha,
"Yamaha cinema DSP club authorised dealer"

4 RUABSON ROAD, WREXHAM
TEL. 0978 3645000

NORTH

ASTON AUDIO HI-FI SPECIALISTS

ARCAM • MERIDIAN • MISSION • CYRUS • AUDIOCAB • B & W • NAKAMICHI • AURA • DENON • QUAD • YAMAHA • KEF • MARANTZ •

ROKSAN • NAD • MF • AIVA • DUAL • CELESTION • ROGERS • AUDIOQUEST • TECHNICS •

WEST STREET • ALDERLEY EDGE • PLUS HOME CINEMA • CHESHIRE • TEL 0625 582704 • INTEREST FREE CREDIT • DISCOUNT CD & TAPE • BADA •



THE HI-FI STUDIOS

HEYBROOK, MONITOR AUDIO, ART AUDIO VALVES, DUAL, SUGDEN, ALPHASON, TDL, MICHELL, ACOUSTIC ENERGY, TEAC, A&R, AURA, ORIGIN LIVE, SYSTEMDECK, EPSILON, SHURE, AUDIO TECHNICA, GOLDRING, ALBARRY AND OTHERS FROM THE COMPANY THAT CARES FOR CUSTOMERS.

DEMONSTRATION IN OUR LISTENING ROOMS OR AT HOME

SUNNYFIELD, DONCASTER
Tel: (0302) 781387

AUDIO COUNSEL HI-FI SPECIALISTS

LINN, NAIM, REGA, ARCAM, ROTEL, ROYD, SHAHINIAN, DYNA VECTOR, EPOS, MARANTZ, NAKAMICHI, MICROMEGA and many more....
"Time spent with staff may prove to be a particularly wise investment"

Audiophile

12/14 Shaw Road, Oldham OL1 3LO
Tel. 061 633 2602

WORLD DESIGNS

by Mail Order

world audio design mail order

K5881 KIT

£395 ▼



Designed for long life, low running costs and excellent sound quality, K5881 is sensitive enough to be used with a simple passive pre-amp. or our own line-drive pre-amp, and it matches modern loudspeakers well. There is a choke-regulated power supply and the channels can be paralleled to turn it into a 40W monoblock if desired.

K5881 costs just £395 as a kit of parts and £595 fully built from our own build service. The U.K./Europe version has a 240/220V transformer but 120/110V can be supplied as an alternative - see Overseas details on Order Form.

SPECIFICATION

| | |
|--------------------|----------------------------|
| Power | 20watts/ch. |
| Frequency response | 16Hz-40kHz |
| Distortion | 0.02% |
| Separation | 60dB |
| Noise (CCIR) | -103dB |
| Sensitivity | 240mV |
| Dimensions (mm) | 400w,300d,180h |
| Supply | 110/120V or 220/240V, 220V |
| Weight | 16kgs(34lbs) |

Here's a superb, Class A, 20watt stereo power amplifier that uses the inexpensive Russian 5881 output valve, a military version of the regarded American 6L6, designed for low distortion audio work. It has super-quality output transformers (4/8/16Ω selected internally) to minimise distortion and the input stage uses triode working. A rugged, sixteen-gauge, all-welded steel chassis is provided, together with protective bottom plate for safety; a protective top cover is an optional extra.

VALVE LINE LEVEL PRE-AMPLIFIER

£295 ▶

We now have finished the design of a super high quality chassis for the line level pre-amplifier. It is constructed from heavy gauge steel with an aluminium anodised and polished front panel. This new chassis comes with the complete kit of parts necessary to build the valve line level pre-amp.

The components are all high quality and include a special screened toroidal transformer, Military Spec. Russian valves, Alps potentiometer, metal film resistors, polypropylene signal capacitors, silver plated copper wire etc.



HIGH DEFINITION LOUDSPEAKER

The High Definition loudspeaker is ideal for low power, high quality amplifiers, transistor or valve. It goes very loud with just 1-5watts, having an enormous sensitivity of 94dB - that's 8dB more than most other speakers. It is also a very easy load for valve amps (8ohms) and it gives a terrifically dynamic and fast sound.

As well as being just about unmatched as a partner for esoteric amps, this speaker is also unusually suited to low powered vintage amplifiers, such as Quad IIs, Radfords, Pye Mozarts and such like.

The High Definition DIY loudspeaker is available as a complete kit, including flat pack cabinet, drivers modified and tested by us, all crossover components and hardware. The flatpack cabinet is finished in an attractive satin black and requires no further finish, but for those who prefer something a little more traditional a mahogany veneer is an option.

If you would like to build your own cabinets we are also offering a drive unit pack that comprises two tweeters and two woofers, modified and tested.

KLS2 LOUDSPEAKER

Drive Unit Pack

£145

WORLD DESIGNS

by Mail Order

300B VALVE AMP KIT

£750

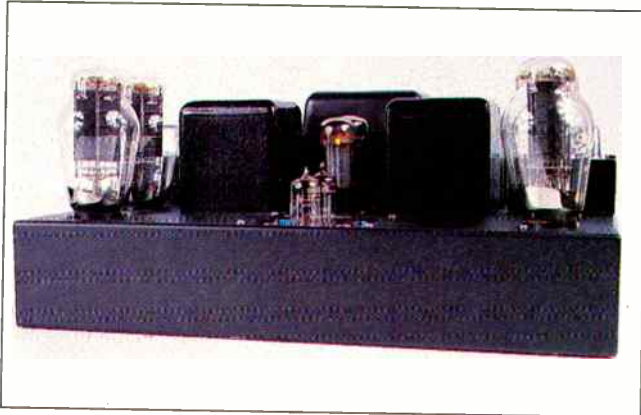

This is a specialised amplifier based on the highly linear 300B triode valve. Tim de Paravicini designed it - including the massive transformers - for minimum distortion without overall feedback. If you want feedback (tertiary or overall), it can be applied without difficulty.

Our 300B runs in Class A, giving one of the most sweet, open and neutral sounds possible today. Matched with good loudspeakers, it is unsurpassed.

The kit comprises a strong 16-gauge mild steel chassis, fully punched, welded and ground smooth. Finish is a durable 'powder coat' black. A protective bottom plate is provided for safety; a protective top cover is an optional extra. Output terminals (one pair) take 4mm plugs axially and radially for bi-wiring, or heavy gauge bare cable. Output options of 4/8/16Ω are selected internally at the transformer. A small circuit board carries most of the components. 240/220V and 110/120V versions available - see Overseas details and prices on Order Form.

All parts are included in the kit, except valves since different 300B makes are available.

A fully built version from an approved build service is also available for £1050 (valves extra).

SPECIFICATION

| | |
|--------------------|----------------------------|
| Power | 28watts |
| Frequency response | 5Hz-36kHz |
| Distortion | 0.2% |
| Separation | 54dB |
| Noise (hiss/hum) | -100dB/-72dB |
| Sensitivity | 240mV |
| Dimensions (mm) | 405w,295d,175h |
| Supply | 110/120V or 220/240V, 220W |
| Weight | 20kgs(44lbs) |

DEMONSTRATIONS!!

By the time you read this we hope to have our K5881 20W valve power amplifier and KLP-1 valve pre-amplifier on demonstration at Hi-Fi Confidential, 34 Buckingham Palace Road, Victoria, London. Phone the patient and understanding Luigi on 071-233-0774 to check availability. He's a valve afficianado, knows Tim de Paravicini and is still sane, and stocks plenty of good products - including World Audio Design. So hear us against the others - and don't you dare buy them

▼ 4W SINGLE-ENDED TRANSFORMERS £190

A set of transformers (8kgs) for our single-ended amplifier (December '93. Supplement No 6).

- 1) Mains (1 off) Secondary: 0-210V a.c. at 150mA, 6.3V centre tapped. Primary: 220/240V or 110/120V - please state which on order form. Drop through fixing.
- 2) Output (2 off) High quality transformers with grain orientated silicon steel laminations. Secondary tapped 4/8/16Ω. Drop through fixing.
- 3) Choke (1 off) Compact 1.2H/150mA choke for under-chassis fixing. Frame mount.

6080 valves - double-triode power valve for the single-ended amplifier - £15.00

K5881 (20W CLASS A) TRANSFORMERS £220

There are four transformers in all, weighing 12kgs.

- 1) Mains (1 off) Secondary: 0-360, 1 x 6.3V centre tapped. Primary 220/240 or 110/120 - please state which on order form. Drop through fixing.
- 2) Output (2 off) These transformers use high quality materials, laminations of thin and best quality grain orientated silicon steel. Output tapped 4Ω, 8Ω and 16Ω. Drop through fixing.
- 3) Choke For smoothing of the H.T. line to provide best sound quality, a 5H choke that fixes under the chassis. Frame mounting.

300B (28W CLASS A) TRANSFORMERS £430

Seven transformers in all, weighing 16kgs (35lbs)

- 1) Mains (1 off) Secondary: 490V-0-490V, 6 x 5V, 1 x 6.3V. Primary 220/240 or 110/120 - please state which on order form. Drop through fixing.
- 2) Output (2 off) Designed for low distortion and broad load compatibility from the 300B. Cores with centre-hole fixing to avoid corner flux concentrations; laminations of grain orientated silicon steel. Output tapped 4/8/16Ω. Drop through fixing.
- 3) Intervalve/phase splitter (2 off) Special Tim de Paravicini design, potted in steel for secrecy. Drop through tags.
- 4) Chokes (2 off) For smoothing of the H.T. lines, two 5H chokes that fix under the chassis. Frame mounting.

HIGH PERFORMANCE 3-WAY SPEAKER £729

Our high performance 3-way DIY loudspeaker featured in Supplement Nos. 3 & 4 is now available as a kit. The cabinet has been designed to be extremely easy to build (even though there are 36 panels for the pair) requiring only wood glue and stretchy carpet tape to clamp the panel in place. All drive units and hardware are supplied.

When built, the loudspeaker is comparable to those costing more than twice the price, with a transparency and openness in the midrange that is unmatched by most. The price for this entire kit, including VAT and p&p is £729.

WARNING

THESE ARE EXPERT KITS, NOT FOR THE INEXPERIENCED.

THE VALVE KITS CONTAIN LETHAL VOLTAGES. WE CANNOT BE HELD RESPONSIBLE FOR ANY ERRORS ARISING FROM THE CONSTRUCTION OF THE KITS.

ORDER FORM

Please send your completed order form to: WORLD AUDIO DESIGNS, 64 Castellain Road, Maida Vale, London W9 1EX
Tel: 071 266 0461 Fax: 071 289 5620

240/120 option - delete the voltage NOT required.

Valves included except where stated.

'BUILT' - we can supply the amplifiers built up and tested by an approved service, for safety and guaranteed performance to specification.

NOW AVAILABLE - 4W SINGLE-ENDED INTEGRATED AMPLIFIER KIT. INCLUDES CUSTOM CHASSIS, TRANSFORMERS, VALVES AND ALL COMPONENTS - £385

| DESCRIPTION | ORDER No. | QTY | PRICES | |
|---|-----------------|----------------------|-------------------------------|--------------------|
| | | | UK (inc VAT & carriage) | OVERSEAS. (net) |
| 4W SINGLE-ENDED | | | | |
| KIT | 4WSE-K240/120 | <input type="text"/> | £385 | £330 |
| transformer set | 4WSE-TR240/120 | <input type="text"/> | £190 | £150 |
| K5881 20W budget valve amplifier | | | | |
| KIT | K5881-K240/120 | <input type="text"/> | £395 | £350 |
| BUILT | K5881-B240/120 | <input type="text"/> | £595 | £550 |
| transformer set | K5881-TR240/120 | <input type="text"/> | £220 | £180 |
| 300B 28W specialised valve amplifier | | | | |
| (prices do not include valves) | | | | |
| KIT | 300B-K240/120 | <input type="text"/> | £750 | £650 |
| BUILT | 300B-B240/120 | <input type="text"/> | £1050 | £950 |
| transformer set | 300B-TR240/120 | <input type="text"/> | £430 | £370 |
| KLP1 line level preamplifier | | | | |
| KIT | KLP1-K240/120 | <input type="text"/> | £295 | £250 |
| BUILT | KLP1-E240/120 | <input type="text"/> | £395 | £335 |
| KLS1 3-way floorstanding loudspeaker | | | | |
| KIT | KLS1-K | <input type="text"/> | £729 | £650 |
| Drive units and hardware | KLS1-D | <input type="text"/> | £429 | £370 |
| KLS2 2-way, high definition, floorstanding speaker | | | | |
| Drive Units + Crossover kit etc | KLS2-C | <input type="text"/> | £195 | £165 |
| Drive units | KLS2-D | <input type="text"/> | £145 | £120 |
| Loudspeaker measurement | | | | |
| mic and preamp + test disc | 3382B | <input type="text"/> | £440 | £390 |

NAME: _____ I enclose cheque/postal order for £ _____
made payable to World Audio design Ltd.

ADDRESS: _____
I wish to pay by Access/Visa debit may account no: _____

POST CODE: _____ TEL: _____ Expiry date:

CREDIT CARD ORDERS TELEPHONE 071 - 266 0461 (24 HOURS)  

OVERSEAS PRICES AND DETAILS
All our kits can be supplied overseas excluding the European Community, free of UK tax (VAT). However, allow for your own local import taxes (customs duties) and for carriage charges, which must be added to our net price.
Surface mail is slow (1-4 weeks) but inexpensive; airmail is fast (up to 7 days) but more expensive. Couriers like Amtrak we recommend for speed and door-to-door service.
We package overseas orders strongly.

METHODS OF PAYMENT
International money order in Sterling, Visa, Mastercard/Access, Local Currency at agreed exchange rate by registered mail.
Payment in advance. Contact us for details.
CONTACT: RICHARD JOHNSON
London, England.
PHONE (9.30am-6pm) 071-289-3533
ANSWERPHONE (24hrs) 071-266-0461
FAX (24hrs) 071-289-5620

world audio design mail order

CHESTERFIELD SHOW

Saturday 23rd & Sunday 24th April 1994

Ringwood Hall, Brimington, Chesterfield, Derbyshire.

Your chance to hear the leading edge in Hi-Fi Technology and to meet the Designers

Over thirty of this country's leading exponents of the Art demonstrating their products plus trade and magazine stands.

Ringwood Hall, a superb setting, has once more been chosen for this year's much enlarged show and offers:

- Real Ale Bars
- Restaurants

"A great day out for all the family...."

- Bar lunches
- Free Car Parking

Ringwood Hall
Brimington
Chesterfield
Derbyshire

Further details: (0709) 875408 or (0246) 200096

On the A619 4 miles West from J30 M1 Motorway

On the A619
4 miles West from J30
M1 Motorway



PREMIER MARBLE LTD.

PRESENTS
A SOUND REVELATION

Uncover the true sound quality and potential of your system. Use the natural benefits of granite and marble, cut and polished by craftsmen. These natural materials offer better base definition, clarity and natural sound staging capabilities. CD/Turntable slates/platforms, custom made stands, shelves or anything you desire cut and polished to any shape or size required, all to enhance the beauty of your audio and visual environment. Trade enquiries welcomed.

For technical services ring John Walker
0603 38752 Fax 0603 721948.

3 Dewing Road (off Wendover Road),
Rackheath Ind Est, Rackheath, Norwich.
Telephone: (0603) 721995.

Soundcraft Hi-Fi

Your Place or Ours?



Hear the difference whilst relaxing in our Traditional Kent Style Listening Room.....

.....or let us deliver and set up your chosen system in the comfort of your own home.

For your convenience we offer an appointment service, where you can hear the best equipment available to-day. You are welcome to bring your own records or CDs, and by arrangement, any part of your existing system for comparison.



We guarantee that you will be thrilled with your music, not just for the first few months but over many years of listening.

Delivery and installation service



Soundcraft Hi-Fi, The New Musical Experience
40 High Street Ashford Kent TN24 8TE
TEL:0233 624441 Fax:0233 640333



Peter Herring

Here's a musical feast to savour: a few French delicacies, an English dish fit for royalty, some Baroque lollipops, and all topped off with a generous helping of Georg Philipp Telemann!



OLIVIER MESSIAEN
Visions de l'Amen*/Piece pour le Tombeau de Paul Dukas/Fantaisie Burlesque/Rondeau/Petites esquisses d'oiseaux
 Peter Hill, Benjamin Frith*, pianos
UNICORN-KANCHANA
DKP(CD)9144 DDD/79.04)

● With this release, Peter Hill completes his six-volume survey of the piano music of Olivier Messiaen and it is, by any measure, a hugely significant

contribution to the discography of twentieth century music. It is wryly amusing that the greatest commitment to the music of this French master has come from a British record label - Unicom Kanchana - both through the work of Peter Hill and through the superlative recordings of the organ music by Jennifer Bate. It is difficult to imagine the French company, Erato, embarking on a similarly-sized Benjamin Britten project for example.

Despite titles such as Visions de l'Amen, Messiaen was not a religious composer in the sense of say, Palestrina or Victoria. True, the majority of his compositions are inspired by - and, indeed, prefaced by - Catholic theology, but Messiaen was as much stimulated by terrestrial nature as he was by the spiritual divine. The two are reconciled because, for Messiaen, the natural world is God's creation.

Messiaen continued to compose large-scale, liturgically inspired works for organ right to the very end of his life; indeed, the epic Livre du Saint Sacrament is almost certainly the longest single work ever written for the instrument. His two great masterpieces for piano, however, both date from the 1940s. At the apex of his piano compositions stands the series of twenty sublime contemplations, Vingt Regards sur l'Enfant Jesus of 1945.

Two years earlier, much impressed by the talents of one of his pupils at the Paris Conservatoire, Yvonne Loriod, he wrote a seven-part work for two pianos whose first performance was given by teacher and pupil on May 10, 1943. In Visions de l'Amen, each piano is given a quite different personality. The first - played by Yvonne Loriod at the premiere - is full of passion and brilliance: it chimes, it sings, it dances it indulges in glittering cascades of decoration. The other piano is consistently more restrained and contemplative, content to present the themes and maintain the underlying harmonies. The result, as can be heard in Peter Hill's collaboration with Benjamin Frith, is both compelling and illuminating.

The colours of the instruments are used to powerful effect to underline the implications of each section, from the harsh, even brutal terseness of Amen de l'Agonie de Jesus to the ecstatic tenderness of Amen du desir and the glorious chorale, with its pealing harmonies, which brings the work to a conclusion with Amen de al

Consummation. But this is not 'programme music': the theology is merely the launching pad for Messiaen's imagination and virtuosity. Included alongside Visions de l'Amen, in what is a generously-filled

CD, are three early pieces, including Messiaen's tribute to his teacher, Paul Dukas, and one of his very last compositions, the Petites esquisses d'oiseaux. Exhausted by the effort of completing not only the Livre du Saint-Sacrament, but the even more vastly-conceived opera St Francis d'Assise, Messiaen declared himself finished with composition. But his wife, the aforementioned Yvonne Loriod, persuaded him to accept one further commission.

It began with a musical sketch of a robin and was subsequently extended to embrace some other feathered creatures. Modestly conceived and spare in its writing, it is nevertheless a most engaging piece. It was also Messiaen's last work for solo piano and, therefore, an ideal way to round off a superlative recording and a quite superlative-conceived series.

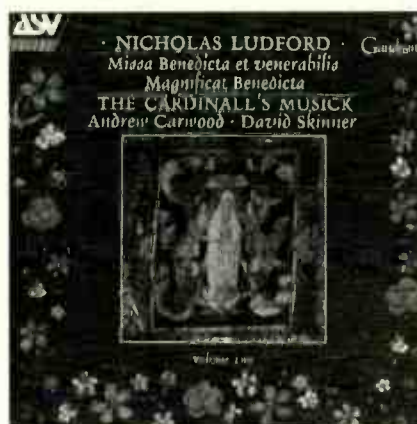

NICHOLAS LUDFORD
Missa Benedicta et venerabilis Magnificat Benedicta
 The Cardinal's Musick; director, Andrew Carwood
ASV GAUDEAMUS CDGAU132
(DDD/79.39)

● The term 'major discovery' is one to be used warily and sparingly, but - for once - it is not only appropriate, but indisputable. Nicholas Ludford is one of those shadowy figures of the Tudor period in England. He is thought to have been born around 1485 and he died in 1557. No tributes appear to have been paid to him, no biographies written, no monuments erected.

One of the reasons for this obscurity may lie in the fact that, unlike many of his more famous contemporaries, his place of employment no longer exists. Tallis's Waltham Abbey is still there, as is Byrd's

RECORD OF THE MONTH

The stature of Georg Philipp Telemann has suffered from the fact that - even by eighteenth century standards - he was a prolific composer, leading to him being seen as more a composer of quantity rather than quality. Stravinsky's mischievous comment on Vivaldi - "the same concerto written five hundred times" - has been echoed in some assessments of Telemann.

In some ways, Telemann's reputation today is inevitably compromised by his dates: he was born four years before J.S. Bach and lived for another seventeen years after his death. Comparisons have been made - mostly in Bach's favour - and it is only comparatively recently that Telemann has been allowed to emerge from the giant shadow cast by his contemporary. I now know of one leading music critic who considers Telemann at least the equal of Bach (he

also adjudges C.P.E. Bach to be a finer composer than his revered father).

Ironically, though now out-of-step with the received wisdom, such a view would have met with general approval in eighteenth century Germany; as a Kapellmeister in various cities, Telemann was ranked higher than his compatriot. He was born in Magdeburg in 1681 and held a large number of posts throughout northern Germany, including Frankfurt, Hamburg and Bach's home town of Eisenach.

Telemann was something of an eclectic: the influence of the Italian and French styles of the day is readily apparent, not least in his use of programmatic titles for many compositions. He also responded to the music originating from countries east of Germany, especially the folk music of Poland, and elements of this are

discernible in his work.

In all, Telemann composed forty settings of the Passion, a similar number of operas and no less than six hundred orchestral works. Some of his finest compositions are to be found in the *Tafelmusik*, a collection of overtures and concertos published in Hamburg in 1733, and in his version of *Water Music*. He is also thought to be the first composer to produce a complete cycle of cantatas for the church year, a feat later emulated by Bach. However, it is a measure of his pre-eminence that - unlike Bach's - Telemann's cantatas were published.

It is encouraging to see several ensembles now exploring Telemann's prodigious output and, like the period-instrument Drottningholm Baroque Ensemble from Sweden, coming up with some veritable jewels.

GEORG PHILIPP TELEMANN
Double Concertos: in F major for recorder and bassoon; in B flat Major for two tenor recorders; in A minor for recorder and gamba; in A minor for two tenor recorders; in E minor for recorder and flute

Clas Pehrsson, treble recorder; Michael McCraw, baroque bassoon; Dan Laurin, treble recorder; Olof Larsson, viola da gamba; Penelope Evison, baroque flute; The Drottningholm Baroque Ensemble; leader, Nils-Erik Sparf

BIS CD-617 (DDD/60.22)

● A recording which bursts from the speakers with all the freshness and vitality of a crisp spring day. The sound is translucent, lively, and naturally projected, pleasingly enhanced by the acoustic of the Petras Church in Stocksund, Sweden. The programme, a collation of tapes made between 1983 and 1993, offers a selection of Telemann's double concertos for what are unusually spicy combinations of instruments: the rich tones of the bassoon, for example, in sharp contrast with the piercing warble of the treble recorder.

Telemann was an accomplished performer on several instruments so it is unsurprising that he was one of the composers pre-eminent in evolving the Baroque solo concerto out of the

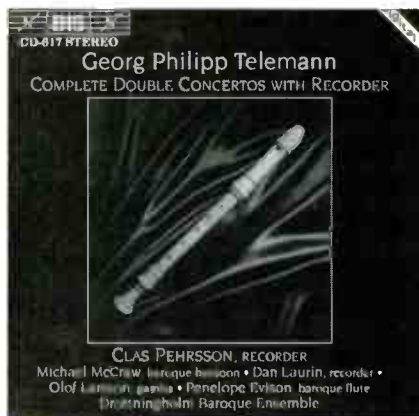

consort music of the Renaissance. The works here are fine examples of both his musicianship, and his invention. In the concerto for recorder and viola da gamba, for example, Telemann allows the gamba to join the orchestral strings in the tutti sections, so bringing a distinctly darker and richer character to the music. He then lightens the proceedings with an idyllic third movement pastorale.

The E minor concerto is remarkable for bringing together the old and the new: the former in the form of the treble recorder, the latter in the shape of the transverse flute which, ultimately, was to sweep the recorder into virtual obscurity. Both are given ample opportunity to demonstrate what they can do and the soloists here, Clas Pehrsson and the New Zealand-born Penelope Evison do not disappoint. Pehrsson appears in all the works here and, in the concertos for two recorders is joined by the equally proficient Dan Laurin. These works are very much in the vein of a concerto grosso, with - as well as their solo roles - the recorders used to add a piquancy to the orchestral tutti.

But it isn't simply the skilful playing of the often taxing virtuoso solo parts that makes this recording so enjoyable and invigorating, nor the buoyant playing of the Drottningholm strings led by Nils-Erik Sparf. It's more the feeling of spontaneous, spirited music-making with everyone relishing their role. Telemann's concertos may not be the most cerebral of music - they were, after all, written to entertain - but, my goodness, they're fun to listen to. And I would guess they must be even greater fun to play!

Continued From Page 85

Lincoln Cathedral and the Oxford colleges which employed the likes of Tavemer and Sheppard. Ludford's Royal Chapel of St Stephen's, Westminster, was destroyed in the fire which also engulfed the old Houses of Parliament in 1834. His music, though, survived and his Mass settings were copied into a huge

choirbook now in the care of the library of Cambridge University.

And there it might have remained, undiscovered, but for the efforts of David Skinner and Andrew Carwood, founders of The Cardinal's Musik (after Cardinal Thomas Wolsey). What a treasure-trove the researches, especially by David Skinner, have yielded. This is sacred

polyphony of the very highest quality, accomplished in its craftsmanship, inventive in its word-painting, exhilarating in its soaring eloquence. Nicholas Ludford's stature as a composer, until now largely unrecognised, is evident in virtually every bar of this magnificent and inspired music.

But, of course, that only becomes

evident through the performances which succeed in combining depth of expression with an immaculate line and, to my ears, great stylistic accuracy. I should also add that the sound, engineered by Martin Haskell, in All Saints, Petersham, Surrey, is near-ideal: airy, lucid and with an involving presence. And how pleasing to hear the high voices so clearly reproduced.

This is the second volume of Ludford's music to appear on ASV's Gaudeamus label and offers the Assumption-tide Mass setting *Benedicta et venerabilis* and a complementary setting of the Magnificat. The Mass is especially noteworthy for Ludford's imaginative use of two bass parts which gives the music a darkly potent gravity. We have no dates for either work, but the more mature part-writing of the Magnificat suggests it may be the later work. More on the background to Ludford's music can be gleaned from Messrs Carwood's and Skinner's scholarly booklet notes; indeed, the whole presentation of this sumptuous, spellbinding music is very fine. I earnestly recommend discovering so for yourself.

JOHANN SEBASTIAN BACH
Sinfonia to Cantata No42 Am
Abend aber desselbigen
Sabbats

ARCANGELO CORELLI
Concerto Grosso Op6 No8
('Christmas Concerto')

JOHANN PACHELBEL
Canon and Gigue

GEORGE FRIDERIC HANDEL
Concerto Grosso in B flat
Major Op3 No2

ANTONIO VIVALDI
Concerto in D minor Op3 Noll
TOMASO ALBINONI (attrib.)
Adagio for organ and strings

Musica da Camera; director, Robert King
LINN RECORDS CKD012 (DDD/53.40)

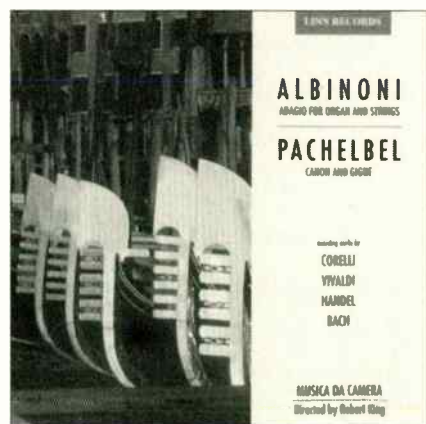

● Taking time out from his mighty Hyperion project to record all the church anthems of Henry Purcell, Robert King here directs an agreeable pot-pourri of Baroque favourites - and less familiar items - for the Linn label. Those old standbys, Pachelbel's Canon and Gigue and the lugubrious adagio wrongly but nevertheless

persistently attributed to Tomaso Albinoni, are spiced with more interesting fare in the shape of the splendid *sinfonia* from Bach's Easter-tide cantata *Am Abend aber desselbigen Sabbats*. I can but agree with the Bach scholar, W. Gillies Whittaker who is quoted in the booklet note thus: "Why this *sinfonia* has never been placed among the world's concert masterpieces is a mystery. It is a heavenly picture of evening!" And that was in 1959.

Arcangelo Corelli (1653-1713) was a key figure in the development of the *concerto grosso* and his opus six set is one of the landmarks of the musical Baroque. The eighth work in the set has long been popular as the 'Christmas Concerto' and, if you are seduced by its charms - and this sparkling performance could well have that effect - then you may well feel investing in the entire Op6; Trevor Pinnock and the English Concert on Archiv is the version to go for.

The two other concertos featured on this recording also come from major sets of such works. From Handel's Op3, a diverse collection of pieces published in 1734, Robert King has chosen the second concerto, one which gives Paul Goodwin plenty of scope to demonstrate his deft and fluent oboe playing. And from Vivaldi's Op3, the collection known as 'L'Estro Armonico' published in Amsterdam in 1711, we are offered a sprightly performance of the eleventh concerto.

After this bright and enterprising fare, the 'Albinoni Adagio' comes as something of a let-down: rather like being offered semolina pudding after salmon en croute. The work is allegedly a 'completion' by the twentieth century Italian scholar, Remo Gazotto, using a fragment of Albinoni's music which he was fortunate to discover. The problem is that no-one has ever been able to locate said fragment.

As ever, Robert King obtains a high standard of playing from his musicians and the recording, made in London's Henry Wood Hall, has been finely produced and engineered by Ben Turner and Philip Mobbs. If I have one cavil - and it may seem churlish when we used to tolerate fifteen minutes a side on LPs - it is that under fifty-four minutes is less than generous on a full-price CD these days.

CLAUDE DEBUSSY
String Quartet in G minor
Op 10

MAURICE RAVEL
String Quartet in F Major
HENRI DUTILLEUX
String Quartet 'Ainsi la nuit'

Juilliard String Quartet
SONY CLASSICAL SK52554
(DDD/74.26)

● Debussy and Ravel wrote but one string quartet each and, given their shared nationality and shared dates, if not shared styles, the two works have become an automatic pairing on LP and now CD. To their credit, the American Juilliard Quartet has augmented this

familiar coupling with another, more recent composition by a French composer, the string quartet entitled 'Ainsi la nuit' by Henri Dutilleux. At the outset, I can affirm that the inclusion of the Dutilleux, written in 1976 to a commission from the Koussevitzky Foundation, is not as a makeweight; it is the perfect contemporary complement to the Ravel and the Debussy and, in many respects, is their linear descendant.

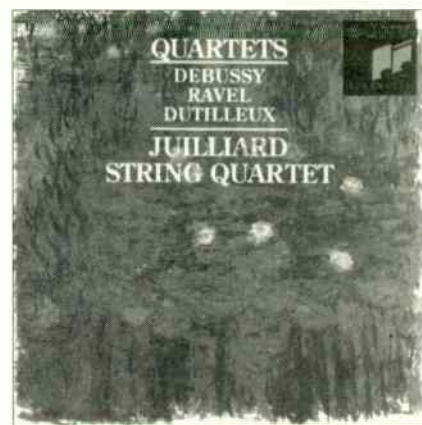

Henri Dutilleux was born at Angers in 1916 and was in charge of music at ORTF, the French national broadcasting network, from 1944 until 1963. He then became a teacher, most importantly at the Paris Conservatoire. His music fuses many diverse influences into an entirely idiosyncratic whole. It is sometimes readily approachable - his delightful Violin Concerto, for example - sometimes less so. But it is never less than fascinating in its structures, textures, colours and atmospheres.

'Ainsi la nuit' ('Thus the night') is made up of seven linked sections each, according to the composer, conveying a particular poetic or spiritual atmosphere. Each section has a title but, emphasises Dutilleux, none are to be interpreted literally. It is a beautifully-constructed work, its organic cohesion becoming more evident with every hearing. Dutilleux makes full use of the delicious sonorities available from the four string instruments and the effect is often mysterious, haunting and even disturbing. The Juilliard Quartet meets the challenges of the score with evident understanding as well as consummate technique.

As in the Dutilleux, atmosphere plays its part in the quartets of Debussy and Ravel, especially in the dreamy slow movement of the latter. The Juilliard Quartet is again responsive and eloquent and, throughout, benefits from a warm, tonally rich recording made with Sony's 20-bit high definition SBM system. I don't pretend to understand the technicalities, but I like the end result! The Juilliard Quartet now offers an excellent option in the 'basic library' quartets of Ravel and Debussy, with the Dutilleux as a valuable and significant bonus.

ARJAY

ST 1
Capacity 600 LPs
price £272.00

ST 15
Capacity
66 Videos
price £207.00



ST 8
Capacity 90 CDs &
120 LPs price £149.00

ST 11
Capacity 270 CDs
price £200.00

All prices are ex-works and inclusive of VAT

THE PROFESSIONAL SOUND & VISION STORAGE SYSTEM DIRECT FROM THE MANUFACTURER

Whether your collection is records, cassettes, CDs or videos, the **ARJAY** system is for you. In fact, at many music studios, stores and libraries throughout the country, **ARJAY** is considered essential equipment. Its classic and original design makes the best possible use of available space to provide the ideal storage and display conditions.

You have a choice of the "Record Collection" the "Compact Disc Collection" or the "Video Collection" which consists of units in varying sizes designed specifically for your personal collection. Additionally, the "Combination Collection" has three different sized units, designed for your mixed collection of records, tapes and CDs. Either way **ARJAY** has designed a unit for your own requirements. We can also make units to customer specifications.

You couldn't put your music collection in better hands.

CONTACT CAROLINE ON: **081-390 2101** or send the coupon below to:-
TEAMPOINT Ltd, 54 Lower Marsh Lane, Kingston, Surrey KT1 3BJ.

Please send me THE **ARJAY** Sound Storage System brochure.

Name

Address

Tel no.

THE MICHELL CONNECTION

"The ultimate connectors for all quality speaker cables"

AN ORIGINAL MICHELL PRODUCT

Made in England

WARNING: Beware of inferior copies!

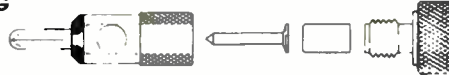

SURE-LOC: Rhodium or Gold Plated Expanding Plug

Details from:

J.A. Michell Engineering Ltd.

2 Theobald Street, Borehamwood, Hertfordshire, England. Telephone: 081-953 0771

SL SonicLink

20 Derwent Business Centre,
Clarke Street, Derby DE1 2BU
Telephone: 0332 674929
Fax : 0332 298836

Read below the verdict from a recent interconnects supertest in What Hi-Fi? Then visit your local Sonic Link dealer.

Sonic Link Violet £80

Violet cable works well in high quality systems- where information retrieval is a priority. Despite having warmer, fatter bass than Pink or Red, it remains exceptionally clear and detailed,

Verdict ★★★★★☆

especially in the mid range and treble. Music's upper registers are very delicately portrayed but instruments nonetheless have a reassuringly solid feel. Not suitable for ragged-sounding systems

Sonic Link Pink £25

Verdict ★★★★★☆

This ultra-slender cable looks unconventional and home-brewed, but it does offer a respectably detailed and cogent sound. Pink's tonal balance is rather light, due to its lean, dry bass, but it doesn't sound too forward in a well balanced system thanks to very refined treble and good overall clarity. In fact this cable's fast, rhythmically urgent sound is very appealing.

Sonic Link Red £45

Verdict ★★★★★☆

Just like Pink, Red is also skinny, but packs loads of musical information into its slim and modest diameter, recommended as a CD to preamp link, red is vividly detailed with a vibrant and lively tonal balance, which is aided and abetted by good dynamic contrast and slick timing. Provides bass with far more substance and weight than the less pricier Pink leads

Sonic Link Blue £120

Verdict ★★★★★☆

Blue uses Sonic Link's rhodium plated plugs, which are claimed- and certainly seem able to out perform the more common gold plated variety. Blue has a very clean and spacious sound that captures low level detail very well. Like the Violet cables though, it can be too revealing for a system.

Sonic Link Black £150

Verdict ★★★★★☆

A heavyweight, even by Sonic Link standards, this cable uses silver plated cable and rhodium plugs. Its sound is weighty too, but bass sounds over bloated, slowing lively music right down. We still prefer the cheaper Blue cable, which gives bass lines more intonation and flow, resulting in the music seeming faster and better articulated overall.

Hi-Fi World Dial-a-Dealer

AVON

AUDIO EXCELLENCE 'Where the music matters', 65 Park Street, Bristol BS1 5PB. Tel. 0272 264975 Fax 0272 251327. Great Hi-Fi carefully selected and demonstrated by friendly enthusiastic staff. Home installations and check-ups. Two year warranty from our own service department. Open 9.00-5.30 Tuesday - Saturday closed Monday.

PAUL GREEN HI-FI LTD. Kensington Showrooms, London Road, Bath. Tel. (0225) 316197. Musical Fidelity, Krell, Creek Rogers, Quad, Cust. car park. Best selection in the West.

V'AUDIO, 36 Druid Hill, Stoke Bishop, Bristol, B59 1EJ. Tel. 0272 686005. ATC, Acoustic Energy, Ruark, AVI, Exposure, Pink Triangle, Wadia, Audio Innovations, SME (incl. 20A), Chord Amps, Michell, AMC, Analogue Electronics, Cadence Valve, Jamo, LFD, REL, Sansui, Sonic Link, Stax, Townsend, Audio Technica, Goldring, Ltra, Ortofon, Sumiko. Demos by appt only. home trial facilities, free install. service facilities.

BEDFORDSHIRE

SOUND DEALS, 52 Shortmead Street, Biggleswade, Beds, SG18 0AP. Tel 0767 312249. FAX 0767 315714. Private listening rooms. Audio/Visual demonstration room. Free delivery and installation. Part exchange welcomed. Pre-owned equipment available. Top tape agents. All major credit cards accepted. Credit facilities (including interest free) STS. Agencies include: AR, Alphason, B&W, Castle, Celestion, Denon, Heybrook, KEF, Marantz, Manticore, Nakamichi, NVA, Pioneer, Ortofon, Rotel, Ruark, Sequence, TDL, Teac etc...

WENTWORTH AUDIO, 83 High Street North, Dunstable, Beds. NU6 1JJ. Tel: 0582 6633 83. Marantz, Pioneer, Rotel, Audiolab, Mission Cyrus, Moth, Sony, HK, NAD, Pink Triangle, Yamaha, Systemdek, Albury, etc. Free installation & delivery. Home dems. . Part exchange. Interest free credit - 6, 9, 12, 18 & 24 month terms. Free car parking at rear of shop. Free refreshments (alcoholic or otherwise!) Open 10-6pm Tues-Sat

BERKSHIRE

NEWBURY AUDIO, 2 Weavers Walk, Northbrook Street, Newbury, Berks, RG13 1AT. Tel. 0635 33929. Linn, Creek, Epos, Denon, Nakamichi, Shahinian, Marantz, Micromega, JPW, Ruark. Single speaker dem room. Appt. necessary. Home trial facilities, free install. service dept. late appts. Access/Visa, interest free credit subject to status. 6 days 9.30am - 6.00pm.

ARC AUDIO, 9 Dukes Ride, Crowthorne, Berks. RG1 16LZ. (0344) 762201. Denon, Harman Kardon, JPW, Marantz, Monitor Audio, Onyx, Rogers, Tannoy, Thorens, Yamaha. Demonstration facilities, no appointments necessary, home trial facilities, free installation. Access, Visa, Diners. Open Mon-Sat 9-6pm (closed Wed at 1pm)

READING HI-FI CENTRE, 4 Queen's Walk, Reading RG1 7QF. Tel. 0734 585463. "The best equipment, advice and service from Berkshire's premier HiFi emporium". Products include: Arcam, exposure, Audiolab, Meridian, Rotel, Sony, sennheiser, Top Tape Centre, and many more.

ASTLEY AUDIO, Wallingford, 0491 839305. See our entry under OXFORDSHIRE

BUCKS

D.L. CHITTENDEN LIMITED, 59-61 The Broadway, Chesham, Bucks, HP5 1BX. (Opposite Boots). Tel: 0494 784441. Philips, Denon, Kenwood, Canon Audio, Koss, Wharfedale, Mitsubishi, Target, Grundig, QED, Mordaunt-Short, Toshiba, Dolby Pro-logic Systems, Nicam TV and Video, Surround Sound, AV Systems. Showroom Demonstrations from expert and friendly staff. No appointments necessary. Service Department. Credit facilities available. Open 8.30 to 5.30 Mon-Sat.

DEJAC HI-FI Consultants, 21 The Broadway, Old Amersham, Bucks, HP7 0HL. Tel. (0494) 433173. AMC, Arcam, Bose, Meridian, Quad, Denon, NAD, Tannoy, Mission, TDL, 2 dem rooms, Appts necessary. Free installation, Tricity finance, instant credit, open 9.30-5.30 pm. including Saturdays.

CAMBRIDGE

CAMBRIDGE HI-FI, 1-3 Hawthorne Way, Chesterton, Cambs. CB4 1AT. Tel. 0223 67773. Kenwood, Pioneer, Ariston, Kef, Technics, Yamaha, Marantz, B&W, AR, Mordaunt-Short, Bose. Single speaker dem room. Tues-Sat 9.30-5.30pm. Closed Monday. Free install, service dept. Vis/Access credit facilities.

STEVE BOXSHALL AUDIO, 41 Victoria Road, Cambs. CB4 3BW. Tel. 0223 68305. 10.00-6.00pm 6 days. 3 dem

HI-FI WORLD MAY 1994

rooms. Denon, Rotel, Yamaha, Mission, Nakamichi, Tannoy, Audiolab, Marantz, Krell, Martin Logan, Magneplanar, Wadia. Home trial facilities. Appointments preferred. Free install. and service dept. Access/Visa.

CHESTER

SWIFT HI-FI, St. Annes Parade, Wilmstow. 0625 526213. Aura, B&W, Denon, Kenwood, Marantz, Nad, Pioneer, Rotel, Systemdek, Tannoy, Revolver, J.P.W., M. Short, Mission, Celestion, Technics, Audiolab, Castle. Open 9.30-6. Dem room. No pressure. BADA member.

THE HI-FI SHOWROOMS, 12A West Str, Congleton, Cheshire (0261)280017, 1 Stanley St, Leek(0533)383780, Celestion, Creek, Exposure, Marantz, Musical Fidelity, Pink Triangle, Project, Rotel, Ruark, Systemdek, Tannoy, Technics 5 Dem Rooms, Noappts nec, Home trial, Free install, Servicedept Access,Visa, Lombard Tricity. Open 9-5.30, Closed Wed.

HALE HI-FI, 2 Bold St, Hale Road, Altrincham, Cheshire WA14 2ER. Tel:061 929 0834. Open Mon - Sat 10am-6pm & later by appointment. Specialising in equipment by: Naim, Quad, Royd, Nad, Denon plus selected others. Large range of quality accessories. On site service department. Installation & delivery. Home demonstrations a pleasure

ASTON AUDIO, 4 West Street, Alderley Edge, Cheshire. Tel. 0625 582704. Products include: Celestion, Creek, Yamaha, Monitor Audio, B&W, Awa, Aura, AKG, Musical Fidelity, Tannoy, Sennheiser, Marantz, Dual, Denon, Quad, Sansui, Technics, Spendor, Mission, SME, Nakamichi, Audiolab, Rogers, Audioquest, Mordaunt-short, Meridian, Deltac, Roksan, Arcam, Kef, NAD, Cyrus and others. Discount CD and tape. Extended guarantee, interest free credit and written details on request.

CHRIS BROOKS AUDIO, 29 Gaskell Street, Stockton Heath, Warrington, Cheshire, WA4 2UN. Tel (0925) 261212. Tues-Sat 10.00-6.00. 2 dem-rooms. credit facilities. All credit cards. Established 1978. Total absence of bulls**t.

CONGLETON HI-FI, 1/1a Duke St, Congleton, Cheshire, CW12 1AP. (0260) 297544. Acoustic Energy, Arcam, B&W, Denon, Epos, Linn, NAD, Nakamichi, Onix, Royd, Target, etc. Superbly appointed single speaker demo facilities. No appointments necessary, home trial facilities, free installation. 2 year guarantee on all equipment. Access, Visa. Open Mon-Sat, closed Weds.

DECIBELS, 12 The Bull Ring, Northwich, Cheshire, CW9 5BU. Tel (0606) 350 343. Free Home Demonstrations. Free Delivery. Free installations. Single speaker listening room. High quality audio AND Home Cinema equipment. Second hand HiFi catalogue on show. Rotel, NAD, Yamaha, Celestion, JPW, Systemdek, Thorens, Sequence, Target, QED, Goldring plus a variety of cables and accessories. Open Mon-Sat 9-6.

DOUG BRADY HI-FI, Kingsway Studios, Kingsway North, Warrington, Cheshire, WA1 3NV. (0925) 828009 "Largest choice of specialist hi-fi in NW. All credit cards 3 dem rooms. Fair demonstrations and home trial facilities. Open 6 days.

CLEVELAND

GILSON AUDIO LTD, 172 Borough Rd., Middlesbrough. (0642) 248793. Linn, Exposure, Arcam, Mission, Cyrus, Denon, Marantz, Rotel, Pioneer, Audiolab, Tannoy. Demonstration facilities in main shop and one demonstration room. Appointments necessary. Home trial facilities. Free installation on request. Service department. Access, Visa, H.P. 10-5-6 days.

ACTION ACDUSTICS, 155-157 High Street, Redcar, Cleveland, TS10 3AN. 0642 480723. Audio Innovations, Denon, Harman Kardon, JBL, Michell, Musical Fidelity, Pink Triangle, Revox, Rogers, Thorens, etc. Dem room. Appointments nec. Home trial facilities, free installation, service dept. Access, Visa & HP. Open 9.15-5.30.

CORNWALL

RJF AUDIO VISUAL, 84 Pendarves Street, Tucking Mill, Camborne, Cornwall. TR14 8NU. 0209 710777/612260. TDL, Michell, Musical Fidelity, NAD, Nakamichi, B&W, SME, Micromega, Pink Triangle, Pro-ject, Perception, Harman Kardon, Triangle. Integral dem/showroom and special home dems. Appts nec. home trial, free install, service dept. All cards Switch and Transax. Open Mon-Sat 9.30-5.30.

CUMBRIA

MISONS SOUND & VISION, 11 Warwick Road, Carlisle CA1 1DH Tel (0228) 22620. Bang & Olufson, B & W, Castle, Sonic Link, Quad, NAD, Yamaha, Sony Demo Suite. No appts nec. Home trial facilities. Free installation. Service Department 9 - 5.30 Mon - Fri, Thurs 9-1, Sat 9-5.

DEVONSHIRE

THE HI-FI ATTIC, 58 New George St., Plymouth, Devon. PL1 1RR. 0752 669511. We stock most leading brands including Linn, Arcam, Denon, Pioneer, Musical Fidelity amongst others, and have an expert enthusiastic staff. Premises include attractive hi-fi and home cinema demonstration rooms. We offer free installation and credit facilities (written details on request) also a fully equipped service department. We can also provide a mail order service for all your LaserDisc requirements. We accept Visa, Access, Amex.

CHELSTON HI-FI, 38 Walnut Road, Chelston, Torquay, Devon TQ2 6HS Tel.(0803) 606863. Denon, Marantz, Rotel, Musical Fidelity, Acoustic Energy, NAD, Castle, Heybrook, Celestion, JPW etc. Two dem rooms. Home trial. Free installation. Access, Visa, Amex, Diners, HiFi Markets Chargecard. Credit facilities. 9.30-7.30 Mon-Fri, 9.30-6.00 Sat

DERBY

STRAD TRADITIONAL AUDIO, 29 Meadowfield, Whaleybridge, nr Buxton, Derbyshire, SK12 7AX. Tel. 0663 733383. We construct custom made reproductions of classic 1950's loudspeaker enclosure designs using authentic blueprints. These have never been bettered for value amplification. Requests for specific designs considered and researched. Superb new speaker units from Richard Allan and Lowther are used.

ACTIVE AUDIO, 12, Osmaston Street, The Spot, Derby. Tel: 0332 380385 Fax: 0332 385185. We have three studios including a dedicated Audio Visual studio for the demonstration of quality equipment from the largest range in the Midlands. Open six days per week. Own service department. Free local delivery, home trial facility. Current special offers and buyers fact pack and quotation on request

DORSET

DAWSONS, 23 Seamoor Road, Westbourne, Bournemouth, Dorset. 0202 764965. B&O, Castle, Canon, Jamo, JBL, Pioneer, Sony, Target, TDL, Technics. No appts necessary. Free installation. Service dept. Various credit facilities available. Open 9-5.30 6 days a week.

SUTTONS HI-FI, 18 Westover Road, Boumemouth, Hants. Tel. 0202555512. Linn, Arcam, Mission, Quad, Audiolab, Rotel, Yamaha, Denon, etc. 2 single speaker listening rooms. Home demonstrations and free installation. Mon-Sat 9.00-5.30. Call for details.

ESSEX

BRENTWOOD HI FIDELITY, 2 Ingrave Road, Brentwood, Essex CM15 BAT. Tel 0277 221210. Audio Innovations, Aura, AVI, Castle, Chord Electronics, Denon, DMN, EAR, Impulse, John Shearne, Kenwood, Marantz, Micromega, Mission, NAD, Nakamichi, Pink Triangle, Pioneer, Pro-ject Quad, Rotel, RuArk, SME, Systemdek, Tannoy, TDL, Townshend Audio, Yamaha plus many more. Single speaker dem rooms, home trials, dems and installations. Mon-Sat 9.30-5.30. Access, Visa, service facilities. Simply THE place to visit if you're serious about music.

PRO MUSICA, 6 Vineyard Street, Colchester, Essex. Naim, Roksan, Rega, Arcam, Audiolab, Creek, Systemdek, Rotel, Marantz, Denon, Shahinian, Micromega, Neat, Aura, Heybrook, EPOS, RUarc, Monitor Audio, Tripod, Sound Organisation, Lots of records, 2 dem rooms, No appts necessary. Service dept, Part exchange. Finance available. 10-6 Mon-Sat.

TWENTY 20 AUDIO VISUAL LTO. Unit 205 Lakeside Shopping Centre, West Thurrock, Grays, Essex OM16 . Tel. 0708 891818 Fax. 0708891300. For your total home entertainment requirements. From a 2" Casio to a 50" Pioneer screen. Dolby surround specialists with three dem rooms dedicated to pro-logic, laser disc software in stock, from Harman Kardon. Pro logic from Yamaha, Marantz, Pioneer, Technics, Kenwood and B&O.

RAYLEIGH HI-FI, Chelmsford, 216 Moulsham St. 0245 265245. RAYLEIGH HI-FI, Rayleigh, 44a High Street. 0268 779762. RAYLEIGH HI-FI, Southend, 132/4 London Rd. 0702 435255.

Over 21 years experience of supplying the best. "The best dealer, the best Hi-Fi equipment, the best service" Carefully selected Hi-Fi from: Arcam, Audiolab, Cyrus, Denon, Epos, Linn, Meridian, Mission, Naim, Nakamichi, Quad, Rega, Roksan, etc. etc. 3 years guarantee on Hi-Fi systems. 0% credit facilities.

AUDIO T, 442-444 Cranbrook Road, Gants Hill, Ilford, Essex, IG2 6LL. (081) 518 0915. Fax (081) 554 8463. Great Hi-Fi from Arcam, Audiolab, B&O, Bose, Cyrus, Denon, KEF, Marantz, Meridian, Mission, Micromega, Nakamichi, Rotel, Sony, Yamaha & many more. Mon-Sat 10-6. 3 year guarantee on Hi-Fi. Free delivery & installation. 30 day free upgrade scheme. Home demonstrations. Part exchange. 2 listening rooms. Home Cinema specialists. BADA Bonded.

GLOUCESTERSHIRE

AUDIO EXCELLENCE 'WHERE THE MUSIC MATTERS', 58 Bristol Road Gloucester, GL1 5SD. Tel. 0452 300046 Fax. 0452 310680. Great Hi-Fi carefully selected and demonstrated by friendly enthusiastic staff. Home installations and check-ups. Two year warranty from our own service department. Open 9.00-5.30 Tuesday - Saturday closed Monday.

AUDIO T, 40-42 Albion Street, Cheltenham, Gloucestershire, GL52 2RQ. (0242)583960. Fax (0242) 226435. Great Hi-Fi from Arcam, Audiolab, Denon, Epos, Linn, Marantz, Meridian, Mission, Quad, Rogers, Rotel, Yamaha, & many more. Mon-Fri 10-6 Sat 9.30-5.30. 3 year guarantee on Hi-Fi. Free delivery & installation. 30 day free upgrade scheme. Home demonstrations. Part exchange. Single speaker listening room. BADA Bonded.

HAMPSHIRE

AUDIO GALLERY, Near Petersfield, Hampshire. Mana, Castle, Alchemist, Albary, Audio Innovations, Wadia, Deltac, Tube Technology, Denon, Pioneer, Alphason, Tripod, Nad, Teac, Audio Alchemy, Klipsch, AMC, Proac, JPW, Moth, Pink Triangle. Mail order cabinets supplied to order in any size, wood & hand painted finishes, stone-granite-marble shelving. For a demonstration with home comforts call us for an appointment on: 0730 895194.

HOPKINS HI-FI, 'FOR THE BEST SEAT IN THE HOUSE' experience home cinema sound with Technics, Denon and Kenwood. Award winning products. Now on demo at HOPKINS HI-FI. 38-40 Fratton Road, Portsmouth, Hants, PO1 5BX. Tel. 0705 822 155. Fax. 0705 830 753

HAMPSHIRE AUDIO LTD., 2-12 Hursley Road, Chandlers Ford, Hants SO5 2FU. (0703) 252827/265232. 3 hi-fi and 2 home cinema/surround sound dem studio's. Thurs late evening, closed Mondays (except in December). Service dept on site (2 yr guarantee). Large free car park - junctions 4 (M27/M3), 5 (M27), 12 (M3) and 13 (M3) all within 3 miles. est. 1969.

AUDIO T, 4 Feathers Lane, Basingstoke, Hampshire, RG21 1AS. (0256) 24311. Fax (0256) 24430. Great Hi-Fi from Arcam, Audiolab, Denon, Linn, Meridian, Mission, Naim, Rotel, Sony, Yamaha & many more. Mon-Sat 9.30-5.30. 3 year guarantee on Hi-Fi. Free delivery & installation. 30 day free upgrade scheme. Home demonstrations. Part exchange. Single speaker listening room. BADA Bonded.

HEREFORDSHIRE

ENGLISH AUDIO, 95 Whitecross Road, Hereford, HR4 0DG. (0432) 355081. Musical Fidelity, Arcam, Castle, Ruark, Rogers, JPW, Micromega, Chord, Audion, Systemdek, Heybrook, Kef, Stax, Pink Triangle, Denon, Marantz, Mission-Cyrus, A.I., Rotel, NAD, Nakamichi, TDL and others. Single speaker dem room, home trial facilities, free installation, service dept, Access/Visa, Credit arranged. Open Mon-Sat, 10-6pm. BADA members.

GOSPEL MUSIC AUDIO, 32a High Street, Kington, Herefordshire, HR5 3BJ. (0544) 230254. Alphason, Allison, Revolver, Luxman, Yamaha, QED Audio, Systemline.

ACOUSTIC ARTS LTD, 101, St. Albans Rd., Watford, Herts. 0923 245250. Fax 0923 230798. Absolute Sounds, Adcom, Acoustic Energy, Audiolab, Chord, Denon, Marantz, Meridian, Orelle, S.M.E., T.D.L. 3 dem rooms, multi-room & home theatre. Expert installation. Credit facilities available, Tues-Sat 10-6.

STUDIO 82, 82 High Street, Harpenden, Herts AL5 2SP. 0582 764246. Fax 0582 467022. ATC/AVI, Arcam, Aura, Audiolab, B&O, Denon, Epos, Mission, Cyrus, Naim Audio, Nakamichi, Quad, NAD etc. Quiet single speaker dem room. Appts nec. Home trial, free installation. Service dept. Visa, Access and finance terms. 9-5.30 (Mon-Sat) Closed Weds.

THE AUDIO FILE, 27 Hockerill St., Bishop's Stortford, Herts, CM23 2DH. Tel 0279 506576. Fax 0279 506638. Linn, Naim, Roksan, Quad, Rega, Mission, Arcam, ProAc, Marantz, Sony etc. 4 dem rooms, installation service. Min 3 year warranty, 0%, BADA.

HERTFORD MUSIC. We want you to feel good when choosing your system in our 3 demonstration rooms (and bar!) . Systems from budget to £15,000. Products include : CR Developments, Micromega, REL Acoustics, Acoustic Energy, Michell, Magnum, Diamond Acoustics, Beard, Lumley, Renaissance, etc. AAccess, Visa. Mail Order. Please telephone: 0992 442425.

RADLETT AUDIO, 141 Watling Street, Radlett, Herts. WD7 7NQ. Tel. 0923 856497. Mark Levinson, Procead, Proac, Magneplan, Martin Logan, Tube Technology, Teac, Roksan, Audiolab, Stax, Systemdek, Jards, Copland, ATC Audio Alchemy, AVI, EAR, Smuok, Quad, Sonus Faber, Home trial facilities, free installation, Service Dept. Visa/Access 9-5.30 Mon-Fri 10-5.30 Sat.

REVOX Service & Repairs, Suite 10, Smuok Business Centre, Lye Lane, Bricketwood, Herts. AL2 3UG. Tel 0923 893711. Seventeen years experience, ex-Bauch.

Hi-Fi World Dial-a-Dealer

Authorised agents for Revox products, sales and spares. All repairs carried out are guaranteed. Fast turnaround. Any enquiries telephone: 0923 893711.

SOUND DEALS, 1 Drapers Way, Stevenage, Herts, SG1 3DT. Tel. 0438 369999.

Private listening rooms. Audio/Visual demonstration room. Free delivery and installation. Part exchange welcomed. Pre-owned equipment available. Top tape agents. All major credit cards accepted. Credit facilities (including interest free) STS.

Agencies include: AR, Alphason, B&W, Castle, Celestion, Denon, Heybrook, KEF, Marantz, Manticore, Nakamichi, NVA, Pioneer, Ortofon, Rotel, Ruark, Sequence, TDL, Teac etc...

KENT

ASHFORD, SOUNDCRAFT HI-FI, 40 High Street, Tel. 0233 624441. Seeking music lovers, male or female any age, to share common interest ie. Multi room, Home Cinema etc. Attractive unusual equipment in unusual setting, your place or ours, we guarantee lasting pleasure. Open Monday - Saturday. Appointment service or just pop in. 1994 approved dealers for Arcam Naim and Rega. Bada dealers.

ELECTRICAL DISCOUNT CENTRE, EDC, 138 Pelham Road, Gravesend, Kent DA11 0JH. Tel: 0474569601. Pioneer, Marantz, Technics, Akai, JVC, Jamo

ELECTRICAL DISCOUNT CENTRE, EDC, 109 The Broadway, Bexley Heath, Kent DA6 7JH. Tel. 081 298 7880. Pioneer, Marantz, Technics, Akai, JVC, Jamo

PROGRESSIVE AUDIO, 2 Maryland Court, Rainham, Nr Gillingham, Kent ME8 8QY. Tel. 0634 389004. Agencies include: Audio Innovations, Audion, Audiophile, Audiostatic, Audiotechnica, Chord amps, Cogan Hall, Conrad Johnson, Convergent, DALI, Decca, Eminent Technology, Goldring, Impulse, Koetsu, Levinson, L.F.D. Lyra, Lumley Reference, Meridian, Michell, Micromega, Moth, Origin Live, Pink Triangle, Proac, Proceed, Ruark, Silversounds, SME, Sugen, Sumiko, Systemdek, Snell, Target, T.D.L., Transfiguration, Townshend, Tube Technology, Voyd, V.P.I., etc. etc. Demonstrations by appointment please.

JOHN MARLEY HI-FI CENTRES, 2 Station Road, West Canterbury. (0227) 769329. Also at Dover - 0304 207562. Arcam, Aura, B&W, Heybrook, JPW, Proac, Pioneer, Rotel, Ruark, Tannoy, Technics. Dem rooms and home trial facilities. Mon-Sat, 9-5.30. Thurs. Free install. Credit to £1,000. Access, Visa and credit charge. Service Dept.

VOLUME ONE, 41 Upper Wickham Lane, Welling, Kent, DA16 3AD. 081 304 4622. Arcam, Dual, Epos, Exposure, JPW, Marantz, Micromega, Nakamichi, Pink Triangle, Rotel, Ruark, Royd, Sony, Systemdek, Alchemist, Celestion, B&W. Large dem room, no appts necessary. Evening dems in shop by appt. Home trial facilities, free delivery and installation. Access/Visa. 10.00-6.00pm Mon-Sat.

KIMBERLEY HI-FI, 193 Broadway, Bexleyheath, Kent. Tel. 081 3043272. Pioneer, Technics, Kenwood, Marantz, Denon, NAD, Aiwa, Tannoy, Mission, Rotel, Wharfedale, Castle. Separate dem room, no appt necessary. Free installation, service dept, instant credit facilities. no early closing.

V.J. HI-FI, 29 Guildhall Street, Folkestone, Tel. 0303 256860 Mon-Sat 9-6. NAD, Yamaha, Marantz, Sony, Tannoy, Denon, Kenwood, Rogers, Musical Fidelity, Quad, Dem and home trial fac. free install. Credit to £1,000, Amex, Diners, Visa, Access, Service Dept.

THE WESTGATE HI-FI, 2 Station Road West, Canterbury, Kent. 0227 769329. Suppliers of quality hi-fi equipment including: Arcam, Akai, Aura, B&W, Denon, Jamo, JPW, Mordaunt Short, NAD, Panasonic, ProAc, Quad, Rotel, Ruark TDL, Technics, Tannoy. Part exchange. Listening room. Service and repairs. Credit facilities. Access/Visa. Open 6 days 9-5.30.

DOVER HI-FI, 43 High Street, Dover. Tel: Dover 207562. Suppliers of quality hi-fi equipment including: Arcam, Akai, Aura, B&W, Denon, Jamo, JPW, Mordaunt Short, NAD, Panasonic, ProAc, Quad, Rotel, Ruark, TDL, Technics, Tannoy. Part exchange. Listening room. Service and repairs. Credit facilities. Access/Visa. Open 6 days 9-5.30.

LANCASHIRE

AUDIO CLASSICS, 8 Lowe Mill Lane, Hindley, Wigan, Lancs. WN2 3AF. Sorry but we are unable to answer queries in writing. I buy, sell, modify and repair all vintage and valve hi-fi equipment. Advice is free. New equipment by EAR, croft, Ortofon and more soon. Phone if just for a chat. Credit cards accepted. Quick worldwide delivery, callers by appointment. Tel. 0942

5725 or Fax. 0942 525861. 7 days a week.

ROMERS HI-FI CENTRE, 94-96 High Street, Rishton, Blackburn, Lancs. Tel. 0254 887799. Stockists of: Sony Esprit HiFi, Technics, Marantz, Musical Fidelity, Pioneer, Kenwood, Rotel, Tannoy, Mission, Ruark, B&W and many others. Dem room, service dept, free delivery and installation (local area) Access/Visa and Switch.

LEICESTER

LEICESTER HI-FI COMPANY, 6 Silver Walk, St Martin's Square, Leics. LE1 5EW. Tel. (0533) 539753. Fax (0533) 626097. Acoustic Energy, Arcam, Marantz, Micromega, Mission/Cyrus, Musical Fidelity, Nakamichi, Meridian, Rogers, Roksan and "oodles more" 2 dem rooms, home trial arranged, free install, service dept. Credit facilities. Access/Visa/Diners/Amex. 6 days. 9.30-5.30

THE LISTENING ROOMS, 6 Hotel Street, Leicester. Tel. 0533 623754. fax. 0533 623758. Linn, Audiolab, Arcam, Tannoy, Definition, Denon, Rotel, NAD, Heybrook, TDL etc. Open 10.00-5.30 (Six days.)

STEREO SHACK, 1-3 Guildhall Lane, Leicester, Tel. 0533 530330. Aiwa, A.R, Denon, Kenwood, Jamo, Mission, NAD, Philips, Pioneer, Home Cinema specialists. Free installation. Open 9.30-5.30 6 days. Credit available.

LINCOLNSHIRE

BOSTON HI-FI CENTRE, 65a Wide Bargate, John Adams Way, Boston, Lincs PE21 6SG. Tel: 0205 365477. Quad, Nakamichi, Arcam, Marantz, NAD, Castle, Tannoy, Rogers etc. Separate demonstration studio inc. home cinema. Free installation. Access, Visa, Tues-Sat. 9-5 pm.

COTTAGE AUDIO, 17 Bridge Street, Saxilby, Nr Lincoln. LN1 2PZ. Tel: (0522) 702834. Evenings: (0522) 696708. ATC, AVI, Chord amplifiers, Harbeth, LFD, Michell, Origin Live, QED, Royd, Sansui. Sequence, Something solid, Sonic Link, etc. Demonstration rooms. Home trial facilities. Free installations and above all a personal, friendly service.

LONDON

ANALOG AUDIO, 849 High Road, Finchly, N12. (081) 445 3267 For friendly service and advice. AR, AKG, Allison, AT, Cerwin, Vega, Denon, Dual, Harmon Kardon, Jamo, Infinity, Marantz, NAD, Pioneer, Rotel, Revolver, Sonab, Teac, Thorens, Tannoy, Wharfedale, Yamaha. Speaker cables and accessories. Free installation. Service

AUDIO CONCEPT, 27 Bond Street, Ealing, W5 5AS. Tel: (081) 567 8703. Acoustic Energy, Audiolab, Aura, B&O, B&W, Boston Acoustics, Canon, Castle, Denon, Dual, Evolution, Infinity, JPW, KEF, Marantz, Mission, Monitor Audio, Musical Fidelity, NAD, Nakamichi, Onix, Quad, Revox, Rogers, Rotel, Systemdek, Target, Teac, Thorens, Van den Hul. Two dem rooms. Interest free credit, free local delivery & installation, service department.

'Hi-Fi Specialists without the attitude'

BABBER ELECTRONICS, 158 UXbridge Road, West Ealing, London, W13 8SB. (081) 579 6315. Akai, Aiwa, A&R, Celestion, Dual, Pioneer, Harman Kardon, JBL, JVC, Kenwood, Marantz, Panasonic, Sennheiser, Sony ES range, Tannoy, Technics, Wharfedale, Yamaha.

THE CARTRIDGE MAN - Front end problems? It doesn't have to cost an arm and a leg to get the best listen to my Koetsu - and - Decca - Eater. Also agents for Croft, Sugden, Thorens, Pentachord Speakers and Notts Analogue. (Plus a cartridge re-tipping service. Tel. 081 688 6565.

DIVA AUDIO FIDELITY: For the finest in real HiFi, AV and Multiroom systems. Accuphase, Audio Innovations, Audio Note, Audiostatic, Aura, Chord, Conrad Johnson, Impulse, Klipschorn, Levinson, Lumley, Lyra, Michell, Micromega, Monitor Audio, Primare, Rel, Rotel, SME, Triangle, Trilogi, XLO. Call us or pop in for a musical experience you'll never forget. Open 10-6, Mon-Sat at Workshop 30, Royal Victoria Patriotic Building, Fitzhugh Grove, Wandsworth Common, London SW18. Tel/Fax: (081) 875 9593. Also see our full page advertisement on page 7 of this issue.

DDUG BRADY HI-FI, 18 Monmouth Road, London WC2H 9HB. Tel. (071) 379 4010 or (071) 479 1346. Fair demonstrations and home trial facilities. Wide range of top specialist hi-fi from Britain, America and Japan. Open 6 days.

GOLF ELECTRONICS, 311 Kentish Town Road, NW5 2TJ Tel 071 482 2518. Fax 071 284 3381. Authorised dealers for: Sony, Panasonic, Aiwa, Akai, Mitsubishi, Philips, Grundig, Bose. We carry an extensive range of

hardware from Walkmans to camcorders, including a wide range of TV and video equipment. Free local delivery & installation on selected items. Open 10-6 Mon-Sat. We regularly have special offers on different products. A visit to GOLF ELECTRONICS could save you ££££

HI-FI & COMPONENTS, 84 Battersea Rise, London, SW11 1EH. (071) 223 1110. Denon, Tannoy, NAD, Rotel, Bose, Dual, QED, Wharfedale, Jamo, Celestion, Kenwood, Ortofon, Infinity, Shure, to name but a few! Established over 29 yrs. Appts necessary. Service dept. 10-6 (closed Weds)

HI-FI EXPERIENCE, 227 Tottenham Court Road, London W11. 071 580 35535. Arcam, Audiolab, Mission, Cyrus, Quad, Celestion, Kef, Meridian, Rogers, Tannoy, Yamaha, TDL, Thorens, Marantz, Nakamichi, Musical Fidelity and many more. Open 10.00-7.00 Mon-Fri. 9-6 on Sat. Service dept, Credit facilities, delivery and free installation.

THE HI-FI SURPLUS STORE, 62 Weymouth Street, W1 Tel. 071 486 9981/071 935 7582. Stock a full range of goods including: Aiwa, Akai, B&W, Bose, Dual, JVC., Jamo, Kenwood, Marantz, Mordaunt-Short, Mission, NAD, Pioneer, Rotel, Sony, Technics, Teac, Thorens, Tannoy, Wharfedale. Full range of "Target" speaker stands always on stock. All goods are brand new in sealed cartons with full 1 yr guarantee. We guarantee you can not buy cheaper elsewhere. Give us your genuine quote and we will beat that price by £10 (goods must be in stock) Access/Visa welcome. Open Mon-Sat 9.30-6pm. Late night 'till 6.30 Thurs.

KAMLA ELECTRONICS, 251 Tottenham Court Road, London W1P 9AD. Telephone. 071 323 2747 Fax. 071 637 2690. Acoustic Research, Aiwa, Akai, Albany, Alchemist, Alphason, Audio Alchemy, Audio Innovations, Audio Technica, Audioquest, Aura, Audiostatic, B&W, Cerwin Vega, Conrad Johnson, Copenhagen, Furukawa, Goldring, Infinity, IXDS, JPW, JVC, KEF, Kenwood, Kuzma, Lynwood, Maxell, Micromega, Mitsubishi, Monster, Mordaunt Short, Moth, Nakamichi, Oracle, Ortofon, Panasonic, Pioneer, Project, QED, Rotel, Ruark, Sansui, Stax, TDK, and many more!!!!

K J WEST ONE, 26 New Cavendish St., London W1M 7LH. 071 486 8262/63. Fax 071 487 3452. Two hi-fi & dedicated home cinema dem studios. Appts pref. Home trial. Installation by arrangement. Service dept. Major credit cards. Interest free credit on selected items. Major brands stocked: Acoustic Energy, Arcam, Audio Innovations, Audio, Aura, Audiolab, Audio Research, B&W, Chord, DPA Epos, Impulse, Krell, Martin Logan, Meridian, Michell, Musical Fidelity, Nakamichi, Nitty Gritty, Dreile, Pink, ProAc, Quad, Roksan, Sonus Faber, Stax, Tannoy, Theta. Open 6 days.

BILLY VEE SOUND SYSTEMS, 248 Lee High Road, London SE13 (081) 318 5755. Arcam, Linn, Naim, Quad, Creek, Cyrus, Marantz, NAD, Rotel, Rega, Denon, Yamaha, Tannoy, Mission, Micromega, Heybrook, etc., 2 dem rooms, instant free credit. Access/Visa. Closed Thursdays

CONNECTIONS, 13 John Prince's Street, London W1M 9AH Tel. 081 348 5676 Dealers in: Absolute, Audio Note, Audioquest, Deltac, Harmonix, Kimber, Mandrake, MIT, Siltech, Symo, Van den Hul, WBT and others

THE LISTENING ROOMS, 161 Old Brompton Road, London SW5 0LJ. (071) 244 7750/59. Fax (071) 370 0192. Linn, Quad, Meridian, Nakamichi, Arcam, Audiolab, Acoustic Energy, SME, Audio Research, Krell, Wadia, Theta, Apogee, Martin Logan, Pioneer, Tannoy, Systemdek, Stax, Pink Triangle, Michell, Monitor Audio, Yamaha, Marantz, Kef, Bose, Celestion, Epos, Mission, Denon, Neat Petite Mon-Sat 10-6pm.

STUDIO 99, 79-81 Fairfax Road, Swiss Cottage, London, NW6 Tel 071 624 8855 or Fax. 071 624 5315. Linn, Naim, Meridian, Rega, Quad, Nakamichi, Mission/Cyrus, Kef, B&D, Yamaha, Creek, etc. 2 single speaker dem rooms. Appts necessary. Home trials, free installation, Visa/Access. 10-7pm Mon-Fri, 10-6pm Saturday.

THE CORNFLEAK SHOP, 37 Windmill Street, London W1 (071) 631 0472 (domestic). (071) 323 4554 (multiroom). Fax (071) 436 7165. Tues-Sat 10-7 Rega, Roksan, Naim, Monitor Audio, Arcam, Nakamichi, Rotel, Epos etc. 3 dem rooms (incl. home cinema) Friendly professional service. Home trial facilities, appts preferred. Full delivery and repair service. Multiroom specialists. Access & Visa.

MUSICAL IMAGES, 173 Station Road, Edgeware, Middlesex. Tel. (081) 952 5535. See advert under Middlesex for more information.

MUSICAL IMAGES, 459 High Street, Hounslow, Middlesex. Tel. (081) 569 5802. See advert under Middlesex for more information.

AUDIO T, 190 West End Lane, West Hampstead, London, NW3 1SQ. (071) 794 7848. Fax (071) 431 3570. Great Hi-Fi from Adcom, Arcam, Audiolab, B&W, Denon, Epos, Marantz, Meridian, Michell, Mission, Philips, Rotel, Proac, Micromega, Nakamichi, Yamaha, & many more. Mon-Sat 10-6. 3 yr guarantee on Hi-Fi. Free delivery & installation, 30 day free upgrade scheme. Home demonstrations. Part exchange. 2 listening rooms. BADA Bonded.

ALPHABEC, 392 Finchley Rd, London NW2 2HR. Tel: 071 431 9133. Denon, Yamaha, Jamo, Hecco, Alanson, JVC, Nakamichi, B&W, Quad, Soundstyle, Stand Design, Boston Acoustics, Thorens, JMC, Grundig, Musical Fidelity and many more. Home Cinema Products. Free installation & delivery. Open Mon-Sat 10-6pm. Thurs 10-1pm.

GREATER MANCHESTER

THE AUDIO COUNSEL, 12 Shaw Road, Oldham, Manchester, OL1 3LQ. Tel. 061 633 2602. Linn, Arcam, Naim, Yamaha, Creek, Nakamichi, Denon, JMC, Marantz, Royd, Lexicon. 3 dem rooms, free install, Visa/Access. Licensed credit brokers up to £1,000

TO FIND YOUR AREA
Use our
COLOUR REFERENCE



To Advertise in this section, please contact Caroline Knott on:

071 266 0969

Hi-Fi World Dial-a-Dealer

Instant credit. Full multi-room & A.V. installation. 10.00-5.30pm Mon, Tues, Wed, Sat, 10.00-7.00pm Thurs & Fri.

HALE HI-FI, Tel 061 929 0834. See our main entry under Cheshire.

BILL HUTCHINSON HI-FI, 50-52 Deansgate, Manchester M3 2FE. (061) 8321600. For the largest selection of Hi-Fi and audio visual equipment in the North West. Specialist A.V. demonstrations of the highest quality. Best prices guaranteed. Minimum 2 year warranty and an optional 5 yr guarantee available. Instant credit and mail order service on offer throughout the U.K. Pioneer, Denon, Kenwood, Yamaha, Technics, Marantz, Mission, Tannoy plus many more.

MERSEYSIDE

DOUG BRADY HI-FI, 401, Smithdown Road, Liverpool, L13 3JJ. (051) 733 6859. Fair demonstrations and home trial facilities. All credit cards. Largest choice of specialist hi-fi in N.W. Closed Wednesdays and lunch 1-2.15pm.

P & A AUDIO (BIRKDALE) LTD. 31 Liverpool Road, Birkdale, Southport (0704) 68373. Arcam, Cambridge, Creek, Denon, Michell, Mission/Cyrus, Mordaunt-Short, NAD, Pink Triangle, QED, Revolver, Rogers, Rotel, Royd, Tannoy. 3 Single speaker demo rooms and Nicam surround sound dem room. Free delivery, installation (Merseyside) Service dept. Mon-Sat 9-5.30 Half day Tues, Access, Visa, Lombard.

MIDDLESEX

HARROW AUDIO, 27, Springfield Rd., Harrow, Middlesex. Tel: 081 863 0938. Open Mon-Sat 9.30-5.30. Most brands available - see our regular advert for full range including Audioblab, Arcam, Audioquest, Apogee, Aura, B&W, Cyrus, Denon, Epos, Krell, Marantz, Mission, Nacamichi, Tannoy, Target, Yamaha etc. AV Specialist including installation, Interest Free Credit - ask for details. The largest range of accessories for miles around. 2 dem rooms. Plus Carriage Free Mail Order.

AUDIOCRAFT, 18 Hillingdon Road, Uxbridge, Middlesex. UB10 0AD. (0895) 253340. Unbelievable but true you can audition these brands here. Audion, Proac, Michell, Erelle, LFO, Lumley, Levinson, Lurne, Triangle, Sentec, Mag Audio, Teac, VHD, Silversounds, YBA, Stax, Theta, Monitor Audio, Fuller Audio, Trilog, Lyra, Sumiko, Ortofon, Decca, Target, Project, Moth, Kelvin, Townshend, Edison, Audio Alchemy, Kesiki, Musical Fidelity.

MUSICAL IMAGES, 45 High Street, Hounslow, Middlesex. Tel: (081) 569 5802. Fax: (081) 569 6353.

MUSICAL IMAGES, 173 Station Road, Edgware, Middlesex. Tel: (081) 952 5535. Fax: (081) 952 5535. Most brands available - see full page advert. Interest free credit, ask for details. Demo rooms. Repairs & Service. Sunday opening - Open all week. A Home Cinema Specialist. Mail order. Part exchange.

AUDIO T, 159a Chase Side, Enfield, Middlesex. EN2 0PW. (081) 367 3132. Fax: (081) 367 1638. Great Hi-Fi from Adcom, Arcam, Audioblab, Celestion, Denon, Marantz, Meridian, Micromega, Mission, Philips, Rotel, Yamaha, & many more. Mon-Fri 10-6. Sat 9.30-5.30. 3 year guarantee on Hi-Fi. Free delivery & installation. 30 day free upgrade scheme. Home demonstrations. Part exchange. 2 listening rooms. Home Cinema specialists. BADA Bonded.

NORFOLK

BASICALLY SOUND, The Old School, School Road, Bracon Ash, Norwich, Norfolk, NR14 8HG. Tel: (0508) 5 70829. Arcam, Heybrook, Chord Co. Rotel, Sound Style, TDL, Royd, Denon, Naim, Spondor, Sound Organisation, Audio Technica, Creek, Epos etc. 2 comprehensive dem rooms, home trial facilities, free installations, Visa/Access, HP facilities. Tues-Fri 9.30-1.00pm, 2.00-5.30pm. Saturday 9.30-5.30pm.

AUDIBLE DIFFERENCE, The Norfolk/Suffolk High End dealer, near Diss, Norfolk. Audio Research, Audion, Art Audio, ATC, Audio Innovation, Audio Note, AVI, Chord, Concordant, Copland, Croft, Dawn Audio, DPA, EAR, Impulse, Lyra cartridges, LFD Audio, Magnepan, Militek, Orelle, Pink Triangle, Roksan, Sugden, SME, Sonus Faber, Tube Technology. At this level of equipment we believe that the highest level of service should be offered. We will book only three demonstrations a day to ensure that you have ample time to evaluate the options YOU have chosen. Demonstrations in our listening room or your home. Equipment loan service available. Tuesday to Friday, 12 to 9pm, Saturday 9 to 5pm. Please ring for an appointment on 0379 740227

PROTECT-A-DISC, Unit 4, Elvin Way, Sweetbriar Industrial Estate, Norwich, NR3 2BB. Tel: 0603 482193. Producers and suppliers of finest quality card record and CD sleeves with taped edges, poly-lined or unlined, mailers and cruciforms etc. Please send SAE for full current price list. Trade enquiries welcomed. Tel: 0603 482193.

NOTTINGHAMSHIRE

LISTEN INN, 32 Gold Street, Northants NN1 1RS. Tel: 0604 37871. Fax 0604 601430. Naim, Linn, Rega, Audiolab, Arcam, Cyrus, Royd, Nakamichi, Mission, Denon, Rotel, Nad, Heybrook, Marantz, Chord Co. etc. etc., Open 10.00 - 5.30 (Closed Thurs)

DEFINITIVE AUDIO, Tel. (0602) 813562. For a carefully considered approach to building a true high fidelity audio system with components derived from the following manufacturers: Audio innovations!, Wadia, Micromega, Deltec, E.M.T., Horning, Voyd, Systemdek, SME, Revox, Impulse, Ortofon, Pioneer. Also the remarkable Living Voice Air Partner loud speaker system. Demos by appt. Please phone for further details, install. free of charge. Mon-Sat 10.00-7pm. Closed Wed a.m.

PETER ELLIS AUDIO, 29 Kirkgate, Newark, Notts NG24 1AD. Tel: 0603 704571. QUAD, Castle, Arcam, QED, Sugden, Tannoy, Threns, Marantz, Denon, Teac. Demo room, free install. Service dept. Access, Visa. Mon-Sat 9-5.30. Closed Thursdays.

CHANTRY AUDIO, 18-18a Eldon Street, Tuxford, Nr Newark, Notts, NG22 0LH. Tel: 0777 870372. Pink Triangle, DPA, Rotel/Michi, Micromega, NVA, Alchemist, Michell, Monitor Audio, Lumley, SME, Audion, and much more! Three dem rooms, home trial, free installation, service department. Access & Visa, credit facilities. Mail order, Mon-Sat 9.30-6.00, Sun and evenings home dem by appointment.

OXFORDSHIRE

AUDIO T, 19 Old High Street, Headington, Oxford, OX3 9HS (0865) 5961. Fax (0865) 60415. Great Hi-Fi from Arcam, Audioblab, Cyrus, Denon, Epos, KEF, Marantz, Meridian, Mission, Musical Fidelity, Rotel, Sony, Yamaha & many more. Mon-Fri 10-6. Sat 9.30-5.30. 3 year guarantee on Hi-Fi. Free delivery & installation. 30 day upgrade scheme. Home demonstrations. Part exchange. 2 listening rooms. Home Cinema specialists. BADA Bonded.

WESTWOOD & MASON, 46 George Street, Oxford. Tel: 0865 247783. Creek, Marantz, Naim, Arcam, Rotel, Rega, Epos, Tannoy, Mission, Nakamichi, Denon, Awa, Quad, Yamaha, Monitor Audio. Open 9.30-5.00pm. Dem room. Closed Thursdays.

ASTLEY AUDIO LTD, 3 Marketplace, Wallingford (3 miles from Berkshire border). 0491 839305. Aura, B&W, Technics, Panasonic, Pioneer, Kenwood, Sony, Yamaha, Denon, Dual, Marantz, Mission, Tannoy. 1 listening room. Home trial, free installation. Service department. Access, Visa, Amex, Diners. Instant credit. Tues-Fri 9-5.30, Sat 9-5. Records & CDs stocked.

SHROPSHIRE

AVON HI-FI, 12 Barker Street, Shrewsbury, Shropshire, SY1 1QJ. Tel: 0743 355166. Awa, Beyer-Dynamic, NAD, Quad, B&W, Mordaunt-Short, Kenwood, Bose, Nakamichi, Dniso, Teac, Sennheiser. Dem room. Home trial. Free install. Service dept. Access/Visa. £1,000 instant credit. Mon, Tues, Wed, Fri, Sat 9-5.30.

SHROPSHIRE HI-FI, St Michael Street, Shrewsbury, Shrops. SY1 2ES. Tel: 0743 232065. Stockists of Musical Fidelity, Mordaunt Short, Sony, Kenwood, Pioneer, Rotel, Denon, B&W, Proac. Audio Visual. Products available. Open 9.30 - 5.30pm Mon-Sat.

SOMERSET

MIKE MANNING AUDIO, 110 Middle Street, Yeovil, Somerset, BA20 1NE. Tel: 0935 79361. Fax: 0935 32923. Mobile 0850 325965. Naim, Roksan, Pink Triangle, A&R (Icom) ION, NAD, Pioneer, Rotel, Denon etc. Dedicated listening lounge, for relaxed and unpressured demos. Appts not necessary but best to telephone first. Home trial facilities on request, free installation and service dept. Instant credit, Access/Visa etc. 9-5.30, closed Mondays.

STAFFORDSHIRE

ACTIVE AUDIO, 95, Stafford Street, Hanley, Stoke-on-Trent, Staffs. Tel: 0782 214994. Fax: 0782 283346. We

have four studios including a dedicated Audio Visual studio for the demonstration of quality equipment from the largest range in the Midlands. Open six days per week. Own service department. Free local delivery, home trial facility. Current special offers and buyers fact pack and quotation service on request.

MUSICAL APPROACH, Unit 7, Woodings Yard, Bailey Street, Stafford, Tel: 0785 55154. Also branch at 37 High Street, Aldridge, nr Walsall. Tel: 0922 57926. Linn, Rega, Arcam, Rotel, Royd, Heybrook, Marantz, Teac, Celestion, Apollo, Target. Mon-Sat 9.30-5.30. Home cinema equipment stocked. 2 single speaker dem rooms. Service dept and free install. Credit facilities. We are now agents for Rega products. Stafford branch only.

ACTIVE AUDIO, 29, Market Street, Tamworth, Staffs. Tel: 0827 53355. Fax: 0827 59513. We have two studios including a dedicated Audio Visual studio for the demonstration of quality equipment from the largest range in the Midlands. Open six days per week. Own service department. Free local delivery, home trial facility. Current special offers and buyers fact pack and quotation service on request.

SUFFOLK

AUDIO IMAGES, 7 All Saints Road, Pakefield, South Lowestoft, Suffolk, NR33 6JL. Tel/fax: 0502 582853. Quad, Triangle, Arcam, Castle, Rotel, Moth, JPW, Finlux, Audio Innovations, plus the amazing ROTHWELL range. Separate dem room, no appts nec. 10-6-30 Tues-Thurs, 7pm Fri, 6pm Sat.

SIGNALS Martlesham Heath, Ipswich. Tel: (0473) 622866. Audio innovations, Fuller's Audio, Goldring, Heybrook, Impulse, JPW, Micromega, QED, Soniclink, Sumiko, Alphason, Apollo, Audioquest, Ixos, Project, Soundsbyte, Stirling, Townshend, Tricord, Sugden and more! Monday to Saturday 10 till 6

BURY AUDIO, 47 Churchgate Street, Bury St Edmunds, Suffolk. IP33 1RG. Tel: 0284 724337. Arcam, Audio Alchemy, Heybrook, Marantz, Michell, Meridian, Nakamichi, Pink Triangle, Quad, Rotel, Sonus Faber, Stax, Tube Technology. Single speaker dem room. Free install. Credit facilities. Mon-Sat 9.30-6.00, closed Wed. Evening dems by appointment.

EASTERN AUDIO, 41 Bramford Road, Ipswich, Tel: 0473 217 217. Fax: 0473. 215705. Quad, Arcam, Audioblab, Meridian, Mission, Denon, Rotel, Marantz, NAD, Sony, Rogers, Nakamichi, Systemdek, Technics, Celestion, B&W, Tannoy, Morel Thorens and Top Tape. Also stock a wide range of accessories. usual credit facilities. A BADA dealer.

SURREY

SPALDINGS HI-FI, 352-4 Lower Addiscombe Rd., Croydon, Surrey. 081 654 1231/2040. 3 dem rooms and home dem. Free installation/credit. Linn, Naim, Quad, Arcam, Audioblab, Cyrus, Marantz, Denon, Ruark. Mon-Sat 9-6, Tues 9-8, Closed Wed. Service dept.

PJ HI-FI, The HI-FI Shop, 3 Bridge Street, Guildford, Surrey GU1 4RY. Tel: (0483) 504801. 9-6 Mon-Sat. Linn, Meridian, Rega, Arcam, Quad, Revox, Musical Fidelity, Rotel, NAD, Nakamichi, Marantz, KEF, Reference etc.

ROGERS HI-FI, 13 Bridge Street, Guildford, Surrey, (0483) 61049. Awa, Creek, Denon, Dual, JPW, Marantz, Onix, Pioneer, Systemdek, Ruark, Tannoy. Teac. Dem facilities available, no appts necessary, free installation, service dept. Access/Visa. Instant credit upto £1,000 subject to status. Monday-Saturday, 9.30-6pm, later by appt.

SURBITON PARK RADIO, 48 Surbiton Road, Kingston-upon-Thames, Surrey. (081) 546 5549. QUAD, Castle, Denon, Dual, Kenwood, Mordaunt-Short, JBL, Rotel, Pioneer, QED. B&W and Tannoy. Demo facil. Access, Visa and Switch. 9.30-5pm.

SURREY HI-FI, 45 High Street, Godstone, Surrey, RH9 8LS. (0883) 744755. Specialist Hi-Fi outlet, demonstration room and parking available. Quad, Audioblab, TDL, Tube Technology, Rel Acoustics, Nakamichi, Kef, Thorens, Magnum, Rotel, Marantz, Denon, Michell, Furukawa, Van den Hul, Musical Fidelity, Tannoy, Target, JPW. Lumley Reference in stock. Single speaker dem rooms. Free installation service dept. Access/Visa/Mastercard. Open 9-6pm Closed all day Wednesday.

SUSSEX (EAST)

THE POWERPLANT 'Brighton's Leading Hi-Fi Shop'. 66 North Street, Brighton, Tel: 0273 775978. Comfortable listening rooms. Knowledgeable and approachable

staff. Roksan, Micromega, Exposure, Audioblab, Epos, Rotel, Marantz, Cyrus, Regal, Arcam, Mission and more.

WORTHING AUDIO, 20 Treville Gate, W Sussex. BN11 1VA. Tel: 0903 212133. "The friendly shop with the best sound systems in the South". Friendly advice, 3 yr guarantees, easy parking, open Mon-Sat 9-6pm. Late night Wed. Arcam, Exposure, Naim Audio, Marantz, Ruark, Restek, Clear Audio, Audio Technica, Target, Tripod, Sennheiser, AR and many more.

CHURCHERS HI-FI, 154 Montague St. Worthing, Sussex. BN11 3HH. Tel: 0903 821595. All major well know brands of Hi-Fi stocked. Please call for details.

SUSSEX (WEST)

AUDIO DESIGNS, 26 High Street, East Grinstead, West Sussex, RH19 3AS. Tel: 0342 314569. Friendly understanding Hi-Fi specialists. Audioblab, Arcam, Cyrus, Epos, Linn, Marantz, Mission, NAIM, NAO, Neat, Quad, Rotel, Sony, Stax, Tannoy, Target, Thorens, Yamaha. Dem rooms, free installation, service dept, credit facilities, mail order, credit cards, 9.30-6.00 6 days a week.

BOWERS & WILKINS Ltd. (est. 1945). 1 Becket Buildings, Little Hampton Road, Worthing, Tel: (0903) 2 64141. Top names in HiFi and audio visual including B&W, Nakamichi, Castle, Denon, Philips, Quad, Technics, Aura, Teac, Sugden, Mission Thorens and many more. 4 dem rooms (budget - high end) expert friendly advice, service dept, local installations free, one minute from A24 & A27, free local parking, Access/Visa, Instant Credit up to £1,000 subject to status. Open 6 days.

CHICHESTER HI-FI, 7 St Panchras, Chichester, W Sussex. PO19 1SJ. Tel: 0243 776402. Linn, Naim, Rega, Creek Nakamichi, A&R, Denon, Roksa, Epos, JPW, Ruark, Rotel, Quad, Spondor. Evening appts available.

JAYSOUND AUDIO, 5 Waterloo Square, Bognor Regis, Tel: 0243 826355. Awa, B&W, Beyer, Denon, Dual, Goodmans, Hecco, Jamo, JVC, Marantz, Mitsubishi, Pioneer, QED, Samsung, Sennheiser, Sharp, Shure, Teac, Wharfedale. Free local delivery and install. Part exchange welcome, licensed credit broker, Repairs on all makes of HiFi & TV/Video. Open 9am-6pm. Cl. Weds.

TAYSIDE

J.O. BROWN, 28-36 Castle Street, Dundee DD1 9NZ. Tel: (0382) 26591. Rotel, Denon, Pioneer, Technics, Awa, Mission, Castle, Mordaunt-Short, Monitor Audio, Bose, Infinity. All equipment ready for demonstration, No appt. nec. free installation service dept. Open 9.30-6pm six days a week, (close 5pm Sat).

TYNE & WEAR

BILL HUTCHINSON HI-FI, 87a, Castle Street, Newcastle-upon-Tyne. (091) 230 3600. For the largest selection of Hi-Fi and audio visual equipment in the North East. Specialist A.V. demonstrations of the highest quality. Best prices guaranteed. Minimum 2 year warranty and an optional 5 yr guarantee available. Instant credit and mail order service on offer throughout the U.K. Pioneer, Denon, Kenwood, Yamaha, Technics, Marantz, Mission, Tannoy plus many more.

WARWICKSHIRE

STRATFORD HI-FI, 25 Henley Street, Stratford-upon-Avon, CV3 9W. Tel: 0789 414533. Pioneer, Technics, Denon, Marantz, NAD, Rotel, Musical Fidelity, Monitor Audio, Mission, Tannoy, Quad, TDL, Sennheiser. 0% finance is available on selected products and all major credit cards accepted. Dem Rooms, Service facilities, open 9.30-5.30pm. Late night Thursday until 8.00pm.

WEST MIDLANDS

FRANK HARVEY HI-FI EXCELLENCE, 163, Spoon Street, Coventry, CV1 3BB. Tel: 0203 525200. The Midlands first choice for specialist Hi-Fi. Audioblab, Audio Alchemy, Arcam, Audio Quest, Alphason, Bose, Bang & Olufsen, Celestion, Cyrus, Denon, Dual, Foundation, Kef, Reference, Marantz, Monitor, Audio Mission, Musical Fidelity, Nakamichi, NAD, Rega, Rogers, Rotel, Quad, Systemdek, Target, Tripod, Tannoy, Thorens, Van den Hul, Yamaha. 3 floors, 3 demonstration rooms. Open 9.30 till 5.30. Closed Thursday. All credit cards incl. Amex & Diners. Instant credit and interest free facilities. Home trials. Free installation, home cinema A/V floor. We are a BADA dealer.

MIDLAND VALVE HI-FI, Specialising in true fidelity systems built around valve amplification - Audion 300B Silver Nights, Audio Innovations, Impulse, Audio Note, KAL, Townsend Audio, Ortofon, Voyd, Micromega,

Hi-Fi World Dial-a-Dealer

Edison, Stax, Apollo, Dynavector, Seismic Sink, Valves. Home demonstrations and part exchange. Also vintage: Leak, Quad, Croft, Radford, etc. Flexible opening 7 days. phone Gary 021 722 2317.

MUSIC MATTERS, 351 Hagley Road, Edgbaston, Birmingham, B17 8DL. Tel 021 429 2811. Roksan, Nakamichi, Arcam, Audiolab, Kenwood, DPA, Tannoy, Royd, Heybrook, Michell, Panasonic, Aura, Celestion, Musical Fidelity, Mission/Cyrus, Meridian, Kef, Monitor Audio, Pink Triangle, Ruark, Epos, Exposure, Pioneer and many, many more! 2 single speaker dem rooms. Appts necessary. Home trial facilities and free install. Service dept. Access/Visa/instant credit up to £1,000. Interest free credit available also. Tues - Thurs 10.30-6pm, Friday 10.30-8.00pm, Saturday 10.00-5.30pm. Check out the new branch in Solihull - Phil works there so it can't be bad! 021 742 0284.

COVENTRY HI-FI, 126, Church Lane (off Walsgrave Road), Coventry, CV2 4AJ. Tel: 0203 440529. Quad sales & service agent, Pioneer Reference Point, Kenwood, Aiwa, T.D.L. B&W, Tannoy etc. Private listening room. 2 year guarantee on all new hi-fi. Open 9.30-5.30 Mon-Sat. Closed Thursdays.

ELECTRO CENTRE, 244 Soho Road, Handsworth, Birmingham, Tel. 021 554 1878. Full range of HiFi, Pioneer, Technics, Kenwood, JVC, Sony, Aiwa, Akai, "Guaranteed the lowest price in the UK". 24 hour mail order facility available.

ELMOON AUDIO, Tel 021 784 8765. Reference Imports Lumley, Alon etc. Esoteric Audio Research 834 integrated on demonstration. Home demonstration can be arranged. Top part exchange prices, lots of used bargains. Quad, Leak, etc. Valves and valve testers, new GEC KT66s available.

FIVEWAYS HI-FIDELITY LTD. 12 Islington Row, Edgbaston, Birmingham, B15 1LD. 021 4550667. Advent, Albarry, AKG, Alphason, AMC, AR, Arcam, Audioquest, Auditechnica, Beyer, Bose, Castle, Chord, Denon, Dual, Gold Ring, Meridian, Michell, Monitor Audio, Nagaoka, Nakamichi, Ortofon, QED, Quad, Revox, Sennheiser, Spendor, Target, TDK, TDL, Thorens, Wharfedale, K Monks Record Cleaning Service. Closed Mondays.

MUSICAL APPROACH, 37 High Street, Aldridge, nr Walsall. Tel 0922 57926. Linn, Arcam, Rotel, Royd, Heybrook, Marantz, Teac, Celestion, Apollo, Target, and others. Mon-Sat 9.30 - 5.30. Closed Thursdays. Home Cinema equipment stocked. Dem rooms, service dept. Free installation and credit facilities. Free parking at rear of shop.

SOUND ACADEMY, Just off the high Street, Bloxwich, Walsall, W. Midlands. (Ample free parking). Tel. 0922 493499. Albarry, Art Audio, Acoustic Energy, Arcam, Audiolab, Audioquest, B&W, Bose, Chord, Cyrus, Cable Talk, DPA, Ensemble, Epos, JPW, Kef, Reference, Marantz, Meridian, Mission, Moth, Musical Fidelity, Nakamichi, Ortofon, Project, Quad, Roksan, Tube Technology, Triangle and many more. Open 6 days a week. Mon-Sat. All major credit cards taken. Part exchange, enquiries welcome.

AMAEUS SOUND & VISION, 10 Boldmere Road, Sutton Coldfield, West Midlands, Tel. 021 354 2311. Audio Innovations, B&O, Castle, QED, Wharfedale. Single speaker demo, appts preferred, service available, installations, B&O link install, home trials, Access/Visa. Interest free credit available subject to status. 9.30-6.00pm 6 days.

GRIFFIN AUDIO, 94 Bristol St., Birmingham, Tel. 021 622 2230/021 692 1359. Tues-Sat 10 a.m. - 6 p.m. Enjoy music at home with a system from Griffin Audio. We demonstrate and install the very best hi-fi, with systems from £500 to £25,000. Ask for Bob, Tim or Alex. Linn, Naim, Shalinian, Quad, Arcam, Rega, Denon, Marantz, Rotel.

WILTSHIRE

THE AUDIO EXCHANGE, 52 Morse Street, Swindon, Wiltshire SN1 5DP. (0793) 539008. Acoustic Energy, Audio Innovations, Beard, Cerwin Vega, C.R. Developments, Impulse, Magnum, Micromega, Michell, REL, Sequence. AV and single speaker demo room. Home trial facilities, free installation, service dept. Mon-Sat 10-6.

AUDIO T, 60 Fleet Street, Swindon, Wiltshire. SN1 1RA. (0793) 538222. Fax (0793) 487260. Great Hi-Fi from Arcam, Audiolab, Denon, Linn, Marantz, Meridian, Mission, Rotel, Sony, Yamaha & many more. Mon-Sat 9.30-5.30. 3 year guarantee on Hi-Fi. Free delivery & installation. 30 day free upgrade scheme. Home demonstrations. Part exchange. 2 listening rooms. Home Cinema specialists. BADA Bonded.

WORCESTERSHIRE

SPAINS HI-FI, 2 +2a New Rd., Bromsgrove, Worcs. Tel: 0527 872460. Aura, B&W, Beyer, Denon, Heco, JVC, Kenwood, Marantz, Mission, Monitor Audio, NAD, Nakamichi, Pioneer, Rotel, Sennheiser, Soundstyle, Sony, Systemdeck, Tannoy, Target, Thorens. Integral demo room/showroom for instant comparisons on Hi-Fi & AV equipment. Free installation. Part exchange welcome. Service department. Access. Visa, 0% finance on sighted products. Mon-Sat. 9.00-5.30 pm. Closed Thursdays.

WEST MIDLANDS

WEST MIDLANDS AUDIO, 158 Ombersley Road, Worcester WR3 7HA. Tel 0905 458046. Fax. 0905 457585. Naim, Rega, Rotel, Marantz, Nakamichi, NAD, Audiolab, Roksan, Meridian, B&W, Audio Research, Krell, Martin Logan, Arcam. 9-5.30 Mon-Sat, eve's by appt only. Free

YORKSHIRE (SOUTH)

HIFI STUDIO'S, Sunnyfields, Doncaster. Tel 0302 781387 TDL, Sugden, ProAc, Ruark, Teac, Impulse, Systemdek, Alphason, Target, Albarry, Heybrook, Monitor Audio, JPW, Totem, Harbeth, Keswick Audio Research, Michell Engineering, AMC (CD and Valves), CR Developments (Valves), Art Audio (Valves), Rel Acoustics, Projekt, Origin Live, Dual, Yamaha plus home Cinema pro-logic dems. Listening room demo's. Home trial, free install, licensed credit broker, 2 yr guarantee on all equipment, service available, Access/Visa. 10-8pm 6 days. phone for further information and free fact pack.

TRC HIFI, 3 Kings Cross Street, Halifax, HX1 (0422) 366832. Agents for Kenwood, Denon, Castle, Rotel. Demonstrations and advice a pleasure. Call at any time to audition some of the best HiFi and pro-logic systems. Delivering and installation free within 20 miles. "The family firm where the customer matters most"

YORKSHIRE (NORTH)

AUDIO CLINIC, 22 Lord Mayors Walk, Yorks, YO3 7HA. Tel. (0904) 646309. Revox - Qed - Audio Innovation - Allison - Celestion - Yamaha - Teac - Revolver - JPW - Kenwood - Bose - Thorens - Mission - Snell - B&W - Heco - Cannon - NAD - JVC - Musical Fidelity - Wharfedale - Micromega - Ruark - Heybrook. Surround sound and demo rooms, free installation. Service Dept. Credit facilities on request. Access, Visa, Open 10am - 5pm 6 days a week.

SCARBOROUGH HIFI, 14 Northway, Scarborough, North Yorkshire YO11 1JL. Tel. 0723 374547. Albarry, Aura, B&W Matrix, Cyrus, Pioneer, Philips, Marantz, Cabasse, Bose, Tannoy, DCC wide screen and lazer vision. Home trial facilities and free installation, service dept. Access/Visa, Credit charge, £1,000 instant credit/ Amex/Diners.

THE SOUND ORGANISATION (YORK) 2b Gillygate, York, YO3 Tel. (0904) 627108. Linn, Meridian, Micromega, Naim, Rega, Arcam, Creek, Nakamichi, Mission, Denon, Epos, Royd, Rotel. 3 single speaker dem rooms, appts preferred, home trial facilities, free install, service dept. Credit facilities on request. Access/Visa. 10.00am-5.30pm. Tues-Sat. Sony dealer award nominated '86, '87 and '88.

VICKERS HIFI, 24 Gillygate, York. (0904) 629659. Audiolab, Harmon Kardon, Marantz, Musical Fidelity, Pink Triangle, Quad, Systemdek, Tannoy, Technics and lots more. 3 dem studio's. (2 by appointment). Superb showrooms. 2 yr guarantee on all hi fi products. Appts. as above. Home trial facilities, free install, service dept. Qualified and experienced staff, over 25 yrs experience. 12 mths interest free credit. 10.30-5.30 Mon-Sat.

YORKSHIRE (WEST)

AUDIOVISION (YORKSHIRE) LTD. 5 Bethel Street, Brighouse, W.Yorks. HD6 1JR. Tel. (0484) 713996. 1 mile from junction 25, M 62. THE NORTH'S LARGEST RANGE OF TECHNICS HIFI SEPARATES. AND SYSTEMS. Yamaha Cinema DSP - Hi-Fi dealer for West Yorkshire, Panasonic, Nikam TV, VCRs and camcorders. Philips widescreen TV, CD-1 and laserdisc players. Sky satellite, Bose, Castle, Cerwin-Vega, Mordaunt-Short, TDL, Aiwa, & Pioneer. AV and LD player. Six home Cinema/ Dolby Pro-logic systems on continuous demonstration. Access/Visa and Credit charge.

BILL HUTCHINSON HIFI, 26-28 Woodhouse Lane, Leeds (0532) 427777. For the largest selection of HiFi and audio visual equipment in the Yorkshire. Specialist A.V. demonstrations of the highest quality. Best prices

guaranteed. Minimum 2 year warranty and an optional 5 yr guarantee available. Instant credit and mail order service on offer throughout the U.K. Pioneer, Denon, Kenwood, Yamaha, Technics, Marantz, Mission, Tannoy plus many more.

DOUG BRADY HIFI, The Forge Cottage, 19 Cross Gate, Otley, West Yorks. LS21 1AA. Tel. (0943) 467689. Naim, Arcam, Rotel, Pink Triangle, Meridian, Epos, Castle. Two dem rooms, fair demonstrations and home trial facilities. Access/Visa. Open 10.00-6pm Tues-Sat.

SCOTLAND

EDINBURGH

BILL HUTCHINSON HIFI, 43 South Clark Street, Edinburgh, (031) 667 2877. For the largest selection of HiFi and audio visual equipment in Lothian Specialist A.V. demonstrations of the highest quality. Best prices guaranteed. Minimum 2 year warranty and an optional 5 yr guarantee available. Instant credit and mail order service on offer throughout the U.K. Pioneer, Denon, Kenwood, Yamaha, Technics, Marantz, Mission, Tannoy plus many more.

ABERDEEN

HOLBURN HI-FI, 441 Holburn Street, Aberdeen. Tel: 0224 585713. Arcam, Audiolab, B&W, Celestion, Denon, Dual, Epos, Heybrook, ION, Kenwood, Creek, Marantz, Meridian, Mission, Cyrus, M.S., NAD, Nakamichi, Pioneer, QED, Quad, Revox, Rotel, Ruark, Tannoy, Technics, Wharfedale, Yamaha. 9.30-5.30 Mon-Sat.

HI-FI EXCELLENCE, Hi-Fi innovators & product designers with 15 years experience. Very much in the business for the music. Musical Fidelity key dealer. Largest Rotel retailer in the area. Particularly keen to make the buying of Hi-Fi a fun experience. Situated in the West End away from the bustle of the City centre - the perfect environment to enjoy quality Hi-Fi. Full time service engineer. Open Mon-Tues 10-6, Wed 10-1, Thurs 10-7, Sat 10-5 or later by appointment. Hi-Fi Excellence, 293 Union Grove, Aberdeen. Tel: 0224 322520

AYRSHIRE

LASER AUDIO, Now at new premises : 1 St Marnock Place, Kilmarnock KA1 1DT. Tel. 0563 40292. Audiolab, Aiwa, Celestion, Cyrus, Denon, Dual, Marantz, Mission, Philips, Pioneer, Systemdek and Tannoy. 2 demonstration rooms, AV dem room. Appointments preferred, home trial facilities. Free installation, service facilities. Access, Visa and written credit. Open Tues-Fri 10-5.30 Sat 9.30-5.30.

GLASGOW

STEREO STEREO, 278 St Vincent Street, Glasgow, Scotland. Tel 041 248 4079. Closed Tuesday. Installations throughout Scotland. Credit facilities available.

BILL HUTCHINSON HIFI, 43 Hope Street, Glasgow, (041) 248 2857. For the largest selection of HiFi and audio visual equipment in South West. Scotland Specialist A.V. demonstrations of the highest quality. Best prices guaranteed. Minimum 2 year warranty and an optional 5 year guarantee available. Instant credit and mail order service on offer throughout the U.K. Pioneer, Denon, Kenwood, Yamaha, Technics, Marantz, Mission, Tannoy plus many more.

INVERNESS

THE MUSIC STATION, 49 Church Street, Inverness, IV 1DR. Tel: 0463 225523. Beyer Dynamic, Celestion, Denon, Jamo, Kef, Kenwood, Misson, Pioneer, Rotel, Sony. Listening room, service department, free local delivery, part exchange, full range of credit facilities.

IRELAND

DUBLIN

ACOUSTIC DIMENSION, 67 Mountjoy Street, Dublin 7. Tel: 305633, Fax: 305839 (from UK + 0103531). Stockists for speakers: ATC, Acoustic Energy, JPW, Triangle, ProAc, Ref 3A, RuArk, Heybrook, Polk Audio, TDL, Impulse, Chario, Audio Static. Amps by: Albarry, AVI, LFD, NVA, Alchemist, Marantz, Audio Innovations, Rotel, CR Developments, EAR, Kinshaw. CD Players and DACs by: AVI, Pierre Lume, Micromega, Kinshaw. Turntables by: Project, Tables/Stands: Apollo, Cables: Straightwire, Ixos, VLS, Eagle. Credit cards and mail

order.

CLONEY AUDIO, 55 Main Street, Blackrock, Co Dublin, Tel. 2889449/2888477 Fax 2834887. Products include: Arcam, Classe, Philips, Rogers, Epos, B&W, Naim Audio, Meridian and others. Open Tues/Sat 10am-6pm. Thurs/Fri 'till 9pm Closed Mondays.

PETER O'ANO & CO LTD. 111 Clonskeagh Road, Dublin 6. Tel. 0103531 2694433. Products include: B&O, Quad, KEF, Thorens, TEAC & many more! 2 demonstration rooms and 2 year guarantee.

BELFAST

LYRIC HIFI, 163 Stanmills Road, Belfast (0232) 381296. Linn, Naim, Rega, Arcam, Denon, Rotel and more. Mon-Sat, 10.00-6.00pm. Late night Thurs. ZEUS AUDIO, 6 Hope Street, Belfast. (0232) 332522. Audio Innovations, Pink Triangle, Roksan, Marantz, Celestion, Meridian and more. Mon-Sat 10.00-5.30pm. Late night Thursday.

COUNTY DOWN

ASTON AUDIO, Unit 8, Kings Road Shopping Centre, Kings Road, Belfast. (0232) 402220. Akai, Technics, JVC, Samsung, Toshiba, Panasonic and many more. Demos. Open Mon-Frid 10-8pm Sat 10-5pm.

LONDONDERRY

ZEUS AUDIO, 23a Kingsgate Street, Coltraine, BT52 4LB. Tel. (0265) 56634. Marantz, Mission, Cyrus, Aiwa, Akai, Alphason, Sony, Pink Triangle, Celestion, Rotel. Mon-Sat 10-5.30pm. Closed Thurs.

WALES

DEWNYWALE

ACTON GATE AUDIO, 4 Ruabon Road, Wrexham, North Wales, Tel. 0978 364 500. Arcam, B&W, Marantz, Mission, NAD, Quad, Rega, Rotel, Tannoy, Yamaha, etc. Dem facilities, A.V. on dem. Mail order. No appts nec. home trial fac. Free install, Service Dept. Access, Visa. 9.30-5.30 closed Wed pm

ELECTRO TRADER, 19 Colwyn Crescent, Rhos on Sea, Colwyn Bay, Clwyd, Wales, LL28 4RN. (0492) 548932. NOW APPOINTED SUGDEN DEALER FOR THE NORTH WEST. Rotel, Yamaha, NAD, Harman, Kardon, Teac, Alphason, Heco, Infinity, Kef, JBL, Sugden, Tannoy, Rotel, Michi, Heybrook, Acoustic Research, RLRC and Soundstyle tri-rod packs etc. Dem room appts preferred. Home trial facilities. Free install. Access, Visa. Open 9.30 - 1.00, 2.00 - 5.30 Mon-Sat.

GLAMORGAN (SOUTH)

AUDIO EXCELLENCE 'WHERE THE MUSIC MATTERS', 134-6 Crnys Road Cardiff CF2 4NR, Tel. 0222 228565 Fax 0222398201. Great Hi Fi carefully selected and demonstrated by friendly enthusiastic staff. Home installations and check-ups. Two year warranty from our own service department. Open 9.00-5.30 Tuesday - Saturday closed Monday.

GLAMORGAN (WEST)

AUDIO EXCELLENCE 'WHERE THE MUSIC MATTERS', 9 High Street, Swansea, SA1 1LE. Tel. 0792 474608 Fax 0792 645087. Great Hi Fi carefully selected and demonstrated by friendly enthusiastic staff. Home installations and check-ups. Two year warranty from our own service department. Open 9.00-5.30 Tuesday - Saturday closed Monday.

GWYNEDD

I&H GRIFFITHS & SONS, 313 High Street, Bangor LL57 1YA. 0248 370655. Yamaha, Tannoy, Teac, Sony, B&W, Wharfedale, Rotel, JVC. Home trial facilities, free installation, service dept. After hours dems by appointment. Access, Visa, Lombard credit charge. Mon-Sat 9-5.30, Wed 9-1. Audio Visual Specialists.

TOP TAPE, 1 Crystal Way, Elmgrove Road, Harrow, Middlesex, HA1 2RJ. Tel: 081 427 1404. The UK's oldest and largest Tape Mail Order Service. TDK, Maxell, Sony, Ampex audio cassettes plus Fuji, JVC, Konica, Memorex, Scotch & TDK video tapes. Send for complete list of latest prices and offers including Video 8, VHS-C, S-VHS, DAT, MiniDisc, Open Reel and tape accessories including Allisop. Local Dealer Listing available. Telephone orders on 081 427 1404 Mastercard, Visa & Switch accepted.

Jazz

Simon Hopkins



PRAXIS
Sacrifist
SUBHARMONIC SD7002-2

● So it's album No. 2 for Praxis, an ad hoc New York group assembled by bassist and producer Bill Laswell. Last year's debut was genuinely one of the records of the year - I said so then and still think so - but *Sacrifist* leaves it standing.

The core line-up remains the same: San Franc-iscan avant metal guitar wunderkind and theme park conceiver Buckethead; funkateer bassman Bootsy Collins; and the latter's longtime P-Funk colleague, keyboardist and organ maestro Bernie Worrell. But this time out they're joined by some extraordinary talent: alto saxist John Zorn - no introductions necessary here, surely; former Napalm Death drummer (not to mention Zorn and Laswell's chum in the awesome power trio Painkiller) Mick Harris; Yamatsuka Eye, vocalist with Japanese dadaist pop-thrashers Boredomes and with Zorn's own Naked City group; and

Andy Hawkins, Gabe Katz and Ted Epstein AKA funk-dub-thrash trio Blind Idiot God.

I have to confess that when I first clapped my eyes on this expanded line-up, my heart sank a tad. What originally appealed about Praxis was their compactness, cohesion and discipline. Like Naked City, they were a small bunch of guys summoning up a city's worth of sound. Any such reservations were blown away - along with my head - by the pulverizing onslaught of the opening track, *Stronghold*.

The group slam from speed metal to dub reggae to screaming noise-for-noise's-sake to superfly funk; from gibbering tortured vocals to virtuoso psychedelic bass solo to jaw-drop HM guitar freak-out (someday, I swear, Mr Buckethead will be a hero to a generation of pale, skinny adolescent boys who all wear waste paper buckets on the bonce and play billion mph guitar). Yet despite this willful cut-and-paste - better make that slash-and-bolt - genre-pillage and despite an expanded line-up - expanded to over twice its original size, that is - Praxis still have a discipline, a leanness that's quite lethal. This music is the essence of "future shock". One day all pop records will sound like this; what will Praxis do then?

KAZUYUKI K NULL/JAMES PLOTKIN
Aurora
SENTRAX STC43 CD

● The world's economic base has moved firmly to the Pacific Rim, we're told by our elders and betters. Yeah, well, maybe, whatever that really means... I do know that a good third of the finest records I get to hear these days - and that's "finest" as in "most inventive, shocking, enjoyable and astonishing" - have some kind of Japanese connection; either made by a Japanese group or

appearing on a Japanese label of featuring the startling contribution of some Japanese musician.

The pummelling grind of Zeni Geva, the absurdist dada-thrash of Boredomes, the mesmerising punk-pop of Shonen Knife - surely the most engaging pop group to emerge - anywhere - since The Sugarcubes, the genuinely scary, desolate landscapes of Haino Keiji's *Fushitsusha*, the all-consuming gumbo served up by producer-composer Seigen Ono... this is some of the most exciting music being made anywhere in the world. This is the voracious, can't-beat-em-then-absorb-them, consumerism-as-existentialism culture that gave us manga comics and anima films and the best monster flicks ever. The next few records reviewed here (and to some extent, with Y Eye's contributions so vital, the Praxis album should be included too) cover a huge range of styles and sounds and are no more truly jazz than they are metal or pop or ambient, but they've all critically absorbed the central spontaneity-aesthetic at all jazz's heart, and that, for my money, gives them greater claim to the mantles of Miles and Coltrane and Free Jazz and the best Jazz-Rock and The New Thing than all the world's respectful, but tired, dead-at-twenty, jazz-as-ad-soundtrack practitioners.



First up, KK Null and Jim Plotkin's beautiful *Aurora*. Null leads the group Zeni Geva, a monstrous vehicle for his noisier leanings, reviewed elsewhere this month. He's also the creator of some pretty ravishing improvised ambient music. I talked last month about Zorn's foray into ambient, the quite frightening *Absinthe*, and about the slow but surely unstoppable growth of a sort of anti-rave ambient, an ambient music which, if it could be equated with a trip at all, would certainly be with a bad one. Check out the music of Thomas Koner, Lull, Final, Techno Animal and PGR for further evidence - if you truly need it - that the early, beautiful experiments of such genuine mavericks as La Monte Young, Terry Riley, John Cage and Morton Feldman could be taken in a more involving and meaningful - if terrifying - direction than the tedious sub-Floyd doodles of the Orb and co.

Null turned in a fine example of this

close your eyes and see



the Arcam Delta system

Close your eyes and see Arcam's Delta system of state-of-the-art hi-fi components.

Ignore the fact that the Delta 290 is our finest integrated amplifier, the recipient of a coveted Design and Engineering Award from the world's pre-eminent consumer electronics show, the Chicago CES. Don't be swayed just because the UK hi-fi press agree, giving it "a compelling and enthusiastic Recommendation"¹ and describing it as "an amplifier with real clout, able to deal with virtually any level of musical complexity".²

Next cast a jaundiced eye on the Delta 280 tuner. Again, disregard the pleasing aesthetics and the convenience of remote control*. Don't even be led by reviews revering its sound as "lucid", "warm" and "attractively open".³

Then, visit your scepticism on the Delta 270 CD player. "Solidly built", it "strikes a balance between smoothness and punch" to gain a class leading, 5 star recommendation.⁴

If that's not enough, take a sideways look at our remarkable two-box CD player, the Delta 250 CD transport and Black Box 50 DAC. "To justify their significant cost, two-box systems really have to offer that little bit extra in terms of sound quality; but Arcam's combination does just that - and more".⁵

Next, move on to the Delta 100 cassette deck. Try to dismiss once again its 1992 Chicago CES award and the reviewer who gushed, "In the beginning, I called for a round of applause for Arcam's bravery in producing a British-made cassette deck. At the end, I'm asking for a standing ovation".⁶

Finally, muster up your best disinterest for the "extraordinarily well engineered"⁷ Delta 2 loudspeakers, "a firm, positive sounding design with bold bass and mid and a firm grip on the musical architecture".⁸

In fact, ignore everything anyone else tells you. Ignore even what your eyes tell you is true. Just let your ears decide.

Just listen. Close your eyes, open your mind, and see the light.

1. Hi-Fi Choice, March 1993. 2. Audiophile, February 1993. 3. Audiophile, April 1993. 4. What Hi-Fi? Awards issue 1993. 5. What Hi-Fi?, November 1993. 6. Hi-Fi World, April 1992. 7. What Hi-Fi? Awards, 1991. 8. Hi-Fi News Buyers Guide, November 1993.
* CR200 System Remote Control handset to operate all the electronics listed here is an optional extra.

ARCAM

For your free copy of our brand-new 'Soundscapes' brochure with full details of the Arcam Delta range and the name of your nearest dealer, complete and return this coupon to us. In addition, if you would like independent reviews of any of our hi-fi equipment, please state which products and we'll be happy to send you the relevant material.
Arcam, Pembroke Avenue, Waterbeach, Cambridge CB5 9PB. Or telephone: (0223) 440964 (24 hours) HFW 1-94

I am interested in reviews on (please state product(s)): _____

Title _____ First Name(s) _____ Surname _____

Address _____ Postcode _____

In Australia: Silver Australia Pty Ltd., 4 Rushdale St., Scoresby 3179, Victoria Tel: (613) 7630177. In Canada: Avalon Audio Ltd., 101 Hanlan Rd., Woodbridge, Ontario L4L 3P5 Tel: (416) 850 7511. In New Zealand: Avalon Audio, PO Box 5373, 119 Wellesley St., Auckland Tel: (649) 779351. In South Africa: Hi-Fi Installations, 134A Fox St., Johannesburg, 2001 Tel: (2711) 3312011. In the USA: Audio Influx Corporation, PO Box 381, Highland Lakes, New Jersey 07 422-0381 Tel: (201) 764 8958.

World Radio History

kind of music last year on *A New Kind of Water*, an album of duets with Australian guitar player Jim O'Rourke. On *Aurora* he's joined by James Plotkin, of American improvising prog-thrashers Old (and check out their two albums - on Earache Records in the UK - for satisfying evidence that the legacy of King Crimson isn't lost to the world - thank the Lord). The really extraordinary thing here is that two musicians capable of such obliterating, ferocious music as that of Zeni Geva and Old can invest music as minimal as *Aurora's* with such beauty. By turns eery, bleak, lush and even industrially harsh, the blasted drones that sweep through this record, at times underscored by throbbing pulses and at others simply hanging in air like some mesmerising sound sculpture, at once recall three decades of minimal and ambient experimentation and yet sound so damed fresh. Fantastic, highly recommended stuff.

FUSHITSUSHA

Fushitsusha

PSF RECORDS PSFD 15-15

● I touched on this group a couple of months back, in a review of their appearance on Zom's Jap based Avant label. Fushitsusha is the realm of guitarist Haino Keiji, of whom I can tell you regrettably little. This double CD comes with a beautiful black 20-page booklet printed on rice paper, written entirely in Japanese; the sleevenotes may well be incredibly illuminating, but somehow I suspect not.

So the stories, the rumours... Keiji never appears without his shades (black, of course). Keiji's albums come pretty much exclusively packaged in black, with the black type often simply in relief or spot gloss. Keiji's been kicking around the Japanese music scene for a good twenty years, in the process building up a fantically adoring following, many of whom record every concert. Keiji hates

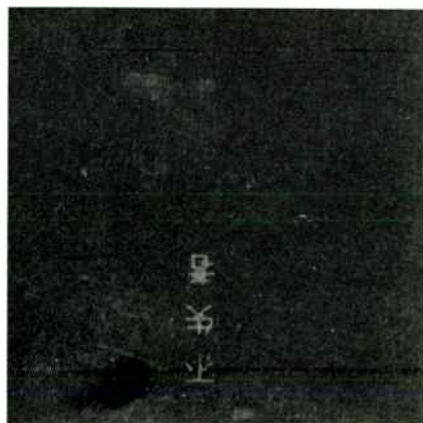

recording studios, so pretty much all his records (this double is a case in point) are live recordings. Last year's album on Avant was a studio record and Keiji ain't happy about it. Keiji listens only to Mediaeval music and 70s hard rock. Keiji plays live through eight Marshall stacks.

And above all Keiji is an obsessive; obsessive about his clothes, obsessive about his music, obsessive about his album artwork, obsessive about Christ knows what else.

I can't confirm or deny any of this. To be honest, I'm not much bothered. I can say this: Haino Keiji is the most extreme improvising rock guitar player to emerge since Robert Fripp (see - I said we'd get round to Crimson again). The thirteen pieces on this set will scare the pants off you. The band lurch from scratchy punk riffing to bludgeoning metal to chilling ambient droning. Through it all Keiji moans and screams and coaxes from his guitar (not to mention, I guess, his eight Marshalls) horrific chords and the odd fifteen-or-more-minute solo that's mind-boggling in its range of ideas and sounds: a grab-bag of Fripp and Derek Bailey and Bitches Brew-period John McLaughlin and Fred Frith and Hans Reichel and Lord knows what/who else.



HAINO KEIJI

Live

PSF RECORDS PSFD-38

● And this is Keiji live and solo, "just" guitar and vocal, no overdubs. I could say that it's more of the same, but of course nothing's ever quite the same with Keiji. There are thirteen pieces here and each is a distinct sound world. The scope of Keiji's musical imagination and his guitar technique is quite staggering.

If you're about to explore this man's music for the first time then I'd recommend the live double, if only because the group interplay and its sheer force are yet another element to relish. But all real improv freaks and certainly all serious guitar junkies will need both sets.



**SUN RA
Outer Spaceways
Incorporated**

BLACK LION BLCD 760191

● An essential CD reissue of a 1968 session by the late and very great Mr Ra, spiritual godfather - acknowledged or otherwise - of so much of the other music reviewed here. Ra's leading a thirteen piece band, whose style is pitched somewhere between his more wildly psychedelic work and his later, more traditionally swinging records. The music veers from hard bop to screaming Free Jazz, with the usual fantastic contributions from altoist Marshall Alan and tenorist John Gilmore.

There's masses of Ra out there, so god knows where the beginner should jump on - given the vast range of Ra's music this would depend a great deal on your own predilections. But *Outer Spaceways* is cracking stuff throughout and highly recommended to Ra neophyte and fanatic alike (but then, the fanatic won't need me to tell them that).

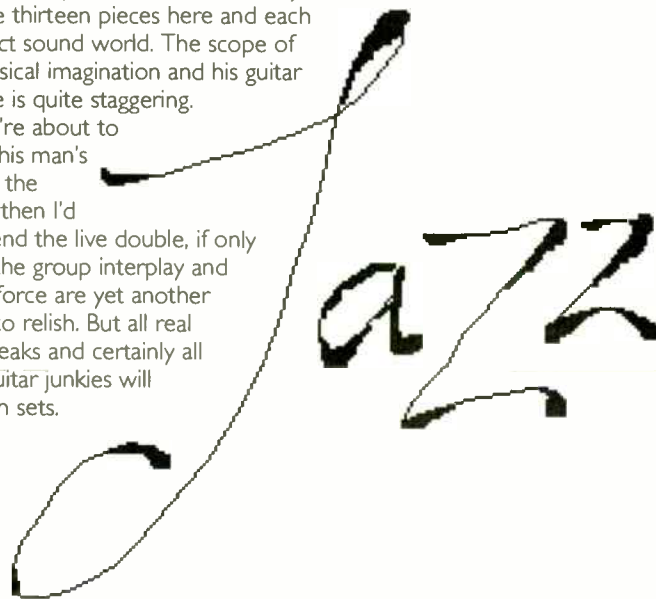

Lumley Reference

"FOR REAL MUSIC LOVERS"



'ST70 STEREO'



'M120 MONOBLOCKS'

FOR THE WORLD'S FINEST AMPLIFICATION CALL US TO AUDITION THE 'LUMLEY' RANGE ALONGSIDE MANY OTHER TOP MAKES.

WE BELIEVE THAT PRICE FOR PRICE 'LUMLEY' LEADS THE FIELD.

**MUSIC
MILL**

**EDINBURGH
SCOTLAND**

**TEL. NO.
031 555 3963.**

PROGRESSIVE AUDIO



DIGITAL BY; SUGDEN, MERIDIAN, MARANTZ, MICROMEGA, PROCEED, AUDIO ALCHEMY, ORELLE AND AUDIOMECA

ANALOGUE BY; MICHELL, PINK TRIANGLE, SME, VPI, BASIS, VOYD, PROJECT, SYSTEMDEK

ARMS AND CARTRIDGES BY; LYRA, MICROBENZ, TRANSGURATION, KOETSU, SUMIKO, GOLDRING, AUDIO TECHNICA, DECCA, SME, GRAHAM, REGA, EMINENT AND KUZMA

AMPLIFICATION BY; LFD, AUDIO INNOVATIONS, AUDION, SUGDEN, CHORD, MOTH, LEVINSON, CONRAD JOHNSON, CONVERGENT, LUMLEY REFERENCE, MICHELL, TUBE TECHNOLOGY

SPEAKERS BY; PROAC, AUDIONOTE, SNELL, IMPULSE TDL, JPW, DALI, ORIGIN LIVE, AUDIOSTATIC, RUARK, SOUND LAB, DIAMOND ACOUSTICS, TOWNSHEND, MONITOR AUDIO, UKD, ALCON

ACCESSORIES CABLES BY; QED, STRAIGHTWIRE, LOGAN HALL, AUDIOQUEST, SILVER SOUNDS, AUDIONOTE, KIMBER, L.F.D., AND VAN DEN HUL, STANDS BY; TARGET, TRIPOD, FOUNDATION, GOLDRING, HEADPHONE BY STAX, SEISMIC SINKS BY TOWNSHEND

HOME DEMONSTRATIONS A PLEASURE
PHONE DAVE ON MEDWAY 0634 389004

HOME DEMRECORD CLEANINGSERVICE, SECOND HAND EQUIPMENT AND RECORDS. PHONE DANNY ON MEDWAY 0634 580763 ONSTRATIONS A PLEASURE
PHONE DAVE ON MEDWAY 0634 389004

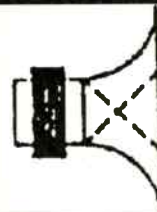

BANDOR

MINIATURE LOUDSPEAKERS
THE SOUND OF EXCELLENCE

BANDOR ALUMINIUM ANODISED CONE DRIVERS
1.3 grams moving mass. 35 YEARS EXPERIENCE

NEW PRODUCT

BANDOR LINE '20'
and
BANDORLINE '30'
TRANSMISSION LINE KITS.
M.D.F. CUT OUTS (Flat Pack)
150Hz Cross Over
CABINETS DESIGNED BY
© G.E BOWMAN

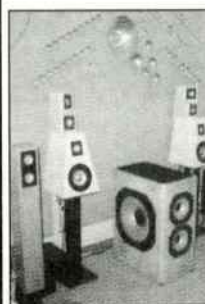

Free technical sheets

Design & Development
Studio
11 Penfold Cottages,
Penfold Lane, Holmer
Green, Bucks. HP15 6XR
Tel: (0494) 714058

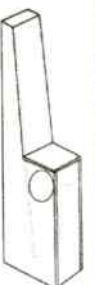

AUDIO ACCESSORIES

HI-FI WORLD SOLID SILVER INTERCONNECTS.

Constructed from strands of solid core silver wire and silver soldered to Neutrik Profi phono plugs which are probably the best available. These line level

interconnects offer the ultimate in transparency, openness and detail. The plugs are bonded to the cable with adhesive heatshrink to ensure that the cable has a long life without

fatigue occurring at the plug join. Available exclusively through Hi-Fi World Mail Order

HI-FI WORLD SOLID SILVER CABLE.....£139.95/1M PAIR.



HI-FI WORLD SILVER PLATED COPPER INTERCONNECTS.

A similar construction to our solid silver cables, but using silver plated copper and standard Gold Phono plugs. Because the majority of the audio signal passed

through the skin of a cable these can approach the quality of silver one but at cost a normal high quality copper cable.

HI-FI WORLD SILVER PLATED COPPER INTERCONNECTS £69.95/1M PAIR.



HIGH QUALITY MAINS CABLES.

Supplied to Hi-Fi World by Campaign Audio Design these mains cables are screened to reduce Radio Frequency and Electromagnetic Noise. They also come with a VDR fitted which protects equipment from mains spikes. The MK plugs have a silver plated fuse and holder for the cleanest supply. Available with IEC or Figure eight (Marantz/Philips CD players) equipment plugs or with a hard wired, soldered 4-way mains block.

1M WITH IEC PLUG.....£19.20

1M FIGURE 8 PLUG.....£15.75

1M 4-WAY BLOCK.....£31.95

RECORD STORAGE CUBE

Designed to hold about a hundred LPs, with an internal width of 37cm, height of 32.5cm and depth of 32cm. The cubes can be stacked or placed alongside each other - and are even strong enough to be used as seats! Made from 15mm MDF (Medium Density Fibreboard) with a smart durable black paint finish, the

cube is supplied in flat-pack form ready for home assembly.

RECORD STORAGE CUBE£45 EACH

SIX CUBES FOR THE PRICE OF FIVE £225.00

EIGHT CUBES FOR THE PRICE OF SEVEN!.....£315.00



MICHELL ENGINEERING PLUGS

Craftsmanship marks out Michell Engineering's range of gold and rhodium plated plugs from the competition.

GOLD-PLATED SIDE ENTRY BANANA PLUGS (4)£10.00

GOLD-PLATED SURE-LOC BANANA PLUGS (4)£14.95

RHODIUM-PLATED SURE-LOC BANANA PLUGS£18.95

GOLD-PLATED SPEAKER CABLE CONNECTORS...£10.00

GOLD PLATED 4MM BANANA PLUGS

Heavy-duty, gold-plated banana plug with a unique type of axial solderless connection for loudspeaker cables. The cable is stripped back and pushed into a clamping collar which is then screwed down tight, accepting cable up to 6mm external diameter and 4mm core diameter. Supplied in sets of four.

BANANA PLUGS (4)£8.00

AUDIO ACCESSORIES

SME Garrard Celebration Arm



GARRARD 401 CELEBRATION SME IV TONEARM

A special version of the SME IV cast magnesium alloy tonearm, dedicated to the Garrard 401. The SME IV is precision engineered to be fully adjustable, making set-up easy and precise. If you want to get the best from your Garrard 401, this is a fantastic tonearm, sympathetically styled to form a perfect combination.

GARRARD 401 CELEBRATION SME IV TONEARM£847.15



BUG AUDIO

A fascinating little device no larger than a hand-held remote which allows the user to adjust bias on any cassette deck perfectly for any tape. You can check the state of your cables and connections with it, too! Supplied with a cassette test tape and full instructions. (See review, Nov. 1992 issue.)

BUG AUDIO£59.99

SOUND SWIVEL

A rotating, upright, double-sided, storage cabinet with space for up to 160 Compact Discs, including 8 double jewel-cases.

Mounted on an all-steel turntable, it swivels smoothly through 360 degrees giving easy access to the storage compartments either side. Manufactured in durable MDF with a Black Ash effect finish, the Sound swivel comes packed for self assembly with full instructions.

SOUND SWIVEL£49.95



AUDIO ACCESSORIES

AUDIO-TECHNICA RECORD CLEANING SYSTEM

Removes both dirt and static; a tiny amount of cleaning agent in the handle removes fingerprints, oil and film, while a pad lifts off dust. Pad brush and fluid are supplied.

AUDIO-TECHNICA RECORD CLEANING SYSTEM £10.50



AUDIO-TECHNICA COMPACT DISC LENS CLEANER

A disc the size of a CD, with fine brushes - one of which is dampened with cleaning fluid. As the disc spins in the player, the brushes clean the laser lens. It may not suit all machines.

CD LENS CLEANER.....£16.25



KONTAK

An effective cleaning solution that removes contaminants from electrical connections. After application, a system regains its original life, sparkle and vigour.

KONTAK£19.00

HI-FI WORLD DRY STYLUS CLEANER

Keep your stylus sharp and bright for perfect tracking without using fluid. Cut a strip about the size of a matchbox striker off this sheet of card and draw it gently under the stylus from back to front. One sheet of this card, with its aluminium-oxide micro-abrasive coating, should be enough to clean your stylus at least forty times.

DRY STYLUS CLEANER ..£1.95

GOLDRING EXSTATIC MAT

For vinyl users, the Goldring Exstatic is a felt mat made with fine carbon fibre strands. This helps to reduce positively charged static electricity that builds up on the surface of records.

GOLDRING EXSTATIC MAT £7.50



SUPER EXSTATIC CARBON FIBRE DISC CLEANER

Effectively removes dust and grime from record grooves, this cleaner is a combination of one million carbon fibre filaments and a soft velvet cleaning pad.

EXSTATIC CARBON FIBRE CLEANER £9.95

EQUIPMENT SUPPORTS

FrameWorks is an innovative range of versatile hi-fi supports whose high standard of strength and rigidity results from their 'triangulate' design. The shelves are supported on struts of thin cross-section and four sturdy corner columns, to reduce resonances.

Versatility is guaranteed by two or three shelf options, an additional isolation shelf and a stacking unit to expand the system as the hi-fi grows. All you need to do is add components as and

when you feel the need.

FrameWorks stands come with attractive 10mm thick toughened smoked glass shelves, supported on rubber-damped spikes to reduce vibration and lessen the tendency for the glass to slide. Metal parts are finished in a hardwearing satin black powder coat.

FrameWorks stands will extract the best out of any equipment.

FrameWorks' excellent hi-fi equipment stands are now available through our Mail Order Department.

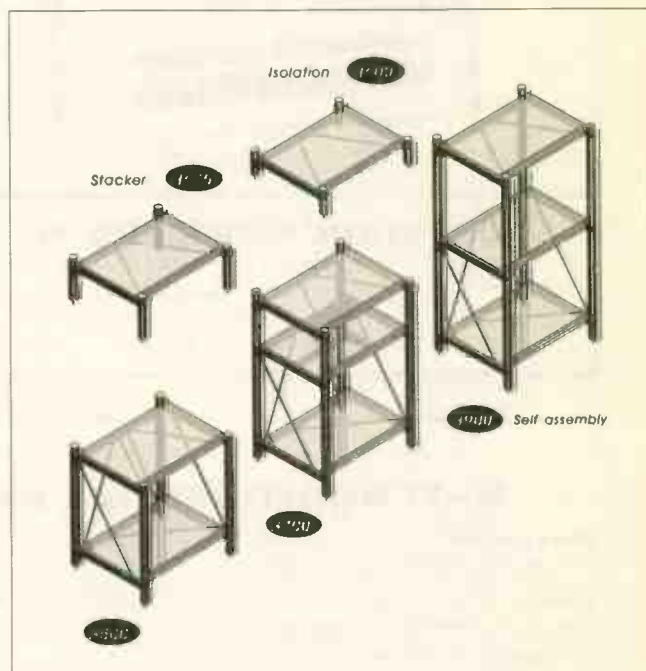

PRICES FOR FRAMEWORKS EQUIPMENT STANDS ARE AS FOLLOWS;

| CODE | HEIGHT | PRICE |
|------|--------|-------|
| H100 | 100MM | £109 |
| H175 | 175MM | £119 |
| H500 | 500MM | £205 |
| H700 | 700MM | £275 |
| H900 | 900MM | £305 |

ALL FRAMEWORKS SHELVES ARE 550MM WIDE BY 450MM DEEP. All prices include VAT & p+p for UK only.



H100 ISOLATION TABLE

AUDIO ACCESSORIES

LASAWAY GREEN PEN

When red laser light hits the reflective surface of a CD, some of it can be scattered off the edges of the disc, causing optical interference. Applying this green coating, formulated by Japanese company Mitsubishi, to the inner and outer edges of the CD reduces this interference, improving sound quality.

LASAWAY GREEN PEN£8.50



ANTI-STATIC RECORD SLEEVES

Translucent sleeves, treated to reduce static and dust attraction, supplied in packs of fifty.

They will fit inside ordinary printed inners.

LP SLEEVES (50) PRICE £8.15



MILTY TRIPLE A

Suitable for all types of cassette players including auto-reverse, the Milty Triple A wipes clean single/dual capstans and pinch rollers with a non-abrasive cleaning action.

MILTY TRIPLE A £6.50

MILTY MAGNET IX

The Milty Magnet IX comes complete with battery. It requires approx one second to de-magnetise the heads removing magnetic charge build up. Recommended after every 30 hours of playing time.

MILTY MAGNET IX £10.50

HI-FI WORLD SPECIAL AUDIO ACCESSORIES ORDER FORM

Please send me:

- Audio Technica CD Lens cleaner£16.25 each
- Audio Technica Green CD Ring Stabilizers£6.50 (Pack of 5)
- Audio Technica Record Cleaning System£10.50
- Automatic CD Cleaner.....£21.95
- Bug Audio Biasbug.....£59.99
- CD sound swivel£49.95
- Garrard 401 Celebration SME IV Tonearm£847.15
- Gold plated 4mm plugs£8.00 (4)
- Goldring Exstatic Mat.....£7.50
- Goldring Super Exstatic Carbon Fibre Disc Cleaner£9.95
- Hi-Fi World Silver Plated Copper Interconnects (1m pair)£69.95
- Hi-Fi World Dry Stylus Cleaner.....£1.95 per sheet
- Hi-Fi World Solid Silver Interconnects (1m pair)£139.95
- Kontak cleaning fluid.....£19.00each
- Lasaway Green Pen.....£8.50 each
- Laserguide.....£14.95
- Michell Gold-Plated Side Entry Banana Plugs (4).....£10.00
- Michell Gold-Plated Speaker Cable Connectors.....£10.00
- Michell Gold-Plated Sure-Loc Banana Plugs (4).....£14.95
- Michell Rhodium-Plated Sure-Loc Banana Plugs (4).....£18.95
- Milty Magnet IX.....£10.50
- Milty Triple A.....£6.50
- Nagaoka Anti-static record sleeves£8.15 (50)
- ON Stylus Cleaning Kit.....£2.50
- Pixall MkII Record Cleaner.....£10.75 each
- Pixall refill roller.....£2.75each
- Record storage cube£45.00 each
- Screened Mains Cable With 4-Way Block (1m)£31.95
- Screened Mains Cable With Fig 8 Plug (1m).....£15.75
- Screened Mains Cable With IEC Plug (1m).....£19.20

All prices are exclusive of postage & packing, please add £1.00 for postage in the UK and £2.00 for postage overseas.

I enclose cheque/PO for £made payable to
World Audio Publishing Ltd.

I wish to pay by Visa/Access, please debit my account no:

| | | | | | | | | | | | | | | | | | | | |
|--|--|--|--|--|--|--|--|--|--|--|--|--|--|--|--|--|--|--|--|
| | | | | | | | | | | | | | | | | | | | |
|--|--|--|--|--|--|--|--|--|--|--|--|--|--|--|--|--|--|--|--|

Expiry date:

| | | | |
|--|--|--|--|
| | | | |
|--|--|--|--|

Name.....

Delivery Address.....

N.B. If delivery address is different to the credit card holder's address please supply both.

Tel:.....

Please send completed order form together with your cheque/PO to:

HI-FI WORLD,
64 Castellain Road,
Maida Vale,
London W9 1EX.

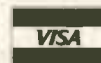

Credit Card Orders
Telephone 071 - 266 0461
24 hour Mail Order Answerphone

Please allow 28 days for delivery

4/94

Try me & see For the very best DEALS for 1994!

**on any current Hi-Fi, A/V,
Home Cinema unit or VCR-
AND all Award Winners**

**AMAZING PRICES GUARANTEED
PHONE NOW—you'll get first-class
service, savings and support.**

- ▶ Budget, Regular and Esoteric Equipment.
- ▶ Insured Overnight Delivery, anywhere in the U.K.
- ▶ Major Credit Cards, Switch/Connect accepted.
- ▶ All goods carry full Manufacturers' Warranty.
- ▶ TMS Warranty covering collection and delivery provided FREE.
- ▶ Extended Warranties up to 5 years available.

*You can always buy from TMS with the complete confidence that we will never let you down.
We ever put our customers first and constantly upgrade and update our systems in order to improve our service.*

**081-563 0003
Fax 081-563 0300**

**Try Me & See Ltd,
5 Rocks Lane, Barnes,
London SW13 0DB**

Relatively Speaking,

GOLD AERO TUBES

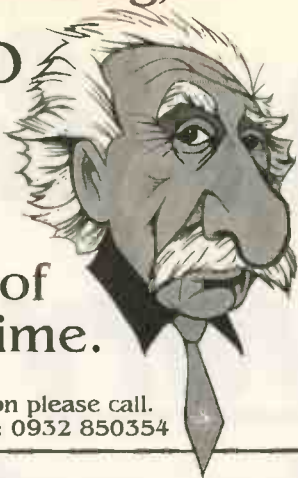

give Music
more Sense of
Space and Time.



For further information please call.
Tel: 0932 850361 Fax: 0932 850354

LORICRAFT AUDIO

Turntable Repair and Record Cleaning Service

Sale and Repair of Classic Hi-Fi Specialising in Garrard and Thorens

Manufacturers of high quality plinth systems. Review (copy available)

Electronic low distortion power supply and active power supply for Garrard 301/401 Thorens TD124

Re-manufactured spindle bearing and correct lubrication kit. Specifically designed for this type of bearing

Loricraft specialist services start at £5.00 for platter damper rings

**New Catalogue
now
available**

4 Big Lane, Goose Green,
Lambourn, Berks. RG16
&XQ. Tel. 0488 72267

**See us with Art
Audio at
Chesterfield**

CLEARAUDIO, S.M.E., AUDIO RESEARCH, KRELL, CHORD

HEATHERDALE AUDIO LTD.

Tel. 0903-261213 or 0860-660001

we are pleased to take your calls from 9am to 9pm
7 days a week.

CLEARAUDIO

PREMIUM PHONO CARTRIDGES FOR SUPERIOR MUSIC REPRODUCTION.

"With the "Clearaudio" Gamma S you get a solid
dependable sound that is smooth, clean, controlled,
dynamic and utterly unflappable"

Jimmy Hughs, Audiophile April 94

Phone now for demonstration.

MAGNEPLANAR, MARTIN LOGAN, SONUS FABER, AUDIONOTE

VOYD, GRAHAM, LUMLEY REFERENCE

THETA, KLIPSCH, APOGEE, COPLAND

THE AUDIO GALLERY

For a Fine Selection of High Quality Audio Equipment

Tube Technology - Audio Innovations - Audio Note - Wadia
Audio Alchemy - DPA - TEAC - Microomega - Alchemist
Martin Logan - ProAc - Klipsch - Acoustic Energy - TDL
Heybrook - JPW - Impulse - Pink Triangle - SME - Denon
Moth - Audio Synthesis - NAD - Pioneer - Alphason - Tripod
Replacement Valves by Gold Aero

Demonstrations by Appointment Only.

Please call - 0730 895194 - Hampshire, Nr. Petersfield

A.R.M.S.

ACOUSTIC RESPONSE MEASURING SYSTEM



Just imagine, with a few touches of a keyboard, being able to measure the Thiele-Small parameters, complete with impedance curves and S.P.L., of a loudspeaker drive unit, and then being able to measure the frequency response of a correctly designed speaker system, based on these parameters.

With A.R.M.S. all this, and more, is possible. A.R.M.S. is not a kit. The package includes the hardware, housed in a 19" case, together with the software and microphone. A.R.M.S. is suitable for use on IBM PCs (or true compatibles) with MS-DOS 3.2 or higher. Further details are available upon request.
PRICE (inc. U.K. delivery) £425.00 + £74.38 VAT.

B.K. ELECTRONICS

Units 1,3 & 5 Comet Way,
SOUTHEND-ON-SEA, Essex, SS2 6TR.
Tel.: 0702-527572 Fax: 0702-420243

G T AUDIO

At G T Audio we pride ourselves on selling an excellent range of sound reproduction equipment, backed up by first-class after sales service. From the vast range of quality audio equipment available we have chosen that which we feel offers the best sound at very competitive prices with a high degree of reliability. We have extensive servicing facilities to cater for all types of equipment whether new or old.

CROFT, NOTTINGHAM ANALOGUE, ANALOGUE TRACER, POSSELT, UKD CALLAS, MONARCHY AUDIO, XLO ELECTRONIC, MATISSE, GROOVE TUBES, GOLD AERO, TOWNSEND SEISMIC SINKS, G T AUDIO CABLES, ATACAMA supports, CLEMENTS, METAXUS, ZIKRO AUDRO are available on demonstration.

WE CAN OFFER A COMPLETE RESTORATION SERVICE AS WELL AS SUPPLYING AUDIOPHILE COMPONENT KIT FOR UPGRADING ALL LEAK, QUAD, RADFORD, PYE and QUICKSILVER amplifiers. P.O.A

G T Audio is situated on the outskirts of London, 5 minutes from junction 16 of the M25/M40 Motorways.

FOR DEMONSTRATIONS OR BOOKING IN EQUIPMENT TO OUR SERVICE CENTRE contact Graham Tricker.

TELEPHONE 0895 833099

(DEMONSTRATIONS STRICTLY BY APPOINTMENT ONLY)



readers' queries

UPGRADING A STUDENT SYSTEM

As a former student with limited means, my enjoyment of music was derived from hi-fi which was cheap and good value for money. To this end, over the last few years I have put together a simple CD system comprising:

Rotel RCD865 CD player
Leak Stereo 70 amplifier
KEF Coda III loudspeakers

After many hours fiddling to extract the best sound performance from the equipment I finished up using the CD player on a paving stone and the loudspeakers on Sound Organisation stands filled with sand and set on flag stones. I use 2.5mm solid-core mains for 'speaker cable (6m lengths) and 0.5m long Sarek interconnects. Home made mains clamps are used on the power supplies to the CD player and amplifier.

I am very satisfied with the sound of the system - it is detailed with a warm and open sound stage. The bass is very extended with superb timing and control. The reproduction of string instruments is truly superb and vocals are well related. The weakness of the system arises when the music becomes very busy. Sometimes the mid-range

Write in with your problems to Hi-Fi World, 64 Castellain Road, Maida Vale London W9 1EX. Our panel of experts will endeavour to solve them or at least offer some practical advice

becomes less controlled during complex percussion and/or electric guitar sections of music.

Now that I am more affluent than in student times, I wish to purchase a better system. In my attempts to do this I have auditioned a Denon PMA350II amplifier with KEF Q60s and a Linn Intek amplifier with Rega Kytes. In both cases the source was a Rotel RCD965. The sound of these systems was well liked, but neither offered substantial (if any) performance improvement over my current set-up. The sound of a Linn Intek driving Linn Index loudspeakers was definitely not liked.

My music tastes vary from Red Hot Chilli Peppers to REM to Pearl Jam to

Beethoven and Tchaikovsky. I have approximately £1,000 to spend on the CD system and would appreciate any comments or help you can offer.

Also, I have a Leak Troughline mono tuner which has a wonderfully smooth and relaxed sound. Is there any way to add a stereo decoder for a reasonable price?

**Richard Ellis
Swallownest,
Sheffield.**

A modern Class A amplifier will not only give you the detail and open soundstage you like, but will also sound a lot cleaner and faster. I'd recommend you audition the superb Sugden A21a in combination with a pair of Epos ES11s. This is a combination I haven't tried, but I can see no reason why it shouldn't give excellent results. Find a dealer who will demonstrate such a system by 'phoning Sugden (0924-404088/9) and Epos (0705-407722).

This will be a vast improvement over the transistor Stereo 70 with Coda IIIs and should retain all of the qualities that you like about your existing set-up. The Sugden A21a has a highly detailed and strongly etched sound and the ES11s are rich and smooth, they've

provided me with many hours of enjoyment in the past. They have enough energy and boogie factor for Red Hot Chili Peppers and REM, but also subtlety and neutrality for Beethoven and Tchaikovsky. They'll certainly be a vast improvement over the KEFs which are now a bit long in the tooth.

The ES11s do tend to be quite room and placement sensitive, so I'd recommend you try and get a home demonstration first, and use the proper open frame stands, since they're the best match for them by far. The Sugden is quite low powered - so should the Epos not suit your tastes be careful to choose alternative loudspeakers that are high sensitivity - around 87dB or more. These include Heybrook Quartets, Snell Ks, Harman Kardon 0500s, Triangle and Cabasse speakers, and most horn loaded designs.

Whilst you're upgrading the rest of the system it would be worthwhile to look at the CD player. Fortunately, there is a very cost effective upgrade path open to you, but you'll need to do a bit of grovelling. If you ask Rotel's service

Continued on page 105...

INFINITY

SPECIALISTS
FOR THE NORTH WEST & NORTH WALES

Phone John Hodgkinson to book a demo on the superb Kappa 6.i speaker (see review on page 36,37 this issue) The kappa 7.i speaker also in stock. A/V enthusiasts should also consider the Kappa centre speaker which is outstanding.

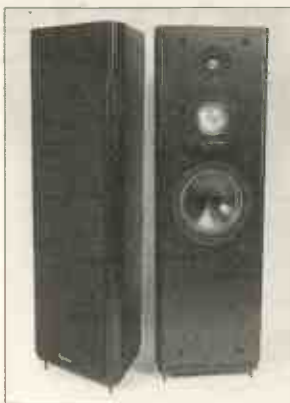

We are also main stockists of:-

**ROTEL • YAMAHA • NAD • HARMAN KARDON
• TEAC • ALPHASON • APOLLO • HEYBROOK
• HECO • JAMO • JBL • KEF • TDL • TARGET
and many more...**

ELECTRO TRADER

The Hi-Fi Centre in North Wales since 1978
19 COLWYN CRESCENT, RHOS-ON-SEA, COLWYN

Tel: (0492) 548932

Mail Order Specialists

Opening hours : 9.30 - 1, 2 - 5.30

Demonstration by appointment preferred



TRIPOS - Quite Clearly the best

for further information or local stockist call:

Derek on 0224 322520

TRIPOS STANDS, ORWELL
HOUSE, SOUTERHEAD ROAD,
ALTENS INDUSTRIAL PARK,
ABERDEEN

FOR THE BEST

→ ADVICE
→ INSTALLATIONS
→ DEMONSTRATIONS
→ AFTER SALES SERVICE

SPALDINGS

The South East's Leading Hi-Fi Specialists

352-354 Lower Addiscombe Road Croydon Surrey CR0 7AF

081 654 1231/2040

.... Continued from page 103

department (Tel: 0908 317707) very nicely, they can fit a Discrete board into your 865 to bring it up to 965 Discrete performance. This is quite a complicated upgrade and not a standard service, but for £125 or so is extremely good value for money. This has the additional advantage of raising the rather low 0.9V output of the 865 up to a full 2V, the Philips standard.

GT Audio can service, align and fit a stereo decoder to your Troughline. This again will increase the output enough to better suit a line level amplifier. Contact: GT Audio, tel. 0895 833099, or Radlett Audio, tel. 0923 856497. **DB**

FINAL UPGRADE

After many years of upgrades I have arrived at a point where I don't know what to do next. My next is possibly my last so I have decided on a final upgrade for the speakers and CD. My present system comprises:

Marantz CD 52 + Arcam Black Box, Audio Innovations 200MM pre + AI series 800 III power amp. (QED interconnect), Celestion DL 4 speakers on Partington Pro 24 stands. (Cyrus Solid Core Cable)

I am pleased with the treble to midrange detail since upgrading the amp from a Mission Cyrus I, but the overall sound has a lack of enthusiasm. The bass quality is precise, but lacks drive and substance. My previous amp (which I've still got) seemed to be better for getting my feet tapping with rhythmic tracks, but doesn't have the refinement and detail that I listen out for. The emotion doesn't seem to exist with the transistor amp. This is why I changed to the AI valve amp, but this doesn't offer

quite the drive that I want from rock and dance tracks. Is there a solution that allows me to have the best of both worlds? My main taste in music is around 80% soul/easy listening and 20% rock/dance. I have thought of many ways to overcome this problem and it is this that is causing me so many sleepless nights. The question is which options shall I take and in what order?

1. I have considered changing the speakers for something

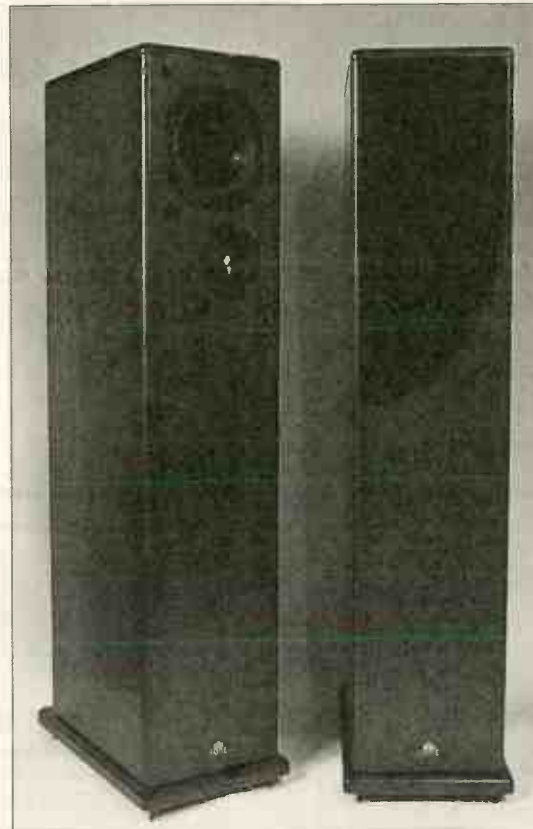

Castle's Howards - a good match for valve amplifiers.

with a bit more emphasis on the bass to compensate for the amp. The speakers must be used against the wall in a room 10x20ft & 10ft high and look visually reasonable. (i.e. no Snell/Audionote/Fuller speaker look alike). Budget approx. £700.

2. Changing the source to a Roksan ROK or Micromega CD.3, possibly with a Pink Triangle Ordinal to give a more aggressive edge. Budget approx. £2000

3. Buying a transistor power amp to drive the bass unit of a suitable bi-wire speakers to

create a hybrid system. I could use the two outputs from the preamp, one for the tweeter using the Series 800III valve power amp and the other for the bass unit. Can this combination give me what I require and can it work? How about an Alchemist Kraken power amp to give this rocking factor? Budget approx. £500

What I have listed above are my plans for my system. I will upgrade the components one

at a time, but keeping my amp. As I am reasonably young, 22 next year, I want something that will last. Can you also suggest some cables and interconnectors which aren't too expensive as I don't really believe there is a big difference between a good quality one and a super deluxe silver FPS Teflon insulated one.

**T.K.Wong
Brandon Hill,
Bristol.**

The DL4s, as I remember, have a rather soft mid and not the most dynamic and punchy bass around, so I

think that these may be part of the problem. Also, rather than change your amplifier, or adding a transistor amp to drive the bass, I'd stick with the Series 800 and find a loudspeaker that matches it really well. Finding a good amplifier and loudspeaker combination is half the battle, but the most difficult part.

If you're after a little more power in the bass and some attack in the midband, then Castle Howards might be ideal, especially as you have a good sized room. These £995 floorstanders have average sensitivity, but offer a very easy impedance load to the amplifier - important for valve amps. They should give you a deep, but well controlled bass with a clear and spacious midband and sweet treble. They're also beautifully made and elegantly styled, so they should suit you especially well. Insist on a home demonstration first though, because they can be a little room sensitive.

With these speakers you'll need a new CD convertor and with a Pink Triangle Ordinal - the one I would recommend - your system should really start to sing. The system can then be fine tuned with careful selection of cables. I'd use Campaign Audio Design's silver plated copper interconnect, which for £28 is a bargain, and Ortofon's £5/m SPK200 high purity copper stranded loudspeaker cable designed for bi-wiring. **DB**

You could also try the Triangle Norma, since this is a very sensitive speaker, yet can be stood against a wall to augment its bass. **NK**

HIGH SENSITIVITY AND REAL BASS

Here's a nice straightforward query to ease you gently into

Continued on page 107... ▶▶

Sussex Surplus

13 STATION ROAD, HORSHAM, WEST SUSSEX RH13 5EZ

Telephone: (0403) 251302 Fax: (0403) 270339

Test Equipment • Components • Accessories
Electromechanical • Mechanical • Engineering

Valves Mostly UK. Makes

Valve Sockets

| Type | Price | Type | Price |
|---------------|--------|------------------------------|-------|
| KT66 G.E.C | £65.00 | UV4 CERAMIC | £2.00 |
| EF86 G.E.C | £9.00 | OCTAL CERAMIC | £4.00 |
| ECC81 MULLARD | £5.00 | B9A P.T.F.E | £2.00 |
| ECC82 MULLARD | £5.00 | B7G PAXOLIN | £1.00 |
| ECC83 MULLARD | £10.00 | | |
| 12AX7 MULLARD | £6.00 | Pre-Amp attenuator | |
| 5R4GY | £4.00 | switches gold plated, solid | |
| 6080 | £10.00 | silver studs British made | |
| E810F MULLARD | £10.00 | P.O.A. | |
| E180F MULLARD | £6.00 | P.T.F.E silver plated wire, | |
| G337 MULLARD | £3.00 | various sizes and colours | |
| EL84 MULLARD | £6.00 | 50p per metre ceramic | |
| 13D3 (CV4068) | £4.00 | stand-off tag strips various | |
| 6SN7GT | £4.00 | sizes. P.O.A. | |
| DA42 G.E.C | £15.00 | P+P. Free on orders over | |
| U19 RECTIFIER | £15.00 | £20.00. Under £20.00 | |
| 6X4 RECTIFIER | £3.00 | Add £5.00 to order. | |
| | | VAT at 17.5% to be added | |
| | | to all orders. | |

All items in this advert are made to mill spec.

Oil Filled H.T

Transformers

| Primary | Secondary | Price | Inductance | Price |
|----------|---------------|--------|------------|--------|
| 230/240V | 612V-0-612V | £25.00 | 10H 25MA | £8.00 |
| | 430 MA | | 2.5H 250MA | £8.00 |
| 115/230V | 1250V-0-1250V | £35.00 | 5H 250MA | £12.00 |
| | 310MA | | 5H 200MA | £12.00 |
| | 4.6V 100 MA | | 5H 120MA | £12.00 |
| 115/230V | 210340 MA | £15.00 | 5H 350MA | £18.00 |
| | 170V 40 MA | | 5H 400MA | £20.00 |
| | 290V 90 MA | | | |

Oil Filled

Paper Capacitors

| | | | | |
|----------|-------------------|--------|-----------|--------|
| 115/230V | 400V-0-400V | £18.00 | 2MFD 500V | £6.00 |
| | 300 MA | | 2MFD 600V | £6.00 |
| | 30V 100 MA.C.T | | 4UF 600V | £6.00 |
| 230V | 275V-0-275V 100MA | £18.00 | 8UF 100V | £12.00 |
| | 6.3V 2.5A | | 8UF 800V | £10.00 |
| | 6.3V 1A | | 8UF 100V | £12.00 |
| | 5V 2.5A | | 1UF 600V | £5.00 |
| | | | .5UF 100V | £4.00 |

Heater Transformers

| | | |
|----------|--------------------|--------|
| 115/230V | 6.4V 3A X2 | |
| | 2.5V-45V-6.4V 3AX2 | £15.00 |
| 115/230V | 6.4V 10A | |
| | 10V 650MA | £15.00 |
| | 26V 650MA | |
| 115/230V | 2.5V-5V-6.4V | £15.00 |
| | 2A XE | |
| 115/230V | 6.4V 5A X3 | £20.00 |

All items in
this advert
are made to
mill spec.

Ultra Analog
20 bit version

DSM-X

LIMITED
EDITION



Audio Synthesis has available a limited quantity of built DSM UltraAnalog converters fitted with the latest DAX electronics at a very special price. These limited edition, one coaxial input, CD locking only dacs, offer: ultra-low jitter from crystal based PLLs; digital de-emphasis; the latest UltraAnalog D20400A, true 20-bit 8 times oversampled dac modules; 13 independent regulated supplies; silver & all Vishay bulk-foil, linear phase analogue outputs producing 3Vrms (ideal for passive attenuators). APS-02, the matching outboard power supply has a total of 40,000 µF of Elna audio-grade capacitance; separate L,R & digital feeds and mains input filtering.

DSM-X benefits from the same sonic qualities as DAX which so impressed the U.K.'s leading reviewer in January's Hi-Fi News:

'Right from the start there was no doubt about the very high attainment of the DAX... on sound quality grounds it was comparable with the very best of the high end. Using the best transports, with coaxial connection, a score of 45 was achieved.'

AUDIO SYNTHESIS

Audio Synthesis: 99 Lapwing Lane, Manchester M20 0UT U.K. Tel: 061 434 0126 (+44 61 434 0126)
PO Box 50, Nottingham NG9 U.K. Tel: 0602 224138(+44 602 224138) Fax: 0602 258431(+44602 258431)



Chord Electronics Ltd

3 Bower Mount Road
Maidstone ME16 8AX
Tel. 0622 764874/692000 Fax. 0622 764506

Chord UK Dealers

| | |
|---|--------------|
| Cottage Audio | 0522 702834 |
| KJ Leisuresound, London W1 | 071 486 8262 |
| Acoustic Arts, Watford, Herts. | 0923 245250 |
| Brentwood Music Centre, Brentwood, Essex | 0277 221210 |
| Progressive Audio, Gillingham, Kent | 0634 389004 |
| Doug Brady Hi-Fi, London WC2 | 071 379 4010 |
| Doug Brady Hi-Fi, Warrington, Cheshire | 0925 828009 |
| Doug Brady Hi-Fi, Liverpool, Merseyside | 051 733 6859 |
| Doug Brady Hi-Fi, Leeds, Yorkshire | 094 346 7689 |
| Photocraft Hi-Fi, Ashford, Kent | 0233 624441 |
| West Midlands Audio, Worcester, West Midlands | 0905 58046 |
| The Reference Studio, Heathfield, Sussex | 0435 868004 |
| Paul Green Hi-Fi, Bath, Avon | 0225 316197 |
| Eastbourne Audio, Eastbourne, Sussex | 0323 25828 |
| Surrey Hi-Fi, Godstone, Surrey | 0883 744755 |
| Sound Academy, Wallsall, West Midlands | 0922 493499 |
| English Audio, Hereford, HR4 | 0432 355081 |
| Hi-Fi Experience, London W1 | 071 580 3535 |
| London Hi-Fi Services, London | 071 263 1015 |
| Diva Audio Fidelity, London SW11 | 071 924 5286 |
| Music Matters, Birmingham, West Midlands | 021 429 2811 |
| Music Matters, Dourbridge | 0384 444184 |
| Vaudio, Stoke Bishop, Bristol | 0272 686005 |
| In Hi-Fi | 031 225 8854 |
| Audio Reflections | 0532 528850 |
| Audible Difference | 0379 740227 |

.... Continued from page 105

the new year. What are the best speakers for my system within my £1000 budget? The system comprises a Teac VRDS 10, Sugden SDA1, Concordant Excelsior preamp (an early model with just 1 ECC 83 per channel), a pair of Audio Classic's Leak TL 12+ and a pair of TDL Studio 1s. I also have a Townshend Avalon/Rega 250/AT-F5, Yamaha CT 7000 and a Denon DRM 500 tape deck, but the bulk of my listening is done using the CD.

I listen almost exclusively to classical music, especially choral and song. As a singer myself, I enjoy the clarity of the current set up and its ability to reproduce deep bass. However, I've always felt that the TDLs leave a bit of a "hole in the middle" and as I listen to so much vocal music, I'd like to improve matters in this area without sacrificing imaging, real bass, and treble clarity. Recently I've also noticed a slight hardening of male vocal and choral music at higher volumes. My room presents a problem in that being a through lounge/dining room, the speakers fire across the width of the room and can't be more than 6" from the wall. I sit about 7 feet from each speaker. The new speakers musn't be much bigger than the TDLs as my wife is very forgiving - but only up to a point!

There, I said it was straightforward didn't it? Thanks in anticipation.

**Paul F. Roberts
Westhoughton,
Bolton.**

Unfortunately, this is not straightforward at all. To get real deep bass, good vocals and enough sensitivity for your Leaks is impossible for £1000. The cheapest option I can think of is to swap the TDLs for a pair of Heybrook Quartets and a powered subwoofer - a REL strata for instance. This, with appropriate stands for the Quartets, comes to around £1300.

The problem is that high sensitivity and real deep bass don't go hand in hand. You are getting good bass from the TDLs, but I suspect that the 'slight hardening at higher volumes' that you've been hearing is the amplifier clipping and running into distortion. The Quartets are much more efficient and will be driven much more easily by the TL12+s, vocals won't harden at high volume and the whole sound will be much more energetic and detailed, but you'll miss the bass of the TDLs.

So you see, it isn't quite as simple as you thought. We discussed this at length in the office and thought of Snell Ks which would also have to be used with a subwoofer, but again take you past your budget being £799 without stands. The Castle Howards wouldn't need a subwoofer and might work, but they aren't as sensitive as the Quartets or the Snells, and they have a dry bass, rather than the rich bass quality you are used to with the TDLs. The Impulse H6s could also be worth an audition. These cost around £1350, are sensitive and have a good bass, but you'd have to arrange a home demonstration to see if they are your cup of tea.

I'm sorry not to be more definite in my answer, but you really are asking the impossible. Try the above options though, I hope that one will appeal. DB

A VINYL SYSTEM FOR ROCK

As a result of a lack of finance, work abroad and for various other reasons, my hi-fi has been sadly neglected over the years. Now I would like to bring it up to date and improve the sound quality. However, I face two dilemmas in deciding how to proceed, which I hope you will be able to resolve.

Firstly the turntable. This is a Linn LP12 which has not been updated since receiving

'Nirvana' mods years ago i.e. no Valhalla, no Lingo, no new suspension bits etc. It still has the 'S' shaped Basik arm with an A&R Cambridge P77 cartridge installed.

and to satisfy the wife a pair that 'blend into the surroundings' a bit more. I am afraid these factors may limit my choice somewhat.

The alternatives are



The REL Strata reproduces real deep bass.

I have about £800 to spend on the turntable, but the cost of bringing it fully up to date appears to exceed my budget. I was therefore wondering if I should consider junking the LP12 and going for a Gyrodec instead, as my 'final' turntable to play my 350 LPs on? The Gyrodec also has the appeal that I can keep it set up properly myself without having to have a dealer look after it as one does with a Linn. Does the Gyrodec really compare to a Lingo'd Linn?

My amp is a Naim 32/110 (old cases, 110 updated to 140 when in for repairs). The 32 pre-dates the Hi-Cap power supply and one day I may have it modified to work with a Hi-Cap, but not until my second dilemma is resolved: the speakers.

These are a pair of A&R Cambridge Arcam Ones. They are OK, if perhaps a bit thick sounding in the bass. They are mounted on open frame metal stands and my wife hates the sight of them.

Due to the room layout I need a pair of speakers that will work up against a wall

therefore small floor-standing units no larger than Tannoy 611/Naim IBL size or shelf (not stand) mounted miniatures. I would prefer the floor standing option as my taste in rock music demands more bass than one could expect from a miniature. It would also be an advantage if there was an alternative choice of finish to the usual Black Ash (again to keep the wife happy).

As to the sound I am looking for, the closer to a 'live' performance the better. I once heard a pair of Gale speakers sounding brilliant, but looking awful with chrome stands and metal grill.

Finally, looking to the future, all your articles on valve amplification have set me off wondering if, one day, I should take the plunge and go for the tubes as an alternative to having the Naim updated for a Hi-Cap, so the easier the speakers are to drive the better.

Perhaps with all the constraints of what the speakers look like/where they

Continued on page 109....





KJ WEST ONE

- the only place to buy your hi-fi !

* Better Choice * Better Advice * Better Service

+ BETTER DEALS !

We may be located in the West End of London but our customer base is nation wide. We can advise and supply by mail wherever you live in the UK. Whether you call-in or deal with us by mail or telephone you get the same deal. We charge no extra for carriage and you can still get INTEREST FREE credit.

These KJ "better deals" are available for a limited period. Don't delay - ring us today!

BRANDS STOCKED

- * Accuphase * Acoustic Energy * Albany * Apogee
- * Arcam * Audio Alchemy * Audio Innovations
- * Audion * Aura * Audiolab
- * Audio Research * B & W
- * Croid * Croft * DPA
- * Epos * Gradient * Impulse
- * KEF * Krell * Lexicon
- * McIntosh * Marantz * Martin Logan * Meridian * Michell
- * Mission * Musical Fidelity
- * Nakamichi * Nitty Gritty
- * Oreille * Pink Triangle
- * Pinar * Quad * Rogers
- * Roksan * Rotel * SME
- * Sonus Faber * Stax
- * Spendor * Systemdek
- * Tannoy * Theta * Thiel * Wacha

2 YEAR GUARANTEE

KJ extend the normal 1 year warranty to a full 2 years covering both parts & labour

DEMONSTRATIONS

We have 3 dem studios - 2 for hi-fi and one dedicated to AV/Home Cinema. Generally we arrange dem's by appointment. We recommend you ring us before traveling any distance

PAYMENT OPTIONS

We can accept payment by Mastercard, Visa or American Express credit cards, and in-store only using switch and Connect debit cards. Cash or cheque payments are still welcome.

AMPLIFIERS (INTEGRATED)

| | | |
|------------------|-----------------|-------|
| ARCAM | ALPHA 5 | £230 |
| | ALPHA 6 | £330 |
| | DELTA 280 | £450 |
| | RP1 | £400 |
| ALBARRY | KRAKEN | £399 |
| ALCHEMIST | 580 (Class A) | £999 |
| AUDIO | INNOVATIONS 700 | £999 |
| AUDIOLAB | 8000A MK2 | £450 |
| AURA | VA100 | £300 |
| MERIDIAN | 51 | £695 |
| MUSICAL FIDELITY | A1 MK3 | £329 |
| | A120 | £549 |
| | A1000 | £1399 |
| PIONEER | A300X | £230 |
| | A400X | £300 |
| ROTEL | RA930AX | £175 |
| | RA935BX | £225 |

AMPLIFIERS (PRE/POWER)

| | | | |
|------------------|---------------------|-------------|-------|
| ALBARRY | AP4 PRE | £350 | |
| | S205 PWR | £500 | |
| | AD2 PRE | £1599 | |
| | M405 PWR | £850 | |
| | M1005 PWR | £1100 | |
| | L1FRE | £299 | |
| AUDIO | INNOVATIONS 800 PWR | £849 | |
| | 1000 PWR | £1499 | |
| | L2 PRE | £899 | |
| | L3 PRE | £1599 | |
| AUDIO | RESEARCH | LS2 PRE | £2798 |
| | LS5 PRE | £5295 | |
| | DS90 PWR | £2800 | |
| | D240 PWR | £3391 | |
| | V35 PWR | £3355 | |
| | V70 PWR | £4480 | |
| AUDIOLAB | 8000G PRE | £480 | |
| | 8000P PWR | £480 | |
| | 8000M PWR | £1400 | |
| | 3030 PWR | £1085 | |
| AUDION | CHORD | SPM 800 PWR | £1095 |
| | OPM 1000B PWR | £2415 | |
| | SPM1200B PWR | £3365 | |
| | SPM2000 PWR | £4800 | |
| | DSP 2000 PRE | £499 | |
| | DPA 2005 PWR | £750 | |
| | KSL PRE | £3000 | |
| | KCA 1005 PWR | £2780 | |
| | 501 PRE | £595 | |
| | 555 PWR | £595 | |
| | 075 PWR | £1850 | |
| | ARGO PRE | £699 | |
| | ARGO HR | £1300 | |
| | ALECTO PWR | £1880 | |
| | ISO HEAD AMP | £399 | |
| | ISOHR HEAD AMP | £860 | |
| | THE PRE AMP | £220 | |
| | TYPHOON PWR | £349 | |
| MUSICAL FIDELITY | MA65 PWR | £950 | |
| | F22 PRE | £999 | |
| | F15 PWR | £1899 | |

| | | |
|----------|----------------|-------|
| McINTOSH | MC275 PWR | £3565 |
| QED | VECTOR REF PRE | £399 |
| QUAD | 34 PRE | £398 |
| | 06 PRE | £863 |
| | 306 PWR | £350 |
| | 808 PWR | £690 |
| ROTEL | RC 970BX PRE | £150 |
| | RB 070 BX PWR | £225 |
| | RC 880BX PRE | £350 |
| | RB 880BX PWR | £450 |

CD EQUIPMENT

(CDP = CD Player, CDT = CD Transport, DAC = D to A Converter)

| | | | |
|------------------|------------------|----------|------|
| AROM | ALPHA 5 CDP | £460 | |
| | DELTA 270 CDP | £800 | |
| | BL/BOX 90 DAC | £450 | |
| | DELTA 250 CDT | £750 | |
| | DAC IN A BOX | £200 | |
| AUDIO | ALCHEMIST | DL22 CDT | £795 |
| AUDIOLAB | 8000D DAC | £750 | |
| AURA | 0060 CDP | £400 | |
| BPA | LITTLE BIT 2 DAC | £450 | |
| | BIGGER BIT DAC | £695 | |
| | T1 CDT | £895 | |
| MARANTZ | CD52 MK2 CDP | £230 | |
| | CD52 SE CDP | £300 | |
| MERIDIAN | 590 CDP | £795 | |
| | 590 CDT | £975 | |
| | 563 DAC | £595 | |
| | 598 CDP | £1350 | |
| MICROMEGA | STAGE 1 CDP | £490 | |
| | STAGE 2 CDP | £800 | |
| | STAGE 3 CDP | £800 | |
| MUSICAL FIDELITY | CDT CDP | £519 | |
| OREILLE | FCD CDP | £1499 | |
| | CD100 2 CDP | £749 | |
| | CD101 CDT | £798 | |
| | DA180 DAC | £599 | |
| | ORDINAL DAC | £798 | |
| | DACAPO DAC | £1450 | |
| | DIGIT DAC | £139 | |
| PINK TRIANGLE | QED | £189 | |
| QUAD | DIGITAL OPTICAL | £829 | |
| | 67 CDP | | |

| | | |
|--------|----------------|-------|
| ROKSAN | DP2P CDP | £1485 |
| | DP2 CDT | £1285 |
| | DA2 DAC | £549 |
| | RC065BX CDP | £300 |
| | RC065 DIS CDP | £375 |
| | RC065SE CDP | £425 |
| | VRDS 10 CDP | £770 |
| TEAC | DATA BASIC CDT | £1990 |
| THETA | DATA MK2 CDT | £3290 |
| | COBALT DAC | £699 |
| | PRO PRIME DAC | £1449 |
| | PULSAR 1 DAC | £1195 |

SPEAKERS

| | | |
|-------------|---------------|-------|
| AVENERGY | AE1 | £764 |
| | AEGIS 1 | £450 |
| APOGEE | CENTAUR MINOR | £1345 |
| AURA | SF50 | £399 |
| B & W | MATRIX 805 | £845 |
| CASTLE | CHESTER | £650 |
| | HOWARD | £995 |
| EFOS | EB11 | £365 |
| | EB14 | £566 |
| IMPULSE | HE | £1350 |
| | H2 | £2150 |
| KEF | REF 103.4 | £1199 |
| | REF 105.3 | £2295 |
| MARTIN | AERIUS | £2222 |
| LOGAN | SEQUEL 2 | £3222 |
| MISSION | 700 | £190 |
| | 760 SE | £150 |
| | 780 | £200 |
| | 751 | £300 |
| | 753 | £699 |
| MONITOR | MA 201 | £250 |
| AUDIO | MA202 | £400 |
| PROAC | TABLETTE 3 | £479 |
| | STUDIO 100 | £699 |
| | STUDIO 200 | £1850 |
| | RESPONSE3 | £3060 |
| QUAD | ESL63 | £2880 |
| | SW63 WOOFER | £650 |
| | STUDIO 3 | £499 |
| ROGERS | OJAN 3 | £895 |
| ROKSAN | MINUETTO | £898 |
| SONUS FABER | MINIMA AMATOR | £1498 |
| SPENDOR | LS35a | £539 |
| TANNOY | 885 MK2 | £170 |
| | 607 MK2 | £200 |
| | 609 MK2 | £285 |
| | 611 MK2 | £430 |
| | D100 | £650 |
| | D500 | £1470 |
| | D700 | £2100 |
| THIEL | CS 1.2 | £1219 |
| | CS 2.2 | £2679 |
| | CS 3.6 | £3600 |

If you didn't find what you are looking for in the above listings, then please ask for a quotation for any item from any of the brands listed in the left hand column of this advert.

10% VOUCHER

Whatever hi-fi equipment you purchase from KJ West One before 31st May 1994, will entitle you to a voucher for 10% of the purchase value to be redeemed in exchange for tape, CD's & Accessories before 31st August 1994.

(This voucher cannot be redeemed for cash or used as a substitute for deposit payments)

Please clip this coupon and present it when making your purchase

KJ/HFW

KJ WEST ONE

26 New Cavendish St
London W1M 7LH

TEL: 071-486 8262/63
FAX: 071-487 3452

LOCATION: We are situated about 50 yards from Marylebone High Street. Roughly 10 minutes north of Bond Street tube station or 10 minutes south of Baker Street underground station

OPEN: Monday - Saturday 10am - 6pm
Thursday open until 7pm

0% APR INTEREST FREE CREDIT

6 Months Scheme - Minimum order value £400 Deposit 50% of order value plus 6 monthly payments by Direct Debit

10 Months Scheme - Minimum order value £1000 Deposit 50% of order value plus 10 monthly payments by Direct Debit

18 Months Scheme - Minimum order value £2000 Deposit 50% of order value plus 18 monthly payments by Direct Debit

.... Continued from page 107

must be positioned, am I asking too much to find a domestically acceptable efficient loudspeaker?

Budget for the speakers will be £600-£700. I know I could combine the budgets for the turntable and speakers giving enough cash to have the Linn fully updated but the speakers have got to go!

The rest of my system consists of a Nakamichi 480

modification consists of: new inner platter and spindle, main bearing housing, sub-chassis, arm board, replacement of springs, grommets and drive belt. This upgrade, which basically amounts to a whole new turntable, is a relatively affordable £285, but the old 'S' shaped arm should definitely go. The cheapest replacement would be a Rega RB250 at £100 or so. This would enable you to use a

The Gyrodec, as you point out, could easily be maintained by yourself and is a very 'fuss-free' turntable to use. The question of whether the sound could match that of the Linn is really up to you to decide on in a demonstration; it's really a matter of personal taste. Many believe that the Gyrodec is superior, but others believe the contrary. The Gyrodec would also suit the Rega RB250 + P77/DL304 combination, so you may be able to find a dealer who can do an A-B comparison for you. This combination comes to around £850 and you should get a reasonable trade-in on your Linn so both options will cost around the same.

As far as loudspeakers go Rogers' LS8a/2s are tall, floorstanding, have good, punchy, energetic bass for rock, are easy to drive should you want to use a valve amplifier in the future, available in a range of finishes and would leave £200 or so of your budget left over to go towards the rest of the system, say the latest Naim interconnects and loudspeaker cable, or some new records. They'll have to be moved out a few inches from the wall, but they should sound superb with the Naim amplifiers. **DB**

TDL BASS

My system consists of a Quad 67 CD player, Denon DRM-44HX cassette deck, Quad 34 and 306 combination for the amplification and TDL RTL 3 loudspeakers. The whole system is interconnected using Tandy gold patchcords (the ones Eric thought were good value) and Ortofon SPK200 bi-wire 'speaker cable (Dominic Baker recommended these on page 23 of the February issue).

The new speaker cables have been a recent addition after having experienced a rather boomy bass from the TDLs which strangely enough increases when listening 'off

axis'. I thought that if you guys at Hi-Fi World had got good results using this cable in your review, then why shouldn't I?

I have since purchased TDL's own spiking kit to try and isolate the boxes somewhat. The boxes themselves are quite close to a brick column which supports the fire place in the upstairs room (I live in the basement). The actual back wall is a few feet behind the rear of the speakers themselves. Could this be the cause of my over exuberant bass response? This room is also my living room and bedroom, so I don't want to have two great big speakers in the middle of the room if I can help it. The floor of the room is solid concrete and its dimensions are approx. 20ft by 15ft.

The whole tonal balance seems to improve when the bass tone control is sloped by one notch (100Hz position) on the pre-amp. This is, of course, not a perfect situation, having thrown out my graphic equaliser more than fifteen years ago. How else can I improve the bass quality of my system? Your advice would be welcomed.

After reading Dominic Baker's "Six steps to getting the best results from loudspeakers" in the February issue, I read his comment (Step 6) about 'running in' speaker cable and quietly laughed to myself at the thought of not taking the cable over 30 miles per hour on the way back from the shop. I couldn't believe how true this could be after just swapping my speaker cable from Cabletalk 3 to the forementioned Ortofon SPK200. To begin with the sound was really thin and lifeless and I began to wonder whether or not I had wasted my money. As the day progressed the sound balance gradually shifted and by switch-on the next day I was more than happy with the

Continued on page 111....



Rogers LS8a/2s offer excellent performance.

cassette deck, Creek 4040 tuner and a Sony CAR Discman, one day (who knows when) to be replaced by a 'proper' CD player.

Any advice you can give will be much appreciated.

**Mr. David E. Oddie
Saltney,
Chester.**

If you were to keep the LPI2, the money you have would be best spent in the following way. The Linn Cirkus

good, cheap moving coil, perhaps the Denon DL304, or if you want to stick with MM, your P77 is one of the best and it would be well worth getting it checked out and a new stylus fitted; both will work very well in the Rega arm. This route would cost you around £500, leaving a little spare for improvement elsewhere in the system, but as you say it'd have to be set up and regularly checked by a Linn dealer still.

SLATE AUDIO

HI-FI Design & Cable Services



THE SPEAKERSTAND Custom made to suit any loudspeaker. Solid slate, supremely rigid & totally stable. P.O.A.

"Immaculately finished, sublimely rigid, on a par with the best stands I've used."

Ken Kessler, Hi-Fi News/RR March '89
"An astonishing degree of instrumental separation, stable and holographic, with great precision and remarkable poise. The ultimate in high fidelity supports." David Praker, Hi-Fi Answers Sept. '89
"Superbly finished, the sound quality was considered to be first rate."

Martin Colloms, Hi-Fi News/RR May '90

"The sound quality when using the Slate Audio stands proved to be a revelation, something special."

"Paul Messenger, Hi-Fi Choice, May '91

"The finish is excellent, the sound quality magnificent and breathtaking."

Tom Bryant, The Telegraph, June '92

The Finest Speaker Supports In The World

GARRARD 401/301 PLINTH SYSTEM With 20 years of experience, we are the leading experts on the 401/301. Our solid marble plinths transform these decks into world class beaters.

(Free servicing and fitting) £349 + £25 p/p

THE GLASSMAT A dedicated platter mat for the Garrard 301/401 that also works with all other turntables. Sensational, unbelievable, brilliant! £49.95 + £2 p/p

SME 309/312/IV/V With special graphics "Garrard 401 Celebration"
£568.39 £660.93 £827.20 £1232.49

THE TURNTABLESLAB Solid slate spiked turntable platform, can be placed anywhere with remarkable results. Size 17" x 14" £175.00

THE TABLESLAB Solid slate shelf which replaces any other shelf normally fitted to equipment racks, dramatically improving your turntable's performance. State size £125.00

THE SPIKEKIT Specially developed to fit directly to floor standing loudspeakers or any wooden support. Adjustable and very simple to fit. £20.00

THE STONESET Spike kit for use with stone, slate or marble only. Fully adjustable. £20.00

ALL PRICES INCLUDE PACKING AND FREIGHT UNLESS OTHERWISE STATED.

(U.K. MAINLAND)

I ENCLOSE A CHEQUE/P.O. for £ _____ made payable to SLATE AUDIO

Name: _____

Address: _____

Tel: _____

47 GEMINI CLOSE, LEIGHTON BUZZARD, BEDFORDSHIRE, LU7 8UD. TEL 0525 384174

definitive audio nottingham

Tel/Fax (0602) 813562

Import/Export

WADIA, VOYD, SME, FMT, MICROMEGA, IMPULSE, AUDIO INNOVATIONS, MIRO, LIVING VOICE, HÖRNING, DALI, PIONEER, VITAVOX, LOWTHER

| | | |
|----------------------------|-------|------|
| SNELL TYPE A2 | *2500 | |
| WADIA 6 INTEGRATED CD | *2800 | 3950 |
| REVOX B215 S | *1100 | 1850 |
| AUDIO NOTE AN.J. SP. | *650 | 1000 |
| AUDIO NOTE AN.E. B. | *800 | 1400 |
| HUYGENS E.4. STANDS | *200 | 300 |
| LINN INTEK | 200 | 440 |
| LINN KAIRN - 8 MONTHS OLD | *950 | 1398 |
| LINN INDEX/KV STONE | 185 | 370 |
| LINN LK 400 S/CABLE | 50 | 80 |
| LINN AXIS/AKITO | 350 | |
| IMPULSE H5 ASH, NEW | *1350 | 1850 |
| FULLER'S AUDIO SULTAN | *190 | 400 |
| KELVIN LABS INTEGRATED | 300 | |
| SME 310 AUDIONOTE (SILVER) | 590 | 800 |
| SME 3009 | *100 | |
| MICROMEGA LEADER ex-dem. | *400 | 750 |
| LEAK TL 10. ORIGINAL | 700 | |
| NVA M.C PHONO STAGE | 180 | 250 |

SOUND ORG. • TRIPOD • SOUND STYLE • HUYGENS • JPW - STANDS AND EQ SUPPORTS:- WIDE VARIETY OF STYLES. *P.O.A.

ALL PRICES EXCLUDE CARRIAGE, WARRANTY ON PRODUCTS MARKED*

| | | |
|-----------------------------------|--|--------|
| VITAVOX COMPONENTS PRICES | | |
| RH300 MID RANGE 4-CELL DISPERSIVE | | 253.80 |
| S2 MID RANGE PRESSURE DRIVER | | 719.10 |
| S5 MID RANGE PRESSURE DRIVER | | 479.40 |
| AK 157 BASS UNIT 15" | | 554.60 |

| | | |
|---------------------------|--|--------|
| LOWTHER COMPONENTS PRICES | | |
| PM 6A | | 180.00 |
| PM 7A | | 220.00 |
| PM 2A | | 240.00 |
| PM 4 | | 420.00 |
| PM 6C | | 130.00 |
| PM 2C | | 160.00 |

SYSTEMS FROM £1,200 TO £40,000
IMPORT/EXPORT/OVERSEAS ENQUIRIES WELCOME

PHONE OR FAX DIRECT 0602 813562



CAMBRIDGE
HI-FI LTD

NATIONAL HI-FI
DEALER OF THE
YEAR - 1987/88

1-3 HAWTHORN WAY,
CAMBRIDGE
CB4 1AT.
TEL. 0223 67773
FAX. 0223 353741

BOSE, KEF,
PIONEER,
MARANTZ,
KENWOOD,
B&W, TECHNICS,
JAMO,
MORDAUNT
SHORT, YAMAHA

AV Prologic
Separates &
Systems
40" Pioneer
projection screen
on AV Demo

WIDE RANGE OF
LASER DISC
SOFTWARE
LATEST
AMERICAN &
BRITISH TITLES

1/2 PRICE LASER
DISC PROMOTION
NOW ON

WESTWOOD
&
MASON

for quality
hi-fi in
Oxford

We stock:

Arcam • Aura
• Denon • Epos
• Marantz •
Mission •
Monitor Audio
• Naim • Quad
• Rega • Royd
• Tannoy •
Yamaha etc...

0865
247783

WESTWOOD
&
MASON
46, George St.
Oxford

(Closed Thursday's)

... Continued from page 109

sound quality. It could have been me getting used to the sound but no, I think I trust my ears more than that.

By the way, when are you going to produce another one of those great CDs? Keep up the good work!

J. Buckley
Wakefield,
W. Yorkshire.

We had a quick word with John Wright of TDL on this

positioning be impossible, then there are some tricks that can be resorted to. Try putting a bipolar electrolytic (non-polarised) capacitor of 470µF-1000µF in series with each speaker to reduce the bass - you'll need to experiment with the value. Alternatively, remove the bi-wire links and take the signal leads direct to the upper treble unit terminals. Connect the red treble terminal to the red bass terminal below it through a

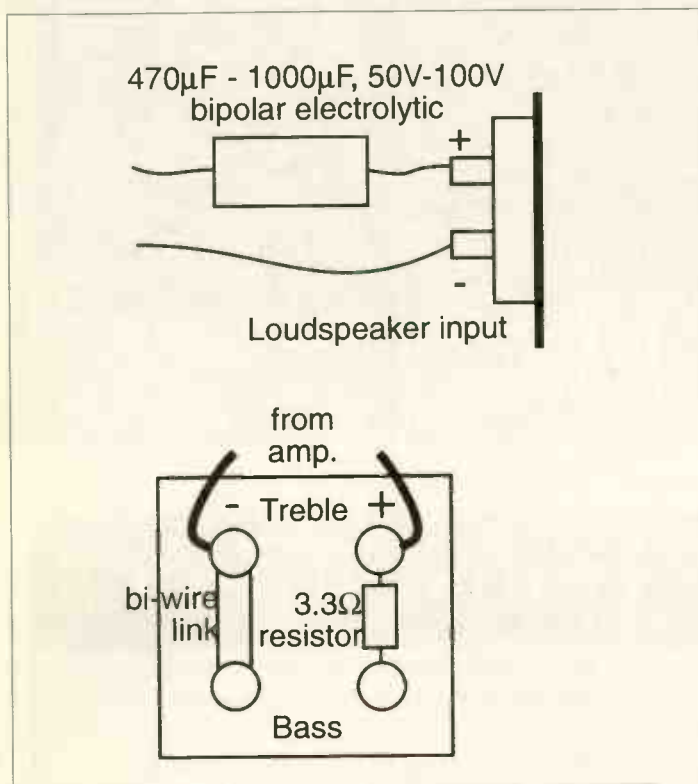

Bass output of the TDL RTL 3s can be reduced in two ways.

one, since he's been designing loudspeakers longer than most and knows the problems.

John felt that in your room a metre (3ft or so) between the loudspeaker and the rear wall was about right and that you should have them facing along the length (longest dimension) of the room. We both felt that your Quad 306 wasn't ideal for these speakers; it will not sound 'tight'. However, it does have light-ish bass, so at least you will not be suffering accentuation from this source.

Should optimal

3.3Ω, 7W resistor. This will reduce the signal to the lower bass/mid section by around 1dB or so, bass being reduced more than midband due to the rising impedance of the midrange unit. Don't worry about the electrical damping, as many people do, because there's an inductor with DC resistance in it in series in any case and, as KEF point out, the electrical damping component in any loudspeaker is of less influence than the acoustic and magnetic components.

The values quoted above are good starting points. You may well need to experiment

before you find the solution that suits your circumstances best. Specialised capacitors and resistors of the sort required can be obtained from The Speaker Co. (0625-500507) or Wilmslow Audio (0565-650605). **NK**

MATCHING AN AMC CVT3030

Unlike most of your correspondents, I have recently completed a near total upgrade of my hi-fi system (only the tuner remained the same). I am writing to you in the hope that you might be able to advise me on a sensible continuation path, as you seem to use the same sort of gear as I purchased.

The relevant equipment for my query is: Michell Mycro, RB300 am, Goldring 1012 cartridge; AMC 3030 amp; Ruark Broadsword loudspeakers (new crossover and set up to bi-wire). Speaker cable is Audioquest type 4.

As someone who cannot leave well alone, I am already considering how the system can be fine tuned. The cartridge is about a year old and ripe for renewal shortly. Any suggestions? Perhaps just a new stylus, or a full upgrade; I'd rather not go down the moving coil/pre-amps road just yet.

Of rather greater concern is the perceived response of the speakers; despite doing many of the 'right things' I cannot help but feel they are not ideally suited to the amp. The balance seems to be a little too heavily weighted towards the bass/mid range at the expense of a light, active top end. The amp also seems to have to work quite hard to drive them; there is a lack of 'ease' about the response. I tried a pair of Snell Ks (yes, really) and had the reverse problem of all top and no depth elsewhere. I can't have floorstanders as it is a low

ceiling'd cottage and feel that more sensitive speakers would suit the AMC better. I recently had the chance to audition a pair of Linaeum speakers and was impressed.

My tastes are almost exclusively jazz, with some classical and I'd rather not break the bank (say up to around £750). Any thoughts on system enhancement gratefully received.

Rod Bushell
W. Wratting,
Cambs.

We've heard good reports of the Linaeum, with its ribbon tweeter. They are imported by Absolute Sounds, who told us there would be no trouble with matching to your amplifier. The other speaker we recommend for valve amplifiers is the Heybrook Quartet, because its excellent balance of qualities have broad appeal. It's an energetic sounding stand-mounter with a revealing midband, easy soft-dome treble and fullsome bass. The price is about right for you too.

The simple answer to your cartridge upgrade query is to buy a new uprated stylus from Goldring, since the 1000 Series share the same body. **NK**

Not quite as sensitive as the Quartets, but excellent all the same, are the ProAc Studio 100s. They are a lively, bright sounding loudspeaker and image particularly well. They should perform superbly with the AMC. **DB**

TIME FOR AN UPGRADE?

I should be glad of your advice as to replacement speakers for my existing elderly 'set up' which comprises two Quad II amplifiers and control unit, a recently added Quad CD player and two Lowther Acousta speakers. Other than the CD player, these all date

Continued on page 113....

The SPEAKER Company

For all your needs in DIY speaker and crossover construction

We offer a large range of speaker chassis and crossover components for hi-fi, car audio, public address & studio uses. The Speaker Company also offers a range of specialist services.

Hi-Fi chassis speakers, crossover's, cabinet kits, cable, cabinet damping materials, spike kits etc

Car Audio chassis speakers, crossover's, sub bass cabinets and amplifiers.

Public Address chassis speakers, crossover's, mixers, amplifiers, cabinets, microphones and stands.

Plus a comprehensive range of accessories

Chassis speakers by

Audax, Seas, Morel, Rcf, Kef, Elac, Rcl, Richard Allan, Fane, McKenzie, Celestion, Eminence, Peerless, Volt, Altai, Soundlab, P.H.L. Please phone or post for a copy of our free comprehensive catalogue and price list which includes hints and tips on DIY loudspeaker construction.

Unit 9, Waterside Mill, Waterside
Macclesfield, Cheshire SK 11 7HG

Tel: 0625-500507

Fax: 0625-500508

All goods dispatched within 24 hours subject to availability

Open 9 am to 6 pm Monday to Friday & 9 am to 5 pm Saturday

The North West's
Big New

 naim
audio

Dealer

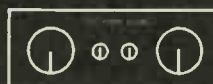

NAIM, RUARK, ROGERS, EXPOSURE, MF,
TANNOY DEFINITION, CREEK, MARANTZ, ROTEL,
TECHNICS, CASTLE, PRO-JECT, TEAC, PINK TRIANGLE.
5 Demonstration rooms.

Open: Mon-Sat 9.00am - 5.30pm
Closed: Wed.

The
Hi-Fi
Showrooms

12a West Street, Congleton,
Cheshire, CW12 1JR.
Tel (0260) 280017

EXPLOIT THE FULL POTENTIAL (and more) OF THE LINN LP12 Turntable

For Only
£568.00 inc.

(Cost much less than a Lingo)

with
Avondale Audio's

Very Naughty (but Stunning) Conversion

For a chat
Tel: (0246) 200096

Please note that we are no longer able to reply to enquiries in writing.

Transformers

Input and Output Transformers designed and manufactured to your requirements, at our OEM prices...

KT66 Single ended valve mono block power amps... **£250.00 pair**

Valve phone stages **MM.. £100.00**
MC.. £135.00

Valve phono stage design sheet, parts and price list.
UK - £3.00 cheque or PO.
Overseas - US \$5.00 in \$ bills only

The Garrard 301/401 power supply 100/130 volt setting.... **£64.45**

All units are fully assembled and tested.
Prices include delivery and VAT
2 week money back guarantee

SAE for data sheets

F&S Trading
31 Brooks Road
Sutton Coldfield
West Midlands B72 1HP
Tel/Fax: 021 - 321 3357

.... Continued from page 111

Quad IIs have been serviced several times by Quad. The turntable is a Dual 1229 with Shure cartridge, but although I have a large collection of LPs my priority now is for my growing CD collection. My musical interest is exclusively classical.

I do not really want to replace my valve Quads which with the right speakers I feel can still give very acceptable results to a non-expert such as myself. The expense of a complete replacement is not worthwhile if an adequate improvement can be achieved by replacing the aged Lowther speakers, which I believe no longer give good enough performance by modern standards, especially in the bass range, although in their 'day' I have felt that they otherwise give a very 'true' sound.

Quad ESLs, which I understand have to be sited at a distance out from a back wall and against a side wall, would not fit into the sitting room environment where my set-up has to be located. The room measures approximately 24' x 18'. I am prepared to spend an equivalent amount on an alternative to ESLs, which preferably should be floor standing rather than on pedestals.

I have recently received a number of brochures from an apparently revived Lowther organisation relating to their new speakers in the Logic series, a copy of which brochure I enclose, and in the Fidelio series, the Fidelio and the Academy, the styling of which I prefer because they are floor standing. All are said

to be acoustic horn type, as are my present speakers, and appear to be the only speakers currently using this method. Is it perhaps now obsolete? Much play is made of their incorporating the Bico system and Hi-Ferric Coil Control.

I have also obtained brochures of the ATC SCM 10 and 20 speakers by Bill Woodman, which however require stands, and the Monitor Studio Series, Number 20 of which is floor standing and which is

produces just 12watts. You cannot match an amplifier of such low output to ATC loudspeakers, for example, which are known for their insensitivity, especially in such a large room. You'll get very little volume.

A sensitive (90dB for 1watt) conventional loudspeaker that should suit the Quad II is the Cabasse Prao (£480). Ideally though, you need even higher sensitivity and there few options available. Our own KLS-2 (94dB for 1watt) was

sure you will find interesting. We'd suggest you try to get a demonstration before you part with your Lowthers and Definitive said they would part exchange them too. **NK**

The obvious starting point is to replace the drive units in your Acoustas with current PM7As (£440). This will then exceed the performance of most contemporary designs. The bass, if not extended, will be fabulous, and the 100dB/watt sensitivity will combine very well with the

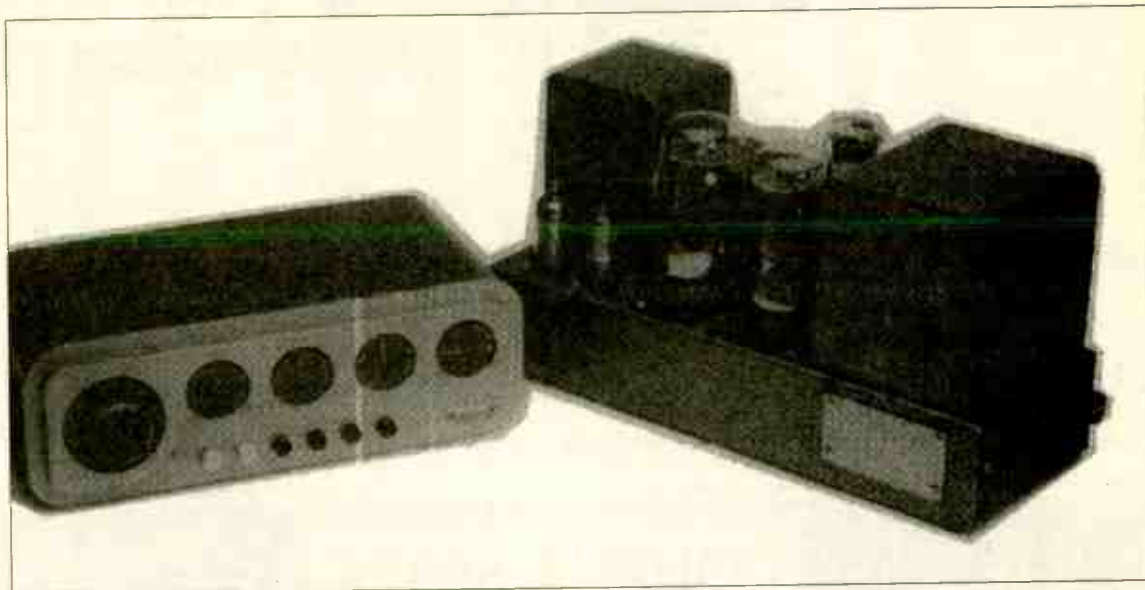

The Quad IIs need sensitive loudspeakers.

therefore the most suitable in this respect.

I should be most grateful if you could advise as to which of these speakers is likely to provide the best replacement and upgrade for my existing speakers, or what other alternative you would suggest. I would be especially interested in your opinion of the new Lowther speakers in the present day even though they may not be the first choice now.

H.W. Garrod Woodton, Bungay, Suffolk,

The problem you face is one of limited power output from the Quad IIs. By all means keep it, since this power amplifier does provide a very sweet, if mellifluous sound, yet it

made just for this purpose, but is now available only as a kit (£195) comprising drive units and crossover components, without wood panels, so you would need to be handy with a saw.

That is about the limit of conventional speakers available to you. However, your Lowther Acoustas are highly distinctive in their sound and have some unusual strengths. In consequence, you may find conventional loudspeakers difficult to adjust to and possibly disappointing too, so tread carefully.

Definitive Audio in Nottingham stock a good range of valve amps and compatible loudspeakers, as well as making Living Voice speakers, which use Vitavox drive units. They provided the following view, which I'm

Quad II. This will leave funds for the Audio Innovations 200/L2 pre-amp to replace your existing control unit - a big improvement.

If the refurbished Acoustas fail to satisfy, you have a saleable design that you could part exchange against the wider bandwidth, more even 95dB/watt Horning Agathon (also using Lowther drive units).

Ideally however, you should throw caution to the wind and achieve the full concert hall experience with the Quad IIs driving the Living Voice 'Tone Scout' (104dB/watt), a three-way horn that will make the most of your 24ft x 18ft room.

Kevin Scott Definitive Audio, Nottingham. ('phone 0602-813562)

HAD A BETTER QUOTE?
THEN PHONE US AND SEE
WHAT WE CAN OFFER
YOU !!!!!

R.S.AUDIO MAIL ORDER CENTRE

☎ 071-255 1403/071-255 1503

FREE DELIVERY!!!

TO ALL CUSTOMERS
PAYING BY CHEQUE/P.O

| | | |
|---------------------------------------|-------------------|---|
| KENWOOD DP7050 £279 | CD PLAYERS | |
| MARANTZ CO-52 II £SALE | AIWA KENWDDD | XC300 £129 DP2050 £135 DP3050 £159 DP5050 £215 DP7050 £279 DPM6650 £215 |
| MARANTZ CO-52 IISE £SALE | MARANTZ | CD42II £SALE CD52II £SALE CD52II SE £SALE |
| KENWOOD KA3020 £135 | NAD | 502 £SALE 504 £SALE 505 £SALE |
| NAD 302 £SALE | PIDNEER | PD102 £122 PD202 £139 PDS502 £189 PDS702 £220 PDS802 £245 PDS901 £409 CDP311 £140 CDP411 £175 CDP335 £200 CDP711E £200 CDP911E £260 |
| PIONEER A-400X £229 | TECHNICS | SLPG340 £120 SLPG440 £149 SLPG520 £157 SLPS620 £163 SLPS740 £205 SLPS900 £285 SLPS840 £340 SLPS2000 £810 |
| KENWOOD KRV6050 £SALE | DAT | |
| | SDNY | DTC750 £SALE DTC690 £SALE |
| | TUNER | |
| | NAD | 402 £SALE |
| | SDNY | STS211 £115 STS311 £SALE |
| | TECHNICS | ST610 £110 |
| | AMPLIFIERS | |
| | KENWDDD | KA1030 £110 |

| |
|--|
| KA3020 £135 KA3050R £165 KA4050R £220 KA4050R £280 KRA4050 £185 PM44SE £SALE NAD 302 £SALE 304 £SALE 306 £SALE PIDNEER A-102 £105 A-202 £139 A-300X £175 A-400 £215 A-400X £229 A-602 £285 SDNY TAF211B £130 TAF442B £219 TAF542E £260 TECHNICS SUV2220K £110 SUA600K £165 SUA700K £205 SUA800K £270 SUA900K £SALE |
|--|

| |
|---|
| PIDNEER KX-90505 £435 " " 20 £139 CT-S320 £165 CT-S420 £205 CT-S520 £230 CT-S820 £269 CT-S920 £515 SDNY TCXF211B £87 TCX311B £130 TCK411B £175 TCK511S £SALE TCW435B £150 TCWR535B £175 TCWR635B £260 TECHNICS RSBX404 £155 RSBX646 £187 RSBX747 £245 RSTR232 £155 RSTR333 £169 RSTR515 £210 RSTR777 £245 RSTR979 £309 |
|---|

| |
|--|
| KENWDDD ADAGID S4 £395 ADAGID S6 £505 ADAGID G7 £670 ADAGID G9 £840 UD301 £355 UD501 £499 UD551M £529 UD701M £609 UD751M £649 UD901 £810 UD951M £850 PIDNEER N-33 £320 N33M £365 N-53 £425 N-53M £465 SDNY MHC-510CD £339 MHC-710CD £399 MHC-2800CD £485 MHCC-60CD £440 MHCC-70CD £530 TECHNICS SC-CH404 £SALE SC-CH550 £SALE SC-CH650 £SALE SC-CH665 £SALE SC-CH750 £SALE SC-CH950 £SALE |
|--|

| |
|-----------------------|
| MISSION 760I £SALE |
|-----------------------|

| |
|--------------------------|
| MISSION 760I SE £SALE |
|--------------------------|

| |
|----------------------|
| BOSE AMS-II £SALE |
|----------------------|

| |
|-----------------------|
| SONY STS311B £SALE |
|-----------------------|

| | |
|---|--|
| RECEIVERS/AV AMPS | |
| KENWDDD KRV6050 £SALE KRV7050 £SALE KRV8500 £SALE MARNATZ PM700V £SALE PIDNEER VSA701S £379 VSA802S £455 SDNY STRD390 £165 STRD590 £205 STRD790 £315 TAAV570 £349 TECHNICS SAGX130 £195 SAGX230 £229 SAGX550 £365 | |

| | |
|---|--|
| LOUDSPEAKERS | |
| BOSE ACJUSTIMASS 3 £SALE BOSE ACJUSTIMASS 5 £SALE BOSE ACJUSTIMASS 7 £SALE XL1000 £SALE XL2000 £SALE XL4000 £SALE JAMD CENTRE 100 £SALE CENTRE 200 £SALE MISSION 760I £SALE 760ISE £SALE 761I £SALE 762I £SALE 780 £SALE NAD 602 £SALE | |

| | |
|---|--|
| MIDISYSTEMS | |
| AIWA Z-720 £345 Z-D3000M £520 JVC £SALE KENWDDD M-27 £440 M-47 £449 M-56AG £649 M-76AG £770 M-97G £970 PIONEER J-10 £459 J-10M £499 J-20 £539 J-20M £580 SDNY CDMPACT109CD £SALE CDMPACT159CD £SALE CDMPAC T209CD £SALE TECHNICS £SALE | |

| |
|------------------|
| NAD 402 £SALE |
|------------------|

| |
|----------------------|
| AIWA ADF810 £SALE |
|----------------------|

| |
|-----------------------|
| SONY TCK611S £SALE |
|-----------------------|

PRICES SUBJECT TO
CHANGE WITHOUT
NOTICE
BUT ARE CORRECT AT
TIME OF GOING TO PRESS

10-12 HANWAY STREET, LONDON W1P 9DD
Turn Left from Tottenham Court Road Tube Station

COURT & SPARK

**RHODIUM PLATED MK
MAINS PLUG FOR A
LONGER LASTING
CLEAN CONTACT.
SUPERIOR GOLD
RHODIUM WILL LAST
TEN TIMES LONGER!!**

13 Amp £12.95
15 Amp £14.95

Wall Socket
Single £20.95
Double £30.95
I.E.C. Plug 9.95

(p+p included)

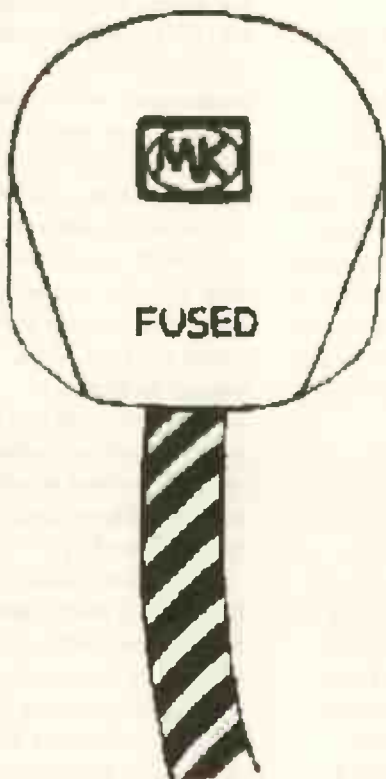

**TO ORDER SEND
CHEQUE/POSTAL
ORDER WITH NAME
AND ADDRESS MADE
PAYABLE TO:**

**T. WESTERMAN
41 GREVILLE STREET
HATTON GARDEN
LONDON EC1**

TEL. 071 - 242 2329

CREATIVE AUDIO

9 DOGPOLE, SHREWSBURY, SHROPSHIRE. Fax: (0743) 271010 Tel: (0743) 241924 (Closed Mondays)

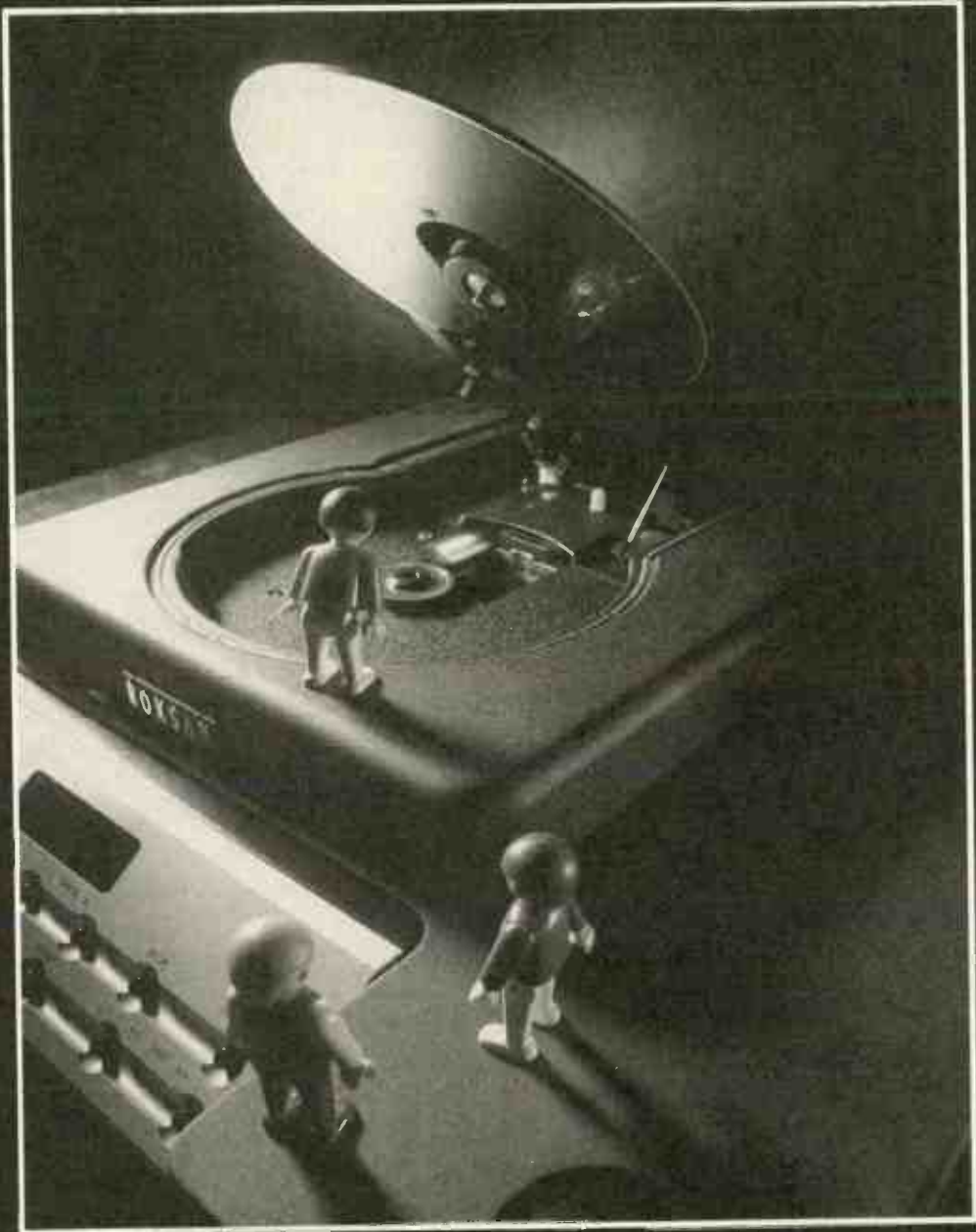

“It’s life Jim...but not as we know it”

Roksan’s CD player boldly goes where only the best in analogue has gone before. Available in two or three-box form, the Roksan sets new standards at the price. Alternatively the DP1 can be partnered by Audiolabs excellent 8000 DAC. Hear them all alongside the Naim CDI & Meridian 200/263.

Authorised retailer for:

ARCAM · AUDIOLAB · CELESTION · CYRUS · DENON · EPOS · KEF · MERIDIAN
MISSION · NAIM · QUAD · REGA · ROKSAN · ROTEL · RUARK · SOUND ORGANISATION
TRIPODS

AUDIO NOTE

AUDIO NOTE AUDIO COMPONENTS PARTS & PRICE LIST.

We have decided to offer a range of the ultra high quality components used in most of the Audio Note amplifiers to the discerning "do-it-yourself" valve amplifier enthusiast. These components include specially made valve bases, paper in oil signal capacitors, copper & silver foil signal capacitors, Black Gate graphite electrolytic capacitors, acid/corrosive-free silver solder, audio output transformers, valves and many other useful bits for upgrading old or constructing new valve amplifiers.

All prices are excluding Vat, which, if you live inside the EEC will be added to your purchase, after the addition of postage and packing costs.

We accept VISA, Mastercard, Access, Diners, and Amex. to pay this way, we will need your address, card no. with start and expiry dates, you can also pay by bankers draft, Eurocheque or cheques drawn on a UK bank account. Please note that there is a minimum charge on credit card transactions of £20.00.

Delivery is normally about 7 days from receipt of cleared funds, but please allow up to 60 days for some items. If not stock at the time or order.

If any of you reading this have possession of any books which contain information relevant to the subject of Audio Design and which would be useful to share with others, please let us know either by fax or telephone. There is an award of £20.00 (payable in valves or other bits, post free) to anybody who sends us a book which contains useful information about valve amplifier design or theory.

Circuits, Valve Data & Basic Technical Information.

If you would like some suggestions to base a future project around, then we shall be happy to provide you with a circuit pack containing good circuits like ONGAKU, KEGON/KASSAI, NEIRO, GAKU-ON plus several other power amplifier circuits and the M7Tube pre-amplifier, which is the best pre-amplifier circuit we have come across. Just send a stamped self addressed A4 size envelope, together with £5.00 in small denomination, or if you live outside the UK a US\$ 15.00 in \$ bills will do, please do not send International Response Coupons or International money orders, as they cost more to cash than their value.

We can also supply a set of data sheets for the most commonly used valves, ECC82, ECC88/6922, 12AY7/6072A 7025/12AX7WA/ECC83, 6SN7, 300B, 211V14C, 845, EL34/6CA7, 2A3, 6X4, 5U4G, GZ34/SAR4, EL84/6BQ5, 6V6GT, 6L6G, 5881/6L6WG/6L6G. Again send a stamped self addressed A4 envelope together with £4.00 in small denomination stamps or if outside the UK another US\$ 10.00 will suffice.

Since nothing really exists which gives a reasonable background to the subject of valve amplifier circuit design, Guy Adams and I have written and assembled a number of articles and extracts from old books which give some background to the subject, do not expect to become an instant expert, but it will serve as a useful reference, for the beginner as well as the more advanced, we have expanded this info-pack to include even more useful information, so if you have already bought the old pack, just send £2.00 or US\$ 5.00. For the full pack a small charge is required, this time £7.00 in small denomination stamps with a stamped addressed envelope, or outside the UK, please send US\$ 25.00.

We do accept a UK cheque or bankers draft in Pound Sterling for the above charges as well

SOUND PRACTICES.

If you are seriously interested in the subject of valve amplifier design, without the usual preconceived notions of what is "good" amplifier design and technology (the traditional view, which has brought us the blessings of the transistor amplifier, has obviously disqualified itself quite monumentally), then SOUND

PRACTICES is the magazine to read, here you will find articles about design parameters, DIY articles for amplifiers and speakers, reviews of new and old. In other words the very subjects that none of the self-serving, advertising led traditional press will touch as they do not enhance the business of their normal advertisers. You can buy SOUND PRACTICES from us at £5.00 per copy (there are currently 4 issues available) or by subscription from SOUND PRACTICES P. O. Box 19302, Alexandria, VA 22320, USA. A regular modern world bargain, and there are practically none of those in Audio today. With enough subscription support SOUND PRACTICES may just bring about the "sound practices" that the hi-fi industry has abandoned for so long. So get a subscription!

OUTPUT TRANSFORMERS.

Specifications:

PP = Push-Pull, PPP = Parallel Push-Pull, SE = Single-ended, PSE = Single-ended Parallel, UL signifies 43% ultralinear taps, as a general rule we do not condone the use of UL-taps, as we consider these detrimental to sound quality. ** Dynaco replacement.

All primary impedances are calculated for Class A operation the main consideration given to maximum dynamic power transfer ability and minimum distortion, rather than meaningless steady state sine- or squarewave conditions.

All our single-ended output transformers are airgapped, and the maximum standing current allowed before saturation is shown in column 5.

All our output transformers have a frequency response well beyond the audible range, typically 20Hz - 40KHz minus 1.5dB, all are IEC-cored with high grade silicon steel laminations, wound with oxygen-free copper wire and supplied with either bell-ends or frames, both with flying leads.

We generally overspecify our transformers by 50% power in Push-Pull (which means that a transformer stated as 25 watts will allow about 35-38 watt peaks, our single-ended outputs are generally over specified by 100%, which means that they will instantaneously allow peaks of double the given maximum power through undistorted.

We do not give any further technical information on our output transformers, as we do not wish to take part in technical competitions, our products are designed to criteria which are and will be understood once they are listened to!

In addition to the output transformers offered below, we offer a design service, where we can supply almost any requirement for wideband transformers, whether for microphones, moving coil cartridges, line input, phase splitter, interstages, driver or power output, we design and manufacture prototypes in-house, the cost for the paper design is £200.00, prototype cost is calculated on a per case basis. We can also produce production quantities.

Sizes are given as Width/Height/Depth, where depth is the depth of the coil itself and width is the length of the core.

PAPER IN OIL SIGNAL CAPACITORS

These handmade signal capacitors are sonically superior to any of the plastic or other paper types we have come across. If you have never experienced the difference that a really good paper/oil capacitor can make in a valve amplifier, then you really should try. Our specially made paper/oil caps have a life, colour, lack of harshness and evenness of dynamic behaviour across the frequency range, which is guaranteed to brighten up your day! Recommended as replacements in old and new valve amplifiers alike (and even in the odd transistor amplifier), and essential for DIY projects. In line with environmental standards, all AUDIO NOTE paper in oil capacitors contain only non-toxic, biodegradable vegetable oil, the paper is specially treated and

impregnated by a method that ensures longevity and sound quality, to enhance optimum performance all round.

| Value | DC Voltage | Size | Price ex. UK Vat |
|----------|------------|----------|------------------|
| 0.015mF | 400volt | 21x9mm | 2.85 |
| 0.022mF | 400volt | 35x10mm | 3.75 |
| 0.047mF | 400volt | 32x11mm | 4.10 |
| 0.082mF | 400 volt | 33x14mm | 4.25 |
| 0.12mF | 400 volt | 33x14 mm | 4.75 |
| 0.18mF | 400volt | 32x16 mm | 5.15 |
| 0.22mF | 400 volt | 35x18 mm | 5.85 |
| 0.33mF | 400 volt | 43x18 mm | 6.75 |
| 1.4mF | 400 volt | 70x24 mm | 14.95 |
| 0.0015mF | 630 volt | 17x9 mm | 2.85 |
| 0.022mF | 630 volt | 20x10 mm | 3.25 |
| 0.082mF | 630 volt | 33x16 mm | 4.55 |
| 0.18mF | 630 volt | 43x18 mm | 5.45 |
| 0.22mF | 630 volt | 52x19 mm | 5.75 |
| 0.33mF | 630 volt | 52x22 mm | 7.25 |
| 0.39mF | 630 volt | 52x26 mm | 7.95 |
| 0.47mF | 630volt | 52x26mm | 8.85 |
| 0.22mF | 1000 volt | 56x26 mm | 6.95 |
| 0.39mF | 1000 volt | 61x26 mm | 11.65 |
| 1.2mF | 1000 volt | 72x40 mm | 16.75 |
| 0.22mF | 1600 volt | 60x26 mm | 9.65 |
| 0.22mF | 2000 volt | 70x29 mm | 11.55 |

All Audio Note paper in oil signal capacitors are axial type. We are preparing a range of very small picolard value paper in oil capacitors at the moment in addition to the above. The range of AUDIO NOTE paper in oil capacitors is steadily expanding, so ask for values that you do not see.

PAPER IN OIL COPPER FOIL SIGNAL CAPACITORS.

We are currently developing a range of paper in oil capacitors where instead of using aluminium foil as in the above paper caps, we use an oxygen free copper foil with 99.99% pure solid silver lead out wires, these copper foil paper signal capacitors are considerably better than standard offerings. Secondly to "bridge" the price-quality gap between the more standard paper/oil caps and the Japanese handmade silver foil signal caps, we will be offering our own 99.99% pure silver foil signal caps, which are pretty staggering in quality, even if I have to say this myself (as I am the only one to have heard the samples so far) the silver foil caps will also have solid silver lead-out wires. To start with there will be a few values/voltages available.

AUDIO NOTE SILVER FOIL SIGNAL CAPACITORS.

Best signal capacitors available, quality really speaks for itself, used in amplifiers like ONGAKU, KEGON, GAKU-ON and M7tube Silver, handmade in very limited quantities at Audio Notes facility in Tokyo, Japan.

| Value | DC Voltage | Price ex. UK Vat. |
|--------|------------|-------------------|
| 0.02mF | 500 volt | 211.75 |
| 0.05mF | 500 volt | 346.75 |
| 0.1mF | 500 volt | 645.75 |
| 0.2mF | 500 volt | 995.75 |

AUDIO NOTE PAPER IN OIL RESERVOIR

CAPACITORS. Mainly for use in inductor power supplies, but have other uses.

| Value | DC Voltage | Size | Price Ex. UK Vat. |
|-------|------------|----------------|-------------------|
| 2mF | 400 volt | 30x40x55 mm | 26.75 |
| 2mF | 630 volt | 35x45x72 mm | 33.65 |
| 2mF | 1000 volt | 45x45x72 mm | 41.75 |
| 2mF | 1600 volt | 50x70x72 mm | 45.95 |
| 4mF | 1000 volt | 45x45x120 mm | 49.95 |
| 4mF | 2500 volt | 70x70x120 mm | 265.75 |
| 10mF | 1000 volt | 70x100x100 mm | 96.75 |
| 12mF | 1000 volt | 70x100x120 mm | 109.95 |
| 12mF | 1600 volt | 100x100x120 mm | 136.75 |
| 12mF | 2000 volt | 100x100x220 mm | 159.75 |

AUDIO NOTE ACID & CHLORIDE FREE SILVER SOLDER.

The best solder we have been able to find, does

not contaminate the junction, which over time increases junction resistance. Used in all our amplifiers from OTD to the GAKU-ON.

| Weight/Measure | Price Ex. UK Vat. |
|---|-------------------|
| 50 grammes or about 8 meter 1 mm diameter | 19.95 |
| 1 kilo roll of 1 mm diameter | 210.65 |

AUDIO NOTE CABLES & WIRES.

We are proud to offer the AUDIO NOTE range of high quality copper and silver coax, speaker and wiring cables, which, depending on the overall price of the project will do justice to any hi-fi system, regardless of price.

Solid 99.99% Pure Audio Note Silver Wire.

| Gauge | Insulation Material | Price per Meter Ex. UK Vat. |
|--------|---------------------|-----------------------------|
| 0.05mm | Polyurethane | 16.75 |
| 0.2mm | Polyurethane | 22.75 |
| 1 mm | ML | 36.75 |
| 0.35mm | ML | 24.95 |
| 0.6mm | ML | 27.85 |
| 0.8mm | ML | 31.75 |

The above solid silver wires are suitable for inductors for speaker crossovers, both active and passive or for internal wiring in tonearms, amplifiers etc.

AUDIO NOTE HIGH QUALITY STEPPED ATTENUATORS & SWITCHES.

These handmade attenuators and switches are manufactured by a friend of Mr. Kondo of AUDIO NOTE, and represent the best available volume controls and switches you can use in your pre-amplifier, the attenuator is 48 steps and with silver/rhodium plated contacts/brushes made with an array of tantalum film resistors. The switches feature silver plated contacts and self cleaning action.

| Type | Value | Price Ex. UK Vat. |
|----------------------|--------------------|-------------------|
| Stereo Potentiometer | | |
| /Attenuator 50KOhms | | 198.75 |
| Stereo Potentiometer | | |
| /Attenuator 100KOhms | | 207.75 |
| 2 Channel switch | 6 - way adjustable | 78.75 |
| 4 Channel switch | 6 - way adjustable | 101.75 |

AUDIO NOTE HIGH QUALITY CERAMIC VALVE BASES

All of our valve bases are of the highest possible metal, made from steeltite and using the best metal parts from alloys which retain their spring tension around the valve pin for longer. They are recommended as upgrades to most old valve amplifiers and should be an essential part of any DIY project.

| Type | Mounting | Plating | Price Ex. UK Vat | |
|--|---------------|------------|------------------|------|
| 4-pin UX4 for 300B | | | | |
| /2A3/801A Chassis | Gold | | 8.25 | |
| 4-pin UX4 for 300B | | | | |
| /2A3/801A Chassis | Nickel | | 7.25 | |
| 4-pin UX4 WE-type for 300B/2A3/801A Chassis | Silver | | 14.75 | |
| 4-pin Jumbo 4 for 211/VT4C/845 Chassis | Silver/chrome | | 159.95 | |
| 5-pin UY5 for 807 | Chassis | Gold | 9.75 | |
| 7-pin B7 for 6X4, OA2 | PCB | Silver | 6.15 | |
| 7-pin B7 for 6X4, OA2 | PCB | Gold | 7.85 | |
| 7-pin B7 for 6X4, OA2 | Chassis | from above | Silver | 6.75 |
| 7-pin B7 for 6X4, OA2 | Chassis | from above | Gold | 7.95 |
| 8-pin UX8 for EL34, 6550, 5U4G, GZ34, 6L6G, etc. | Chassis | Silver | 5.65 | |
| 8-pin UX8 for EL34, 6550, 5U4G, GZ34, 6L6G, etc. | Chassis | Gold | 8.65 | |

| | | | | |
|--|------------|------------|--------|------|
| 9-pin B9 for ECC83, ECC88, 5687, 6350, etc. | PCB Silver | | 3.85 | |
| 9-pin B9 for ECC83, ECC88, 5687, 6350, etc. | PCB Gold | | 5.75 | |
| 9-pin B9A for ECC83, ECC88, 5687, 6350, etc. | Chassis | from above | Silver | 4.45 |
| 9-pin B9A for ECC83, ECC88, 5687, 6350, etc. | Chassis | from below | Silver | 4.95 |
| 9-pin B9A for ECC83, ECC88, 5687, 6350, etc. | Chassis | from below | Gold | 7.15 |
| Topcap for 807 pentode | | | Nickel | 9.75 |

You may want to start your project with less overall cost, and for this purpose we can offer the following industrial grade ceramic valve bases.

| Type | Mounting | Price Ex. UK Vat. |
|---|---------------------|-------------------|
| 8-pin for EL34, 6550, KT66, 6L6G Chassis with bracket | | 1.45 |
| 9-pin for ECC83, ECC88, 5687, 6350 | Chassis with shroud | 1.85 |

AUDIO NOTE SELECTED AUDIO VALVES.

Our valves are selected from the best available sources and are tested to the same stringent standards that we apply in the production of our own amplifiers, they fall into two categories, standard production items and rare, mostly NOS (New Old Stock) valves which are no longer in production. We have compiled a special list of the NOS items, which is available on request, beware the valves on this list are NOT cheap.

Standard Stock Items,

| Type No. | Type | Price Ex. UK Vat |
|------------------------|--|------------------|
| ECC835/12AX7WA/7025 | double triode | 2.95 |
| E88CC/6922/6DJ8WA/7308 | double triode | 3.95 |
| EF86/6267/2729 | pentode | 2.45 |
| ECC82/12AU7/61 89W | double triode, mill spec | 5.75 |
| 65N7 | double triode, UBX base | 1.75 |
| 65L7GT | double triode, UBX base | 2.85 |
| 65J7 | pentode | 1.75 |
| 5687WA | double triode | 4.55 |
| 6350WA | double triode | 4.75 |
| EL84/6BQ5 | small power pentode | 1.55 |
| EL84M/6BQ5WA | small power pentode, mill spec version | 4.75 |
| 6V6GT | small power pentode | 2.45 |
| 6L6G | medium power pentode | 2.75 |
| 5881/KT66/6L6WGC | medium power tetrode | 4.95 |
| EL34G | power pentode | 7.45 |
| 6550/KT88 | large power tetrode | 12.45 |
| 6C33 | powerful regulator, indirectly heated triode | 24.65 |
| 6A57/6080 | strong regulator, indirectly heated triode | 6.45 |
| 2A3 4pin | directly heated small power triode | 17.95 |
| 300B | directly heated power triode | 57.95 |
| 5U4G | HT-rectifier | 3.25 |
| 5Y3GT | HT-rectifier | 2.25 |
| 5V4GT | HT-rectifier | 2.25 |
| GZ34/SAR4 6X4 | HT-rectifier, very good for pre-amplifiers | 2.65 |

RESISTORS

Beyschlag

We offer three quality levels of resistor quality, all are 1%, starting with the Beyschlag metallfilm, which are slightly magnetic (as are the vast majority of other makes of metal film resistors), but nonetheless very good sounding, as used in all our UK-made amplifiers, up to quality level 3 (the MEISHU/P3) no-feedback triode amplifiers.

Beyschlag 1 watt, 1% resistors up to 500KOhm, E 0.11, above 500KOhm £0.13 each.

HOLCO.

Better sound quality can be achieved with the H2, 1 watt, 1% non-magnetic resistors, which we regard as the best "industrial grade" metallfilm resistors available. They have one small drawback, as they are quite fragile, and require careful handling, do not bend the legs too close to the body, they may become noisy.

HOLCO resistors type H2 50PPM cost £0.36 each from 1000hm to 500KOhm, higher and lower values are all £0.63 each.

SHINKOH Tantalum Film Resistors.

This is definitely the best sounding resistors available, forget the VISHAY, which may be ok in high feedback transistor amplifiers, but in our opinion quite uncomplimentary to the qualities of real Audio Amplification (i.e. directly heated triode amplifiers running feedback free in single-ended Class A), this is where you will need the tantalum film resistor for the best results.

Up to now the tantalum film resistors have been extremely difficult to get however, after much persuasion and against a minimum quantity guarantee from AUDIO NOTE UK, the manufacturers have agreed to widen the range of 1/2 watt and reintroduce the 1 watt range, I consider this to be a major breakthrough, since without a reasonable range of values at the 1 watt rating it is pretty difficult to get the very best out of our best circuits. As with most handmade specialist items.

Anyway, the 1/2 watt, 1% tantalum resistors are non-magnetic and cost £2.06 each for all available values. There is long delivery on all values, so be prepared to wait if a value is not stock.

BLACK GATE ELECTRON TRANSFER, High Performance, Graphite Electrolytic capacitors.

There are very few audio parts that promise a guaranteed improvement when replacing practically any other part, but this is what the BLACK GATE capacitors actually do. Exchanging any electrolytic capacitor anywhere in the circuit of an amplifier or in the crossover of a speaker will greatly improve sound quality. We are working on some guidelines as to where, how and which types of Black Gates to use in different circuits, the first such technical guideline is available now and is called "Improving your CD-Player" and can be obtained by sending a stamped addressed envelope to us requesting this leaflet. It is very important to note that all BLACK GATE capacitors take time to charge-up or stabilize, when first put in circuit, depending on type and application this "maturing" time can be between 100 and 300 hours.

| Value | Voltage | BG-Type | Suggested Use | Price Ex. UK Vat |
|---------------|----------------------|----------|--|------------------|
| 0.47mF | 50volt | PK | Anywhere | 1.05 |
| 1 mF | 50volt | PK | Anywhere | 1.25 |
| 2.2mF | 50volt | PK | Anywhere | 1.55 |
| 4.7mF | 50volt | PK | Anywhere | 2.15 |
| 22mF | 50volt | PK | Anywhere | 3.35 |
| 100mF | 100volt | Standard | Anywhere | 7.75 |
| 1 000mF | 50volt | Standard | Anywhere | 24.55 |
| 220mF | 1 6volt | Standard | Anywhere | 4.35 |
| 470mF | 1 6volt | Standard | Anywhere | 6.35 |
| 2200mF | 50volt | standard | Anywhere | 13.45 |
| 10,000mF | 80volt | Standard | PSU smoothing | 234.65 |
| 4700mF | 1 6volt | Standard | Anywhere | 14.25 |
| 47mF + 47mF | 500volt - 550v surge | SK-Type | PSU filter capacitor | 85.95 |
| 100mF + 100mF | 500volt - 550v surge | SK-Type | PSU filter capacitor | 101.95 |
| 100mF | 500volt - 550v surge | SK-Type | PSU filter capacitor | 72.75 |
| 220mF + 220mF | 350volt - 400v surge | SK-Type | PSU filter capacitor | 92.65 |
| 100mF + 22mF | 350volt - 400v surge | SK-Type | PSU filter capacitor | 75.35 |
| 220mF | 350volt | VK-Type | Decoupling or filter capacitor | 18.95 |
| 220mF | 1 6volt | F-Type | Low ESR version | 6.75 |
| 220mF | 1 6volt | FK-Type | Ultra low ESR version, comparable to film caps | 9.95 |
| | | | As above use anywhere | 43.95 |
| | | | As above use anywhere | 98.85 |
| | | | For circuits with DC potential difference | 3.35 |
| | | | Bipolar for use in negative feedback circuits etc. | 4.95 |
| | | | as above | 5.75 |
| | | | as above | 6.95 |
| | | | as above | 13.75 |
| | | | as above | 18.95 |
| | | | For loudspeaker crossover networks | 8.95 |
| | | | as above | 10.85 |
| | | | as above | 17.45 |
| | | | as above | 27.95 |
| | | | For super low noise PSU's | 24.65 |
| | | | as above | 28.95 |
| | | | as above | 99.95 |
| | | | as above | 423.35 |
| | | | 50volt | FK-Type |
| | | | 50volt | FK-Type |
| | | | 50volt | C-Type |
| | | | 50volt | N-Series |
| | | | 50volt | N-Series |
| | | | 50volt | N-Series |
| | | | 50volt | N-Series |
| | | | 50volt | N-Series |
| | | | 50volt | Bipolar |
| | | | 50volt | Bipolar |
| | | | 50volt | Bipolar |
| | | | 50 volt | Bipolar |
| | | | 16volt | BG-N Type |
| | | | 16volt | BG-N Type |
| | | | 50volt | BG-N Type |
| | | | 100volt | BG-N Type |

On the next page is a list of all BLACK GATE capacitors available, together their sizes, best usage etc. Lastly, we can supply a range of more modestly priced components, still good quality, but more industrial grade, if you like.

AUDIO QUALITY OUTPUT TRANSFORMERS.

Single-ended Circuits.

| Suggested Valve VAT | Max Cl. A Power | Prim-Sec. Impedance | Size/Weight Max. | Current | Price ex. UK |
|---------------------|-----------------|---------------------|------------------|-----------|--------------|
| EL84/ECL86/6V6 | 20 watts | 2K6 - 4/8 Ohms | 117x98x90 mm | 110mA PEE | 07.00 |
| 300B/2A3/6B4G | 25 watts | 2K5 - 4/8 Ohms | 117x98x90mm | 90mA SE | 91.00 |
| EL34/6550/KT88 | 30 watts | 1K5 - 4/8 Ohms | 115x98x95mm | 180mA PSE | 113.00 |
| 2A3/6B4G | 30 watts | 1K25 - 4/8 Ohms | 98x82x95mm | 130mA PSE | 97.00 |
| 5881/KT66 | 30 watts | 2K1 - 4/8 Ohms | 115x98x95mm | 140mA PSE | 106.00 |
| 211/VT4C | 30watts | 10K - 4/8ohms | 117x98x100mm | 150mA SE | 124.00 |
| 211/VT4C/845 | 50 watts | 10K - 4/8 Ohms | 112x134x150mm | 150mA SE | 114.00 |
| 300B | 50 watts | 1K25 - 4/8 Ohms | 135x115x125mm | 180mA PSE | 151.00 |
| 845 | 50watts | 2K5 - 4/8 Ohms | 137x114x130mm | 180mA PSE | 172.00 |
| 211/VT4C | 75 watts | 5K-4/8 Ohms | 137x115x145 mm | 240mA PSE | 237.00 |

New SE Product

| | | | | | |
|----------------|----------|---------------|--------------|-----------|--------|
| EL34/6550/KT88 | 20 watts | 3K - 4/8 Ohms | 117x98x92 mm | 130mA SE | 104.00 |
| 6L6G | 30 watts | 3K - 4/8 Ohms | 115x98x95 mm | 140mA PSE | 107.00 |

Push-Pull Circuits

| | | | | | |
|----------------|----------|----------------|--------------|-----|--------|
| EL84/ECL86/6V6 | 15 watts | 8K - 4/8 Ohms | 80x67x68 mm | PP | 42.00 |
| EL34/6L6G/5881 | 25 watts | 6K - 4/8 Ohms | 88x73x80 mm | PP | 59.00 |
| 2A3/6B4G/300B | 30 watts | 5K - 4/8 Ohms | 88x75x80 mm | PP | 63.00 |
| KT88/6550 | 50 watts | 6K6 - 4/8 Ohms | 108x91x90 mm | PP | 73.00 |
| EL34/KT66/5881 | 50 watts | 3K - 4/8 Ohms | 98x82x83 mm | PPP | 74.00 |
| 845 | 50 watts | 6K8 - 4/8 Ohms | 108x91x90 mm | PP | 114.00 |

Pure Silver Wired Outputs.

| | | | | | | |
|----------------|----------|----------------|---------------|-------|----|----------|
| 300B/2A3/ 6B4G | 25 watts | 2K5 - 4/8 Ohms | 11 7x98x90 mm | 90mA | SE | 1,645.00 |
| 211/VT4-C/845 | 50watts | 10K - 4/8ohms | 112x134x150mm | 150mA | SE | 1,975.00 |

The AUDIO NOTE silver wired outputs listed here are designed and made in the UK, we can supply the AUDIO NOTE Japan manufactured outputs for the ONGAKU of the KEGON, but they are exceptionally expensive, as you would expect from items that take upwards from 100 hours each to make, for example an output transformer for an ONGAKU costs £16,500.00.

AUDIO NOTE CHOKES & INDUCTORS.

| Value | Size | Price Ex. UK Vat |
|------------------------|-------------|------------------|
| 3H/1 00mA | | 14.00 |
| 5H/1 50mA | | 21.00 |
| 10H/125mA | 63x74x76 mm | 26.00 |
| 10H/200mA | 98x65x83 mm | 33.00 |
| 0.5H/400mA | | 18.00 |
| 3H/2250mA for ONGKU/Cu | | 24.00 |
| 5H/400mA | | 31.00 |
| 20H/50mA | 68x56x58mm | 24.00 |

Other values can be supplied by order, ask for quote.

AUDIO NOTE Coax Interconnect Cables.

| Type/Colour code | Construction | Price per Stereo Meter Ex. UK Vat. |
|-------------------------------------|-------------------------------------|------------------------------------|
| AN-A yellow | symmetrical 6N copper litz coax | 15.32 |
| AN-C red | symmetrical OFHC copper litz coax | 29.79 |
| AN-S dark grey with yellow stripe | symmetrical 99.99% silver litz coax | 84.25 |
| AN-V silver grey with yellow stripe | symmetrical 99.99% silver litz coax | 152.35 |
| AN-Vx silver grey | symmetrical 99.99% silver litz coax | 382.98 |

It is recommended to use the internal twin silver wires in the AUDIO NOTE coax cables as internal wiring cable, this is what we do in amplifiers like the ONGAKU, M7Tube etc.

AUDIO NOTE COMPLETE KITS.

We are developing a range of complete kits; to give those of you who have the ability, but do not have the time to develop a project from the ground, so to speak. In order to be able to offer the best possible quality - price relationship the kits we offer will be good basic circuits with no-frills power supplies and components.

Kit One.

Based around the justly famous 300B directly heated triode, we see this kit as the introduction to real Audio Amplification, as it covers all the important aspects of design necessary, Single-Ended, No-Feedback, Class A, Directly Heated Triode, to become a member of this exclusive club of amplifiers.

Kit One has one 300B per channel running at 420 volts with 75mA current giving 9/10 watts of the cleanest power you will ever hear, the input stage consists of a 65N7GT with a 5687 double triode driver stage running in SRPP.

The powersupply is a capacitor-choke-capacitor with a 5U4G HT rectifier, the heaters are AC heated.

Component quality is similar to our Level 2 finished products, AUDIO NOTE paper in oil signal capacitors, Beyschlag watt 1% metallfilm resistors, good quality electrolytics (sorry NO Black Gates!) and a simple, attractive stereo chassis in grey paintwork. Protecting cover is extra.

Price £750.00 incl. Vat, which includes all valves (yes, also the 2 x 300B needed) but not postage/packing which to UK customers is £12.00, topcover is £99.00 extra. The Kit One is available now.

Kit Two.

Kit Two features a single 6550WA Sovtek tetrode running in Single-Ended mode, yielding some 17 watts of pure Class A, valve rectified HT for the output stage, stereo chassis, and 6SL7GT input and 6SH 7GT SRPP driver stage, componentry and chassis as Kit One. Price £600.00 incl. Vat, includes valves, but not postage/packing, cover is extra at £99.00. Available in March '94.

Write to:
AUDIO NOTE (UK) Ltd, Unit 1, Block C, Hove Business Centre, Fonthill Road, Hove, East Sussex, BN3 6HA, England. Telephone +44 0273 220511, fax +44 0273 731498. Direct Line to sales +44 0273 8 8 5 1 1.

MAINS TRANSFORMERS

This range relates to our finished products, mains transformers are notoriously difficult items to offer as the number of permutations of HT and Heater voltages are almost endless. We shall be offering a more comprehensive range as opportunities arise.

| Primary Voltages | Secondary HT Windings | Secondary Heater Windings | Price Ex. UK Vat |
|----------------------|---------------------------------|---|------------------|
| 0v/100v/110v/120v | 0v-230v at 350mA | 0v-12.6v at 1 Amp | 34.00 |
| 0v/220v/230v/240v | 3.1 5v-0v-3.1 5v at 4 Amp | | |
| 120v/1 10v/100v/0v | 0v - 230v at 0.4 Amp | 0v-12.6v at 1 A | 41.00 |
| 0v/1 00v/11 0v/1 20v | 3.1 5v - 3.1 5v at 4 Amp | | |
| 0v/1 00v/11 0v/1 20v | 0v - 290v at 40mA | 1.2 6v-0v at 1.5A | 26.00 |
| 0v/100v/110v/120v | 0v- 6.3v at 300mA | | |
| 0v/100v/1 10v/120v | 310v-244v-0v-244v-310v at 320mA | 3.15v - 0v-3.15v at 4.5 Amp | 72.50 |
| 0v/100v/1 10v/120v | 0v-920v at 160mA | 0 -10v at 4 Amp, 0v-6.3v at 12.6v at 1.5 Amp | 98.00 |
| 0v/100v/110v/120v | 150v-150v at 50 mA 1.5A. | 0v - 5v at 2.5A | |
| 120v/1 10v/1 10v/0v | 390v-0v-390v at 200 mA | 3.15v-0v-3.15v at 1.2Amp, 7v | 86.70 |
| 0v/1 00v/11 0v/1 20v | 20v1 70v at 50mAat 3A, | 7v at 3A, 5v at 2A | |
| 0v/1 10v/100v/0v | 425v-0v-45v at 220mA | 3.15v-0v-3.15v at 2.5A | 95.60 |
| 100v/110v/120v | | 7.0v-0v, 7.0v-0v, 5.0v-0v for KIT ONE or 3.15v-0v-3.15v at 750mA "KASSAI" replica | |

AUDIO NOTE Speaker & Wiring Cables.

| Type/Colour code | Construction | Price per Mono Meter Ex. UK Vat. |
|-------------------------|--|----------------------------------|
| AN-D green | single core 6N copper speaker wiring | 6.85 |
| AN-B blue white writing | double strand, screened 6N speaker | 12.34 |
| | wire | |
| | double strand, screened 6N litz copper | |
| AN-L blue black writing | single core 15 strand 99.99% litz | 25.11 |
| | speaker wire | |
| AN-SP silver | single core 20 strand 99.99% litz | 106.38 |
| | silver speaker wire | |
| AN-SPx silver | single core 20 strand 99.99% litz | 382.98 |

silver speaker wire

PTFE Insulated Silver Plated Copper Wires.

We can also provide less expensive wiring wires for hard wiring circuits, these PTFE insulated silver plated copper wires are 19 strands of 0.15 mm wire and come in brown, black, blue, pink, red, green, orange, violet, white and red/white, they cost £1.60 per meter in any colour

Tel. +44 0273 220511
Fax. +44 0273 731498
Sales +44 0273 885511

AUDIO NOTE

HART

Hart Audio Kits - Your Value for Money Route to Ultimate Hi-Fi

2 Penylan Mill, Uswestry, Shropshire, England SY 1U 9AF
phone Uswestry (0691) 652894

Hart Audio Kits and factory assembled units use the very best audiophile components in circuit designs by the renowned John Linsley Hood to give you unbeatable performance and unbelievable value for money. We have always led the field for easy home construction to professional standards, even in the sixties we were using easily assembled printed circuits when Heathkit in America were still using tagboards! Many years of experience and innovation, going back to the early Dinsdale and Bailey classics gives us incomparable design expertise in the needs of the home constructor. The current range of Hart kits is designed to give you the important core components of a system as a matching ensemble of audio excellence

1100 Series. LH80W "Audio Design" Mosfet Power Amplifier.



Another masterpiece from the drawing board of John Linsley Hood and another opportunity to give a system mega sound performance for only a few hundred pounds cost. A host of advanced features, in the hands of the skilled designer, give this amplifier a performance that really is only equalled, not exceeded, by the 4 or 5 figure price tagged exotica.

As always with a HART kit you have the pleasure of building selected, state of the art equipment, allied to the knowledge that your money has all been spent on quality components, you save all the costs of building and testing, plus the dealers margin on top of these by doing it yourself.

To give an idea of the measures taken to achieve ultimate quality and linearity in this amplifier each of the four output devices is only called upon to work at one NINETY-SIXTH part of its ultimate power rating.

We are proud to offer this latest John Linsley Hood masterpiece, the flagship of our range, which we believe is truly the ultimate design for the perfectionist, combining as it does the best circuit design, the best engineering and the best components, surely the only recipe for REAL sound fidelity. The HART KIT concept also makes it possible to build an amplifier with the facilities YOU want and we offer no less than three variations with options on the basic theme to suit your needs. One of these versions will, we feel sure, cater for your requirements. Should your requirements change at a later date then upgrades or alteration to a different version are no problem, try doing that to your High St store amplifier!

The Standard version has a passive input selector circuit with Alps Precision Low-noise volume and balance controls, switchable CD, Tuner and Pre-amp inputs and an optional stereo bargraph output level display. The 'Slave' version has stereo power amplifiers and standard power supply. The 'Monobloc' version again has the standard power supply but since it is only driving one power amplifier higher than normal output power is achieved with total channel separation. The slave and monobloc versions enable very sophisticated bi-amping and active crossover systems to be constructed.

K1100 Complete STANDARD Amplifier Kit, two power amplifier channels and one power supply module, direct input passive signal selector stage, Construction Manual and RH11 Reprint.

SPECIAL DISCOUNT PRICE FOR COMPLETE KIT IS ONLY £395.21

A1100 Factory Assembled **£499.21**

K1100S Complete SLAVE Amplifier Kit, as above but without passive input stage.

SPECIAL DISCOUNT PRICE FOR COMPLETE KIT IS ONLY £333.62

A1100S Factory Assembled **£422.62**

K1100M Complete MONOBLOC Amplifier Kit, consists of all parts for one power amplifier channel and one power supply module and all chassis parts.

SPECIAL DISCOUNT PRICE FOR COMPLETE KIT IS ONLY £261.20

A1100M Factory Assembled **£329.20**

All HART kits are designed for easy home construction to the very highest standards, and can be built by anyone of average manual ability. If you are still not convinced how easy it is to build it yourself with a HART kit you can order the Instruction Manual to read for yourself and we will refund the cost when you buy your kit.

PROBABLY THE LAST VINYL PREAMP YOU EVER BUY.

For those who love the vinyl medium the listening pleasure can only be enhanced by using the very best phono preamplifier available. The Hart range of phono preamps feature a special shunt feedback circuit topology and are designed by John Linsley Hood. This circuit format gives audibly superior sound to the standard series feedback system normally used and gives a performance that will exceed or equal that given by the best of the mega priced offerings. Our range includes units to suit everyone from the occasional user to



the serious audiophile. All can be changed to suit moving coil or moving magnet cartridges at the flick of a switch.



K1500 Series. This is an integrated circuit version of the shunt feedback concept, using so little power that it may be run from batteries. An ideal "first kit" project as it is very simple to put together and no mains voltages are involved.

K1500 Complete Kit With Full Instructions (Battery Powered) **£73.76**

A1500 Factory Assembled **£118.76**

K1450 Features a totally discrete component implementation of the Shunt Feedback concept. Audiophile grade components fitting to an advanced double sided printed circuit board make this a product at the leading edge of technology that you will be proud to own. Nevertheless with our step by step instructions it is very easy and satisfying to assemble. Due to the higher current consumption this unit is powered by our mains driven K1565 Audio Power Supply, itself an advanced piece of technology in a matching case. This supplies the superbly smoothed and stabilised supply lines needed by the preamplifier and features a fully potted Hi-grade toroidal transformer along with a special limited shift earth for hum free operation. Suitable for all moving coil and moving magnet transducers this unit is especially recommended for, and will extract the very best from the modern generation of low output high quality transducers.

K1450/1565X. Complete RIAA Phono preamplifier, Power Supply and power connect cable **Kit form £196.29.**

1450/1565X Factory assembled & tested. **£285.29.**

ALPS PRECISION LOW-NOISE STEREO POTS

Now you can throw out those noisy ill-matched carbon pots and replace with the real hi-fi components only used selectively in the very top flight of World class amplifiers. The improvement in track accuracy and matching really is incredible giving better tonal balance between channels and rock solid image stability.

On the motorised versions the 5v DC drive motor is coupled to the normal control shaft with a friction clutch so that the control can be operated manually or electrically.

Our prices represent such super value for pots of this quality due to large purchases for our own kits.



MANUAL POTENTIOMETERS

2-Gang 100K Lin **£15.67**

2-Gang 10K, 50K or 100K Log **£16.40**

2-Gang 10K Special Balance, zero crosstalk and zero centre loss **£17.48**

MOTORISED POTENTIOMETERS

2-Gang 20K Log Volume Control **£26.20**

2-Gang 10K RD Special Balance, zero crosstalk and less than 10% loss in centre position **£26.98**

HC80 Replacement Cassette Head.



The excellent performance of modern cassette recorders depends totally on the quality of the R/P head. Even the slightest amount of wear can impair the frequency response and distortion levels. Our HC80 is a top quality head from one of the foremost manufacturers in Japan. It is easily fitted to most standard stereo recorders (except Sony) and will transform the performance over a worn head. Only the fact that we buy these in vast quantities enables us to offer them at the amazing price of **only £11.70 each or 2 for £17.60.**

SPECIAL OFFER

PRECISION Triple Purpose TEST CASSETTE TC1DD.

Are you sure your tape recorder is set up to give its best? Our latest triple purpose test cassette checks the three most important tape parameters without test equipment. Ideal when fitting new heads.

A professional quality, digitally mastered test tape at a price anyone can afford.
Test Cassette TC1DD **Our price only £10.99.**

DISK-COUNT Classical CD's.

Top quality, Full Digital (DDD) Compact Disks of the great classical favourites. Like everyone else we didn't like the idea of paying silly prices for CD's. After a long search we have now located a source of top quality classical recordings at prices that make you suspect the quality - until you try them! Send for our list of titles.

TECHNICAL BOOKSHELF

Modern Books. Selected to represent the state of the art today.

"THE ART OF LINEAR ELECTRONICS."

J.L.Linsley Hood.
Just Out! Hot Off the Press, the definitive electronics and audio book by the renowned John Linsley Hood. This 300+ page book will give you an unparalleled insight into the workings of all types of valve and solid state audio circuits. Learn how to read circuit diagrams and understand amplifiers and how they are designed to give the best sound. The virtues and vices of passive and active components are examined and there are separate sections covering power supplies and the sources of noise and hum. As one would expect from this writer the history and derivation of audio amplifier circuitry have an entire chapter, as does test and measurement equipment. Copiously illustrated this book is incredible value for the amount of information it contains on the much neglected field of linear, as opposed to digital, electronics. Indeed it must be destined to become the standard reference for all who work, or are interested in, this field.

SPECIAL OFFER. With each book purchased you may request a **FREE** extended index, written by the Author, exclusively from HART.
0-7806-0868-4. **£16.95**

Don't forget most of our kits have reprints of articles by John Linsley Hood that you can purchase separately.

"THE LOUDSPEAKER DESIGN COOKBOOK" Vance

Dickason. (4th Edn.)
All the information you need to build the loudspeaker system you have always wanted but could not afford. Easy ways to pick the exact box size, the ideal drivers, and the correct way to feed the music to your new super loudspeaker system. Over 140 pages packed with important design data.

1991. 152 Pages.
0-9624-191-7-6 **£19.97**

"THE ART OF SOLDERING"

R. Brewster.
Absolutely essential reading for anyone who ever picks up a soldering iron. Written from knowledge gained in a lifetime in the field, this is the first book ever solely devoted to this essential and neglected skill for all electronic enthusiasts. Covers everything from the correct choice of soldering iron and solder to the correct procedures to follow with many illustrations and practical exercises.
0-85935-324-3. **£3.95**

Classics from the "Golden Age"

"THE WILLIAMSON AMPLIFIER."

D.T.N.Williamson.
In April 1947, Williamson's power amplifier, using excellent-quality push/pull output valves, a special output transformer, and a highly filtered power supply, became an overnight success. The author takes the reader deep into his design considerations, offering practical advice on how to build the units plus concise instructions on setting up the new amp. A cult classic.

1947, Reprinted 1990. 40 Pages.
0-9624-1918-4 **£4.95**

LOUDSPEAKERS: THE WHY AND HOW OF GOOD

REPRODUCTION. G.A.Briggs This easy-to-read classic, last revised in 1949, introduces the reader to concepts such as impedance, phons and decibels, frequency response, reponse curves, volume and watts, resonance and vibration, cabinets and baffles, horns, room acoustics, transients, crossovers, negative feedback, Doppler and phase effects, and much more. A provocative survey of the right questions about sound reproduction.

1949 Reprinted 1990. 88 Pages.
0-9624-1913-3 **£6.95**

Send or phone for your copy of our FREE list of these and many other Kits & Components. Enquires from Overseas customers are equally welcome, but PLEASE send 2 IRCs if you want a list sent surface post, or 5 for Airmail. Ordering is easy. Just write or telephone your requirements to sample the friendly and efficient HART services. Payment by cheque, cash or credit card. A telephoned order with your credit card number will get your order on its way to you THAT DAY. Please add post cost of carriage and insurance as follows: **INLAND Orders up to £20 - £1.50, Order over £20 - £3.50. Express Courier, next working day £10. OVERSEAS - Please see the ordering information with our lists.**

QUALITY
AUDIO KITS

24hrs. SALES LINE
(0691) 652894

ALL PRICES
INCLUDE
UK/EC VAT

World Radio History

HART

you don't have to be a ..

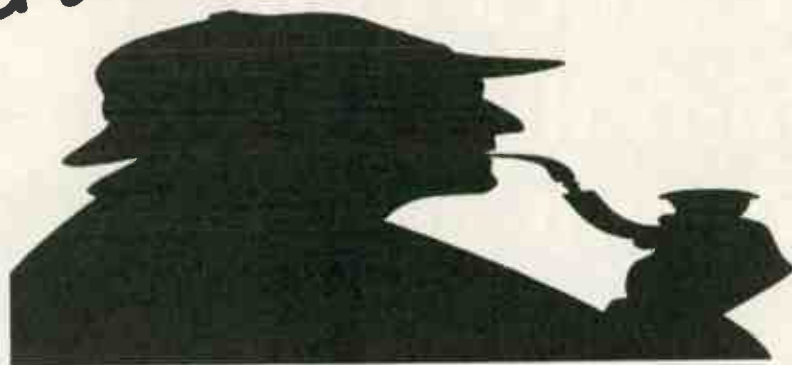

.. to discover the **Best of British** hi-fi in the west country
at..

mike manning
the hi-fi specialists **audio**

quadsan avi naim
toksan avicam
arcanate ega
arcate ega naim

Together with other fine Hi-Fi from..

**Sugden - Rotel - Pink Triangle - Audio Alchemy - Mission - B&W
Heybrook - Marantz - Restek - Epos - Shahinian - LYRA - Acoustic
Energy - JPW - Nakamichi - Denon - AURA - NAD - Pioneer - Philips**

NOT ALL MAKES STOCKED AT BOTH BRANCHES PLEASE CHECK FOR AVAILABILITY

*Audition some of the finest Hi-Fi in our purpose built listening lounges where you can,
with our expert guidance, choose an ideal system to suit your ears and your pocket.*

Full Servicing Facilities - 2 Year Guarantees - Mail Order - Instant Credit Facilities - Access - Visa - Switch

BOURNEMOUTH

128, Poole Road
Westbourne
Bournemouth
0202-751522

YEOVIL

110, Middle Street
Yeovil
Somerset
0935-79361

0% - INTEREST FREE CREDIT - PLEASE PHONE FOR DETAILS - 0%

“ We stock only
one hi-fi that
will suit you. ”



COLIN WELFORD

At Son et Lumière, we hold what we believe is the best audio solution at every price level from £800 to over £25,000.

So, you won't find us trying to confuse you with numerous hi-fi solutions. As far as we're concerned, we've only got one answer to your requirements.

And with our purpose built listening rooms, we make a point of inspiring you with a musical solution that will give unbridled listening pleasure.

Whatever your aspirations.



SON ET LUMIÈRE, 67 TOTTENHAM COURT ROAD, LONDON W1P 9PA. TEL 071 580 9059.

THE MIDLANDS FIRST CHOICE FOR SPECIALIST HI-FI FRANK HARVEY HI-FI EXCELLENCE

THREE FLOORS - THREE DEMONSTRATION ROOMS
3000 SQ FEET IN THE PURSUIT OF HI-FI



THE FIRST CHOICE FOR THE
BEST HI-FI SET AMIDST THE
ELEGANCE OF OUR 14TH
CENTURY SHOWROOMS

ON OUR FIRST FLOOR WE ARE
NOW SHOWING THE LATEST
DOLBY PRO-LOGIC AND SOUND
PROCESSING PRODUCTS
AVAILABLE FOR AUDIO-VISUAL
SYSTEMS

MAKE FRIENDS AT FRANK HARVEY OUR KNOWLEDGABLE AND ENTHUSIASTIC STAFF ARE ALWAYS AVAILABLE TO ADVISE ON YOUR HI-FI REQUIREMENTS. AS MEMBERS OF THE BRITISH AUDIO DEALERS ASSOCIATION WE REALLY DO CARE. WE BELIEVE IN THE PRODUCTS WE STOCK AND THE AFTER SALES SUPPORT WE GIVE. WE BELIEVE THAT YOU OUR CUSTOMER ARE OUR MOST VALUABLE ASSET.

CAREFULLY SELECTED PRODUCTS

AUDIOLAB - AUDIO ALCHEMY - AUDIO - TECHNICA - ARCAM CAMBRIDGE - AUDIO QUEST ALPHASON - APOLLO - BEARD - BOSE - BANG AND OLUFSEN - CELESTION - CREEK - CYRUS - DENON - DUAL - FOUNDATION - GOLDRING - HEYBROOK - KEF - MARANTZ - MERIDIAN - MONITOR AUDIO - MISSION - MORDAUNT SHORT - MUSICAL FIDELITY - NAKAMICHI - NAD - PHILIPS - PIONEER - QUAD - REGA - ROGERS - ROTEL - SENNHEISER - SYSTEMDEK - TARGET - TRIPOD - TANNOY - THORENS - VAN DEN HUL - YAMAHA HOME THEATRE ETC

FROM CAREFULLY SELECTED AGENCIES

OUR PRICE PROMISE GARANTEE ENSURES THE BEST DEAL AT THE LOWEST POSSIBLE PRICE

FREE CARRIAGE UK MAIL ORDER
EXPORT SERVICE AVAILABLE

PART EXCHANGE SERVICE 2 YEAR
FULL GUARANTEES FULLY EQUIPPED
SERVICE FACILITIES 5 YEAR
EXTENDED GUARANTEES AVAILABLE

FRANK HARVEY HI-FI EXCELLENCE

163 MEDIEVAL SPON STREET TEL 0203 525200
FAX 0203 631403 COVENTRY CV1 3BB
ALL MAJOR CREDIT AND BANK
CHARGE CARDS ACCEPTED

INTEREST REL CREDIT ON
SELECTED PRODUCTS
(WRITTEN DETAILS ON REQUEST)

APR 0%

FREE INSTALLATION AND DELIVERY SERVICE OPEN
MONDAY TO SATURDAY 9.30 TILL 5.30 CLOSED ALL
DAY THURSDAY

WE HAVE MOVED!

LOUGHBOROUGH

HI-FI

38 BAXTER GATE, LOUGHBOROUGH, LEICS. LE11 1TQ
 TEL: 0509 239521/236113

We still buy and sell all kinds of secondhand Hi-Fi equipment from budget to exotic, but have extended our selection of new brands including:- Aiwa, Allsopp, Atacama, Audio Technica, Aura, Beyer, Bug Audio, Goldring, J.P.W, Marantz, Moth, NAD, Nakaoka, Partington, Pink Triangle, QED, Sennheiser, Systemdek, TDL, etc..

* Huge new demonstration room; Evening and out of hours demonstrations with pleasure; Home demonstrations; Delivery; Repairs.

* Thousands of secondhand LP's, 7" singles, cassettes and a few CDs - All kind of music bought and sold.

* We wish to buy all kinds of secondhand Hi-Fi equipment from budget to exotic, old or modern, working or not, odd items or complete systems.

To make the most of
 your projects, start with
 the right tool.

1994
 Catalogue
 The Audio Hobbyist's
 Definitive Parts source

Get connected with
 the widest selection
 of audiophile grade parts.
 Send £2.85 along with
 your mailing address
 and you will receive our
 1994 parts catalogue
 and a \$10 discount coupon good
 on your first order over \$100.

**THE PARTS
 CONNECTION**

A DIVISION OF SONIC FRONTIERS INC

2790 Brighton Road, Oakville, Ontario, Canada L6H 5T4
 Telephone (905) 829-5858 Facsimile (905) 829-5388

MIT MultiCap • Wonder Cap • Kimber Kap • Solo • Solen • Siemens • Hovland MusiCap
 Wima • Holco • Rel-Cap • Draloric • Vishay • Caddock • Mills • Matsushita • TKD • Noble
 Cardas • Kimber Kable • Discovery • Audioquest • MIT • ClearAudio • Alps • Boms • Elma
 Shalco Attenuators • Electros witch • Flna • Nichicon • Gold Aero • RAM • Mallory
 Ruby Tubes • Linear Technology • Analog Devices/PMI • Motorola • Edison Price
 International Rectifier • MagneQuest • Sonic Frontiers
 Pearl • Tube Sockets • WBT • Neutrik • Curcio Audio Engineering • Kits

* or \$5.00 US, or credit card information
 ** catalogue pricing and discounts
 are in US Dollars



Transfiguration, Wilson Benesch, Magnum, Dynalab, Graham,

M.J.S. HI-FI

We at M.J.S. Hi-Fi are dedicated in the quest for excellence in the reproduction of recorded music. You can be assured that we are not influenced by reviews and all the hype in Hi-Fi magazines. We devote time and patience when auditioning before we recommend and stock the product. We feel very sad about the way in which most Hi-Fi equipment is chosen and sold. We offer a refreshing alternative to the norm:-

- * EXTENDED AUDITION TIMES
- * HOME AUDITIONS
- * HOME VISITS
- * OPEN DISCUSSIONS
- * TUNING SUGGESTIONS
- * EVENING AUDITIONS

AND ABOVE ALL COMMITMENT TO YOU AND YOUR MUSIC.
 For More Details, Please Phone:

M.J.S. HI-FI
 80 Stapleton Lane, Barwell, Leicestershire
 LE9 8HE
 Telephone: (0455) 846977
 BY APPOINTMENT ONLY

Lumley Reference, Nottingham Analogue, Townshend,
 L.F.D. Helius, Silver Sounds, Cogan Hall

John Shearman, Concordant, S.D. Acoustics,
 Diamond Acoustics, Origin Live, Basis, S.M.I.

Ortofon, CAT, Unistar, Sonic Link,
 Pearl, Gamma, Moth

“ We don't offer comparisons. Only absolutes. ”



COLIN WELFORD

At Son et Lumière, you won't find us trying to confuse you with numerous hi-fi solutions. As far as we're concerned, we've only got one answer to your requirements.

We hold what we believe is the best audio solution at every price level from £800 to over £25,000.

With our purpose built listening rooms, we make a point of inspiring you with a musical solution that will give unbridled listening pleasure.

Whatever your aspirations.



SON ET LUMIÈRE, 67 TOTTENHAM COURT ROAD, LONDON W1P 9PA. TEL 071 580 9059.

RING FOR DETAILS



UXBRIDGE, MIDDLESEX (0895) 253340

Unbelievable but true you can audition all these brands here. Audion, Proac, Michell, Lumley, Levison, Lurne, Triangle, Teac, VHD, Silversounds, Stax, Monitor Audio, Trilogy, Lyra, Sumiko, Ortofon, Decca, Target, Project Moth, Townshend, Edison, Sudgen, Trichord Research, Cadence, Kinshaw, SD Acoustics, Totem.

7 days a week 10am - 7pm
RING FOR DETAILS
UXBRIDGE, MIDDLESEX
(0895) 253340

The NORFOLK/SUFFOLK High End Dealer
audible difference
near DISS, NORFOLK

| | | |
|----------------|--------------------------|--------------------|
| Audio Research | <i>Audion (Alema)</i> | ART Audio |
| ATC | <i>Audio Innovations</i> | Audio Note |
| AVI | CHORD | Copland |
| Croft | DAWN AUDIO | dpa |
| EAR | Impulse | Kinshaw Perception |
| Linaeum | <i>Lyra</i> | <i>LFD Audio</i> |
| Magnepan | Micromega | neat |
| <i>Orelle</i> | Pink Triangle | ROKSAN |
| Sumiko | SME | Sonus Faber |
| SUGDEN | Tube Technology | van den Hul |

At this level of equipment we believe that the highest level of service should be offered. We will book only three demonstrations a day to ensure that you have ample time to evaluate the option YOU chosen,

DEMONSTRATIONS IN OUR LISTENING ROOM OR YOUR HOME EQUIPMENT LOAN SERVICE AVAILABLE

Tuesday to Friday, 12 to 9 pm
Saturday 9 to 5 pm
PLEASE RING FOR AN APPOINTMENT

0850 983233 OR 0379 740227

Spring Specials at Sevenoaks Superfi.

AMPLIFIERS

Arcam Alpha 5
Great delivery and vivacity
Claim 3 year warranty Free

£229.95

AMPLIFIERS

Audiolab 8000A
Transparency and power,
notably neutral
Claim 3 year warranty Free

£449.95

AMPLIFIERS

Aura VA100
Big sound,
open shimmering tone
Claim 3 year warranty Free

£299.95

AMPLIFIERS

Kenwood KA3020
Controlled delivery with plenty
of dynamic tension
was £169.95

£149.95

AMPLIFIERS

Marantz PM44SE
Power and subtlety, an
absolute bargain
Claim £20 CD voucher Free

£199.95

AMPLIFIER

Musical Fidelity A1.3
Sweet string tone and
warm bass
Claim £20 CD voucher Free

£329.95

AMPLIFIERS

Technics SUA600K
Excellent mid range and bass,
good value
was £199.95

£169.95

CASSETTE DECKS

Aiwa ADF410
Great sound from this award
recommendation
was £119.95

£99.95

CASSETTE DECKS

Aiwa ADF810
Stable and sure footed with
plenty of punch
was £229.95

£199.95

CASSETTE DECKS

Nakamichi DR3
Sound quality with ambience
and presence
was £399.95

£339.95

CASSETTE DECKS

Sony TCK511S
Dolby S-3 head, an
absolute steal
was £279.95

£229.95

CASSETTE DECKS

Sony TCK611S
Excellent sound, facilities and
value for money
was £329.95

£259.95

CASSETTE DECKS

Yamaha KX360
High performance deck with
vibrant sound
was £199.95

£149.95

CD PLAYERS

Arcam Alpha 5
Exciting presentation, fluid bass
and fine treble
Claim 3 year warranty Free

£449.95

CD PLAYERS

Arcam Delta 70.3
Precise, stable stereo imaging
was £999.95

£449.95

CD PLAYERS

Aiwa XC300
Great presence for the price
was £149.95

£119.95

PRICE PROMISE

We always try to ensure our prices are competitive. In the unlikely event of a product being available from an *authorised* dealer at a lower price -
WE WILL BEAT THAT PRICE BY UP TO £20.

Values = £110 to £500 = £10. £501 to £1000 = £15. £1001+ = £20.

CD PLAYERS

Aiwa XC750
Placing sonic purity before
sonic thrills
was £199.95

£149.95

CD PLAYERS

Denon DCD595
Punchy, dynamic and larger
than life sound quality
Claim 3 year warranty Free

£179.95

CD PLAYERS

Marantz CD52II
Probably the best budget
player on the market
was £229.95

£199.95

CD PLAYERS

Marantz CD52IISE
The sound simply bubbles with
energy and vitality
Claim £30 CD voucher Free

£299.95

CD PLAYERS

Marantz CD63
5 star stunner from Marantz
Claim £10
CD voucher Free

£249.95

CD PLAYERS

NAD 502
Sensibly equipped
accommodating player
was £219.95

£189.95

CD PLAYERS

Teac VRDS10
This player sounds big
and beefy
Claim £30 CD voucher Free

£769.95

CD PLAYERS

Technics SLPG440AK
High grade, MASH, 4 DAC
was £169.95

£144.95

CD PLAYERS

Yamaha CDX870
An audiophile component user
was £329.95

£229.95

TUNERS

Audiolab 8000T
Fantastic performance, once
heard never forgotten
Claim 3 year warranty Free

£699.95

TUNERS

Denon TU260L
Warm sound
for cold evenings
Claim 3 year warranty Free

£119.95

TUNERS

Sony STS311
User friendly design, clear and
involving sound
was £199.95

£179.95

TURNTABLES

NAD 5120 Inc cart
Seriously good sound at a
super low price
was £119.95

£89.95

TURNTABLES

Project 0.5 Inc cart
Hallmarks of audiophile design
at a budget price
old price held

£129.95

TURNTABLES

Project 6 Inc cart
A tweakers delight and best
turntable title holder
old price held

£399.95

TURNTABLES

Technics SL1210II
The professional DJ's
turntable
was £399.95

£339.95

SPEAKERS

JPW MinIm
Nicely finished with pleasantly
detailed presentation
was £79.95

£59.95

SPEAKERS

Mission 751
Big, fast bass plus open
midband and treble
free stands & cable

£299.95

SPEAKERS

Mission 760I SE
Enjoyable 3D music with
hefty bass
free stands & cable

£149.95

SPEAKERS

TDL NFM
Small but powerful,
superb speakers
old price held

£99.95

MINI/MICRO SYSTEMS

At least 10% and up to
25% off all mini/micro
systems in stock,
excluding Denon

Min 10% off

Sevenoaks Superfi - There's no better place to buy Hi Fi.

THIS ADVERTISEMENT IS VALID TO AT LEAST 31ST MARCH 1994 (11).
ADDED VALUE OFFERS ARE NOT AVAILABLE ON PRICE BEAT SALES. PRICE BEAT CONDITIONS ON LISTINGS PAGE.

GOLMUND ACCESSORIES

| | | |
|--|----------------|------|
| *Lineal Cable | 1.5 meter | £425 |
| digital & analogue reference | | |
| - any other length: £725. - (= 0 meters) plus £50. - per meter | | |
| * Powercord standard | up to 1 meter | £200 |
| (all hifi components) | up to 2 meters | £375 |
| - any other length: £375. - (= 0 meters) plus £35. -per meter. | | |
| * Powercord special | up to 1 meter | £200 |
| (heavy power amp version) | up to 2 meters | £375 |
| - any other length: £375. - (= 0 meters) plus £35. -per meter. | | |
| *Cones | set of 3 | £215 |
| applicable under all hifi components | | |
| *Bananas | set of 4 | £250 |
| improve speaker connections | | |
| * Miracle Cleaner | 1bottle | £20 |
| clean acryl & CD | | |

YOU'VE TRIED THE REST, NOW BUY GOLDMUND

Documentation can be obtained from the address mentioned below. Prices include p&p.
Please allow up to 28 days for delivery. Send your cheques or money order to:
PHOENIX, Grootzeil 7, 3891 KH ZEEWOLDE, The Netherlands.
In. Tel.: +31 3242 3000. Int. Fax.: 31 3242 3510

HALE HI FI



We stock:-

ROYD, NAIM, LINN, DENON, CREEK,
ARCAM, QUAD, YAMAHA etc....

A wide range of accessories always available.

Full demonstration facilities - no appointment necessary - full service department.

Free delivery and installation

2 Bold Street, Hale Road Altrincham, Cheshire

WA14 2ER

Telephone: (061) 929 0834

A MANTRA AUDIO

CARTRIDGES AND STYLUS
• MAIL ORDER DIRECT 1-10 DAYS
• COMPETITIVE PRICE inc P&P
• 10% DISCOUNT ON STYLUS QTY 2+

| TYPE | SWISS QUALITY DIAMOND STYLUS | PRICE | MAKE | MODEL | CARTRIDGE | STYLUS |
|------------------|----------------------------------|--------|----------------|-----------------|------------|----------|
| ADC | RK 8, RO 4 OLM 30, RL 3/5 | £8.00 | Arcam | C 77 | £27.00 | £15.00 |
| | R20 XE, OLM 32/34/36, XLM III | £12.50 | | E 77 | £45.00 | £33.00 |
| Alwa | AN 5/6/7/10/11/13/15/17/19/21 | £8.00 | | P 77 | £56.00 | £45.00 |
| | AN 2/5/7/10/11/13/15/17/19/21 | £10.00 | | P 77Mg | £66.00 | £49.00 |
| Akal | APN 2/5, RS 33/35/38/83 | £8.00 | Audio Technica | AT 95 E | £21.00 | £12.50 |
| Audio Technica | ATN 3401/3472/3600/360 | £8.00 | | AT 110 E | £25.00 | £16.00 |
| Denon | ATN 72/105/345/3452-E | £12.50 | | AT 412 EP (T4P) | N/A | £13.50 |
| | DSN 24/28/39/44/47/51/66 | £8.00 | | AT402 E | £36.00 | £24.00 |
| | DSN 50/54/60/65 | £12.50 | | AT OC 3 | £92.00 | £64.00* |
| Dual | DN 140/236/237/245 | £10.00 | | AT OC 5 | £125.00 | £98.00* |
| | DN 145/155/165 E, DN 149S | £12.50 | Denon | DL 110 MC | £65.00 | £52.00* |
| | G 800/820/850 | £8.00 | | DL 160 MC | £85.00 | £68.00* |
| Goldring | G 800 Super E (0110E) | £12.50 | | DL 304 MC | £180.00 | £150.00* |
| | DT 35/45/55/60, DT 21 S | £8.00 | Goldring | ELECTRA | £24.00 | £16.00 |
| JVC | N32/33/47/48/52/60/61/66/72 | £8.00 | | 1006 | £44.00 | £29.00 |
| Kenwood | N35/36/43/45/56/62/67/69/71 | £10.00 | | 1012 GX | £58.00 | £38.00 |
| (Trio) | TT 33/44/55/15/53 | £10.00 | | 1022 GX | £76.00 | £49.00 |
| Marantz | EPS 23/24/25/30/33/35/51 CS | £8.00 | | 1042 | £94.00 | £61.00 |
| Mat Pan/Technics | EPS 2700, EPS 313/34/43 ST50 | £8.00 | | Erica (LX)/(H) | £90.00 | £55.00* |
| | EPS. 30ES, EPS 202/270 ED | £10.00 | | Elite | £180.00 | £117.00* |
| Ortofon | FF 15A/VMS 10/20 EIL, OMMP 10/20 | £12.50 | Nagaoka | TS 10 | N/A | £20.00 |
| Philips | GP 371/400/780/400/III | £8.00 | | TS 11 | £63.00 | £38.00 |
| | GP 330/401/401 II/412 II | £10.00 | | TS 12 | £72.00 | £33.00 |
| Pioneer | PN 110/210/220/K65/250T/295T | £8.00 | | MP 10 | £90.00 | £10.00 |
| | PN 303/501/35/200/290T | £10.00 | | MP 11 | £25.00 | £12.50 |
| Pickering | V15 ATACAMA/AT3, XV 15/50 | £10.00 | Ortofon | OM/P 10 | £25.00 | £16.00 |
| | XV15 200/400, TL1/2 | £12.50 | | OM/OMP 20 Super | £54.00 | £31.50 |
| Sansui | SN 10/27/28/37/41/50/80 | £8.00 | | OM 30 Super | £72.00 | £50.00 |
| Sanyo | STG 8/9/10, ST 28/29 D | £8.00 | | OM N'CLUB S | £28.00 | £18.00 |
| (Fisher) | ST 35/36/37/40/42/55 D | £8.00 | | OM N'CLUB E | £33.00 | £21.00 |
| | ST 26/30/38/44/66 D | £10.00 | | CONC N'CLUB S | £50.00 | £18.21 |
| Sharp | STY 104/111/116/117/118 | £8.00 | | CONC N'CLUB E | £54.00 | £21.00 |
| | STY 123/124/127/136/141/160 | £8.00 | | 510 | £28.00 | £19.00 |
| Shure | N 75 6C N 70/91G | £8.00 | | 520, 520P (T4P) | £49.50 | £36.00 |
| | N 75 ED/EJ T2, N 95 ED/EJ | £10.00 | | 530, 530P (T4P) | £76.00 | £57.00 |
| | N 97 ED, VN 35 E | £13.50 | | MC 1 TURBO | £54.00 | £46.00* |
| Sony | ND 133/134/150/155/200/300G | £8.00 | | MC 3 TURBO | £99.00 | £82.00* |
| | ND 115/135/143/148/153 G/250 G | £10.00 | | MC 10 Super | £78.00 | £65.00* |
| Stanton | D 5100 E/5107 A/6071A | £12.50 | | MC 15 Super | £99.00 | £82.50 |
| Tenoret | N 2001 D | £10.00 | | QUARTZ | £128.00 | £105.00* |
| | N 2001 ED | £12.50 | | QUATTRO | £190.00 | £150.00* |
| Toshiba | N 62, N 290 D, N 292 | £8.00 | Shure | ME 92 E (T4P) | £22.00 | £16.00 |
| | N 37/27/67/68 D, N 500 | £10.00 | | ME 97 HE | £50.00 | £42.50 |
| | | | | VN 35 MR | (V 15 III) | £63.00 |
| | | | | VN 45 MR | (V 15 IV) | £90.00 |
| MAKE | ACCESSORY | | | V 15 V MR | £225.00 | £130.00 |
| Shure | SFG 2 Stylus Force Gauge | £15.00 | Stanton | 500 AL DISCO | £30.00 | £18.00 |
| Altai | Cartridge Alignment Protractor | £7.00 | | 680 AL DISCO | £45.00 | £32.00 |

* Exchange any MC ★★★ Other types available ★★★ Tel (0757) 288652

Please state Stylus ident no/colour. Cartridge/ref on all orders/enquires - No credit cards

MANTRA AUDIO (HFW), 22 GARTH AVENUE, NORTH DUFFIELD, SELBY, NORTH YORKS YO8 7RP

Inaccessible accessories by post.

If you can't get to us, we'll get our accessories to you.
CARTRIDGES: Arcam, A.T., Denon, Dynavector, Goldring, Lyra, Ortofon, Sumiko. CABLES: Audioquest, Cable Talk, Ixos, Kimber, Ortofon, Sonic Link, Van den Hul. (including the new carbon cables.) STANDS: Alphason, Sound Organisation, Stands Unique, Target. HEADPHONES: Beyer, Sennheiser, Stax. ACCESSORIES: Allsop, BIB, Discwasher, Hunt, Kontak Last, Michell, Milty, Nagaoka, Pixall, QED. LP's/CD's: Audioquest, DCC, Fone, Klavier, Naxos, Opus, Proprius, Reference Recordings, Sheffield Labs. PLUS a full range of quality equipment available.

Bury Audio

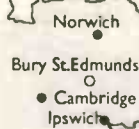

47 Churchgate Street, Bury St. Edmunds, Suffolk IP33 1RG.
For a full catalogue or to order telephone or Fax. 0284 724337 or telephone 0850 565693.

Access, Visa, Diners Club, American Express.



LOVE HERTZ

"You pays your money and you takes your choice"
but our pure silver cables and quality mains interconnects will improve your Hi-Fi system or we will give you your money back.

- ★ High Purity Silver interconnects with PTFE
- ★ Silver tone arm wires & digital interconnects
- ★ Silver speaker cables & mains leads

"We will improve your Hi Fi or give you your money back!"

Campaign Audio Design
Llandudno Road (HW) Cardiff CF3 8PG

Tel: 0222 779401

TRADE & INTERNATIONAL ENQUIRIES WELCOME

**No one was
ever sorry that
they bought
the best!**



As audiophiles you demand the best.

Groove Tubes Performance tested valves certainly measure up every time to those demanding standards. Whatever kind of music you prefer, you'll appreciate it better with Groove Tubes. Simply changing to Groove Tubes will create a whole different set of tonal characteristics to your amplifier, and they are used or approved as the ultimate upgrade to any preamplifier or any power amplifier, by many manufacturers.

Hundreds of professional musicians like Bryan Adams, ZZ Top, Tina Turner, Genesis and Chris Rea use Groove Tubes and G.T. Electronics in their stage and recording amplification.

Now we are introducing the Groove Tubes D.75s power amplifier which is a professional 75 watts per channel stereo amplifier currently in use in top recording studios around the world and of course it comes complete with Groove Tubes as standard. *Retail price £1950-00*

and now...

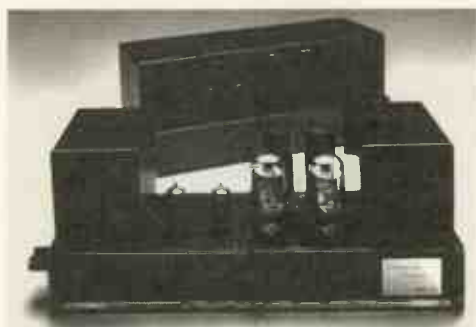

We are pleased to announce an exciting new range of British made valve pre and power amplifiers. Models currently available include:

AMESON-COOPER TWIN 44 MONOBLOCKS
44 watts per channel based on Groove tubes 6L6 valves.
Retail price £1300-00 per pair.

For further information and your nearest stockist contact the Groove Tubes Hotline now.

Telephone: 0902-620156
Fax: 0902-620207

The Groove Tube Centre, Groove Tubes UK, 8 Barn Green,
Bradmore, Wolverhampton WV3 7AY England.



FOR STATE OF THE ART HI-FI

STUDIO ONE

Our dedicated 'Absolute Sounds' Studio. We have on permanent demonstration the following equipment:
APOGEE – from Centaur Minor to Diva
AUDIO RESEARCH – including the LS2b, LS3b & D200
CLASSE – 30, 70, DR4, DR5, DR6, DR10, DR15
KRELL – amplification and digital, now on dem the new KSA50s
MAGNEPLANAR – from SMGa to MG3.3
P S AUDIO – complete range including the Lambda transport
SONUS FABER – Minima Amator, Minuetto, Electa
THETA – Data Basic, Pro basic, Pro prime
WILSON AUDIO speakers

STUDIO TWO

Our new purpose built audio visual room
ADCOM processors
CELESTION shield speakers
CELESTION HT3 package
DENON av amplifiers
LEXICON processors

STUDIO THREE

ACOUSTIC ENERGY
ADCOM
AUDIOLAB
CHORD ELECTRONICS
KEF REFERENCE
MICHELL
MICROMEGA
ORELLE
PROFESSIONAL MONITOR COMPANY
ROKSAN
SME
TANNOY
TDL

Call us or drop in for a chat or to arrange a demonstration. We stock a complete range of speakers from £109 including B&W, CELESTION, HEYBROOK, KEF, SEQUENCE & TANNOY and separate components from £119 from DENON, MARANTZ, SONIC LINK and THORENS all available for audition in **STUDIO FOUR**

A wide range of accessories, headphones and equipment supports available.

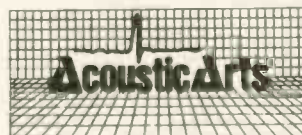

Tel: 0923 233011 Tel: 0923 245250 Fax: 0923 230798

Acoustic Arts Ltd

101 St Albans Rd, Watford WD1 1RD
Opening hours: 10am – 6pm Tues to Sat
100 yards from Watford Junction Station

World favourites

COMPACT DISC PLAYERS

| | | | |
|------------------|-------|---|--------|
| NAD 501 | £180 | A break from the MASH tradition, the Philips powered 501 gives excellent results. | Apr'94 |
| DENON DCD 890 | £270 | Exciting and forceful sounding player, but slightly characterful | Nov'92 |
| ROTEL RCD965 DIS | £350 | A smooth and easy sound make this one of the best value players around. | Jan'94 |
| QUAD 67 | £790 | A new breed of Quad. Lacking nothing in verve or excitement. | May'93 |
| SUGDEN SDT 1 | £850 | Airy and spacious with a rare quality of ambience. | Mar'93 |
| NAIM CDI | £1598 | Single box, 16 bit player. Close to the two box CDS, has vital 'tingle factor'. | Apr'92 |

COMPACT DISC TRANSPORTS

| | | | |
|-----------------|-------|---|--------|
| DPA DIGITAL T-1 | £795 | Superbly detailed sounding transport when sync-locked to DPA's converters. | Jan'93 |
| ORELLE CD10-T | £799 | Very involving, unforced and natural when used with Orelle's DA-180 DAC. | Feb'94 |
| M'MEGA DUO CD.2 | £1850 | Seriously priced, serious CD using Philips' CDM-9 PRO mechanism. Exemplary. | Apr'93 |

DIGITAL TO ANALOGUE CONVERTERS

| | | | |
|----------------|----------|--|--------|
| QED DIGIT/OPTO | £139/169 | Excellent value, with no rough edges. Now with optical input (Opto). | May'92 |
| DACULA | £376 | This little devil from Select Systems really gets its fangs into the music. | Dec'93 |
| DPA DACS | £450-2K | The current masters of DAC-7, their DACs offer superb performance at a range of prices. | |
| ORELLE DA-180 | £599 | 'Analogue' sounding converter, best with matching transport. | Feb'94 |
| P. T. ORDINAL | £695 | Pure sound, smooth and free from hardness. One of the best at any price. | Jul'93 |
| M'MEGA DUO PRO | £1050 | Spacious and dynamic presentation, with a detailed and informative manner. | Apr'93 |
| P. T. DA CAPO | £1450+ | Pink Triangle's own one bit DAC reaches new standards in digital. One of the very best. Even better with DC supply and new filter options. | Mar'94 |

TURNTABLES

| | | | |
|--------------------|-------|--|--------|
| PRO-JECT 6 | £350 | Great involvement and rhythm. Comes with Ortofon MC15 for £399 | Dec'93 |
| MICHELL MYCRO | £397 | In between the Syncro/Gyrodec, the Mycro has superb midband clarity and poise. | Apr'92 |
| TOWNSHEND ROCK III | £799 | The MkIII has a fabulously stable, solid image and terrific bass. | Feb'94 |
| P. T. ANNIVERSARY | £1200 | Very neutral turntable. Excellent imagery and detail. | May'92 |
| SME MODEL 20 | £2495 | The last great turntable, bettered only by the £11,000 Model 30. | Oct'92 |

TONEARMS

| | | | |
|--------------|-------|---|--------|
| REGA RB 300 | £139 | Simple and superb; dynamic with solid bass. | |
| SME 309 | £568 | Based on IV and V: Aluminium armtube and detachable headshell. | Jan'93 |
| SME IV | £850 | Looses little to the fabulous V, possibly the best value for money SME. | Dec'93 |
| SME SERIES V | £1232 | A masterpiece of precision engineering, with a cohesive sound. | May'92 |

CARTRIDGES

| | | | |
|-------------------|------|--|--------|
| GOLDRING 1012 GX | £60 | Rounded bass, slightly forward midband, clean transients. A bargain. | Jul'93 |
| GOLDRING 1022GX | £80 | Extra degree of dynamic range and speed over the 1012GX | Jul'93 |
| SUMIKO BLUE POINT | £100 | The Blue Point casts a romantic charm over all types of music. Robust too. | Oct'92 |
| ORTOFON MC15 | £100 | Moving coil cartridge at a moving magnet price. Has a tight grip on rhythm. | Jun'92 |
| GOLDRING 1042 | £100 | A reference to all other MMs regardless of price | May'92 |
| GOLDRING ELITE | £200 | British made moving coil. Good value, smooth and detailed. | Apr'92 |
| ORTOFON MC2000 | £650 | We came across this one by accident; used on a Garrard 401 with an SMEIV it gave one of the best results we've ever heard. | Dec'93 |

CASSETTE RECORDERS

| | | | |
|----------------|-------|--|--------|
| SONY TC-K611S | £330 | A Dolby S bargain. All the gadgets necessary to produce great recordings. | Feb'94 |
| NAKAMICHI DR2 | £500 | Worth every penny, pushes recordings to the limit and remains unflustered. | Feb'94 |
| NAKAMICHI DR1 | £780 | Nakamichi sound quality, and manual head azimuth adjustment. | Jun'93 |
| NAKAMICHI CR-7 | £1500 | No Dolby 'S', but auto tape tuning and motorised head. The Best! | Aug'92 |

TUNERS

| | | | |
|-------------------|------|--|--------|
| NAD 402 | £160 | Stunning budget tuner, with a warm and open sound. Can compete with the best. | Jan'94 |
| AURA TU-50 | £230 | Superb FM-only tuner. Produces a delightful, three-dimensional sound. A cracker. | May'92 |
| YAMAHA TX-950 | £260 | Fine all-rounder, with good AM section. | Jul'92 |
| MISSION CYRUS FM7 | £299 | Clear and lucid sound. One of the best, regardless of price. | Apr'94 |

World favourites

| | | | |
|-------------|-------|---|--------|
| H/K TU9400 | £300 | Fairly basic facilities, but sound which beats most at the price. | Jul'93 |
| QUAD 66FM | £490 | Among the very best in terms of tonal colour and imagery. Remote controllable. | Nov'92 |
| NAIM NAT 03 | £500 | Warm and easy sound with a good sense of atmosphere. Good value. | Sep'93 |
| NAIM NAT 01 | £1377 | The best solid state tuner currently available. For better radio, live in the studio! | Mar'92 |

INTEGRATED AMPLIFIERS

| | | | |
|-------------------|-------|--|--------|
| H/K HK6150 | £159 | Good sounding starter amplifier. Great dynamic range, excellent bass. | Jun 92 |
| NAD 302 | £160 | Lots of insight and detail, but could sound a little rough in the wrong system. | Jan 93 |
| PIONEER A-300X | £200 | Exceptionally sweet mid and treble, plus the superb dynamic range of the A400. | Dec'92 |
| DENON PMA-350II | £220 | Powerful and with deep rhythmic bass drive. | Sep'93 |
| H/K HK6550 | £349 | Thoroughly refreshing, tonally neutral amplifier with a realistic price tag | Nov'92 |
| AUDIOLAB 8000A | £430 | Very neutral and superbly built. Good bass, great imagery, but can be sterile. | Apr'92 |
| J.SHEARNE. Phase2 | £495 | Gorgeous looks, even better sound. Tight, quick bass and valve-like mid and treble | Dec'93 |
| MISSION CYRUS III | £499 | Superb engineering, a solid cast chassis and a clear and spacious sound. | Apr'94 |
| SUGDEN A21a | £639 | Class A transistor amp. Sharp, crisp, deep, tight, and it images well too. | Feb'94 |
| AUDIONOTE OTO | £1250 | 12w Valve amplifier. More in tune with music than hi-fi. Superb dynamic range. | Jun'92 |
| EAR 834 | £1295 | Valve integrated amplifier with a sweet, open and detailed sound. | Feb'93 |

PRE-AMPLIFIERS

| | | | |
|--------------------|-------|--|--------|
| EAR.834P | £290 | MM/MC phono stage. Uses valves to create a rich sound with tremendous depth. | Jan'94 |
| A. Innovations. L1 | £299 | Valve line level preamplifier. Outstanding results with vdH carbon interconnect. | Feb'94 |
| A. SYNTH. PASSION | £475 | Or £275 for the kit version. Unrivalled transparency from a passive pre-amp. | Aug 93 |
| ROSE RV23-S | £495 | Valve/Transistor hybrid. Smooth and clean, rich and spacious. | Nov'93 |
| DPA DSP 200S | £495 | Not quite the 50S, but there's still nothing to match it at the price. | Jun'93 |
| MICHELL ISO HR | £850 | Impossible not to recommend. What more does your vinyl want? | May'93 |
| NAIM NAC82 | £2000 | Remote control preamp. The NAC82 thrusts detail forwards in true Naim fashion. | Apr'94 |

POWER AMPLIFIERS

| | | | |
|--------------------|---------|--|---------|
| ROSE RP-190 | £495 | Used with the Rose pre-amp it gives 70 watts of smooth relaxing sound. | Nov'93 |
| SUGDEN AU41P | £530 | 100 Watts of smooth, detailed, full bodied sound. And at a bargain price. | Apr'93 |
| QUAD 606 | £675 | 140W powerhouse. Smooth and civilized, with the legendary Quad back-up. | Aug'93 |
| DPA DPA 200S | £750 | Not as cold as the 50S. Better than anything else at the price. | July'93 |
| MICHELL ALECTO (S) | £1300 | Valve like transparency, big warm easy going sound. | Sep'93. |
| MICHELL ALECTOS | £1800 | The Alectos have a lucidity and three dimensional realism that is rarely attained. | Dec'92 |
| NAIM NAP180 | £898 | Partner to NAC82. Has real drive and grip on loudspeakers. | Apr'94 |
| CHORD SPM 1200 | £2995 | Massively powerful, dynamic and detailed sound. Among the best of solid state. | Mar'93 |
| E.A.R. YOSHINO | £25,000 | Single-ended valve design. Noel is still suffering withdrawal from this product. | Jul'93 |

LOUDSPEAKERS

| | | | |
|--------------------|-------|---|--------|
| R' ALLAN MINETTEII | £120 | Fast and lively sounding, competent bass. | Sep'93 |
| GLL MAXIM | £120 | Replacing the Maxim 3; not as tight in the bass but still one of the best at the price. | Aug'93 |
| MISSION 760ISE | £150 | One of the best miniatures around, very musically involving. | Jan'94 |
| HARMAN LS 0300 | £200 | Glass fibre woofer gives a forward and open mid with good bass kick | Nov'93 |
| TDL RTL 2 | £250 | Bass on a budget. Solid, vibrant and spacious sound. | Dec'93 |
| SYSTEMDEK 931 | £300 | Poor man's LS3/5a? Coherent and involving, these little gems really sing. | Mar'94 |
| HARBETH HL-P3 | £400 | There probably isn't a more neutral sounding design anywhere near the price. | Feb'93 |
| ROGERS LS8a/2 | £449 | Big, enjoyable, room filling sound from this 2-way floorstander. | Feb'94 |
| REL STRATA | £499 | REL's Strata offers excellent bass depth and power. | Mar'94 |
| H'BROOK QUARTET | £555 | Sensitive enough to work with low power valve amps. Fast and detailed sound. | Jul'93 |
| JPW RUBY I | £500 | Metal driver speaker with an exciting and lively presentation. | Aug'93 |
| TANNOY D100 | £650 | Believable 3D images produced by this small dual concentric speaker. | Jan'94 |
| PROAC Studio 100 | £699 | Excellent monitors with detailed, natural sound and plenty of atmosphere | Feb'94 |
| SPENDOR SP2/3 | £769 | Smooth sounding speaker with a superb mid-range. Very easy to listen to. | Feb'94 |
| PROAC RES 1 S | £918 | Small box design. Can convey the spirit, drive, and passion of music. | Jul'92 |
| TANNOY D700s | £1970 | Dynamic and powerful. Needs a good clean power amplifier for best results. | Sep'93 |
| TANNOY GRFM | £3500 | Giant loudspeakers. Capable of awesome sound. Need good valve amplification. | Jul'92 |

HI-WAY HI-FI LTD

071-723 5251

WE GUARANTEE YOU CAN'T BUY BETTER!

(FROM AUTHORISED DEALER AND IN STOCK)

MAIL ORDER HOTLINE (071) 723 5251

SAVE ££s
TRY US
FIRST!

• AWARD WINNERS • BEST BUYS • RECOMMENDATIONS •

| | | | | | | |
|--------------------------------|--------------------------------------|-----------------------------|--------------------------------|----------------------------|------------------------------|---------------------------------|
| KENWOOD KR-V6060 | MARANTZ CD-52 Mk II SE | SONY TCK-611S | TECHNICS SU-A900 | SONY ST-S311 | MARANTZ PM44SE | TECHNICS SC-CH950 |
| NEW IN STOCK | IN STOCK | IN STOCK | IN STOCK | IN STOCK | IN STOCK | IN STOCK |

MINI SYSTEMS

| | |
|-----------------|------------------|
| AIWA | |
| LCX-07 | £299.00 |
| NSX-220 | £249.00 |
| NSX-270 (New) | £279.00 |
| NSX-500 | £349.00 |
| NSX-D606 | £409.00 |
| NSX-D707 | £479.00 |
| NSX-D909 | £529.00 |
| AKAI | |
| MX-570 | £429.00 |
| MX-670 | £529.00 |
| MX-92 | £289.00 |
| DENON | |
| D65 | £369.00 |
| D90 | £369.00 |
| D110 | £799.00 |
| D250 | £329.00 |
| JVC | |
| Adagio G7 | £789.00 |
| Adagio G9 | £989.00 |
| Adagio S2 | £389.00 |
| Adagio S3 | £389.00 |
| Adagio S4 | £459.00 |
| Adagio S6 | £589.00 |
| MX-55M | £439.00 |
| UX-A3 | SPECIAL |
| UX-A4 | £339.00 |
| UX-A5 | £349.00 |
| UX-T1 | £289.00 |
| KENWOOD | |
| MS-A7 | £379.00 |
| UD-301/351M | £419.00/£469.00 |
| UD-501/551M | £589.00/£639.00 |
| UD-701/751M | £739.00/£789.00 |
| UD-901/951M | £989.00/£1039.00 |
| PIONEER | |
| N-33/33M | £369.00/£419.00 |
| N-56/53M | £489.00/£539.00 |
| N-57T | £539.00 |
| N-53M/73T | £790.00/£668.00 |
| SONY | |
| MHC-2800 | £539.00 |
| MHC-3600 | £739.00 |
| MHC-510CD | £369.00 |
| MHC-710CD | £439.00 |
| MHC-C50CD | £489.00 |
| MHC-C70CD | £589.00 |
| TECHNICS | |
| SC/CH404 | £499.00 |
| SC/CH50 | SPECIAL |
| SC/CH550 | SPECIAL |
| SC/CH655 | SPECIAL |
| SC/CH750 | £899.00 |
| SC/CH950 | £999.00 |

MID SYSTEMS

| | |
|----------------|-------------------|
| AIWA | |
| ZD-3000M | £579.00 |
| Z-720 | £379.00 |
| AKAI | |
| FX-440CD | £489.00 |
| M-48CD | £319.00 |
| M-55CD | £339.00 |
| JVC | |
| W-37CD | £489.00 |
| W-58CD | £489.00 |
| W-78CD | £729.00 |
| KENWOOD | |
| M-27 | £519.00 |
| M-47/M47G | £589.00/£739.00 |
| M-56AG | £789.00 |
| M-57MG | £839.00 |
| M-76AG | £939.00 |
| M-77MG | £989.00 |
| M-97G/7MG | £1139.00/£1188.00 |
| PIONEER | |
| J1010M | £539.00/£579.00 |
| J2020M | £639.00/£679.00 |
| J3030M | £739.00/£779.00 |
| J4040M | £829.00/£879.00 |
| J5050M | £1129.00/£1179.00 |
| SONY | |
| COMPACT 108CD | £339.00 |
| COMPACT 109CD | £389.00 |
| COMPACT 159CD | £439.00 |
| COMPACT 209CD | £489.00 |
| COMPACT 259CD | £549.00 |

| | |
|----------------------|----------|
| COMPACT 359CD | £589.00 |
| COMPACT 559CD | £749.00 |
| COMPACT 759CD | £1089.00 |
| TECHNICS | |
| CD-X120 | £569.00 |
| CD-X320 | £799.00 |
| CD-X520 | £899.00 |
| REVOX | |
| EVOLUTION SYSTEM | £2249.00 |

AMPLIFIERS

| | |
|-------------------------|---------|
| DENON | |
| PMA-250 III 30W | £159.00 |
| PMA-350 II 50W | £219.00 |
| PMA-450 II 60W | £249.00 |
| PMA-480R 50W Remote | £219.00 |
| PMA-880R 75W Remote | £299.00 |
| JVC | |
| AX-335TN 65W "Special" | £149.00 |
| AX-442 75W "Special" | £189.00 |
| AX-435TN 85W "Special" | £189.00 |
| AX-R337TN 45W AV Remote | £159.00 |
| KENWOOD | |
| DA-9010 100W | £579.00 |
| KA-1030 65W | £139.00 |
| KA-3020 45W | £189.00 |
| KA-3050R 45W Remote | £189.00 |
| KA-4050R 70W Remote | £249.00 |
| KA-5020 80W | £219.00 |
| KA-5050R 95W Remote | £339.00 |
| KA-7050R 100W Remote | £479.00 |
| PIONEER | |
| A-102 30W | £119.00 |
| A-202 40W | £159.00 |
| A-300X 40W Award Winner | £189.00 |
| A-351R 35W Remote | £189.00 |
| A-400X 60W | £299.00 |
| A-602 80W | £339.00 |
| SONY | |
| TA-F211 30W | £149.00 |
| TA-F242 60W | £189.00 |
| TA-F442 80W | £239.00 |
| TA-F542 90W | £289.00 |
| TECHNICS | |
| SU-A500 40W | £199.00 |
| SU-A700 45W | £249.00 |
| SU-A800 55W | £329.00 |
| SU-A900 80W "Best Buy" | £399.00 |
| SU-VZ220 30W | £129.00 |
| SU-VZ320 45W | £169.00 |
| YAMAHA | |
| AX-470 65W | £239.00 |
| AX-570 100W | £289.00 |
| ROTEL | |
| RA-940AX 40W | £199.00 |
| RA-920AX 20W | £129.00 |

AV/PRO LOGIC AMPS/RECEIVERS

| | |
|-----------------|----------|
| DENON | |
| AVC-1530 | £479.00 |
| AVC-3020 | £729.00 |
| AVC-3530 | £999.00 |
| AVC-1000 | £919.00 |
| JVC | |
| RX-508V 40W | £349.00 |
| RX-808V 100W | £579.00 |
| KENWOOD | |
| KR-V8500 55W | £689.00 |
| KR-V6050 | £349.00 |
| KR-V7050 | £399.00 |
| PIONEER | |
| VSA-701S | £489.00 |
| VSA-D802S | £589.00 |
| VSX-452 | £389.00 |
| SONY | |
| TA-AV570 70W | £389.00 |
| TECHNICS | |
| SA-GX350 60W | £329.00 |
| SA-GX550 100W | £449.00 |
| YAMAHA | |
| DSP-A1000 Award | £899.00 |
| DSP-A2070 | £1099.00 |
| DSP-A500 | £469.00 |

| | |
|------------------|---------|
| DSP-A970 | £799.00 |
| DSP-E1000 | £669.00 |
| DSP-E200 | £359.00 |

CASSETTE DECKS

| | |
|---------------------|---------|
| AIWA | |
| AD-F410 | £119.00 |
| AD-F810 | £229.00 |
| AD-WX828 | £189.00 |
| AD-WX929 | £219.00 |
| DENON | |
| DRM-540 | £159.00 |
| DRM-710 | £259.00 |
| DRS-610 | £199.00 |
| DRS-810 | £299.00 |
| JVC | |
| TD-X352 "Special" | £199.00 |
| TD-W708 | £229.00 |
| KENWOOD | |
| KX-3050 | £119.00 |
| KX-5050 | £219.00 |
| KX-5530 | £209.00 |
| KX-7030 | £289.00 |
| KX-7050 | £319.00 |
| KX-7050S | £389.00 |
| KX-W4050 | £159.00 |
| KX-W8050 | £189.00 |
| KX-W8050 | £249.00 |
| PIONEER | |
| CT-S220 | £159.00 |
| CT-S320 | £189.00 |
| CT-S420 | £239.00 |
| CT-S520 | £269.00 |
| CT-620 | £319.00 |
| CT-M601 | £369.00 |
| CT-W420 | £189.00 |
| CT-W620 | £239.00 |
| CT-W820 | £289.00 |
| SONY | |
| TC-FX211 | £99.00 |
| TC-K311 | £139.00 |
| TC-K411 | £189.00 |
| TC-K511 | £269.00 |
| TC-K611 | £319.00 |
| TECHNICS | |
| RS-BX404 "Best Buy" | £179.00 |
| RS-BX646 | £229.00 |
| RS-BX747 | £299.00 |
| RS-TR232 | £179.00 |
| RS-TR333 | £199.00 |
| RS-TR515 | £259.00 |
| RS-TR777 | £299.00 |
| RS-TR979 | £379.00 |
| YAMAHA | |
| KX-260 | £159.00 |
| KX-360 | £199.00 |
| KX-650 | £259.00 |
| KX-W262 | £199.00 |
| KX-W362 | £249.00 |
| ROTEL | |
| RD-945AX | £149.00 |

COMPACT DISC

| | |
|----------------|---------|
| AIWA | |
| XC-300 | £139.00 |
| XC-750 | £189.00 |
| DENON | |
| DCD-1290 | £329.00 |
| DCD-595 | £179.00 |
| DCD-695 | £199.00 |
| DCD-890 | £269.00 |
| DCM-340 | £349.00 |
| KENWOOD | |
| DP-2050 | £159.00 |
| DP-3050 | £189.00 |
| DP-5050 | £259.00 |
| DP-7050 | £339.00 |
| DP-M6650 | £259.00 |
| PIONEER | |
| PD-102 | £149.00 |
| PD-202 | £169.00 |
| PD-DM802 | £439.00 |
| PD-M602 | £259.00 |
| PD-M701 | £319.00 |
| PD-M901 | £439.00 |
| PD-S502 | £219.00 |
| PD-S602 | £259.00 |
| PD-S702 | £289.00 |

| | |
|----------------|---------|
| PD-S802 | £339.00 |
| PD-S901 | £489.00 |
| PD-TM3 | £489.00 |

| | |
|-------------|---------|
| SONY | |
| SL-PG340 | £159.00 |
| SL-PG440 | £189.00 |
| SL-PG520 | £179.00 |
| SL-PG620 | £199.00 |
| SL-PS740 | £249.00 |
| SL-PS840 | £419.00 |
| SL-PS900 | £349.00 |

| | |
|-------------|---------|
| TEAC | |
| CD/Z5000 | £329.00 |

| | |
|---------------|---------|
| YAMAHA | |
| CDC-635 | £299.00 |
| CDX-1060 | £599.00 |
| CDX-470 | £199.00 |
| CDX-570 | £239.00 |
| CDX-670 | £289.00 |
| CDX-870 | £329.00 |

| | |
|--------------|---------|
| ROTEL | |
| RCD-955AX | £229.00 |
| RCD-965BX | £279.00 |

CDV PLAYERS

| | |
|----------------|---------|
| PIONEER | |
| CLD-150 | £839.00 |
| CLD-1850 | £969.00 |
| CLD-2700 | £989.00 |
| CLD-2850 | £689.00 |
| CLD-800 | £349.00 |
| CLD-M5 | £589.00 |
| MDP-650 | £589.00 |
| MDP-850 | £689.00 |

TUNERS

| | |
|------------------|---------|
| AIWA | |
| XT-003 | £109.00 |
| DENON | |
| TU-260 "Award" | £119.00 |
| TU-580 RDS | £219.00 |
| JVC | |
| FX-342 "Special" | £99.00 |
| KENWOOD | |
| KT-1050 | £109.00 |
| KT-2050 | £139.00 |
| KT-3050 | £179.00 |
| KT-6050 | £289.00 |
| PIONEER | |
| F202 | £119.00 |
| F301 RDS | £189.00 |
| F401L | £168.00 |
| F502 RDS | £239.00 |
| SONY | |
| STS-211 | £129.00 |
| STS-311 RDS | £199.00 |

PLUS FULL RANGE OF RECEIVERS IN STOCK.
RING FOR THE FULL RANGE IN SPEAKERS OR CALL IN FOR A DEMO. AR, BOSE, CERWIN VEGA, B&W, GOODMANS, JAMO, MORDAUNT-SHORT, STUDIO POWER & WHARFEDALE.

MAIL ORDER HOTLINE
Please supply ▶ 071-723 5251

Send to HI-WAY HI-FI
318-324 EDGWARE ROAD, LONDON W2

Enclose Cheque/PO for £ _____
or Access/Visa/Credit Card No. _____
Expiry date _____

Name _____
Address _____
Post Code _____

Tel _____ WHF/4/94
E&OE

NOW OPEN
HI-WAY SUPERSTORE
318-324 EDGWARE ROAD
LONDON W2 1DY
TEL: 071-723 5251
FAX: 071-724 6101

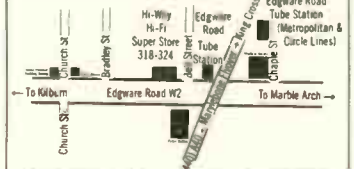

HI-WAY HI-FI (WEST END) LTD
242 TOTTENHAM COURT ROAD
LONDON W1 9AD
TEL: 071-636 5974
FAX: 071-323 4159

VIEWDATA RETURNS £6 made by Tandata, includes 1200.75 modem, kb/d, RGB and comp o/p, printer port. No PSU. £6 MAG6P7
IBM PC CASE AND PSU Ideal base for building your own PC. Ex equipment but OK. £14.00 each REF: MAG14P2
SOLAR POWER LAB SPECIAL You get TWO 6"x6" 6v 130mA solar cells, 4 LEDs, wire, buzzer, switch plus 1 relay or motor. Superb value kit just £5.99 REF: MAG6P8
SOLID STATE RELAYS Will switch 25A mains. Input 3.5-26V DC 57x43x21mm with terminal screws £5.99 REF MAG4P10
300DPI A4 DTP MONITOR Brand new, TTL/ECL inputs, 15" landscape, 1200x1664 pixel complete with circuit diag to help you interface with your projects. JUST £24.99. REF MAG25P1
ULTRAMINI BUG MC 6mmx3.5mm made by AKG, 5-12v electret condenser. Cost £12 ea, Our 7 four for £9.99 REF MAG10P2
RGB/CGA/EGA/TTL COLOUR MONITORS 12" In good condition. Back anodised metal case. £99 each REF MAG99P1
GX4000 GAMES MACHINES returns so ok for spares or repair £9 each (no games). REF MAG9P1
C64 COMPUTERS Returns, so ok for spares etc £9 ref MAG9P2
FUSELAGE LIGHTS 3 foot by 4" panel 1/8" thick with 3 panels that glow green when a voltage is applied. Good for night lights, front panels, signs, disco etc. 50-100v per strip. £25 ref MAG25P2
ANSWER PHONES Returns with 2 faults, we give you the bits for 1 fault, you have to find the other yourself. BT Response 200's £18 ea REF MAG18P1, BT Response 400's £25 ea REF MAG25P3 Suitable power supply £5 REF MAG5P12
SWITCHED MODE PSU ex equip, 60w +5v @5A, -5v @.5A, +12v @2A, -12v @.5A 120/220v cased 245x88x55mm IEC input socket £6.99 REF MAG7P1
PLUG IN PSU 9V 200mA DC £2.99 each REF MAG3P9
PLUG IN ACORN PSU 19v AC 14w. £2.99 REF MAG3P10
POWER SUPPLY fully cased with mains and o/p leads 17v DC 900mA output. Bargain price £5.99 ref MAG6P9
ACORN ARCHMEDES PSU +5v @ 4.4A. on/off sw uncased, selectable mains input, 145x100x45mm £7 REF MAG7P2
GEIGER COUNTER KIT Low cost professional twin tube, complete with PCB and components. £29 REF MAG29P1
SINCLAIR C6 13" wheels complete with tube, tyre and cyde style bearing £6 ea REF MAG6P10
AA NICAD PACK encapsulated pack of 8 AA nicad batteries (tagged) ex equip, 55x32x32mm. £3 a pack. REF MAG3P11
13.8V 1.9A psu cased with leads. Just £9.99 REF MAG10P3
360K 5.25 brand new half height floppy drives IBM compatible industry standard. Just £6.99 REF MAG7P3
PPC MODEM CARDS. These are high spec plug in cards made for the Amstrad laptop computers. 2400 baud dial up unit complete with leads. Clearance price is £5 REF: MAG5P1
INFRA RED REMOTE CONTROLLERS Originally made for hi spec satellite equipment but perfect for all sorts of remote control projects. Our clearance price is just £2 REF: MAG2
TOWERS INTERNATIONAL TRANSISTOR GUIDE. A very useful book for finding equivalent transistors, leadouts, specs etc. £20 REF: MAG20P1
SINCLAIR C6 MOTORS We have a few left without gearboxes. These are 12v DC 3,300 rpm 6"x4", 1/4" OP shaft. £25 REF: MAG25
UNIVERSAL SPEED CONTROLLER KIT Designed by us for the above motor but suitable for any 12v motor up to 30A. Complete with PCB etc. A heat sink may be required. £17.00 REF: MAG17
VIDEO SENDER UNIT. Transmits both audio and video signals from either a video camera, video recorder, TV or Computer etc to any standard TV set in a 100' range! (tune TV to a spare channel) 12v DC op. Price is £15 REF: MAG15 12v psu is £5 extra REF: MAG5P2
***FM CORDLESS MICROPHONE** Small hand held unit with a 500' range! 2 transmit power levels. Reqs PP3 9v battery. Tuneable to any FM receiver. Price is £15 REF: MAG15P1
LOW COST WALKIE TALKIES Pair of battery operated units with a range of about 200'. Ideal for garden use or as an educational toy. Price is £8 a pair REF: MAG 8P1 2 x PP3 req'd.
***MINIATURE RADIO TRANSCENERS** A pair of walkie talkies with a range of up to 2 kilometres in open country. Units measure 22x52x155mm. Complete with cases and earpieces. 2 PP3 req'd. £30.00 pair REF: MAG30.
COMPOSITE VIDEO KIT. Converts composite video into separate H sync, V sync, and video. 12v DC. £8.00 REF: MAG8P2.
LQ3600 PRINTER ASSEMBLIES Made by Amstrad they are entire mechanical printer assemblies including printhead, stepper motors etc etc in fact everything bar the case and electronics, a good stripper £5 REF: MAG5P3 or 2 for £8 REF: MAG8P3
SPEAKER WIRE Brown 2 core 100 foot hank £2 REF: MAG2P1
LED PACK of 100 standard red 5m leds £5 REF MAG5P4
JUG KETTLE ELEMENT good general purpose heating element (about 2kw) ideal for heating projects. 2 for £3 REF: MAG3
UNIVERSAL PC POWER SUPPLY complete with flyleads, switch, fan etc. Two types available 150w at £15 REF: MAG15P2 (23x23x23mm) and 200w at £20 REF: MAG20P3 (23x23x23mm)
***FM TRANSMITTER** housed in a standard working 13A adapter! the bug runs directly off the mains so lasts forever why pay £700? or price is £26 REF: MAG26 Transmits to any FM radio.
***FM BUG KIT** New design with PCB embedded coil for extra stability. Works to any FM radio. 9v battery req'd. £5 REF: MAG5P5
***FM BUG BUILT AND TESTED** superior design to kit. Supplied to detective agencies. 9v battery req'd. £14 REF: MAG14
TALKING COINBOX STRIPPER originally made to retail at £79 each, these units are designed to convert an ordinary phone into a payphone. The units have the locks missing and sometimes broken hinges. However they can be adapted for their original use or used for something else?? Price is just £3 REF: MAG3P1
100 WATT MOSFET PAIR Same spec as 25K343 and 2SJ413 (8A, 140v, 100w) 1N channel, 1P channel, £3 a pair REF: MAG3P2
VELCRO 1 metre length of each side 20mm wide (quick way of fixing for temporary jobs etc) £2 REF: MAG2P3
MAGNETIC AGITATORS Consisting of a cased mains motor with lead. The motor has two magnets fixed to a rotor that spin round inside. There are also 2 plastic covered magnets supplied. Made for remotely stirring liquid! you may have a use? £3 each REF: MAG3P3

BULL'S BULLETIN BOARD

100MHZ DUAL TRACE OSCILLOSCOPES JUST £259 RING FOR DETAILS

MASSIVE

WAREHOUSE CLEARANCE FANTASTIC £20.00 REDUCTION REFURBISHED PC BASE UNITS COMPLETE WITH KEYBOARD

FROM ONLY **£29.00**

AMSTRAD 1512 BASE UNITS GUARANTEED PERFECT WORKING ORDER.

A LOW COST INTRODUCTION TO THE HOME COMPUTER MARKET.

AMSTRAD 1512SD

1512 BASE UNIT, 5.25" FLOPPY DRIVE AND KEYBOARD. ALL YOU NEED IS A MONITOR AND POWER SUPPLY. WAS £49.00 NOW ONLY **£29.00** REF: MAG29

AMSTRAD 1512DD

1512 BASE UNIT AND KEYBOARD AND TWO 5.25" 360K DRIVES. ALL YOU NEED IS A MONITOR AND POWER SUPPLY. WAS £59.00 NOW ONLY **£39.00** REF: MAG39

SOLAR POWER PANELS

3FT X 1FT 10WATT GLASS PANELS 14.5v/700mA NOW AVAILABLE BY MAIL ORDER £33.95

(PLUS £2.00 SPECIAL PACKAGING CHARGE)

TOP QUALITY AMORPHOUS SILICON CELLS HAVE ALMOST A TIMELESS LIFESPAN WITH AN INFINITE NUMBER OF POSSIBLE APPLICATIONS, SOME OF WHICH MAY BE CAR BATTERY CHARGING, FOR USE ON BOATS OR CARAVANS, OR ANYWHERE A PORTABLE 12V SUPPLY IS REQUIRED. REF: MAG34

FREE SOFTWARE!

Brand new, UNUSED top quality Famous brand licensed software discs. Available in 5.25" DSDD or 5.25" HD only. You buy the disk and it comes with free BRAND NEW UNUSED SOFTWARE. We are actually selling you the floppy disc for your own "MEGA CHEAP" storage facilities, if you happen to get software that you want/need/like as well..... you get a "MEGA BARGAIN" tool DSDD PKT10 £2.99 REF: MAG3P7 PKT100 £16.00 REF: MAG16

*****WE BUY SURPLUS STOCK*****

TURN YOUR SURPLUS STOCK INTO CASH. IMMEDIATE SETTLEMENT. WE WILL ALSO QUOTE FOR COMPLETE FACTORY CLEARANCE.

1994 CATALOGUE.

PLEASE SEND 45P, A4 SIZED SAE FOR YOUR FREE COPY. MINIMUM GOODS ORDER £500 TRADE ORDERS FROM GOVERNMENT, SCHOOLS, UNIVERSITIES, & LOCAL AUTHORITIES WELCOME. ALL GOODS SUPPLIED SUBJECT TO OUR CONDITIONS OF SALE AND UNLESS OTHERWISE STATED GUARANTEED FOR 30 DAYS. RIGHTS RESERVED TO CHANGE PRICES & SPECIFICATIONS WITHOUT PRIOR NOTICE. ORDERS SUBJECT TO STOCK. QUOTATIONS WILLINGLY GIVEN FOR QUANTITIES HIGHER THAN THOSE STATED.

*SOME OF OUR PRODUCTS MAY BE UNLICENSABLE IN THE UK

BULL ELECTRICAL

250 PORTLAND ROAD HOVE SUSSEX BN3 5QT

MAIL ORDER TERMS: CASH PO OR CHEQUE WITH ORDER PLUS £3.00 POST PLUS VAT.

PLEASE ALLOW 7 - 10 DAYS FOR DELIVERY

TELEPHONE ORDERS WELCOME

TEL: 0273 203500

FAX: 0273 323077



TOP QUALITY SPEAKERS Made for HI FI televisions these are 10 watt 4R Jap made 4" round with large shielded magnets. Good quality general purpose speaker. £2 each REF: MAG2P4 or 4 for £6 REF: MAG6P2

TWEETERS 2" diameter good quality tweeter 140R (ok with the above speaker) 2 for £2 REF: MAG2P5 or 4 for £3 REF: MAG3P4
AT KEYBOARDS Made by Apricot these quality keyboards need just a small modification to run on any AT, they work perfectly but you will have to put up with 1 or 2 foreign keycaps! Price £6 REF: MAG6P3

XT KEYBOARDS Mixed types, some returns, some good, some foreign etc but all good for spares! Price is £2 each REF: MAG2P8 or 4 for £6 REF: MAG6P4

PC CASES Again mixed types so you take a chance next one off the pile £12 REF: MAG12 or two the same for £20 REF: MAG20P4
COMMODORE MICRODRIVE SYSTEM mini storage device for C64's 4 times faster than disc drives, 10 times faster than tapes. Complete unit just £12 REF: MAG12P1

SCHOOL STRIPPERS We have quite a few of the above units which are 'returns' as they are quite comprehensive units they could be used for other projects etc. Let us know how many you need at just 50p a unit (minimum 10).

HEADPHONES 16P These are ex Virgin Atlantic. You can have 8 pairs for £2 REF: MAG2P8

PROXIMITY SENSORS These are small PCB's with what look like a source and sensor LED on one end and lots of components on the rest of the PCB. Complete with flyleads. Pack of 5 £3 REF: MAG: 3P5 or 20 for £8 REF: MAG8P4

SNOOPERS EAR? Original made to clip over the earpiece of telephone to amplify the sound - it also works quite well on the cable running along the wall! Price is £5 REF: MAG5P7

DOS PACKS Microsoft version 3.3 or higher complete with all manuals or price just £5 REF: MAG5P8 Worth it just for the very comprehensive manual 5.25" only.

DOS PACK Microsoft version 5 Original software but no manuals hence only £3 REF: MAG3P6 5.25" only.

FOREIGN DOS 3.3-German, French, Italian etc £2 a pack with manual. 5.25" only. REF: MAG2P9

CTM644 COLOUR MONITOR. Made to work with the CPC464 home computer. Standard RGB input so will work with other machines. Refurbished £59.00 REF: MAG59

PIR DETECTOR Made by famous UK alarm manufacturer these are hi spec, long range internal units. 12v operation. Slight marks on case and unboxed (although brand new) £8 REF: MAG8P5

WINDUP SOLAR POWERED RADIO AM/FM radio complete with hand charger and solar panel £14 REF: MAG14P1

COMMODORE 64 TAPE DRIVES Customer returns at £4 REF: MAG4P9 Fully tested and working units are £12 REF: MAG12P5

COMPUTER TERMINALS complete with screen, keyboard and RS232 input/output. Ex equipment. Price is £27 REF: MAG27

MAINS CABLES These are 2 core standard black 2 metre mains cables fitted with a 13A plug on one end, cable the other. Ideal for projects, low cost manufacturing etc. Pack of 10 for £3 REF: MAG3P8 Pack of 100 £20 REF: MAG20P5

SURFACEMOUNT STRIPPER Originally made as some form of high frequency amplifier (main chip is a TSA5511T 1.3GHz synthesiser) but good stripper value, an excellent way to play with surface mount components £1.00 REF: MAG1P1

MICROWAVE TIMER Electronic timer with relay output suitable to make enlarger timer etc £4 REF: MAG4P4

MOBILE CAR PHONE £5.99 Well almost complete in car phone excluding the box of electronics normally hidden under seat. Can be made to illuminate with 12v also has built in light sensor so display only illuminates when dark. Totally comnding! REF: MAG6P6

ALARM BEACONS Zenon strobe made to mount on an external bell box but could be used for caravans etc. 12v operation. Just connect up and it flashes regularly! £5 REF: MAG5P11

FIRE ALARM CONTROL PANEL High quality metal cased alarm panel 350x165x80mm. With key. Comes with electronics but no information. sale price 7.99 REF: MAG8P6

SUPER SIZE HEATSINK Superb quality aluminium heatsink. 365 x 183 x 61mm, 15 fins enable high heat dissipation. No holes! sale price £5.99 REF: MAG6P11

REMOTE CONTROL PCB These are receiver boards for garage door opening systems. You may have another use? £4 ea REF: MAG4P5

6"x12" AMORPHOUS SOLAR PANEL 12v 155x310mm 130mA. Bargain price just £5.99 ea REF MAG6P12.

FIBRE OPTIC CABLE BUMPER PACK 10 metres for £4.99 Ref MAG5P13 ideal for experimenters! 30m for £12.99 ref MAG13P1

LOPTX Line output transformers believed to be for hi res colour monitors but useful for getting high voltages from low ones! £2 each REF: MAG2P12 bumper pack of 10 for £12 REF: MAG12P3.

SHOP OPEN 9-5.30 SIX DAYS A WEEK

PORTABLE RADIATION DETECTOR

£49.99

A Hand held personal Gamma and X Ray detector. This unit contains two Geiger Tubes, has a 4 digit LCD display with a Piezo speaker, giving an audio visual indication. The unit detects high energy electromagnetic quanta with an energy from 30K eV to over 1.2M eV and a measuring range of 5-9999 UR/h or 10-99990 NR/h. Supplied complete with handbook.

REF: MAG50

V^c audio

Hi-Fi Consultants

Echoes from the past

There are so many new brand names in the hi-fi world these days it's reassuring to find some old favourites re-appearing in the British market. One of these is SUGDEN, who have been doing well in export markets for many years but are now getting back into the U.K. market. These hand built units are superb to look at, particularly the '51' pre-power units, and produce some of the sweetest sounds around. Also worth an audition is their SDT-1 CD player.

Then there is ELECTRO COMPANET amplifiers which many of you may remember from the late 70's when their 25 watt amplifiers won rave reviews and a wide following. Their new range from this Norwegian company include phono stages to 250 watt dual mono balanced power amps plus a 20th anniversary limited edition pre-power combination with rare blue stone facia at £4,972; only 400 available world wide, so don't delay!

Another old favourite of our's was the American Dahlquist loudspeakers, which are now available here in an improved build standard as the ALON range produced by Carl Marchisotto-chief design engineer at Dahlquist for 15 years-of Acarian systems. The range starts at the ALON 1 for £1,300 and are now in stock with the ALON 2 at about £1,900 due shortly. Their top model, the Phalanx, costs a mere £25K, so we haven't got that yet!

So do come and hear some of the most interesting products around; we always have something out of the ordinary.

36 Druid Hill, Stock Bishop,
Bristol BS9 1EJ.
Tel. Bristol 686005

DAN DULEY Hi-Fi

Ultra High Quality Negus System :- Comprising Passive pre-amp active crossover, 3 matched Stereo amplifiers, Power pack, 3 way active loudspeakers and all interconnects. This system gives unrivalled clarity and realism at the price of £1800 fully installed.

Video Companion: Anyone who has connected a V.H.S video to Hi-Fi equipment will know about hiss.

The Dan Duley Video Companion successfully reduces hiss by 12-14 dB using a dynamic filtering system. An essential piece of equipment for video lovers at £90.

Handbuilt Equipment: - Constructed on an individual basis. Amplifiers from 50wpc (rms) to 1Kwpc. All equipment is tailor made and installed to the clients requirements.

Tape Machine Alignment: Carried out using test tapes and an oscilloscope, rather than "set by ear", for the very best results. Very reasonable rates for all tweaking and tuning work.

For full details of any of the above items either write or telephone Dan Duley Hi Fi at:
15 St. Georges Square,
Forest Gate,
London E7 8HN
Telephone: 081 470 9795



The
Audio Room
Pure Sound



For High End Hi-Fi

0784 458176 / 081 893 1074

You can audition any of these products in your own home or in any of our three permanent demonstration rooms.

| | |
|--------------------------------|----------------------------------|
| Audio Note Oto SE | Micromega T/Dac, T/Drive |
| Audio Note Soro SE | Ortofon cartridges |
| Audio Note DACs | Project Turntable |
| Audio Note speakers | Townsend Rock III |
| Arion valve amps | Transfiguration Cartridge |
| Audio Innovations Alto | Triangle T60 amp |
| Audio Innovations valve range | Triangle Alcante, Icare, Scalene |
| Audiomeca Mephisto/Kreatura | Trilogy 958 monos, /stereo/ pre |
| Basis turntable | Wilson/Benesch turntable/arm |
| Graham Tonearm | YBA amps, CD players |
| Impule H2, H5, H6, H7 speakers | Apollo stands |
| Kinshaw amps, phono, DAC | Base stands/platforms |
| Lumley Reference 120s /ST70 | Frameworks stands |
| Lumley Monitor speakers | Seismic Sink |
| Magnum Dynalab FT101 Etude | Cables: Audio Note, Cogan Hall, |
| Micromega Stages | Silver Sounds, Lieder, XLO |

Ex-dem & p/ex bargains:

| Item | Sale |
|-------------------------------------|------|
| Jadis JP80 MM | 3200 |
| Audio Innovations L2 preamp | 499 |
| Audio Innovations 2nd Audios | 1999 |
| Manley 350 monoblocs | 2999 |
| Pink Triangle PIP2 c/w battery pack | 1599 |
| YBA 3 Power/2 pre | 1999 |
| Trilogy 858 100w monoblocs | 1799 |
| Trilogy 901 preamp | 599 |
| Trilogy 902 preamp | 1099 |
| Lumley 120s | 2499 |
| Apogee Scintillas (4/1 ohm) | 999 |
| Kef 107/2 as new | 1799 |
| Kef 105/3 as new | 1499 |
| Ensemble PA1 ref. (Piano Black) | 2199 |
| Snell Type E's | 599 |
| Impulse H1 | 1699 |
| Triangle Icare | 1199 |
| Triangle Alcante | 850 |
| Triangle Scalene | 550 |
| YBA CD2 player | 2150 |
| T/Dac T/Drive | 1999 |
| Audiomeca Kreatura player | 999 |
| Proceed PIP PDT2 | 2200 |
| Theta DS pro-prime (as new) | 850 |
| Gyrodec Zeta arm | 625 |

Credit Cards



Open: 10 - 6pm Mon-Sat
10 - 9pm Thursday
World wide tax free export

Welcome
24 hrs. delivery service

071 - 233 0774

ENJOY THE MAGIC OF VALVES

Pure Natural Sound

0%

**INTEREST FREE CREDIT
ON SELECTED ITEMS**



*Audio Innovation, E.A.R,
Lumley Reference, Tube
Technology, Conrad Johnson,
D.D. Audio, Hi-Fi World Kit*

We Offer

- 24hrs. delivery services
- Part x-change
- Free three years warranty on selected product
- Home load
- Home installation
- Interest free credit
- We are located very new to Victoria main line underground station. One minute walk & open late 9pm (Thursday)

*We have in stock:
Spendor • Quad • Royd • Triangle • KEF •
Tannoy • Proac • Castle Speakers
Please ASK for our special offer list*

*CD Player From:- Quad • Micromega • Teac • Marantz • Rotel • AMC •
Pioneer • Orelle Musical Fidelity*

Cassette Decks from:- Aiwa • Denon • Sony • Nacamichi • Harman • Marantz

*Amps From:- Orelle • Quad • Alberr • Musical Fidelity • Alchemist • John
Sheren • Aiwa • Pioneer*

Tumtables From:- Pink Triangle, Thoren, Alphason, Townsend Rock

*DACS from
Pink Triangle • Deltac • Kinshaw
Orell • Musical Fidelity • Teac*

HI-FI CONFIDENTIAL LTD

34 Buckingham Palace Road, London SW1W 0RE (Victoria Station) Phone 071 - 233 0774 Fax. 071 - 233 7226

AMADEUS SOUND & VISION

**Aura, Audio Innovations,
Bang & Olufsen,
Castle Acoustics, Micromega,
Mordaunt-Short,
Musical Fidelity, Nacamichi, NAD,
Pioneer, Quad, Spondor, Technics.**

**10 BOLDMERE ROAD
SUTTON COLDFIELD
WEST MIDLANDS**

Tel: 021-354-2311

**making the most
of the music**



PETITE

CRITIQUE

**neat
acoustics**

62 High Northgate
Darlington
Co Durham DL1 1UW
0325 460812

Billy Vee

sound systems

Telephone: 081 318 5755 & 852 1321

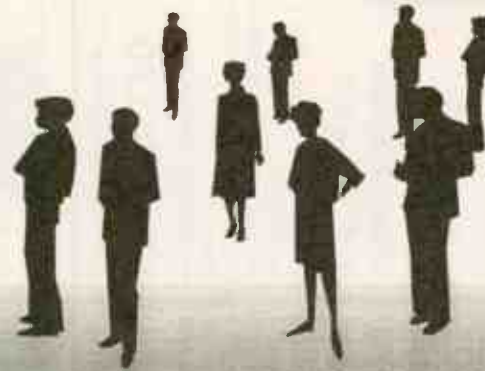

THE CHOICE IS YOURS

We demonstrate everything we sell so you can be sure that any of the products you see advertised here are on display and available for audition. Our helpful and experienced staff are on hand every day (except Thursday and Sunday) to help explore the possibilities open to you. We welcome your visit.

- > Two listening rooms
- > Two year minimum guarantee
- > Free 24hr delivery service
- > 0% Finance available
- > Part exchange service available
- > Outstanding product range

Welcome to the home of good hi-fi!



248 Lee High Road, Lewisham, London SE13 5PL

Contributors: ARCAM - CYRUS - DENON - HEYBROOK - JPW - MARANTZ - LINN - MISSION - NAD - NAIM - NAKAMICHI - QUAD - REGA - ROGERS - TANNOY etc

Our services include, two listening rooms, part exchange, systems installation and :-

0% A.P.R. CREDIT - PLEASE CALL FOR DETAILS.

If you would like to join our mailing list and expose yourself to our new 1994 catalogue of Musical evenings, events and Concerts featuring top artists, presented in conjunction with the Blackheath Concert Halls. Please contact Peter or Ian. Come and join in the Lewisham festival of sound - Recorded and Live!

CHOOSE

the powerplant

BRIGHTON'S LEADING HI-FI SHOP

REGA and ARCAM products now on demonstration

Roksan, Micromega, Audiolab, Rega, Arcam, Aura, Exposure, Rotel, Marantz, Ruark Epos, Thiel and other fine equipment

66 Upper North Street Brighton 0273 775978

NB-2000™

active noise reduction headset



NB-2000 can reduce annoying noise by 50-95%, while leaving desired sounds, such as speech, music and warning signals clearly audible.

Use NB-2000 in conjunction with your portable audio equipment or in-flight entertainment system to reduce environmental noise, and enjoy better audio quality.

Use the comfortable, lightweight NB-2000

- in the plane, car, bus, truck, boat, train, tube, city, home, office
- with lawnmowers, vacuum cleaners, home power tools, computers
- and in many other everyday situations where noise is a nuisance.

How does "active" noise reduction work ?



Microphones in both headset earcups listen to the offensive noise, feed that information to the NB-2000 electronic controller where it is analysed, and an anti-noise wave is generated.

The anti-noise meets the offensive noise, that noise is reduced.

£139.99 + £5.00 P&P. To order, send a cheque or postal-order made payable to "Don Fordy Ltd." for £144.99 to :

For further information,
Tel 0792-895435 or
Fax 0792-891235



Don Fordy Ltd., 7 Orchard Grove,
Penllergaer, Swansea, SA4 1AD.

Oxford Audio Consultants

HI-FI SPECIALISTS



Our superb service is the name, regardless of price.

SONUS FABER GUARNERI

The nearest thing to a musical instrument you've ever heard!!

NOW DEMONSTRATING

SME 20 TURNTABLE top notch analogue built to last
TEAC VRDS 7 - a snip at £599
MICROMEGA T DRIVE AND DAC - tremendous value for money
MUSICAL FIDELITY F SERIES Including the fabulous new CD PLAYER
HEYBROOK SEXTETS AND QUARTETS on dem!
COPLAND CTS14 - a bargain at £999
AUDIO VISUAL SYSTEMS including PIONEER, LASERDISC, DENON, NAD, ROTEL
AUDIO ALCHEMY DAC IN THE BOX - unbelievable value for money.
AUDIO RESEARCH LS5 - earth shattering!
AUDIO RESEARCH CDT TRANSPORT - Simply brilliant.
DENON - NEW AGENCY
KRELL DSP CD PLAYER and STUDIO DAC - give them a go!
THETA COBALT 307 -stunning sound and value for money!
THETA BASIC CD TRANSPORT -excellent value
B&W MATRIX 805
TEAC P700 2 BOX COMBO -brill!
MARANTZ CD 10 -The latest MARANTZ heavyweight
MICHELL GYRODEC -Try the latest power supply
LYRA LYDIAN CARTRIDGE -simply stunning!
KRELL KSA 100S & KRC 2 (remote control) - Fabulous
AUDIO RESEARCH LS2B & LS3 PREAMPS & V70 POWER AMP
SONUS FABER - THE COMPLETE RANGE; WE LOVE THEM ALL!
MARTIN LOGAN AERIUS -Stunning looks and sound
REL STADIUM SUBWOOFERS
VAN DEN HUL CABLES -including The First, Second and Revelation

EX DEM & P/EX BARGAINS

WADIA 6 CD PLAYER £2995
AUDIO RESEARCH V70 ex dem £3495
AUDIO RESEARCH DAC 1-20 £1995
SONUS FABER MINUETTOS £795
MUSICAL FIDELITY TEMPEST £150
ACOUSTIC ENERGY AE 1s ex dem £550
KRELL MD1 TRANSPORT NOW £1995
REVOX EVOLUTION SYSTEM £1295 (originally £2295)
APOGEE DUETTA SIGNATURES £1995
PIONEER PD75 CD PLAYER £495
KRELL CD DSP CD PLAYER EX DEM £3495
KRELL STUDIO DAC £3495
THETA DS PRO PRIME £995
MAGNUM 125 PRE/POWER EX DEM £675
NEAT PETITE SPEAKERS ££395

Please ask for details or our current list
Agencies include: Accuphase, Acoustic Energy, Air Tangent, Apogee, Audio Alchemy, Audio Research, Audio Technica, Basis, B&W, Castle, Copland, Denon, Denon Cartridges, DPA, Dual, Goldring, Harmonix, Heybrook, HPW, Kimber, Koetsu, Krell, Lyra, Magneplanar, Magnum, Mandrake, Marantz, Martin Logan, Michell, Micromega, Music Fidelity, NAD, Nakamichi, Onix, Orelle, Ortofon, Pioneer, Proceed, PS Audio, QED, REL Subwoofer, Revox, Rogers, Roksan, Rotel, Ruark, SD Acoustics, Seismic Sink, Sennheiser, Sequence, Sequerra, Slate Audio, SME, Sonus Faber, Stax, Target, TDL, Teac, Theta, Thorens, Van den Hul, Wadia, Wharfedale

TAX-FREE EXPORT SERVICE
MAIL-ORDER AVAILABLE ON MANY ITEMS
Open Mon-Sat 10am-6pm

Oxford Audio Consultants

Oxford Audio Consultants, Cantay House, Park End Street OX1 1JE
Telephone: Oxford (0865) 790879 Facsimile: Oxford (0865) 791665



**THE PAST &
THE PRESENT**

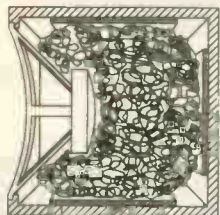

Inside a Typical Cabinet

**LISTEN TO
THE FUTURE**

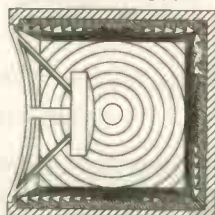

Deflex Panels Fitted

**GET THE MUSIC OUT OF YOUR SYSTEM, AND LET
YOUR SPEAKERS BREATHE!**

Replaces the existing damping material inside your loudspeakers – quick and easy to fit. Available for any loudspeaker.

Deflex acoustic panels have excellent performance characteristics. The polymer is specially formulated to absorb shock and vibration, thus minimising cabinet resonances.

The surface emulation has been carefully designed to eliminate standing waves

The energy inside the enclosure is controlled – ***NOT ABSORBED***, as in other cabinets.

Independent tests on MLSSA show energy gains over 50%.

DEFLEX® A.P.T. ACOUSTIC PANEL TECHNOLOGY

PURPOSELY DESIGNED HI-TECH SPEAKER LININGS
NOT BY-PRODUCTS FROM ANY OTHER INDUSTRY

**"NEW APPROACH STUNS THE EXPERTS"
"BIGGEST BREAK-THROUGH IN 20 YEARS"
"RESULTS NEVER ACHIEVED BEFORE"
"THE MUSIC IS FASTER, BRIGHTER,
CLEANER, WITH DEEP, CONTROLLED BASS"**

U.K. DISTRIBUTOR

The
SPEAKER
Company

UNIT 9,
WATERSIDE MILL,
WATERSIDE,
MACCLESFIELD, CHESHIRE
SK11 7HG
Phone 0625 500507

CURRENT PRICES

Standard Panels
@ £7.95 each

Sub-woofer Panels
@ £11.95 each

Adhesive from
£3.50 (200ml)



Are you tired of getting ONLY what you pay for?

Call me and see how different it can be.

For the Best of British...

DPA Digital, LFD, Michell, Orelle, Pink Triangle

And the Best of the Rest...

***Classé, Copland, Linaeum, Magnepan,
Sonus Faber, Van den Hul***

'Phone or fax me anytime, 9am - 10pm, any day including weekends on:

0252 - 377952

0385 - 317952

Part Exchange/Ex Demo equipment:

Acoustat Model 3 electrostatics £1500, Musical Fidelity A370 £1000, Sonus Faber Electa £1350

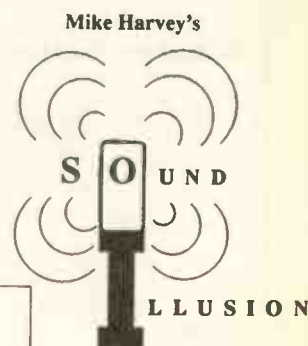

Major credit cards accepted

WorldRadioHistory



MUSIC MATTERS



THE AUDIO SPECIALISTS

THE FINEST HI-FI AND AUDIO VISUAL SYSTEMS

From our comprehensive range we can assemble for the discerning customer carefully selected and matched components from a simple audio system at around £500 to a complete hi-fi and video installation costing many thousands of pounds. Illustrated is a selection from the magnificent Meridian range which includes compact disc players from £995, amplifiers, tuners, loudspeakers and even facilities for multi-room to enable music to be carried to other locations in the home. With the addition of a television, V.C.R. and surround sound processor you can be transported into the concert hall, opera house, cinema, stadium or even join the crowd at major sporting events. Please contact us to arrange a demonstration. We are confident you will not be disappointed!

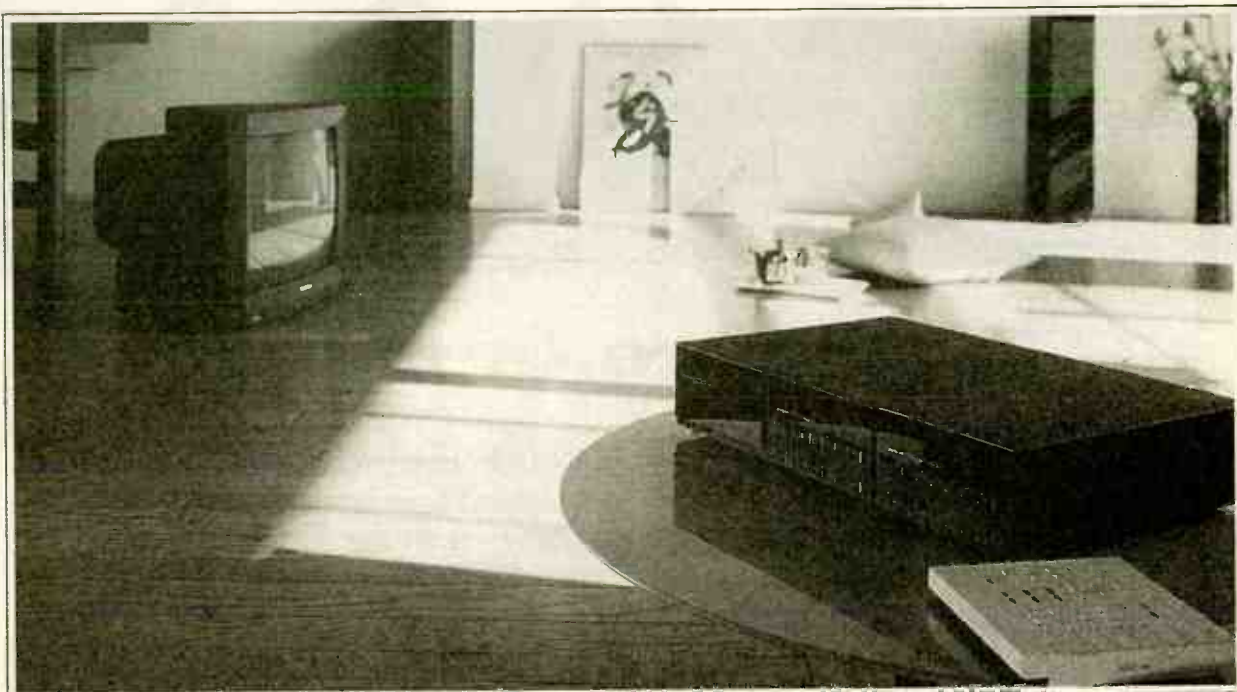

We also stock a wide selection of classical compact disc at competitive prices.

**INTEREST FREE
CREDIT AVAILABLE**

APR - 0% Written details on request.
Licensed Credit Broker



OPENING HOURS

Tuesday - Saturday
10.30 - 6.00
Late night Friday till 8.00
Demonstrations by Appointment

**New Store now open in Solihul 93-95 Hobs Moat Road, Solihul
W. Midlands. Tel. 021 742 0254**

**251, Hagley Road, Edgbaston, Birmingham B15 8DL
Tel:- 021 429 2811**

**156/7, Lower High Street, Stourbridge DY8 1TS
Tel:- 0384 444184**

Full service department on premises

JPW, KEF, Lexicon, Marantz, Meridian, Michell, Micromega, Mission, Monitor Audio, Moth, Musical Fidelity, Nakamichi, NVA,

Airwa, Alphason, Alchemist, Apollo, Arcam, Audiolab, Audio-Technica, Auro, Beyer, B&W, Canon, Celestion, Chord, Cyrus, Denon, DPA, Ducl, Epos, Exposure, Heybrook,

Panasonic, Pioneer, Pink Triangle, Pro-oc, Revox, Rogers, Rolsan, Rotel, Ruark, Sennheiser, Systemdek, Tannoy, Target, Teac, Technics, Thorens, Tripod, Wharfedale, Yamaha.

Hi-fi for as little as £50,000.

[And more. Or less.]

If you take your hi-fi seriously – and we do mean seriously – this should sound familiar.

One, you'd like totally unbiased advice on all the available options.

Two, you're not prepared to settle for less than the best your money will buy.

Three, you feel you deserve a professional to tailor a one-off system to your personal requirements.

Four, you expect to test drive equipment – at length – before you decide.

And last, but not least, you'd love to have your own expert on permanent call.

In short, you want Serious Kit.

Simply ring 061-707 4823 for access to all the above.

Plus, most of the world's finest names in top-end equipment. And all the experience of the UK's top talent in hi-fi system design.

Serious sound. Serious sense. Serious service.

Serious Kit.

Music to your ears.

SERIOUS KIT

SERIOUS KIT · 21 ALGERNON STREET · MONTON · ECCLES · MANCHESTER M30 9QA · TELEPHONE 061-707 4823.
THE TOP NAMES. THE TOP EQUIPMENT. ACCUPHASE · ALCHEMIST · APOGÉE · AUDIO INNOVATIONS · AUDIOLAB
AUDIO RESEARCH · COPLAND · COUNTERPOINT · EPOS ACOUSTICS · GROOVE TUBES · HEYBROOK LOUDSPEAKERS
IMPULSE LOUDSPEAKERS · JADIS · KRELL · LYRA · MAGNEPAN · MARTIN LOGAN · MICHEL · MICRO-MEGA
PINK TRIANGLE · P.S.AUDIO · ROKSAN · SONUS FABER · SUODEN · SYSTEMDEK · TEAC · THETA · THIEL · WILSON AUDIO

PIONEER

BEST PRICES GUARANTEED

KENWOOD

LICENSED CREDIT BROKERS ASK FOR DETAILS

LICENSED CREDIT BROKERS ASK FOR DETAILS



ALL BILL HUTCHINSON HI-FI SHOPS ARE DEDICATED AUDIO VISUAL CENTRES

ALL BRANCHES ARE MAJOR LASER DISC STOCKISTS

PIONEER

Bill Hutchinson

Hi-Fi • CD • Audio Visual Centre

THE PROFESSIONALS

When you purchase from Bill Hutchinson you're buying the best names in Hi-Fi from the best name for Hi-Fi.

Our Product Guarantee and Pricing Policy ensure you obtain an excellent deal.

My staff and I look forward to being of service to you.

Bill

YAMAHA DSP-A2070



PRICE PLEDGE

Should you find any local dealer offering a better price for goods currently in stock at Bill Hutchinson and the alternative quoting retailer, we will better that deal.

- MARANTZ CD52 MK11SE - CD PLAYER - AWARD WINNER '93 ✓
- MARANTZ PM44SE - AMPLIFIER - AWARD WINNER '93 ✓
- MISSION 751 - SPEAKERS - AWARD WINNER '93 ✓
- SONY TCK-611S - CASSETTE DECK - AWARD WINNER '93 ✓
- SONY STS 311 - TUNER - AWARD WINNER '93 ✓
- AIWA NSX-360 - MINI SYSTEM - AWARD WINNER '93 ✓
- TECHNICS SC-CH950 - PRO-LOGIC SYSTEM - AWARD WINNER '93 ✓

THE LARGEST SELECTION OF QUALITY HI-FI AND AUDIO VISUAL SYSTEMS

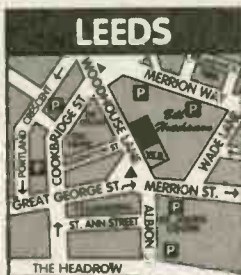

26-28 WOODHOUSE LANE
0532-427777

OPEN MONDAY - SATURDAY
9.30AM - 6.00PM
THURSDAY LATE OPENING

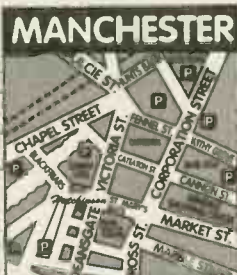

50-52 DEANSGATE
061-832 1600

OPEN MONDAY - SATURDAY
9.30AM - 6.00PM
THURSDAY LATE OPENING

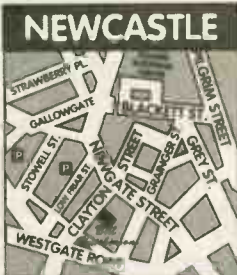

87A CLAYTON STREET
091-230 3600

OPEN MONDAY - SATURDAY
9.30AM - 5.30PM
THURSDAY LATE OPENING



43 HOPE STREET
041-248 2857

OPEN MONDAY - SATURDAY
9.30AM - 6.00PM
THURSDAY LATE OPENING



43 SOUTH CLERK STREET
031-667 2877

OPEN MONDAY - SATURDAY
SAT 9.30AM - 6.00PM
SUNDAY 11.00AM - 5.00PM
THURSDAY LATE OPENING

ROTEL

ALL WITH 2 YEAR GUARANTEE

AIWA

For Collectors

| | |
|--|-----------|
| WESTRESX 60W CINEMA VALVE AMP- PAIR | £350 |
| VITAVOX 15 INS CINEMA SPEAKER - CN352(5) | £55 each |
| VITAVOX HF DRIVER AND HORN CN 149 | £125 |
| VIAVOX CROSSOVER CN 222 | £40 |
| PYE HF25 VALVE AMP - PAIR | £295 |
| PAMPHONIC 2001 VALVE AMP - PAIR | £295 |
| SONY TA3200F STEREO AMP 2x120W (2) | £250 each |
| SONY TA 2000 STEREO CONTROL AMP | £150 |
| SONY TA 3120 STEREO AMP 2x50W (2) | £120 each |
| LINN BASIK LVV ARM - NEW | £25 |
| ORTOFON PICK UP ARM | £25 |
| TECHNICS LINEAR TRACKING T/TABLE SL7 | £110 |
| ROGERS CORNER HORN SPEAKER CABINETS (2) PAIR | £70 |
| WHARFEDALE SUPER 8 RS/DD SPEAKER (2) | £30 each |
| WHARFEDALE SUPER 10 RS/DD SPEAKER (4) | £50 each |
| WHARFEDALE SUPER 3 HF UNIT (2) | £20 each |
| SONY SERVO TURNTABLE ITS 3000 - PUA 237 ARM | £50 |
| K177 VALVES (4) OSRAM NEW | £60 |

WESTRESX RA1142 MICROPHONES (2) USED TO RECORD
GONE WITH THE WIND
RCA 10.001 RIBBON MICROPHONES - FILM
RCA M1-3027 RIBBON MICROPHONE - FILM
QUAD MONO PREAMP - FM TUNER

OFFERS
INVITED

PYE HF25 VALVE AMPS SUITABLE FOR REBUILD £40 each
VARIOUS 35/16 MM MAGNETIC FILM RECORDERS CALL

081 - 452 2666

Lockwood Audio

Tel: 081-207 4472 Fax: 081-207 5283

**WE BUY AND SELL NEW,
USED AND VINTAGE
SPEAKERS, DRIVERS,
CABINETS, PARTS.**

**SPEAKER REPAIRS
THE**

Authorised **TANNOY** Specialist



**MAJOR CREDIT
CARDS WELCOME
IMPERIAL STUDIOS,
MAXWELL ROAD,
BOREHAMWOOD, HERTS. WD6 1WE**



VINYL & CDs

FROM THE RECORD CONNOISSEUR

WE CARRY THE FOLLOWING GREAT LABELS:

| | | | |
|--------------------------|------------|---------------------------|------------|
| ALTARUS | LP | KING SUPER ANALOGUE | LP |
| ALTO | LP | KAMEI | CD |
| ANALOGUE | | MAPLESHADE | CD |
| PRODUCTIONS | LP/GOLD CD | MOBILE FIDELITY | LP/GOLD CD |
| ATHENA | LP | ORIG. JAZZ CLASSICS | LP |
| AUDIOQUEST | LP/CD | POP/ROCK | LP/CD |
| BLUE NOTE (JAPAN) | LP | PROPRIUS | LP/CD |
| CHESKY | LP/CD | REFERENCE | LP/CD |
| CBS MASTERSOUND | GOLD CD | RYKO | LP |
| CONCORD AUDIOPHILE | LP | SHEFFIELD LAB | LP/CD |
| DCC | GOLD CD | VITAL | LP/CD |
| DECCA (180 GM HQ) | LP | WATER LILLY | LP/CD |
| ENJA (180 GM HQ) | LP | WILSON | LP/GOLD CD |
| GRP JAZZ | LP | | |
| JAPANESE PRESSINGS | LP | SUMIKO & LYRA CARTRIDGES | |
| JAZZ IMPORTS | CD/LP | NAGAOKA SLEEVES | |

For a Free 40-page Catalogue send 28p SAE to PO Box 132, Wokingham, Berks, RG11 4NG.

Free to overseas customers
Tel:/Fax 0344 780262



RECORDS WANTED

Paying up to £100 each for Classical LPs on Decca SXL, EMI ASD Columbia Sax, Mercury SR, RCA SB. **Top prices paid for Mobile Fidelity, Nimbus Supercuts, Nautilus, 1/2 Speed Master, Japanese Pressings, Rock, Pop, Jazz, Folk, Blues & more.**

hi Best prices for new, xdem & s/h equipment fi

| | | | | | |
|--------------------------------|----------|-------|---------------------------|----------|-------|
| Krell KSA 250 | mint s/h | £3750 | SD Acoustics SD1 | mint s/h | £550 |
| Audio Research D400 mki | as new | £3750 | Totem + Giftstone stds | mint s/h | £795 |
| Audio Research D 115 | mint s/h | £1195 | Snell K's +stds | mint s/h | £350 |
| Trilogy 958/902 pre/pwr | as new | £2750 | EAD T7000 tran/dac | mint s/h | £1795 |
| VTL Manley 350 monoblocks | mint s/h | £3500 | Theta DS Pro - Pnme | mint s/h | £850 |
| Musical Fidelity P470/MVX | mint s/h | £2950 | Marantz CD 12 | mint s/h | £1595 |
| Musical Fidelity P270 | mint /sh | £750 | Arcam Alpha Plus | mint s/h | £260 |
| Albary 1008 | mint s/h | £795 | Meridian 602 transport | mint s/h | £995 |
| Audio Innovations 2nd (2A3) | mint s/h | £1795 | Arcam Delta BBS | mint s/h | £260 |
| Be Yamamura 211 Stereo | x-dem | £4750 | Sony CDP/DAS R1 reference | mint s/h | £1895 |
| Musical Fidelity P140/p3a | mint s/h | £350 | The Voyd (3-motor) | as new | £995 |
| Gryphon Limited Edition | mint s/h | £3995 | Alphason Sonata/Zeta | mint s/h | £495 |
| Audio Research LS 5 | as new | £3750 | Michell Gyrodec/Zeta/Psu | mint s/h | £650 |
| Krell KRS 2/RKSP | mint s/h | £1995 | Decca London Jubilee | as new | £695 |
| Mod Square Deluxe L.D. | mint s/h | £550 | Ortofon MC 3000/T3000 | as new | £900 |
| Meridian 601 DSP | mint s/h | £1695 | | | |
| Burmester 838 phone stage | mint s/h | £595 | | | |
| Pioneer HZ1 phone stage | mint s/h | £1495 | | | |
| Audio Note OTO | mint s/h | £895 | | | |
| Beard BB100 | as new | £795 | | | |
| Monitor Audio Studio 20SE | as new | £1495 | | | |
| Meridian M100 | mint s/h | £1650 | | | |
| Monitor Audio Studio 10 + stds | mint s/h | £750 | | | |
| Snell E II's +Hoygan stds | mint s/h | £795 | | | |
| Dali Skyline | mint s/h | £895 | | | |

PLEASE CALL WITH YOUR SPECIFIC REQUIREMENT
(081) 568 8808

hi **CHOICE fi**
Equipment bought or part exchanged
Full demonstration facility - by appointment
Major credit cards accepted
Open 7 days 9.30am - 8.00pm

IAN HARRISON DISCOUNT HIFI

* BRAND NEW GOODS WITH FULL UK. GUARANTEES * NO EX-DEM GOODS * NO GREY IMPORTS * REVIEWS & DETAILS ON REQUEST (0283) 702875

| DENON | ORTOFON | AUDIO TECHNICA | SENNHEISER | AUDIOQUEST | BEYER | | |
|---------------|---------|----------------|------------|------------|------------------|--------|------|
| DL304 | £170 | MC7500 | HD 1000 | £179 | DIAMOND FPS | DT911 | £169 |
| DL103D | EPOA | MC5000 | HD580 | £155 | LAPIS FPS | IR5790 | £139 |
| DL 103 | £75 | MC3000H | AT-ART1 | £109 | EMERALD PPC-8 | DT901 | £153 |
| DL160 | £70 | MC2000H | AT-OC5 | £99 | QUARTZ PPC-6 | DT960P | £135 |
| DL110 | £55 | QUASAR | AT-OC3 | £95 | RUBY PPC | DT990 | £99 |
| | | QUATTRO | AT-OC3 | £89 | TOPAZ OFHC | DT811 | £136 |
| | | QUARTZ | AT110E | £80 | TURQUOISE OFHC | DT801 | £105 |
| | | MC155II | ATH9000 | £49 | PHONE FOR PRICES | DT511 | £85 |
| V15VMR | £199 | MC105 | ATH9100 | £415 | | DT431 | £45 |
| VN35MR | £56 | T3000 | ATH911 | £415 | | DT311 | £33 |
| TEST DISC 117 | £15 | T201 | ATH908/2 | | | | |

ARCAM, POA. I OPERATE A MOVING COIL EXCHANGE SYSTEM. PLEASE PHONE FOR DETAILS AND PRICE. NO OLD MOVING COIL? DON'T WORRY, JUST PHONE. ALL GOODS ARE BRAND NEW WITH FULL UK. GUARANTEES. NO EX-DEM EQUIPMENT. PLEASE PHONE OR WRITE FOR DISCOUNT PRICES. CD'S: TDK, MAXELL, SONY, AMPEX, BASF. DISCOUNT AUDIO & VIDEO TAPE, AUDIOQUEST, SONIC LINK, REVOK, QUAD, DISCWASHER, TELARC, BIS, ATC, SPENDOR, DELIVERY CHARGE IS £5.

IAN HARRISON DISCOUNT HIFI (MAIL ORDER ONLY), 7 MILL HILL, REPTON, DERBY, DE65 6GQ 9am - 9pm

NAIM 135S £750 each. Linn Isobanks black with Linn Stands £650.
Tel 0269 591 333 evenings.

SPENDOR SP2/2 speakers walnut boxes £300. Matching heavy stands £40. Notts Analogue Tracer No.1 MM cartridge (£90) £30. Target TT2 wall shelf £25. Marantz ST50L digital tuner (£175) £75.
Tel 0908 644254 Bucks.

ROGERS LS4A speakers. Excellent condition with Foundation stands. I have replaced all electrolytics with polypropylene caps and have split crossover for by-wiring. Very good sound indeed - but have gone up to LS7s! £200.
Tel: 0705 781 449.

NAIM NAC72. Hi-Cap and NAP250 £1,650. Epos ES14 inc. stands £350. TOCS and ATOC3 £100 little used. All boxed and mint condition.
Tel 0423 504267 Harrogate.

QUAD Electrostatics Bronze £400. Quad 303 Poweramp £60. Quad FM3 Tuner £40. Quad 303 Pre-amp £40. Rotel RCD-955AX CD Player £150. Thorens TD125 SME Plinth SME 3009 £60. Thorens TD 160 £15. Revox 77A Reel to Reel £100. Stax Headphones SR3-S £20.
Tel 0952 510554.

ROKSAN XERXES. Tabriz, PS1 VGC £389. QED Digit. Positron + Digiflex as new £119
Tel Horsham (0403) 250570 evenings or weekends.

QUAD II Valve Amplifiers Groove Tubes fitted £325. Leak Troughline / Hi Fi World Decoder £250. Quad 306 Power Amplifier £230. JR DW2 Super Woofer £60.
Tel 0752 491924 (Plymouth).

HI-FI WORLD Miking 5-20 Monoblocks. Fully built and worked, but too large for my room. Exchange for smaller valve power amp(s), (modern design) or sell (offers?). Rotel RCD965BX CD, mint £180. Micromega Microdac, superb £150.
Tel Rod 0706 521365.

QUAD 34/306. As new in boxes. Very little use £450.00. (Sevenoaks).
Tel 0732 780244 Eve/Weekends.

LINN ITTOK Pick-up Arm £250; Rotel RCD 965 BX CD Player £180. Both boxed as new with manuals.
Tel Ramsgate 0843 592066 (Eves).

NVA PRE-AMP P70 (coil phono input); Power-amp A60, PSU, 10 metres VVA cable. 18 months old. £430. Will split or exchange Linn LK100 Power-amp.
Tel 085 715650 (Staffs).

ROTEL RCD-965BX £200; Cyrus I (Series B Board) £170 o.n.o.; Leak Stereo 20 Valve Amp £250.
Tel: 0792 896285 (Swansea).

PINK TRIANGLE LPT/GTI Turntable plus Rega RB300. Mint 18 months old, fully boxed £470. Linn K9 cartridge plus spare stylus £45 or £30 with turntable.
Tel Enrico on 0222 499561.

EMINENT TECHNOLOGY Tonearm ME11-Linear Tracing, air bearing ugs offers over £550. Rata Torlyte Turntable Stand £65. Sound organisation Table £35. Yamaha NS1000 Dedicated Xovers - reletory - from £100.
Tel 0602 619991.

ROGERS HE88 MK2 integrated valve amplifier. £160 o.n.o. Garrard 301, Bastin Bearing RB250 Slate Plinth £250. Musical pipelit MA65 class A 65W Power-amps. 8 months old. £500 (new £950).
Tel Paul (0533) 553176.

MICHEL GYRO Power PSU mint condition, £50 o.n.o.
Tel Ray 081-854 6738.

ORACLE DELPHI T/Table with up-graded power supply. Well Tempered arm with latest up-grading modifications. Both mint condition. Koetsu Red Cartridge (brand new) £1,495 o.n.o.
Tel 0268 402 368 Day
0376 571 682 Eve/Wkends.

FOR SALE. AVI 5200M Mono Blocks 150 watts each £450. Audio Synthesis PAS-02 Passive Pre-amp £150.
Tel 081-531 5979.

NAIM NAIT £199. Cyrus One £199 Onix OA21 £275. Audiolab 8000A £295. New Quad CD67 £730. Arcam, Royd, Roksan, TDL, Heybrook, Marantz, Rotel, P/Exchange available. Mail Audio, Colchester 0206 861457 (6-11pm).

WANTED - Impluse H6 or H5 speakers. Also '70's Lescon power amplifier (API etc) and Tuner (TFI). Good price paid for equipment in good condition.
Tel Dave on 0332 676775.

PIONEER A400 amp (280) only 6 months old, Marantz CD Player (199), F410 (120) Cassette Deck, Wharfedale 425 Speakers (199) and Alphan Stands (65). Will separate Bargain! £450.
Tel 0228-513477 (eves: Carlise).

GARRARD 301 with SME 3009/11 Arm and ADC26 Cartridge in custom made plinth, excellent condition, handbooks etc. £200. Extending mike boom approx. 15ft. made for professional use. Offers.
Tel 0203 (Nuneaton) 348375.

ROGERS LS6 Speakers, mint boxed £145. Something solid stands £35. Apollo turntable £20. Technics digital tuner £45.
Tel 0223 292815.

BOSE ACOUSTIMASS '5' Speakers including wall-mounts and tri-pod stands in mint condition £395.00. MK1 Naim Nait £149.00 also mint will accept £500 the pair. Tel 0708 869 669 Daytime only.

LINN KEILIDH Speakers. Black Ash. Including Linn Ceramic Plinths which greatly improve sound. 11 months old. Immaculate condition. Linn extended 5 year warranty. £475.
Tel 0904 631023 for details or leave message.

LINN ISOBARIK Speakers - beautifully figured walnut cabinets - including panelled stands and cables. Mint condition. Boxed. £880.
Tel 061 928 8464.

MAGNUM MP 300 Stereo Pre-amplifier
Magnum MI-300 Dual Mono Model
Argued RRP £700 wanted £195 for the pair also ready to go for S.V.I.S. VCR.
Tel 0203 292815

APOGEE CALIPER full-range ribbon speakers. Grey. Boxed, with manual. £890. "Hi Fi News" Class A Headphone Amp (design by T.de Paravicini) little use. £45. Tel: 081-5797451 (West London).

AUDIO RESEARCH LSI Pre-amp. Silver, immaculate, boxed. Only two years old, £720 (original price £1,950). Happy to demonstrate.
Tel Colchester 0206 825887.

CROFT SUPER Micro A Valve Pre-amp £350. Croft Series III OTL 30 watt Valve Power-amp £550. Both recently up-dated excellent condition and sound.
Tel 0403 891349. Evenings, Weekends. Long ring.

ENTHUSIAST'S CLEAROUT! Superb Valve Amps - Leak (several), Quad, E.M.I., Radford, Armstrong, Rogers etc. Mint Garrard 301. Thorens TD124. Quad Electrostatics. Spendor BCIs. Please 'phone for details. Can despatch.
Tel 0364 72153.

COLLECTORS CLEAROUT. KEF 101/2 Speakers (boxed - only 22 months old) £285, KEF Chorale Speakers (bookshelf, boxed) £50. Goldring Lenco GL75 Transcription Turntable £65. Leak Stereo 70 Amp £45. Samsui 4000 Amp/Tuner (Glowing Rosewood Case) £60. Armstrong 625 FM Receiver £45. Armstrong 521 Amp £40. Reference 2' Stands £25.
Tel 0483 - 233952.

GARRARD 401 mint boxed £150. Garrard 301 £125. Leak Troughline Stereo Tuner mint boxed £160. Leak TL12 £165. Leak Stereo 20 Rebuilt £225. Troughline II £65.00 Cadet III £65.
Tel: 0533 835821.

NAIM 32.5 Pre-amp £250. Hi-cap £310 low usage boxed. Sound org table £35.
Tel Brighton (0273) 309761 evenings.

BEARD P35 Valve Power Amplifier, three sets Valves Sovteks, Dragons, offers. Thorens TD150 Grace G707+MC £95, WANTED Oracle, Xerxes, Koetsu, Transformers, QED Digit, Robertson 4010, Magneplanar MGB, Target AE4-5.
Tel 0642 559543.

EPOS ES14 Speakers Black Ash finish - with stands. Little used, immaculate. £260. Tel: Work 061 - 419 9717 Home 061 - 498 8966.

NAIM 62/90. Last Spec. (Green Facia). MM Board. As new with boxes and manuals. Up-grading. £450.
Tel 0204 707653 (Manchester area).

EARSON PARAVICINI 100 watt Valve Mono Blocks £1,250. Dedicated Stands £80. EARSON Valve Pre-amp £550 Bargain £1,450 complete set-up! Could deliver! Leak 5170 £50. Tandberg TCD310 Cassette £50. Pair for £70!
Tel 0924 - 870361.

LOUDSPEAKER CABLE Rotel Supra 4mm. 2 x 15 metres complete with gold plated 4mm banana plugs. £80. (Cost £136).
Tel 081-302 9063.

WANTED Rotel RB870 BX Power Amp must be good condition.
Tel: Richard 0263 733366.

TECHNICS SL110 Turntable / S.M.E. and New Ortofon 520 cartridge. £175 o.n.o. Musical Fidelity P270 II / 3A PRE £850. Mission 753 Speakers £500 (new) (save £200) Mendian 203 D.A.C. £190. Hi-Fi year books offers.
Tel: 091-4877796 (Tyneside).

JIM ROGERS JR150 Loudspeakers immaculate condition including foam covering. Hardly used. £175. Or exchange for JR149's or LS3/5A.
Tel: 021 427 8810

ARISTON RD90 Superior Turntable, D.C. Supply, superbly built, high quality sound, cost £899, Accept £295.00 o.n.o. With RB250, expensive MM cartridge £395.00 o.n.o. Plus other items.
Tel Paul for details 0895 446713).

AUDIO NOTE KSP silver wired loudspeakers, black with Huygens K4 stands £650. Magnum Dynalab FT-11 Tuner, Black £325. Everything immaculate condition, (ideal with valve amps).
Tel 081 572 2504.

ROKSAN XERXES, white ash finish, Artemiz arm and Shiraz cartridge, very little use. £1,350 o.n.o.
Tel: 081 646 2750

ALBANY 408 Mono Block Amplifiers £500. Meridian 206 Delta Sigma CD Player £650. Audio Synthesis PAS-02 Passive Pre-amp £250. Oscilloscope (Telequipment) Offers.
Tel 0621 860 630 (Essex).

MICHELL Argo / Hera - ISO / Hera with Furukawa Interconnects. Cost £1,400 - sell £750. Hardly used.
Tel George Watford 0923 230214 .

ACCOUSTIC RESEARCH Legend Turntable (Teak) a/R Tonearm excellent condition £85. Wharfedale XPE Glendales (Teak) Offers Tel 0732 850915 Tonbridge evenings.

LINN LP12, Linn Basik LVV, AT3IEMC, Transformer, Turntable Isolating Wall Stand £295. Quad 22 Control Unit, Quad II Power Amplifiers, Quad FM Tuner, Quad Multiplex Decoder £295.
Tel 0524 735483.

ARCAM ALPHA CD Player Excellent Condition. Boxed. £175.00 o.n.o. Tel Bill on 0708 222845 evenings & weekends.

PINK TRIANGLE PIP pre-amp £350. Quad 405-II power-amp £250. Celestion SL600 speakers £400. Wife forces sale. Also Aiwa F770 Cassette £150. Phillips CD371 compact disk £50.
Tel 0622 814970 (Maidstone).

AUDIO INNOVATIONS Series 300 Class A Valve Amp (integrated) £250. Sony PS 4750 Direct Drive Turntable £65. Kirk Revolution Mountain Bike, Magnesium Alloy. Looks great in purple £235. 0983-291197.

LEAK TL25A Power Amplifiers, plus two matching Vanslope III Pre-amps, all new components and valves. circuit diagrams supplied, power amps: are 1957 vintage, very rare. Can be heard. £400. Tel: 0386-553942.

FURUKAWA FS-2T35P Speaker Cable - 4 x 2 MTR Bi-wired lengths with connectors £50. Also standard Seismic Sink £90. 0483-275389 Malcolm for details.

CASTLE WINCHESTER Speakers c/w floor stabilisers. Yew wood veneered, as new. Too large for new location. £1,150 buyer collects, ferry costs refunded. Tel: 0983 (I.O.W.) 565849.

ACTED
Bought new, A & B 1/2, stereo, 2000, 3000, 4000, 5000, 6000, 7000, 8000, 9000, 10000, 11000, 12000, 13000, 14000, 15000, 16000, 17000, 18000, 19000, 20000, 21000, 22000, 23000, 24000, 25000, 26000, 27000, 28000, 29000, 30000, 31000, 32000, 33000, 34000, 35000, 36000, 37000, 38000, 39000, 40000, 41000, 42000, 43000, 44000, 45000, 46000, 47000, 48000, 49000, 50000, 51000, 52000, 53000, 54000, 55000, 56000, 57000, 58000, 59000, 60000, 61000, 62000, 63000, 64000, 65000, 66000, 67000, 68000, 69000, 70000, 71000, 72000, 73000, 74000, 75000, 76000, 77000, 78000, 79000, 80000, 81000, 82000, 83000, 84000, 85000, 86000, 87000, 88000, 89000, 90000, 91000, 92000, 93000, 94000, 95000, 96000, 97000, 98000, 99000, 100000, 101000, 102000, 103000, 104000, 105000, 106000, 107000, 108000, 109000, 110000, 111000, 112000, 113000, 114000, 115000, 116000, 117000, 118000, 119000, 120000, 121000, 122000, 123000, 124000, 125000, 126000, 127000, 128000, 129000, 130000, 131000, 132000, 133000, 134000, 135000, 136000, 137000, 138000, 139000, 140000, 141000, 142000, 143000, 144000, 145000, 146000, 147000, 148000, 149000, 150000, 151000, 152000, 153000, 154000, 155000, 156000, 157000, 158000, 159000, 160000, 161000, 162000, 163000, 164000, 165000, 166000, 167000, 168000, 169000, 170000, 171000, 172000, 173000, 174000, 175000, 176000, 177000, 178000, 179000, 180000, 181000, 182000, 183000, 184000, 185000, 186000, 187000, 188000, 189000, 190000, 191000, 192000, 193000, 194000, 195000, 196000, 197000, 198000, 199000, 200000, 201000, 202000, 203000, 204000, 205000, 206000, 207000, 208000, 209000, 210000, 211000, 212000, 213000, 214000, 215000, 216000, 217000, 218000, 219000, 220000, 221000, 222000, 223000, 224000, 225000, 226000, 227000, 228000, 229000, 230000, 231000, 232000, 233000, 234000, 235000, 236000, 237000, 238000, 239000, 240000, 241000, 242000, 243000, 244000, 245000, 246000, 247000, 248000, 249000, 250000, 251000, 252000, 253000, 254000, 255000, 256000, 257000, 258000, 259000, 260000, 261000, 262000, 263000, 264000, 265000, 266000, 267000, 268000, 269000, 270000, 271000, 272000, 273000, 274000, 275000, 276000, 277000, 278000, 279000, 280000, 281000, 282000, 283000, 284000, 285000, 286000, 287000, 288000, 289000, 290000, 291000, 292000, 293000, 294000, 295000, 296000, 297000, 298000, 299000, 300000, 301000, 302000, 303000, 304000, 305000, 306000, 307000, 308000, 309000, 310000, 311000, 312000, 313000, 314000, 315000, 316000, 317000, 318000, 319000, 320000, 321000, 322000, 323000, 324000, 325000, 326000, 327000, 328000, 329000, 330000, 331000, 332000, 333000, 334000, 335000, 336000, 337000, 338000, 339000, 340000, 341000, 342000, 343000, 344000, 345000, 346000, 347000, 348000, 349000, 350000, 351000, 352000, 353000, 354000, 355000, 356000, 357000, 358000, 359000, 360000, 361000, 362000, 363000, 364000, 365000, 366000, 367000, 368000, 369000, 370000, 371000, 372000, 373000, 374000, 375000, 376000, 377000, 378000, 379000, 380000, 381000, 382000, 383000, 384000, 385000, 386000, 387000, 388000, 389000, 390000, 391000, 392000, 393000, 394000, 395000, 396000, 397000, 398000, 399000, 400000, 401000, 402000, 403000, 404000, 405000, 406000, 407000, 408000, 409000, 410000, 411000, 412000, 413000, 414000, 415000, 416000, 417000, 418000, 419000, 420000, 421000, 422000, 423000, 424000, 425000, 426000, 427000, 428000, 429000, 430000, 431000, 432000, 433000, 434000, 435000, 436000, 437000, 438000, 439000, 440000, 441000, 442000, 443000, 444000, 445000, 446000, 447000, 448000, 449000, 450000, 451000, 452000, 453000, 454000, 455000, 456000, 457000, 458000, 459000, 460000, 461000, 462000, 463000, 464000, 465000, 466000, 467000, 468000, 469000, 470000, 471000, 472000, 473000, 474000, 475000, 476000, 477000, 478000, 479000, 480000, 481000, 482000, 483000, 484000, 485000, 486000, 487000, 488000, 489000, 490000, 491000, 492000, 493000, 494000, 495000, 496000, 497000, 498000, 499000, 500000, 501000, 502000, 503000, 504000, 505000, 506000, 507000, 508000, 509000, 510000, 511000, 512000, 513000, 514000, 515000, 516000, 517000, 518000, 519000, 520000, 521000, 522000, 523000, 524000, 525000, 526000, 527000, 528000, 529000, 530000, 531000, 532000, 533000, 534000, 535000, 536000, 537000, 538000, 539000, 540000, 541000, 542000, 543000, 544000, 545000, 546000, 547000, 548000, 549000, 550000, 551000, 552000, 553000, 554000, 555000, 556000, 557000, 558000, 559000, 560000, 561000, 562000, 563000, 564000, 565000, 566000, 567000, 568000, 569000, 570000, 571000, 572000, 573000, 574000, 575000, 576000, 577000, 578000, 579000, 580000, 581000, 582000, 583000, 584000, 585000, 586000, 587000, 588000, 589000, 590000, 591000, 592000, 593000, 594000, 595000, 596000, 597000, 598000, 599000, 600000, 601000, 602000, 603000, 604000, 605000, 606000, 607000, 608000, 609000, 610000, 611000, 612000, 613000, 614000, 615000, 616000, 617000, 618000, 619000, 620000, 621000, 622000, 623000, 624000, 625000, 626000, 627000, 628000, 629000, 630000, 631000, 632000, 633000, 634000, 635000, 636000, 637000, 638000, 639000, 640000, 641000, 642000, 643000, 644000, 645000, 646000, 647000, 648000, 649000, 650000, 651000, 652000, 653000, 654000, 655000, 656000, 657000, 658000, 659000, 660000, 661000, 662000, 663000, 664000, 665000, 666000, 667000, 668000, 669000, 670000, 671000, 672000, 673000, 674000, 675000, 676000, 677000, 678000, 679000, 680000, 681000, 682000, 683000, 684000, 685000, 686000, 687000, 688000, 689000, 690000, 691000, 692000, 693000, 694000, 695000, 696000, 697000, 698000, 699000, 700000, 701000, 702000, 703000, 704000, 705000, 706000, 707000, 708000, 709000, 710000, 711000, 712000, 713000, 714000, 715000, 716000, 717000, 718000, 719000, 720000, 721000, 722000, 723000, 724000, 725000, 726000, 727000, 728000, 729000, 730000, 731000, 732000, 733000, 734000, 735000, 736000, 737000, 738000, 739000, 740000, 741000, 742000, 743000, 744000, 745000, 746000, 747000, 748000, 749000, 750000, 751000, 752000, 753000, 754000, 755000, 756000, 757000, 758000, 759000, 760000, 761000, 762000, 763000, 764000, 765000, 766000, 767000, 768000, 769000, 770000, 771000, 772000, 773000, 774000, 775000, 776000, 777000, 778000, 779000, 780000, 781000, 782000, 783000, 784000, 785000, 786000, 787000, 788000, 789000, 790000, 791000, 792000, 793000, 794000, 795000, 796000, 797000, 798000, 799000, 800000, 801000, 802000, 803000, 804000, 805000, 806

Aria. A new way to look at hi-fi support.

Introducing the Aria Modular Hi-Fi Support System. It can change the way you look at your components.

Build up separate vertical shelves. Or link units side by side. Either way, Aria lets you vary shelf heights to suit your components. Start with a Base Pack and go from there.

There's no limit to the number of ways you can build it up.

Not only does Aria give you more flexibility than any other hi-fi support system, it also provides positive sound deadening and decoupling benefits. With black tubular steel legs. Grey tinted glass or black MDF shelves.

And adjustable carpet-piercing spikes.

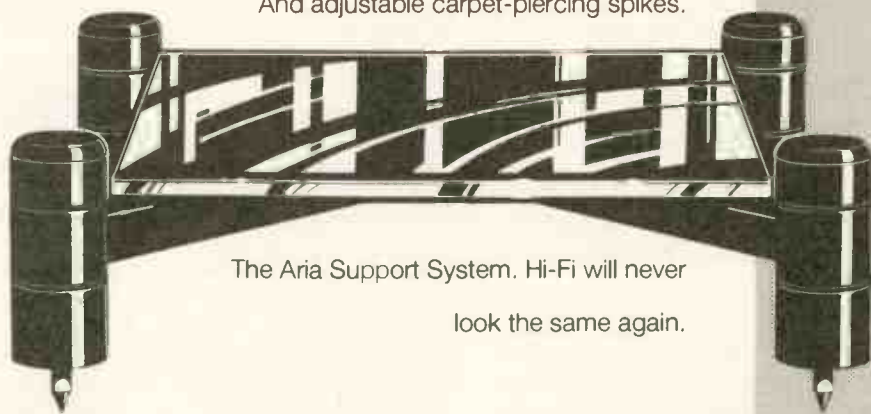

The Aria Support System. Hi-Fi will never look the same again.

I want a good look at the Aria system. Please send me a brochure.

Name _____

Address _____

Post code _____

APOLL
HI-FI FURNITURE

Our components improve yours

Zenith Crown Ltd., Tipton road, Dudley, West Midlands, DY1 4SQ Tel: 021 520 5070/1432

WANTED: 50 Watt Valve Monoblock by Magneta (B.V.C.) Ltd, Leatherhead, Surrey also information about this equipment. Telephone: 0392-469242 evenings please.

LINN INDEX Loudspeakers plus KU-Stone Stand. Excellent condition £230. Tel: (0780) 53079 (eves/weekends).

MICHELL ISO/HERA £275.00. Concordant Exhilarant £400.00. Concordant Modified Quads £300.00 (per pair). Groove Tubed Audio Technica at OCS £30.00. Denon DL304 £50.00. Tel: Dean 0902-788648 or work: 0384-262470.

LINN LP12 Lingo, Trampolin, Akto, Klyde (2 years old), £850. Audio Innovations 200 pre-amp (MM/MC) and power amp £200 each. Linn Pretek pre-amp £200. Epos ES11 speakers with stands £275. All in pristine condition. Tel: 0904 631515.

FOR SALE: Linn Ittock LV2 boxed £175; Quad II Stereo Tuner (valves) £65; Audio Technica ATH70 Electret Headphones boxed £100; Thorens TD160/SME3009, wood plinth £65. Tel: 081-989 6434.

KL51 SPEAKER Cabinets built by furniture-maker. Finished in satin black simulated woodgrain with chamfered front baffles. £150 o.n.o. or swap Creek/Cyrus amp. 0787-374399. (W. Suffolk).

WANTED: Roksan latest spec record deck, prefer rosewood. Also large Denon monoblock power amplifier. Tel: Dave 0455-616932.



ACCUSTAT 1100's £600.00, Revox A77, serviced, remote booklet, £300. Elite Townsend pre/power monoblocks M/M £250.00. Audio Research STC-70 power-amp. Offers? Electrocompact 25W Class A, £225.00. Thorens TD 125 MKII. Lots more. 0932-849849.

MICROMEGA MICRODAC, newly new, £250 (£350). Wilmslow Crossover and Tweeter up-grade for KEF Concertos/Kelkit 3's. £80 (£135). Wanted: Leak Stereo 20 for re-building. Phone 0283-820818 eves.

TOWNSHEND ELITE Rock MKII Moth Arm (Rega RB250) AT-OCS M/C £335 o.n.o. Tel: 0423 568627.

LINN LP12. Black, Valhalla, Ittock LVII, A.T.5. £375. LK1 Pre-amp, inc. XLR's, latest spec. £275. Meridian component integrated amp, C.D., Aux., Tape and moving magnet inputs. £150. Tel: Banbury (0295) 272925.

HAFLER XL600 Power-amp and Hafler D110 Pre-amp excellent condition £850. Tel: Steve 0229-827980 (Cumbria).

MERIDIAN 206B CD Player (DAC 5). Excellent condition £550. Tel: 041-639 7036 (Glasgow).

HEYBROOK POINT Five Series 2 Loudspeakers. Approx 20 months old. As new, boxed. £100. Tel: Rugeley (0889) 575655.

MAGNEPLANAR: White Electrostatic Loudspeakers, Slimline (50 x 120 x 5cm). Great Sound and brilliant imagery. As new. £430 o.n.o. Southend (0702) 470633.

WANTED: Quad FM4, in exchange for Meridian 203 B.S.C. as new. New set of matched valves for Quad II Amps £50.00. Tel: after 6.00 pm 0455-617784.

TANDBERG RECEIVER TR2025MB, FM, Long, Med and short wave, presets, £110. Technics turntable SLQ3 Quartz Direct Drive Auto £70. Sony Single Tape Deck TC-FX420R, Dolby, Autoreverse, £70. Tel: 0606-782556.

LINN LP12/EKOS/LINGO power supply / AT-F5 Cartridge excellent condition. New £2,455.00. Will sell for £1,000.00. Tel: 081-964 8356 (after 6.00 pm).

QUAD 33 Pre-amp and 405 Power-amp. Recent QUAD service. Offers. Pair Sony Speakers SSE 30, 50 watts. 12" W x 24" H 11" D. Offers 0782-395797 (Staffs).

PINK TRIANGLE Turntable, Helius Scorpio and Audio Technica AT-F5, recently serviced, boxed, little used, unmarked deck, £380. Tel: Haywards Heath (0444) 413660.

CHURCH DONATION SALE: Quad 303/FM4/44. SME Series II/Shure V15 Type V. Garrard 401. Marantz SD35/CD54. Sennheiser 2000 ES Phones. Lowther Acoustas. Inclusive offers please: details. 0293 532825.

WANTED: Keith Monks Record Cleaning Machine must be in good working order. Tel: Paul (0533) 553176.



NAIM NAIT 2. Great sounding amplifier. Very good condition. Box and manual. £190 o.n.o. Tel: Andy (0753) 825928 Slough.

ARCAM ALPHA plus CD: Alpha 3 amplifier, Alpha 3 Tuner, Mission 780 Speakers; Cyrus Stands; Sound Organisation Rack; Linn-Chord leads. 1 year old, boxed. £699. Tel: 0494-873187 (South Bucks).

LEAK TROUGHLINE 3 Stereo Tuner, working order, original condition £150 o.n.o. Phone: 0270 68300.

ACOUSTAT SPECTRA 1100 Electrostatic Hybrid Loudspeakers. Very good condition £600 o.n.o. MOD SQUAD Line Drive £200. Tel: 0843 584030 eves or days (answer phone).

PIONEER A400GTE NAD CD TL, Cassette Deck, Clearwater Speakers and Stands £325 - boxed. Tel: 0639-701104. Anytime.

AUDIO INNOVATIONS 600 Valve Pre-amp £240. Leak Stereo 20 Sugden re-build £230. Linn KANS and KANII Stands £320. All o.n.o. Tel: 0209-820066.

HELP! Sage Amplifier Module wanted. Supermos 100 watt, others considered if in pairs. Desperate. Tel: 0482-470961.

LINN LP12, EKOS, Troika (all '91). Naim 32.5/SNAPS/250. EPOS ES14, tables, stands. Yamaha K-340 deck. £2,400 o.n.o. Tel: 081-547 1264.

SUGDEN, SDA-1 DAC, latest spec, superb sound. £475. Sugden, SDD-1 transport, £450. Oracle Delphi MK3, Turbo supply, Randall Tonearm Terminator, Sumiko MIDC800 "The Arm", £995. All mint and boxed. Tel: 0273-775302.

J.E. SUGDEN Power Amp P51, control unit CS1, stereo F.M. tuner RS1. Including instruction leaflets (circuit diagrams). Celestion Driton 55 speakers, all in good working order. Sensible offers, (0865) 390884 (Oxon).

NAKAMICHI CR7 - The ultimate cassette deck. Automatic record Bias/Azimuth. Manual playback Azimuth control. Auto Fade. Remote control. cost £1,995 new. Reluctant sale £1,150 o.n.o. Tel: 0895-258193 (Uxbridge).

LS3/5a SPEAKERS on customised heavyweight stands offered in exchange for a pair of bronze Quad Electrostatics or £295. A & R T21 Tuner £80. HFV silver plated Interconnect (un-used) £50. Tel: 0202-735987 (Ponle).

LINN SONDEK LP.12 Lingo, Ittock MK3 21/2 years old, boxed and in mint condition, approx 400 hours use. Tone-arm to be retained hence price £750 o.n.o. Any demo welcome. Tel: 021 558 1248

ACOUSTIC ENERGY AE-1 (Rosewood) boxed pair only 2 months old £695 o.n.o. or swap for mint Nakamichi cassette plus cash. Target T-20 stands 10" boxed pair £30. Tel: 081-778 6174

WANTED: SONY TAE - 1000 ESD, DSP Pro-logic Pre-amp. Cash waiting. For sale: Nakamichi Receiver 1; top of range; 80w/p/ channel; audio/video inputs/outputs; remote will operate two NAKAMICHI decks and CD player. Excellent condition, 1 year old. R.R.P. was £800 will sell for £300 Reason for Sale: up-grading. Contact Leonel on 0483-771731 (Home - Days) or 0483-32791 (work-evenings).

MICHAELSON ODYSSEUS Integrated Valve Amplifier. Recently re-valved, line level. Art-Deco Style. 45 watts. Boxed can demo, £450 (£999new). Tel: Rochdale 0706-357804.

LINN ISOBARIKS, Walnut Finish, including stands, panels, 1987 model, sounds great with Naim amps. Lovingly cared for example. Mint condition. £850 o.n.o. Tel: 0524-381389.

Pair Wharfedale Teesdale speakers, reproduction style cabinets, with new drive units. Very little used £110. Tel: (0535) 671427.

ION NEXUS System. SP1 Pre-amp (MM & MC), X-Pak 2 power supply, SAM 40 Power-amp, FMT1 Tuner, TCI Speakers/Crossovers, 4 x 6M Kimber Cable. Target Table. £1,150. Arcam Alpha CD Player £250. All mint. Tel: 051-342 8463.

LINN AXIS Turntable. AKITO K9 as new. £250. Mana Acoustics Sound Shelf - mounts to wall - was £150 new; £70 (081) 428 7201.

CHORD SPM 1000. 250 watts into 8 OHMS. Black front with black ash sides. As new, boxed £1,250. Birmingham 021-472 8746 after 6.30 pm.

NAKAMICHI CR-7E cassette deck. New, with unopened remote control unit. Now £1,995, will accept £1,300 or v.n.o. Tel: 0424-220171 (eve).

HELIUS SCORPIO Tonearm, Audionote re-wired £75. Koetsu Rosewood, mint £160. Supex SD9000 cartndge, boxed. Mint £65. Rogers Ravensbrook amplifier £45. JPW Minimis, mint £45. Wanted: Nakamichi 480 cassette. Tel: 0280-701145.

TANNOY 15" Dual Concentric DU386 speakers, complete with crossovers, all fixings and technical manual and enclosure construction guide with or without Tannoy York Cabinets £480 call any evening after 6.00 pm. 34c, Girta Park, Norwood, SE19 2LQ.

QUAD II AMPS 22 and FM2 with stereo decoder (fault on tuner) £275. Garrard 301 £80. Ferrograph valve reel to reel model 422U £80. May part-ex FM4. Nakamichi. Tel: 051-734 0965.

LEAK TL/25 PLUS £85 o.n.o. Rogers Cadet 3 £50 o.n.o. Both in perfect working order. Telephone: 0302 885742 after 4 p.m. (Doncaster).

PINK TRIANGLE LPT GTI Turntable with Rega RB250 arm. Excellent condition, boxed with purchase receipt. GTI board still under B.A.D.A. warranty. £350 Tel: (0204) 68455 (Lancs).

ARCAM BLACK Box 3 DAC £150 Pioneer F4D11L Tuner £95 both boxed and perfect condition three target audio wall shelves £40 or £15 each. Phone: Steve 0625-619076.

KEF CR 200's Flush mount wall speakers, black, new unused. Cost £360. Accept £230. Tel: 0963-350844 Somerset.

GOOD-SOUNDING Equipment-built to last! Original model KEF105 speakers, AKAI GX95 cassette deck, Marantz PM84/2 amplifier (Class A). Telephone offers to Homrocks on 021-429 9143 or leave message.

ALPHASON SONATA Turntable, Zeta Tonearm & Madgal Carnegie Cartridge (MC) very low use £800 (list £2,000). Audio Innovations Senes 800 Power Amplifier also hardly used £420. Both items in mint condition. Tel: 081 878 1127

MANA ACOUSTICS Isobank speaker stands £250 - 'Soundstage' reference tables for Isobank stands £120 - 5 tier amplifier stand £250 - all under 1 year old. COD delivery via UPS. Tel: 01049-7243 67582.

2 PAIRS OF 8 metre interconnect by Avondale Audio. Gold RCA plugs £50.00 each. 1 pair Audioquest live-wire clear - 2 metre. Gold Spades £150.00 Kimber KCAG Diglink 1/3 metre. £30.00. Tel: 0253-872402 evenings.

RSO TRANSMISSION Line Speakers. Rosewood & Black. Professionally built (units £497.00 from Wilmslow Audio). Too large for New House. Tel: 0270-589322 or 0246-290049.

LEAK STEREO 20 Fully Re-built Kimber Caps and New Valves fitted beautiful open sound £200. Audio Research 5P8 unmodified and new valves fitted £750. Quad Stereo FMZ & Pre-amp £50 pair. Grants valve pre-amp £120 Leak mono valve tuner £30. Tel: Alan 0661-852874.

FOR SALE: AVI S2000A POWER Amplifier 250w/CHA. £950. Trilog 948 Valve Stereo Amp 50w/CHA. £850. Audio Synthesis PAS-02 Passive/Pre £150. Phone 081-531 5979

TDL MONITOR Reference Speakers, excellent condition £1,095. Meridian 203 DAC £195. Pioneer F737 Tuner £95. Tel: 0869-278249



VALVE AMPLIFIERS. Beard P100-MK2. 100WPC £475. Radford STA15 £300. Leak Stereo 20 (Croft re-built) £200. Rogers Cadet Pre-power £100. Also Tannoy Chevots £220. Phone or Fax 0903-200705 (Sussex).

LEAK STEREO 20 Valve Amp £120. PROAC Tablette EBT Loudspeakers with Foundation Stands £95, IPL M2 Loudspeakers £95. Tel: 0895-637 846.

PINK TRIANGLE PTT00 RB300 Ortofon Quasar mint boxed £350. PROAC Studio Towers Prototype 1 Mint £1,600. Nakamichi MR2 Pro Tape Deck Mint Boxed £200 LINX Stratos Pre-power mint boxed £200. Felixstowe 282838.

AUDIO INNOVATIONS Senes 500 Amplifier. Golden Dragon Valves. Good condition boxed. £450 Tel: Joe (0609) 779739 N. Yorks. (Shift worker - days/evenings).

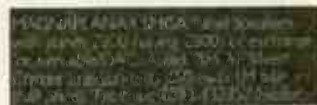

QUAD ELS black, pr. Overhauled, protection circuits fitted. £450. Audio Innovations S800 Power-amp £375. Audio innovations S300 Integrated amp £225. Tel: 0883 349298 (Surrey).

WANTED: Leak TL 12+ and Stereo 20 or Leak TL10 and Stereo 20 or Leak TL12+ and TL10 in exchange for: AVIS2000A Power Amplifier 250WPC. Phone: anytime 081-531 5979.





HARMAN KARDON

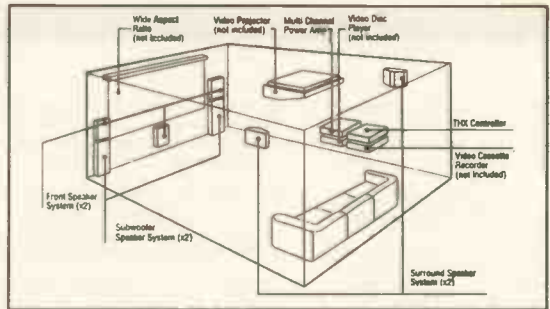

AV ROOM 1 = BANG & OLUFSEN AV9000
 AV ROOM 2 = YAMAHA DSPA2070
 AV ROOM 3 = THX, WIDESCREEN & LASERDISCS

POLK AV PACKAGE

RM3000 SATELLITES & SUBWOOFER
 CS100 CENTRE CHANNEL LOUDSPEAKER
 M3 MULTI APPLICATION MONITORS

PIONEER CLD2850

TAKES ALL SIZES CD AUDIO, PAL/NTSC
 DUAL SIDE PLAY, REMOTE CONTROL WITH
 SHUTTLE DIAL, NTSC PLAYBACK ON PAL
 TV's, DIGITAL SOUND LEVEL CONTROL

**YAMAHA DSPA 2070
 PRO LOGIC AMPLIFIER**

UPMARKET AV CONTROL AMP
 7 CHANNEL AMPLIFICATION
 DOLBY PRO LOGIC DECODER
 DIGITAL SOUNDFIELD PROCESSOR
 24 DSP SETTINGS

MAIL ORDER ACCEPTED ON ALL DISCS
 ALL DISCS SUBJECT TO BBFC CERTIFICATION



STAR WARS



ALSO LASER DISCS IN STOCK
 PAL & NTSC – Over 7,000 Titles available

TWENTY 20 AUDIO VISUAL LTD

CATALOGUE AVAILABLE



UNIT 205,
 LAKESIDE SHOPPING CENTRE,
 WEST THURROCK, GRAYS RM16 1ZQ
 Tel: 0708 891818 • Fax: 0708 891300

£7.99

CHEQUES ONLY

Advertisers Index

| | | | | | |
|------------------------|-----------|----------------------|--------|------------------------|---------|
| A P ELECTRONICS | 88 | GROOVE TUBES | 127 | PROGRESSIVE AUDIO | 96 |
| ACOUSTIC ARTS | 127 | HALE HI-FI | 126 | Q.E.D. | 40 |
| AMADEUS SOUND & VISION | 133 | HAMPSHIRE AUDIO | 18 | R.S. AUDIO | 114 |
| APOLLO | 142 | HART ELECTRONIC KITS | 118 | REFERENCE IMPORTS | 96 |
| ARCAM | 94 | HEATHERDALE | 102 | RON SMITH AERIALS | 32 |
| ART AUDIO | 57 | HI WAY HI-FI | 130 | RUSS ANDREWS | 22 |
| AUDIBLE DIFFERENCE | 122 | HI-FI CONFIDENTIAL | 133 | SERIOUS KITS | 138 |
| AUDIO CRAFT | 122 | HIFI EXCELLENCE | 104 | SEVENOAKS HI-FI | 124,125 |
| AUDIO FREAKS | 16 | IAN EDWARDS | 46 | SLATE AUDIO | 110 |
| AUDIO NOTE | 116,117 | IAN HARRISON HI-FI | 140 | SON ET LUMIERE | 120,122 |
| AUDIO SYNTHESIS | 106 | INFIDELITY | 32 | SONIC FRONTIERS | 121 |
| AUDIO TECHNICA | 56 | J. E. SUGDEN | I.B.C. | SOUND ILLUSION | 136 |
| AUDIOLAB | 48 | K.J. LEISURE | 108 | SOUNDCRAFT | 10,84 |
| AUDIOPHILE FURNITURE | 20 | KINSHAW ELECTRONICS | 64 | SPALDINGS | 104 |
| AVONDALE AUDIO | 112 | LEONARD BOOTH | 46 | STANDENS | 32 |
| B.K. ELECTRONICS | 102 | LINN RECORDS | 32 | STUDIO 82 | 10 |
| BANDOR | 96 | LISTEN INN | 10 | SUSSEX SURPLUS | 106 |
| BILL HUTCHINSON HI-FI | 139 | LOCKWOOD AUDIO | 140 | SYSTEMDEK | 38 |
| BILLY VEE HI-FI | 134 | LORICRAFT | 102 | TABULA RASA | 62 |
| BRENTWOOD | 10 | LOUGHBOROUGH | | TEAMPOINT | 88 |
| BULL ELECTRICAL | 131 | HI-FI EXCHANGE | 121 | TESSERAC | 16 |
| BURY AUDIO | 62,126 | M.A.F. STANDS | 56 | THE AUDIO GALLERY | 102 |
| CAMBRIDGE HI-FI | 110 | M.J.S | 121 | THE AUDIO ROOM | 132 |
| CAMPAIGN AUDIO DESIGN | 126 | MANTRA AUDIO | 126 | THE CHESTERFIELD | |
| CHELMER VALVE COMPANY | 123 | MICHELL ENGINEERING | 88 | HIFI SHOW | 84 |
| CHOICE HI-FI | 140 | MIKE MANNING AUDIO | 119 | THE HI-FI SHOWROOM | 112 |
| CHORD ELECTRONICS | 106 | MISSION | O.B.C. | THE MUSIC MILL | 56 |
| CONNECTIONS | 18 | MUSIC MATTERS | 137 | THE POWER PLANT | 135 |
| COURT 'N' SPARK | 114 | NAIM | 8 | THE RECORD CONNOISSEUR | 140 |
| CREATIVE AUDIO | 115 | NEAT ACOUSTICS | 133 | THE SOUND GALLERY | 26 |
| DAN DOOLEY | 132 | ORELLE HIFI | 38 | THE SPEAKER COMPANY | 112,136 |
| DEFINITIVE | 110 | ORTOFON | 16,18 | TRIANGLE (& DEALERS) | 46 |
| DIVA | 62 | OXFORD AUDIO | | TRY ME & SEE | 101 |
| DON FORDY | 135 | CONSULTANTS | 135 | TUBE TECHNOLOGY | 64,102 |
| DOUG BRADY HIFI | 20 | P.M. COMPONENTS | 70 | TWENTY 20 A/V | 144 |
| DPA | I.F.C., 3 | PHILIPS | 12,13 | V'AUDIO | 132 |
| ELECTROTRADER HIFI | 104 | PHOENIX | 126 | W. MIDS RADIO SUPPLIES | 20 |
| F&S SUPPLIES | 112 | PIM (CD STAX) | 40 | WESTWOOD & MASON | 110 |
| FRANK HARVEY HI-FI | 120 | PREMIER MARBLE | 84 | WILMSLOW AUDIO | 64 |
| G.T. AUDIO | 102 | PROAC | 6 | WOLLATON AUDIO | 40 |

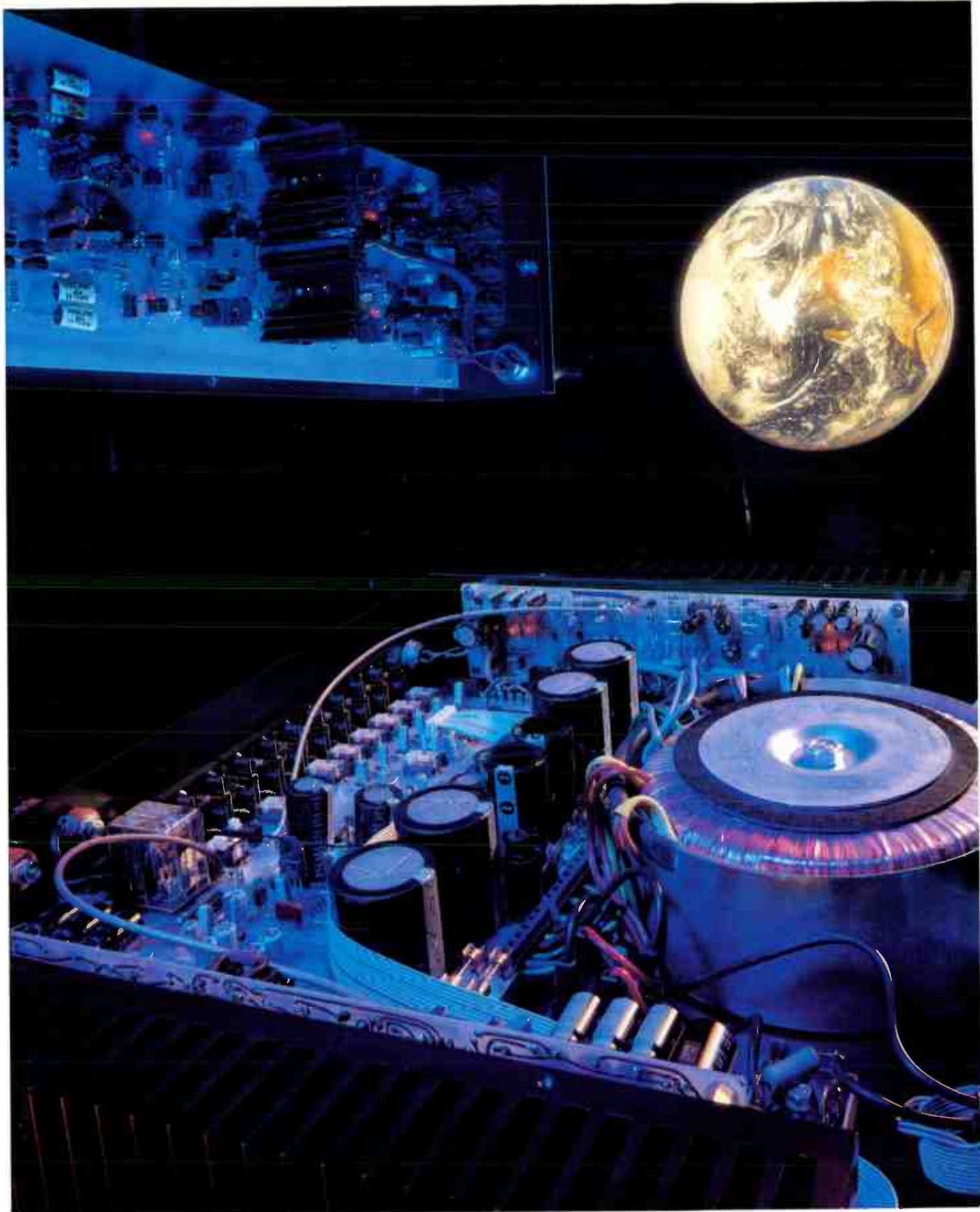

SUGDEN

HAND CRAFTED ■ FAIT À LA MAIN

DESIGNERS & MANUFACTURERS OF HI-FI & AUDIO EQUIPMENT

J. E. SUDGEN & CO. LTD.

Valley Works,

Station Lane, Heckmondwike,

West Yorkshire WF16 0NF

Tel. Heckmondwike 0924 404088/9

Fax No. 0924 410089

World Radio History

MISSION

because...



Mission Group, Huntingdon PE18 6ED England. Tel: 0480-451777 Fax: 0480-432777.

World Radio History