

# Hi-Fi WORLD SUPPLEMENT

No. 7 APRIL 1994

DISC STAGE - PART II

Pages  
12 + 13

LETTERS

IPL'S S3  
TRANSMISSION LINE  
LOUDSPEAKER KIT  
TESTED

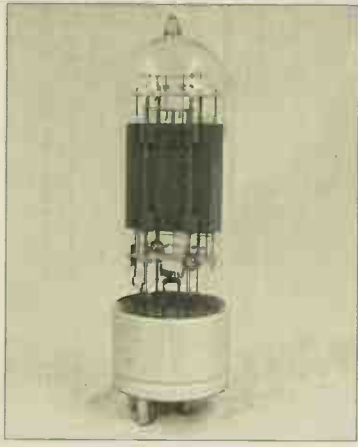

**KNOW YOUR POWER  
VALVES - SIX FEATURED**

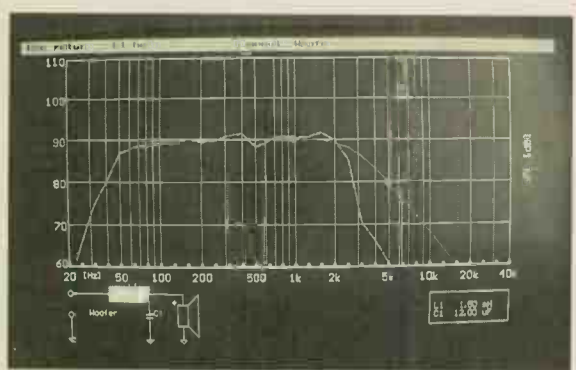

**DESIGN YOUR OWN  
LOUDSPEAKER  
- TWO CAD PACKAGES  
REVIEWED**

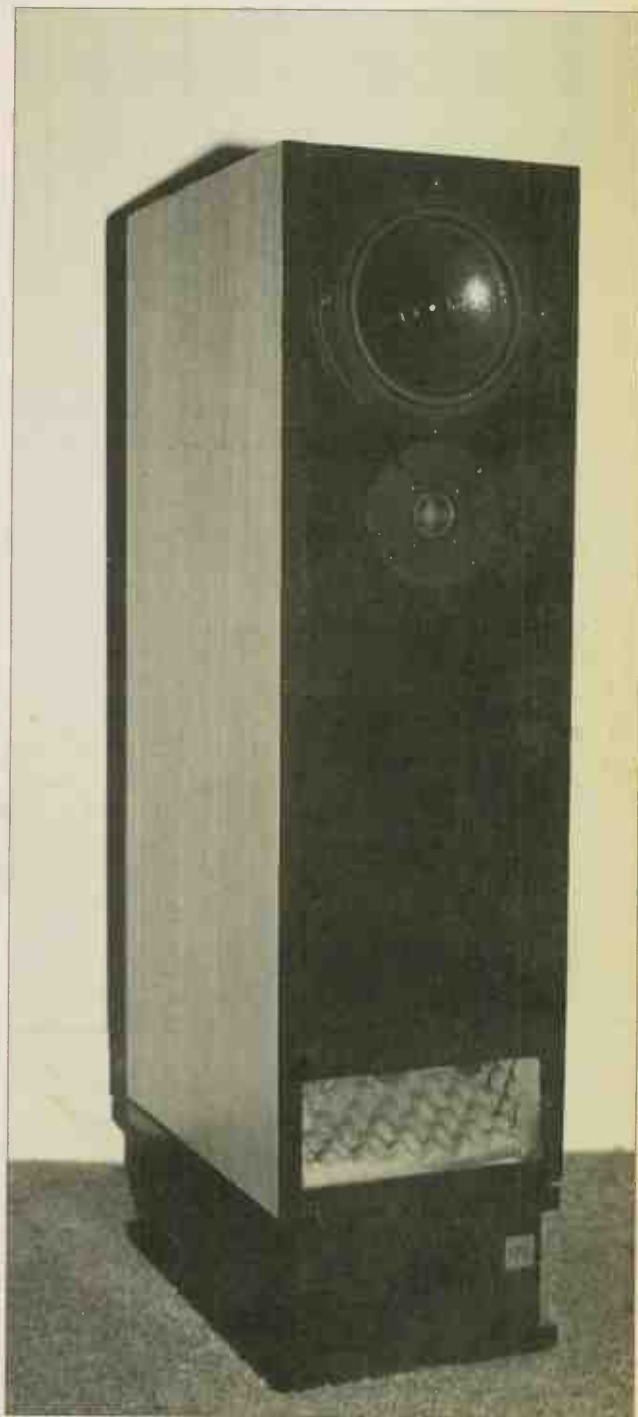

**FREE D.I.Y. SUPPLEMENT No. 7**



# Chelmer Valve Company for Audio Valves

Audio valves with famous Brand Names of yesteryear such as MULLARD, MOV, GEC, RCA etc., are in very limited supply and their scarcity also makes them very expensive.

We at Chelmer Valve Company however provide high quality alternatives to these old makes. We have over 30 years experience in the supply of electronic valves of all types and during this time have established close ties with factories and sources worldwide.

For high fidelity use we further process valves from these sources using our specially developed facilities. After rigorous testing - including noise, hum, microphony, post burn-in selection and matching as needed - we offer this product as CVC PREMIUM valves.

A selection of the more popular types is listed here.

## Price list & Order Form for CVC PREMIUM Audio Valves

	UNIT PRICE	QTY.	TOTAL PRICE		UNIT PRICE	QTY.	TOTAL PRICE
				CARRIED FORWARD...			
<b>PRE-AMP VALVES</b>				<b>RECTIFIERS</b>			
ECC81/12A T7	5.00			GZ33	4.50		
ECC82/12AU7	4.00			GZ34/5AR4	5.00		
ECC83/12AX7	5.00			5U4G	5.00		
ECC85	4.00			5Y3GT	3.20		
ECC88	5.00			5Z4GT	3.50		
EF86	4.00			<b>SOCKETS</b>			
E81CC (GOLD PIN)	6.00			B9A (PCB)	1.60		
E82CC (GOLD PIN)	6.00			B9A (CHASSIS)	1.60		
E83CC (GOLD PIN)	6.00			OCTAL (CHASSIS)	1.75		
E88CC (GOLD PIN)	7.00			4 PIN (UX4)	3.00		
E80F	9.00			4PIN (FOR211)	11.00		
E83F	5.50			MATCHING CHARGES * ..... POST & PACKING ..... 3.00 TOTAL EXC. VAT ..... VAT @ 17.5% ..... TOTAL TO PAY ..... £			
6SL7GT	4.00						
6SN7GT	4.20						
6922	5.00						
<b>POWER VALVES</b>							
2A3 (4PIN)	14.00			* MATCHING, if required; state valve types & if PAIRS, QUADS or OCTETS - Allow £1.00 per valve for this service.			
2A3 (OCTAL)	14.00			Make CHEQUES payable to: 'CHELMER VALVE COMPANY or pay by ACCESS/MASTERCARD/VISA, give details: <input type="text"/>			
211	22.00			Signature .....			
300B	50.50			Name .....			
811A	9.50			Address .....			
845	29.90			.....			
EL34/6CA7	7.50			.....			
EL84/6BQ5	4.00			.....			
E84L/7189A	5.10			.....			
KT66	9.20			.....			
KT77	12.00			.....			
KT88	12.50			.....			
KT88 (GOLDQ)	18.50			.....			
6L6GC	6.50			.....			
6L6WGC/5881	8.00			.....			
6V6GT	5.00			.....			
6146B	10.20			.....			
6336A	30.00			.....			
6550A	11.00			.....			
6550A - S	13.50			.....			
7581A	11.00			.....			
TOTAL CARRIED FORWARD.....				.....			
				..... Post Code .....			

**Valves amplifiers sound better still with CVC PREMIUM valves!**

130 New London Road, Chelmsford, Essex CM2 0RG, England. Telephone: (0245) 355296/265865 Fax: (0245) 490064

# D.I.Y. Supplement

## Contents

### NEWS

What's new and what's on its way for the DIYer

5

### IPL S3 TRANSMISSION LINE LOUDSPEAKER

We build a floorstanding loudspeaker kit from IPL acoustics. This £290 Transmission Line loaded loudspeaker offers excellent bass and dynamics.

7

### RIAA PHONO HEAD AMPLIFIER

The concluding part of our design for a high quality, low noise, phono head amplifier. The final design is highly versatile allowing it to be matched to any cartridge.

12

### KNOW YOUR POWER VALVES

We find six rare and special power valves for you to drool over.

18

### LOUDSPEAKER CAD PACKAGE

Two very affordable loudspeaker design packages tested. Boxcalc offers fuss free box design and Netcalc can make crossover networks fun.

23

### KIT SUPPLIERS

Want to know where to get those bits for your DIY project? Our list of the best suppliers shows you the way.

26

### LETTERS

Your views aired, opinions discussed and queries answered.

27



# KIT NEWS

## HOT ON THE HEELS OF HD-A

Following the development of their High Definition Aerogel drive units, soon to be used by Mission Cyrus in their forthcoming 752 loudspeaker, Audax have announced an even newer material, HD-I. High Definition Inertal is currently only available as a 15inch, 4Ω, 101dB sensitive (!) drive unit intended for car subwoofer operation, but expect to see a range of hi-fi drive units in the near future.

HD-I uses a three dimensional array of long carbon fibres coupled with a polymer laminate to give an ultra-light, ultra-stiff cone material. HD-I is around half the weight of a similarly sized paper unit.

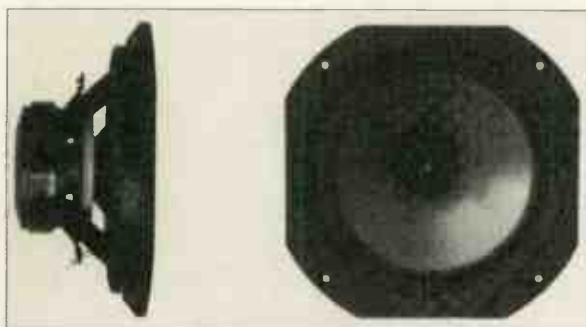

Audax have also just produced a new catalogue which features new 4inch midrange, 5.25inch bass/mid, 6.5inch bass and 8inch bass HD-A drive units. As yet, most of these new units are unavailable to the DIY-er, but hopefully they should appear on the market within the next few months.

## MAPLIN KIT VALVE AMPLIFIER

Maplin Electronics have recently introduced a new valve amplifier kit, the Millennium 4-20. Based on the Mullard 5-20, Maplin's 4-20 uses transformers that are around half the size of those found on the original, thanks to modern materials. It is a Class AB1 push/pull design offering 20watts. The 4-20 costs just £179.95 for a stereo kit and is suitable for domestic hi-fi systems, public address and musical instrument amplification. We hope to be offering a review soon.

## STRIKING SILVER

Another new addition to Maplin's range are two pure silver cables. The pure silver loudspeaker cable is made up of 7/0.28mm twisted strands and sells for

£60/m. The screened silver interconnect uses 5/0.28mm strands and is available for £16/m. Maplin now also offer silver solder, a 50cm length costs £3.95.

**Maplin Electronics,**  
**P.O. Box 3,**  
**Rayleigh,**  
**Essex,**  
**SS6 8LR.**  
**Tel: 0702 554161**

## GT UPGRADE KITS

GT Audio now offer a wide range of audiophile upgrade kits for vintage amplifiers and tuners. The kits are available for all Leak amplifiers and tuners, Quad amplifiers and tuners, Radford amplifiers, PYE PF91, HF12 Mozarts, PYE tuners, RCA and many more. Typical prices for the upgrade kits are £160 for a Leak TL12+ kit and £120 for a Quad II kit (not including power supply capacitors). The kits include all components necessary to bring your vintage delight

back to glory, including high quality polypropylene capacitors and Military Spec Resistors.

GT Audio can also supply any switch gear, sockets, valves, valve bases, re-enameled or re-chrome metalwork and anything else you could wish for to restore your vintage hi-fi.

**GT Audio,**  
**5 Upper Road,**  
**Higher Denham,**  
**Bucks,**  
**UB9 5EJ.**  
**Tel: 0895 833099**

## TRANSMITTING METAL

Bandor loudspeakers, best known for their range of aluminium drive units, have just launched two transmission line loudspeaker kits, the Bandorline '20' and '30'. Free technical sheets are available on request.

**Bandor, 11 Penfold Cottages, Penfold Lane, Holmer Green, Bucks. Tel: 0494 714058**



## DIY ON THE UP

The 1994 Mintel Marketing Intelligence report on British Lifestyles shows encouraging news for both hi-fi and the DIY-er. More people than ever are confident about taking on DIY tasks themselves and, combined with the news that "When it comes to leisure, home based activities will continue to predominate, boosting the sales of brown goods such as televisions, hi-fi equipment and recorded music" it looks as if DIY hi-fi is likely to grow in popularity.

Mintel also predicts "a healthy growth in book, magazine, newspaper and stationary sales" which gives us heart as well.

So what are you waiting for - now's the time to go out and get those kit loudspeakers you've been thinking about, or that valve amplifier. You know we'll be hard at it, producing more DIY Supplements to feed your growing interests.

**Mintel, '94 Lifestyles £895.**  
**Sales Tel: 071 606 6000**

## PADDED MAGNETS

Following the success of their Deflex loudspeaker cabinet damping pads, Spectra Dynamics have added three new pads, designed to be fixed to the back of the magnets of drive units. By covering the hard reflective surface of a drive unit's magnet with the new 3, 5 or 7inch Deflex pads, the performance of a loudspeaker is said to be greatly improved.

**The Speaker Co.,**  
**Unit 9, Waterside Mill,**  
**Waterside, Macclesfield,**  
**Cheshire, SK11 7HG.**  
**Tel: 0625 500507**

# DAX

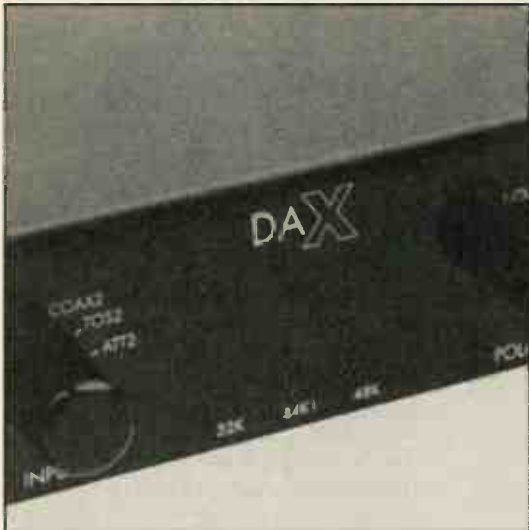

Reference Grade Crystal locked Digital to Analogue Converter

# AUDIO synthesis

99 Lapwing Lane, Manchester M20 OUT U.K.  
Telephone 061 434 0126 Fax 0602 258431



## Falcon Acoustics Ltd

Send for our Free price list PL22A: just send a large S.A.E (36p stamp) or \$2bill (air) overseas. (Europe - 3 international reply coupons)

SYSTEM DESIGNS (Total Kits): Focal, KEF Constructor, Seas, etc.  
DRIVE UNITS: FOCAL, KEF, Audax, Coies, Peerless, Seas, Siare, Elac Metal Dome, Scanspeak, etc. Also Group/Disco Units

CROSSOVER NETWORKS - Active & Passive Components, Accessories, SOLEN Polypropylene Caps. + FALCON Custom-wound Inductors

AUDIO AMATEUR PUBLICATIONS

BACK ISSUES:

Speaker Builder, Audio Amateur & Glass Audio, L/S Cookbook + Audio books

FALCON ACOUSTICS LTD.

(Dept HFW) Tabor House, Norwich Road, Mulbarton, Norwich, Norfolk NR14 8JT (0508) 578272



## SOWTER TRANSFORMERS

Sowter Transformers have been used by the Professional Audio Market throughout the world for at least the last twenty - five years.

Using modern technology and Computer Aided Design we are now able to offer a complete design and manufacture service.

Our current lists show a range of over 50 output, 70 power transformers and nearly 30 chokes.

E. A. SOWTER LTD

P.O. BOX 36, Ipswich IP1 2EL

Tel: 0473 252794. Fax: 0473 236188 SEND S. A. E. FOR DETAILS.

# BIE

Billington  
Export  
Limited

1E Gillmans Trading Estate,  
Billingham, Billingham,  
Sussex RH14 9EZ UK  
Telephone: (0403) 784961  
Fax: (0403) 783519 Telex: 923492

TOP QUALITY AUDIO TUBES from West Europe/USA.

We have 1 million valves/tubes in stock including vintage and high quality audio types. Please enquire for any type not listed below.

2A3 Chinese	£15.16	ECC82 Mullard UK	£4.65
5AR4 refer to G234/G237		ECC83 Russian	£2.75
5C-450A	£295.00	ECC85 Tungfram	£2.66
5R4GY RCA	£4.98	ECC88 Russian	£3.32
5U4G W European	£7.99	ECC88 Mullard UK	£5.51
5Y3WGTA Sylvania	£3.99	ECL82	£2.59
6AS7D Russian	£4.38	ECL86 Mullard	£4.38
6R4G American	£33.24	EF86 GEC UK CV4085	£14.63
6H6 RCA	£2.19	EF86 Russian	£3.45
6C33CB Russian	£23.70	EF80AS AEG	£25.00
6CG7 Philips	£4.32	EL54 Chinese Billington	£7.96
6D6B refer to ECC88		EL84 Mullard	£3.30
6L6GC GE USA	£14.63	EL84 Tungfram	£3.05
6L6GC Philips 5881	£4.65	EL84 GE USA	£3.92
6L6GC Philips 5881	£18.62	EL519 Russian	£9.24
6SL7G1 TTC UK	£5.98	GZ32 Mullard UK	£8.37
6SN7GT1 TTC UK	£3.58	GZ34 Mullard UK	£12.00
6V6GT1 STC UK	£3.45	GZ34 Genline Russian	£5.98
6X4 UK 800	£2.39	GZ37/CV378 Mullard	£4.39
12AT7 refer to CV4024/ECC81		KT66/751A GE	£15.89
12AT7W4 Sylvania	£3.92	KT88 Chinese Billington	£15.96
12AU7 refer to ECC82		KT88 refer to 6550A GE	
12AX7WA Russian	£2.75	M8136 refer to CV4000/ECC82	
12AX7WA ECG Philips	£9.99	M8137 refer to CV4000/ECC83	
12BH7A Sylvania/RCA	£10.97	M8162 refer to CV4024/ECC81	
12E1 STC/TTC UK	£13.30	ECC83 China	£1.75
1303 CV4068	£5.99	Mu14 Binray UK	£3.99
13E1 STC UK	£133.00	PLS19 Sylvania USA	£7.91
85A2 Mullard	£5.98	VT4C GE	£42.56
211GE	£42.56	SOCKETS	
8898 Chinese	£53.13	UX4 used for types 2A3/900B etc	£2.32
805 Union USA	£33.25	VT4C/211 ceramic	£14.36
807 RCA	9.29	85	£3.99
811A Russian	£10.40	UX5 McMurdo	£1.85
845 Chinese	£86.00	87A Teflon, used for types 6C33CB etc	£1.60
4212a STC UK	£120.00	B7G McMurdo UK chassis mounted and skirted	£0.63
5687 USA	£5.99	Octal McMurdo Chassis:	£0.86
5751 USA	£6.50	Octal PCB	£2.99
5881/6L6WGB Russian	£4.25	89A chassis unskirted	£0.69
6189 Mazda	£5.99	89A chassis skirted	£0.79
ECC82 refer to CV4024		89B gold pins	£1.73
6922 Sovtek	£4.30	Topcap for 807	£2.66
6550 Sovtek	£12.00	Topcap for 58-254-234M 12E1 PLS19 etc	£2.66
6550 Philips	£12.36		
6550A GE 12SA1991	£29.00		
CV4003 Billiard	£7.31		
CV4004 Mullard	£15.53		
CV4024 Mullard UK	£7.65		
CV4085 refer to EF86			
D67-32 Tungfram	£28.80		
ECC82 refer to CV4003			
E83CC refer to 12AX7WA			
ECC91 Binray UK	£3.12		

**BILLINGTON EXPORT LIMITED**

MIXIMUM ORDER - UK £5 00/- V.A.T. EXPORT £1 00 00 Callers strictly by appointment only

Order over £400 (mix of types is ok) quality for 25% discount

Band: Lloyds, West street, Horsham RH12BP Account 0702105, Sort Code 30-94 41 Gatwick Airport (south London) 15 miles away, Company registered in London no 2728987 Directors: M.H. Billington, C.M. Billington

1E Gillmans Trading Estate Billingham, N. Sussex RH14 9EZ UK Telephone: (0403) 784961 Fax: (0403) 783519

## LYNWOOD MAINS CONDITIONER

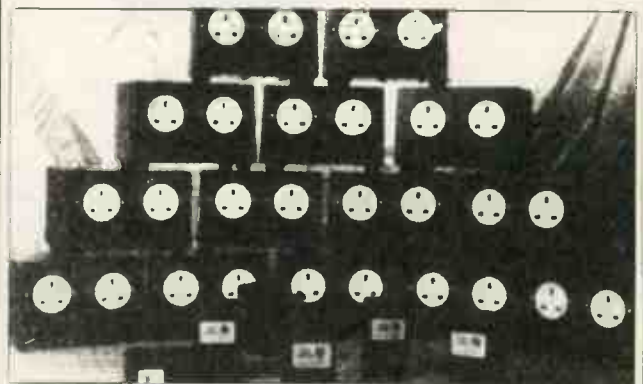

Price:-	Source	£295.00
	Basics	£59.95
	Advanced	£149.95
	Mega	£295.00
	Rack	£345.00

For further information and dealer list send SAE to

## LYNWOOD ELECTRONICS

Coley Lane Farm  
Wentworth  
Rotherham  
South Yorkshire

# BASS TRANSMISSION

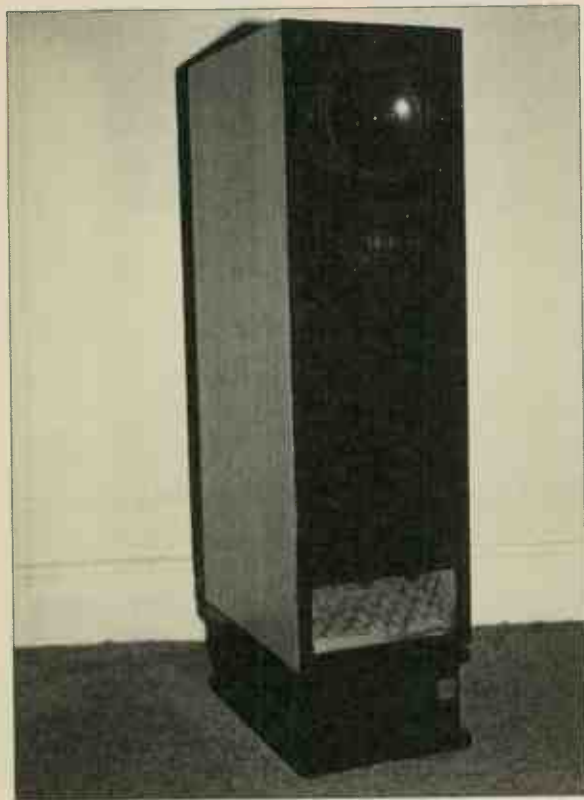

## Dominic Baker builds IPL's latest S3 Transmission Line loudspeaker kit.

Building your own loudspeakers can be quite a task. Their design, if it is to be effective, demands a lot of specialised test work and probably several prototypes before respectable results can be achieved. Fortunately, there are an increasing number of kits available from companies who specialise in doing this donkey work for you. These days the chances are you will be able to find something that suits your needs.

IPL's S3s are small, floorstanding, transmission-line loaded loudspeakers intended

to offer good bass and dynamics from a reasonably low cost kit. They come complete with everything, including flat-pack cabinets, drive units, crossover and even grilles. The cabinets in this kit come pre-veneered, which is a nice touch, as finishing a kit loudspeaker can turn out to be the biggest nightmare. There's nothing worse than completing a carefully glued pair of cabinets and then spraying them black, only to find you've achieved the consistency of tarmac.

The drive units are both extremely high quality. The tweeter is the same excellent SEAS soft dome used in the Heybrook Quartets and the bass unit is a specially made 6inch doped paper cone. The bass unit has a hard plastic dust cap which helps to extend the response of this unit smoothly upwards to meet the tweeter. Crossover components are also very good: Ansar Supersound polypropylene capacitors are used for the treble, for example.

## BUILDING THE KIT

Building the S3s turned out to be a lot easier than I initially thought. Although none of the panels were rebated, which helps their location, I found construction straightforward.

First of all, as with any loudspeaker kit, I would suggest that you attempt a dry run, since this gives you an idea of how the cabinet goes together and what problems are likely to occur when glueing. For example, I realised during my dry run that if I didn't hammer in the threads for the drive unit bolts first, then it would be nigh on impossible to do so after the glue had been applied.

The trick to glueing up a cabinet like this is not to use too much glue. If you do, not only does the glue pour out of the joints and fix the cabinet to the newspaper beneath, but the panels slide around, making it extremely difficult to hold them square. A thin smear should be used and the panels worked into place by sliding them slowly against each other. This builds up stiction and the panels stay firmly in place even without clamps. IPL

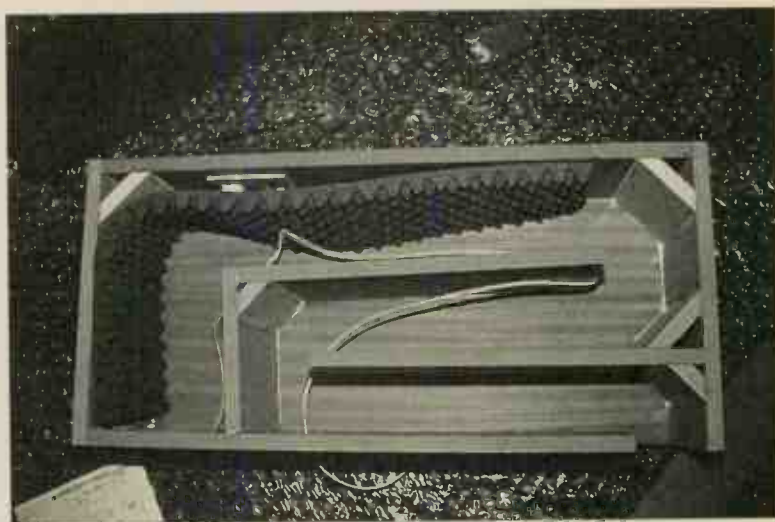

recommend using a hot melt glue gun and small, square, wood blocks to hold each panel in place, but in practice I found these unnecessary.

The cabinet is built up on one side panel so that the crossover and internal damping can be located before the

cabinet is closed. It is very important to solder up the crossover correctly first time, because once the other side panel is glued in place it is virtually impossible to correct it. However, the instructions

Continued on page 9... ►

# SPEAKER KITS FROM IPL ACOUSTICS

Over a 5 year period I.P.L. Acoustics have developed a range of high quality speaker kits, using the best units from SEAS, MOREL, AUDAX, VISATON and I.P.L. and have produced a comprehensive range of speakers which will compete with the most expensive of commercial designs. All speakers have BIWIRED crossover kits containing high quality components and terminals.

## AS6 PANEL KIT



PLUS KIT.....£262.77  
PANEL KIT.....£302.77

## FOUR TRANSMISSION LINE KITS

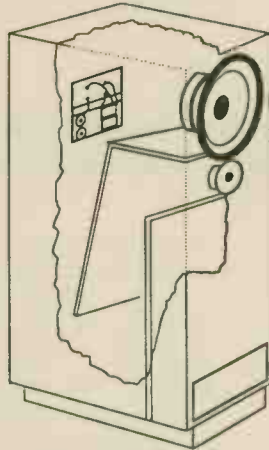

TRANSMISSION LINE  
PLUS KIT  
£167.00 - £280.00

## M3TL



PLUS KITS.....£167.00  
TOTAL KIT.....£226.00

## A2 RIBBON KIT



PLUS KIT.....£222.00  
TOTAL KIT.....£291.00

## M2 MINI-MONITOR



PLUS KIT.....£166.00

PRE-VENEERED CABINET NOW AVAILABLE. Carriage charge extra on all kits.

If you would like further details please send £1.50 for **36 PAGE SPEAKER BUILDING CATALOGUE**, comprising **VALUABLE ADVICE** on **DESIGNING, BUILDING** and **TESTING** speakers and full technical specifications including response curves of eight kits, drive units, and details of **SPECIALIST CABLES** and **ACCESSORIES**

I.P.L. Acoustics, 2 Laverton Road, Westbury, Wiltshire, BA13 3RS. Tel: 0373 823333

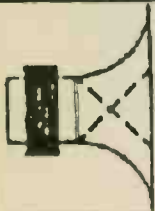

## BANDOR

MINIATURE LOUDSPEAKERS  
THE SOUND OF EXCELLENCE

BANDOR ALUMINIUM ANODISED CONE DRIVERS  
1.3 grams moving mass. **35 YEARS EXPERIENCE**

### NEW PRODUCT

BANDOR LINE '20'  
and  
BANDORLINE '30'  
TRANSMISSION LINE KITS.  
M.D.F. CUT OUTS (Flat Pack)  
150Hz Cross Over  
CABINETS DESIGNED BY  
© G.E BOWMAN



### Free technical sheets

Design & Development  
Studio  
11 Penfold Cottages,  
Penfold Lane, Holmer  
Green, Bucks. HP15 6XR  
Tel: (0494) 714058



## DYNACO STEREO-70



This is one of the most famous American tube amps ever made. Rated at 35 watts per channel, it uses 4-6L34's, 1-6Z34 and two 6X4's. This very reliable amp is great for those who wish to modify parts or use it just as is. Bias is easy to adjust, and the unit can switch between mono and stereo. The output tubes can operate at 65% of their capacity, and the filter caps at less than 85% of their rated voltage. A true classic.

Dynaco, Sherwood, Scott, The Fisher, McIntosh, Eico, Harman-Kardon, Heath, Altec, Stromberg-Carlson

Prompt Insured Delivery. Vintage Parts Available on Request  
Looking for a particular piece of vintage equipment?  
Send Us Your Requests.

FAX: (604) 876-5876  
P.O. BOX 147, STATION A, VANCOUVER, B.C.  
CANADA V6C 2M3



## MEASURED PERFORMANCE

IPL's S3s are a transmission line loudspeaker venting low bass from a mouth at the bottom of the cabinet. This makes measurement difficult, since to get output from this port to integrate with the midband and treble you need to be well back from the front of the cabinet, but here you tend to suffer room reflections badly.

The response was taken far enough back to get the effect of low bass, albeit not integrated as well as it would be in the listening position, but not too far back that unwanted reflections appear. Through the midband and treble the IPLs are very smooth, the small lift in the upper midband should help to push vocals out of the box and, apart from this, the response is flat right up to the 16kHz band.

The S3s are quite sensitive too, producing an above-average 87.5dB for a nominal watt measured at 1m. This means that they will go loud with relatively little power, suggesting that amplifiers in the region of 20-40 watts should be ideal. Their high overall impedance of 11Ω confirms this, showing that the S3s will not demand much current to drive them either. Neither are they reactive, since from 200Hz upwards their impedance characteristic is almost flat, suggesting that good results could be obtained from feedbackless amplifiers which are affected by the load they drive.

The IPL S3s are well engineered to give a flat, well extended frequency response and provide an easy load for almost any amplifier. This, along with their price, makes them appealing to a wide audience (DIY skills excepted) - and they sound pretty good too. **DB**

### Frequency Response

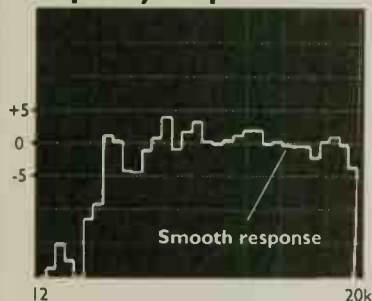

### Impedance

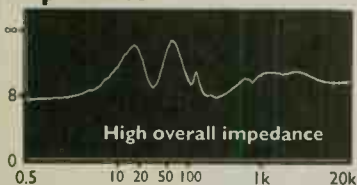

include a circuit diagram, schematic and a photograph to ensure that disasters don't happen.

Once all of the internal guides for the transmission line and the cabinet baffles have been glued into place the crossover needs to be mounted. I fed the wires from the crossover to the drive units through the internal damping pads and then out through the cut-outs in the front baffle.

Finally, if you're sure that everything is installed correctly, the other baffle can be

glued into place. A heavy weight should be used to hold this firmly in place and the cabinet left to dry.

Meanwhile, the stand can be glued together. This came undrilled, as did the grilles, presumably because not everyone will want to fit spikes to the stand or grilles to the speakers. The stands should be filled with

sand once they are glued up and thick carpet tape used to seal the hole to prevent it escaping.

The rest of the construction was all quite straight forward. The front and rear of the cabinets can be lightly sprayed black and the sides and top, which are pre-veneered, polished to a high shine. Thin strips of adhesive veneer are supplied to cover the bare MDF ends that show on the top. The result is a very professional looking loudspeaker. Now let's hear what it sounds like.

## SOUND QUALITY

Plugging-in after five hours of sweat and toil, hearing them work first time - and sounding better than you expected - is a thrill. The feeling of satisfaction you get from successfully completing a project like this makes the effort worthwhile. For just £290 you get a day's worth of DIY, followed by countless hours of listening pleasure.

The new IPL S3s have a lovely light, fast sounding midrange that clearly etches female vocals into the soundstage. Aimee Mann had a large, spacious atmosphere around her and the bass lines were solid, rhythmic and deep. 'Put Me On Top' has a rich, flowing bass line that was free from overhang and fast enough to keep time with the rest of the music on the S3s. This gave them a good foundation upon which to build.

The S3s now use the same SEAS tweeter found in Heybrook's Quartet loudspeakers and, similarly, they had a sweet and spacious quality that you only get from really good soft domes. Unfortunately, again like the Quartets, they don't really image that well, the members of the band could only be vaguely placed with any certainty, but the soundstage was both wide and reasonably deep, giving a large room-filling sound.

The heavy, pre-veneered boxes, with plenty of internal bracing, thanks to the transmission line, are very inert. Even at high (party) levels, box colouration was virtually undetectable.

The S3s are a lively loudspeaker; they resolve a wealth of detail and play it with

energy and enthusiasm. They are involving - when I was writing this article I had them playing in the background and constantly found myself turning around to listen to what they were doing - a zing from a metal guitar string or vocals sounding more open and transparent than I remembered, catching my attention. They aren't intense, but they do involve.

Grant Lee Buffalo once again sounded superb. This is a fine recording, real atmosphere and good acoustics to be found on most tracks. The sharply focused guitars, underlying kick drum and slightly coarse vocals of Grant Lee Phillips all combined perfectly to give an engaging and musical presentation.

The S3s had a good amount of slam too, with The Blue Aeroplanes' 'Broken and Mended'. They filled the room with powerful drumming, squealing electric guitars, and the half spoken, half sung vocals of Gerard Langley.

Ultimately, these speakers don't have the holographic projection of the better quality British loudspeakers, or the precise imaging, but those qualities tend to cost three or four times the asking price of the S3s. If you can do a little neat soldering, and some simple woodwork, you'd be daft not to consider the S3s. They're fun to build, are well designed and sound superb.

**IPL Acoustics, 2 Laverton Road,  
Westbury, Wilts BA13 3RS.  
Tel: 0373 823333**

# AUDIO NOTE

## AUDIO NOTE AUDIO COMPONENTS PARTS & PRICE LIST.

We have decided to offer a range of the ultra high quality components used in most of the Audio Note amplifiers to the discerning "do-it-yourself" valve amplifier enthusiast. These components include specially made valve bases, paper in oil signal capacitors, copper & silver foil signal capacitors, Black Gate graphite electrolytic capacitors, acid/corrosive-free silver solder, audio output transformers, valves and many other useful bits for upgrading old or constructing new valve amplifiers.

All prices are excluding Vat, which, if you live inside the EEC will be added to your purchase, after the addition of postage and packing costs.

We accept VISA, Mastercard, Access, Oiners, and Amex. To pay this way, we will send your address, card no. with start and expiry dates, you can also pay by bankers draft, Eurocheque or cheques drawn on a UK bank account. Please note that there is a minimum charge on credit card transactions of £20.00

Delivery is normally about 7 days from receipt of cleared funds, but please allow up to 60 days for some items, if not stock at the time or order.

If any of you reading this have possession of any books which contain information relevant to the subject of Audio Design and which would be useful to share with others, please let us know either by fax or telephone. There is an award of £20.00 (payable in valves or other bits, post free) to anybody who sends us a book which contains useful information about valve amplifier design or theory.

## Circuits, Valve Data & Basic Technical Information.

If you would like some suggestions to base a future project around, then we shall be happy to provide you with a circuit pack containing good circuits like ONGAKU, KEGON/KASSAI, NEIRO, GAKU-ON plus several other power amplifier circuits and the M7Tube pre-amplifier, which is the best pre-amplifier circuit we have come across. Just send a stamped self addressed A4 size envelope, together with £5.00 in small denomination, or if you live outside the UK a US\$ 15.00 in \$ bills will do, please do not send International Response Coupons or International money orders, as they cost more to cash than their value.

We can also supply a set of data sheets for the most commonly used valves, ECC82, ECC88/6922, 12AY7/6072A 7025/12AX7WA/ECC83, 6SN7, 300B, 211VT4C, 845, EL34/6CA7, 2A3, 6X4, 5U4G, GZ34/SAR4, EL84/6B05, 6V6GT, 6L6G, 5881/6L6WGC/KT66. Again send a stamped self addressed A4 envelope together with £4.00 in small denomination stamps or if outside the UK another US\$ 10.00 will suffice.

Since nothing really exists which gives a reasonable background to the subject of valve amplifier circuit design, Guy Adams and I have written and assembled a number of articles and extracts from old books which give some background to the subject, do not expect to become an instant expert, but it will serve as a useful reference, for the beginner as well as the more advanced, we have expanded this info-pack to include even more useful information, so if you have already bought the old pack, just send £2.00 or US\$ 5.00. For the full pack a small charge is required, this time £7.00 in small denomination stamps with a stamped addressed envelope, or outside the UK, please send US\$ 25.00. We do accept a UK cheque or bankers draft in Pound Sterling for the above charges as well

## SOUND PRACTICES.

If you are seriously interested in the subject of valve amplifier design, without the usual preconceived notions of what is "good" amplifier design and technology (the traditional view, which has brought us the blessings of the transistor amplifier, has obviously disqualifed itself quite monumentally), then SOUND

PRACTICES is the magazine to read, here you will find articles about design parameters, OIY articles for amplifiers and speakers, reviews of new and old. In other words the very subjects that none of the self-serving, advertising led traditional press will touch as they do not enhance the business of their normal advertisers. You can buy SOUND PRACTICES from us at £5.00 per copy (there are currently 4 issues available) or by subscription from SOUND PRACTICES P. O. Box 19302, Alexandria, VA 22320, USA. A regular modern world bargain, and there are practically none of those in Audio today. With enough subscription support SOUND PRACTICES may just bring about the "sound practices" that the hi-fi industry has abandoned for so long. So get a subscription!

## OUTPUT TRANSFORMERS.

Specifications.  
PP = Push-Pull, PPP = Parallel Push-Pull. SE = Single-ended. PSE = Single-ended Parallel. UL signifies 43% ultralinear taps, as a general rule we do not condone the use of UL-taps, as we consider these detrimental to sound quality. \*\* Dynaco replacement.

All primary impedances are calculated for Class A operation the main consideration given to maximum dynamic power transfer ability and minimum distortion, rather than meaningless steady state sine- or squarewave conditions.

All our single-ended output transformers are airgapped, and the maximum standing current allowed before saturation is shown in column 5.

All our output transformers have a frequency response well beyond the audible range, typically 20Hz - 40KHz minus 1.5dB, all are IE-cored with high grade silicon steel laminations, wound with oxygen-free copper wire and supplied with either bell-ends or frames, both with flying leads.

We generally overspecify our transformers by 50% power in Push-Pull (which means that a transformer stated as 25 watts will allow about 35-38 watt peaks, our single-ended outputs are generally over specified by 100%, which means that they will instantaneously allow peaks of double the given maximum power through undistorted.

We do not give any further technical information on our output transformers, as we do not wish to take part in technical competitions, our products are designed to criteria which are and will be understood once they are listened to!

In addition to the output transformers offered below, we offer a design service, where we can supply almost any requirement for wideband transformers, whether for microphones, moving coil cartridges, line input, phase splitter, interstages, driver or power output, we design and manufacture prototypes in-house, the cost for the paper design is £200.00, prototype cost is calculated on a per case basis. We can also produce production quantities.

Sizes are given as Width/Height/Depth, where depth is the depth of the coil itself and width is the length of the core.

## PAPER IN OIL SIGNAL CAPACITORS

These handmade signal capacitors are sonically superior to any of the plastic or other paper types we have come across. If you have never experienced the difference that a really good paper/oil capacitor can make in a valve amplifier, then you really should try. Our specially made paper/oil caps have a life, colour, lack of harshness and evenness of dynamic behaviour across the frequency range, which is guaranteed to brighten up your day! Recommended as replacements in old and new valve amplifiers alike (and even in the odd transistor amplifier), and essential for OIY projects. In line with environmental standards, all AUDIO NOTE paper in oil capacitors contain only non-toxic, biodegradable vegetable oil, the paper is specially treated and

impregnated by a method that enhances longevity and sound quality, to ensure optimum performance all round.

Value	DC Voltage	Size	Price ex. UK Vat
0.015mF	400volt	21x9mm	2.85
0.022mF	400volt	35x10mm	3.75
0.047mF	400volt	32x11mm	4.10
0.082mF	400 volt	33x14mm	4.25
0.12mF	400 volt	33x14 mm	4.75
0.18mF	400volt	32x16 mm	5.15
0.22mF	400 volt	35x18 mm	5.85
0.33mF	400 volt	43x18 mm	6.75
1.4mF	400 volt	70x24 mm	14.95
0.0015mF	630 volt	17x9 mm	2.85
0.022mF	630 volt	20x10 mm	3.25
0.082mF	630 volt	33x16 mm	4.55
0.18mF	630 volt	43x18 mm	5.45
0.22mF	630 volt	52x19 mm	5.75
0.33mF	630 volt	52x22 mm	7.25
0.39mF	630 volt	52x26 mm	7.95
0.47mF	630volt	52x26mm	8.85
0.22mF	1000 volt	56x26 mm	6.95
0.39mF	1000 volt	61x26 mm	11.65
1.2mF	1000 volt	72x40 mm	16.75
0.22mF	1600 volt	60x26 mm	9.65
0.22mF	2000 volt	70x29 mm	11.55

All Audio Note paper in oil signal capacitors are axial type. We are preparing a range of very small picofarad value paper in oil capacitors at the moment in addition to the above. The range of AUDIO NOTE paper in oil capacitors is steadily expanding, so ask for values that you do not see.

## PAPER IN OIL COPPER FOIL SIGNAL CAPACITORS.

We are currently developing a range of paper in oil capacitors where instead of using aluminium foil as in the above paper caps, we use an oxygen free copper foil with 99.99% pure solid silver lead out wires, these copper foil paper signal capacitors are considerably better than standard offerings. Secondly to "bridge" the price-quality gap between the more standard paper/oil caps and the Japanese handmade silver foil signal caps, we will be offering our own 99.99% pure silver foil signal caps, which are pretty staggering in quality, even if I have to say this myself (as I am the only one to have heard the samples so far) the silver foil caps will also have solid silver lead-out wires. To start with there will be a few values/voltages available.

## AUDIO NOTE SILVER FOIL SIGNAL CAPACITORS.

Best signal capacitors available, quality really speaks for itself, used in amplifiers like ONGAKU, KEGON, GAKU-ON and M7Tube Silver, handmade in very limited quantities at Audio Notes facility in Tokyo, Japan.

Value	DC Voltage	Price ex. UK Vat.
0.02mF	500 volt	211.75
0.05mF	500 volt	346.75
0.1mF	500 volt	645.75
0.2mF	500 volt	985.75

## AUDIO NOTE PAPER IN OIL RESERVOIR CAPACITORS.

Mainly for use in inductor power supplies, but have other uses.

Value	DC Voltage	Size	Price Ex. UK Vat.
2mF	400 volt	30x40x55 mm	26.75
2mF	630 volt	35x45x72 mm	33.65
2mF	1000 volt	45x45x72 mm	41.75
2mF	1600 volt	50x70x72 mm	45.95
4mF	1000 volt	45x45x120 mm	49.95
4mF	2500 volt	70x70x120 mm	265.75
10mF	1000 volt	70x100x100 mm	96.75
12mF	1000 volt	70x100x120 mm	109.95
12mF	1600 volt	100x100x120 mm	136.75
12mF	2000 volt	100x100x220 mm	159.75

## AUDIO NOTE ACID & CHLORIDE FREE SILVER SOLDER.

The best solder we have been able to find. does

not contaminate the junction, which over time increases junction resistance. Used in all our amplifiers from OTO to the GAKU-ON.

Weight/Measure	Price Ex. UK Vat.
50 grammes or about 8 meter 1 mm diameter	19.95
1 kilo roll of 1 mm diameter	210.65

## AUDIO NOTE CABLES & WIRES.

We are proud to offer the AUDIO NOTE range of high quality copper and silver coax, speaker and wiring cables, which, depending on the overall price of the project will do justice to any hi-fi system, regardless of price.

Solid 99.99% Pure Audio Note Silver Wire.

Gauge	Insulation Material	Price per Meter Ex. UK Vat.
0.05mm	Polyurethane	16.75
0.2mm	Polyurethane	22.75
1 mm	ML	36.75
0.35mm	ML	24.95
0.6mm	ML	27.85
0.8mm	ML	31.75

The above solid silver wires are suitable for inductors for speaker crossovers, both active and passive or for internal wiring in tonearms, amplifiers etc.

## AUDIO NOTE HIGH QUALITY STEPPED ATTENUATORS & SWITCHES.

These handmade attenuators and switches are manufactured by a friend of Mr. Kondo of AUDIO NOTE, and represent the best available volume controls and switches you can use in your pre-amplifier, the attenuator is 48 steps and with silver/rhodium plated contacts/brushes made with an array of tantalum film resistors. The switches feature silver plated contacts and self cleaning action.

Type	Value	Price Ex. UK Vat.
Stereo Potentiometer		
/Attenuator	50KOhms	198.75
Stereo Potentiometer		
/Attenuator	100KOhms	207.75
2 Channel		
switch	6 - way adjustable	78.75
4 Channel		
switch	6 - way adjustable	101.75

## AUDIO NOTE HIGH QUALITY CERAMIC VALVE BASES

All of our valve bases are of the highest possible quality, made from stellite and using the best metal parts from alloys which retain their spring tension around the valve pin for longer. They are recommended as upgrades to most old valve amplifiers and should be an essential part of any OIY project.

Type	Mounting	Plating	Price Ex. UK Vat	
4-pin UX4 for 300B		Gold	8.25	
4-pin UX4 for 300B				
/2A3/801A	Chassis	Nickel	7.25	
4-pin UX4 WE-type for				
300B/2A3/801A	Chassis	Silver	14.75	
4-pin Jumbo 4 for 211/				
VT4C/845	Chassis	Silver/chrome	159.95	
with bayonet		Chassis	Gold	9.75
5-pin UY5 for 807				
7-pin B7 for 6X4,				
0A2	PCB	Silver	6.15	
7-pin B7 for 6X4,				
0A2	PCB	Gold	7.85	
Chassis from above		Silver	6.75	
7-pin B7 for 6X4, 0A2				
Chassis from above		Gold	7.95	
8-pin UBX for EL34, 6550,				
5U4G, GZ34, 6L6G, etc.		Silver	5.65	
Chassis				
8-pin UBX for EL34, 6550,				
5U4G, GZ34, 6L6G, etc.		Gold	8.65	

9-pin B9 for ECC83, ECC88,			
5687, 6350, etc. PCB	Silver		3.85
9-pin B9 for ECC83, ECC88,			
5687, 6350, etc. PCB	Gold		5.75
9-pin B9A for ECC83, ECC88,			
5687, 6350, etc. etc.	Silver		4.45
Chassis from above			
9-pin B9A for ECC83, ECC88,			
5687, 6350, etc. etc.	Gold		6.75
Chassis from above			
9-pin B9A for ECC83, ECC88,			
5687, 6350, etc. etc.	Chassis		
from below		Silver	4.95
9-pin B9A for ECC83,			
ECC88, 5687, 6350, etc.			
etc. Chassis from below		Gold	7.15
Topcap For 807 pentode		Nickel	9.75

You may want to start your project with less overall cost, and for this purpose we can offer the following industrial grade ceramic valve bases.

Type	Mounting	Price Ex. UK Vat.
8-pin for EL34, 6550,		
KT66, 6L6G	Chassis with bracket	1.45
9-pin for ECC83,		
ECC88, 5687,		
6350	Chassis with shroud	1.85

## AUDIO NOTE SELECTED AUDIO VALVES.

Our valves are selected from the best available sources and are tested to the same stringent standards that we apply in the production of our own amplifiers, they fall into two categories, standard production items and rare, mostly NOS (New Old Stock) valves which are no longer in production. We have compiled a special list of the NOS items, which is available on request, beware the valves on this list are NOT cheap.

Standard Stock Items,

Type No.	Type	Price Ex. UK Vat
ECC835/12AX7WA/		
7025	double triode	2.95
E88CC/6922/		
6DJ8WA/7308	double triode	3.95
EF86/6267/ZZ29	pentode	2.45
ECC82/1 2AU7		
/61 B9W	double triode, mil spec	5.75
65N7	double triode, UBX base	1.75
65L7GT	double triode, UBX base	2.85
65J7	pentode	1.75
5687WA	double triode	4.55
6350WA	very powerful	4.75
EL84/6B05	double triode	1.55
EL84M/6B05WA	small power pentode, mil spec version	4.75
6V6GT	small power pentode	2.45
6L6G	medium power pentode	2.75
5881/KT66/6L6WGC	medium power tetrode	4.95
EL34G	power pentode	7.45
6550/KT88	large power tetrode	12.45
6C33	powerful regulator, indirectly heated	24.65
6A57/6080	strong regulator, indirectly heated	6.45
2A3 4pin	directly heated small power triode	17.95
380B	directly heated power triode	57.95
5U4G	HT-rectifier	3.25
5Y3GT	HT-rectifier	2.25
5V4GT	HT-rectifier	2.25
GZ34/SAR4	HT-rectifier	8.75
6X4	HT-rectifier, very good for pre-amplifiers	2.65

**RESISTORS**

**Beyschlag**

We offer three quality levels of resistor quality, all are 1%, starting with the Beyschlag metallfilm, which are slightly magnetic (as are the vast majority of other makes of metal film resistors), but nonetheless very good sounding, as used in all our UK-made amplifiers, up to quality level 3 (the MEISHU/P3) no-feedback triode amplifiers.

Beyschlag 1 watt, 1% resistors up to 500KOhm, E 0.11, above 500KOhm £0.13 each.

**HOLCO.**

Better sound quality can be achieved with the H2, 1 watt, 1% non-magnetic resistors, which we regard as the best "industrial grade" metallfilm resistors available. They have one small drawback, as they are quite fragile, and require careful handling, do not bend the legs too close to the body, they may become noisy.

HOLCO resistors type H2 50PPM cost £0.36 each from 1000hm to 500KOhm, higher and lower values are all £0.63 each.

**SHINKOH Tantalum Film Resistors.**

This is definitely the best sounding resistors available, forger the VISHAY, which may be ok in high feedback transistor amplifiers, but in our opinion quite uncomplimentary to the qualities of real Audio Amplification (i.e. directly heated triode amplifiers running feedback free in single-ended Class A), this is where you will need the tantalum film resistor for the best results.

Up to now the tantalum film resistors have been extremely difficult to get however, after much persuasion and against a minimum quantity guarantee from AUDIO NOTE UK, the manufacturers have agreed to widen the range of 1/2 watt and reintroduce the 1 watt range, I consider this to be a major breakthrough, since without a reasonable range of values at the 1 watt rating it is pretty difficult to get the very best out of our best circuits. As with most handmade specialist items.

Anyway, the 1/2 watt, 1% tantalum resistors are non-magnetic and cost £2.06 each for all available values. There is long delivery on all values, so be prepared to wait if a value is not stock.

**BLACK GATE ELECTRON TRANSFER, High Performance, Graphite Electrolytic capacitors.**

There are very few audio parts that promise a guaranteed improvement when replacing practically any other part, but this is what the BLACK GATE capacitors actually do. Exchanging any electrolytic capacitor anywhere in the circuit of an amplifier or in the crossover of a speaker will greatly improve sound quality. We are working on some guidelines as to where, how and which types of Black Gates to use in different circuits, the first such technical guideline is available now and is called "Improving your CO-Player" and can be obtained by sending a stamped addressed envelope to us requesting this leaflet. It is very important to note that all BLACK GATE capacitors take time to charge-up or stabilize, when first put in circuit, depending on type and application this "maturing" time can be between 100 and 300 hours.

Value	Voltage	BG-Type	Suggested Use	Price Ex. UK Vat
0.47mF	50volt	PK	Anywhere	1.05
1 mF	50volt	PK	Anywhere	1.25
2.2mF	50volt	PK	Anywhere	1.55
4.7mF	50volt	PK	Anywhere	2.15
22mF	50volt	PK	Anywhere	3.35
100mF	100volt	Standard	Anywhere	7.75
1 000mF	50volt	Standard	Anywhere	24.55
220mF	1 6volt	Standard	Anywhere	4.35
470mF	1 6volt	Standard	Anywhere	6.35
2200mF	50volt	standard	Anywhere	13.45
10,000mF	80volt	Standard	PSU smoothing	234.65
4700mF	1 6volt	Standard	Anywhere	14.25
47mF + 47mF	500volt - 550v surge	SK-Type	PSU filter capacitor	85.95
100mF + 100mF	500volt - 550v surge	SK-Type	PSU filter capacitor	101.95
100mF	500volt - 550v surge	SK-Type	PSU filter capacitor	72.75
220mF + 220mF	350volt - 400v surge	SK-Type	PSU filter capacitor	92.65
100mF + 100mF	350volt - 400v surge	SK-Type	PSU filter capacitor	75.35
22mF	350volt	VK-Type	Decoupling or filter capacitor	18.95
220mF	1 6volt	F-Type	Low ESR version	6.75
220mF	1 6volt	FK-Type	Ultra low ESR version, comparable to film caps	9.95
1000mF	50volt	FK-Type	As above use anywhere	43.95
2200mF	50volt	FK-Type	As above use anywhere	98.85
4.7mF	50volt	C-Type	For circuits with OC potential difference	3.35
1 mF	50volt	N-Series	Bipolar for use in negative feedback circuits etc	4.95
4.7mF	50volt	N-Series	as above	5.75
10mF	50volt	N-Series	as above	6.95
47mF	50volt	N-Series	as above	13.75
100mF	50volt	N-Series	as above	18.95
6.8mF	50volt	Bipolar	For loudspeaker crossover networks	6.95
1 0mF	50volt	Bipolar	as above	10.85
22mF	50volt	Bipolar	as above	17.45
47mF	50 volt	Bipolar	as above	27.95
100mF	16volt	BG-N Type	For super low noise PSU's	24.65
470mF	16volt	BG-N Type	as above	28.95
1000mF	50volt	BG-N Type	as above	99.95
220mF	100volt	BG-N Type	as above	423.35

On the next page is a list of all BLACK GATE capacitors available, together their sizes, best usage etc. Lastly, we can supply a range of more modestly priced components, still good quality, but more industrial grade, if you like.

**AUDIO QUALITY OUTPUT TRANSFORMERS.**

**Single-ended Circuits.**

Suggested Valve VAT	Max Cl. A Power	Prim-Sec. Impedance	Size/Weight Max.	Current	Price ex. UK
EL84/ECL86/6V6	20 watts	2K6 - 4/8 Ohms	117x98x30 mm	110mA PSE	87.00
300B/2A3/6B4G	25 watts	2K5 - 4/8 Ohms	117x98x30mm	90mA SE	91.00
EL34/6S50/KT88	30 watts	1K5 - 4/8 Ohms	115x98x35mm	180mA PSE	113.00
2A3/6B4G	30 watts	1K25 - 4/8 Ohms	98x82x35mm	130mA PSE	97.00
5881/KT66	30 watts	2K1 - 4/8 Ohms	115x98x35mm	140mA PSE	106.00
211/VT4C	30watts	10K - 4/80hms	117x98x100mm	150mA SE	114.00
211/VT4C/B45	50 watts	10K - 4/8 Ohms	112x134x150mm	150mA SE	124.00
300B	50 watts	1K25 - 4/8 Ohms	135x115x125mm	180mA PSE	151.00
845	50watts	2K5 -4/8 Ohms	137x114x130mm	180mA PSE	172.00
211/VT4C	75 watts	5K-4/8 Ohms	137x115x145 mm	240mA PSE	237.00

**New SE Product**

EL34/6S50/KT88	20 watts	3K - 4/8 Ohms	117x98x32 mm	130mA SE	104.00
6L6G	30 watts	3K - 4/8 Ohms	115x98x35 mm	140mA PSE	107.00

**Push-Pull Circuits**

EL84/ECL86/6V6	15 watts	8K - 4/8 Ohms	80x67x63 mm	PP	42.00
EL34/6L6G/5881	25 watts	6K - 4/8 Ohms	88x73x60 mm	PP	59.00
2A3/6B4G/300B	30 watts	5K - 4/8 Ohms	88x75x60 mm	PP	63.00
KT88/6550	50 watts	6K6 - 4/8 Ohms	108x91x90 mm	PP	73.00
EL34/KT66/5881	50 watts	3K - 4/8 Ohms	98x82x63 mm	PPP	74.00
845	50 watts	6K8 - 4/8 Ohms	108x91x90 mm	PP	114.00

**Pure Silver Wired Outputs.**

300B/2A3/ 6B4G	25 watts	2K5 - 4/8 Ohms	117x98x90 mm	90mA	SE	1,645.00
211/VT4-C/B45	50watts	10K - 4/80hms	112x134x150mm	150mA	SE	1,975.00

The AUDIO NOTE silver wired outputs listed here are designed and made in the UK, we can supply the AUDIO NOTE Japan manufactured outputs for the ONGAKU or the KEGON, but they are exceptionally expensive, as you would expect from items that take upwards from 100 hours each to make, for example an output transformer for an ONGAKU costs £16,500.00.

**AUDIO NOTE CHOKES & INDUCTORS.**

Value	Size	Price Ex. UK Vat
3H/1 00mA		14.00
5H/1 50mA		21.00
10H/125mA	63x74x76 mm	26.00
10H/200mA	98x65x83 mm	33.00
0.5H/400mA		18.00
3H/2250mA for ONGKU/Cu		24.00
5H/400mA		31.00
20H/50mA	68x56x58mm	24.00

Other values can be supplied by order, ask for quote.

**AUDIO NOTE Coax Interconnect Cables.**

Type/Colour code	Construction	Price per Stereo Meter Ex. UK Vat.
AN-A yellow	symmetrical 6N copper litz coax	15.32
AN-C red	symmetrical OFHC copper litz coax	29.79
AN-S dark grey with yellow stripe	symmetrical 99.99% silver litz coax	14.25
AN-V silver grey with yellow stripe	symmetrical 99.99% silver litz coax	152.35
AN-Vx silver grey	symmetrical 99.99% silver litz coax	182.93

It is recommended to use the internal twin silver wires in the AUDIO NOTE coax cables as internal wiring cable, this is what we do in amplifiers like the ONGAKU, M77 tube etc.

**AUDIO NOTE COMPLETE KITS.**

We are developing a range of complete kits, to give those of you who have the ability, but do not have the time to develop a project from the ground, so to speak. In order to be able to offer the best possible quality - price relationship the kits we offer will be good basic circuits, with no-frills power supplies and components.

**Kit One.**

Based around the justly famous 300B directly heated triode, we see this kit as the introduction to real Audio Amplification, as it covers all the important aspects of design necessary, Single-Ended, No-Feedback, Class A, Directly Heated Triode, to become a member of this exclusive club of amplifiers.

Kit One has one 300B per channel running at 420 volts with 75mA current giving 9/10 watts of the cleanest power you will ever hear, the input stage consists of a 6SN7GT with a 56B7 double triode driver stage running in SRPP.

The powersupply is a capacitor-choke-capacitor with a 5U4G HT rectifier, the heaters are AC heated.

Component quality is similar to our Level 2 finished products, AUDIO NOTE paper in oil signal capacitors, Beyschlag watt 1% metallfilm resistors, good quality electrolytics (sorry NO Black Gates!) and a simple, attractive stereo chassis in grey paintwork. Protecting cover is extra.

Price £750.00 incl. Vat, which includes all valves (yes, also the 2 x 300B needed) but not postage/packing which to UK customers is £12.00, topcover is £99.00 extra. The Kit One is available now.

**Kit Two.**

Kit Two features a single 6550WA Sovtek tetrode running in Single-Ended mode, yielding some 17 watts of pure Class A, valve rectified HT for the output stage, stereo chassis, and 6SL7GT input and 6SH7GT SRPP driver stage, componentry and chassis as Kit One.

Price £600.00 incl. Vat, includes valves, but not postage/packing, cover is extra at £99.00. Available in March '94.

Write to, AUDIO NOTE (UK) Ltd, Unit 1, Black C. Hove Business Centre, Fonthill Road, Hove, East Sussex, BN3 6HA, England Telephone +44 0273 220511, fax +44 0273 731498. Direct Line to sales +44 0273 8 8 5 5 1 1 .

**MAINS TRANSFORMERS**

This range relates to our finished products, mains transformers are notoriously difficult items to offer as the number of permutations of HT and Heater voltages are almost endless. We shall be offering a more comprehensive range as opportunities arise.

Primary Voltages	Secondary HT Windings	Secondary Heater Windings	Price Ex. UK Vat
0v/100v/110v/120v	0v-230v at 350mA	0v-12.6v at 1 Amp	34.00
0v/220v/230v/240v	3.1 5v-0v-3.1 5v at 4 Amp		
120v/1 10v/100v/0v	0v - 230v at 0.4 Amp	0v-12.6v at 1 A	41.00
0v/1 00v/11 0v/1 20v	3.1 5v - 3.1 5v at 4 Amp		
0v/1 00v/11 0v/1 20v	0v - 120v at 40mA	1.2 6v-0v at 1.5 A	26.00
0v/100v/110v/120v	0v - 6.3v at 300mA		
0v/100v/1 10v/120v	310v-244v-0v-244v-310v at 320mA	3.15v -0v-3.15v at 4.5 Amp	72.50
0v/100v/110v/120v	0v-920v at 160mA	12.6v at 1.5 Amp	
0v/100v/110v/120v	150v-150v at 50 mA1.5A.	0 -10v at 4 Amp, 0v-6.3v at	98.00
120v/1 10v/1 10v/0v	390v-0v-390v at 200 mA	0v - 5v at 2.5A.	
0v/1 00v/11 0v/1	20v1 70v at 50mA at 3A,	3.15v-0v-3.15v at 1.2Amp, 7v	86.70
120v/110v/100v/0v	425v-0v-45v at 220mA	7v at 3A, 5v at 2A	
100v/110v/120v		3.15v-0v-3.15v at 2.5A	95.60
		7.0v-0v, 7.0v-0v, 5.0v-0v	for KIT ONE or
		3.15v-0v-3.15v at 750mA	"KASSAI" replica

**AUDIO NOTE Speaker & Wiring Cables.**

Type/Colour code	Construction	Price per Mono Meter Ex. UK Vat.
AN-O green	single core 6N copper speaker wiring double strand, screened 6N speaker wire	6.85
AN-B blue white writing	wire double strand, screened 6N litz copper	25.11
AN-L blue black writing	speaker wire single core 15 strand 99.99% litz	106.38
AN-SP silver	silver speaker wire single core 20 strand 99.99 % litz	382.98
AN-SPx silver	PTFE Insulated Silver Plated Copper Wires.	

We can also provide less expensive wiring wires for hard wiring circuits, these PTFE insulated silver plated copper wires are 19 strand of 0.15 mm wire and come in brown, black, blue, pink, red, green, orange, violet, white and red/white, they cost £1.60 per meter in any colour

Tel. +44 0273 220511  
Fax. +44 0273 731498  
Sales +44 0273 885511

**AUDIO NOTE**



# DIY PHONO HEAD AMPLIFIER - PART 2

**Andy Grove - our in-house designer - builds a phono head amplifier for the enthusiast, while Robert Wilson listens.**

The first, introductory part of this project, published in Supplement No6 accompanying the December issue, was structured around a basic prototype phono stage. In this second part we decided that the final design deserved to be a little more complex, since the increase in price was likely to be acceptable to most readers. As a result two Integrated Circuits (silicon chips) are used in this final version to give better network isolation and improved interfacing.

To make the project more suitable to experimenters, we also decided to use

chip sockets, which are frowned upon, rather than surface mount devices. However, having chosen the most suitable IC for your own purpose - MM or MC - it is advisable, ultimately, to use a surface mount package for best sound quality.

The original purpose of this project was to provide a very low noise preamp for moving coil cartridges, since most MC stages hiss audibly. However, by using sockets, an IC suitable for MM cartridges can be plugged in as an alternative. This broadens the project's appeal and gives a lot of scope for experimentation.

## CIRCUIT DESCRIPTION

The phono stage uses two Op-Amps as gain blocks, with a passive R.I.A.A. equalization network placed between them. This configuration isolates the sensitive network from the outside world, avoiding any interference.

IC1 is configured to have a gain of 561; IC2 has a gain of 23, but there is a loss of about -20dB (the signal is reduced by ten times) through the equalization network, so the overall gain is approximately 1300.

R1 is the cartridge loading resistor. Here it is set at 100Ω, but some moving

## M.C. Phono Stage

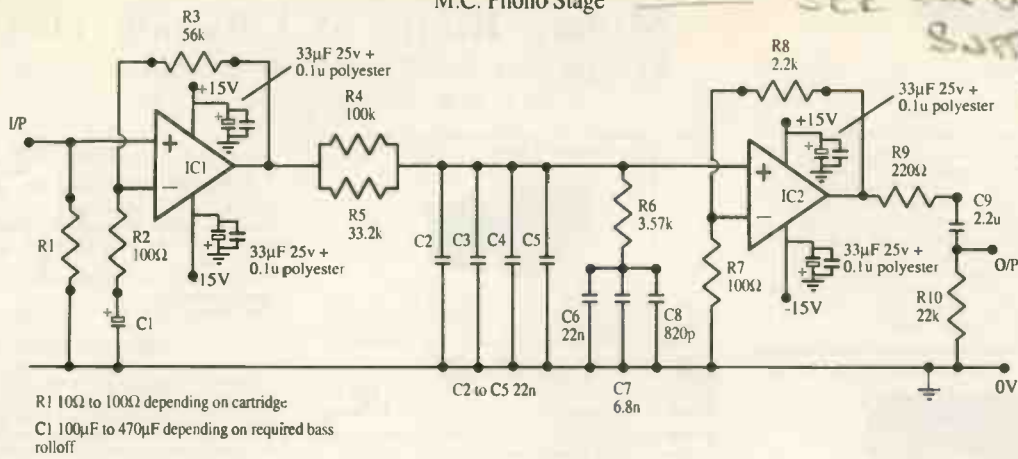

## Power Supply

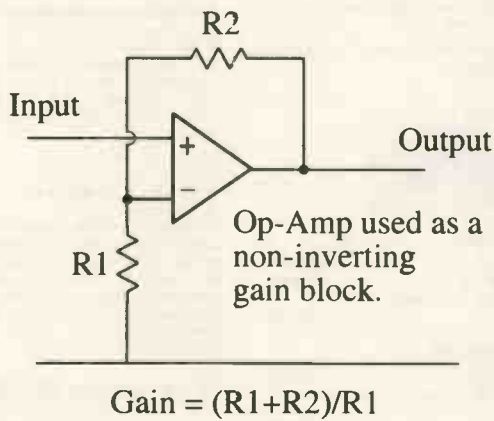
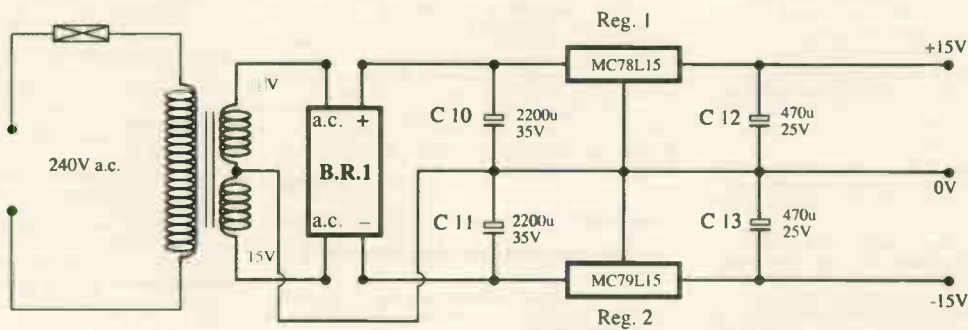

## Parts List

R1.....10-100	C7.....6.8nF
R2.....100	C8.....820pF
R3.....56k	C9.....2.2µF
R4.....100k	C10/11...2200µF/35V
R5.....33.2k	C12/13...470µF
R6.....3.57k	IC1.....AD797
R7.....100	IC2.....AD743
R8.....2.2k	Reg.1.....MC78L15
R9.....220	Reg.2.....MC79L15
R10.....22k	BR1.....DF08
C1.....100µF-470µF	2 x 33µF/25V + 0.1µF polyester for each IC.
C2-5.....22nF	
C6.....22nF	

coil cartridges prefer lower impedances, sometimes as low as 3Ω; check your data sheet and experiment for best results.

The circuit shown is for moving coil (M.C.) cartridges. If you have a moving magnet (M.M.) cartridge, reduce the gain of IC1 by changing R3 to 5.6k. You will also need to change the loading resistor to 47k and put a capacitor of around 100pF across the input. Again, a little experimentation will allow you to optimize the circuit for your cartridge.

C1 gives a lot of D.C. feedback to eliminate any D.C. offset at the output of IC1, which would be amplified by IC2, possibly causing it to latch up. C1 also determines the low frequency rolloff. A larger value of up to around 470µF will extend the bass, but it will also allow turntable rumble and record warps

through in all their glory, causing severe cone flap with reflex loudspeakers. Reducing the capacitor to 100µF or even 47µF will eliminate warps and give a lighter, faster bass quality. Try different values and assess the trade-off of bass depth against cone flap, bearing in mind that cone flap won't be a problem with sealed-box (infinite baffle) loudspeakers, nor will it occur with power amps that roll off at low frequencies.

C1 needs to be a high quality component because it is in IC1's feedback loop. Even super-quality electrolytics like Black Gates only cost a few pounds for a small component such as this, so it is worth the extra expense if you have a decent cartridge.

Next is the equalization network itself. The components used here must all be

high precision components or the accuracy of the R.I.A.A. curve will be compromised. The values given here have been carefully calculated and if high precision resistors and capacitors are used (1% or better) the R.I.A.A. equalisation should be accurate to within +/-0.1 dB! You will notice that there are resistors and capacitors paralleled up all over the place in the network. This is to get specific, non standard values by using more or less standard components.

IC2 is simply an output buffer with a gain of 23. There is a 220Ω resistor on its output (R9). This helps the op-amp remain stable when driving capacitive loads, such as cables. C9 stops any D.C. from reaching your power amplifier, even under a fault condition. R10 ensures that the output is always held at 0V D.C.

# HART

## Hart Audio Kits - Your Value for Money Route to Ultimate Hi-Fi

2 Penylan Mill, Oswestry, Shropshire, England SY 1U 9AF  
phone Oswestry (0691) 652894

Hart Audio Kits and factory assembled units use the very best audiophile components in circuit designs by the renowned John Linsley Hood to give you unbeatable performance and unbelievable value for money. We have always led the field for easy home construction to professional standards, even in the sixties we were using easily assembled printed circuits when Heathkit in America were still using tagboards! Many years of experience and innovation, going back to the early Dinsdale and Bailey classics gives us incomparable design expertise in the needs of the home constructor. The current range of Hart kits is designed to give you the important core components of a system as a matching ensemble of audio excellence

### 1100 Series. LH80W "Audio Design" Mosfet Power Amplifier.



Another masterpiece from the drawing board of John Linsley Hood and another opportunity to give a system mega sound performance for only a few hundred pounds cost. A host of advanced features, in the hands of the skilled designer, give this amplifier a performance that really is only equalled, not exceeded, by the 4 or 5 figure price tagged exotica.

As always with a HART kit you have the pleasure of building selected, state of the art equipment, allied to the knowledge that your money has all been spent on quality components, you save all the costs of building and testing, plus the dealers margin on top of these by doing it yourself.

To give an idea of the measures taken to achieve ultimate quality and linearity in this amplifier each of the four output devices is only called upon to work at one NINETY-SIXTH part of its ultimate power rating.

We are proud to offer this latest John Linsley Hood masterpiece, the flagship of our range, which we believe is truly the ultimate design for the perfectionist, combining as it does the best circuit design, the best engineering and the best components, surely the only recipe for REAL sound fidelity. The HART KIT concept also makes it possible to build an amplifier with the facilities YOU want and we offer no less than three variations with options on the basic theme to suit your needs. One of these versions will, we feel sure, cater for your requirements. Should your requirements change at a later date then upgrades or alteration to a different version are no problem, try doing that to your High St store amplifier!

The Standard version has a passive input selector circuit with Alps Precision Low-noise volume and balance controls, switchable CD, Tuner and Pre-amp inputs and an optional stereo bargraph output level display. The 'Slave' version has stereo power amplifiers and standard power supply. The 'Monobloc' version again has the standard power supply but since it is only driving one power amplifier higher than normal output power is achieved with total channel separation. The slave and monobloc versions enable very sophisticated bi-amping and active crossover systems to be constructed.

**K1100** Complete STANDARD Amplifier Kit, two power amplifier channels and one power supply module, direct input passive signal selector stage, Construction Manual and RH11 Reprint.  
SPECIAL DISCOUNT PRICE FOR COMPLETE KIT IS ONLY **£395.21**  
**A1100** Factory Assembled **£499.21**

**K1100S** Complete SLAVE Amplifier Kit, as above but without passive input stage.  
SPECIAL DISCOUNT PRICE FOR COMPLETE KIT IS ONLY **£333.62**  
**A1100SC** Factory Assembled **£422.62**

**K1100M** Complete MONOBLOC Amplifier Kit, consists of all parts for one power amplifier channel and one power supply module and all chassis parts.  
SPECIAL DISCOUNT PRICE FOR COMPLETE KIT IS ONLY **£261.20**  
**A1100M** Factory Assembled **£329.20**

All HART kits are designed for easy home construction to the very highest standards, and can be built by anyone of average manual ability. If you are still not convinced how easy it is to build it yourself with a HART kit you can order the Instruction Manual to read for yourself and we will refund the cost when you buy your kit.

### PROBABLY THE LAST VINYL PREAMP YOU EVER BUY.



For those who love the vinyl medium the listening pleasure can only be enhanced by using the very best phono preamplifier available. The Hart range of phono preamps feature a special shunt feedback circuit topology and are designed by John Linsley Hood. This circuit format gives audibly superior sound to the standard series feedback system normally used and gives a performance that will exceed or equal that given by the best of the mega priced offerings.

Our range includes units to suit everyone from the occasional user to

the serious audiophile. All can be changed to suit moving coil or moving magnet cartridges at the flick of a switch.



**K1500** Series. This is an integrated circuit version of the shunt feedback concept, using so little power that it may be run from batteries. An ideal "first kit" project as it is very simple to put together and no mains voltages are involved.

**K1500** Complete Kit With Full Instructions (Battery Powered) **£73.76**  
**A1500** Factory Assembled **£118.76**

**K1450** Features a totally discrete component implementation of the Shunt Feedback concept. Audiophile grade components fitting to an advanced double sided printed circuit board make this a product at the leading edge of technology that you will be proud to own. Nevertheless with our step by step instructions it is very easy and satisfying to assemble. Due to the higher current consumption this unit is powered by our mains driven K1565 Audio Power Supply, itself an advanced piece of technology in a matching case. This supplies the superbly smoothed and stabilised supply lines needed by the preamplifier and features a fully poited Hi-grade toroidal transformer along with a special limited shift earth for hum free operation. Suitable for all moving coil and moving magnet transducers this unit is especially recommended for, and will extract the very best from the modern generation of low output high quality transducers.

**K1450/1565X.** Complete RIAA Phono preamplifier, Power Supply and power connect cable **Kit form £196.29.**

**1450/1565X** Factory assembled & tested. **£285.29.**

### ALPS PRECISION LOW-NOISE STEREO POTS

Now you can throw out those noisy ill-matched carbon pots and replace with the real hi-fi components only used selectively in the very top flight of World class amplifiers. The improvement in track accuracy and matching really is incredible giving better tonal balance between channels and rock solid image stability.

On the motorised versions the 5v DC drive motor is coupled to the normal control shaft with a friction clutch so that the control can be operated manually or electrically.

Our prices represent such super value for pots of this quality due to large purchases for our own kits.



### MANUAL POTENTIOMETERS

2-Gang 100K Lin **£15.67**  
2-Gang 10K, 50K or 100K Log **£16.40**  
2-Gang 10K Special Balance, zero crosstalk and zero centre loss **£17.48**

### MOTORISED POTENTIOMETERS

2-Gang 20K Log Volume Control **£26.20**  
2-Gang 10K RD Special Balance, zero crosstalk and less than 10% loss in centre position **£26.98**

### HC80 Replacement Cassette Head.



The excellent performance of modern cassette recorders depends totally on the quality of the R/P head. Even the slightest amount of wear can impair the frequency response and distortion levels. Our HC80 is a top quality head from one of the foremost manufacturers in Japan. It is easily fitted to most standard stereo recorders (except Sony) and will transform the performance over a worn head. Only the fact that we buy these in vast quantities enables us to offer them at the amazing price of **only £11.70** each or **2 for £17.60.**

### SPECIAL OFFER

#### PRECISION Triple Purpose TEST CASSETTE TC 1DD.

Are you sure your tape recorder is set up to give its best? Our latest triple purpose test cassette checks the three most important tape parameters without test equipment. Ideal when fitting new heads

A professional quality, digitally mastered test tape at a price anyone can afford.

Test Cassette TC1DD

Our price only **£10.99.**

#### DISK-COUNT Classical CD's.

Top quality, Full Digital (DDD) Compact Disks of the great classical favourites. Like everyone else we didn't like the idea of paying silly prices for CD's. After a long search we have now located a source of top quality classical recordings at prices that make you suspect the quality - until you try them! Send for our list of titles.

#### TECHNICAL BOOKSHELF

Modern Books. Selected to represent the state of the art today.

#### "THE ART OF LINEAR ELECTRONICS."

J.Linsley Hood.

Just Out! Hot Off the Press, the definitive electronics and audio book by the renowned John Linsley Hood. This 300+ page book will give you an unparalleled insight into the workings of all types of valve and solid state audio circuits. Learn how to read circuit diagrams and understand amplifiers and how they are designed to give the best sound. The virtues and vices of passive and active components are examined and there are separate sections covering power supplies and the sources of noise and hum. As one would expect from this writer the history and derivation of audio amplifier circuitry have an entire chapter, as does test and measurement equipment. Copiously illustrated this book is incredible value for the amount of information it contains on the much neglected field of linear, as opposed to digital, electronics. Indeed it must be destined to become the standard reference for all who work, or are interested in, this field.

**SPECIAL OFFER.** With each book purchased you may request a **FREE** extended index, written by the Author, exclusively from HART.

0-7806-0868-4.

**£16.95**

Don't forget most of our kits have reprints of articles by John Linsley Hood that you can purchase separately.

#### "THE LOUDSPEAKER DESIGN COOKBOOK" Vance Dickason. (4th Edn.)

All the information you need to build the loudspeaker system you have always wanted but could not afford. Easy ways to pick the exact box size, the ideal drivers, and the correct way to feed the music to your new super loudspeaker system. Over 140 pages packed with important design data.

1991. 152 Pages.

0-9624-191-7-6

**£19.97**

#### "THE ART OF SOLDERING"

R. Brewster.

Absolutely essential reading for anyone who ever picks up a soldering iron. Written from knowledge gained in a lifetime in the field, this is the first book ever solely devoted to this essential and neglected skill for all electronic enthusiasts. Covers everything from the correct choice of soldering iron and solder to the correct procedures to follow with many illustrations and practical exercises.

0-85935-324-3.

**£3.95**

### Classics from the "Golden Age"

#### "THE WILLIAMSON AMPLIFIER."

D.T.N. Williamson.

In April 1947, Williamson's power amplifier, using excellent quality push/pull output valves, a special output transformer, and a highly filtered power supply, became an overnight success. The author takes the reader deep into his design considerations, offering practical advice on how to build the units plus concise instructions on setting up the new amp. A cult classic.

1947, Reprinted 1990. 40 Pages.

0-9624-1918-4

**£4.95**

#### LOUDSPEAKERS; THE WHY AND HOW OF GOOD REPRODUCTION.

G.A. Briggs. This easy-to-read classic, last revised in 1949, introduces the reader to concepts such as impedance, phons and decibels, frequency response, resonance curves, volume and waits, resonance and vibration, cabinets and baffles, horns, room acoustics, transients, crossovers, negative feedback, Doppler and phase effects, and much more. A provocative survey of the right questions about sound reproduction.

1949 Reprinted 1990. 88 Pages.

0-9624-1913-3

**£6.95**

Send or phone for your copy of our **FREE** list of these and many other Kits & Components. Enquiries from Overseas customers are equally welcome, but **PLEASE** send 2 IRCs if you want a list sent surface post, or 5 for Airmail. Ordering is easy. Just write or telephone your requirements to sample the friendly and efficient HART services. Payment by cheque, cash or credit card. A telephoned order with your credit card number will get your order on its way to you **THAT DAY.** Please add part cost of carriage and insurance as follows: **INLAND Orders up to £20 - £1.50, Order over £20 - £3.50. Express Courier, next working day £10. OVERSEAS - Please see the ordering information with our lists.**

QUALITY  
AUDIO KITS

24hrs. SALES LINE  
(0691) 652894

ALL PRICES  
INCLUDE  
UK/EC VAT

# HART

We checked several op-amp types for their sound quality and noise. For M.C. the best combination was ICI as AD797 and IC 2 as AD743. This combination gave a very crisp and detailed sound, and low noise, but these ICs are quite expensive. Also, the AD 797 would not be suitable as a front end for M.M., as I shall explain.

Although these chips are relatively expensive, you can literally plug in any good op-amp which has a 741 type pinout. I tried TL071 and SSM2131, but neither had the focus of the AD797/AD743 combination. Others to try are OP37, NE5534(!) and OPA604, although with these ICs you may suffer from noise on M.C.

The power supply is very straightforward. There is a centre tapped transformer and a full wave bridge rectifier to give a raw supply of +/- 20V,

with a 0V earth rail. This is fed to two regulator ICs to supply the chips with a stabilised +/- 15V supply,

There is plenty of decoupling around the ICs themselves to eliminate any parasitic instability. It comprises a 33µF electrolytic and a 0.1µF polyester capacitor soldered very close to the IC itself.

**Voltage Noise or Current Noise?**

I stated earlier that the AD797 would not be suitable for M.M. use. Why? Because it would be too noisy. This may seem strange because I have recommended it for M.C. which is even more sensitive to noise. The reason for this is that the AD797 is a bipolar input type, designed for use with low impedance signal sources around the 100Ω mark. It has a

very low voltage noise of 0.9nV/√Hz, but a current noise of 2pA/√Hz. At low impedances the voltage noise will predominate. Moving coil cartridges are very low impedance devices, having a source impedance of just a few ohms, and a load impedance of up to 100Ω (Ω = ohms).

As impedance rises the current noise of a device will start to dominate. Moving magnet cartridges require a load impedance of 47k - around 500 times greater than that required for M.C. Here, we need an op amp with low current noise and the AD743 fits the bill nicely, possessing a current noise of 6.9fA/√Hz, which is about 500 times lower than the AD797. It has a rather poorer voltage noise of 3.2nV/√Hz which is 3 times higher. This is because the AD743 is a F.E.T. input op-amp, designed to work with high impedance circuits.

**MEASURED PERFORMANCE**

The bandwidth of this stage has been set to roll off just above 20kHz, such that droop at 20kHz is no more than -0.5dB maximum. In practice it is a little less than this, putting the -1dB point out at 37kHz. The idea is to make sure as little unwanted information as possible above 20kHz gets through to subsequent stages, to remove any likelihood of transient distortions. Ticks and pops typically produce the sort of high level supersonic information that may cause problems, especially from the peaked-up treble response of many moving coil cartridges.

Down at the other end of the spectrum lies another consideration. Extend gain downward to 5Hz or so, as many Japanese designers do, and there's no doubt that really deep bass will often be audible. However, warp signals, which can be very large, will also be amplified, causing cone flap in reflex loudspeakers in particular. Also, drop the arm onto a record clumsily and you'll likely slam the cones against their end stops. For these reasons the International Electrotechnical Commission (IEC), who set electrical equipment standards, long ago recommended use of an extra time constant that rolls off response below 40Hz (-1dB point). This produces slightly lean sounding bass in a balanced system, but it does cure cone flap problems.

A disc pre-amp must swing quite a lot of volts at its output if it is to possess good overload limits. This is generally limited by the maximum tolerable working voltage of silicon chips, which is around +/-15V on the supply lines, giving around 10V rms maximum output. In our case, the maximum output was 7.5V, which gives a maximum input of 5.7mV (1kHz), which is perfectly adequate for moving coil cartridges.

These days, amplifiers commonly have an input sensitivity of around 200mV-300mV.

When the pre-amp gives 300mV out, or enough to fully drive a normal amplifier, it has a high input sensitivity of 0.24mV. For 1V out, a high level demanded by some power amplifiers, the sensitivity figure becomes 0.75mV, which is relatively low. So this pre-amp is best used with conventional amplifiers; it doesn't have enough gain to feed insensitive power amps direct through a passive pre-amp. If it had more gain, then the overload margin would go down, within the common constraint of a +/-15V chip supply voltage.

The pre-amp was meant to give low hiss with a low output moving coil cartridge. To do this, it must have an equivalent input noise of 0.1µV or less (using CCIR noise weighting to measure hiss alone). The actual noise figure achieved measured 0.09µV, comfortably within the standard I use as acceptable for hiss to be all but inaudible at a distance from the loudspeakers, when a low output moving coil is used.

As you can expect from a modern silicon chip, distortion was negligible. Channel separation depends to some extent upon layout, but since cartridges rarely give better than 30dB, there isn't a great need to get much better in theory and this is borne out in practice I find. In truth, poor separation often sounds better than good separation, since it firms up centre images - commonly lead singers. However, this pre-amp gives a good 60dB or so separation when built well. **NK**

**DISC (MC)**

Frequency response	40Hz-37kHz
Separation	62dB
Equivalent input noise	0.09µV
Distortion	0.002%
Gain	x1316
Sensitivity (300mV out)	0.24mV
Overload	5.7mV in/7.5V out

**SOUND QUALITY**

While I was listening to the Cyrus amp our engineer, Andy Groves, came in to the listening room and asked for my opinion of his phono stage. The front-end used was the resident Garrard 401/SME 312, but in this case fitted with a Goldring Elite moving coil cartridge. The first album on the player was the B-52's original LP. It came over as incredibly fresh sounding. The phonostage has a very incisive quality that helps to cut through a lot of the grunge inherent in vinyl replay, the top end is especially sharp and crystal clear which leads to a very coherent overall picture with a large, solid and well defined soundstage. Bass reproduction was vivid, the lack of euphonic colouration and reduction of obvious vinyl overhang leads to a vibrant, tight and highly enjoyable sound, full of life and dynamics. **Robert Wilson**

A circuit board and kit of parts will be available shortly - ring 071-266 0416 for further details.

## TABULA RASA LOUDSPEAKERS



"It is a rare experience to play a track that you have known for the better part of, say, twenty years and suddenly, to hear new details and information."

(Hi-Fi World - Dec '93 on CT77 loudspeaker kit)

With the increased popularity of "do it yourself" hi-fi, Tabula Rasa are offering an extensive range of quality loudspeaker kits and car audio kits from top German manufacturer Mainhattan Akustik.

All loudspeakers kits are simple, fun to build, and at prices to suit all pockets. Each kit comprises

drivers, filters, connections, terminals, and all the necessary fittings needed to complete your chosen loudspeaker, and every kit is available with or without cabinets. Furthermore, each kit comes with a 10 year warranty as standard and will be delivered within 14 days of confirmation of your order. For a catalogue (including price lists and a brief guide to speaker construction) please send £2.00 (refunded after first kit purchased) and a self addressed A4 envelope to:

**Tabula Rasa, 136 Kilnwood, Walters Ash, High Wycombe, Buckinghamshire, HP14 4UR, Tel 0494 565116**

Cheques and postal orders should be made payable to Tabula Rasa. Trade prices available on request.

30 days money back guarantee offered on all drivers & kits.



## Wilmslow Audio



As any discerning sound engineer will tell you, the ATC SCM50 and 100 are the ultimate in accurate low distortion professional monitoring. But what they may not know is that self assembly versions based on these classic monitors are now available from the UK's leading speaker kit supplier, Wilmslow Audio, at a fraction of the ready built price. ATC and Wilmslow Audio have worked very closely on the cabinet and crossover design to ensure that the completed kit lives up to the very high standards associated with the ATC name. As with all Wilmslow products, the ATCK50 and K100 kits come complete with precision machined cabinet panels, crossovers, and all necessary hardware, including

factory matched ATC drivers. Cabinet parts are machined from high grade MDF for easy assembly and consistent acoustic performance. ATC's MK I Tri-Amp Pack systems are available as an option if required.

- The Result . . .**
- *Stunning accuracy and clarity*
  - *Clean well damped bass*
  - *Smooth detailed treble*
  - *Totally transparent mid range*
  - *No overdraft!!!*

If you aspire to the unrivalled quality of ATC monitoring, but are working to a tight budget, contact Stephen Leigh who will be pleased to tell you exactly how economical these kits are. ATCK50s and 100s are on demonstration by appointment.

Wilmslow Audio Limited, Wellington Close, Parkgate Trading Estate, Knutsford, Cheshire, WA16 8DX, England. Tel: (0565) 650605 Fax: (0565) 650080

### HEATHERLEY LTD.

CYNTRA PLACE  
201 MARE STREET, HACKNEY  
LONDON, E8 3OE

Telephone: 081 985 1646

PRECISION WOODWORKERS & CABINET MANUFACTURERS  
ESTABLISHED 1934

### HEATHERLEY LIMITED

MANUFACTURERS OF SPEAKER CABINETS SINCE 1962

For sale speaker cabinets manufactured by craftsman in various sizes and finishes made for the trade surplus to requirements.

**Set up your own speakers in professional built cabinets and get the sound you want to hear.**

Give us a ring and find out what we have got and the price you will have to pay you will be surprised at the silly prices we are asking for these cabinets.

**But only while stocks last.**

**Phone: 081 985 1646 FAX: 081 986 0112**

## BADGER BOARDS

**Printed Circuit Boards**

**Prototype-Singles-Multiple runs.  
Minimum charge £15.00.**

**Artwork, Plotting from Schematic to final board layout.**

**Send S.A.E. now for Catalogue of Kits-Boards-Projects available. Many magazine boards produced for individual customers.**

**Dept. HFW 87, Blackberry Lane, Four Oaks, Sutton Coldfield, B74 4JF  
Tel: 021 353 9326**

## A Sound Investment

95 Balham High Road Balham SW12 9AP

Quality Branded Names Secondhand Hi-Fi Sales Speaker driveunits, Crossover networks, cabinets made to order. Modifications, Rebuilds, Servicing. Project work undertaken. A wide variety of specialist parts and accessories.

**Current Hi-Fi examples.** Garrard 401/301 Chasis £75 Leak Stereo 20 valve £230. Spendor BC1 MK1 pair D/units £50. Tannoy 12" Dual concentric Pair inc X/Overs £POA. Part exchange available on all listed products. Quality British Hi-Fi examples always in stock. DIY enthusiasts.....Make your problem our problem. Telephone 081 673 4165 Anytime. Send A4 SAE For Current Price List.





## KNOW YOUR POWER VALVES

"Single Endophiles" (aka "rode managers") like myself dream about valves like these rare beauties. We meet at secret locations away from the barefaced eye of the law: Brother of conventional Hi-Fi wagers, it's a hidden place, a dark place, a place where money is safely not being tracked.

It's much more secretive and covert than truth spotting and they've got the direct wire in Japan, Hong Kong and Singapore - not to mention the USA - where valves of the sort pictured here are prized with great devotion, as well as the west.

For example, take the Type 4212 pictured here. Obsolete, rare, extremely expensive and potentially dangerous, it hasn't yet appeared in any hi-fi magazine. So who buys them and what for? Simple. Billington's and Cochrane - UK valve warehouses - have both told us that they dispose into Japan where they tend to find their

way into the homes of the rich (exceedingly rich) and into the oil.

Big News in the valve world typically comes a crate of 211s discovered in a French Scrapyard for, in some versions of this story, a Greek vineyard left over from World War 2, complete with Stars and Stripes on the crate and US Army Signal Corps insignia on the sides. More prosaic is the old boy who pops his clogs, leaving behind a heap of valves in the post office. A humble twist to this one is the widow who decides they are worthless junk and smashes the lot to get rid of them!

So this is a universal human disease, one suffered more acutely in countries



# GLASS

A guide to the glassier (sorry, classier) audio output valve triodemaniac and lover of bottles from

other than the UK. Not yet recognized by the WHO, I must add, to date there's no known cure other than the in-built one of an electric shock trigger than any administered at Alcatraz. Real enthusiasts claim to be able to survive and enjoy even this, however, which must cause concern to The Great Reaper.

You will find valves in the bedrooms, bathrooms, cars and back-mat pockets of enthusiasts, let alone in the 3.5-watt PX4 amp gracing the front room.

The use of the stermine device has traditionally been a male preoccupation, much like blood-throat,

but even this is beginning to change. Flying back from a Christmas break in Tenerife, a colleague struck up a conversation with a woman sitting beside him. They found they had a love of music and hi-fi in common. Then she whispered conspiratorially "but really I'm into valves". For the rest of the flight the subject didn't change (this is a true tale - Hi-Fi World has her number!). So the problem is spreading and may well get listed soon as communicable and dangerous by the WHO.

I hope this visual review will fire your imagination. It's a look at an almost illicit trade, one that few people want to really talk about too much, because

then the prices go up and availability becomes even more of a problem. There's much talk about restarting valve manufacture to satisfy demand, but capital costs are frightening. The reality is that factories in the West like MPE in Kentucky, are closing down. Only the Camaro and the Roberts, currently manufacture valves and Sovteks in particular are highly regarded. So the craving goes uncured. Remember this if you are tempted into sampling the forbidden fruit of directly heated triodes, for example. In the end they'll come and take you away - either in a straight jacket, or on a stretcher.



# ACT

by **Andy Grove, self-confessed single-endophile, General Electric, Western Electric, Mullard and points East.**

# Hi-fi for as little as £50,000.

## [And more. Or less.]

If you take your hi-fi seriously – and we do mean seriously – this should sound familiar.

One, you'd like totally unbiased advice on all the available options.

Two, you're not prepared to settle for less than the best your money will buy.

Three, you feel you deserve a professional to tailor a one-off system to your personal requirements.

Four, you expect to test drive equipment – at length – before you decide.

And last, but not least, you'd love to have your own expert on permanent call.

In short, you want Serious Kit.

Simply ring 061-707 4823 for access to all the above.

Plus, most of the world's finest names in top-end equipment. And all the experience of the UK's top talent in hi-fi system design.

Serious sound. Serious sense. Serious service.

Serious Kit.

Music to your ears.

# SERIOUS KIT

SERIOUS KIT · 21 ALGERNON STREET · MONTON · ECCLES · MANCHESTER M30 9QA · TELEPHONE 061-707 4823.

THE TOP NAMES. THE TOP EQUIPMENT. ACCUPHASE · ALCHEMIST · APOGÉE · AUDIO INNOVATIONS · AUDIOLAB

AUDIO RESEARCH · COPLAND · COUNTERPOINT · EPOS ACOUSTICS · GROOVE TUBES · HEYBROOK LOUDSPEAKERS

IMPULSE LOUDSPEAKERS · JADIS · KRELL · LYRA · MAGNEPAN · MARTIN LOGAN · MICHEL · MICRO-MEGA

PINK TRIANGLE · P.S.AUDIO · ROKSAN · SONUS FABER · SUGDEN · SYSTEMDEK · TEAC · THETA · THIEL · WILSON AUDIO

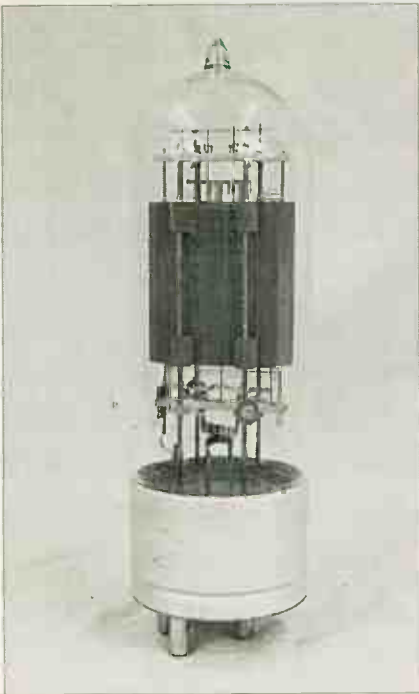

### Type 4212 Triode, STC U.K.

What a monster! Look at the comparatively tiny 211/VT4C next to it in the main picture. This beast can run at a hair raising 3000V and output 70watts or more of single-ended power, or if you are into earthquake simulation (or VERY insensitive speakers!) a push-pull pair will deliver 1.4 kW! With its maximum anode dissipation of 275watts and a filament which burns up nigh on 90watts just to fire it up, the 4212 will keep you AND your neighbours warm during those cold winter evenings!

### Type 211/VT4C Triode, G.E. U.S.A.

This is one of my favourite power valves. With a recommended maximum anode dissipation of 75watts at a not so much hair raising but definitely spine tingling 1250V, this is still a serious valve, capable

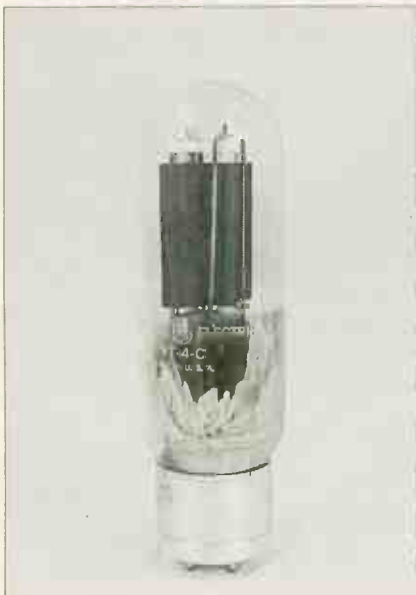

of 20 to 27watts single-ended or up to 250watts push-pull. The VT4C is the US military version of the commercial 211. Used in the AudioNote Ongaku and other Oriental dream machines the 211 gives one of the most open and dynamic sounds I know. When using the 211 I prefer to run at slightly lower than maximum voltage to get a sweeter sound, 1150V seems about optimum. With its brightly glowing filament lighting up your room and sublime sounds caressing your ears you know you've reached Nirvana.

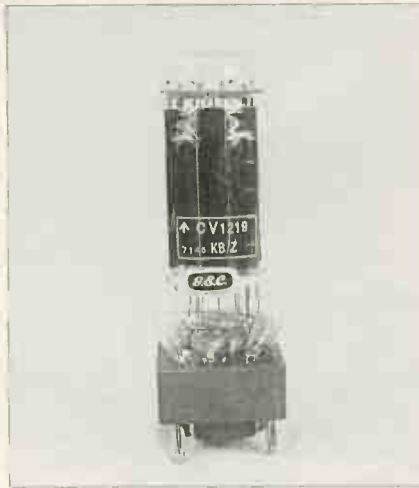

### Type DA100 Triode, G.E.C. U.K.

True British muscle, this is the Aston Martin of audio valves. Shown here is the stiff upper lip military selected version CV1219. As the type number suggests, this is a 100watt dissipation valve, and its maximum rated voltage is 1000V, slightly lower than the previous Volt-hungry valves. With 35watts of single-ended power and up to 300watts in Class AB2 push-pull, the DA100 is a juicy valve, but being a low impedance type it needs a large driving voltage to make it sing.

Similar in many ways to the American 845, another 100watter, but with a walnut interior the DA 100 is a very rare valve and even used examples fetch high prices on the underground market.

### Type DO60 Triode, Mullard U.K.

There are two types shown in the main picture, the gorgeous bulb snape of the earlier and more valuable DO60, and the restrained military numbered CV1206. Both have the odd square base like the DA100, and in fact the Mullard DO60 and the G.E.C. DA60 are interchangeable. This is a 60watt dissipation valve with a much more down to earth 500V maximum anode voltage. A respectable 10 to 11watts of single-ended power should be available, running the valve

somewhat below its maximum ratings. DA60, like a veteran car, cannot compare to later models for sheer measured performance, but it is a work of art in its own right and its rarity means that if you own a pair you are very lucky indeed.

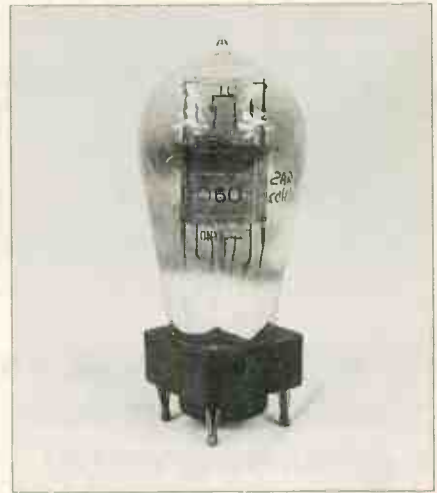

### Type 300B triode, W.E. U.S.A.

This example is not an original. It is most likely Chinese in origin, as original Western Electric valves have legendary status in Japan and therefore prices soar and availability is limited.

300B is a 40watt dissipation valve which can be used at (comparatively) low voltages in the order of 350 to 450volts, and in fact Western Electric developed the 300B to work at these lower voltages for use in horn loaded cinema sound systems. Single-ended, anything between 8 and 15watts can be extracted, depending on how much you want to cane the valve. I would say that for best sound quality about 375 to 450volts across the valve, running the anodes at around 36-38watts dissipation is optimum giving around 9 to 10watts output. 300B is renowned for its warm, textured and smooth sound and, if driven properly, excellent bass and dynamics.





**THE PAST &  
THE PRESENT**

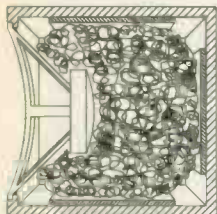

*Inside a Typical Cabinet*

**LISTEN TO  
THE FUTURE**

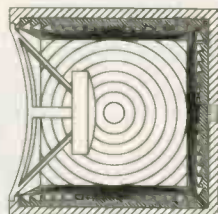

*Deflex Panels Fitted*

**Get the music out of your system, and let your speakers breathe!**

# DEFLEX® A.P.T. ACOUSTIC PANEL TECHNOLOGY

**PURPOSELY DESIGNED HI-TECH SPEAKER LININGS  
NOT BY-PRODUCTS FROM ANY OTHER INDUSTRY**

## THE FACTS

**Standing Waves** are additive at some frequencies and cancelling at others, thus causing irregularities in the response. It is therefore necessary to reduce them to a minimum.

**Resonance** is the nightmare of speaker enclosure design and is responsible for most of what is normally termed "colouration" and "muddle".

**In practice** the speaker enclosure exerts a considerable influence over the sound of a complete system. If not controlled properly, unwanted acoustic output can give subjective colouration.

**Speaker** manufacturers have set the trend of fitting out enclosures with bitumen, wool, and foam etc., in an attempt to combat these problems.

**However,** trying to absorb energy falls short in performance terms, and can muffle the sound, especially in reflex designs where air flow is critical. The infill wool and foams move with high sound pressure levels and this can become audible.

Replaces the existing damping material inside your loudspeakers – quick and easy to fit. Available for any loudspeaker.

Deflex acoustic panels have excellent performance characteristics. The polymer is specially formulated to absorb shock and vibration, thus minimising cabinet resonances.

The surface emulsion has been carefully designed to eliminate standing waves

The energy inside the enclosure is controlled – **NOT ABSORBED**, as in other cabinets.

Independent tests on MLSSA show energy gains over 50%.

**U.K. DISTRIBUTOR**

**The  
SPEAKER  
Company**

UNIT 9, WATERSIDE MILL,  
WATERSIDE, MACCLESFIELD,  
CHESHIRE SK11 7HG  
Phone 0625 500507

**CURRENT PRICES**

Standard Panels @ £7.95 each  
Sub-woofer Panels @ £11.95 each  
Adhesive from £3.50 (200ml)

**Spectra Dynamics** have combined advanced polymer technology with computer aided design to reduce unwanted cabinet distortion to an absolute minimum.

**Deflex panels** control the energy, not absorb it, and thus enhance the performance of the system without further unnecessary damping.

**"NEW APPROACH STUNS THE EXPERTS"**

**"BIGGEST BREAK-THROUGH IN 20 YEARS"  
"RESULTS NEVER ACHIEVED BEFORE"**

**"THE MUSIC IS FASTER, BRIGHTER,  
CLEANER, WITH DEEP, CONTROLLED BASS"**

**"THE ONLY REAL CURE FOR BOX NOISE  
AND STANDING WAVES"**



# DESIGN YOUR OWN LOUDSPEAKER AND CROSSOVER

**Dominic Baker takes a look at two computer packages that, between them, can completely design a loudspeaker.**

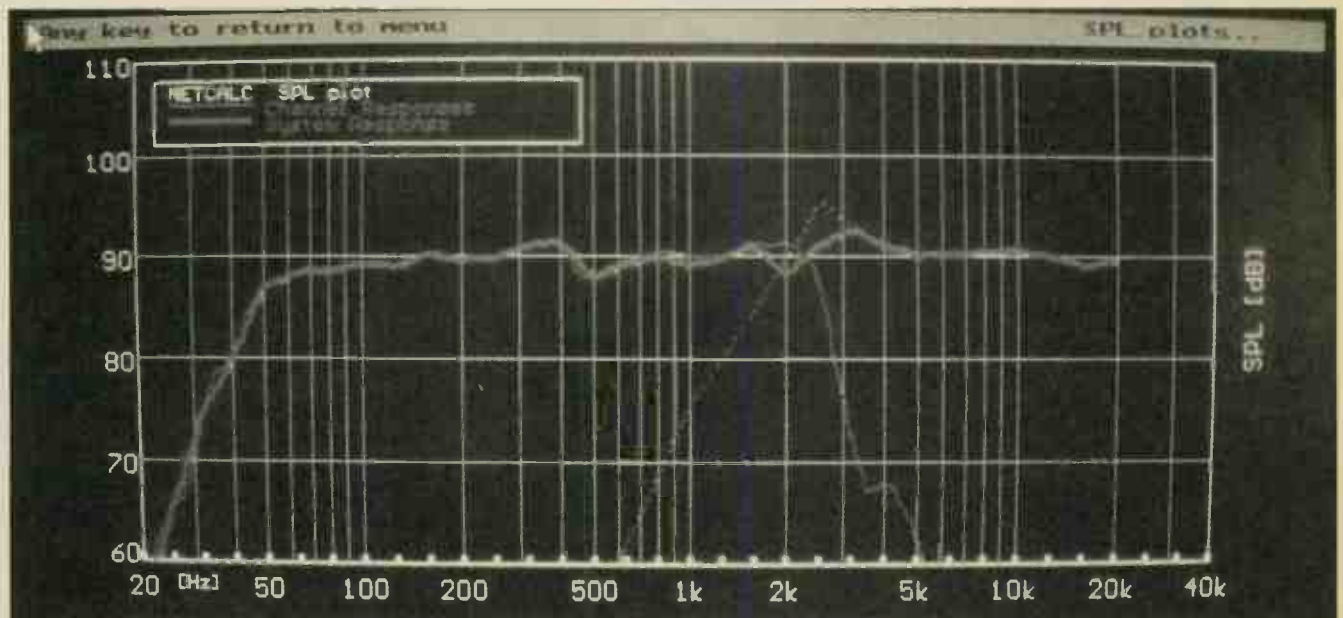

The outputs of the two drivers can be combined and the crossover tuned to give the smoothest transition.

My experiments with a large number of loudspeaker design packages show they are all much the same. The majority are bass-alignment packages: that is, they suggest the dimensions of an infinite baffle or reflex enclosure for a particular bass driver. They all rely upon the same set of Thiele-Small parameters and the same mathematical equations to predict enclosure dimensions. So, they all come up with the same answer, whatever they cost.

The more complex and expensive packages allow you to design isobaric enclosures, can calculate missing Thiele-Small parameters for you from the ones you do have and some can even suggest a simple crossover. But for the majority of DIYers, all that is needed is a basic package that gives a good starting point from which to experiment.

## BOXCALC

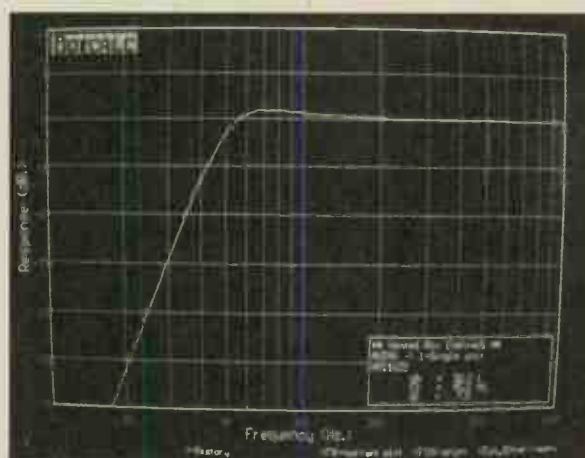

Boxcalc does just that. It is simple to use and easy to understand. It is a no-frills design package that is as accurate as any other. It needs just a few simple parameters to work, Vas, Qts, R, etc which most manufacturers supply on data sheets with their drive units.

This package is a little unsophisticated: it doesn't support a mouse and the instructions are

**Boxcalc's display is plain, but adequate. Plots of impedance, power, max SPL etc. can also be shown.**

Continued on page 25

# Lockwood Audio

Tel: 081-207 4472 Fax: 081-207 5283

**WE BUY AND SELL NEW,  
USED AND VINTAGE  
SPEAKERS, DRIVERS,  
CABINETS, PARTS.**

**SPEAKER REPAIRS**

**THE**

Authorised **TANNOY** Specialist



**MAJOR CREDIT  
CARDS WELCOME  
IMPERIAL STUDIOS,  
MAXWELL ROAD,  
BOREHAMWOOD, HERTS. WD6 1WE**



# WOLLATON A•U•D•I•O

## XLO FOR THE HOME CONSTRUCTOR

Whether you are building equipment from scratch, or upgrading existing equipment then XLO wiring will improve the performance. Also available are the XLO chassis mount phono and the XLR connectors, and the speaker binding posts.

### Cables and wires.

PRO 100 interconnect	£5.50 per foot
PRO PL1000 mains cable	£12.00 per foot
REF PL10 main cable	£25.00 per foot
PRO 16P* Chassis hook up wire	£1.00 per foot
REF 16T* Chassis hook up wire	£10.00 per foot

### Connectors

Neutrik gold plated XLR male	£6.00
Neutrik gold plated XLR female	£7.00
XLO pro phono plugs (4 pack)	£25.00
XLO ref phono plugs (4 pack)	£44.00
XLO spade plugs (4 pack)	£13.00
XLO Signature XLR chassis mount (2 pack)	£28.00
XLO Signature XLR chassis mount	£28.00
XLO BNC connectors (2 pack)	£16.00

\* Note that the chassis wire is excellent for loudspeakers internal wiring or to replace the jumper connectors used when Bi-wire speakers are used in single wire mode. When using the wire to carry signals of less than 100hz a double run should be used. High quality preamps should be wired with 16T.

WOLLATON AUDIO - TEL/FAX: 0602 284147

# LANGREX SUPPLIES LTD

DISTRIBUTORS OF ELECTRONIC VALVES, TUBES AND SEMI-CONDUCTORS AND I.C.S.  
1 MAYO ROAD • CROYDON • SURREY CR0 2QP  
24 HOURS EXPRESS MAIL ORDER SERVICE ON STOCK ITEMS

PHONE  
081 684 1166

FAX  
081 684 3056

A selection of our stocks of New Original Mullard - Brimar audio type made in UK.

STANDARD TYPES			SPECIAL QUALITY TYPES			
ECC88	MULLARD	6.00	E88CC - GOLD PIN MULLARD		8.50	
ECH81	MULLARD	3.00	ECC81 - M8162 / CV4024 MULLARD		6.00	
ECL86	MULLARD	3.50	ECC81 - 6201 / GOLD PIN MULLARD		8.50	
EF86	MULLARD	7.50	ECC82 - M8136 / CV4003 MULLARD		6.50	
EL84	MULLARD	6.00	ECC83 - M8137 / CV4004 BRIMAR		6.50	
GZ32	MULLARD	8.50	EF86 - M8195 / CV4085 G.E.C		10.00	
GZ34	MULLARD	10.00	<b>AMERICAN TYPES GE.</b>			
6SL7GT	BRIMAR	4.50	6146B.G.E	15.00	6L6GC G.E	12.50
6SN7GT	BRIMAR	4.50	6550A.G.E	17.50	12AX7A G.E	7.00
6V6GT	BRIMAR	4.25	7581A.G.E	12.00	12BN7A G.E	6.50
					12BY7A G.E	7.00

OPEN TO CALLERS MON.-FRI. 9AM - 4PM. CLOSED SATURDAY

QUOTATIONS FOR ANY TYPES NOT LISTED.

OVER 6000 TYPES AVAILABLE FROM STOCK

OBSOLETE ITEMS A SPECIALITY

TERMS C W O/VISA/ACCESS ETC...

P&P 1-3 VALVES £1.00, 4-6 VALVES £2.00 ADD 17.5% VAT TO TOTAL INC P+P





Continued from page 25

basically one side of A4, but that's all you need. It is easy to use and the graphics are clear and intelligible. I picked out a few drive units and optimised the cabinets for them. Using the data from Boxcalc I used LEAP and MacSpeakerz to check the results - and as you'd expect they were identical.

This is one of the cheapest packages on the market, it is simple to use and gives the enthusiast DIYer all he or she might need to get started on a box design. And it comes with a good library of drive unit parameters already programmed in, so the chances are you will find the data for the drive unit you want to use already entered.

**NETCALC**

This is Boxcalc's sister package. As the name suggests, it's a network or crossover designer. In fact, I feel that this, if it works well, is much more use to the hobbyist than a box designer. There are a number of good, and easy to understand, books around that show how to calculate

a basic box from simple Thiele-Small parameters. However, to get a crossover to work well, and integrate two drive units smoothly, expensive loudspeaker measuring equipment is a must. If this package can successfully replace such equipment, then it will open up DIY loudspeaker design to a much wider audience.

To assess Netcalc, I decided to input the parameters of a drive unit, optimise a crossover for it and then check the results with our measuring equipment. To do this you have to draw in the response and impedance curves of the drive units you wish to use. Again, in most cases these are supplied by the manufacturer and entering them in is easier than it sounds. For this bit a mouse is extremely useful, since it makes the drawing process faster.

Once you have drawn in the response and impedance curves of the drivers you wish to use the crossover can be designed. There are two ways to do this. A Standard crossover is selected by the computer and it will automatically compensate for impedance if you ask it

to. There is also a Free option, which allows you to build your own crossover network with individual components. I only wanted to use a simple second order network to start with and I also wanted to add a series resistor to the treble arm to level match the two units; the tweeter I had selected was more sensitive than the bass driver. So I chose the Free option.

Once the basic crossover has been constructed, it can be optimised. Pressing the ALT-O keys does this automatically, but it is more interesting to vary the value of the individual components yourself, observing the changes they have on the response. Whilst you are doing this a target response is displayed for you which in this case was a second order filter with fr -3dB being at 2.8kHz. This gives you something to aim for with your response.

When the individual crossover network for each drive unit has been optimised, the net overall response of the system can be viewed. Mine had a big suck-out in it in the crossover region to start with, but it is here that the package becomes really useful. The individual

network for each channel can now be modified to smooth the response. You can vary each component to put in peaks, move the peaks up and down, move the crossover point to get more or less overlap, add extra components to compensate for lumps or dips, etc. etc. Within an hour or so I had entered the response and impedance for each driver, designed the crossover and then tuned it to give a flat response - good eh? The practical measurements showed it to be usefully accurate too.

This is a superb package. It really teaches you what the effect of varying each individual component of a crossover will do to the response. It gives you a good feel for how the crossover is interacting with the drive units - it's got to be better than ploughing through the equations each time you want to make a change.

Boxcalc £69  
Netcalc £79

Netcalc and Boxcalc are available from:

The Speaker Co. Unit 9,  
Waterside Mill,  
Waterside, Macclesfield,  
Cheshire, SK11 7HG.  
Tel: 0625 500507

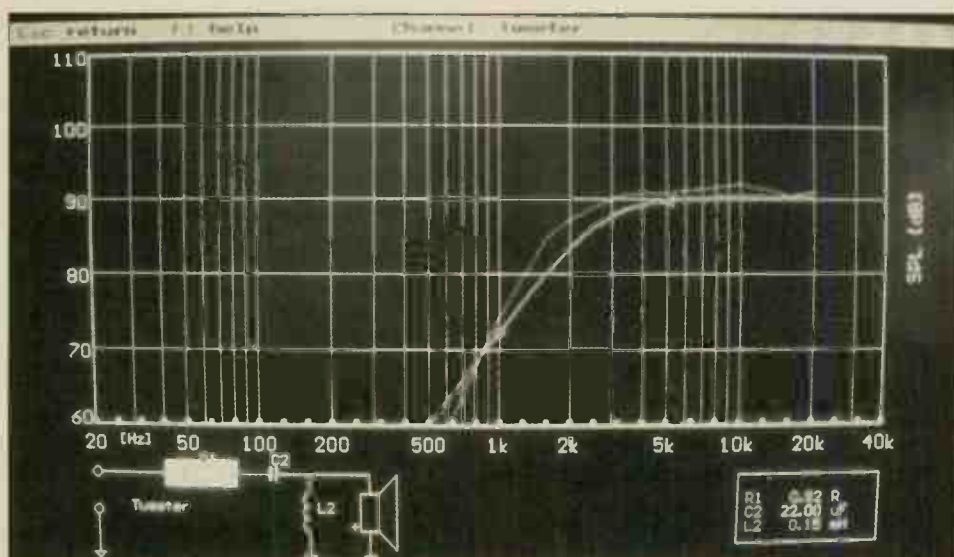

Netcalc allows you to vary the individual components of the crossover network whilst viewing the effects on-screen.

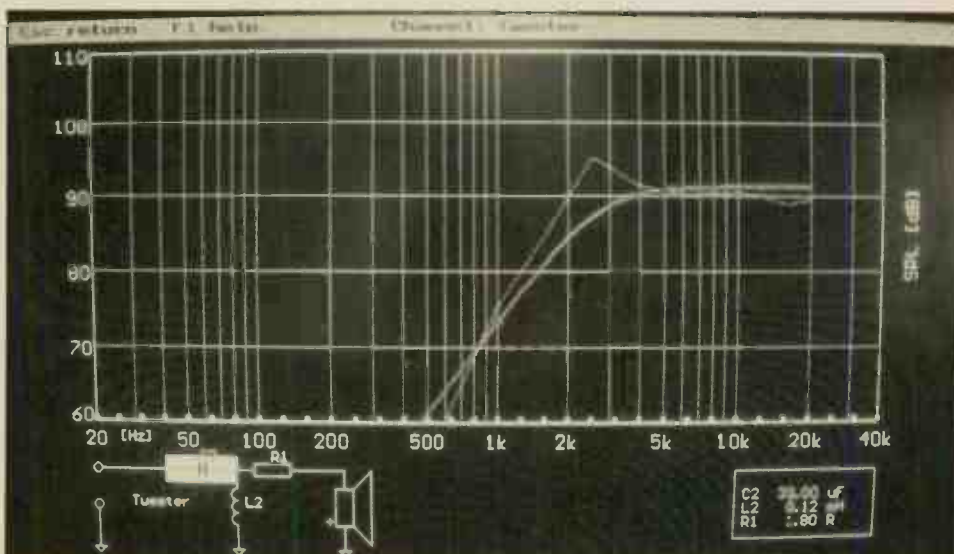

# KIT & COMPONENT SUPPLIERS

## LOUDSPEAKER KIT SUPPLIERS

**Bandor Design & Development Studios**  
11 Penfold Cottages, Penfold Lane, Holmer  
Green, Bucks HP15 6XR  
Tel. (0494) 714058

Bandor Musical Drive Units cover the entire audio spectrum with one 50mm (100Hz - 35K) and one 150mm (20Hz - 8K). One driver covers 2/3 RD of the frequency. Crossovers 150 Hz/8K. Anodised aluminium spun cones. 1.3 grams moving mass gives crisp transients. Good power handling. Robust. 35 YEARS EXPERIENCE.

**Tabula Rasa**  
136 Kilnwood, High Wycombe, HP14 4UR  
Tel. (0494) 565116

A young company specialising in the distribution of loudspeaker kits, components, accessories, and design measuring equipment from Germany, where the DIY loudspeaker has been well established and very successful for many years. We handle speaker kits (with or without cabinets), a wide range of drivers, filters, filter components and accessories. Very low cable prices. Loudspeaker designs, measurement systems and high quality filter components also available. 30 day money back guarantee on all speaker kits. Send £2.00 (returnable on purchase of any speaker kit) for our catalogue. Trade enquiries welcome.

**Faraday Sound**  
248 Hall Road, Norwich, NR1 2PW.  
Tel. 0603 762967

Loudspeakers in Concrete  
Now you can build your own low density concrete cabinet enclosure Faraday FS1, Siren, FS5, FS10 or a design of your own choice. Stunning sound. Simple DIY skills only. Full instructions including cabinet construction for only £10.00. Includes reviews, photo's etc. and at least £10.00 discount off any further products purchased from us e.g. ready made cabinets. Also £25 - £150 off any complete loudspeakers!

**Hart Electronic Kits Ltd**  
Penylan Mill, Oswestry, Shropshire SY10 9AF  
24 Hr sales / enquiries Tel. 0691 652892  
A range of Audiophile kits for 80 watt Power Amplifiers, Tuners, Pre-Amps and Moving Coil / Moving Magnet RIAA Pickup Preamps. All kits are fully engineered, with our thirty years design experience, for easy constructions from circuits by John Lindsey Hood, the most respected designer in the field. Send for lists.

**The Speaker Company**  
Unit 9, Waterside Mill, Waterside, Macclesfield,  
Cheshire SK11 7HG  
tel. 0625 500507

The Speaker Company are a new company offering a wide range of loudspeaker drive units from Audax, Celestion, KEF, Morel SEAS, Volt and a new ribbon tweeter. Also a wide range of associated accessories for the speaker builder.

**Falcon DIY Speakers**  
Falcon Electronics, Tabor House, Mulbarton,  
Norfolk NR14 8JT  
Tel. 0508 78272  
Falcon sell kits, drive units and crossover components and have a large range of books and back issues of kit magazines. Please send large SAE (34p) for free price list.

**Wilmslow Audio**  
Wellington Close, Parkgate Trading Estate,  
Knutsford, Cheshire WA16 8DX  
Tel. 0565 650605 Fax. 0565 650080  
Extensive range of drive units and over 30 different designs of self-assembly kit. Two 'ATC' kits now available. Drive units include those from KEF, Dynaudio, Audax, SEAS, Peerless, Scanspeak and Morel. Everything required for the loudspeaker builder and four dem rooms to listen to the kits in built-up form. Two new kits from Morel - one 3 litre, magnetically shielded, one 11 litre book shelf.

**IPL Acoustics**  
2 Laverton Road, Westbury, Wilts BA13 BRS  
Tel. 0373 823333  
IPL supply a range of eight speaker kits using drive units from SEAS, Morel, Audax, Visaton etc. including four transmission lines to suit all room sizes. We also supply a full range of drive units, capacitors, and cabinet accessories as well as silver plated P.T.F.E. insulated cables.

**DBS Audio**  
PO Box 91, Bury St Edmunds, Suffolk IP30 0NF  
Tel. 0284 828926  
Sole authorised supplier of DBS loudspeaker kits designed by Dave Berriman. The acclaimed DBS6 kit includes Morel tweeters and custom built woofers, plus top quality pre-assembled crossover and components.

## VALVE AND OUTPUT TRANSFORMER SUPPLIERS

**Langrex Supplies Ltd**  
1 Mayo Road, Croydon, Surrey CRO 2QP  
Tel. 081 684 1166 or fax. 081 684 3056  
One of the largest distributors of electronic valves, tubes and semi-conductors in the UK by original UK and USA manufacturers. Obsolete types are a speciality. Telephone or fax for an immediate quotation.

**GT Audio**  
5 Upper Road, Higher Denham, Bucks UB9 5EJ  
Tel. 0895 833099  
Professional repair/restoration of all hi-fi including classic and vintage equipment. Supplier of very high quality electronic components, in particular types which are difficult to source. Original valves available, i.e. Mullard, Brimar, GEC, GE, RCA, Sylvania etc.

**Billington Export Ltd.**  
1E Gillmans Trading Est., Billingham, Sussex RH14 9EJ  
Tel. 0403 784961 or fax. 0403 783 519.  
Billington Export Ltd. are one of only two or three suppliers of obsolete cathode ray tubes in England. DG7-32, DG7-36, and 3VWP1. Data can be sent on request with any valve or cathode ray tube order. (minimum order £50.00)

**PM Components**  
Springhead Enterprise Park  
Springhead Road, Gravesend, Kent DA11 3HD  
Tel. 0474 560521  
Suppliers of Shuguang Golden Dragon valves amongst others.

**Sowter Transformers**  
EA Sowter Ltd  
PO Box 36, Ipswich IP1 2EL  
Tel. 0473 219390/252794  
Output and mains transformers for GEC KT88 circuits. Can also make any other transformer to order. Send

SAE for lists and data.

**Chelmer Valve Company**  
130 New London Road, Chelmsford, Essex  
CM20RG  
Tel 0245 265865 Fax. 0245 490064.  
Supplier of premium range of audio valves, other valves and components also available. (Please see our ad on inside back cover of this supplement).

## COMPONENT SUPPLIERS

**Audio Components Ltd**  
Albany Court, Albany Road, Granby Industrial Estate, Weymouth, Dorset, DT4 9TH  
Tel. 0305 761017 Fax. 0305 761492  
Audio Components supply the Audio Innovations Classic 25 Kit Amplifier. This valve Line Intergrated design offers 4 line inputs, a tape loop and 25 watts of Class A power in an elegant, domestically friendly casework. It comes with a comprehensive 40 page instruction manual and a guaranteed fixed price competition service should any difficulties be encountered. Price is £699.

**AP Electronics**  
20 Derwent Centre, Clarke Street, Derby, DE1 2BU  
Check out the AP electronics 1993 catalogue. It's free with every order over £30.00. AP - for pre-amp kits, power amp kits, integrated amp kits plus everything else from resistors to mains cables.

Chelmer Valve Company (pls look under valves)

**Electromail**  
PO Box 33, Corby, Northants NN17 9EL  
Tel. 0536 204555  
The branch of the well known RS Components trade mail order business that deals with the public. They have a huge range of components and catalogues to match.

**Norwood Electronics**  
Unit 8 Pinbush Road, South Lowestoft Ind Est,  
Lowestoft, Suffolk NR33 7NL  
Components suppliers:-  
DACs, digital filters, Digital interface ICs, Optical transceivers/Cables, OP-Amps.  
Kits:- DACs and Power Amps.

**Omni Electronics**  
174 Dalkeith Road, Edinburgh EH16 5DX  
Tel. 031 667 2611  
A wide range of components aimed at the hobbyist, competitive VAT incl. prices, mail order and a friendly service. Open Mon-Thurs 9.15-6.00, Friday 9.15-5.00 and Sat's 9.30-5.00.

**RATA Ltd**  
Edge Bank House, Skelsmergh, Kendal, Cumbria  
LA8 9AS  
Tel. 0539 823247  
RATA specialise in supplying high grade audiophile components and cables. They also have a small range of drive units and kit amplifiers.

## VINTAGE DIY

**Loricraft Audio**  
4 Big Lane, Goose Green, Lambourn, Berks RG16 7SQ  
Tel. 0488 72267  
Specialist restoration of 301's and 401's using genuine spares and re-manufactured parts to original pristine standards in our newly built workshops designed primarily for these purposes.

**YOU CAN ADVERTISE IN THIS SECTION FOR ONLY £20.  
CONTACT CAROLINE KNOTT ON:  
071 - 266 0969.**



# D.I.Y. Letters

## TUNING MORELS

I've been an avid reader of your magazine since its inception and particularly enjoy the DIY sections.

I've recently acquired a pair of home made 'speakers. On looking inside I find the drivers are by Morel, the tweeter is the MDT30 and the bass unit the MW166. These are mounted in a closed box of approx. 13 litre internal volume made from 1/2in. MDF. Internal surfaces are lined with foam. The crossover is 3rd order to the tweeter. An inductor is fitted in series to the bass unit with a capacitor/resistor circuit across the driver presumably for impedance equalisation.

My question, which I hope you may help me on, is this: the sound is smooth and clear but it lacks punch and excitement. There also seems to be some mild mid-range resonance. Certainly these

speakers seem slower and less involving than the Monitor Audio 14s I normally listen to, although they do have a slightly sweeter treble.

I have the feeling that there's a good speaker in there somewhere trying to get out. Is the problem with the crossover, box damping, or choice of drive units? I enclose a diagram of the crossover with component values as far as I can ascertain.

I'm sure this must be a problem faced by many people who like to build their own speakers i.e. how do you get a fast dynamic sound, whilst still retaining smoothness and tonal correctness?

**J. A. Luntz**  
**Church Stretton**  
**Shropshire**

Firstly, let's start with the box. I entered the data for the Morel MW166 bass unit

into our loudspeaker design CAD package. A sealed box of 13 litres does give a flat response down to around 55Hz (-3dB), but peaking up the bass a little will give them a little more punch. In addition the -3dB point of 55Hz can be improved upon.

I came up with this solution for you, after experiment. If you insert a reflex port, 2inch diameter and around 10inches long (final size will have to be determined by listening and fine tuning) the bass peaks up by around 2.5dB at 80Hz, which will give speed and slam, and the bass extension moves down to a much more respectable 43Hz, low enough to play fundamentals properly.

Although you give most of the values of the components in the crossover, you do not mention what type of components are used.

In the treble arm, both the 2.2 $\mu$ F and 6.8 $\mu$ F capacitors should be high quality polypropylene, the Solen 400V series should give best results. The inductor should be also be a high quality component: speak to Wilmslow Audio about the best type to use - Tel: 0565 650605. As the capacitor in the bass arm is also a low value, this too can be polypropylene.

Working back through the equations it looks like you have a crossover point of just below 6kHz for the tweeter. This, out of interest, suggests that the inductor you couldn't identify is around 0.16mH. The bass/mid unit is rolled off at around 3kHz. However, if a standard value of 8 $\Omega$  is picked for the '166 driver, you may have a suck-out in the midband caused by the two units not integrating properly. I'd suggest making the treble filter second order at around 4kHz, as we recommended when we tested the MDT30 in the December '93 supplement. Use a 4 $\mu$ F capacitor in series with the tweeter and a 0.4mH inductor from tweeter to ground. The simpler crossover will not only improve the treble quality, but will also raise the treble level by 2dB or so. In this case the 10 $\Omega$  resistor may have to be increased, you can tune the treble by ear until you get a balance you like.

One other little thing you might like to try is placing a Deflex panel behind the MW166. This is a new type of acoustic damping that promises excellent results (see the review in this issue). The Deflex panels are available from The Speaker Co. Tel: 0625 500507.

Obviously, these are all just ideas and without measuring your loudspeakers we can't guarantee they will work perfectly, but at least they'll give you a good starting point, giving you

plenty more to try on these long and dark winter nights.  
**DB**

### OHMS LAW

I have just read DIY Supplement No. 6 and feel I must comment about a couple of items contained within.

The first point concerns the single-ended valve amplifier. You state that valve V2 draws 1mA producing +1V bias across resistor R12. Ohms law states the voltage across a resistor is equal to the product of current flowing through the resistor and the resistance of the resistor,  $V = IR$  using Ohms law surely the above bias voltage is incorrect and the bias voltage should be +0.82V with the 820R resistor shown.

The second comment refers to your reply to Malcolm Berege's letter concerning increased technical explanations. I agree that the pages of the main magazine are not the place for technical explanations, but the DIY Supplements are an ideal vehicle in which to publish technical explanations. All of your electronics projects (valve or silicon) have been accompanied by circuit details, theory of operation etc. If these articles are not of a technical nature please explain what constitutes a technical explanation.

Finally, please keep-up the good work. The DIY supplements are excellent, how about producing supplements on a monthly basis for addicts like myself?

**Mr Andrew Dean  
Milverton  
Somerset**

Yes, indeed you are correct to say that the bias voltage at the grid should be 0.82V, in theory. As you know there is a tolerance on all components, wires and solder are not perfect conductors and the valve may not be drawing exactly 1mA, for example it may draw 1.1mA, or 0.9mA. And the 820Ω resistor, if it has a

tolerance of 5% say, could be anything between 780Ω and 860Ω, and the value will also change with temperature. By quoting +1V, not +1.0V, it is taken to mean that the voltage should be nominally 1V. There's no point in becoming too pedantic about all this or what was a simple fact becomes wrought about with qualifications.

Although the explanations that go with each of the circuits are technical, they are only technical to a basic and, we hope, understandable level. We avoid lengthy mathematical equations and derivations and instead try to explain how a circuit works in more understandable terms. We aim to provide

even those with a limited knowledge of electronics an insight into how the circuit functions. Hopefully, this makes the DIY supplement, and the designs in it, more approachable for a wider audience. **DB**

### LANDMARKS

I had to giggle when reading David Wyllie's letter in December 1993's HFV. His letter talks of post-war 'landmark' amplifiers reaching 'new levels of excellence'. In my view, this is cobblers. A Williamson is in no way as good as pre-war, state-of-the-art triode design. 'New levels of compromise' would be a more fitting -statement.

Audio amplifier design

peaked in the mid-1930s. After that time designers became obsessed with reducing the cost of the equipment. The use of feedback allowed the designer to achieve certain design compromises to attain the same level of measured performance as the very expensive triode designs, while at the same time cutting costs. The output transformer could be poorer spec. The power supply could have a AC ripple content - Good old Uncle Feedback will hide these problems. Only thing is, it tends to hide some of the music as well!

As for the 5-10, it can't really hold a candle to the Williamson, but it did cost less

# Letter of

## BAD VIBRATIONS

Thank you for the D.I.Y. element of your magazine, it's a breath of fresh air in a boring black-box world.

With regard to tweaking machinery, I have always made a practice of carrying out simple things learnt in the far off days of packing platters and plinths of turntables with plasticine. I have found improvements to the sound of all the tin boxes of electricians can be made by lining the boxes with this simple cheap material. However, I have discovered how to make a quantum leap in the sound of all hi-fi components for ridiculously small amounts of money.

This all came about through reading a review of the Tannoy 605LE which stated that the capacitor was packed in a type of Blue-tak, because "it sounded better". As all hi-fi electronics are packed with these components I decided to drag an old Technics SL-PI I

CD out of the loft, have a listen, then wrap the tin cans in Blue-tak and reassess the sound. The improvement was immense - and all for the sum of 99p. I have subsequently carried out this process on my Rotel 965BX, Cyrus amp etc. and all have become markedly more airy, detailed and tuneful. I noticed during this process that lots of the components soldered vertically into the boards were actually at various angles and touching each others and decided, after listening to the improvements wrought by the Blue-tak, to carefully re-align them so that none were touching. This little tweak further improved the sound, though to a much lesser degree.

The foregoing just goes to prove that even those of us with little knowledge of electronics can still make improvements to modern equipment with a little thought.

It goes without saying that equipment must be unplugged to carry out this work and that care must be taken not to sever any of the connections - and you will obviously bid bye-bye to any guarantees.

I was interested to notice that some aspects of the sound of my old Technics player are actually better than the Rotel despite it being an old 14 bit model. It has a much more airy, detailed midband and treble and a bigger soundstage, but a less focussed and less solid bass, but the difference is much less than 10 years of progression and press hype would have led one to believe. In fact, I often turn to it in preference to the Rotel. Strange, huh?

Anyway I hope this will be of some interest to you and your readers. Please keep up the good works.

**P Stephenson  
Darlington**

than a third to build and its measured performance was just as good, if not better. It used 26dB of negative feedback, 6dB more than Theo Williamsons. This extra feedback was possible because it was a three-stage amplifier against Theo's four stages., therefore minimising phase shift.

Another 1950s obsession was the use of so called 'forward feedback'. Very loosely, the idea was to increase the amount of feedback by 'forward feeding' part of the signal to the output, thus increasing the amount that you could feedback. A knob was fitted allowing you to adjust for the maximum feedback for your

loudspeakers. You turned it up until the amplifier went unstable and started to oscillate (at a frequency beyond audibility). You then backed off the control a fraction and were left with the maximum feedback possible. PYE were major users of this system, also R.C.A.

At the same time that amplifier quality was slowly dropping, the quality of the source was improving in leaps and bounds. In the late thirties your pickup would probably use thorn needles and track at pounds instead of ounces. Frequency response was severely limited, perhaps to 7 kHz if you had a top model.

After the war Decca introduced the Full Frequency

Range Recording. This offered extended frequency response beyond 12kHz. (Decca's top record player, the Decola, used an all-triode push-pull circuit from the input to the output).

Throughout the 1950s improvements were made. 1955 saw 'FM' radio, 1957 saw the first Stereo records. By 1960 the quality of the music available was so high it has never been surpassed.

No one cared if amplifier quality dropped slightly, after all they measure better these days don't they?

All of the top boffins at the time were obsessed with bringing costs down. Take the original Leak TL12 point one (With KT66s strapped as

triodes). It cost £28-7 shilling when it was replaced in 1957. The TL12+ (launched in '57 with EL84s ultra-linear) cost only £18-8 shillings, with better measured performance than its predecessor (my father reckons he was earning about £9 a week at this time - and was well paid!)

Since time immemorial the cost of 'text book' measured high fidelity has been dropping. Look at the specification for any sub £150 (less than one weeks wage for the average person) amplifier you care to mention. It's state of the art on a test bench compared with a Williamson or virtually any other valve amplifier known. As for the sound, forget it.

I established a couple of years ago the more basic and therefore simpler an amplifier is, the better it sounds. Forget push-pull, ultra-linear, OTLs, transistor, mosfets, OP amps, and heavy negative feedback. Keep it simple and the sound will shine through.

And what's wrong with 1920s mains energised loudspeakers? Sure moving iron speakers are a joke, as are most of the 1920s earpieces on horns. Never heard of Paul Voight? Possibly the most important audio engineer of the time?

In the nineteen twenties he must of filed more patents than any other audio engineer. His 6.5" loudspeaker has not changed that much in over 60 years. Tractrix horns (a Voight patent) are currently all the rage in America (thanks to some excellent articles by Dr Bruce Edgar).

Voights original mains energised speakers are superb. But as magnet material improved (Alnico, Alcomax, Ticonal G, etc.) it was possible to produce strong magnetic fields equivalent to the mains energised units, with the obvious advantage of not needing several hundred DC volts to energise them!

Current loudspeakers (KEF 104s for example) tend to use ceramic impregnated with iron filings as magnets. These awful

# The Month

Everything has a resonant frequency, and this 'ringing' can be destructive to the sound quality of hi-fi. As you point out, Tannoy discovered that an improvement could be made by wrapping the capacitors in their LE loudspeakers in Blue-tak, which damped down this 'ringing'. It's interesting that you have taken this a stage further with your CD player, and had good results.

Whilst we would recommend this tweak to anyone interested in trying it, do be aware of the dangers of electronic products. Your guarantee will certainly be invalidated, and there is a risk of electric shock even with the mains disconnected. The capacitors used in the power supplies of all hi-fi equipment hold charge for some time after the equipment has been

switched off. If you are not qualified in electronics and do not know how to test for safety, leave the item you wish to tweak disconnected for at least 24hours before opening the case. **DB**

One of the discussions we have with our capacitor supplier is how tight we want the wrap of the foil to be, and how strong its case, since both affect sound quality. Our 300B polypropylene power supply capacitors are specified in these areas, being fitted into a sturdy metal can to improve sonic isolation. So, nowadays, specialist audio capacitor manufacturers - and ourselves - are trying to improve capacitor structure, in order to attain improvements similar to those you have heard. **NK**



## WIN A MAPLIN SOLDERING IRON KIT COMPLETE WITH A LENGTH OF SILVER SOLDER

The writer of the most interesting DIY letter each month will receive a superb Maplin soldering iron, stand, booklet on good soldering practice and a length of high quality silver solder.

Write in to: **Hi-Fi World  
DIY letters, 64  
Castellain Rd, Maida  
Vale, London W9 1EX.**

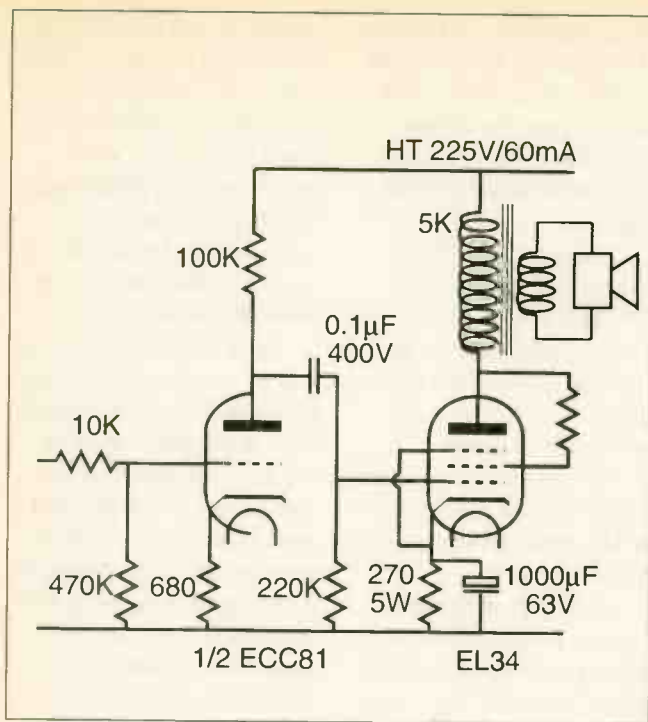

beasts can in no way match the strength and efficiency of a solid metal magnet.

I recently had the pleasure of measuring an early Voight unit. Off 1 R.M.S. watt at 1 kHz, 1 metre distance I measured 103dB - now that's sensitive!

In its cabinet (Tractrix horn on the front of the unit, and to the rear quarter-wave loading, another Voight patent) frequency response was -6dB at 48Hz and pretty flat to 21kHz. Not bad for a single drive unit.

Voight's basic units are still made by Lowther Voight Ltd. of Bromley, Kent. Although the chassis have changed over the years and different models with varying sizes of magnet have been introduced, the basic paper cone and double wound voice coil (it is wound on the inside of the former as well as the outside) have remained unchanged. Sadly Lowther chose to introduce some ceramic magnets called 'High Ferrics', these are good, but not in the same league as the ALuminum NiCol CObalt types. Thankfully ALNICO magnet types are still available. The actual material used is Ticonal G.

I do not believe that Mr Wyllie has had a serious listen to a single-ended valve amplifier. He could have a go

at this little circuit, but be warned, you may find its 3.5 watts quite compelling. Especially if you're using some old Voight speakers!

**Haden Boardman,**  
**Audio Classics,**  
**8 Lowe Mill Lane,**  
**Hindley,**  
**Wigan,**  
**Lancashire .**  
**WN2 3AF**

### VALVES AND KEILIDHS

Since reading your magazine I've become interested in valve amplifiers and DIY hi-fi.

Can you think of an amplifier, either integrated or pre and power, of the valve type which would drive a pair of Linn Keilidh's. My front-end is a Meridian 200/203 CD player combination.

In the Keilidh owners manual it says that the speakers should be used with an amplifier of at least 80W per channel into 4ohms, which doesn't sound like a valve amp!

Building one of your kit amplifiers is tempting, would they be a match?

Also, do you think that you could give advice on building some of your amps, starting with the very basics i.e. what a capacitor or resistor do, what the colour bands mean or how best to solder

components and how to measure components and circuits. Hi-Fi World appears to be a great "hands on" hi-fi magazine. Brilliant. I look forward to my next copy of Hi-Fi World.

**Keith Wilding**  
**38100 Braunschweig**  
**Germany**

You can get 80watts from a valve amplifier without too much difficulty, other than size and weight, due to the immense transformers required. Tim de Paravicini produces behemoths known as 549s that turn out an easy 200watts, for example. Bear in mind, however, that for high power, fixed-bias working (it gives more power) substantially in Class B is most practicable, but it often gives glassy hard, remorseless treble, so listening tests are required before purchase. Valve amps can deliver power, but to do so they become heavy and expensive - and sound quality can suffer.

You need a four ohm tapping on the output transformer too. Velleman, a German kit manufacturer, make a high power valve amplifier, which may interest you. We urge you to listen before buying though. Alternatively, our own K588I can be monoblocked by paralleling its 8ohm taps to give 45watts output into four ohms, but you'll need two kits. **N.K.**

### LIVE VOLUMES

Hello again. After reading so much about valves these days I feel I want to up-grade my Audiolab 8000 C/P to a good quality DIY KIT valve amp that would match my Quad ESL63s and Accuphase 70V CD player, and give a sweeter sound with more involvement and bigger soundstage, or go for a Quad 606 power amp? I would still use the 8000 pre-amp and later on go for another pre-amp if you recommend so.

I would be happy to have

your recommendations. I also use a self-powered sub-woofer connected to the 2nd pre-amp output of the 8000C, which is practical for volume control. I would appreciate your recommendations on speaker cables for my present system and also the suggested up-grade (I now use QED 79 strands).

I mainly listen to Jazz and Classic music at live volumes preferably.

I love Hi-Fi World and all the people who make it what it is: "A friendly magazine".

**Jean-Paul Hagger**  
**Alexandria**  
**EGYPT**

There aren't so many valve amp kits around, but as you are probably aware, we do make a 30watt/ch. 300B amplifier that we run with Quad ESL-63s to give an incredibly open and spacious sound. However, "live" volumes usually means very loud and we'd hesitate to say that 30watts provides this, even from valves. You can either buy two and monoblock them (60watts/ch.), which is very expensive, but popular all the same. Or you could consider a Velleman valve amplifier kit from Maplin Electronics (0702-552911, fax - 0702-553935), but we cannot get one for review and would recommend you hear it first, since high power valve amps aren't necessarily of the highest audio quality, because of the unacceptable cost/weight penalties incurred when designed properly.

A Quad 606, on the other hand, provides oodles of power at far less cost, but it is not convincingly better in sound quality than your current Audiolab 8000P, which can drive the Quads as loud as they can go.

The only other option is to buy two K588I kits and monoblock them to get around 45watts/ch., but you'll get a little less volume than at present. **N.K.**

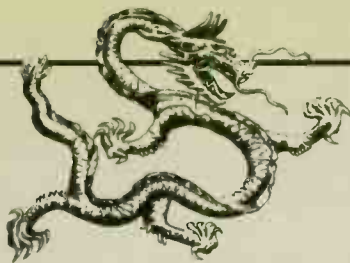

# Golden Dragon

Precision Audio Tubes

Please enquire or any tube types not listed. We have an inventory of over 2,500 different types in stock.

## RETAIL PRICE LIST

Golden Dragon Pre-amplifier Tubes	Singles
6AQ8/ECC85	£6.50
12AT7A/E81CC/ECC81	£6.50
12AU7A/E82CC/ECC82	£6.50
12AX7A/E83CC/ECC83	£6.50
6DJ8/E88CC/ECC88	£10.95
6SL7GT/ECC35	£7.50
6SN7GT/ECC33	£7.50

Special Quality Golden Dragon Pre-amplifier Tubes	Singles
E81CC-01 Gold Pins	£9.50
E82CC-01 Gold Pins	£9.50
E83CC-01 Gold Pins	£9.50
E88CC-01 Gold Pins	£14.50

Golden Dragon Triodes	Singles	Pairs	Quads
2A3 4PIN	£22.50	£47.50	£95.00
2A3 OCTAI	£22.50	£47.50	£95.00
211	£28.50	£59.00	£118.00
300B	£69.00	£140.00	£280.00
811A	£11.50	£25.00	£50.00
845	£36.50	£75.00	£150.00
805	£36.50	£75.00	£150.00

Golden Dragon Powder Tubes	Pairs	Quads	Octets
EL34/6CA7	£25.00	£50.00	£100.00
<b>NEW DESIGN</b>			

Golden Dragon Powder Tubes	Pairs	Quads	Octets
EL84/6BQ5	£8.50	£17.00	£34.00
E841/7189a	£12.50	£25.00	£50.00
KT66	£25.00	£50.00	£100.00
KT88	£49.50	£99.00	£198.00
KT88 SUPER	£59.00	£118.00	£236.00
6L6GC	£18.50	£37.00	£74.00
6550A	£39.50	£79.00	£158.00
50CA10	£75.00	£150.00	£300.00
6L6WGB	£25.00	£50.00	£100.00
807	£25.00	£50.00	£100.00

## Gold Dragon Select Tubes

5AR4/GZ34	£8.50
5U4G	£8.50
85A2	£6.50
ECL82	£4.50
ECL86	£4.50
EL509	£7.50
PL509	£7.50
12E1	£25.00
6072A	£7.50
5687	£8.50
6AS7G	£15.00 pair
6C33C/B	£75.00 pair
6550 Super	£75.00 pair

## Gold Plated Ceramic Valve Bases

4 PIN UX4	£3.50
4 PIN JUMBO GOLD PLATED	£25.00
7 PIN B7G CHASSIS	£3.50
8 PIN OCTAL PCB	£3.50
8 PIN OCTAL CHASSIS	£3.50
9 PIN B9A PCB	£2.50
9 PIN B9A CHASSIS	£2.50
GOLD PLATED ECC83 SCREENING CAN & SKIRT	£8.50
GOLD PLATED ECC83 DAMPING CAN	£4.50

Carriage charge: £2.50 on any order. All prices plus VAT @ 17.5% Payment: Cash with order or Visa - Mastercard - American Express. 23 Hour Answerphone Services

We also have available ceramic valve sockets and holders for the entire Golden Dragon range. For further details please contact:

## A SELECTION FROM OUR VAST STOCK OF VINTAGE AND AUDIO QUALITY VALVES.

Please enquire for items not listed.

ECC81	BRIMAR	4.50	UU5	MAZDA	5.50
ECC82	G.E.	4.50	UU6	MAZDA	6.50
ECC82	RFT	4.50	2X2A	RCA	5.00
ECC83	TEONEX	3.50	3A/167M	ITT	10.00
ECC85	TEONEX	3.50	5Y3WGTA	SYLVANIA	4.50
ECC88	G.E.	5.50	5V4G	BRIMAR	3.50
ECC88	BRIMAR	4.50	6AG7	RCA	3.50
ECC88	TEONEX	4.50	6A7G	RCA	8.50
ECH81	MULLARD	3.50	GBH6	BRIMAR	3.50
ECL82	TEONEX	3.50	6C8G	RCA	3.50
ECL86	TEONEX	3.50	6DQ6B	PHILIPS	3.50
EF86	TEONEX	4.50	6K7G	RCA	3.50
EF804S	TELEFUNKEN	25.00	6SL7GT	BRIMAR	4.50
EL34	TEONEX	6.50	6SN7GT	TEONEX	3.50
EL85	MULLARD	4.50	6SN7GT	BRIMAR	4.50
EL86	MULLARD	4.50	6SQ7GT	TEONEX	4.50
EL504	TEONEX	4.50	6V6G	RCA	5.50
EL509	TEONEX	5.50	6V6GT	TEONEX	4.50
EL519	TEONEX	5.50	6X4	TEONEX	2.50
EM84	TEONEX	3.50	12AT6	BRIMAR	2.50
GZ32	MULLARD	8.50	12AV6	RCA	2.50
GZ33	MULLARD	5.50	12BA6	WESTINGHOUSE	3.50
GZ34	TEONEX	5.50	12J5GT	RCA	3.95
GZ34	MULLARD	16.50	12AX7WA	ECG	10.50
GZ37	MULLARD	4.50	12AY7	RCA	8.95
KT66	TEONEX	6.00	12E1	STC	15.00
KT66	GE	16.50	13E1	STC	140.00
LS9B	COSSOR	6.95	13D3	BRIMAR	6.50
M8136	MULLARD	8.50	85A2	MULLARD	6.50
M8162	MULLARD	8.50	1625	RCA	6.50
M8137	MULLARD	15.00	5687WA	RCA	6.50
MHLD6	MAZDA	5.50	5751	RCA	6.50
OA2WA	TEONEX	3.50	5814A	GE	5.50
PCC88	SIEMENS	3.50	5881	USSR	4.95
PL36	MAZDA	3.50	6146B	TEONEX	8.50
PL504	MAZDA	2.50	6158	BRIMAR	6.50
PL509	MAZDA	5.50	6189	SYLVANIA	6.50
PL519	THORN	5.95	6201	GE	6.50
PY32	MULLARD	2.50	6463	UNITED	7.50
TT100	GEC	65.00	6550A	TEONEX	12.50
U19	GEC	8.50	6870	BRIMAR	11.50
UCC85	MULLARD	3.50	6072A	RAYTHEON	6.50

P.M. COMPONENTS LTD., Springhead Enterprise Park, Springhead Road, Gravesend, Kent DA11 8HD, England

Tel: 0474 560521. Telex: 966371 TOS-PM-GM. Fax: 0474 333762

GOLDEN DRAGON MAIN DEALERSHIPS, available in selected areas. Please call Clive Norris for details

## THE HI-FI LAW OF DIMINISHING RETURNS

Ask a Hi-Fi dealer to upgrade your system, and he'll sell you ever more expensive bits of hardware, giving you a constantly changing sound, new solutions producing more problems which can only be solved with more expensive equipment. The harder you try, the more it costs and the less satisfying the results. This is the well known Hi-Fi law of diminishing returns. We have an alternative:

## THE RATA LAW OF INCREASING RETURNS

Why buy new equipment when it makes more sense to realise the full potential of your existing equipment. Don't replace it, upgrade it; it's cheaper. Most equipment can be transformed by us for the cost of a dozen CDs. Magic? No - logic! To find out how we do it, ask for our new free Catalogue; it provides discussion, analysis and a definitive resource of audiophile components and advice on the art of recreating music in the home.

# Russ Andrews Audiophile Catalogue

Includes :-

- CD Players, Preamplifiers, Disc Preamplifiers, Power Amplifiers,
- Loudspeakers
- Kimber Kable
- Upgrading Services and Guides
- Audiophile Kits and Components
- Accessories
- Reviews

**1993 Edition 2 Available Now**

### **RATA**

Edge Bank House,  
Skelsmergh,  
Kendal,  
Westmorland, LA8 9AS

**Tel: 0539 823247**

**Fax: 0539 823317**

UK: Post Free,  
Europe: 3 International Reply Coupons.  
Overseas: Send US \$3 bill or four IRC