

Hi-Fi WORLD

APRIL 1993 £2.00

**THE NEW ACOUSTIC
ENERGY AEGIS
loudspeaker**

GARRARD 401

REVIVING A CLASSIC TURNTABLE

PRE AND POWER AMPLIFIERS

QUAD, MARANTZ, QED AND SUGDEN

NEW KENWOOD BUDGET

RDS TUNER

THE NEW CRYSTAL

CD CONVERTOR

from EMF

SCOOP!

POWER
MUTE
DE-EMPHASIS

VOLUME

EMF
DIO

INPUT OPTICAL
MUTE
MAX 2

SCOOP!

SCOOP!

SCOOP!

SCOOP!

COMPETITION WIN AN EAR 834 VALVE AMPLIFIER & ROGERS STUDIO 3 LOUDSPEAKERS

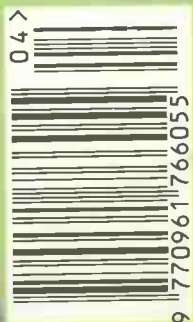

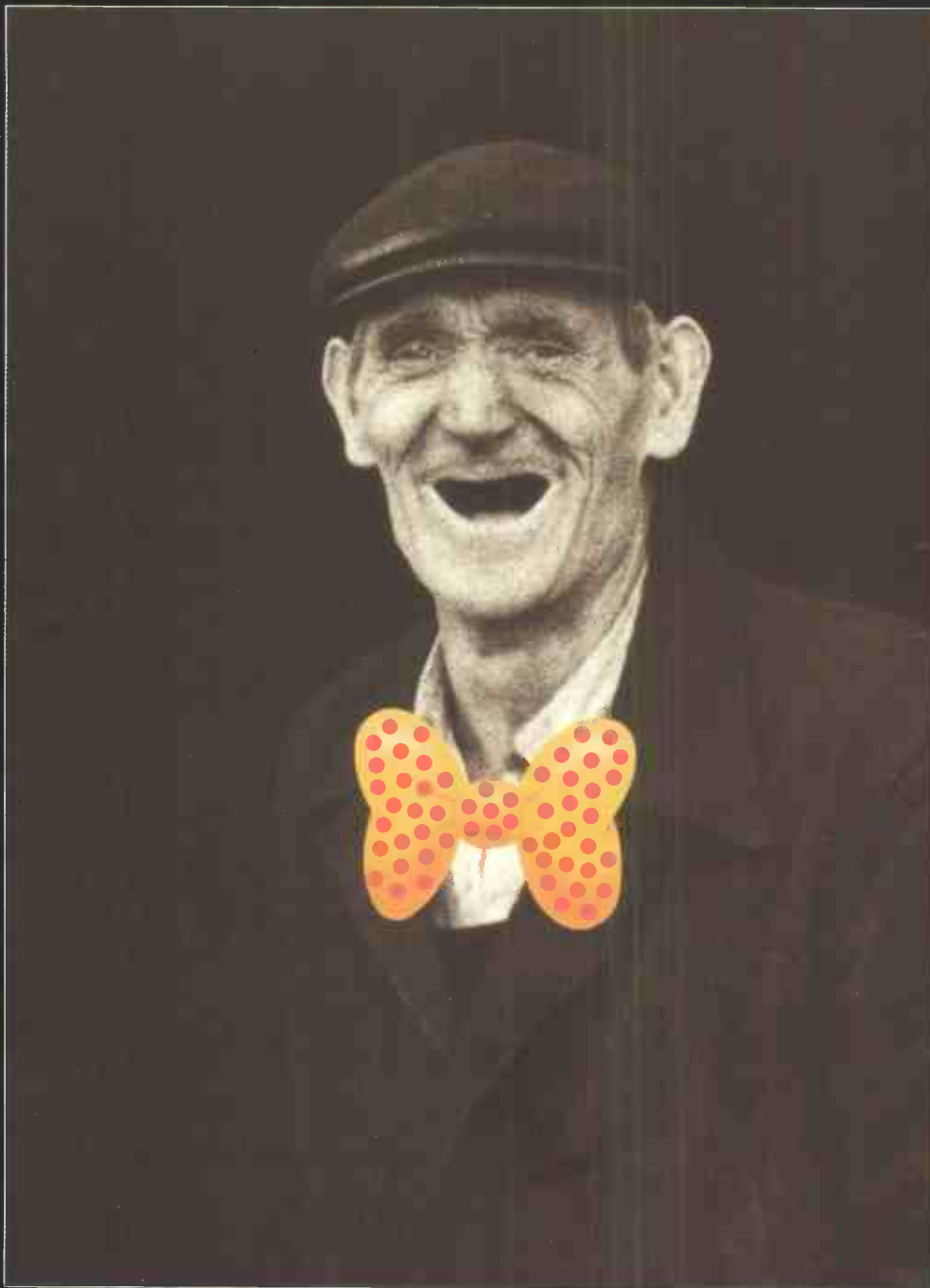

I'M SORRY, I THOUGHT YOU SAID
UPGRADE YOUR TRAMP...

Upgrade your amp is the message - the new Naim NAP 180 power amplifier could be your hi-fi system. Dual rectified power supply, 90 watts per channel into 4 ohms, dependable Naim engineering and a sound that will put a smile on your face too!

The only tramp involved is the one along to your nearest Naim retailer.

Now you know what's in a Naim



na naim audio

Naim Audio, Southampton Road, Salisbury SP1 2LN, England. Tel: (0722) 332266

LONDON

Audio Venue
24 Church Rd, Crystal Palace, SE1. Tel: 081 771 7787
Billy Yee Sound Systems
246 Lee High Rd, Lewisham SE13. Tel: 081 318 5755
Doug Brady Hi-Fi
18 Monmouth St, Covent Garden WC2. Tel: 071 378 4010
The Cornflake Shop
37 Windmill St, W1. Tel: 071 631 0472
Grahams Hi-Fi
Canonbury Yard, 190a New North Rd, N1. Tel: 071 226 5500
See at Lumiere
67 Tottenham Court Rd, W1. Tel: 071 580 9059
The Sound Organisation London
4 Pickfords Wharf, Chok St, SE1. Tel: 071 403 2255
Studio 99
79-81 Fairfax Road, NW6. Tel: 071 624 8855
Uzbridge Audio
108 Chawick High Rd, W4. Tel: 081 742 3444

NEAR LONDON

Infidelity Hi-Fi
9 High St, Hampton Wick, Kingston-upon-Thames.
Tel: 061 943 3530
Radford Hi-Fi
43 King Edward Court, Windsor, Berks. Tel: 0753 856913
The Sound Gallery
65 Castle St, High Wycombe, Bucks. Tel: 0494 531682
Spaldings
352-354 Lower Addiscombe Rd, Croydon, Surrey.
Tel: 081 654 1231
Studio 99
82 High St, Harpenden, Hertfordshire. Tel: 0582 764246
Unilet Products
25 High St, New Malden, Surrey. Tel: 081 942 9567
Uzbridge Audio
278 High St, Uzbridge, Middlesex. Tel: 0895 230404

SOUTH

Audio Designs
26 High St, East Gosstead, W Sussex. Tel: 0342 314569
Chichester Hi-Fidelity
7 St Pancras, Chichester, Sussex. Tel: 0243 776402
Jeffries Hi-Fi
63 London Road, Brighton, E Sussex. Tel: 0273 809431
Jeffries Hi-Fi
4 Albert Parade, Green St, Eastbourne, E Sussex.
Tel: 0232 313356
Jeffries Hi-Fi
29 London Road, Portsmouth, Hampshire. Tel: 0705 663600
Soundcraft
40 High Street, Ashford, Kent. Tel: 0233 624441
Sound Waves
1 Holbury Drive Praecond, Holbury, Hampshire.
Tel: 0703 599121
Worthing Audio
20 Teville Gate Praecond, Worthing, W. Sussex. Tel: 0903 212

EAST

The Audio File
27 Woodhall St, Bishops Cleeve, Herts. Tel: 0278 506578
The Audio File
No.2 Foundry Walk, St Ives, Cambridgeshire. Tel: 0480 6611
Basically Sound
The Old School, School Rd, Bracon Ash, Nr. Norwich, Norfolk.
Tel: 0508 70829
Cam Audio
110 Mill Road, Cambridge. Tel: 0223 60442
Pro-Musica
6 Vineyard St, Colchester, Essex. Tel: 0206 575719
Rayleigh Hi-Fi
218 Moultham St, Chemsford, Essex. Tel: 0245 265245
Rayleigh Hi-Fi
132-4 London Rd, Southend-on-Sea, Essex. Tel: 0702 4352
Rayleigh Hi-Fi
44A High St, Rayleigh, Essex. Tel: 0268 779782

WEST

Audio Excellence
58 Bristol Rd, Gloucester, Tel: 0452 300048
Audio Excellence
65 Park St, Bristol, Avon. Tel: 0272 264975
Radford Hi-Fi
8 Fore St, St Marychurch, Torquay, Devon. Tel: 0803 32672
Radford Hi-Fi
28 Cowick St, St Thomas, Exeter, Devon. Tel: 0392 218895
Radford Hi-Fi
12 James Street West, Bath, Avon. Tel: 0225 446245
Radford Hi-Fi
107 Cornwall St, Plymouth, Devon. Tel: 0752 226011
Radford Hi-Fi
52/54 Gloucester Road, Bristol, Avon. Tel: 0272 428248
Mike Manning Audio
110 Middle Street, Yeovil, Somerset. Tel: 0935 79361

WALES

Audio Excellence
134 Cnys Rd, Cardiff, South Glamorgan. Tel: 0222 228565
Audio Excellence
9 High St, Swansea, West Glamorgan. Tel: 0792 474508

MIDLANDS

Creative Audio
9 Dogpole, Shrewsbury, Shropshire. Tel: 0743 241924
Griffin Audio
94 Bristol St, Birmingham 5, West Midlands. Tel: 021 692 13
Litton Inn
32 Gold St, Northampton. Tel: 0604 37871
Sound Advice
The Sound Factory, Duke St, Loughborough, Leicestershire.
Tel: 0509 218254
West Midlands Audio
158 Omersley Road, Worcester. Tel: 0905 58046
Overture
3 Church Lane, Banbury, Oxfordshire. Tel: 0295 272158
Westwood & Mason (Oxford) Limited
46 George Street, Oxford. Tel: 0865 247763

NORTH

Audio Projects
45 Headingley Lane, Leeds, West Yorkshire. Tel: 0532 3045
Better Hi-Fi
16 Cook Street, Liverpool 2, Merseyside. Tel: 051 227 5007
Doug Brady Hi-Fi
The Forge Cottage, 19 Crossgate, Otley, Leeds West Yorkshire.
Tel: 0943 467599
Doug Brady Hi-Fi
401 Smithdown Rd, Liverpool 15, Merseyside. Tel: 051 733
Doug Brady Hi-Fi
Kingsway Studios, Kingsway North, Warrington, Cheshire.
Tel: 0925 828009
Litton Audio
9 The Arcade, Metro Centre, Gateshead, Tyne & Wear.
Tel: 081 460 0999
Litton Audio
7-11 Park Lane, Gateshead 8, Tyne & Wear. Tel: 081 477 41
Litton Audio
20-22 Monument Mall, Newcastle-upon-Tyne, Tyne & Wear.
Tel: 091 232 3994
Litton Audio
242 Park View, Whiteley Bay, Tyne & Wear. Tel: 091 252 4661
Moorgate Acoustics
184 Fitzwilliam St, Sheffield, S. Yorkshire. Tel: 0742 756048
Moorgate Acoustics
8 Westgate Chambers, Westgate, Rotherham, S. Yorkshire.
Tel: 0709 370866
Murray Hi-Fi
58a Winslow Rd, Handforth, Cheshire. Tel: 0625 549277
Murray Hi-Fi
East Anglian Buildings, Princes Dock St, Hull, Humberside.
Tel: 0482 227867
Sound with Style
81 Nether Hall Rd, Doncaster, S Yorkshire.
Tel: 0302 321421
Sound with Style
284 Crossop Rd, Sheffield, S Yorkshire. Tel: 0742 737891
The Sound Organisation
28 Gillygate, York. Tel: 0904 627108

SCOTLAND

Stereo Stereo
278 St. Vincent Street, Glasgow, Strathclyde. Tel: 041 248 4
Robert Ritchie
102 Murray St, Montrose, Tayside. Tel: 0674 73765

NORTHERN IRELAND

Lyric Hi-Fi
163 Stranmillis Road, Belfast. Tel: 0232 381296
Lyric Hi-Fi
84 Bridge St, Portadown, Co. Armagh. Tel: 0762 358059

Contents

THIS
MONTH'S
FEATURES
ON PAGE 7



Cover Photograph by
Paul Hartley Studios 071-482 3768

Editor
Noel Keywood

Assistant Editor
Eric Braithwaite

Editorial Assistants
Dominic Baker
Jonathan Jordan

Production Editor
Peter Downes

Marketing Manager
Akila Lingham

Marketing Assistant
Rachel Boulton

Contributors
Richard Brice
Peter Herring
Simon Hopkins
Martin Rae
Malcolm Steward

Cartoonists
Freddy Ahmet
David Simonds

Advertising Director
Rob Debenham

Advertising Executive
Caroline Knott
Advertising Tel: 071-266 0969

Distributed by:
COMAG, Tavistock Road, West
Drayton, Middlesex, UB7 7QE
Tel: 0895 444055

Origination by:
Minerva, 56C Minerva Road,
London NW10 6HJ
Tel: 081 961 6468

Printed by:
Southernprint, Poole, Dorset.
Tel: 0202 622226

AUDIO PUBLISHING LTD.,
64 Castelain Road, Maida Vale,
London W9 1EX.
Tel: 071-289 3533
Fax: 071-289 5620
Queries cannot be answered
by telephone.
MAIL ORDER
Tel: 071-266 0461 (24 hours)

Subscription Rates:
UK: £22,
Overseas Surface: £29, Airmail: £42
(Europe & Middle East),
£52 (USA, Canada & Far East),
£62 (Australia, Japan & China).

No material may be reproduced
from this magazine without
the publisher's permission.
© Audio Publishing Ltd

THIS MONTH'S REVIEWS

AMPLIFIERS

JVC AX-A662: Big and beefy in appearance, this integrated amplifier offers plenty of power for its pounds. 42

FOUR PRE/POWER COMBINATIONS
The next step up from an integrated amplifier on the hi-fi ladder is a pre-amplifier and power amplifier combination. We check out four from £700 to £2,200.

MARANTZ SC-22/MA-22

QED 300C/300P

QUAD 34/606

SUGDEN AU41C/AU41P 28



LOUDSPEAKERS

ACOUSTIC ENERGY AEGIS: One of the best-kept secrets in speakerdom? We listen to Acoustic Energy's brand-new small monitor and borrow Bulfinch's Mythology to find out where the name comes from. 26

MAG AUDIO A90: This floorstanding full-range ribbon design may be tall, but does it have a handsome sound? 23

CANON S-30: If you're tired of sitting in the hot seat, Canon's latest 'Wide Imaging Stereo' loudspeaker is supposed to allow you to lounge almost anywhere and still hear stereo. 39



COMPACT DISC

MICROMEGA DUO CD2 TRANSPORT AND DUO PRO CONVERTOR: One of the first sightings of a Compact Disc transport which uses Philips' top-of-the-range CDM-9 PRO mechanism. Partnered with Micromega's Duo Pro convertor, could this be the way forward for CD? 15

EMF CRYSTAL: From Mike Creek's EMF company, a new digital-to-analogue convertor incorporating the highly-rated Crystal chip. 18

TURNTABLES

GARRARD 401: Rebuilt and revised, this old favourite revives our Editor's interest in vinyl. 48



TUNER

KENWOOD 3050L: Another affordable Radio Data System tuner. Could reading the radio become as popular as reading the Radio Times? 46

FREE WITH THIS ISSUE!

28-page supplement.

Build your own monoblock valve amplifier based on the superb Mullard 5-20 circuit.

Turn a Creek active: we demonstrate how to make an active bi-wired speaker out of the Creek CLS-10

Loudspeaker measuring kit

Test equipment

MORE FOR THIS MONTH'S FEATURES, SEE PAGE 5



simply the best

An overused advertising statement? After all, "Simply the best" is such a cliché in today's marketing run world. No, it is something we at DPA believe in and are justly proud of.

Our revolutionary new T1 transport, DAC's, amplifiers and cables are the best for numerous reasons, which start at the design stage. Uniquely DPA designs are heuristic in nature - with each design an incredible number of factors is taken into consideration and carefully balanced to produce the most transparent performance. We believe everything can make a difference to the sound quality and everything is rigorously explored and examined to an unprecedented degree. This approach, of making no assumptions, leads to radically unique designs.

This unrivalled passion and care are not just the province of the design stage; this passion is carried through to the production of the unit. Unique production methods with advanced surface mount technologies are employed again with the ultimate care. Final assembly is carried out unhurriedly by one technician, with fully automated testing of each unit, so that each parameter that can affect performance is tested.

So why should you believe us? After all, we could be accused of bias. Throughout the world, fair but discriminating critics have been universal in their praise for DPA products. Take for example a recent review in Australia's High-End magazine Stereo Buyers Guide where the PDM2, in a group test of 27 DAC's, was quoted"you get a sound that can't be matched by any other. Only for those that demand the very best." Hi-Fi Choice Dec '91 also states that"(the PDM2) goes on to redefine many areas of CD sound quality."



However, rave reviews are not just the exclusive domain of DPA's PDM2. Hi-Fi World, on the PDM1 S3 said "Any enthusiast who wants the best from CD at a reasonable price should consider (the PDM1)." What Hi-Fi, Nov '91 said ..."the Bigger Bit is set to destroy all its competition." Our amplifiers are equally well respected with Hi-Fi Choice saying of the 50S pre-power ..."unmatched detail resolution, control and transparency."

Why should you believe the Hi-Fi critics? After all, it's your money and your Hi-Fi. Visit one of our dealers and ask for a demonstration of DPA products. If you value music and not distortion we think you will agree with DPA - simply the best.

dpa digital ltd

Unit 7, Willowbrook Lab Units, Crickhowell Road, St. Mellons Cardiff CF3 0EI,
tel: (0222) 795621 fax: (0222) 794267

BUDGET EQUIPMENT GUIDE

A declining bank account need not mean your interest in hi-fi has to decline with it. This is the section to read when times are tough and there's only the small change left.



WHARFEDALE DIAMOND V: The successor to the famous Diamond IV. Can it beat its best-selling predecessor? 102

BUDGET QUERIES: It costs nothing to ask - except paper and a stamp. 121

COMPETITION



Your chance to join the fraternity of the golden ears with two great prizes.

First Prize - worth over £1,700!

Esoteric Audio Research's gorgeous EAR 834 integrated line-level valve amplifier, with a pair of Rogers Studio 3 monitor loudspeakers finished in equally glorious Rosewood.

Second prize:

A pair of Rogers Studio 3s, in walnut. 64

REGULARS

NEWS: North, South, East or West, whose news is the best? 9

LETTERS: Whether it's a moan from Manitoba or a new notion from Narvik, we welcome them all. 12

COLUMNS: Our regular team encompasses all shades of opinion. 35

QUERIES: Wondering of Whitby, even Puzzled of Poland, it doesn't matter where the questions come from, we'll work out an answer. 59

SPECIAL OFFERS: A world of goodies and accessories from our mail-order section. 66



NEXT ISSUE: What's coming up in our May issue will have it read from Pole to Pole. 73

READERS' CLASSIFIEDS: Take a peek at these pages to pick up your heart's desire. 97

ADVERTISERS' INDEX 97

AERIAL REFERENCE: Give your tuner some additional airs and graces with a good aerial. 105

WORLD FAVOURITES 112



Hi-Fi World produces the majority of reviews in-house, using our own lab facilities and listening rooms.

FEATURES

A VINYL CLASSIC: THE GARRARD 401
We have a classic design re-built and fitted with a top arm, the SME 312. Can it beat the best?

THE GARRARD 401 TURNTABLE. 48

A history of Garrard, from clockwork to clocks and on to two of the great post-war turntables, by someone who was there. 52

How the cobwebs were dusted off the 401: we explain the rebuild. 55

STREET FORMAT FIGHT: Two newly-launched digital formats, Philips' Digital Compact Cassette and Sony's MiniDisc, are both out on the street looking for customers. Which does the consumer favour? We talk to the big retail chains. 44

MUSIC

The pick of the pack.

ROCK RECORD OF THE MONTH:

ELVIS COSTELLO & THE BRODSKY QUARTET
The Juliet Letters.

CLASSICAL RECORD OF THE MONTH:

RAVEL
Complete Works for Piano

ROCK AND POP 75

JAZZ 80

CLASSICAL 83

FEATURE:

A Soho studio session with Airtó Moreira and his Fourth World band. We talk to the star percussionist, producer Mark St. John and listen to the results on B&W's Silver Signature loudspeakers. 86

RECORD OFFERS:

Pages and pages of Pop - and Rock, and Jazz, and Blues, and Classical - all ready on CD, LP and DAT waiting to be packed off to your door.

Music never felt this good before.

You are alone with the music of your mood. Its sound takes you onto a higher plane, into another world. This is music as it's meant to be heard. The KEF experience. Superb loudspeakers; beautifully constructed for unerringly faithful reproduction. And the only colouration is of your feelings.



Featuring KEF Uni-Q technology the Reference Model 105/3 creates the perfect tonal balance, wherever you are in the room.



The experience of sound

KEF Audio (UK) Limited, Maidstone, Kent ME15 6QP.
For further information please telephone 0622 672261

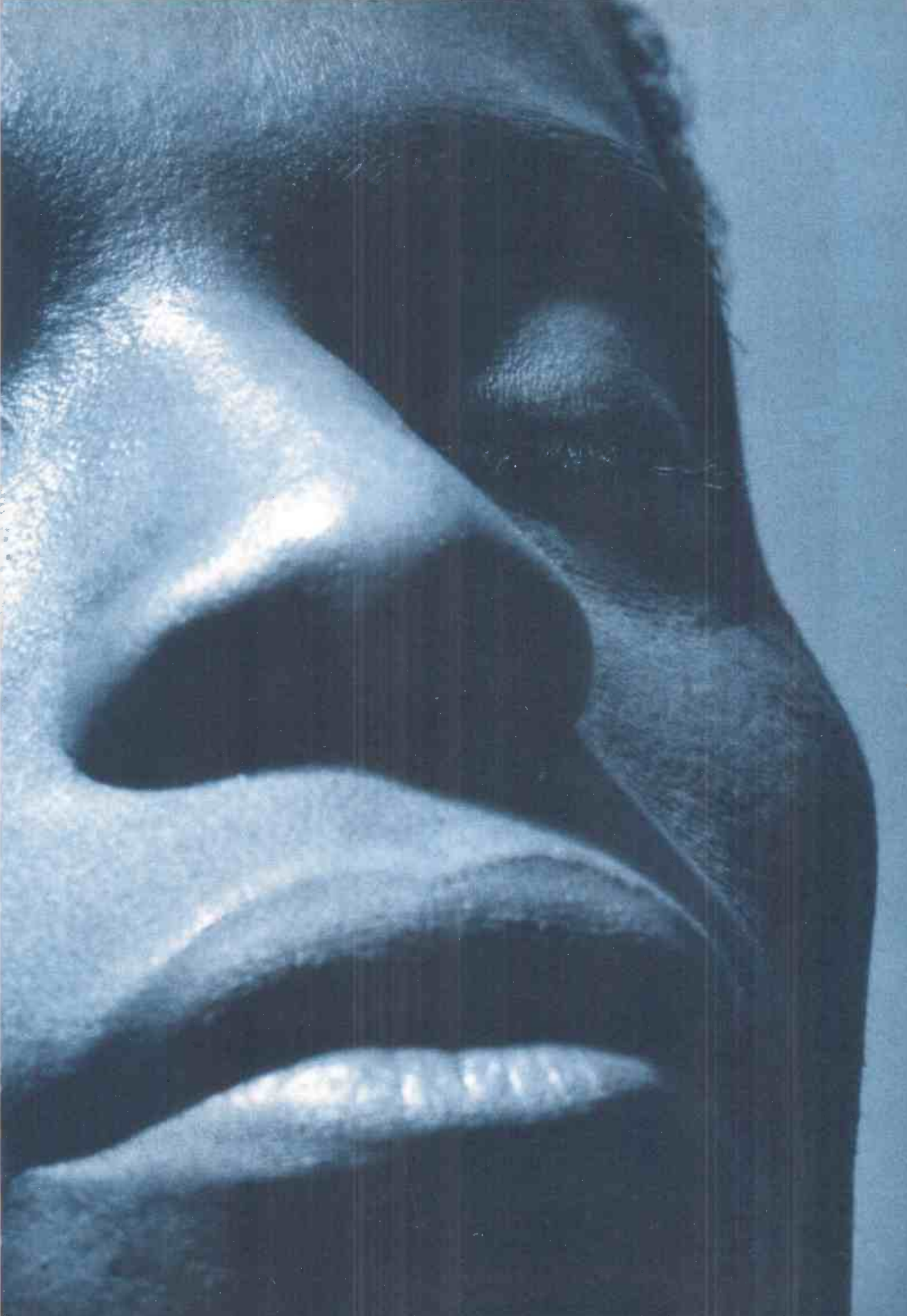

CHORD SPM 1200

AUDITION THE CHORD SPM 1200 AT ANY OF THESE HI-FI SPECIALISTS OR CALL-
CHORD ELECTRONICS LTD. 3 BOWER MOUNT ROAD, MAIDSTONE, KENT.
TEL: 0622 764874 FAX: 0622 764506

MAKE FRIENDS AT

DOUG BRADY HI-FI

ONE OF THE BEST SELECTIONS OF QUALITY HI-FI IN BRITAIN AND DELIGHTED TO DEMONSTRATE
"THE CHORD" CONTACT-

JOHN AT:
401 SMITHDOWN RD.
LIVERPOOL
MERSEYSIDE L15 3JJ
(051) 733 6859
Closed on Wednesday

ROGER AT:
THE FORGE COTTAGE
CROSSGATE
OTLEY
LEEDS LS21 1AA
0943 467689

PAUL AT:
14/18 MONMOUTH ST
COVENT GARDEN
LONDON WC2H 9HB
(071) 379 4010
Fax: 071 497 9205
Open 7 days

DOUG AT HEAD OFFICE:
KINGSWAY STUDIOS
KINGSWAY NORTH
WARRINGTON
CHESHIRE
(0925) 828009
Fax: (0925) 825773
Open 6 days

Audio Reflections *The Northern Alternative* DISCOVER ACCURACY IN HIGH FIDELITY

On permanent demonstration exclusively in Yorkshire and the North East of England—ATC, SCM10, SCM20, SCM50A and SCM100A, ATC, AV International, Castle, Chester Winchester, Concordant, Chord SPM Power Amplifiers, Equinox, Harbeth Acoustics, JPW, Kelvin Labs, Marantz, Michell Gyrodec, Michell 'ISO', the new Michell Argo Preamp., Michi, Music Link, Ortofon premier range, Jeff Rowland, Rotel, SME, Sumo, Slate Audio, Sony, Sugden, Target, Townsend. Demonstrations by arrangement in LEEDS, or in your own home without obligation. For further details contact JOHN BLEAKLEY. Phone/Fax Leeds (0532) 528850 (evening calls welcome).

Part Exchange and Second Hand Equipment available.



MUSIC MATTERS HI-FI THE AUDIO SPECIALISTS

for the most exciting range of equipment available in the Midlands which includes:

Arwa, Alchemist, Alphason, Apollo, Arcam, Audiolab, Audioquest, Audio Innovations, Audio-Technica, Aura, B&W, Beyer, Canon, Celestion, Chord, Cyrus, Dattec, Denon, Dual, Epos, Exposure, Harman Kardon, Heybrook, Impulse, Infinity, KEF, Luxman, Marantz, Meridian, Michell, Micromega, Mission, Mordaunt-Short, Michaelson Audio, Monitor Audio, Monster, Musical Fidelity, Nakamichi, Panasonic, Pink Triangle, Pro-Ac, Revolver, Revok, Rogers, Roksan, Rotel, Royd, Ruark, Sansui, Sennheiser, Shure, SME, Strahlwire, Systemdek, Target, Technics, Thorens, Wharfedale, Yamaha etc.

351 HAGLEY ROAD, EDGBASTON,
BIRMINGHAM B17 8DL
Tel: 021-429-2811

156/7 LOWER HIGH STREET
STOURBRIDGE, WEST MIDLANDS DY8 1TS
Tel: 0384 444 184

OPENING TIMES: Tues-Thurs 10.30-6.00 Friday 10.30-8.00
Saturday 10.30-5.00 Demonstration by Appointment

EST 1981 SOUND ACADEMY

THE MOST EXCLUSIVE INDEPENDENT HI-FI STUDIO

The informal atmosphere and easy access makes it so much more exciting choosing your HI-FI from the finest audio products available

YOUR MIDLANDS CHORD STOCKIST

Plus LFD, ROKSAN, AUDIOLAB, VANDERSTEEN,
ACOUSTIC ENERGY AND MANY MORE

Just off the High Street, Bloxwich,
Walsall, West Midlands

Tel: 0922 473499/493499

Ample FREE parking off M6 (junction 10)

JUST CALL IN OR PHONE RICHARD FOR A
DEMONSTRATION

London Hi-Fi Services

Tufnell Park

Call Colin Howard on
071 263 1015

Evening and weekend calls
welcome

KJ WEST ONE
26 NEW CAVENDISH ST
LONDON W1M 7LH

TEL: 071-486 8262/8263
FAX: 071-487 3452

OPEN Mon-Sat 10am-6pm
Thurs untill 7pm

PROGRESSIVE AUDIO

**CHORD 800, 1000
and 1200**

ALL ON PERMANENT
DEMONSTRATION
(BY APPOINTMENT)

call:

0634 389 004

BRENTWOOD MUSIC CENTRE

SIMPLY THE BEST HI-FI
THE BEST ADVICE • THE BEST CHOICE
CHORD

SIMPLY THE FINEST RANGE OF
BRITISH POWER AMPLIFIERS
AVAILABLE

For demonstration, phone John Rogers
on (0277) 200210

2 INGRAVE RD., BRENTWOOD,
ESSEX
TEL: (0277) 221210



MISSION NEW PRODUCTS

Mission have unveiled their new range for 1993. The famous Cyrus name is now applied to a new, shapely range comprising Cyrus III stereo integrated amplifier at £499.90, Cyrus FM tuner, £399.90, PSX-R outboard power supply at £299.90 and Cyrus 751 loudspeaker which will also sell for £299.90.

New to the Cyrus philosophy is a built-in capability for full remote control when the components are linked. Amplifier, tuner and power supply all feature die-cast chassis and magnesium alloy enclosures, the amplifier also using slit-foil capacitors, military grade components and star grounding. The new FM tuner offers quartz phase-locked tuning, fifty pre-sets and remote control, while the PSX-R automatically selects the correct output voltage for its partner. According to the literature, it should be positioned "alongside the mating product". Owners should politely avert their eyes when installing to save the Cyrus' blushes.

Mission's Cyrus 751 loudspeaker is a two-way, reflex-loaded bookshelf design, the drivers inverted in Mission's usual style. The tweeter is said to combine the advantages of metal and soft-dome, constructed from a five-layer laminate of aluminium and polypropylene.

Last but not least is Mission's top-of-the-line Discmaster CD transport and Dacmaster digital-to-analogue convertor. Initially, the two will be sold together for £1,899.90. The transport clock frequency is automatically locked to the master oscillator in the DAC.

Mission Cyrus Group, Huntingdon, Cambridgeshire, PE18 6ED. Tel: (0480) 451777.

MICROMEGA MEGA RANGE

Micromega, the French company that has become a leading specialist CD manufacturer, aim to build on their success in '93, completing their range of products for different budgets. Micromega's entry-level player, the Junior Integrated costs £374.99; top of the line is the £2699.99 Trio BS/AL Digital-to-Analogue Convertor and power supply unit. Micromega also aim to add to their MicroLine range, designed to combine performance and style.

Micromega Digital Audio Ltd, Marketing Division, P.O. Box 13, London. E18 1 EG. Tel: (081) 989 0692

CARBON CABLE

The world's first - called 'The First!' - metal-free interconnect cable has just been announced by van den Hul. The conducting medium is Linear Structured Carbon (L.S.C.) which is claimed to have purity superior to metal conductors. The construction is co-axial with 12,000 strands forming the conductor and the outer braiding woven from 38,000 strands in two layers. Finally the cables are coated in Hulliflex, a halogen-free material offering both chemical and mechanical protection. Provided as stereo pairs The First costs £169.99 for a 1m length and £139.99 for 80cm.

TEAC UK, 5 Marlin House, The Croxley Centre, Watford, Herts. WD1 8YA. Tel: (0923) 819630

Hi-Fi World brings you all the latest news from the hi-fi industry



CELESTION'S THREESOME

Latest entrant into the ever-increasing numbers of satellite-cum-subwoofer systems is Celestion's Trinity. Comprising a pair of ported bookshelf speakers with a titanium dome tweeter and new 105mm felted fibre cone main driver and with a subwoofer, total cost of the system is £248.

Celestion international Ltd., Ipswich IP3 8JP. Tel: (0473) 723131.

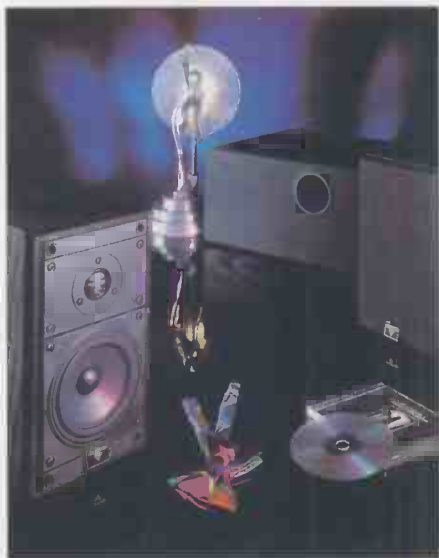

VERTICALITY

Spotted in B&W's private room at last year's Penta Show and later at Belfast, the Verticale is the tiny speaker that looks as though it intended to be a reading lamp and changed its mind. Adjustable in exactly the same way as a lamp, it uses a Neodymium Iron Boron drive unit while the partnering subwoofer is claimed to take care of the bass down to 38Hz. The satellites are magnetically shielded so they can be used near a television or computer screen.

The - very! - original shape is the brainchild of Morton V. Warren, who created the 'Solids' People who want speakers that look like the Martians' mode of transport in The War of the Worlds should contact: Rock Solid Sounds Inc., a division of B&W Loudspeakers, Tel: (0903) 750750.

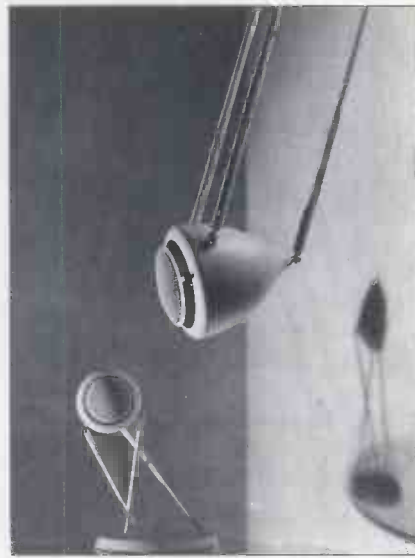

QED CONTROL FOR THE REMOTE ROOM

QED's Roomlink Solo allows any infra-red controlled hi-fi system to be extended to full-remote control throughout the home. A free-standing terminal receives infra-red signals from the original equipment's handsets and relays the commands via a thin wire to a tiny transmitter which sticks to the receiving window of the tuner, CD player or whatever. The system, including power



supply, transmitter, terminal and connecting wire, costs £99.95. QED Audio Products Ltd., Ridgeway House, Ridgeway Close, Lightwater, Surrey GU18 5XU. Tel: (0276) 451166.

MINETTE

Richard Allan Audio have just announced their launch of their Minette 2 loudspeaker. At £120, this entry-level ported design includes bespoke features such as special inductors and a paper cone bass unit which are designed and manufactured in house! The speakers also employ a ferrofluid-cooled polymer tweeter and are available in a Black Ash finish.

Richard Allan Audio Ltd, Bradford Road, Gomersal Cleckheaton, West Yorks. BD19 4AZ. Tel: (0274) 872442

DENON DATA

Flushed with the success of the TU 260 budget tuner, a Radio Data System equipped tuner priced at £199.99 has been sprung on the market. Of the various RDS functions, the remote-controlled TU 580RD will display station name and search for particular types of programme being transmitted. Thirty presets are offered for FM and MW, along with auto-scan and manual tuning.

Hayden Laboratories Ltd., Chiltern Hill, Chalfont St. Peter, Gerrards Cross, Bucks. SL9 9UG. Tel: (0753) 888447.



COLOUR ME RED, BLUE, GREEN . . .

Goldring's new Soundstyle Tripod equipment stands are available in half-a-dozen rich colours. The triangular shaped shelving system utilises black-tinted glass shelves and can be extended with additional shelf modules. Colours are Rock Red, Opus Green, Sonata Blue, Concert Blue and boring grey and black. (Sony: Symphony Grey and Classic Black.) Price is from £180-£200 including VAT.

Goldring Products Ltd., 8 Greyfriars Road, Bury St. Edmunds, Suffolk IP32 7DX. Tel: (0284) 71101.

GARRARD ON THE SLATE

Slate Audio have announced their Green Monster, a solid marble plinth for the Garrard 401, which they claim guarantees the elimination of motor noise, rumble and feedback and costs £349 plus £25 for UK mainland freight. This monster comes complete with full instructions and tweaking advice and adds to Slate Audio's range of Garrard accessories for both 9" and 12" arms.

Slate Audio, 47 Gemini Close, Leighton Buzzard, Beds. LU7 8UD. Tel: (0525) 384174.

IN BRIEF

RAM WIN DUAL AGENCY

RAM U.K. Ltd. are importing Dual into Britain and expanding the range of electronics and turntables with televisions built in Europe and designed for the audio enthusiast. RAM U.K. has agreed to honour all outstanding warranty obligations on Dual products and intend to launch an owners' club and free newsletter. Dual owners can register by writing or phoning:

RAM U.K., Unit 27, Stretford Motorway Estate, Barton Dock Road, Manchester, M32 0ZH. Tel: (061) 868 8101.

MORE FROM MICHELL

Following on from the highly regarded Iso moving-coil cartridge amplifier, the Iso HR should be available in the shops by the time you read this. First listening - we will be reviewing it soon - suggests that its suffix, standing for 'High Resolution' means exactly what it says. Price is £850, including a dedicated Hera power supply. Following soon will be an Argo High Resolution pre-amplifier in acrylic and an Alecto stereo power amplifier.

Michell, 2 Theobald Street, Borehamwood, Herts. Tel: (081) 953 0771

MORE NEODYMIUM FROM MOREL

A small 4in woofer, also with a Neodymium magnet, joins Morel's recently launched tweeter. Boasting a 2.125in diameter Hexatech voice coil with claimed power handling in excess of 150W, details and prices are available from:

Clere Electronics, 24 Swan St., Kingsclere, Newbury, Berks. RG15 8PN. Tel: (0635) 298574; or:

Morel (U.K.) Ltd., 11 Foxtail Road, Nacton Road Industrial Estate, Ipswich, IP3 9RT. Tel: (0473) 719212.

SPENDOR SOLD

Spendor have announced that the whole of the issued share capital of the company has been acquired by Soundtracs plc, manufacturers of Audio Mixing Consoles. Founded by Spencer Hughes in the Sixties, Spendor was carried on after his death by his wife Dorothy and son Derek, who will continue as Managing Director for two years. Todd Wells, Managing Director of Soundtracs plc will become Chairman and Chief Executive of the loudspeaker company.

MISSION MOVE INTO MAJOR'S HOME

Mission, whose home is in John Major's constituency, have installed an all-British hi-fi system in 10 Downing Street. Sources are a Revolver turntable from Warrington, a Mission CD5 CD player/DAC combination and Cyrus tuner. The amplifier is a Cyrus Two with PSX power supply and the speakers Mission 753s. Leads and connectors were supplied by Beverley Reynolds of The Audio File in St Ives, the only hi-fi shop in the Prime Minister's constituency, while equipment stands came from The Stands Firm of Loughborough and CDs from Covent Garden Records in London.

ROKSAN MOVE

Roksan Engineering plc transferred its business to Roksan Digital Ltd - which will be the company's new name - at the end of December last. Roksan's return to London, after moving out to Wales in 1988, is now complete, with the new factory near Heathrow Airport occupied.

Roksan Digital Ltd., Stockley Close, Stockley Road, West Drayton, UB7 9BB. Tel: (0895) 436384.

QUAD AND THE KEYBOARD

Quad are sponsoring a number of keyboard recordings on the Isis label. The series will feature authentic instruments particularly relevant either to the composer or the music. First is a CD of Handel's Suites 1-5, performed by Martin Souter on a harpsichord made by William Smith in 1720, now in the Bate Collection at Oxford and reputed to have been owned by Handel himself. Forthcoming recordings in 1993 will include a recording of Purcell on the earliest known English two-manual harpsichord.

The classic Quad ESL-63 loudspeaker has been awarded the Stereophile Product of the Year Award by the U.S. magazine, Stereophile in its guise of USA Monitor. We would recognise it as the ESL-63 Pro, minus the handles.

Quad Electroacoustics Ltd, Huntingdon, Cambs. PE18 7DB. Tel: (0480) 52561

Isis Records, 2 Henley Street, Oxford, OX4 1ER. Tel: (0865) 726553.

GOODMANS PAID UP

Goodmans Industries, the consumer electronics group formed after a management buy-out in February 1991 has completed its repayments to TGI, its original parent company three years ahead of schedule. With a turnover of £38 million, Goodmans reckon they are the largest privately-owned UK company in the consumer electronics business.

A NEW STAKE IN DIGITAL

Rumour has it that a DAC will soon be joining Select System's Frankenstein Compact Disc replay enhancer. We know it's April, but we hear it will be called the Dacula (!) all the same.



SHOWS

The Fifth Annual Chesterfield Hi-Fi Show is scheduled to take place on Saturday 17th and Sunday 18th April '93 at Ringwood Hall, Brimington, Chesterfield, Derbyshire, just off Junction 30 on the M1.

For further details, contact David Rusby, Wentworth Audio, Coley Lane Farm, Wentworth, Rotherham, South Yorks. S62 7SQ. Tel: (0709) 873667.



World



COLORATION I

Over the years I have made some interesting observations on the colour of the cabinets used for hi-fi equipment.

When I purchased my first separates in 1972 everything was in a wood veneer cabinet, often with an aluminium front panel. When I upgraded in the early Eighties, almost everything was boxed in silvery metal, although there was evidence of a matt black metal finish creeping in. The strange thing was that at the time cameras were also changing from a silvery finish to matt black. By the start of the

Nineties, all hi-fi equipment seemed to be encased in matt black.

Recently I have noticed that TVs and video recorders are being cased in a new shade of dark grey matt finish. Strangely enough, my new camera is the same colour. When will hi-fi equipment follow suit?

In the TV, video and hi-fi fields I cannot help think the change of colour is used as an incentive to persuade people to upgrade. I understand there are some people who actually look for colour co-ordinated boxes of electronic wonders and do not

worry too much about how effectively they work. Who are these people, and do they read Hi-Fi World? I hope not!

Incidentally, I wonder what the next fashion in cabinets will be - see through, white, or even a design to co-ordinate with curtains and wallpaper?

**Alan Mason,
Nottingham.**

Suddenly struck by the proliferation of curves appearing on various Japanese companies' hi-fi components, I once asked several if there was a kind of concerted agreement about the

shape - or colour - for any one season.

They all said not - it was just coincidence. If it was, as you point out, there have been a lot of coincidences over the last decade or two!

One reason for the demise of wood was the increasing expense of the real thing; though in the Sixties, Trio did clothe an amplifier and tuner's aluminium case in a very nasty sort of fake walnut Formica, which fooled nobody. The reasons why charcoal grey has suddenly become the current

I read Dominic Baker's article on DCC, MD and DAT with great interest - can I add a few thoughts of my own?

While DAT is undoubtedly attractive to audiophiles as a recording format, it isn't attractive to the recording companies as a mass market replacement for the analogue tape. Firstly, the mechanical complexity of the rotating head used to read the digital data means that the price could never fall to mass market levels (£150 - £250 for separate tape decks, much lower for decks incorporated in package systems); secondly DAT uses metal powder tape which becomes unstable above 45 Celsius, thus making it unsuitable for use in motor cars which can reach 90 Celsius in the summer.

The big problem for audiophiles who don't mind these drawbacks is the lack of software. Basically there isn't any, and the few pre-recorded DAT tapes are very expensive, £20 or so.

DAT was, and is, a terrific idea which should have succeeded but didn't mainly because the record companies blocked it, due to fear of mass CD copying. By the time SCMS was agreed, DCC was on the horizon and DAT's chance was gone.

It strikes me as ironic that Philips are offering us a second

rate version of DAT, in the form of DCC, and we are supposed to be excited about it. Well, not me! DAT spools much faster, has the potential to make higher quality recordings and play back pre-recorded tapes with greater fidelity, offers up to four hours uninterrupted recording time in long play mode (no end of side break with auto-reverse like DCC), and to cap it all, is, at present, cheaper than DCC - £450 will buy you a state of the art DAT recorder from Sony.

I don't usually make predictions about what consumers will opt for - it's too easy to make a mistake. But, I will break my own rule, and make a prediction about DCC: it will fail! And I don't mean that it will gradually lose the format war to Sony's MD over a period of several years. I mean it will not take off at all, sink like a stone (like Philips Video 2000 or the Sony Elcassette), and the general public will be totally uninterested in it. I know for a fact that DCC is not selling at the moment - the biggest hi-fi retailer in Bristol, Paul Roberts has not sold a single DCC900 in any of its three branches. MD, on the other hand, is selling; not in vast numbers, because Sony isn't producing them in vast numbers, but the Bristol Sony Centre sold out of

MZ-1s on the first day of release (it only had a couple in) and demand is exceeding supply. DCC offers few sonic or convenience advantages over analogue tape, not sufficient to persuade customers to part with £500.

Having made this prediction about DCC, I am not going to predict that MD will succeed. There are still a few obstacles to overcome before anyone can say that MD is a sure fire winner, such as short battery life, unresolved sound quality, and the cost, which is far too high at present.

Why have Sony launched MD? The main reasons are that CD is not quite a portable medium and it won't record. (CD-R is ruled out as a mass market replacement for tape, because of its inability to re-record).

What I want to know is this: why can't a full sized machine be designed to record either on to a 2.5" MiniDisc using Sony's ATRAC data compression, or onto a five inch disc without it.

Granted, the portable MZ-1 loads a MiniDisc in a different

way to a CD player's drawer mechanism, retaining the disc in a protective case to help protect it from fingerprints and scratches, but does this rule out a dual recording capability on a full sized magneto-optical player?

I suspect the reasons for Sony not adopting this are not purely to do with extra expense, and are more to do with the fear of damaging CD sales, especially now that they own CBS. Sony are reluctant to even imply that MiniDisc can make near perfect recordings from CD. Sanyo proposed such a system.

Am I asking too much of Sony, or is this something that audiophiles and hi-fi critics should push for? I hope you will discuss it, perhaps even get in touch with Sony and see what their reaction is.

I am certainly suspicious of data reduction; I would happily pay extra to get higher fidelity recordings.

**Julian Osborn,
Westbury-on-Trym,
Bristol.**

I am as uncertain about the

Letter of

Send your letters to: Hi-Fi World Letters Page,

writes

flavour are obscure, but attempts at bright colours in hi-fi - or television, for that matter - nearly always seem to have failed. It seems the consumer votes with his or her feet unless the hi-fi lurks gloomily and anonymously in the shade when it's switched off. Even Quad, who stuck to their 'bronze' colour for three decades finally succumbed and turned grey, it's said because that was the colour the American market preferred.

I recall that some years ago Wharfedale experimented by painting several examples of the

same loudspeaker different colours. As you might expect the results corresponded to what psychologists would tell us about the effect of colour: the red ones sounded too warm, the blue ones too cold.

In the past, transparency doesn't seem to have fared too well either; I remember various perspex amplifiers and even speakers which didn't last. People don't seem to be attracted by visible innards. The notion of wallpaper-covered hi-fi might not be too far-fetched; at the Penta Show last year one exhibitor was demonstrating a

pair of speakers finished in a kind of Laura Ashley flowered print. It doesn't seem to have caught on. **EB**

TA, TANNOY

I am very grateful to Mr Weller of Tannoy for his comments on my query in your January 1993 issue. The Tannoy 605s are an excellent speaker. My stands are balanced to Tannoy specifications and are fitted with spikes and plastic sand bags with Bluetak, etc. My budget JVC R-533L has always sounded soft, silky and warm in my listening room; reviewers point out that

WIN FURUKAWA FA-2010 BALANCED ANALOGUE INTERCONNECT CABLES

(1 metre pairs)

The writer of the most interesting or funniest letter will receive a free set of Furukawa FA-2010 "balanced analogue" interconnect cables, worth £95.



the 605s are stand-sensitive and it's difficult to find their optimum performance. I would suggest using four small 'peas' of Bluetak

The Month

outcome of the current confusing situation as you are. It appears to me that in trying to manipulate the market to suit their own ends, both the music biz. and the electronic giants are going badly wrong. The recent assertion by W.H. Smith that music sales are in decline because of overpricing seems to set the seal on this view, one I know is held by many of our readers - and perhaps a majority of the once-buying public.

Just before its launch in 1987 I thought that DAT would prevail over all else. Looking back on events since then has been an education, even if the lesson seems to be that making predictions based on a manageably finite number of facts is a dangerous process. Such predictions can be dramatically overturned by unforeseen and unforeseeable events. I won't be making any more!

However, I maintain now as I did then that people simply want to listen to and enjoy music and that the carrier must be subservient to this purpose. I see no reason or justification for the existence

of more than one carrier, and that one must be "dual-role" - it must record and replay, just like the cassette. It was mainly because DAT fulfilled these requirements that I believed it would succeed. As you say, it didn't succeed because it was held back for commercial reasons.

If I am right, then in a simple world, no more single-role media would be introduced and those in current existence would die out. In other words, if we had a good dual-role medium to replace them, the CD and LP would wither away.

But we don't. Now we have no fewer than five dual-role mediums (cassette, DAT, DCC, MD and CD-R), all with their own particular and peculiar advantages and disadvantages. The new ones seem over priced and under-needed. I was taken back to see pre-recorded DCC tapes and MD discs priced at £13.49 in the shops. Phew! These people don't learn. Doubtless, blank DCC tapes, which contain inexpensive video tape, will be priced at around £5 -

an unjustifiably high price, double that of a good metal cassette. I wouldn't be surprised if both DCC and MD failed.

Listening to what people not involved in hi-fi say to me and, especially, reading the steady stream of letters we get on this subject from readers who, I believe by definition are right (because, overall, they are 'the market'), I suspect that high pricing and general confusion will severely affect both DCC and MD sales, to the point where both may, like DAT, become moribund technologies.

Like you and other readers I find the proposal for putting high quality audio onto a large recordable disc, accompanied by a smaller 'portable' version containing lower quality data-compressed material, an interesting one. Two disc sizes would be needed, the smaller one having its content data-compressed. A domestic hi-fi recorder would have to be able to record onto the small disc using data compression, and onto the large one without it, preferably using an 18-bit or even 20-bit level description and a higher sampling rate so that a true advance in fidelity is offered. As we understand it, Decca Studios, with whom Philips already co-operate on sound quality assessment, already have a minimum

specification for high quality audio that excludes 16-bit, so the knowledge and experience to guide such choices already exists.

Problems? A conventional 5in recordable CD wouldn't be big enough to accept a digital format of higher specification than the current one. Discs of 8-10in would be needed, making CD obsolete, unless today's CDs could be read as well. Shops would need to stock two pre-recorded disc sizes: small/data compressed for portables and large 'hi-fi' versions for home use. This wouldn't be much of a problem if the cassette died, making shelf space available.

A two-part format of this nature is what Sony are, in effect, currently proposing by having MDs and improved-quality ('bit-mapped') CDs on offer, but their solution is cobbled together. It lacks inter-machine compatibility and a sufficiently large distinction in sound quality to justify the existence of the larger format. Philips were to introduce the CD-E, a recordable CD using magneto-optical technology, but whether they will amongst the current confusion remains to be seen. The CD-E would offer no improvement in sound quality over CD and it wouldn't be portable either, so I cannot see any great strengths. **NK**

64 Castellain Road, Maida Vale, London W9 1EX.

on the small 'bumps' on the underside of the loudspeakers to hold them in place, because if using the bolts tightened to the stands it will affect the sound quality of the system if using older equipment. I did appreciate your comments in Jan. '93.

**Paul Rowe,
Camborne,
Cornwall.**

THERMIONIC FRIEND

I am sorry to have given you the impression (Letters, October issue) that the valve is dead, or should be. Let me assure you that such is not the case. I maintain a keen interest in this technology and its application in sound reproduction, as I have done for more than half a century.

I must confess, however, to mild astonishment that devices bearing type numbers last heard of in my extreme youth have not only been resuscitated, but are definitely high end! Plus ca change, indeed.

But as you say, modern technology has given us greatly improved components, hence my suggestion that the inter-valve coupling transformer might be revived. I think, though, that it is a pity that the valve itself remains much as it was many decades ago. Had Shockley ('inventor' of the transistor) not achieved his goal I believe that we would now be using amplifiers built around a single 'thermionic device' containing all the electrode structures and many of the components (capacitors, resistors) necessary to process the signal from input to output, and in which the problems of heat dissipation, mis-matching with age etc., would be resolved. But is there now sufficient market pressure to drive such development?

Your statement that the best valve equipment is superior to its solid-state equivalent I believe to be true, and indeed there is an element of mystery here. The explanation may lie in the basic differences between the two technologies. When I first began, as a very young man, ignorant of all but the very essentials of physics, to study valve theory, I found that every explanation could be clearly understood and the interaction of the devices with resistive and reactive components seemed to follow quite naturally.

Later in life, as a qualified engineer, alas, solid-state theory did not follow this logical path! When designing analogue solid-state circuitry, empirical methods and experimentation seemed to be mandatory, a state of affairs

never experienced with even the most complex of valve circuits.

I think that the answer somehow lies in the nature of the two paths followed by the signal. Resistive and reactive components are common to both technologies, but in the one case we have that virtually unpolluted near-vacuum, and in the other a tangle of silicon (impure!), doping, and Lord knows what else.

Is it too much to hope that perhaps one per cent of the enormous effort put into solid-state development might be sidetracked into the improvement of our ancient thermionic friend? Yes, of course it is, but who knows what T de P might come up with?

**Norman T. Butler,
HarrowWeald,
Middlesex.**

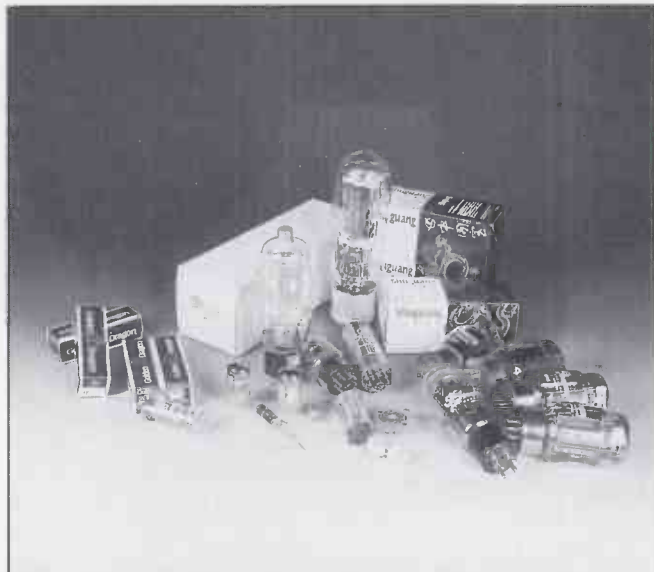

Should we have developed the "unpolluted" valve instead of a "tangle of impure silicon"?

GARRARD REVIVED

I was pleased to see that I am not alone after reading D. B. Conell's letter in the January issue. I too have two turntables, both in regular use next to each other. Both were bought two years ago to replace a Fons CQ30 which had a 78rpm plus variable speed facility. Its replacements are a Pink Triangle Export and a Garrard 401, both sporting Rega/Moth RB250 arms and Arcam P77 cartridges. The Garrard was bought primarily to play 78s on, but I was so surprised at the quality that it is used for vinyl as well.

Having the same arm/cartridge combination allows very close comparisons to be made and the two are surprisingly close. The PT has the edge, music is more detailed and secure, although the Garrard is in an unfinished chipboard plinth

which is due to be replaced with a properly isolated MDF unit.

Both units sit on Sound Organisation turntables.

The rest of the system is very modest compared with R. B. Conell's so it is possible that the differences between the two could be greater. I do urge you to review a 301, but with a modern arm and cartridge; I am sure that it will push the prices higher, which will be a shame as I want to complete the set. (I have a Garrard 201 as well.)

**Richard Zaryioszcz,
Reading,
Berks.**

No 301 review - yet! - but in response to a series of pleas from our readers NK climbed into his attic, dusted off his 401 and had it refurbished. The results are on p48. EB

pair of Spendor BCI loudspeakers; all these from 1980.

I have been contemplating refurbishing my 301 turntable with a new idler wheel etc. because I am satisfied with the reliability and although my LPs are not producing 'hi-fi' (I have not bought vinyl for about fifteen years) the Ortofon cartridge makes them sound very pleasing between any snap crackle and pop!

Thirty-five years ago I witnessed a recorded (mono) recital of music, compared, on the spot, with the same musicians 'live'. That was the closest approach to the original sound (thanks, Quad!).

Now, thirty-five years on, many people are still trying to get (near) perfect (natural) sound from their equipment! One cause for the disappointment when playing CDs is that the recording engineer, in many cases, has to produce the overall sound that the Record Producer wants. This must be so, because, so many CDs have reviews which comment on poor sound balance, and if the engineer had full control we would be receiving better sounding discs.

The change from LP to CD was too drastic as far as acoustic and silent background is concerned.

About ten years ago, some digital vinyl LPs were issued, but not many. If we had had a few years of all LPs being digital, then when progressing to CD our ears would have been more 'in-tune' with the new medium.

Back to my hi-fi set-up. During the last three years I have added a CD player and cassette deck and I am very pleased with it all, especially as (generally) it is the source which is at fault.

Refurbishing older items of equipment is really worthwhile, especially if it is 'quality' equipment (no names!).

**John Hone,
Epsom,
Surrey.**

By and large, I entirely agree, and thanks for the compliment. We're quite a civil lot here, you know; but I know what you mean about "You have a what!!!" answers to readers.

Our rule is simply "If it's good, it's good" whoever made it or however old or unfashionable it is. Lest people run away with the impression we're going to abandon current product altogether in favour of cobweb-festooned hi-fi, that's not the case. We just thought we'd let the odd ray of sunlight into the

Continued on page 24...



TWO'S COMPANY

French company Micromega's Duo CD2 transport and Duo Pro convertor come under the scrutiny of Dominic Baker.

For many years now Micromega have enjoyed close links with Philips. Perhaps it's because, being a French company, Micromega are simply closer geographically, as well as in their commercial relationship. They have benefited by getting Philips' high quality CDM-9 Compact Disc mechanism in four of their current line up of transports. Not only is it the latest generation, but it is reputedly the best yet - and it is used in the Duo CD2 transport reviewed here.

Whilst many British manufacturers are struggling to incorporate the specialised CDM-9 in their latest players, Micromega have quietly been using it for some time. Above the CDM-9 however, lies the little heard of CDM-9 PRO. I think I am right in saying that Micromega are the only company using this sophisticated variant. It can be found in their Trio transport, as well as the Duo CD2 transport.

Philips' CDM-9 PRO is a massively engineered and precision built metal chassis version of the standard plastic CDM-9 mechanism. It is non-magnetic and so specialised that those wishing to use it must design their own control circuitry rather than use the Philips board supplied with the standard CDM-9. So the control circuits of this transport have been designed by Micromega, not Philips.

Exemplary Build

Internally the Duo CD2 is nothing short of exemplary in build quality. The CDM-9 PRO mechanism is bolted to an unusually thick metal plate and, generally, the construction of this player seems over generous. Although damping is used, the metal of the CDM-9 will tend to ring. Since mechanical motion would interfere with the tracking of the disc and laser head Micromega have applied a number

of solutions.

Firstly, the transport is heavily damped and even has a 5mm thick piece of high density Perspex on the base plate.

Secondly it employs Micromega's unique energy-sink technique for removing unwanted energy which is channelled downwards from the mechanism, where it originates, through various metal coupling components into a 'sink' - a heavy slab of granite. The granite acts also as an attractive and stable base for the player.

The Duo CD2 possesses both a coaxial electrical output via a WBT phono socket and an optical output. Micromega recommend Sterling mains cables, digital interconnect and audio interconnect for use with their players, another indication of their attention to detail. The front panel is fairly bland, possessing a simple four digit display, plus basic disc operation controls in the form of pressure pads.

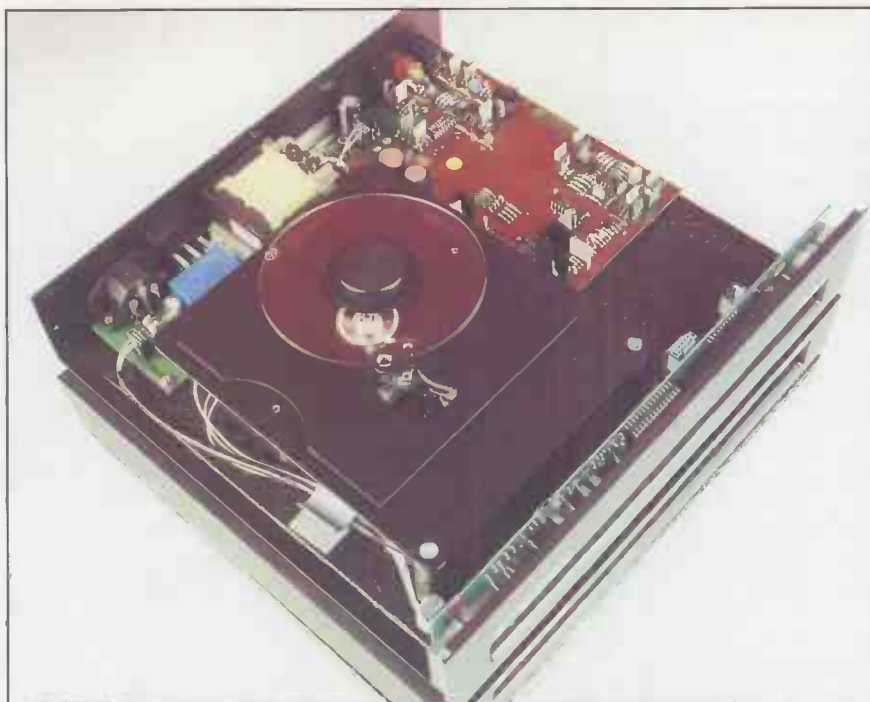

A top-loader, Micromega's Implementation of Philips' CDM-9 PRO 'Engine' requires a perspex plate and puck to be fitted over the CD.

Functional would best describe its appearance.

As can be seen from the picture the Duo CD2 is a top loading player. The disc is, unusually, perched on a small hub, just 3cms in diameter. It is held down by a heavy puck, placed on top. This also serves to damp disc vibrations with a clear perspex disc that covers the CD. As if this wasn't enough, Micromega use a thick clear perspex lid that closes firmly over the disc to eliminate acoustic vibration from the loudspeakers. This is one of the great attractions of the CD2. I find nothing more unemotional than watching a disc disappear into an inert black box, tarted up with flashing lights. You get some of the hands on, eyes on, enjoyment that spinning vinyl gives to an audiophile junky and I suspect this factor accounts for many Micromega sales.

The Duo CD2 transport was supplied with the new Duo Pro digital converter. The Duo CD2 costs £1850 and the Duo Pro convertor £1050, bringing the total price to £2900. This however does not include a £535 price tag for the granite slab and recommended mains leads, digital link and interconnects. These items bring the final price up to £3435.

The Duo Pro convertor uses a development of Philips' SAA-7323 convertor chip which overcame the noise problems of earlier versions. A pair of these are used in differential mode, one per channel. The convertor has two coaxial electrical inputs and two optical inputs. It also has a coaxial and optical output for digital recording. Separate Record and Listen selectors are provided, so the Duo Pro can function as a digital record monitor. It automatically determines the correct decode frequency, which is then displayed on the front panel.

Absolute phase can be inverted using a front panel button. Quite whether this

produces any audible effect is open to debate; some claim it does, others that it doesn't. It causes a drum to push, instead

"the sound just opens out and layers of intricate detail reveal themselves"

of pull, for example, meaning the ear first receives a positive pressure wave, as it would with a real drum, rather than a rarefaction wave.

Inside the Duo Pro Bitstream convertor.

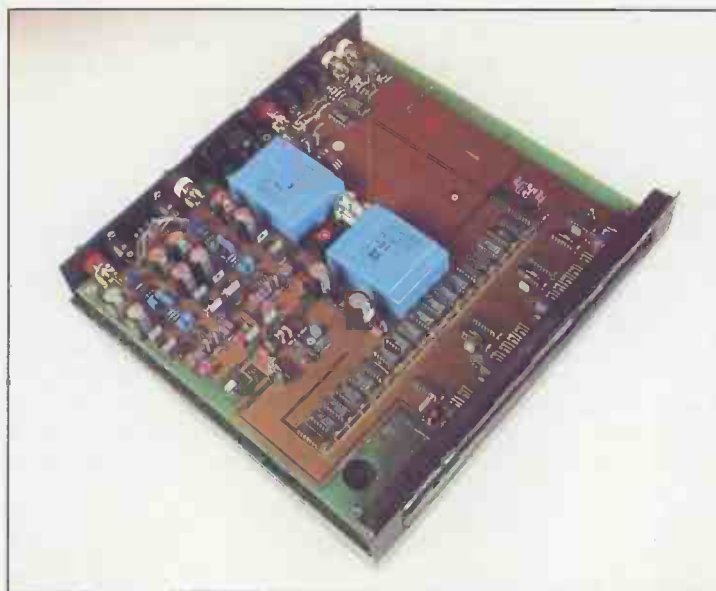

The Duo Pro convertor has the same width and depth dimensions as the Duo CD2 transport, so it can be placed neatly below it. The spiked foot of the transport rests on a metal column that runs through the Duo Pro to a spike below so that the energy sink path remains intact.

Listening to this player, I was immediately struck by its strong and forceful bass. I swapped back to my normal Teac P500 Esoteric and sync-locked Bigger Bit, which admittedly cost a lot less, to confirm the observation; I wasn't mistaken. Bass lines appeared where before it seemed there was little more than a hint of their presence. They had good control as well. Bass guitar on REM's track 'Low' was sharp and hard edged, possessing real attack, where on lesser players it would sound a little loose and floppy. It was also very tuneful. Rather than being assigned a small area to play in, bass lines seemed more freely to scale up and down a wide range, bringing a strong sense of true extension.

I found the granite slab plays an important part in the operation of the Duo CD2 transport. Placing the system on the shelf of a hi-fi stand, without the granite, mars image focus and weakens some of the impressive bass control. This indicates that Micromega's theory on sinking energy into a high mass material works very well. I could not obtain a thick piece of slate for comparative purposes, which was a pity because I'm sure this would bring about further improvements to the performance of the transport. It could well be a cheaper, better material for sinking energy into.

Over the rest of the music spectrum some may describe the Micromega's sound as cold, but I prefer to label it as cool. Whichever way, it is certainly not warm and favours the accurate rather than euphonic approach to music. Some CDs could sound distinctly unpleasant though; the Micromega was revealing the poor quality of the recordings.

This could be regarded as a point against this player, until a well recorded CD is played. Then the sound just opens out and layers of intricate detail reveal

themselves in a clear and uncluttered manner. Vocals are sharply etched and project forwards, strong in emotion; the treble is delicately and positively played.

I heard a character and richness within Suzanne Vega's voice on her first album that had never flowed through so freely or expressively. It seemed as if she had stood to sing into the microphone, to get power and projection into her voice, rather than sit and sing limply. It was a change of delivery, a strengthening of her voice that I appreciated from the Micromega. The steel guitar strings sounded like steel guitar strings, sharp and piercing and with all the reverberation and resonance of the instrument becoming clearly apparent.

An array of input and output options.

Micromega's Duo Pro DAC offers tape monitoring and balanced outputs, as well as optical and coaxial inputs.



MEASURED PERFORMANCE

The Micromega Duo Pro DAC uses two specially selected SAA7323 digital convertor chips, one per channel, in differential mode. The SAA7323 was introduced by Philips about two years ago to replace the SAA7320 and SAA7321 and offers the low noise floor of the former without "idle pattern" noise in the audio band. Since then Philips have introduced both the SAA7350 and DAC7 (TDA-1547) which gives an indication of the rate of progress of CD. The use of this relatively old Bitstream chip reflects Micromega's policy of using technology they are familiar with and can trust, rather than jumping to a new technology they are unsure of.

The frequency response we measured was very characteristic of the 7320 series of chips. It is generally flat up to 5kHz where it starts to fall, rippling its way to 20.7kHz where it finally falls sharply off. This drop from 5kHz to 20.7kHz is actually only 0.25dB or so but in practice when amplified is usually quite audible. The rippling effect as the response falls will not be so easily noticed because of the limited amount of information at high frequencies.

The distortion figures are all quite low, measuring 0.008%/0.014% at -30dB for the left/right channels. These are not the best figures ever but are certainly very respectable for the chips used. At least their distortion pattern doesn't have the horrible inharmonic distortion spectrum of the Philips SAA7350 chip, caused by over-sampled noise appearing in-band. Separation figures are not particularly spectacular, being if anything a little below average.

On the -30dB distortion plot below it can clearly be seen that the noise floor of the chip is quite high, lifting the plot up from the bottom of the screen. Thus the noise figures with and without emphasis are both quite high, being 20dB or so higher than the better measuring CD players on the market. Because of this, dynamic range is also slightly limited but is still plenty wide enough to reproduce music with no problems.

The Duo Pro is competent rather than exceptional in its specification which is as would be expected from a DAC using relatively old conversion chips. However, if Micromega know these chips as well as they

claim then what they have built should provide a long and trouble free life, which is important to someone paying this much for a CD player. **DB**

TEST RESULTS

Frequency response 4Hz-20.7kHz

Distortion		
-6dB	0.005	0.005
-30dB	0.008	0.014
-60dB	0.55	0.57
-90dB	30.4	30.1
-90dB dithered	8.3	8.3

Separation	left	right
1kHz	107	107
10kHz	98	98

Noise	-107dB
with emphasis	-108dB

Dynamic range	104dB
Output	2.2V

Frequency Response

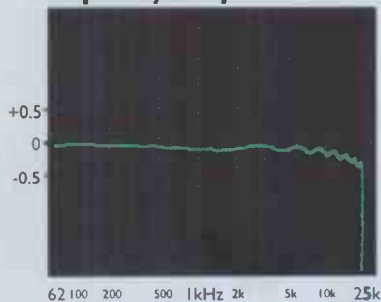

Characteristic h.f. ripple of 7320 series.

Distortion

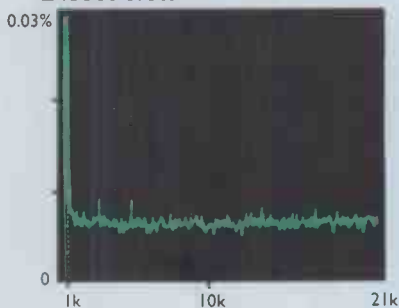

Small amount of odd order distortion.

The Micromega has a spacious and dynamic presentation. Even with the most complex of recordings it would somehow manage to sort out the strands, presenting complex music in a detailed and informative manner. Instruments were separated properly and each could be easily followed through the performance. And it was not only the leading instruments that could be followed with ease, but the layer below could also be picked out and closely inspected, revealing with analytical precision the composition of a performance.

If any area of the Micromega could be picked out for criticism it would be the smallest hint of midrange coarseness and a lack of expression in the extreme treble. I'm sure I have become more sensitive to mild grittiness through the midrange since listening to the very lucid mid of sync-locked players. In the Micromega's case this was very mild, but still noticeable if you are used to the few alternatives superior in this respect, if not in others.

A Potential Reference

The extreme treble was a little lacking in truthfulness, making the distinction between, say, two different makes of cymbal a little harder than with some other top flight convertors. One combination I would love to try would be the Duo CD2 transport with the Pink Triangle DaCapo convertor. This combination, from what I have heard of each individually, has the potential to be a reference for all others in terms of accuracy and drama.

The Duo CD2 transport and Pro convertor from Micromega offer excellent build quality and a sound quality to match; they rate high on my list of ultimate CD players. But perhaps this isn't surprising. Their close relationship with Philips has given them an enviable technological edge. Before Philips have launched their own audiophile CD transport before the rest of the world has learnt of it, Micromega have incorporated the unit into a superb transport, the Duo CD2

Mike Creek is a classic independent designer, free to alight quickly on updated technologies and new methods for their application. From him and others like him, the promise is of something different, new and better - an alternative to the stultifying product range 'upgrade' that's really just a piece of marketing strategy. Would his new Crystal digital-to-analogue convertor (DAC) for Compact Disc spring a surprise? We had been waiting and hoping that his use of a new chip set from the U.S., cossetted in carefully designed support circuits, would bring a better sound from CD.

Our anticipation wasn't misplaced. The new EMF Crystal convertor, priced at £500, brings - literally - interesting new dimensions to the medium. It's the dimensions of sound staging I'm thinking of, but this unit's physical dimensions aren't so unattractive either.

Big Sound, Small Box

Here's a big sounding convertor wrapped in a small box. The Crystal is housed in a steel case measuring 216mm wide, 220mm deep and 72mm high. It is compact enough to slide into spaces too small for much else other than those odds and ends that gather around a system, notably Blu-tak. The chromed front panel carries a rotary input selector and, unusually, a volume control. The latter feeds a 'variable' output that can be taken direct to a power amplifier, making a preamp unnecessary in a simple CD-only system based around the Crystal. There is the usual fixed output giving Philips' specified 2V of signal, plus one optical and two electrical digital inputs. Three front panel LEDs add some colour to the chrome face: one is a red power indicator, the others show when muting and de-emphasis are working.

Since CD was introduced its

▶ **A small box with a big heart. One of the Crystal chips from which the new EMF DAC takes its name is visible just beyond the toroidal transformer.**



CLEAR AS



technology has been rapidly improved by fruitful competition between Philips, who invented the medium, and Sony who helped develop it. Other Japanese chip manufacturers have joined in, adding to the pool of available silicon chips that CD is based upon, due to the sheer weight of specialised signal processing it requires. They have been joined by the American company, Burr Brown, who have got their high performance sixteen-bit chips into a wide range of Japanese players. This became a relatively stable situation. There was competition between the chip

manufacturers, but at a commercial level, out of the public eye. Only when a company like Denon, for example, alluded to "eighteen-bit technology" in its consumer literature did the claimed benefits of a commercial chip - in this case the Burr Brown PCM67 - get public exposure.

The advent of one-bit processing a few years ago gave CD a useful fillip. Its underlying technology suddenly became news, as Philips and the Japanese embarked upon a curious publicity war to justify their particular implementations of this new and apparently improved processing scheme. A rapid about-turn took place as companies rushed to move from more bits to fewer bits; eighteen bit and twenty bit wasn't in fashion any more; one-bit was the way to go. The ensuing melee brought us a range of competitive systems, not all true one-bit. From Japan Matsushita (Panasonic and Technics brands) promoted MASH, JVC their own DD convertor and Sony their Pulse DA convertor. It all got so finely differentiated that the Japanese systems had to be labelled bitstream with a small 'b', whilst Philips' original true one-bit convertor was called Bitstream with a big 'B' and the number of bits being juggled reached from one to three-and-a-half.

CRYSTAL

**Mike Creek's new Crystal digital-to-analogue convertor
has Noel Keywood re-assessing the sound from
Compact Disc.**



All this brought useful publicity and coverage, not to mention sales. It also attracted other chip manufacturers who, looking at the techniques and claims, obviously decided they could do better. The Crystal Semiconductor Corporation from Austin, Texas is one of them. Their new chip set is used in this convertor. It comes complete from low-jitter input interface chip through to an advanced convertor with eighteen-bit resolution. This data is modulated down to a one-bit signal that is converted to analogue through a switched capacitor network. Extensive filtering is provided on the chip. Interestingly, as the industry starts to take the effects of jitter very seriously, Crystal claim their chip set produces little jitter of its own and is inherently insensitive to the phenomenon - one they have researched.

The EMF Crystal convertor does not have a transport sync-lock line to reduce jitter, unlike Arcam and DPA convertors. But it will interface with a wide range of digital input formats,

and 32kHz to 48kHz sampling rates. By using the new Crystal chip set, Mike Creek has brought to the market, at an affordable price, a genuinely different high quality convertor that's an interesting alternative to the Philips/Burr Brown options we have been served up to date.

The Crystal has a different presentation to the one I have become used to and one that differs from the common currency too. At first I resisted the change that was - as likely as not - contrived. Time and exposure answer this conundrum though and it took little of each to win me over. Never did the EMF sound implausible or blemished; it only became more persuasive in its version of the music from silver discs. It could be argued, from the non-flat frequency response (see Measured Performance) that a little contrivance does in fact exist, but it was minor in

the scheme of things.

Compact Disc can sound tonally thin and sterile. I'm taken aback when returning to LP, after half a dozen changes/upgrades to the CD playing set up, to find that the old black disc is still better in many areas, richness of tonality and the ease with which musical expression is conveyed, rather than being pinched and constrained, being the most obvious and, to me, important. I wouldn't tell you that "at last, here's a DAC that sounds like LP." Hah! How many times have I read those words? The authors have usually heard the warmth brought to CD by a rolled-off treble response; testing identifies this piece of subjective engineering and its benefits are made at the expense of accuracy - and often insight too.

The EMF Crystal DAC did initially sound warm, at least in contrast to my own Deltec PDMI Series 3 convertor, but it was not due to rolled-off treble. Rather, I was quickly made aware of its full bodied sound, anchored down by unusually strong and rounded bass and fleshed out with very good projection in the lower mid-range, a property that diminishes progressively with rising frequency.

High Energy

Higher frequencies apparently occupy less of the overall picture, at least on first acquaintance. However, any DAC with such a well maintained measured treble response as this one just has to be able to deliver treble energy and in due course - in fact after a short time - I soon became aware of the Crystal's potential in this area. It can sound hard-etched in its treble, with a hint of edginess to what is otherwise a basically pleasant nature. Although the EMF has a low jitter interface chip and uses reclocking to lessen jitter further, I have become accustomed to the unusually smooth treble of a sync locked Deltec convertor. In contrast, most other transports/convertors sound a little gritty across the upper mid-band, including the EMF - if a little less so than some.

There was also some latent spit. Nothing to do with Punk CD players, I should add, but a curious and at times disturbing phenomenon caused by the upper treble response lift. Frequency response lifts like this have no subjective effect - they are completely inaudible - until very high frequency energy exists in the recording. Then, this energy is magnified and produces a sudden, sharp spit, typically from sibilance. So the Crystal sounded warm and fulsome except with certain recordings, when it would suddenly develop sharp upper treble. This won't be a problem with some speakers, but



close your eyes and see

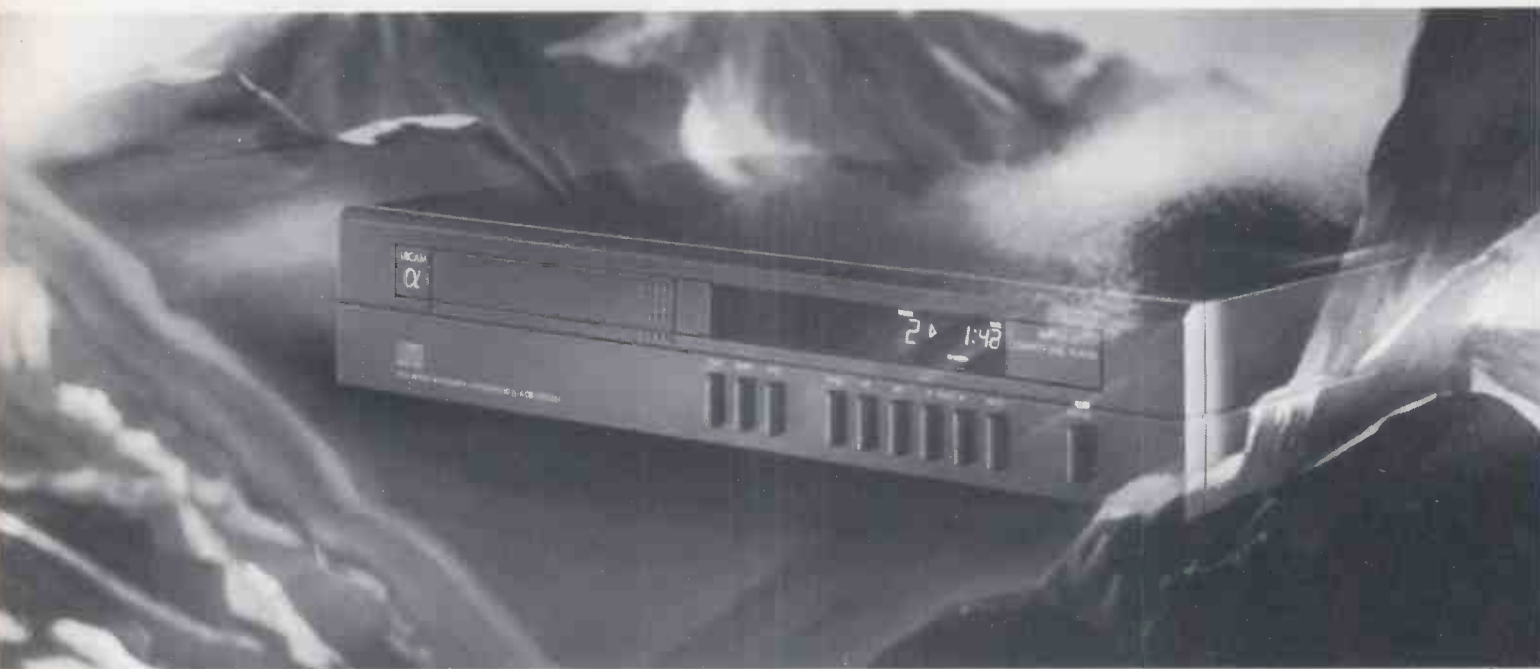

the arcam alpha plus CD player

Close your eyes and see the difference. Between ordinary mid-price CD players, and Arcam's Alpha Plus.

As you're enveloped by the beautifully clear reproduction of your favourite piece of music, as you hear each individual instrument sing out with startling sweetness and depth, take care not to hear simply what you'd expect from other players in this price range.

Just listen.

Notice how the Alpha makes the music seep into your senses, paints the vividest pictures, stirs your deepest emotions.

Sample the Alpha CD experience.

Just close your eyes, open your mind, and see the light.

ARCAM

For more information, complete the coupon and post it to: Arcam, Pembroke Avenue, Waterbeach, Cambridge CB5 9PB. Or telephone: (0223) 440964

Please send me information about: (please tick box) HFW 2/93

Arcam CD players Arcam tuners Nicam TV tuner

Arcam amplifiers Arcam speakers Arcam cassette deck

Please send me a brochure with details of all your products

Title _____ First Name _____

Surname _____

Address _____

Postcode _____

In Australia: Silver Australia Pty Ltd., 4 Rushdale St., Scoresby 3179, Victoria Tel: (613) 7630177

In Canada: Avalon Audio Ltd, Unit 17, 975 Frazer Drive, Burlington, Ontario L7L 4X8 Tel: (416) 333 4633

In New Zealand: Avalon Audio, PO Box 5373, 119 Wellesley St., Auckland Tel: (649) 779351

In South Africa: Hi Fi Installations, 134A Fox St., Johannesburg, 2001 Tel: (2711) 3312011

In the USA: Audio Influx Corporation, PO Box 381, Highland Lakes, New Jersey 07 422-0381 Tel: (201) 764 8958

conversely it will be emphasised by those with peaky metal dome tweeters.

But all this was discovered after the initial readjustment. The Crystal resolves and highlights depth information, putting in stronger front-rear contrasts to singers and lead instrumentals in particular. Together with a fuller, richer characterisation of singers, it brought both dimension and involvement to the sound, especially with simpler arrangements like those found on John Lee Hooker's superbly recorded recent album 'Boom Boom'. The Crystal had Hooker further forward on the stage, stronger and fuller in voice and with greater lyrical inflexion. It was an almost curious rearrangement of emphases and perspectives, not one I immediately accepted as right, since it represents a break with the Philips/Burr Brown tradition we have, in effect, become accustomed to hearing since CD arrived a decade ago. Quite how and why front-stage should become more apparent and demanding of attention I'm not sure; it may just be that the Crystal better engages a listener's attention by ekeing out more of the natural character of a singer or instrument.

The extra emphasis of Hooker's simple repetitive riff on 'Bad like Jesse James' was too strong to ignore. I'd heard it and had been close to jumping up and rooting around my Blues to find other examples, notably from Hendrix, just to satisfy my

curiosity. The Crystal brought extra emotional force to Hooker's riff - I had to remind myself, in fact savour the way Hendrix had taken it and used it. Of course! It was 'Voodoo Chile (Slight Return)' - a reminder if ever one was needed of just how far he could extend a simple, traditional Blues riff.

The unusual presentation of the Crystal can be heard in other ways,

"tracks speed along, fleet of foot but with precise tempo"

some good, some less so. It has superb dynamics and timing; tracks speed along, fleet of foot but with precise tempo. I believe the unit's clean, quick transient behaviour was responsible: it delivers the power of a single strike against a drum without restraint - and with tight precision. I was very surprised to hear more drama in the percussion used by Steve Earle with 'Roadmaster', the ending chant to 'This Highway's Mine'. Prior to the Crystal, my preferred Deltec PDMI Series 3 had confidently handled this small obstacle with greater force and fluency than

rivals. The Crystal brought even greater power, but equal precision.

In addition to the slight sense of coarseness I mentioned earlier, there was also a little more muddle, a little more overlap of images. I found this effect difficult to put my finger on: whilst the Crystal heightened the dynamic contrast of instruments, which had the effect of giving them a stronger sense of independence, it also let them get a little too close and at times slightly tangled. I wondered whether this phenomenon was linked with another that I found initially disturbing: lateral stage contraction. The sound stage was seemingly drawn in a little, relative to that from other convertors. This was another way in which the basic presentation of the Crystal differed from the norm. It had a narrower stage, yet one that extended both forward and backward further! It's not an effect I have come across before. Nor is it really a target for criticism: the Crystal just has a different presentation that can be enjoyed for what it is.

For all the little blemishes I have identified, the new EMF Crystal convertor offers a different and, ultimately, very enjoyable interpretation of music from Compact Disc. In particular, by adding detail and texture, it represents a small but significant step away from what is often described critically - but not inaccurately - as the thin and sterile sound of CD ●

MEASURED PERFORMANCE

Frequency response, seen in the analysis, had a curious 'bow' to it, with upper treble and lower bass both slightly raised relative to the mid-band. The treble lift in particular is one I view with caution; raised upper treble can result in a hard, bright presentation with discs possessing substantial treble energy in the recording. Response limits, within a tight 1dB variation, measured 3Hz-21.2kHz, a normal spec.

Distortion was low right down through the dynamic range, except at -90dB. Here, second harmonic dominated, so whilst the Crystal looks inferior in measured terms to other convertors, I wouldn't expect the difference to make itself audible in any significant manner. Basically, this is a low distortion convertor and, in spite of oversampling, it also has low out-of-band noise (i.e. above 21kHz), unlike recent Philips machines.

Although Crystal claim low noise for their chips, the convertor muted at digital zero, giving a misleadingly low noise figure of -120dB. In truth, the distortion analysis shows, at high frequencies, a

slightly higher noise floor exists than that found in the quietest convertors. The mediocre dynamic range figure of 104dB reflects this situation more accurately, but since noise at around -100dB is below audibility, the matter is academic.

With good channel separation and virtually no spurious outputs, the Crystal convertor measures well, possessing no real weaknesses. **NK**

TEST RESULTS

Frequency response 3Hz-20.2kHz

Distortion		
-6dB	0.006	0.006
-30dB	0.012	0.008
-60dB	0.43	0.36
-90	34	38
-90dB dithered	19	24

Separation	left	right
1kHz	109	106
10kHz	89	87

Noise -120dB
with emphasis -120dB

Dynamic range 114dB
Output 2.02V

Frequency Response

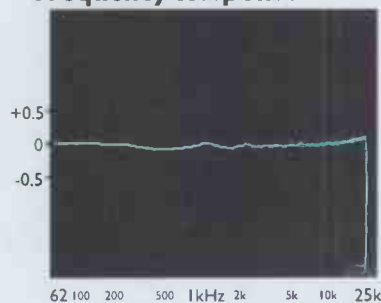

Some bass and treble lift

Distortion

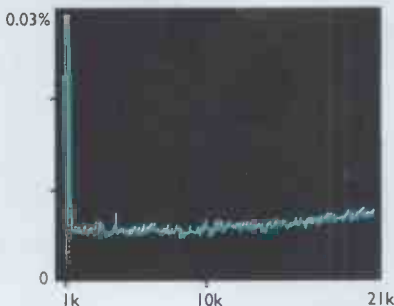

Negligible distortion of 0.01% at -30dB

MANUFACTURERS OF HIGH QUALITY
VALVE AMPLIFICATION



Reviewers comments on the Unisis integrated; "From top to bottom this is a remarkably well engineered amplifier. Appearance doesn't substitute for performance." Noel Keywood, HiFi World.
"Most valve amplifiers present the bass about half a beat behind the treble. The Unisis played both with spot-on timing accuracy" Alan Sircom, HiFi World, August 1992.

Pictured from top to bottom; The Genesis 100w Monobloc, The Prophet Pre-Amplifier with Power Supply & The Unisis 30w Integrated



TARGET

by Mail!

AUDIO

CARRIAGE FREE U.K. MAINLAND (N. IRELAND £10)

Most dealers cannot physically stock all the range of equipment racks and speaker stands made by Target Audio. It can therefore be quicker and simpler to have what you need sent by mail. It costs no extra, there's no hassle, the carrier brings them to your door. (Please allow 10-14 days for delivery).

AER EQUIPMENT RACKS

Tubular welded construction with adjustable spiked feet (with the option of castors if spikes are unacceptable). The upper shelf is supported on 4 adjustable spikes for improved decoupling. Size 505 x 393mm (W x D). Shelves 465 x 355mm (W x D).

	Height (exc. spikes)	Number of shelves	Distance between	Price
AER 2	515mm	2	380mm	£110.00
AER 3	515mm	3	180mm	£128.00
AER 4	660mm	4	165mm	£156.00
AER 5	845mm	5	165mm	£170.00
AER 3TV	515mm	3	190mm	£150.00

(+ depth 395mm)



AER 4

TT WALL MOUNT RACKS

Wall racks with adjustable isolated upper shelf. Size 505 x 475mm (W x D). Shelves 465 x 355mm (W x D).

	Height (exc. spikes)	Number of shelves	Distance between	Price
TTW1	Wall	1	—	£ 53.00
TTW2	Wall	2	305mm	£ 65.00



TTW2

HJ SPEAKER STANDS

A fully welded multi-pillar design which provides maximum control of your speakers. Fine-tuning by use of speaker platform spikes and by filling the pillars (using the filler provided).

	Height (exc. spikes)	Top Plate W x D mm	Base Plate W x D mm	Price
HJ10/3	250mm	280 x 280	305 x 305	£113.00
HJ15/3	380mm	240 x 240	305 x 305	£113.00
HJ17/2	430mm	200 x 200	250 x 305	£100.00
HJ20/2	510mm	165 x 190	250 x 305	£100.00
HJ24/2	610mm	165 x 190	250 x 305	£107.00
HJ20/2T	510mm	152 x 215	250 x 305	£100.00
HJ24/2T	610mm	152 x 215	250 x 305	£107.00



HJ15/3

BETA "B" SERIES RACKS

Tubular welded construction with adjustable spiked feet. The upper shelf is supported on 4 adjustable spikes for improved decoupling. Shelf size 465mm x 355mm (W x D). Optional castors kit £9.99 extra. Finished in black ash effect.

	Height (exc. spikes)	Number of shelves	Distance between	Price
B1	65mm	1	—	£ 60.00
B2	480mm	2	380mm	£ 90.00
B3	455mm	3	155mm	£110.00
B4	645mm	4	155mm	£130.00
B5	840mm	5	155mm	£150.00
B5a	840mm	5	200(2)/110(2)	£150.00



B5

MODULAR "M" SERIES RACKS

A very versatile system with options allowing modules to be added to suit varying equipment heights. Finished in black ash effect or glass shelves. Select the base module and add shelf modules as required. Supplied with spiked feet (optional castors kit £9.99 extra). Distance between columns 465mm x 395mm depth. Supplied in flat pack for easy self-assembly.

SHELF UNITS

Type No.	Distance between	Single Shelf Price	Single Shelf Glass	Type No.	Double Shelf Price	Double Shelf Glass
M1/90	90mm	£38.00	£50.00	M2/90	£70.00	£90.00
M1/125	125mm	£38.00	£50.00	M2/125	£70.00	£90.00
M1/165	165mm	£38.00	£50.00	M2/165	£70.00	£90.00

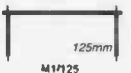

M1/125

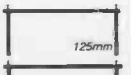

M2/125

BASE UNITS

Type No.	Distance between Shelves	Wood Shelves	Glass Shelves
MB3/125	125mm	£100.00	£130.00
MB3/165	165mm	£100.00	£130.00
MB3W/165	165mm	£160.00	—



MB3/125

MB3W/165

HS SPEAKER STANDS

Medium mass single pillar stands supplied with adjustable spiked feet and top spikes. Can be sand or shot filled. All base plates 250 x 305mm (W x D).

	Height (exc. spikes)	Top Plate (W x D mm)	Price
HS8	200mm	240 x 240	£ 67.00
HS12	300mm	240 x 240	£ 67.00
HS16	410mm	200 x 200	£ 68.00*
HS20	510mm	165 x 190	£ 68.00*
HS24	610mm	165 x 190	£ 72.00*
HS28	710mm	160 x 160	£ 72.00

*Asterisked models can be supplied with Tannoy 600 series mounting top plate for £4 extra — please state speaker model No. when ordering



HS16

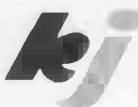

KJ WEST ONE (HFV)
26 NEW CAVENDISH STREET, LONDON W1M 7LH
TEL: 071-486 8262/8263 Fax: 071-487 3452
Open: Mon-Sat 10am-6pm Thurs until 7pm



Hatch Farm, Chertsey Road, Addlestone, Surrey
Tel: 0932 850361 Fax: 0932 850354
HAND BUILT IN ENGLAND

The MAG Audio A90s are, well, magnificently big. They stand nearly six feet tall, but even in their Black Ash finish with black grille cloth they don't loom over the listener like the dark thunder cloud you might expect. When they're connected up to the system, they don't loom at all. Far from it.

A full-range ribbon design, made in Denmark, they have all the best attributes of the beast. Foremost is an incisive treble clarity and purity; second, but equally important, is an ability to image and convey spatial information with a precision that is normally the prerogative of electrostatic designs. Last, but not least - and you need a good length of ribbon to do the job, which is one reason they stand nearly as high as a Guardsman on their spikes - they really do produce credible bass.

So far the plus points. Now the trade-offs. Their weight - thirty-five kilos each - won't matter to most buyers, who are unlikely to shift them once they're installed. To me, two floors up from the street and with a constant supply of loudspeakers tramping through the door, shifting them developed a pectoral or two I'd forgotten I had. Once set down, despite their slim depth, they are certainly stable. They arrived, by the way, in one of the most substantial wooden packing-cases I've ever seen. If you're short of a tool-shed for the garden, that's your answer.

Space Needed

The second problem is that they need space. Their remarkable ability to portray a long-focus depth of field only really blossoms when they have quite a few feet between them and the walls, and - I suspect - is probably at its best when you can put a rug the size of a Savoy hotel double room between them and you. Lastly, they are difficult to drive, with a load impedance that starts off around three ohms and goes down from then on. That said, you don't have to pay the earth for a power amplifier: a Quad 606 drove them without complaint to acceptable levels. The Chord SPM 1200 I had at home for a while drove them superbly - and at a price, allowing for the current currency fluctuations - broadly comparable to the three grand they cost.

Substantial gold-plated terminals for bi-wiring are mounted on the rear of the base. Judging by my experience, bi-wiring is obligatory - otherwise the glorious scale

of the music they are capable of producing thins and shrinks a little. Operating a small switch on the base plate is not obligatory though; this takes out one or other set of the treble ribbons in each speaker and also removes the sparkle, making them as dull as ditch water. Why, I don't know. Are there some weird amplifiers in Germany (where these loudspeakers have come top in at least one hi-fi magazine's poll) that have such ear-piercing treble it's necessary?

One of the reasons for putting a fair amount of space between the Mags and the listening seat is that since the ribbons which handle treble and bass are disposed laterally, there can occasionally be physical stretching of upper notes. Being a London flat-dweller, and square footage costing what it does, I sat near enough to hear a



Magnificent

Tall dark and handsome Eric Braithwaite listens to the tall dark and handsome Mag Audio A90 ribbon loudspeakers.

soprano's notes just discernibly switch position by half-an-inch or so as she went up the scale while I was listening to Verdi's *Otello*. It could also be noticed on long sustained flute notes, though the more controlled and beefy the power amplifier the less obvious this appears.

A splendid attribute of this ribbon design is its ability to provide a level of mid-range clarity which gives vocals, especially, a crispness and lucidity that generally only electrostatics manage. Every subtlety of inflection rings true, clear as a bell. It makes listening to opera, or music like Mary Black's, endlessly engaging.

Equally delightful is the near ultimate retrieval of ambience; a studio echo becomes practically measurable in the distance it travels.

Ambient information adds a great deal to the atmosphere of a recording - and the MAGs let it through in abundance. Certainly, their almost limitless depth of stage is founded on this ability. Equally, their crispness extends to the bass end, where double basses have a gutsy resonance that keeps them realisti-

cally large; there's no diminution of force in a bass guitar as it travels downwards. One of the delights in Classical pieces was to hear side drums and timpani rattle and roll in proper dynamic fashion without blurring fuzzily.

Where I might feel my enthusiasm a little more restrained is when it comes to the upper strings, when the breadth of tonal colour is thinner. Where an electrostatic design, like the equally tall Audiostatics I heard recently, is capable of reproducing the pressure of a bow on strings in Bach's Cello Suites, or defining unmistakably the difference between the violins of an Early Instrument group and a modern string section, the A90s concentrated more on the attack and speed than the nuances.

All the same, you can go a long way - further even than Denmark - before you'll hear such realistic staging, or such mid-range purity from a pair of speakers that aren't electrostatics. A clean, detailed, rhythmically tight bass is a bonus. If you have the space, the MAG Audio A90s are well worth a listen; even with fluctuating exchange rates hiking the price - at around £3000 - to a few hundred above comparable Quad electrostatics, they are still good value; few loudspeakers can match them ●



Two pairs of gold plated terminals allow for bi-wiring.

... Continued from page 14

dustier corners every now and then. **EB**

I'm constantly struck by the diversity of interest of our readers and the knowledge and dedication so many bring to areas not commonly covered by 'the magazines'. It was those readers who have written in describing the merits of the 401, that they have so discerningly compared with modern belt drives, that forced me to finally dig mine out and get it fixed. And all I can say is: thanks! It is superbly easy to use and has a great sound, causing me to start buying LP again, in addition to CD. I love every second of using it. **NK**

TOM'S TWEAK

Having just had my Pioneer A-400 returned to me from being upgraded by Tom Evans of Michell fame, I feel I must write to you to tell you how good the upgrade is. I use the Pioneer in a high-end system and the only criticism I can make of it is in the bass region where there is a 'wedge' of bass from the mid-band to its lowest point. Well, Tom has not only made the bottom octave audible, which was missing on the standard A-400, but the whole mid-band is clearer. The bass is now very tight and it goes straight down. You would not believe the difference that he has made to the Pioneer unless you had heard his other products. The Pioneer is a very good amplifier. What Tom has done is build on its strengths and get rid of its weaknesses. I cannot sing the praises of this man enough, as he has made glorious music accessible to paupers like me. He has the ability to take on the big boys and beat them at their own game. Oh, by the way, all this for £120 plus VAT.

**Adrian Jones,
Cwmbran,
Gwent.**

Being something of a fan of Tom Evans' designs, I was intrigued when I heard of the beefed-up A-400 and prevailed on him to divert one from a customer and send it down to us. Said customer, fortunately, is in the hi-fi business so he didn't mind waiting while we had a listen. Read next month's issue! **EB**

MIDI MYTH

Your attempt at dispelling the Hi-Fi myth (January 1993 issue) in which you compared the performance of four midi systems against a budget separates system made good reading. Above all, one got a palpable sense of your frustration in wanting to be proved wrong by the midis, but with the separates winning through!

Like what I suspect must be most of Hi-Fi World's staff, I too have 'done my time' in retailing. Like you, I too want to believe that "people will always recognise and value a good quality product and that quality will always win out in the end." Consequently, like you, I'm baffled by the success of the midis (or I used to be!).

Noel's opinion piece went some way towards explaining this disparity, but not far enough. He mentions that the midis sport every feature possible. And as he

The second marketing basic is that the benefits of the product, not its features, should be 'sold' to the consumer. How may these two conditions be reconciled with marketing's primary objective, which is to fulfil the customer's needs?

The glib answer is that different customers have different needs... but we all want a hi-fi system, don't we? The difficulty arises in defining what we mean by hi-fi, which is a bit like asking "what do we mean by motoring?" Apparent discrepancies in what we mean may, in my view, be attributed to cross-cultural differences - perhaps more literally, differences in expectation between different socio-economic groups.

We quickly find ourselves returning to the grey area of quality, taste and price in a circular argument, and indeed, whether judgements about any

us well in the past, with their friendly, knowledgeable, impartial advice, as well as a carefully selected product range. The High Street multiples can go their own way.

**Chris Moorhouse,
Poole,
Dorset.**

I don't believe the buying inclinations of various social groups is the basic problem; such things are commonly shaped by advertising and economic circumstances. I believe that the desire and even need to listen to music is as deep rooted as its history would suggest, one that goes back to man's prehistory. It isn't difficult to look at the audience for Classical music and deduce that it is currently the prerogative of a particular social group, but whether it should be or has to be is another matter. I don't

believe such things are immutable realities, merely current ones. Similarly, I don't subscribe to elitism in hi-fi, nor do I believe that it substantially shapes the market, even though I do appreciate that there may, at present, be a dominant buying group tramping its way into Curry's and Rumbelows every Saturday for "a hi-fi" and another one - perhaps more mixed - doing the same through the doors of independent dealers up and down the land.

The notion of "impartial advice" and the euphemism "selected product range" may bring a hollow laugh from many readers. Independent dealers are valuable and needed, but

these aren't their strengths. A limited product range is an inevitability, since no one can stock everything and partiality is an inevitable outcome; no dealer will tell someone that an amplifier they don't stock is better than ones they do and that it can be bought at a competitor down the road. None of us are saints.

Surely their partiality - let's call it enthusiasm for the products they stock - is the spur to offering consumers good advice and demonstrations of those particular products. Buyers aren't daft; they well know that it is their responsibility to make an informed decision based on the advice that may come from many dealers and magazines alike. **NK**



What do we mean by hi-fi - does it include midi-systems?

says, "surely, wrapping up cheap circuits and components in a glittering package is deception isn't it?"

I couldn't agree more, but shouldn't we ask a little more about the marketing process and whether or not consumers knowingly acquiesce to that deception?

Elementary marketing teaches that, given the opportunity, the consumer must be driven up-market where profit margins are higher. It is assumed that less high-margin product will be sold, due to its higher retail price, but if not, then all to the good, since that high margin is mostly profit.

The very existence of such a paradigm suggests that market-segmentation can and does occur, in that different groups or classes of consumer buy at different levels in the marketplace.

of these things are class-related. I firmly believe that they are, and that for this reason, the consumer, however subconsciously, makes buying decisions based upon his or her own perceptions of themselves within society.

Peer group pressure plays a massive part in our own self-perception. (It probably comes as no surprise to learn that the Corus Black on my Pink plays through valves!). So too does the immense fear of choosing the wrong stuff and looking a duffer. Hence the enduring success of Which? magazine. I am as unhappy as you are with the apparent elitism of hi-fi, but it seems to be the price we pay for consumer choice in a market-driven economy

The onus is on us all, as consumers, to remain loyal to those retailers who have served

COLORATION II

Will you please put a stop to the silly practice of printing copy on coloured backgrounds. What do you achieve by making the magazine more difficult to read?

**John Limon,
Wendover,
Bucks.**

Oops! Mr Limon refers particularly to the EAR review in the February issue which came out a darker shade of blue than our Production Editor intended. Since it was me who wrote it, I wear tinted specs, and I had a bit of a problem with the first lines as well, the air was even bluer than the page when I found out what had happened to one of my little gems. I mean, I know you out there hang on my every word, or would do if you could see all of 'em. Anyway, point taken and 'nuff said - our Production Editor's ears look as though they're going to burst into flame. **EB**

PLEA FOR PLAIN JAZZ

Somewhat to my surprise, I have just received the free Virgin record you offered several months ago, for which thank you (it was Taboo by Ronald Shannon Jackson). It was interesting, but I'm afraid did nothing for me as a Jazz fan.

The same can be said for your so-called Jazz reviews I am the first to admit that defining jazz is impossible, but your critic covers Jazz-rock, Jazz-fusion and Jazz-something but not plain Jazz. If my Jazz appreciation society is anything to go by, only about ten per cent of Jazz fans can listen to the sort of music your reviewer has covered so far without pained looks on their faces as they persist, in the interests of broadening their musical horizons. The horizons so far have not moved!

Your reviewer is no doubt required to concentrate on newer recordings (you are a hi-fi magazine, after all) - but there are an awful lot of re-releases on CD, some with very successful cleaning up of old material, some not. It would be nice to know in advance which ones kept the baby while throwing out the scratchy bathwater!

If you must review guitarists, what about Len Pass and Howard Alden; reeds Ken Peplowski, Scott Hamilton and Kenny Daverne; brass, the man described to me by his contemporaries (at the Edinburgh Festival) as the World's greatest living musician - Ruby Braff? All alive, all recording now, all

virtuosos and all of them know what a melody is!

**George Haddock,
Dunblane,
Perthshire.**

Simon's particular enthusiasm is for the avant-garde, and with only two pages, as you say, new releases have to take precedence. However, we shall I hope, soon have more space, so don't despair. **EB**

DOWN TO EARTH

There have been recent references to the necessity of a good earth, especially with regard to tuners, and the usefulness of having our own earth rod outside the house. In general I'd wholeheartedly agree with this, but before you go digging a hole in the garden readers would be advised to look at the mains distribution board in the house. Does it carry a small "PME System" sign? If so, there is slight chance that the use of a ground stake could cause problems.

PME stands for "protective multiple earth", a system which started to be widely used during the 60s. Instead of the main earth being at the substation, in a PME system the neutral cable is bonded to earth at many points along the supply cable run, which provides a much lower earth resistance.

So far, so good, but there is a snag. If the neutral, but not the live, is broken then the neutral terminal on your distribution board could rise to 240v above earth. All metalwork in the house is connected together so if no-one can contact true earth then no shock hazard exists. It must be stressed that this is an unlikely eventuality, but neutral faults do sometimes occur. But what happens if you have connected your tuner, or other hi-fi to an outside earth stake?

The fault occurs when the earth stake is temporarily disconnected, for relocation, or redecoration, then as you try and re-connect the lead you will have one hand at true earth and probably the other one touching the metalwork of your kit . . . which is at 240v. Exit one hi-fi buff.

If the neutral is ruptured while your earthstake is connected then in the worst case the whole of your house mains, and maybe even next door's, will

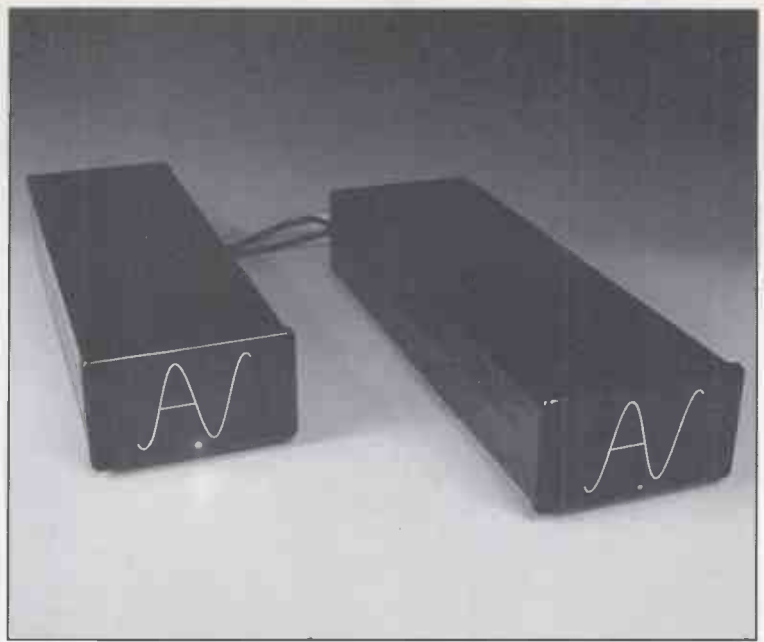

Audio Synthesis offer an upgrade to the DSM digital-to-analogue convertor reviewed recently.

feed current to your earth stake.

There is a good chance of the current surge damaging your mains wiring.

This scenario is one which is familiar to Radio Hams (one of my other hobbies) and various solutions have been described in "Radio Communication" magazine, as well as in a book published by the Radio Society of Great Britain, Lambda House, Cranborne Road, Potters Bar, Herts. EN6 3JE. The descriptions are too lengthy to be outlined in this letter, and too serious a matter to be paraphrased, so perhaps Hi-Fi World staff could do some serious creeping to RSGB and arrange for a version of the original article to be reprinted in these pages?

As I've already said, a neutral fault is very unlikely, but so is winning the pools and someone manages that every week.

**David Reynolds,
Kingswinford,
West Midlands.**

Eh? If the neutral is broken, then every electrical item in the house will stop and the lights will go out. So it isn't a scenario that will go unnoticed and untended. And for the mains to feed current to earth, there must be a breakdown of insulation between the two. All this could not, I would have thought, outweigh the often quoted problem of the house earth not actually running to earth efficiently.

But as you say, earthing can in itself be a dangerous practice if, somehow, live mains become exposed. It struck me that when tinkering with valve amplifiers for example, contrary

to what would normally seem to be sensible advice, the chassis should not be earthed, or an earth trip should be used. Dominic has used the latter and says its a nuisance in practice, but that might be a small price to pay if it saves you from an across-the-heart shock.

If there is something I have missed here, then please write to tell me, since domestic safety is important. **NK**

AUDIO SYNTHESIS UPGRADE

Thank you for the well balanced and informative review of the Burr Brown version of DSM in the recent Hi-Fi World supplement.

I would like to bring your readers' attention to two points:

1. The Burr Brown DACs and I to V stages are mounted on a separate daughter board. This can easily be unplugged and replaced by the UltraAnalog D20400 hybrid DAC, as used in the Mark Levinson, Audio Research and Stax convertors. We can therefore offer owners of DSM a substantial upgrade path to the UltraAnalog as and when funds allow.
2. The digital sections and PCB layouts of all the Audio Synthesis DSM products to date (with the exception of the Arcam clock feedback circuit) were designed by myself, whereas the purely analogue products and the analogue stages of DSM were, of course, designed by Ben Duncan.

**Paul Freer,
Digital Design Engineer,
Audio Synthesis,
99 Lapwing Lane,
Manchester M20 0UT.**

**Named after the shield of
Athene, Acoustic
Energy's new Aegis
loudspeaker has Jonathan
Jordan communing with
the gods of music on
Mount Olympus.**

Olympian Speaker



Acoustic Energy first made their attack on the U.K. hi-fi market back in 1987 with the AEI mini-monitor loudspeaker. It featured a tiny metal-coned bass unit with an aggressively pointed dust cap and a metal dome tweeter. Since then Acoustic Energy have continued using metal coned drivers in all of their models; the Aegis is no exception.

Aegis? The name had us resorting to a dictionary of mythology. It was the name of a shield belonging to Athene, who in Classical Greek legend sprang fully-armed from the head of Zeus. The aggressive look of that metal-coned bass unit suggests that its own war cry could be something to fear.

This loudspeaker, at £452 a pair, is Acoustic Energy's first entry into the strongly competitive middle ground. Previously their products have all been aimed at areas where there is less competition, so this represents possibly their most important product to date. The Aegis looks surprisingly good value for money when compared with the AEIs, which are about a quarter of the size and £250 more.

The new design uses a bigger bass unit and the tweeter has been extensively upgraded.

The bass unit is in fact a brand new driver from Acoustic Energy using a tri-layer ultra-rigid alloy diaphragm. It has a 170mm cone with a 38mm voice coil that is covered with a pointed, hard plastic dust cap which serves to extend its upper frequency limit. High frequency radiation from the dust cap produces peaks in response; Acoustic Energy remove them with a tuned notch filter.

Cooled And Damped

The treble unit uses a 25mm magnesium alloy dome. It is thermally coupled to the voice coil so that heat developed in the coil is dissipated by the metal dome, increasing power handling. The unit is also ferrofluid cooled and damped, further increasing power handling and lessening any unwanted vibrations that may occur.

Two sets of chunky gold-plated binding posts at the rear allow for bi-wiring and are accompanied by a large reflex port. This has a thin foam insert, to tailor the air load and

provide some damping.

Finding the best listening position requires a little experimentation, I found. These speakers need to be at least 20"-24" clear of a rear wall or their bass will be a little overwhelming and lacking in definition. Equally, they have quite a tight focus and hence the degree of toe-in will have to be set to match your environment and listening position.

Acoustic Energy recommend their own matching stands, at £139 for the pair and £29 for the lead shot to fill them. Spiked top and bottom, these high supports form a steady platform. The listening session suggested they are a worthwhile investment.

The Aegis' initial impact was positive. During some Talking Heads tracks, the bass hummed harmonically right down to the low frequencies. The depth of bass notes was well defined, and there was excellent detail in both bass guitar and drums. Acoustic Energy's new speaker steered well clear of the 'one-note' effect that can afflict some bass reflex models, giving ill defined bass in terms of frequency and content.

Even with exceptionally bass-heavy

pieces, such as Prince's 'Get Off', the Aegis had to be driven to uncomfortable volume, with the furniture and knick-knacks starting to resonate, before definition was lost. Both the mid-frequency and high frequency ranges remained even and detailed, dealing with any music, however fast or complicated, with a certain flair. The middle ranges could handle both acoustic and lead guitars; even high range vocals posed no problem; these speakers just kept the warmth and precision of the music flowing. The Aegis moved along with speed and fluency and it seemed that it never needed to pause for breath but just kept delivering the goods even at high volume.

A New Dimension

Otis Reading's 'Sitting on the Dock of the Bay' was brought into a new dimension through the depth of imagery created by the speakers. Waves crashed harmoniously in the background and seagulls flew overhead while the speakers calmly relayed that well known melody his vocals complement so well. Van Morrison's 'Moondance' had the cymbals resonating gently, with the flute and bass guitar portrayed individually, rather than as a cacophony of simultaneous noise.

Classical music is often a grey area as far as a loudspeaker's imaging quality is concerned, but Joseph Haydn's 'Stabat Mater' was also delivered with such clarity and depth that I could sense from which row of the chorus each vocalist was singing. The Aegis created a swirling maelstrom of instrumentation and vocals that were all accurately and dramatically placed within my listening horizon. If the musical stage contracted or expanded these gems were there shielding my ears from any threat of a two-dimensional wall of sound.

Pure Harmony

Through the high frequencies the Aegis still continued to flow, allowing Domingo and Plowright to soar through 'Il Trovatore' without any loss of grip on image, definition or stereo separation. Suzanne Vega's *a capella* rendering of 'Tom's Diner' was pure vocal harmony where the only distractions were her breathing and pauses to swallow.

With heavy Rock, the Aegis' bass is as heavy as required, but rarely steps over the mark. For its size, this relatively small speaker delivers an enormous amount of it. The mid-range handles everything from crash lead to gentle strumming, with vocals at the high end streaming out with knife-edged precision.

These speakers have such depth and transparency that they could

almost be described as having the same effect on a listener as the 'Tango Man' reputedly has on the soft drink fan! The only discrepancy in a good all-round performance that I could detect was a slight hint of distortion on mid to high range transients. This, however, could have been due to a number of factors other than the speakers. To say that the Aegis is a good all-rounder is not to suggest that it does not excel, but to simply state that it reproduces everything from a single voice to an orchestra in full crescendo with such clarity, depth, image, warmth and pedigree of character that I cannot help but recommend it.

The Aegis requires good amplification, a good source and the stands. At £620 this places a pair in the price bracket of many floorstanding speakers and some very good



◀ Rear view of the Aegis, showing the reflex port and two sets of terminals for bi-wiring.

monitor designs. Even so, I feel it has such an attractive character Acoustic Energy will not have a problem establishing a market for it ●

MEASURED PERFORMANCE

Very rarely do we see a response as flat as that of Acoustic Energy's Aegis. This kind of ruler-flat frequency plot is normally a hallmark of the likes of KEF with their vast design knowledge and several hundred thousand pounds' worth of test gear. As Monitor Audio did with their MA1200 Golds, Acoustic Energy have shown with their Aegis that whether by design or accident it is possible for a small specialist company to rival the big boys when it comes to monitor accuracy.

The frequency response plot for the Aegis lies within 2dB limits from 200Hz up to 16kHz; this speaker should sound very neutral with nothing standing out as obviously wrong in basic tonal balance. If a loudspeaker has a peak or a trough in its response it will be heard. Sometimes a deviation - such as a gentle rise in the mid-band or a fall in the treble - can be quite pleasing subjectively; sometimes a deviation, like a treble peak, can be unpleasant. Either way, neither is correct or truthful and both alter the intended balance of the music. A flat response loudspeaker has something about it which sounds right, nothing seems out of place.

The extreme treble is a little rolled off above 16kHz, which will take some of the sharpness out of the sound. The only other departure from the straight and narrow is below 200Hz where there is a peak before the bass finally rolls off. This could be due to the reflex port, a room resonance, or more likely a combination of both, but it is still only 3dB up.

As far as measurement is concerned the only thing against the Aegis is the load it presents to the amplifier. Although the overall impedance across the audio band averages out to 10Ω, it presents an insensitive and reactive load. The Aegis managed to produce only 84dB at one metre for a nominal watt of

input (2.84V), a few dB below average; a hefty amplifier will be required for the best results.

Additionally, the impedance curve is the complete opposite of the frequency plot, resembling a mountainous region of the Alps. The load is certainly reactive, which will not make the amplifier's job any easier. The sharp dip in the impedance plot between 2kHz and 5kHz is probably caused by the use of a notch filter in the crossover network. This filter is designed to remove peaks in the frequency response and if there was a spike in the Aegis, then the filter seems to have completely removed it.

Because of the insensitivity and the reactive load presented to an amplifier I would recommend the use of a separate pre/power amplifier if the Aegis is on your shopping list. These tend to deliver more current than an integrated amp and thus have the power and control that will be necessary to get the best from Acoustic Energy's new design. **DB**

Frequency Response



Flat frequency response.

Impedance

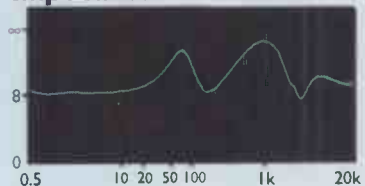

A reactive load.

THE LONG AND THE SHORT OF COMBINATIONS

Report by Dominic Baker.

Measurement by

Noel Keywood.

Separate pre and power amplifier combinations are, for many buyers, the next step up from an integrated amplifier.

We look at four examples.



In the days of the space consuming, heat producing valve, accompanied by a brace of bulky transformers, pre-amplifiers and power amplifiers had to be separate. Combining them was possible, but in the interest of saving cost rather than gaining performance. Ever since, the pre-amplifier and power amplifier in combination have come to represent quality and power, leaving the integrated amplifier on a rung below in perceived quality terms.

The arrival of the transistor enabled small integrated amplifiers to take over from the valve dinosaurs and a mass market evolved. Nowadays, up-market models separate the pre-amplifier from the power-amp. So what makes them better than an integrated, when heat and size are not a problem any more?

Separate power supplies for each unit, higher power output, dual-mono circuits, more inputs and, in some cases, pairs of mono power amplifiers (monoblocks) are all options. The higher power outputs available allow insensitive loudspeakers to be driven, making 'difficult' mini-monitors and low impedance electrostatics useable. Powerful integrated amps do exist, but they are mostly of lesser quality.

Flexibility is another benefit accompanying pre-amplifiers. They commonly offer a wide variety of inputs, with precise cartridge matching for LP, for example. Nowadays, line level only pre-amps possessing no disc input are becoming available.

However, with sensitive power amplifiers (0.5V or less for full output) pre-amplifiers are not even

essential any more. All that is needed is a passive volume control, saving money and improving sound quality at the same time.

Though none of the four pre/power combinations reviewed here are behemoths, the power amplifier can be kept well away from the pre-amplifier for space saving. It can be hidden away, leaving only the control unit in sight.

Also, separate power amps offer leeway for a little experiment. Opinions are still divided over whether short interconnects between the pre and power amps and long cables to the speakers are better than the other way around. Not only can the user decide, without too much expense, but two separate boxes offer greater flexibility in arranging the hi-fi to suit the layout of the living-room.

And finally, having pre and power amps separate allows for either or both to be upgraded - or, given current recessionary problems, even downgraded - at any time. Since most manufacturers' designs these days are compatible with each others', they can even be mixed and matched as either taste or finances dictate.

In this report, however, we have taken four pre/power combinations from different manufacturers, each with their own individual stamp. The cheapest comes from QED at £699, followed by models from Sugden at £899, and from Quad at just over a thousand. Representing the Orient is a combo from Marantz, in totally different style to its British rivals and also, at £2,199, the most expensive of the group.





MARANTZ SC-22/MA-22

£2,199

The Marantz £799 SC-22 pre and £1400 MA-22 mono power amplifiers have a champagne gold finish in typical Japanese high-end style. Power-on is indicated by ice-blue LEDs, a colour I favour, but unfortunately they clash with the gold of the amplifiers. All the same, the effect was strong; these amplifiers draw attention to themselves.

The power amplifier front panels carry only the blue LED power indicator, plus a power switch and the Marantz name badge. A word of warning: the power amps get quite hot and need a good deal of space around them, which fortunately is quite easy to organise due to their small size.

This is a line-level only combination, offering four line inputs and one for a tape

deck, for which there is a monitor circuit. The inputs are selected via front panel push buttons, rather than the normal rotary control. They are similar in style to those for other functions on both the pre and power amplifiers, giving the whole combination a simple, uncluttered look.

Because of the low power output of the MA-22 power amplifiers, Marantz recommend the costly route of purchasing a second set, which are then bridged (BTL mode in their parlance), in order to provide twice the power output and eliminate 'common-mode' distortion and crosstalk. The preamplifier has two sets of outputs, one phase reversed, to feed this arrangement. Of course, twice as many power amplifiers are needed for this mode of operation and care has to be taken to

ground the pre-amp to both power amplifiers even when used in normal configuration due to the floating signal. The MA-22s only have one set of outputs each; however, their large binding posts allow bi-wiring to be easily implemented. Because of the BTL ability of the Marantz pre/power amps, careful reading of the instruction manual is mandatory if disasters are to be avoided.

SOUND QUALITY

The division of two power amp channels into a mono-bloc format has the advantage of providing improved stereo separation due to the decreased amount of crosstalk between the two channels. I had forgotten to some extent the marked difference that mono-blocs have in this area of their presentation against their stereo counterparts. Images that had previously been slightly blurred snapped clearly into focus becoming altogether more realistic. This also had the effect of sorting out the separate instruments which comprised the performance, allowing them to be more easily followed.

Overall the sound was quite soft and sweet. Across the midband the Marantz was clean and reasonably well detailed but perhaps with less resolution than would be expected from the best £2000 pre/power amps available. They gave the impression that they were resolving more information than they actually were, by concentrating on the more obvious detail within a recording. The majority of fine detail, such as a bass player's fingernails on a bass string or the sharp breaths taken just before a vocal onslaught, were missing, resulting in an overall lack of atmosphere.

On the Blue Aeroplanes' album Swagger there is a track called 'Anti-Pretty' which starts with a count into a sax solo. The click of the keys, the vibration of the reed and the short quick breaths taken whenever possible were all disguised by the Marantz combo. Knowing that they were there, I was still able to spot them, but without my knowledge of this particular track it was detail that would certainly have passed unrecognised.

What the Marantz does have going for it is the unflagging manner in which it presents music. These items are neither bright nor harsh - and their sound is certainly not hard. In fact, the bass can become a little too soft at times, leaning toward a warm quality, rather than the more intense and dynamic bass of some rivals.

CONCLUSION

An easy-going sound with good imaging and focus will recommend the Marantz SC-22/MA-22 to those who place a high priority on these aspects of performance. Best-suited to loudspeakers which provide an amenable load - and not particularly powerful given their price - stylish packaging by Marantz may well swing the balance in their favour for some buyers.

MEASURED PERFORMANCE

The MA-22 is a neat little monoblock that produces 66watts. The advantage of a monoblock is its independent power supply; whatever demands are made upon the other channel's supply by the music cannot feed through. However, the Marantz output figure into 8ohms is not high, something that users of British loudspeakers in particular (typically 10ohms) should bear in mind.

Having good regulation and the ability to deliver current, like most good modern power amps, the MA-22s fare a lot better with low loads. They will deliver 110watts into a 4ohm loudspeaker and I found they could pulse 182watts into a low 2ohm load (some speakers go this low at certain frequencies). American and continental European loudspeakers utilise these amps' abilities better than higher impedance UK designs.

As expected, the Marantz units measured well in all other areas. I was interested to see they have been sensibly tailored for CD, having an extended bass response to 5Hz, but treble that rolls off above 20kHz. Since CD produces nothing but unwanted signals above 21kHz, the upper limit will help keep output clean.

Distortion was minimal at all levels and frequencies, hovering at around 0.005%, just a small trace of second and third harmonics being visible in the noise floor.

The Marantz amplifier is well engineered. It turns in a fine set of measured performance figures, but it does have limited power into high impedance loudspeakers. **NK**

TEST RESULTS

Power (8Ω)	66watts
CD/tuner/aux.	
Frequency response	5Hz-26kHz
Separation	84dB
Noise	-100dB
Distortion	0.005%
Sensitivity	220mV
dc offset	27/7mV

Distortion

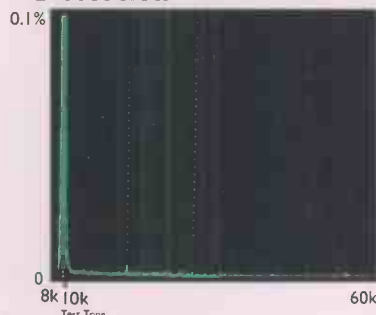

The 300C/P is styled in the slightly bland but functional way that we have come to expect from QED. The front panel of the pre-amp possesses three knobs and one power switch, which is just about the bare minimum. Usefully, it has separate Listen and Record selectors for the six possible inputs. These comprise CD, two tape inputs, tuner, video, and phono.

Around the back all the phono sockets are of the high quality, gold plated variety, including separate pairs for moving magnet and moving coil. The pre-amplifier we had was the Premium Analogue version which retails for £329 and has an uprated phono card inserted. Outputs are provided for both cassette decks and for the power amp.

The 300P power amplifier sells for £370 and again follows the minimalist approach, with only a power switch on the front panel. There are two pre-amp inputs, of 200mV and 640mV sensitivity, the former being for the 300C. Two sets of 4mm only output sockets are provided which enables bi-wiring to be handled with minimal stress. Additionally, the unit can be internally switched to mono operation to facilitate bi-amplification, or even linked up with a QED integrated amp which could act as both pre-amp and second power amplifier.

Both units are well built and finished with the controls having a reassuringly smooth action; all input and output sockets are mounted firmly. Channel balance is adjusted by a dual-concentric volume control, rather than a separate potentiometer, reducing channel interaction.

Internally, the QED units sport discrete transistor circuits, rather than the cheaper and lower performance ICs used in many modern designs, but after all this effort has been made to keep the signal clean, output protection is provided. However, QED say that their circuit avoids any disruption of the signal path, so sound quality remains unaffected.

Overall, the QED 300C/P has been well thought out in all the more crucial areas. A sensible design approach has then been taken, attending to details whilst keeping the price low. This makes the QED outfit possibly one of the most honest designs considered here; it offers good value for money.

SOUND QUALITY

In comparison to the other more expensive and powerful pre/powers in this test these units lacked control and gusto. However, they did manage to hold their head high in other areas, particularly by painting a large and reasonably deep soundstage.

The 300C/P combo didn't have the ability to stop and start with quite the precision of some rivals and tended to get confused by complex passages of music, with instruments becoming a little tangled. The treble was not particularly open or detailed, but it remained clean in all but the most demanding of circumstances. The



QED 300C/P

£699

bass was quite slow and undynamic and tended to blur strong bass lines. The power amp seemed to have a good grip on the loudspeakers most of the time, however, it was only at higher volumes that it gave up trying and let go.

The soundstage was one of the better ones in the group with the music being cast well outside the outer edges of the loudspeakers. It also possessed a quite exciting and involving sound, yet remained smooth with no rough edges. In fact, it was possibly a little too rounded, with the guitar on the Blue Aeroplanes track 'Angelwords' losing some of its sheen.

Ultimately, there was a loss of the finer detail that was revealed by the more expensive combinations. Imaging sharpness and position - not to be confused with

soundstage dimensionality - was acceptable, if not special. Only a rough idea of the locations of the various components forming a band was given. The good sense of depth helped ameliorate this to some degree, putting vocals well forward and drums at the back of the stage.

CONCLUSION

Though compromised at the frequency extremes by an undynamic bass and a slightly dull treble this combination is certainly worth a listen. It sounds clean and involving and produces a large and convincing soundstage. Taking the price into consideration, the QED, the cheapest of this group, is a competent performer which takes some beating.

MEASURED PERFORMANCE

Delivering 50watts into 8ohms, the QED is no powerhouse, but for an inexpensive power amplifier, the QED P300 has very good regulation, making it best value in watts per pound when paired with low impedance loudspeakers. But the power supply holds up well as heavier current is drawn, allowing output to rise to a healthy 90watts into 4ohms. Used with high impedance British loudspeakers, it will go loud - but not very loud. Users would find it giving a better account of itself power-wise into European or American loudspeakers.

The main reason for providing good regulation is to ensure an amplifier can deliver strong, solid bass. To this end, the P300 had a pulsed current delivery of 8.45A into a very low load of 2ohms (144watts), comparing well with the other designs in this report.

Whilst the QED power amp has muscle, it lacks finesse. I was concerned about its 0.2% distortion figure, when delivering high outputs at high frequencies. Although this sank to a more acceptable 0.1% at low output, distortion harmonics were extended and odd order, as the analysis shows. I'd expect some slight treble coarseness to be evident as a result. The P300 is not a low distortion amplifier, but if this means little feedback has been used, then it may well benefit by sounding

a little less restrained and 'flat' than many high feedback/zero distortion types.

Output rolls off below 16Hz and above 50kHz, both sensible limits, but the former means there will be a small curtailment of deep bass. **NK**

TEST RESULTS

Power	50watts
CD/tuner/aux.	
Frequency response	16Hz-50kHz
Separation	63dB
Noise	-83dB
Distortion	0.04%
Sensitivity	100mV
dc offset	31/7mV

Distortion

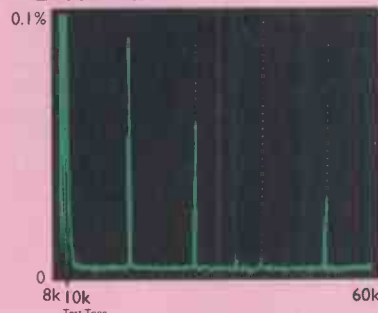



QUAD 34/606

£1,061

Although the spartan fascia of the £398 Quad 34 pre-amplifier is nearly bereft of legends and lacks the visual appeal of the old 33, it carries a wide range of controls. Some of them are carry-overs from the past, others are not. There is a treble frequency filter, with low and high cut-off frequencies, plus optional roll-off rates. This was once a common feature on amplifiers, including Quads, but as LPs became less noisy and cartridges and speakers less peaky, it fell out of favour. The amount of treble cut is too large relative to modern standards of response flatness, limiting its practical value.

This is not the case with the novel 'tilt' control though, which replaces the usual tone controls and is a better acknowledgement of current hi-fi standards. The Quad tilt control is more subtle - suffi-

ciently so, in fact, to be able to finely alter the overall nature of a system, changing it from bright to warm sounding in basic character. It's a facility that suits modern CD based systems well.

To the left of the tilt control lies another curious but interesting tone shaper, marked both 'Bass Lift' and 'Step'. The 'Lift' positions are meant to apply varying degrees of low bass boost to small speakers. However, not all speakers will take stick applied in this fashion without complaining. Their cones may bottom, making the remedy worse than the ailment. 'Step' cuts bass in a carefully tailored manner, to enable ordinary loudspeakers to be used against a wall without bass boominess. There is no innate drawback to its use, although its effectiveness depends upon the speaker

loudspeakers usable against, or close to a rear wall.

The 34/606 measured very well, but the 606 is best used with high impedance loudspeakers. **NK**

TEST RESULTS

Power	128watts
CD/tuner/aux.	
Frequency response	13Hz-30kHz
Separation	80dB
Noise	-90dB
Distortion	0.004%
Sensitivity (CD/tuner)	330/100mV
dc offset	0/0mV

Distortion

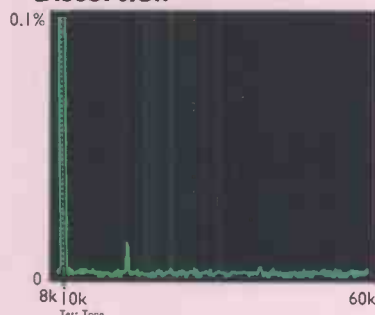

MEASURED PERFORMANCE

Whilst the 606 I measured delivered a healthy 128watts into 8ohms and no less than 210watts into 4ohms, the figure falls when the current limit is reached, being just 120watts into 2ohms. The 606 is best paired with 8ohm loudspeakers, with which it gives plenty of output.

Distortion from the 34/606 combination remained low right across the audio band, at all outputs. The spectrum analysis shows 0.01% at 10kHz, comprising innocuous second harmonic only.

The preamp has enormous flexibility and superb tone controls. The response tilt control applies tilt with great precision, measurement showed, giving exactly the boost/cut indicated (+3/-3dB maximum around 1kHz). The treble filters introduce roll-off above 5kHz, with a minimum of -6dB cut at 20kHz and a maximum of -15dB. Such things used to be useful for taming peaky cartridges or tweeters and for reducing disc surface noise, but those days are gone. The tilt control is a good enough replacement, especially for CD.

Bass boost is a bit violent, at minimum providing a +13dB peak at 20Hz, and at maximum a +15dB peak at 40Hz. Bass cut is a clever shelf effect designed to make ordinary

in question.

The 34 pre-amp has Radio, Disc (LP), CD and Tape (monitor) buttons - a limited range of inputs by today's standards. The click-stop volume control feels sturdy and incorporates a concentric balance control. The disc module is removeable. There are moving magnet and moving coil versions, adjustable to suit a wide range of cartridges. This provides excellent compatibility.

Although simply styled, the 34 is very well built and finished; the fascia is a solid casting with lightly bevelled edges. Likewise, the £673 606 power amplifier is compact, solidly built and very well finished. It has one pair of 4mm output terminals which can, with difficulty, be used for biwiring. A trip protects against the ESL-63 crowbar and, like the pre-amp, there is a remote power output socket.

SOUND QUALITY

The Quad sounded very much as I'd remembered it - smooth, soft and unengaging. Quad are happy to offer an amplifier that does not offend, by being harsh or thin sounding for example, even if it does not excite in the way some amplifiers do. Even P. J. Harvey's raw power and sharp vocals failed to offend.

Switching to the radio I found a Classical broadcast played from LP and realised why people still buy Quad. Most of the musical information is around the midband, where the Quad sounds best, the character of the recording shining through. This combination may be criticised in many subjective areas including imaging, focus and speed, but it lends a soothing richness to orchestral pieces that pacifies any anxieties.

The bass was quite big and soft, the midrange pleasantly clear and possessed of surprisingly good tonal colour, but the treble lacked sparkle. One friend commented "this one sounds a bit lack-lustre" - a not-inaccurate one line summary.

The 606 power amplifier sounded powerful driving the variety of loudspeakers I used during tests, all of which it handled with ease. Although the bass was never really tight, it never seemed to lose control either.

CONCLUSION

With Quad you buy a product that will still be running in twenty years and when it does finally give up Quad will still be there with a full range of spares to repair it. That makes any Quad product an extraordinary investment and good value too. Quad admit they don't cater for the upgrading audiophile; their appeal is to music lovers, rather than hi-fi lovers. If, however, you are like me - continually looking for the ultimate reproduction of recorded music - and you enjoy the excitement of upgrading regularly then the 34/606 may be unsuited.

The AU41P power amplifier and AU41C pre-amplifier form Sugden's entry level pre/power combination, priced at £530 and £369 respectively. Both pre and power amplifier are very well finished, with silky smooth, black, brushed aluminium fascias and classy gold-coloured screen-printed lettering. Conveniently, they are both of a standard width and depth and the taller power amplifier only measures 8cm high. Construction is of a high standard, with only a few small details needing attention, most notably the square aluminium washers that hold the sliding lid on the pre-amplifier. They look a little crude.

Both the AU41 pre-amp and power amp are hand built and tested at Sugden's factory in West Yorkshire. Their attention to detail is typically that of a small British manufacturer, with high quality components used throughout, including a chunky 500VA transformer for the power amplifier. The power amp boards carry 2.5amp output fuses which are user-replaceable in the event of failure.

The pre-amplifier - ours was a line-level only version - has gold plated input sockets for CD, tape, tuner and two auxiliary line sources. These - apart from the tape input which is selected separately - are switched via a rotary selector which had a good action, as did the volume control which uses a high quality Alps potentiometer. It also has a mono button, a rare item these days. Two pairs of output sockets allow for bi-amping.

SOUND QUALITY

The Sugden, like all of the other pre/powers in this group test, was given 48 hours to warm up. However, even when stone cold it was obvious that this combination had a lot to offer, already sounding as good as, or better than, most of its competitors.

When fully run in, the AU41 pre/power lay somewhere between a Deltec (now DPA) 50S and the Quad 34/606. It had nearly all of the amazing detail resolution of the 50S combo, but possessed some of the smoothness of the Quad. This was quite a surprise and throughout the test I found myself repeatedly coming back to the Sugden to check what I was hearing.

The Sugden AU41 has a full sound, with guitar strings and vocals taking on a three-dimensional quality, rather than the normal 2D image produced by most solid state amps. However, it was not over-rich, a characteristic that would have compromised both speed and resolution of the beautifully sweet treble. The AU41 is an amplifier for every taste; I can't see anyone taking a dislike to the blend of clarity, warmth, detail and speed.

REM's 'Talk about the Passion' can sound thin and rather compressed on some systems. With the Sugden installed this track took on the extra depth that it needed, pushing itself outwards from the loudspeakers. The AU41 has the knack of letting music breathe more openly and



SUGDEN AU41P/AU41C

£899

project further forwards, without making it become forceful or heavy handed.

However, the Sugden is not perfect in all areas. Its imaging, although very good, was restricted to a boundary set by the loudspeakers; it did not extend as far beyond them as I would have liked. This was shown up particularly by a Radio 4 broadcast of Classical music. The sound was excellently presented between the loudspeakers, but beyond this it was lost, detracting from the width and height of the performance somewhat. This doesn't mean that the Sugden is not suited to Classical music; for many its tonal qualities

alone will be the deciding factor, overruling this small deficiency.

CONCLUSION

Sugden's AU41 pre-amp and power amplifier can be recommended to anyone who wants a balance between detail and fullness, without serious compromise. It has the tonal character of a good valve amplifier, retaining the feeling and emotion within music entrusted to it, whilst also sounding as clean and accurate as solid state can. Sugden seem to have got this difficult balancing act right and I'm sure that it will win them many friends.

MEASURED PERFORMANCE

The stoutly built Sugden AU41 power amplifier can swing a lot of volts, making it effective with high impedance speakers. It will deliver 105watts into 8ohms, a figure that will generally appertain in Britain. Overseas users wouldn't be disappointed by its regulation and, therefore, current delivery: the figure rises to 156watts into 4ohms and the unit will pulse 200watts into a low 2ohm load.

Knowing the innate conservatism of many UK designers, who feel that any excess is wrong (very Victorian, this!), I expected the Sugden to have limited feedback, even if it resulted in some high frequency distortion. Measurement showed a few harmonics starting to appear at high outputs, but the worst figure I could coax from this unit was 0.01% at full output at 10kHz - always a strenuous test. Since 0.1% seems from experience to be a good rule-of-thumb limit as far as audibility of treble distortion goes, the Sugden amp stays well within the bounds of audio decency.

All inputs have high sensitivity; at 170mV; this amp will deliver full output even from those signal sources with low output of 300mV or so.

Frequency response extended downward to 5Hz, the lower limit of CD, so the power amp will amplify subsonics fully. The upper limit of 80kHz will allow CD nasties through if they exist, so good partnering items should be used.

The Sugden units have plenty of muscle. They also have a good all-round performance, making them an interesting potential choice for those tempted to own a make known for ruggedness and audiophile sound quality. **NK**

TEST RESULTS

Power	105watts
CD/tuner/aux.	
Frequency response	5Hz-80kHz
Separation	82dB
Noise	92dB
Distortion	0.005%
Sensitivity	170mV
dc offset	1/1mV

Distortion

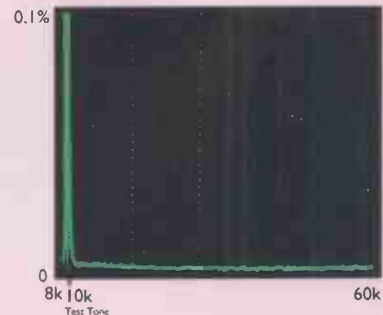

AMPLIFIER CONCLUSION

Each pre/power combination in this test clearly illustrates the different outlooks of the companies and the designers. Each has its own personality and set of virtues.

The Quad 34/606 is the workhorse of the group, with long life and good service high on the list of priorities. It simply gets on with the job without demanding attention. Marantz, in their SC-22/MA-22, represent an opposite approach, the bright appearance begging for attention. QED's 300C/P combination, on the other hand, is the working man for whom every penny counts. Plain and simple, it is an honest design with neither unnecessary extras nor deficiencies.



path which begins with the 240 integrated amplifier. Step-by-step the pre-amplifier and two power amplifiers can be added to produce a full bi-amped system.

For the enthusiast on a limited budget the QED offers an excellent way to enter the pre/power market. The 300C/P is confident without being over-enthusiastic. Although the bass could be criticized as somewhat slow and undynamic, bi-amping may offer a useful extra degree of control over loudspeakers and provide livelier bass.

In terms of sound-per-pound, the Quad 34/606 is perhaps one of the hardest to justify, at least in the short term. Yet on a longer time scale it offers the best value for money. In twenty-five years' time, when it is still - given Quad's reputation for reliability - providing good service, it will have cost a measly forty pounds a year. By then, that will be pocket money and buyers may well be congratulating themselves on a wise purchase.

Allied with ESL-63 loudspeakers and the new 66FM tuner, the Quad could be



At first glance, Sugden's AU41P/AU41C lies somewhere between the QED's no-nonsense style and Quad's obvious dependability. More than any other in this group it combines finesse and detail with guts and power, a balance rarely achieved at this price level, and one which puts the Sugden out in front.

The power amplifier is a strong performer, its output reserved for control and dynamics rather than the last ounce of loudness. It can cope on a large scale without running out of steam. Its partnering pre-amplifier is smooth and refined, with a tendency to richness, and despite a slightly squashed soundstage by comparison with its competitors, rates very highly among them.

QED and Quad both occupy the middle ground, the QED 300C/P being part of a short but well-structured upgrade



hard to beat. While some of the alternatives may have better resolution of detail, some may be more dynamic, few rival the smooth, relaxed sound.

Finally, the Marantz. Despite its monoblock construction and very good stereo separation and imaging, it falls short of the others in the group. It is bettered in sound quality by the Sugden and in functionality by the QED. While the SC-22/MA-22 looks like £2,200's worth, its limited power, finicky setting-up and comparatively uninspiring sound all act against it.

Overall, then, the Sugden takes Gold, with a balance of performance, power and price the others cannot match ●



Do the ear and brain prefer a psycho-acoustic trick to the truth? I've heard some great sounding pieces of hi-fi recently, yet paradoxically, little of it measured as well as so many everyday products. It's a peculiar and unsettling situation that makes me wonder whether the truth can be unpleasant, and hi-fi can be a means of disguising it. It was comparing CD to LP that revived my fears and reservations in this area, but the survival of the LP is a dead topic. I'm not about to harp on about LP. There are some interesting implications for the direction future technologies should take though.

Feeling I ought to bring some objectivity to the business of comparing LP to CD, I dug out about eight CDs for which I also have LPs and patiently compared the two again. I was reminded that this test makes some interesting points, but none about which medium is best.

That question remained unanswered. In some cases LP lacked real see-through clarity across the mid-band; here CD was often the winner - but not always. I became aware also that some LPs sounded a bit muddled, a bit tangled up at higher frequencies with cymbals blurring into a triangle, flute into piccolo. This sounded like the stylus tip was failing to make real sense of what was in the groove and I suspect a difference between what's known as modulation slant angle and stylus rake angle was to blame; they should be identical.

Failing

Trouble is, the failings of CD were generally greater and more aurally disturbing. In particular its hardness across the upper mid-range, weaker dynamics and so-so imaging were perplexing. The difficulty of comparing CD with LP I remembered, is that it is not a case of comparing like with like. I could have been trying to choose between honey and jam; the comparison was fatuous. All the same, it did raise many interesting points.

One of them was the question of whether I was listening to an entertaining psycho-acoustic trick. The differences between LP and CD are easily measurable and, superficially, LP is the loser on all counts by a large margin. It's wracked by various distortions, it has inferior measured dynamic range, inferior speed stability, undulating frequency response

and poor channel separation. So what trickery was at work to make it sound so good?

The ear and brain relate loudness to distortion. If transient peaks or crescendos from LP are tinged by distortion, then perhaps they just seem louder and dynamic range appears stretched, even if it isn't. Additionally, it could be argued that because cartridges commonly have falling upper mid-range output, including the Goldring 1042 I currently use, then LP would sound warmer and more amenable simply because of this characteristic. Finally, poor stereo separation may actually serve to strengthen centre-stage (mono) images, giving them more apparent body. None of these arguments is watertight; I could refute all of them, but they are plausible all the same, suggesting that the good sound of LP is a trick.

Emotional Experience

But does it matter? Listening to music isn't an exercise that has to be related to science or engineering; it's an emotional experience. Anything that encourages and enhances that experience is valuable - it is worthwhile in itself. Perhaps I don't have to ask whether it is right, so much as whether I enjoy it. We are listening to an illusion and, thought of in this manner, it is easy to see how manipulating the illusion may make it more exciting or interesting or just closer to our own expectations or requirements.

There's a philosophical difficulty here. If hi-fi is merely about choosing your illusion, then accuracy can be ditched altogether, as a notion and as an engineering goal. This implication makes me uneasy. Directly we ditch accuracy, then any old midi-system becomes acceptable as a standard of goodness. For this reason - and because it seems to epitomise sophisticated engineering dedicated to the notion of accuracy, I could feel obliged to like and endorse anything and everything - including CD - that measures well, a thought which horrifies me. Long ago, amplifiers became 'perfect' in measured terms but those same amplifiers never sounded special in any way. Am I now to tell myself and others that they are?

So is LP a clever psycho-acoustic trick or not, one with huge failings that actually sound good, rather than bad? There is one more phenomenon that for me tips the balance of this



Reflections from Noel Keywood kaleidoscope

argument in favour of LP, suggesting it is actually very right. Speed it up a little, to 45rpm, and the sound becomes so much better that its superiority over CD becomes undoubted. I haven't found anyone who feels that CD sounds better than 12in, 45rpm singles. Since speeding up LP reduces nearly all of its innate problems, reducing distortion and improving dynamic range, then if those problems really were fooling me, producing a pleasant illusion, then this illusion should be diminished. Speeded up LP should sound more like CD in other words, and less like LP. So does it?

Rightness

It doesn't - and here things get interesting. Vinyl at 45rpm becomes even more dynamic - startlingly so. But distortion has decreased, so this junks my link with it and perceived dynamic range. The sound becomes cleaner, more precise and generally more robust in every area. Cleaning up LP makes it sound better, but this improvement process only enhances its innate strengths, it doesn't make LP sound more like CD. This offers fairly compelling evidence in favour of the rightness of LP I believe. In other words, the good sound of LP isn't a psycho-acoustic trick.

Perhaps, in light of reality - namely that the LP is all but dead and the CD has taken over

- I should start to rephrase this argument, because it has other implications, ones that are intriguing. What I should perhaps say is that with a little bit of improvement, an analogue system could be made to offer appreciably better sound quality than current sixteen-bit digital. CD never offered us better sound quality in absolute terms; it gave us convenience and a hassle free replay medium of consistent quality, all from a £250 player as far as the average man is concerned. In a nutshell, CD has brought good sound quality to the masses. It's as simple and as glib as that. It hasn't improved fidelity one little bit. Just making LPs spin at 45rpm (or cassette run at 3.75

ips) would have done that.

More importantly though, I now feel that what some of our perceptive readers have been suggesting for some time is probably blindingly correct: that should exploit current magneto-optical technology differently. Ideally, we could encode either an analogue signal onto a disc, like Laservision or a digital signal of higher specification (18 or 20-bit).

A Halfway House

Enquiring about this possibility was fascinating. Philips told me that Laservision, CD-V and, now, Laserdisc all encode the basic signal onto disc using a Pulse Code Modulation system, which is a half-way house between analogue and digital. If hours of TV can be crammed onto a 12in disc, audio would need only 5-10in of disc size at most. We would be able to return to analogue, with its easy, natural sound, whilst retaining most of the practical advantages of CD. If magneto optical discs could be analogue encoded, then recording onto disc may become possible too. Whilst this would be a possibility, I was told, error correction would not. We would probably hear ticks and pops. Sounds familiar to me!

The LP might be dead, but the sooner we can return to LP the better. A recordable Laservision disc would do nicely I suspect ●

Every now and again, a truly innovative idea surfaces in the world of recording. I was recently privileged to witness a demonstration of such an idea when some revolutionary loudspeakers were being tested during a Classical recording session in London. Dubbed the 'Hautparleur Numerique', the 'Digital Loudspeaker' is the brain-child of Dr. Pierre Gavan who works and studies at IRCAM, the electronics and musical research institute housed in the Pompidou Centre in Paris. Gavan's breakthrough is the practical realisation of a truly digital transducer and it may represent as great an advance as the invention of digital audio tape itself.

Ever since the widespread adoption of digital audio in recording sessions twelve years ago there has existed a worried worry in engineers' minds. It is this: how does he or she know what is actually being recorded onto tape? After all, the engineer can only listen to an analogue conversion of the digital signal and is therefore limited, as you or I are in our own homes, by the standard of the digital-to-analogue converter.

Obscuring The Signal

In fact, it is true to say that the engineer risks making more judgements about the standard of the conversion than about the positioning and performance of the microphones! And the digital-to-analogue converter is just part of the problem because the audible signature of every power amplifier and conventional loudspeaker all contribute to the obscuration of the original digital signal.

By contrast, Dr Gavan's invention promises a completely digital signal route from the analogue-to-digital converters following the microphone amplifiers to the loudspeaker diaphragm. In fact beyond, because Pierre Gavan's loudspeaker converts digital signals directly to acoustic energy. I was able to speak to the loudspeaker's mercurial designer during a break in the recording session.

"In order to fully appreciate this approach," he explained, "it's first necessary to recap a little on the theory behind digital audio. Remember that a

digital audio signal has two characteristics which separate it from an analogue signal. First, it is a sampled signal. Second, it is a quantised signal. In other words, instead of a continuous electrical waveform, it is a time-discrete sequence of binary numbers. How many numbers is a constant source of debate within the audio industry, but in practice the signal is usually divided into two raised to the power sixteen - hence the term sixteen bit. Sixteen bit allows for 65536 different levels."



cones, which is used to filter acoustic energy at the digital wordclock frequency of 44.1kHz. The diagram also illustrates the AES/EBU digital interface receiver and the serial complement-to-parallel offset binary converter box. All the electronics was designed and built for IRCAM by the electronics department at Lyons University.

Unfortunately, time at recording sessions is always limited, so a prolonged listening test was impossible. Nevertheless, the sound quality was

recorded message

Left by Richard Brice

"Inside the digital-to-analogue converter, the electronics tries to create these sixty-five thousand different levels from the sixteen bit binary number it receives via its digital input. But this is a very hard thing to do. Instead, inside the Hautparleur Numerique is a set of amplifiers and loudspeakers each scaled in binary sequence. Each digit of the final digital signal drives an amplifier and loudspeaker cone directly." So the most significant amplifier/loudspeaker pair is formed from a hundred watt amplifier and a 25 centimetre bass loudspeaker, the next most significant digit triggers a fifty watt amplifier and a 25 centimetre cone and so on until we reach the least significant digit which triggers a

12 mW amplifier driving a 2.5 centimetre soft-domed tweeter. In each case the loudspeaker is either driven hard in or hard out, just like the binary signal itself so there can be no distortion. This experimental version is fourteen bit but it can easily be extended to twenty bit and beyond as digital recording technology gets better."

Like most great inventions one is struck by its underlying simplicity, fourteen loudspeakers each handling just one bit of the digital signal and responding by moving simply in or out. A distortionless, entirely digital transducer. Fig. 1 is the diagram accompanying Dr Gavan's French patent application. Note the acoustically treated material in front of the

remarkably clean and detailed. Despite the French government's generosity to blue-sky research, like all such groups IRCAM are always pressed for funds and are anxious to licence the commercial manufacture of Dr. Gavan's loudspeakers. Pierre Gavan himself is convinced that, with a modest investment, it would be possible to produce a domestic version of the loudspeaker economically. As the IRCAM press release points out:

"Although the loudspeakers are themselves complicated, they dispense with the need for power amplifiers and a digital-to-analogue converter. In the home, all that would be needed is the CD player and the loudspeakers!" ●

Fig. 1

Block diagram illustrating the 'Hautparleur Numerique' from the French patent application.

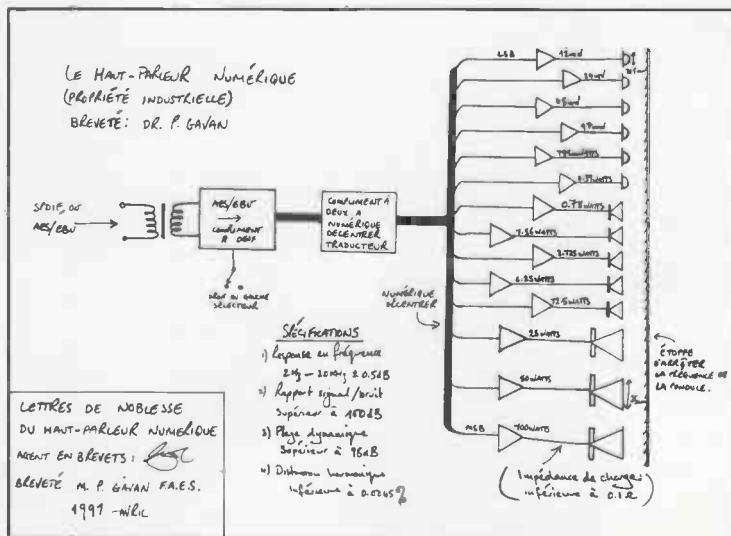

Second-hand hi-fi is cheap and plentiful in this current climate. I won't go into the reasons why because they tend to be depressing, but for those of you who do still have a few pennies to rub together, now is the time to pick up a bargain.

On many occasions I have scoured the second-hand market for myself and for friends who aspire to hi-fi above their means. Each time, with careful negotiation, it has proved worth while and no problems have arisen. However, you do hear nightmare stories about people who buy second hand hi-fi and either never receive the goods they've paid for or they arrive damaged or faulty. A few simple precautions can reduce the chances of this happening and provide you with some come-back if all doesn't run smoothly.

The first problem to tackle is deciding on the age of the equipment to look at. If you are looking for a simple system that will be reliable and easy to repair should something go wrong in the future then I would suggest looking at equipment no more than five years old. There are exceptions such as Quad, who carry spare parts for just about everything that they have made and Nakamichi, whose cassette decks seem to go on for ever, and who also service old machines.

Reliability And Service

It is best to look for hi-fi from larger manufacturers that have a good reputation for reliability and service back-up, as well as those who produce the best sounding equipment. Real enthusiasts may like to try their luck with some of the excellent vintage equipment that is around. In hi-fi terms something is not vintage unless it is over twenty-five years old and either uses valves or was used with valve equipment. Vintage equipment very often requires renovation, total modification or at the very least, a good service. You really need to know what you are looking for because although some vintage equipment can sound wonderful once restored, but a lot of it is best left in junk shops.

There are three basic places that you can buy second hand

hi-fi, each having their own advantages and disadvantages. There are special, dedicated second-hand retail outlets which tend to specialise in vintage equipment, hi-fi dealers who sell equipment that they have part exchanged and private advertisers.

The safest way to buy second hand is to take one of the first two options. The vintage specialist will very often be someone who has a good technical background; this is virtually a necessity because much of the equipment that he sells will have needed renovation or repair. In this



Dominic Baker dB on the level

instance you can be reasonably sure of purchasing something that works and that can be repaired by the person who sold it to you.

Of course you never get something for nothing and this kind of service costs. Vintage equipment can also vary widely in quality, condition and price. Before we ran our Leak Troughline articles it was possible to pick up one of the later stereo versions for about £30 - or even less if it turned up at a jumble sale. But I know of one that was sold recently which was in average condition and in need of some restoration that fetched £200.

In terms of sound quality alone it is worth this figure but it is still possible to find the occasional bargain. In addition the Troughline very often needs extensive renovation, re-calibrating and in the case of the mono versions a stereo decoder must be added for stereo. This is all necessary if you want the kind of results that we get from ours. This is a problem common to most vintage hi-fi and if you are non-technical yourself a lot of trust must be put in the person who does the necessary work.

For more recent second hand goods hi-fi dealers are a

good place to search. Many will swap a customer's old hi-fi in exchange for a shiny new one and a handful of cash. They are then left with second hand hi-fi to sell which in some cases can be very new, since some customers will buy a hi-fi and after several months get the bug! Upgrading follows shortly, their nearly-new budget hi-fi being traded in for new, mid priced hi-fi - something I saw occasionally in a shop I worked in.

Part Exchange

Unfortunately, when a hi-fi dealer does take a piece of equipment in part exchange it is not just a simple job of sticking a fiver on and selling it. Not only does VAT at 17.5% have to be added but also the dealer's own margin. This has to cover the time and money expended and the guarantee that the dealer has to provide. For example, if you wanted to part exchange an amplifier which has an approximate second hand value of £200, the dealer has to take off 17.5% plus his margin of, say, 15% - a total of 32.5% to keep the original price competitive. In practice this 32.5% is split two ways. The customer wishing to part exchange will

get around £170 and the second hand buyer will pay approximately £230.

This may seem a bit harsh. But for an extra £30 the second hand buyer can view, borrow and listen to the amplifier first and then if they do buy it, it will come with a guarantee. This is quite different to buying from a private advertiser.

Second hand hi-fi advertised for sale privately can be found in various places including Exchange and Mart, Loot, local papers and inside this magazine. This method of purchase is the cheapest but

the risks are also the highest. In practice, if you buy from a private advertiser and either the goods don't arrive or they are faulty when they do, there is very little that you can do about it.

When purchasing from a private advertiser through a paper or magazine a few simple precautions can considerably reduce the risk of losing your money. The law concerning this type of purchase basically says caveat emptor: 'let the buyer beware'.

This is not much use if you have just been ripped off. What you can do however is make sure that the person you intend to give your cash to is genuine. For example you could ask them to send you a signed letter detailing the make, model, cosmetic appearance, the functional condition and the price of the item. So if there is any argument later, written evidence is available. Hopefully this will normally be enough to ensure that problems do not arise in the first place. Purchasing second hand goods from any source has its benefits - especially on the buyer's cash-flow - as long as some degree of care is exercised ●

MAKE BEAUTIFUL MUSIC

Even if you have a modest Hi-Fi system, adding a pair of our 3 way SPHINX loudspeakers will enable you to attain its maximum potential. Compatible with a wide range of amplification and sources they will take you to the heart of every performance. Just sit back and let the music flow.

For more information and a demonstration visit your dealer or contact us direct.

fuller's audio combining innovation with classic design. 20 Tunbridge Road, Southend-on-Sea, Essex, SS2 6LT. Tel 0702 612116

Michell - Symbol of Precision

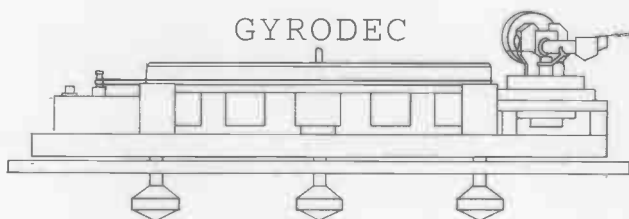

GYRODEC

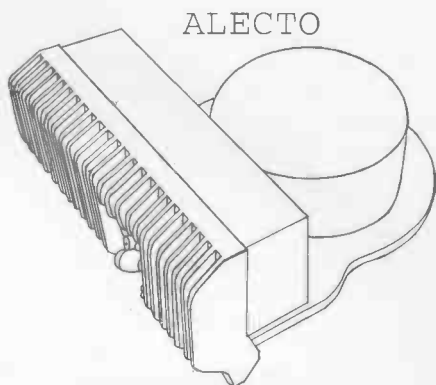

ALECTO

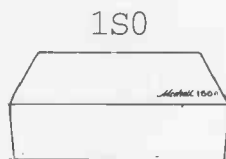

150



ARGO

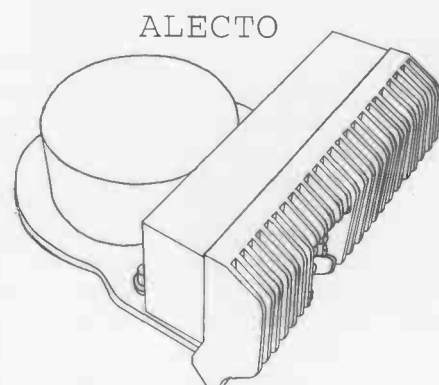

ALECTO

Information on our full range of products available from:-
J.A.Michell Engineering Ltd., 2 Theobald Street, Borhamwood, Herts WD6 4SE

Tel: 081 953 0771
Fax: 081 207 4688

Sure- Fire Canon

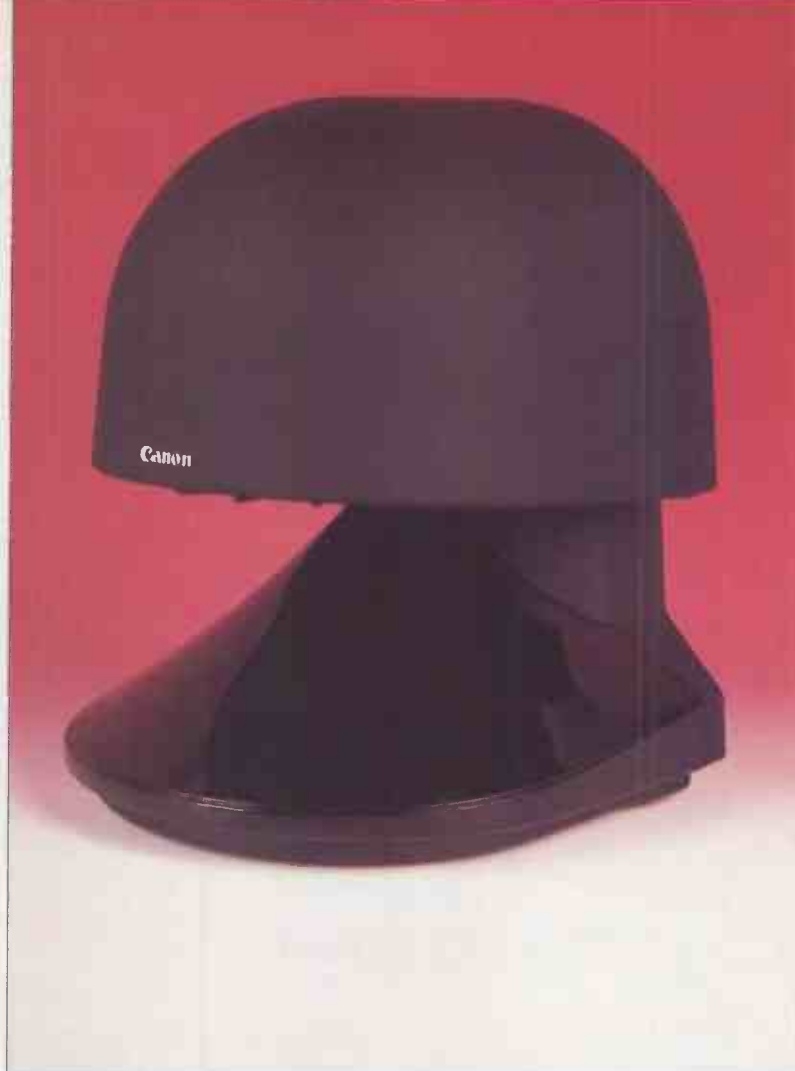

Is Canon's latest "Wide Imaging" loudspeaker a hit or a miss-fire?

Eric Braithwaite finds out.

More than a year ago, Canon burst on to the audio scene with their first loudspeaker, the eccentrically dome-shaped S-50. Now it's been joined by a cheaper model, the S-30 at £150. First in what was to be a range of "Wide Imaging Stereo" speakers, this bookshelf-cum-stand-mounting design used a downward firing single drive unit above a cone-shaped acoustic reflector. The idea was that, unlike the notorious omnidirectional speakers of the Seventies, this novel design would produce a coherent stereo image from a wide variety of listening positions; the days of the 'hot-seat' were over.

Well, yes and no. An extravagant and broad advertising campaign failed to seduce the hi-fi press; while the notion worked, there was no denying that the sonic signature was little better than mid-fi and the S-50 carried a price tag that put it nearly on the same shelf as the classic LS3/5a monitor. For a hi-fi freak, there couldn't really be a contest. Not, apparently, that that stopped the

S-50 selling; I've heard persistent stories that it's actually done quite well in the marketplace.

Canon's new made-in-Britain S-30 shares the same fundamental design and constructional details as its older brother. The matt-black dome - like a crash-helmet - is the 'cabinet', this time including two small slits as ports at either side round the back. The shiny acoustic reflector is die-cast, a zinc-based alloy not dissimilar to the material from which Dinky Toys were cast, if anyone remembers them, which accounts for a good pound sterling/pound avoirdupois ratio for a hundred and fifty notes.

Some scrimping has been indulged in to keep costs down, however; the terminals are a nasty spring-clip type, which will hold thicker cable than bell-wire, but nothing of serious audiophile dimensions. At least, this time, they are placed at the back, which makes them more accessible than the S-50's which were underneath. A set of small plastic stick-on dome feet are supplied, which

are essential if you are using stands or placing them on a shelf, for otherwise the S-30's have a distinct tendency to wobble. To give the review pair a chance, I used them on a pair of single-column sand-filled Foundation stands out in the open wired with flat loudspeaker cable from Ortofon which I'm gradually coming to believe is one of this year's unsung bargains.

Listening, I couldn't obliterate a contentious comment by Dr Johnson from my mind: "Like a dog walking on its hind legs," he said, "it is not done well, but one is surprised to see it done at all." He was referring to something quite different to loudspeakers, but all the same the observation seemed appropriate in this case. What is surprising is that Canon's claim to reproduce a stereo image over a wide listening area is borne out in practice. Sit between them, in the normal 'hot-seat', and the stereo image is stable and coherent; shift two yards along the settee, and you do still hear stereo, you can still place instruments and vocals. ▶▶

WHY BUY A NEW C.D. PLAYER ?

When you can transform the performance of your existing C.D. player, with the award winning DIGIT the D.A.C. at a truly incredible price of only £139.00 + £19.00 for the DIGIFLEX interconnect cable.

To quote Audiophile magazine, " its effect is remarkable. Add the Digit and the performance of the MARANTZ CD 52 SE which is already excellent for its price, leaps one stage further towards the magically true to life transparency of two box players costing £1000.00 or more.

In recent What Hi Fi ?, Audiophile and Hi-Fi Choice awards, Digit beat products costing 2 or 3 times the price - so don't be fooled in to paying more, it's not necessary.

To obtain DIGIT, with a money back guarantee, please telephone (0276) 451166 or complete the coupon below.



Please send more information on DIGIT including the POSITRON Power supply upgrade and dealer list.

I enclose a 1st class stamp

NAME _____

ADDRESS _____

POSTCODE _____

QED

QED Audio Products Ltd, Ridgeway House,
Ridgeway Close, Lightwater, Surrey GU18 5XU England



BANDOR

MINIATURE LOUDSPEAKERS
THE SOUND OF EXCELLENCE

Design & Development Studio 11 Penfold Cottages Penfold Lane
Holmer Green Bucks HP15 6XR Tel: (0494) 714058



2" 50MM MODULE	£36
6" 100MM DRIVER	£72
8" 150MM DRIVER	£82
15" 300MM DRIVER	£215

Prices excude VAT & postage.

PASSIVE & ACTIVE X/OVER
AVAILABLE

SPECIALITY:

1. Exceptionally fast transient response
2. Moving mass under 2 grams (2")
3. Covers 2/3rds of the frequency spectrum 200Hz/20kHz

ANODISED SPUN ALUMINIUM CONE DRIVERS
DEVELOPED AND DESIGNED BY DOREEN
JORDAN SINCE OCTOBER 1984

SUPPLIED ONLY DIRECT FROM
BANDOR MANUFACTURING (UK)

Trade Prices and brochures available on request.
35 YEARS EXPERIENCE • BUILT FOR RELIABILITY
WARRANTY

DYNAUDIO®

AUTHENTIC FIDELITY

Dynaudio is considered one of the most distinguished manufacturers in audio. By means of untiring and successful research and exceptional solutions to questions of concept, design and construction. Dynaudio has acquired this excellent reputation, yet success has not altered their independence and single minded concentration on creating products of the highest quality. Dynaudio continues to search for solutions to the basic problems of loudspeaker engineering and then puts these solutions to the test in loudspeakers of their own design. This is especially true for chassis technology. They have set the standards that others must follow.

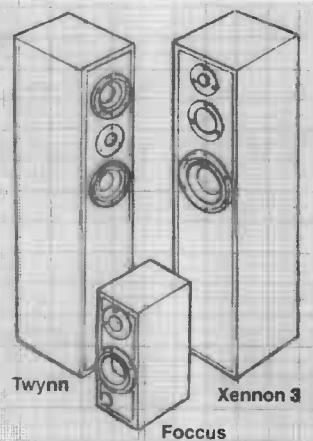

Full demonstration facilities.

4 listening rooms.

We also sell a wide range of
quality Hi-Fi equipment.

	Plus Kit	Carr/Ins	Total Kit	Carr/Ins
Gemini	£590.00	£10.00	£645.00	£15.00
Foccus	£360.00	£10.00	£395.00	£15.00
Twynn	£425.00	£10.00	£510.00	£18.00
Xennon 3	£675.00	£10.00	£750.00	£20.00
Finale	£1,200.00	£15.00	£1,600.00	£25.00
Myrage	£1,350.00	£15.00		

Wilmslow Audio

DIY Speaker Catalogue £2.00
post free (export £3.50)



Dept. HW
Wellington Close,
Parkgate Trading Estate
Knutsford, Cheshire
WA16 8DX
Tel: (0565) 650605
Fax: (0565) 650080

Telephone credit card
orders welcome



Open Tuesday to Saturday, 4 demonstration rooms available.

The effect, as it was with the S-50s, is odd, because the sound-stage becomes a rhomboid, shifting on its axis, but it does remain reasonably credible. It's quite different to the way box loud-speakers lose a quarter or more of the stereo as you move more off axis. It's an effect that will delight those people who will persist in putting one speaker on a bookshelf and the other on a window-sill across the other side of the room and then inevitably complain they can't make out what 'stereo image' means.

All the same, they do need to be placed with reasonable care to display any pretensions to hi-fi, about six feet apart and toed in towards the listener. Unfortunately, the new Canons do only make a pretence at hi-fi quality. A loudspeaker designer who hadn't heard any of the "Wide Imaging" designs - and who had better remain anonymous - sat with one eyebrow raised at the fact they reproduced a stereo image, and then very quickly raised the other at what he called the 'disconnected' bass. It huffs and puffs, trying to catch up with the mid-range like a string of carriages trying to catch up with the engine in one of those disaster movies.

A tidy recording of Bach's Cello Suites, for example, was barely recognisable as a Sony 20-bit special. Tone was uneven, lower notes thickened and slurred, with a tendency to squeak on the way up. The effect was curious, as though the cello was being played horizontally. Much the same was true of the double bass in a jazz quartet, which lacked the 'twang' and 'buzz' of the instrument, missing its resonance. Timpani in classical pieces were a wobbly muddle, while castanets sounded like clothes pegs.

Playing REM's latest, the S-30 was flabby in attack, sounding a little pot-bellied, with an over-round guitar sound. Vocal presence was diminished, with a tendency to sound swimmy and recessed. Rock music generally failed to give the impression of there being a driving force behind it, turning into a somewhat mushy easy-listening Desert Island Disc selection. The sound is

markedly coloured, with a quack in some parts of the mid-range and a cuppiness in others, with voices both palatal and chesty in equal degrees - not a happy combination.

In a recording of the Ludus Danielis, the clear churchy acoustic was blanketed, the chorus likewise, making it difficult to follow the words, let alone the choir's Eastern European-accented Latin. Throughout the listening session there was an odd impression of certain notes in the scale setting off resonances and going off. Top notes could squeak and any instrument heading up the scale was liable to hit a point at which

"there was an odd impression of certain notes in the scale setting off resonances and going off"

it would take on an unwelcome edge. Stick to the mid-range, however, and the S-30s could be reasonably fluid and controlled - but the outer ends are loose enough to make for a distinctly unimpressive performance from the hi-fi point of view.

I strongly suspect that Canon have defined a market for this speaker, and it's the sector that buys a midi-system or a hi-fi stereo video. In the hi-fi sector there are rivals enough from Rogers, Wharfedale and Mission, to name but three, at the same price or obtainable for very little more. Admittedly, none offer the prospect of sitting in the corner and still hearing stereo, but they offer a more lifelike tonality and a more realistic musical quality. A friend who dropped in pursed her lips and described the Canon's apparent frequency response as "pear-shaped", the bulbous part being the mid-range. I couldn't have put it better, but out shopping the following day for some reason found my eyes drawn to the lemons on the grocers' stalls ●

MEASURED PERFORMANCE

The S-30s are the latest to join Canon's range. They are the cheapest and smallest of the three models, using a single 130mm full range driver. This small paper coned drive unit fires downwards at a "sleek black acoustic mirror", as Canon put it. This is used to disperse the sound in a uniform manner, removing the directional property of the actual cone.

In practice this is not as effective as Canon would have you believe. We tried the measurement microphone at every possible angle and distance but could not obtain a flat response. However the majority of the information was present in the majority of positions, so in some ways Canon have achieved what they set out to do. If flat frequency response is any arbiter of hi-fi quality, then the S-30s are not a serious hi-fi loudspeaker. However, they do offer a good attempt at producing a loudspeaker that is non-critical in its positioning.

There is a large suck-out in the speaker's upper midrange, between 2.5kHz and 5kHz, followed by a sharp peak at 6.3kHz. This will almost certainly be noticeable, the peak being centred very close to the ear's most sensitive point. Because of this they may become a little uncomfortable at times.

The S-30s are quite sensitive, producing 88.5dB at one metre for one watt (2.83V) of input signal. Additionally, they have a high overall impedance of 10Ω which makes them an easy load for most amplifiers. This is important because of the kind of market that the little Canons are aimed at. If they were difficult to drive they would preclude the use of low powered, budget integrated amplifiers.

The impedance curve shows that all is not as straight forward as the other figures suggest though. It is very erratic and doesn't flatten out at all between 10Hz and 20kHz. This indicates that the speaker presents a mainly reactive load to the amplifier which will not make its job any easier. **DB**

Frequency Response

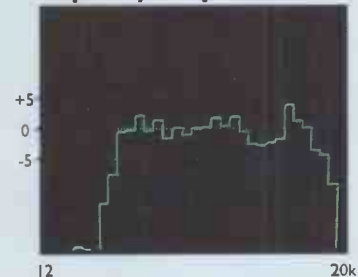

An obvious suck - out in the upper mid-range.

Impedance

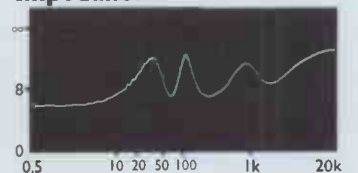

A high overall impedance of 10 ohms



Visible here is the single driver with "whizzer" cone firing downwards over the acoustic reflector.



Pound Power

A real power-house, JVC's new big amplifier offers weight and watts.

Peter Paine lets the AX-A662 pound his ears.

Weighing in at a substantial thirteen kilos JVC's AX-A662 shouts 'large!' Actually 'only' seven inches high, visually it seems much bigger. Most of the top part under the ventilated top plate is air, but a weighty frame-wound transformer and substantial heatsinks take up a fair amount of room. Also visible through the top on the blue circuit board are two glowing LEDs - just one fewer than are on the front panel. For such a big beast, the AX-A662 is surprisingly free of bells, whistles and brash legends.

If it isn't quite as pristinely free of controls on the front panel as the Pioneer A-400, which belongs in much the same market, the ergonomics are equally straightforward. A large volume knob - which has a firm, assured feel - is centrally placed, flanked by separate rotary Listen and Record selectors on the right and rotary switches for choosing between two pairs of speakers and by-passing the tone controls on the left. The latter, curiously, does not switch out the Loudness circuit. Since these controls are different sizes, the fascia has a slightly lop-sided look.

Below this array are the more superfluous controls: round knobs, with a somewhat plasticky feel, for Balance, Bass and Treble and push-buttons to cut in the loudness circuit and a sub-sonic filter. You can choose between mono and stereo output and moving magnet or moving coil disc input options. While most of the listening was done using a DPA Digital Compact Disc source (PDM I Series 3 sync locked to a TI), the phono stage was brought into play (Systemdek IIXE, SME309 and Goldring 1042) and proved to work equally as well as the line-level inputs.

Terminal Difficulty

Inputs include two for tape, phono, CD, tuner and auxiliary. All the sockets are standard nickel-plated in a vertical line on the rear panel with two pairs of screw-down speaker terminals. British hi-fi buffs will curse these, as they don't accept 4mm banana plugs axially, although they will tangentially. Legislation in some countries, Holland being one, bans our more favoured multi-way binding posts on amplifiers and the JVC is aimed at a world market, not just the

UK. At least they present an opportunity for bi-wiring.

Listening to the sound quality of the JVC left me with enthusiastic but slightly mixed feelings. I was drawn by the power of the bass, especially in the spacious drum sequences now used on so many commercial Pop recordings. You know the processed, widening effect. There would be the song playing along and then you'd suddenly be hit by the bass guitar or some spectacular piece of drumming, and instantly impressed. Dynamic stuff indeed and with Rock music, one of this amplifier's most desirable features, the lower regions being superbly kicked along. Anyone whose musical diet is composed of Rock, Dance or the records that are spun on Kiss FM would have to put this amplifier on their short list for this attribute alone.

Pumping the songs along nicely, the bottom regions had a fine degree of weight. Perhaps the last ounce of the drummer's skill was not quite discernible, with some muddle creeping in, but the AX-A662 could certainly provide an insight into his technique, if not precisely how he was going about it.

In the upper-mid region, however, the JVC had problems achieving that extra insight that differentiates between a merely average vocalist and a more accomplished one. In the upper mid to treble region, although voices had a coherent character, they could sound a tad nasal and shut in. It was most evident in the more expressive of Classical recordings. Oh how disappointing that was for me in comparison to the bass!

Real 'raving chewns' gained a new dimension. Those mixed with artificial phase effects and the aurally deceiving 3-D echo ones came out with more realistic depth than others, the recording techniques laid bare. On the whole, the JVC's portrayal of depth was better on simpler pieces, collapsing just that bit too far into the mix on more complex ones, but resulting on the whole in a good average for the £250 price.

With all music, be it complex or simple, the sound washed over the boundary of the speakers. The sound stage was wide and high. Images didn't wander, but were a little out of focus, the edges of instruments overlapping, giving an overall view of

the placement of players rather than the precise pin-pointing some amplifiers can pull off.

Particularly on smaller scale works, JVC's AX-A662 proved very likeable, achieving an almost Audiolab neutrality in displaying a musician's technique. In some respects it showed great

subtlety, in others it was average for the price. The problem was that the subtleties didn't always come over often enough. Even so, it compares very favourably with its rivals and it possesses such weight, power and slam even at low listening levels it should be on every heavy Rock listener's list ●

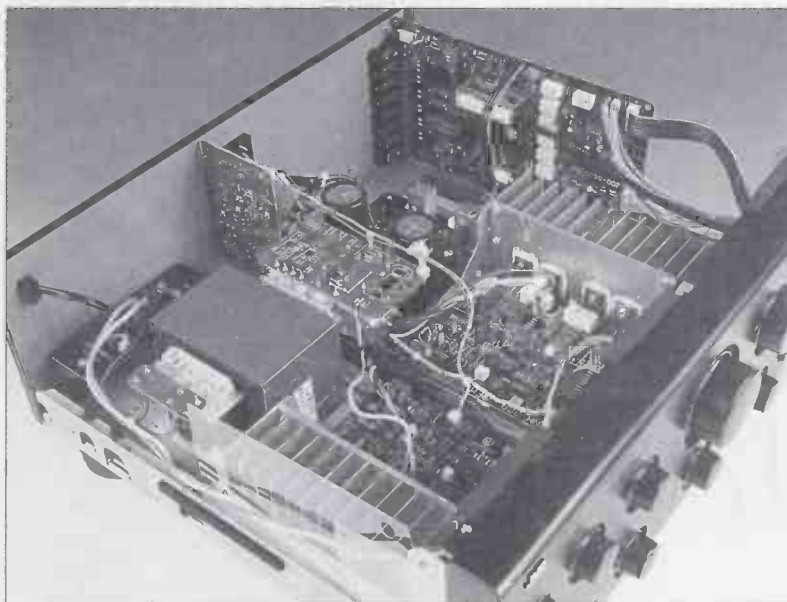

◀ Although the lowest loudspeaker loads are not the JVC's strongest point, the big frame transformer visible at left supplies substantial amounts of power, over a hundred watts.

MEASURED PERFORMANCE

This monster's huge proportions don't mislead: it turns out monstrous amounts of power. Inside, a huge frame transformer supplies oodles of current and volts, allowing the AX-A662 to deliver 112watts into eight ohms. Lower impedances draw more, with 182watts into four ohms and no less than 264watts into a two ohm load when pulsed with tone bursts so as not to blow up the output stages. The waveform clipped asymmetrically and developed transient instabilities under these conditions, so low loads are not its forte, even though it can cope.

Big outputs are in fact more useful to get power into high impedance loudspeakers, measuring more than eight ohms. We find most British loudspeakers have an impedance of 10-12ohms. They need to have a lot of volts applied (electrical pressure) to get a current to flow through them in order to go loud and, at this, the JVC will excel. Think of it as a headbangers' amp if you will, an impression JVC may well want to convey, seeing the thing is so darned large, but it could be seen also as an amplifier for high impedance loudspeakers.

The unequalised inputs (everything except phono) have a very wide bandwidth of 6Hz-64kHz. There's plenty of bass extension there for a good deep shove to be developed from CDs, from recordings that go low; there will be no shortage of bass from this monster. However, excessive bass can be an embarrassment from LP if warps are reproduced as well, causing cone flap in

reflex loudspeakers. JVC fit a switchable warp filter to prevent this. With the filter out, disc response goes down to 9Hz (-1dB). With the filter engaged output drops by -3dB at 20Hz, which will be effective in stopping cone flap.

A front panel switch allows moving magnet (MM) or moving coil cartridge sensitivity to be selected for the phono stage. Surprisingly, MC was relatively quiet considering the large amount of gain available. This means that high quality, low output MC cartridges can be used. The moving magnet and moving coil stages were well engineered compared to many modern Japanese amplifiers, where it is quite obvious that LP has been added as an afterthought, now that CD dominates.

I was very surprised to find that even the tone controls work quite well. They're not up to Audiolab or Quad standards, but they do introduce fairly well defined and sensible amounts of bass and treble lift, if not treble cut, which tilts the whole audio band.

A complete absence of distortion right across the audio band suggests large amounts of feedback have been applied to high gain/bandwidth output transistors. It makes for an impressive specification, but not necessarily for good sound quality.

JVC seem to have put a little more into this amplifier than most out of Japan these days. The AX-A662 is a high power monster, with no great weaknesses, one flexible enough to cater effectively for LP, as well as putting muscle behind the sound of CD. NK

TEST RESULTS

Power	112watts
CD/tuner/aux.	
Frequency response	6Hz-64kHz
Separation	65dB
Noise	-100dB
Distortion	0.004%
Sensitivity	250mV
dc offset	-27/-25mV
Disc (MM)	
Frequency response	11Hz-53kHz
Separation	64dB
Noise	-86dB
Distortion	0.005%
Sensitivity	2.8mV
Overload	125mV
Disc (MC)	
Frequency response	9Hz-48kHz
Separation	56dB
Noise	-68dB
Distortion	0.005%
Sensitivity	0.22mV
Overload	10mV

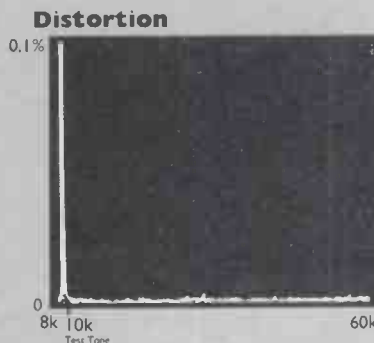

Negligible high frequency distortion

By now many people will know from the weight of publicity that two new digital recording formats have just hit the marketplace: Digital Compact Cassette (DCC) from Philips and MiniDisc (MD) from Sony. They are in direct and fierce competition; both manufacturers would dearly love to capture the global tape market occupied by the cassette, worth billions of pounds.

Now that MiniDisc has officially arrived, albeit in haste to prevent DCC gaining too much of a lead, we carried out a survey to see how well each was being received by the market - especially the major retailers.

Media Melee

Out in the High Street, the battle between Philips' Digital Compact Cassette and Sony's MiniDisc has begun. Will it end in a draw or will there be a single winner? We spoke to some of the people who are selling the hardware and the software.

Report by Eric Braithwaite.

It is for the hearts and minds of the retail trade that Philips and Sony have to battle hard. Both companies are painfully aware from experience that if retailers refuse to stock a technology in depth from the outset, there's a strong chance it will fail. Just look at the current emphasis upon stockists in advertisements.

Retailers for their part are commonly sceptical about new technologies like these, making them reluctant to devote shelf space that may be wasted because of poor sales. Digital Audio Tape (DAT) had plenty of promise, but it failed to sell through to the public in quantity. Lack of availability of hardware and software in the shops contributed significantly to this. We contacted a variety of major retailers to get their views and policies on this latest skirmish by the world's electrical giants.



THE HARDWARE

SONY (MINIDISC)

"Dealers just cannot get enough players, they are screaming down the phones for more stock" said a Sony spokesman. Even though Sony's portable MZ-1 player is barely a couple of months old, Sony UK claim sales have exceeded their expectations, with specialist car hi-fi retailers expressing interest in the new machine for in-car use.

PHILIPS (DIGITAL COMPACT CASSETTE)

A different kettle of digital fish, in that Philips' first Digital Compact Cassette player, the DCC900, is a full-size domestic machine rather than a portable; UK sales are up to the company's expectations. Germany, however, has apparently really taken DCC on board: there the machine is doing very well, they say: "an amazing success," according to a spokesman from Philips' PR company Mathieu Thomas. A midi-system player, the DCC300 and a hi-fi separate, the DCC600 finished in black with styling more amenable to the British separates market, are two new products due in March or April. They are the ones Philips believe will really take off.

THE RETAILERS

DIXONS

One of the biggest 'Brown Goods' chains on the High Street, Dixons are stocking DCC players and software in forty-five stores, MiniDisc in twenty. Both formats, Dixons say, are currently selling equally well, but there are no hard and fast figures yet. Walk into your Dixons store and the two digital media are clearly distinguished: you'll find MiniDisc among the portables and the personals, DCC in the hi-fi sector. Stores are also selling pre-recorded and blank DCC tapes, but not MD. Could this be a hint as to the likely winner of the format war?

COMET

Equally prominent is Comet, with two hundred and thirty outlets around the country, fifty of which stock Sony's MZ-1 MiniDisc player. Digital Compact Cassette, however, figures in only twenty of the chain, but "We're expanding as fast as we can," said Merchandise Director Peter Hopper. Numbers depend simply on the availability of the machines. Comet aren't discriminating in favour of one or the other. "I don't think it'll be a battle to the death" said Hopper. "Both can survive side by side; they



both cater for different needs. For example, you have to look at the customer's music library: if they have a lot of cassettes, that will dictate the hardware; they'll buy DCC rather than MiniDisc."

THE SOFTWARE

When Compact Discs came onto the market, one of the greatest disappointments to those people who rushed out and spent their £400 on one of the first players was the serious shortage of recordings to play. The initial launch catalogue comprised a mere hundred titles.

When Digital Compact Cassette and MiniDisc were first mooted, both Philips and Sony made it known that they were determined that buyers wouldn't be left short. Planning releases on the new formats was aided by the fact that both companies are major players on the software scene: Philips with the Polygram group, and Sony having taken over the American giant CBS. Nonetheless, both companies spent considerable time and effort demonstrating their hardware to record companies around the world. Philips gained support from - obviously - their own labels, but also from EMI, MCA, BMG and Time Warner, resulting in a

varied initial catalogue of 350 titles. Outside the majors, Koch International announced their first DCC titles this month, with the intention of having a hundred releases for sale by the end of the year.

The story for MiniDisc is somewhat different, with three hundred titles on offer, all from the Sony/CBS stable. There have been strong rumours of a 'wait and see' attitude to the MiniDisc format from other record companies, but the launch was later than DCC.

The issue of software availability has been complicated for both formats by some resistance from artists. Every artist receives a royalty payment from each recording sold; there have been a number of complaints that artists have been pressured into accepting lower royalties from DCC and MD sales than CD, even though the retail prices are similar. The record companies argue that they are bearing the expense of promoting a new format - some recording artists, quite understandably, don't see why they should share it. The disputes are continuing, which accounts for some notable gaps in the current listings, Dire Straits being one of the most obvious.

Virgin

Of the large record stores (or should it be 'music' stores?), Virgin are stocking the full range of pre-recorded MiniDiscs in all eighteen Megastores on the UK mainland. Virgin's initial agreement with Polygram (Decca, Deutsche Grammophon, Philips and their associated Rock labels) was to stock DCC titles in their eight city-centre stores: Aberdeen, Belfast, Birmingham, Glasgow (Argyle Street), London (Oxford Street), Manchester, Newcastle and Nottingham.

For the moment, these remain the only outlets, but the situation will be reviewed later this year. In the meantime, sales are not exactly spectacular, MiniDisc apparently selling slightly more than DCC. "There's not much in it," said Virgin's Retail division, "neither are selling in huge amounts; there's no comparison with CD sales." When pressed, Virgin estimated sales of both formats at less than a hundred a week each across the whole chain - hardly likely to pay for another balloon for Richard Branson! "But it's early days" said the spokesman.

HMV

Another major presence in the High Street is HMV, who have been taking hardware availability into account in deciding where and whether to stock DCC or MD. Twenty stores currently stock DCC, with a range of seventy-five Rock and Pop titles and sixty

Classical. Five stores hold stocks of seventy-three MD titles covering all the musical genres. Sales are said to be slow, but then, ten years ago Compact Disc sales also took a while to take off.

AND THE WINNER IS ...

Well, it's too early to say. Both Sony and Philips are fairly obviously pinning their hopes on the midi-system buyers for this year, neither apparently anticipating a massive demand for their first models. Obviously, there's a chicken-and-egg situation: until the queues start forming on the pavements waving their chequebooks and asking for the hardware, software sales will remain low.

Equally, there will be some resistance to stocking two more formats from the smaller retailers until demand improves. We're still in recession, and no retailer likes to occupy space with slow-moving stock.

We'll take a final view from the sharp end. Peter Hopper of Comet told us that he felt most potential buyers would not hear a difference between the two new formats. "In the end, convenience and portability will be what counts: most will find the quality acceptable." Could he tell the difference? He laughed: "Actually, yes; I must have what you call 'golden ears!'"



"What could influence the market in favour of one or the other though, is the availability and the price of the software. That could make or break either. Against that, to a certain extent, the hardware becomes secondary." So, which company will be the first to make their software available at cassette prices instead of CD ones? Neither Sony nor Philips are saying, but to break the commercial deadlock and stimulate sales, we might yet see a price war that gives us CD quality (well, almost) at cassette prices. It would leave Compact Disc untouched as a top-end, high cost medium, one of the few things that Sony and Philips would be able to agree upon ●

Radio News Reader

Kenwood's 3050L tuner is the latest of the budget Radio Data System tuners to hit the streets. Eric Braithwaite reads the messages and listens to the news.

Even after all this time, there's still a frisson of excitement in opening a box when you know the contents haven't been seen by anyone outside the factory. Kenwood's new £170 3050L RDS tuner is a case in point: even the trade hadn't seen it. It's part of Kenwood's new-look separates range, typified by a coolly-curved, black full-width fascia, matching the latest amplifiers and cassette decks from the

company. In common with other Japanese companies, Kenwood are feeding some of a midi-system's convenience into their separates, but without overdoing the gizmos and gadgetry.

Prime among these, in Kenwood's view, is the ability to link any of their range of separates together so a tuner or CD player can be controlled from a single remote handset. Select Tuner on the amplifier, for example, and the tuner will power up from standby. More important from our point of view, however, looking at the 3050L in isolation and its appropriateness for a mix n' match system, is that the Kenwood is an RDS (Radio Data System) tuner.

Data Enthusiasm

I've been an enthusiastic proponent of RDS from the beginning, since it brings an element of user-friendliness to tuners that has been lacking. As the number of stations increases, it's asking a lot of anyone to remember the frequencies of twenty-odd different broadcasts; RDS's most useful attribute is that it will give a display read-out of the station name: if you thought you'd tuned to Classics FM but you find yourself hearing Genesis, a few seconds after the frequency comes up on the Kenwood's display you'll read 'KISS FM' and 'POP' so you know the programming policy hasn't suddenly changed.

RDS has more potential than this, though the Kenwood only makes use of the basics. Pressing the Display button under the Power switch will display the station name, programme type or time; as far as I know only one tuner in this price bracket, from Pioneer, displays the messages and text that can also be transmitted.

On this tuner, accessing the RDS functions is a little awkward. Persuading the tuner to scan the FM band for

a particular Programme Type involves pressing the PTY button on the left, toggling the round tuning knob on the right to scan through the types available and then pressing PTY SEARCH to set it hunting. The RDS labelling



convention has some curiosities which it takes time to familiarise yourself with and the system is still far from fully implemented by the broadcasters. I was put out, when asking the Kenwood to go looking for 'Culture', to discover it couldn't find any, a sad comment on the state of broadcasting in this country!

Name Calling

There are one or two anomalies: in London, Capital obviously doesn't know what to call itself, Jazz FM turns up under 'Other' and while 'Classics' brings up R3, Classic FM is 'Light'. Kiss FM is 'Pop' and GLR is 'Rock'. While breakfasting I thought I'd like to listen to the news; it seemed there wasn't any! For a moment, I thought the RDS system had a super-subtlety to it I didn't know about: trying 'Affairs' brought in Radio 4's Today programme and the first item as it tuned in was about an alleged liaison

MEASURED PERFORMANCE

Like many RDS tuners, I am beginning to notice, the Kenwood lacks sensitivity, needing 4mV from the aerial for least noise, at which level hiss sank to -72dB. Neither figure is especially good by modern standards. Although budget tuners commonly offer a -72dB noise level, making hiss undetectable in everyday use, they usually manage it with an aerial signal of around 1mV. The KT-3050L needed four times as much, which means using a considerably larger aerial in areas of low signal strength. In fact, this amount of signal would simply be unavailable in sheltered locations further than about forty miles from a transmitter, no matter how large an aerial was used.

With a relatively strong 'benchmark'

signal of one millivolt, hiss measured -64dB, at which level it will be audible and of roughly the same intensity as hiss from a pre-recorded tape using Dolby B. As a result I have some reservations about the KT-3050L; it requires a good aerial even when close to a transmitter, or hiss will be audible and I suspect this would surprise and disappoint many potential listeners. Whilst there are precious few silences in the output of Rock stations where hiss would be noticed, the situation is different with Radio 3 and 4. Then this deficiency of the Kenwood will be revealed.

Channel separation was good on stereo and distortion very low at 0.08%. The spectrum analysis shows that just a trace of third harmonic existed, not enough to produce any roughness or unpleasantness in the sound however.

Pilot tone at 19kHz and sub-carrier at 38kHz, both unwanted on any tuner output, were well suppressed. The sudden roll-off in frequency response above 16kHz caused by the filter needed to achieve this can be seen at extreme right in the frequency response analysis. Just to the left can be seen a slow roll down in treble level, probably due to filter mismatching, which curtails the measured upper limit to 10kHz (-1dB). In practice it will also result in soft treble and a slightly warm sound, although not one that could be described as overtly dull.

The Kenwood has Wide and Narrow selectivity options and, as expected, Wide was still reasonably narrow, providing a good selectivity figure of 74dB. Switching to Narrow took selectivity right up to an impressive 85dB, at which even the

between John Major and his cook! So that's why they don't call it News any more: 'affairs' is more appropriate.

Anyway, enough of this, by now you should have the idea. The rest of

station is off-tune. Red segments light at either left or right of the main central column, either when strong stations are very close by or when the tuner is off-tune. The central display

is something which few budget tuners can bring out.

Tuning through the band to hear voice had me momentarily flummoxed; the tuning knob might look as though you turn it, but it's sprung and you merely twist it left to tune down the scale and right to tune up. Odd! However, having satisfactorily tuned into R2, R4, GLR, Jazz FM and so on, male announcers had just a touch of nasality; Jazz FM's notorious bass continuity announcer was less graunchy and hoarse than usual, though each announcer's enunciation was perfectly clear.

Female vocals were quite unaffected, a trifle short on sparkle, but lucid and crystalline. Rock and M.O.R. came over very attractively, a little

slow in the rhythm department, but with plenty of vivaciousness elsewhere. The 3050L produced a good, broad stage with plenty of inner detail, offering up much more insight into mixes and instrumentalists' positions than tuners of this price generally achieve.

As usual, AM reception, while not the worst I've heard by a long way, did have a blotting-paper, muffled quality, but Capital Gold, the World Service and R4 on Long Wave were acceptable, less of a poor relation than they are in most of the 3050's rivals.

At this price, despite my reservations, the Kenwood is very good value. Apart from requiring a better aerial than most budget buyers are likely to have - hiss on R3 was evident even via my six-element affair sixty-odd feet above the London pavement - it has practically no real vices. Its prime virtue is a consistently enjoyable listenability. Not once was I ever tempted to pick up a book instead of listening to the wireless - and I've done that with much more expensive tuners ●



the functions, with which the Kenwood is well-supplied, are now the norm for Japanese tuners: automatic bandwidth selection, three wavelengths, FM, MW and LW, manual and automatic tuning, and a good bank of programme memories accessed by I-O buttons under the display in association with the dual purpose '+10/PTY Search' control. There's even a mono button.

In the absence of an instruction manual (locked away in a store we couldn't open at the time) I couldn't manage to work the titling function, so its modus operandi is hardly transparent. Programmes entered in the memory can be labelled with letters and figures using 'Digit' and 'Character' buttons along with the tuning knob, which then brings up numerals and the alphabet on the display.

The display panel displays station identity and it will flag Wide or Narrow IF bandwidth, Stereo and so on. It also has a useful signal-strength meter which indicates when the

lights to show signal strength when a station is correctly tuned in.

Competent rather than spectacular would best describe the Kenwood's sound quality. The word 'pleasant' kept cropping up in my listening notes. A spell with R3 and a piano piece by Percy Grainger offered quite credible tone, albeit with the lower notes lacking some weight. A recording of Tchaikovsky's Rococo Variations confirmed a degree of constriction; the cello was splendidly gutty and resinous, but the viola tone of the ECO was a shade less dark than it should have been.

Good Listening

The violin section, too, gave an impression of being boxed in, short on range in the upper reaches. Top notes, didn't quite scale the heights they should have done. Even so, this made for good listening and the generous perspective of the Chandos recording was fully portrayed, sounding broad, reasonably deep and nicely detailed - unmistakably the Chandos 'house-style' of sound. That

strongest station should be effectively rejected when receiving a weak one close by. In this respect, Kenwood's signal strength meter was interesting; it is able to show the presence of nearby signals, spaced 0.3MHz above or below the tuned signal. Since both the main display bar and those at either side have five sectors, ranging in displayed level from 63µV up to 1250µV, this meter can display a lot more than most. Not only does it show whether any wanted signal is strong enough (just, at 1.25mV), but also whether there are nearby stations likely to cause interference. If they exist, then Narrow IF bandwidth needs to be selected.

The KT-3050L measured well, except for poor sensitivity. It needs to be used in areas of good signal strength, and with a proper aerial as well, if hiss is to be inaudible. **NK**

TEST RESULTS

Frequency response	4Hz-10kHz
Stereo separation	-56dB
Distortion (50% mod.)	0.08%
Hiss (CCIR)	-72dB
Signal for minimum hiss	4mV
Selectivity (0.4MHz) W/N	74/85dB
Sensitivity	
mono	16µV
stereo	60µV
signal strength meter	

LED No.	level (µV)
1	63
2	125
3	400
4	800
5	1250

Frequency Response

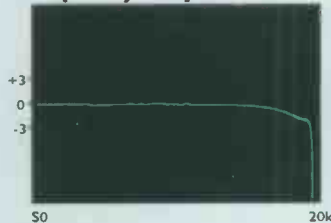

Falling treble

Distortion



Minimal distortion



Garrard Revived

Spurred by growing interest in the famous Garrard 401 turntable, Noel Keywood dusts the cobwebs off his own and brings it up to date.

I once bought a gorgeous new hi-fi turntable, the best there was - and it rumbled. I remember the disappointment now and I never quite accepted that this wonderfully built machine, a Garrard 401, could really rumble so badly. It had an excellent reputation even then, back in the early Seventies, and boy did I ever want to own one. The massive cast platter with its machined-in strobe markings was incomparable and it has never really been bettered even now.

I collected a 'solid wood' plinth from a company in Peterborough. This, I was told, would cure the rumble. It didn't. That massive motor and the huge rubber idler wheel looked far too purposeful to be compromised in their activities by a

few bits of real wood, I remember thinking - and so it was.

All that was back in prehistory, when, in the naivety of youth, I thought that life had just started when I got a job on Hi-Fi Answers magazine.

I could not bring myself to give up on that Garrard; it really was so beautifully engineered. Only years earlier I had been crawling around the spectacular frame of Concorde, immersed in the finest engineering anyone could hope to see, and even with that as a contrast the 401 didn't look like the duffer it turned out to be.

For some reason, I never did contact Garrard to tell them my 401 rumbled like an express train. I'm not sure I wanted to believe it myself so, hoping that one day I might learn how

to suppress the huge 25Hz tone it produced, I carefully put it up into the loft.

It only just survived. Reaching the loft is preparatory to life in another world. When, after a few years, something has sat there unwanted and unused, it eventually goes to the great tip in the sky. Then another item takes its place. Even in my most brutal and heartless of moments, the Garrard survived, sitting there quietly gathering dust - wanted, but only just. One day, I thought, I'll find time to fix that turntable, then it'll take pride of place.

It didn't quite turn out like that. As Hi-Fi World got under way I began to find others who thought the 301 and 401 were under-rated. Then I saw a

INDEX

The Garrard 401: a twenty year journey from attic to listening room. pp48-49

Revitalised and fitted with SME's most modern twelve-inch arm : how the combination sounded. pp50-51

A history of Garrard from its origin in the First World War to its final closure last year. pp52-53

How the transformation of a 401 from dusty relic to top vinyl spinner was achieved. pp55-56

warehouse full of them awaiting export to Japan; then I heard that Loricraft restored and built plinths for these turntables; then I was told that if I phoned a number a man called Martin Bastin would be able to help me with a new, even heavier plinth for my 401 and - amazingly - an improved main bearing. Together, they might just cure the rumble.

Would that be possible? I doubted it; mine was too badly afflicted. All the same, I decided I was prepared to spend quite a lot of money on the off-chance that my 401 would at least become useable. No one, I noted, actually made any firm promises about this, but then it isn't something that you can promise. Off went the 401 for major surgery, on a prayer that it would return in full health.

Twelve Inch Tube

During our visit to the SME factory some months ago I spotted an awesome looking 12in arm. It wasn't the lightweight classic 3012 used by jocks at radio stations, but a new 312 with tapered arm tube and solid headshell. But surely, I thought to myself, no one is interested in vinyl any more, so it'll never see the light of day. People wouldn't even know why you might want a 12in arm these days. Even SME seemed a little non-committal about this fine looking piece of engineering. Rather than let it get passed over by progress, I thought the 312 would be in a perfect setting if paired with the upgraded Garrard before being exposed in a review.

After all, both are part of an old technology, yet both also incorporate modern ideas in an effort to advance that technology. Neither unit has turned its back on development; neither is an anachronism, nor a worthy veteran. Together, I suspected, these two components, made for each other a long time ago, might show just how well they can perform together today.

Awesome And Massive

A massive drawback of the 12in SME always was that - it's massive! Awesome it may well appear to be, but then so is any plinth big enough to accommodate it. Martin Bastin had to make a specially large plinth and he brought the arm forward (clockwise around the Garrard in effect) in order to limit front-rear depth. This means the arm sits at an angle when in its rest and the plinth is wider than it might be, but it is more likely to fit onto a shelf or wall bracket. I have a bay window, with a firm and wide sill. It just manages to accommodate this 52lb plinth, offering a firm, vibration-free horizontal location for it.

Did it work? Yes - and better than I dared imagine. I admit to fitting a

Goldring 1042 cartridge in some haste, bothering little with fine alignment, just to test for rumble. I thought it unlikely that the mods that had been performed would be adequate. It seemed more likely that the motor or idler wheel of my unit were at fault, meaning a new main bearing and plinth might have

"The 401 hasn't just been rejuvenated; it has been transformed, entering the mainstream of hi-fi life splendidly after twenty years of idleness"

precious little effect.

It was great to be proved wrong. The Garrard had miraculously become very quiet. Even vinyl roar seemed in good check. At enormous volume I could hear the speaker cones flapping hard, stimulated by record warps, but there was no sign of feedback into the plinth, from loudspeakers about six feet away. Only the spectrum analyser could tell whether a hint of that 25Hz rumble remained. But if it did, I couldn't hear it.

I wasn't expecting miracles, and certainly not this degree of improvement. The 401 hasn't just been rejuvenated; it has been transformed, entering the mainstream of hi-fi life splendidly after twenty years of idleness. It is effectively new, having

never been used in earnest before, of course. But from the moment I found it fully useable all this changed. The cartridge was installed, the arm carefully set up and LPs started to build up in little, vertical groups around the lounge as I set about enjoying them again.

It's not that I haven't been able to enjoy them before, but solid-plinth turntables are very easy to use, especially if you hand-cue, like me; I just cannot use a lift/lower. With a rock-solid plinth offering a firm foundation, and with a beautifully machined, magic-wand of an arm, the 401 finally proved what I had always suspected: it is a superb machine to own and use.

A Good Raft Of Strengths

I'm not going to claim at this point that, with the improved bearing, it is unequivocally better in its sound than good, suspended sub-chassis turntables, although I believe it has firmer, more tuneful and better resolved bass than most of them. What I would say is that, when mounted properly and fitted with a good arm it is up amongst the best, with a good raft of strengths, some of which are quite a surprise, subjectively. The huge, high torque motor and no-slip idler drive give it some impressive advantages. There are also a few small blemishes, minor colourations we might say, that could usefully be expunged, but then this is always the case. A perfect hi-fi product hasn't been invented.

Such a beautifully engineered turntable was built to have a use in this life, and now it has. Not only does it sound superb but it is a delight to use. The gorgeous new turntable I once bought has finally entered my hi-fi system after twenty years - and it was worth the wait ●

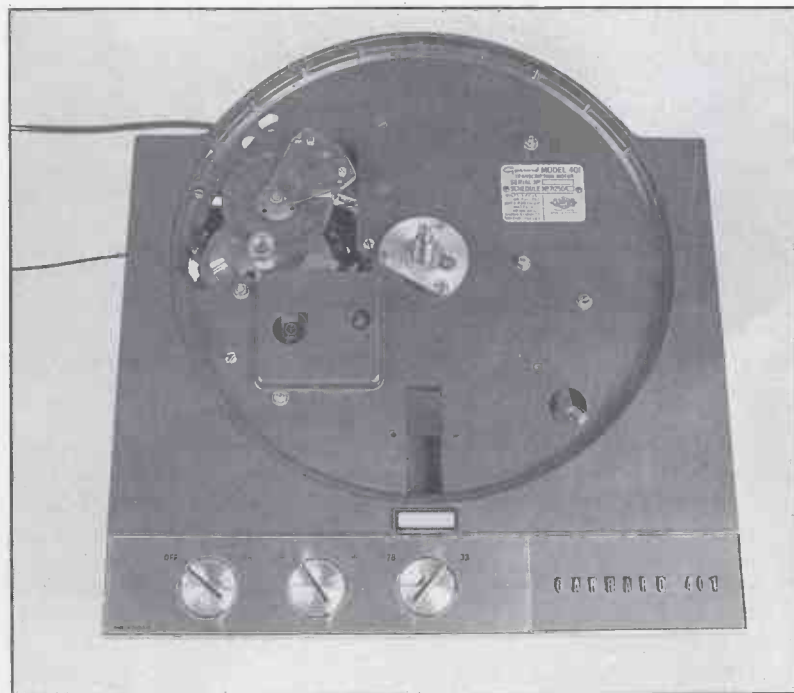



Garrard 401

Sound Quality

A new turntable of this potential encourages a trawl through all the oldies. Like most of us, these days I buy CD in preference to LP, even though I still prefer the sound of a good LP-based system by quite a significant margin. This does mean that most of my LPs are from way back when, and with this deck I was spurred to dig out a whole range of old faves played so often that their sound - including blemishes - is imprinted indelibly upon my mind.

Memory wasn't all I worked from though. Most recently a Systemdek IIXE with SME 309 arm (from now on called IIXE/309) and Goldring 1042 have been in use quite a lot. Naturally, for validity I removed the very same cartridge from the 309 and installed it in the 312 arm.

One of the most recent LPs in my collection is Tracey Chapman's *Crossroads*. I also have the CD for comparison, although comparisons are not necessarily valid since LP cutting masters are usually equalised to make up for losses. However, the stronger apparent dynamics of the LP that I noticed with the IIXE/309 were further reinforced by the 401/312 combination. Tracey Chapman's voice had better centre stage focus and was possessed of greater dynamic contrast against the background, especially when compared to the CD. There was more detail within the acoustic guitar; the strings resonated richly on LP. Bass was lighter but more in balance from LP (in truth, it is overblown on CD due to deliberately applied EQ) and there was none of the

treble sharpness and incisiveness of CD.

I made this LP versus CD comparison for the sake of thoroughness as part of a listening test regime; I had already noticed from listening to various LPs on the 401/312 that, generally, there was stronger resolution of dynamic contrasts than I previously recall hearing from LP. Vocalists were better resolved in terms of image sharpness, but, especially, in terms of their dynamics. This applied to instruments too; their range from soft to loud sounded greater on the 401/312 combination and, by any standard - especially CD - it was very wide and exciting.

Clearer Bass

There were other particular strengths that I noticed though. Certain classically bad/strong/important bass lines were much clearer; in fact the whole bass end sounded cleaner and had more upper bass detail. Far less gloopy than usual was the bass line behind Van Morrison's gorgeous track *Madame George*, from *Astral Weeks*. It gained control, as well as string and body detail, making what I have generally heard as vague and overblown sound reasonably normal. What the 401/312 brought to bass was control, inner detail and superb resolution of tempo as a result of these improvements. An album like Grace Jones' *'Nightclubbing'*, which relies on the considerable talents of Messrs Dunbar and Shakespeare, displayed drier, tighter and speedier bass; in fact the tracks snapped into focus generally, with Robbie Shake-

peare's bass lines seeming to meld into the rest of the performance naturally. It isn't uncommon for his bass to sound a bit woolly in all senses on many decks. The 401/312 were able to resolve and deliver unusually well defined bass.

I suspect there are two reasons for the superb bass performance. The deck and arm are very high mass, rigid items well located on a heavy plinth. Vibration and consequent signal loss are reduced as a result. Additionally, the 401 does appear to have better timing than a belt drive turntable, probably as a result of its high-torque drive system. It sounded to me as if dynamic slowing on transients was reduced, since there was a fine sense of timing generally, with unusually clean stops and starts to transients.

Although CD/LP comparisons aren't strictly valid, the 401/312 combination sounded so controlled, but dynamic, I couldn't resist trawling through a range of albums, making comparisons. Annie Lennox on the album *Touch* sounded more natural on LP, having a richer and fuller voice with more to it: more natural character. By contrast, she sounded a trifle thin and sterile on CD, like Tracey Chapman as I mentioned earlier. However, instruments were more emphatic at very high and very low frequencies.

On *Learning to Crawl* I again felt Chrissie Hynde sounded more natural on LP, but this time the band sounded a bit more diffuse on LP than CD, as if the stylus wasn't matching the groove modulation

angle in fact. The CD had it for clarity, although it still sounded sharp and uneasy to listen to.

The situation was radically reversed on that all-time balls-up of a CD, Heaven 17's 'The Luxury Gap'. The LP has excellent sound quality; the CD is all treble. Something went very wrong!

And finally I was surprised to hear The Lords of the New Church on their eponymous album sound better on CD than LP. Again, at full thrash the band sounded clearer on CD, like the Pretenders, yet LP still sounded easier on the ear and more amenable.

Comparing LP to CD is usually unenlightening. The differences are many and various, like their reasons for being so. However, the 401/312 did bring a stronger sense of control and timing to LP that usefully elevated it toward the sound of CD, provoking comparisons. It is still the case that LP breathes more easily, sounds less sterile and forced. However, with a high level complex signal it can also sound more muddled than CD. Whether another cartridge may have helped I do not know; the 1042 is actually clearer than most.

With vocals in particular, I feel LP wins quite easily. Here, the 401/312 showed what superb results are obtainable. Similarly, bass performances from LP were handled very well by these components, removing the blurring and imprecision that often colours results.

So it is true, that when made to perform properly, and mounted in an

appropriate plinth, the Garrard 401 doesn't rumble and can provide absolutely superb results. I believe Japanese audiophiles got it right a long time ago when they took to turntables like the 301, mounted on an enormous plinth, in preference to all else. Handled with due knowledge and placed in a suitable environment, the Garrard 401 is a superb turntable, every bit as good - possibly better - than more modern belt drives. We never knew what we had when we had it

Eric Says . . .

When the refurbished 401 arrived at my flat it instantly sent me on a reflective trip down memory lane. The first touch of finger on the silky but firmly sprung control knobs had me practically purring with pleasure.

The whole purpose of taking the Garrard home was not just to indulge in a time-warp fantasy, however, it was to compare it against a modern turntable. In this case, a Michell Gyrodec with SMEIV arm and Morch da Capo cartridge. Not having two da Capos, the Garrard's SME312 was fitted with my Koetsu Black moving coil.

The results were startling. Put on any vinyl with pace to it - and that meant anything from Roxy to Techno to Rachmaninov's Symphonic Dances - and the Garrard's evident speed and dead-stop transients were astounding. So much so, that another listener kept getting up from his seat to check the strobe to convince himself it wasn't running fast. That's a good

metaphor: the 401 had an unparalleled ability to run with the rhythms at Olympic speed.

Percussion stayed crisp and tight, not the least sign of flabbiness or uncertainty. The Koetsu tracked like a dream, riding warps that on my Gyrodec make a record clamp mandatory. One of the fundamental virtues of the solid plinth was a near-total lack of feedback: I'd be surprised if the stylus would shift out of the groove even with a drop-kick from Will Carling.

Where the Gyrodec did score was with a more expansive staging: wider and with more subtle depth. Other subtleties were also evident, particularly in vocal presentation. While the Garrard could produce a remarkably three-dimensional portrayal, the Gyro came up trumps on Mary Black with much more detail in intonation. It's that subtle difference between following a score and being able to amend it according to the performer's interpretation. Instrumental textures were just that much less thick, too.

Also noticeable was a trait which I (and someone else, who had also recently heard a 312) ascribed more to the arm than the cartridge or the turntable. There was a wininess to the upper strings and a touch of sting to some guitar notes or higher vocal notes. None of this detracted from the liveliness or lucidity of the 401: if those are among the major criteria for a turntable, the old Garrard stands up well against the modern competition ●

MEASURED PERFORMANCE

The measured performance of the 401 with SME312 and Goldring 1042 was far better than I had expected, being up with the best. The 401 had some low frequency drift at 0.55Hz, caused by cyclic effects at 33rpm rate. This is to be expected and, luckily, the ear is relatively insensitive to such low rate effects, providing they are smooth and regular (i.e. contain no higher order components). Much of the problem in practice comes from record eccentricity, but in this case the DIN test disc was carefully centred, as always.

The weight of the platter irons out high rate wow and flutter components, as the speed stability analysis shows. The 401 had wow components at 2.25Hz and 6Hz, but they are very low. What the LP lacks, to its great benefit, is higher order speed variations, such as flutter on cassette and, we might say, jitter on CD, which affects musical timing in a different way. I also strongly suspect, after listening to the very clean transient starts and stops supported by this turntable, that its high torque drive system suffers less from dynamic slowing than belt drives. That's why it not only sounds dynamic, but has a very good sense of pace and rhythmic control.

The rumble demon has been banished completely by Martin Bastin's new bearing and plinth. Previously it measured around -25dB at 25Hz, relative to the DIN rumble test tone. Now, the spectrum analyser shows 25Hz level measures -60dB, looking like ordinary disc surface noise rather than a discrete rumble component. The smoothness of the rumble spectrum indicates there is no rumble as such. The downward slope of the curve across the centre of the picture is due only to RIAA correction boosting low frequencies.

The peak lies at 8Hz, being caused by arm/cartridge resonance, stimulated by the motion of the disc. It shows that the arm is quite well matched to the medium compliance of the Goldring 1042, since this frequency should ideally be above the warp region (i.e. above 6Hz). Although the 312 is long, its lightweight tapered tube has quite low effective mass.

These measurements show that the Garrard 401, fitted with Martin Bastin's revised bearing and fitted in his heavyweight plinth, possesses a superb measured performance, comparable to the best turntables ever built. **NK**

TEST RESULTS

Drift	(pk-pk)	0.2%
Wow	(unweighted)	0.12%
Flutter		0.05%
Rumble	(unweighted)	-47dB
"	(DIN weighted)	-72dB

WOW AND FLUTTER



RUMBLE

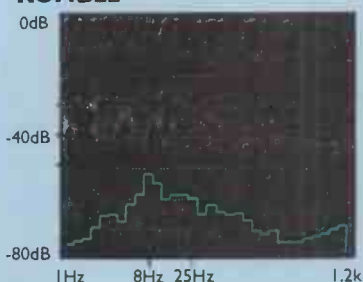

Garrard

the
finest
of
them
all



A Garrard brochure from the early Sixties, starring an unknown model with typical bouffant hairstyle of the period.

Loss of a Jewel

The history of Garrard, from its origin as an offshoot of the Crown Jewellers up to its closure in 1992, is told by Roy Poulton, who spent twenty eight years in the company.

The Garrard story goes back a long way, to the 'Great War' of 1914-18 when Garrard the Crown Jewellers were anxious to make a contribution to the war effort, but at the same time retain their skilled craftsmen. In 1915 they rented a small building in Willesden, North West London, and formed the Garrard Engineering and Manufacturing Company, producing precision mechanisms for the Ministry of Defence.

After the war the gramophone became a popular source of home entertainment. Although manufacture of various parts, such as amplifiers and loudspeakers, had begun in Britain, most turntables were imported.

Right: The Garrard Factory in Swindon in the Thirties. At one time the company employed 4500 people there. A clay pit behind the factory was used for skating and swimming.

Garrard saw an opportunity here and decided to make a gramophone motor. Although experiments in electrical recording and reproduction had begun in Britain and America, early turntables were driven by spring motors. Garrard's first spring motor,

called the Number 1, was a quality design having a cast iron mainframe with a thick baseplate, between which were supported two strong coil springs. With a full wind it would play three ten-inch or two twelve-inch diameter records. The ratchet

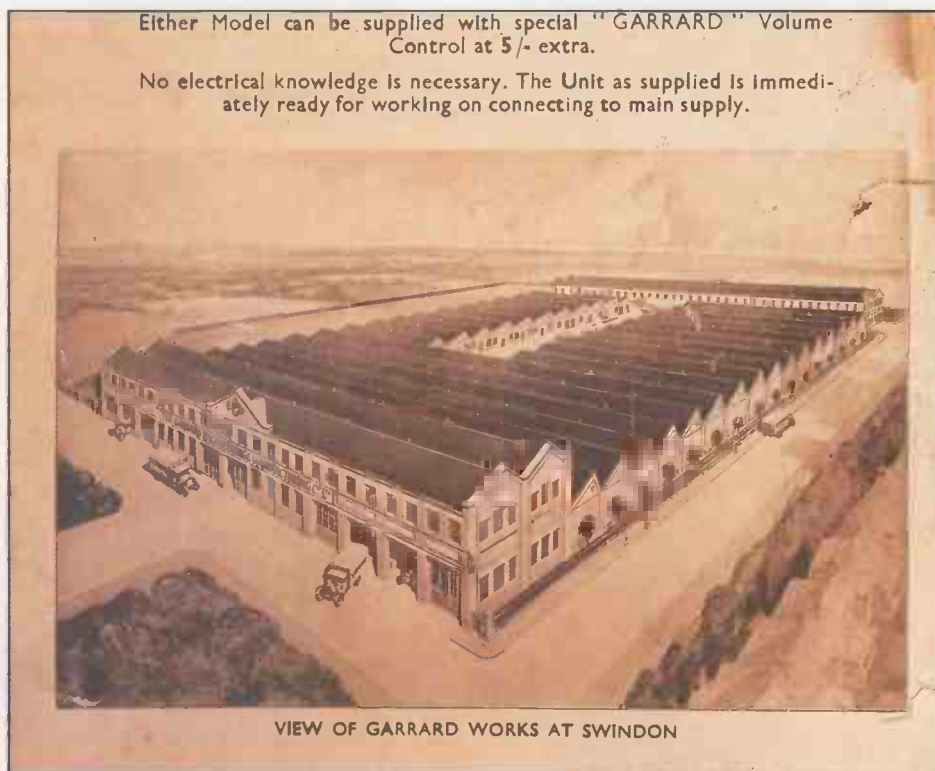



An original box for a Garrard 301 transcription turntable, first produced in 1954. Many are still in use today.

winding mechanism was virtually silent and the twelve-inch turntable was driven at 78 rpm through gears. Its speed was controlled by a worm drive to a centrifugal governor with three springs and bob weights, plus a sliding polished steel disc which was pulled on to felt pads as the governor springs rotated.

This turntable quickly became popular, so it was followed by several cheaper models and then a prestige model called the Garrard Super Spring Motor. This was totally enclosed, with an oil pump and sump contained within the casing. As the motor was wound, the pump operated and small copper tubes carried the oil to the bearings. Business boomed and production reached 25,000 per week.

In The Swim

Garrard didn't stay long at Willesden. The company soon found a site in Swindon, Wiltshire, with a 27,000sq.ft. factory. Behind it was an old water filled clay pit, useful for swimming, skating and suicides! The late Mr. H.V. Slade ran the company for many years as both Chairman and Managing Director. Eventually he was succeeded by his son, Hector Slade, who now lives in retirement in Australia. The claypit was filled in, consolidated and the company continued to expand.

With the development of radio and the spread of electricity into homes, the management decided to research and produce electric gramophone motors. In 1932 they made their first record changer, designed by the late Edmund Mortimer. The R.C.I. was a fearsomely heavy beast. It would accept up to ten shellac 78 rpm records, either ten or twelve inches diameter, and play them sequentially with a pickup

whose needle pressure was over half a pound (230gms!). It was quickly followed by the R.C.I.A., which was similar, but the records could be mixed. The mechanism would sense their diameter and deposit the



Centre: The heavy cast rotor of the 201, which carried the platter. Frequent oiling was required to minimise flutter.

needle automatically on the correct spot at the beginning of a record, tripping at the end and returning the arm to its rest. It would also switch off at the end of the last record.

Around this time Garrard cashed in on their mechanical expertise and

began to manufacture clocks of various kinds, still maintaining their by now wellknown quality. During the 1939-45 war large quantities of clock type mechanisms were produced for use in strategic mining, course plotting, mine sweeping, radar and such like. After the war there was heavy competition from cheap clocks produced in subsidised factories, so in 1954 clock making was abandoned.

Even in the early Thirties there was a recognised need for a high performance, heavy duty turntable for broadcasting and recording studios, so Garrard designed and produced the Model 201. It had a direct-drive electric motor, plus a heavy cast rotor carrying a twelve inch turntable. Its speed of 78 rpm was controlled by a three-ball governor, similar to that used on the first spring motor unit and it needed frequent oiling to minimise flutter. A special version was made for the B.B.C. for 'instant' starting.

Shipment Sunk

Just before the 1939/45 war a complicated unit, the R.C.100, was designed, which would accept and play both sides of a stack of ten mixed ten and twelve-inch records. About a hundred were made and shipped to America, but the ship sank, the units were lost and they were never mentioned again.

After the war the company grew rapidly, exporting 70% of its output throughout the world. The U.S.A. was a very strong market, taking about 50% of production, so an independent American company called Garrard Sales Inc was formed. It sold their record changers directly into the retail market of the U.S.A. Later, more British products were taken on, among them Leak amplifiers, and Ersin Multicore solder, so the name was changed to British Industries Corporation.



Garrard's heavy-duty 201 player from the early Thirties, designed for reproducing 78s in broadcasting and recording studios. Direct drive was used, plus a mechanical speed governor.

Great efforts were made by both companies to keep autochangers, the new name for record changers, at the forefront of the hi-fi market, because the difficulty of producing them to give good performance and reliability helped keep out foreign competition; it is much easier to make a single play turntable.

Over the years various high performance changers were made, the most popular being the R.C.80 and culminating in the Zero 100S, which had a precision parallel tracking pickup arm. But it was the budget SP25 that ended up in most homes, metamorphosing through numerous model changes to keep it competitive.

Despite the company's interest in mass production, it never lost sight of more serious hi-fi requirements and in 1954 produced the world famous Model 301 turntable, with its high power motor, heavy cast aluminium turntable, three speeds with variable control and meticulously designed and produced bearings. The unit dominated the market for many years, until the need for an update was felt necessary; then the 401 was introduced.

The 401 was similar to the 301, but its motor was encased in a heavy iron cage to minimise hum induction into sensitive cartridges, notably Deccas. Despite its similarity to the 301, extra features and attractive styling, the 401 was not as well accepted by the market; Garrard could never understand why.

The company didn't stick with turntables. An attempt was made in

THE Autoslim



There are two versions of the Garrard Magazine Tape Deck. Both are one speed models—3 $\frac{1}{2}$ " per sec.—and have the magazine loading principle. One model however incorporates reverse wind and is fitted with a Tape Position Indicator. Available as half or quarter track.

Cabinet space required—12 $\frac{1}{2}$ " long by 8" back to front, 1 $\frac{1}{2}$ " clearance above motor-board and 2 $\frac{1}{2}$ " below.

The Battery model (half track) has two speeds—3 $\frac{1}{2}$ " and 1 $\frac{1}{2}$ " per sec. and is suitable for both magazine or open spools.

Cabinet space required—9" long by 4 $\frac{1}{2}$ " back to front, 1 $\frac{1}{2}$ " clearance above motor board and 2 $\frac{1}{2}$ " below.

There is also an Automatic Tape Deck suitable for industrial purposes and where continuous play is required.

Cabinet space required—12 $\frac{1}{2}$ " long by 8" back to front, 1 $\frac{1}{2}$ " clearance above motor-board and 2 $\frac{1}{2}$ " below.

AUTO TURNTABLE

The Autoslim has been designed to occupy as small a space as possible. Construction is simplified without sacrificing quality. Fitted with finger-tip adjustment for pickup stylus pressure. Automatic selection of all sizes of records which can be record. No wiring required. May also be played manually. The Autoslim shows here has a plug-in pickup head which will accommodate a wide range of pickup cartridges of Garrard and other manufacturers. A fixed head version is also available.

Volt age range: 100-130 or 200-250 volts. 50 or 60 cycles according to motor pulley selected. Cabinet space required—14 $\frac{1}{2}$ " long by 11 $\frac{1}{2}$ " wide by 4 $\frac{1}{2}$ " above and 2 $\frac{1}{2}$ " below top of motor-board.



BATTERY MODEL

MAGAZINE TAPE DECKS WITH INSTANT LOADING

At the beginning of the Sixties, Garrard introduced the 'Autoslim' series of LP turntables. There can be few people in that decade who did not, at some time, have a Garrard SP25 model from the range in a 'starter system' of thirty years ago. Less attractive in the marketplace was Garrard's reel-to-reel tape magazine, seen on the other page of this brochure, which was bulky and clumsy compared to the Compact Cassette which was launched by Philips just a few years later.

for mass production demands very high financial investment. When in 1959 the new 'Autoslim' series, including the SP25, was designed, Garrard teamed up with Plessey for assistance. Plessey had proved their worth in the defence industry but had never significantly been able to break into the domestic market. This was their chance.

Plessey also used the Garrard name as a spearhead to enter the U.S. and quickly dispensed with the services of The British Industries

Corporation. This proved to be a bad move for a variety of commercial reasons - and Japanese competition had begun to hot up as well. Garrard lost valuable U.S. sales and went into rapid decline, from which it never recovered. In 1979 it was sold to the Brazilian company Gradiante Electronica. From employing no fewer than 4500 people in the early Seventies, the company ended up with a staff of four who continued to work in Swindon until June 1992. Then the operation was finally closed.

Garrard Sales Corporation was set up just after the Second World War, when U.S.A. sales accounted for half of the company's production. It also sold Leak amplifiers in the States.



Garrard the Crown Jewellers in London's Regent Street, now long separated from its Garrard Engineering offshoot.



the early Sixties to break into the tape market with a cartridge tape deck, the Magazine Tape Deck. It was robustly made, featuring a plastic magazine enclosing two 4" tape spools. Most of these recorders were sold into the instrumentation field because record companies could not be persuaded to issue prerecorded tapes on the format; the magazine was cumbersome compared to the Philips Compact Cassette which followed some time after, in 1963.

A total design change and tooling



The Fine Details

**How the 401 was brought up to date and who to contact
to bring one into the nineties.**

GARRARD 401

The Garrard 401 was a 'transcription' turntable unit made by Garrard of Swindon, Wiltshire. It was one of the last idler-drive turntables, surviving into the early Seventies. The unit has a substantial diecast aluminium base plate, ribbed for rigidity and strength. Similarly, the platter was also a sturdy casting weighing 6lbs. It had machined-in strobe markings around the periphery, illuminated by an orange light at the front. This platter was supported by a massive main bearing.

Drive came from a strong shaded pole motor, being transmitted by a large rubber idler wheel to the inside of the platter rim. Three speeds were provided: 33, 45 and 78rpm. Speed adjustment was by eddy current brake. There was no suspension system, a feature that gives the platter very firm location in relation to an accompanying arm; only the motor sits on compliant spring mounts.

The 401 followed on from the popular 301, but it had an unhappy history. Even now, the 301 is more popular amongst enthusiasts. 401s could and sometimes did rumble badly. Their bearings needed maintenance which, if not provided, resulted in loss of lubrication and wear.

A 501 was being readied as a replacement, but Garrard by that time

were suffering from numerous commercial problems, not the least being fierce competition from the Japanese, especially from Pioneer with their PL-12D belt drive turntable. In the end, belt drive displaced idler drive, since it was difficult to rid the latter of rumble and wow and flutter.

The 401 was in effect the last representative of a dying breed, sealing its own fate by being problematical. Yet at the same time, it was at heart well designed and very well built. For a 401 to work properly nowadays, it is likely to need the sort of treatment ours - which had never been used - received.

Spares are not easily obtainable, but some re-manufacturing exists. Contact Terry O'Sullivan of Loricraft for 301 and 401 plinths, service and repairs. He has been in contact with a little known source about a Garrard parts sales operation in Swindon (closed recently) and knows the situation regarding spares.

Terry O'Sullivan,
Loricraft,
4 Big Lane,
Goose Green,
Lambourn,
BERKS. RG16 7XQ.
Tel: 0488-72267

SME312 ARM

The 12in arm was originally designed for commercial use, mainly in radio stations and such like. Its main advantage was around 25% less lateral tracking error distortion than a domestic 9in arm. Effective mass is higher and rigidity lower than that of a 9in arm, although not greatly so.

The SME312 is part of the 300 Series; it is partnered by 9in and 10in versions. The arm tube is aluminium alloy, tapered for rigidity and fitted with a removeable magnesium headshell. The special 312 shell has less offset (17degrees) than usual and the geometry needs less overhang (12mm).

The 300 Series arms run on stainless steel precision ball races giving unhindered movement, yet without free play. SME arms have fixed basic geometry, so the cartridge does not move in the headshell; there are no headshell alignment slots. Instead, the whole arm is moved forward or backward on a sliding base to minimise tracking error. It clamps tightly for locational rigidity.

SME Ltd.,
Steyning,
SUSSEX BN44 3GY.
Tel: 0903-814321
Fax: 0903-814269



Above: Noel's Garrard 401, newly-mounted in its plinth with SME312 arm before veneering.

Far left and centre: Garrard brochures showing motor units from the pre-LP era.

MODIFIED GARRARD BEARINGS AND SPECIAL HEAVYWEIGHT PLINTH

Remarkably, a bearing modification is available for the 301 and 401, to eliminate lubrication problems and improve performance. Martin Bastin offers the 'Magum' modified bearing housing with new, improved thrust pad, leak-free oil gaskets and better oil. The original bearing must be supplied for machining, since replacements aren't available. My 401 had this new bearing fitted as part of its renovation.

Both the 301 and 401 need to be mounted on a very sturdy plinth. Even in their time, adequate plinths were

ACKNOWLEDGEMENTS

Our thanks for help in the preparation of this piece to Terry O'Sullivan (Loricraft) for the photograph of the original 301 carton and - along with Haden Boardman (Audio Classics) - for advice and background; and to John Howse (British Vintage Wireless Society) for the original Garrard brochures and publicity material.

VENEER

Our Garrard 401 was veneered in American Cherry by: F. W. Chandler Ltd., 271 Poyser St., London E2 9RE. Tel: 071-739-7471. Cost, including sanding and sealer, was £88.71 incl. VAT.

rare. Martin Bastin also makes the massive 'Maxplank' plinth, which is undoubtedly a work of some speciality and dedication. It is built up from layers of heavy, quality plywood to form what is, in effect, a solid block with cutouts and grooves to accept the various underside projections of the turntable and arm. The idea is to provide a rigid, damped, non-resonant structure without large or symmetrical air spaces. Each plywood layer has machined cutouts and is tacked and glued to the others, forming a massive laminated structure with integral wells and pathways. The top board is removeable for attachment of the arm and turntable assembly. Ours weighed 51 lbs, making it just liftable. This plinth is supplied unfinished. Owners must stain, paint or varnish it themselves. A removeable dust cover can be supplied.

The revised bearing assembly and new plinth were spectacularly successful, more so than I dared hope.



Martin Bastin, the man who revived our Garrard 401.

They furnish the 401 with a level of performance it rarely achieved in its day, fully exploiting its potential.

Martin Bastin,
225 Tettenhall Road,
Wolverhampton WV6 0DE.
Tel: 0902-751861

EXHIBITION

Swindon, Garrard's home in its heyday, will be hosting an exhibition from March in the newly refurbished Bath Road Museum and Art Gallery. Swindon holds the 'Garrard Collection' which the museum acquired when the company finally packed its bags and departed, and the display will include a number of classic items, from the early auto-changers through to the 301 and 401 turntables. There will even be some of Garrard's clocks on show! Focal point of the display will be a reconstruction of a Garrard stand from one of the great Olympia shows of the Fifties. Opening by the end of March 1993 (the precise date wasn't fixed when we went to press), the semi-permanent 'Entertainment in Swindon' exhibition will run throughout the year. Entrance is free.

Bath Road Museum and Art Gallery,
Bath Road,
Swindon,
SN1 4BA



Heart of Oak

Splendidly finished in light oak veneer, Monitor Audio's latest miniature loudspeaker takes up a small corner of Dominic Baker's system.

The MA7 Golds are one of Monitor Audio's most recent additions to their ever-expanding, ever-changing range. They are a bookshelf loudspeaker designed to accurately portray recorded music from a small, unintrusive cabinet. Priced at £180, or £230 when finished in rosewood, these speakers fall into a very competitive area of the market.

As ever, the cabinets were finely finished, an area where Monitor Audio lead the mass-market loudspeaker manufacturers. The pair supplied for review were real-wood veneered with oak, which had been left in its natural light colour. At every

edge of the loudspeaker the veneers were neatly joined, leaving no gaps, and firmly bonded down.

As an additional service to all of Monitor Audio's customers, over the twenty or so years that they have been in business, the company now offer a free cabinet polishing service. The veneers that are used on loudspeakers will, as all wood does, tend to fade over the years. If your pair of Monitor Audios suffers from this, they can be restored to their former glory for no charge.

Beneath the veneer the cabinets are constructed from Medium Density Fibreboard (MDF) which is easy to machine accurately and has

better damping properties than chipboard. The boxes measure 344mm high, 165mm wide and 175mm deep, which corresponds to approximately seven litres. The rear of the loudspeaker enclosure plays host to a small reflex port that is used to tune the bass.

The MA7 Golds use a three-quarter inch version of the one inch gold anodized alloy tweeter used in the MA1200 Golds reviewed in our December 1992 group test. Its one-piece construction will help to transfer heat away from the voice coil and improve power handling. The gold dome is protected from inquisitive fingers by a fine wire mesh grill.

The bass unit is a 130mm doped paper cone, reflex loaded. For the size of the cone, a high temperature voice coil and a hefty magnet are used. This, and the tweeter, are connected via a simple crossover to a single set of binding posts at the rear of the loudspeaker, eliminating bi-wiring as an option.

I used the MA7 Golds with a variety of items, the two main systems consisting of Denon's DCD890 CD player, with a Harman Kardon HK6150 amplifier and my normal P500 Esoteric CD transport and Bigger Bit convertor with the Cyrus I Series 8 amplifier. The former system was better matched in terms of price but the lighter more delicate sound of the Cyrus I suited the character of the MA7 Golds better.

Close To A Wall

I quickly found that Monitor Audio's baby speakers worked best on heavy stands placed in close proximity to a rear wall. If not treated in this manner, the midrange became rather hollow and dry, sounding almost sterile. Placing them on heavy stands removed some of the dryness and moving them closer to a rear wall thickened up and warmed the midband, as well as extending the bass.

Even when set up in this fashion the midband was still a bit short of body but it carried a reasonable amount of detail. The MA7 Golds are a fast sounding loudspeaker, possibly due to their small, lightweight bass unit and the distinctive gold coloured metal dome tweeter. As a consequence they possess a sharp and well focussed sound, not the more sluggish kind heard from speakers with heavier and more damped paper and plastic cones.

Treble quality was quite good but a definite peak was noticeable which became more intrusive at higher volume levels. Because of the fast nature of these loudspeakers they convey light, fast acoustical music with a good sense of realism. The Blue Aeroplanes track 'Picture Framed' was particularly well handled, the slightly shrill but speedy MA7 Golds responding to the fast plucking of the lead guitar with zest and apparent truthfulness.

More Tuneful Bass

Although the bass extension was commendable for the small size of the loudspeaker it could tend to thud with deep bass. This could be cured to a certain extent by plugging the small reflex port with a foam bung. It had the effect of making the speakers more tuneful in the bass without compromising their extension. However, there was still a hint of boxiness that I found could not be cured.

Stereo separation was good, each loudspeaker seeming clearly focussed on the signal being fed to it. Complex passages of music could be unsettling, but this blemish was only apparent at reasonably high volumes. Despite their firm bass, the MA7s are not an ideal Rock music loudspeaker. With large scale performances they simply are not dynamic enough to reproduce the levels of energy and power that commonly exist.

"they convey light, fast acoustical music with a good sense of realism"

On light music they image well through the midrange, but the treble was a bit vague with an almost phasey quality to it. Firing straight down the room found the MA7s at their best, with good separation and imaging, but with their sharp treble being fired past my ears instead of straight into them! The metallic sound of the tweeter, although fast and clear, could become painful on a recording with a lot of treble energy.

The soundstage was quite wide and had good height to it which helped to create space around the music. However, like the KEF 103/4, the monitors sounded shallow, offering a limited impression of depth. This precluded them from doing well with orchestral music to which otherwise they would have been fairly well suited.

On reflection, I feel the MA7 Golds are a reasonable attempt at getting a good sound from a small cabinet, their speed and clarity saving them from mediocrity. Unfortunately, the foreshortened soundstage and peaky treble can make them shrill to listen to and they don't reproduce high volume levels with ease. However if you need a speaker that can be mounted close to the wall and you like a light, fast and clear presentation, then the MA7 Golds can deliver. With the additional advantage of good bass extension, they may well find their way into many people's homes ●

MEASURED PERFORMANCE

Measuring a loudspeaker after listening to it is always revealing, especially when the measurements correspond with your own subjective analysis made beforehand. The frequency response plot shows quite clearly bass lift, midrange suck-out and a treble peak. The bass lift at 160Hz is almost certainly caused by a combination of the box and port resonance and will be partly responsible for the heavy bass quality.

The suck-out centred around 2-3kHz, although only dropping -2dB from the flat position, is mirrored either side by small peaks. The dryness or lack of projection in the midrange is likely to be due to this feature. The higher frequency peak of the two either side of the trough was noticed in the form of a sharpness to the treble. This is not surprising, as it is very close to the ears' most sensitive point: 7kHz.

Sensitivity was average, measuring 85.5dB at 1m for one watt of input (2.8V) of pink noise input. This is actually a voltage sensitivity reading rather than true power sensitivity. It gives a clear indication of how loud a particular loudspeaker will go for a given point on the volume scale. This is more useful than true power figures which are of no practical use to users - and they give a more flattering result.

At 11.5ohms impedance was high, but this is not uncommon amongst British loudspeakers, where 8ohms is usually taken, conservatively, as a minimum. It corresponds with an impedance curve that stays above 8ohms for much of its frequency range. The slopes of the curves were not severe, indicating that only modest amounts of reactance exist. With their average sensitivity and high overall impedance the MA7s should prove reasonably easy to drive. I would suggest that 30-40watts will suffice. **DB**

Frequency Response

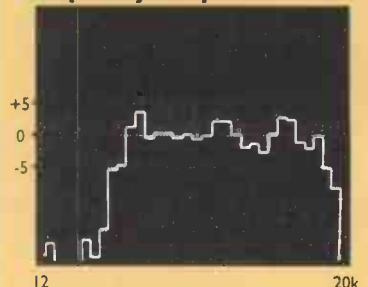

Impedance



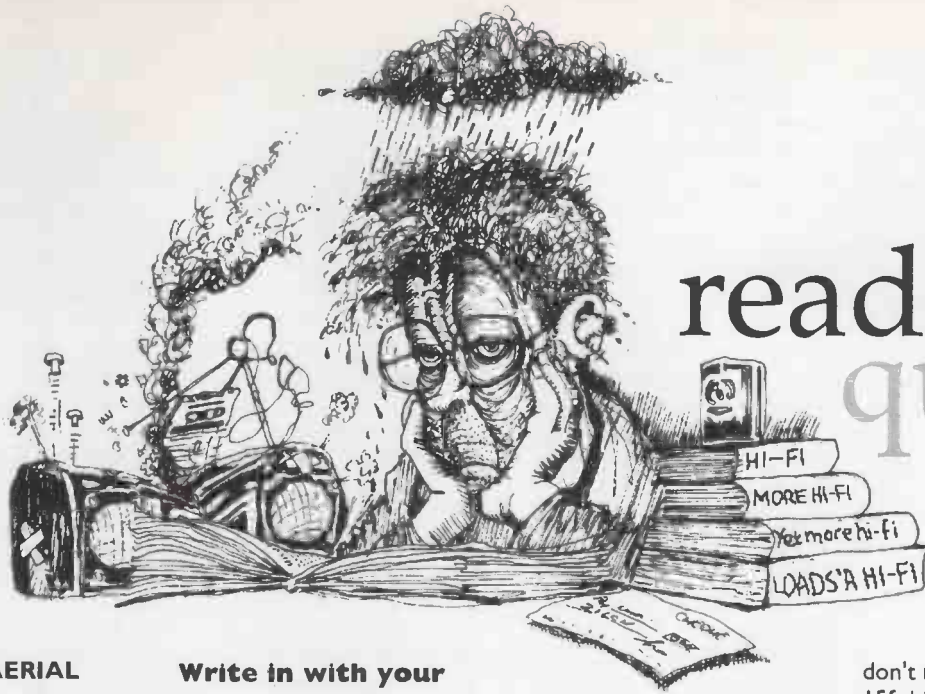

readers' queries

AIRING AN AERIAL PROBLEM

Since reading your report on a Leak Troughline tuner in the July issue I have been lucky enough to acquire a stereo version and had this altered and serviced by our old friend Haden Boardman and have added the Paravicini decoder.

My problem is noisy reception and distortion, although I have a three-element roof mounted aerial directed at the Sutton Coldfield transmitter some twenty miles away.

Wondering whether the aerial was up to the job, knowing the Leak to be insensitive, I wrote to the BBC Engineering Information Department for advice, quoting the 5mV signal requirement suggested on p79 of the January 1993 issue of your magazine.

At the same time I wrote to Ron Smith Aerials for their

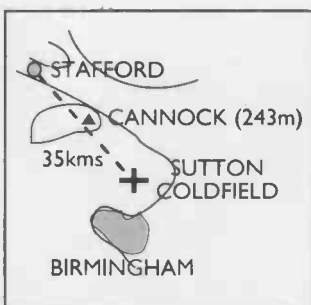

Cannock probably accounts for poor reception on a Troughline in Stafford, even though the transmitter is only 35kms away.

advice and they recommend their Orion 8 model with 14dB of gain, equivalent to 5.1µV of signal strength.

Before I make an expensive mistake, could you please

Write in with your problems to Hi-Fi World, 64 Castellain Road, Maida Vale, London W9 1EX.

Our panel of experts will endeavour to solve them or at least offer some practical advice.

explain why the two parties offer conflicting solutions and let me have your advice regarding the aerial I need.

Alan Jones, Stafford.

Whilst, as the BBC claim, "noise free stereo" is possible with 500µV (just), full quieting is commonly achieved at 1mV. This is where hiss drops to a minimum and quality is best. The Troughline needs 5mV for full quieting, or 5 times more signal - not 10 times. However, the BBC engineer would not have known that our 5mV figure was for full quieting, rather than their own criterion, which I suspect is 60dB signal-to-noise ratio (little better than cassette without Dolby). They're talking about low-hiss reception; we're talking about optimum sound quality; there's a difference in outlook here!

But onto the nitty gritty. The Beeb say your three-

element aerial will produce about 500µV across the aerial input. You are well within the service area of the Sutton Coldfield transmitter, suggesting that this estimate is a little conservative. However, a look at the geography shows that Stafford sits low down in a valley and Cannock, at 243 metres high, is likely to be screening you from the transmitter. This situation looks none too promising for an insensitive tuner. The BBC's estimate of signal strength from your aerial should be about right, we feel.

The Beeb said, in effect, you can't get the signal you want - and they are right. You would need a gain of 24dB - and even Ron Smith hasn't got around to making an aerial that big. What he has offered you is a very high gain aerial, on the grounds that it will give the best results possible and they'll be better than those you are currently suffering. In fact, 14dB of gain means five times more signal than a simple dipole aerial. This should give you around 1.5mV - not 5µV as you understandably suppose from the chart you sent us (that shows gain relative to 1µV, which is a bit confusing).

Will 1.5mV be adequate? We would say: only just. Our own Troughline gives hiss free results on little more. I suggest you try Ron Smith, since he'll put up an amazing aerial. Bear in mind the need for height; if your house/chimney pot/neighbours or local planning department

don't mind a big pole, one 15ft high or more will help. Ron should be able to advise you on the problem of windage and structural strength of the building.

You will notice the difference this aerial makes. If it isn't quite good enough though, you could try either a very quiet head amplifier (ask Ron) or ask Tim de Paravicini, from whom you bought the stereo decoder, about installing an additional valve RF stage, which improves sensitivity of the Troughline. But our bet is that the Orion will just do the trick.

Finally, you mention hiss and distortion. Hiss is expected; distortion is not. It could just be that your tuner is not perfectly aligned. If this is the case, then sensitivity will be down as well. Get it checked if possible. **NK**

IN A FLAP

Last year I bought a Rotel RA-840 BX4 amplifier to drive some KEF C90 loudspeakers from a Linn K9 cartridge on a Thorens TD166 turntable, as well as some Celestion Dittons, which used to be the main speakers but are now next door.

With the subsonic filter on the old amp, cone flap used to be kept well under control but now the woofers wobble alarmingly between tracks when on high volume. If nothing else, the amplifier seems to be spending a large amount of energy flapping cones instead of, or as well as, playing music. My Shure TTR115 test record would suggest a tonearm/cartridge resonance frequency of 12Hz.

Would changing to a Shure VST-V do the trick, or should it be tonearm damping or a low filter? I would be grateful for any suggestions.

Matthias von Boeventer, Bradford on Avon, Wiltshire.

You are faced with an awkward problem. Rotel amps have extended subsonic gain within the disc stage, which gives a more open and powerful sounding bass, if not one as fast and tight sounding as that from an amplifier with a warp filter. Since the IEC laid down a specification for the latter, it has become widely used, so your problem is not now as common as it once was.

Solutions? You could get a Shure VST-V, since its damped brush is effective in suppressing warp information, by pushing the cartridge up over warps. But how much improvement I am concerned about. The arm/cartridge resonance you currently have

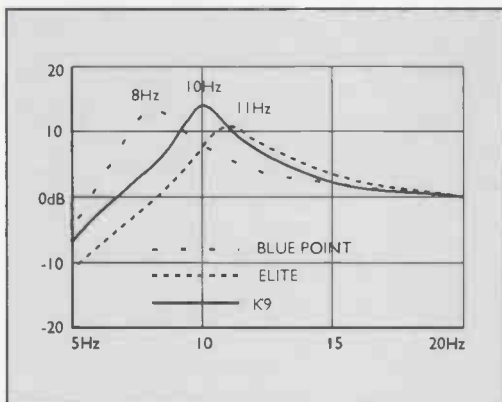

Relative arm/cartridge resonances of Linn K9, Sumiko Blue Point and Goldring Elite cartridges.

is ideally placed at 12Hz, believe it or not, and it's about right for a K9 in a medium mass arm. According to research carried out by Shure many moons ago, most warps lie around 6Hz, as the sleeve notes of your TTR115 test record explain. At 12Hz resonance your arm/cartridge combo is riding most of the warps, not reproducing them.

I ran tests to see why you should experience such a problem, assuming your Thorens is the one fitted with a Rega arm. The results are shown in the accompanying graph. The K9 I tested produced an enormous +14dB peak at 10Hz in a Rega, showing that its cantilever is relatively

undamped (which aids tracking). This amount of gain, coupled with the fact that the reflex KEF Q90s are themselves undamped below their bass resonance, greatly emphasises disc surface ripples and warps, even though in theory your system is optimised.

Alternative solutions to the Shure VST-V are difficult to think of - and none are cheap. Simple filters cannot be devised; commercial ones don't exist. You may be able to trade your amplifier in for one with a warp filter, such as a Mission Cyrus 1 or 2, for example.

Few cartridges will possess less compliance than your K9, which is what you need to get arm resonance up even further. Tests showed that a Sumiko Blue Point would be worse, for example, but a Goldring Elite moving coil cartridge offers some improvement, being less compliant and better damped. It would be a good choice and

warps a little less of a problem. So the Shure does seem the best bet. Alternatively, you could try putting an acoustic resistance in the port of the loudspeakers, which should damp down

woofer movement. Long haired wool is very good for this (contact Wilmslow Audio on 0564-650605), or even drinking straws bundled longitudinally and bonded together, believe it or not. There will be some loss of bass. To restore it try moving the speakers back close to a rear wall. **NK**

IN A SOLID STATE

My present system includes an Audio Research SPI4 preamp and D70 power amp driving Quad ESL-63s

Although I like the sound from the D70 I am considering a change as the quality (and the cost) of recent replacements of output valves has been rather disappointing.

I shall therefore be grateful if you can suggest which solid-state power amps may be suitable in place of the D70. I have a Quad 405 which sounds thin compared to the valve amp, nor do I care for the sound of Krells with the ESL-63s. Having heard so much about the Pioneer A-400 I wonder if it is worthwhile buying one of these and having it converted to a power amp only.

John Davison, Richmond, N. Yorks.

Oh dear me, no. Quite the wrong league. Fundamentally, the A-400 is pretty good, but it's pretty good for a £250 amplifier. As an ESL-63 user, over the years I've learnt the better the power amplifier, the better - and bigger - they sound. Not all partnering items, however, will give of their best, which does tend to disappoint ESL owners when they hook up something which is beautiful with moving-coil speakers but rudely revealed by electro-statics.

I have four great favourites to drive them: first and foremost the Michell Alecto monoblocks. My friends and neighbours have come to love my '63s and their unanimous reaction to the Alectos was "Wow!" if it's what you are looking for, the combination produced a superb three-dimensionality of image and more bass than the '63s are normally considered capable of, all delivered with an effortless sense of dynamic ease.

It's a good while since I heard an SPI4, so I cannot comment on how well they will work together: the Alectos are extremely transparent to pre-amplifiers. Alan, and others who heard them, all commented on their velvety, valve-like quality. There is only one snag: the Alectos have no short-circuit protection, so you have to exercise some caution with the volume control, but everyone agreed my '63s apparently went quite loud enough before I risked shutting them down.

Next in line, if you want to aim for equal detail but a leaner and drier presentation - particularly in the bass - is the Chord SPM 1200, though

we are moving up the price scale from £1800 to £2,750.

Also high in the detail stakes, and cheaper, is LFD's extremely clean-sounding Power Stage, at around £800.

Somewhat different in style, but one equally adept at driving ESLs is Tim de Paravicini's latest line-level valve integrated the EAR834 which is bright, very clear, and more up-front than the previous amplifiers (and adored by NK). It was described by one listener as the amplifier that Naim might have made if the company built a valve amplifier. This is a steal at £1200.

Last, but not least, are Pink Triangle, whose sound using ESL-63s is always remarked on at Shows. Worth seeking out, but since I've not experienced them at home driving mine, I cannot comment in detail. I do know that quite a few of their customers have gone away after a visit impressed enough to put in an order for a pair of '63s. Now, all you have to do is decide how much you want to spend and go listen! **EB**

P-MOUNT POINT

I was very interested to read the review of the Sumiko Blue Point cartridge in the October '92 edition of Hi-Fi World, particularly because it is a P-mount type cartridge which you recommend for use in presumably more up-market arms than the manufacturer intended.

I also have a P-mount cartridge, namely a Technics, which is left over from when I had a Technics direct-drive linear tracking turntable. I have since been through a couple of turntable upgrades and now possess a Roksan Xerxes with Artemiz arm and AT-F5 cartridge. However, I have fond memories of the Technics cartridge which I don't believe I ever heard at its best. It had little use, which was why I hung on to it, but I have never found a suitable way to connect the small diameter P-mount to the larger diameter terminations on the Artemiz arm cable.

It occurred to me that as Alan Sircom obviously found a way of using the P-mount Sumiko in a variety of arms, there may be a suitable adaptor available to enable me to hear my Technics cartridge

before it is sadly consigned to the dustbin. If so, I would be very grateful if you would tell me how to get one.

**Andy Aldridge,
Northwich,
Cheshire.**

Perhaps we didn't make it clear enough; the Blue Point is a selected version of what was originally a P-mount cartridge, not simply a P-mount just supplied with an adaptor. I think you might be best to retain fond memories of the Technics, remembering they are based on the arm you heard it in too. As far as I know, there are no adaptors around now, and Technics told us they cannot help, since the cartridge is obsolete. All I can suggest is a bit of dextrous DIY in order to make a bracket. **EB**

UNSUITABLE FOR VALVES?

I use an LP12/Ittok/A-T OC5, Michell Iso, RATA passive controller and a Quad 306 driving LS3/5a speakers. I listen to Classical (mostly) with some Opera and Jazz. The system is quite listenable but a little polite, which I suspect may be due to the power amp, which I intend to replace sometime soon.

I recently managed to borrow an Audio Innovations First Audio power amp which, while probably not an ideal match for the speakers, managed to produce quite a dynamic sound with much better mid-range and much wider sound-stage. It left me with a taste for valves. But, having listened to a couple of dealers, I have been advised against using valves with these speakers.

Would you please let me have your views on whether you feel this is correct or not and, either way, advise me on what is a suitable amp. (valve or solid state) to insert into this system.

Budget is not too critical, although I probably wouldn't want to spend more than £1500.

**David Lewis,
London NW1.**

My view is that the idea that valves don't mix with LS3/5a's is nonsense. Well, mostly, anyway. There is one common valve amplifier trait which does trip up over a by-

product of the way the LS3/5a was designed. The little BBC monitor was originally

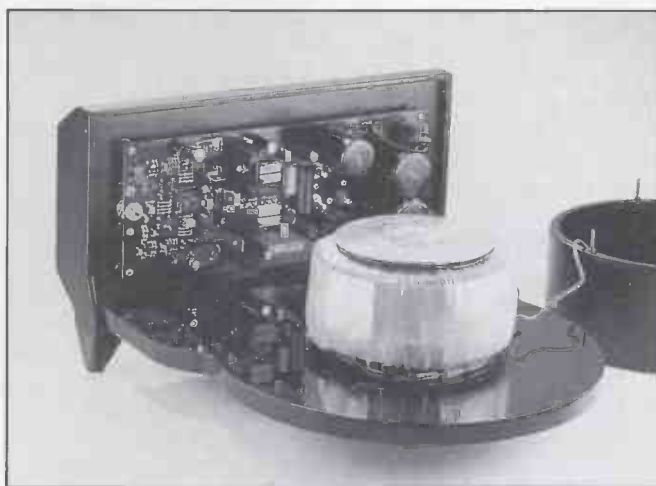

Some of the elements of valve sound, but solid-state: the Michell Alecto.

designed primarily as a near-field voice monitor; it so happens it has a 'lump' in its response at 100Hz. Many valve designs tend also to be slower and softer in the bass than solid-state designs, so putting the two together can result in a soggy bottom end, or the bass develops a wobble. (That is Rogers designer Andy Whittle's phrase, by the way. Just as an aside, he too is showing valvophile symptoms. He's even borrowed the little Pye Mozart I listened to not long ago.) On the other hand, valve amps also, as a rule, have a more lucid, more evocative mid-range, which is precisely where the BBC monitor excels.

It is only that question of how tolerant - or intolerant - a listener is of a looser bass that in any way militates against using pretty well any current valve design, though as Andy Whittle himself says, the more current any amplifier can supply the better. I strongly suspect that having acquired a taste for valves you may find the addiction hard to give up. If you must have firmer bass than the First Audio or a Copland, for example, can offer, try the EAR 834, which has the tightest bass delivery of any valve amplifier I've heard. Since it's a line-level integrated and you use an Iso, you wouldn't need the passive controller, which, to be honest I suspect is adding an additional degree of over-civility in any case. Otherwise,

stretching the budget a bit further and at the risk of being boring, do try the solid-

state Michell Alectos, which at the moment are the best of both worlds. **EB**

SPEAKER STRAIN

My system comprises Linn Sondek LP12/Lingo/Ittok/K18, Naim 72/90, all on a Sound Factory tripod stand. Heybrook HBI Mk11s on spiked stands are firing across the short axis of a 16ft x 13ft room.

I listen mainly to Classical orchestral music and I would like to improve the ability of the system to cope with those loud complex passages. At the moment I feel that the sound is also contained within the boxes and I would like it to be more open-sounding and less strained during musical climaxes.

I can't make up my mind whether I should first upgrade the cartridge or the speakers. I would also, at a later date, add a Hi-Cap and NAPI40. I have Karma boards available for the NAC72.

My room has always displayed a tendency for a slight bass boom, so I don't think a larger speaker would be suitable. Would Epos ES1s be a meaningful step or should I aim higher? If so, what cartridges should I audition? Budget for the first move is about £500.

**Hunter Kennedy,
Carlisle,
Lanarkshire.**

I'm liable to land up to my neck in a controversy here, I strongly suspect, but what's a neck for if it's not for sticking out? If you listen mostly to

Classical music, then I think you should aim for the best cartridge you can in the long term, which does mean utilising the Karma board or considering the new Arkiv. However, given the budget, my own first move would be to go for different speakers. By all means audition the Epos ES11 or 14, which can produce that 'out of the box' sensation along with the high-quality imaging that to me is an essential corollary of satisfying Classical listening.

However, they would be at their best firing the length of the room - as would the Heybrooks you currently possess. If you must fire them across the shorter dimension, I would say you should listen to the Rogers Studio 3 at £450 which we reviewed in the March issue and will do exactly what you want. **EB**

QUICK, QUICK, SLOW

I am writing to ask what makes some systems sound faster than others?

My system comprises a Linn Basik/A-T 95E, Arcam Alpha 3, Celestion 3, Pioneer CT339, Sony ST-S370 and Sony D-22. Although I listen mostly to the Celestions, I also use a set of Pioneer SE-300 headphones which sound faster, although less detailed than the 3s.

I thought that the speakers could only sound as fast as the signal from the front end.

I am also looking to add a better CD player and cartridge and have shortlisted these: Goldring 1012, Audio-Technica AT-450 (OCC), A&R P77. For CD, the new NAD player, Rotel RCD-965BX or the Arcam Alpha.

I have around £70 to spend on the cartridge and £350-£400 on the CD. I have yet to properly audition all of these and would appreciate your opinions. Will you be reviewing the new Sugden player?

**Paul Jones,
Slough,
Berks.**

We have reviewed the new Sugden player - in the March issue - and both I and Noel found it absolutely superb from a musical point of view. Unfortunately, it's double your budget. Since your amplifier is an Alpha 3, I would go for the latest Alpha Plus CD player, but apart from the Rotel would also

Continued from page 55

consider current Pioneer models at about the same price level. You may find the Legato Link players too smooth, but you could find their detail very much to your taste.

Of the cartridges, the Goldring is the best bet, but don't ignore the Denon DL110 - within your budget - or Ortofon MC15 Super high-output moving coils - just above it. I know NK doesn't much care for the high-output MC breed generally, but friends of mine with relatively inexpensive systems have been very happy with both.

As to why some systems sound 'faster' than others, admittedly, if the speed isn't in the source it won't come through. But then, it's a notorious fact that people faced for the first time with loudspeakers with real bass extension - like transmission lines - often feel the pace has slowed down. A speaker - like a pair of headphones - with a frequency response severely curtailed at the lower end will appear to be speedier. **EB**

QUAD QUERY

My current system comprises LPI2, LVX/Basik with AT95E stylus, Denon DCD-580 into Croft Super Micro A IV PP, Quad 306 and Heybrook HB1s (original). Interconnects are Tandy Gold Series (excellent).

While generally happy, I find the HB1s a little brash and sharp. Having listened to many possible replacements at Penta and at dealers, I am becoming increasingly dissatisfied with box speakers. They all seem to shout "box", with the single exception (to date) of the MA Studio 20SE, which had superb transparency and musicality and, of course, Quad Electrostatics. Surely, it isn't necessary

to spend £2000 plus to achieve the neutrality and transparency I am looking for. What do you think of the original Quad with a REL subwoofer? They would have to be convincing to get past the Board (girlfriend) on account of their size.

On the subject of sources, I recognise the Denon is far for



An Ortofon MC15 may contribute to a faster sound.

perfect, but I do like the clean, dynamic distortion-free sound CD offers. I want to improve the Linn in these areas. Should I go for Ittok/Lingo, or would a change of cartridge suffice, for example Goldring 1042?

With the CD I'm considering buying an old Philips/Marantz player with the CDM1 transport (apparently a goody) and a DAC, perhaps from Orelle, AVI or Meridian. Would this sort of combination seriously outperform the Rotel '965 or the new Aiwa, or should I consider a modern transport?

Also, I wish to buy a tuner for R3/4 broadcasts. I have heard the Aiwa and was impressed. Does the FM4 offer an improvement or should I consider a rebuilt Troughline?

I'm very happy with the Croft/Quad which provides an excellent soundstage, detail and welly when required. However, I recognise the Croft's strength is in its phono stage. When using the line inputs all valves remain lit, thereby shortening their life uselessly. I tried, therefore, using the Croft passively, switched off and although level is reduced dramatically I

noticed a definite improvement to CD depth, clarity and timbre. I'm therefore considering a passive preamp/phono stage. Is this the right direction to go?

Finally, my listening room is 12ft x 14ft and musical tastes range from Blues, female vocals to Classical.

**David Coles,
East Ham,
London.**

Once you start to recognise box honk and echo for what it is, rather than as part of the music, dissatisfaction will haunt you! We know of no loudspeaker that is truly boxless in its sound other than Quad Electrostatics. It isn't coincidence that three of us use them as a result. Like many, I find the basic ESL-63 dull and flat sounding until its decorative 'sock' and aluminium grills are removed, but then it becomes potentially dangerous. Eric uses '63s unmodified and Richard Kelly found a pair of original Electrostatics in a junk shop. Because the owner thought they were a pair of old, oil-filled electric radiators, he got them for £50!

Surely, this is your best bet: try to find a pair of Electrostatics second-hand. Many people find them too large, intrusive and even boringly 'flat' sounding, after the resonantly enhanced dynamics of a box. Find someone in this position and make them an offer. You never know, you may get a pair at a bargain price, since there aren't so many people able or willing to house an electrostatic properly.

Talking about housing them introduces the problem of small room size that will confront you. Ideally, you need at least one dimension of around 18ft minimum. In a smaller room like yours, try hanging curtains of underlay felt behind to cut down high frequency rear radiation. Keep them at least 4in away and experiment. They'll minimise treble muddle from early reflections when the speakers have to go close to a rear wall.

Richard Kelly is currently using the REL subwoofer with his originals and the system sounds wonderful. Just bear in mind that the REL is difficult to tune and, when done by

trial and error, lengthy too. I found you must set the frequency and level controls to their lowest settings and slowly increase both until the bass just marries up with the rest of the audio range seamlessly. It is very easy to get the settings wrong, whereupon the unit will not integrate and 'disappear' properly. Once correctly set though, the REL works extremely well with either of the Quad electrostatic loudspeakers and we can recommend the combination from first hand experience.

You certainly do need a better cartridge, since the AT95E really can sound bright, vague and coarse. I would emphatically recommend the Goldring 1042. It has a wonderful Gyger S stylus that gets more high frequency information out of the groove than you'd ever believe; it really does leave other cartridges in the shade here. Being of reasonable compliance, it will match the LVX well enough. General opinion here is that the Basik through early HB1s would sound sharp and both should go. You may well be happy enough with the sound after improvement in this area, further arm/cartridge upgrades being unnecessary.

Once having upgraded, we would suggest that you consider getting a transport with Philips' recent CDM9 mechanism or, better still, the impressive CDM9 PRO, in a Sugden (CDM9) or Micromega Duo CD.2 (CDM9 PRO). It comes with a different and better motor, glass laser lens (they're usually plastic) and heavyweight, precision cast chassis. It would be better suited quality wise. Try an EMF Crystal or Orelle convertor.

Don't worry about valve life too much. Our valve amps tend to stay on so that they reach thermal equilibrium. Low power valves have a long life. A passive preamp with the 306 is a possibility, since its sensitivity of 375mV for full output (50W) is just enough for most tuners and cassette decks, but volume will often have to be close to or even at maximum. The 306 is fine for driving electrostatics, but it isn't the last word in lucidity, so gains might be small. **NK**

provided by the Tannoy Dual Concentric philosophy.
Alex Garner,
Technical Director,
Tannoy Ltd.

Touching up a TANNOY GOLD

If the paper cone is fractured the whole cone and coil assembly may be replaced with a currently manufactured dedicated replacement. As the approved Tannoy repairer, we regularly carry out this procedure with complete success.

A 'retrofit' replacement crossover for these loudspeakers was made by Tannoy in the 1980s, to the original specification but using improved components and

to match the original response exactly as the cone mass will have changed and the break-up modes will be unpredictable because of the

good, domestically harmonious size.

Our older Lancaster cabinet would be a good starting-point, with alterna-

local of
Howev
trying t
commi

Use
flexible
such as
Sandwi
betwee
strips c
spreadi
and ev
- don't
techniq

out the
cone al
tissue p
the tear

As a
DIY tec
cone th
Depart
Eugene
to advis
Please t
history
indicate
been ve
therefor
coned I
some co
run in t
and th
mend r
the spe
their m
a studio
instance

The
indeed I
allowing
work ou
around
smallest
unit will
(2.8 cub
with an
maximal
damped
(10.7 cu
35Hz). I
the latte
althoug

TOUCHING UP TANNOYS

I have acquired a pair of Tannoy 15 inch dual concentric speakers, Monitor Golds. They date from the 60s and were originally built for the Royal Shakespeare Company. When I 'adopted' them, they were housed in purpose-built Ashley cabinets of enormous size, at approx 4'6" x 4' x 2'; I did consider converting them into wardrobes!

I have several problems in renovating them. Firstly, one of the paper cones is fractured, there is an inch long tear, but no paper missing. I have received much conflicting advice. One theory holds that I would be better to glue up the damaged cone, but with what? The glue would need to be very flexible.

If gluing would not work, where could I get these cones repaired, and would it be better to get both repaired to keep them matched? Should they be re-coned with paper or could a more modern material be used without spoiling the character?

As the cabinets were damaged as well as overlarge, I intend to build new cabinets modelled on the dimensions of standard Tannoy models. The Ashley cabinets were fully sealed, except for a heavily damped vent into the plinth; would this be the best design? The original cabinets were extremely rigid and heavily damped throughout. This I presume to be essential, but would this best be served by using chipboard, ply or M.D.F. as the cabinet material?

Should I keep the original crossovers, or would it be better to replace them with more modern designs, and might an additional very high frequency drive unit be usefully added to brighten the speaker?

I want to do as good a job as possible, but cash is limited.

Paul Hatton,
Willesden,
London.

As you haven't lost any of the original paper cone material on the damaged area of your 15" Tannoy Gold (Type Number LSU/HF/15-8) you can do a very good 'home repair' on this drive unit without going to the expense of a full Tannoy original equipment re-cone. Obviously, you cannot guarantee

WORTHY OF THE MOST ESOTERIC EAR

TWO SUPERB PRIZES THIS MONTH

FIRST PRIZE!

WIN AN ESOTERIC AUDIO RESEARCH EAR 834 INTEGRATED VALVE AMPLIFIER AND A PAIR OF ROSEWOOD-VENEERED ROGERS STUDIO 3 LOUDSPEAKERS.

WORTH OVER £1,700!

SECOND PRIZE!

THE RUNNER-UP WILL WIN A PAIR OF ROGERS STUDIO 3 LOUDSPEAKERS FINISHED IN WALNUT.

WORTH £450!

"It's designed to have a long life and need no adjustment," Tim de Paravicini told us about his new line-level integrated valve amplifier, the Esoteric Audio Research EAR 834 - first prize in this month's competition.

"Beautifully made," we said in our review, with its shining face-plate and brass finished control knobs. Equally impressive is the array of four valves either side which supply a more than healthy 40watts, which makes it "powerful, precise and vivid." Even the bass - the weak point of many valve designs - stays tight and firm.

Designed to be at its best with 8ohm loudspeakers, we decided to partner the EAR with a pair of Rogers' Studio 3s. These new miniatures replace the classic BBC small monitor, the LS3/5a, in Rogers' range. With all the essential virtues of precise imagery and a bigger sound than a small box is usually expected to reproduce, the Studio 3 is a perfect partner.

One of the longer-established British hi-fi companies, Rogers takes its name from its founder, Jim Rogers. Initially based in Hampstead in London, haunt of artists and sculptors, the firm began in 1947 by producing the famous Williams mono valve amplifier under licence. Two years later, Rogers Developments Ltd., their full title, moved in search of more space to Woolwich and then, in 1954 to Greenwich.

It was at Greenwich that the first Rogers amplifier was made, a small valve monoblock called the 'Minor', followed shortly by the 'Junior', which was joined by the Junior AM tuner and Junior Compact Loudspeaker. Later models from the Greenwich factory included the Master stereo amp and the Cadet - a small valve integrated, many of which can still be found in use.

Two names for later electronics ranges - the Ravensbourne and Ravensbrook - resulted from Rogers' next move. Both names were borrowed from the two rivers which



The wonderful EAR 834 valve amplifier from Tim de Paravicini; we loved it.



The Rogers Studio 3 loudspeaker.

ran close to the new factory in Catford. In the Sixties and Seventies, a liaison developed between Rogers and the BBC which resulted in a licence to build the BBC Monitor designs with which the name has long been associated. Apart from the famous miniature LS3/5a - now replaced in the range by Rogers' own Studio 3 miniature - these included the LS5/8 and LS5/9.

Richard Ross took over design responsibilities, allowing Jim Rogers to retire. In 1976 the company was acquired by Swisstone Electronics and in turn bought Chartwell, another manufacturer of BBC designs, moving to their factory in Surrey. With the increasing demand for loudspeakers, Rogers gave up electronics. Richard Ross's last designs were the P Series; now the designer is Andy Whittle, late of Goodmans, Epos and Celestion. The new compact miniature, the Studio 3, is the first to appear under his exclusive direction.

Please send your entry form, completed in block capitals, to arrive by 19th April 1993, to:

EAR/ROGERS COMPETITION,
Hi-Fi World Magazine,
64 Castellain Road,
London W9 1EX

In the event of more than one entrant submitting all the correct answers, winner and runner-up will be decided on the tie-breaker. We will endeavour to publish the results in the May issue. Audio Publishing reserve the right to publish such entries or parts of entries as the company sees fit. We regret that photocopies of the entry form cannot be accepted. No correspondence about this competition will be entered into and the Editor's decision is final. Employees of Esoteric Audio Research, Swisstone Electronics and Audio Publishing Ltd. may not enter.

QUAD COMPETITION WINNER

The Hi-Fi World reader who will shortly be waxing ecstatic over a pair of Quad ESL-63 electrostatic speakers - and a complete remote-controlled Quad hi-fi system to go with them - is Mr James Evans of London. His winning entry was chosen by Quad from a huge response. They were obviously the result of a good deal of hard thought; thanks to all entrants.

SPECIAL MAIL ORDER



ANTI-STATIC RECORD SLEEVES

Translucent sleeves, treated to reduce static and dust attraction, supplied in packs of fifty. They will fit inside ordinary printed inners.

LP SLEEVES (50) PRICE £7.50

NAGOAKA CD CLEANING KIT

Careful manual cleaning is the most effective way of removing surface contaminants. Nagaoka's kit includes a solvent and chamois leather pad to bring back a pristine shine to Compact Discs.

NAGOAKA CD CLEANING KIT £10.50

NAGOAKA ROLLING RECORD CLEANER

A hand-held roller with a sticky coating to lift dust from an LP - even from the bottom of the groove. The roller can be washed after use.

ROLLING RECORD CLEANER £10.20

AUDIO-TECHNICA GREEN CD RING STABILIZER

Detachable rings which fit around the circumference of a Compact Disc, which add a small but significant amount of mass, improving its stability when it rotates at high speed in the CD player. Improvements can include better focused images and a denser and richer sound.

GREEN RING STABILIZER (5) £6.50

AUDIO-TECHNICA RECORD CLEANING SYSTEM

Removes both dirt and static; a tiny amount of cleaning agent in the handle removes fingerprints, oil and film, while a pad lifts off dust. Pad brush and fluid are supplied.

AUDIO-TECHNICA RECORD CLEANING SYSTEM £10.50

AUDIO-TECHNICA CD LENS CLEANER

A disc the size of a CD, with fine brushes - one of which is dampened with cleaning fluid. As the disc spins in the player, the brushes clean the laser lens. It may not suit all machines.

CD LENS CLEANER £16.25

AUDIO-TECHNICA ELECTRONIC STYLUS CLEANER

No need to touch that fragile stylus! Just rest it on the

vibrating pad and the cleaner will vibrate the gunge right off the tip. Powered by an AA battery.

ELECTRONIC STYLUS CLEANER £19.95

CD JEWEL CASE

To house and protect your CD.
CD JEWEL CASE £1.00

LASAWAY GREEN PEN

When red laser light hits the reflective surface of a CD, some of it can be scattered off the edges of the disc, causing optical interference. Applying this green coating, formulated by Japanese company Mitsubishi, to the inner and outer edges of the CD reduces



AUDIOQUEST LASER GUIDE

Laserguide is a silicone based treatment - not a cleaner - for CD which has a refractive index close to that of a disc's polycarbonate surface. Applied using a cotton cloth, it allows the laser to read the pits below the transparent layer more clearly. Openness and depth of sound are said to be improved, while Laserdiscs benefit with a sharper picture and less noise. one bottle treats approximately 300 CDs.

AUDIOQUEST LASERGUIDE £14.95

this interference, improving sound quality.

LASAWAY GREEN PEN ... £8.50

HI-FI WORLD DRY STYLUS CLEANER

Keep your stylus sharp and bright for perfect tracking without using fluid. Cut a strip about the size of a matchbox striker off this sheet of card and draw it gently under the stylus from back to front.

One sheet of this card, with its aluminium-oxide micro-abrasive coating, should be enough to clean your stylus at least forty times.

DRY STYLUS CLEANER ... £1.95



PIXALL MK II RECORD CLEANER

Made in the UK, this simple record cleaner uses a replaceable roll of sticky tape which lifts dust out of the groove. After use, the dirty length of tape can be peeled off, reducing the risk of any gritty particles picked up being ground back into the vinyl. When the tape runs out, a new roller is simply clipped in.

PIXALL MARK II £10.75
REFILL ROLLER £2.75

Hi-Fi World AUDIO ACCESSORIES

accessory offers

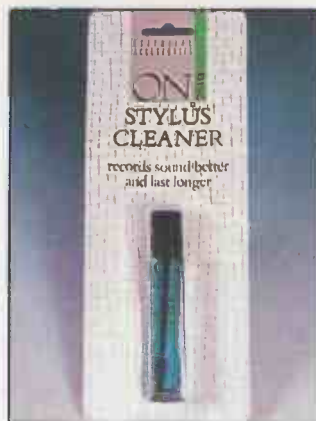

ON STYLUS CLEANER

A simple but effective cleaning kit, consisting of a stylus brush and cleaning solution. Used carefully, it will keep your stylus sparkling.

STYLUS CLEANING KIT
£2.50

TDK HEAD CLEANING KIT

TDK's CK-A1 head cleaning kit offers two bottles of cleaning fluid, one for the heads, the other for the rubber pinch wheels, and cotton buds for applying them. The CK-TB kit has a single bottle of dual-purpose fluid.

TDK HEAD CLEANING KIT CK-A1 £5.50
TDK HEAD CLEANING KIT CK-TB £4.65.

AUTOMATIC CD CLEANER

About the size of a portable CD player, this battery-operated disc cleaner spins the disc while two replaceable sponges clean it radially. Spray the CD with the cleaning fluid supplied, insert it into the



Record storage cubes



machine, and the cleaning cycle is completed in twenty seconds. Supplied with washable foam cleaning pads and cleaning solution (but not batteries) the cleaner can be powered by any standard transformer like those used for Personals with a 3v dc 350mA output.

AUTOMATIC CD CLEANER
£21.95

RECORD STORAGE CUBE

Designed to hold about a hundred LPs, with an internal width of 37cm, height of 32.5cm and depth of 32cm. The cubes can be stacked or placed alongside each other - and are even strong enough to be used as seats! Made from 15mm MDF (Medium Density Fibreboard) with a smart durable black paint finish, the cube is supplied in flat-pack form ready for home assembly.

RECORD STORAGE CUBE .. £42 EACH

FREE!

20 RECORD SLEEVES WITH 2 CUBES
50 RECORD SLEEVES WITH 4 CUBES

6 CUBES FOR THE PRICE OF FIVE! £210

8 CUBES FOR THE PRICE OF SEVEN! £294



SORBOTHANE CD FEET

Four round rubber feet, 50mm in diameter and 18mm deep, made from an artificial form of rubber known as Sorbothane. These feet have the ability to soak up vibrations and improve sound quality by providing a platform for CD players or any hi-fi sensitive to vibration.

SORBOTHANE CD FEET £27.95



Hi-Fi World

SPECIAL MAIL ORDER



SWEATSHIRTS AND T SHIRTS

Printed with 'Hi-Fi World' and our slogan 'The Magazine for Enthusiasts' front and back to prove to everybody you read probably the best magazine in the universe.

SWEATSHIRTS £12.00
HOODED TRACK TOPS . £15.00
T-SHIRTS £7.99



SOUND SWIVEL

A rotating, upright, double-sided, storage cabinet with space for up to 160 Compact Discs, including 8 double jewel-cases. Mounted on an all-steel turntable, it swivels smoothly through 360 degrees giving easy access to the storage compartments either side. Manufactured in durable MDF with a Black Ash effect finish, the Sound swivel comes packed for self assembly with full instructions.

SOUND SWIVEL £49.95

MICHELL ENGINEERING PLUGS

Craftsmanship marks out Michell Engineering's range of gold and rhodium plated plugs from the competition. Simple but elegant.

GOLD-PLATED SIDE ENTRY BANANA PLUGS (4) £10.00

GOLD-PLATED SURE-LOC BANANA PLUGS (4) .£14.95

RHODIUM-PLATED SURE-LOC BANANA PLUGS £18.95

GOLD-PLATED SPEAKER CABLE CONNECTORS £10.00



ARCAM RCA PHONO PLUGS

This heavy-duty phono plug, specially made in Japan to Arcam's specification, will accept cable up to 7mm in diameter. The body is nickel-plated, the contacts plated in gold. Supplied in pairs marked with either one ring or two to allow directionality to be taken into account.

RCA PHONO PLUGS (4) £15.50

GOLD PLATED 4MM BANANA PLUGS

We have a new style, heavy-duty, gold-plated banana plug with a unique type of axial solderless connection for loud-speaker cables. The cable is stripped back and pushed into a clamping collar which is then screwed down tight, accepting cable up to 6mm external diameter and 4mm core diameter. Supplied in sets of four.

BANANA PLUGS (4) £8.00

GOLD-PLATED SPADE CONNECTOR

A heavy-duty gold-plated spade connector for loudspeaker screw terminals with a unique axial clamp connector which requires no soldering.

SPADE CONNECTOR (4) £10

NEW FROM HI-FI WORLD!

CD/MC TOWER

Ready built, the CD Tower is of all metal construction with slot-in side panels finished in either mahogany or black ash. Each of the trays slides out for access to the stored cassettes and discs. Total capacity is 160 CDs and 52 cassettes.

CD/MC TOWER £199.90



LIFT JUMBO

This aluminium Compact Disc stacker holds seventy-five CDs, which can be flipped forward by the fingertips to display the insert. Browse through your CD collection without having to squint at the small lettering on the spine.

LIFT JUMBO £44.95

AUDIO ACCESSORIES

MATROW BIASBUG

A fascinating little device no larger than a hand-held remote which allows the user to adjust bias on any cassette deck perfectly for any tape. You can check the state of your cables and connections with it, too! Supplied with a cassette test tape and full instructions. (See review, Nov. 1992 issue.)

MATROW BIASBUG £59.99



AUDIOQUEST OPTICAL LINK Z

A wide-bandwidth, ultra-high performance optical cable for digital links such as that between CD transport and convertor. Available in 1m and 2m lengths with conventional Toslink connectors.

OPTICAL LINK Z (1M) £69

OPTICAL LINK Z (2M) £99

AUDIOQUEST QUARTZ INTERCONNECT CABLES

A fully balanced analogue signal cable with heavy duty welded gold-plated phono plugs and advanced ultra-pure copper Quartz Hyperlitz cables using polypropylene insulation.

AUDIOQUEST QUARTZ CABLE

1 METRE LENGTHS £79/PAIR
2 METRE LENGTHS .. £120/PAIR

KONTAK

An effective cleaning solution that removes contaminants from electrical connections. after application, a system regains its original life, sparkle and vigour.

KONTAK £21.20

HI-FI WORLD SPECIAL AUDIO ACCESSORIES ORDER FORM

Please send me:

- CD sound swivel £49.95
- Record storage cube £42.00 each
- Sweatshirt (state size and colour) (XL, L, M) £12.00 each
- Hooded track-top (one-size) £15.00 each
- T-Shirt (state size and colour) (XL, L, M) £7.99 each
- Pixall MkII Record Cleaner £10.75 each
- Pixall refill roller £2.75 each
- Hi-Fi World Dry Stylus Cleaner £1.95 per sheet
- Kontak cleaning fluid £21.20 each
- CD Jewel Case £1.00
- Nagaoka Anti-static record sleeves £7.50 (50)
- Nagaoka rolling record cleaner £10.20 each
- Nagaoka CD cleaning kit £10.50
- ON Stylus Cleaning Kit £2.50
- Lasaway Green Pen £8.50 each
- Laserguide £14.95
- Audio Technica CD Lens cleaner £16.25 each
- Audio Technica Record Cleaning System £10.50
- Audio Technica Green CD Ring Stabilizers £6.50 (Pack of 5)
- Audio Technica electronic stylus cleaner £19.95
- Audioquest Sorbothane feet £27.95 (4)
- Audioquest Optical link Z £69 (1m)
- Audioquest Optical link Z £99 (2m)
- Audioquest Quartz cable (pair) £79 (1m)
- Audioquest Quartz cable (pair) £120 (2m)
- TDK Head Cleaning Kit CK-A1 (double bottle) £5.50
- TDK Head Cleaning Kit CK-TB (single bottle) £4.65
- Gold plated 4mm plugs £8.00 (4)
- Gold plated spade connectors £10.00 (4)
- Arcam RCA phono plug £15.50 (4)
- Automatic CD Cleaner £21.95
- Michell Gold-Plated Side Entry Banana Plugs (4) £10.00
- Michell Gold-Plated Sure-Loc Banana Plugs (4) £14.95
- Michell Rhodium-Plated Sure-Loc Banana Plugs (4) £18.95
- Michell Gold-Plated Speaker Cable Connectors £10.00

- CD/MC Tower £199.90
- Lift Jumbo £44.95

All prices include postage & packing in the UK only.

I enclose cheque/PO for £ made payable to **Audio Publishing Ltd.**

I wish to pay by Visa/Access, please debit my account no:

--	--	--	--	--	--	--	--	--	--	--	--	--	--	--	--	--	--	--	--

Expiry date:

--	--	--	--

Name

Delivery Address

.....

.....

N.B. If delivery address is different to the credit card holder's address please supply both.

Tel:

Please send completed order form together with your cheque/PO to:
HI-FI WORLD,
64 Castellain Road,
Maida Vale,
London W9 1EX.



Credit Card Orders
Telephone 071-266 0461
Answerphone during evenings and weekends

Specialist Hi-Fi Dealers

WEST & WALES

audio excellence

WHERE THE MUSIC MATTERS

BRISTOL
65 Park Street,
Bristol BS1 5PB
Tel: (0272) 264957

SWANSEA
9 High Street, Swansea
W. Glamorgan SA1 1LE
Tel: (0792) 474608

CARDIFF
134/6 Crwys Road,
Cardiff, S. Glamorgan
Tel: (0222) 228565

GLOUCESTER
58 Bristol Road,
Gloucester GL1 5SD
Tel: (0452) 300046



Tues - Sat 9.00 - 5.30
Closed Monday

ACTON GATE AUDIO

THE HI-FI CENTRE IN
WREXHAM

Aiwa, ARCAM, Audio Technica, B&W, Cambridge, Celestion, Cyrus, Hasler, Marantz, Michel, Mission, NAD, Nakamichi, Ortofon, Proton, Quad, Radford, Rega, Rogers, Rotel, Sansul, Spondor, Teac, Tannoy, Thorens, Wharfedale, Yamaha etc...

4 RUABON ROAD, WREXHAM
TEL: 0978 364500

VAUDIO 36 Druid Hill, Stoke Bishop, Bristol BS9 1EJ.

ATC, AVI, Acoustic Energy, Analogue Electronics, Audio Innovations, Audio plan, Boulder, Micromega, Pink Triangle, Threshold, Ruark, SME, Exposure, Mitchell, Dahlquest, Threshold, Pink Triangle, Wadia.

Deals by Appointment only, Home trial facilities,
Free Installation, Servicing Facilities. We are not a shop.

All roads lead to Bournemouth

It's where you'll find superb Hi-Fi listening facilities, staff with expert knowledge and one of the finest selections of Hi-Fi equipment including...

LINN, DENON, YAMAHA, ROTEL, MONITOR AUDIO, NAD, MARANTZ, CREEK, ARCAM, NAKAMICHI, CELESTION, AIWA, DUAL, AUDIOLAB, QUAD, QED, WHARFEDALE, TANNOY, SONY'S, SENNHEISER, TARGET, SOUND ORGANISATION, ADCOM, and others.

If you're serious about Hi-Fi you probably know these names and you probably already know the name Suttons... we've been around for 42 years.

Suttons

18 Westover Road, Bournemouth BH1 2BY. Tel: 0202 555512

ENGLISH audio

95 WHITECROSS ROAD, HERFORD
TEL: 0432 355081

AMC - ALBARRY - ALPHASON - ARCAM - CELESTION - CYRUS - DENON - DUAL - HEYBROOK - JPW - MARANTZ - MICHELL - MICROMEGA - MISSION - MOTH - MUSICAL FIDELITY - NAKAMICHI - PINK TRIANGLE - NAD - ROGERS - ROTEL - RUARK - SENNHEISER - SYSTEMDEK - STAX - TANNOY - and others

OPENING HOURS 10.00 - 6.00
EXTENDED GUARANTEES, DEMONSTRATION ROOM,
SERVICE DEPT.

art of music

Does your system lack deep bass? If so, consider a demonstration of REL ACOUSTICS Sub-woofers which will plunge down low without altering the positive qualities of your own speakers (bring them along for the dem.)

At the same time, treat yourself to the thrill of hearing LUMLEY REFERENCE valve amps - quite stunning!

Other Agencies: BASIS • CARY • C. A. T. • COGAN HALL • DIAMOND ACOUSTICS • M. A. S. • MAGNUM • MAGNUM DYNALAB • SILVER SOUNDS • TRANSFIGURATION

Tel: 0566 86649

LONDON & SOUTH EAST

"One of the 5
best hi-fi shops
in the world"

GRAHAM'S HI-FI

Canonbury Yard, 190A New North Road
London N1 7BS, ☎ 071-226 5500
Ring for a chat, an appointment and a map!



79/81 Fairfax Road
Swiss Cottage
London NW6 4DY
071-624 8855/6
Mon-Fri 10-7 Sat 10-6

82 The High Street
Harpenden Herts AL25P
0582 764246
Mon-Sat 9-5.30 (Closed Wed)



Spaldings

ESTABLISHED IN SOUND

☎ 081-654 1231/2040
352/4 LOWER ADDISCOMBE RD.,
CROYDON, SURREY

THE CORNFLAKE SHOP

(071) 631 0472 Fax (071) 436 7165
37 Windmill Street, London W1P 1HH
(Just off Tott. Court Road)

3 Demo Rooms. Complete Installation Service. Multi-Room Specialists. Knowledgeable Friendly Service
Stockists of: REGA, NAIM, ROKSAN, MERIDIAN, ARCAM NAKAMICHI, ACOUSTIC ENERGY, ION, DNM, EPOS, ROTEL DYNAUDIO, MONITOR AUDIO.

NEWBURY AUDIO

where music matters most

Linn • Naim • Roksan • Creek • Ion • Royd • Epos • Dual
Ruark • JPW • Aura • Audiotech • Nakamichi • Denon
Rotel • Deltec Micromega • Beyer • Sennheiser
Tripod • Can Opener

2 WEAVERS WALK • NORTHBROOK STREET
NEWBURY • BERKSHIRE RG13 1AL
TEL (0635) 33929



SPECIALIST HI-FI OUTLET
DEMONSTRATION ROOM - PARKING

QUAD • AUDIOLAB • TDL • TUBE
TECHNOLOGY • REL ACOUSTICS •
NAKAMICHI • KEF • THORENS • MAGNUM
• ROTEL • MARANTZ • DENON • MICHELL
• TANNOY • JPW

'REFERENCE IMPORTS DEALER'

Just 2 minutes off Junc. 6 M25 (A25)

GODSTONE 0883 744755
45 High St., Godstone, Surrey RH9 8LS

ANALOG AUDIO

(Hi-Fi Specialists)

849 High Road, London N12
Tel: 081 445 3267

LEADING STOCKISTS OF
ROTEL, YAMAHA AND MARANTZ
Stockist of full range of speakers and
electronics for all major manufacturers.
Please phone for details.

AUDIO VENTURE

AUDIO CONSULTANTS AND RETAILERS
24 CHURCH ROAD, CRYSTAL PALACE,
LONDON SE19 2ET - TEL: 081 771 7787

Stockists of - Creek, Denon, Dual, Epos, Mana, Acoustics,
Marantz, Monitor Audio, Naim Audio, Nakamichi,
Professional Monitor Company, Revolver,
Rotel, Yamaha, etc.

1,000s of LPs stocked

Two single-speaker demonstration rooms

Interest free and various credit facilities available
All equipment delivered and installed.
Comprehensive turntable rebuilds etc.

2-year warranty
Open 10-5.30p.m. & late night Fridays 'til 7p.m.
Closed all day Wednesday

RECORDS AND CDs BOUGHT FOR CASH

SOUTH

STATION SOUNDS

FOR A SELECTION OF VALVE AMPLIFIERS
AND OTHER OLDER QUALITY EQUIPMENT
Valve amplifiers (combos and hi-fi) overhauled at sensible
rates. Valve and other equipment always wanted.

Mike Pointer 0903 239980

DOWN PLATFORM WORTHING STATION SUSSEX

HOPKINS HI-FI

No.1 Specialist

Best Advice - Best Prices - Naturally

- LONG ESTABLISHED
- SUPPLIES TO UNIVERSITY

38-40 FRATTON RD. Tel. 0705 822155



B & W, Bose, Dual, Kenwood, Marantz, Pioneer,,
Philips, Sony, Tannoy, Technics.

*Dem Room facilities *0% credit

*Service Department *Free installation
PIONEER REFERENCE POINT DEALER
83B High Street Gillingham (0634) 513141
117 Week Street Maidstone (0622) 661488



Jeffries

69 London Road
Brighton
0273 609431

4 Albert Parade
Green Street
Eastbourne
0323 31336

29 London Road
Portsmouth
0705 663604

Excellent Listening Facilities

LATE NIGHT - WEDNESDAY - 8pm

CLOSED MONDAYS

Specialist Hi-Fi Dealers

o v e s t u r e

Oxfordshire's Premier HiFi Store

- Linn • Naim • Arcam • Epos • Quad • JPW •
- Heybrook • Mission • Nakamichi • Meridian •
- Acoustic Energy • Denon • Cyrus • Yamaha •

3 Church Lane, Banbury, Oxon
(0295) 272158

the powerplant

BRIGHTON'S LEADING HI-FI SHOP

- Comfortable listening room
- Knowledgeable and approachable staff

66 Upper North Street, Brighton. Telephone 0273 775978
Roksan, Micromega, Musical Fidelity, Exposure, Audiolab, Onix, Epos, Rotel, Marantz, Yamaha, Nakamichi, Heybrook, Rogers, Tannoy and other fine equipment.

Cam Audio

ARCAM, CASTLE ACOUSTICS, CREEK, DENON, EPOS, EXPOSURE ELECTRONICS, JPW, MARANTZ, MICROMEGA, MISSION, MORDAUNT SHORT, NAIM AUDIO, NAKAMICHI, REGA RESEARCH

0% Interest free credit

SPECIALIST AUDIO RETAILERS (0223) 110 MILL ROAD, CAMBRIDGE 60442

MANA - CASTLE - ALCHEMIST - ALBARRY - AUDIO INNOVATIONS
AUDIO ALCHEMIST - TEAC - NAD - TRIPOD - ALPHASON - PIONEER - DENON

AUDIO GALLERY

NR PETERSFIELD HAMPSHIRE

MAIL ORDER CABINETS SPECIALLY ORDERED IN ANY SIZE VOYD & HAND PAINTED FINISHES STONE, GRANITE, MARBLE SHELVING

FOR OPENING HOURS AND APPOINTMENTS PLEASE RING ANYTIME

HOME DEM ON DEM WADIA 6, MICROMEGA CD3, TDL, SME, TEAC, VRDS 10, IMPULSE

0730 - 895194

VALVE SPECIALISTS ON A SUPERIOR LEVEL

WORTHING AUDIO

20 Treville Gate, W. Sussex. BN11 1UA
(0903) 212133

The friendly shop with the best sound systems in the South. Friendly advice • 3yr guarantees • easy parking

Open Mon-Sat 10am-6pm Lat night Wed 7.30pm

Agencies include: Arcam, Exposure, Naim Audio, Marantz, Ruark, Mordaunt-Short, AudioTechnica, Target, Tripod, Sennheiser, AR, and many more.

RADLET AUDIO

"They have a breadth of knowledge and experience in Hi-Fi that is rare."

N. Keywood, Hi-Fi World July '92.

141 Watling Street, Radlett, Herts. WD7 7NQ
0923 856497

Audio Designs

FOR THE BEST IN HI-FI KNOWLEDGEABLE FRIENDLY SERVICE

COMFORTABLE DEMONSTRATION FACILITIES

26 HIGH STREET, EAST GRINSTEAD.
Tel: 0342 314569

CHICHESTER HIGH FIDELITY

7 ST. PANCRAS, CHICHESTER, WEST SUSSEX
CLOSED ALL DAY MONDAY
Tel: (0243) 776402

Appointed stockists of: A-R Cambridge, Castle Acoustic, Creek, Dual, Goldring, Linn Products, Monitor Audio, Naim, Nakamichi, Quad, Rega, Rogers, Royd Audio, Spendor

GOSPEL MUSIC AUDIO

32A High st, Kington Hertfordshire. Tel: 0544 230254
Castle Video, 1 Spa Centre, Station Crescent, Llandrindod, Wells. Tel 0597 824020

Alphason • Allison • Revolver • Luxman • Yamaha • QED • audio Systemline • Wharfedale • Jamo • Micromega •

No appointments necessary, Home trial facilities.
Service department. Open till 5.30 + evening demonstrations.

NORTH

ASTON AUDIO HI-FI SPECIALISTS

CELESTION • YAMAHA • CREEK • MONITOR AUDIO • B & W • AIWA • AURA • MUSICAL FIDELITY • AKG • TANNOY • SENNHEISER • MARANTZ • DUAL • DENNON • QUAD • SANSUI • TECHNICS • SPENDOR • MISSION • SME • NAKAMICHI • AUDIOLAB • ROGERS • AUDIOQUEST • MORDAUNT-SHORT • MERIDIAN • DELTEC • ROKSAN • ARCAM • KEF • NAD • CYRUS •

4 WEST STREET, ALDERLEY EDGE, CHESHIRE.

TEL: 0625 582704

DISCOUNT CD & TAPE EXTENDED GUARANTEE INTEREST FREE CREDIT WRITTEN DETAILS ON REQUEST.

THE HI-FI STUDIOS

HEYBROOK, MONITOR AUDIO, ART AUDIO VALVES, DUAL, SUGDEN, ALPHASON, TDL, MICHELL, ACOUSTIC ENERGY, TEAC, A&R, AURA, ORIGIN LIVE, SYSTEMDECK, EPSILON, SHURE, AUDIO TECHNICA, GOLDRING, ALBARRY AND OTHERS FROM THE COMPANY THAT CARES FOR CUSTOMERS.

DEMONSTRATION IN OUR LISTENING ROOMS OR AT HOME

SUNNYFIELD, DONCASTER
Tel: (0302) 781387

THE SPECIALISTS

Swift hi-fi of wilmslow

ST ANNES PARADE (ON A34) WILMSLOW CHESHIRE
(0625) 526213

ARCAM • AUDIOLAB • AURA • B & W • CASTLE • DENON • CYRUS • CELESTION • KENWOOD • MARANTZ • M.F. • MISSION • NAD • PIONEER • TANNOY • ROTEL • TECHNICS • WHARFEDALE

ACTION ACOUSTICS

Products Include: Acoustic Energy, Albarry, Croft, Denon, Harman Kardon, Michell, Pink Triangle, Revox, Rogers, TDL, Thorens etc.

Demonstration and Credit Facilities available

155-157 High St., Redcar, Cleveland.
Tel: 0642 480723

EIRE

Acoustic Dimension

67 Mountjoy Street, Dublin Tel: 305633 Fax: 305839
AURA - AUDIOSTATIC - AVI - AMC - AIWA - JPW - HEYBROOK - TDL - RUARK - ALBARRY - SONOGRAPHE - PROAC - IMPULSE - ION - STRAIGHTWIRE - EAGLE - VLS - YAMAHA - ROTEL - MARANTZ - + ACCESSORIES
PART EXCHANGE - CREDIT CARDS ACCEPTED
DEMONSTRATION ROOMS.
DECEMBER/JANUARY SALE OF USED AND DEMO STOCK

EAST

The Audio File

27 HOCKERILL STREET, BISHOP'S STORTFORD, HERTS.
TEL: 0279 506576
2 FOUNDRY WALL, MARKET HILL, ST. IVES, CAMBS.
TEL: 0480 66123

BADA
THE ULTIMATE IN SOUND ADVICE

FOR QUALITY EQUIPMENT AND QUALITY SERVICE

Bury Audio

47 Churchgate Street
Bury St. Edmunds, Suffolk
Telephone 0284 724337

2 dem rooms, Home dems, free delivery / Installation

DEFINITIVE AUDIO

FOR A CAREFULLY CONSIDERED APPROACH TO BUILDING A TRUE HI-FI AUDIO SYSTEM

WADIA • AUDIO INNOVATIONS • IMPULSE • MICROMEGA • TEAC • SNELL • SME • SYSTEMDECK • GOLDRING • REVOX • VOYD • SYSTEMDECK • ORTOFON PREMIER DEALER

ALSO THE REMARKABLE LIVING VOICE AIR PARTNER LOUDSPEAKER SYSTEM AND AMPLIFICATION FROM BOROER PRINT INCLUDING THE 'BIG 9' AND THE 'TONE SCOUT'.

Please phone for further details
(0602) 813562
Mon-Sat 10-7pm. Closed Wednesday am.

MIDLANDS

CREATIVE AUDIO

9 DOGPOLE, SHREWSBURY, SHROPSHIRE
Tel: (0743) 241924
Closed Mondays

- Comfortable listening rooms
- Home demonstrations available
- Part exchange welcome
- Free home installation
- Interest Free credit

Authorised retailer for:
A & R ARCAM, AUDIOLAB, CELESTION, CYRUS, DENON, DUAL, MERIDIAN, MISSION, MONITOR AUDIO, QUAD, REVOLVER, ROKSAN, ROTEL, YAMAHA, EPOS, NAIM, KEF, RUARK

Specialist Hi-Fi Dealers



Chantry Audio
"No Ordinary Hi-Fi Dealer"

A fresh approach to the World of Specialist Hi-Fi

NEW SHOP - NEW STOCK - 3 DEM. ROOMS

Pink Triangle, Micromega, Rotel inc. Michl, N.V.A., Monitor Audio, Alchemist, Michell, S.M.E., Ortofon, d.p.a., Celestion, Ruark, SD Acoustics, Lumley, Diamond Acoustics, Ortofon, Croft, A.M.C., Aiwa, Sequence, Project, Denon, + much more. Friendly service and advice in relaxed surroundings. First time buyers to high-end enthusiasts. Easy access. Free parking.

18-18A Eldon St., Tuxford,
Near Newark, Notts NG22 0LH.

Tel: 0777-870372

Fax: 0777-870437

REPAIRS & D.I.Y.

If you like the hi-fi equipment you have but want a better performance, don't change it - **UPGRADE IT!**

You can build better than you can buy and we offer kits, parts and instructions for everything from simple component upgrades to complete rebuilds, plus kits to build high end equipment from scratch..

New upgrading service

If you are daunted at the prospect of taking the lid off your prize possession, send it to us and we can upgrade it for you. We will advise on cost and feasibility before starting work and upgrade to the level of performance you require and can afford. We have a secure, low-cost door to door collection and delivery service covering the UK and Europe plus a collection/delivery point in Manchester.

Upgrades to: Audio Research, Celestion, KEF, Kröll, Linn, Meridian, Naim, Nytech, Quad, Leak, Radford ... in fact, EVERYTHING!

SEND NOW FOR FULL DETAILS AND A COPY OF OUR NEW 1992 COMPONENTS CATALOGUE.



Russ Andrews Limited
Edge Bank House, Skelsmergh, Kendal,
Westmorland, LA8 9AS.
Telephone: 0539 83247.

Lockwood Audio

Tel: 081-207 4472

Fax: 081-207 5283

WE BUY AND SELL
NEW, USED AND VINTAGE
SPEAKERS, DRIVERS, CABINETS, PARTS.

SPEAKER REPAIRS
THE

Authorised **TANNOY** Specialist

MAJOR CREDIT CARDS WELCOME



IMPERIAL STUDIOS,
MAXWELL ROAD,



BOREHAMWOOD, HERTS. WD6 1WE



THE AUDIO SPECIALISTS

for the most exciting range of equipment available in the Midlands which includes:

Arcam, Aiwa, Alchemist, Alphason, Apollo, Arcam, Audiolab, Audioquest, Audio Innovations, Audio-Technica, Aura, Beyer, Cambridge Audio, Canon, Celestion, Chord, Cyrus, Deltec, Denon, Dual, Epos, Exposure, Heybrook, Impulse, Infinity, KEF, Luxman, Marantz, Meridian, Michell, Micromega, Misslon, B+W, Mordaunt-Short, Michaelson Audio, Monitor Audio, Monster, Musical Fidelity, Nakamichi, NVA, Panasonic, Pink Triangle, Pro-Ac, Revox, Rogers, Roksan, Rotel, Royd, Ruark, Sansui, Sennheiser, Stratwire, Systemdek, Target, Technics, Thorens, Wharfedale, Yamaha etc.

OPENING TIMES:

Tues-Thurs 10.30-6.00

Friday 10.30-8.00

Saturday 10.00-5.00

Demonstration by Appointment

351 HAGLEY ROAD, EDGBASTON,
BIRMINGHAM B17 8DL

Tel: 021-429-2811

156/7 LOWER HIGH STREET
STOURBRIDGE, WEST MIDLANDS DY8 1TS
Tel: 0384 444 184

INTEREST FREE

(for Ltd Period) APR 0%

Written details on request.

Licensed Credit Broker.

Switch card accepted



NEW IPL A2 RIBBON SPEAKER KIT
Featuring: Superb 8" TPX bass unit with cast chassis and 5" magnet, and the excellent Visaton Ribbon Tweeter.
Top quality components and terminals for hardwiring the biwired crossover and quality accessories and instructions to build a speaker to compete with the best!
A2 PLUS KIT: 504mm x 294mm x 300mm
£217 + £6.75 P&P
A2 TOTAL KIT: With sturdy H.D.F. Flatpack Cab Kit
£286 + £19.00 P&P
Alternatively, send £1.50 for 36-page Speaker Building Catalogue with details of 8 kits and accessories, and valuable advice on speaker building, upgrading and testing to: IPL ACOUSTICS, 2 LAVERTON ROAD, WESTBURY, WILTS BA 13 3RS. Tel: (0373) 823333.

Audio South

We are probably the only specialist Hi-Fi Dealers who have recorded as well as listened to live music.

0% INTEREST AVAILABLE ON MOST EQUIPMENT OVER 6 TO 9 MONTHS

Please ring for further details

Dolby Pro Logic Surround sound through your Hi-Fi will give you cinema sound in your home.

"What impressed me most was Audio South's obvious love of music, the demonstration was both a pleasure and an education; certainly well worth a visit."

Audiophile with Hi-Fi Answers October 1990

EX-DEM AND SECONDHAND EQUIPMENT AVAILABLE ON SPECIAL OFFER, RING FOR DETAILS

24 (The Woolmead) East Street, Farnham, Surrey GU9 7TT. Tel (0252) 714555

Open Monday-Saturday 11am-6pm. Closed Tuesday

Demonstrations, preferably by appointment.

Advertising your business in the Specialist Hi-Fi Dealer section of Hi-Fi World costs as little as £37.50 per month.

To find out more call Caroline Knott on:
071 289 3533
or Fax your enquiry on: 071 289 5620.

VINTAGE AND VALVE HI-FI

Haden Boardman buys, sells, modifies & repairs all vintage hi-fi equipment.

Always quality hi-fi available, new and secondhand. Advice is free, phone if just for a chat. Credit cards accepted. Quick worldwide delivery, callers by appointment. Golden Dragons available ex. stock. Sorry but we are unable to answer queries in writing.

GARRARD 301/401 IN STOCK

Audio Classics

Tel/Fax: (0942) 57525 7 days a week

Coming in our May issue!

KAL 211 FIRST EVER REVIEW!

An integrated amplifier that needed two men to lift it and is one of the biggest in the world. It also costs £12,500 and uses giant 211 valves. Hailing from Folkstone (!), we provide the first ever review.

SATELLITES AND SUBWOOFERS

Will you be propelled into orbit by the heavenly sound of a satellite, or brought down to earth by a weighty sub-woofer? Dominic Baker checks out the case for bass with five celestial combinations.

A-400 GTE AMPLIFIER

Michell designer Tom Evans tweaks Pioneer A-400 amplifiers to make them go faster. Does this upgrade break any limits? Malcolm Steward gets into the driving seat.

U.S. VINTAGE TUNERS

What did the CIA use for entertainment? What did GCHQ use for eavesdropping from Cheltenham? Reportedly, a Nems Clarke VHF tuner, with its special valves and silver-plated chassis. Hi-Fi World brings this rare animal - and other top US tuners - in from the cold.

NAD 502

NAD's new budget CD player hits the streets. The competition has got stronger and the market more fierce. Can NAD still compete? Jonathan Jordan gets to grips with MASH technology.

COMPETITION

Win a pair of Audion Silver Night monoblock valve amplifiers. Spectacular to look at, these thoroughbreds offer a superbly silky sound from a pair of 300B valves. Be one of the select few to experience the magic of the triode!

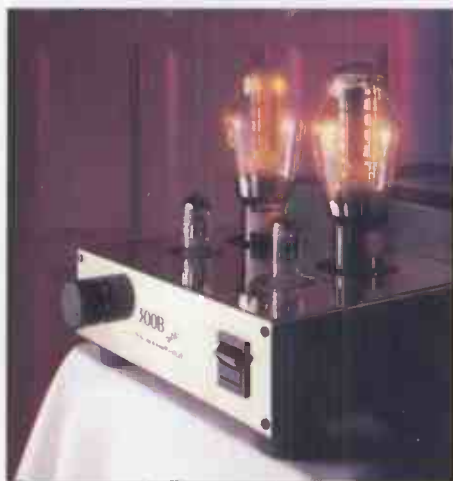

Back Issues

HI-FI WORLD BACK ISSUES ORDER FORM

Please tick the box next to the issue(s) you wish to order

<input type="checkbox"/> September 1991	£2.00
<input type="checkbox"/> October 1991 (incl. CD)	£2.80
<input type="checkbox"/> December 1991	£2.00
<input type="checkbox"/> January 1992	£2.00
<input type="checkbox"/> March 1992	£2.00
<input type="checkbox"/> June 1992	£2.00
<input type="checkbox"/> August 1992	£2.00
<input type="checkbox"/> September 1992	£2.00
<input type="checkbox"/> October 1992	£2.00
<input type="checkbox"/> November 1992	£2.00
<input type="checkbox"/> December 1992	£2.00
<input type="checkbox"/> January 1993	£2.00
<input type="checkbox"/> February 1993	£2.00
<input type="checkbox"/> March 1993	£2.00

Total no of issues ordered

Total price

We are now offering back issues of Hi-Fi World. Unfortunately, all issues prior to September 1991 are completely sold out, but subsequent issues are available for £2.00 including postage and packaging. Issues with Compact Discs (Oct.'91) are available for £2.80.

(UK only)

I enclose cheque/PO for £ made payable to **Audio Publishing Ltd.**
I wish to pay by Visa/Access, please debit my account no:

--	--	--	--	--	--	--	--	--	--	--	--	--	--	--	--

Expiry date:

Name

Address

Post Code Tel:

Please send completed order form together with your cheque/PO to:
HI-FI WORLD, 64 Castellain Road, Maida Vale, London W9 1EX.

Subscriptions

12 ISSUES FOR ONLY £22

(UK only)

Please send me the next 12 issues of Hi-Fi World, starting with the _____ issue.
I enclose my cheque/postal order for £22 (UK only) made payable to **Audio Publishing Ltd.**

Name

Address

Daytime Tel No:

Please debit my VISA/ACCESS Card No:

--	--	--	--	--	--	--	--	--	--	--	--	--	--	--	--

Expiry Date: _____ Tel: 071-266 0461

Send to: **Audio Publishing Ltd., 64 Castellain Road, Maida Vale, London W9 1EX.**

Overseas subscription rates. Surface Mail: £29.
Airmail: £42 (Europe & Middle East), £52 (USA, Canada & Far East), £62 (Australia & Japan).

Airmail Surface Mail (tick as appropriate)



E&OE

Remember the best hi-fi equipment is only available from the best hi-fi shops

Our job is to give you the best possible sound; so we choose the best sounding equipment. You won't get better performance and value anywhere else. Our hi-fi is well built, with a long life and an easy path to further upgrades, if required.

Our shops are staffed by music enthusiasts; we'll make you welcome and give you the experience of hearing what the best hi-fi can do, in comfortable listening rooms. Only you can decide how good a sound you need and we make the choosing easy.

You will find us here:

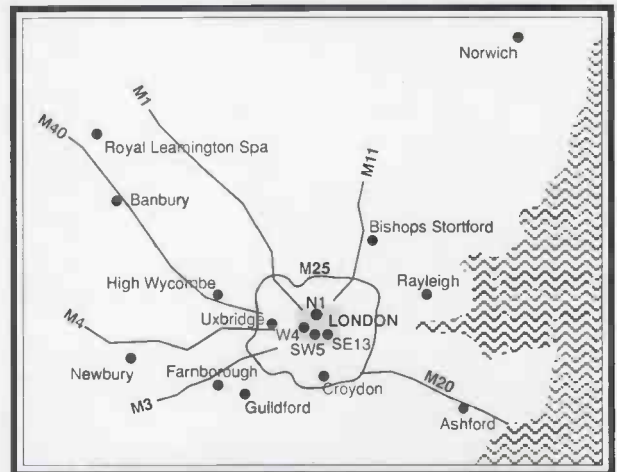

Choose the one that's nearest

Ashford
Soundcraft Hi-Fi
40 High Street
0233 624441

Banbury
Overture
3 Church Lane
0295 272158

Bishops Stortford
The Audio File
27 Hockerill Street
0279 506576

Croydon
Spaldings
352/4 Lower
Addiscombe Rd.
081-654 1231

Farnborough
Farnborough Hi-Fi
7 Queensmead
0252 520146

Guildford
PJ Hi-Fi
3 Bridge Street
0483 504801

High Wycombe
Sound Gallery
65 Castle Street
0494 531682

Leamington Spa
Hi-Fi Experience
44 Park Street
0926 881500

London N1
Grahams Hi-Fi
190A New North Rd.
071-226 5500

London SE13
Billy Vee
248 Lee High Road
081-318 5755

London SW5
The Listening Rooms
161 Old Brompton Rd.
071-244 7750

London W4
Uxbridge Audio
109 Chiswick High Rd.
081-742 3444

Newbury
Newbury Audio
2 Weavers Walk
Northbrook Street
0635 33929

Norwich
Basically Sound
Old School
Bacon Ash
0508 70829

Uxbridge
Uxbridge Audio
278 High Street
0895 230404

These retailers are the selected Linn dealers in the South-East

You can sit back and relax, secure in the knowledge that we will provide the most vital part of any hi-fi system: the detailed preparation and careful installation that is needed to achieve the best sound in your home; we can also connect your TV or video to the hi-fi so that you and your family get maximum benefit. Not to mention comprehensive back-up long after your initial purchase. Customer service has built our business and reputation, so you can be sure that we will look after you.

Choose your Dealer, come & listen Take the risk out of buying hi-fi

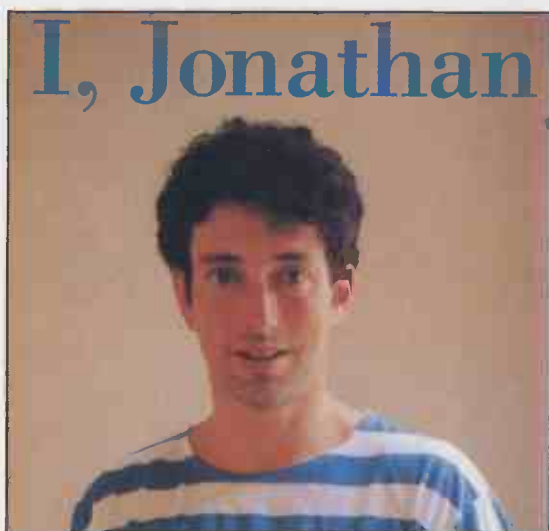
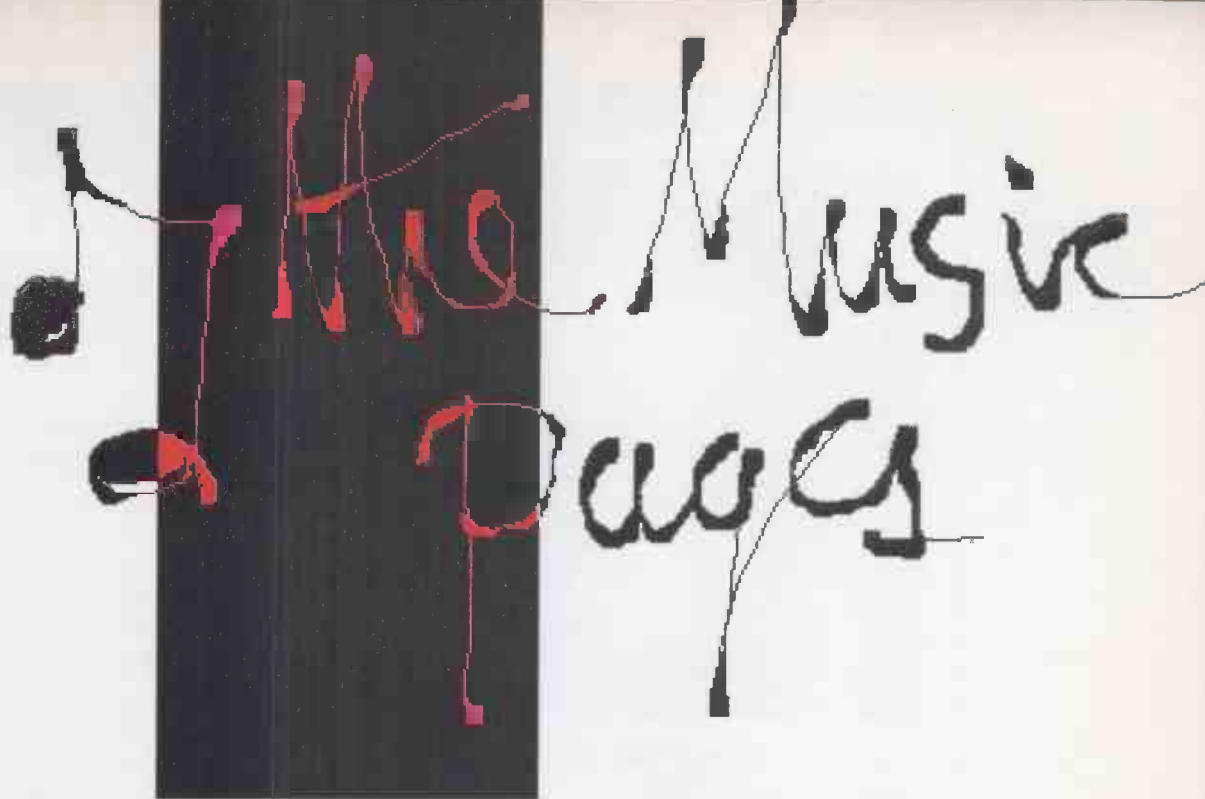

the world were they making that sound?' He then answers the question he's just posed with several delightfully morose bars that could have been pulled straight off The Velvet's Live At Max's, Kansas City album. Hear him wail - just like Lou - when he talks of Sally who's 'licking off her pusher's hand' while he is preoccupied with 'looking for my mainline.' A sublimely perverse thought that - the image of

innocent Richman, sporting his Ivy League haircut, searching for a vein while clutching his spike. The song is swimming in pastiche, but it's obvious that there's no disrespect intended: Richman's psyche is merely dominated by his sense of humour and the ridiculous.

The track that follows is another of the CD's high spots. On 'I Was Dancing In The Lesbian Bar', you'd swear that you were listening to '2-4-6-8 Motorway' era Tom Robinson. But what appeals to me most about this album, apart from the music and the way that Richman's personality emerges so strongly, is its purity. This isn't one of those clinical, antiseptic, rehearsed-until-it's-stopped-breathing kind of records. You sit listening to it and there's nothing between you and the garage in which it was recorded. I can't get enough records like this; they represent what music is supposed to be - spontaneous, a bit rough around the edges, but human and fun. MS

This month Malcolm Steward is pleased to see another hole punched in music's equivalent of the Berlin wall. . . while Giovanni Dadomo finds truth and beauty.

INDEX

RECORD REVIEWS

ROCK & POP75

Malcolm Steward and

Giovanni Dadomo

JAZZ80

Simon Hopkins

Martin Rae

CLASSICAL83

Peter Herring

RECORD MAIL ORDER

.....89

JONATHAN RICHMAN I, Jonathan ROUNDER ROUNDER CD 9036

● Jonathan Richman, singer, songwriter and guitarist, is a cult hero of mine. I wish I could describe him without having to use the word cult because the term unfortunately signifies someone who has a peculiar talent that far too few people have recognised.

In Richman's case his talent derives from the way he looks at things, his ability to approach a subject with an extraordinarily perceptive interest and an inquisitiveness that's outwardly very child-like.

A fine example of this is his appropriately naive homage to the Velvet Underground on the eponymous fourth track of this CD. A more quasi-intellectual paean might have delved into the arty sub-culture and drug ethic that spawned the band, but all Jonathan wants to know is 'how in

RECORD OF THE MONTH

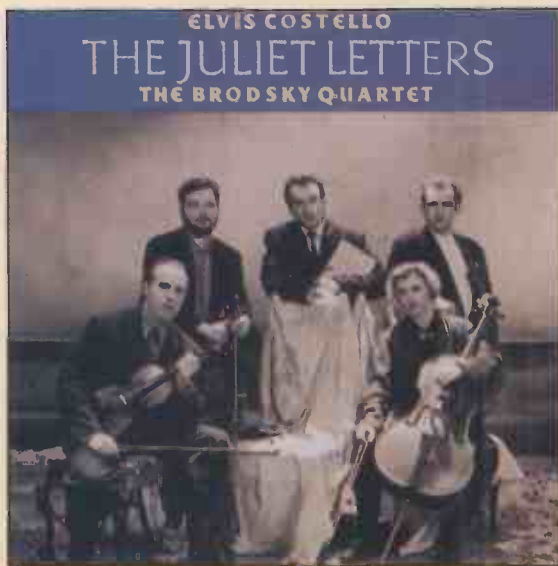

ELVIS COSTELLO & THE BRODSKY QUARTET
The Juliet Letters

WARNER BROS

9362-45180-2

● The signs indicate that the barriers that exist to demarcate musical genres are being broken down. While that will doubtless annoy the categorisers, pigeonholers and elitists, I welcome any blurring of the distinctions between "different" styles of music. It surprised and delighted me when I discovered, for example, that the Rex Foundation, which supports the music of many British classical composers, both dead and alive, whose music would otherwise remain unheard, was founded and is administered by the Grateful Dead! The Dead's bass player, Phil Lesh, seems to be doing more to promote the music of composers like Havergal Brian and young emerging writers than the Arts Council or any other "proper" establishment body. Classical snobs take note that many new symphonic and other recordings that you might hear in coming months wouldn't have found their way onto CD was it not for the philanthropic efforts of a band of West Coast, long haired acid casualties!

distinctions between genres and making folks realise that there are only two kinds of music - good music and bad music - is more overt. His collaboration with the Brodsky Quartet - lauded for its readings of the string quartets of Beethoven and Shostakovich among others - arose from mutual respect. At one time Costello was arranging his schedules so that he could catch their recitals of Shostakovich's cycle of quartets,



unaware that the Brodskys were doing the same to attend his concerts.

The Juliet Letters takes as its theme replies to letters written to Shakespeare's most famous character. The songs revolve entirely around the Quartet's playing and Costello's voice, two

The Dead's involvement in the Rex Foundation's work isn't widely publicised; it's a low-key operation and not designed to bring them acclaim. (They hardly need it - they still gross more money from touring than any other band.) Elvis Costello's contribution to blurring the

elements that often fuse quite magnificently. Costello is keen to point out that this is not his attempt at "going classical" nor does it represent a token stab at rock by the Brodskys. And it certainly is not "cross over" or fusion music, simply an exploration of what can emerge when voice, violins, viola and cello combine.

The results are intriguing and, if you approach the music with an open mind, immensely rewarding. If you're looking for "Oliver's Army" with violins, forget it. The same goes if you expect EC to be on some kind of Pavarotti trip. This isn't glorified punk and it's not watered down "serious" music. It's an experiment and one that, thankfully, doesn't blow up in anyone's face.

I'll admit having a real liking for Costello's voice and a great deal of respect for his compositions but that doesn't make me any less critical; while others were raving about "Spike", for example, my copy sat gathering dust while I played "My Aim is true" and wondered what all the fuss was about. No such reaction has occurred with this disc. The Brodsky's playing is lyrical and touching: EC's singing is

impassioned but free from the dubious - if delightful at the time - invective that characterised much of his earlier work. When these forces combine the result is music that's mature, thoughtful and frequently entrancing.

Costello and the Brodskys might at first appear to be disparate bedfellows whose work and approaches couldn't be united with any degree of success, like a mix of oil and water. However, the music this unusual quintet produces powerfully suggests otherwise. The members speak the

same language but in different registers and with different dialects, that's all. Their corporate voice is, nonetheless, quite beguiling, alarmingly genuine and honest.

This ain't no crossover; This ain't no classical-punk miscarriage; this is real music that's actually going somewhere.

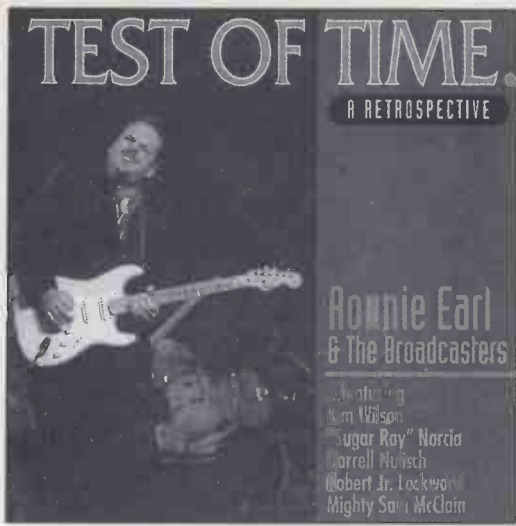

RONNIE EARL AND THE BROADCASTERS
Test of Time - A Retrospect
 BLACK TOP CD BT 1082

● The material that makes up Test of Time has been drawn from the past decade of guitarist Ronnie Earl's career, cuts being taken from the albums Smokin', They Call Me Mr Earl; Soul Searching; Peace Of Mind; Hubert Sumin's Blues Party and Surrounded By Love.

The band line-up featured on each album changes and some interesting players contribute to this disc's eighteen song roster. These include such luminaries as Sugar Ray Norcia, Duke Robillard, Ron Levy, and Kaz Kazanoff. What remains consistent throughout, however, is the music, which is mostly hardcore R'n'B that definitely originated from a smokey roadhouse on the wrong side of the tracks.

There's a generous helping of up-tempo Stratocaster grind here but there are also interesting interludes to provide the necessary touch of contrast; flat-out boogie is fine when you're out clubbing with a beer in your hand but it doesn't have the same appeal as an accompaniment to sober Sunday morning breakfast.

Earl shows that he is not a one-dimensional player by adopting a more soulful groove for tracks like 'Soul Searching' and 'Ships Passing in The Night' while he allows strong Swing and Jazz influences to emerge on 'Off The Hook' and 'Akos'.

However, this album took a while to win me over, mainly because its first four tracks taken from the album Smokin' sound rather flat and lifeless. The first time I played it I came close to consigning it to the not-worth-bothering-with pile, but it was pulled back from the brink by the more promising-sounding kick drum and cymbal motif that opens Track Five 'You Give Me Nothing But The Blues'. Thereafter the sound displays the sort of vitality and animation that this kind of music deserves. MS

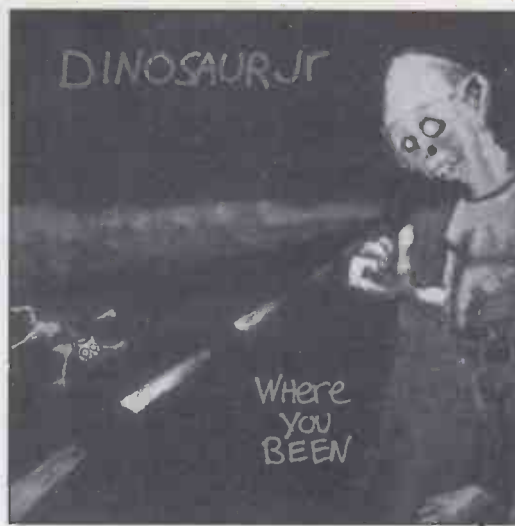

DINOSAUR JUNIOR
Where You Been
 BLANCO Y NEGRO 4509 91627-2

● J. Mascis is a great, demented guitar player of the new school, witness only the opening cut on this latest Dinosaur Jr opus, 'Out There'. On the other hand, he's also one of the very worst singers ever to hit vinyl - this guy makes latterday Lou Reed sound positively positively tuneful. No joke, Where You Been contains some of the most appalling falsetto it's ever been my misfortune to hear. But then, like Reed, Mascis has a unique non-vocal style which, at its best (the muddy thrashings of 'On The Way', say) is as appealing and convincing as any in Rock.

Dinosaur Jr have, for this listener anyway, the sort of snot-nosed, street-wise punk appeal that Iggy and The Stooges had all those years ago. And when Mascis (who writes, produces and plays most of the instruments here, has the good sense to get a decent singer to take care of the falsetto - as Tiffany Anders does on 'Get Me' - then this can result in near-perfect Rock and Roll, '93 style.

There are one or two surprises too, from these erstwhile thrash-and-grunge-meisters. 'Not The Same', with its gently melodic start and light vocals reminiscent of Love's Bryan McLean on 'Forever Changes' is all mellow acoustic guitar and (synthesised?) strings very reminiscent of the aforementioned Sixties classic combo. The more familiar Mascis drawl is at its best on 'Hide' - "I walk over and we smile and all the rest", Mascis intones with all the don't care laissez faire of a transplanted Peter Perret. there's more acoustic chiming on

'Going Home' with its Stones-ey (circa 'Miss You') back-up vox and warm keyboards (more echoes of Love) whilst diehards are well catered for by more traditional Dinosaur antics such as 'Drawerings', with its sinuously sexy guitarings, or the so hot it's luminous soloing on the closing 'I Ain't Saying'.

Where You Been is the sound of a band being brave, stretching out and, for the most part, making it. It's what we in the trade call 'a grower'. Let it grow on you, babe. GD



THE WEDDING PRESENT
hit parade 2
 RCA 74321 12775 2

● Leeds' finest, The Wedding Present, did a brave thing in '92: they came up with the fairly novel idea (mooted, but not to my knowledge ever put into action by the likes of The Smiths and Who yonks past) of releasing a single a month for an entire year. The first half of this enterprise was released as hit parade 1 and this, as they say, is Part Two. Even better, there's a free CD consisting of Radio 1 sessions featuring the first half-dozen songs, so you get the lot for the price of one. Yippee!

Rock
 rock & pop record reviews

Specialist Hi-Fi Dealers

A limited number of
EX-DEMONSTRATION

players are now available through your local
Micromega dealer.

Example prices:

Logic £349.99
Leader £499.99
Solo £899.99

please contact:

The Musical Design Company

Tel/Fax: 081 989 0692

We will then arrange your purchase through
your nearest official Micromega dealer.

All units are ex-demonstration in as-new
condition with full manufacturers' warranty.



MICROMEGA

READERS!

Do you want to sell your second-hand goods, or are you looking for that special bargain?

Advertise in the cheaper and bigger Readers Classifieds section in Hi-Fi World.

SPECIAL OFFER!

Now you can advertise in the Classified section for only **£10 (incl. VAT)**.

Maximum length is thirty words; each additional word 50p extra.

NEW!
Display ads -
2cm box,
£15 (incl. VAT)

Book your ad. for two consecutive months - we'll give you the second month's insertion free!

(This offer does not apply to Trade Advertisers.)

the powerplant

BRIGHTON'S LEADING HI-FI SHOP

■ Comfortable listening room

■ Knowledgeable and approachable staff

66 Upper North Street, Brighton. Telephone 0273 775978

Roksan, Micromega, Musical Fidelity, Exposure, Audiolab, Onix, Epos, Rotel, Marantz, Yamaha, Nakamichi, Heybrook, Rogers, Tannoy and other fine equipment.

HI-FI WORLD SPECIALIST DEALER DIRECTORY ORDER

BOOK 12 MONTHS FOR A 30% DISCOUNT!! OR 6 MONTHS FOR A 20% DISCOUNT.

I wish to be included in Hi-Fi World's Specialist Dealer Directory starting with the _____ issue For a total of _____ insertions

Please find enclosed my artwork/copy details. I wish to book _____ column centimetres at £12.50 per col. cm.

Name _____

Company _____

Address _____

Postcode _____ Telephone No. _____

Please return to: **Caroline Knott, Hi-Fi World, 64 Castellain Road LONDON W9 1EX**

The opening 'Flying Saucer', all thundering guitars and drums, shows The Wedding Presents' strengths and weaknesses all at once - the aforementioned apocalyptic playing is all very fine and as good as can be, but that just makes a weak vocal seem all the weedier. As flying saucer songs go, this isn't a patch on the Fifties' classic 'Flying Saucers Rock 'n' Roll' or John Fogarty's Credence Clearwater Revival 'It Came Out Of The Sky', but it's saved by a stonking arrangement and sturdy performance instrumental-wise. The strongly Velvet Underground-influenced 'Boing!' is a great title in search of a song to go with it. Give me the lava guitars and Vesuvius drums of 'Love Slave' any day, with its suitably langorous vocals declaring "Every single kiss is just like the first". Echoes of the Velvets recur on 'Sticky'; this is a re-run of 'White Light, White Heat' and all it really proves is the original's still the greatest. Still, the requisite clanging guitars and deep-down subdued vocals are done with extreme polish, give 'em that much. 'Queen of Outer Space' is all mild verses and frenzied choruses (touch of the early Stranglers, maybe?) and full marks for being familiar with the psychotronic movie classic with Zsa-Zsa Gabor. 'No Christmas' is a rather nondescript wail, but the guitar blitzkrieg that is 'Rocket' could teach Manic Street Preachers a bit about Rock 'n' Roll essentials.

There's also a trio of cover versions: you can't go wrong with Ike Hayes' wah-wah extravaganza 'Theme From Shaft' if you're a guitar band and the Weds do it plenty big justice. I'm not sure about Bowie's 'Chant Of The Ever-Circling Skeletal Family', a weakling in the first place and stronger here than on the original, but really lads, why bother? Even more ditto for Bow Wow Wow's 'Go Wild In The Country'. They were such an original sound that it's really pointless going back unless you do something drastically different - and sadly, Wedding Present don't.

Overall, it's ironic but true that even in the Radio versions the earlier material ('Blue Eyes', 'Silver Shorts' etc.) is rather more sturdily consistent than the latter selection. But then, that's the problem with such an ambitious project. What happens if you start to lose steam half-way through? Still, a solid, value-for-money selection all told. GD

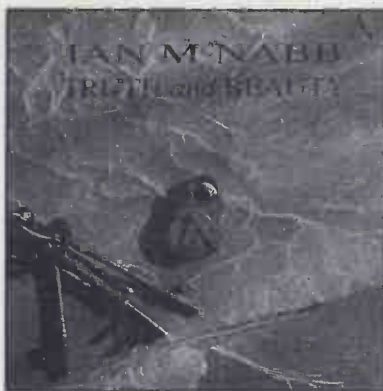

IAN MCNABB
Truth and Beauty
QUICKSILVER 574 378 2

● Ian McNabb was founder/main man of Liverpool's Icicle Works, a band which, for one reason or another, your reviewer never really got to grips with. He's since made a couple of very well-received 45s, both songs featured on this extremely likeable debut solo LP. From the opening '(I Go) My Own Way', with its glorious multi-voiced chorus and touch of Arabia, this is a strong, distinctive debut, with nods to, among others, classic Beatles and even The Hollies. Lyrically, McNabb can be a tad twee - see 'These Are The Days' - but his chiming telecaster (thanks, Mick) tends to save the day. 'Make Love To You' is unsurprisingly) a sensual mid-tempo item with more chiming guitars and hard-on vocals. Plus, it has a rocking middle eight worthy of Townshend at his best and some rather neat, squidgy organ. By contrast 'Presence Of The One' is a gentle - religious? - ballad featuring delicate guitar and the warmest synth. There's also a bril Beach Boys tribute in the first half of 'Truth And Beauty' (the title track) which manages to meander off into something completely different (love the Gorge Harrison-style guitar) mid-way, prior to returning majestically to its principle motif. There are one or two clinkers - the bland-ish balladeering of 'Trip With Me' for one - but in the main this is a likeable, imaginative outing with its fair share of pleasant surprises. GD



BARE NAKED LADIES
Gordon
SIRE/REPRISE 7599 26956-2

● This is a Canadian quintet named Andy, Steven, Tyler, Jim and Ed and they're absolutely brilliant! They're somewhat eccentric and very funny and no-one who enjoys the likes of King Missile or Violent Femmes will want to miss this delightful album. Take 'Enid', a warm harmonised love song with lines like this: "It took me a year to believe it was over/It took me two more to get over the loss/Woah oh woah . . . and every time I remember/ The taste of your lip gloss". And 'Grade Nine' is a great schooldays memoir as good as any Chuck Berry or The Coasters ever cut. An American Madness? Or, if you remember them, Kursaal Flyers? I think that's what we have here. Bare Naked Ladies - and who doesn't like them? - are, as the name suggests, one of the great novelty bands. There are fifteen cuts here, and nary a stinker among 'em, from the wryly tongue-in-cheek ballad of 'Brian Wilson' to the cynical music-biz talk of 'Box Set', the satirical 'If I Had \$1,000,000' to the wry 'Be My Yoko Ono' . . . This is a splendid, highly entertaining debut and anyone with a sense of the absurd would be a fool not to check it out. Can't wait to see them do it live. GD

Rock & Pop



Simon Hopkins

Jazz

**If the avant-garde
adopts Debussy,
Charles Ives, Aaron
Copland and even Bob
Dylan, is it still Jazz?
And what kind? Read
on . . .**

**NAKED CITY
Grand Guignol
AVANT AVANCD 002**

● It's not entirely inconceivable that too much John Zorn gets reviewed in this column, but that's pretty much a reflection of how much material the New York altoist, composer, collagist and all-round iconoclast (yeuch) has been responsible for of late. And now: Grand Guignol, second outing on his very own label Avant, from his very own 'supergroup' (and again, yeuch) Naked City. A quick reminder for those napping in the back row: Bill Frisell, guitar; Fred Frith, bass; Joey Baron, drums; Wayne Horvitz, keyboards; and Yamatsuka Eye - once a guest, now, it would seem, a permanent member - on vocals.

The album follows hot on the heels of its Avant predecessor Heretic (NC's only genuinely free jazz offering, Zorn's Gothic Rock chamber piece 'Elegy' (Wave Records), and the immensely difficult-to-locate, macabre tone poem 'Leng T'che' (Toys Factory), all appropriately swooned over here. Grand Guignol, of course, sets off in other directions altogether, consisting of the title track (a single through-composed piece) and Zorn's arrangements for NC of pieces by Debussy, Alexander Scriabin, Orlando Di Lasso, Charles Ives and the recently deceased great French composer Olivier Messiaen. On to the end of this little lot is tagged the thirty-three devastating vignettes that made up 1991's *Torture Garden*, previously available as either an expensive Jap import or on vinyl only from Nottingham's hardcore and thrash loonies Earache.

So, a piece-by-piece breakdown. The title track is without doubt the centre-piece here, recalling 'Elegy' in its form, a seventeen-odd minute single composition, and his collage pieces (check out the stupendous Ennio Morricone tribute 'The Big Gundown' or the title track from his

Spillane album) in its head-on-collisionist tendencies. Beyond that, any point of comparison starts to be with another artform altogether: film.

Zorn's always shown an obsession with the cinema. The Morricone tribute aside, his work is peppered with covers of work by film composers like John Barry and Henry Mancini. (Which is applauded here: any serious look at Twentieth Century music which neglects to talk about the work of such score writers as Eric Korngold or Bernard Herrmann is as worthless as a film history that overlooks Japanese monster movies or James Bond or porn; sadly, there are plenty of examples of both.) It's no accident that Zorn namechecks Goddard and Scorsese alongside his fave groups like The Boredomes and SPK in his obligatory sleeve note thank-yous.

Grand Guignol is essentially a soundtrack to a non-existent film about the nature of horror and, indeed, the horror of nature. As Zorn points out in the eloquent programme notes accompanying this exquisitely designed, if visually nauseating CD booklet, Grand Guignol goes way beyond an obscure French theatrical style: it's a state of being. He's right of course; any child that doesn't learn monster stories will probably never control the infinitely more real beasts that rage inside him as an adult.

And so this piece moves through a series of sound pictures of torture, trauma and terror: an astonishing piece of music, a splatter movie soundtrack quite beyond genre, certainly beyond any conservative definition of Jazz, but indisputably pushing that genre forward.

And the polar opposite of Zorn's Classical arrangements. As these visions of (at the very least) purgatory have barely faded, we're confronted with Zorn's exquisite arrangements of music which is all implicitly heavenly, and almost certainly all Christian, (explicitly so in the case of the Catholic Messiaen's 'Louange a L'Eternite De Jesus'). All these pieces are shot through with a crystalline brilliance that owes now small gratitude to Frisell's immaculate guitar playing and Horvitz' synthesizer chording.

If Zorn stands directly in a line of American maverick composers that goes right back to Ives, if his obsession with terror echoes Messiaen's struggle to assimilate the realities of the holocaust into his own work, and even if the mad Russian Scriabin's predilection for eclecticism and (very early) thoughts about multi-media events makes him an obvious hero for Zorn, it's nonetheless the Debussy piece ('La Cathedrale Engloutie') which stands out. The English music critic and historian Paul Griffiths

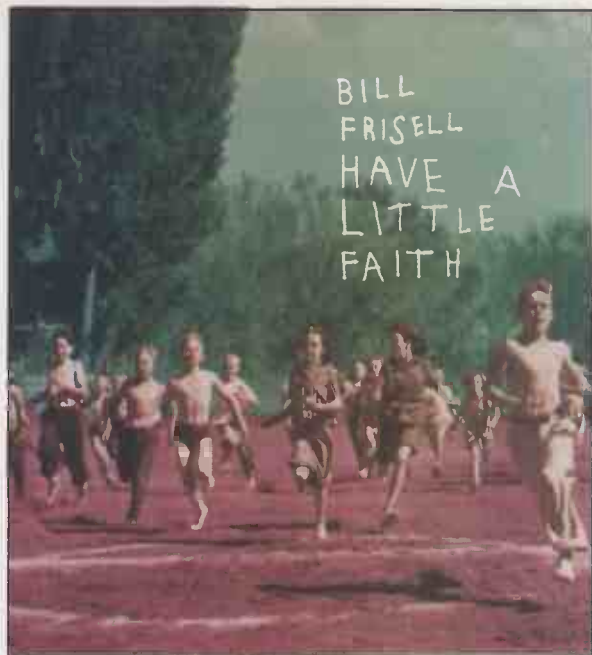

BILL FRISELL
Have a Little Faith
 ELEKTRA NONESUCH 7559 79301-2

● When Nonesuch released *Naked City*'s first, eponymous album, they sent out a promotional CD to the American media entitled 'The John Zorn Radio Hour'. On it the composer talks his way through some of his favourite records, some Napalm Death, some Mauricio Kagel, some Pharaoh Sanders and generally gives us his thoughts on the world. One of his observations is that audiences in general, and critics in particular, had utterly misunderstood NC's raison d'être: they responded as though the band's, say, cover of the James Bond theme, or their gleeful eliding of surf guitar and Free Jazz were some sort of ironic parody. Which couldn't be further from the truth, of course. Zorn unashamedly admits that all the band do is play some different music with as much love as possible.

On his fourth Nonesuch album, the band's guitarist Bill Frisell does pretty much the same thing, turning in a long set of twelve arrangements of work by American composers and musicians as diverse as Aaron Copland, Sonny Rollins, Bob Dylan and Stephen Foster. It's not a unique project, but of all the musicians on the European scene (Jan Garbarek, Paul Motian, Arild Andersen) he quickly landed himself a contract with the German ECM label and over the course of three albums for them and - now -

four for Nonesuch, he's demonstrated a facility for melding American musics - Bebop, Blues, Free Jazz, Country, Gospel, Pop - not with the collagist zeal of his chum Zorn, but unassumingly building up a catalogue of work that has made an album like *Have A Little Faith* seem inevitable.

Frisell worked with a regular rhythm section since 1987's

ECM swansong *Lookout For Hope*: bassist Kermit Driscoll and fellow *Naked City*-er, drummer Joey Baron, for my money the most exciting drummer around, a whirlwind collision of Han Bennink, Jim Keltner and John Bonham. The extraordinary cellist and singer Hank Roberts has departed, and Bill, Kermit and Joey have been

primarily to the electric, which sounds wonderful alongside the clarinet. I wouldn't be the first to suggest that his entire electric guitar career, one spent endlessly fiddling around and experimenting with guitar loops, fuzz boxes, and above all else, the volume pedal, has been one long attempt to recreate the sound of his first love.

The band also recreate two moments from the 'St. Gaudens' section of Ives' haunting 'Three Faces In New England' and it sounds as sinister as anything on Grand Guignol. They rip up Muddy Waters' 'I Can't Be Satisfied'; marinate 'When I Fall In Love' in rich dissonances; turn in the sort of post-Bop that Baron can hammer the heck out of like no other on Sonny Rollins' 'No Moe'; treat fine Country-Rock songwriter John Hiatt's 'Have A Little Faith In Me' with all the appropriate tenderness; and tear electric guitar slashes through Sousa's romping 'Washington Post March'. But the best moment?

Halfway through a charming rendition of Madonna's ballad 'Live To Tell', Frisell lets rip with some searing distortion and, for pretty much the only time on the whole record, the band mutate into the sort of nasty, gloomy, aggressive electric Jazz outfit that characterised the finest cut from

albums like *Lookout for Hope* and the debut for Nonesuch, *Before We Were Born*. And that's my only caveat really; beyond all his free-wheeling eclecticism and commendable determination to steer clear of anything vaguely resembling muso-tosh, Frisell can be an incredible guitarist, certainly one of the Eighties' most extreme. But fans of that side of the man will have to wait for another album; let's hope that their wait's worthwhile.



BILL FRISELL (STANDING) with GUY KLUCEVSEK, JOEY BARON, KERMIT DRISCOLL, DON BYRON

joined by clarinetist Don Byron (to whose excellent 'Tuskagee experiment' Frisell contributed last year) and accordionist Guy Klucevsek.

The centrepiece of the album is the opener, a sparkling arrangement of Copland's great cowboy ballet score *Billy The Kid* that doesn't look down from its yearning opening 'The Open Prairie'. It's plain from here on that the instrumental combination works perfectly. Although Frisell turns in some work on the acoustic guitar and even some banjo, he sticks



Since the Fifties Ronnie Scott's in London's Frith Street in the heart of Soho has played host to innumerable bands, a roster of almost every conceivable name. One of the important names, however, no-one really knows. It's Chris Lewis, who, in a tiny studio on the other side of the wall, engineers recordings of many of the live sessions. The hallmark is simplicity - what you hear is what you get. Martin Rae pays the entrance fee to two recent recordings on the club's own label: Ronnie Scott's Jazz House.

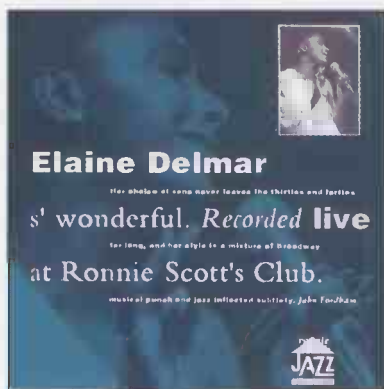

ELAINE DELMAR
S'Wonderful
RONNIE SCOTT'S JAZZ HOUSE
JHCD 027

● Elaine Delmar comes of a good pedigree. She's the daughter of Leslie 'Jive' Hutchinson, one of the luminaries of the pre-war London jazz scene, who's still spoken of with some awe by those who heard him - and there are plenty of collectors of 78s around who seek out the discs he figures on. It's the pre-war era that Delmar has adopted; the classic song-writers of the Twenties and Thirties must have permeated the air in that household. The songs she picked for this set, recorded live at Ronnie Scott's in January '92 are what you'd expect with that background: Ellington, Gershwin, Cole Porter, Jerome Kern. All are sung fairly straight - with one exception, of which more later - with the understated and cleverly subtle backing of Brian Dee on piano, Duncan Lamont, tenor sax and flute, Mario Castronari on bass and Bobby Worth on drums.

There are no fireworks in this seventy-odd minute concert, but just good renderings; the trouble with songs like 'The Touch Of Your Lips' or 'They Can't Take That Away From Me' is that we've all had a long exposure to them and Elaine Delmar ain't no Ella. But then, who is? Listen to 'S'Wonderful' or 'There's A Small Hotel' and almost anyone could name half-a-dozen more striking renditions, darker-hued voices and

more emotional depth, but that's the risk of this kind of programme. Sometimes, for example, Delmar's theatrical background betrays her into a misbegotten intonation or flourish; when she sings "Who will sample my supply. . ." in 'Love for Sale' her tone suggests a street-corner crack dealer more than anything else, but she recovers from this hint of waywardness quickly enough to be forgiven the lapse.

Looking back, all this sounds maybe over-critical. This is a cabaret album, in essence, and listened to from that point of view it's extremely enjoyable. Of all the seventeen tracks, there's really only one I'd avoid and several - especially the perky Niewood/Buffa 'Joy' - I'd be quite happy to put on to perk myself up after a heavy spell of nine-to-five. The one to avoid? It's the exception I mentioned earlier. O.K., there's not a lot you can do to 'interpret' 'Ol Man River', but taking it up-tempo - and as fast as it is here - pushes credibility. But then, I wore out my 78 of Paul Robeson years ago. Maybe I'll take it in my stride the third time.

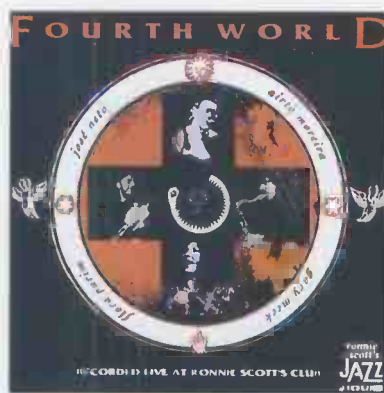

FOURTH WORLD
Fourth World
RONNIE SCOTT'S JAZZ HOUSE
JHCD 026

● A briefer mention here than this deserves. As you'll gather from elsewhere in this issue Brazilian percussionist Airto Moreira (so EB tells me) is more than happy with his new Fourth World line-up. Particularly - and very obviously listening to this live session recorded at Ronnie Scott's last year - he gets on blazingly well with multi-instrumentalist Gary Meek. There is nothing that Moreira can't make a striking (sorry!), beautiful, often downright amazing percussive sound out of. At Ronnie Scott's, the band was in full free-form flow, with Meek's saxes (all

three), flute, synths and vocoder dipping in and out, sometimes driving, sometimes weaving halos of expansive sound in perfect relationship to Moreira's almost shaman-like command of his universe of sound.

Jose Neto, too, on electric guitar, is superbly complementary. Hearing a band like this, you wonder how on earth anyone can be so crass as to put together nothing but squealing samples. Vocalist Flora Purim couldn't be sampled! This is a lengthy session - good value at just over an hour and a quarter - and while it doesn't pale it needs a little dedication to cope. Fourth World was so named "because it describes the uniting of man and nature in complete harmony" says Moreira; and the eight pieces on this disc are a swirling maelstrom of near-natural sounds. It's like being bombarded among the primal forces of nature; maybe if whales made jazz, this is what they would sound like.

I've not been too keen on some of Moreira's earlier outings - somehow they've seemed too precious, even pretentious, striving for a philosophy instead of letting the music run. This is different - more structured, more together, much less liable to the spells of musical lecturing that I felt have sometimes marred his pieces. It's not for everyone's taste: some are going to dismiss it as a musical mash-up, a kind of Radiophonic Workshop amalgam for some earnest 'World in Crisis' documentary. But please take my word that Fourth World, for all Moreira's avowed (and unashamed) holistic philosophy and belief in faith healing, is a band worth getting to grips with. If nothing else, it's worth it for the awesome range of sounds Moreira conjures up like a spirit possessed. He - and the band - were well on form in Soho last year, and on this evidence the forthcoming studio album should be quite something. But as an introduction, try this.

[We hope to have the Fourth World album recorded in Soho - see the feature in this issue - for review next month. EB]

jazz

Classica



FRANZ LISZT
**Hungarian Rhapsody No2/
Fest-Polonaise/The Entrance
of the Guests to the
Wartburg (from Wagner's
Tannhauser) Benediction
and Sermon (from Berlioz's
Benvenuto Cellini)/March
and Cavatina (from
Donizetti's Lucia di
Lammermoor)/Fantasy and
Fugue on the chorale 'Ad
nos, ad salutarem undam'
(from Meyerbeer's Le
Prophete)**

David Bradshaw and Cosmo Buono,
pianos

ALBANY TROY039 (DDD/64.15)

● Liszt was not the first to transcribe others' orchestral and vocal music for the piano, but he was by far the best at it, and the most prolific. All the performances here are claimed as premiere recordings, on the strength that they are the two-piano transcriptions of the pieces involved. The Hungarian Rhapsody No2 will probably be the most familiar, if not in its orchestral guise, then in that for piano solo. Liszt made the piano-duo version in 1874, nearly thirty years after the original composition; on the evidence of this performance, it was a worthwhile exercise. Messrs Bradshaw and Buono indulge the keyboard fireworks of this old war-horse to the full and with considerable panache.

The Fest-Polonaise was Liszt's only original composition among his 107 works for two pianos and piano four hands. It's a splendidly celebratory piece, full of pomp and passion. Liszt explored the technical possibilities of the piano as no-one before him; virtuosity is hardly an adequate description. The glittering torrents of notes may at times be in

questionable taste but the skill with which these transcriptions are made compels admiration.

The Wagner, Berlioz and Donizetti transcriptions here are all remarkable in their way, but it is the magnificent Fantasy and Fugue on the chorale from Meyerbeer that steals the show. The development here is quite extraordinary, combining music of both brilliance and beauty and building to a stunning climax. David Bradshaw and Cosmo Buono are undaunted by the demonic fugue that Liszt constructs and produce a winning performance.

There is much to enjoy here, and the pianos are recorded with lustre, clarity and fullness of tone. I'd have to say, though, that an hour's sitting at this feast of Liszt proved just a bit indigestible. PH



ROBERT SCHUMANN
**Piano Concerto in A minor
Op4**

FREDERIC CHOPIN
**Piano Concerto No2 in F
minor Op21**

Louis Lortie, piano; The Philharmonia;
conductor, Neeme Jarvi
CHANDOS CHAN9061 (DDD/62.21)

● You tend to forget just what a fine piece of music the Schumann concerto is, so much a part of the staple repertoire has it become. Yet, listening to this performance, I was reminded just how original it is in many ways, not least in its thematic development. And, like so much of Schumann's music, it has such an invigorating, open-air quality to it, mostly quite at odds with the depressive character of its composer. However, at the time of the composition of the Piano Concerto, Schumann must have been in an agreeable frame of mind: he

**Pianism takes pride of
place this month, in the
form of transcriptions by
Liszt, concertos by
Schumann and solo piano
pieces from Ravel.**

Peter Herring
&
Eric Braithwaite

was thirty-four, and in love with a certain Fraulein Wieck; and it was his beloved Clara who gave the first performance in Leipzig in 1846.

Chopin's F minor concerto was written when he was just eighteen and predates the work which is now listed as his First Piano Concerto. Chopin too was infatuated with a lady, an eighteen year-old Polish singer, and he expressed it all in the beautiful second movement Larghetto. Throughout the work, the melodies fizzle with a romantic fervour but it is Chopin's glittering embellishments which seduce the

ear. He has always been criticised for his orchestrations in the two piano concertos, not least by Berlioz who thought the orchestra superfluous to the proceedings. But given that Chopin only intended the orchestra to play the support not join in a partnership, the economical but effective accompaniment is exactly right.

It is not often that these two Romantic concertos are coupled together and, in general, the performances are wholly enjoyable. Louis Lortie's innate pianism has already been amply demonstrated in his solo recordings for Chandos and both he and Jarvi choose their tempos well, other than in the slow movement of the Schumann which languishes in the manner of Rachmaninov's Second; too saccharine and self-indulgent for my taste. The recordings are warm and spacious in the Chandos style, and the piano sound is especially refined. PH

RECORD OF THE MONTH

MAURICE RAVEL
Complete works for solo piano: Serenade grotesque/ Menuet antique/Pavane pour une infante defunte/ Jeux d'eau/ Sonatine/ Miroirs/Gaspard de la nuit/ Menuet sur le nom de Haydn/Valses nobles et sentimentales/Prelude/ A la maniere de Borodine/A la maniere de Chabrier/Le tombeau de Couperin
 Jean-Yves Thibaudet, piano
DECCA 433 515-2 (2 CD SET)
(DDD/130.18)

● As befits the son of a Swiss engineer, Ravel's music is never less than exquisitely crafted, with meticulous attention to detail. Which observation may suggest an impersonal kind of beauty. Not so: it is sophisticated but rarely soulless. Ravel appeared set for a career as a virtuoso pianist. He certainly had the technique; what he may have lacked was the temperament. He was a shy, even introspective personality, as fastidious in his personal life as he was in his music.

The majority of Ravel's orchestral works - the evergreen Pavane, for example - were first conceived for piano, which comes as a surprise given his mastery of orchestration. To explore the solo piano music is to encounter a picture book of ravishing imagery and wealth of invention. Ravel explored the possibilities of the piano very much as Chopin had done a century earlier, but with quite different results. But, like Chopin, he wrote with economy: the longest piano works, Le tombeau de Couperin and Miroirs are both under half-an-hour.

Miroirs displays Ravel's musical language, especially its harmonic development, at its most innovative. It is a set of exquisite sound paintings: the Vallee des Cloches, said to be inspired by the bells of Paris chiming midday; the Spanish gaiety of Alborada del gracioso; the magic of Oiseau tristes. A later work, the Valses nobles et sentimentales, modelled on Schubert's waltzes, marks another

stage in Ravel's development. Its skilful use of dissonance eluded some early listeners who thought they were hearing wrong notes!

The nightmarish Gaspard de la nuit inhabits an altogether different world, one of phantoms and shadows. The imagery here, derived from poems by Aloysius Bernard, sets out to shock. Le gibet, with the hanged man swinging from the gallows and the bell tolling is woven around just one note, an omnipresent B flat. The evil embodied in the devilish dwarf, Scarbo, is vividly expressed, while Ondine, the dancing water-sprite, is a tracery of shimmering light. It is far removed from the finely-chiselled, affectionate

By omitting just the piano transcription of the orchestral La Valse, Decca have comfortably accommodated all of Ravel's solo piano music on two discs. Thoughtfully, it has also been arranged in order of composition, beginning with the early Serenade grotesque, the glitteringly descriptive Jeux d'eau and the work which remains Ravel's most popular piece after the infamous Bolero - the Pavane pour une infante defunte. Each disc also concludes with a major work, the first with Miroirs of 1909, the second with Le tombeau de Couperin from 1914/17.

Consistency is the overriding quality of this set. Thibaudet offers considered and faithful accounts with

not a hint of self-indulgence. I liked the cool urbanity of the playing, very much the kind of style I imagine Ravel himself would have adopted. Thibaudet catches the character of each piece well, from the macabre echoes of Le gibet in Gaspard de la nuit to the lively dances of Le tombeau de Couperin. His confident but far from showy technique is never found wanting, even in Ravel's most dazzling passagework, and he displays a keen understanding of the rhythmic nuances. There are times when he sounds a little too

literal, too objective, so losing the subtle gradations of light and shade, and with them something of the spell of the music. Overall, though, Thibaudet does justice to Ravel's invention.

The recording, made in Amsterdam in 1991, is cleanly-balanced, with telling detail and striking immediacy. Yet I detected a certain flat, monochrome quality to the lower register which inevitably affects the tonal colouring. Taken individually, there are better performances available of certain of the major works performed here, though Thibaudet's vivacious flair in Le tombeau de Couperin would be hard to match, as would his finely-honed performance of Miroirs. But, as remarked upon above, the set has the virtues of completeness and consistency and offers, if not the last word, then at least a sympathetic introduction to some of the most individual piano music composed this century and, through that individuality, to the imagination of its creator. PH



pastiche of Le tombeau de Couperin, Ravel's homage to French music of the eighteenth century, as typified by the works of Francois Couperin.

Le tombeau, composed during the First World War and dedicated to friends who died in the conflict, marked the end of Ravel's pianistic explorations, at least for the solo instrument. Thereafter he concentrated on chamber music and song-cycles, but did write two piano concertos during 1931/32.

The piano music is central to any appreciation of Ravel's art. To hear it is to pass through a well-lit gallery, its walls hung not with large canvases in the manner of, say, Beethoven, but with smaller, but no less arresting images, where the emphasis is on clarity and jewel-like colouring. It is a gallery I earnestly recommend visiting and Jean-Yves Thibaudet proves an objective and knowledgeable guide.



TOMAS LUIS DE VICTORIA
Missa pro defunctis a 6vv
(Requiem Mass)/Magnificat
primi toni/Motet: O Quam
Gloriosum/Mass: O Quam
Gloriosum eccia
 Choir of St John's College, Cambridge;
 conductor, George Guest
DECCA OVATION 430 267-2 (ADD/69.59)

● It was through this recording that I first became acquainted with the music of the Sixteenth Century Spanish composer, Victoria, and with his intense and deeply moving setting of the Office of the Dead. That was in the late Sixties, when LPs of Victoria's music were few and far between. So this St John's Cambridge performance has always had a special place in my affections but, sadly, twenty-five years on, its flaws cannot be overlooked.

The Requiem of 1605 (Victoria had composed an earlier setting in 1583) was dedicated to Princess Margarita of Spain, daughter of the Dowager Empress Maria, who had died two years earlier. Victoria headed the dedication, "For the obsequies of your Reverend Mother." The texture here is brighter than in the 1583 setting, the dramatic highlighting of key points in the text more arresting. Within the constraints of liturgical polyphony, it is highly-charged, passionate music, at times imploring, at others ethereal and ecstatic. If the music of Palestrina is akin to the art of Raphael, then the parallel to Victoria is El Greco.

It is this sense of mystery which the St John's performance misses. The vibrato in the men's voices now sounds excessive, the boy trebles are uninspired and dull, especially in the plainchant. It is as though they were utterly unaware of the implications of the texts they were singing. The well-focused recording has stood the test of time reasonably well. It sounds a little 'beefy' now compared to more recent alternatives and the sibilance is pronounced. It is rich in atmosphere though, without becoming cloudy. But for a performance of this towering Renaissance masterpiece, I would now have to suggest the Westminster Cathedral version on Hyperion or that of the Tallis Scholars on Gimell.

In its favour, this generously-filled

reissue is at mid-price and it does include three other fine examples of Victoria's art in performances which still have much to commend them. The Magnificat Primi Toni is one of no less than eighteen settings Victoria made of this Marian text, while the Mass O Quam Gloriosum is a glorious example of the 'parody Mass'; in other words, its musical basis is borrowed from an existing motet - in this case the eponymous O Quam Gloriosum, which is also included here. Over half the Masses Victoria composed were of this nature and it is an enlightening exercise trying to spot how the motifs of the motet are reworked into the Mass. PH

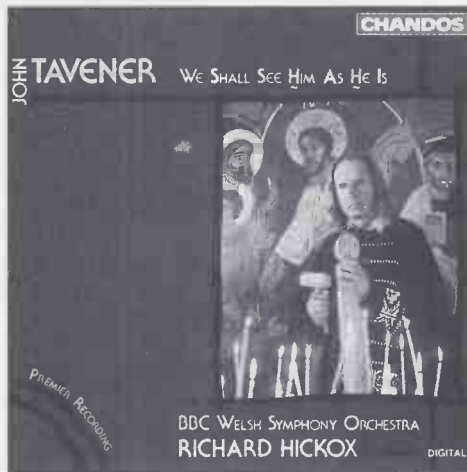

JOHN TAVENER
We Shall See Him As He Is
 Patricia Rozario, soprano; John Mark Ainsley, tenor; Andrew Murgatroyd, tenor; BBC Welsh Chorus; The Britten Singers; Chester Festival Chorus; BBC Welsh Symphony Orchestra, cond. Richard Hickox
CHANDOS CHAN 9128

● John Tavener is one of our most accessible contemporary composers for all that his sacred compositions are the work of what might be best described as a musical mystic. "In everything I do, I aspire to the sacred... music is a form of prayer, a mystery" he is quoted in the notes to this recording. We Shall See Him As He Is is what would have been described in Mendelssohn's day - or Holst's, if it comes to that - as an oratorio. It is sparsely orchestrated for two trumpets, two timpanists, organ, strings, chorus, two tenors and soprano. Sparse, however, simply fails to convey the choral and orchestral textures - the chorus is a large force indeed - and the string writing is rich in atmosphere. With organ and choral forces underpinning the melodic line and solos it shimmers like the gold leaf and symbolic designs of the ikons of the Orthodox Church. The whole piece is like a musical evocation of a Greek Orthodox service when the lights gradually come up and the ikons and Byzantine decoration are infused

with a numinous but sparkling light of their own.

Tavener himself is a member of the Eastern Orthodox Church; the words - short snatches or snapshots from St John the Theologian, illustrative of the episodes of Christ's life - are by his spiritual adviser and friend Mother Thekla, Abbess of the Orthodox Monastery of Normanby in North Yorkshire.

The work is best envisioned as a series of mosaics which make up a large pattern; Tavener himself refers to this aspect of his work as 'Ikons'. Thematically, the common parts of the shifting series of static musical images are held together by a strand for cello, which first appears in Ikon I, and is extended occasionally until it appears in its full melismatic form for ten cellos in Ikon VIII, the Last Supper. The climax is in

Ikon X, a great triumphal hymn with a solo violin of great pathos interspersed by brief Elgarian fanfares, dying finally in a numinous, cathartic ppp of distant strings which brings us full circle with the Greek words of the opening ikon repeated in English. It's an extraordinary meeting of East and West, with Greek dance rhythms - the piece was written on the Greek island of Regina - and tenor parts where the singer is instructed to adopt the Orthodox style of singing. It's expressive, deeply emotional and truly inspirational.

Originally commissioned by Cheshire County Council to mark the 900th anniversary of Chester Cathedral (where it was first performed in 1992) We Shall See Him As He Is was performed in last year's Proms Season, during which this recording was made. Engineer Ralph Couzens has made an excellent job of a difficult venue, with the Albert Hall acoustic having enough of its echoey signature to aid the mystical atmosphere without muddying the tonal colours unnecessarily. The perspective is finely balanced, though inevitably in the pp passages the hiss and hum of the hall become a little intrusive. Though there were a few summer colds and dry throats among the audience, mostly they are remarkably restrained. An essential recording, despite that. EB

Classical

SILVER SESSION

Ace Brazilian percussionist Airtó Moreira came to Soho in November to record an audiophile album. Monitoring was done on B&W Silver Signatures. Eric Braithwaite spoke to both the producer and the artist.



Last November, Brazilian percussionist extraordinaire Airtó Moreira brought his Fourth World Band into the cosmopolitan ambience of Soho and a small Wardour Street studio. Apart from Moreira on percussion, the band is made up of vocalist Flora Purim to whom he's married, guitarist Jose Neto and saxophonist, flute and keyboard player Gary Meek. The aim was to make an 'audiophile' recording - and this band's first studio recording - for Robert Trunz's new record label, B&W Music.

Yes, there is an association with B&W the hi-fi company: Trunz is President and there at either end of the control room desk were a pair of £4,000 B&W Silver Signature loudspeakers on which the recording was being mastered. Moreira - who worked with Miles Davis on 'Bitches Brew', was a founder-member of Weather Report and co-founder of Chick Corea's Return To Forever band - is no stranger to audiophile recordings, having made several for Reference Recordings in the States. This, however, was going to be different.

For one thing, as producer Mark St. John put it, Studio 145 is "State of the Artist, not State of the Art", though visible through the control-room window were Calrec Soundfield microphones and the only Neumann 'sphere' microphone system in Europe. As he explained later, the

master tape would be analogue; even Neumann U47 valve mics were in use. The primary aim was to capture the sound of the band the way it would be live.

"The recordings sound just like the band playing live," said Mark St. John. "That's for a couple of reasons; for a start they're on analogue, so there are no holes in the information, no unpleasant analogue-to-digital conversion, and also because the microphones have been chosen so we don't have to wind in great daubs of equalisation. Most of the instruments get to speak properly. It has to sound as though you were there - for which, of course, there's no substitute."

"I have made two or three audiophile recordings in California" added Moreira, "and they have a nice 'wide' sound; we were miked the same way, in big amphitheatres, with the mics far away in the audience, then a couple, say, a little closer, so you get all that space before the actual sound, which makes everything sound big - but not clear. Even though my drums sounded great - like a gigantic drumset or a gigantic wood block - you lose the actual impact, because when the sound gets to those mics they're pure, but not as accurate as those Mark is using. I don't know about technology, I just play, but this sphere they're using is spectacular. You close your eyes, it's like life, the real thing."

Mark: "There are two dummy heads, one Sennheiser, one Neumann; but there's also the Neumann sphere - the only one in Europe at the moment - which is a wooden sphere which has its own fundamental resonance. It's in the same area, qualitatively, as the Soundfield; it uses a much smaller capsule, so the diaphragm's capable of responding far quicker than the dummy heads that have been used. The mistake a lot of audiophile recordings make is that they overlook the dynamic range that exists in something like this; Airtó will make these little dry sounds with little bags of beads that are very low in level but very specific in terms of tonality. Within the next bar he'll be beating hell out of a twenty-four inch Chinese cymbal, rising up to 105dB - very loud. The Sphere and the Soundfields have come out clear winners in the way they're able to absorb that dynamic punishment."

Speaking to Flora Purim, Fourth World's vocalist, later, I learnt she was as happy as Airtó with the sound that was coming from the tapes. "I have a range of six octaves - I

▶ The control desk at Studio 145. Standard near-field monitors are flanked by a B&W Silver Signature and an AR Powered Partner.





kind of speaker is more than there is," said Mark St. John. "What they do have is imagery - that's lovely. They're brilliantly good at giving you image placement: the definition is really excellent, probably of the highest order I've come across. They have a pretty unwelcome lump in the bass end, which exists because the port isn't properly tuned; in a room that sounds good - most people's don't - the vagaries of the mid-range are clear. The highs are very extended on a lot of current audiophile loudspeakers - especially on those without a soft dome tweeter. What's missing in the B&Ws is an element of mid-range that exists in everything that isn't properly dealt with. Most audiophile speakers accordingly flatter things tremendously. However, it is probably true that audiophile hi-fi has reached the stage now where in sonic detail and accuracy it's ahead of what can be achieved in the sound-chain in professional audio."

Top:
Bags of beans, car springs, and drums. An amazing array of percussion.

don't think it's really been recorded before."

"The purist concept is a stereo microphone placement, in a specific environment," said Mark St. John. "As soon as you have an element like Flora, who has a huge range in this band, and people like Airtio who raises enormous peaks, the strictly purist American audiophile recording wouldn't allow her to be heard. You have to enable the performance to exist in an environment that is appropriate to the dimension you want."

Airtio again: "When Mark mentioned to me they were going to use two mics on my bass drum - both at the back - I said 'Oh'. It was the first time I heard my bass drum the way I played it; when you're playing live, you don't stop and say 'I wonder how my bass drum is sounding'. The energy's there; you're playing. For some reason, stage monitors don't sound good. We recorded a little of the bass drum here when we arrived - and I heard this nice



Centre right:
Neumann's 'Dummy Head' recording set-up.



The recording will mostly be made up from first takes - ten basic tracks laid down in five days. It is due to be released in March. The final words come from Mark St. John, who has worked with Dave Gilmour of the Pink Floyd, Billy Idol, The Clash and Stevie Wonder, among others. In conversation, he mentioned, among other things, a liking for Tannoy 15in dual-concentrics and valves - but that's another story. "The music is of the essence here. I think we'll end up with a recording that sounds like this band - which is in my view what an audiophile recording should be. That event, at that time, correctly recorded with the most energy and the greatest accuracy." ●

Centre left:
"Airtio will make these little sounds with bags of beans... within the next bar he'll be beating hell out of a 24" cymbal..."

sound. There were three different sounds I played - the same beat but different resonances - I didn't know that. They were playing about to get that sound for three days. Three days! I've recorded an audiophile record in one day! You just put the microphones up, you play, and it's done."

"My percussion sounds real good - the sound is very open, and you hear the impact. You want to hear a triangle go 'ping!' like that, because when you play live that's the way it sounds. You can hear it in the middle of an orchestra." Airtio illustrates his points by turning himself into a vocal percussion section: the tape of our interview is punctuated by bangs, slaps, claps, noises that all relate to his drumming, but could be mistaken on tape for a soundtrack to a cartoon. We spent some time in the studio where he delightedly rattled beans, showed off springs, whirled strange things round his head - even produced clicking and whining toys.

Back in the control room, we turned to a playback on the B&W Silver Signatures. "What I think you hear on this



Bottom:
"My percussion sounds real good... you hear the impact," said Moreira, illustrating.

NUMBERS ALWAYS 'IN STOCK'

The best hi-fi Dealers know when they're on to a good thing. Get on to a good thing too by quoting these award winning numbers on your next hi-fi shopping spree.

AT-110E

← MOVING MAGNET →



AT-OC5_{MC}

← MOVING COIL →



AT-95E

← MOVING MAGNET →



ATH-L1a

HEADPHONES



Available at Good Hi-Fi Stores **ONLY**



audio-technica
□ INNOVATION □ PRECISION □ INTEGRITY

ATC-003

WOLLATON A·U·D·I·O

For those on a budget with a passion for the best:

Audio Synthesis Passion passive preamplifier £560

See the review by Martin Colloms in Hi Fi News, April 1993.

Clements Spatial Image 300Si loudspeaker £595

"All of our listeners thought we were listening to loudspeakers in the \$1200 to \$1500 range."
Inner Ear Report, Summer '92.

XLO Pro Interconnects and Cables

Sounds like . . . nothing at all.
Interconnect £85/metre pair
Speaker cable £155/9ft pair

"Its superb quality more than justifies the cost."
Alan Sircom, Hi-Fi World, December 1992.

TEAC VRDS 10 £770

"My first choice for a sub-£2000 player."
Alan Sircom, Hi-Fi Choice, March 1993.

Monarchy 22 D to A converter £995

"The Monarchy 22 thoroughly trounces the PS Audio Ultralink and the Audio Research DAC1 which cost double and triple the amount of the Monarchy."
Paul Cervantes, The Audio Observatory.

"Best Buy of the Year"
Hi-Fi Review

Ring us.

We offer a money-back guarantee of satisfaction and have a number of ex-dem special offers at low prices.

Demonstrations by appointment.

Wollaton Audio
Tel/Fax: 0602 284147

SALE

MARCH MADNESS !

Reductions strictly for one day only

Massive reductions on selected 'boxed' new stock and most of our dem' and display stock with individual items at 50% of the original price. Our popular one day sales offer a unique opportunity to get the 'best' hi-fi at the 'lowest' prices. Come and see for yourself!

Sunday parking around the store is very easy. You can park 'free' on meters and single yellow lines.

SUNDAY
28 TH
MARCH
10.00AM

Established brands stocked by KJ

Accuphase ● Acoustic Energy ● Alberry ● Alchemist ● Apogee ● Arcam
Audio Alchemy ● Aura ● Audiobab ● Audio Research ● B&W ● BBAP ● Chord
Croft ● DPA ● Dail ● Epos ● Gradient ● Impulse ● KEF ● Krell ● Marantz
Martin Logan ● Meridian ● Micromega ● Michell ● Mission Cyrus
Morch ● Monitor Audio ● Musical Fidelity ● Nakamichi ● Nitty Gritty
Pink Triangle ● Pioneer ● PS Audio ● Pro-Ac ● Quad ● Rogers ● Roksan
Rotel ● Siltech ● SME ● Sonus Faber ● Stax ● Spondor ● Systemdek
Tannoy ● Theta ● Thiel ● Wadia ●



KJ WEST ONE

26 New Cavendish Street, London W1M 7LH
(Close to Marylebone High Street)

Tel: 071 486 8262/8263 ● Fax: 071 487 3452

Open: Mon-Sat 10.00 a.m. - 6.00 p.m. Thurs until 7.00 p.m.



**Simply the best and
most experienced
Hi-Fi dealer you
will find anywhere**

FOR THE STATE OF THE ART

AKG, Acoustic Energy, Apogee, Audiolab, Audio Research, B & W, Basis, Beyer, Bose, Celestion, Chord, Classe, Convergent, Denon, Dual, Ensemble, Jadis, KEF, Koetsu, Krell, LFD, Magnephanar, Marantz, Martin-Logan, Meridian, Michell, Micromega, Nakamichi, PS Audio, Professional Monitor, Quad, Radford, Revox, Rogers, Roksan, SME, Sennheiser, Sonus Faber, Spondor, Stax, TDL, Tannoy, Target, Teac, Theta, Thorens, Tripod, Wadia, Wharfedale, Wilson.

Acoustic Arts Limited 101 St. Albans Road Watford Herts
Telephone: Watford 245250 Fax: 0923 230798
Open Tuesday — Saturday 9.30-6.00 p.m. (Closed Monday)

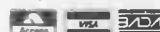



★★★ NEW TITLES ★★★

Mastersound Album Classics remastered with Sony's 20-bit 'Super Bit Mapping' process. The reflective coating is pure 24-carat gold.

AEROSMITH
TOYS IN THE ATTIC
CK 525857
BOSTON
BOSTON
CK 52856
DAVE BRUBECK
TIME OUT
BOB DYLAN
BLONDE ON BLONDE
CK 53016
Special price: £32.95

BILLY JOEL
52ND STREET
CK 5258
MILES DAVIS
KIND OF BLUE
CK 52861
BRUCE SPRINGSTEEN
BORN TO RUN
CK 52859
WEST SIDE STORY
ORIGINAL CAST
CK 53152

Hi-Fi World record mail order service

A rich and varied selection of recordings, all offered at very competitive prices!



Zakir Hussain: Making Music

SPECIAL DELIVERY TOPIC (CD ONLY)

JUNE TABOR
AIRS AND GRACES
ASHES AND DIAMONDS
MARTIN CARTHY
RIGHT OF PASSAGE
JOHN KILPATRICK
PLAIN CAPERS
PETER BELLAMY
THE TRANSPORTERS
RICHARD THOMPSON
STRICT TEMPO
MARTIN CARTHY & DAVE SWARBRICK
SKIN AND BONE
TERRY ALLEN
LUBBOCK (ON EVERYTHING)
WOODY GUTHRIE
STRUGGLE
NICK JONES
PENGUIN EGGS (CD ONLY)
DICK GAUGHAN
GAUGHAN (CD ONLY)
RON KAVANA
HOME FIRE
PETER HOLSAPPLE & CHRIS STAMEY
MAVERICKS
PATRICK STREET
IRISH TIMES
RORY BLOCK
TURNING POINT (CD ONLY)
GREGSON/COLLISTER
MISCHIEF
A CHANGE IN THE WEATHER
LOVE IS A STRANGE HOTEL
THE LAST WORD (£12.99 CD ONLY)
CLIVE GREGSON
WELCOME TO THE WORKHOUSE
JONATHAN RICHMAN
JONATHAN GOES COUNTRY
JONATHAN RICHMAN
REBIRTH BRASS BAND
REBIRTH KICKIN' IT LIVE
VARIOUS ARTISTS
HARD CASH
MARTIN CARTHY AND DAVE SWARBRICK
LIFE AND LIMB
BLOWZABELLA
VANILLA
WEBB WILDER & BEATNECKS
IT CAME FROM NASHVILLE (LP)

BOBBY KING & TERRY EVANS
LIVE & LET LIVE
RHYTHM, BLUES, SOUL
MIGHTY FLYERS
UNDERCOVER (LP ONLY)
SUGAR RAY & THE BLUETONES
KNOCKOUT
ROBERT EARL KEEN JNR
WEST TEXTURES
THE METERS
THE METERS JAM
GOOD OLD FUNKY MUSIC

SD LPs £7.49, CDs £10.99

DELMARK (CD ONLY)

ART HODES & BARNEY BIGARD
BUCKETS GOT A HOLE IN IT
GEORGE LEWIS & DON EWELL
REUNION
FRANZ JACKSON & JIM BEEBES
CHICAGO JAZZ
SNAG IT
MALACHI THOMPSON
THE JAZZ LIFE
JODIE CHRISTIAN
EXPERIENCE
TAB SMITH
ACE HIGH
SPECKLED RED
THE DIRTY DOZENS
MAGIC SAM
WEST SIDE SOUL
BLACK MAGIC
GIVE ME TIME
T-BONE WALKER
I WANT A LITTLE GIRL
DINAH WASHINGTON
MELLOW MAMA
SUNNYLAND SLIM
HOUSE RENT PARTY

Delmark CDs 12.99

RAVEN

RASCALS
IN INTROSPECT (66-69)
MARC BOLAN & T.REX
SOLID GOLD RAPID ACTION
THE FOUR TOPS
SHAKE ME, WAKE ME (HITS FROM 64-73)
GRAM PARSONS
WARM EVENINGS, PALE MORNINGS 63-73
THE MONKEES
TALK DOWN UNDER (LP ONLY)
ROY ORBISON
COMMUNICATION BREAK-DOWN
THE ANIMALS (CD only)
THE MOST OF (ALL ERAS COMP)
ROADRUNNERS (CD ONLY)
THE BYRDS
FULL FLYTE (CD ONLY)

THE YARDBIRDS (CD only)
OVER UNDER SIDEWAYS
DOWN
JOE COCKER (CD only)
CONNOISSEURS COCKER '69-78

Raven LPs £7.99, CDs £12.99

BULLSEYE BLUES

ANN PEEBLES
FULL TIME LOVE
SUGAR RAY & BLUETONES
DON'T STAND IN MY WAY (CD)
CHAMPION JACK DUPREE
FROM NEW ORLEANS (CD)
LITTLE JIMMY KING & THE MEMPHIS SOUL SURVIVORS
LITTLE JIMMY KING (CD)
OTIS CLAY
SOUL MAN (CD)

Bullseye CDs £11.99

ROUNDER

(AVAILABLE ON CD ONLY)

ALISON KRAUSS
I'VE GOT THAT OLD FEELING
OTIS CLAY
I'LL TREAT YOU RIGHT



Rory Block: Aint I A Woman

LEADBELLY
MIDNIGHT SPECIAL
ROD PIAZZA & THE MIGHTY FLERS
ALPHABET BLUES
TOM RUSSELL
HURRICANE SEASON
IRIS DEMENT
INFAMOUS ANGEL
SPANIC BOYS
STRANGE WORLD
MISSISSIPPI JOHN HURT
AVALON BLUES 1963
WORRIED BLUES 1963
AARON NEVILLE
MY GREATEST GIFT
DUKE ROBILLARD & THE PLEASURE KINGS
TOO HOT TO HANDLE
DUKE ROBILLARD
YOU GOT ME
SWING
ROCKIN BLUES
RORY BLOCK
HOUSE OF HEARTS
BEST BLUES AND ORIGINALS
RHINESTONES & STEEL STRINGS
I'VE GOT A ROCK IN MY SOUL

BLUE HORIZON
HIGH HEELED BLUES

JOHNNY COPELAND
WHERE THE RAIN STARTS FALLIN
AIN'T NOTHING BUT A HOUSE-PARTY 'LIVE'
BOOM BOOM
JOHNNY ADAMS
SINGS DOC POMUS - THE REAL ME (WITH DR. JOHN/DUKE ROBILLARD)
IRMA THOMAS
NEW RULES
REBIRTH BRASS BAND
FEEL LIKE FUNKIN' IT UP
SOLOMON BURKE
SOUL ALIVE
WALTER 'WOLFMAN' WASHINGTON
WOLF AT THE DOOR
NATHAN & THE ZYDECO CHA CHAS
YOUR MAMA DON'T KNOW
CLARENCE 'GATEMOUTH' BROWN
TEXAS SWING

Rounder CDs £11.99

LYRICHORD

WORLD MUSIC SAMPLER
£7.99
MUSIC OF THE RAIN FORESTS PYGMIES
JAPANESE KOTO CONSORT
PERU-MUSIC FROM THE MACCHU PICCHU (HIGH ANDES)
INDIAN BAMBOO FLUTE
GOUR GOSWAMI & STAVEN GORN
Lyrichord CDs £12.99

MUNICH

RORY BLOCK
AIN'T I A WOMAN
MAMAS BLUES
CULTURE IN CULTURE
CULTURE
IRMA THOMAS
LIVE - SIMPLY THE BEST

Munich CDs £10.99

AMALTHEA

THE DUKE ROBILLARD BAND
TURN IT AROUND
AFTER HOURS SWING SESSION (Amalthea CD £11.99)

COOKING VINYL

THE OYSTER BAND
STEP OUTSIDE (CD ONLY £6.99)
LITTLE ROCK TO LEIPZIG
DESERTERS
FOUR BROTHERS
MAKOROKOTO
MICHELLE SHOCKED
TEXAS CAMPFIRE TAPES
ARKANSAS TRAVELLER

EDWAROLKAS
SWEET HONEY IN THE ROCK

BREATHS...THE BEST OF
DAVY SPILLANE
ATLANTIC BRIDGE
COWBOY JUNKIES
TRINITY SESSIONS
JUNE TABOR
ANGEL TIGER
JUNE TABOR & THE OYSTER BAND
FREEDOM AND RAIN
BRUCE COCKBURN
LIVE
CLANNAD
FUAIM
BOILED IN LEAD
ORB

Cooking Vinyl CDs £10.99

CROSSCUT

CHARLIE MUSSELWHITE
MEMPHIS, TENNESSEE

Crosscut LP only £7.99

WORLD CIRCUIT

BHEKI MSELEKU
CELEBRATION
JEAN TOUSSAINT
WHAT GOES AROUND
OLODUM
REVOLUTION IN MOTION
JOE ARROYO Y LA VERDAD
REBELLION
BLACK UMOFOSI
UNITY
JALI MUSA JAWARA
SOUBINDOOR
LISANDRO MEZA
LISANDRO'S CUMBIA (NOT ON LP)
ABDEL GADIR SALIM ALL-STARS
THE MERDOUM KINGS PLAY
SONGS OF LOVE (NOT ON LP)
ALI FARKA TOURE
ALI FARKA TOURE
OUMOU SANGARE
MOUSSOLOU
ABDEL AZIZ EL MUBARAK
STRAIGHT FROM THE HEART

World Circuit LPs £5.95
CDs £8.99

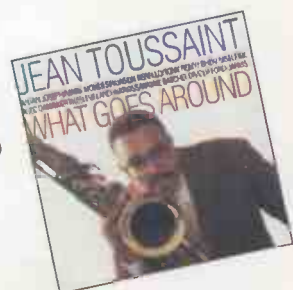

HURRY LIMITED STOCKS OF LINN RECORDS AVAILABLE NOW!

LINN RECORDS

OTIS GRAND & THE DANCE KINGS
ALWAYS HOT!
THE HORSEFLIES
HUMAN FLY
JOHNNY ADAMS
ROOM WITH A VIEW OF THE BLUES
UDITEI AMANT
17TH CENTURY ITALIAN LOVE SONGS
BLUE NILE
HATS
A WALK ACROSS THE ROOFTOP



CAROL KIDD
CAROL KIDD
ALL MY TOMORROWS
NICE WORK
THE NIGHT WE CALLED IT A DAY
GLAD WE MET
DAVID NEWTON
VICTIM OF CIRCUMSTANCE
MARTIN TAYLOR
DON'T FRET
POLISH CHAMBER ORCH.
MOZART/MIVALDI/BACH/
BARTOK/ELGAR (DBL)
£11.99 (LP & CD)
WILLIAM CONWAY & PETER EVANS
CELLO SONATAS
ENGLISH CLASSICAL PLAYERS
MOZART 40TH & SCHUBERT
5TH (DBL) £11.99 (LP & CD)
Linn Records LPs £7.99
CDs £11.99

RECUT

RECORDS
BEETHOVEN
5TH SYMPHONY £8.99

LINN SELEKT

LPS
ROBERT CRAY
FALSE ACCUSATIONS
ABC
THE LEXICON OF LOVE
THE BEATFUL SOUTH
WELCOME TO.....
STAN GETZ/CHARLIE PARKER
JAZZ SAMBA
JONI MITCHELL
CHALK MARK IN A RAINSTORM
ELLA & LOUIS
ELLA & LOUIS AGAIN
TALKING HEADS
STOP MAKING SENSE
BILLIE HOLIDAY
STORY VOL II
ELTON JOHN
ICE ON FIRE
KATE BUSH
THE DREAMING
STEELY DAN
AJA

COUNT BASIE
KANSAS CITY SUITE
ART BLAKEY & THE JAZZ MESSENGERS
LIVE AT BUBBA'S
LISA STANSFIELD
AFFECTION
JACKIE WILSON
GREATEST HITS
THE DOORS
LA. WOMAN
VAN MORRISON
ASTRAL WEEKS
NEIL YOUNG
HARVEST
THE EAGLES
HOTEL CALIFORNIA
RY COODER
PARIS, TEXAS
EDIE BRICKELL
SHOOT RUBBERBANDS AT THE STARS
STEVE EARLE
COPPERHEAD ROAD
OSLO PHILHARMONIC
TCHAIKOVSKY MANFRED SYMPHONY
OSLO PHIHARMONIC
TCHAIKOVSKY SYMPHONY NO.6- PATHETIQUE
LONDON SYMPHONY
BRAHMS SYMPHONY NO.4
LENINGRAD PHILHARMONIC
PROKOFIEV SYMPHONY NO.5
SOLOMON BURKE
A CHANGE IS GONNA

COME
STEVE PHILIPS
STEEL RAIL BLUES
MILCHO LEVIEV QUARTET
BLUES FOR THE FISHERMAN
CRUSSELL CLARINET QUARTETS
THEA KING/ALLEGRI ST QUARTET
DEBUSSY/RAVEL STRING QUARTETS
FAIRFIELD QUARTET
T-BONE BURNETT
PROOF THROUGH THE NIGHT
J. B. LENOIR
ALABAMA BLUES!
MUSICIANS OF SWANNE ALLEY
IN THE STREETS & THEATRES OF LONDON
AL GREEN
LET'S STAY TOGETHER
JUNE TABOR & THE OYSTER BAND
FREEDOM & RAIN
CAMBRIDGE SINGERS &



CITY OF LONDON SINFONIA
FAURE REQUIEM
THE SIXTEEN
HANDEL CHANDOS ANTHEMS NO.1-3
HANDEL
WATER MUSIC
CORELLI
CONCERTI GROSSI
KAPSBERGER
PIECES FOR LUTE
Linn Select £8.99

GRAPEVINE

MARY BLACK
COLLECTION
BABES IN THE WOOD
NO FRONTIERS
BY THE TIME IT GETS DARK
WITHOUT THE FANFARE
COLLECTED
MARY BLACK
LPs £7.99 CDs £10.99

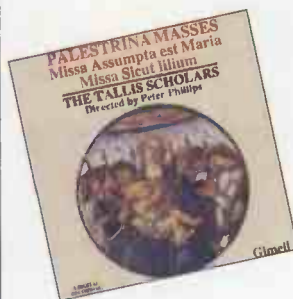

GIMELL RECORDS

An excellent selection of digital recordings from Gimell Records which has won acclaim around the world, and has picked up awards from Gramophone Featuring The Tallis Scholars directed by Peter Phillips renowned for their clarity and perfect intonation.

THOMAS TALLIS
SPEM IN ALIUM
LAMENTATIONS OF JEREMIAH (CD ONLY)
PALESTRINA MASSES
MISSA ASSUMPTA EST MARIA / MISSA SICUT LILIUM
MISSA BENEDICTA ES
MISSA BREVIS
MISSA NIGRA SUM
ALLEGRI
MISERERE (CD ONLY)
HEINRICH ISAAC
MISSA DE APOSTOLIS (CD ONLY)
JOSQUIN
L'HOMME ARME MASSES
MISSA PANGE LINGUA / MISSA LASOL FA RE MI
JOHN SHEPPARD
MEDIA VITA
WILLIAM BYRD
THE THREE MASSES (CD ONLY)
THE GREAT SERVICE
CLEMENS NON PAPA
MISSA PASTORES QUIDNAM
VIDISTIS
JOHN TAVENER
IKON OF LIGHT (CD ONLY)
VICTORIA
REQUIEM
TENEBRAE RESPONSORIES (CD ONLY)

Gimell LPs £8.49 CDs £12.99

HANNIBAL

VARIOUS ARTISTS
THE YOUNG FLAMENCOS CD ONLY
R&L THOMPSON
SHOOT OUT THE LIGHTS
HOKEY POKEY
RICHARD THOMPSON
HANDS OF KINDNESS
HENRY THE HUMAN FLY
JUNE TABOR
SOME OTHER TIME
BALKANA
MUSIC OF BULGARIA
All Hannibal LPs £7.99, CDs £11.99

HANNIBAL BOX SETS

SANDY DENNY
WHO KNOWS WHERE THE TIME GOES (3XCDs: £35.95) (4XLPs: £29.95)
NICK DRAKE
FRUIT TREE (4XCDs: £38.95) (4XLPs: £29.95)

DEMON

DUKE ROBILLARD & THE PLEASURE KINGS
DUKE ROBILLARD & THE PLEASURE KINGS
CLIVE GREGSON
STRANGE PERSUASION
GEORGE THOROGOOD & THE DESTROYERS
GEORGE THOROGOOD & THE DESTROYERS
T BONE BURNETT
TRUTH DECAY
CHRISTY MOORE
ORDINARY MAN
RORY GALLAGHER
DEFENDER
IRISH TOUR '74
JOHN LEE HOOKER
THE DETROIT LION
ELVIS COSTELLO & THE ATTRACTIONS
THIS YEARS MODEL
GET HAPPY
TRUST
PUNCH THE CLOCK
JOHNNY WINTER
JOHNNY WINTER
SECOND WINTER
STEVE NIEVE
KEYBOARD JUNGLE
ELVIS COSTELLO AND THE ATTRACTIONS
TEN BLOODY MARYS AND TEN HOWS YOUR FATHERS
BLOOD AND CHOCOLATE
BILL HURLEY (WITH JONNY GUITAR)
DOUBLE AGENT
IAN DRURY AND THE BLOCKHEADS
SEX & DRUGS & ROCK & ROLL
DO IT YOURSELF
EARL KING & ROOMFUL OF BLUES
GLAZED
JOHNATHAN RICHMAN & THE MODERN LOVERS
MODERN LOVERS '88
PERCY SLEDGE
WANTED AGAIN
OTIS RUSH
TOPS
RIGHT PLACE WRONG TIME
THE BYRDS
SWEETHEART OF THE RODEO
SCREAMIN' JAY HAWKINS
BLACK MUSIC FOR WHITE PEOPLE
TIM BUCKLEY
DREAM LETTER (LIVE IN LONDON '68)
SEFRONIA
LOOK AT THE FOOL
BEN E KING
HERE COMES THE NIGHT
THE PARAMOUNTS
WHITER SHADES OF N'N'B
DEL SHANNON
I GO TO PIECES
THE EVERLY BROTHERS
TWO YANKS IN ENGLAND
BO DIDDLEY
THE 20TH ANNIVERSARY OF ROCK 'N' ROLL
NILSSON
THE POINT
CAPTAIN BEEFHEART & HIS MAGIC BAND
THE LEGENDARY A&M SESSIONS
GERRY RAFFERTY
BLOOD AND GLORY (LP ONLY)
All Demon LPs £7.99, CDs £11.99

MOBILE FIDELITY

24 CARAT GOLD PLATED COMPACT DISCS

A unique opportunity to obtain the ultimate in CDs. For high resolution and immortality Mobile Fidelity plate these discs with 24 carat gold. Almost unobtainable elsewhere, they are not cheap - but what price excellence?

Mobile Fidelity Gold Discs offer better sound quality for many reasons, not least in that they are specially manufactured in Japan using real gold as a coating. The gold Ultradisc was developed in conjunction with the Ultech Corporation. It has



fewer pinholes, better durability and a more extended life. Accelerated ageing tests have shown that these gold discs outlast normal types by a considerable margin.
ERIC CLAPTON
SLOW HAND
ELTON JOHN
TUMBLEWEED CONNECTION
BRYAN ADAMS
RECKLESS
STING
NOTHING LIKE THE SUN
JOHN COLTRANE
BLUE TRAIN
B B KING
LIVE AT THE REGAL
EARL KLUGH
FINGER PAINTINGS
TOM PETTY
DAMN THE TORPEDOES
CHARLIE MUSSLEWHITE
MEMPHIS, TENNESSEE
BELAFONTE
RETURNS TO CARNEGIE HALL
MAXINE SULLIVAN
SINGS THE MUSIC OF BURTON LANE
THE WHO
QUADROPHENIA (DOUBLE)
TOMMY (DOUBLE)
SUPERTRAMP
BREAKFAST IN AMERICA
CRIME OF THE CENTURY
FRANK SINATRA
SONGS FOR SWINGING LOVERS
ELTON JOHN
HONKEY CHATEAU
MADMAN ACROSS THE WATER
GOODBYE YELLOW BRICK RD (DBL)
BOZ SCAGGS
SILK DEGREES
ROD STEWART
EVERY PICTURE TELLS A STORY
JEFF BECK
WIRED

JOE JACKSON
NIGHT & DAY
BLIND FAITH
BLIND FAITH
HUEY LEWIS & THE NEWS
SPORTS
JETHRO TULL
THICK AS A BRICK
STAND UP
THE POLICE
SYNCHRONICITY
MOODY BLUES
DAYS OF FUTURE PASSED
ALLMAN BROTHERS
EAT A PEACH (DBL)
STEELY DAN
AJA
GAUCHO
CAT STEVENS
TEA FOR THE TILLERMAN
DEF LEPPARD
PYROMANIA
BEACH BOYS
SURFER GIRL/SURFIN USA (DBL)
JOHN KLEMMER
TOUCH
JEFFERSON AIRPLANE
CROWN OF CREATION
VOLUNTEERS
CARPENTERS
SONG FOR YOU
THE BAND
MUSIC FROM THE BIG PINK
STING
THE DREAM OF THE BLUE TURTLE
HALL & OATES
VOICES
HARRY NILSSON
NILSSON SCHMILLSON
AFTER THE HURRICANE
SONGS FOR MONSERRAT
PINK FLOYD
THE WALL (£38.99 GOLD CD)
DARK SIDE OF THE MOON (£23.95 GOLD CD)
All Gold CDs: £22.95 (single); £32.95 (dbl)

NEW CLASSIC ROCK ON VINYL

JEAN MICHEL JARRE
OXYGENE
DAVID LEE ROTH
EAT 'EM AND SMILE
DAVID GILMORE
ABOUT FACE
CAN
SOON OVER BABALUMA
YES
TIME AND A WORD
CLOSE TO THE EDGE
FRAGILE
GOING FOR THE ONE
NEIL YOUNG
AMERICAN STARS N BARS
TIME FADES AWAY
FREEDOM
DECADE (TRIPLE ALBUM)
MORRISSEY
VIVA HATE
GONG
LIVE AT SHEFFIELD '74
BLUES BROTHERS
BRIEF CASE FULL OF BLUES
TEARS FOR FEARS
THE HURTING
TOM PETTY AND THE HEARTBREAKERS
SAME TITLE
THE BYRDS
BALLADS OF AN EASY RIDER
BOB MARLEY AND THE WAILERS
CONFRONTATION
VAN MORRISON
TB SHEETS
BLIND LEMON JERRFERSON
ONE DIME BLUES
CAT MAN BLUES
AC/DC
74 JAILBREAK

BLACK SABBATH
BORN AGAIN
SACRIFICE
BLONDIE
PARALLEL LINES
PLASTIC LETTERS
BLONDIE
ALICE COOPER
KILLER
BILLION DOLLAR BABIES
CHRISTOPHER CROSS
CHRISTOPHER CROSS
DEEP PURPLE
LAST CONCERT IN JAPAN
FLEETWOOD MAC
GREATEST HITS
CHRIS ISAAK
SILVERTONE
LINTON KWESI JOHNSON
BASS CULTURE
MCS
BACK IN THE USA
HIGH TIME
KICK OUT THE JAMS
VINTAGE YEARS
VAN MORRISON
TB SHEETS
VAN MORRISON
TOM PETTY & THE HEART-BREAKERS
YOU'RE GONNA GET IT
RUSH
A FAREWELL TO KINGS
SIMON & GARFUNKLE
SOUND OF SILENCE
THIN LIZZY
RENEGADE
THUNDER & LIGHTNING

THE BAND
ROCK OF AGES DBL
APHRODITES CHILD
666
ROGER WATERS
THE PROS & CONS OF HITCH
HIKING
STANLEY ORANGE
CLOCKWORK ORANGE
THE CHAMELEONS
THE FAN AND THE BELLOWS
THE SMITHS
RANK
IRON BUTTERFLY
LIVE
YES
GOING FOR THE ONE
VAN HALEN
WOMEN & CHILDREN FIRST
CROSBY STILL
SO FAR
GRATEFUL DEAD
THE GRATEFUL DEAD
AMERICAN BEAUTY
LIVE DEAD
WORKING MANS DEAD
TOM WAITS
BLUE VALENTINE
FOREIGN AFFAIRS
BOUNCED CHECKS
SANTANA
LOTUS (TRIPLE)
NEIL YOUNG
DECADE (TRIPLE)
NEIL YOUNG
VELVET UNDERGROUND
VU
RY COODER
CROSSROADS(SOUNDTRACK
FROM THE MOTION PICTURE)
SHOWTIME
BORDERLINE
THE SLIDE AREA
PARADISE AND LUNCH
JACKSON BROWN
THE PRETENDER
CAPTAIN BEEFHART AND THE MAGIC BAND
CLEAR SPOT
LED ZEPPELIN
CODA
JIM MORRISON/MUSIC BY THE DOORS
AN AMERICAN PRAYER

GRAM PARSONS
GRIEVOUS ANGEL
CROSBY STILLS & NASH
DEJA VU
4 WAY STREET
LOU REED/JOHN CALE
SONGS FOR DRELLA
RICKIE LEE JONES
PIRATES
RICKIE LEE JONES
SLY AND ROBBIE
LANGUAGE BARRIER
OTIS REDDING
DOCK OF THE BAY
GRACE JONES
SLAVE TO THE RHYTHM

Single LP £8.99
Double LP £12.99
Triple LP £14.99

LIMITED EDITION
THE ALLMAN BROTHERS
LIVE AT FILLMORE EAST
DBL LP £12.99

CLASSIC ROCK
ON VINYL ONLY, FOR A
LIMITED PERIOD WHILE
STOCKS LAST!

HUSKER DU
SONGS & STORIES (DBL)
CANDY APPLE GREY
ZEN ARCADE (DBL)
FLIP YOUR WIG
RAMONES
LEAVE HOME
END OF THE CENTURY
CAPTAIN BEEFHART
TROUT MASK REPLICA (DBL)
BLUE OYSTER CULT
SPECTRES
SECRET TREATIES
JONI MITCHELL
BLUE
MINGUS
HEJIRA
LADY OF THE CANYON
JANIS JOPLIN
PEARL
LOU REED
TAKE NO PRISONERS (DBL)
STEVIE RAY VAUGHAN
TEXAS FLOOD
EMERSON, LAKE & PALMER
TRILOGY
TARKUS
NEIL YOUNG & CRAZY HORSE
LIVE RUST (DBL)
ZUMA
IGGY POP (dbl)
LIVE AT THE CHANNEL, BOSTON
BOB SEGER & SILVER BULLET BAND
LIVE BULLET (DBL)
TIM BUCKLEY
GOODBYE AND HELO
THE DOORS
WEIRD SCENES INSIDE THE
GOLDMINE (DBL)
JONAS HELLBORG
ELEGANT PUNK
BASS
CHRIS ISAAK
CHRIS ISAAK
HEART SHAPED WORLD
LPs £8.99(single)
£12.99(dbl), £14.99(triple)

LPs £9.99

AUDIOQUEST

Audioquest recordings are recorded and mastered on valve equipment - not only that, but using microphones, tape decks and amplifiers built or customised by our own favourite valve expert Tim de Paravicini no less. Combined with simple mic techniques, these releases have an unparalleled pristine purity and clarity of sound.

WORKS OF ART
COMPILATION (CD ONLY) £7.99
ROBERT LUCAS
USIN' MAN BLUES
LUKE & THE LOCOMOTIVES
STRUNZ & FARAH
MISTERIO
TUXEDO COWBOY
WOMAN OF THE HEART
Audioquest LPs and CDs £14.95

SHEFFIELD LABS

DIRECT TO DISC
THELMA HOUSTON & PRESSURE COOKER
L'VE GOT THE MUSIC IN ME
HARRY JAMES & HIS BIG BAND
THE KING JAMES VERSION
STILL HARRY AFTER ALL THESE YEARS
DAVE GRUSIN
DISCOVERED AGAIN
HARRY JAMES & HIS BIG BAND
COMIN' FROM A GOOD PLACE
THE SHEFFIELD TRACK RECORD
& THE SHEFFIELD DRUM RECORD
JAMES NEWTON HOWARD AND FRIENDS
ROCK INSTRUMENTALS
SHEFFIELD LABS CDS £14.49

CHESKY RECORDS

JAZZ SERIES COMPACT DISCS
Oversampled x 128
Audiophile Quality,
considered by some to be the finest quality jazz recordings.
JAZZ SAMPLER
& AUDIOPHILE TEST CD
DAVID CHESKY
THE NEW YORK CHORINHOS
CLUB DE SOL
JOHN PIZARELLI
MY BLUE HEAVEN
HERBIE MANN
CAMINHO DE CASA
JOHNNY FRIGO & JOHN PIZARELLI
LIVE FROM STUDIO A
PHIL WOODS
HERE'S TO MY LADY
LUIS BONFA
NON-STOP TO BRAZIL
PAQUITO D'RIVERA
TICO! TICO!
CLARK TERRY
PORTRAITS (NOW AVAILABLE ON LP)
LIVE AT THE VILLAGE GATE
ANA CARAM
RIO AFTER DARK (NOW ON LP)
AMAZONIA
NATASHA
NATASHA
Chesky CDs £13.49

NEW CHESKY

CLASSICAL CDS
EARL WILD
PLAYS MEDTNER
TRANSCRIPTIONS OF GERSHWIN
CHOPIN: 4BALLADES, 4 SCHERZI
GARY SCHOCKER (FLUTIST)
BACH, HANDEL, TELEMANN
RACHMANINOFF
PIANO CONCERTO NO.2/ ISLE OF THE DEAD
SIBELIUS
SYMPHONY NO. 2
TCHAIKOVSKY/DOHNANYI
PIANO CONCERTO NO. 1/VARIATIONS ON A NURSERY SONG
DVORAK/WAGNER
SYMPHONY NO. 9/ OVERTURE FROM THE FLYING DUTCHMAN
BRAMMS
SYMPHONY NO. 4
MOZART/HAYDN
SYMPHONIES 35 & 41/ NO. 104
STRAUSS/RAVEL/TCHAIKOVSKY
DER ROSENKAVALIER/BOLERO/
ROMEO & JULIET OVERTURE
BEETHOVEN
SYMPHONIES 2 & 5/LEONORE OVERTURE NO. 3
BRAMMS/STRAUSS
PIANO CONCERTO NO. 1
SALOME-DANCE OF THE 7 VEILS
BIZET/TCHAIKOVSKY
SYMPHONY IN C/FRANCESCA DA RIMINI
RESPIGHI
PINES OF ROME/ROMAN FESTIVALS, FOUNTAINS OF ROME
RACHMANINOFF
CONCERTO NOS 4 & 1,
RHAPSODY ON A THEME OF PAGANINI
TCHAIKOVSKI
VIOLIN CONCERTO
BRAMMS
SYMPHONY NO. 1
STRAVINSKY
PETROUCHKA, LA SACRE DU PRINTEMPS

Chesky CDs £13.49

ORIGINAL BLUES CLASSICS FROM FANTASY

SONNY TERRY
SONNYS STORY
LIGHTIN' HOPKINS
BLUES IN MY BOTTLE
MEMPHIS SLIM
ALL KINDS OF BLUES
JIMMY WITHERSPOON
EVENIN' BLUES (LP ONLY)
TAMPA RED
DON'T TAMPA WITH THE BLUES (LP ONLY)
OTIS SPANN
THE BLUES NEVER DIE
JOHN LEE HOOKER
THATS MY STORY
THE COUNTRY BLUES OF JOHN LEE HOOKER(CD ONLY)
MEMPHIS SLIM/TAMPA RED/ LONNIE JOHNSON
BAWDY BLUES(CD ONLY)

LPs £7.99 CDs £11.99

ORIGINAL JAZZ CLASSICS

DAVE BRUBECK
GREATEST HITS
GERRY MULLIGAN
MULLIGAN PLAYS MULLIGAN
GERRY MULLIGAN/PAUL DESMOND

NEW
TITLES

BILLY TAYLOR
 BILLY TAYLOR TRIO WITH CANDIDO
ERIC DOLPHY
 OUTWARD BOUND
BILL EVANS
 NEW JAZZ CONCEPTIONS INTERPLAY
 SUNDAY AT THE VILLAGE VANGUARD
ART BLAKEY AND THE JAZZ MESSENGERS
 CARAVAN
CHARLES MINGUS
 TOWN HALL CONCERT
CLARK TERRY
 SERENADE TO A BUS SEAT
CHET BAKER
 CHET
WES MONTGOMERY
 FULL HOUSE
 SO MUCH GUITAR
 FUSION
COLEMAN HAWKINS
 SOUL
 AT EASE WITH COLEMAN HAWKINS
CHARLIE PARKER
 BIRD ON 52ND STREET
PAUL DESMOND QUARTET
 FEATURING DON ELLIOT
EDDIE DURAN
 JAZZ GUITARIST
STAN GETZ
 STAN GETZ QUART

SONNY ROLLINS
 TENOR MADNESS
JOHN COLTRANE
 LUSH LIFE
BENNY CARTER
 JAZZ GUITAR
 LP'S £7.99 CD £11.99

FANTASY

A truly amazing catalogue of top flight artistes. These American LPs capture all the life and zest of the jazz scene in the post war years.

DAVE BRUBECK
 BEST FROM THE FANTASY YEARS
MILT JACKSON QUARTET
 MILT JACKSON QUARTET
 THE BEST OF MILT JACKSON
THE MODERN JAZZ QUARTET
 CONCORDE
MILES DAVIS
 THE MUSINGS OF MILES
 FEATURING SONNY ROLLINS
 BLUE MOODS
 AND HORNS
 NEW MILES DAVIS QUINTET
 COOKIN
 RELAXIN WITH MILES
 STEAMIN

WORKIN
 BLUE HAZE
STAN GETZ/ZOOT SIMS
 THE BROTHERS
ZOOT SIMS QUINTET
 ZOOT!
ZOOT SIMS
 THE BEST OF ZOOT SIMS
THE THELONIOUS MONK TRIO
 THE THELONIOUS MONK TRIO
S.ROLLINS/MODERN JAZZ QUARTET
 S ROLLINS/MOD JAZZ QUARTET
MILES DAVIS/MILT JACKSON QUINTET/SEXTET
GENE AMMONS ALL STARS
 THE HAPPY BLUES
THELONIOUS MONK MONK
 THELONIOUS MONK
 PLAYS DUKE ELLINGTON
 BRILLIANT CORNERS
KENNY BURRELL
 KENNY BURRELL
COLEMAN HAWKINS
 THE HAWK FLIES HIGH
SONNY ROLLINS
 WORKTİM
 SOUND OF SONNY
 MOVING OUT
 FREEDOM SUITE

WES MONTGOMERY
 WES MONTGOMERY TRIO
 INCREDIBLE JAZZ GUITAR
 MOVIN ALONG
THELONIOUS MONK/JOHN COLTRANE
 THELONIOUS MONK/JOHN COLTRANE
CHARLIE PARKER
 BIRD AT ST NICKS
PHILWOODS QUARTET
 WOODLORE
MODERN JAZZ QUARTET
 DJANGO
COUNT BASIE
 THE BEST OF COUNT BASIE
THELONIOUS MONK/SONNY ROLLINS
 THELONIOUS MONK/SONNY ROLLINS
JOHN COLTRANE
 COLTRANE
 SOULTRANE
 SETTIN THE PACE
BILL EVANS TRIO
 EXPLORATIONS
 PORTRAIT IN JAZZ
 Fantasy LPs £7.99

ANTILLES

BEN SIDRAN
 BOP CITY
 OLD SONGS FOR THE DEPRESSION
 Antilles CD only £10.99

ECM

EDWARD VESALA/SOUND & FURY
 INVISIBLE STORM
JON BALKE
 NONSENTRATION
ARVO PART
 MISERERE
KENNY WHEELER
 MUSIC FOR LARGE & SMALL ENSEMBLES
KEITH JARRETT
 J.S. BACH WELL-TEMPERED KLAVIER
JAN GARBAREK/MIROSLAV VITOUS/PETER ERSKINE
 STAR
ELENI KARAINDRU
 MUSIC FOR FILMS
SHANKAR
 MRCS
ARILD ANDERSEN
 SAGN
JAN GARBAREK
 WAYFARER
 EVENTYR
 THOSE BORN WITH WINGS
 PATHS AND PRINTS
PAT METHENY
 TRAVELS (DBL)
 FIRST CIRCLE
 WATERCOLOURS
 AMERICAN GARAGE
DAVID TOR
 CLOUD ABOUT MERCURY
CHICK COREA
 TRIO MUSIC LIVE IN EUROPE
RALPH TOWNER/GARY BURTON
 SLIDE SHOW
MARK JOHNSON
 SECOND SIGHT
 BASS DESIRE
 OREGON CROSSING
ABERCROMBIE/JOHNSON/ERSKINE
 LIVE
KEITH JARRETT
 PARIS CONCERT
 NUDE ANTS
 KOLN CONCERT
 STANDARDS VOL I
 PERSONAL MOUNTAINS
 DARK INTERVALS
 KEITH JARRETT TRIO
 STILL LIVE
 CHANGELESS
Z.HUSSAIN/J.MC,LIN
 MAKING MUSIC
RALPH TOWNER
 SOLSTICE SOUND & SHADOWS
 OLD FRIENDS NEW FRIENDS
 BLUE SUN
CHICK COREA
 TRIO MUSIC (DOUBLE)
 LIVE 80/81
GARY BURTON/CHICK COREA
 DUET

ECM LP (single): £8.99,
 (double): £12.99

ECM CD (single): £12.99
 CD (dbl): £16.99

INDIGO RECORDS

JAY OWENS
 THE BLUES SOUL OF JAY OWENS
JIMMY WITHERSPOON
 THE BLUES, THE WHOLE BLUES
 AND NOTHING BUT THE BLUES
LIGHTNIN' SLIM
 BLUE LIGHTNING
HONEYBOY EDWARDS
 DELTA BLUESMAN
 Indigo CDs: £10.99

RECORD MAIL ORDER SERVICE ORDER FORM

PLEASE FILL IN THE DETAILS BELOW IN BLOCK CAPS

ARTIST	TITLE	LABEL	PRICE	LP	CD	DAT
_____	_____	_____	_____	<input type="checkbox"/>	<input type="checkbox"/>	<input type="checkbox"/>
_____	_____	_____	_____	<input type="checkbox"/>	<input type="checkbox"/>	<input type="checkbox"/>
_____	_____	_____	_____	<input type="checkbox"/>	<input type="checkbox"/>	<input type="checkbox"/>
_____	_____	_____	_____	<input type="checkbox"/>	<input type="checkbox"/>	<input type="checkbox"/>
_____	_____	_____	_____	<input type="checkbox"/>	<input type="checkbox"/>	<input type="checkbox"/>
_____	_____	_____	_____	<input type="checkbox"/>	<input type="checkbox"/>	<input type="checkbox"/>
_____	_____	_____	_____	<input type="checkbox"/>	<input type="checkbox"/>	<input type="checkbox"/>
_____	_____	_____	_____	<input type="checkbox"/>	<input type="checkbox"/>	<input type="checkbox"/>
_____	_____	_____	_____	<input type="checkbox"/>	<input type="checkbox"/>	<input type="checkbox"/>

Sometimes titles on vinyl may be deleted without notice. If you would like an alternative please use the space below.

In the United Kingdom add £1.00 per item for postage and packing. Five or more items postage free.
 Overseas: add £2.00 per item P&P. Five or more items add £1.00 each.

Total number of albums ordered: _____ Total for P&P: £ _____ Total Price: £ _____

I enclose cheque/postal order for £ _____
 made payable to **Audio Publishing Ltd.**

Send to: **Hi-Fi World, 64 Castellain Road,
 Maida Vale, London W9 1EX.**

I wish to pay by Visa/Access, please debit my account no:

Name: _____

Address: _____

Expiry date: _____

Daytime tel. no: _____



CREDIT CARD ORDERS
TELEPHONE 071-266 0461
(24 HOURS)

Delivery within 28 days subject to availability.
 Prices are subject to alteration without prior notice. E&OE

·W·

REFERENCE GRADE AUDIOPHILE COMPONENTS YOU CAN AFFORD

·A·

Wilfred Audio offers a unique approach to the appreciation of top quality audiophile products. Our passion for music is such that we are forever seeking out those components that best convey the true feeling and sound of the music, while at the same time representing the real value. The products described here are such, and we guarantee listening satisfaction.

If you are in the market for reference grade components and you have a passion for music, please call Wilfred Kok on (081) 698 7386 to find out more about these fine products.

ATC Loudspeakers

ATC design and build demonstrably the finest sounding loudspeaker system in the world. In professional and audiophile circles, ATC are renowned for tremendous clarity, neutrality, dynamic range and imaging capability. That is why you'll find many of the world's most respected professionals, including the BBC, Chandos, and the San Francisco Symphony Orchestra monitoring through ATC systems. In a domestic system, you will be able to simply sit back in comfortable, relaxed surroundings and enjoy the most dynamic, transparent, purest sound you've ever experienced outside of the concert hall.

Prices from £950.
See reviews *Audiophile* 9/91
Recording Musician 9/92
Gramophone 8/92

XLO RS Cables

XLO Electric Reference Series audio cables are "The Best in the World." They offer, without exception, the highest level of total system performance achievable today. It is also important that they are easily affordable. XO Electric RS cables are not system dependent, so most audio systems can use them to sound their best.

In systems of the very highest quality, RS cables deliver unmatched freedom from sonic coloration at component interfaces, and achieve near perfect clarity, timbral accuracy, imaging, focus and retrieval of spatial and ambient field information.

See reviews *Stereophile* 2/92 & 12/92, *The Absolute Sound* 4/92.

AVI S2000MC CD Player

Utilising the Burr-Brown PCM63 20 bit multi-bit converter and 8 times oversampling filters, this AVI CD player also features the latest Philips CDM 9 engine. It is available right now for £999, giving the finest audio quality at an affordable price.

AVI S2000MP Preamplifier

With a THD and IMD distortion figure of -120dB, this preamplifier betters the majority of its competitors by 40dB. This pre-amplifier will substantially outperform models that are many times its price of £599.

AVI S2000MM Monoblock

With a distortion figure (THD + IMD of 0.001%), a damping factor of 1000, it competes

against amplifiers costing six times its price.
Price £899 a pair.

Audio Synthesis Passion

Price £558.
See forthcoming issue of *HFN/RR* 3/92

Audio Synthesis Digital Sources Module DAC

Price £1234.
See review *HFN/RR* 3/92

Alchemist Kraken

Probably the best value-for-money integrated amplifier. Price £444.

See review *Hi-Fi World* 9/92,
Audiophile 2/93. What *Hi-Fi* 12/92.

LFD Amplifiers

"An extremely lucid, crystalline performer. Both instrument and vocals were diamond-edged, discs coming through with transparent clarity, every facet firmly in place . . . Records were extremely lifelike, perfectly proportionally scaled and holographic . . . Ambience and depth were reproduced near perfectly, with pinpoint imagery and extremely stable positioning."
- *Hi-Fi World* 9/92
See also *Audiophile* 1/93

Priced from £699.

orelle DA 180

A new reference standard DAC is now available in its improved 1993 edition, with a new toroidal power supply, ALPS switch and higher standard case and fascia finish. The resulting sound is a genuine breakthrough at £549.

See review *HFN/RR* 11/92

Wilfred Audio

High Quality Audio Equipment

London (081) 698 7386. MON-SAT 9AM-7PM



Opening Hours:
Mon-Fri 10-6pm
Sat 10-3pm

Tel: 071-233 0774 Fax: 071-233 7226

HOT SOUNDING ITEMS

- Teac VRDS 10 CD
-
- ALCHEMIST KRAKEN PRE AND POWER
-
- ALCHEMIST FREYA AND ODIN PRE-POWER AMP
-
- ALBARRY AP4+S60A
-
- ORELLE DAC 180
-
- CASTLE WINCHESTER
-
- AUDIO INNOVATIONS
SERIES 1000 MONOBLOCKS
L-2 L-1 PRE-AMPS



HIFI CONFIDENTIAL
34 Buckingham Palace Rd
London SW1W 0RE
Tel: 071-233-0774
Fax: 071-233 7226

**BEST BUY
MUSICAL FIDELITY CDT
£499.00**

ONIX OA31

ONIX BWDI TUNER

**PINK TRIANGLE DA
CAPO DAC**

**"NEW MUSICAL
FIDELITY"
PRE-POWER F22+F18
"EXCELLENT"**

**MOTH PASSIVE AND
40W MONOS
ALSO 100VA PHONO
STAGE**

**JOHN SHEARNE PHASE
2 INTEGRATED AMP**

**HEYBROOK
SIGNATURE**

PRE-POWER AMP

**CARTRIDGES
DYNAVECTOR - DENON
- SHURE - SUMIKO - A.T.
- ORTOFON**

QUINTET 25w Stereo

CONCERTO 40w Stereo

TEMPO 30w Mono

All Class A with hard wired P.C.B. and Star earthing (the best of both worlds).

IN THE NORTH
Doncaster Hi-Fi Studios,
Sunnyfields (0302) 781387

Hi-Fi Experience
Glasgow (041) 226 4268

IN THE SOUTH
Vinyl Tube Audio
43-45 Fortress Road
Kentish Town
London
071-485-4854

Paul Green Hi-Fi
Bath, Avon
(0225) 316197

What do the critics say:

QUINTET

The Art Audio gives you music with a sense of rightness that you don't really question but simply get on and enjoy. Sweet, open and lucid, the music is produced with an easy sense of naturalness which makes long term listening fatigue free and especially rewarding. Roy Gregory, Hi-Fi Choice.

TEMPO

I feel that the Art Tempo amplifiers are among the finest valve power amplifiers currently available. The imagery that the Tempos create is vivid, lifelike and full of space and air.

**Alan Sircom, Hi-Fi World
MAESTRO**

... they are just so stunningly gorgeous and open to listen to, I can barely imagine anything more alluring.

Noel Keywood, Hi-Fi World

...the Maestro is part of that rare breed of hi-fi that makes you forget about the equipment and think about the music. In all, unlike the car, the Maestro lives up to its name.

Alan Sircom, Hi-Fi World



130 MAIN STREET, CALVERTON, NOTTINGHAM NG14 6LU Tel: 0602 653604

QUALITY HI-FI IN NORTH WALES

Contact John Hodgkinson for expert advice and friendly service. All equipment may be taken on home demonstration.

Main stockists of:

- ROTEL ★ YAMAHA ★ HARMAN KARDON ★ NAD ★
- TEAC ★ MICHI ★ TANNOY ★ KEF ★ HEYBROOK ★
- INFINITY ★ JBL ★ JAMO ★ HECO ★ KEF ★ TDL ★
- INFINITY RENAISSANCE ★ ALPHASON ★ ARISTON ★
- APOLLO ★ TARGET and more!

ELECTRO TRADER

THE Hi-Fi Centre in North Wales since 1978
19COLWYN CRESCENT, RHOS-ON-SEA, COLWYN BAY
Tel: (0492) 548932



Mail Order Specialists

Opening Hours: 9.30-1, 2-5.30

Demonstrations by appointment preferred



A

AUDIOCRAFT

(0895) 253340 UXBRIDGE, MIDDLESEX

SA ACOUSTICS SA

(0626) 67060 NEWTON ABBOT, DEVON

THE SYSTEM BUILDERS

- A&R LTD - AUDIO TECHNICA - AVI - CHORD -
- IMPULSE - J.A. MICHELL - LEVINSON - LURNA -
- L.F.D. AUDIO - MICROMEGA - ORTOFON - OCM
- TECHNOLOGY - PROAC - SD ACOUSTICS - SUMIKO
- SEISMIC SINK - SOUND AUDIO - SUGDEN -
- SUPERPHON - SANSUI - TARGET AUDIO - VOYD -
- WILSON AUDIO (RECORDINGS) - YBA - CABLES -
- STERLING - LFD - CANARE - ORTOFON

**STOCKIST OF GOLDEN DRAGON TUBES
PLUS OTHER FINE EQUIPMENT**

**EX-DEM AND USED EQUIPMENT SOMETIMES AVAILABLE
PLEASE RING FOR DETAILS**

**THE MUSIC IS THERE, THE SPEAKER ISN'T,
THAT IS THE ART OF HIGH FIDELITY**

V'AUDIO

**36 Druid Hill, Stoke Bishop, Bristol BS9 1EJ
0272 686005**

In the November Classic CD Hi-Fi Supplement, the **Ruark Swordsman Plus II** was recommended as the best speaker in the £200-£300 price bracket, and in addition the **Ruark Accolade** was joint winner with the **ATC SCM 50A** in the above £2K category. As these are three of our permanent demonstration speakers we heartily agree. They didn't include the **Ruark Templar** in the £400-£500 bracket, but then it's probably too new.

This latest little gem, when driven by the **Analogue Electronics Jupiter Amplifier (£300)**, produces one of the most enjoyable and musical sounds we have experienced for some time in this price bracket.

So do come and hear these and the new **AVI CD Player (£999)** on the SCM 50A's which have new amplification. Also worth an audition is the Analogue Electronics new **£450 Mercury Power Amplifier - a beefy but musical 150 watts/CH** and the new **AMC CD6 Player**. Ring one of the few really independent consultants around for a home demonstration. (Ask for Ian Vaudin).

Alchemist Products

KRAKEN:

"Every now and then a product comes along that causes a stir in the Hi-Fi industry. I feel the Kraken well built and with a superb sound quality has this potential."

Alan Sircom - Hi-Fi World

GENESIS:

"The genesis amplifiers express dynamic contrasts so dramatically that few British built power amplifiers can match them.

It is refreshing in the realm of the big Krells, heavyweight musical Fidelitys and gigantic thresholds, that the Alchemist amplifiers are diminutive by comparison."

Alan Sircom - Hi-Fi World



FOR MORE
INFORMATION
CONTACT:

ALCHEMIST
PRODUCTS
Tel: 081 883 3008
FAX: 081 883 1160

KRAKEN INTEGRATED£399

KRAKEN/PRE£395

KRAKEN/POWER£380

FREYA PREAMPLIFIER£1020

BRAGI PHONO STAGE£495

ODIN STEREO AMPLIFIER ..£1020

GENESIS MONO AMPS£1525

OPTIONAL UPGRADES:

KRAKEN MM MODULE£45

KRAKEN MC MODULE£55

UPGRADE P.S.U.£45

UK DEALER LIST

LONDON

KAMLA ELECTRONICS W1 (071) 323 2747
HIFI CONFIDENTIAL SW1W (071) 233 0774
BRADYS WC2H (071) 379 4010
CORNFLAKE SHOP W1 (071) 631 0472
KJ WEST ONE W1M (071) 486 0552

KENT

SEVENOAKS (0732) 459 555
STANDENS (0732) 353 540

HAMPSHIRE

AUDIO GALLERY (0730) 895 194

WEST MIDLANDS

MUSIC MATTERS (021) 429 2811
WEST MIDLAND AUDIO (0905) 58046

WILTSHIRE

SALISBURY HIFI (0722) 322 169

MILTON KEYNES

AUDIO INSIGHT (0908) 561 551

NORTHERN IRELAND

ZEUS AUDIO (0230) 332 522

"look, believe me, a good Hi-Fi shop is not that hard to find."



mike manning
the hi-fi specialists **audio**

- our wide range includes -

Naim Audio - AVI - Audio Innovations - Arcam - Rega - Roksan
ATC - Rotal - Pink Triangle - Audio Alchemy - Mission - Heybrook
Marantz - Marantz - Linn - Shalimar - Linn - Acoustic Energy

Listening Lounge - Home Installations - 2 Year Guarantees - Full Servicing Facilities

110 Middle Street, Yeovil, Somerset. Telephone (0935) 79361

0% - INTEREST FREE CREDIT- PLEASE PHONE FOR DETAILS - 0%

Try me and save on ANY current Hi-Fi AV or Home Cinema unit

SENSATIONAL PRICES GUARANTEED

Whether it's **TECHNICS** or **TESSERAC** -

TRY ME - you'll get first-class service, savings and support.

081-563 0003

Try Me & See Ltd, 5 Rocks Lane, London SW13 0DB

- ▶ Budget, Regular and Esoteric Equipment
- ▶ Full Manufacturer's Warranty
- ▶ Fax us your priority order 081-563 0300
- ▶ Free Insured Delivery, anywhere in the U.K.
- ▶ Minimum order £250
- ▶ Credit Cards accepted including Switch and Connect

QUALITY FM AERIALS

If you've spent a lot of money on your hi-fi gear, give your system the final touch with one of our Trix 3 element antennas. These are simply the "bees knees" in terms of construction and performance and feature heavy-duty seamless aluminium tube, anodised metal fittings, PCB connector and heavy duty clamp (with chunky wing nuts for easy installation). For information on these superb Danish aerials, send for a spec. sheet or to order, send a cheque for £34.95 (inclusive of P&P) to the address below or use your credit card.

TV MASTERS, 52 St Andrews Street, Northampton, NN1 2HY Tel: 0604 37769.

SUPERIOR SOUND AUDIO

Bespoke Audio Engineers

Listen to these remarkable amplifiers by AUDION

300B MONOBLOCKS "Probably the best amplifiers in the world" £1995.00
 EDISON STEREO "The original pwr/line integrated" £399/499
 845 POWERBLOCKS "Handbuilt to order, finish to suit" £35,000.00
 CHESSELL REFERENCE "m/c input superb '93 spec" £2495.00

(ALL POWER AMPS, ERIK ANDERSSON DESIGNED)

-tubes-amplifiers-speakers-cartridges-

-REPAIRED-MODIFIED-REBUILT-SERVICED-SALES-
ORIGINAL SNELL LOUDSPEAKER UPGRADES

Full Cartridge testing and rebuilding service

TUBE TESTING STATION

AUDIOPHILE COMPONENTS | CABLES | OUTPUT TRANSFORMERS

GROOVE TUBES EDISON ORIGINAL GOLD DRAGON

(main tubes agents for sussex 1000's in stock)

FOR ALL YOUR REQUIREMENTS

+AUDION+EDISON+ANDERSSON+AUDIONOTE+REFERENCE+JPW+COGAN
 HALL+SILVER SOUNDS+MAGNUM
 DYNALAB+MICHELL+TRANSFIGURATION+WILSON BENESCH+
 TRADE INQUIRIES WELCOME FOR OUR NEWLY EXTENDED RANGE
TAX FREE EXPORT SPECIALIST'S
 25 MONTEFIORE ROAD, HOVE, SUSSEX. Tel:/Fax 0273 202637

SAVE & ENJOY YOUR RECORD COLLECTION

Diamond Cantilever MC Cartridge

17-d2 Mk II



£298

inc. VAT, P&P

Solid diamond is the hardest possible material and is supreme for cantilever use. All musical information is transferred from the record with great speed and accuracy, with minimum loss of signal.

The 17D2's superb sound is appreciated by not only the domestic user but is installed in many Hi-Fi manufacturer's laboratories.

"The clarity and precision of sound that the 17D2 MkII can produce are about the best I have ever come across".

-Richard Black, Hi-Fi Choice

"This cartridge has all the hoped-for virtues in the best moving coils"

-John Borwick, Gramophone

Take this copy to your local Hi-Fi dealer or contact us directly. For a full refund, the cartridge should be returned in good condition within 14 days.

14 DAYS HOME TRIAL

DYNAVECTOR SYSTEMS LTD. 32 READING ROAD,
WOODLEY, READING, BERKS., RG5 3DB

Please send me further information on Dynavector cartridges, and 14 days home trial

Name _____
 Address _____
 Postcode _____

The Seismic Sink

A revolutionary approach to equipment support



For £169 the *Seismic Sink* provides a more impressive upgrade to the sound of your CD player than adding an outboard D/A converter -- even the Award-winning £700 Audiolab DAC! (WHAT HI-FI?, December 1992)

Spikes are essential for speakers, but - contrary to popular belief - are not the solution to equipment isolation. More vibration is fed into the equipment from so-called 'ground' than is taken away. Reviews to date have shown that the *Seismic Sink* outperforms Sorbothane, cones, MDF, glass and all spiked tables. The acoustic open circuit afforded by the *Seismic Sink* eliminates structure-borne vibration, dramatically improving the performance of your CD player, turntable, amplifier (especially valve kit), Laser Disc, VCR - even an outboard DAC.

Standard size: 43cm x 35cm (W x D), takes up to 7Kg

Heavy duty version (£189) takes up to 20Kg

Custom sizes for esoteric audio components available to order.

The ultimate isolation platform, with built-in spirit level and three adjustable feet for precise levelling.

Can be shipped worldwide. Contact your local dealer or Townshend Audio for further information and specifications.

Townshend Audio, Tims Boatyard, Timsway, Staines, Middx TW18 3JY.

Tel: (44) 0784 455866. Fax: (44) 0784 455044

CLASSIFIED ADS

FOR SALE

PRIVATE

ARCAM Black Box plus Deltec lead. Boxed. Good condition, £150. Also S.O. wall brackets, suit Kans or similar, £15. Birmingham. 021-476-8507 after 6pm.

EPOS ES14 loudspeakers with stands, £380. Gyrodec, clear acrylic, no arm but with armboard for SMEIV, £450. Both 20 months old, immaculate and boxed. Tel: 0423-504267.

EQUATION Zero loudspeaker, £600 (Hi-Fi Choice recommended) v.g.c., one year old. Tel. Anthony 0223 357906. (Cambridge.)

FOUR Leak Stereo 20s, four Leak TL12+. Recapped high quality caps, Holco resistors, good valves. Lots spare caps, resistors and valves. £1200. Yamaha C2 pre-amp, good match with Leaks. Tel: 0803-313340.

LECSON API amplifier, AC1 preamplifier, £250. Dynaudio 17W75 mid/bass units £75. Volt/Shackman electrostatic panels and PSU £150. Denon DCD1420 CD player, £150. Tel: (Cheltenham) 0242-676830.

LINN Kabers LS500 (latest version). Superb sound and condition; cost £1200, only £695.00 o.n.o. Acoustic Energy AE1, Rosewood; cost £850, only £535 o.n.o. (Stands available.) P/X considered. AE2a (£1000) only £595. Tel: 0225-480990.

PRIVATE

LINN LP12, Ittok, Troika under manufacturer's four-year warranty, £1150 o.n.o. Exposure XI pre-amplifier with PSU, £800 o.n.o. Arcam integrated amplifier, 10m Naim cable, gold plugs. Phone Mr Giles, 081-339-9081.

LINX Nebula integrated amplifier, hardly used, mint and boxed with handbook, £350. Armstrong 523 AM/FM stereo tuner, £75; Toshiba ST-230 tuner, £50, both excellent. Wanted: Rotel RB850 amplifier. Tel: 0582-25166.

MICROMEGA Solo CD, 14 months old, £550. Denon DRM07 cassette, £55. The Pre Amp, £100. Grant G100 pre-amp with new high-quality valves, £200. All in v.g.c. 0803-313340.

NAIM NAC 72, £395. Naim NAP 140, £395. Naim IBL speakers £395. Naim Hi-Cap, £395. All equipment is current spec boxed in new condition. Tel. 0635-40242

RECORD collection: 20 'Direct Cut', 5 'Super Cut' and 9 'Binaural' LPs, all pristine condition. 1975/79 originals (not re-runs) including 'Thelma Huston I've Got The Music In Me'. Telephone for list: 0492-878107.

LINN Ekos tonearm in mint condition, boxed, £650. Sony tuner, £20. Tel: 0344-773465.

PRIVATE

REVOLVER, LVX, MP10 SB, £115.00. Heybrook HB1s, £95.00. Decca revised unipivot arm, £70.00. Rogers amp £25.00. Celestion speakers £25.00. All v.g.c. Wanted: Garrard 301/401, SM100E, Yorkshire Hi-Fi 1.35. Tel: Paul 0895-446713.

TRADE

AUDIO NOTE Type Js, boxed, new, £395. Also Ks, £295. Innovations First Audio £795, Second, £1200 pair. B&W DM70 speakers, £150; DM4s, Tannoy, Garrard, valve amplifiers, other items. Tel: 0903-239980.

COLLECTORS: 200,000 out-of-print phono records. 1950-1985, all categories. Free catalogs, but kindly state your interests. International service since 1972. Craig Moerer, Box 19231-HF, Portland OR. 97280, U.S.A.

STRAD TRADITIONAL AUDIO are specialists in the construction of classic 1950s loudspeaker enclosures, including corner horns, using the latest Hi-Ferric Lowther drive units. High standard of quality veneering and marquetry, hand French Polishing. We make other cabinets to your specification. S.A.E. to 29 Meadowfield, Whaley Bridge, via Stockport, Cheshire SK12 7AX.

advertisers' index

A&R CAMBRIDGE	20
A-3 (MICRO PRO)	98
ACOUSTIC ENERGY	IBC
ALCHEMIST PRODUCTS	95
ALEMA UK	96
ANALOG AUDIO	108
ANTIFERANCE	104
ART AUDIO	94
AUDIO NOTE	116
AUDIO TECHNICA	88
BANDOR	40
BARTLETTS	112
BILLY VEE	118
CAMPAIGN AUDIO DESIGN	99
CLEAR CRYSTAL SYSTEMS	113
CONNECTIONS	106
CHESTERFIELD SHOW	108
DPA DIGITAL	4
DYNAVECTOR SYSTEMS	96
ELECTROTRADER HI-FI	94
FULLERS AUDIO	38
HAILEY AUDIO	113
HARROW AUDIO	113
HI-FI ATTIC	106
HI-FI CONFIDENTIAL	94
HIGH FIDELITY	101
IAN HARRISON HI-FI	107
J. E. SUGDEN	115
KEF	6, 7
KIMBERLEY HI-FI	101
KJ LEISURESOUND	22, 88, 113
LISTENING ROOMS	107
LORICRAFT	99
MAG AUDIO	100
MANTICORE	107
MAX TOWNSHEND	96
MICHELL ENGINEERING	38
MIKE MANNING	95
MONITOR AUDIO	OBC
MUSIC MATTERS	117
MUSICAL DESIGN CO	100
MUSICAL IMAGES	109
NAIM AUDIO	IFC
NORTHWOOD AUDIO	114
OXFORD AUDIO	99
PRECISION CABLES	100
QED	90
REFERENCE IMPORTS	119
REL ACOUSTICS	120
RON SMITH AERIALS	104
ROOM ACOUSTIC SERVICES	106
SEVENOAKS	110, 111
SLATE AUDIO	101
SPALDINGS	101
STUDIO ACOUSTICS	94, 106
SUBURBAN AERIALS	104
THE AERIAL SHOP	104
THE POWER PLANT	106
THE SPEAKER CO.	99
TRY ME + SEE	96
TUBE TECHNOLOGY	22
TV MASTERS	96
V / AUDIO	94
WEST MIDLANDS AUDIO	Supp.
WILFRED AUDIO	93
WILMSLOW AUDIO	40
WOLLATON AUDIO	88

HI-FI WORLD CLASSIFIED ADS

Please write your advertisement copy on a separate sheet of paper and return with this completed form.

Name

Address

Post Code

Daytime Tel No:

Private Advertiser Trader (Tick where applicable)

Display (2cm box £15 Inc. VAT.)

I enclose cheque/postal order for £

Made payable to **Audio Publishing Ltd.**

Please debit my VISA/ACCESS Card No.

<input type="text"/>	<input type="text"/>	<input type="text"/>	<input type="text"/>	<input type="text"/>	<input type="text"/>	<input type="text"/>	<input type="text"/>	<input type="text"/>	<input type="text"/>	<input type="text"/>	<input type="text"/>	<input type="text"/>	<input type="text"/>	<input type="text"/>	<input type="text"/>	<input type="text"/>	<input type="text"/>	<input type="text"/>	<input type="text"/>
----------------------	----------------------	----------------------	----------------------	----------------------	----------------------	----------------------	----------------------	----------------------	----------------------	----------------------	----------------------	----------------------	----------------------	----------------------	----------------------	----------------------	----------------------	----------------------	----------------------

Expiry Date:

Send to: **Hi-Fi World Classified Ads.**,
Audio Publishing Ltd.,
64 Castellain Road, London W9 1EX.



SPECIAL OFFER! Now you can advertise in the Classified Section for only £10 (incl. VAT). Maximum length is thirty words, each additional word 50p extra.

NEW!
Display ads -
2cm box,
£15 (incl. VAT).

Telephone and model numbers are treated as one word. All advertisement copy should be typed or written in block capitals and accompanied by the form on this page.

Cheques should be made payable to **Audio Publishing Ltd.**

Please send your copy to:
Hi-Fi World Classified Ads.,
Audio Publishing Ltd.,
64 Castellain Road,
London W9 1EX.

Classifieds will be published in the first available issue after receipt.

A TO Z ELECTRONICS (MAIL ORDER CENTRE)

8 ALFRED PLACE, LONDON WC1 E7EB
TEL: 071-636 4084

BOSE	
XL3000	SALE
XL4000	SALE
AMZII	SALE
AMZ	SALE

NAD	
302	£125
304	£165
306	£225
902	£129
906	SALE
402	SALE
701	SALE
705	SALE
502	SALE
505	SALE
6100	SALE
1700	SALE

TECHNICS	
SCCH900	£635
SCCH700	£529
SCCH550	£399
CDX120	£419
CDX320	£475
CDX920	£785

PIONEER	
J2T	£545
J3T	£635
N52T	£355
N52M	£385
N72T	£505
N72M	£545
N92T	£599
N92M	£645
S137T	£355
S137M	£399

JVC	
UXA3	£239
UXA5	£315

SONY	
MCH1700CD	£399
MCH2700CD	£475
MCH3700CD	£565
MCH700CD	£359
MCH500CD	£259
COMPACT 307CD	£365
COMPACT 357CD	£399
COMPACT 507CD	£485
COMPACT 557CD	£519
COMPACT 607CD	£565

AIWA	
NSX990	£299
NSXD55	£355

TANNOY	
603	SALE
605	SALE
607	SALE
609	SALE
611	SALE

HI-FI SEPARATES

TECHNICS	
SLPG320	£115
SLPG420	£129
SLPG620	£179
SVVX920	SALE
SVVX626	SALE
RSBX727	SALE
SONYTCK590	SALE
SONY CDP797	SALE
PIONEER PDS801	SALE
PIONEER PDS901	SALE
MARANTZ CD52II	SALE
KENWOOD KAV8500	SALE

All above prices include VAT and are correct at the time of going for copy and are subject to change & availability.

KENWOOD



M-85G

DOLBY SURROUND PRO LOGIC

REMOTE CONTROLLED MIDI HI-FI SYSTEM

- * 70 WATTS X 2 MAIN, 15 WATTS X 2 REAR; DIN 8 OHMS
- * DIGITAL SOUND PROCESSING (DSP) * PRO LOGIC CENTRE CHANNEL FACILITY * DOUBLE AUTO REVERSE CASSETTE DECK
- * SINGLE BIT CD PLAYER * QUARTZ SYNTHESIZED TUNER
- * ELECTRONIC GRAPHIC EQUALISER/SPECTRUM ANALYSER
- * 3-WAY SPEAKER SYSTEM * BELT DRIVE TURNTABLE

M-76G

DOLBY SURROUND

REMOTE CONTROLLED MIDI HI-FI SYSTEM

- * 60 WATTS X 2; DIN 8 OHMS * DIGITAL SOUND PROCESSING (DSP)
- * DOUBLE AUTO REVERSE CASSETTE DECK * SINGLE BIT CD PLAYER
- * QUARTZ SYNTHESIZED TUNER * ELECTRONIC GRAPHIC EQUALISER/SPECTRUM ANALYSER * 3-WAY SPEAKER SYSTEM
- * BELT DRIVE TURNTABLE



UD-900M

DOLBY SURROUND PRO LOGIC

REMOTE CONTROLLED MINI HI-FI SYSTEM

- * SEPARATE PRE AND POWER AMPLIFIERS * 40 WATTS X 2 MAIN, 20 WATTS X 2 REAR; DIN 8 OHMS * DOUBLE AUTO REVERSE CASSETTE DECK * SINGLE BIT, 6 + 1 MULTI-PLAY, CD PLAYER * QUARTZ SYNTHESIZED TUNER * FULL DIGITAL SOUND PROCESSOR GRAPHIC EQUALISER * PRO LOGIC CENTRE CHANNEL FACILITY
- * 3-WAY DUAL STEREO, OMNI-DIRECTIONAL SPEAKER SYSTEM

UD-700M

DOLBY SURROUND

REMOTE CONTROLLED MINI HI-FI SYSTEM

- * 35 WATTS X 2 MAIN, 15 WATTS X 2 REAR; DIN 8 OHMS * DIGITAL SOUND PROCESSING (DSP) * DOUBLE AUTO REVERSE CASSETTE DECK
- * SINGLE BIT, 6 + 1 MULTI-PLAY, CD PLAYER
- * QUARTZ SYNTHESIZED TUNER * ELECTRONIC GRAPHIC EQUALISER/SPECTRUM ANALYSER * 2-WAY SPEAKER SYSTEM

Oxford Audio Consultants

HI-FI SPECIALISTS



Our superb service is the same,
regardless of price.

SONUS FABER LOUDSPEAKERS

WE LOVE THEM ALL!

NOW DEMONSTRATING

TEAC VRDS 10 CD PLAYER
SEQUENCE LOUDSPEAKERS
AUDIO ALCHEMY DTI - CONNECT BTN CD & D/A CONVERTOR
FOR A BIG IMPROVEMENT
VAN DEN HUL THE FIRST CABLE
THETA DATA 2/DS Pro Prime
AUDIO RESEARCH LS3 PREAMP
AUDIO RESEARCH LS2B
COPLAND CTA 401
KRELL KSL preamp & KRELL KST 100 power amplifier
HEYBROOK SIGNATURE AMPLIFIERS & LOUDSPEAKERS
AUDIO RESEARCH V70 POWER AMPLIFIER
PROCEED SERIES 3 CD DIGITAL PROCESSOR & CD TRANSPORT
REVOX EVOLUTION AUDIO SYSTEM
WADIA — latest range on demonstration
LYRA LYDIAN CARTRIDGE — simply stunning!
SONUS FABER MINUETTO/ELECTA/AMATOR/EXTREMA
MICHELL GYRODECK — Still a Classic!
MUSICAL FIDELITY PREAMP & TYPHOON
MAGNUM PREAMP & MONOBLOCK POWER AMPS
MICHELL ISO/ARGO
REL STADIUM SUBWOOFERS
HARMONIX ACCESSORIES

NOW DEMONSTRATING

Ex Dem & P/ex Bargains

CLASSE DR6 PREAMP - MINT £1995.00
CLASSE DR9 POWER AMPLIFIER - MINT £1995.00
BEARD BB1 BB100 11 £795.00
KRELL KSA 50 £895.00
REVOX H6 TUNER £595.00
AUDIO RESEARCH CLASSIC 60 new valves £2495.00
THETA DS PRO PRIME D/A as new £995.00
MARANTZ PM80 AMPLIFIER £299.00
PIONEER PD8700 £225
CHORD 1000 POWER AMPLIFIER £1495.00
REVOX Hill cassette £595.00
MUSICAL FIDELITY CD1 £250.00

Please ask for details or our current list

Agencies include: Audio Research, Apogee, Air Tangent, Koetsu, Krell, Magnephanar, PS Audio, Sonus Faber, Audio Technica, Goldring, Marantz, Micromega, Ortofon, Rogers, SD Acoustics, Stax, Thorens, Wharfedale, Kimber, Sennheiser, Slate Audio, Target, QED, van den Hul, NAD, Nakamichi, SME, JPW, Revox, Dual, Monitor Audio, Pioneer, Proceed, Onix, Teac, Rotel, T.D.L., Ruark, Acoustic Energy, Audio Alchemy, Deltec, Musical Fidelity, Accuphase, Basis, Wadia, Theta, Sequerra, Castle, Heybrook, Copland, Denon, Cartridges, ART Accessories, Harmonix.

TAX-FREE EXPORT SERVICE

MAIL-ORDER AVAILABLE ON MANY ITEMS.

Open Mon-Sat 10am-6pm.

Oxford Audio Consultants

Cantay House, Park End Street, Oxford OX1 1JE
Telephone: Oxford (0865) 790879
Facsimile: Oxford (0865) 791665

The SPEAKER Company

For all your needs in DIY speaker and crossover construction

We offer a large range of speaker chassis and crossover components for hi fi, car audio, public address & studio uses. The Speaker Company also offers a range of specialist services.

Hi-Fi chassis speakers, crossover's, cabinet kits, cable, cabinet damping materials, spike kits etc

Car Audio chassis speakers, crossover's, sub bass cabinets and amplifiers.

Public Address chassis speakers, crossover's, mixers, amplifiers, cabinets, microphones and stands.

Plus a comprehensive range of accessories

Chassis speakers by

Audax, Seas, Morel, Rcf, Kef, Elac, Rcl, Richard Allan, Fane, MCKenzie, Celestion, Eminence, Peerless, Volt, Altai, Soundlab, P.H.L. Please phone or post for a copy of our free comprehensive catalogue and price list which includes hints and tips on DIY loudspeaker construction.

Unit 9, Waterside Mill, Waterside
Macclesfield, Cheshire SK 11 7HG

Tel: 0625-500507

Fax: 0625-500508

All goods dispatched within 24 hours subject to availability

Open 9 am to 6 pm Monday to Friday & 9 am to 5 pm Saturday



LOVE HERTZ

We will improve your Hi Fi or give you
your money back

Campaign Audio Design
Llandudno Road (HW)Cardiff CF3 8PG

Tel: 0222 779401

TRADE & INTERNATIONAL ENQUIRIES WELCOME

LORICRAFT AUDIO

TURNTABLE SERVICE & REPAIR AND PROFESSIONAL RECORD CLEANING SERVICES

NEW RANGE of craftsman made plinths in solid Oak/Mahogany. 18mm MDF substructure, machined in motor, board in various finishes. Resiliently mounted with cover and hinges. Suitable for Garrard 301, 401 and Thorens TD124.

DEDICATED POWER SUPPLY for Garrard 301. Improves performance dramatically.



S.A.E. for catalogue
4 Big Lane, Goose Green,
Lambourn, Berks.
RG16 7XQ.
Tel: 0488 72267

'Were you aware that most
of the worlds most exciting
digital electronics come from
one manufacturer?'



Micromega

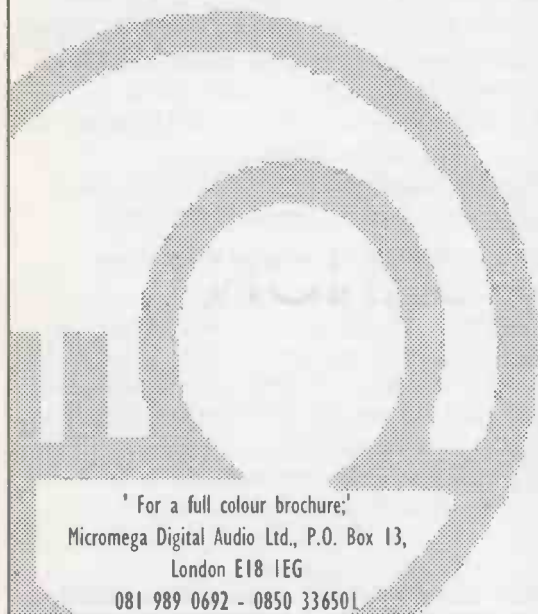

'For a full colour brochure,'

Micromega Digital Audio Ltd., P.O. Box 13,
London E18 1EG

081 989 0692 - 0850 336501

PRECISION CABLES LTD

We really do stand alone for **UNBEATABLE SERVICE** both in **QUALITY** and **REALISTIC PRICES** making our customised cable service simply the best available **TODAY AND TOMORROW.**

OLYMPIC RANGE OF HI-FI CABLES

BRONZE QUALITY

Precision Neutrik XLR, Jack Plugs
Musiflex cable is well known throughout
the Professional Music Industry for its
neutral transparent sound.

DESCRIPTION	LENGTH	PRICE
Phono-Phono pair	0.25m.	£12.75
Phono-Phono pair	0.5m.	£13.50
Phono-Phono pair	1m.	£15.00
Phono-Phono pair	2m.	now £17.00
Phono-Phono quad	0.25m.	£27.00
Phono-Phono quad	0.5m.	£28.50
Phono-Phono quad	1m.	£30.00
Phono-Phono quad	2m.	now £34.00
Jack-Jack patch lead		£6.00
Jack-Jack	0.5m.	£7.50
Jack-Jack	1m.	£8.00
Jack-XLR (mic)	1m.	£8.50
Jack-XLR (mic)	2m.	£9.50
Jack-XLR (mic)	5m.	£12.50
XLR-XLR	1m.	£8.50
Scart-Phono pair	1m.	£10.00
Scart-Phono pair	2m.	£12.00
Scart-phono quad	1m.	£16.00
Scart-Phono quad	2m.	£20.00

SILVER QUALITY

Neutrik ProFi Connectors possibly the
best quality Phono connectors available.

DESCRIPTION	LENGTH	PRICE
Phono-Phono pair	0.25m.	now £26.00
Phono-Phono pair	0.5m.	now £27.50
Phono-Phono pair	1m.	now £29.00
Phono-Phono pair	2m.	now £31.00
Phono-Phono quad	0.25m.	now £41.00
Phono-Phono quad	0.5m.	now £42.50
Phono-Phono quad	1m.	now £44.00
Phono-Phono quad	2m.	now £48.00

Musiflex cable

Please add £1.00 per extra m. single		
Please add £2.00 per extra m. pair		
Please add £4.00 per extra m. quad		
Scart-Phono pair	1m	£17.00
Scart-Phono pair	2m	£19.00
Scart-Phono quad	1m	£26.00
Scart-Phono quad	2m	£30.00

LINN K20 CABLE USED

Unterminated per m. £2.00
Gold plated 4mm banana plugs std.

J. A. Michell available

DESCRIPTION	LENGTH	PRICE
4mm-4mm	2m.	£16.50 ea.
4mm-4mm	4m	£20.50 ea.
Jack-Jack	2m.	£12.50 ea.
Jack-Jack	4m.	£16.50 ea.
Jack-XLR	2m.	£13.00 ea.
Jack-XLR	4m.	£17.00 ea.
XLR-XLR	2m.	£13.50 ea.
XLR-XLR	4m	£17.50 ea.

Prices are for single cables (per channel)
not pairs.

PC SCREENED MAINS CABLE

16 amp 1.5mm per m.	£4.50
20 amp 2.5mm per m.	£6.20

To: **PRECISION CABLES LTD. 53**
EFFINGHAM ROAD, LEE GREEN, LONDON
SE12 8NT.
TEL: 081-297-0255.

Please send me: _____

I Enclose Cheque/Postal Order (Made
Out To Precision Cables Ltd.)/Cash

For _____

£ _____

Name: _____

Address: _____

Post Code: _____

tel: _____

Please Phone for FREE catalogue

All Prices include V.A.T.

Please add £5.00 for postage.

Personal Callers only by appointment.

MAG. AUDIO

MAG. AUDIO have produced a brand new two-way full ribbon panel speaker based on the magnestatic principal, but by using new technology the cost has been substantially reduced - without changing the quality which will satisfy the most demanding music lover.

MAG. AUDIO A90X is able to reproduce the finest details which will dsappear in a traditional speaker. This is due to the extreme light weight of the membranes which are driven over the whole area by 184 single magnets. The result is unique low dlstortion.

MAG. AUDIO A90X is built without compromise, from first class com-
ponents.

MAG. AUDIO A90X has been placed in the TOP CLASS by the German hi-fi Magazine HI-FI VISION, which also gave it the verdlct "very fast, very understandable and extremely trans-
parent."

MAG. AUDIO A90X can be delivered in Mahogany, Ash,
Pine, Pear tree or Oak natural or stained. Rare woods are
available at extra cost.

For further information contact:

MAG. AUDIO UK,
43 Hennker Point, Leytonstone Road,
Stratford, London E15 1LG
Tel/Fax: 081-555 1222

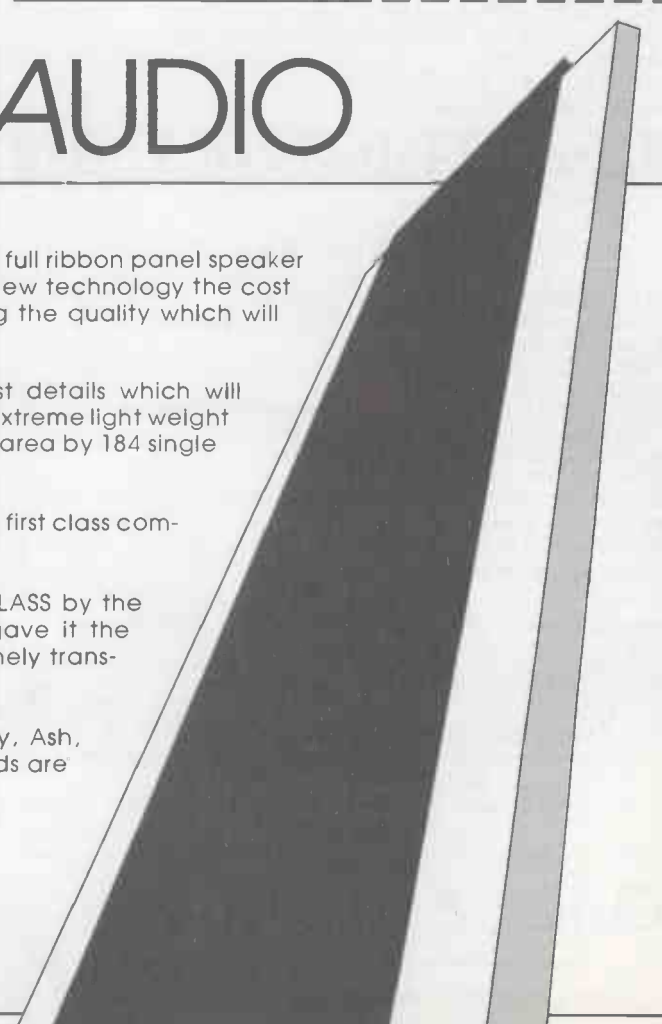

352-354 Lower Addiscombe Road,
Croydon, Surrey CRO 7AF
Telephone: 081 654 1231/2040

Fax: 081 655 3922

High Fidelity/Loudspeaker
and Video Specialists



SPALDINGS THE HI FI SHOP

THAT PROBABLY HAS
THE HIGHEST STANDARDS
IN THE SOUTH EAST.

Whether you are a complete beginner or have many listening hours under your belt, you need the facilities a really good hi-fi shop offers to ensure you get the best value.

We carefully select equipment in every price range, from good value products at around £200 per item, to more expensive and even more enjoyable systems costing thousands.

In our demonstrations we use listening rooms separate from the main shop and our extensive experience enables us to get the best from every piece of equipment. This makes differences and improvements pleasantly obvious.

We offer free of charge the most vital part of any hi-fi system, the detailed preparation and installation necessary for us to achieve the best sound in your home.

We guarantee that you will be thrilled with your music, not just for the first few months but over many years of listening.

Equipment From:

ARCAM•AUDIOLAB•LINN•NAIM•QUAD
DENON•ROTEL•MARANTZ•KEF
RUARK•EPOS•MISSION•CYRUS
CELESTION•DUAL•MERIDIAN•MICHELL
AND OTHERS

PLEASE DO NOT HESITATE TO CONTACT
US TO ARRANGE A DEMONSTRATION OR
JUST FOR ADVICE ON:

081 654123 / 6542040

HIGH FIDELITY

0582 504560

This Month's Special Offers

Rotel 965 BXLE	£330
Pink Triangle LPT GTi turntables	£449
Audio Alchemy BDE1	£349
Acoustic Energy AE1 speakers	£595

6 Carolyn Court, Trinity Road, Luton, Beds. LU3 2NF

KIMBERLEY HI-FI

"A Sound Investment"

DENON

LIFESTYLE
HI-FI SYSTEMS
on demonstration

DENON • TECHNICS • KENWOOD • AIWA • DUAL •
WHARFEDALE • CASTLE • MISSION • TANNOY • HECO • PIONEER
• MONITOR AUDIO • B&W •

193, BROADWAY, BEXLEYHEATH, KENT.
TEL: 081-304 3272

SLATE AUDIO



HI-FI Design & Cable Services

THE SPEAKERSTAND Custom made to suit any loudspeaker. Solid slate, supremely rigid & totally stable. P.O.A.

"Immaculately finished, sublimely rigid, on a par with the best stands I've used."

Ken Kessler, Hi-Fi News/RR March '89

"An astonishing degree of instrumental separation, stable and holographic, with great precision and remarkable poise. The ultimate in high fidelity supports."

David Praker, Hi-Fi Answers Sept. '89

"Superbly finished, the sound quality was considered to be first rate."

Martin Colloms, Hi-Fi News/RR May '90

"The sound quality when using the Slate Audio stands proved to be a revelation, something special."

Paul Messenger, Hi-Fi Choice, May '91

"The finish is excellent, the sound quality magnificent and breathtaking."

Tom Bryant, The Telegraph, June '92

The Finest Speaker Supports In The World

GARRARD 401 PLINTH SYSTEM With 20 years of experience, we are now the leading experts on the 401. In solid marble, this plinth eliminates motor noise, rumble and feedback.

The sound quality from this classic motor has now reached superdeck status. £349 + £25 p/p

THE TURNTABLESLAB Solid slate spiked turntable platform, can be placed anywhere with remarkable results. £175.00

THE TABLESLAB Solid slate shelf which replaces any other shelf normally fitted to equipment racks, dramatically improving your turntable's performance. State size: £125.00

THE SPEAKERCABLE LC OFC. Meets the same high standard set for our loudspeaker stands. A supremely neutral and clean sound. Please state length required. £15 per metre

THE SPIKEKIT Specially developed to fit directly to floor standing loudspeakers or any wooden support. Adjustable and very simple to fit. £20.00

THE STONESET Spike kit for use with stone, slate or marble only. Fully adjustable. £20.00

ALL PRICES INCLUDE PACKING AND FREIGHT UNLESS OTHERWISE STATED. (U.K. MAINLAND)

I ENCLOSE A CHEQUE/P.O. for £ made payable to SLATE AUDIO

Name:

Address:

Tel:

47 GEMINI CLOSE, LEIGHTON BUZZARD, BEDFORDSHIRE, LU7 8UD. TEL 0525 384174

Wharfedale's Diamonds are possibly the most famous of the mass of sub-£150 miniatures on the market. The latest version of this budget favourite is the Diamond V, priced at £130, which has evolved with the times to include a metal dome tweeter and designer-contoured plastic front baffle.

The competition in this area has become increasingly strong, with loudspeakers such as the Goodmans Maxim 3 and the Celestion 1 currently being the ones to beat. The reasons why the budget miniature has become so popular are basically down to cost and performance. They are cheap to produce which is a major determining factor in the current economic climate. Additionally, because the bass and treble units are close together a miniature closely resembles a point source, giving well defined and coherent sounding stereo images.

For the best imaging and focus all the sound should come from the same point on each loudspeaker. Theoretically, mounting the treble unit at the centre of the bass unit, such as KEF do with their point source Uni-Q driver, should produce the best image. However, this method has other problems, so currently the miniature with its closely spaced drive units offers the best compromise.

Market Niche

This combination of low price and high performance has prompted many manufacturers to aim for the same market niche, further increasing the amount of competition, raising the quality of sound per pound. The consumer has also recognised this new raised ability in current miniatures, adding demand into the equation. As a result, quality is spiralling upwards as the price stays low.

The Maxim 3 has most recently set the standard, with its ultra flat frequency response, low price and superb sound quality. The Diamond V costs £20 more than the Maxim but looks better finished, due mainly to their stylish moulded front baffle, which makes the Maxim's black vinyl covering look a little crude. The moulding is contoured around the bass and treble units, presumably to help efficiency and dispersion.

The treble unit is a 19mm alloy dome unit which is protected by a plastic frame and by the grille when it's in place. This and the bass unit, which has a plastic cone attached to a supple rubber surround, are connected to a simple crossover and then to a set of single 4mm binding posts. Bi-wiring is not an economical option for the budget miniature.

At the rear of the Diamond is a small reflex port. This port is tuned to

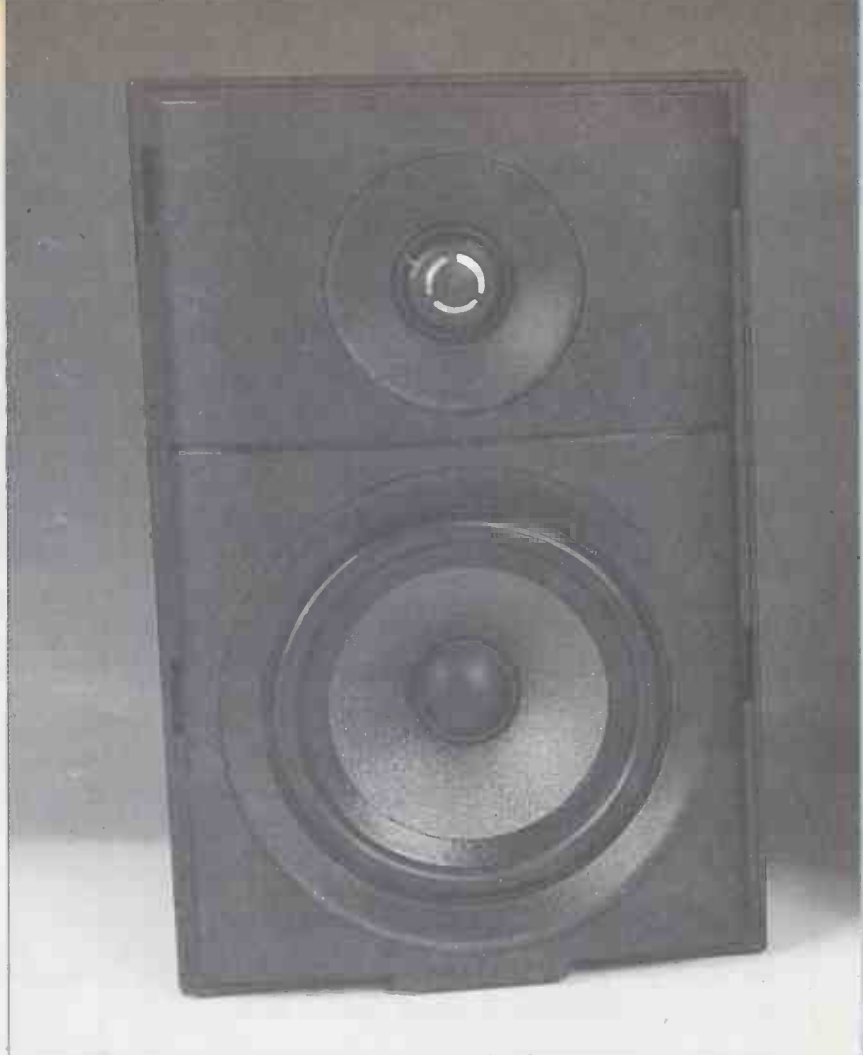

A Little Gem?

Wharfedale's new small loudspeaker is the Diamond V. Dominic Baker listens to the latest of the famous line.

aid bass extension, which it would otherwise lack. It highlights a drawback of miniature loudspeakers; small size means efficiency must be compromised to provide adequate bass. However, because of their low price they tend to be paired up with budget, low-powered amplifiers which need an efficient loudspeaker if they are to go loud. In the end, the miniature becomes a trade-off between bass extension and sensitivity.

I was lucky enough to have Goodmans Maxim 3 and Celestion 1 loudspeakers to hand which I used to help me assess the Wharfedale Diamond Vs. All were used on suitable Foundation stands placed close to a rear wall. Because the

Diamonds, like most miniatures, have their port at the rear of the cabinet, when sited on a bookshelf it may be necessary to plug the port with some soft foam. This reduces the effect of the port, whose job is partially catered for by wall re-inforcement in this situation.

The Diamonds were left to run overnight before critical listening commenced. Although they have such modest dimensions, some miniatures have an out-of-the-box character, helping make them seem far larger than they really are. The Diamond Vs do not enter this category: they sound small.

I found the bass was well extended and quite meaty, but it was also boxy and slow. I tried several

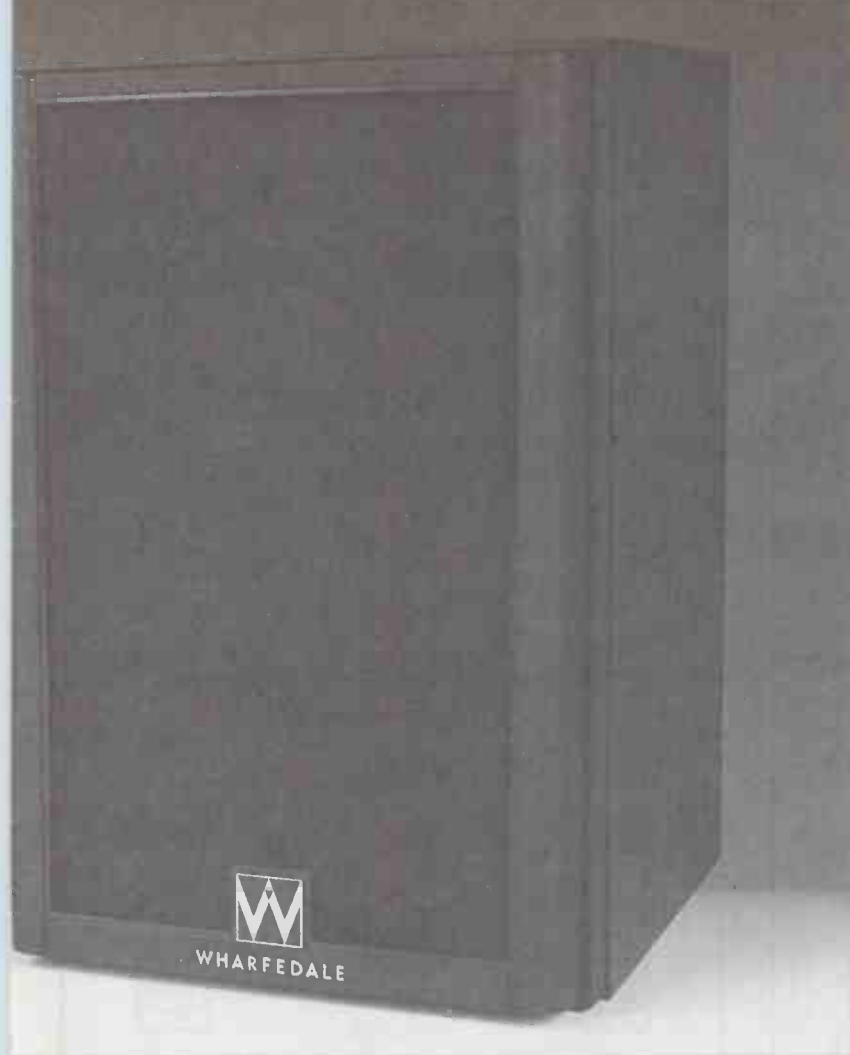

amplifiers in an attempt to overcome this, but even a costly pre/power-amp could not produce the speed in the bass that superior competitors have on offer. Plugging the ports with foam and moving them into the room a little produced better results. Although some bass depth was lost, what was left became solid, controlled and quite dynamic. Spiking them to the stands rather than using Blue-Tak also brought about an improvement in speed and they sounded altogether lighter and more open after being tweaked in this manner.

My experiments were getting me nearer to the result that I was expecting from this most famous of miniatures. Removing the grilles and toeing the speakers in very slightly cleaned up the rest of the spectrum and the sound became focused in the way you would expect from a near point-source. Set up in this manner they imaged well and gave the impression of having a reasonably large soundstage.

With REM's album *Out of Time* the little Diamond Vs gave a clean and delicate performance, only disturbed by the track 'Low' where their over-heavy bass crept back. There did seem to be something missing in the lower midrange where instruments lost some of their attack, and the boxiness remained noticeable, but otherwise all seemed in order.

I felt that the treble remained a bit 'shut in', which may possibly be due to the tweeter's necessary protective plastic moulding. It lacked bite when a cymbal was hit hard, turning it into a more of a laid back tingle than an ear shattering crash. However, for a metal dome tweeter it was well behaved, free of peaks right up to the top of its range which also sounded well extended. This is certainly a lot better than a peaky unit that could become fatiguing after some time.

Not For The Shelf

The Diamond Vs can sound very good when treated carefully and given a high quality recording. The problem is that most people will tend to just throw them on a shelf in the corner for convenience, which is possibly where they will sound worst. Even after the trouble I went to with them, they could still sound slightly muggy and thick on a lesser recording. A small amount of box colouration remained audible, but this was not a serious problem.

The latest version of the Wharfedale Diamond doesn't live up to its predecessor's reputation or, more importantly, that of its competitors either. In the fierce sub-£150 mini loudspeaker market the balance between price and performance is critical and the Diamond V doesn't, in my view, quite achieve the degree of balance expected these days ●

MEASURED PERFORMANCE

The response plot for the Wharfedale Diamond Vs is not quite as ruler flat as that of the Maxim 3s. However, it is still highly commendable, showing good high frequency extension and a reasonable degree of bass for a miniature. The only slight problem area I can see is the shallow trough centred around 800Hz, a couple of notes below the highest a soprano can reach. This may be noticed as a hollow quality in the lower mid, but as the trough only drops by 2dB it will hardly be noticeable.

Sensitivity measured a very respectable 86dB for one nominal watt of input (2.8V). This figure is possibly helped by the dished moulding of the baffle around the cones, since it forms a shallow horn which improves acoustic matching to the air. This results in a more efficient system, which yields better sensitivity figures.

As with many modern British loudspeakers, overall impedance is quite high measuring 10ohms. This figure is obtained using a full frequency a.c. signal which more accurately represents the load an amplifier will see than a simple single-tone measurement at one frequency. The impedance curve is quite smooth down to 200Hz where the characteristic double peak of a reflex loaded loudspeaker upsets the flow. There is reactance in the load, but it shouldn't affect the amplifier too much. Coupled with the high overall impedance and reasonable sensitivity, the Diamond Vs will be easily driven by an amplifier of 25-50 watts. **DB**

Frequency Response



Lumpy response.

Impedance

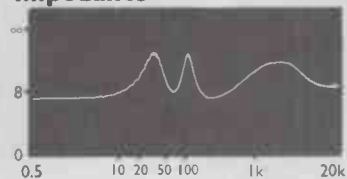

High overall impedance of 10 ohms.

CHOICE HI-FI

SECOND HAND NEVER SECOND RATE

Take the uncertainty out of buying secondhand hi-fi and save both time and money. Whether up-grading or starting a system you can listen in relaxed surroundings to a wide and varied range of continually changing stock.

This month's choice:

DYNAFLEXOR DVS45 (complete) mint	£150	MERIDIAN 200/201 dec7 mint	£1100
AUDIO TECHNICA AT 1100 new	£95	APOSEE DUEFA SIGNATURE mint	£3400
AUDIO RESEARCH D250 pre. amp mint	£3400	SONUS FABER AMATOR & STONEWOODS mint	£2300
AUDIO RESEARCH SP14 pre. amp. mint	£1900	KEF 105.3 mint	£650
IRELL ISA 80 pre. amp. mint	£1900	LINN KABERIS vgc	£750
AUDIO RESEARCH D115 pre. amp. good con	£900	ATC SCM 200/PLATE AUDIO STDS optional mint	£850/1250
TULLOCH monoblocks as new	£1900	KEF 107 PRO II + TUBE mint	£1950
COUNTERPOINT SA12 pre. amp. good con	£550	BASES OVATION + GRAHAM LS AMP new	£4900
AUDIO INNOVATIONS 2nd AUDIO monos as-dem	£1700	YOYO REFERENCE complete new	£3500
MICHELL ALECTO/ARGO HERALDO HERA mint	£1990	SME SERIES V boxed mint	£800
MERIDIAN 602/606 dec7+109 remote	£1990	AUDIO NOTE UO LIMITED mint	£2500
SONY S551 new	£425	AT OCT 10th year Life v.g.c.	£225
MICROREGA TMO MK III mint	£2500	LINN/RAIR EQUIP. ALSO IN STOCK	p.a.a.
		MOD SQUAD LINE ORITE PRE AMP mint	£225

- Please contact us for details of other equipment (all major brands available).
- Equipment bought or part exchanged.
- Mail Order facility available. Major credit cards accepted.
- Agencies: Target, Ortofon, Audio Technica, Sound Organisation.
- Full demonstration facility by appointment.

WE ARE OPEN 7 DAYS A WEEK, 9am-9pm.

081-892 5231

GET THE BEST FROM YOUR HI-FI

100's OF AERIALS, 100's OF FITTINGS FOR HI-FI AERIALS, TV AERIALS & SATELLITE DISHES
DIY OR FITTED BY OUR ENGINEERS

THE AERIAL SHOP

188 HALFWAY ST., SIDCUP, KENT
(NR. ELTHAM SE9)

(081) 300 5588/8990/7454

EXPENSIVE TUNER??

THEN HAVE THE AERIAL IT DESERVES

You spend many hours and quite a lot of money choosing that new tuner, so don't ruin the whole effect by fiddling with bits of wire or old aerials. Have the full benefit of the multipath-free, clean signal which only a well designed and properly installed dunit can achieve. If D.X. is your scene, then go for the ultimate in rotating, high gain narrow beam systems like our G.23 with 19dB forward gain, 38dB F. to B. and Acc. Ang. down to 15 Degrees or have a "one off" special built, up to 32 elements.

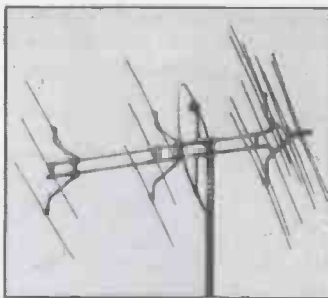

GALAXIE CIRCULAR 17-ELEMENT STEREO
GAIN 15.9dB F. to B. 33.7dB. L. 74"

WE DESIGN, MANUFACTURE, SUPPLY AND FIT

- ★ FM arrays from 4 to 23 Element. TV from 10 to 92 Element.
- ★ British-built and designed to withstand our weather.
- ★ Interested D.I.Y. advice freely given, backed by our complete range of masts, brackets, rotors, cables and aerials. Systems available for chimney, loft, wall, or through roof mounting.
- ★ Professional installation service available within a nominal 200-mile radius of LUTON. Full details of this service available on receipt of a large S.A.E. which will bring you our complete "Aerial Guide" which is more than just a list of our products and prices, and carries details of all our services, including MAIL ORDER and site surveys.

SEE THE REST, THEN FOR THE BEST, CALL

RON SMITH
AERIALS

98 ASH ROAD, LUTON, BEDS.

Day — Luton 36561 9.0 to 6.0 Eve — Luton 29560 after 7.30 pm

5 Minutes from M1 Motorway, Turnoff No. 11



Antiference

TV ANTENNAS

THE CHOICE IS YOURS:

Allrounder for reception from all points of the compass.



Mushkillers for the ultimate directional performance



Fitted by all good aerial installers.

Antiference Ltd.

TV Division
Bicester Road
Aylesbury
HP19 3BJ

Fax: 0296 84284



SUBURBAN AERIALS

THE FM AERIAL SPECIALIST

SALES, SERVICE & INSTALLATION
BY QUALIFIED ENGINEERS

A NEW AGE IN BROADCASTING HAS BEGUN

RADIO IN CD QUALITY

IIIIIDSR 38 CM / 15 DISH
TECHNISAT 5000 DSR
RECEIVER

DIGITAL - SATELLITE - RADIO

16 CHANNELS 24 HOURS A DAY
CLASSICAL, CULTURE, OPERA, ROCK,
POP, LIVE CONCERTS ETC...

AERIAL HOUSE, EBBERNS ROAD,
HEMEL HEMPSTEAD, HERTS

0442 211511

WHY A HI-FI TUNER NEEDS A GOOD AERIAL

For best sound quality, a hi-fi tuner must have a strong signal of around 1mV minimum.

The question is: how do you get it?

INDOOR AERIALS

Simple pin-up wire types (dipoles) only provide enough signal within a few miles of a transmitter. Otherwise they are noisy and prone to receiving multipath signals that produce distortion.

We've tested powered indoor aerials and expensive hi-tech designs costing up to £50 and find they give no more signal than simple, horizontal dipoles, either of the wire type or of rigid aluminium. Their only benefit is smaller size. It is better to buy a rigid aluminium dipole and mount it high, upstairs on a wardrobe, at the top of a stairwell, or similar.

LOFT AERIALS

Loft aerials have the advantage of height and, if there are many elements, gain as well, so they provide a stronger signal than a simple dipole indoor aerial. In areas of reasonably high signal strength - which usually means within ten miles or so from a transmitter, a loft aerial may be satisfactory.

Usually with three elements, a director rod (short), reflector rod (long) and dipole element in between, loft aerials are also directional; they must be pointed toward the transmitter. They reject interference and reflected signals better than dipoles, giving a cleaner signal to the tuner.

The best mounting position is high up in the V of the roof, away from metal objects like water tanks. A long downlead will be needed, preferably of good quality to minimise signal loss.

BALCONY & WALL MOUNTING AERIALS

Balconies in blocks of flats have the advantage of height, giving a much stronger signal. However, the balcony should face the transmitter for good results.

It is often possible, if a little difficult, to wall-mount an aerial on a stub mast outside a window, but you may need consent to do so. Hanging out of a window can be dangerous, so consider using a professional installer. And make sure the wall faces toward the transmitter of course.

OUTDOOR AERIALS

In most locations, only an outdoor aerial will give a signal strong enough and clean enough (i.e. free from interference and multipath reflections) to provide true hi-fidelity from a good tuner. Benefits are height (the higher the better), crucial for

obtaining a strong signal free of reflections, and number of elements, which determine both gain and directionality.

Multi-element aerials are used in areas of medium to weak signal strength, meaning up to around forty miles from a transmitter. Any further away is judged as a 'fringe' area and will demand even more elements.

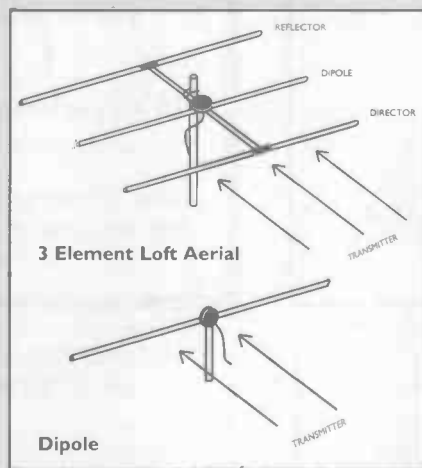

ALL-ROUND AERIALS AND WHIPS

Whip aerials, vertical dipoles and all-round aerials (curved horizontal dipoles) provide less signal than a simple, indoor dipole (i.e. negative gain). They are suitable only for areas of high signal strength.

Although whips and curved dipoles offer all-round reception, this means they provide little rejection of reflections, interference and distant stations. They are not especially suitable for hi-fi use.

AERIAL AMPLIFIERS AND ROTATORS

Aerial amplifiers are useful only at the masthead to overcome losses in a very long downlead. They are also used to provide enough signal for distribution around a house.

These roles apart, amplifiers boost noise and rubbish from an aerial by the same amount they boost wanted stations, giving no gain in quality, even though the signal strength meter of a tuner might go up. Not recommended.

Rotators are used to swing a directional aerial around, to receive more stations. A simpler solution is to have two aerials pointing in different directions, with their outputs diplexed together or, for more signal but less convenience, twin

downleads with an aerial switch at the bottom.

ATTENUATORS

When it's necessary to use a directional aerial to cut down reflections from tower blocks, but the aerial then gives too much signal (i.e. more than 10mV), an in-line attenuator can be used to prevent tuner overload.

AERIAL INSTALLERS

The best and overriding reason for using an installer is personal safety; roof work is very dangerous. Installers are also very quick and well equipped; DIY may take the large part of a day. Local installers should know about area-specific problems, the location of repeat and fill-in transmitters, and such like - all matters that are likely to be a mystery to most people.

Finally, good installers should have a Field Strength Meter that not only enables them to see whether an aerial is giving the required result, but can prove this to the satisfaction of the customer. Around 1mV is wanted, meaning powerful stations will come in higher (say 3-5mV) but weak ones a bit lower (0.3-1mV). If for no other reason, knowing that the aerial works properly is enough reason for using an installer.

Discuss this matter with them first though. In some areas, it may be impossible to obtain such a strong signal, no matter what aerial is used; get a variety of opinions if necessary.

CONFEDERATION OF AERIAL INDUSTRIES

The CAI has a countrywide list of aerial installers who are members that abide by the rules below.

To find a local service, contact -

CAI Ltd.,
Fulton House Business Centre,
Fulton Road,
Wembley Park,
MIDDLESEX HA9 0TF

Tel: 081-902-8998
Fax: 081-903-8719

CAI members must employ staff competent for the business conducted. They must follow standards of practice, agree to investigation, examination or test at any time. They must guarantee any aerial, equipment and/or installation work for a minimum period of twelve months ●



ONE OF THE WORLD'S GREAT CONCERT HALLS

With the help of

Room Acoustics Services

you can achieve near concert hall
realism in your home

Please send me full details, and magazine
reviews, of the Room Acoustics Services
computerised postal consultancy.

NAME: _____

ADDRESS: _____

POST CODE: _____

ROOM ACOUSTICS SERVICES

3, Queen Elizabeth Way, BARTON-upon-HUMBER,
South Humberside, DN18 6AJ. Tel: (0652) 635523

/HFW



REFRESHINGLY DIFFERENT

the powerplant

66 Upper North Street Brighton 0273 775978

Comfortable listening room, knowledgeable and approachable staff

Roksan, Micromega, Musical Fidelity, Exposure, Audiolab, Onix,
Epos, Rotel, Marantz, Yamaha, Nakamichi, Heybrook, Rogers,
Tannoy and other fine equipment.

THE HI-FI ATTIC

58, NEW GEORGE STREET, PLYMOUTH
DEVON PL1 1PJ

(INDEPENDENT HI-FI SPECIALISTS)
(0752) 669511

QUAD, ARCAM, ARISTON, PIONEER,
DENON, MARANTZ, AIWA, ALBARRY,
HARMAN-KARDON, JPW, MISSION, B&W,
MONITOR AUDIO, KEF, ARCAM, HEYBROOK

UXBRIDGE, MIDDLESEX
(0895) 253340

NEWTON ABBOT, DEVON
(0626) 67060



TWO GREAT STORES, ONE GREAT PRODUCT

L.F.D. AUDIO
(A HIGH END ALTERNATIVE)

LINESTAGE LSI · PHONOSTAGE MCI · POWERSTAGE PAI

High end does not have to equal high priced. Something most manufacturers don't
understand. The challenge as L.F.D. see it, is to offer an integrated system of audio
components that delivers high end sound.

Main Dealers For
L.F.D. AUDIO

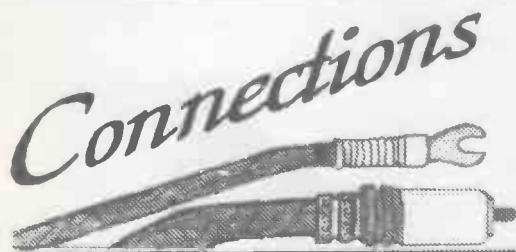

Tel: 081 348 5676 (2.00-7.00 pm)
Fax: 081 341 9368

Esoteric High Fidelity CABLES

Dealers in: Absolute, Audio Note, Audioquest, Deltec, Harmonix, Kimber,
Mandrake, MIT, Siltech, Symo, Van den Hul, WBT, and others

... the *RIGHT* cables
... in *YOUR* system
... for *YOUR* ears
... in *YOUR* home

Contact us by phone, fax, or letter and we'll do
our best to help you achieve your goal.

(Auditions may be subject to a handling charge)

CONNECTIONS 11 Archer St, London W1V 7HG (A division of Connection 90' Travel Ltd.)

MANTICORE MAKE MORE MUSIC

Turntable Servicing - all makes - please ring for details.

WE ARE APPROVED THORENS SERVICE AGENTS

Arm rewiring - Manticore standard cable	£80.00
Arm rewiring - Van den Hul or Isoda	£160.00
Arm rewiring - Cardas	£160.00
Silver plated mains cable with IEC socket	£50.00
Aerolam equipment support	£54.00
Fibrelam equipment support - superior performance	£130
Mantra replacement belt - supplied in twos	£22.00
Logic DM101 belt - supplied in twos	£25.00
Logic DM101 spring sets	£22.00
Rega armspacers - polished aluminium 1mm increments	£11.00
Impex motor, pulley and PCB	£65.00
Manticore Mantra - no tonearm	£460.00
Manticore Madrigal with Musician	£570.00
Manticore Magister with 12" Magician	£3,800.00
Manticore Musician tonearm	£320.00
Manticore Magician tonearm	£650.00
Manticore 12" Magician tonearm	£720.00

Part-ex available against all other tonearms

MB5 off-board power supply	£250.00
MB6 off-board power supply	£490.00
Motor rebuild	£150.00
RIAA and preamplifier	£490.00

Please telephone or write for more information and a copy of Mumbo Jumbo.



MANTICORE AUDIO VISUAL
The Courtyard, 56c Shortmead Street,
Biggleswade, Beds. SG18 0AP
Tel: 0767 318437

PRECISION TEST CASSETTES

Each Harrison test cassette is individually digitally mastered in real time using high quality equipment and tape. They are used by the hi-fi enthusiast, radio and tv stations, recording studios and service departments.

"The Harrison multi purpose test cassette is an excellent product, well worth the asking price. We'd recommend it to anyone in need of a test cassette, for either domestic or professional use." (Australian HiFi)

"Professional test cassettes cost up to £80 but I obtained a very good, comprehensive one from Ian Harrison." (Hi-Fi Choice, Oct. 1988)

THE RANGE CONTAINS THE FOLLOWING CASSETTES:

Multi-Purpose (120us eq & 70us eq types are available) Contains 5 tests: Dolby Level, Azimuth, Replay Frequency Response (30Hz-15kHz), Dolby B/C Tracking (white noise), Speed.	Price: £20.00
Dolby Level, Azimuth & Replay Frequency Response 30Hz-15kHz (120us eq & 70us eq types are available)	Price: £15.00
Dolby level, Azimuth & Speed	Price: £15.00
Dolby Level & Azimuth	Price: £10.00
Azimuth Price: £7.50	Speed Price: £10.00
Level Price: £5.00	

Each test cassette is supplied with instructions and specifications. Test equipment is advisable for use with these cassettes, although the Azimuth & Speed cassettes can be used without test equipment.
Please phone for further details.

AUDIOPHILE CARTRIDGES

Please phone for discount/exchange prices on the following moving Coil Cartridges. Substantial discounts for Moving Coil trade-ins!! All cartridges are totally brand new with full U.K. guarantees.

ORTOFON MC5000 MC3000II MC2000II QUASAR QUATTRO QUARTZ MC15SR + OTHERS	AUDIO TECHNICA AT-ART 1 AT-OC30 AT-OC10 AT-OC5 + OTHERS	DENON DL304 DL110 DL103 DL103D	GOLDRING EXCEL GS EXCEL ELITE EROICA H EROICA LX
	SHURE P.O.A. ATH9000 PHONES P.O.A.		

ORDERS/ENQUIRIES TO:
IAN HARRISON, 7 MILL HILL REPTON, DERBY, DE65 6GQ. TEL: 0283 702875



35 years combined experience.

Two Fully equipped listening rooms.

Home installation service.

Multi-room design and installation.

2 years Parts and Labour guarantee

Home cinema surround-sound.

Export and Credit facilities.

It costs the same to get it right as it does to get it wrong.

At The Listening Rooms, we pride ourselves on matching your needs with exactly the right equipment, (even on a budget), and because we only stock the best, that's what you get.

What you'll also get is sound professional advice and a chance to relax and listen to some of the world's finest Hi-Fi equipment.

LINN · QUAD · MERIDIAN · NAKAMICHI · ARCAM · AUDIOLAB · ACOUSTIC · ENERGY
SME · AUDIO RESEARCH · KRELL · CLASSE AUDIO · WADIA · THETA · MICROMEGA · APOGEE
MARTIN LOGAN · SONUS FABER · KOETSU · MUSICAL · FIDELITY · REVOX · ROGERS · PIONEER
TANNOY · STAX · SYSTEMDEK · PINK TRIANGLE · MICHELL MONITOR AUDIO · YAMAHA
MARANTZ · KEF · BOSE · CELESTION · EPOS · MISSION · DENON · NEAT PETITE ·



161 Old Brompton Rd. London SW5 0LJ. Tel: 071- 244 7750/59. Fax: 071-370 0192.
Monday - Saturday 10am-6pm. Nearest Tube: South Kensington or Gloucester Road.

ADVENT
 AUDIO TECHNICA
 AR
 A.K.G.
 BOSTON
 BEYER
 CAMBRIDGE
 CANON
 CARVER
 CERWIN VEGA
 DENON
 DEMON
 DUAL
 GOLDRING
 HARMAN-KARDON
 HECO
 JAMO
 JBL
 KENWOOD
 MARANTZ
 MICHELL
 MORDAUNT-SHORT
 NAD
 ORTOFON
 PIONEER
 PROJECT STANDS
 PROTON
 ROTEL
 RUARK
 SENNHEISER
 TANNOY
 THORENS
 TDK
 TEAC
 WHARFEDALE
 YAMAHA

analog audio

SUPER SPECIALS

ROTEL RC 960 AX PRE AMP	£299.99	MARANTZ CD 52 MK II COMPACT DISC PLAYER	£229.90
ROTEL RB 960 BX POWER AMP	£299.99	AUDIO TECHNICA ATH 610 HEADPHONES	£24.95
YAMAHA DSP A1000 AV AMP	£799.95	ROTEL RCD 955 AX COMPACT DISC PLAYER	£190.00
TEAC VRDS-10 COMPACT DISC PLAYER	£769.95		

MANY OTHER OFFERS
 CALL OR PHONE
 FOR GOOD SERVICE AND ADVICE

849 HIGH ROAD
 LONDON N12
 (NORTH FINCHLEY)

analog audio

TEL 081-445 3267
 FAX 081-445 1443

CHESTERFIELD SHOW

Saturday 17th & Sunday 18th April 1993

*Your chance to hear the leading edge in
 Hi-Fi Technology and to meet the Designers*

Over thirty of this country's leading exponents of the Art demonstrating their products plus trade and magazine stands.

Ringwood Hall, a superb setting, has been chosen for this year's much enlarged show and offers:

- **Real Ale Bars**
- **Restaurants**
- **Bar Lunches**
- **Free Car Parking**

"A great day out for all the family..."

Ringwood Hall
 Brimington
 Chesterfield
 Derbyshire

Further details: (0709) 875408 or (0246) 200096

On the A619
 4 miles West from J30
 M1 Motorway

MUSICAL IMAGES
173 STATION RD,
EDGWARE, MDDX HA8 7JX
081 952 5535

MAIN DEALERS FOR:
ACOUSTIC ENERGY

AIWA
AKAI
AKG/AR
ALBARRY
ALPHASON
APOLLO
ARCAM
AUDIO ALCHEMY
AUDIO INNOVATIONS
AUDIOQUEST
AUDIOTECHNICA
AURA
B&W
BANG & OLUFSEN
BEYER DYNAMIC
BOSE
BOSTON
CANON
CASTLE
CELESTION
CREEK
CYRUS
DENON
DUAL
GOLDRING
HAFLER
HECO
HEYBROOK
INFINITY
JAMO
JPW
KEF
KENWOOD
LUXMAN
MARANTZ
MICHELL
MICROMEGA
MISSION
MITSUBISHI

MAIL
ORDER

PART
EXCHANGE

Mini Systems
Midi Systems
Repairs
Service Accessories
Interest free credit

MUSICAL IMAGES

ROTEL®

AWARD WINNING
CD PLAYER

RCD-965BX

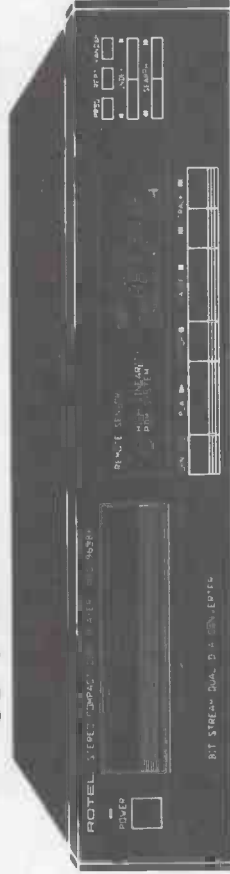

MONSTER CABLE

AWARD WINNING TUNER RT-950BX



AMPLIFIER

RA-940BX



INFINITY SPEAKERS

SUNDAY
OPENING

BUY NOW
PAY LATER

MUSICAL IMAGES
45 HIGHSTREET,
HOUNSLOW, MDDX TW3 1RH
081 569 5802

MAIN DEALERS FOR:
MONITOR AUDIO
MORDAUNT SHORT
MUSICAL FIDELITY
MICHAELSON

NAD
NAGAOKA
NAKAMICHI
ORTOFON
PANASONIC
PHILIPS
PIONEER
PROJECT
PROTON
QED
QUAD
REVOLVER
ROGERS
ROKSAN
ROTEL
ROGERS
SANSUI
SENNHEISER
SHURE

SOUND ORGANISATION
SME
SONY
SPENDOR
STAX
SYSTEMDEK
TARGET
TANNOY
TEAC
TECHNICS
TDL
THORENS
TOSHIBA
WHARFEDALE
YAMAHA
AND MANY MORE

DEMO
ROOMS

THE
BEST Selection
BEST Service
BEST Prices
Best Choice







SEVENOAKS SUPERFI

This advertisement is valid until at least 31st March 1993.

THE AWARD WINNERS NOW ON SHOW AT SEVENOAKS SUPERFI

Too Good to be True!

The moment you step through the door of any one of our branches, you'll be better looked after at Sevenoaks Superfi.

-  An outstanding selection of products from leading manufacturers – all on display.
-  Friendly helpful staff that are there to help you choose the hi-fi that's right for you, without pushing you to buy.
-  Dedicated listening rooms allow you to appreciate the quality before you make your decision.
-  Comprehensive after sales service. We can, where appropriate, deliver and install your equipment and we have our own service department at Sevenoaks.
-  Real value for money. Our prices are highly competitive and our 'Added Value Offers' famous throughout the industry.

0% Finance

We offer 0% finance on selected manufacturer's products where there is no cash discount available. These are:-
Audiolab, Quad, Kef Reference, Exposure, Ruark, Cyrus, Denon, Musical Fidelity, Rogers, Yamaha A/V and Arcam.

- Option 1:** 10% deposit followed by 6 equal monthly payments. Example. Cost £600. Deposit £60 plus 6 payments of £90.
- Option 2:** 25% deposit followed by 9 equal monthly payments. Example. Cost £600. Deposit £150 plus 9 payments of £50.

Both options: minimum balance £400. Subject to status. 0% APR. Personal shoppers only. Written details on request.

and 3 Year Warranty

Our prices on the above products also include our no quibble 3 Year Warranty. And virtually all warranty work is carried out by fully trained staff in our own service department.
5 Year Extended Warranty is also available on selected purchases at extra cost.

Avoid the Saturday Crowds

Visit us Monday to Friday to choose your new Hi Fi, TV or Video.

Getting it Together

Once you've chosen your new hi-fi, a small additional expenditure on a quality interconnect, stand or other accessory can enhance its performance. In fact, if you buy a quality interconnect or stand from us and you don't think your sound has improved, just return it in 'as new' condition and we'll refund your money in full.

Interconnects

We carry a comprehensive range of superb interconnects. Choose from **Audioquest, Monster, IXOS** and **Furukawa**. There's one ideally suited to your system. We also stock a complete selection of Speaker Cables.



Loudspeaker Stands

You need a strong stable platform if your speakers are to sound their best. Our extensive range includes **Partington, Target** and **Apollo**.



Consoles and Racks

Our extensive range includes **Alphason** universal and expandable variable height units in smoked glass and Nextel coated MDF, **Partington** and **Target** rigid steel.



Headphones



Keep the sound in and the neighbours happy. We have a range of headphones to suit all budgets. Choose from leading names; **Sennheiser, Audio Technica** and **Beyer**.

Too Numerous to Mention

We sell a huge number of essential and useful accessories; audio and video tape – switching boxes – leads – record, tape, CD and stylus cleaners. All too numerous to mention. If you have a particular requirement, ask us, we probably have the solution.

**22
Branches
Nationwide**



BUY WITH CONFIDENCE

IN STORE & MAIL ORDER - You can buy with confidence from Sevenoaks Hi-Fi. We've been in business for 21 years and have lots of experience with personal callers and Mail Order customers. All goods are BRAND NEW, FULLY GUARANTEED and maintained by OUR OWN SERVICE DEPARTMENT. For personal attention and demonstration call into any of our branches. If you live too far away, simply post or phone your order through and our efficient Mail Order department at Sevenoaks head office should have your equipment safely delivered within 2 or 3 days, subject to availability. Carriage is only £7 per order and generally FREE if total exceeds £300 (UK mainland only). All goods are insured against loss or damage in transit. Payment may be made by cash, cheque, Access or Visa (Barclaycard). Prices include VAT.

PLEASE CALL US BEFORE TRAVELLING TO VERIFY PRICE AND AVAILABILITY

Amplifiers

- Albany PP1 £429.95
- Albany S508 £499.95
- Albany AP4 £349.95
- Alchemist Kraken £529.95
- AMC CVT3030 (w/vel) £299.95
- Arcam Alpha III £549.95
- Arcam Delta 60 £749.95
- Arcam Delta 120.2 £649.95
- Arcam Delta 110S £219.95
- Arcam Delta 110 £299.95
- Arcam Delta 290 £429.95
- Aura VA100 Black £399.95
- Audiobac 8000AII £629.95
- Audiobac 8000C/II £569.95
- Audiobac 8000M (leach) £249.95
- Audiobac 8000P/II £299.95
- Cyrus One II £189.95
- Cyrus PSK II £199.95
- Cyrus Two II £249.95
- Denon PMA250 III £549.95
- Denon PMA350 £299.95
- Denon PMA480R £209.95
- Denon PMA450 £269.95
- Exposure EXP7 £299.95
- Exposure EXP7 £299.95
- Exposure EXP15 MM £159.95
- Exposure EXP85TD £159.95
- Harman Kardon HK6150 £139.95
- Kenwood KA302D £249.95
- Kenwood PM 305E £649.95
- Marantz PM32 £579.95
- Marantz PM 40SE £299.95
- Marantz PM62 £299.95
- Marantz PM62SE £299.95
- Marantz PM62 £299.95
- Marantz PM72 £299.95
- Musical FID A1 Mk II £199.95
- Musical FID Pre B £239.95
- Musical FID Typhoon £374.95
- Musical FID MA65 (Pair) £199.95
- Musical FID Tempest £45.95
- Musical FID Bridging cable £159.95
- Nad 302 £209.95
- Nad 304 £299.95
- Nad 306 £199.95
- Pioneer A300K £328.95
- Pioneer A400 £341.95
- Philips FA930 £673.95
- Quad 66 inc RL £149.95
- Quad 34 £179.95
- Quad 306 £249.95
- Quad 606 £299.95
- Rotel RA920AAX £399.95
- Rotel RA930AAX £199.95
- Rotel RA940BAX £394.95
- Rotel RA960BAX £149.95
- Rotel RB960BAX £299.95
- Rotel RB980BAX £299.95
- Rotel RC960BAX £299.95
- Rotel RC980BAX £299.95
- Technics Range P.O.A.

Cassette/DCC Decks

- Awa ADP410 £499.95
- Awa ADP810 £349.95
- Awa ADP910 £529.95
- Denon DRM100 £199.95
- Denon DRM150 £249.95
- Denon DRM710 £299.95
- Denon DRM610 £649.95
- Denon DRW610 £219.95
- Denon DRW620 £299.95
- Marantz SD40 £189.95
- Marantz SD52 £699.95
- Marantz SD62 £499.95
- Marantz SD415 £299.95
- Nakamichi DR1 £549.95
- Nakamichi DR2 £179.95
- Nakamichi DR3 £199.95
- Philips DCC 900 £139.95
- Pioneer CT5410 £249.95
- Rotel RD945AAX £179.95
- Rotel RD965BAX £159.95
- Roly TCK520 £199.95
- Sony TCK550 £249.95
- Technics RS8M40AK £159.95
- Technics RS8M62BK £139.95
- Technics RSTR515K £209.95
- Technics RSTR232K £429.95
- Technics RSTR333K £269.95
- Yamaha RX260 £299.95
- Yamaha RX360 £299.95

Speakers

- Acoustic Research 0.5 £129.95
- Acoustic Research M1 £299.95
- Arcam Delta 2 (Black Vinyl) £199.95
- B & W DM610 £349.95
- B & W DM620 £795.95
- B & W 805 £1225.95
- B & W 804 £249.95
- Castle Chester £349.95
- Castle Durham II £99.95
- Castle Durham III £114.95
- Castle York £154.95
- Celestion 1 £219.95
- Celestion 3 £299.95
- Celestion 5 £99.95
- Cerwin Vega AT20 £249.95
- Cerwin Vega AT40 £119.95
- Gale GS210 £169.95
- Heybrook HB1.3 £299.95
- Heybrook Prima £199.95
- Heybrook Solo £139.95
- Heybrook HB100 £249.95

SALE MUST END 31st MARCH!
Up to **30% OFF** Selected Products

Compact Disc Players

- Mission 755 £599.95
- Mission Cyrus 780 £199.95
- Mission Cyrus 781 £249.95
- Mission Cyrus 782 £349.95
- Mon Audio 1 (Bk) £149.95
- Mon Audio 7 (Bk) £179.95
- Mon Audio 14 (Bk) £399.95
- Mon Audio MA1.4 Gold (Bk) £399.95
- Mon Audio MA1.4 Gold (P/W) £449.95
- Mordant Short £2384.95
- Quad ESL 63 £229.95
- Rogers LS24.2 £299.95
- Rogers LS4A.2 £499.95
- Rogers LS6A.2 £299.95
- Rogers LS8A.2 £449.95
- Rogers Studio 3 £384.95
- Ruark Swarzman Plus £699.95
- Ruark Sabre £479.95
- Ruark Talsman II P.O.A.
- Ruark Tempair P.O.A.
- Spendor P.O.A.
- Thiel Tannoy 603 £124.95
- Tannoy 605 £159.95
- Tannoy 607 £199.95
- Tannoy 609 £269.95
- Tannoy 611 £399.95
- Tannoy 613 £599.95
- Tannoy 615 £749.95
- Wharfedale Diamond V £124.95



22 Branches Nationwide

- 109-113 London Road SEVENOAKS 0732 459555
- 24 Pittville Street CHELTENHAM 0242 241171
- 162 Powls Street WOOLWICH 081 855 8016
- 67 Smallbrook, Queensway BIRMINGHAM 021 2675
- 4 Dock Street HULL 0482 24051
- 55 Preston Street BRIGHTON 0273 733338
- 1 Grove Centre Witham ESSEX 0376 501733
- 73b North Street GUILDFORD 0483 36666
- 34 Mount Ephraim TUN. WELLS 0892 531543
- 7 King Edward Street LEEDS 0532 449075
- 271a High Street LINCOLN 0522 520265
- 20a Lower Bridge Street CANTERBURY 0227 462787
- 369-373 London Road CROYDON 081 665 1203
- 94 Granby Street LEICESTER 0533 557518
- 478 St. Albans Road WATFORD 0923 212736
- 2-4 Camden High Street LONDON 071 388 1300
- 15 Market Street NOTTINGHAM 0602 412137
- 4 Railway Street CHATHAM 0634 846859
- 7 Genotln Road ENFIELD 081 342 1973
- 41 St. Clements OXFORD 0865 241773
- Sevenoaks Branch only MAIL ORDER 0732 458985
- 1 Rockingham Gate, The Moor SHEFFIELD 0742 723768
- 51 Picadilly, Hanley STOKE ON TRENT 0782 265010

Midi/Mini Systems

- Awa, Denon, JVC, Kenwood, Sony, Technics and Yamaha P.O.A.

Audio Visual

- Celestion HT1 System £499.95
- Celestion HT3 System £699.95
- P.O.A. £299.95
- Denon AV300 £399.95
- JAMC £209.95
- Kenwood KR7040 £399.95
- Kenwood KR8040 £399.95
- Kenwood KAV8500 £399.95
- Marantz SP90 £89.95
- Marantz PM700 II £229.95
- Mordant Short Stereo or £179.95
- Mordant Short Stereo & sw £179.95
- Mordant Short Pro logic £59.95
- Mordant Short Dialogue £149.95
- Mordant Short Sub Woofer £29.95
- Mordant Wait bracket £499.95
- Mordant CD205 £449.95
- Philips DSPA500 £899.95
- Yamaha DSPA1000 £649.95
- Yamaha DSPA2000 £449.95
- Yamaha DSPA1000 £449.95
- Yamaha RXV660 £449.95
- Heybrook Trio £299.95
- Heybrook Quartets £499.95
- JPW AP3 £699.95
- JPW Sonata P.O.A.
- JPW Mimim £299.95
- Kel RI02.2 £399.95
- Kel RI02.2 £209.95
- Kel RI03.4 £89.95
- Kel RI04.2 £229.95
- Kel RI05.3 £179.95
- Kel RI07.2 £59.95
- Kel K140 £149.95
- Kel K160 £49.95
- Kel O60 £29.95
- Kel O80 £49.95
- Mission 753 £449.95
- Mission 760 £449.95
- Mission 761 £449.95
- Mission 762 £449.95
- Mission 763 £449.95
- Mission 764 £449.95

Turntables

- Dual CS503-2 £159.95
- Dual CS505-4 £69.95
- Nad 5120 P.O.A.
- Pink Anniv/Export/LPT £229.95
- Roksan Radius/Genies £324.95
- Systemdek IX 900 (Lex) £419.95
- Systemdek IX 900 + RB250 £369.95
- Systemdek SL1200 II £149.95
- Technics SL1200 II £199.95
- Technics SL1210 II £279.95
- Thorens TD180 £259.95
- Thorens TD280 Mk IV £199.95
- Thorens TD166/RB250 £279.95

Tuners

- Aura TU50 £259.95
- Arcam Alpha 3 £199.95
- Arcam Delta 280 £299.95
- Audiobac 8000T £119.95
- Cyrus Tuner £199.95
- Denon TU260L £249.95
- Denon TU560L £109.95
- Denon TU660L £159.95
- Harman Kardon TU9400 £149.95
- Marantz ST40L £199.95
- Marantz ST50L £149.95
- Musical Fidelity T1 II £199.95
- Nad 402 £149.95
- Pioneer P676 £519.95
- Philips FT930 £424.95
- Quad 66FM £159.95
- Quad FM4 £199.95
- Rotel RT930AAX £149.95
- Rotel RT950BAX £199.95
- Sony STS37ORDS £149.95
- Technics P.O.A.

Prices include VAT and were correct at time of going to press (approximately 5 weeks before publication) but are subject to change without prior notice. E&OE.

State finish required

Most but not all of the offers displayed above are also available from our associates Superfi, whose addresses appear above. Please always phone first to check price - availability before travelling.

MAIL ORDER TO SEVENOAKS HI-FI 109/113 LONDON RD. SEVENOAKS, KENT. TEL: (0732) 458985.

Please send me I enclose a cheque/cash/card No. + Expiry Date

Name _____ Address _____ Daytime Tel No: _____

music made live... music made live... music made live... music made live... music made live...

175 HOLLOWAY ROAD, LONDON N7 8LJ

TEL: (071) 607 2148 / 229

11 THE BROADWAY, WOKING, SURREY GU21 5AJ

TEL: (0483) 77117

MAIL ORDER TEL: (071) 607 229

Bartletts
HI-FI

Access, Visa cards accepted. Demonstrations by appointment - Please phone

Opening times: 9.30am-6.00pm Mon-Sat. Mail order customers please contact Holloway branch

It is advisable to phone before travelling to check availability of products

March Madness

- Up to 30% OFF -

Phone or drop in for the best prices around
March Madness Sale starts 9.30am 20th March
and must end 6pm 3rd April

Mail order carriage charge £12 per order

BARTLETTS SUGGESTED SYSTEMS

The Bartletts Suggested systems listed below are supplied with either the Dual CS 503-2 or Revolver Rebel turntable, an alternative Turntable or CD player are available at extra cost, see below for details. All systems are supplied with 8 metres of 79 strand loudspeaker cable, QED 4mm banana plugs are available at a cost of 1.00 each. Carriage & Insurance are free for all deliveries on the U.K. mainland. Prices correct at time of printing but are subject to change without notice. E&OE.

SPEAKERS	W/Dale Delta 30.2 JPW Sonata Vinyl Celestion DL 4 II Celestion One	Mission 760 i Tannoy 603 JPW Sonata Wood W/Dale Diamond 4 Royd A7 II Celestion 3	Celestion 5 BeW DM 600 Tannoy 605	Mission 761 i	Tannoy 607 BeW DM 610 Celestion 7 Marantz DS 110	Mission 762 i Rogers LS2a2 Cerwin Vega AT20	Tannoy 609	Rogers LS 4a2 BeW DM 620 Cerwin Vega AT Marantz DS 22
AMPLIFIERS								
Marantz PM 32	329.95	345.95	373.95	389.95	409.95	429.95	449.95	489.95
Marantz PM 30 SE	339.95	355.95	383.95	399.95	419.95	439.95	459.95	499.95
Marantz PM 40 SE	403.95	419.95	447.95	463.95	483.95	503.95	523.95	563.95
Nad 302	339.95	355.95	383.95	399.95	419.95	439.95	459.95	499.95
Nad 304	371.95	387.95	415.95	431.95	451.95	471.95	483.95	523.95
Rotel RA 920 AX	332.95	348.95	376.95	392.95	412.95	432.95	452.95	492.95
Rotel RA 930 AX	343.95	368.95	396.95	412.95	432.95	452.95	467.95	507.95
Sony TAF 540 E	395.95	411.95	439.95	455.95	475.95	495.95	515.95	555.95
Yamaha AX 550	403.95	419.95	447.95	463.95	483.95	503.95	523.95	563.95

CD PLAYER INSTEAD OF CS 503-2 / REBEL

Aiwa XC 300	Deduct	5.00
Aiwa XC 700	Add	30.00
Denon DCD 590	Add	28.00
Denon DCD 690	Add	50.00
Denon DCD 890	Add	116.00
Marantz CD 42 II	Add	44.00
Marantz CD 52 II	Add	74.00
Marantz CD 52 SE II	Add	150.00
NAD 502	Add	50.00
Philips CD 634	Add	10.00
Philips CD 930	Add	15.00
Philips CD 940	Add	50.00
Philips CD 950	Add	200.00

Rotel RCD 955 AX	Add	110.00
Technics SLPG 420	Add	10.00
Technics SLPG 520	Add	50.00
Technics SLPS 620	Add	80.00
Technics SLPS 700	Add	120.00
Technics SLPS 900	Add	200.00
Sony CDP 497	Add	10.00
Sony CDP 797	Add	50.00
Yamaha CDX 460	Add	20.00
Yamaha CDX 560	Add	50.00
Yamaha CDX 660	Add	100.00
Yamaha CDX 860	Add	150.00

IMPROVED TURNTABLES

Dual CS 430	Deduct	14.00
Dual CS 505-4	Add	56.00
Thorens TD 280 IV	Add	64.00
Systemdek IIX 900 Moth AT 110e	Add	146.00
Systemdek 1/920 Moth AT 110e	Add	100.00



BARTLETTS HI-FI GUARANTEE
ALL NEW HI-FI EQUIPMENT FOR
A PERIOD OF 3 YEARS.

HARROW AUDIO

MAIL ORDER
Carriage Free Hi-Fi
To Your U.K. Address

Hi-Fi Separates

Amplifiers	
Denon PMA250 III	149.99
Rotel RA930AX	179.95
Arcam Alpha 3	199.90
Mus.Fidelity Tempest	199.00
Rotel RA940BX	249.90
Denon PMA450 - Best Buy	249.90
Aura VA100 - New	299.95
Audiolab 8000A	429.90
Audiolab 8000C Preamp	399.90
Audiolab 8000P Pwamp	569.00
A&R Delta 280 - New	449.90
Receivers	
Denon DRA345	249.99
Denon DRA545RD	299.99
Tuners	
Denon TU260	119.99
Denon TU580RD New	199.99
Aura TU50	259.95
Mus.Fidelity T1	270.00
A&R Delta 280 - New	349.90
Audiolab 8000T At Last!	899.90
Cassette Decks	
Yamaha KX260	159.95
Denon DRM510	149.95
Yamaha KX360	199.95
Denon DRS610 Drawer	199.95
Denon DRW650 Double	199.95
Denon DRM710 3-Head	249.95
Denon DRS810 3-Hd Drwr	299.95
Nakamichi DR3 New	299.95
Nakamichi DR2 3-Hd New	499.95
Arcam Delta100 Dolby-S	849.90

Speakers	
Acoustic Energy AE1	695.95
B & W 2001 New	119.95
2002 New	149.95
DM600i	169.95
DM810i	219.95
Twin Bass Sub Woofers	
Epos ES11	350.00
Mission	
M760i	129.90
M761i	179.90
M762i	249.90
M763i	379.90
Cyrus	
780	199.90
781	249.90
753	599.90
Mon Audio	
MA1 Gold	149.95
MA7 Gold	179.95
MA9 Gold	209.95
MA11 Gold	329.95
MA14 Gold	399.95
Tannoy	
6o3	124.99
6o5	159.99
6o5-LE	189.99
6o7	199.99
6o9	269.99
611	399.99
Wharfedale Diamond V	
2130 Satellite/Sub Sys.	299.90
Turntables	
Dual CS505-4	199.95
Thorens TD180 NC 78rpm	159.90
TD280-IV	199.90
TD166/TP50arm	219.90
• incl. AudioTech.AT95E Cart	
Thorens TD166 VI/Reqa	279.90

Hi-Fi Separates

Compact Disc	
Yamaha CDX460	179.95
Denon DCD590	179.90
Yamaha CDX560	199.95
Denon DCD690	199.99
Denon DCD890	269.99
Marantz CD52 II Se	299.90
Mission DAD5 *	299.99
Nakamichi CD4 New	299.99
Yamaha CDC625 - 5 Discs	299.95
Denon DCD1290	329.99
Rotel RCD965BX	349.95
Aura CD50	399.95
Mus.Fidelity CD2	350.00
Arcam Alpha + CD	449.90
Arcam Delta 70.3	699.90
Arcam Delta 170.3	699.90
Nakamichi CD2 M/Bank	599.95

CD Specials

Mission *CD Package - comprising
DAD5 CD, DA Converter & Isoopt
Total Value £630.00 549.90
 Denon DCP100 Portable CD Package
FREE Maxell Car-Cassette Adaptor
OR HD55 Headphones 249.90

RIAA Pre-Amp

QED Discaver	34.95
D-A Converters	
QED Digit MB52	134.95
Mission DA	299.90
Arcam Delta Box 5	449.90
Audiolab 8000DAC	699.00

A-V Systems

Yamaha - Denon - Marantz		
Rear Chan. FX Amps		
DSP-E200 3 Channel	349.95	
DSP-E1000 5 Channel	649.95	
Surround Sound FX		
DSP-A500 5 Ch. Amp	449.95	
RX-V660 5 Ch. Recvr	449.95	
DSP-A1000 7 Ch. Amp	899.95	
Effects Spkrs		
NS-C90 Centre Spkr	119.95	
YST-SW50 Active	199.95	
YST-SW100 Sub Woofer	259.95	
Plus		
Marantz SP50 Add-on Amp	209.90	
Denon AVC3020 5 Ch.	699.99	
A-V on Permanent Demo		
** FREE Info Leaflet **		
Denon Mini Systems		
D70 Ex.Spkr	589.99	
D100 Ex.Spkr	769.99	
D250 Ex.Spkr	929.99	

Target

Speaker Stands

T20 or T30	51.95
T40 or T50	53.95
T60 or T70	55.95
HS12 or HS16	66.95
HS20	67.95
HS24 or HS28	74.95
HJ17/2 Heavyweight	99.95

Hi-Fi Stands & Tables

TT2 Table	69.95
TT4sa Flat Pack	101.85
TT6sa Flat Pack	114.95
AER2 DeLuxe	109.95
AER3	127.95
AER4	155.95
AER5	169.95

** Check for full range **

Audio Technica

Headphones

ATH-L1A Lightweight	19.95
ATH-308 - New	25.95
ATH-910 Closed Back	69.95
ATH-70 Electret Cond	195.95
ATH-900 Electret Cond	249.95

Microphones

AT-9100 Dynamic Mono	24.95
AT-9350 Uni Shotgun	69.95
AT-9500 Omni Clip	31.95
AT-9740 Stereo	59.95

Cartridges

AT-101P P-Mount	16.95
AT-95E Bi-radial	18.95
AT-110E LC-OFC	24.95
AT-OC3 Moving Coil	94.95
AT-OC5 Moving Coil	129.95

** Check for full range **

Denon DL304 MC Cart 199.90

All goods insured against loss or damage in transit. Prices correct at time of going to press (5 Weeks prior to publication). Prices incl. VAT and are valid for current month. Next Day FREE delivery on cleared payments. E&OE

Accessories

Interconnects - Per Pair

Turquoise 1 Metre	34.95
Topaz 1 Metre	47.95
Ruby 1 Metre	69.95
Quartz 1 Metre	99.95
Emerald 1 Metre	199.95

Speaker Cable - Per Metre

F14	1.95
Type 2	2.95
F18	3.60
Type 4	4.50
Indigo	7.50
Crystal	13.50
Midnight	22.00
Cobalt	42.00

Video & Optical - each

Video X 1 Metre	29.95
Video Z 1 Metre	49.95
Digital Pro 1 Metre	89.95
Optilink X 1 Metre	49.95
Optilink Z 1 Metre	99.95

Headphones & Mics

HD 55	29.95
HD 440 II	29.95
HD 450 II	39.95
HD 480 II	54.95
HD 480 II Classic	64.95
HD 520 II	79.95
HD 530 II	89.95
HD 250 II Closed Back	119.95
HD 560 II	124.95
MKE 300 Camcorder Mic.	99.95

TOP TAPE Bargains

Send for our Mail Order List - over 200 different tape lines in stock at the lowest prices

Mail Orders to:	I enclose Cash/ Cheque/ Card N° + Expiry Date
Harrow Audio 27 Springfield Rd. Harrow HA1 4QF	Name
Credit Card Line: 081 863 0938	Address
Fax Orders: 081 863 2443	Daytime Tel. N°
	Please Send Me

HFW 4

CLEAR • CRYSTAL • SYSTEMS

WANTED: EARLY HI-FI

Loudspeakers and Units:

Tannoy Gold and Red units, ILLZ, Lancaster, York, GRF etc. Western Electric/Westrex drivers and Cinema speakers. Lowther, Voigt, Axion 80, RCA, Parmeko, Seimans, Vitavox, Lockwood, Altec, Quad, JBL, Dual Concentric units etc.

Turntables:

Garrard 301, 401, BBC, EMT 927/930
 Thorens TD124 and TD224

Pickup Arms and Heads:

SME 12" Arms, Ortofon Arms and Heads,
 FR-64 and FR-66, Decca FFSS, EMT

Valve Amplifiers:

Dynatron, Quad, Radford, McIntosh, Leak,
 BTH, AEI, Western Electric, Pye, RCA etc.

Valves:

Audio Valves: DA30, DA60, KT66, KT88, KT77
 ECC83, GZ34, PX4, PX25, PP5/400, WE300 etc.

Interesting early Hi-Fi and Valves Bought and Sold.

John Petrie-Baker,

CLEAR CRYSTAL SYSTEMS

Flat 2, 18 Canfield Gardens, London NW6 3JY

Tel: 071-328 9275 - Fax: 071-833 3008

Mobile: 0831-860499.

Hertford Music

Stockists of High Quality
 British Hi-Fi

including:

REL Acoustics sub-woofers

- the only ones that really work

A.C. Magnum amplifiers

- mosfet amplification currently receiving
 critical acclaim

Lumley valve amplification

- probably the best valve amplifiers
 in the world.

also, Rotel, Diamond Acoustics

Home demonstrations arranged

Telephone: (0992) 700900

Fax: (0992) 788271

Northwood

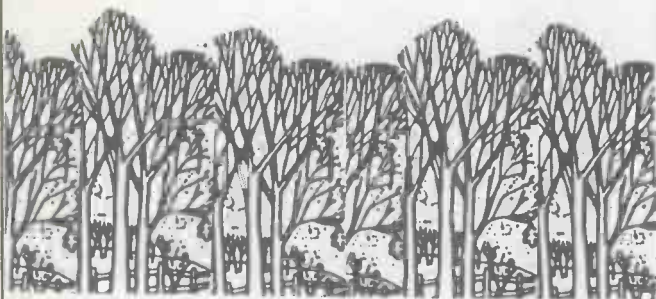

A U D I O
Hi-Fi Specialists

10% FREE
ACCESSORIES WITH ANY
PURCHASE OVER £200

Can't separate the wood from the trees?

Come and audition the very best that Hi-Fi has to offer and let your ears hear music like they've never heard before!

RUARK, ALBARRY, ROTEL, CELESTION, NAD, TANNOY, MICROMEGA, GYRODEK, HEYBROOK, MARANTZ D.C.C./A.V., PIONEER, EXPOSURE, AUDIOLAB, MERIDIEN, AUDIO INNOVATIONS, TDL, MISSION, HECO, THORENS, DENON, KEF, TARGET, plus many more

BOTH BRANCHES NOW HAVE 2 DEM ROOMS

126 Pinner Rd, Northwood
Middx HA6 1BP.
Tel: (0923) 820877.

NEW BRANCH NOW OPEN AT:-

98 Cambridge Street
Aylesbury, Bucks HP20 1BP
Tel: (0296) 28790.



NEW CAVENDISH STREET WI

CITY OF WESTMINSTER

FREE Express Mail

Take advantage of our FREE door to door express mail order facility. We guarantee to despatch stock items by return and they are fully insured against loss or damage. In addition you get the benefit of KJ's two year guarantee. (*cleared payments only).

INTEGRATED AMPLIFIERS

ARCAM	Delta 290 (Line Stage)	£1449.00
	Alpha 3	£1998.00
ALBARRY	PP1 (Line Stage)	£399.00
ALCHEMIST	Kraken	£399.00
AMC	CVT 3030	£529.00
AUDIOLAB	8000A	£429.00
AURA	VA100	£299.00
COPLAND	CTA401	£1699.00
CROFT	Integrated	£499.00
PIONEER	A 300X	£229.00
	A 400	£279.00

PRE-AMPLIFIERS

AUDIOLAB	8000 C	£399.00
ALBARRY	AP4	£349.00
ALCHEMIST	Freya	£1020.00
CROFT	Super Micro A	£689.00
MICHELL	Ango (+ Here P/S £155.00)	£699.00
	ISO-MC to Line Level	£399.00
QUAD	34	£389.00

POWER AMPLIFIERS

ALCHEMIST	Genesis Mono Blocks	£1525.00
ALBARRY	M408/2 Mono Blocks	£850.00
	M1008/2 Mono Blocks	£1100.00
AUDIOLAB	8000 P	£569.00
AUDIOLAB	8000 M Mono Blocks	£1259.00
CHORD	SPM 1200	£2995.00
CROFT	Series 5	£555.00
MICHELL	Alexio Mono Blocks	£1880.00
MUSICAL FID	P 180	£799.00
	C75 P/Supply	£499.00
QUAD	306	£341.00
	606 Mk2	£675.00

CD PLAYERS

ARCAM	Alpha +	£449.00
MARANTZ	CD 52 Mk2	£229.00
	CD 52 SE Mk2	£299.00
MISSION	DAD 5	£299.00
	DAD 5/CDS/Isoplat	£499.00
MERIDIAN	206 B	£995.00
ROTEL	RCD 965 BX	£299.00
	RCD 965 BX Limited Ed.	£379.00

CD TRANSPORTS

ARCAM	Delta 173.03	£699.00
DPA DIGITAL	T1	£895.00
MERIDIAN	200	£895.00
	602	£1750.00
ROKSAN	DP1	£995.00
THETA	DATA	£2998.00

D/A CONVERTERS

ARCAM	Black Box 5	£449.00
AUDIO LAB	8000 D	£699.00
AUDIO ALCHEMY	DJ.E	£419.00
DPA DIGITAL	Little Bit	£423.00
	Bigger Bit	£695.00
	PDM 1 Series 3	£1280.00
	PDM 2	£2350.00
MERIDIAN	203 (DAC 7) Special Offer	£360.00
	263	£495.00
	606	£1350.00
ROKSAN	DA 1	£495.00
THETA	DS Pro Prime	£1399.00

AUDIO VISUAL - SURROUND SOUND

CELESTION	HT3 Pro-Logic 5/S Kit	£499.00
DENON	AVC 3020 P/Logic Amp/Pro	£699.00
INFINITY	See Speakers	
LEXICON	CP2 DSP P/Logic Decoder	£995.00
	CP3 THX P/Logic decoder	£2995.00
PIONEER	CLD 1750 Laserdisc Player	£579.00
YAMAHA	DSP A1000 P/Log Amp/Pro	£899.00
	DSP E 1000	£649.00
	DSP A500	£449.00
	DSP E200	£349.00
	YST-SW50 Subwoofer	£199.00

SPEAKER SYSTEMS

AC ENERGY	AE 1 (Stands + £300)	£764.00
APOGEE	Centaur Minor	£1345.00
B & W	Matrix 805	£845.00
	Matrix 804	£1395.00
EPOS	ES 11 (Stands + £85)	£350.00
IMPULSE	H2	£2250.00
	H6	£1250.00
INFINITY	Infinitesimal 4	£249.00
	Infinitesimal Subwoofer	£549.00
KEF	103/4	£1095.00
MISSION	760 I	£129.00
	761 I	£179.00
	780	£199.00
	753	£599.00
PRO-AC	Studio 1 Mk 2	£613.00
	Supertower Mk 2	£1229.00
	Response 1	£919.00
QUAD	ESL 63	£2384.00
	Subwoofers for ESL 63	£1650.00
ROGERS	LS2z2	£229.00
SONUS FABER	Minoetto	£898.00
TANNOY	605	£160.00
	609	£270.00
	611	£399.00
	CS 1-2	£1219.00

TURNTABLES (Less arm)

MICHELL	Myco	£399.00
	Gyro	£699.00
PINK TRIANGLE	L.P.T. with GTI	£585.00
	Export	£895.00
	Anniversary	£1495.00
ROKSAN	Radius + Tabrig Arm	£640.00
	Kernas	£865.00
SYSTEM DEK	11X/900	£229.00
	11X/900+RB250 Arm	£327.00

TONEARMS (Fitted Free)

MORCH	DP6	from £665.00
MOTH	Mk 3 (RB300) - Rega fit	£149.00
	Mk 250 - Rega fit	£98.00
ROKSAN	Tabrig	£190.00
SME	Series 4	£827.00
	Series 5	£1232.00

CARTRIDGES

AUDIO TECHNICA	ATOC 3	£95.00
	ATOC 5	£129.00
	ATOC 10	£319.00
DENON	DL 304	£199.00
LYRA	Lydian	£549.00
ORTOFON	MC 15	£99.00
ROKSAN	Corus Blue	£75.00
	Corus Black	£130.00
SHURE	V15T	£175.00
SUMIKO	Blue Point	£99.00
	Blue Point Special	£199.00

How to pay - by cheque, postal orders or by credit card (stating expiry date).

How to order - by post, by telephone or fax. When paying by credit/debit card (Access, Visa and Connect).

All prices include VAT and were correct at time of going to press.

Please send me

I enclose my cheque/Postal Order for £ or please debit my Access/Visa account No:

Expiry Date

Signature

Name

Address

Daytime Tel No Post Code HFW 6

SUGDEN

HAND CRAFTED AUDIO PRODUCTS

A WORLD OF MUSIC

SDA-I Digital To Analogue Converter

U.K. - Sugden's SDA-I bowled us over with a sound populated by masses of high-resolution details and complemented by very quiet, dark backgrounds and tremendous dynamics...

Canada - At a price well below many DACs of similar sound quality it offers real value for money in addition to its sonic refinement.

Germany - D/A converters from the Sugden stable have established themselves on a solid platform within the hi-fi scene.

SDT-I CD Player

Canada - The combination of excellent transport and high-quality parts make the Sugden a very relaxed and easy player to listen to, with no digital edge.

U.K. - I have to say Sugden's CD player just has to be near the top of any buyer's list.

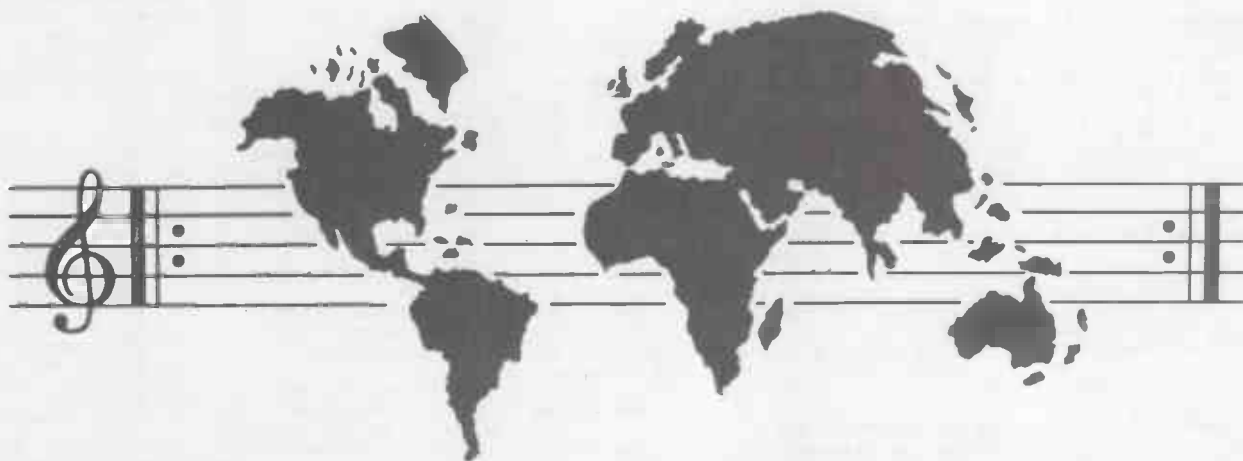

A21a Class 'A' Amplifiers

U.K. - A true thoroughbred that will undoubtedly attract newcomers to Sugden's dedicated band of followers. It almost begs you to put on more music and then proceeds to play it with aplomb.

Holland - A concert hall in your living room. The reproduction quality of the amplifier is without any stress and gives total involvement in the music.

A25B Integrated Amplifier

U.K. - Not only does the little A25B look more refined than many of its peers, it also has a sophistication to its sound that is sadly lacking in most of its immediate competitors.

Singapore - The Sugden A25B will not fail to please in the way it presents the music. It is therefore, highly recommended.

Canada - The quality of sound produced by this amplifier is exemplary.

Australia - We are hard pressed to think of an amplifier quite so musical. A delight to the ear.

France - The general transparency of sound and the punch delivered by the amplifier are really astonishing.

A48 Integrated Amplifier

U.S.A. - In terms of sound quality the A48 is a revelation. More than any other integrated amplifier in my experience. The Sugden imbues music with a warmth and body that is quite addictive.

U.K. - Coherent and musical, the Sugden A48B is on the warm side of neutral, well suited for those who like the valve sound.

Au51c Pre-amplifier

Canada - You can tell that the Au51c is special. Five minutes convinced everybody present that a pre-amp must sound like this if it is to be of reference quality.

Canada - Cold, out of its packing carton, the Sugden instantly sounded better than great. During the next few hours of operation, the unit literally blossomed and developed the sort of sound closely akin to a live performance.

Au51p Power amplifier

Canada - We've never tested an amplifier which sounds this big and did its job so well.

FOR FURTHER DETAILS:

**J. E. SUGDEN & Co., LTD. VALLEY WORKS, STATION LANE, HECKMONDWIKE, WEST YORKSHIRE WF16 0NF
0924 404088**

OVER 25 YEARS SERVICE TO MUSIC LOVERS

Audio Note Audio Component Parts Price List.

We have decided to offer a range of the ultra high quality components used in most of the Audio Note amplifiers to the discerning "do-it-yourself" valve amplifier enthusiast. These components include specially made valve bases, paper-in-oil and silver foil coupling capacitors, Black Gate and Carfine electrolytics, acid-free silver solder, output transformers and valves. In addition to this we can supply various silver cables and wires for internal wiring.

It should be noted that all prices are exclusive of Value Added Tax and postage/freight. For all EEC citizens it must be noted that we are now required to charge UK Value Added Tax at the standard rate of 17.5% on all sales to individuals living within the EEC, so your payment must include 17.5% added on to the total value of your purchase. Sorry about that, but those are the rules!

Ceramic Valvebases.

All our valve bases are of the highest quality made from sialite and using metal parts alloys which retain their spring tension around the valve pin for a very long time indeed. They are recommended both as upgrades for existing amps as well as use in any amplifier construction projects.

Type	£
4 pin UX4 gold plated chassis	8.25
4 pin Jumbo silver plated chassis	157.50
5 pin UY5 gold plated chassis	9.50
7 pin silver plated PCB	6.15
7 pin silver plated chassis	6.75
8 pin silver plated chassis	5.65
8 pin gold plated chassis	8.50
9 pin silver plated PCB	3.70
9 pin gold plated PCB	5.80
9 pin silver plated chassis	4.10
9 pin gold plated chassis	6.50
Topcap with connector	9.50

If the above bases are too expensive, we can supply the following "industrial grade" ceramic valve bases.

8 pin chassis clip mount	1.45
8 pin chassis bracket	1.45
9 pin chassis bracket with shield	1.85

Cables & Wires.

We can offer the Audio Note range of copper and silver coax and wiring cables, depending on the end-quality of your project, I feel that it deserves at least a piece of silver twin coax on the input, prices as follows.

Coax Cables	£ cost per metre
AN-A copper twin coax litz	15.00
AN-C copper twin coax litz	19.95
AN-S silver twin coax litz	80.00
AN-V silver twin coax litz	145.00

Wiring/Speaker cables	£
AN-D copper single strand	6.99
AN-B copper screened speaker cable	12.50
AN-SP Silver speaker cable	125.00
AN-SPx Silver speaker cable	350.00

It should be noted that the cost for the coax cables is per stereo metre and the speaker cables per mono metre. It is recommended to use the internal twin wires of the AN-S and AN-V as internal signal wiring wires, this is what Audio Note do in their best amplifiers.

Paper-in-Oil Signal Capacitors.

These handmade paper in oil signal capacitors are sonically superior to any of the plastic types we have come across. If you have never experienced the difference that a good paper/oil capacitor makes in a valve amplifier, you really should try. They are easy to put in as a replacement for most plastic capacitors,

improvements will be experienced in Audio Research, Conrad Johnson and other more "modern" valve amplifiers, but most certainly in old Leaks, Radfords, McIntosh and Quad power amplifiers.	
0.015mF/400vDC	2.85
0.022mF/400v DC	3.70
0.18mF/400v DC	4.30
0.22mF/400v DC	4.95
1.4mF/400v DC	12.00
0.0015mF/630v DC	3.15
0.082mF/630v DC	2.70
0.22mF/630v DC	5.35
0.33mF/630v DC	7.05
0.39mF/630v DC	7.60
0.22mF/1000v DC	6.50
0.39mF/1000v DC	10.30
1.2mF/1000v DC	14.75
0.22mF/1600v DC	8.05
0.22mF/2000v DC	11.00

Other values available by special order.

Audio Note Silver Foil Capacitors.

Quality speaks for itself! Best signal capacitors available, without question, made by hand at Audio Note's factory in Tokyo, Japan.

0.02mF/500v	210.00
0.05mF/500v	345.00
0.1mF/500v	645.00
0.15mF/500v	988.00

Other values available by special order, and at a price.

Paper-in-Oil Reservoir Capacitors.

Can be used in many applications, choked power supplies where low storage capacity of high quality is needed, for example.

2mF/400vDC	30x40x55mm	26.00
2mF/630vDC	35x45x72mm	33.50
2mF/1000vDC	45x45x72mm	39.40
2mF/1600vDC	50x70x72mm	42.60
4mF/1000vDC	45x45x120mm	46.90
4mF/2500vDC	70x70x120mm	264.00
10mF/1000vDC	70x70x120mm	92.00
12mF/1000vDC	70x100x100mm	106.00
12mF/1600vDC	100x100x120mm	127.00
12mF/2000vDC	100x100x220mm	151.00

Many of these values are available only in small quantity, and values will be added as we can produce relevant values in competitively priced packages.

Other values available by special order.

Audio Note Acid & Chloride

Free Silver Solder.

50 grammes	24.50
------------	-------

BLACK GATE Electron Transfer, High Performance, Electrolytic Capacitors.

These electrolytics will greatly improve any amplifier or loudspeaker, when used as substitute for any other type of electrolytic.

Type/Value	£
0.47mF/50v	PK-type 1.05
1mF/50v	PK Type 1.25
2.2mF/50v	PK Type 1.55
4.7mF/50v	PK Type 2.15
22mF/50v	PK Type 3.35
2200mF/100v	BG-N Type 423.00
1000mF/50v	BG-N Type 92.30
470mF/16v	BG-N Type 21.75
100mF/16v	BG-N Type 18.50
100mF/50v	Standard Type 5.05
1000mF/50v	Standard Type 24.55
220mF/16v	Standard type 4.30
470mF/16v	Standard type 6.35
2200mF/63v	K-Series 36.90
4700mF/16v	Standard type 14.10
47mF + 47mF/500v SK Type	58.56
100 + 100mF/500v SK Type	73.20
220 + 220mF/350v SK Type	67.85

220mF/16v	F type	6.25
220mF/16v	FK type	9.95
1000mF/50v	FK Type	43.90
220mF/63v	FK Type	75.75
22mF/350v	VK type	8.90
1mF/50v	N Series bipolar	4.90
4.7mF/50v	N Series bipolar	5.45
10mF/50v	N Series bipolar	6.80
47mF/50v	N Series bipolar	13.75
100mF/50v	N Series bipolar	17.65
6.8mF/50v	Bipolar	8.90
10mF/50v	Bipolar	9.75
22mF/50v	Bipolar	17.30
47mF/50v	Bipolar	25.95

Many other values available by special order, please enquire about values and prices.

Valves.

The valves we offer are selected from the best available in terms of sonic performance, microphonics, longevity, consistency and price.

EC83S/12AX7WA Ultra low microphony	2.70
E88CC/6922/6DJ8W Mil spec version	3.65
EF86/6267 Mil spec version	1.95
6SN7	1.60
6SJ7	1.60
EL84/6BQ5	1.25
EL84M/6BQ5WA Close tolerance Mil type	4.10
6L6GC	2.40
6L6WGC/5881 Mil spec type	4.30
VT4C/UV211 GE 1942 version	36.50
5687 National	4.50
5687 RCA	8.75
5687 GE	6.80
6350	4.30
6072A Fine sounding ECC83 equivalent	6.00
6072A RCA	9.20
6072A GE	7.50
5J4G	3.20
GZ34/5AR4 Best available	8.80

Output Transformers.

We can supply almost any requirement for impedance or power by special order, write for quote. We offer a design service, where we will design almost any output, line or driver transformer for a standard fee of £ 200.00, prototype cost will be quoted on an individual basis.

Common stock items include:	
15 watt for EL84/ECL86/6V6PP	9K-60hm 34.00
15 watt for EL84/ECL86/6V6PP	9K-4/80hm 42.00
25 watt for 2A3/300BPP	5K-4/80hm 57.00
25 watt for EL34/6L6PP	6K-4/80hm 51.00
50 watt for KT88/6550APP	6K-4/80hm 69.00
50 watt for EL34/6L6PP	3K-4/80hm 69.00
50 watt for 845PP	11K-4/80hm 119.00
15 watt for EL84/6V6PSE	2K6-4/80hm 81.00
25 watt for 300B/2A3SE	2K5-4/80hm 91.00
25 watt for 2A3PSE	1K2-4/80hm 97.00
30 watt for 211/845SE	10K-4/80hm 111.00
50 watt for 211/845SE	10K-4/80hm 121.00
50 watt for 300BPSE	1K25-4/80hm 146.00

PP = Push-Pull, PPP = Parallel Push-Pull, SE = Single-ended, PSE = Parallel Single-ended. All impedances are calculated for Class A operation with best power transfer and minimum distortion. All single-ended amplifiers are airgapped.

All our output transformers have a frequency response well beyond audible range, typically 20Hz to 40kHz - 1.5dB, IE - core with high grade silicon steel laminations, and either bell-ends with flying leads or frames and solder tags.

Arrangement of replacement output transformers for DYNACO, Leak and others are under design, enquire in April 1993, if this is what you are looking for.

Resistors.

We can offer 1 watt 1% metal film resistors from

Beyschlag, which are the best commercial metal film resistor available, most values available at 6 pence each.

Better quality H2 1 watt resistors from HOLCO are available at 36 pence each, the main advantage of the HOLCO is that they are non-magnetic. It must be noted, however, that HOLCO resistors are quite fragile and can become noisy if their legs are bent too close to the body of the resistor.

Very high or very low values of Holco H2s (above 500Kohm and below 100hm) will cost 0.61 pence each.

The best sounding resistor type is the Tantalum film. They are also non-magnetic, but of a finer grain than standard metal film resistors.

Tantalum film resistors are available in 1/2 watt, 1 watt and 2 watt, most standard values are available, but production is limited and delivery of some values may be restricted.

Prices for tantalum resistors are as follows:

1/2 watt 1%	2.06 each
1 watt 1%	3.70 each
2 watt 1%	7.05 each

Some very low or very high values may cost more.

The best way to ascertain whether the improvement of a tantalum resistor is worthwhile is to exchange a loading resistor on the input of any amplifier with a tantalum resistor.

Electrolytic Capacitors.

We can supply a suitable range of standard electrolytics for valve amplifier builders, apart from the good but expensive Black Gates.

Stocks vary, but the following is always available.

220mF/10volt	0.25
470mF/16volt	0.70
33000mF/16volt	3.10
33mF/350volt	1.35
33mF/450volt	1.95
220mF/400volt	6.10
220mF/450volt	6.90

Potentiometers & Switches.

We have selected the best available potentiometers and switches covering the affordable and the "state of the art" types.

Noble High Quality Carbon Film Type.	
100KOhm frame type	3.20
100KOhm Encapsulated type	8.60

Noble High Quality Balance Controls.	
100KOhm frame type	3.70
100KOhm Encapsulated type	9.70

Audio Note High Quality Attenuators.

Handmade silver plated, double brushed attenuators, made with an array of tantalum resistors, probably the ultimate volume control.

50KOhm	172.50
100KOhm	178.00

Other values available by special order.

Standard Type 6-way Switches.

This switch is adjustable 2 - 6 way, has gold plated contacts and a stainless steel ball for best possible contact and corrosion protection.

6-way Switch	3.30
--------------	------

Audio Note High Quality Switches.

These switches are commensurate with the quality of the volume controls, silverplated, self-cleaning.

2 channel 6 way	64.50
4 channel 6 way	89.00

We have a range of aluminium knobs to complement your project and add that touch of professionalism that is required.

Stand-offs.

If you are building power amplifiers with very high HT rails, like 845, 211, 4212A, 849 or the like, then getting the HT rails "suspended" from the chassis, can be very problematic. We have therefore designed a small range of ceramic stand-offs that are highly suited for this purpose. They are eminently suited for all other hard wiring purposes as well.

1 way chassis mounted	1.70
3 way chassis mounted	4.20
5 way chassis mounted	6.70
7 way chassis mounted	9.40

Should you require other parts like, phono sockets, speaker outputs, mains inlets or fuseholders, we can supply these too.

Circuits, Valve Data and Basic Information.

If you would like some suggestions as to which circuits to base your project amplifier around, we shall be happy to provide you with some, please send us a stamped self addressed letter (for A4 size enclosures) plus £4.00 in UK stamps (small denominations, please), or a US\$10.00 for foreign enquiries.

We have many circuits for 300B, 211, 845, 2A3/6B4G and EL34.

If you require valve data, add another pound, and I shall copy what I have got.

Due to the very large number of enquiries with specific and in some cases very complicated, technical questions, which require considerable time to respond to, I am having to put a small charge on any such enquiries. So accordingly, if you have any technical questions regarding your upcoming project or in general, please include £12.00, either by cheque or in small denomination stamps. For foreign enquiries a US\$ 20.00 bill will suffice.

There may still be some delay in responding to such enquiries, as I travel a great deal, however, I will guarantee a reply if this small charge is enclosed.

A small (to start with at least!) range of suitable mains transformers is under preparation, and by the end of February we should be able to offer chokes and mains transformers suitable for a variety of projects. Likewise, I am hopeful that we should be able to offer one or two complete kits, in a few months time, starting with a single single-ended 300B kit and possibly a 211 kit (poor-mans-ONGAKU sort of thing), keep in touch.

I am constantly being asked about books on the subject of valve amplifier technology, and since nothing exists which gives any basic grounding in the design of Audio Circuitry with valves, Guy Adams and I have written and collected a number of articles and extracts from old books, which together contain a thorough background to the subject, you will not become an instant expert from this, but it will give beginners and the more advanced a good "tool" and basic guideline to the subject.

Again we have to make a small charge for this, a cheque for £6.00 or small denomination UK stamps, or if you live outside the UK and 10.00 US\$ bill. Available March 1993.

Just write to,

Peter Qvortrup

Audio Note UK Ltd.
Unit 1, Block C,
Hove Business Centre,
Fonthill Road,
Hove,
Sussex, BN3 6HA,
0273 220511/731498 (fax).

UPGRADE 1

Get your Audio Innovations Series 500 upgraded to Audio Note specification, this two stage upgrade includes paper-in-oil signal capacitors and Black Gate capacitors in all important parts of the bypasses, new perspex saying Audio Note Series 500, and a complete new set of valves of best quality.

£250.00 incl. Vat.

UPGRADE 2

Upgrade 2, which is only done in conjunction with or after upgrade 1 has been effected, includes new output transformers, new gold plated valve bases, Black Gate power supply capacitors, 100kΩ high quality Noble potentiometer and balance control, goldplated switches, including lowering of the feedback to take full benefit of the better output transformers, this will make the Series 500 a genuine killer amplifier.

£300.00 Incl. Vat.

We have worthwhile upgrades for Quad II, Leak TL10, TL12, Stereo 20, TL25, TL50, Radford STA15, STA25, Audiomaster, Pamphonic, Dynaco, Croft, Tube Technology, Audio Research, Conrad Johnson, and most other Audio Innovations models.

All Audio Note upgrades are covered by a full 12 months warranty against failure, valves are guaranteed for 3 months. An original Audio Note certificate of conformity is issued with each upgrade.

AUDIO NOTE



MUSIC MATTERS



THE AUDIO SPECIALISTS

PRESENT THE ULTIMATE SOUND SYSTEM

Alwa, Alphason, Apollo, Arcam, Audiolab, Audioquest, Audio-Technica, Aurc, Beyer, BRW, Canon, Celestion, Chord, Cyrus, Denon, DPA, Dual, Epos, Exposure,

Panasonic, Pink Triangle, Pro-oc, Revox, Rogers, Roksan, Rotel, Ruark, Sennheiser, Strathwire, Systemdek, Tannoy, Target, Technics, Thorens, Tripod, Wharfedale, Yamaha.

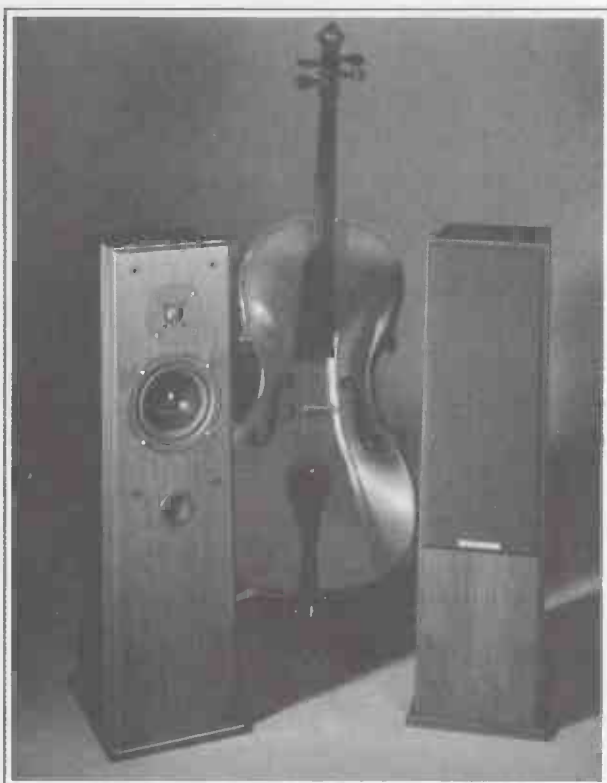

The Ruark Talisman II

Behind the Talisman's elegant design lies a quality loudspeaker for today's discerning audiophile. Manufactured from selected materials known for their acoustic properties, the cabinet is precision assembled for the highest quality appearance. The drive units and crossover feature the very latest technological developments including Ferrofluid cooling in the tweeter and specially treated materials for the bass unit. The Talisman, when partnered with equipment of a similar calibre, will bring any music lover closer to the original performance and provide a lifetime of musical enjoyment for only £699.

**INTEREST FREE
CREDIT AVAILABLE**

(for a limited period)

APR - 0% Written details on request.

Licensed Credit Broker

The Revox "Evolution" was conceived as a designer system with the facilities and performance of the best HI-FI. Capable of pleasing the most discerning of customer both aesthetically and audibly, the "Evolution" incorporates an LCD display to simplify operation, a 100 watt per channel amplifier, RDS (Radio Data System), 36 station tuner, Bit-stream CD player and optional high quality cassette deck. A DCC (Digital Compact Cassette) can be added when available and all functions can be controlled by an Infra-red remote control. **Prices start at £2249 excluding speakers.**

Revox Evolution System.

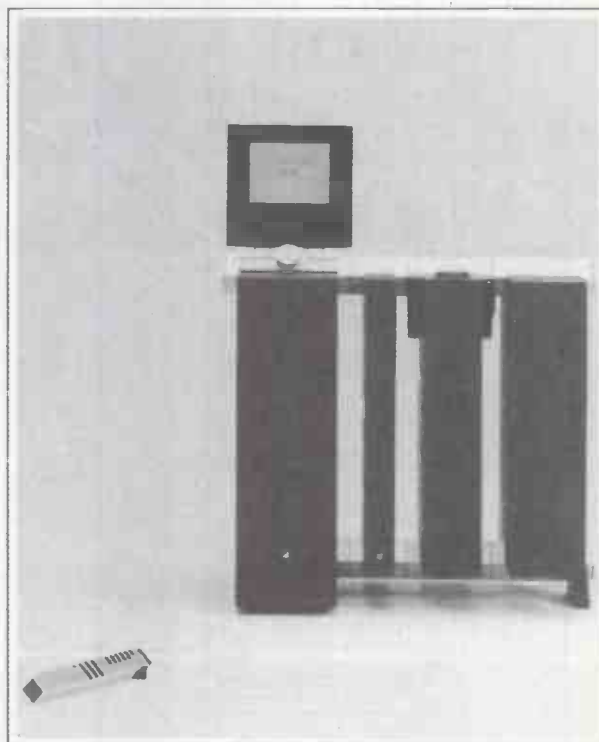

OPENING HOURS

Tuesday - Saturday
10.30 - 6.00

Late night Friday till 8.00

Demonstrations by Appointments



351 Hagley Road, Edgbaston. Tel:- 021 429 2811
156/7, Lower High Street, Stourbridge, DY8 1TS
Tel:-0384 444184

Heybrook, Infinity, JPW, KEF, Marantz, Meridian, Michell, Micromega, Mission, Monitor Audio, Musical Fidelity, Nakamichi,

World Class Hi-Fi

Fantastic!

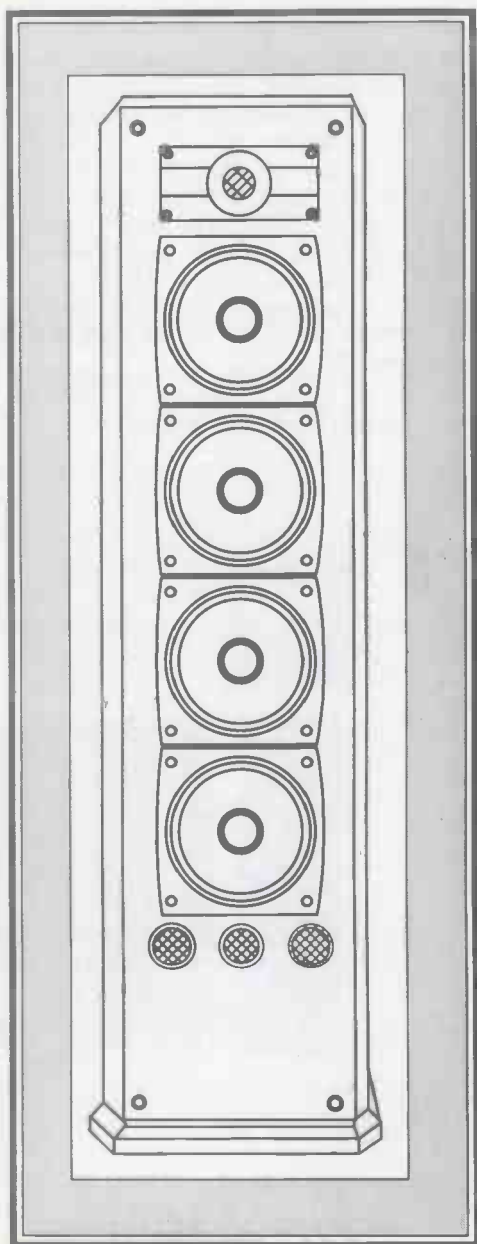

Yes, we could devote a whole page telling you how wonderful we are, but with so many good products arriving every month we feel we just have to break the mould and say some of these are really fantastic!

When you walk into our large display area you'll immediately see exciting new models from Naim, Rega, Linn and Marantz and you'll be more than welcome just to browse or chat about some of the new features these products offer.

Should you wish to listen, our friendly and experienced sales staff will be pleased to devote as much time as you require to demonstrate, in our pre-bookable and comfortable listening rooms, the advantages of new models such as the Mission 753 or Linn Keilidh loudspeakers, Arcam 290, AMC3030, Linn Klout or Naim NAP 180 amplifiers and the benefits they can bring.

Understandably, as you are listening you may find yourself suffering more than a mild attack of enthusiasm and may want to take advantage of our 0% APR, 10% Deposit finance and full installation service with 2 year warranty.

Some dealers are just happy to supply the equipment and let you supply the interest, but that's where we start - not finish.

Billy Vee
SOUND SYSTEMS
Welcome to the world of good Hi-Fi

- * Arcam * AMC * Acoustic Energy
- * Aiwa * Creek * Cyrus * Denon
- * Heybrook * JPW * KEF * Linn
- * Mission * Marantz * NAD * Naim
- * Nakamichi * Quad * Rotel * Rega
- * Ruark * Rogers * TDL * Target
- * Tannoy * Yamaha * Woodside

248 Lee High Road, Lewisham, London SE13 5PL
Tel : 081 318 5755 or 852 1321 Fax 081 318 0909
Mon to Sat 10.00am - 6.30pm (Closed Thursday)

MISSING CHANNEL

I am writing for some advice to help solve a rather baffling problem with my current hi-fi set-up. The system is made up as follows: Marantz PM26 stereo amplifier, Marantz SD151 cassette deck, Marantz CD-42 Compact Disc player, NAD 5120 stereo turntable and a pair of Mordaunt-Short MS.10 loudspeakers.

Everything has worked well together for some time, being used for playing records, cassettes and CDs through the amplifier and, on several occasions, recording on blank cassettes from the CD player or the turntable. My current problem relates to use of the turntable (not so much nowadays since the the almost complete take over by CDs).

My problem is as follows. When trying to record on cassette from an LP, the signal only appears to be coming through on one channel. This is evidenced by the fact that the cassette player's peak level meter only lights up on the left channel and no sound comes out of the right speaker. This also happens when playing a

BUDGET QUERIES

Write in with your problems to Hi-Fi World, 64 Castellain Road, Maida Vale, London W9 1EX.

Our panel of experts will endeavour to solve them or at least offer some practical advice.



amplifier and the right channel (red) into the left phono input. If when playing a record only the left loudspeaker works then the problem lies within the amplifier's phono stage. If, however, only the right loudspeaker works, the problem can be narrowed down to the right channel of the record deck. The residual indication on the record level meter may be hum due to a broken connection.

If the fault is due to the phono stage of the amplifier then I suggest you contact your nearest NAD dealer who has a service department. I believe Listen Inn of 32a Gold St, Northampton is the closest; their telephone number is 0604 37871. If you deduce that the fault lies with the record deck itself then a little further detective work should save you the fees of a repairs engineer.

At the back of the cartridge there are four pins onto which the tonearm wires are connected. If you have access to a multimeter the continuity between the phono plugs that connect to the amplifier and the sleeves that slide over the cartridge pins can be tested. This will tell you whether the problem is due to either the cartridge or the wiring.

On the back of the cartridge the pins should be colour-coded red, white, green and blue. The white and the blue pins refer to the signal and ground connections of the left channel respectively so they can be ignored. Remove the right phono plug from the amplifier and test the continuity between the wire connected to the red pin and the centre pin of the red phono plug. Do the same for the green pin and the

outside of the phono plug. If either are open circuit or of a higher resistance than a few ohms then there is a poor connection or a break in the wire.

This may simply require cutting the phono plug off and re-soldering a new one on. However if the wires have snapped inside the tonearm, which is unlikely, a visit to your friendly hi-fi service department will be needed. If all is well then it must be the cartridge to blame for the lack of sound in one channel.

Unfortunately the Ortofon OM5 MM cartridge used in the NAD 5120 turntable, like most, has the sensing coils located within the cartridge body. These coils are wound from very thin copper wire and are used to convert the movement of the magnet into an electrical current. If one channel has stopped working then it could be due to a small break in one of these coils.

Just replacing the stylus will not cure the problem so the whole cartridge will need replacing. Replacing the OM5 will cost you £14.95 but if you wish to upgrade at the same time the £24.95 OM10 super may be worth going for. If you contact NAD they will be able to send you a double sided sheet which describes cartridge mounting and alignment for the 5120 record deck. The reference number of this information sheet is 169 and it is entitled 'Phono Cartridge Mounting and Alignment'. **DB**

**NAD,
Adastra House,
401-405 Nether St.,
London N3 1QG
Tel: 081 343 3240**



Is it the cartridge, the cassette player or something else? A problem with the NAD 5120.

record but not recording - i.e. no right-hand speaker sound and, when using the cassette deck as a monitor, only the left hand channel lighting up. An additional symptom is that, just prior to starting the turntable (or in the case of a recording, just prior to releasing the Pause button), three of the lights in the right channel of the peak level meter stay lit - even though no sound is being transmitted.

Everything else is fine - the CD player plays through both channels when recording or just playing a CD - and all connections appear sound. I am puzzled as to whether the problem lies

with the turntable, the phono section of the amplifier, or the cassette deck
**A J Stevens,
Northampton.**

Your problem almost definitely lies with the record deck as recording and playing of CD is fine. This indicates that the line stages of the amplifier and the cassette deck are O.K. The problem is, as you have already observed, pin-pointing the fault.

The first thing to try is swapping the left and right phono plugs over, connecting the left channel (white or black) to the right phono input of the



CONFUSED BY THE MARKET

I urgently need advice regarding my hi-fi. I am writing to you for some expert advice after recently purchasing a Pioneer A-400 amplifier and Kenwood KX3050 stereo cassette deck. I have always been keen to learn the ins and outs of hi-fi separates but with so many units on the market to choose from I am a little confused. Would you please advise me on a CD player tuner and speakers to go with the above amp and cassette deck; funds available: £450. Please give comments on the amp and cassette deck, plus whether it would be worth hanging on a bit for the new DCC and MD units instead of buying a CD player.

**Bob Jennings,
Coventry.**

The A-400 is an old favourite among audiophiles and does offer very good value for money. It does have a slightly full or rich bass quality, so for an ideal balance the loudspeakers considered should be dry and fast sounding. This will produce the most neutral result from the system.

Both the Mission 760is and the Maxim 3s will suit the tonal quality of the Pioneer. In both cases they will work best on spiked stands and should be connected with high quality cables such as those from QED or Furukawa. The cost of the loudspeakers, stands and cables should come to around £160.

This leaves you £290 of your budget to spend on a CD player and tuner. The tuner will require an aerial for the best reception to be received and this is going to add to the cost. Your closest transmitter is at Meriden, approximately 10 miles West North West, which transmits at a healthy 2.2kW. This means that a two or three element aerial will feed the tuner with a reasonably strong signal, if there are no intervening obstructions.

The tuner I would recommend is the Denon TU260L. It is an excellent tuner with a

spacious and clean but warm sound and secondly, at £110, it suits your budget. The aerial will cost around £30 on top of this leaving just £150 for a CD player.

This is not a lot to spend on a source to go with a £230 amplifier. Normal practice would be to allocate the main portion of your budget to the source that you use most. The reasoning behind this being that once information is lost it can never be retrieved, so you want to feed the amplifier as much information as possible.

Fortunately there are now some very good CD players under the £200 mark that will work well with your A-400. The Sony CDP-497 at £160 and the Aiwa XC-950 at £199.95 are both very competent players, the Aiwa being the more exciting of the two but the Sony has a sharp and well focused sound.

DCC and MiniDisc are still in their early days. You could hang on for one or the other to become dominant but by then there will doubtless be another medium on the horizon!

The question is: how long you wait.

At some point you will have to take the plunge and at the moment I feel that CD is the best option for you, especially since pre-recorded DCCs and MDs are being priced at a whopping £13.49. Which to buy is difficult to answer and no-one can really say what will happen within the next few years, but at least you can make good recordings on the Kenwood cassette deck you have purchased. You might be best advised to stick with it, using good quality metal tapes to get the best performance. Metal might be expensive, but it is still cheaper than blank DCCs or MDs. **DB**

MORE FROM A SUBWOOFER?

My room size is 20ft by 12ft with a patio door filling one end and the TV in the corner. The loudspeakers sit 6-7ft apart either side of a fireplace which is two thirds down one side of the room. The equipment cabinet is in the opposite corner from the TV (believe me, these are the best optimum positions for this congested solid-floor environment).

My present modest equipment is: Mordaunt-Short 3.30

speakers on Maxi-fust metal castor stands for bringing the speakers out from the wall if desired, NAD 3240PE amplifier, NAD 6325 cassette deck, Rotel RT845 AXL tuner and Pioneer 6700 one bit CD (no record deck now). These are connected with Tandy patch cords and QED 79 strand speaker cable.

I find the NAD a very versatile amplifier for my various needs (including T.V. sound). It is very fast and sharp, ideal for Classical music and its generally warm bottom end makes the lively Pioneer CD sound very attractive. The Mordaunt Shorts are also a very forward sounding loudspeaker with a pleasant controlled bass, so generally I thoroughly enjoy my music which is mainly Classics, Brass Bands, Dance and Easy listening. (I'm the wrong age for Heavy Metal).

Reading one of the letters in your magazine got me thinking.



A good CD player under £200: Sony's CDP-497.

Would a modest type of sub-woofer give more depth to my sound-if I stood it behind the settee at the foot of the long wall opposite the fireplace? Also, could I get the correct matching woofer electrically to be compatible with the Mordaunt Shorts? I expect a balance or volume control would have to be fitted to control the sub-woofer, or am I expecting too much in a medium sized room? I remember in the early days of hi-fi I tried the old Hafler method but found that it took the sharpness off the music at the front so I reverted back to straight stereo.

**A Tattersdill,
Bognor Regis.**

In a forthcoming issue of Hi-Fi World we are group-testing five satellite and sub-woofer combinations. Luckily, these five are all in the office at the moment so I decided to have a quick listen to see if any were particularly suitable for your needs.

Both the Monitor Audio and the Celestion subs were initially quite promising, but as you observe, they would require a volume control to set the level of the subwoofer output. QED

make a suitable loudspeaker volume control which could be installed between the amplifier and the sub-woofer. Most of the sub-woofers have two sets of speaker terminals, the idea being that you string the satellites off the subwoofer, which itself is connected directly to the amplifier. For maximum quality and to enable the volume control of the subwoofer to be used independently of the satellites, you should take one set of cables straight to your Mordaunt Shorts and a second set via the volume control to the sub-woofer.

The addition of a sub-woofer will sound impressive at first but the strong bass drone of the cheaper ones can tend to become fatiguing after a while. I would recommend arranging a home demonstration where you can borrow the subwoofer for a week or so to confirm

that this is the option that you wish to take.

The other option is to change your loudspeakers. The sub-woofers mentioned above are around the £300 mark, which may be more wisely

invested on a new pair of loudspeakers and a little fine-tuning of your existing equipment. Firstly, try changing your interconnects and loudspeaker cables for Campaign Audio Design and Furukawa FS-2T07 respectively. This should allow a little more information to reach the loudspeakers and firm-up the sound a bit. Then do away with the stands and replace them with either Heybrook HSB-1 or sand-filled Target HS stands. The castors on the stands you have may be convenient but they do not provide a rigid support for the loudspeakers which will result in a loss of focus and bass extension.

Your system should now sound considerably better than before, but if you still feel that there is a lack of depth, a change of loudspeakers to either Rogers LS2a2s or Tannoy 605LEs should prove worthwhile. Both of these are excellent loudspeakers, the Rogers being smoother and the Tannoys the sharper focused pair. If a change of loudspeakers is not required then I would suggest that you treat yourself to some more CDs, then sit back and enjoy them. **DB ●**

The Legend Continues

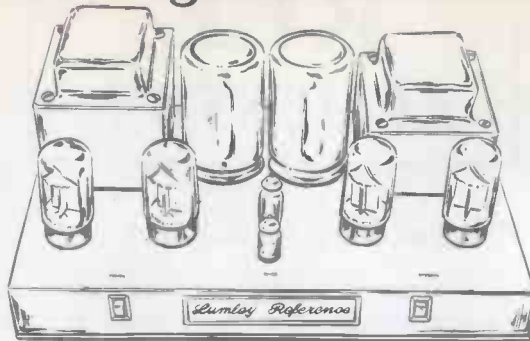

Lumley Reference

**VALVE AMPLIFICATION AT ITS VERY BEST
120, 250 AND 500 WATT MONOBLOCKS
LINE AND PHONO PRE-AMPS**

**ALL BRITISH ● HAND/HARDWIRED ● BEST COMPONENTS ● NO PRINTED CIRCUITS
2 YEAR PARTS AND LABOUR GUARANTEE (VALVES 6 MONTHS)**

The Lumley Challenge

PRICE FOR PRICE, SOLID STATE OR VALVE, **NOTHING** COMES ANYWHERE NEAR,
DON'T JUST TAKE OUR WORD – CALL OUR DEALERS BELOW.

THIS IS WHAT THEY SAY:

*"REAL POWER & DRIVE WITH SUBTLETY & FINESSE.
LISTENING IS BELIEVING."*

NIGEL BROWN © CHANTRY AUDIO, TUXFORD, NOTTS.
0777 870372.

"POWERFUL, DYNAMIC AND MUSICAL. THE LUMLEY'S SET A NEW STANDARD IN AMPLIFICATION."

GABRIELLE GORNA © THE ART OF MUSIC, CORNWALL.
0566 86649.

"BRITISH AMPS TO BEAT THE BEST. SONICALLY WONDERFUL, AESTHETICALLY BEAUTIFUL."

DAVE HARVEY © PROGRESSIVE AUDIO, RAINHAM, KENT.
0634 389004

Now also at LINTONE AUDIO, GATESHEAD, TYNE AND WEAR and HEATHERDALE AUDIO, WORTHING, SUSSEX. To find out why they have chosen 'Lumley Reference', Call Tony Gascoigne on 091-477 4167 (Linetone) and Dave Ruffell on 0903-261213 (Heatherdale).

"POWERFUL, DYNAMIC & ACCURATE, SUBTLE & MUSICAL – YOU'VE NOT HEARD VALVE AMPS LIKE THESE."

JEREMY BALDWIN © THE RIGHT NOTE, BATH, AVON.
0225 424334

"FORGET VALVE PRECONCEPTIONS, LUMLEY REFERENCE WILL EXCEED YOUR EXPECTATIONS. ABSOLUTELY SUPERB!"

MIKE GILMOUR © HIGHLAND ANALOGUE, INVERNESS.
0381 20655

"A SOUND STAGE OF TOTAL REALISM THAT SETS THE LUMLEY'S STREETS AHEAD OF THE REST..."

TONY LONG © SURREY HI-FI, GODSTONE, SURREY
0883 744755.



STOP PRESS...



**NOW TRIODE OR
PENTODE SWITCHABLE**



WRITE OR CALL FOR DETAILS AND DEALERS LIST TO:

REFERENCE IMPORTS

PINERIDGE, SANDY CROSS, HEATHFIELD, EAST SUSSEX TN21 8BS

Tel: 0435 868004

Fax: 0435 864481

EXPORT ENQUIRIES WELCOME

News update from REL Acoustics

It is now almost 2 years since we appeared at our first Hi-Fi Show, Chesterfield in May 1991. Time has flown by. I still squirm with embarrassment at the memory of that appearance. I had to use the only model in existence of our new design (a Stygian and long may the memory of that milestone model remain). I remember the hotel porter looking at his hands after helping to unload it - the gloss paint was still wet!! Well, things have certainly moved a long way since those halcyon days. It was about this time last year that we first introduced Stadium. Little did we know what lay in store. Most companies try and do their best to make their products sound as well as possible, remembering there is always a cost penalty to pay. The trick is to juggle the options to get that slight advantage over the rest. We have an unfair advantage over most of the larger companies, being an audiophile I am driven to extremes of perfectionism. The best is only just good enough. Stadium benefited from this drive. We have constantly sought to improve our models in small but cumulatively significant ways.

By the time you read this, the Bristol Hi-Fi Show will have come and gone. Perhaps we met you there. Now we can look forward to the Chesterfield Show, held this year for the first time at Ringwood Hall. This is a large country house style of hotel and I am told an ideal venue for the Show. Dates to circle in your diary are: Saturday/Sunday 17th/18th April. We are on the first floor in the Devonshire. This is a largish (19' x 18') room with I am assured excellent acoustics. Please come up and introduce yourself if you are an old or a new customer, or even if you just want a chat.

There are still a few old fuddy duddies out there who cannot believe what a genuine improvement a well designed sub-woofer can make to a system. Note I say "well designed". There are some horrors on the market, but a few minutes spent on a critical listen will soon show the most cautious or closed minded listener that ours really does the business.

REL ACOUSTICS

The Benefits of Owning a REL

Most people will concede that a wide system bandwidth is not just beneficial, but essential to anyone aspiring to true high quality musical reproduction in the home. With a conventional big box speaker not only is room matching a hit and miss affair, but your amplifier will become a limiting factor. The more critical the speakers, the more need for a very high end amp. Remember the speaker is the slave of the amplifier. It can do no more than it's told to do and frequently will try and do much less. With the REL sub-woofer there is no need to worry about upgrading your amp. The REL has its own built-in power amp which has been optimised for bass. It is DC coupled, meaning there are no harmful capacitors in the signal path causing phase problems and limiting its ultimate low frequency performance. Because of this built-in amp, there is no power drain on your main stereo amp. It goes on happily driving your main speakers exactly as before. The REL takes care of the bass and ensures by means of its clever internal Active Bass Controller that it fits perfectly beneath your main speakers. It can be "tuned" to your system and room, whatever your system's capabilities and listening room size. This is of enormous benefit, particularly if like many others, your listening room is not perfect. The REL will pressure drive your listening room beneath its lowest eigentone and ensure that those previously missing or masked frequencies are heard cleanly and clearly, no false emphasis or boom - you control its sound in your system. The REL is bi-wired from the main amplifier ensuring no interference with the main speakers. However, although there is no harmful interference with the main speaker there is a magical enhancement of the sound stage giving greater validity and depth due to the deep harmonics that are

present in all music.

Another benefit is more long term. If you decide to upgrade any item in your system, the REL will simply blossom more and more. In other words it will grow with your system, never becoming dated. This of course can be said about some upmarket speakers, but unlike those very revealing ones that simply show up your system faults, the REL is fully adjustable, thus it will never be obtrusive (unless you want it to be, for example at that Christmas party).

A further benefit is more domestic. It can be positioned where you want and not restricted to a single "hot spot" as would be the case with a pair of very large monoliths. Because of its harmonious styling, particularly true of Stentor, it can be of practical use as a coffee table or lamp or ornament stand.

Perhaps its biggest benefit is it allows you to keep what is best about your existing system. It is very likely that you spent a lot of thought, time and trouble choosing your main speakers, so why risk spoiling the sound they produce by compromising with a conventional sub-woofer? With a REL there is NO compromise. The REL will only add to your already high quality sound. It will never overwhelm, but confidently underpin your main system. It is very likely the most cost effective upgrade you will ever make. This has been repeated back in countless customers letters, time and time again.

As many of our dealers have confirmed, there is nothing else on the market that even approaches its performance. Every single sub-woofer we make has been individually and very carefully tested, checked and tested over and over at each stage of its production. Not a cheap way to build, but the only way to ensure consistently high quality. We build sub-woofers for audiophiles. Test one yourself.

Richard Lord

REL Acoustics

2 New Street, Bridgend Industrial Estate, Bridgend, Mid Glamorgan CF 31 3UD

Write, phone or fax for a fact pack and dealer list on Telephone: 0656 768777 • Fax: 0656 766093

AEGIS

AEGIS SERIES MODEL 1 LOUDSPEAKER BY ACOUSTIC ENERGY



(((AE)))

ACOUSTIC ENERGY

Manufacturers and distributors of the finest audio products

For full details of these products and our dealers contact:

Acoustic Energy Ltd

3A Alexandria Road London W13 0NP

Tel 081-840 6305 Fax 081-579 1761

M O N I T O R A U D I O

To listen.

To see.

To *feel*.



The MA 1200 Gold

Founded in 1972, Monitor Audio is one of the UK's most innovative loudspeaker manufacturers.

While many other specialists have come and gone, Monitor Audio continues to design and manufacture products true to the principles of quality in engineering and craftsmanship.

Only the best materials are used in Monitor's own cabinet manufacturing plant, where matched, real wood veneered cabinets are hand crafted to a quality finish rarely found in modern day products.

Every loudspeaker, from the highly acclaimed *Studio 20* to the compact *Monitor One*, is conceived and designed with equal attention. And each pair is built, tested and packed by one craftsman.

Listen to a pair of Monitor Audio Speakers and feel the difference.

What the press say

"What the reference 1200 Gold MD offers for a not considerable sum is a speaker which excels in two areas - imaging and bass reproduction."

HI-FI NEWS MAY 1989

"This smooth and civilised slimline floorstanding loudspeaker is well built and nicely presented."

HI-FI CHOICE MARCH 1989



The Symbol of Quality

MONITOR AUDIO

Sole UK distributors Hayden Laboratories Ltd.,
Freeport enquiries, Chiltern Hill, Chalfont St Peter,
Gerrards Cross, Buckinghamshire SL9 9BS.