

WIN!! ARCAM'S AWESOME DV27A DVD-AUDIO PLAYER!



CLEARAUDIO Emotion turntable



FOCAL-JMLAB Chorus 707 S speakers

# HI-FI CHOICE

PASSION FOR SOUND WWW.HIFIChoice.CO.UK MARCH 2004

EXCLUSIVE TEST ACOUSTIC ENERGY'S NEW AE1 AND AE3

## RETURN OF A LEGEND

AE's classic high-end monitor is back – now it's even better!

FIRST IN-DEPTH REVIEWS



### DIGITAL DREAM MACHINES

New CD players from Ayre and BAT take on the mighty Krell SACD Standard

Arcam storms the hi-fi high-end – C30 preamp and P1 monoblock tested inside



### ULTIMATE GROUP TEST STEREO VS MULTICHANNEL AMPLIFIERS

FEATURING...

- > Arcam DiVA A80
- > Denon AVR-2803
- > Creek A50iR
- > Pioneer VSX-AX3
- > Roksan Kandy KA-1 MkIII
- > Sony STR-DB790
- > Rotel RA-1062
- > Yamaha RX-V1400RDS



### DAVID SYLVIAN ZEN AND THE ART OF AUDIO ARCHITECTURE

£3.60 0.2 MARCH 2004 9 770955 111052 future publishing Media with passion

+ BUYER'S BIBLE THE WORLD'S FINEST HI-FI BUYING GUIDE



> *CLEANSER*

One damn good song  
I'm moving on



**B&W** Bowers & Wilkins

THE NEW B&W

703

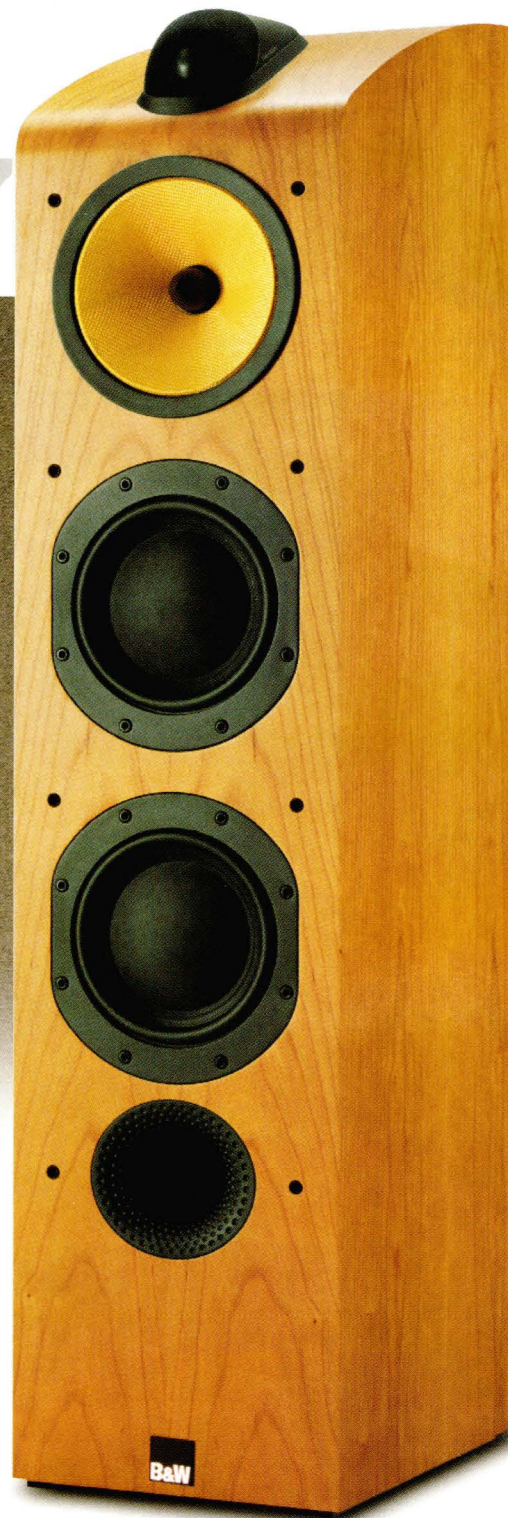

[www.bw700.com](http://www.bw700.com)

For your virtual tour of the B&W 703 and 700 Series please visit our site, or call +44 (0) 1903 221500



# TANNOY®

## S E N S Y S

E N G A G E T H E S E N S E S .



Tannoy has combined the core element of sound quality with cutting edge technology, clean aesthetic design and affordability, to produce a class leading range of exceptional loudspeakers.

The refreshingly uncluttered appearance of Sensys is as reassuringly unpretentious as it is timeless.

Sensys combines aesthetic appeal with a host of technological features designed to benefit acoustic performance.

The Sensys range offers stereo and multi channel AV system solutions that will provide complete audio satisfaction for years to come.

WIDEBAND TECHNOLOGY | DUAL CONCENTRIC™

T: +44 (0) 1236 420199 F: +44 (0) 1236 428230 E: enquiries@tannoy.com

tannoy.com



# HI-FI CHOICE

MARCH 2004 ISSUE 251

Future Publishing Ltd, 99 Baker Street, London W1U 6FP  
Tel: +44 (0)20 7317 2600 Fax: +44 (0)20 7317 2686

## EDITORIAL

Tim Bownen **editor** tim.bownen@futurenet.co.uk  
Dan George **reviews editor** dan.george@futurenet.co.uk  
Howard Malone **art editor** howard.malone@futurenet.co.uk

## CONTRIBUTORS

Richard Black, Faz Choudhury, Del Gentleman, Alvin Gold, Jimmy Hughes, Jason Kennedy, Paul Messenger, Paul Miller, Dave Oliver, Mark Prendergast, Dominic Scott, Phil Strongman, David Vivian, Nigel Williamson

## PHOTOGRAPHY

Chris Foster

## ADVERTISING

Debbie Maclaren **head of sales, London**  
020 7317 2637 debbie.maclaren@futurenet.co.uk  
Michelle Blackwell **senior advertising manager**  
020 7317 2602 michelle.blackwell@futurenet.co.uk  
Mark Bezodis **advertising manager**  
020 7317 2656 mark.bezodis@futurenet.co.uk  
Matt Dalton **key accounts manager**  
020 7317 2622 matt.dalton@futurenet.co.uk  
Tom Denning **senior sales executive**  
020 7317 2683 tom.denning@futurenet.co.uk  
Eloise Simpson **sales executive**  
020 7317 2429 eloise.simpson@futurenet.co.uk  
Stuart Harris **classified sales executive**  
01225 442244 stuart.harris@futurenet.co.uk

## HFC ONLINE

www.hifichoice.co.uk  
Lucy Price-Lewis **online editor** lucy.price-lewis@futurenet.co.uk  
Mark Phillips **online ad manager** mark.phillips@futurenet.co.uk

## SUBSCRIPTIONS

Tel: +44 (0)870 444 8650  
Email: customerservice@futurenet.co.uk  
Prices (13 issues): UK £29.97, Europe £43,  
North America £49.99, rest of the world £62

## BACK ISSUES

Tel: +44 (0)870 444 8650  
Prices: UK £4 per issue, overseas £6.95 per issue

## MARKETING & LICENSING

Philippa Montgomery **marketing manager**  
philippa.montgomery@futurenet.co.uk  
Simon Wear **licensing director**  
simon.wear@futurenet.co.uk

## PRODUCTION & DISTRIBUTION

Matt Gregory **production manager**  
Craig Broadbridge **senior production controller**  
Helen Ramjuttan **ad coordinator**  
Rob Brock **circulation manager**

## PUBLISHING & MANAGEMENT

Simon Maxwell **publisher**  
simon.maxwell@futurenet.co.uk  
Aubrey Ganguly **editor-in-chief**  
Andy Sutcliffe **editorial director, London**  
Jacquie Duckworth **advertising director**

All contents ©Future Publishing Ltd 2004.

No part of this publication may be reproduced in any form without the express permission of the publisher. While we make every effort to ensure that everything we print in *Hi-Fi Choice* is factually correct, we cannot be held responsible if factual errors occur. Advertisements are accepted by us in good faith as correct at the time of going to press.



Future Publishing is part of The Future Network plc. The Future Network produces carefully targeted specialist magazines for people who share a passion. We aim to satisfy that passion by creating titles offering value for money, reliable information, smart buying advice and which are a pleasure to read. Today we publish more than 90 magazines in the UK, US, France and Italy. Over 80 international magazines are also published in 28 other countries across the world. The Future Network plc is a public company quoted on the London Stock Exchange (symbol: FNET).

John Bowman **group finance director**  
Roger Parry **non-executive chairman**  
Greg Ingham **chief executive**

Tel: +44 (0)1225 442244 www.thefuturenetwork.plc.uk  
Bath • London • Milan • New York • Paris • San Francisco • Wrocław

## CONTRIBUTORS

To make sure you get the best advice, *Hi-Fi Choice* employs the most talented and experienced writers in the business.



### JASON KENNEDY

Jason previously edited *Hi-Fi Choice*, but can now be found swanning about the wilds of Sussex indulging himself with the very best hi-fi money can buy. His own system is simply sensational (trust us) and his love of music knows no bounds.



### PAUL MESSENGER

A former editor of *Hi-Fi Choice*, Paul has been writing about his beloved hi-fi hobby for some 26 years. In that time he has become one of the world's most respected sonic scribes and probably the UK's foremost loudspeaker reviewer. He also writes for respected US hi-fi journal *Stereophile*.



### PAUL MILLER

Science officer Miller is hi-fi's undisputed king of lab testing. He employs his own specially designed equipment to pull apart every measurable parameter and explain its effect on a product's performance.



### ALVIN GOLD

Alvin cut his hi-fi teeth in the retail trade, and has now been writing about his obsession for more than 20 years. In that time he has contributed to almost every hi-fi periodical you can think of (and several more besides). Few can match his encyclopedic knowledge of all things audio.



### DAVID VIVIAN

An award-winning journalist of considerable experience, David's sharp ears and equally sharp powers of description are a valuable mix for *Hi-Fi Choice*. He also writes about cars, but who needs to take the latest Lotus for a spin when you've got the finest hi-fi to test drive?

Our reviewers may possess golden ears and our listening rooms drip with sonic jewels, but *HFC* is no ivory tower. We exist to serve you, dear reader, and so your feedback is of fundamental importance. We need you to tell us where you think we're going right, and where we're going wrong, so we may continue to evolve this title for 21st century hi-fi enthusiasts.

Thankfully, you rarely hold back. Take Mr RK Lee from Gloucestershire, for example. Though he feels we deliver "an excellent magazine", he takes exception to "the home cinema rubbish" he has found within our pages. While I have some sympathy for this perception, there are some inescapable truths to consider. First, the march of technology dictates that music replay has become entwined with video playback and multichannel surround sound, a fact that now applies as much to high-resolution audio as it does to low-end home cinema.

Second, high-quality multichannel products from the best producers can qualify as genuine hi-fi, even with two-channel formats on which the vast majority of our music is based. We will always cherry-pick any multichannel products we feature according to their hi-fi credentials across multiple sources, and never at the expense of purist two-channel kit, which remains central to our labours and our pleasures. And our standards will never, ever drop.

Personally, I get a huge kick out of hearing great music on multichannel SACD or DVD-Audio. But, naturally, most of my listening is still stereo, and every time the needle falls I'm reminded of just how rock solid and musically coherent this 'ancient' technology remains. So here's to hi-fi in all its many guises. And keep those letters coming...



Tim Bownen **editor**

## Star products in this issue



36 **KRELL SACD STANDARD**  
SACD player



43 **CHORUS 707 S**  
Focal-JLab loudspeaker



56 **AYRE CX-7**  
CD player



68 **SONY STR-DB790**  
Six-channel amplifier

# CONTENTS

## HI-FI CHOICE

### PRODUCT REVIEWS

- 32 Acoustic Energy AE1 MkIII and AE3 MkII loudspeakers
- 36 Krell SACD Standard SACD player
- 40 Clearaudio Emotion turntable (with Satisfy arm and Aurum Classics Wood cartridge)
- 43 Focal-JMLab Chorus 707 S loudspeaker
- 44 Arcam FMJ C30 preamplifier and P1 mono power amplifiers
- 48 BAT VK-D5SE CD Player
- 51 Creek T50 AM/FM radio tuner
- 52 Final Sound Electrostatic loudspeakers
- 56 Ayre CX-7 CD player
- 58 Nordost Valhalla Reference mains cable

### 60 ULTIMATE GROUP TEST STEREO VS MULTICHANNEL AMPS £300-£800

- 62 Arcam DiVa A80
- 63 Creek A50iR
- 64 Roksan Kandy KA-1 MkIII
- 65 Rotel RA-1062
- 66 Denon AVR-2803
- 67 Pioneer VSX-AX3
- 68 Sony STR-DB790
- 69 Yamaha RX-V1400RDS



48



52

26



10

36



51



32

20

## NEWS & FEATURES

### 8 AUDIOFILE

- 8 Product News
- 12 Industry and Technology News
- 14 Beats 'n' Pieces
- 17 Essentials

### 19 COMPETITION

Win Arcam's stunning FMJ DV-27A DVD-Audio player worth £1,900!

### 20 CHOICE CUTS

New music rated for sound and content

### 22 MUSIC INTERVIEW

Aural alchemist David Sylvian reflects on being big without Japan.

### 24 CHOICE MAIL

A selection of your letters and emails

### 26 BEAUTIFUL SYSTEMS

A high-end set-up of genuine sonic beauty... This issue: grace under pressure from Rotel and Monitor Audio

### 73 RETRO

The strange and wonderful story of Linn's Isobarik loudspeaker

### 75 MUSO

John Coltrane's epic poem to freedom and spirituality, *A Love Supreme*

### 77 DIGITALIA

Blu-ray and next-generation DVD

### 130 HI-FI EXTREME

David Vivian explores the far side of well-meaning but bizarre hi-fi tweekery

## READER SERVICES

Our regular information service, including where to buy, how to get a back issue and second-hand kit for sale

- 79 How to Subscribe
- 115 Glossary
- 116 Choice Bits accessories shop
- 119 Reader Classified
- 120 Dealer Guide
- 126 Dealer Directory
- 129 Back issues and what's in next month's *HFC*

EST. 1975

**HI-FI CHOICE** magazine

Hi-Fi Choice is your essential guide to audio excellence in the home, from vinyl records to the latest digital music formats. For 29 years, our unique tests have brought you the most thorough and reliable hi-fi journal around. And our mix of rigorous group tests and in-depth solo reviews continues to ensure that *HFC* is the magazine you can trust. Published 13 times a year, it's the *smarter* hi-fi read...

# COVER HIGHLIGHTS

## 60 ULTIMATE GROUP TEST TWO AND SIX-CHANNEL AMPS £300-£800



## 40 CLEARAUDIO EMOTION TURNTABLE



## 22 DAVID SYLVIAN THE AURAL ALCHEMIST SPEAKS OUT

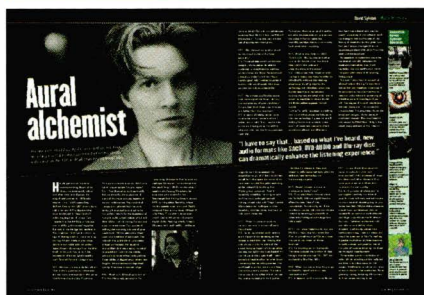

## 44 ARCAM FMJ C30/P1 PREAMPLIFIER/MONO POWER AMPLIFIERS



56

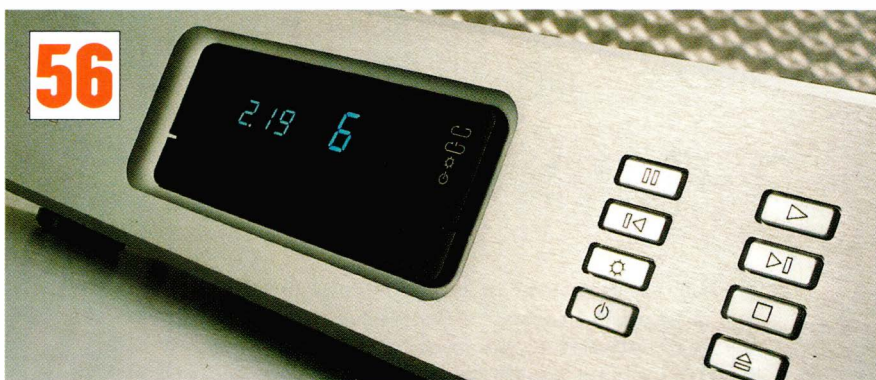

## 81 BUYER'S BIBLE

The ultimate guide to high performance hi-fi and AV – our favourite products for your perusal. Your shortlist starts here...

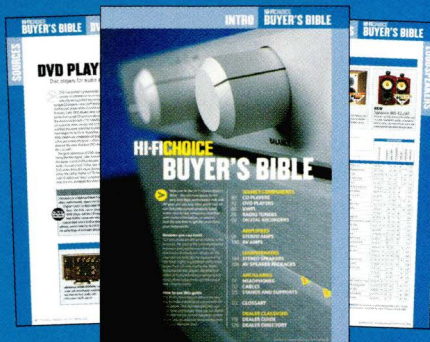

## SOURCE COMPONENTS

- 82 CD players
- 84 DVD players
- 86 Vinyl
- 89 Radio tuners
- 90 Digital recorders

## AMPLIFIERS

- 98 Stereo amps
- 100 AV amps

## LOUDSPEAKERS

- 106 Stereo speakers
- 110 AV speaker packages

## ANCILLARIES

- 112 Headphones
- 113 Cables
- 114 Stands and supports

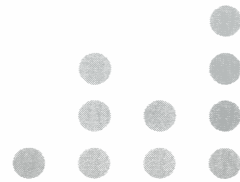

## DELECTABLE DIVA

NEW UTOPIA MODEL FROM FOCAL-JMLAB

A new Beryllium-equipped Utopia speaker from Focal-JMLab has been launched for smaller rooms and wallets everywhere. The three-way Diva Utopia Be (£7,600) is a slender floorstander that slots between the Alto and Micro models, (see *HFC* 248 and *HFC* 245 for reviews). Diva has the same specifications as the Micro – both share a beryllium inverted-dome tweeter and the 165mm W-cone sandwich driver. However, in a first for Focal-JMLab, the Diva has twin 210mm bass drivers mounted on each side of the cabinet in push-push configuration. The

design is said to give an effective cone area of 30cm increasing the bass output while allowing the W cone midrange driver to be placed at the optimum position from the floor.

Many technologies have been passed down from the flagship Grande Utopia Be, including crossovers, cabinet design, drivers and circuitry. Specs include 200 watts power handling, bass extension down to 30Hz (-6dB) and a 90dB efficiency. The Diva is the most affordable Utopia floorstander yet and we're looking forward to printing a review soon.

☎ 0845 660 2680  
 🌐 www.focal-fr.com



## GO WHEST

ULTRA-SONIC GHOST-BUSTER

A new sonic 'ghost-buster' that zaps high-frequency noise created by digital sources is available from Whest Audio. Called the DAP-10, the device is positioned between CD player/ DAC and the amplifier and has no effect on frequencies between 0 and 35kHz. Above this figure, the DAP-10 works on so-called audio ghost signals exhibited by digital sources – these are low-level reflections of high-frequency harmonics and ambience. The ghost signals are brought into alignment with the main signal using a proprietary circuit that gives improved transparency and resolution, it's claimed. The DAP-10 is priced at £900, and if there's something weird in your hi-fi rig, who you gonna call?

☎ 01635 291357  
 🌐 www.activdistribution.com



## BIG NAD

SERIOUS NEW AV RECEIVER FROM NAD

Weighing in at a tidy £1,000, NAD's new heavyweight T763 AV receiver is said to offer more power and flexibility than its predecessor, the T762. With 100 watts per channel on tap, the T763 has all the on-board decoding formats you could want and a host of features that makes the world's two-channel amplifiers look positively expensive.

There's a revised heat management system, a new volume control and input switching circuit which is said to reduce noise and distortion, plus upgradeable operating software via the RS-232 port. The full gamut of connection options is available from the rear panel and extra sets of stereo speakers can also be added, selectable from the remote handset. The T763 is available now.

☎ 01908 319360  
 🌐 www.nadelectronics.com



# A LA CARTRIDGE

## WILSON BENESCH'S CARBON CARTS

Wilson Benesch is celebrating the vinyl resurgence with two new high-end cartridges. The new models include the Carbon Naked (£1,200) and the Analog (£1,450), both featuring a carbon fibre structure that is said to provide the stiffest and best damped platform possible. The Analog uses a Japanese-sourced generator and a 'Nude Elliptic' diamond with a boron and alloy cantilever construction. The same diamond is used in the more affordable Carbon cartridge, which has a Swiss-sourced generator. As with all Wilson Benesch cartridges, the units can be rebuilt for a fixed fee of £300.

☎ 01142 852656

🌐 www.wilson-benesch.com

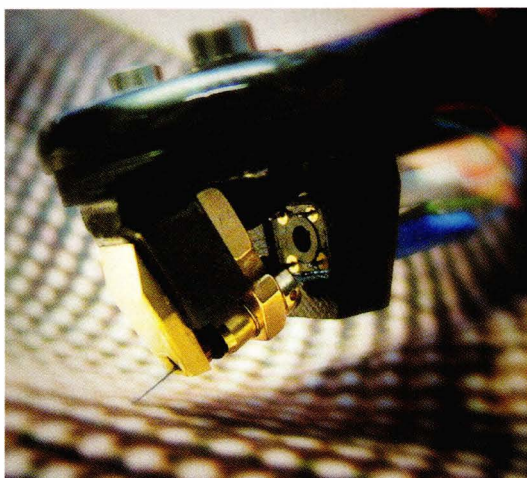

# HEAD FOIL

## NEW FLAGSHIP CANS

Late-night listening sessions are likely to gain momentum with the news that Sennheiser has released a new flagship headphone, the HD 650 (£300). The Reference Class can be described as a no-compromise open headphone benefiting from advanced duofoil drivers, damped fibre frames and a low resonance design. Sennheiser has developed something called



'acoustic silk' to help damp the diaphragms and reduce distortion whilst increasing clarity. Frequency response is quoted at 16Hz-30kHz (+/- 1dB) and Sennheiser claims the HD 650 is one of the best sounding

headphones ever made. See next month's *HFC* for a full review.

☎ 0800 652 5002

🌐 www.sennheiser.co.uk

# UP THE PHONO CREEK

## NEW MM/MC STAGE FROM HEMEL

Creek's latest hi-fi offering is the OBH-15 phono stage, an MM/MC device housed in a diminutive silver box. The OBH-15 has two input circuits optimised for both types of cartridge and users can change between MM and MC by means of a rear-mounted switch. The box can now drive longer cables thanks to its low output impedance and a host of high-quality components can be found inside including Burr-Brown op-amps throughout. The OBH-15 is available now priced at £200.

☎ 01442 260146

🌐 www.creekaudio.com



# ATLAS AT LAST

## NEW CABLES WIRED

Ten new products from Atlas cables will be vying for your upgrade budget this year. The new products include speaker and interconnect cables with some new innovations such as Atlas's 'All Cu Z', an all-copper plug for speaker cable terminations. Atlas also has a new coating method that allows OCC copper cables to be coated with a type of Teflon without altering the integrity of the wire. The products that benefit from this treatment (Ichor, Titan and Elektra) are said to provide a "major advancement in

transparency". Prices start at £2 per metre for the Basic 2 unterminated speaker cable and £25 for the Element RCA interconnect.

☎ 01563 524320

audiofile  
PRODUCT NEWS

Soundbites



PRO-JECT is releasing a new limited edition Phonobox phono stage to celebrate 100,000 sales of the original model. The Phonobox Limited Edition (LE) has upgraded components of higher tolerances than the standard version and comes in a gold-plated finish and hand-made presentation case. With only 500 units available worldwide, you'd best be quick if you want your £65 worth. ☎ 01235 511166

CAMBRIDGE AUDIO's budget DVD-Audio player the DVD57 (*HFC* 243) can now be snapped up for just £150 at Richer Sounds. With £50 off the original selling price the player with its Crystal 24-bit/192kHz DAC and six 12-bit/54MHz video DACs is a steal. The DVD57 is the most affordable way to enjoy DVD-Audio in the UK. ☎ 020 7551 5339



THE CHORD COMPANY has a new digital cable to add to its Signature range. The Signature Digital cable is said to represent the highest quality that Chord can currently achieve within a real-world budget. Its unique twin conductor configuration uses specially treated ultra-cast copper surrounded with polythene, then a carbon/silver plated braid screening system. It costs £200 for a one-metre pair and comes with Chord's RCA plugs or military-grade BNC type. ☎ 01980 625700

MONSTER CABLE has a new eight-gang mains cleaning socket board that claims to provide "excellent mains noise rejection". The HTS 1000 (£200) is a surge-and-spike-protected board that will disconnect equipment if hit by a big surge. Monster will even replace kit up to a value of £250,000 if it is damaged by an over-voltage condition. The mains lead is a heavy-duty type with a gold-plated flat profile plug. ☎ 01923 431 634

**Soundbites**

**KEF's new flagship KHT multichannel speaker system is here. Rejoicing in the moniker of the KHT 9000 ACE, the new speakers use KEF's 165mm Uni-Q driver array with a long-throw bass driver.**

KEF has implemented its Acoustic Compliance Enhancement (ACE) technology in the range which involves adding a mass of activated carbon granules into the cabinet. The granules absorb the compressed air in the cabinet caused by the driver, fooling it into thinking there is a larger cavity available, and hence giving lower bass. Sold separately, the KHT 900 ACE speakers will sell for £500 each. ☎ 01622 672261

**CD GIVEAWAY!**

This month's giveaway CD, *Talkin' Loud* celebrates Gilles Peterson's influential label and the bands that brought it success in the early nineties. The new two-CD compilation

includes tracks from bands such as Omar, Galliano, Incognito and Young Disciples, all of whom contributed to the unique and timeless sound that

grooved up the decade.

We've got ten copies to give away, for your chance to win one send your name, address and daytime telephone number to: I love Talkin' Loud, Hi-Fi Choice, Future Publishing, 99 Baker Street, London, W1U 6FP. Closing date is 19th February.

**Hi-Fi diary**

**FEBRUARY**

15 Audiojumble 2004  
 Tonbridge, 01892 540022  
*Go for a rumble in the Tonbridge Audiojumble*  
 20-22 Sound and Vision  
 The Bristol Show  
 Marriott Hotel, Bristol  
 01242 239 839  
 www.bristolshow.co.uk  
*A major UK hi-fi show*

**MAY**

20-23 High End 2004  
 Munich, Germany  
*The dog's danglies at the Former Frankfurt show*

**JUNE**

1-4 Cedia Expo 2004  
 ICC, Birmingham  
 01462 627377



**E-POSSE**  
 TWO NEW MODELS  
 FROM BRIT STALWART

Two new loudspeakers from Epos have been announced to replace the much admired M12 and M15 models. The new products, to include the floorstanding M12.2 (£450) and standmount M15.2 (£700), will look noticeably different due to a veneered front baffle that will replace the traditional Epos black frontage. The two-way, reflex loaded M12.2 uses a 150mm driver with a new die-cast chassis, a 25mm aluminium tweeter and comes with

complete with full provision for bi-wiring and a real wood veneer finish.

An extra octave of bass (to 50Hz) has been squeezed out of the M15.2 for this year and the cabinet size in the lower chamber has increased accordingly. It shares the same driver as the M12.2 with a similar tweeter, all in a two-way floorstanding box. The new models are available now.

☎ 01442 260146

www.epos-acoustics.com



**£100 DAB SOLUTION**  
 PIN-MONEY DIGITAL TUNER

Budget supremo Acoustic Solutions is the latest electronics firm to jump on the sub-£100 DAB tuner wagon. Despite the £99.99 price, its 'new generation' SP111 tuner uses the new RadioScape RS200 DAB module supplied by Texas instruments, an LCD display panel with radio data display and aluminium casework.

Further features include an autoscanner feature, four dedicated presets and a favourite station preset facility. Currently available in Argos and Richer Sounds stores, Acoustic Solutions also has a CD player (£70) and an amplifier (£80) all finished in the same aluminium casework. The new SP111 is available now and replaces the SP110.

☎ 01327 340601

www.acousticsolutions.co.uk

**JOIN THE Q**  
 MORE Q SERIES FROM KEF

Three new speakers will soon join KEF's popular Q-Series. The line-up now includes the Qcompact (£200), an entry-level standmount model, the Q6c (£150) a dedicated AV centre channel and the floorstanding Q4 (£400). There are now nine products in the range, all using KEF's Uni-Q 130mm bass unit with a 19mm dome tweeter. The Q4 floorstander is a three-way design with a dedicated 130mm bass driver that offers extension down to a claimed 42Hz.

☎ 01622 672261

www.kef.com





v63 - European Loudspeaker of the Year 2003/2004

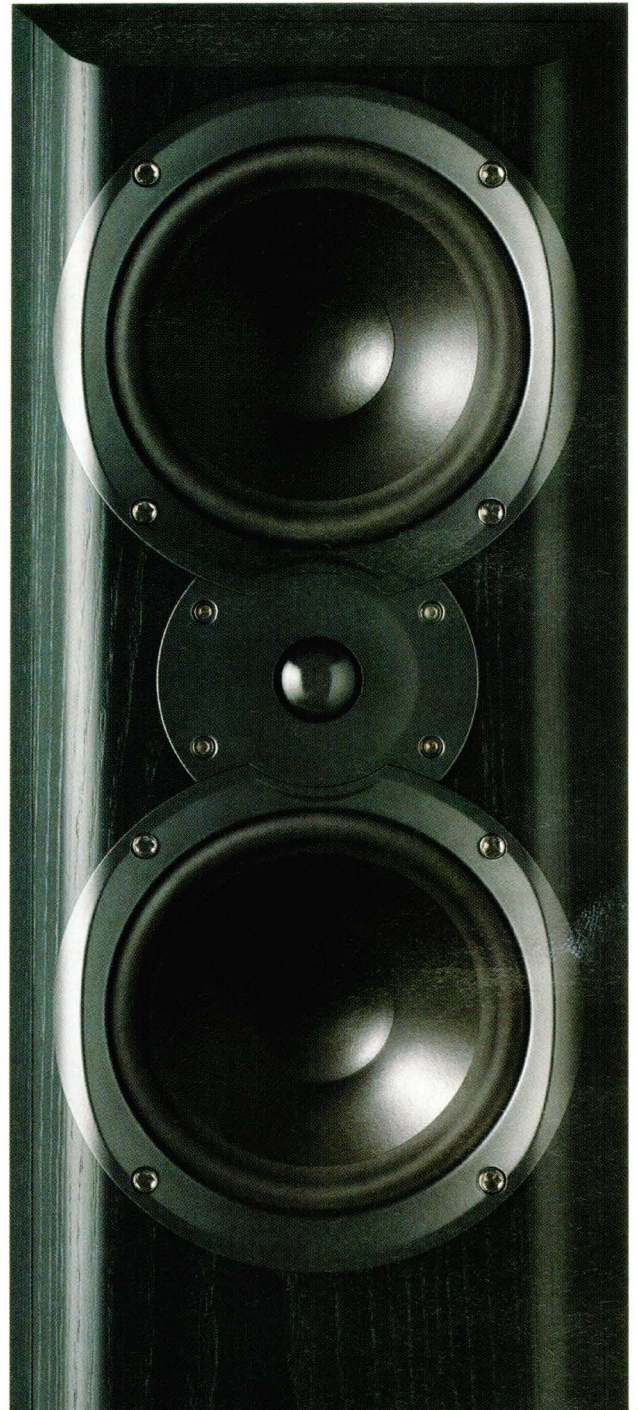

Simple Perfect Sound

**volare**

MISSION

Tel: +44 (0) 1480 423700  
[www.mission.co.uk](http://www.mission.co.uk)

## ROYALTY-FREE DV

The Chinese government has sponsored the development of a video format called EVD or enhanced versatile disc, a direct competitor to DVD offering a claimed five-fold increase in picture quality. It has partly come about because of the licence costs that Chinese companies have to pay when making DVD players – each of the 30 million players produced last year cost their manufacturers \$9 each in royalties. EVD does not yet have the backing of the major movie studios yet,



though players were due to be in Chinese stores by Xmas. Prices are likely to be three times those for DVD players to start with because of the higher quality on offer –

resolution is said to be of HDTV standard.

The development of this red laser system was begun in 1999 by E-World Technology in Beijing but \$1.2 billion of the costs were contributed by the Chinese government. It looks likely that EVD machines will play DVD discs but royalties would only be applicable if players carry a DVD logo.

## PATH PREMIER RIP

Path Premier, high-end distributor and long-time Mark Levinson agent for the UK, has been wound up. Its

parent company the Path Group continues as usual and Path Premier main man Nigel Crump will be setting up his own operation distributing most of the PP brands. The main reason for the change has been delivery problems with Mark Levinson components. Ever since the closing of the Madrigal factory and its relocation to the Lexicon facility in Bedford, Massachusetts no dealers or agents have been able to get hold of ML stock. HSG (Harman



Specialty Group) which owns the brand has said that deliveries will not recommence until March or April this year. As Mark Levinson represented a significant proportion of Path Premier's turnover this has had a knock-on effect on its viability. Nigel Crump will continue to distribute Ayre, Stax, Lyra, Sumiko, Grand Prix furniture and Stereovox cables, he will also be negotiating with HSG with regard to Mark Levinson and Revel.

## COMPACT POWER

Sony's engineers have been having a bit of fun with digital amplification technology. To prove just how compact a digital amplifier can be they have fitted a 200-watt example into a case that's designed to hold business cards.

Using the same S-Master Pro technology found in its latest TA-DA9000ES multichannel amplifier, Sony produced this super-slimline amp and used it to drive a pair of loudspeakers with a signal supplied by a CD Walkman that looks positively enormous next to it.



## iTUNES ASCENT

Apple claims its iTunes online music downloading service is selling 220,000 songs a day at 99 cents a go. Since its debut in September Apple has sold over 25 million songs, the rate of sales tripling after it made tracks available to PC users in October. The service is now even easier to use for AOL users who can pick up a tune with just a couple of clicks of their mouse if payment details have been logged. Retailer Wal-Mart, which owns Asda, is trialling its own service with a typically low-cost approach, recordings will be available for 88 cents each via its online store run by Liquid Audio. Apple is expected to announce iTunes for the UK soon.

Brits can however get online music downloads from Coca-Cola which is offering 250,000 songs at 99p (\$1.70) a throw. Coke has recently signed up to sponsor the Official UK Music Charts and will be heavily marketing the service throughout 2004.

## MORE DAB

Digital One, the commercial radio multiplex operator, has announced two more transmitters for its network of eight stations including Planet Rock, talksport and Oneworld. The Manningtree transmitter will bring DAB to residents of Ipswich, Colchester and North Essex while the Kirkton Mailer mast boosts coverage in Perth and surrounding areas. To check whether Digital One stations are available in your neck of the woods log on to [www.ukdigitalradio.com](http://www.ukdigitalradio.com).

## PETER J. WALKER 1916-2003

Peter Walker, founder of Quad, died on 15 December. One of the most influential figures in British hi-fi, he produced the first electrostatic loudspeaker, the ESL, in 1957. It's hard to overestimate his influence on hi-fi – the principles he established and the quality of Quad products are legendary. Without speakers like the ESL whose successors are in production today (ESL 988) high fidelity reproduction would still be in the dark ages. He is survived by his daughter Victoria and son Ross.

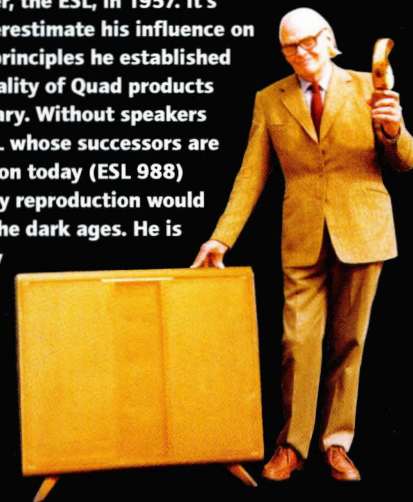

# ABRACADABRA



## The magic of TEAC DAB radio

Following on from the award winning Reference 300 system, TEAC is proud to announce the World's first mini component Hi-Fi system tuner with Digital Audio Broadcasting. Fully matching the Reference 300 series, the T-H300DAB offers amazing audio quality, not just from the many new digital stations now available, but also the existing FM stations. This, coupled with the exciting information display and easy to use DAB channel selection, makes it the ultimate upgrade for your system. The Reference 300 DAB tuner has the same stunning good looks, style and build quality you have come to expect from TEAC. As if by magic, digital radio has now arrived in a mini format.



The Award Wining Reference 300 System

What Hi-Fi? Best Buy 2001 and 2002



Digital Audio Broadcast from TEAC, the future of radio has arrived

**TEAC**

### TIME MACHINE FIVE YEARS AGO

Hi-Fi Choice  
March 1999

In a packed issue, KEF unveiled its flagship reference loudspeaker, the Maidstone, (which is a bit

like calling a new Porsche the Munchen), David Vivian listened to a concerned Udo Zucker (Tag McLaren boss) who was at a

loss to fathom slow UK sales for the new brand, and we exposed a pre-production version of Arcam's upcoming Alpha 10 DAB tuner. A massive eleven-way CD player test put Naim's CD3.5, Arcam's Alpha 9, and Musical Fidelity's E624 on the top of the podium, the latter of which still entertains us in the office to this day.



### TEN YEARS AGO

Hi-Fi Choice  
March 1994

Electrocompaniet returned to these shores in March 1994 with its exotic Norwegian kit that's received favourable

reviews in *HFC* over the years. During these boom times for the hi-fi industry we were busy testing subwoofers in a

conventional hi-fi system and it was REL which was able to steal the show with its compelling £500 Strata. Meridian loaned us a fully active version of its 500 series digital system that offered a simple if frankly expensive hi-fi solution, while at the other end of the scale, Sony's £170 CDP-311 stormed our exhaustive CD player test.



## SYSTEM BUILDER

EACH MONTH, WE PICK A FAVOURITE DISC AND BUILD A SYSTEM TO SHOW IT AT ITS BEST



### NICK DRAKE

*Pink Moon* Island

His life was tragically cut short at just 26, but in the few short years he had, Nick Drake produced three of the finest UK folk albums to emerge from the late sixties/early seventies. While this, his final album, reflected the darkest period of the artist's depressive psyche, it is also a work of incredible beauty and subtlety. Many consider it to be his greatest moment – an artist expressing himself through some of the most soulful poetry ever put to music.

The album features Nick's guitar and plaintive vocal with no additional instrumentation, except for the piano on the title track. It's a fragile work – but the simplicity of arrangements makes it light work for most systems with good tonal resolve. A series of alternative tunings gave Nick a unique guitar style that complements his finger-picking technique and downbeat melodies.

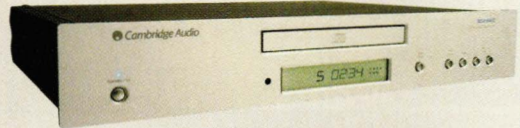

### CD PLAYER

**CAMBRIDGE AUDIO AZUR 640C** £250

Perhaps the best budget CD player around right now, fully deserving of a partnership with equipment costing far more. A smooth and coherent player in every regard that will expose lots of depth for relatively little outlay.

### LOUDSPEAKERS

**FOCAL-JMLAB CHORUS 716 S** £550

The fine voicing of this new French model offers a window into the subtle delights of *Pink Moon* that few other speakers can match. A group test winner in *HFC* 250, the 716 S floorstander makes an excellent all-rounder.

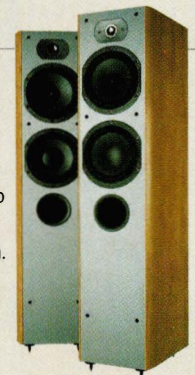

### AMPLIFIERS

**ROTEL RA-1062** £600

This champ of an amp is still the one to beat in its price category. It sounds expansive and revealing and will bring out the best in the Azur CD.

**CD WOW!** SALE Top 75 Chart CDs now £7.99 or less!

CD WOW! CD DVD

SALE Sale Sale - Save E's E's!

Chart CD Crucial New Releases

ORIGINAL SOUNDTRACK Lord of the Rings: Complete Trilogy £12.99

LUTHER VANDROSS Radio City Music Hall 2003 £8.99

HUBEN-STIGGARD Soulful £8.99

Chart CD Essential New Releases

ORIGINAL SOUNDTRACK Doctor Doom £8.99

LARRY BIRN Trading (Repack for reissues) Release / Dispatch Date: Monday 15 Jan £8.99

Taboo (with DVD) Release / Dispatch Date: Monday 26 Jan £8.99

More of the Month

ELLIS - Tasty £7.99

The Official Complete Series Region 2 £12.99

These albums into a short career, and the New York-based, soul star has re-proved herself. The singer of her landscape debut from 1999 (or at least, the 'No Talk' mix) inspired lyrics on the 'Caught Out There' single (success) may

There is a relatively good chart here reading the work. You

## WEBSITE OF THE MONTH

[www.cdwow.com](http://www.cdwow.com)

No doubt you've had your fill of the January sales by now, but there's little to beat the bargains to be had at CD wow. CD wow launched its small website in February 2000 specialising in chart CDs, and with prices starting at just £7 including delivery, it feels like it's always sale time. The bargain basement is always worth a look and if you've birthdays to buy for check out the DVD and video games section. The discs are often sourced from different territories so you don't always get the standard UK version. We've recently found Dido's new album *Life For Rent* for £7 and the new Norah Jones album, *Feels Like Home*, for just £9.

## READERS' DEMO DISCS

### YOUR FAVOURITE MUSIC FOR HI-FI AUDITIONS

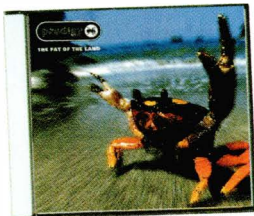

#### PRODIGY

**Fat Of The Land** XL Recordings

This CD should have been called *Phat Of The Land* – such is the devastating bass on this dance classic. Despite the strength of the tracks, critics thought the album didn't live up to the hype surrounding the band at the time. You could call it

'electronica', but the dance motivation is crystal clear, and there are some rock undertones that give the album an unmistakable aggression.

But with standout anthems such as *Firestarter*, *Breathe* and the infamous *Smack My Bitch Up* to blow the cobwebs from your dealer's stock, who cares what the music press say?

**Richard Cash** via email

**What's your favourite disc for hi-fi auditioning?** Why not write in and tell us – 100 words on what and why – we'd love to hear about it. Email your choice to dan.george@futurenet.co.uk or write in to Classic Demo Discs, Hi-Fi Choice, Future Publishing, 99 Baker Street, London W1U 6FP.

## JIMMY'S TWEAKS #17

HANDY HINTS FROM JIMMY HUGHES – HI-FI'S SUPER TWEAKER



#### One change at a time

Sometimes, when you're making changes or upgrades to your system, there can be a tendency to make two or three alterations at once. For example, you audition a new amplifier and (at the same time) try a different set of speaker cables and add support cones under the CD player.

Now it may well be that what you hear is an improvement over what you started out with.

But even so, it could be a case of three steps

forward, one step back. Always evaluate each change individually. Don't move on to the next change/upgrade until you're satisfied the first one is a definite improvement. Give yourself time to evaluate the difference; live with it for a day or two, or more if necessary, then go back to what you had before.

## ON THE OFFICE STEREO

MUSIC THAT AMUSED US WHILE CREATING THIS ISSUE

Tori Amos *Tales Of A Librarian*  
 Metallica *Garage Inc*  
 Sharon Jones *Dap-Dippin' With...*  
 OutKast *Speakerboxxx/*  
*The Love Below*  
 Nick Drake *Bryter Layter*  
 Beenie Man *Tropical Storm*  
 Various *Favela Chic*  
 Ryan Adams *Love Is Hell*  
 (Parts 1 and 2)  
 The Autumn Defense *Circles*  
 Emmylou Harris *Stumble Into Grace*

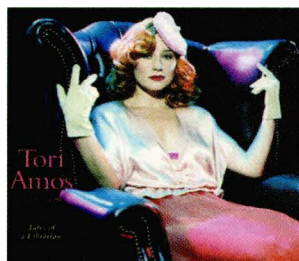

## NEW MUSIC IN THE STUDIO

ARTISTS RECENTLY ABSENT FROM THE CUT AND THRUST OF SHOWBIZ HYPE DUE TO FINISHING THEIR LATEST ALBUMS



#### U2

**Title:** TBC

**Release date:** March/April

The follow-up to 2000's *All That You Can't Leave Behind* finds Brian Eno and Daniel Lanois vacating the producer's role in favour of seventies veteran Chris Thomas (Sex Pistols/Roxy Music). "It's filled with big tunes and it's driven by a guitar player who's sick of the sight of me shaking hands with politicians. The anger is unbelievable," says Bono.

#### ZERO 7

**Title:** *When It Falls*

**Release date:** March

The north London duo made the Mercury shortlist three years ago with their debut *Simple Things* and went on to sell 800,000 albums. The follow-up finds Sam Hardaker and Henry Binns adding an even lush sheen to their down-tempo electronic beats. Soulful vocals are provided by guest singers Mazeez, Tina Dico, Sia Furler and Sophie Barker.

#### COLDPLAY

**Title:** TBC

**Release date:** autumn

Coldplay have 60 songs from which to choose for their third studio album, according to the recently wed Mr Gwyneth Paltrow (aka singer Chris Martin). "As soon as we finished our world tour last year, we went straight into the studio to get these ideas down in case we died or something before they were recorded," adds Chris Martin. Mike Skinner of The Streets has reportedly recorded a guest vocal on one track.

#### YOUSSOU N'DOUR

**Title:** *Prayers Of Peace*

**Release date:** March

One of the greatest voices in world music, Senegal's Youssou N'Dour's

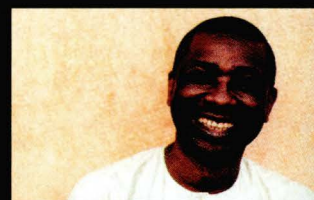

forthcoming album is far removed from the pop stylings of his hit duets with Neneh Cherry and Peter Gabriel. Recorded in Cairo with an Egyptian symphony orchestra supplementing his band of West African musicians, it's described as "subtle and understated with a strong socio-religious context".

#### USHER

**Title:** TBC

**Release date:** 15 March

Arguably the biggest male artist in contemporary urban R&B right now with a staggering 37 million record sales under his belt, Usher returns with an album he describes as "more personal" than anything we've heard from him before. Producers include the Neptunes, Jermaine Dupri, Jazzy Jeff and Rich Harrison (the man behind Beyoncé's *Crazy In Love*).

#### ALSO COMING SOON

##### ROCK/POP

**David Byrne** tbc (Mar), **Anastacia** *Anastacia* (Mar), **Hundred Reasons** *Shatter Proof Is Not A Challenge* (Mar), **Cypress Hill** *Till Death Do Us Part* (Mar), **Beta Band** tbc (Apr)

##### CLASSICAL/JAZZ

**Jacques Loussier Trio** *The Best of Play Bach* (SACD only, Mar), **Benjamin Zander/Philharmonia** *Mahler 3* (Mar), **Paavo Jarvi/Cincinnati**  
**Ravel:** *Bolero, Pavane For A Dead Princess* (Mar)

# Kandy

**It's not all  
black and white.**



**Roksan, for those with a little more grey matter.**





## Bright Star Isonode feet £21

▶ Do we really need another squidgy foot? Well, these are unusually small (though nominally 'large'!) and neat, despite which they claim to support an extremely useful 10lb each. They are made of something very similar to Sorbothane and do the usual trick of absorbing and damping vibrations.

They actually manage to do it very well, and as with most such devices, they are in fact more versatile than they might at first appear. By all means place them under the equipment's original feet, but you may find that they can be even more effective as replacement feet or perhaps arranged at slightly different positions under the chassis. Or try them on top, maybe with something moderately heavy and inert over them in turn. At this price, you can afford to! The reduction in 'hash' they can bring about is always welcome.

📞 Absolute Analogue 020 8459 8113  
 🌐 [www.absoluteanalogue.co.uk](http://www.absoluteanalogue.co.uk)



## Goldring Perfect Sound discs £12 (set of 6)

▶ First we put spikes on equipment, then for largely practical reasons we put discs under the spikes – but is this sonic nonsense? It depends why you like spikes. Spikes are at least in part successful because they provide minimum damping of resonances in the surfaces they contact, and in some circumstances resonances can sound quite nice, at least initially. These discs (steel-cored, covered with decorative plastic and with a soft rubber underside) are undoubtedly both household-friendly and smart, and their effect on the sound can be beneficial in some cases. Under speakers they added the slightest extra detail in the review system, while under a turntable on a glass-topped stand they reduced 'impact' but significantly reduced grain too. Aesthetically – very nice, sonically – worth a try.

📞 Veda 01284 701101 🌐 [www.veda-uk.co.uk](http://www.veda-uk.co.uk)



## Russ Andrews TipTonic stylus cleaner £10

▶ Stylus cleaning is a good idea, no question. A dirty stylus will mistrack, causing rough sound and increased wear to both the record and the stylus itself. But careless cleaning, or cleaning with inappropriate solvents, can damage the stylus and/or the mounting of the cantilever. This simple kit marries a suitably harmless solvent with a little brush – just put a drop of the former on the latter and carefully wipe the stylus free of accumulated grime. It works very well and the improvement after cleaning is frequently far from subtle, even when the stylus was not previously visibly contaminated. Do be careful, though, about fibres stuck to the stylus which can be very hard to remove. A highly effective and practical cleaner.

📞 Russ Andrews 0800 373467  
 🌐 [www.russandrews.com](http://www.russandrews.com)



## Vileda Microfibre Plus cleaning cloth £2

▶ Having made passing reference to this in past *AudioFile Essentials* columns, we thought we'd give it a direct plug. It's sold in supermarkets everywhere as a general-purpose household cloth, yet the specialised microfibre material makes this an incredibly versatile hi-fi accessory. Use it dry to polish CDs and DVDs – you can be surprisingly rough with it, though do check it hasn't picked up any grit before you do so. Use it wet to spread and then remove cleaning fluid on LPs. Use it with household spray polish to clean metal or wooden chassis and cabinets. In general it absorbs liquid and contaminants very well and is completely non-scratchy, much kinder than kitchen paper for instance. Machine washable, too!

📞 Freudenberg 0845 769 7356  
 🌐 [www.vileda.com](http://www.vileda.com)

# SHOW TIME

MANCHESTER, LONDON, SCOTLAND & UK REGIONAL ROADSHOWS

5 STAR VENUES

SPECIAL SHOW OFFERS

LARGE ROOMS

## 2 WEEKS TO GO

WILSON BENESCH  
LYNWOOD  
QUADRASPIRE  
HARMAN KARDON  
AUDIONOTE  
EPOS/CREEK  
DALI  
KORATO  
OPUS 3  
HI-FI+  
AUDIOCRAFT  
THE AUDIOWORKS  
REFERENCE AUDIO  
SMARHOUSE -  
SHOWCASE  
CRESTRON  
ARTCOUSTIC  
VIVANTE  
DIVERSE VINYL  
RINGMAT  
LARC

CHERISHED RECORDS  
CUSTOM DESIGN  
DOUG BRADY  
SEVENOAKS  
ACOUSTICA  
NAIM  
FERGUSON HILL- STUDIOS  
SUGDEN  
QUAD  
ARCAM  
AUDIO ANALOGUE  
BCD-ENGINEERING  
DIAPASON  
FINAL  
FONE  
GRAAF  
HI DIAMOND  
KEMP ACOUSTICS  
TRIANGLE  
UNION RESEARCH  
BOSE

SPECTRAL  
ACCUPHASE  
NAGRA  
FOCAL.JM LAB  
PRO-JECT  
VIBE  
ORTOFON  
ROKSAN  
VIENNA  
BEYERDYNAMIC  
BLACK RHODIUM  
SIM2  
ANDERS & KERN  
VIDIKRON  
STEWART  
FIREHAWK  
GRAVES AUDIO  
IKON AUDIO  
WEMBLEY-  
LOUDSPEAKERS  
EXPERIENCE- FILTRATION

TRUE COLOURS  
MARTON MUSIC  
WILLIAMS HART  
MUSICWORKS  
OBELISK AUDIO-  
SYSTEMS  
BLUE PEARL AUDIO  
TCI LIMITED  
CASTLE ACOUSTICS  
CHORD ELECTRONICS  
NORDOST  
OVERKILL AUDIO  
MONITOR AUDIO  
MANA ACOUSTICS  
CSE  
PHILIPS  
AEN  
CLEARCOVER  
CLEARPLAY  
BEL CANTO  
METROPOLIS MUSIC  
PEAR AUDIO  
ORACLE

## Entertainments & Special Attractions

### Hi-fi+ Products of the Year Awards, 2003

We are delighted to be hosting this prestigious event at Northern Sound & Vision. Look out for the Rosetted rooms that will indicate some of the winners.

### Best sounds, best vision

Your chance to make a positive contribution to the show! Give us your choice of best rooms & displays, we've three awards to give away.

### Home Cinema

With our new venue we have all the space we need to present this dynamic market to it's best advantage, be prepared to be impressed.

### Class acts

Quality live entertainment will be a hallmark of the Northern Sound & Vision show. Continuous and tasteful sessions throughout the weekend.

### Visitor Goody Bag

All visitors to Northern Sound & Vision receive 2 FREE Hot-of-the-Press magazines, Hi-fi+ (March issue!) and Smarhouse, worth £7.25. Plus a FREE Programme, making Northern Sound & Vision the bargain show of the YEAR.

**Continuous live entertainment throughout both days.**

### Subwoofer + Supertweeters Stand-off!

Get the lowdown on both extremes in Suite 201, all professionally presented by Show Media Sponsors – Hi-fi+ High-end audio.

In order that visitors have the best chance of hearing top quality sound, quality audio will have it's own section of the show.

### Budget systems

Here you will find top quality systems that won't break the bank.

### Accessory bars

Throughout the show we will have trade stands for browsing those exclusive accessories.

### See & Buy?

Northern Sound & Vision is not just THE shop window – it's a selling show. Many items, including show specials, can be bought on the day!

### Local Radio on site with live broadcasts

### Smarhouse Showcase

See cutting-edge technology all in an actual home setting, lounge area, kitchen, all brought together in a unique display. Presented by Show Media Sponsors – Smarhouse.

Northern  
2004  
Sound & Vision  
Hi-fi & Home Cinema show  
Radisson SAS, Manchester Airport  
7/8 February 2004

THE HEATHROW HIGH FIDELITY SHOW IS NOW IN IT'S 3RD YEAR SO IF IT'S HIGH QUALITY HI-FI YOU'RE LOOKING FOR – LOOK NO FURTHER.



NOW CONFIRMED AT THE RADISSON EDWARDIAN – ONE OF THE WORLDS' TOP 'AWARD WINNING'

AIRPORT HOTELS, 3 & 4 APRIL 2004. EXCLUSIVE LARGE DEMO ROOMS FOR ALL EXHIBITORS. THIS IS A HIGH QUALITY AUDIO EVENT – WITH TOP QUALITY SOUND OUR ONLY OBJECTIVE.

OVER 30 BRANDS ALREADY COMMITTED TO THIS UNIQUE EVENT. LIVE MUSIC – FREE MAGAZINES AND PROGRAMME – SEE & BUY! FULL DETAILS ON OUR WEBSITE AND NEXT MONTHS PRESS.

IN CONJUNCTION WITH  
**MUSIC MATTERS – PINNER**



### PROMOTING HIGH QUALITY SOUND AROUND THE COUNTRY

7 MARCH 2004  
HUNTINGDON MARRIOTT  
HOTEL, CAMBRIDGESHIRE

MAY 2004  
NORTHUMBERLAND

JUNE 2004  
EAST SUSSEX

JULY 2004 – DEVON/DORSET

OCTOBER 2004 – WORCESTERSHIRE

NOVEMBER 2004 – NORTHERN IRELAND AND EIRE



FOR DETAILS OF THE LONDON, MANCHESTER, SCOTLAND SHOWS OR THE UK HIGH FIDELITY REGIONAL ROADSHOWS ORGANISED BY CHESTERFIELD COMMUNICATIONS, CONTACT: ROY BIRD

Tel: 01829 740650 Mobile: 07810 697123

E-mail: roy@chestergrp.fsnet.co.uk

Website: www.chestergroup.org

hi-fi+

WHAT'S NEW IN  
**SOUND**  
AND VISION

INTERNATIONAL  
**smarhouse**

The  
**Audio Works**

**ACOUSTICA**  
Hi-Fi & HOME CINEMA



Doug Brady Ltd

# HI-FI CHOICE COMPETITION



## WIN Arcam's stunning FMJ DV-27A DVD-Audio player worth £1,900!

**W**e've heard some superb DVD-Audio discs recently – there are certainly a lot more discs utilising the format these days – and we've found that a particularly good way of getting the best out of them is by playing them on this month's competition prize, Arcam's award-winning FMJ DVD-27A.

It demonstrates superb sonic resolving power and is equally adept at DVD-Video and of course CD. We raved about its



videophile credentials in our review (*HFC 246*) and felt the FMJ DV-27A was more than a worthy winner of its Product Of The Year Award 2003/4.

In addition to its services to video – PAL progressive, broadcast quality chipsets etc, the DV-27A makes high-resolution audio extra special.

It's a free-breathing, open-sounding player that clearly demonstrates just how a dedicated machine can go the extra mile for the true audio and videophile.

### HOW TO ENTER:

To win simply answer the question below by circling the correct answer, then fill in your name, address and daytime telephone number below. Please also take the time to fill in our small questionnaire – we want to make *Hi-Fi Choice* as good as you deserve.

### QUESTION

What types of disc can be played on the FMJ DV-27A?

- A. Slipped discs
- B. Frisbee discs
- C. DVD-Audio, DVD-Video and CD

### YOUR DETAILS (BLOCK CAPITALS)

Title \_\_\_\_\_ Initials \_\_\_\_\_ Surname \_\_\_\_\_

Address \_\_\_\_\_

Date of Birth \_\_\_\_\_ Daytime tel number \_\_\_\_\_

What type of hi-fi product do you intend to buy next? \_\_\_\_\_

What brands would you most like to read about? \_\_\_\_\_

Would you like to see more expensive or less expensive kit reviewed? \_\_\_\_\_

What would you like to see more of in *Hi-Fi Choice*? \_\_\_\_\_

Please tell us if there's anything you don't like. \_\_\_\_\_

### COMPETITION RULES

The closing date for this competition is 19th February 2004. Winners of the Arcam competition will be judged from all correct entries submitted, and drawn at random after the closing date. Winners will be notified by post. The Editor's decision is final and no correspondence will be entered into. The Arcam competition is not open to employees of Arcam, Future Publishing Ltd, nor their suppliers, agents or associates. We regret this competition is only open to UK residents. No cash alternatives will be offered. By entering the competition you will be bound by the rules. We reserve the right to substitute alternative prizes with equivalent value to those shown, in the unlikely event of stock being temporarily unavailable. All entries must be on this official coupon, but photocopies are acceptable. Only one entry per household.

### Send your entry to:

**Arcam Competition, Hi-Fi Choice, Future Publishing,  
99 Baker Street, London, W1U 6FP.**

# ChoiceCuts



This month's varied musical morsels

Reviews by Dan George, Alvin Gold, Jason Kennedy, Dave Oliver, Mark Prendergast, Phil Strongman, Nigel Williamson



## AUDIOPHILE VINYL

### PATTI SMITH

Horses

Arista/Simply Vinyl 180g vinyl

Music: Patti Smith's debut album from 1975 illustrates that while Malcolm McLaren and the Pistols made punk a musical landmark, it was artists like Smith and the Stooges that got the ball rolling. Arguably her strongest album, *Horses* has a neo-primitive feel, a sense of rediscovering the fundamentals of rock. It contains two idiosyncratic cover versions: Van Morrison's *Gloria* and Wilson Pickett's *Land Of A Thousand Dances* alongside six originals of depth and power. This is nonetheless a subtle album that rewards exploration, the singing style may sound crude, but Smith is foremost a poet so there's plenty to appreciate apart from the simple but effective three-chord backing. ★★★★★

Sound: Not the quietest vinyl, this is still a good-sounding LP with plenty of energy and atmosphere, though it warrants a decent system to give its best. ★★★★★ JK

Sound: Not the quietest vinyl, this is still a good-sounding LP with plenty of energy and atmosphere, though it warrants a decent system to give its best. ★★★★★ JK

### CAROLE KING

Tapestry

Epic/Simply Vinyl 180g vinyl

Music: An album for which the word 'classic' could have been coined,

*Tapestry* is one of 1971's defining musical moments, and one whose appeal has not lessened over the intervening years. The Spice Girls might have preached 'girl power' but King created woman power with her unusually fine song writing and composition. Anyone over the age of 35 will have heard some, if not all of *Tapestry* but it's only when you come back to it that its quality is made obvious. There's not a weak song here and two extra cuts have been added: *Out In The Cold* and a live version of *Smackwater Jack*. Her voice is a little harder than most these days and the production shows its age but it's still a superb album. ★★★★★

Sound: Not the slickest of productions, this is a good quiet slab of vinyl which while not as sweet sounding as an old worn copy fully reveals the quality of musicianship and singing. ★★★★★ JK

These and other audiophile LPs are available from Simply Vinyl: ☎ 0208 545 8580 @ www.simplyvinyl.com

## COMPACT DISC & VINYL

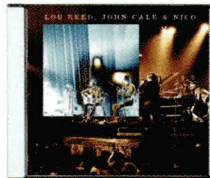

### LOU REED, JOHN CALE & NICO

Le Bataclan '72

Pilot/Alchemy

Music: It was a cold January night at the Rue Voltaire, Paris 1972. Outside Le Bataclan theatre, 2,000 people waited, hoping to get into an already full house. Inside, the legendary Velvet Underground had reformed in the guise of its three most luminous stars. All played music from their recent solo albums – Reed's *Berlin*, Cale's *Church Of Anthrax* and Nico's *Marble Index* and *Desert Shore* sets. But the electric stuff here is all Velvets originals, *Waiting For The Man*, *Heroin*, *All Tomorrow's Parties*, all delivered as if walking narcosis was the ultimate cool of the day. ★★★★★

Sound: A low-key chamber feel of acoustic instrumentation, caught live, will work especially well with a bass-biased system. ★★ MP

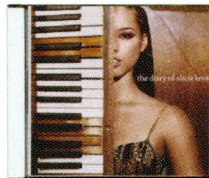

### ALICIA KEYS

The Diary Of Alicia Keys

J Records

Music: It seems every new R&B diva is hailed as 'the new Aretha Franklin'. But Alicia Keys established herself at the head of the queue with her 2001 debut *Songs In A Minor*. The follow-up once more finds her combining classic soul with a hip-hop sensibility, plus the semi-classical motifs of her piano, on tracks such as *Harlem's Nocturne*. Above all, unlike so many of her rivals, her innate musicality enables her to recognise that a great song requires more than just a slamming groove. *The Diary Of...* isn't a significant advance on her precocious debut, but it consolidates her place as new soul queen of her generation. ★★★★★

Sound: The beats are pneumatic but there's a warmth and cohesiveness that's rare on modern R&B albums. ★★★★★ NW



### MANDALA MALTA

Music From A Lighthouse

Mandala

Music: World music Maltese style in the shape of, and I quote, 'psychedelic ambient rap', a description which doesn't really quite do justice to this frankly bizarre blend of deep bass, sitar, bongos and flutes – plus, of course, Maltese raps and moody talkovers from local hero Fish and his keyboardist Monique. If it all sounds a bit strange and far out that's because, well, it is. The whole enterprise meanders to a stunning climax in the form of the jazzy, nursery-rhyme laden *Igudikat Toni Tghana* (get your laughing gear round that one, Jools Holland). ★★★★★

Sound: The mixture of acoustics and electronics are both magically atmospheric and crisply recorded, quite simply a pleasure to listen to. ★★★★★ PS



### NELLY FURTADO

Folklore

Dreamworks

Music: The golden rule of pop is that when you have a hit, you repeat the formula. All credit, then, to 23-year-old Nelly Furtado for trying something different. Folklore departs from the frothy pop of the Canadian chanteuse's biggest hit, *I'm Like A Bird*, with thoughtful lyrics supported by clever arrangements including such unlikely instruments as a banjo and a pipe organ. Yet the melodies are still full of a potent pop urgency and her vocals brim with youthful exuberance to create a sparkling gem of a record that is danceable and yet mature. ★★★★★

Sound: She's no 'one-trick pony' as she claims on the opening track. Yet the sheer diversity at times runs the risk of sounding jumbled. ★★★★★ NW

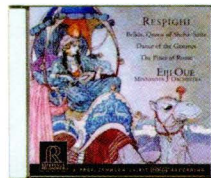

### RESPIGHI

Belkis, Queen Of Sheba Suite, Dance Of The Gnomes, The Pines Of Rome Eiji Oue (conductor), Minnesota Orch Reference Recordings RR-95CD (HDCD recording).

Music: *Pines Of Rome* is a tour de force of vivid orchestration which pushes every button. It is good musically too, and the Minnesota Orchestra applies great élan and skill. *Belkis, Queen Of Sheba* was written as a ballet very late in Respighi's life, and condensed into the orchestral suite included here. The orchestra sounds well rehearsed, and the performances are stunning: full-blooded, colourful and offering plenty of insight into the complexity of the scores. ★★★★★

Sound: The orchestra is almost tangibly real on a good system, spaced out front to back and laterally in a realistic manner, captured in a full, rich acoustic. ★★★★★ AG

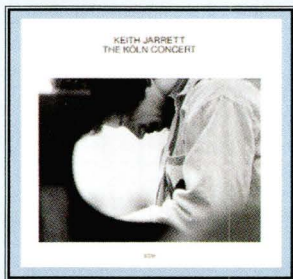

## THIS MONTH'S CLASSIC HI-FI TEST DISC "Jarrett is a master in his element."

**KEITH JARRETT** *The Köln Concert* ECM 2x120g vinyl

**Music:** This double album from 1975 is a highlight from a career with more than a few. It finds Jarrett alone in Köln, a very much live situation which brings out some of the best improvisation you'll hear in contemporary jazz. The piano may sound a little hard but it is nonetheless an eloquent communicator. Jarrett produces moments of exceptional beauty and poise and never disappears up his proverbial as

is sometimes the danger with this genre. Some may find his murmurings a distraction and the occasional boot thumping is uncalled for but it's hard not to be carried away by the explorations of a master in his element. ★★★★★

**Sound:** Everything is unusually clear and there's a great sense of the venue, instrument and playing sensibility. ★★★★★ JK



### ELECTRELANE

*The Power Out*

Too Pure

**Music:** The second album from Brighton's all-girl four piece adds lyrics and song structures to their earlier instrumental escapades and there is a great sense of trying stuff just to see if it works, a musical naivety but also assurance that is a great part of their charm. There's some spiky guitar work, leaning towards the trad indie at times, and lots of Farfisa organ which seems bound to invite Stereolab comparisons but there's also a choir (*The Valleys*) and some lovely piano trills (*You Make Me Weak At The Knees*). Founding member but new singer Verity Susman occasionally sounds as though she's struggling to voice the melodies in her head but when it all comes together, like on the gorgeous *Enter Laughing*, the results are sublime. ★★★★★

**Sound:** Recorded and produced by former Big Black front man Steve Albini in his Chicago studio the sound is characteristically bare, but it's far from raw, and there's a warmth to the recording that enhances its intimacy. ★★★ DO

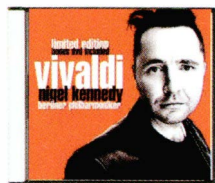
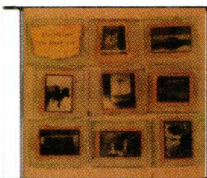

### VIVALDI

*Concerto For Two Violins, Strings and Continuo In A Minor, Four Seasons*  
Nigel Kennedy, Daniel Stabrawa (violin) Berlin Philharmonic  
EMI Classics 7243 5 57666 0 1

**Music:** Part of an ongoing Vivaldi project, this disc brings together the popular *Four Seasons* with several lesser known works including the excellent *Concerto For Two Violins*. There is no questioning Kennedy's virtuosity as he steers a clean path through the fastest and most complex passages while retaining supreme clarity of line. The Berlin Phil are not exactly beginners either, but there is something hard and aggressive in their interpretation. ★★★★★

**Sound:** A clean, vivid sound, but also a dry one that is somehow in keeping with the performance, but which lacks grace and air. ★★★ AG



### LHASA

*The Living Road*

Warner Jazz

**Music:** Lhasa De Sela is based in Quebec, is born of an American mother and Mexican father and sings spooky, haunting songs in English, French and Spanish. There are echoes of Tom Waits, PJ Harvey and Jacques Brel, with a heavy dash of Mexican folk tradition, moody chanson, gypsy melodies and wandering minstrel ambience. Her voice sounds raw and untutored, but never rough, though there's a feral quality that hints at primal forces at work, a world away from the confectionery stylings of pop. ★★★★★

**Sound:** There's a smoky, evocative air to the recording that complements the mood of the varied instrumentation (including marimba, cello, steel guitar and glockenspiel). ★★★ DO

## DVD-AUDIO & SACD

### SHOSTAKOVICH

*Symphony No 7 'Leningrad'*

Valery Gergiev (conductor), Kirov & Rotterdam Philharmonic Orchestras

SACD (stereo + multichannel SACD plus stereo CD layer)

Philips 470 623-2

**Music:** Although ostensibly written in response to the Nazi invasion of Leningrad, there is some evidence (alluded to in the disc notes) that Shostakovich may have had another agenda, namely Stalin's rein of terror. Either way, it is a powerful testament to the forces of evil, and they way they can creep up unbidden in the most ordinary of times. Insofar as this music has a programmatic element, this is it. It is an immense work, requiring two orchestras in this performance, which are marshalled to great, driving effect and with real passion by Valery Gergiev. ★★★★★

**Sound:** Mastered on PCM rather than directly to DSD, the sound is a bit grainy and shut in, although it has tremendous power and range. The surround sound coding is excellent, and the recorded acoustic is well conveyed. ★★★ AG



### DISHWALLA

*Opaline*

DVD-Audio (24/96 stereo/multichannel Dolby Digital 5.1, PCM 2.0)

Immergent

**Music:** The fourth outing from this California-based post-grunge outfit is disappointingly short of bhangra beats, but if you are into U2 or ballad-style Soundgarden it has plenty of appeal. Mixing some tasty guitar work with well honed playing, Dishwalla is a good example of the contemporary west coast rock sound – mature but edgy. It doesn't break new ground but there is plenty to keep the more sophisticated rock fan happy. Strong tracks include *Angels Or Devils* which builds well and conveys the slightly jaded outlook of the band without undermining its entertainment factor. Best when they are not trying too hard, it's a slow burner that could go far. ★★★

**Sound:** The 24/96 stereo mix that results has real shape and colour with lovely bass guitar. The surround mix places ambience rather than instruments or voices behind you which makes complete musical sense. ★★★★★ JK



### FLEETWOOD MAC

*Say You Will*

DVD-Audio (24/96 surround, 24/192 stereo,

Dolby Digital 5.1 and 2.0)

Universal

**Music:** The story goes that *Say You Will* was originally a Lindsey Buckingham solo album before the Mac got involved, with Stevie Nicks penning the rest of the tracks. This makes for an album of two halves – the Buckingham stuff rocks upbeat, with Nicks' material sounding more classically Mac. Lindsey controlled most of the production, hiring engineer Mark Needham to work the stereo and multichannel mixes. The plan was to keep the stereo 'feel' across the front three channels, something Needham has achieved while creating a stunning and coherent surround experience. Superb production values stay true to the Mac's high standard. ★★★★★

**Sound:** There are lots of musical layers, dozens of effects and a broad spectrum of instruments. The delightful 5.1 mix is a result of lots of hard work and a continual reference to the stereo version for a believable listen. ★★★ DG

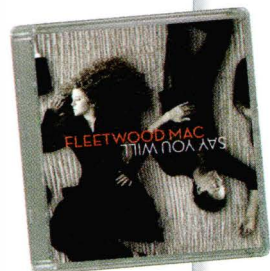

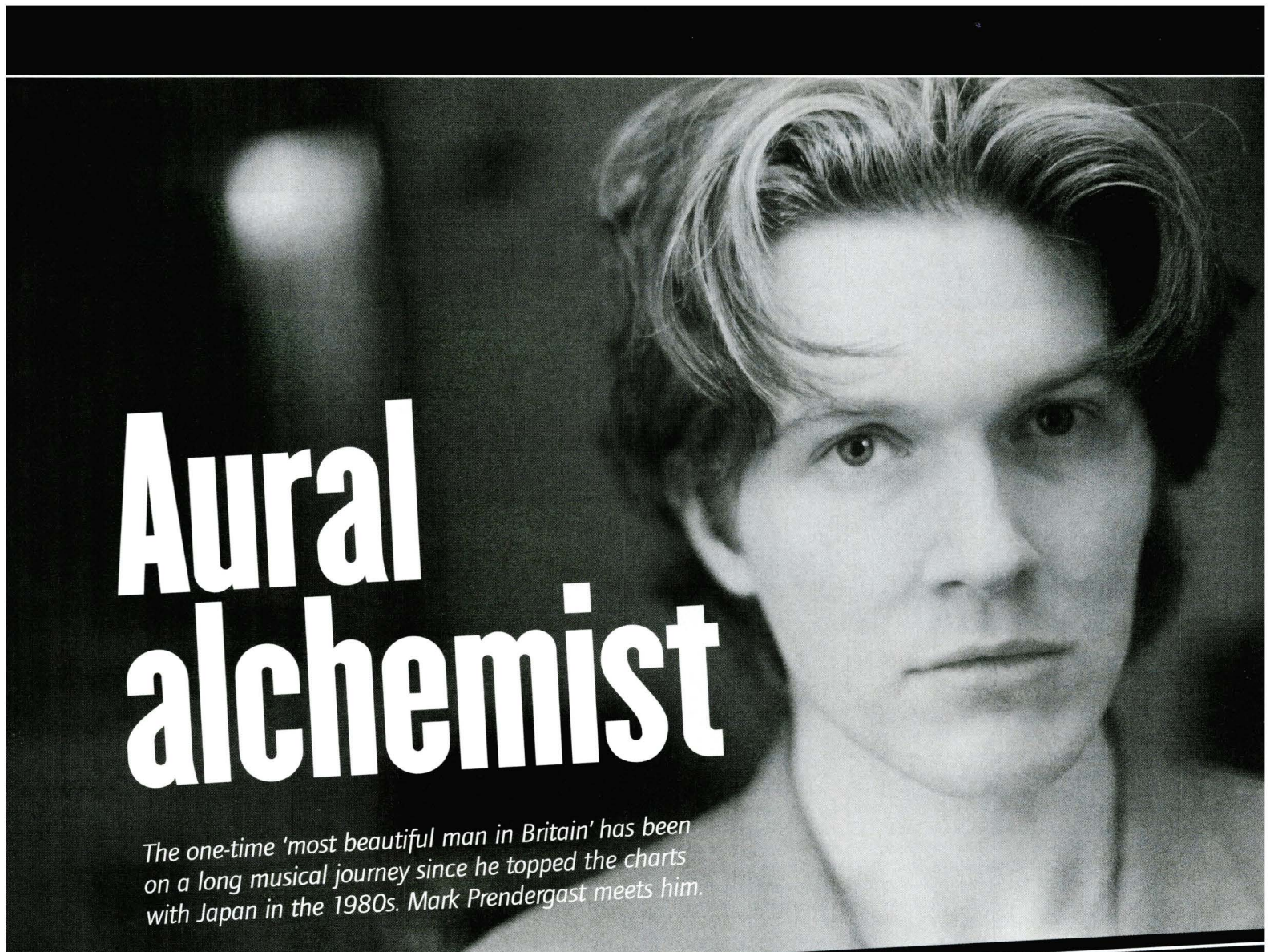

# Aural alchemist

The one-time 'most beautiful man in Britain' has been on a long musical journey since he topped the charts with Japan in the 1980s. Mark Prendergast meets him.

**H**e has just toured the most uncompromising album of his career, the emotionally naked and often dissonant *Blemish*. His magnificent quartet of 1980s solo albums, from 1984's bestselling *Brilliant Trees* to the 1987 *tour de force* that is *Secrets Of The Beehive* have been remastered by Peter Gabriel's mastering engineer of choice, Tony Cousins, and are available in lustrous new 'metallic gold themed' digipaks. But now in middle age and resident in New England, David Sylvian shows no sign of slowing down or compromising his high artistic ideals. A new, more radical music made with his brother Steve Jansen may emerge from his barn studio in the near future. In a rare moment of reflection Sylvian speaks from America about all things music.

**HFC:** *Blemish* is a much darker album than anything previously attempted. It's also truly avant-garde in the sense that former albums like *Plight* and

*Flux* were consonant works, this has a lot of jagged edges. Do you agree?

**DS:** I find *Blemish* to be a technically and emotionally raw exploration of some of the more complex aspects of human relationships. The method of composition selected and the sonic territory it explored turned out to be the perfect vehicle for the expression of this particular subject matter which is a little 'darker' than anything I've touched upon in recent times. The process of making the recording was one of pure spontaneity. All the pieces are based upon improvisation of some sort. The majority are guitar-based. Lyrics were written on the spot and recorded immediately as a response to the initial improvisation. Some of the pieces, particularly those written with guitarist Derek Bailey, a jagged edge, others, less angular, have a somewhat disjointed quality, a nervous or neurotic edge.

**HFC:** What was *Blemish* recorded on?

**DS:** The album was recorded in Pro

Tools using Earthworks and Summit mic preamps, Earthworks microphones and the usual Sony C-800G on the voice. I used an old Ampeg 'Reverberocket' tube amp with vibrato for the Steinberger and Klein guitars, a Lexicon MPX 62 for greater flexibility where vibrato speeds were concerned. Pedals included Z-Vex stomp boxes, Waldorf 4 pole filter, TC sustain/compression pedal, Electro Harmonics 16-second digital delay. Nothing overtly 'hi-tech', all pretty basic stuff really – whatever



Pic: Ingrid Chavez

came to hand! The only keyboards used were the Nord Rack III, and the Waldorf Microwave XT. There was very minimal use of synthesizers throughout.

**HFC:** Was *Blemish* as good a record as you could make at the time sonically?

**DS:** The emphasis wasn't on the sonic integrity of the pieces. Its relative crudeness in comparison to previous works echoes the rather raw emotional content so while I think the album sounds good, had I wished to polish it further, that would surely have been possible but maybe undesirable.

**HFC:** Were there any fidelity issues that were important to you during the remastering of your catalogue? Do you feel that these new re-issues are better than the originals?

**DS:** In terms of fidelity issues, there were some minor concerns which I made note of with Tony Cousins prior to the work being done. I'm reliably informed that they are an improvement

Production values must be of a certain standard because that can only service the material for the better but, ironically perhaps, this isn't the primary focal point when recording.

**HFC:** What is your take on SACD, DVD-Audio and DTS surround and other new audio formats? Do you think they add to the listener's understanding of the music?

**DS:** I have to say that, based on what I've heard, these new audio formats can dramatically enhance the listening experience. It's early days for this technology but ultimately, when one format rises above the others to become the new standard in its field, it would be desirable to have material available created expressly for that format.

Truth is I'm really interested in creating new work that explores the features of this new technology. I guess we're still waiting for the dust to settle to see which of these new mediums take a permanent place in our affections.

how fresh the material is to me, the overall complexity of the material itself, the strengths and weaknesses of the line-up of musicians for any given tour, and yes, the tour's budget (it is the mundane problems that often force the most creative solutions).

An essential consideration would be the level of interplay between the musicians themselves, how much flexibility they can be afforded within the given parameters of an existing arrangement.

The tour I undertook in support of *Blemish* was unlike any I'd ever done before and was therefore something of an exception to the rule. I tended to view the performance as something of a theatre piece, a monologue if you will. The degree of musical interaction between Steve and I was somewhat circumscribed. The emphasis was on the emotional integrity of the pieces, a sustained intensity. We were aided in this respect by Masakatsu Takagi's live visual interpretations of the material.

**"I have to say that, based on what I've heard, new audio formats like SACD, DVD-Audio and DTS surround can dramatically enhance the listening experience."**

upon the originals but I have resisted the temptation to go back and check them myself as I have spent too much of my time over the past five years reworking earlier material (*Everything And Nothing* and *Camphor*). I find it incredibly unhealthy focusing on past work for such prolonged periods. Having parted ways with Virgin I would like to leave the catalogue in their, hopefully, capable hands, and focus on that which drives me.

**HFC:** When it comes to making records are you conscious of sonic ingredients?

**DS:** 'Sonic ingredients' could refer to every aspect of the recording so the answer is inevitably 'yes'. Having said that too much can be made of the sound designer aspect of the recording process, but again this does depend on the nature of the project itself. I tend towards a flexible stand on most issues concerning the recording process. The work itself must live, must come alive, this is the primary concern. You are in the service of the material and you use any means necessary to do it justice.

I do have an interest in them and intend to make some headway with this relatively new technology on forthcoming projects.

**HFC:** Would you say you are an analogue or digital man?

**DS:** Does one have to choose? I love the flexibility that the digital domain offers the user. Ease of use, compatibility, functionality etc. If it's possible to couple that with the warmth created by recording acoustically or direct with analogue technology then that's ideal.

**HFC:** For casual listening do you use MiniDisc, tape, digital players like iPod or something else? Do you have any particular views on these formats?

**DS:** I'm anything but an audiophile. I've never enjoyed the medium of tape though, and tend to use CDs, DAT, and occasionally MiniDisc/MP3.

**HFC:** When you are on tour do you go for faithful reproduction or new interpretations?

**DS:** It depends on a number of factors:

**HFC:** Do you think that recorded music is today too slick and formulaised at the expense of happy accidents and other elements that gave your music and others that necessary human quality?

**DS:** It's a question of where you fix your sights. Certainly, the state of popular music is a sorry one but there's so much more of interest going on just below the radar. Maybe that's where we should focus our attention and not necessarily on what the multinationals and large corporations would have us buy into. I believe the elements that you refer to such as the 'happy accident' comfortably coexist with today's technology. I see no reason why they'd be ruled out. In fact I'm hearing a greater application of these elements in today's music compared to that of the past, oftentimes aided by the latest technological developments.

There is less human interaction on many of the recordings made today but we have in its place elements that weren't available to us before, the value of which shouldn't be overlooked. We're growing, coping, adapting, all the time. In a real sense, nothing is lost. **HFC**

## Essential David Sylvian Records



**Brilliant Trees** (1984)  
His ravishing debut album, embraces 'world' music, ambient and power ballads with incredible rhythmic drive.



**Gone To Earth** (1986)  
A double album, one vocal, one instrumental including awesome contributions from guitarist Robert Fripp.



**Secrets Of The Beehive** (1987)  
Perfect chamber pop with a spice of the avant-garde with gorgeous arrangements by friend Ryuichi Sakamoto.

**Plight & Premonition/ Flux & Mutability** (1988/1989)  
Sylvian goes to Köln and dives into Stockhausen/Eno territory. Peerless ambient electronica.

**Dead Bees On A Cake** (1999)  
Eclectic masterpiece including Indian music, jazz, blues, rock, ambient and Ryuichi Sakamoto. Some of it was used in hit TV series CSI.



**Blemish** (2003)  
Totally avant-garde and yet a supreme accomplishment from the man in possession of the most beautiful tenor voice in popular music.

# Choice Mail

Please PRINT the Postcode

Hi-Fi Choice  
99 Baker St  
London W1U 6PP



Write to: Hi-Fi Choice, Future Publishing Ltd, 99 Baker Street, London W1U 6PP

Right: Denon's DVD-2900 – do we really need it?



## FUMING AT CONSUMING

Are we being conned? Are hi-fi companies just trying to sell more of everything? Take multichannel audio – I myself have been suckered in and bought a Denon DVD-2900 primarily for hi-res audio which I have been enjoying. Then I bought a 5.1 speaker system but I, like most normal people, have the seats against a wall, so the ideal position for my speakers was the hall – why is it assumed that we can all accommodate large AV systems like they can in the US?

Do we even need it? At a gig the musicians are in front of you and reflected sound is intentionally minimised. I am happy with stereo from both CD and high-res. Multichannel is not my cup of tea, something is lost in the barrage of sound emanating from all round. My friends even agree some 15 to one.

Michael O'Grady via email

**HFC:** We all know the hi-fi market has taken a big lead from the US with its love of home cinema, and now it's our turn. But we're not being conned. Home cinema is a question of choice and so is multichannel audio. The experience is quite different and your appreciation of it is very personal. At least you've tried it, even if you don't like it. No-one's forcing us to buy this stuff and let's face it, most of us have collected too many CDs to jump in without thinking.

With regard to 5.1 speaker positioning, though, for optimum performance the rear channels should be placed behind the listener(s). It's crucial you get a 5.1 speaker system set up well, as even the best discs can sound uninspiring with incorrect positioning. Level setting is also crucial and an SPL meter essential

## CLASSIK DILEMMA

I'm looking to buy a new CD player for use exclusively with my Grado headphones and Creek headphone amp. I've got £400 to £600 to spend and aside from a dedicated player I like the idea of the Linn Classik. If I were to go to the next level and spend £1,000 on an upmarket model would I notice much difference?

Ric via email

**HFC:** There are plenty of excellent CD players available to fit your budget, we'd suggest the excellent Arcam DiVA CD73T (£400), or if you can still find one, Marantz's classic CD6000KI Signature (£500). Go up to £1,000 and you enter audiophile territory – the improvements in transparency, detail and soundstaging should be obvious, but both the Marantz and Arcam can punch well above their weight if you're on a budget. The Linn Classik is a very elegant hi-fi-in-a-box solution and will serve you well should you want to add speakers in the future.

## PORTION CONTROL

For someone new to this game, is there a rule of thumb on the spend ratio on hi-fi? For CD, amp and speakers for example?

Null via email

“Why is it assumed that we can all accommodate large AV systems like they can in the US?”

## LETTER OF THE MONTH

### CAN'T BUY ME LOVE

I've finally achieved my dream system, spending about £6,000 on CD, amp and speakers. Of course I love it and I'm as happy as Larry. However, it's with fond recollection that I remember my first hi-fi system. The jump from an early music centre to budget hi-fi was the most significant improvement in fidelity I've experienced – considerably better than the jump from an entry-level system to my current audiophile rig.

My point is that we needn't all wish for big, expensive systems. Often the most pleasure to be gained is from those first eye-opening hi-fi systems that expose the music and enter us into a lifelong love affair with high fidelity.

Richard Overtt via email



WIN IXOS INTERCONNECTS!

The author of our letter of the month receives a free pair of Ixos XHAG06 interconnects worth £60, featuring Gamma Geometry and silver plated OFC conductors for superior sound. So get writing! (250 words max please...)



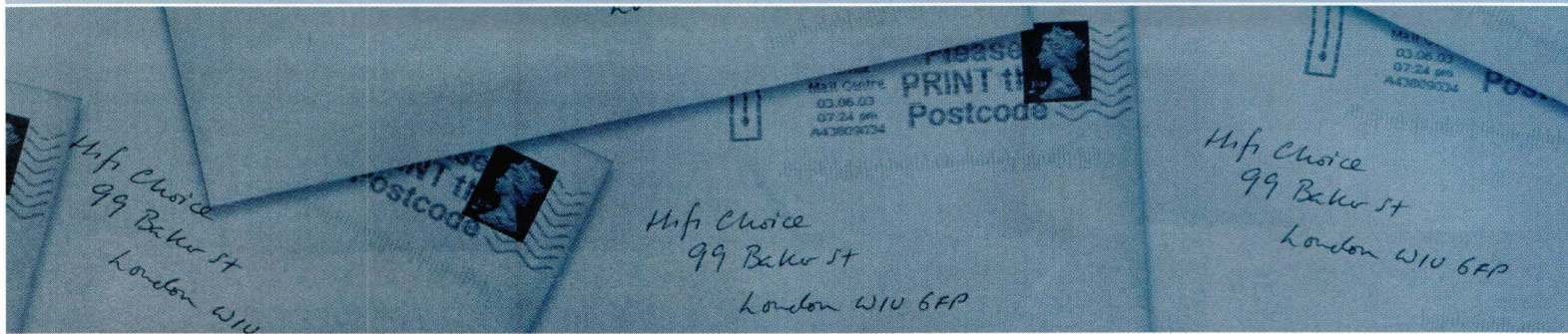

Or email your letters to [dan.george@futurenet.co.uk](mailto:dan.george@futurenet.co.uk)

You have mail



**HFC:** We've touched upon this in the past but it's worth repeating. Convention dictates splitting the budget into three, while allowing ten per cent for cables. Another established approach is 'source first', where a greater portion of the budget is allocated to the source (CD player or turntable etc). A contemporary take is to plough a bit more towards your speakers, as these boxes will have the most influence on sound in any system. Three approaches then, all with their individual merits. We like the last one and feel that advances in CD/universal players recently mean you can get cracking machines for little money.

Speakers evolve more slowly and are influenced heavily by your room. So take time and effort in this area, and spend a bit more time getting it right from the off.

#### BALANCING ACT

I'm assembling my first home cinema set-up, but how do I balance the desire for good quality stereo with good surround while maintaining a contemporary, minimalist look? I have an MF CD player and pre/power, with Oheocha D1 speakers and would like something to match at the rear if this is possible? I also own a Pioneer AX5i and wonder if the new Pioneer DV-868AVi using the i.Link output will relieve itself on the MF kit for stereo?

**Peter Bodman** via email

**HFC:** Oheocha makes a dedicated 5.1 speaker package and its D1-S standmount is the perfect match for your D1 floorstanders. Unfortunately, you can't plumb in speakers from another brand and hope to get a coherent balance – you must buy the matching rears for your front speakers. Your second question is almost impossible to answer without an A/B test between the MF gear and the Pioneer. However, we will be testing the new Pioneer player very soon, using the AX5i for both stereo and multichannel performance, listening both with and without the i.Link connection.

#### LORD OF THE DANCE

I listen to a lot of dance tracks with the volume control up to at least half-way on the amplifier to achieve realistic sound levels. I'm worried that I might be doing my Monitor Audio Studio 50s damage. My NAD S300 is only a 100-watt amplifier and although it really is a beast, I wonder, has it got enough juice to drive the speakers? I am also noticing some sibilance that I would like to eliminate.

**Nick Gaiger** via email

## ONLINE FORUM

A few choice comments plucked from our online forum. Join in the fun at [www.hifichoice.co.uk](http://www.hifichoice.co.uk)



I want to buy an iPod from the states for music on the move. It will be used with a laptop which currently only has a USB1 port. Doesn't iPod need USB2 or a FireWire socket to download in decent time? **Mad Dog 2**

**HFC:** You're right – you'll either need a FireWire port or a USB2 port, because USB1 doesn't provide enough speed. Apple will sell you an USB2 cable to go with your iPod if required, but check if you can upgrade your laptop with a USB2 card first.

Does anyone agree that upgrading can lead to a never-ending cycle of disappointment? Since I got my first hi-fi I've found that upgrading has caused mismatching and now I have gear that I didn't like as much as the old stuff. **Pioneer31**

Ladies and gentlemen, behold the ultimate audiophile accessory – the Silver Rock Signature Knob. A wooden replacement volume knob on [www.referenceaudiomod.com](http://www.referenceaudiomod.com). Apply now and beat the rush at only \$485. Where will the madness end? **Pete H**

Calling all Linn users, you can now enjoy a new forum run by an enthusiast for discussing all things Linn. It's called LinnkUp and is well worth a look despite the long URL. <http://linnkup.proboards26.com/> **LinnkUp**

**HFC:** The position of the volume knob depends on the gain of the amp and the sensitivity of the speakers, but if you are getting sibilance at high levels the chances are your amplifier is clipping. Unfortunately there is a good chance that you are damaging both your speakers and your hearing! If you want to play at these sort of levels you either need to get more efficient speakers that the NAD will be able to drive and control, such as Spendor S8s or Castle Howard S3s, or you could tackle the problem from the other side and get an amplifier that will retain its composure when you turn the wick up. A good example is ATC's SIA2-150 (£2,375) integrated which is both beefy and sophisticated. If you are committed to high levels there's a lot to be said for an active system such as those made by ATC and PMC.

**“How do I balance good quality stereo with good surround and maintain a contemporary look?”**

Below: The Pioneer DV-868AVi, due for a thorough HFC test soon.





ROTEL RCD-1072 CD PLAYER | ROTEL RA-1062 INTEGRATED AMP  
MONITOR AUDIO S8 LOUDSPEAKER | £1990

# Let Us Rock

*Fed up with powder-puff hi-fi? Fancy being pinned to the wall? This combo delivers on all fronts*

Know what you're thinking. Where are the curves? That achingly sexy aesthetic dripping with industrial designer inspiration – it's, er, missing. Yes it is. Moreover, I offer no excuses. This month's beautiful system just isn't very beautiful. At least not in the conventional, can't-take-your-peepers-off-it sense. But in another, perhaps less frivolous way, I think it is. Because sometimes lissom, meticulously measured prettiness doesn't quite hit the spot. Sonic suavity has its limitations, too. The lush build and honeyed clarity of the Unison Research/Diapason combo from a few months back is hugely alluring but it may not be the answer to all your musical needs.

Neither might this unashamedly angular and beefy CD-based combo from Rotel and Monitor Audio, of course. But, for starters, it does successfully poke fun at two rather pretentious hi-fi maxims, 'namely less is more', and 'power is the enemy of agility and high-res fidelity'. Let's consider its two-fisted take on these cherished principles. Beginning with the speakers, there's nothing detectably minimalist about Brit-fi stalwart Monitor Audio's weighty S8 floorstander. In fact it's a whole lotta rather densely-engineered speaker for your £800, toting no fewer than three gleaming metal-cone main drivers, all using 150mm non-magnetic polymer frames and 115mm diameter diaphragms. Operating in a two-and-a-half-way configuration, the lower two handle the bass only while the upper unit works in its own separate enclosure, taking care of affairs up to 3.2kHz where it hands over to Monitor Audio's signature gold-coloured metal

dome tweeter. Although quite slim and not particularly deep, each twin rear-ported enclosure is very sturdily built with extensive internal bracing and a meaty stability-enhancing plinth. And know what? It may be just a trad, hip-high box but it looks stunning. The superb quality of the natural oak veneers (one of four available finishes) is a contributing factor, but whip the grilles off and the sight of all those shiny metal drivers is something of a knee-wobbler.

The cast polymer chassis design used for the bass and mid-range drivers have an unusually large working cone area considering the modest overall chassis size. The general idea is that the new, larger drivers can be used with slimmer and more attractive cabinet designs.

The cones' rubber surrounds have been redesigned to be flush with the cone edge and take advantage of the larger drive unit size which, claims MA, allows greater cone excursions with lower distortion and improved frequency response linearity. The new chassis and driver assemblies have no screws or loose parts in the interests of consistency and reliability.

The shielded magnet structures have been designed for higher performance and more precise control of bass frequencies. The S8's bass and bass/mid drivers use four-layer voice coils, giving a claimed efficiency boost over conventional drivers of 2-3 decibels at bass frequencies.

Although it's an easy enough load to drive, no pale and interesting single-ended triode is going to properly get to grips with this modest behemoth. Rotel's £600 RA-1062 integrated amp is a rather different kind of beast, though. Already an exceptional solo ■

**"It pokes fun at two rather pretentious hi-fi maxims, 'namely less is more', and 'power is the enemy of agility and high-res fidelity'."**



**Rotel RCD-1072 £595**

Energetic balance and lots of drive find great synergy with matching 1062 amp. More rock than romance – that goes for build and design, too.



**Rotel RA-1062 £595**

A crisp, dynamic and expressive-sounding amp with excellent build quality at a keen price. Capable of serious volume hooked up to the efficient Monitor Audios but also very impressive control.



**Monitor Audio S8 £800**

Hard to believe such a slim box can weigh so much or feel so solid, but then the S8 does have four drivers per enclosure and is very sturdily constructed. Fine performance all-round but bass and clarity excel.

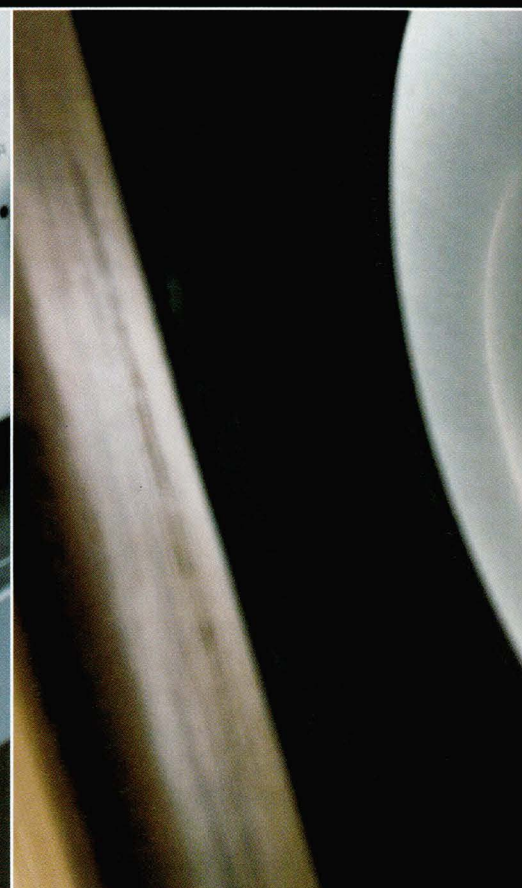

performer in these pages, it's very much an audiophile-oriented design in the Rotel tradition, but one with a notably plush fascia and well-stacked rear panel. The armchair convenience quotient is exceptionally high. There are six line-level inputs with independent listen/record selectors, a full set of tone or "contour" controls, a headphone jack, a 12-volt trigger circuit and an extra set of terminals for a second pair of speakers (all microprocessor-controlled from the slim but neatly laid out remote, of course).

The 1062 isn't exactly fading away under the bonnet, either, packing a substantial Rotel-made toroidal transformer, fine tolerance rectifiers and very high grade British Aerovox T-Network capacitors. The bottom line is a conservatively-rated 60 watts a side into eight ohms and a high damping factor, good news for the S8s which appreciate and can ably demonstrate the benefits of muscle and control when it comes to dynamics and loudness. It's clearly this amp's ambition to up-end convention by providing the best of all worlds. It seems, once again, that more is more.

You might be surprised to see the 1062's matching CD player, the RCD-1072, here – after all, it didn't exactly grab group test glory on its last *HFC*

outing. Well, for a start, it makes a smart stack with the amp. Both are slimline but purposeful – together the effect is compellingly chunky. Second, Rotel designed it as a natural coupling for the amp, so synergy just might overcome the standalone shortcomings. And third, the 1072's noted strengths – its ebullience, dynamics and sense of power – are, in any case, just what the system job description ordered.

#### NOT LEAN, JUST MEAN

Again, this is almost the antithesis of a lean machine. The 1072 boasts more functionality than most of its peers with programme (including review), repeat, random play and a ten-second intro scan feature. The choice of Burr-Brown's PCM1732 DAC is interesting, too. This IC doesn't have a reputation as a cutting-edge performer for its price, but it does have an on-board HDCD decoder. It might seem a bit old hat in the era of SACD and DVD-A, but Rotel is a long-time supporter of Pacific Microsonics' performance-massaging encoding scheme for CD, and there's a healthy smattering of HDCD-enhanced discs out there to take advantage of the extra circuitry, including some real honeys on the Linn label.

The 1072 is basically an update of the RCD-1070 with a revised fascia

layout designed around a centralised Sony drawer mechanism and upgrades to 60 internal components, including a new Burr-Brown op-amp, which is said to offer lower noise and distortion. Although Sony components, the drawer, mechanism and display have been modified to Rotel's specification. One downside is that the mechanism doesn't reliably handle CD-RW discs and nor does it support CD Text.

But never mind that. Never mind that the looks, far from being drop dead gorgeous, won't even leave you feeling slightly unwell. Smart and simple will have to do. In fact, it's a wonderful disguise for the frankly enthralling dimension of believability this powerful, unfrilly combo brings to the business of listening to your favourite music.

In short, it motors in a way The Darkness can only dream about. First and foremost, it's hi-fi for the big occasion. Give the rear-ported S8s a little space to breathe, place a suitably energetic CD in the tray (it isn't genre-dependent), lean on the volume and stand back. The scale, authority and dynamics will, I guarantee, blow you away. Rock played at high levels is underpinned by a powerful, fast and tuneful bass. With jazz or classical material, the system relaxes beautifully, sounding expansive, airy and tactile.

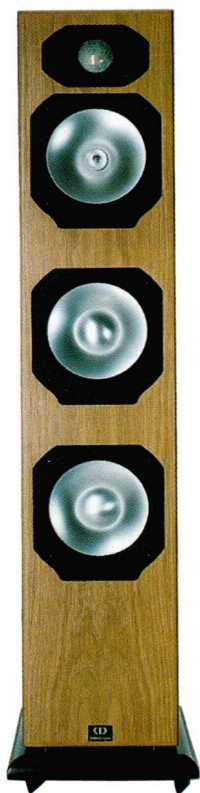

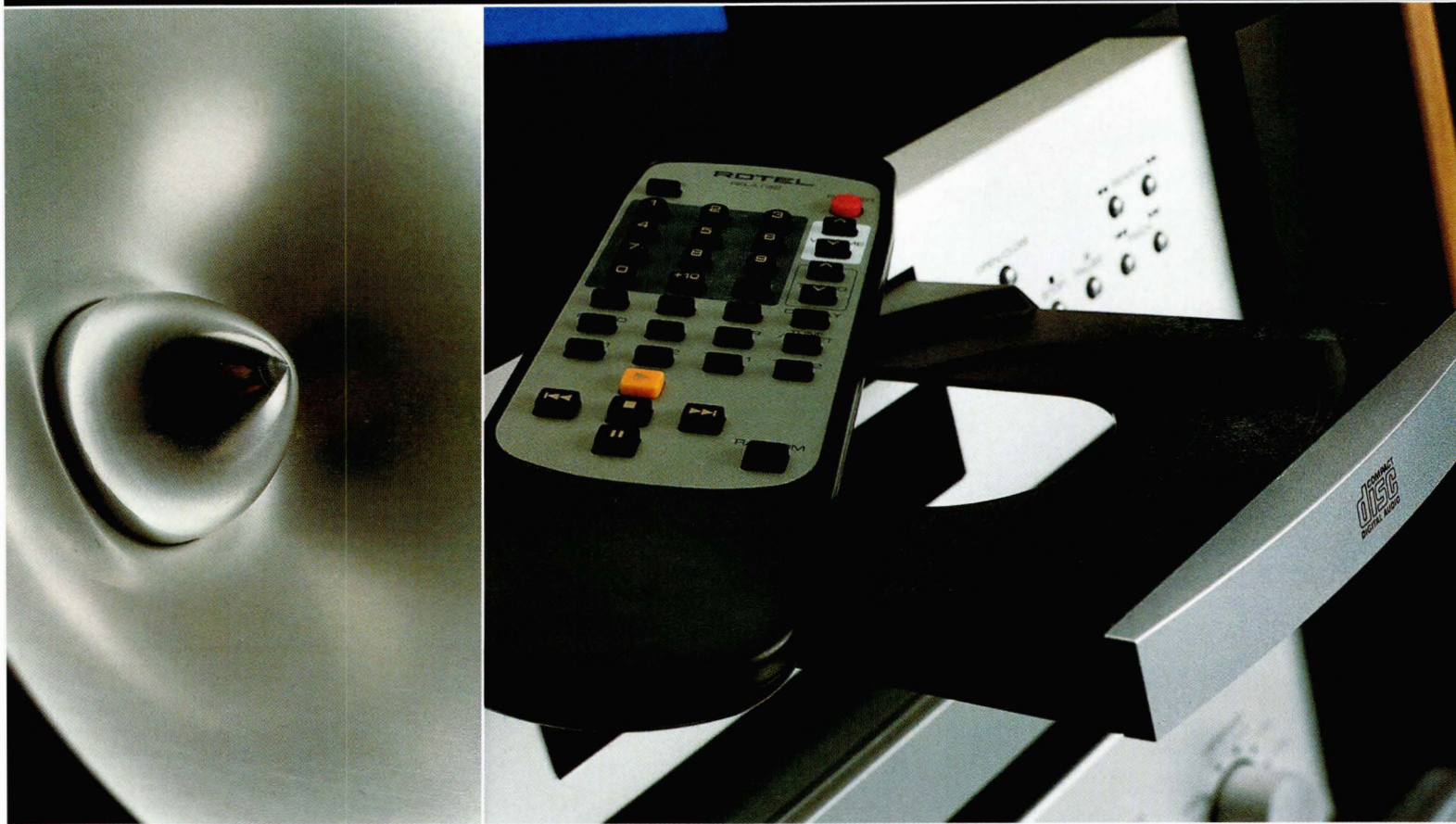

## “The way this system combines power, weight and presence with lightning response is far more unusual than the way it looks.”

The clear, finely resolved presentation remains clean at high volumes and well controlled at the frequency extremes. Also remarkable is the way this kit delivers warmth with detail and insight.

But that's what's so remarkable. This system does killer dubs and subtle acoustic ambient cues with equal skill, while slickly recorded jazz has a shimmering, almost scalp-tingling presence. Deep, weighty bass is an obvious advantage of the Monitor Audio's tall, multi-drivered enclosure, but even more impressive is the way the effortlessness and obvious dynamic freedom of the S8 makes it a truly unflagging listen for long periods.

### GOOD AND PURE

MA designer Dean Hartley's brief for this speaker was for it to combine knockout dynamics with decent loudness capability and power handling but without sacrificing subtly, finesse and transparency. Outstanding mid-treble transparency, a taut, propulsive delivery and fine rhythmic coherence say he got his sums right. The way this system combines power, weight and

presence with lightning responses and a light touch is far more unusual, it has to be said, than the way it looks.

So, to summarise – real grip and power from the bass and a pure, accurate midrange. The system goes effortlessly loud, hits hard and has a big, expansive soundstage. Yet there's nothing overblown about its presentation: when the material dictates, it's as light on its feet as much smaller speakers. It can also sound very classy and clean, with an attractive absence of grain and harshness that sometimes makes CD edgy to listen to. In fact, despite the sheer physicality of this system's performance, an outstanding amount of information is present in the signal but it's so well integrated into the larger musical picture, it never seems spotlighted. In the end, there does appear to be genuine synergy between the Rotel components which, with the help of the Monitor Audios, produces an amazingly assured style of music making, good at unravelling the densest of mixes, at making stuff sing and tug at the emotions while, at the same time,

sounding explicit and finely detailed.

One thing seems certain. If you've never experienced what real power and dynamics can bring to the hi-fi party, this aesthetically self-effacing system just might shock you to the core. It isn't just that it goes louder, higher and lower with more freedom than people would usually expect from a “mid-fi” system, but the gripping believability it brings to the activity of listening to music. In fact, it makes it less of an activity – more of an occasion.

But I think what I like about it most is the way it combines such infectious drive and energy with a decent helping of more conventional hi-fi virtues such as low colouration, precise imaging capabilities and spacious soundstaging. It might not be the last word in sleek, svelte design, but it is easy to use and enthralling to listen to whatever CD you choose to slip in the tray. If you're after a cosy, comfortable ride, this probably isn't the system for you. If you want real kick when you press the pedal to the metal, it could change your life. **HFC**

*David Vivian*

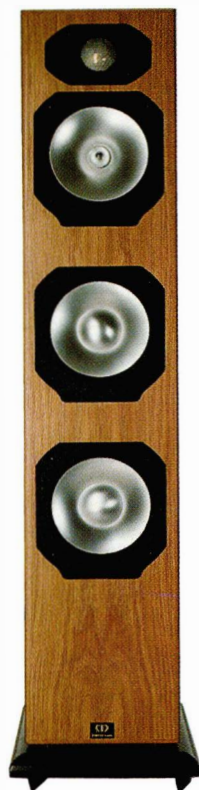

# where Sight

▶ TO HEAR ANTHONY GALLO LOUSPEAKERS AND FIND YOUR NEAREST DEALER CALL 0870 350 1348 OR VISIT WWW.ANTHONYGALLO.CO.UK



Please visit us at Sound and Vision - the Bristol Show  
20th - 22nd February 2004 - Room 316

## meets Sound

Anthony Gallo doesn't make ordinary speakers...

Instead he designs *beautifully different* loudspeakers  
He doesn't build conventional 'boxy' rectangular speakers  
either, preferring to **design** his *creations* around **spheres** -  
thus *eliminating* internal **resonance** and external **diffraction**,  
the two main causes of loudspeaker distortion

Quite simply - Anthony Gallo produces *the world's finest*  
'small' speaker systems



**ANTHONY GALLO**  
ACOUSTICS

t . 0 8 7 0 3 5 0 1 3 4 8

e . enquiries@anthonygallo.co.uk

Gallo loudspeakers are available in a variety of *colours* and  
*finishes* to **complement** any room, from *striking polished*  
*stainless steel* to *vibrant canary yellow*.

Above all, Anthony Gallo speakers bring *exceptional*,  
*expansive sound* to living spaces **large** and small.

Whether your **interest** is **Stereo**, **Home Cinema** or **Multi**  
**Room** use, why not visit an approved Anthony Gallo dealer

## SOUNDATIONS

original high performance support furniture

" a rare combination of **art** and **science** results in a  
**new genre** of high performance support furniture "

Soundations are based on advanced technologies and are designed to  
enhance the enjoyment of music and film.

Audio and video equipment should be isolated from acoustic  
feedback if it is to perform optimally.

We use a combination of coupling, absorption and mechanical isolation to ensure  
that our Soundations provide maximum acoustic isolation.

Soundations differ from rival products in that aesthetic values, versatility and  
engineering excellence are given equal emphasis.

For further information please visit our website or call 0870 350 1349  
to request our comprehensive product guide and dealer list.

www.soundations.co.uk



Since 1982

Visit Soundations at Sound and Vision - the Bristol Show  
20th-22nd Feb 2004 - Conservatory Level

## hi-fi and av support furniture redefined



soundationultimo



soundationf1



soundationveloce



soundationhf

# REVIEWS



Welcome to the HFC hardware reviews section – the only place for definitive tests of the latest hi-fi components. Our unique combination of extensive listening, unsighted comparisons and scientific lab reports, conducted by the UK's most experienced set of reviewers, ensures you're holding the most comprehensive and reliable guide to high performance hi-fi in the world.

## SOLO REVIEWS

- 32** Acoustic Energy AE1 MkIII and AE3 MkII loudspeakers
- 36** Krell SACD Standard SACD player
- 40** Clearaudio Emotion turntable (with Satisfy arm and Aurum Classics Wood cartridge)
- 43** Focal-JMLab Chorus 707 S loudspeaker
- 44** Arcam FMJ C30 preamplifier and P1 mono power amplifiers
- 48** BAT VK-D5SE CD Player
- 51** Creek T50 AM/FM radio tuner

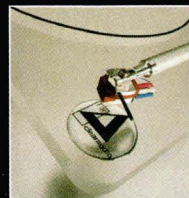

- 52** Final Sound Electrostatic loudspeakers
- 56** Ayre CX-7 CD player
- 58** Nordost Valhalla Reference mains cable

## ULTIMATE GROUP TEST STEREO VS MULTICHANNEL AMPS £300-£800

- 62** Arcam DiVa A80
- 63** Creek A50iR
- 64** Roksan Kandy KA-1 MkIII
- 65** Rotel RA-1062
- 66** Denon AVR-2803
- 67** Pioneer VSX-AX3
- 68** Sony STR-DB790
- 69** Yamaha RX-V1400RDS



## OUR RATINGS EXPLAINED

Percentage ratings for various different criteria, like sound quality and value for money

Our overall conclusion

...nor an... we liked point here is p to the job of... recommend you... this with Marantz's £800 player, the 17 MkII M, which has excellent build and... a very good impression in HFC 243. At... same price there's also the Cyrus 7, a... ng all-rounder in a compact case... 'er trying the Heart with the standard... s we switched over to the Siemens... grade, a comparison somewhat muddled by... e fact that it was a cold for hot swap – the... lower had been on for several days with the... after a livelier... w tubes shone... through. The Siemens-equipped player has an... n snappier sound with better timing that... es with dense material with remarkable... fidence and ease. It even seems to be

You can find... civilised players for the... money. But few combine dynamics with fine... timing skills as effectively as this. **HFC**  
Jason Kennedy

**VERDICT**

**SOUND >> 83%**

**FEATURES >> 85%**

**BUILD >> 85%**

**VALUE >> 85%**

**PRO** Well built and fully featured, with a snappy, open and dynamic sound.

**CON** Externally it's a £300 Marantz – no bad thing in itself, but it's hotter than it looks!

**RECOMMEND** This is a highly entertaining and colourful player, at a competitive price. The build quality is good and the feature list... it's not the most subtle £750 player but if you're looking for a speaker to inspire you, it costs price a bargain.

**HI-FI CHOICE OVERALL SCORE >> 84%**

The things we like most about the product

The things we think could be better

The product's final score. All criteria are taken into account but the emphasis is on performance. Components scoring more than 85% may qualify for an HFC Award Badge

## OUR AWARD BADGES EXPLAINED



**Best Buy**

A component receiving the coveted Hi-Fi Choice Best Buy Badge has been judged to deliver excellent performance at its price point, thereby offering outstanding value for money.



**Editor's Choice**

This Badge is awarded only to those components that are judged to deliver reference-standard performance, regardless of cost. These products may be considered among the very best of their kind.

Turn the page for the most rigorous tests of serious hi-fi in the business...

# UPDATING A CLASSIC

Acoustic Energy has re-worked its classic AE1 miniature – and fashioned a floorstanding version too

**PRODUCT** Acoustic Energy AE1 MkIII and AE3 MkII

**TYPE** Standmount and floorstanding loudspeakers

**PRICE** AE1 MkIII £1,990 per pair ('piano black' finish), AE3 MkII £4,490 per pair

**KEY FEATURES** Size (WxHxD): AE1 MkIII 18.5x31x25cm, AE3 MkII 18.5x99x29cm • Weight: AE1 MkIII 11kg, AE3 MkII 30kg • Hyperbolic metal cone bass/midrange drivers • Fabric annular 'ring radiator' tweeter • Solid 30mm alloy plinth (AE3 MkII)

**CONTACT** ☎ 01285 654432

🌐 www.acoustic-energy.co.uk

This review brings together two closely related loudspeakers, one of which is the latest version of an acknowledged classic from the 1980s, the other a three-way floorstanding variation on the same theme.

Acoustic Energy's first product, the diminutive and defiantly pro-looking AE1 caused quite a sensation when it first appeared. Way back in *HFC* 59 (1988), it was described as: "the most awesomely articulate and dynamic miniature ever made", a comment which undoubtedly helped underpin the model's – and the company's – early reputation and success.

*Hi-Fi Choice* re-tested an evolved version of the same speaker in 1991, with rather more equivocal results, followed by a more luxurious Signature version in 1995. That Signature subsequently formed the basis of a formal MkII version of the AE1, which ran from 1996 until this new and considerably revised MkIII first saw the light of day, priced from £1,690. Though available since the summer of 2003, this is the first time a magazine has been deemed worthy of its appraisal.

Recently, Acoustic Energy has also introduced a new £4,490 Signature series model codenamed AE3 MkII. This actually has little in common with an earlier AE3, but rather is an AE1 MkIII converted into a three-way,

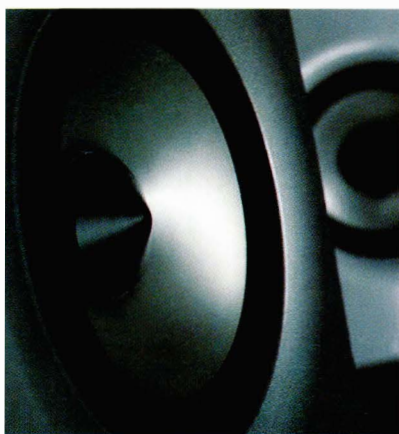

extending the enclosure down the floor, changing the crossover network and adding a couple of bass-only drivers, so we thought it would be interesting to compare both models in one review.

Although there are still links between the original AE1 and these latest models, there are, in truth, probably as many differences as similarities. The most obvious common factor between old and new is the small (130mm) but very advanced metal cone drive unit, used as bass/mid in the AE1 MkIII and as midrange in the AE3 MkII, and even this has changed quite substantially. Now made by the very skilful Danish Sound Technology (DST) operation to AE's specific requirements, the deep-anodised hyperbolic-shaped alloy cone is significantly lighter (33 per cent thinner) than the 'spun' alloy original. The tweeter too comes from DST, and represents a much greater break with tradition, eschewing the metal dome of its predecessor in favour of the clever fabric annulus ('ring radiator') device that has recently appeared in a number of top quality designs.

Most significant, perhaps, is the shift in emphasis over the fifteen or so years. The original AE1 was designed by Phil Jones (now with AAD), who came from a ProAudio background and created a mini-monitor with considerable studio appeal, in a hard-wearing textured finish and capable of handling very high power, albeit at the expense of limited bass extension. Subsequent models have moved much more towards hi-fi sensibilities, featuring luxurious (and costly) furniture finish and, in the case of this MkIII, supplying greater bass extension at some cost in terms of power handling.

This trade-off between deep bass and power





handling is unavoidable with very small speakers. The shift adopted for the latest MkIII makes plenty of sense for a hi-fi-oriented model, partly because it will still go loud enough for most domestic listeners – but also because those who want more level and/or bass weight can go for the AE3 MkII instead.

The styling is drop-dead gorgeous, our samples coming in top-quality piano black lacquer – the real thing here, requiring some seven layers of lacquer to give that really deep-down, mirror-flat shine. Although this surface treatment carries a handsome premium over the various alternatives (maple and cherry cost £1,790, black ash £1,690), it's actually by far the most popular. In fact, it's the only option available on the AE3 MkII.

No less attractive is the beautifully shaped aluminium front plate, which is a full 10mm thick and ensures exceptional mechanical rigidity and integrity between the two forward-facing drivers. It also covers over the driver fixings and is carefully shaped around the edges and the driver orifices. For the very best consistency, it's painted in very durable Mercedes-silver automotive metallic paint.

The MkIII AE1 is just a little larger than the original – 15mm taller and 5mm deeper – but it still qualifies as a genuine miniature. It's intended to be used on standard 60cm stands, which AE can supply (as pictured) as an optional £490-per-pair extra.

The AE3 MkII looks similar from the front but is 45mm deeper, and sits on a column-like bass enclosure that takes the total height to around a metre. This too has some elegant detailing, very much in the Art Deco style. There's a 30mm thick aluminium alloy plinth, made up of three 10mm sections, each with radiused edges and slightly larger than the one above, creating a solid platform that not only looks very attractive, but also ensures great stability and a secure mounting for the 8mm spikes. More radiused 10mm alloy panels are mounted on each side near the base, covering up the mounting hardware of the twin alloy-cone 165mm bass drivers, while five shiny rods form an Art Deco motif which protects the cones.

There's plenty of hidden engineering in both speakers. The AE1's rear-ported enclosure is a combination of 12mm MDF backed by 5mm steel plates fixed by a damping adhesive, with a tensioned cross-bolt bracing the sides apart. High-power (400V-rated) crossover capacitors are used to reduce microphony, alongside radiometal-cored inductors (those used in the AE3 are mostly air-cored). ▣

**“The AE3 MkII is very easy to like, with a warm, rich balance that is very relaxing yet also possesses fine clarity.”**



## SET-UP

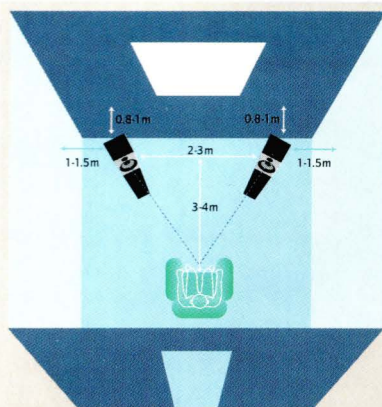

### POSITIONING

Both these models are primarily intended for siting well clear of walls, partly in order to take full advantage of their spectacularly fine stereo imaging capabilities, as well as their inherently low midband coloration.

Ideally they should be directed either straight towards the listener or so that their axes cross about a metre in front of the listening zone, though the inherently wide and even lateral distribution of both models means they can also be positioned 'square on' with room boundaries without significant compromise if desired.

Close-to-wall siting is quite inappropriate for the AE3 MkII, though it could be a viable – albeit a compromised option – for the AE1 MkIII, if the rear ports are blocked.

### LAB MEASUREMENTS & SYSTEM MATCHING

AE claims quite respectable sensitivity figures for both of these models – 87dB/W for the AE1 MkIII and 90dB/W for the AE3 MkII – though these figures are considerably at variance with our findings, which give ratings of 83dB/W and 87dB/W for the smaller and larger models respectively, both significantly below average.

Figures as low as these suggest that powerful solid state amplifiers will make the most sensible partners, and low-powered valve amps, especially of the single-ended variety, ought to be avoided.

Happily the impedance characteristics of both models seem benign, the AE1 MkIII showing a five-ohm minimum at 3.8kHz, while the AE3 MkII also registers a five-ohm minimum but at 110Hz. Neither will therefore make particularly strenuous current demands on the driving amp, though it's important that there should be plenty of voltage headroom to avoid clipping and so loss of control of the speaker by the amplifier's power stage.

Neither speaker delivered impeccable in-room frequency responses, though both gave broadly well balanced results, with slight tendencies to emphasise the low end. The AE1 MkIII has an energetic port output centred on 45Hz, which is close to one of the main modes in our listening room. There's also some emphasis around 260Hz, and a gentle but broad dip around 2.8kHz. The AE3 MkII is smoother through the bass and again through the mid and treble, though there is loss of energy at 100-200Hz and again at 300-600Hz.

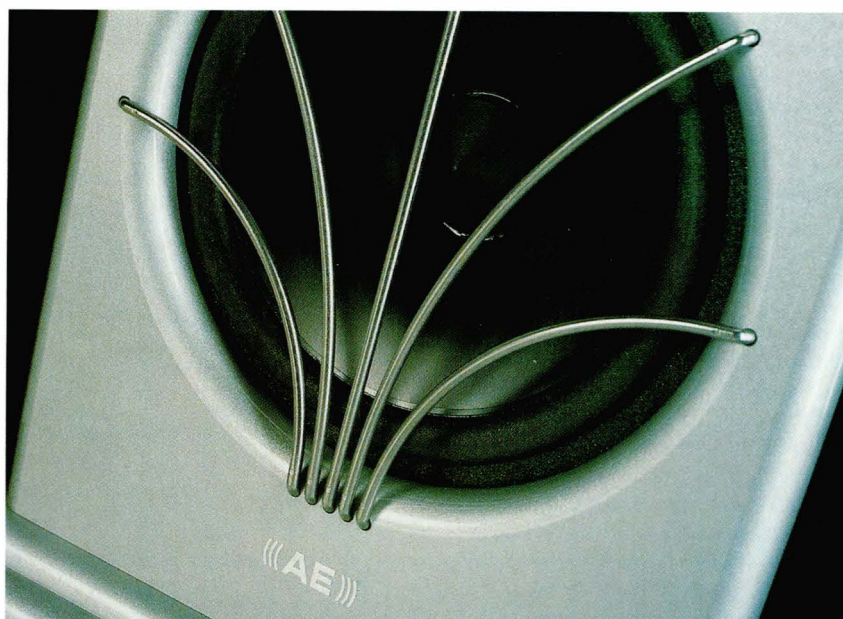

## “The low ‘box sound’ of the AE1 MkIII is obvious, in its prodigious dynamic range and astonishingly fine stereo imaging.”

▣ The AE3 MkII is internally divided into separate bass and mid enclosures, both rear-ported. The former is well braced, horizontally and vertically, with steel plates reinforcing the driver mounting. Using twin drive units back-to-back, mechanically coupling their magnets together via a rubber gasket, cancels out any Newtonian reaction forces.

Each speaker is fitted with a single pair of quality WBT terminals, though these seemed a loose fit with our 4mm plugs – products of this nature ought really to be using terminals with a full-locking collar mechanism.

### SOUND QUALITY

Any reviewer should at least be aware of his/her prejudices and preferences, and probably ought to disclose these predilections prior to reviewing something that operates according to different paradigms.

My preference has long been for high sensitivity loudspeakers, so something which is not only costly but also has exceedingly low sensitivity would seem unlikely to have much appeal. However, there's more than one way to skin a cat, as the old saw goes. And while we wouldn't condone any form of felicide, Acoustic Energy's rather different approach to music making has proved quite persuasive.

When AE's head of R&D Steve Phillips brought the speakers down, we immediately placed the AE1 MkIIIs on our usual Kudos S100 stands and connected them up to our test system. This consisted of Naim NAC552/NAP500 amplification, a Naim CDS-3 CD player, a hybrid Linn/Rega vinyl

record player and Magnum Dynalab tuner. These are supported by Mana and Vertex AQ Kinabala supports, and mainly connected up by Vertex AQ and Naim mains, interconnect and speaker cables.

The relatively recent acquisition of the various Vertex AQ components has served to 'quieten' the background 'grunge' level of the system significantly, and that seems to suit the AE1 MkIII well. The amazingly low 'box sound' of these speakers is immediately very obvious, in their prodigious dynamic range and astonishingly fine stereo imaging.

Indeed, shut your eyes and it would be quite impossible to pinpoint the location of the speakers themselves – all you hear are the positions of the musical instruments and voices, according to where they have been placed in the mix. The tight precision of the central focus is nothing short of magnificent – makes you wonder why anyone's worrying about adding an extra centre channel!

This little speaker does fall a little short of perfection, to be sure, but that's true of any loudspeaker you care to name, and there's no denying that the overall compromise drawn here is a very attractive one, and the criticisms are minor in nature.

Certainly there's less dynamic tension and expression than one finds with high-sensitivity designs, but the dynamic range is all there because of that extraordinarily low enclosure contribution. The voicing might perhaps be a little too restrained through the presence region for some tastes – speech sounds just a shade 'shut in' here – but the up side is a

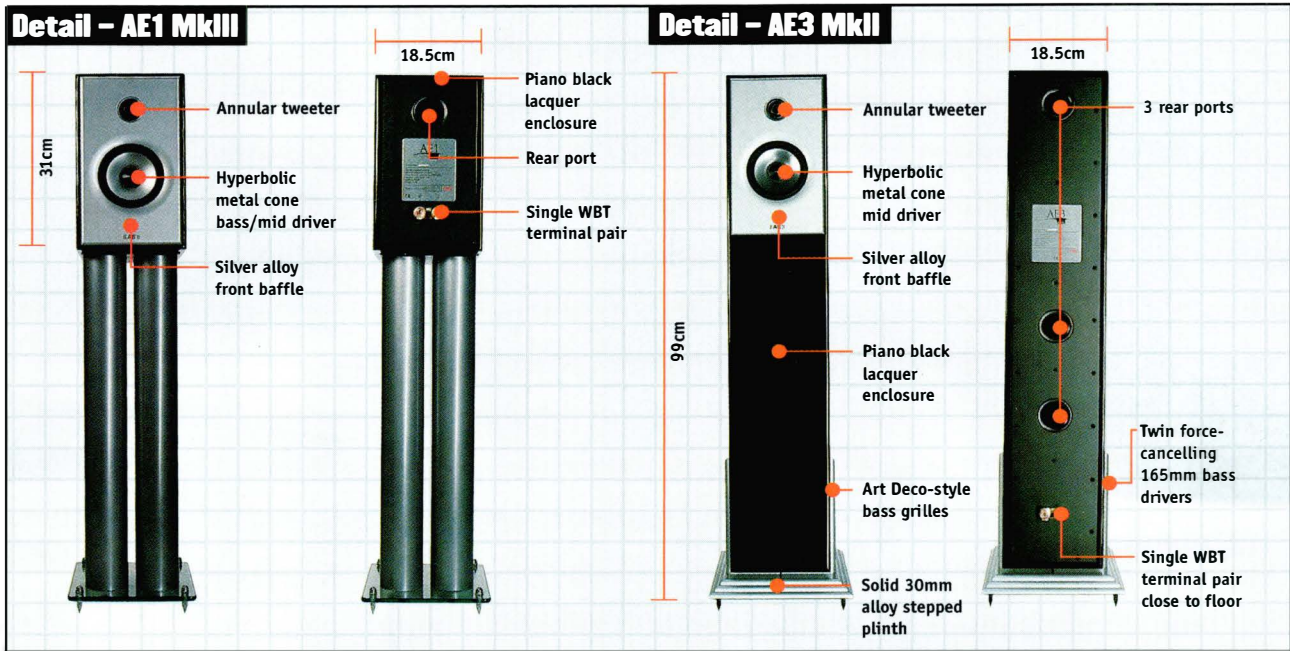

useful freedom from aggression, whatever the musical source material.

The bottom end, with the port tuned to 45Hz, wasn't an ideal match for our room, leading to some mid-bass over-emphasis, but even so it sounds clean and quite agile, and also adds useful weight that helps to make up for some lack of ultimate extension.

Changing over to the AE3 MkII brought an immediate improvement in bass weight and authority, which seemed altogether worthwhile. There's an easiness about the bass end here which is both relaxing and informative, and significantly more comfortable and capable than that which its smaller brother can provide. That said, it does verge a little on the heavy side with some material, with an occasional tendency to 'thump', and shows a little less total top-to-bottom coherence.

Interestingly, the voicing is slightly different here, the AE3 MkII turning out to be just a

little more open and neutral through the voice band. This is a very easy speaker to like, with a warm, rich balance that is very relaxing yet also possesses fine clarity.

It's also a very precise device. At one point there seemed to be a slight image shift towards the left side of the two speakers. On measuring the precise distances between each speaker and the main listening seat, we discovered that the left speaker had been placed about 5cm closer than the one on the right. This was corrected and the image immediately centred up properly.

One might complain that the sound is a little lacking in dynamic tension and expression, and perhaps the overall effect could be a little more edge-of-seat exciting. But like its smaller brother, the AE3 MkII delivers a stereo image that is superbly stable and well focused, though there is slightly more male voice 'chestiness' here. Once again any enclosure coloration is exceptionally well

controlled, ensuring a very wide dynamic range with fine low-level detail resolution.

While these two Signature-series models from Acoustic Energy have much in common – two drive units and a magnificently solid and rigid front baffle for starters – they also show quite a number of differences. The AE3 MkII is not merely an AE1 MkIII with additional bass drivers, rather it's a quite distinctive design in its own right. Despite the commonality of components, its character is quite distinct from that of its baby brother.

While the AE3 MkII is the superior speaker in most respects – it has superior bass weight and authority, greater openness and overall neutrality, and significantly higher sensitivity – it would be a mistake to overlook the sheer charm of the little AE1 MkIII. Partly because there's fresh air all round its tiny front baffle, this cheeky chappie has a definite 'fun factor' advantage over its bigger brother. **HFC**

Paul Messenger

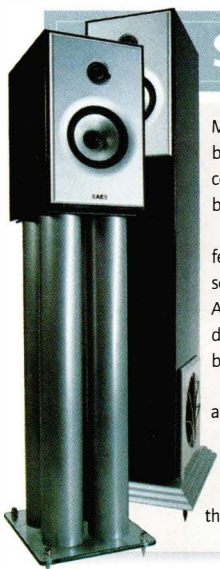

## SECOND OPINION

My experience with the original AE1 goes back to its launch in the 1980s. I remember being enormously impressed by this little box of dynamite, with its lack of cabinet coloration and supreme dynamic clout. Its latest replacement is just as dynamic, but its bass is deeper and it is palpably more refined, if rather dry and 'cool' in balance.

Both the AE1 MkIII and its floorstanding brother have a beautifully solid, well anchored feel. Large-scale dynamics are forceful, though microdynamic expression is curiously less so. The new AE1 fulfils the promise of excellent bass from a miniature enclosure, and the AE3 MkII subjectively adds a clear half-octave or more bass extension. The extraordinarily disciplined quality through the bass and indeed the midband extends into the treble of both models – it's smooth and detailed, but it has a slightly 'airless' quality.

In my room at least, extending the AE1 concept to the floorstanding AE3 MkII has been achieved largely without compromise, and cost aside there are few reasons not to go for the bigger model. But of the two, the AE1 MkIII is surely the star. It is one of the most coolly controlled and seamlessly competent miniatures ever contrived, and a much more complete animal than the model its ancestor was originally designed to tackle all those years ago – the (in)famously seductive but fatally flawed LS3/5a. *Alvin Gold*

### VERDICT – AE1 MkIII

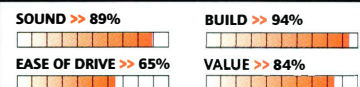

#### CONCLUSION

Sounds restrained and free from aggression, even a tad 'shut in', but has a marvellously wide dynamic range with fine coherence.

### HI-FI CHOICE OVERALL SCORE

>> **87%**

### VERDICT – AE3 MkII

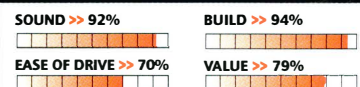

#### CONCLUSION

Essentially neutral with a marvellously wide dynamic range, very superior imaging and impressively low box coloration.

### HI-FI CHOICE OVERALL SCORE

>> **86%**



# SUPER AUDIO KRELL

*Krell's first foray into high-resolution multichannel music replay plumps for SACD*

**PRODUCT** Krell SACD Standard

**TYPE** Stereo & multichannel CD/SACD player

**PRICE** £4,244

**KEY FEATURES** Size (WxHxD): 44x15x42cm

- Weight: 11.4kg • 4 user-selectable SACD replay filter settings (2 for CD) • Custom install features
- Balanced and single-ended analogue outputs

**CONTACT** ☎ 020 8971 3909

🌐 www.krellonline.com

In the ongoing battle between the two high-resolution music disc media, DVD-Audio and SACD, the latter remains well ahead in software, and has made inroads with an expanding number of key hardware manufacturers now actively supporting the format. Significant new 'universal' audio/video players like Denon's DVD-A11 and Linn's Unidisk 2.1 are helping drive SACD inexorably towards critical mass, and the format is also gathering support from key high-end audio specialists, the likes of Musical Fidelity and Classé brandishing high-quality dedicated players. Now the doyen of the high end, Krell, has joined the party with its own player, the SACD Standard – a relatively 'inexpensive' (in Krell terms) dedicated model designed for all types of single and dual-layer SACDs and CDs.

The SACD Standard is a true SACD player – not a DVD player (DVD-Audio or otherwise) which also plays SACDs. The difference is that there is no video element, which eliminates at a stroke the compromises that plague many combination players and which at this quality level tend to hamstring their performance. The SACD Standard makes a natural partner for the similarly packaged Krell DVD-Video player, the DVD Standard.

The impressively fortress-like non-magnetic alloy structure is built from fabricated U-shaped side channels and flat horizontal panels screwed onto a rigid chassis, with solid rounded caps with a polished finish at each corner providing additional reinforcement and a separate structural enclosure for the mechanism. Appearance is a close match for

Krell's Showcase amp components which might be naturally used with multichannel SACD, and also for two-channel purposes from SACD and CD. The Showcase system in its various guises has long shown that it is as capable in stereo as in multichannel.

Inside, the player's Philips mechanism feeds a dual differential DAC stage using three Burr-Brown PCM 1738 hybrid 24-bit D/A converters, which have enough bandwidth to cope with DSD data, with a part-multibit, part-bitstream division of labours. The audio gain stage uses Krell's current mode topology for the main channels, though not for centre and surround. The differential converter configuration makes it a simple matter for it to drive the balanced mode output directly, though a single-ended RCA phono output is





**“With SACD, although the sound remains similar to CD, the player sustains a much more complex sound picture.”**

also available as usual. Digital optical and electrical outputs are fitted, but they're disabled when playing SACDs in the usual way. Other rear-panel fittings include an infrared input and a 12V trigger for integrating with a custom install system, and an RS222 port for third-party controllers.

Control is available from a beautifully made slimline remote which is a little larger and thicker, but otherwise similar to a credit card remote, or by using the matrix of very tiny buttons on the front panel. For the most part the control options are self explanatory. Exceptions include the SACD/CD button, which selects the part of a disc to be played (stereo or multichannel SACD, or stereo CD), the selection remaining with each disc inserted until changed. A switchable filter provides two settings for CD and four for SACD. With CD, Filter 1 is flat to 20kHz with a sharp brick wall filter, and Filter 2 offers a more gradual roll-off, but more in-band attenuation (-3dB at 20kHz). With SACD, Filter 1 has the widest bandwidth (180kHz) and the slowest out of band roll-off, while Filter 2 operates up to 75kHz with a more rapid roll-off and 0.5dB extra gain across the audio band. Filter 3 (SACD only) covers up to

80kHz with a relatively steep roll-off and a massive +5.5dB gain across the band, and Filter 4 is specified up to 90kHz, with a slower roll-off and +3.5dB overall gain.

#### SOUND QUALITY

First task in the listening sessions was to ascertain whether or not SACD sounded consistently better than CD. Unless the player passed this rather fundamental test, the SACD Standard would have to be regarded as at best an honourable failure, with SACD simply filling the role of CD sound through extra loudspeakers – a travesty of what the format is about. The way this was assessed was to compare the nominally identical CD and stereo SACD recordings on a number of hybrid discs. There are dangers in this approach as the two recordings may not be of equal provenance, but given a large enough selection of discs, a pattern should emerge.

And it did. The Krell was more than capable of demonstrating the inherent superiority of SACD, which is not always so clearly apparent through lesser players. A key difference that remained consistently identifiable in nearly every case was what might be described as a widening of the musical focus. From CD, lead

instruments and voices tend to hog the attention, while low-level background singers and supporting instruments tend to lose distinctiveness, audibility and focus. Time after time with SACD, although the sound remained tonally and dynamically similar to CD, the player sustained a much more complex sound picture, without losing the thread of background events. The effect is like looking at a scene through a small hole which restricts peripheral vision, and then taking in the whole scene at once – a much more complete and satisfying experience.

But there is another generic difference, related to the fact that SACD is both more subtle and less obvious. CD tends to reproduce leading transient edges particularly clearly, more so perhaps than is always justified. SACD recordings through the Krell generally sounded more organic and fluid, which with lazy listening could be mistaken to mean a lack of impact, just as good analogue sound can be written off for similar reasons.

The remaining task was to place the player in the firmament of its peers, both as a CD and SACD player. We briefly auditioned the SACD Standard playing CDs against Krell's flagship CD player, the KPS25, at a public

Q & A

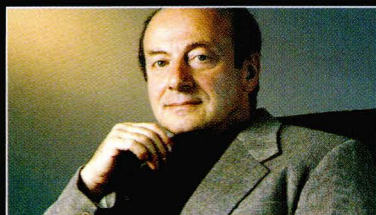

Dan D'Agostino, chief executive officer and chief engineer of Krell Industries Inc talks about the SACD Standard

**HFC:** What are the key points in the design of the SACD Standard?

**DDA:** The output stage is extraordinarily good. It's been done with discrete parts with an extremely wide bandwidth using current mode gain stages on the main front channels in a fully balanced configuration. There are no op-amps in this part of the circuit at all. The centre and surround channels are slightly simpler and use voltage gain, and although we do use op-amps, they are not in the output section. Most of the circuitry is housed on a huge PC board taking up much of the space inside the box, and is fully surface mounted. It has a very high component count, though its size makes it rather deceiving.

**Please explain the double chassis construction.** The mechanism is housed at the bottom of the player in a metal box with screening across the top which gives it a great deal of stability. The main circuit board is mounted above.

**A lot of emphasis appears to have gone into the power supplies.**

It has. The analogue section has its own transformer and power supplies, and the transport has its own digital dedicated switch mode supply, which is very effectively screened and positioned a long way from any circuitry that it could interfere with.

**Why did you decide to base your first high-resolution player on the SACD format rather than DVD-Audio?**

I like both formats, but the decision I took was based on the fact that there is much more software around on SACD. It is the format that we believe has the best chance of surviving in the long term. I'm not as confident that DVD-Audio will survive as long.

**Does this mean that Krell has no ongoing interest in DVD-Audio?**

Not at all. We've been working on DVD-A playback for some time and we will be releasing a player, but it will be a universal DVD-A/SACD player.

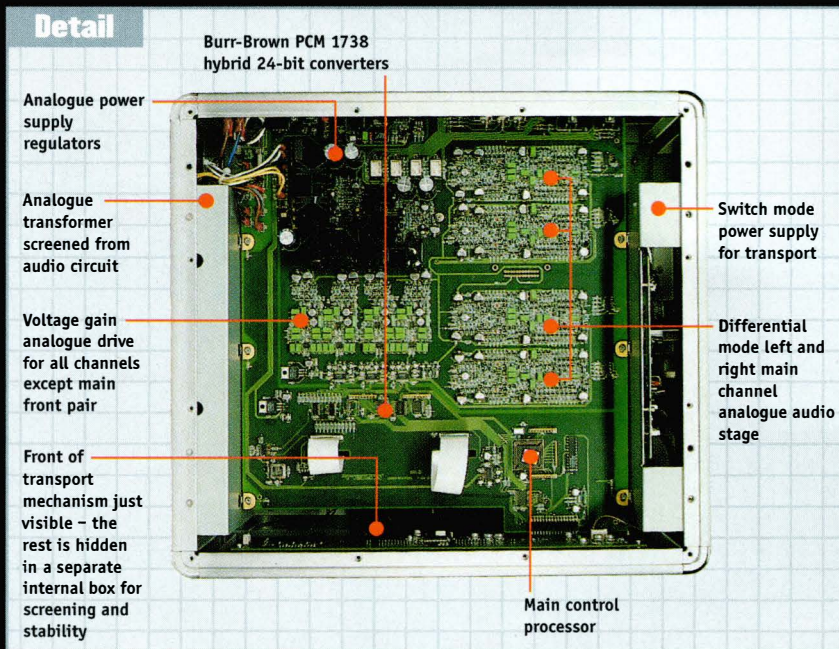

show, and have used the KPS25 extensively on other occasions, and know that it's in a different class. But we're talking here about chalk and cheese – a £4.5K SACD player and a £25K CD player/preamp which is one of the most consistently capable CD playing engines ever devised. At its particular price point, the SACD Standard is a vibrant and engaging CD player, which has softer bass and less of what can only be called 'slam' or 'power' than the senior model, but which is otherwise difficult to fault. This is not just a routine CD player when SACDs are put aside. It offers excellent three-dimensional imagery, a high level of detail and a very sweet top end which is completely free of grain and hardness. But the balance leans perceptibly towards precision and clarity of line rather than sonority when compared to, say, the Mark Levinson 390S.

As an SACD player the Krell is one of the best we've heard, its sense of detail even better than with CD. Given source material of appropriate quality it is nothing short of exquisite, and with favourable recordings (the Benjamin Zander *Mahler 6*, the Boulez *Song Of The Earth* and Chailly's *Turangalila* are three discs that figured prominently in the tests) the ability of the Krell to cast light into

the deepest recesses of the very complex scores was utterly thrilling. But the Krell would also show in unequivocal terms when a recording had gone wrong – witness the recent SACD of Gergiev's *Shostakovich 7* on Philips, where the DSD mastering was made from a grainy-sounding 48kHz/24-bit PCM master. High resolution, no less. **HFC**

Alvin Gold

**VERDICT**

**SOUND >> 94%**

**FEATURES >> 87%**

**BUILD >> 96%**

**VALUE >> 84%**

**CONCLUSION**  
 No technological quantum leap perhaps, but it defines the quality standard for SACD players at its price point. The fact that it's also a superb CD player adds to the attraction, but it's the SACD performance that will win this player most plaudits.

**HI-FI CHOICE OVERALL SCORE >> 90%**

**PRO**  
 This player provided many hours of truly compelling music making, to the extent of sometimes making it difficult to concentrate on the job at hand.

**CON**  
 If you want DVD playback in your multichannel system, you'll need an extra player. No speaker management or SACD-capable digital output.



# the AUDIO CONSULTANTS

FINE TWO CHANNEL AUDIO SYSTEMS

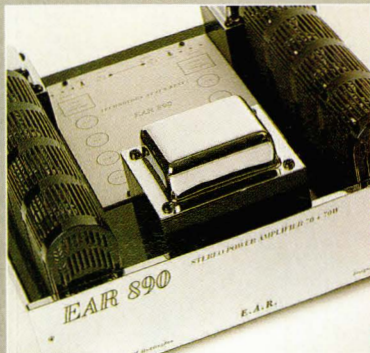

**EAR/Yoshino 890 stereo amplifier**  
Ideal match with the 834L pre-amplifier.

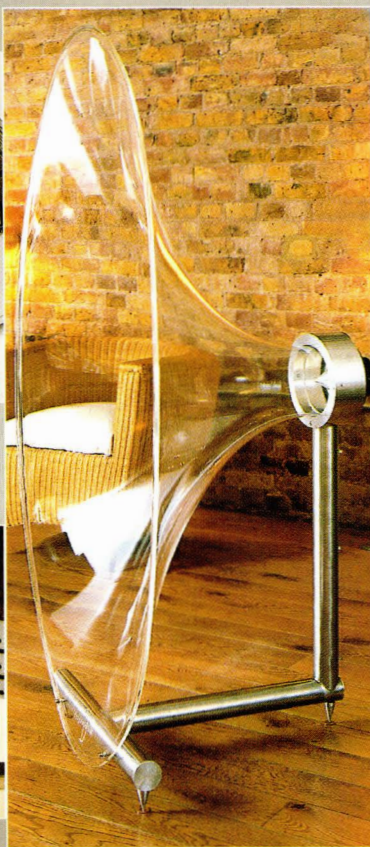

**Ferguson Hill FH001 horn loudspeakers**  
Very stylish with a dynamic, immediate sound.



**Kuzma Stabi Reference with Tri-Planar VII tonearm**  
One of the very best vinyl replay systems.

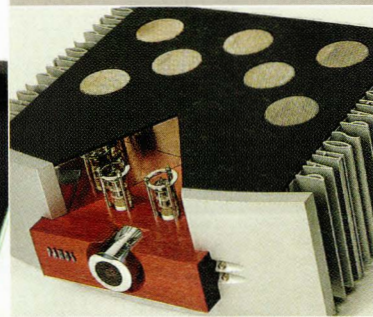

**Pathos Logos integrated hybrid amplifier**  
A popular amplifier with great looks.



**conrad-johnson MV60SE stereo amplifier**  
We now have the superb Premier 140 on demonstration.



**Amphion Xenon loudspeakers**  
Fast and articulate with neutral tonal balance. Slim floorstander which does not mind walls.



**Nottingham Analogue Space Deck**  
With the new, thicker platter and upgrade kit it produces an even more neutral and stable image



**Finite Elemente Pagode furniture**  
For extracting the very best from your equipment.

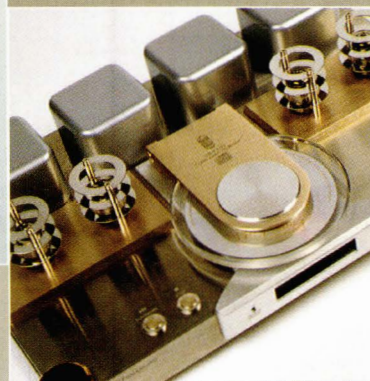

**Shanling CD T100 valve CD player**  
Superb sound and appearance.



**Exposure new electronics xxii CD player, xxiii pre-amplifier and xxvii amplifier**  
Tonally correct with good dynamics.

ACCUSTIC ARTS ▶ AMPHION ▶ A.R.T. LOUDSPEAKERS ▶ AVALON ACOUSTICS ▶ BENZ-MICRO ▶ CARDAS ▶ CLEARAUDIO ▶ CONRAD-JOHNSON ▶ EAR/YOSHINO ▶ EXPOSURE  
FERGUSON HILL ▶ GAMUT ▶ ISO TEK ▶ KUZMA ▶ LAVARDIN ▶ LYRA ▶ MONO PULSE ▶ MOON ▶ NORDOST ▶ NOTTINGHAM ANALOGUE ▶ OPERA ▶ PAGODE ▶ PATHOS  
QUADRASPIRE ▶ ROGUE AUDIO ▶ SME ▶ SHANLING ▶ SHUN MOOK ▶ SUGDEN ▶ TRANSFIGURATION ▶ TRI-PLANAR ▶ UNISON RESEARCH ▶ WADIA

Conveniently located between Reading and Basingstoke, we are approximately 15 minutes drive from either Junction 12 on the M4 or Junction 6 on the M3. Free and easy parking, outside the building. We have a home evaluation scheme for those who might find this method more convenient.

7 Comet House, Calleva Park, Aldermaston Reading, Berkshire RG7 8JA

T **0118 981 9891**

E [info@audioconsultants.co.uk](mailto:info@audioconsultants.co.uk)

[www.audioconsultants.co.uk](http://www.audioconsultants.co.uk)

*Demonstrations by appointment, Mondays to Saturdays 10:00 to 18:00. It is advisable to call us before visiting.*

*Part exchange welcome. Ex-demonstration and previously owned equipment listed on our website.*

# SWEET EMOTION

Clearaudio's beautiful new baby aims for some very grown up sound reproduction

**PRODUCT** Clearaudio Emotion (with Satisfy and Aurum Classics Wood)

**TYPE** Turntable, tonearm and cartridge

**PRICE** £655

**KEY FEATURES** Size (WxHxD): 40x13x36cm

○ Weight: 3.8kg ○ Freestanding synchronous motor

○ Geometrically resonance-optimised shape

○ Speeds: 33rpm & 45rpm (optional 78rpm)

**CONTACT** ☎ 01252 702705 🌐 www.clearaudio.de

**Y**ou have to hand it to Clearaudio – this is a stunning looking record player for a very reasonable price. The German company has achieved this by paring everything back to the basics yet executing the fundamental design in an inherently attractive material and fitting a decent looking tonearm – that isn't made by Rega! This is one of the few occasions in years that HFC has had a serious sub-£1,000 deck that hasn't got an RB250 variant on it. Alternatives do exist of course, notably from Nottingham Analogue and Pro-Ject, but they are few and far between and rarely look as solidly hewn as the bizarrely named Satisfy, presumably so-called because it manages to satisfy the basic requirements of

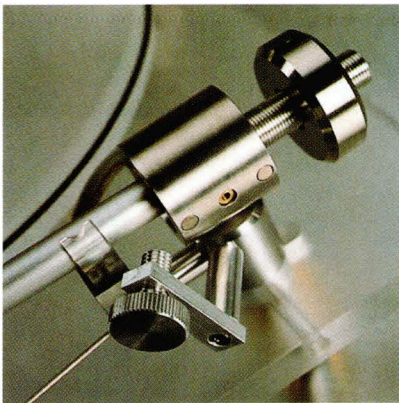
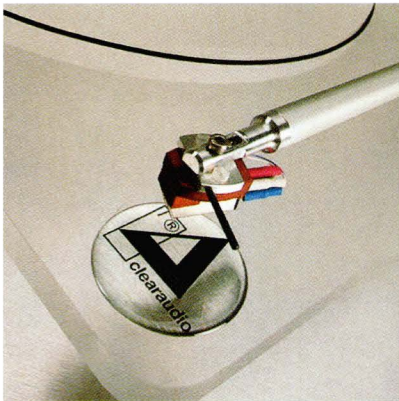

a good quality turntable tonearm.

Clearaudio has been in the vinyl replay game for twenty years now so it should know a thing or two about building the things, yet it has waited this long before producing a budget-oriented design. It is surely a healthy sign when a company like this makes the decision to get into a market sector it had previously ignored. Perhaps this is partly due to *Hi-Fi Choice* wittering on about record players for the past 15 years, all through the dark days of vinyl's supposed final hour! Fortunately, that turned out to be a bit like a Status Quo final tour, never quite ending, although in the latter case it might be best for all concerned if it did.

What you get with this package is the Emotion turntable, a simple but effective combination of a solid acrylic plinth supported on three acrylic cones that screw on with the aid of stainless steel studs. The plinth supports an aluminium-bodied bearing that contains a polished and hardened steel shaft running in a sintered bronze precision cap, which supports a 20mm-thick acrylic platter. The chunky, freestanding motor sits in a cut-out in the plinth and is located with rubber rings. On/off switching is located on the side of the motor, which means that the fixed mains lead points toward the tonearm base. It would perhaps be neater if the lead came out the back of the motor at this point but you can place the deck nearer a wall with this arrangement.

Drive is via belt and speed can be switched the manual way between two gears on the acrylic pulley. A clear plastic Souther record clamp called the Clever clamp is supplied with the deck. Adding or removing this device requires that you stop the platter when changing LPs, which means that the slightly fiddly on/off switch on the motor needs to be used. Because the motor isn't a monster you have to be careful not to move it as this can result in it transmitting energy into the plinth, which can be felt in the tonearm. It requires a small tweak to eliminate but may be enough to discourage clamping, which would be a pity as the Clever clamp is quite effective.

The deck has very little in the way of isolation or damping and will be affected by the surface used to support it – a solid shelf or isolating table is essential for best results.

The Satisfy tonearm is a substantial looking beast with remarkable build and

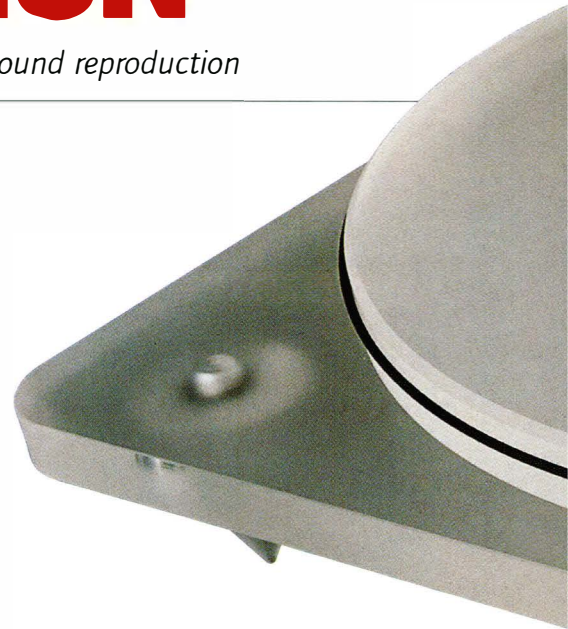

finish for the price. It uses gimbal-style bearings and an unusual magnetic anti-skate system that doesn't look as though it could achieve anything very much but seems to work nonetheless. The headshell is different too, utilising a single bolt to hold a plate which bears both fingerlift and cartridge, so tracking angle is infinitely adjustable if slightly trickier than usual to set. No arm cable is supplied but any interconnect will plug into the sockets in the arm base.

At the end of the arm sits an Aurum Classics Wood moving magnet cartridge, the least expensive wooden-bodied needle we've come across to date – take it away and you might save £70 on the package price. Yet as you'll see it produces a more than respectable result.

## SOUND QUALITY

Sitting atop the well isolated top shelf of a Townshend Seismic Stand and hooked up to a Trichord Dino+ phono stage via Living Voice Potato interconnects, the Emotion delivered a very engaging performance with a decent slab of vinyl clamped to its platter. Richard Thompson's *Old Kit Bag* was reproduced with fine timing and coherence – the balance may be less substantial than heavier turntables but it produces sufficient bass to inform you of what's going on in the nether regions. The Cinematic Orchestra's exertions revealed the deck's penchant for drums, its nimbleness and kick proving highly convincing.

After a few more records we decided to see if tweaking the VTA would change the balance and discovered that lowering the arm base a bit the opened up the midband





and gave the bass more welly. The whole sound is more coherent and relaxed like this and compares very favourably with considerably more expensive CD players. It has that vinyl openness that is so appealing and seems to track the groove or timing of the tune better. We slipped a strobe disc on to check speed and discovered it was a shade fast, but remarkably solid considering the lack of a power supply.

The Emotion produces a remarkably homogenous sound and one that will be hard to beat at the price. Competition can be found in the Rega P25 and Audio Note's TT1, the former offering a similarly well timed but possibly more substantial sound while the TT1 probably has the edge in terms of dynamics. But neither looks as good and both have a lot of work to do to outgun the Emotion. It has a good grip on dynamics as acrylic-plattered decks often do, and instruments are full of vigour, sitting steadily in a soundstage that, while not the deepest, is still pretty substantial.

Some vinyl can bring out a hard edge to the Clearaudio's sound which is probably down to the cartridge. Spinning two audiophile albums, Mary Black's *By The Time It Gets Dark* was a touch too sharp-edged for comfort while Santana's *Abraxas* was superb, the extra zip bringing the classic tunes to life. This aspect will however be considerably less obvious with speakers and amplification

**“Lowering the arm base opens up the midband and gives the bass more welly. The sound is more coherent and relaxed like this and compares well with pricier CD players.”**

of a similar price – it definitely punches above its weight in this regard.

Comparing the heavyweight pressing of Santana with an old standard copy reveals quite a lot of wear-induced distortion in the latter and suggests that you should shy away from worn vinyl with the Emotion. This is a factor where a better cartridge will have a significant effect and the deck and arm are clearly good enough to warrant it. Clearaudio's own cartridges usually tend to cost as much as the Emotion itself but there are plenty of great needles around for less.

All-in-all a great result for a beauty of a deck. It does what it says on the tin, brings out the emotion from your vinyl and as a bonus it delivers the detail and presence too. **HFC**

Jason Kennedy

<b>VERDICT</b>		
<b>SOUND &gt;&gt; 83%</b>	<input type="checkbox"/> <input type="checkbox"/> <input type="checkbox"/> <input type="checkbox"/> <input type="checkbox"/> <input type="checkbox"/> <input type="checkbox"/> <input type="checkbox"/> <input type="checkbox"/> <input type="checkbox"/> <input type="checkbox"/>	
<b>FEATURES &gt;&gt; 82%</b>	<input type="checkbox"/> <input type="checkbox"/> <input type="checkbox"/> <input type="checkbox"/> <input type="checkbox"/> <input type="checkbox"/> <input type="checkbox"/> <input type="checkbox"/> <input type="checkbox"/> <input type="checkbox"/>	
<b>BUILD &gt;&gt; 81%</b>	<input type="checkbox"/> <input type="checkbox"/> <input type="checkbox"/> <input type="checkbox"/> <input type="checkbox"/> <input type="checkbox"/> <input type="checkbox"/> <input type="checkbox"/> <input type="checkbox"/> <input type="checkbox"/>	
<b>VALUE &gt;&gt; 87%</b>	<input type="checkbox"/> <input type="checkbox"/> <input type="checkbox"/> <input type="checkbox"/> <input type="checkbox"/> <input type="checkbox"/> <input type="checkbox"/> <input type="checkbox"/> <input type="checkbox"/> <input type="checkbox"/>	<p><b>PRO</b> Timing, coherence, clarity, build and design all very high for the relatively low price.</p> <p><b>CON</b> You'll need to look very hard to find a dust lid, damping or indeed any attempt at isolation with this deck.</p>
<p><b>CONCLUSION</b> This is an engaging and coherent turntable that offers a whole lot of audiophile credibility for the money and looks gorgeous too. But bear in mind it needs a decent support for the best sonic results.</p>		
<b>HI-FI CHOICE OVERALL SCORE &gt;&gt; 84%</b>		



**Sugden Music Master System**

Housed in the distinctive Biju case design the Music Master has an identical footprint to the other Biju components and is only slightly taller than the CD Master. The heatsinks are custom made and anodised in the familiar titanium colour, giving the Music Master a very solid presentation. These attractive aesthetics give the appearance of a solid block of titanium.

[www.midlandaudio-x-change.co.uk](http://www.midlandaudio-x-change.co.uk)

call John Roberts Tel 01562 731100

The Old Chapel • Forge Lane • Belbroughton • DY9 9TD

e-mail [sales@midlandaudio-x-change.co.uk](mailto:sales@midlandaudio-x-change.co.uk)

Fax 01562 730228 Mobile 07721 605966

*Suppliers and installers of High Quality Audio Systems*  
 47 Laboratory • Accuphase • ATC • Audio Physic • Audio Research  
 Avalon • Accoustics • Avid • bel canto • Benz Micro • Cardas  
 Clearaudio • Conrad Johnson • dCS • Densen • DNW/Rezon  
 Electrocompaniet • Frinite Elementie • Graaf • Gryphon • J.M Labs  
 Krell • Kuzma • Lavardin • Mark Levinson • Martin Logan • Michell  
 Nagra • Primare • ProAc • Rega • Silech • Sonus Faber • Spectral  
 Nordost • Sugden • Transparent Audio • Verity Audio • Wacia

Photography & Design: Tom Foxall 01952 727866

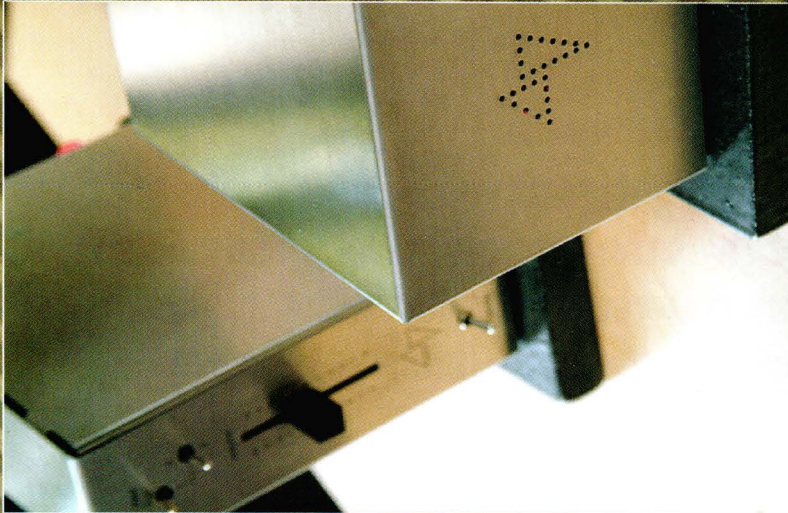

**47 Laboratory**

For some it's Zen - for others, radical. Call it what you will, but at the end of the track, it's all about trusting your ears. About letting the simplicity of design, the energy and flow of the music carry you away.

Small in size, big on sound, and more music than mere audio jewels, 47 Lab distills technology down to its simplest, purest form. And when you listen you'll know that this path - *your path* - is the one to follow. Why? because designer Junji Kimura preserves the life of the music. There are no compromises. No unnecessary flash - no B.S., just dynamic, unadulterated music. Radical? Maybe.

47 Laboratory is now exclusively available at Midland Audio X-change the Shigaraki Line is the first of many solutions to musical wellbeing. Please call John Roberts to find out more about this truly wonderful product.



**Orpheus**

Orpheus Zero is an innovative CD drive or player. It reads CD, CD-R and CD-RW formats with 100% precision. Consequently, the standard reading correction mechanism is always switched off during track reading. When used as a player, the incoming data stream is converted into analogue with a 24bit/192kHz component

Orpheus Two is a versatile multi-channel analogue domain preamplifier with digital control of volume setting. The unit can be configured as a pure stereo preamplifier or as a multi-channel preamplifier. Each input and output channel has an independent volume level set-up to optimise the interface between sources having different output levels.

Orpheus Three is an analogue domain power amplifier, 150W mono and 40W stereo units are available. They both have XLR and RCA inputs, as well as two speaker outputs (allowing bi wiring of the mono power amplifiers). Orpheus Three excels with coherence and optimal transient response throughout the whole frequency spectrum, and adapts to every speaker configuration and load.

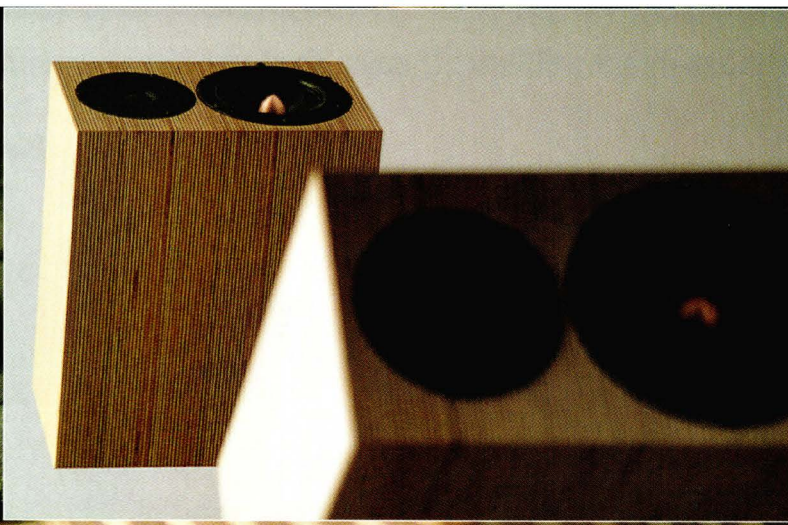

**Penaudio Charisma**

The Charisma is a small stand mounted loudspeaker for those who want to maximise space and sound quality. The custom-made woofer and hand made birch finish make these the most transparent 2 way we have heard. Also now available is the Rebel 2, priced at £995, another great 2 way for the money, truly a giant in a small package, it creates a sound stage and depth you would not imagine. Please take the time to listen to these superb mini monitors.

# CHORUS OF DELIGHT

Focal-JMlab's new 'budget' Chorus S range includes this 'classic' large standmount

**PRODUCT** Focal-JMlab Chorus 707 S

**TYPE** Standmount loudspeaker

**PRICE** £350 per pair

**CONTACT** ☎ 0845 660 2680 🌐 www.focal-fr.com

France's leading hi-fi speaker maker has grown steadily into one of the world's largest and most successful brands, and is even having an impact here in the UK.

The 'Chorus S' range is the company's latest budget series of models, a nine-strong line-up of three floorstanders, three standmounts, two centre channels and a compact active subwoofer, providing plenty of choice for both stereo and multichannel users. The *Ultimate Group Test* in our last issue saw the £550 floorstanding Chorus 716 S rated as a Best Buy, so the question is whether the 707 S at £350 can emulate its bigger brother.

For a standmount it's an unusual size and shape – larger than most (23.5x49x30cm, WxHxD) and significantly taller too, giving an internal volume of over 20 litres. As a matter of interest, this speaker's dimensions are virtually identical to B&W's (£300) DM 602 S3 – and like the B&W, the 707 S uses a slightly larger (175mm) main driver than the 165mm norm. B&W may or may not be flattered by the comparison, but its own large standmount has done remarkably well over the last twenty odd years, and while it's true this isn't the cutest or most fashionable size/shape around, it's surprising there haven't been more imitators.

The 707 S comes in three finish options, including the Classic (pictured) with mid-colour 'Calvados' mix of woodprint vinyl with wood veneer side panels. The tweeter has a new aluminium/magnesium alloy inverted dome – lighter and more rigid than titanium, with superior self-damping too. The suspension is more flexible than before, allowing the tweeter to be used with a lower



(2.4kHz) crossover point, and the motor has a push-pull double neodymium magnet arrangement. The bass/mid driver has the company's Polyglass-damped cone, 130mm in diameter, and a Zamak cast chassis. Twin terminal pairs permit bi-wiring or bi-amping.

## SOUND QUALITY

Room measurements show an excellent overall balance. The bass region is slightly dry, favouring free-space siting but also permitting some wall reinforcement if desired. There are peaks at 280Hz and again at 7kHz, but in-between, the broad midband is remarkably flat and impressively smooth.

There's definitely the suspicion that, provided it's used on a high quality stand, this simpler two-way speaker with its reduced cabinetwork is at least a match for its larger sibling, and perhaps even its superior overall.

Certainly there's no sign of the slight 'heaviness' and 'thickening' effects that were noted with the two-and-a-half-way model, and if the bass here is a little less muscular, it certainly has fine agility and ample weight.

And if the bottom end is very well judged, the midrange voicing is equally classy. There is a slight chestiness on male voice, and a touch of brightness too, but these are very minor aberrations.

The Chorus 707 S came into the listening room immediately after the models included

in last month's group test, and although it's significantly less expensive than any of those, it by no means suffered in the comparison. Indeed, the pair remained on the end of the system, doing a sufficiently fine job not to encourage their upgrading to anything more exotic for several days.

Because this is a budget speaker, it does inevitably involve some compromise, showing a degree of dynamic range limitation, for example. But the bottom line is that it's an exceptional speaker at a very sharp price. **HFC**

Paul Messenger

VERDICT	
<b>SOUND &gt;&gt; 87%</b> [Progress bar]	<b>PRO</b> Great value for money with an excellent overall balance alongside a very useful and flexible bass alignment. Superbly smooth and even midband/presence voicing.
<b>EASE OF DRIVE &gt;&gt; 80%</b> [Progress bar]	<b>CON</b> Not the prettiest size or shape. Dynamic range is a little limited in absolute terms, and there's a touch of excess brightness too.
<b>BUILD &gt;&gt; 84%</b> [Progress bar]	
<b>VALUE &gt;&gt; 90%</b> [Progress bar]	
<b>CONCLUSION</b> The size and shape might not be the most fashionable, and dynamic range and resolution could be greater, but this is a very well-balanced speaker for the money with superior midband perspectives and fine, flexible bass alignment.	
<b>HI-FI CHOICE OVERALL SCORE &gt;&gt; 88%</b>	

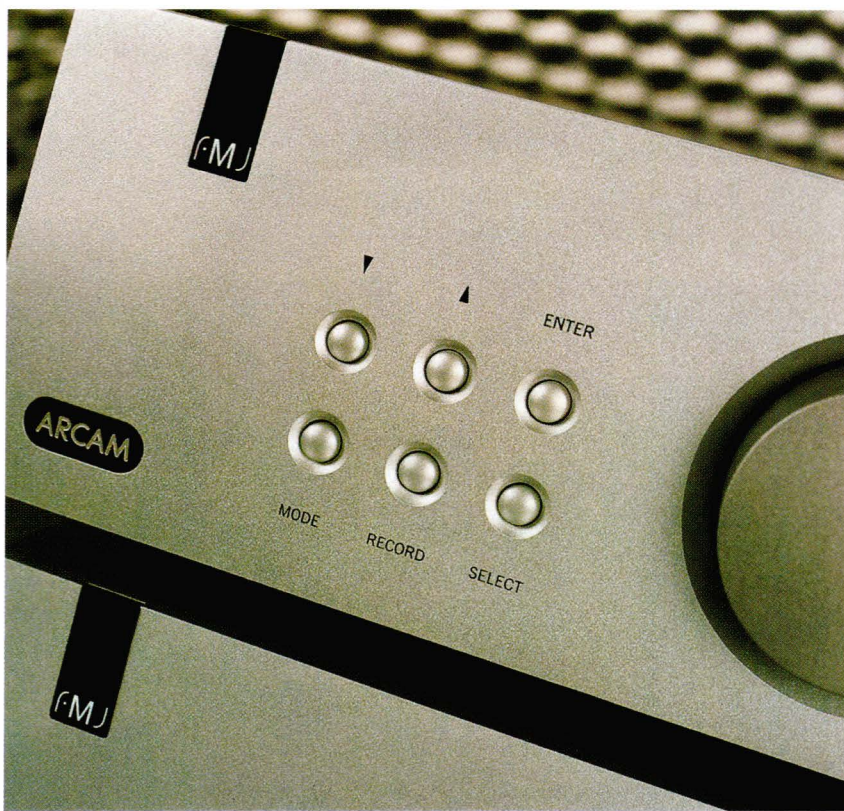

# THREE-BOX STEREO

*Can Cambridge's king of affordable kit make the high-end pre/power amp grade?*

**PRODUCT** Arcam FMJ C30 and P1 (x2)

**TYPE** Preamp and monoblock power amps

**PRICE** £1,200 (C30), £1,100 (each P1)

**KEY FEATURES** C30: Size (WxHxD): 43x11x37cm  
 ◉ Weight: 9kg ◉ MM/MC phono stage ◉ 6/7 line inputs  
 P1: Size (WxHxD): 43x11x35cm ◉ Weight: 12kg  
 ◉ Continuous power: 180W/8 ohms (300W/4)

**CONTACT** ☎ 01223 203200 🌐 www.arcam.co.uk

The P1 is Arcam's first monoblock power amplifier for 27 years. The last time they made one was when John Dawson founded the company under the A&R Cambridge name in 1976. So it seems a strange turnaround to produce one now, or at least it does until you look at what the company has been doing in the multichannel field. Arcam's ambitions for high-end home cinema were realised a year or so ago in the form of the AV8 processor and P7 seven-channel power amplifier, both of which are high-end components costing several times the asking price of previous Arcam models. Obviously, the lessons learned from the creation of the P7 could be applied equally well to stereo and monoblock power amps. And perhaps just as importantly, those customers who wanted to go further than the

P7 allowed might be interested in an all-monoblock surround system, or at least a way of purchasing seven channels by combining, say, two P35s with a P1 for the centre channel. The P35 is the stereo/three-channel version of the P1, offering 140 watts per side compared to the P1's 180 watts, but with the same gain so that the two can be combined.

The C30 preamp is a well equipped beast with a lot more functions than the buttons on its front might suggest. The clue is in the 'enter' and 'select' buttons used to navigate through a list of variables displayed on the LCD screen. These include three levels of volume control sensitivity with the finest being half-decibel increments, graphic or numeric level display, input trims which can be used to even out variations in source input levels (albeit that this will vary with software) and tone controls which can be applied globally or to individual inputs, which is a nice touch.

Other useful features include a variable level processor mode so that both the C30 and partnering power amps can be integrated into a multichannel system by controlling overall volume from a processor and using the stereo system as the front left/right channels. Prior examples of this facility have not allowed you

to vary the level of the stereo system, meaning the processor has to accommodate variations in gain between amps. Of course, if you use Arcam FMJ power amps all round this would not be an issue. One pleasing inclusion in the C30's specification is its phono stage – an MM and MC one at that. It's been a while since an Arcam preamp came with one of these as standard. Naturally, if you haven't (re)discovered the delights of vinyl this converts into a line-level input.

The C30 is the first Arcam preamp with XLR-balanced output sockets, an odd move given the single-ended nature of both it and the P1. The logic is that when long leads are used to allow monoblock power amps to be placed close to speakers the noise-cancelling nature of balanced leads comes into its own.

The P1 therefore has matching balanced inputs as well as outputs to allow daisy chaining, something one might find useful for



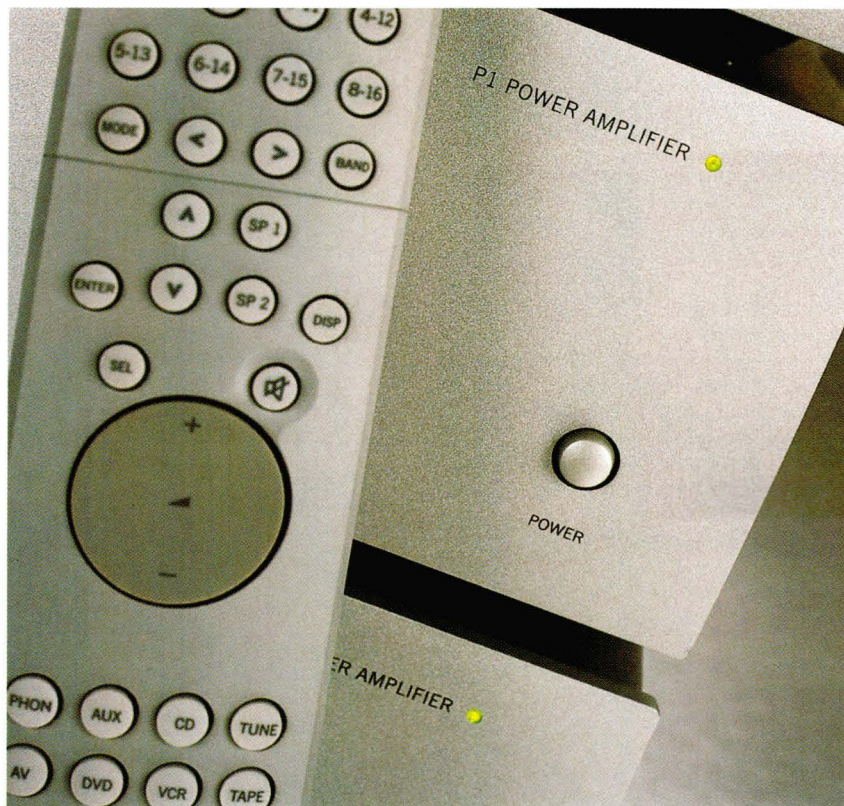

multiroom installs. This is a heavy but modestly clad power amp that has a couple of extra switches on its rear end alongside the aforementioned XLRs. There are RCA phono in/outputs, remote control and triggering sockets, as well as two pairs of speaker terminals marked 4-16 ohms, although presumably it can cope with loads greater than this for short periods. Switches exist to change gain and choice of input socket used (XLR or phono).

#### SOUND QUALITY

We began listening to these amps using a single-ended phono connection from the direct rather than buffered outputs on the C30, the latter being for interconnect runs longer than three metres. Living Voice cables were used to hook up the amps and Townshend DCT speaker cable connected our Living Voice OBX-R speakers.

Playing EST's *Strange Place For Snow* CD, impressive high-detail resolution was immediately obvious – it's easy to hear all the elements within the mix and to follow individual instruments. Low-level detail is clearly well served too, opening up spaces around each instrument and letting you in on exactly what's being played. The tonal presentation is a touch on the dry side and probably not best suited to the Living Voice speakers which are extremely transparent in the midrange – something like B&W 804s or bigger Tannoys might be a happier match.

This aspect was partly offset by Ayre's CD player (see p56) which has a richer balance than the Resolution Audio we were using as

**“The Arcam C30 and P1 are very even and controlled, and are also highly sensitive to changes in recording quality.”**

reference. With the Ayre, Ali Farka Touré's *Niafunke* sounded funky, sparkly and vibrant, with no shortage of natural reverb from the recording venue. The electric guitar on this album came across well too, encouraging continued listening despite looming deadlines!

These are not the most dynamic amplifiers around – something from the Exposure or

Sugden ranges would be more explicit in this respect. On the other hand, the Arcams are very even and controlled, and are also highly sensitive to changes in recording quality. Peace Orchestra's 'band aid' disc, for instance, is reproduced with all of its vibrancy, scale and elastic imaging – the bass could perhaps be juicier but there's no denying its depth ■



Q & A

John Dawson, chairman of Arcam, discusses the thinking behind his company's new amps



**HFC:** Are there any new ideas in these components or are they beefed-up (and specced-up) versions of your integrated amps?

**JD:** These are new designs, although we've used what we already know to maximise performance. The C30 uses the same input PCB as the A32 integrated amp but with a number of superior components – the operating software is shared with the A32 and DVA A85/A90. The power supplies and output section are 100 per cent new – I don't think we've ever had the luxury of being able to specify a power supply so well before, as is reflected in the size of the toroidal transformer!

The P1 has a similar circuit topology to the P7 amplifier, but with an all-new and carefully optimised PCB layout. Layout is particularly important as this ensures that non-musically related currents do not flow in signal ground and interfere with the integrity of the audio signal. There are lots of associated circuit improvements too, including independent regulation for sensitive nodes on the amplifier driver stage and separate power supplies for the driver and output stages. You can really hear these improvements and the amplifiers are unquestionably the most transparent and 'disappearing' we have ever built.

**It's great to see an MM/MC phono stage on an Arcam preamp again – is this a 'classic' from the archives or a ground-up design?**

The phono stage is a relatively new single stage design – it was designed from the ground up four years ago, initially for the A85/A32 integrated amplifiers. We have found its sound quality to be very good and are happy to use it in both the AV8 (it is an option there) and in the new C30.

**Your literature describes the C30 as being modular. In what respect is this the case?**

If you look on the back panel you will see a fairly big horizontal slot which is covered by a blanking plate. This accepts our new multichannel audio board (two 7.1 channel inputs) and so can be used to extend the C30 to work with multichannel DVD-Audio and SACD players, and AV processors too. We have already sold systems with a DV27A, C30/7.1 and a P7 amp. Of course, it would sound even better with five or seven P1s!



Detail – C30

- MM/MC phono input card (vertically mounted)
- All electronic input and volume controls
- Secondary power regulation
- Primary power regulation

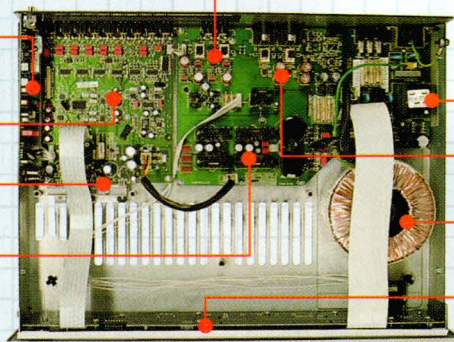

- Buffered & unbuffered unbalanced output stage
- Standby transformer
- Balanced output stage
- Low flux density mains transformer
- Display/control PCB (vertically mounted)

Detail – P1

- Balanced input stage
- Unbalanced inputs
- Sanken output transistors
- Heatsink

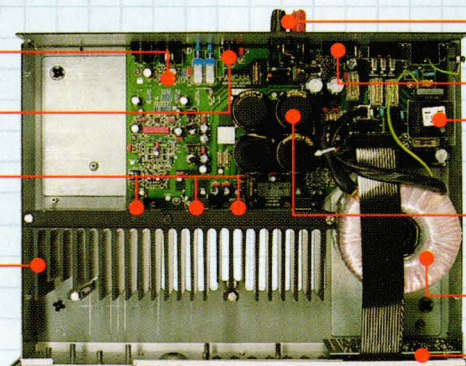

- Loudspeaker terminals
- 12v trigger input
- Standby power transformer
- Reservoir capacitors
- Main power transformer
- Control PCB

and power. Timing, while not sluggish, could be more sprightly, and Four Tet's *Rounds* doesn't have quite the spring in its step that one expects. However, you can hear precisely what's going on.

The C30's built-in phono stage made a good stab at the job, even though our van den Hul Grasshopper cartridge is not the easiest of moving coils to accommodate. Jeff Buckley's live moments aren't the best recorded but the Arcams helped give them some drive while keeping up with his passionate exhortations. Him's infectiously elastic rhythms sounded a lot more energetic without having to wind up the wick thanks to a great recording (the LP *Many In High Places Are Not Well*). This really sounded good through the system, suggesting that the Arcams are able to exploit decent cuts as well as they reveal the compression in lesser ones.

Going over to a balanced pre/power interconnect (Madrigal CZ1) didn't dramatically change things, and Arcam doesn't suggest that this would be the case with normal cable lengths. Nonetheless, Eminem did give up more of the lyrics and FX on *Stan* than usual, inasmuch as it became possible to understand the words he is saying even if the sense, if there is any, is still not entirely clear.

Putting Richard Thompson's exquisite track *First Breath* under the Grasshopper was as special a treat as ever, the acoustic guitar sounding very real and tactile – sometimes it's tempting to paraphrase Frank Zappa and

just tell him to shut up and play!

These amplifiers are clearly well built and intelligently equipped designs which are capable of gripping results. In partnership they're detailed, controlled and very keen on great recordings – there is almost a tendency to exaggerate differences in this respect, as the change from one disc to another can be great. If anything these amps are a little short on charm (the complete opposite of Arcam's very first creation, the A60 integrated) and while this quality should ultimately come from the software alone, the ability to reproduce it is not to be underestimated. **HFC**

Jason Kennedy

VERDICT

SOUND >>> 83%



FEATURES >>> 90%



BUILD >>> 90%



VALUE >>> 84%



PRO

Comprehensive feature set and good build quality combine with a highly detailed sound that really appreciates a good recording.

CON

Slightly dry quality in the mid undermines its ability to reach the parts that the best of the competition does.

CONCLUSION

These components offer a lot for the money – plenty of features, good build and high flexibility, but their sound, while revealing and detailed, lacks the dynamic and timing qualities that would put them ahead of a competitive field.

**HI-FI CHOICE** >>> **84%**  
**OVERALL SCORE**

**"This amplifier can blow your house over but loses nothing from the music"**

Your Guide to Hi-Fi and Home Cinema, January 2004, Stan Curtis



**"Combining clarity with control is virtually a three word encapsulation of the KAV400xi"**

Hi Fi Choice, November 2003, Alvin Gold

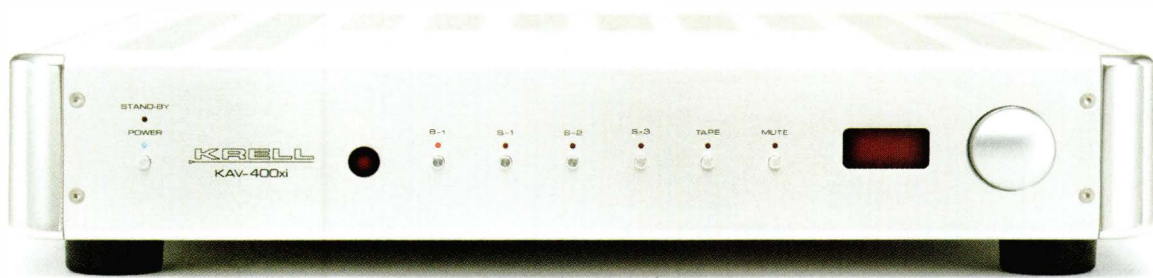

KAV400xi

**"The new player not just delights with the still quite rare SACDs, it also knows how to please with CDs"**

Audio, Germany, September 2003

**"If I had to choose one SACD player, (regardless of price), I'd go for the Krell."**

Stereophile, December 2003, Michael Fremer

**"A unit capable of delivering performance at the very top in the reproduction of CD and SACD"**

Audio Review, Italy, November 2003, Franco Guida

**"The 'Standard' is a player with...guts"**

Diario de Noticias, Portugal, September 2003, JVH

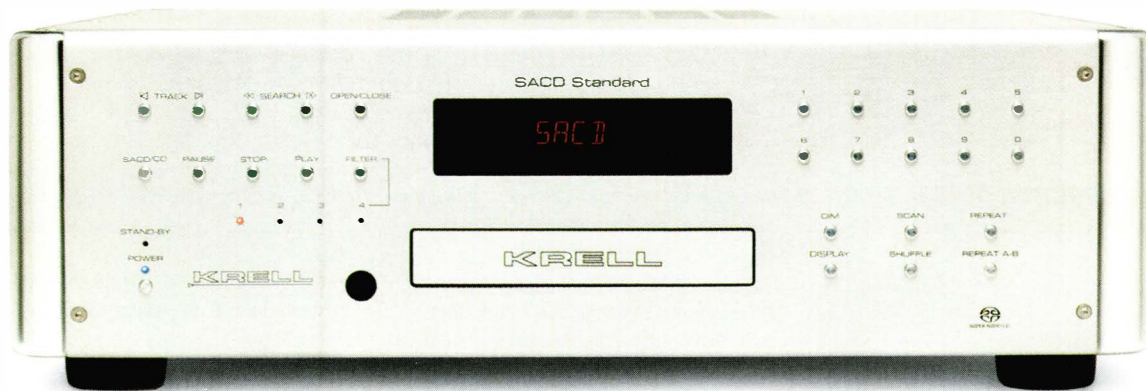

SACD

# KRELL'S ANGELS THE NEXT CHAPTER

From its arrival with a single power amplifier in 1980, Krell's exclusive product range has evolved into a total system concept. Because it is now recognised as the premier high-end audio and home theatre brand, Krell has been compelled to create the ultimate in audio-only and audio-video systems from front to back. Its range of amplification devices have been augmented over the years by CD transports, digital converters and audio/video processors. In 2004, the concept reaches fruition with the ascendancy of both definitive source components – the SACD Standard and the DVD Standard – and a range of loudspeakers suitable for pure music or multi-channel cinematic pleasure.

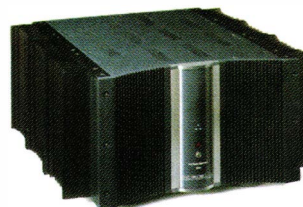

Krell FPB 700cx

**"There's a timeless quality to all-round excellence, and the FPB 700cx has just that"**

Hi Fi News, June 2003, Martin Colloms

Krell has also expanded its catalogue vertically, with the KAV and Showcase ranges for entry-level and mid-level systems, and the rare and exotic Reference Series for systems without limit. Regardless of the model, however, a component must attain the highest standards of sonic performance, ergonomic excellence, superior build quality and long-term dependability before its front panel is graced with the Krell badge.

Krell - a premier high-end company by excellence .



**absolutesounds ltd.**



# BOTTLED HEAVEN

*Enhanced version of BAT balanced mode valve CD player takes a shot at the high-end high rollers*

**PRODUCT** BAT VK-D5SE

**TYPE** Valve-based CD player

**PRICE** £5,495

**KEY FEATURES** Size (WxHxD): 48x15x40cm

- ◉ Weight: 14kg
- ◉ Differential mode valve CD player
- ◉ BNC coaxial digital output
- ◉ Absolute phase switch
- ◉ HDCD filter

**CONTACT** ☎ 01892 539245 🌐 www.balanced.com

**U**S-based Balanced Audio Technology is – how shall we put this? – an unreconstructed exponent of high-end products based on thermionic valves and balanced circuit topologies (there appears to be a clue to the latter somewhere in the company name). BAT mostly makes pre and power amps, but also has the VK-D5, its first valve-based CD player, and the new 'SE' version reviewed here. The SE's feature set includes a number of upgraded components – mostly the valves themselves, the power supply and the output coupling capacitors – and it costs only a little more than the entry-level model in percentage terms.

What the VK-5SE is, most obviously, is a large and rather imposing single-disc CD player. The unusually high weight (14kg is what you'd expect of a decently powerful amp) is largely accounted for by the massive power supply featuring no less than three toroidal transformers and multiple regulated

supplies, not forgetting the heavy-duty steel metalwork and extruded aluminium front panel. What the player emphatically is not is just an ordinary CD player with the output stage ripped out and replaced by 'glowing bottles'. There have been a number of such players over the years, and they have helped give valves a bad name in some quarters.

The Philips mechanism is controlled by a proprietary servo board and clocked by a single master oscillator, one of a number of design features intended to minimise jitter. The D/A converter stage of the SE player uses four 24-bit PCM-1704 DACs with DF1704 24 bit upsamplers which drive a novel passive linear phase differential I/V reconstruction filter, which in turn feeds a valve-based filter, gain and signal buffer. (The non-SE player by the way is a 20-bit design using a different D/A chipset). Consistent with BAT standard practice, there are no op-amps, either integrated or discrete, no negative feedback and no separate buffer stages. Just a very short, direct and simple audio circuit that is fully differential and balanced, providing the benefits of common-mode noise rejection. The high frequency analogue low-pass filter is also balanced – it's this balanced topology that

helps account for the 100dB specified signal/noise figure which, though unremarkable by CD player standards, is impressive for one based on valves.

The analogue amplifier is a high-current, six-valve design based on 6H30 tubes, an upgrade from the basic player, which are fed from an upgraded power supply. There are also new SIX-PAK output capacitor modules which are said to couple to the load better than the earlier design on the VK-D5.

Inside the player, a cut-out switch is provided for the BNC digital output, and a front panel switch controls absolute phase. The remote control, a beautifully engineered all-metal item, addresses all the play modes supported by the player including simple track programming, and also the basic functions of BAT remote-controlled preamps.

In day-to-day use, it might escape your attention that the player is valve based rather than solid state, except that it takes nearly a minute to wake up from standby before the flashing blue 'wait' LED goes out and the







**“It is an extraordinarily expressive player, at once refined and eloquent, but at the same time surprisingly physical.”**



controls become responsive. The player runs only slightly warm, not as warm in fact as the Krell and Mark Levinson players that were available for comparison. From cold, the player is on peak form in under an hour.

**SOUND QUALITY**

There were initial problems eliminating high levels of hum and noise with this player when using a Hovland HP-100 preamplifier, which was essentially noise-free in other combinations. The problem was eventually resolved by judicious lifting of earth terminals on some components (no pack drill here as both the problem and the solution appeared to be highly specific to the test system) and by routing the mains through different terminal blocks, even though the blocks were eventually connected back to the same mains ring. Very odd. In a final test system which used ECS power amplifiers, and the multichannel inputs of a Denon AVC-A1SR AV amp (don't ask) as a preamplifier, there was just noticeable hum when the ear was close to the tweeters and the volume was on a high setting, and virtually no hiss at all. At a normal listening range, the player was effectively completely silent at any practical listening level.

With the test system (in its various guises) feeding Focal-JMLab Alto Be speakers, the BAT delivered some of the most tactile and holographically presented music yet experienced from CD, demonstrating (if it were needed) that the old CD format has more to give than many of us may have suspected. The VK-5SE is not a speed demon like the Krell Standard SACD player in CD mode, and nor is it quite as detailed as the Mark Levinson 390S. But it is not noticeably

lacking in these areas either, except in a direct comparison. The effect of the phase invert switch for example is almost always as clear as a pikestaff. But the player has other qualities that lift it out of the ordinary. It is an extraordinarily expressive player, at once refined and eloquent, but at the same time surprisingly physical, at times even tactile in the way it presents music.

A Reference Recordings disc of Respighi (*Belkis, Queen Of Sheba* etc, with Eiji Oue conducting the Minnesota Orchestra) was spine-tingling stuff, not just in the well known louder parts from the *Pines Of Rome*, but in the hushed *Pines Of The Janiculum* and also in the *Dance Of Belkis At Dawn*, where the player extracted subtle nuances from the recording, with an almost uncanny sense of being present in a real living acoustic. The playing was unusually lively and expressive, with no hint of the stultifying smoothness and lack of grip often associated with valves, and detail emerged organically from a coherent acoustic without any undue emphasis.

Susannah McCorkle's *The People That You Never Get To Love* from her *Bessie To Brazil* album on the Concord Jazz label also pressed exactly the right buttons. The soundstage was wide, deep and airy – no sense here of cardboard cut-out stereo – and the bass was deep enough to practically roll out of the speakers. The whole effect, vocally and instrumentally, was masterful – the music swung from pianissimo to fortissimo with no hint of stress or artifice. Indeed the music swung, full stop, and the BAT helped show unequivocally why Susannah McCorkle is such a great artist. Gripping stuff.

This is a costly player, but it is a remarkable one which has exquisite timing and subtlety,

and combines them with real bottle. Music making is refined and delicate when needed, but it can also be a physical experience, and moving one given music of sufficient calibre. Imagery is always large scale and out of the box (the rest of the system was contributory to this, of course), and this is one of that select group of CD players that passes muster as a source worthy of a high-end, high-resolution system. It doesn't do SACD like the Krell Standard, nor can it double as a minimalist preamplifier like the Mark Levinson, but if these things are not relevant to a buying decision, the BAT is a truly terrific CD player. **HFC**

*Alvin Gold*



**VERDICT**

<b>SOUND &gt;&gt; 93%</b>	<input type="checkbox"/> <input type="checkbox"/> <input type="checkbox"/> <input type="checkbox"/> <input type="checkbox"/> <input type="checkbox"/> <input type="checkbox"/> <input type="checkbox"/> <input type="checkbox"/> <input type="checkbox"/> <input type="checkbox"/>
<b>FEATURES &gt;&gt; 85%</b>	<input type="checkbox"/> <input type="checkbox"/> <input type="checkbox"/> <input type="checkbox"/> <input type="checkbox"/> <input type="checkbox"/> <input type="checkbox"/> <input type="checkbox"/> <input type="checkbox"/> <input type="checkbox"/>
<b>BUILD &gt;&gt; 93%</b>	<input type="checkbox"/> <input type="checkbox"/> <input type="checkbox"/> <input type="checkbox"/> <input type="checkbox"/> <input type="checkbox"/> <input type="checkbox"/> <input type="checkbox"/> <input type="checkbox"/> <input type="checkbox"/>
<b>VALUE &gt;&gt; 83%</b>	<input type="checkbox"/> <input type="checkbox"/> <input type="checkbox"/> <input type="checkbox"/> <input type="checkbox"/> <input type="checkbox"/> <input type="checkbox"/> <input type="checkbox"/> <input type="checkbox"/> <input type="checkbox"/>

**PRO**  
The first truly convincing high-end valve CD player we've seen, this is a design that manages to avoid the usual stereotypes.

**CON**  
Slight background hum, sensitive to mains routing and possible earth interactions, minor loss of resolving ability.

**CONCLUSION**  
Not the only paradigm for high-end CD replay, but a truly excellent one that lacks little in resolution or control, and which doesn't sound soft or sanitised. The VK-D5SE presents music in an unfailingly expressive and musical way.

**HI-FI CHOICE OVERALL SCORE >> 89%**

MISSION

Pioneer

SHARP

ANTHONY GALLO  
ACOUSTICS

BOSE

DENON



N.A.D

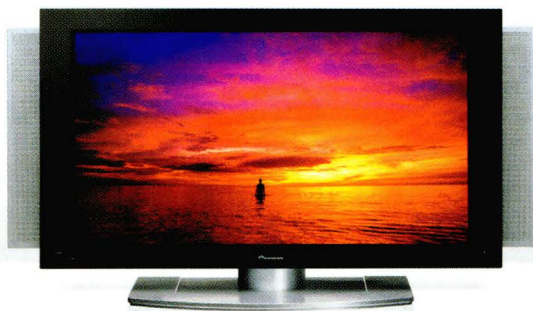

YAMAHA

ARCAM



KEF

SONY



# The Practical Hi-Fi Experience

*The North's Leading Group  
of Hi-Fi and Home  
Entertainment Stores.*

**MANCHESTER:**

65 Bridge Street / 0161 839 8869  
(Sunday Opening - 12noon to 4.00pm)

**PRESTON:**

43 Friargate / 01772 883958

**WARRINGTON:**

88 Bridge Street / 01925 632179

**CARLISLE:**

106 English Street / 01228 544792

**BLACKPOOL:**

81 Whitegate Drive / 01253 300599

**LANCASTER:**

84 Penny Street / 01524 39657

**BOLTON:**

33 Knowsley Street / 01204 395789

<http://www.practicalhi-fi.co.uk>

## Practical Hi-Fi

TEAC

B&W

ACOUSTICS  
REL

ROTEL

SUGDEN

PHILIPS

DYNAUDIO

CYRUS

ProAc

marantz

Panasonic



# ETHEREAL ANGEL

*DAB, what DAB? Yet another classy FM tuner vies for the title of 'last great analogue contender'*

**PRODUCT** T50

**TYPE** AM/FM radio tuner

**PRICE** £499

**CONTACT** [www.creekaudio.co.uk](http://www.creekaudio.co.uk)  
01442 260146

We seem to have done the justification for FM in the DAB age a few times recently, but there'll always be new readers for whom the case can be swiftly summarised: established technology, wide range of programmes, no switch-off envisaged within a generation, excellent coverage, very good sound possible compared with too-often-disappointing DAB.

Now if you live in an FM reception hell hole and find DAB a godsend, this tuner won't change your situation or your mind. But if you find FM satisfactory but have a nagging feeling you could perhaps wring more from it, pay close attention because this is rather a natty bit of kit.

Features first. This is a pukka, almost-no-frills, audiophile model, the one luxury being RDS. Actually, it's not even complete RDS, just the station name – nice, but full RDS implementation would be really sexy. In these days of round-the-house audio, quite a few people listen to a decent tuner in the kitchen of a morning and would welcome traffic newflashes, for instance. Never mind, it makes storing and finding presets easy – 99 of them on FM and 29 on AM should serve any radiohead. You get LW as well as MW too.

Functions are basic and simple to operate either from the front panel or the remote, though the useful 'mono' switch is only on the remote. The tuning knob can skip quickly through the list of presets, and in manual mode centre tuning is neatly indicated. Inside, a rather unusual chipset (previously seen in another Creek model, though no other hi-fi tuners we can recall) does most of the hard work, with Creek's own output stages. Assembly, by the way, is excellent.

## SOUND QUALITY

As always, if for an antenna you have a piece of wire limply dangled off the back of this tuner you won't be hearing its full worth by a long way. Connect it up to any half-decent 'twig', though, and it instantly puts in a very strong case for its higher price when compared with any reference budget models, fine though many of them are.

Good budget tuners can offer clean and crisp sound. What this one adds is precision, polish and insight – spadefuls of all three. Starting with the basics, it is gratifyingly quiet, among the best in that respect that we've heard, and has a neutral tonal balance that is particularly flattering to well-recorded voices and doesn't over-emphasise the sibilance on badly-recorded ones.

But when the music comes in the amount of detail that the T50 seems to manage to coax from the ether is quite remarkable. In any musical genre there's a solid, unflappable and well-focused core to the sound that makes it easy to follow what's happening on the large scale and equally on the small.

Take classical music, for example. A symphony orchestra is a physically large and disparate array of several dozen individuals which, in a good performance, can be listened to as a whole or as an intricate mesh of individual lines. In a good recording, well replayed, the same choice should be available. With the T50 playing Radio 3's best, it is. The tone, phrasing and position of each instrument is beautifully clear, in all honesty running close to the standard achieved by the best CDs and high-resolution discs. There's not quite the ultimate insight of the latter, but the gap is surprisingly small.

With rock, jazz or pop the same holds true. This isn't the finest tuner ever made but it runs much closer to that rank than to the general pack and should definitely be on the shortlist of any radio fan with 500 notes to spare. **HFC**

*Richard Black*



VERDICT	
<b>SOUND &gt;&gt; 89%</b>	<p><b>PRO</b> Some of the purest and most detailed sounds to be found on the dial, in a smart and well-built unit.</p> <p><b>CON</b> RDS only partially implemented. Remote and front panel don't quite duplicate each other.</p>
<b>FEATURES &gt;&gt; 80%</b>	
<b>BUILD &gt;&gt; 88%</b>	
<b>VALUE &gt;&gt; 88%</b>	
<p><b>CONCLUSION</b> This is a very fine analogue radio tuner indeed that can rock with the best of 'em and also produce sweetly beguiling small-scale sounds. All with superb manners, great articulation and exemplary levels of detail.</p>	
<p><b>HI-FI CHOICE</b> &gt;&gt; <b>88%</b> <b>OVERALL SCORE</b></p>	

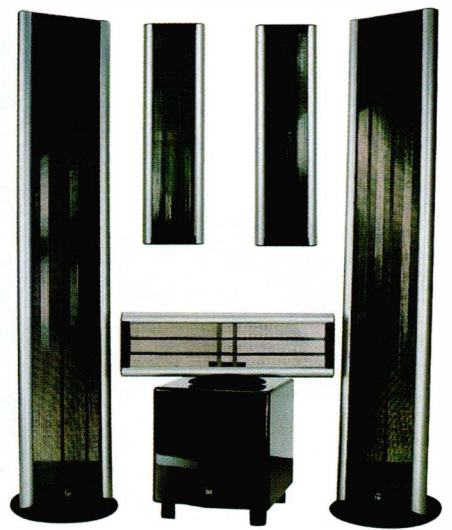
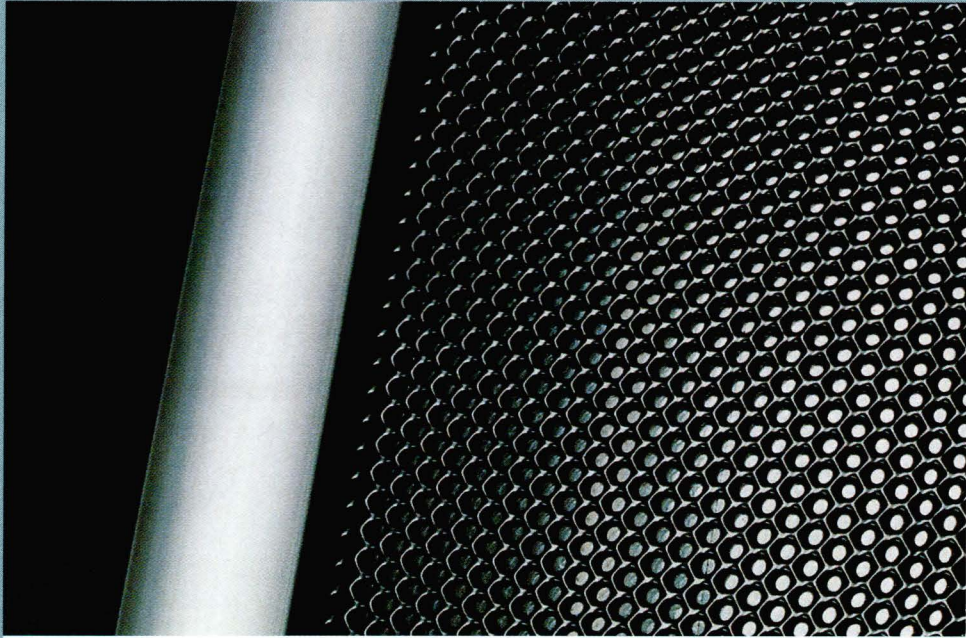

# THIS IS FINAL TAP

*They may be elegant, but can these Dutch electrostatics possibly sound as good as they look?*

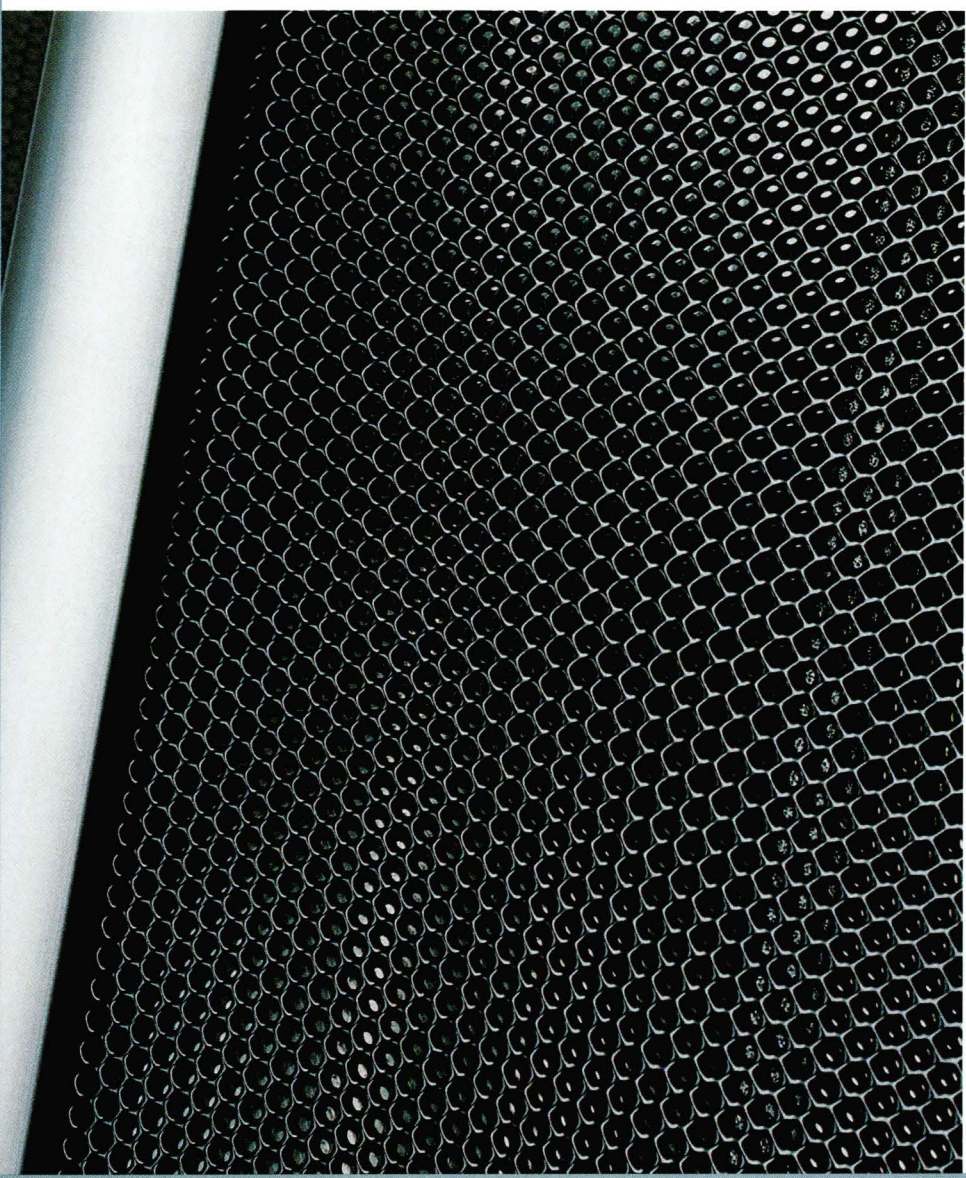

---

**PRODUCT** Final Sound electrostatic loudspeakers

---

**TYPE** Stereo and multichannel speaker packages

---

**INDIVIDUAL PRICES** 500 PL floorstander: £2,750 per pair  
◊ 100 PL wall-mounted panel: £1,395 per pair  
◊ 200 CP/STB centre speaker: £850 ◊ S200 subwoofer: £1,250 ◊ FCU 'energiser box': £395

---

**PACKAGE PRICES** Multichannel package (as above) £4,875  
◊ Stereo package 1 (2x 500 PL, S200, FCU): £3,495  
◊ Stereo package 2 (2x 100 PL, 2x S200, FCU): £2,895

---

**CONTACT** ☎ 01753 652669 🌐 [www.finalsound.com](http://www.finalsound.com)

---

**E**lectrostatic speakers are very rare indeed, but ever since Quad launched its famous example, back in the 1950s, enthusiasts have held them in respect bordering on awe.

Quad's original Electrostatic (the ESL 57) stayed in production for more than twenty years, and its ESL 63 successor (now embodied in the ESL 988) has repeated the same trick. If Quad set the original agenda, other companies have also used the electrostatic principle, sometimes just for tweeters, but also in full-range designs. Many of those alternatives came from the US, and although few have achieved long-term success, MartinLogan has a good presence on the UK scene, and is the exception.

Perhaps surprisingly, Holland is another country with an electrostatic tradition. Dutchman Ben Peters has been making his Audiostatics for thirty-odd years, but now there's this new Dutch kid on the block called Final Sound, with a wide range of very slim and elegant panel electrostatics that may be configured in various ways.

But if electrostatics are so good, why haven't they taken over the market? There are

a number of good reasons, the most obvious being that they're costly to make and therefore expensive to buy. Sales volumes are therefore modest, so there are few economies of scale. Then there's a whole industry geared up for producing regular moving coil drive units and enclosures, but any brand wanting to make electrostatics has to do so virtually from scratch, using totally different manufacturing processes.

A big plus here is that – unlike many electrostatics – the Final Sound examples look very elegant. They're not exactly small, but they are semi-transparent, very slim front-to-back, and also quite narrow when viewed from the front too. The sides are formed from silver extruded aluminium sections, ensuring good structural integrity in supporting the black-tinted panels proper. Various versions are available, for floor/free-space siting and also for wall-mounting.

The package originally sent was essentially a 5.1 surround sound system, comprising a pair of tall, slim 500 PLs for the main front left/right channels, one 200 CP/STB for the centre, two 100 PLs for the surround/rear channels, plus one active (powered) S200 subwoofer. While this combination is well suited to home cinema and surround sound music material, it also offers two obvious stereo combos, one based on the two 500 PLs, the other around the pair of 100 PLs. However, because the small size of the 100 PL in particular will seriously limit its bass output (see later), we used an extra S200 subwoofer with these models.

Most electrostatics have built-in power supplies that need mains connection, in order to set up the high-voltage electrostatic field, and this is often inconvenient. But Final has come up with a neat alternative solution. Each electrostatic panel comes with its own three-conductor cable, and all are fed via an energiser box, codenamed FCU (Final Central Unit), which is mains-powered and fitted with a flexible number of panel-driving modules. The gloss-black and rather bulky (and costly) subwoofer has its own built-in power amplifier (and may be fed via a choice of preamp, '1', or speaker-level sockets).

Electrostatics operate quite differently from regular conventional speakers, and that translates directly into the way they reproduce sound. Radiating the sound from an open-back panel produces a dipole (or doublet) *modus operandum*, giving a 'figure-8' (rather than essentially spherical) distribution pattern. That's because the sound from the front of the panel is out of phase with that generated from the back, so these will cancel out where they meet at the sides.

This means the speakers will have less room interaction than box (monopole) speakers, but the laws of physics also mean that sound frequencies with wavelength greater than the width of the panel will cancel themselves out,

so a narrow panel will never generate deep bass. Furthermore, the larger the panel, the more it will tend to direct higher frequencies into a narrow beam.

## SOUND QUALITY

Let's start with the stereo performance. The 500 PL is a fairly large floorstander, but because it's physically fairly narrow the bass extension is quite limited. Room measurement shows useful output down to 70Hz, which is more than sufficient to maintain full stereo imaging, but you'll still need a subwoofer to cover the bottom two octaves, while some augmentation of the 500 PL's rather lean sub-200Hz output is also useful. While two (or more) are always preferable, a single subwoofer does the business here, with its roll-off filter set around the halfway point.

The much smaller and narrower 100 PL has considerably less bass extension, and only operates above 200Hz. To maintain good stereo (with the bonus of a more even room drive), a second subwoofer was added, and both were set to operate up to the nominal top of their working ranges (200Hz).

Whether the 500 PL is deemed to have insufficient bass and treble or an excessive midrange is debatable, as these are essentially opposite sides of the same coin. This speaker is not strictly neutral. It does rather over-emphasise the midband, and the top end is a little too restrained. As for the ▶

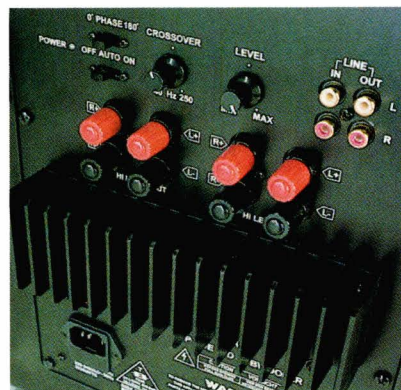

## KEY FEATURES

### 500 PL FLOORSTANDING SPEAKER

- Size (WxHxD): 29x155x5cm • Weight: 8.1kg • Base has appropriate tilt for treble 'beam' • Special three-conductor connecting cables for all speakers

### 100 PL WALL-MOUNTED PANEL

- Size (WxHxD): 20x71x4cm • Weight: 3.6kg • Wall bracket has flexible universal joint

### 200 CP/STB CENTRE SPEAKER

- Size (WxHxD): 20x62x4cm • Weight: 3.4kg • Has flat base for lateral mounting on TV

### FCU 'ENERGISER BOX'

- Size (WxHxD): 43x10x27cm • Weight: 2.3kg • Modules: up to six

### S200 SUBWOOFER

- Size (WxHxD): 35x40x37cm • Weight: 23kg • Inputs: stereo line, stereo speaker, '1' • Low pass filter: variable 40Hz-250Hz

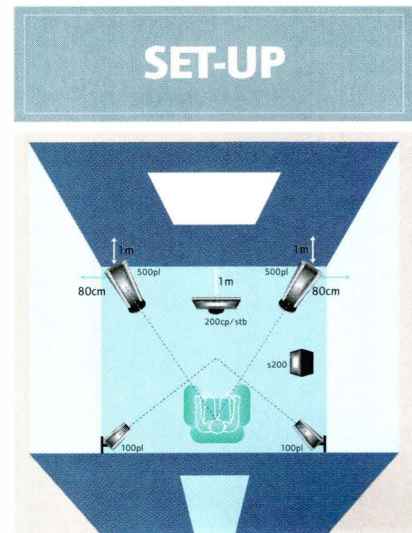

## POSITIONING

Dipole panel speakers such as these operate to rather different rules from regular monopole (box) speakers. Their output is directed forward and backward (out of phase with each other), with none at all towards the sides. Furthermore, depending on the height of the panel, treble and upper midband frequencies will be focused into a relative narrow vertical 'window'.

Both these factors increase the ratio of direct to reflected sound, which is one reason why the stereo imaging is so precise and well focused (the lack of crossover also plays its part). They also have implications for the ideal placement. Because side wall reflections will be much reduced, the front speakers should be placed rather wider than the positions normally adopted for box loudspeakers. And despite Final's provision of 12cm wall brackets for the 100 PL, a dipole should always be placed as far from reflective walls as practicable, in order to minimise the colorations that strong reflections can introduce. There's a strong case for using additional spacers here between bracket and wall.

Do make sure that the front panels are pointed directly towards the prime listening seat, as the treble output of three of these is far from generous, and maximised when directly on axis. When used for surround duties, the 100 PLs are best directed a little away from the listener.

While two will always be smoother than one, siting a subwoofer is unpredictable, and experimentation is essential in order to obtain the best interaction with room modes.

## LAB MEASUREMENTS & SYSTEM MATCHING

These speakers are not particularly demanding in terms of amp current through the bass and midband, but their capacitive nature shows the impedance falling to very low values at high frequencies, so good amp stability is essential.

Furthermore, the sensitivities are very low indeed here – only around 80dB under in-room far-field conditions – so a good reserve of amplifier voltage capability is pretty well essential. Low power valve types shouldn't bother to apply. That said, there's an upper limit on the voltage that can be applied to an electrostatic panel if arcing is to be avoided, so even a powerful amplifier won't overcome the limited loudness capabilities of these systems.

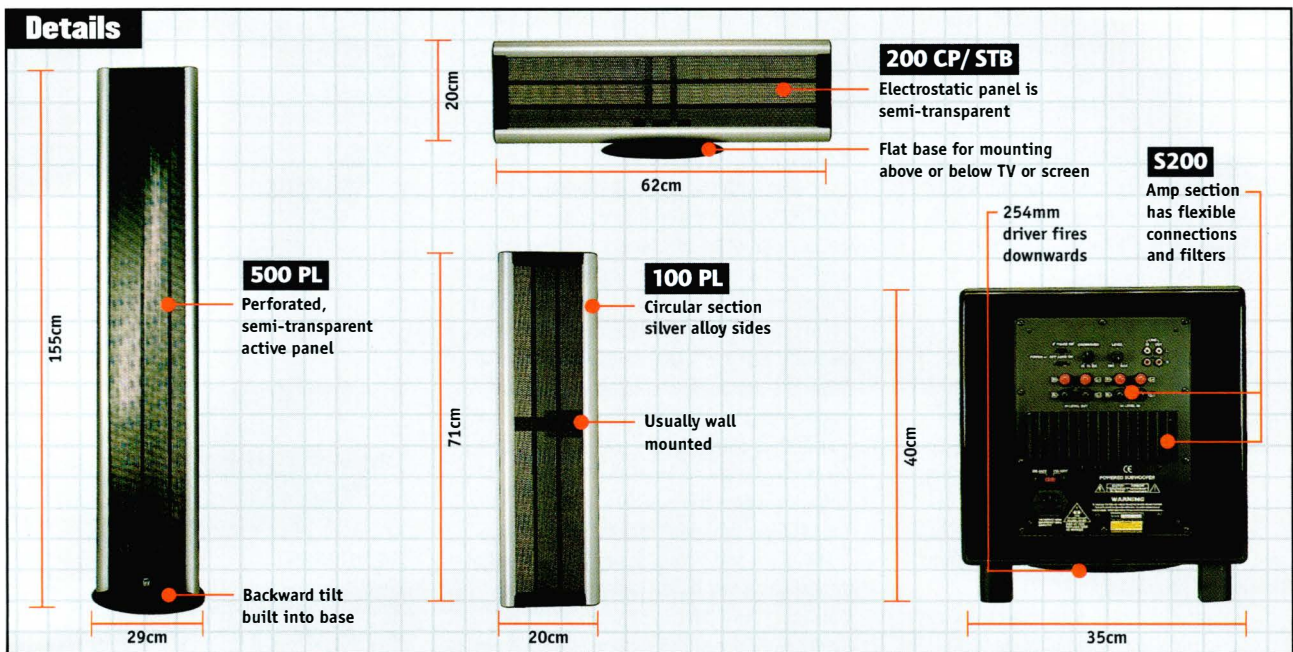

“There’s real magic here, particularly in the way it makes human beings sound human.”

▣ bass, you can leave that to the sub. But that departure from neutrality is really just a side issue, against the very real strengths that a good quality electrostatic panel brings to the party. By eliminating any form of box from the design, one eliminates any form of *boxiness*, and a speaker without even a trace of *boxiness* is something of a revelation, irrespective of its other capabilities.

And those are also very impressive. This speaker system might not go very loud, but what’s really important is how good it does the low-level stuff, aided no doubt by the lack of any form of crossover. There’s real magic here, in the way it makes human beings sound human; in the delightful way it brings real texture to orchestral strings; in the beautiful layering effect on choral material. There’s also a delightful freedom from ‘overhang’, so while the dynamics aren’t the punchiest around, they’re exceptionally clean and well delineated. Imaging is outstanding, with great transparency and superior focus.

The much smaller 100 PL makes a very interesting contrast. Its modest dimensions mean that a pair of subs are needed here, operating right up to 200Hz, but after taking

some care over sub positioning, a decent overall balance was achieved. Most significantly, it doesn’t suffer the loss of treble output of its bigger brother, and in consequence adds a wonderfully delicate openness to the already very impressive party.

However, it’s normally supplied with a wall bracket that has a neat universal swivel joint, and which holds the panel a mere 12cm out from the wall. That, frankly, is insufficient to avoid spoiling the potentially excellent frequency balance, introducing a significant suck-out and a subsequent peak that adds quite obvious coloration and a touch of aggressiveness too. Mounted well clear of walls, this speaker has great smoothness, openness, transparency and neutrality, so while the wall bracket looks an attractive proposition, it is a sonic compromise.

The final stage is to do the complete multichannel thing, with the 500 PLs at the front, along with a 200 CP centre channel, plus the 100 PLs for the surround channels. The centre (used horizontally) makes an excellent voicing match for the big 500 PLs, and while the restrained treble is still evident, the sweetness and delicacy of the top end proved particularly delightful, especially with the new ‘high band’ (SACD and DVD-A)

format multichannel material. Imaging in particular was notably precise and convincing.

The 100 PLs used as surround speakers can be too bright and draw too much attention to themselves if directed towards the listening zone, but the flexible universal

joint mounting easily allows the panel to be directed slightly off-axis to match the fronts. Whichever combination you use, these are very interesting speaker systems, if somewhat extreme in their capabilities. High volume is not on the agenda, but few can match their delicacy, sweetness and transparency. Some form of bracket or stand to mount the 100 PL in free space would be welcome, and significant savings could also come with less expensive subs from alternative brands. **HFC**

Paul Messenger

Below: FCU ‘energiser box’ provides power to drive up to six Final Sound electrostatic speakers



**VERDICT – Stereo (2x500 PL, S200, FCU)**

<b>SOUND</b> >> 87%	<b>BUILD</b> >> 92%
<b>EASE OF DRIVE</b> >> 68%	<b>VALUE</b> >> 78%

**CONCLUSION**  
Very seductive delicacy and transparency, with superb imaging and voice reproduction. Particularly good with low-level detail.

**HI-FI CHOICE OVERALL SCORE**  
**>> 83%**

**VERDICT – Stereo (2x100 PL, 2x S200, FCU)**

<b>SOUND</b> >> 83%	<b>BUILD</b> >> 92%
<b>EASE OF DRIVE</b> >> 64%	<b>VALUE</b> >> 81%

**CONCLUSION**  
Wonderfully delicate ‘openness’, though wall mounting inevitably has a negative effect on frequency balance.

**HI-FI CHOICE OVERALL SCORE**  
**>> 82%**

**VERDICT – Complete 5.1 channel system**

<b>SOUND</b> >> 83%	<b>BUILD</b> >> 92%
<b>EASE OF DRIVE</b> >> 64%	<b>VALUE</b> >> 78%

**CONCLUSION**  
Beautifully natural voices, superb imaging and very superior midband coherence are a real bonus with multichannel music.

**HI-FI CHOICE OVERALL SCORE**  
**>> 81%**

# What HiFi Turntable of the Year

2002 & 2003

We have been retailing Audionote products for over 10 years and are the **exclusive Audionote Dealer for Scotland.**

**An**  
Audio Note  
EXCLUSIVE DEALER



▶ **THE AUDIO NOTE TT1 TURNTABLE** is a three point fully floating suspended sub-chassis model and will provide an exceptionally stable platform from which to replay the finest vinyl collection. *Available in a choice of finishes.*

▶ Also available is the TT2 which is a two motor version of the above

## ▶ THE AUDIO NOTE CDT ONE & DAC ONE

A superb sounding combination presented in an elegant extruded aluminium chassis.



**CDT One**

**DAC One** 1x Signature

▶ To book a demonstration or for pricing call **01563 574 185**

audio note // accuphase // nagra // dcs // bel canto // spectral // Focal-JMLab // verity  
audio orelle // densen // sme // quad // orpheus // lamm // lavardin // roksan  
penaudio // harman kardon // LFD audio // dynavector // metronome // siltech

**T (01563) 574 185**

**W [www.kevingallowayaudio.co.uk](http://www.kevingallowayaudio.co.uk)**

**E [info@kevingallowayaudio.co.uk](mailto:info@kevingallowayaudio.co.uk)**

**Kevin**  
**Galloway**  
AUDIO

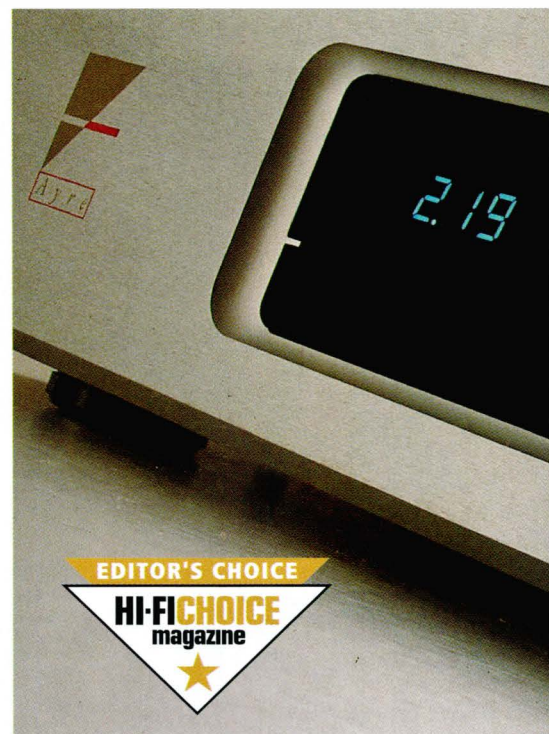

# IN THE AYRE TONIGHT

*This Colorado brand may not do much, but what they do they do extremely well*

**PRODUCT** Ayre CX-7

**TYPE** CD player

**PRICE** £2,950

**KEY FEATURES** Size (WxHxD): 44x12x35cm

Weight: 11.5kg Analogue outputs: balanced XLR,

single-ended RCA Digital output: AES/EBU XLR

Switchable filtering

**CONTACT** 01844 219000 www.ayre.com

Still making the V1 power amplifier that introduced the brand ten years ago, Ayre Acoustics is arguably Colorado's most consistent audio electronics company. The K1 matching preamp which followed that classic is also still in production, though there are plans afoot to replace both components.

The brand was co-founded by Charles Hanson, the guy who started speaker company Avalon and designed the Eclipse and Ascent models that you might remember for their stealth-style cabinets. He sold that company to current owner Neil Patel and took a sabbatical, going back to nature and living the outdoor life, but must have run out of fire lighters because in 1993 he started designing and making amplifiers under the Ayre brand and is now head of R&D for this small but steady operation.

The CX-5 is one of Ayre's more affordable components, sitting alongside a matching

integrated amp and two pre/power combos in a range of fully balanced components that includes a high-end DVD player. Inside the neatly constructed casework you will find some unusual thinking. For instance, the multi-stage digital filter upsamples to 24-bit/176.4kHz and then oversamples at 1.4112Mhz. A Burr-Brown PCM1738 DAC converts the signal to analogue by dividing the bits up and using multibit conversion for the upper six bits and Sigma-Delta conversion for the lower 18 bits. Current to voltage conversion happens outside the DAC where the differential current output is converted to a differential voltage signal to produce a balanced analogue output. Analogue circuitry is all zero feedback for minimum timing error.

The transport mechanism is a Digital Video Systems DVD unit, which probably explains why the player takes longer than average to

get started but moves like lightning once it has figured out where everything is. Unfortunately there aren't direct track access buttons on the remote but the next track key provokes a far quicker response than you get with dedicated CD mechanisms.

The balanced ethos extends to the digital output – this is only available via an AES/EBU terminal, so you'll need to convert it to single-ended RCA for recorders and most onboard DACs. Fortunately Ayre, among others, makes such a converter. Alternatively you can turn it off and play via the single-ended or balanced outputs straight into an amp (few DACs costing less than this player could actually improve it anyway). As well as the digital out defeat there's a cryptically labelled switch on the back marked listen and measure. It turns out that these are alternative filter settings, the 'listen' setting optimised for tonal balance







**“A beautifully executed player with a highly musical yet revealing sound, it is advanced in both technological and sonic respects.”**

and 'measure' dedicated to timing. The 'listen' setting seemed preferable because, while 'measure' does marginally improve timing, it adds bite to leading edges in the process and undermines the tonal finesse of the player. The effect will of course depend on partnering amps and speakers and no doubt some will prefer the more lively setting.

**SOUND QUALITY**

Ayre recommends using the balanced outputs on this player if you have a balanced amp, so we used one of their AX-7 integrateds. The player does indeed sound better via its chunky XLR connections, but as most of us Brits still use RCA phonos, much of the listening was carried out in an RCA style.

However you use it though, this is a fine CD player, one which combines many of the more desirable attributes of the genre and does so in a highly engaging fashion. It's unusually natural sounding, being both relaxed and warm while not smothering information in the process. Strings and bells alike are reproduced with plenty of air and shine while Norah Jones's voice retained its full presence and scale – there's a fine dustiness to it that many players smooth over, but not the Ayre. It's not what you'd call a gritty player but transparency is certainly high. You can revel in the lush west coast sound of this disc and enjoy the easy pace without feeling that

anything is being blanded out.

The angular rhythms of Four Tet's remarkable *Rounds* were also well handled, the tonal colour and dynamics coming across with engaging coherence. Energy is likewise well represented without the merest whiff of glare. This largely electronic work of musical art has plenty of vibrancy, enough to reveal edginess wherever it might hide but nothing untoward escaped the CX-7's outputs. What might well be high-speed balalaikas and temple bells on the track *Spirit Fingers* were delivered with good contrast and dynamic propulsion, the colour and vibrancy of the instruments given full range.

Tension is a key musical tool, one which Swedish jazz groovers EST use to great effect, and which the Ayre is only too happy to render. It played tracks like *Behind The Yashmak* (from *Strange Place For Snow*) with a light but firm grip on the restrained pace and an engaging and convincing delivery. There was plenty of power behind the double bass and one couldn't help but appreciate the quality of playing from Dan Berglund.

The Ayre is not the only serious contender at this price – the three grandish price range is getting to be a popular area for high-end players. There's the new Wadia 302 and the Gamut CD1R, not to mention the popular Naim CDX2 and Densen Beat XS, but one of the strongest competitors is the Resolution

Audio Opus 21 (HFC 244). Next to the Ayre this displays a fraction greater transparency and integrity. Both have a similarly fine sense of timing and a good grip of dynamics and imaging but the Opus has the slight edge where single-ended amplification is used.

With its own amplifier in tow the CX-7 is clearly a very strong contender – the noise floor is lowered and fine detail is revealed. Tori Amos's breathing became clearer and with it her voice expanded to its preferred full-scale proportions. Captain Beefheart in the full *Trout Mask Replica* flow of *Ella Guru* was delivered with Don van Vliet's voice towering over the contortions of the Magic Band, the twisted groove reproduced with a nimbleness rarely encountered. The Ayre is clearly highly responsive and low on both character and distortion, as this album is rarely easy listening in the digital format. Kick drums kick and guitars were angular yet funky on *Moonlight On Vermont*, so much so that you've just got to dance!

Switching over to the Arcam pre/power amps reviewed this month, their slightly more gritty delivery works well with the Ayre, the player's timing and tonal colouring combining well with the slightly drier balance of the amps – even with a single-ended connection. Earlier in the year we tested the more affordable of the Ayre pre/power amp combos and briefly had the player to go with it. The amps have stunning stereo separation and the combination produces superb detail and massive scale when its called for, and Radiohead's *Hail To The Thief* provided the calling in no small way with the track *Where I End And You Begin*. This track has a lot of 'the Robert Fripp' about its guitar work, with beautifully realised reverb providing a cavernous depth that the player revels in.

The CX-7 is a beautifully executed player with a highly musical yet revealing sound. It is advanced in both technological and sonic respects and deserves to be a contender for any music lover's three grand. **HFC**

Jason Kennedy

<b>VERDICT</b>	
<b>SOUND &gt;&gt; 93%</b> [Progress bar]	<b>PRO</b> Natural, highly resolved and well timed sound that is good enough to give high-end turntables a hard time plus a very nice bit of casework.
<b>FEATURES &gt;&gt; 87%</b> [Progress bar]	<b>CON</b> System remote is devoid of direct track entry keys, XLR digital output needs converting for most recorders and DACs.
<b>BUILD &gt;&gt; 95%</b> [Progress bar]	
<b>VALUE &gt;&gt; 87%</b> [Progress bar]	
<b>CONCLUSION</b> A superbly built and natural sounding player that will win you over with its range of capabilities and transparency to the music. Refinement and energy of this calibre is a rare combination in digital electronics.	
<b>HI-FI CHOICE OVERALL SCORE &gt;&gt; 90%</b>	

# ELECTRIFYING SPEED

After a wait of two years, mains cables finally get the Valhalla treatment



amplifiers disproportionately, followed by CD players. Imaging becomes more layered and complex, detail less homogenised. The soundstage as a whole became cleaner, similar to the effect of what you see through the viewfinder of a single lens reflex camera which is snapped into focus after being slightly mis-set. Musically, the effect is livelier, closer, more immediate, and it's easier to hear into the nooks and crannies of the musical performance. In various recordings used for test, Valhalla Reference provided more striking internal contrasts, and a clearer access to secondary instruments and voices that are otherwise lost.

There is also the question of ranking different types of cable in a system. From previous experience, Valhalla interconnects are outshone by the benefits of the speaker cable. Valhalla Reference appears to provide if anything even more fundamental improvements than the speaker cable. Remarkably, although we were supplied with a mains distribution block also wired with the same stock (not a commercial product), the use of Nordost wired all the way back to the wall socket was by no means a prerequisite to showing the improvement noted, and neither was the quality of the wall wiring enough to spoil the party. The only logical assumption must be that the cable closest to the audio system itself makes the biggest audible difference. But if you can stand the indubitably huge price, it's a cable upgrade that certainly does the business. **HFC**

Alvin Gold

**PRODUCT** Nordost Valhalla Reference Power Cord

**TYPE** Hi-fi mains cable

**PRICE** £1,750 (2m terminated, each additional metre £300)

**CONTACT** ☎ 01352 730251 🌐 www.nordost.com

The major missing element in Nordost's flagship Valhalla cable system has finally arrived. The Valhalla Reference power cable complements Valhalla speaker cables and interconnects, and uses similar construction techniques and materials. It even comes in the same garish violet hue. By any standards it is costly stuff, but there are two other new Nordost mains cables at much lower prices.

Valhalla Reference is based on seven 70-micron silver over 16 AWG solid core 99.99999% oxygen free copper conductors (pew!). Construction mirrors that of other Valhalla cables, where the prime requirements are extreme levels of geometric accuracy and the use of air as an ideal dielectric. The seven cores are split three each for live and neutral, and one for earth. Instead of simply sheathing the conductors in the chosen insulating material, two filaments of Teflon are woven around each other, and the resulting rope-like structure is wound over the cable in a precisely defined helical pattern which Nordost describes as a 'spiral bridge'. Only then is the cable covered in transparent THC co-polymer sleeving, an arrangement that reduces physical contact between the conductor and the dielectric by more than 85 per cent. The raw cable has a current rating of 60 amps, which reduces to a standard 13

amps when fitted with a Wattgate three-pin IEC connector and a military grade mains plug, each of which has triple gold coating.

The claims made for the cable are even more extraordinary. While most mains cables are said to have a propagation velocity of under 50 per cent of the speed of light in a vacuum, Nordost claims 91 per cent for the Valhalla Reference. It also has a very low insertion loss and a high thermal efficiency.

### SOUND QUALITY

In a nutshell, this cable is stunning. It worked brilliantly with Krell and Mark Levinson CD players, and with Hovland and ECS amplifiers, but it also worked with Denon AV amplifiers and Arcam mid-price CD players and amplifiers, which are absurdly mismatched on paper, at least in price terms. The Nordost cable was compared to ordinary IEC mains cable of the kind you'll find packaged with most components, and also to Nordost's now discontinued El Dorado and also TCI Constrictor mains cables, which are a viable lower-cost alternative but simply not in the same class.

The Nordost cable appears to benefit



<b>VERDICT</b>	
<b>SOUND &gt;&gt; 98%</b> [Progress bar]	<b>PRO</b> A state of the art mains cable that lifts almost any system you can name, adding exquisite detail, imaging and transparency.
<b>PRACTICALITY &gt;&gt; 75%</b> [Progress bar]	
<b>BUILD &gt;&gt; 94%</b> [Progress bar]	
<b>VALUE &gt;&gt; 60%</b> [Progress bar]	
<b>CON</b> The deep, fat, IEC plug could be inconvenient in some applications, but the only substantial objection to this cable is its price.	
<b>CONCLUSION</b> You might think that the product description and claims are so much BS, or that no mains cable can possibly be worth this much. But the acid test is whether any alternative can match it for sheer sonic effect. The answer: an unequivocal no.	
<b>HI-FI CHOICE OVERALL SCORE &gt;&gt; 85%</b>	

# definitive audio

Peddlers of fine wares, including:

Record players: **SME** models 10, 20 and 30; **Kuzma**;  
**Nottingham Analogue**; **Michell**; **VPI**; **Living Voice** Mystic Mat.  
 Arms: **Rega**; **SME** Series IV and V; **Kuzma** inc Airline; **Triplanar**.  
 Cartridges: **VanDenHul**; **Kuzma**; **Reson**; **Cartridge Man**; **Benz-Micro**;  
**Kondo**.

Amplifiers: **Kondo**; **Border Patrol**; **Canary**; **Sugden**; **Art Audio**;  
**Monarchy**; **Western Electric**; **Icon**; **Tom Evans Audio Designs**.

CD Players: **Resolution Audio**; **Wadia**; **Sugden**.

Louspeakers: **Living Voice**; **Vitavox**.

Cables and Tables: **Kondo**; **Living Voice**.

We now have the lovely Eastern Electric "MINI MAX" line preamp at £800 for the standard configuration, or £1200 for the Definitive Audio magic dust version.

Sale of part exchanged and ex-dem items	Sale	New
Clearaudio Insider Wood Reference - moving coil cartridge - a long name for a small thing (10 hours only)	£4000	£7500
EAR MC3 moving coil step up transformer - 4/12/40 ohm compatibility (i.e ideal for Ortofons) - better than your active moving coil input!!	£500	£750
Canary Audio 303 pwer amps - glorious	£5000	£7600
Canary Audio 309 power amps - glorious - as new - dem use only	£7000	£10000
Canary Audio 601 pre-amp - as new - dem use only - fabulous	£2500	£3200
ATC 50A loudspeakers - walnut - scuffed cabinets otherwise perfect - bargain	£2000	£5500
Tom Evans Groove - 500 ohm, 0,2 mV - perfect - 1 week of use	£1500	£1850
Horning Agathon - 98dB 2 way horn - Mahogany - new PM6As (alnico)	£1400	£3850
Ruark Crusader II - April 2000 very good condition	£900	£1800
AudioNote (UK) M3 pre-amp - line only	£2000	£3700
Audio Innovations P2 phono stage - standard, unmodified - collector's item	£700	
Roksann Xerxes Cognoscenti - black marble finish, very tidy	£600	
Audio Innovations 1st Audio - 8 Watt 2A3 4pin - collector's item - joy	£900	
Nottingham Analogue - Mentor with LV Mystic Mat - spotless	£1400	£2900
Avid Acutus turntable - 10 hours use if that, perfect.	£4000	£6500
Avid Volvere Sequel turntable - sealed box new	£3000	£3500

## LIVING VOICE



### Auditorium Avatar

Hi-Fi Plus *Editor's Choice*  
 Hi-Fi Plus *Product of the Year*  
 Hi-Fi Choice *Editor's Choice*

"The Avatar is a near perfect balance of size, bandwidth, efficiency and tonal refinement. Its slim lines and small footprint deliver a genuine 94db sensitivity, and excel when it comes to delivering the scale, vibrance and colour of the music. Its unobtrusive quality allows it to cut straight to the heart of a performance, unlocking the music trapped in the recording, whilst its refinement makes it equally at home with both basic and surprisingly expensive amplification."

## 'S' series

S3e

S5e

S6e

S8e

S9e

SR5

C5e

C9e



Walls without boundaries

Don't be contained, be entertained  
 Prepare for deeper, wider, higher  
 Let the technology work, hear the music  
 Reset your definition of exceptional  
 Experience sound without limits  
 Enjoy the Spendor magic

Spendor Audio Systems Ltd

Tel +44 (0)1323 843474

Fax +44 (0)1323 442254

info@spendoraudio.com

www.spendoraudio.com



AMEX VISA MASTERCARD  
 Tel 0115 973 3222 Fax 0115 973 3666  
 internet: www.definitiveaudio.co.uk email: shout@definitiveaudio.co.uk

GROUP TEST & LAB REPORTS: PAUL MILLER

# TWO & SIX-CHANNEL AMPLIFIERS

So which one's your favourite? We pitted some sterling two-channel amps against a few of the multichannel variety to see if the bulky brigade can cut it with the purists

## ON TEST (TWO-CHANNEL)



ARCAM DIVA A80  
£600



CREEK A50IR  
£550



ROKSAN KANDY KA-1 MKIII  
£595



ROTEL RA-1062  
£595

## ON TEST (SIX-CHANNEL)

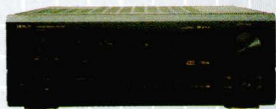

DENON AVR-2803  
£650

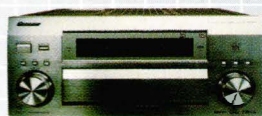

PIONEER VSX-AX3  
£800

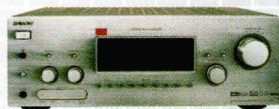

SONY STR-DB790  
£300



YAMAHA RX-V1400RDS  
£800

Perhaps you're thinking of buying a new amplifier to partner your CD player? Well then why not treat yourself to a multichannel audiovisual amp in place of the traditional integrated, two-channel models? Ah yes, I can hear the hackles rising among hardcore audiophiles – after all, AV amplifiers and their ilk are beneath consideration, if not actual contempt. The question is why does this opinion persist? The reasons are not foolish, but they are historical and stem from the generally dire performance of the earliest AV receivers, way back in the days when Dolby Pro Logic was the highest of tech.

These first and second generation amplifiers were often based on established and typically mass market stereo designs, to which were added additional centre and surround amplifiers, often as integrated power modules. Little or no reinforcement was added to the power supply, which now had to sustain four or five power amps instead of two. Meanwhile, the individual amplifiers were often mismatched in terms of performance, power output and sound quality. The result was AV receivers that represented the worst of both worlds – unnecessarily complex for two-channel duty and unable to adequately drive multiple pairs of speakers in home cinema surround sound mode.

Time, experience and the introduction of wideband, multichannel audio formats such as DVD-A and SACD have changed all that. Today's AV amplifiers are usually built with five, six or even seven properly matched power amplifiers supported by an appropriately beefy power supply. That's the main reason why the damn

things are so big after all! Even those models that cannot deliver high, continuous outputs into five or more speakers at once are engineered to provide a substantial dynamic power output across all available channels under entirely realistic music or movie-like conditions.

So here's the mission. We assembled eight amplifiers, four dedicated stereo designs and four not dissimilarly priced multichannel models. As far as our blind listeners were concerned, all of the eight amplifiers tested were stereo models and were auditioned under identical matched-level conditions with two-channel material until told otherwise. So will the dedicated, two-channel amplifiers rise confidently from the pack or would some of the feature laden AV amplifiers give their lightweight competition a bloody nose? **HFC**

## EQUIPMENT USED

- Denon DVD-2900 universal disc player
- B&W Nautilus 802/804 loudspeakers and 850 subwoofer
- Townshend Isolda DCT interconnect & QED X-Tube 400 speaker cable

## MUSIC USED

- Eleanor McEvoy *Yola* (hybrid SACD/CD)
- James Taylor *Hourglass* (SACD)
- Paul Simon *You're The One* (DVD-A)
- Rebecca Pidgeon *Raven* (SACD)
- Vivaldi *Stabat Mater* (SACD)

## EARS USED

Many thanks go to the following panellists for their experience and diligence in facilitating our unsighted listening tests:  
 Roger Batchelor (Hayden Labs)  
 Mark Hockey (Harman International)  
 Andy Whittle (Exposure Electronics)

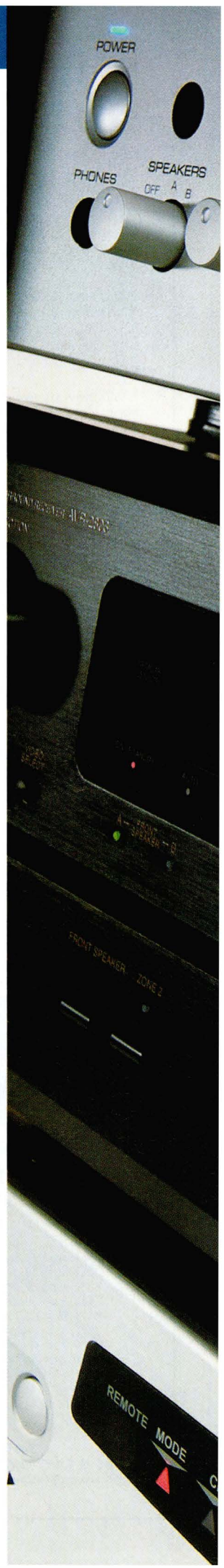

# ROTEL

STEREO INTEGRATED AMPLIFIER RA-1062



## STRUCTURED LAB & LISTENING TESTS

Each of these amplifiers was subject to a penetrating series of lab and listening tests which together provide a unique insight into their performance and compatibility. The latest QC Suite Functional Testing Station was used to probe every crevice of the amplifier's electrical performance including power and current output under dynamic conditions, trends of distortion versus frequency and output, response and output impedance all the way up to 100kHz. These, together with standard noise, crosstalk and DC measurements leave no stone unturned in our quest to get under the skin of these products.

The listening tests were no less rigorous, being conducted under blind, level-matched conditions with the assistance of some of the industry's most experienced panellists. Levels were electrically, rather than acoustically, matched for greatest precision. This means any perceived difference in level between one amp and another is a reflection of that amplifier's character and long-term suitability rather than a result of differences in actual volume.

**No other magazine offers an equivalent test and listening programme for comparative tests.**

## LAB REPORTS: THE BAR GRAPH

Our 3D bar graphs are a simple way of showing how the products in this group compare across five technical parameters. In each case, a percentage is given that falls above or below the group average. In this test, the five parameters are:

**1] Dynamic power output:** Depending on the nature of the amp's power supply, this will be somewhat higher than its *continuous* output and provides an indication of its delivery under realistic, music-like conditions.

**2] Speaker load tolerance:** As the name suggests, this indicates the amplifier's capacity to maintain a given level of performance into tough, low-impedance speaker loads.

**3] Audible distortion:** A measure of how distortion changes with frequency (bass through midrange to treble) and power output. The type of distortion harmonics are also factored into this equation.

**4] Noise:** This is a direct representation of the amplifier's A-wtd S/N ratio, measured with reference to 1W/8ohm.

**5] Overall compatibility:** An important category that not only includes both load tolerance and distortion but also wideband frequency response (for DVD-A/SACD sources) and output impedance.

## OUR BAR GRAPHS: AN EXAMPLE

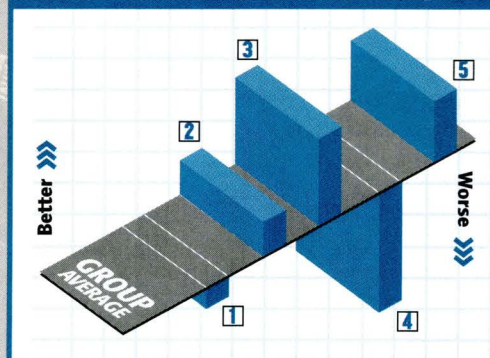



£600 ☎ 01223 203200 🌐 www.arcam.co.uk

## ARCAM DIVA A80

*Can the 'son of A85' live up to its parent's expectations?*

History may well judge Arcam's previous A75 integrated as something of a technical 'glitch', which is probably why its replacement is more accurately described as the 'son of A85'. In practice, the A80 represents a new, standalone design that leverages off the experience of the costlier A85 (now replaced by the A90) while using a more efficient, single-board design. It's a complete solution with MM phono stage, headphone socket, electronic volume/balance and remote control but no bass or treble tone adjustment.

Under the lid, it uses the same high-current Sanken power amp that graced the A85 but with simpler input switching and nine-element starburst graphic display. Fit for purpose then, but not as fancy as the A85/A90 which also benefit from an expansion port utility. The volume knob is actually a rotary encoder that also serves to guide you through its various settings. The little 'satellite' buttons that orbit this control either select or enter your settings, which include balance, record output selection and maximum 'on' volume.

Other options include the ability to set input trims for each channel, normalising the output level of different sources, a 'processor' mode that allows you to set the gain of the amplifier and a 'volume resolution' facility. The latter is used to determine the size of individual volume steps, an alternative to the more common approach of varying the rate of volume adjustment according to the speed with which the knob is rotated.

### SOUND QUALITY

"This is clearly a classy amplifier" announced the panel as the first strains of Eleanor McEvoy's *Yola* reached into the room. The lowest frequencies were not as deep as we've heard them, but what remained was still very punchy and refined, stripping out layers of bass with an ease lost to all but the Rotel. But above all, the sound is inherently 'musical', relaxed but not lazy and delivering gallons of



detail without shouting "hey, look at me".

The A80 controls but does not manipulate the sound, never struggling to keep up with big swings in dynamics which are captured in an expansive, albeit two-channel, field of sound. Criticisms were few but revolved around its slight exaggeration of tight, central images that, quite frankly, were a little 'loose'. The Stabat strings, while free of 'scratchiness' did sound a little flat and in the same plane as the soloist, just as Rebecca Pidgeon's voice was "a little fuzzy about the edges".

Nevertheless while the vocal image was not as focused or rounded as is possible, neither was its articulation, vocal control or clarity obviously compromised. This is after all, a very sophisticated sounding amplifier that exerts an impressive control over all transient detail.

In no way could the A80 be described as wishy-washy, but a very big and clean sounding product that never gives any suggestion of getting out of its depth or being 'pressured' by the music. Like the bigger A85, even with the most demanding speakers it has the capacity to hold and release each note before the next, making for a seamless and agile performance free of muddling. A rare combination of bells, whistles and an enduringly insightful sound. **HFC**

### VERDICT

**SOUND >> 85%**

**FEATURES >> 82%**

**BUILD >> 85%**

**VALUE >> 85%**

Arcam's most successful mid-range amp to date is a thoughtful distillation of all that made the bigger A85 such a cracking product. With slick-acting software, the A80 is a modern audiophile dream.

**HI-FI CHOICE 85%**  
OVERALL SCORE >>



### LAB REPORT

This 'son of A85' is only marginally less powerful, delivering 2x90W/8ohm and 2x135W/4ohm in place of the A85's 2x105W and 2x155W, respectively. The A80 extends this output under dynamic conditions to 2x125W, 210W and 280W into 8, 4 and 2ohm loads, with its 16.7A current limit holding the output at 2x280W into the lowest 1ohm loads. Distortion is much lower than in previous designs – just 0.007% at 20kHz, falling to 0.0003% through the midrange.

It offers a marginally flatter response with very wideband DVD-A/SACD software, stretching to 100kHz at just -0.4dB (A85 was -1.5dB at 100kHz). The biggest difference between the A85 and A80 is reflected in their respective S/N ratios. Both amps have a similar and relatively low 32.2dB and 31.6dB overall gain (input trims notwithstanding) but while the A85 possessed an 85.0dB A-wtd S/N, the A80 offers a very 'below average' 76.8dB. As this increase in noise is smooth, however, its subjective 'dithering' effect may well turn out to be quite euphonic.

### HOW IT COMPARES

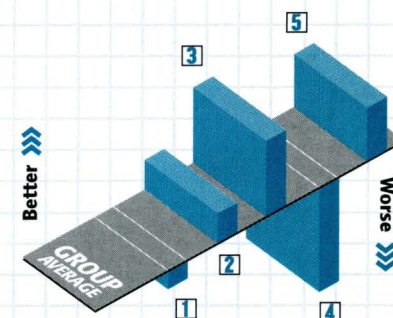

- 1] Dynamic output >> -12%
- 2] Speaker tolerance >> 27%
- 3] Distortion >> 67%
- 4] Noise >> -88%
- 5] Compatibility >> 44%

### SPECIFICATIONS

Measurement	Rated	Actual
Continuous power output (8ohm)	65W	90W
Distortion (1kHz/8ohm)	0.005%	0.0003%
Input sensitivity (CD/Aux)	250mV	710mV



£550 ☎ 01442 260146 🌐 www.creekaudio.com

# CREEK A50iR

*A familiar chassis, tickled-up and graced with a new remote*

**E**ven with one eye shut and both hands tied behind his back, the enthusiast cannot fail to recognise the slim chassis and elegant simplicity of a Creek amplifier. No aesthetic surprises from the new A50iR, but in practice, it's a development of the 4330 MkII, employing pairs of N-channel MOSFETs in what appears to be a quasi-complementary power amp configuration.

The plain silver fascia is punctuated by a rotary selector for its video, tuner, CD and aux/phono inputs and another for volume with a button for tape monitoring. Now, the A50iR comes complete with Creek's attractive ARC-53 remote 'palmset' which, on the face of it, offers control over volume, balance, mute and input selection. However, while the A50iR receives all these commands, only the volume control and relay-fired muting can make any use of them. It's a one-size-fits-all solution, only fully utilised by Creek's top A5350SE integrated amp and forthcoming preamp.

Under the bonnet, it uses a bank of low-ESR reservoir capacitors instead of one or two caps of larger value while the novel power amp stage is bolted to a central heatsink. This vents through a series of slots beneath the casework. Around the back, Creek has fitted a single pair of 4mm speaker outlets.

## SOUND QUALITY

Regular readers will know that our group listening tests are conducted at precisely matched *electrical* levels, so that perceived differences in volume are really a reflection of the amp's character. In this instance, the A50iR was described as "not a loud-sounding amp". Instead, our panellists considered it smooth but also a little slow and perhaps 'tired'.

James Taylor sounded as if he were dragging his feet, his voice lacking its customary energy while any sense of sparkle and acoustic space surrounding the harmonica was also diminished. The simpler sequences were no more vivid but were



slightly less congested, making the best of the amplifier's gentle demeanour. For the A50iR is a mellow performer whose sound washes over rather than directly engaging your senses. The *Stabat Mater* chorus failed to lift its game and rise to the vaults. So, while one listener found the gentle and unfatiguing sound to be very beguiling, another was disappointed by the general lack of "spice, energy and acoustic".

If there is potential in the A50iR's inherently warm and very agreeable balance, it often fails to achieve this promise through a lack of fine and subtle detail. Listen to Rebecca Pidgeon's raw-sounding *Grandmother* from the *Retrospective* SACD, and the edginess in her voice is sweetened just as the copious reverb is dampened to the point where you'd never have known it was there in the first place. A pleasant sound, then, but not strictly faithful to the source.

To be fair, the A50iR is no great departure from previous Creek designs and so fans of those earlier models will find much to appreciate in this latest incarnation. But times move on and the A50iR really needs a pair of lively or even slightly bright speakers to bring it out of its shell. If MOR is your thing, then the A50iR will not disappoint – late night listening every day of the week. **HFC**

<b>VERDICT</b>	
<b>SOUND &gt;&gt; 68%</b>	Creek's latest, remote-controlled amplifier sounds as discreet and unassuming as it looks. Its tolerance of difficult speakers is better than its mere 50-watt specification would tend to suggest.
<b>FEATURES &gt;&gt; 50%</b>	
<b>BUILD &gt;&gt; 70%</b>	
<b>VALUE &gt;&gt; 60%</b>	
<b>HI-FI CHOICE 62%</b> OVERALL SCORE >>	



## LAB REPORT

Bearing in mind this A50iR is derived from the 4330, we were able to make direct comparisons with QC report data from 2000 on a sample of the 4330SE. The newcomer is only fractionally more powerful (2x55W/8ohm vs 2x53W/8ohm) but offers a dynamic output of 2x79W, 145W, 240W and 310W (17.6A) into 8, 4, 2 and 1ohm loads respectively. This is sourced through a usefully low ~0.03ohm output impedance and a response that rolls out gently beyond 20kHz (-0.3dB) to reach 100kHz at -4.0dB.

The passive volume circuit means that the A50iR's gain (amplification factor) is largely determined by the power amp and, at ~33dB, is low but perfectly adequate for today's CD, DVD-A and SACD sources. The A-wtd S/N ratio, however, has deteriorated from the 89dB offered by the 4330SE to just 80.0dB here (re. 0dBW). Distortion, however, is low and very consistent at ~0.006% through the midrange from 1W to 50W/8ohm, even if it does increase to ~0.1% at 20kHz.

## HOW IT COMPARES

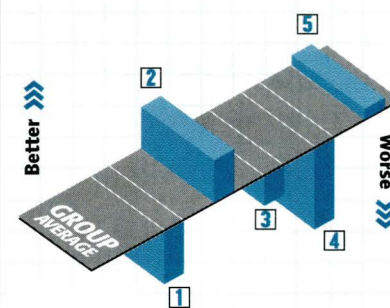

- 1] Dynamic output >> -47%
- 2] Speaker tolerance >> 35%
- 3] Distortion >> -24%
- 4] Noise >> -68%
- 5] Compatibility >> 10%

## SPECIFICATIONS

Measurement	Rated	Actual
Continuous power output (8ohm)	50W	55W
Distortion (1kHz/8ohm)	<0.05%	0.006%
Input sensitivity (CD/Aux)	450mV	470mV



£595 ☎ 0208 900 6801 🌐 www.roksan.co.uk

## ROKSAN KANDY KA-1 MKIII

*Now in MkIII guise, but is the Kandy as sweet as ever?*

While not as sophisticated as the Arcam A80, for example, Roksan's beefy Kandy MkIII still offers full remote control over both input selection and its (motorised) volume control. The fact that its five line, phono and tape inputs are all switched by logic assists in this operation, which is further reflected in the up/down source toggle buttons on its fascia.

Some might say the colour-coding of the triangular 'mode' LED is counter-intuitive: green means 'off', amber means the output is muted by -20dB and red means fully on. The remaining LEDs glow red when the associated input is selected. Additional features include pre/power in/out connections and a headphone socket.

Much of the Kandy's weight is explained by its large, flat, 500VA toroidal mains transformer which feeds two 'mono' power amplifier modules, isolated over to the right and left of the chassis. Both modules are 'joined', however, as they meet on a common switched-output board that supplies the single pair of 4mm speaker terminals. The chassis is formed from 1.6mm sheet steel and the fascia from 6mm aluminium, so the Kandy is as rugged as it is heavy.

### SOUND QUALITY

While this amp had the benefit of following the disappointing Pioneer during our panel tests, its inherently tidy-sounding midrange could not disguise the fact that busy-sounding mixes sounded rather too muddled. Spatially a trifle 'flat', the James Taylor disc also suffered at the hands of this mild confusion, where vocals, percussion, strings and harmonica remained "just a little too mixed-up, lacking individuality and space to breathe". "This is all a bit restricted" suggested another listener, in response to the gentle, even-handed but slightly small-scale rendition of *Stabat Mater*.

There was no question over the tonal accuracy of the strings or, indeed, the subtle



nuances of the solo tenor, who sounded supremely detailed if not quite as passionate as we know to be possible. Then again, this is a relatively 'lightweight' recording, so the muddling heard with denser, typically rock-orientated music was rather less apparent. Midrange clarity is its forte. Rebecca Pidgeon, for example, was painted with real flair, even though the bass line sounded slightly disjointed and the finger drums and other percussive accompaniment were relegated firmly into the background.

If only this mid detail was extended into the low bass and high treble, then the KA-1 MkIII would prove a potent foil for the likes of Rotel's RA-1062. But, as it stands, this Kandy has lost much of its earlier flavour.

While companies with Roksan's specialised knowledge are readily equipped to produce higher-end audio like the Caspian range, lower-cost products call upon other skills and, typically, prohibitive economies of scale. So, while the KA-1 MkIII is an updated version of a well-known amplifier, and despite its robust engineering and generous paper specification, it still failed to excite our panel. It's an amplifier summed-up by our listeners as offering "plenty of character, but little emotion" – a description as apt as any. **HFC**

### VERDICT

SOUND >> 64%

FEATURES >> 75%

BUILD >> 75%

VALUE >> 70%

This is a powerful amplifier capable of sustaining high sound levels and driving a broad spectrum of loudspeakers, but others have simply moved on in delivering a more sophisticated sound quality.

**HI-FI CHOICE 70%**  
OVERALL SCORE >>

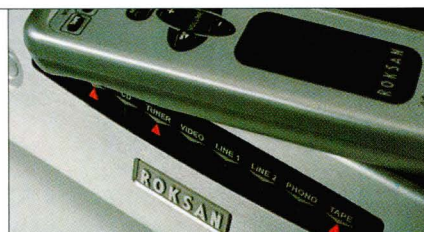

### LAB REPORT

We were able to compare the performance of this MkIII Kandy with the very original version, tested in early 2001. The intervening period has seen its 8ohm power output rise very slightly from 2x125W to 2x135W and still further from 2x170W to 2x195W into 4ohm. Roksan has teased out a higher dynamic power too, now achieving 2x175W, 275W, 325W and 245W into 8, 4, 2 and 1ohm loads, respectively. The asymmetric noise performance of the two ostensibly 'matched' power amp modules remains, with 86.3dB/80.9dB (left/right) in the original model, 85.3dB/92.5dB in this MkIII. The hard-wired earth link that runs between the two power amps and output board probably accounts for this lack of symmetry.

Distortion is now much lower, from the 0.02-0.06% (20Hz-20kHz) of the original to 0.003-0.035% in this model. The response is extended from -0.7dB/20kHz to -0.05dB/20kHz in this version, stretching to just -1.4dB at 100kHz. Finally, stereo crosstalk is improved (reduced) by around 10dB.

### HOW IT COMPARES

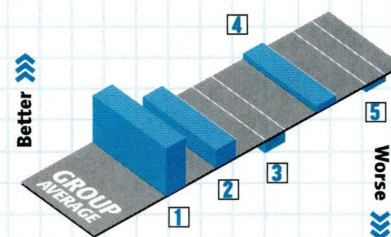

- 1] Dynamic output >> 42%
- 2] Speaker tolerance >> 12%
- 3] Distortion >> -8%
- 4] Noise >> 5%
- 5] Compatibility >> -5%

### SPECIFICATIONS

Measurement	Rated	Actual
Continuous power output (8ohm)	>115W	135W
Distortion (1kHz/8ohm)	<0.005%	0.003%
Input sensitivity (CD/Aux)	470mV	440mV





£595 ☎ 01903 221500 🌐 www.rotel.com

# ROTEL RA-1062

Still the two-channel benchmark at this level

**B**ack in HFC 244, Rotel's then new RA-1062 integrated amp overwhelmed its counterparts in that month's group test. Not only is it still current but it will remain available through 2004, making it the target for all have-a-go-heroes launched this year. The Rotel formula is simple – use a tried-and-tested, symmetrical power amp circuit with a home-grown power supply that includes its own, in-house-wound mains transformer.

With this as its bare bones, exhaustive listening tests are then undertaken to establish the ideal peripheral components, including reservoir and decoupling capacitors, signal path resistors and op-amps. Just as much work goes into optimising the circuit layout as a minor re-routing can exert a big impact on sound quality.

In practice, the two-tone RA-1062 is an evolution of the RA-1060 and now includes an MM phono stage, balance control and substantial WBT-like speaker connectors. A rotary encoder handles the six input options while conventional analogue controls are provided for record out selection, volume and balance adjustment, A+B speaker selection and Rotel's proprietary 'contour' facility. More flexible than tone controls, this contour option offers two levels of bass enhancement, one level of treble lift and a combination of the two, not unlike a loudness boost.

### SOUND QUALITY

Described by our listeners as "punchy, if a little bit forward", the Rotel's very weighty, dynamic and all-round wholesome sound garnered as much enthusiasm as it had under blind conditions some 12 months ago. So, while the RA-1062 made a fine two-channel reference, it was also refreshing to 'validate' our blind listening procedure. If the panel had decided it did not like the amp on this occasion, it wouldn't look good! But the RA-1062 rose further above the pack than it had before, a reflection both of the nature of



its competition this time but also the benefit of having bedded firmly into production.

Now, the reedy rasp of Taylor's harmonica was realised with a deal of bite and realism while the sax really began to 'sing', leaving our listeners eager to hear more. The thump of bass has a decent impact, vocals have real 'presence' and character while percussion sounds crisp, clear and detailed. The choral *Stabat Mater* came in for particular praise, as the soloist was positioned well into the room with a solid, focused image that was busy with characterful detail. The staccato sound of strings also brought life to a performance that had sounded rather flat and relaxed with many of the other amplifiers in the test.

Here is an amp that makes the best of both source and speakers, even the 'audiophile' gear used in our tests. It creates a huge sound vastly out of proportion with its physical stature, a sound succinctly described by our panel as "in the room but not in your face".

Time has not weakened the RA-1062's grip. Much of its competition has striven to achieve a similar standard, but they have fallen back on sound quality. So the RA-1062 is still the two-channel benchmark, offering a generous assortment of features with an unmistakably powerful, purposeful and crisp sound. **HFC**

### VERDICT

**SOUND >> 90%**

**FEATURES >> 70%**

**BUILD >> 85%**

**VALUE >> 90%**

In every respect, the RA-1062 remains the pick of crop. Fabulous sound quality, useful features and the ability to drive almost any speaker in its path maintains its position as the top two-channel dog.

**HI-FI CHOICE 90%**  
**OVERALL SCORE >>**



### LAB REPORT

Running production changes have seen the RA-1062 improve. The +43.5dB gain and 83dB A-wtd S/N have not changed but the output impedance is now more consistent between left and right channels while the response not only extends out to 100kHz but also lifts slightly to +0.5dB. This is about as 'DVD-A or SACD-ready' as an analogue amplifier can get! Distortion remains higher on the left rather than right channel, increasing from ~0.015% at 1kHz closer to 0.5% and 0.25%, respectively, at 20kHz.

Otherwise, the 2x95W/8ohm output now increases to 2x155W/4ohm and 2x130W, 245W, 400W (14.1A) and a whopping 2x525W (22.9A) are possible into 8, 4, 2 and 1ohm loads, respectively, under dynamic conditions. This makes the RA-1062 the most speaker tolerant amplifier in our test. As before, the L2 contour provides a +6.8dB boost at 20Hz, L1 a +3.4dB lift from 80-20Hz, while H provides a high treble boost amounting to +4.5dB at 35kHz. The LH option is a combination of L2 and H.

### HOW IT COMPARES

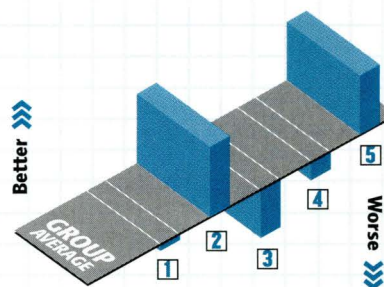

- 1] Dynamic output >> -5%
- 2] Speaker tolerance >> 60%
- 3] Distortion >> -40%
- 4] Noise >> -15%
- 5] Compatibility >> 50%

### SPECIFICATIONS

Measurement	Rated	Actual
Continuous power output (8ohm)	60W	95W
Distortion (1kHz/8ohm)	<0.03%	0.015%
Input sensitivity (CD/Aux)	160mV	185mV



£650 ☎ 01753 888447 🌐 www.denon.co.uk

## DENON AVR-2803

A mid-range AV receiver to complement Denon's universal players

Replacing the AVR-2802 and clearly modelled on the costlier AVR-3803, this mid-market AV receiver houses no less than seven independent power amps all rated at 90 watts into eight ohms. Four optical and two coaxial digital inputs will accept LPCM inputs up to 96kHz (from DVD-Video sources) in addition to compressed Dolby and DTS bitstreams. Decoding for a wide variety of formats is available, including DTS 96/24 and 6.1 channel DTS-ES and Dolby Surround EX. Denon's own 'wide screen mode' extends this to 7.1 channels and even includes an eight-channel preamp output driven via the internal eight-channel master volume control.

Fine control over any sound format that's directed via this internal processing is available via the learning remote and the amplifier's own on-screen menu system. Individual channel levels, delays, sub/speaker crossover frequency and speaker configuration options are all supported as are numerous surround modes for two-channel inputs.

The most straightforward path for two-channel analogue sources is achieved via the 'analogue' input setting and in 'direct' mode. The 'stereo' mode also bypasses any internal DSP but does enable the bass and treble tone control function. The six-channel analogue output from DVD-Audio and SACD players should be routed via the eight external line-level inputs before selecting 'Ext-In' via the front panel or remote control, as we did in our tests. The multichannel master volume control still takes charge, but the signals otherwise bypass any surround DSP.

### SOUND QUALITY

In keeping with its balanced engineering, the AVR-2803 provides an equally balanced and composed sound even if, for all its articulation, there's not the perceived power to drive the music home. The strong bass line on James Taylor's SACD did not overwhelm the amplifier but neither did it have the clout,



impact or sheer presence of the best in this test. Nevertheless, this was judged a very acceptable compromise in the light of the composure and general level of detail realised by this unassuming AV amplifier.

Denon's even-handed presentation suited our classical selection down to the ground, even if it failed to set the world on fire. Without real energy and power in the recording, the relaxed demeanour of the amplifier becomes a little too soporific, failing to realise the thrill of strings and passion in the performers' vocals. For an AV amplifier, this is actually no bad thing in the light of the vigorous soundtracks and effects associated with modern movies. In this respect, the AVR-2803 successfully keeps a lid on the sort of movie and music events that would tip bolder-sounding products over the edge.

Either way, the gentle-sounding *Sabat Mater* really had our listeners engrossed, its multichannel mix developing a very subtle but attractive and not unrealistic acoustic bearing in mind its lightweight balance. Rebecca Pidgeon sounded light, once again, but still very 'musical' and unencumbered as the sound of Irish percussion and pipes from McDougal's men floated across the front of the room. Once again, multichannel audio successfully builds upon a weaker two-channel performance.

In many respects this is the archetypal AV amplifier, with features, technical performance and sound quality all entirely commensurate with the £650 price tag. It's a very well judged product, lightweight in balance but never tripped up by busy or demanding material. An amplifier with a keen sense of its limits and an even keener sense of value. **HFC**



### LAB REPORT

This is another AV amp that, while able to sustain a high (2x130W) output in stereo mode, is less able to maintain this power when all channels are driven together. In practice, the AVR-2803's continuous multichannel output amounts to 5x36W/8ohm, although under dynamic and arguably more realistic conditions this increases to 5x145W, 5x255W and 5x305W into 8, 4 and 2ohm loads. Power tests into lower 1ohm loads are prevented by very fast-acting, short-circuit protection. Continuous two-channel output into 4ohm also drops to 2x105W, suggesting it's best suited to 8ohm speaker systems.

Distortion is well managed, falling to ~0.003% through the midrange and just ~0.012% at 20kHz while its response stretches out to 100kHz with the loss of just -1.7dB. The output impedance is moderate at ~0.08ohm (front) and ~0.06ohm (surrounds). Noise, too, is very low indeed and the AVR-2803 has the widest A-wtd S/N of the group at 92.2dB (front) and 93.0dB (surrounds).

### HOW IT COMPARES

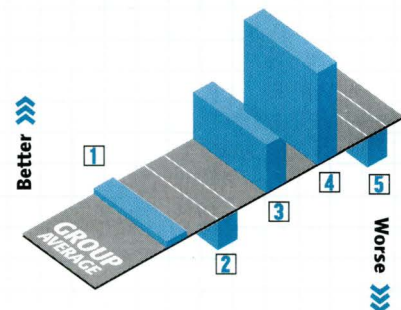

- 1] Dynamic output >> 5%
- 2] Speaker tolerance >> -26%
- 3] Distortion >> 42%
- 4] Noise >> 81%
- 5] Compatibility >> -24%

### SPECIFICATIONS

Measurement	Rated	Actual
Continuous power output (8ohm)	90W	2x130W; 5x36W
Distortion (1kHz/8ohm)	<0.05%	0.003%
Input sensitivity (CD/Aux)	200mV	535mV

### VERDICT

- SOUND >> 72%**  
 >> SUB RATINGS  
 STEREO 62% SURROUND 82%
- FEATURES >> 92%**
- BUILD >> 80%**
- VALUE >> 85%**

Denon has learned to walk the tightrope between affordability and performance, so while the AVR-2803 offers a fairly 'average' sound it's impossible to argue against the flexibility and value of its engineering overall.

**HI-FI CHOICE**  
 OVERALL SCORE >> **82%**



£800 ☎ 01753 789789 🌐 www.pioneer.co.uk

## PIONEER VSX-AX3

Pioneer's entry-level 'AX' series receiver is a true heavyweight

Look quickly and this VSX-AX3 might be mistaken for its bigger brother, the VSX-AX5i, itself derived from the prodigious VSA-AX10i. The 'budget' model has a slightly less robust chassis and, crucially, lacks the i.Link input that facilitates the secure passage of uncompressed multichannel audio from SACD and DVD-Audio. But for a saving of some £300, the VSX-AX3 is ostensibly no less powerful nor any less flexible in its support for 5.1 and 6.1 channel surround formats. The likes of Dolby EX, DTS ES, 96/24 and NEO:6 are all decoded while THX approval brings additional THX Cinema and Music modes.

This very substantial amp comes with Pioneer's MCACC (Multi-Channel Acoustic Calibration) system which, with the aid of a supplied microphone, outputs a series of test tones to gauge the size, distance and output level of each speaker in the room. The appropriate equalisation is then applied to each channel, getting you at least 95 per cent of the way along the road to the ideal set-up. These settings can be manually 'tweaked' once you've got the hang of things.

There are two coaxial and three optical digital inputs, all assignable naturally, plus a bank of eight line-level multichannel audio inputs for use with DVD-A and SACD players. This input is selected via the 'Multi Ch' button above the huge volume control or via remote, and bypasses all Pioneer's extensive DSP except the multichannel level adjustment.

### SOUND QUALITY

The sound of this amplifier is as big and substantial as it looks, but for all its easy-going weight there's also some loss of control and grip throughout the bass. While this contrasts with the more 'rigid' sound typically associated with other highly regulated amp designs, the low frequency rhythm line through James Taylor's *Hourglass* was just too dominant without releasing the multi-layered detail we had heard earlier. This 'resonance'

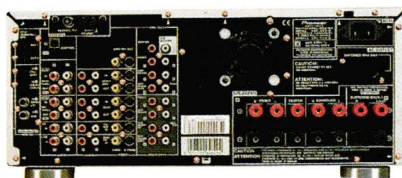

can kill any natural ambience stone dead, for while the music has energy and vibrancy it does not reflect its subtler atmosphere.

The natural ambience of Vivaldi's *Stabat Mater* was crushed, leaving the oddly-stilted strings and solo vocalist lacking both projection and presence. Music that relies on an emotive atmosphere seems stunted by the Pioneer while music that has its own 'energy' can sound overblown and, according to our blind panel, "basically quite uninteresting".

So would the VSX-AX3 be rescued by a riveting multichannel performance? Rebecca Pidgeon sounded far too flat and dry in two-channel mode and while this same, fairly measured balance was unchanged with extra centre and surround channels in tow, at least the performers moved into and around the room. Nevertheless, the live sound of this recording, the twinkling piano, the space invoked by the percussion and vocal reverb were still diminished.

The VSX-AX3's very matter-of-fact performance is surprising bearing in mind that both the VSX-AX5i and VSA-AX10i are leaders in their respective fields and that Pioneer as a company is generally acknowledged to be at the forefront of AV technology. What it suggests is that, somewhere along the line, the baby has been thrown out with the 'AX5i's bathwater. We are left with the irony that while music with a strong bass content sounds powerful but without sufficient control, lighter tracks are controlled to the point of having little atmosphere at all. Make no mistake, the VSX-AX3 may look the part, but it's no cut-priced VSA-AX10i. **HFC**



### LAB REPORT

This is a highly regulated and compensated design, capable of a 2x145W/8ohm and 5x135W/8ohm power output with midrange distortion typically <0.003% up to 100W. Pioneer's tight supply regulation is revealed in the massive 2x260W/4ohm power output, achieved at the expense of very little increase in output under dynamic conditions. Here, the VSX-AX3 can sustain 5x150W, 5x280W and 5x460W into 8, 4 and 2ohm loads (protection activates above ~60W/1ohm) which, while barely above its continuous output capacity, is better than competing AV amps.

Judicious compensation (feedback) is implicated in the low distortion which falls to 0.0004% at ~400Hz and increases to just 0.04% at 20kHz (five channels, 10W/8ohm). Front and surrounds are matched to within 0.08dB (just -1.3dB down at 100kHz) while the output impedance(s) are around 0.03-0.1ohm across the audio band. Interchannel crosstalk could be better (~55dB at 20kHz) but A-wtd S/N ratios are on-target at 86.0dB across all channels.

### HOW IT COMPARES

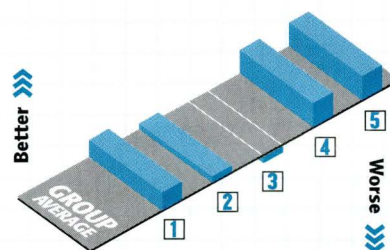

- 1] Dynamic output >> 15%
- 2] Speaker tolerance >> 5%
- 3] Distortion >> -5%
- 4] Noise >> 19%
- 5] Compatibility >> 21%

### SPECIFICATIONS

Measurement	Rated	Actual
Continuous power output (8ohm)	100W	2x145W; 5x135W
Distortion (1kHz/8ohm)	<0.09%	0.003%
Input sensitivity (CD/Aux)	335mV	410mV

### VERDICT

**SOUND >> 58%**  
 >> SUB RATINGS  
 STEREO 52% SURROUND 64%

**FEATURES >> 94%**

**BUILD >> 85%**

**VALUE >> 72%**

Here is a multichannel amplifier with the sort of heritage that most other manufacturers would kill for but that, ultimately, makes for a far better home cinema solution than a bridge to the audiophile high-end.

**HI-FI CHOICE 72%**  
 OVERALL SCORE >>



£300 ☎ 01932 816000 🌐 www.sony.co.uk

## SONY STR-DB790

*It's significantly cheaper than it looks and sounds – is it a ringer?*

**A**t the risk of jumping directly to our conclusion, no-one in our blind panel could believe the STR-DB790 was pitched at £300. They were even less convinced when, at the day's end, they were finally allowed to grapple with its sophisticated RM-LG112 learning remote control and navigate its on-board menu system. Sure enough, the STR-DB790 lacks the automated speaker calibration option of its costlier partners and even lacks the sort of sophisticated OSD to which we've become accustomed. Nevertheless, the various speaker set-up, level, EQ, customise and tuner menus are just as easily navigated via the amplifier's own display and +/- selection knobs (or, indeed, the matching remote control).

The physical construction of this amplifier is not quite as sturdy as its £600 'competition' just as the volume control, for example, feels a little less secure. But these are acceptable compromises in the light of its six individual power amplifiers and full compatibility with Dolby EX, DTS ES and 96/24 media. Hooking up to the six multichannel line inputs is straightforward enough for DVD-A and SACD users, but selecting this 'Multi Ch' option is not because the input is only accessible via remote. It's also worthwhile tracking down the 'D.Pwr' facility and switching off all peripheral DSP before settling back to enjoy these analogue inputs (two-channel CD included) in their unadulterated form.

### SOUND QUALITY

This is a livelier-sounding amplifier than the gentle two-channel Creek or very composed Denon, for example, but its bass is still extended and "rolls better with the musical punches" as one listener suggested. Elegant recordings, like the James Taylor SACD, are "interesting but not arresting" for despite the good extension, resilience and punchiness of the sound there's still not the cleanliness or articulation we know to be possible. Vocal



sibilance, for example, is not disguised while there's a hint of roughness to brassy percussion that brings some added colour and, indeed, some slight added 'tension' to the music.

However, take a gloriously open recording like Vivaldi's *Stabat Mater* and the STR-DB790 really comes into its own with the strong, central image of the soloist counterpointed by the more distant sound of strings that echo back into the chamber. The sublime skill of the vocalist is easy to admire, along with the professionalism of the other players, as the Sony pulls out plenty of spatial detail without sounding hard or aggressive.

These qualities grow as the amplifier is used in multichannel mode, the sound flooding effortlessly into the room creating an ambience and palpable, musical tension that was only suggested in two-channel mode. "This sounds awesome" suggested one listener as Rebecca Pidgeon moved smartly into the room, her voice vivid and articulate but rather less forced than it had sounded in two-channel mode. The multichannel rendition builds a bigger and more impressive sound, placing you in the centre of the action without drilling you with detail – the spaciousness of its sound speaks volumes.

What a result! The benefits of a blind listening panel has revealed, once again, the true quality of an ostensibly 'ordinary' budget AV amplifier. So the STR-DB790 is unveiled as a very fluid and communicative amplifier with a strong but controlled bass that, while very impressive with stereo material, really shows its mettle with multichannel music. A fabulous surround sound quite out of keeping with the ludicrously low asking price. **HFC**



### LAB REPORT

While the STR-DB790 neither looks, weighs or performs like any other £300 multichannel amplifier, it is still built to a price, and there's some lack of symmetry between the front and surround amps. For example, the 'DB790 will sustain 2x112W/8ohm through the front channels but only 5x32W/8ohm through all channels simultaneously. Under dynamic, music-like conditions this increases markedly to 5x125W and 5x195W into 8 and 4ohm. However, current limiting on the surrounds means they are restricted to 140W/2ohm while the front channels have sufficient headroom to deliver >160W.

Output impedance is slightly higher at ~0.2ohm and ~0.14ohm (surround vs front) as is distortion at 0.018% vs 0.014%, respectively. Similarly, while the front channel responses are almost entirely flat to 100kHz (-0.08dB), the surrounds roll (inaudibly) away beyond 20kHz to reach -0.6dB at 100kHz. The S/N ratio, meanwhile, is consistent at 87.6dB (front) and 86.9dB (surrounds) re 0dBW.

### HOW IT COMPARES

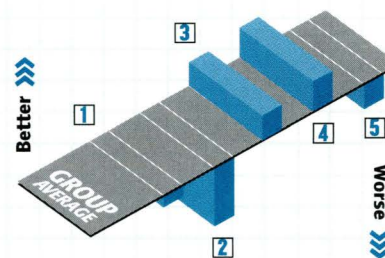

- 1] Dynamic output >> -12%
- 2] Speaker tolerance >> -48%
- 3] Distortion >> 18%
- 4] Noise >> 27%
- 5] Compatibility >> -20%

### SPECIFICATIONS

Measurement	Rated	Actual
Continuous power output (8ohm)	100W	2x112W, 5x32W
Distortion (1kHz/8ohm)	<0.09%	0.018%
Input sensitivity (CD/Aux)	150mV	120mV

### VERDICT

- SOUND >> 82%**  
 >> SUB RATINGS  
 STEREO 75% SURROUND 88%
- FEATURES >> 86%**
- BUILD >> 77%**
- VALUE >> 98%**

Frankly, no six-channel amplifier has any right to sound this good at such a preposterously affordable price. But, for whatever reason, Sony's STR-DB790 does and rewrites the book on value en route.

**HI-FI CHOICE** **90%**  
OVERALL SCORE >>



£800 ☎ 01923 233166 🌐 www.yamaha-audio.co.uk

## YAMAHA RX-V1400DS

*The past masters of AV have returned with a multichannel bang*

Time was when Yamaha all but 'owned' the AV market with sophisticated, DSP-driven amps that set the technological pace for others to follow. But follow they did and, in the case of Pioneer and Denon, often overtake Yamaha in respect of sound quality if not features. Yamaha has redoubled its efforts, and receivers like this RX-V1400 are the result – an integration of seven independent power amps with powerful, custom DSP. All Dolby EX and DTS ES 6.1 channel formats are accommodated while the extra amp drives Yamaha's 'Presence' speaker outputs used by various examples of its DSP soundfield modes.

Yamaha has its own version of Pioneer's MCACC called YPAO (Yamaha Parametric Room Acoustic Optimiser) which automatically checks your speaker connections, assesses the distance(s), size, level and response(s) before applying a truly parametric equalisation. Once again, while YPAO gets you 95 per cent of the way there, it's always possible to dip into the graphical menu and 'fine tune' a host of parameters to suit your personal taste. Frankly, with 55 variations on 31 different 'hi-fi' and 'cinema' DSP surround modes, the RX-V1400 brings a whole new meaning to flexibility.

This receiver even includes powerful video processing like composite/S-Video to component upconversion and correction for lipsync errors, provided both audio and video are routed through the RX-V1400. The six-channel analogue inputs, meanwhile, can be expanded to eight-channel by using the DVD input for the front L/R channels. Otherwise, selecting 'Multi Ch Input' bypasses all internal downmixing and DSP and provides the cleanest path for SACD or DVD-Audio.

### SOUND QUALITY

While not exactly neutral, this amplifier still has a very bubbly and tactile sound that will make it stand out in a crowd at your local

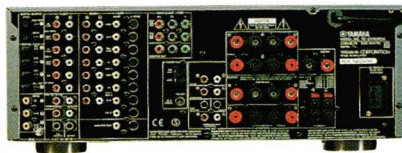

dealer. The bass is sufficiently powerful to convey a deal of weight without sounding overblown while the treble has what was described as "that artificial, plinky plonky quality that so many people seem to like". This big and easy West Coast sound suits the likes of Crosby, Stills and Nash, the Eagles and Neil Young, for example, but also did a pretty good job with Rebecca Pidgeon. She may not have sounded quite so seductive as she had with the Rotel, for example, but was still broadly appreciated by our listeners!

The bass line was judged to be slightly disjointed, but the RX-V1400 retains a truly communicative quality with decent vocal material, a quality that put this Yamaha ahead of all bar the remarkable Sony in two-channel mode. As ever, a merely good-sounding amplifier becomes a rather better product when judged in multichannel mode. With six channels on song, vocalists now sounded bigger and bolder, striding purposefully into the room, supported by a transparent acoustic and instrumental counterparts that were far easier to interpret and enjoy. This amplifier really has a lot going for it. Sure enough, it's not quite the last word in tonal detail, but neither is its performance grey or unimaginative.

This is a very consistent-sounding amplifier whether used in two or multichannel mode. It also represents a very dependable choice, unfazed by the most diverse musical styles or, indeed, by the number and orientation of speakers in a complex, multichannel setup. Frankly, the RX-V1400 is the sort of product that will stand out in a dealer demo but that should also ensure long-term listening satisfaction. **HFC**



### LAB REPORT

Unlike many mid-priced AV amps, this has a supply robust enough to support very high, *continuous* power outputs in both two (2x175W/8ohm) and multichannel (5x107W/8ohm) modes. In dynamic conditions, this increases further to 5x210W/8ohm, 5x330W/4ohm and 5x380W/2ohm, although loads as low as 1ohm are judged to be a 'short' and Yamaha's output protection swiftly activated.

Distortion is higher at ~0.015% up to about 10W output, but settles back to ~0.004% over the bulk of its dynamic range through mid frequencies. Through both bass and treble, distortion increases slightly to ~0.015%. The output impedance(s) are low enough at ~0.045ohm (front channels) and ~0.065ohm (surround channels) while the response(s) are very extended – flat to 20kHz and just -0.9dB down at 100kHz. Front/surround channel balance is within tolerance at 0.18dB (re. 0dBW) although the A-wtd S/N ratios are slightly different at 87.1dB and 92.1dB. Either way, this is a solid performer.

### HOW IT COMPARES

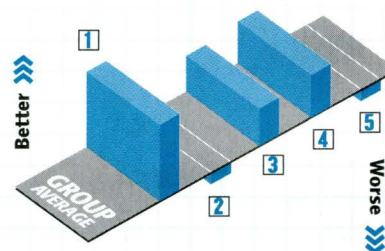

- 1] Dynamic output >> 66%
- 2] Speaker tolerance >> -11%
- 3] Distortion >> 31%
- 4] Noise >> 33%
- 5] Compatibility >> -10%

### SPECIFICATIONS

Measurement	Rated	Actual
Continuous power output (8ohm)	110W	2x175W, 5x107W
Distortion (1kHz/8ohm)	<0.04%	0.015%
Input sensitivity (CD/Aux)	20mV	245mV

### VERDICT

**SOUND >> 80%**  
 >> SUB RATINGS  
 STEREO 75% SURROUND 85%

**FEATURES >> 95%**

**BUILD >> 85%**

**VALUE >> 85%**

With no less than seven amplifiers and a fully automated set-up on-board, the RX-V1400 is equipped for every occasion. It's a good two-channel product, but a better multichannel amplifier for DVD-A and SACD sources.

**HI-FI CHOICE**  
 OVERALL SCORE >> **85%**

# CONCLUSIONS

*As multichannel amps improve, their stereo counterparts need to work harder to keep ahead*

**A**lthough this test was hardly exhaustive, it includes the major brands and is broadly representative of market trends.

The real point here is that while two-channel audio is the be-all and end-all of the four integrated amps, it is just the beginning for the AV receiver. On almost every level – engineering, features, flexibility and potential – the AV receivers represent better value than their equivalently-priced stereo cousins. Buy one to enjoy CD as well as the future benefits of multichannel SACD and DVD-Audio, and home

cinema comes bundled almost as a 'free upgrade'. This puts pressure on traditional stereo amps to offer a very special sound quality, which, sadly, neither the Creek nor Roksan could produce.

Not that the AV receivers were a universal success. The Pioneer disappointed, though it's still hard to understand how such engineering can be delivered for the price. Even Denon's AVR-2803, a *tour-de-force* in its own right, is pretty representative of the 'average' £600-£700 AV receiver and a good match for its various

universal disc players. Yamaha's RX-V1400 costs a little more but has more channels, higher power output and more DSP soundfields than anyone could need. It sounds impressive with two-channel material but really comes alive with SACD and DVD-Audio.

Sony's STR-DB790 six-channel amp costs less than any of the two-channel amps in our test but has a sound that puts both the Creek and Roksan to shame.

Of course, there will always be those for whom two-channel audio remains king and stereo

electronics the only solution. For those individuals, Arcam's A80 is very special, a marriage of modern flexibility with decades of musical know-how in a very elegant package. But judged on sound quality alone, Rotel's RA-1062 was still substantially more engaging than all the other amps in this test. The fact that this subjective performance is reinforced by massive reserves of power suggests that this 'mere 60-watter' is a lion in sheep's clothing, ready to devour all sub-£800 stereo competition. **HFC**

## TRY THEM WITH THESE

### DISC PLAYERS

**ARCAM DIVA CD73T** £400  
A finely judged player that will do justice to the stereo amps in the group.

**DENON DVD-2900** £850  
Arguably the best all-round universal disc player to date below £1,000.

### SPEAKERS

**B&W DM603 S3** £600  
Great bass and midrange but the top-end is better suited to 'sweeter' amps.

**CASTLE CONWAY 3** £930  
Amps like the Sony and Rotel will bring this cultured-sounding speaker to life.

## HINTS AND TIPS

- ⊕ Don't assume the input labelled 'CD' or 'DVD' is best. Other line level inputs ('aux', 'tuner' etc) may have a higher input impedance that better suits your silver disc machine.
- ⊕ Make sure your multichannel speakers match tonally – It is better

to use five matching satellites and a sub than larger, disparate models.

- ⊕ Not all amps have captive mains leads, so you can experiment with an aftermarket IEC cable or construct your own from a 13A (or higher) solid core twin and earth.

## AMPLIFIERS AT A GLANCE



	TWO-CHANNEL STEREO				SIX-CHANNEL AV			
MAKE MODEL	Arcam Diva A80	Creek A50iR	Roksan Kandy MkIII	Rotel RA-1062	Denon AVR-2803	Pioneer VSX-AX3	Sony STR-DB790	Yamaha RX-V1400
PRICE	£600	£550	£595	£595	£650	£800	£300	£800
SOUND	██████████	██████████	██████████	██████████	██████████	██████████	██████████	██████████
FEATURES	██████████	██████████	██████████	██████████	██████████	██████████	██████████	██████████
BUILD	██████████	██████████	██████████	██████████	██████████	██████████	██████████	██████████
VALUE	██████████	██████████	██████████	██████████	██████████	██████████	██████████	██████████
OVERALL	██████████	██████████	██████████	██████████	██████████	██████████	██████████	██████████
CONCLUSION	A sophisticated stereo model offering impressive sonic refinement and good value for money.	Sounds as discreet as it looks, with good tolerance of difficult speakers.	High sound levels but its rivals have simply moved on with a more sophisticated sound quality.	Fabulous sound quality, useful features and the ability to drive almost any speaker. Top stereo dog.	Merely 'average' sound but it's impossible to argue against the flexibility and value of its engineering.	Outstanding heritage, but makes for a far better home cinema solution than a bridge to the audiophile.	No six channel amplifier has any right to be able to sound this good at such a ridiculously affordable price.	Equipped for every occasion, it's a good two-channel product, but better for multichannel DVD-A and SACD.
<b>KEY FEATURES</b>								
LINE	5	4	6	3	6 + multichannel	5 + multichannel	4 + multichannel	5 + multichannel
TAPE	1	1	1	2	3	4	3	4
PHONO	MM	MM	MM	MM	MM	MM	MM	MM
PRE OUT	Yes	Yes	Yes	Yes	Yes	Yes	Yes	Yes
REMOTE	Yes	Yes	Yes	Yes	Yes	Yes	Yes	Yes
<b>LAB CONCLUSIONS</b> E = EXCELLENT • G = GOOD • A = AVERAGE • P = POOR								
POWER	90W <b>A</b>	55W <b>P</b>	135W <b>G</b>	95W <b>A</b>	130W <b>G</b>	135W <b>G</b>	112W <b>A</b>	175W <b>E</b>
DYN POW.	125W <b>G</b>	79W <b>A</b>	175W <b>G</b>	130W <b>G</b>	145W <b>G</b>	150W <b>G</b>	125W <b>G</b>	210W <b>E</b>
CURRENT	16.7A <b>G</b>	17.6A <b>G</b>	15.7A <b>G</b>	22.9A <b>E</b>	12.3A <b>A</b>	15.2A <b>G</b>	8.9A <b>A</b>	13.8A <b>G</b>
DISTORTION	0.0003-0.007% <b>E</b>	0.006-0.1% <b>A</b>	0.003-0.035% <b>G</b>	0.015-0.5% <b>P</b>	0.003-0.012% <b>G</b>	0.0004-0.04% <b>G</b>	0.005-0.018% <b>G</b>	0.004-0.015% <b>G</b>
NOISE	-76.8dB <b>P</b>	-80.0dB <b>P</b>	-85.3dB <b>A</b>	-83.0dB <b>A</b>	-92.2dB <b>E</b>	-86.0dB <b>G</b>	-86.9dB <b>G</b>	-87.1dB <b>G</b>

**RICHER Sounds**  
THE UK'S BUSIEST HI-FI & HOME CINEMA RETAILER

# SALE!

**RICHER Sounds**  
THE UK'S BUSIEST HI-FI & HOME CINEMA RETAILER

## STORES NATIONWIDE

- LONDON 020 8466 6565
- BROMLEY 020 7352 8496
- CHELSEA 020 7626 8006
- CITY 020 8667 1100
- CROYDON 020 8566 4422
- EALING 020 7329 7374
- FARRINGDON 020 8549 9999
- KINGSTON 020 7403 1201
- LONDON BRIDGE 020 7722 3359
- SWISS COTTAGE 020 7831 2888
- WEST END/HOLBORN 020 7831 2888
- BELFAST 028 9032 1332
- BIRMINGHAM 0121 643 1516
- BOURNEMOUTH 01202 720 380
- BRIGHTON 01273 673 333
- BRISTOL 0117 973 4397
- CAMBRIDGE 01223 304 848
- CARDIFF 0292 039 9988
- CHELLENHAM 01242 572 572
- CHESTER 01244 400 102
- COLCHESTER 01206 56 31 31
- COVENTRY 024 7655 5959
- EDINBURGH 0131 226 3544
- EXETER 01392 272 772
- GLASGOW 0141 226 5551
- GUILDFORD 01483 449 222
- HULL 01482 329 289
- LEEDS **RELOCATED** 0113 245 5717
- LEICESTER 0116 255 4656
- LIVERPOOL 0151 708 7484
- MAIDSTONE 01622 67 70 67
- MANCHESTER NORTH 0161 773 0333
- MANCHESTER SOUTH 0161 480 1700
- MIDDLESBROUGH 01642 211 115
- MILTON KEYNES 01908 608 908
- NEWCASTLE 0191 230 1392
- NORWICH 01603 620 860
- NOTTINGHAM 0115 924 1551
- OXFORD 01865 243 444
- PLYMOUTH 01752 222 256
- PRESTON **NEW** 01772 888 757
- READING 0118959 1111
- ROMFORD 01708 747 727
- SEVENOAKS 01752 456 573
- SHEFFIELD 0114 266 1616
- SOUTHAMPTON 0238 023 1311
- STOKE (HANLEY) 01782 289 009
- SWINDON **RELOCATED** 01793 612 652
- WATFORD 01923 218 888

Ring our call centre for a guide to stock availability.

Due to variations in store sizes and our massive sales, inevitably stores occasionally run out of key lines. If you experience ANY problems getting hold of a particular item at your local branch, please call our General Stock Enquiry Line on:

**0870 366 1296**  
(NATIONAL RATE)

who will try their best to locate the stock for you.

OR FAX: **0870 900 1881**  
(NATIONAL RATE)

OR EMAIL: [customerservices@richersounds.com](mailto:customerservices@richersounds.com)  
Calls will be answered in person 10-6pm Mon-Fri, 10-5pm Sat, Bank Holidays 12-4pm

**MASSIVE RANGE OF PRODUCTS IN STOCK**

**R2 DVD Machines Limited Stock**

**WE'LL BEAT ANY COMPETITOR'S PRICE 'TIL IT HURTS and give you up to**

**100!**  
Ask in-store for details.

**WE ARE OPEN BANK HOLIDAYS**

**12-4PM** (Local Rate)  
PLEASE CALL FOR NORMAL STORE OPENING TIMES

## SPEAKER SAVINGS!

**M71i (beech)** **70 OFF TSP**

WHAT HI-FI? ★★★★★

LOWEST PRICE GUARANTEED!

**59.95** Pair  
BRAND NEW BOXED

TSP £129.95

## AWESOME AMPLIFIERS!

**Cambridge Audio A1 v.3** **30 OFF TSP**

Picture Approximate

"Strong and effortless with a wide range of equipment... a bargain piece of hi-fi with a magic all of its own," said What Hi-Fi? SOUND AND VISION magazine. **WERE £99.95**

LOWEST PRICE GUARANTEED!

**69.95**  
BRAND NEW BOXED

## AWARD-WINNING DVD PLAYER!

**Pioneer DV360** **60 OFF TSP**

"This Pioneer handles everything with ease... any way you look at it, this is a very tempting proposition from Pioneer" - *What Video* magazine. **TSP £119.95**  
**WERE £99.95 £79.95 £69.95**

**SALE!**  
**59.95** REGION 2  
**69.95** MULTI-REGION  
BRAND NEW BOXED

## DAB TUNER SAVINGS!

**ES SP110** **40 OFF TSP**

Also available SP111 with FM for only **£59.95**

LOWEST PRICE GUARANTEED!

**79.95**  
BRAND NEW BOXED

WERE £119.95

## CRAZY CD PLAYER SALE!

**marantz CD5400** **50 OFF TSP**

"The backbone of the Marantz's impressive delivery is the level of detail it uncovers. This means individual instruments are easy to follow and the overall performance sounds highly believable" - *What Hi-Fi? SOUND AND VISION* magazine. **TSP £149.95**

**SALE!**  
**99.95**  
BRAND NEW BOXED

## RAVISHING RECEIVERS! RDS

**YAMAHA RXV340** **80 OFF TSP**

"It democratises home cinema without sacrificing performance too dramatically. And that, intellectually, makes it a winner" - *What Video* magazine. **TSP £199.95**  
**WERE £129.95 £149.95**

**SALE!**  
**119.95**  
BRAND NEW BOXED

## SPECTACULAR CD RECORDERS!

**SONY RCDW3** **80 OFF TSP**

"Given its great design, friendly price and ease of use, the wait has been worthwhile" - *What Hi-Fi? SOUND AND VISION* magazine. **TSP £249.95 WERE £199.95**  
**£189.95 £179.95**

**SALE!**  
**149.95**  
BRAND NEW BOXED

## STUNNING CD PLAYERS!

**SONY SCDXE680** **150 OFF TSP**

This astonishing CD player is also capable of playing SACDs, and exhibits breathtaking authority and scale in both modes of operation - and with a massive price reduction, too! **TSP £399.95 WERE £299.95**

**SALE!**  
**149.95**  
BRAND NEW BOXED

## CRACKING CD PLAYERS!

**Cambridge Audio AZUR 640C** **AMAZING VALUE**

"This is a fine all-round performer, capable of scaring a few pricier machines" raved *What Hi-Fi? SOUND AND VISION* magazine when awarding the 640C five stars.

Also available Cambridge Audio Azur 540c for only **£199.95**

**LOWEST PRICE GUARANTEED!**  
**249.95**  
BRAND NEW BOXED

## SIZZLING DVD/CINEMA SYSTEMS!

**SONY DAVS550** **150 OFF TSP**

LOWEST PRICE GUARANTEED!

**249.95** REGION 2  
**269.95** MULTI-REGION  
BRAND NEW BOXED

WERE £349.95 £299.95

## TOSHIBA 42WP27B

**42" Plasma Screen**

**2200 OFF OSP**

**LAST FEW TO CLEAR**  
Some may be ex-display at this price.

## SIZZLING DVD RECORDER DEALS!

**PHILIPS DVDR75 DVD RECORDER** **400 OFF TSP**

"The DVDR75's copies are remarkably faithful. Thankfully, no compromises seem to have been made in accommodating the recording features" - *Home Cinema Choice* magazine. Large quantity of slight seconds to clear. **TSP £599.95 WERE £199.95**

**SALE!**  
**199.95** REGION 2  
**219.95** MULTI-REGION

**Also available Relisys 42" plasma screen including FREE tuner, stand and pair of speakers for only £1999.95**

**SALE!**  
**2299.95** INC VAT  
**1957.40** EX VAT

**We stock the UK's biggest range of Plasma Screens, and always have over 1,000 pieces in stock! Please come in for a demo/bargain!**

**PLASMA SCREEN**  
Picture quality is pin-point accurate, and colours are richly reproduced, without being overblown.  
**TSP £4499.95 WERE £2499.95**

**For a free 24 page bargain packed catalogue call**  
**0845 1 300 200**  
(Local Rate)

**FREE!** MUG, BLANK MD, CDR OR TAPE FOR EVERYONE!

**Simply present this voucher at your local store. No purchase necessary.**  
ONE VOUCHER/ITEM PER CUSTOMER. WHILE STOCKS LAST. HI-FI CHOICE MAGAZINE (NOT IN CONJUNCTION WITH ANY OTHER OFFER/PROMOTION)

Visit our 'LIVE' online catalogue at [www.richersounds.com](http://www.richersounds.com)

PLEASE QUOTE THIS AD WHEN CALLING. AVAILABLE UNTIL 26TH FEBRUARY 2004. WHILE STOCKS LAST. HUNDREDS MORE BARGAINS IN STORE. Prices correct at time of going to press. £&O.E. All trademarks are acknowledged. All prices include VAT

# AUDUSA



## AUDUSA EUPEN CSA 2.5 AUDIO AC MAINS CABLE

**GNLM 05/04 and GNLM 05/2.5 ( CSA 2.5) Cable with FERRITE TECHNOLOGY** - A polymer material mixed with a considerable quantity of homogeneously fine high quality ferrite powder is extruded around the copper conductors. As a ferromagnetic material, it will go through hysteresis loops whenever it is under influence of an alternating magnetic field. Consecutively magnetizing and demagnetizing the material will cause considerable losses of high frequency energy.

This energy is absorbed in the ferrite grains and converted into heat. The GNLM cables which in addition to the above described ferrite technology is further protected with a foil shield and a drain wire and specifically manufactured for High End audio use. **Said by some to be the most neutral sounding audio ac mains cable on the market.**

Fitted with IEC (Martin Kayser) and MK Tough plug Cable can be supplied fitted to our all steel 4, 6 and 8 way distribution blocks. We can rewire the distribution blocks with Eupen cable as an extra cost option. Refer to our web site for details.

**AUDUSA – OOM Silverlink OCC balanced speaker cable** – stranded, silver on OFHC plus three strands of OCC (Ohno Continuous Casting - single crystal copper) for improved bass performance. Mylar infill and with designed in protection against RF and EMI. conductor of 3mm diameter (approx 8 gauge). Cable Overall Dimension: 14.72 mm.

### GNLM 05/2.5 (CSA2.5)

£48 for 1.0m, £58 for 1.5m, £68 for 2.0m. Off the reel £30 for 1st meter, £20 per m thereafter.

Eupen GNLM 05/2.5 (CSA 2.5) shown with Marínco IEC 320 will be fitted at extra cost.

### GNLM 05/04

£58 for 1.0m, £72 for 1.5m, £86 for 2.0m. Also available of the reel.

Both GNLM cables are available for export.

**SILVER SILVER** - upgrade the cable with silver plated contacts on IEC and and MK plug for £6. AUDUSA

- Eupen and LAT AC-2 mains cable available with 16 amp IEC ( for certain models of amps by Krell, MF, Levinson etc), Marínco/Wattgate IEC 320, Figure of eight, Bulgin, Hubble, European Schuko, French, Australian, Swiss, Danish, Neutrik and other plugs see our web site for IEC's, MK plugs RCA and Banana connectors with silver plate contacts and other audio and ac mains connectors

## LAT International AC-2 AUDIO AC MAINS CABLE

We have developed a cabling (weaving) pattern along with an unusual shielding/filtering system that gets rid of the garbage that contaminates your components. The difference you hear with our cord is astounding. Our power cord takes advantage of silver in its design through use of our proprietary Silverfuse conductors. The conductors are 10 gauge and with PTFE; the best insulation available. Fitted as standard with IEC / MK Toughplug. . 60cm £62, 90cm £75, 1.2m £88, 1.5m £101, 1.8m £112 etc Other lengths available and off the reel. **4,6 and 8 way all steel mains distribution blocks** fitted with **UK, Schuko or USA sockets.** CE tested & approved mains distribution units manufactured of heavy gauge steel, finished in black and fitted with high quality 13amp sockets. It has no filters, circuit breakers, surge protection, transformers, resistors, capacitors, LED's, on/off switches, chokes, regulators, just fitted with 1m of AC-2 mains cable. From £166 for 4 way, £198, 6 way, £229 for 8 way.

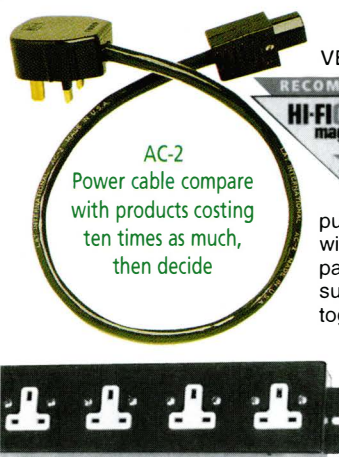

AC-2  
Power cable compare  
with products costing  
ten times as much,  
then decide

### SILVERFUSE

is a near alloy of silver and copper. IT IS NOT SILVER PLATED OR SILVER CLAD. Plating (or clad, which is the same thing as plating) causes a dioding effect when signal is passed through resulting in brightness and distortion. The Silverfuse process starts with seven nines OFHC copper wire with a diameter that is slightly larger than the required size. It is then pulled through a trough of molten silver. The wire with a silver deposit, is then forced through a compacting die where it is subject to tremendous pressure. The silver and the high purity copper are fused together into a near alloy. The compacting fusion also reduces the wire diameter to the desired size. No dioding subsequently occurs with this process. The result provides for the benefits of silver; which are excellent definition and clarity, with the high purity copper benefits of warmth and mellowness.

LAT INTERNATIONAL Inc USA - Analogue, Digital and Video interconnects and Speaker cable better than most others at double the price.

## SUNFIRE CORPORATION - Snohomish USA



New for 2003 Sunfire Ultimate - world's most powerful home cinema

Receiver. 7 x 200 watts, Cinema Seven power amps, 7 x 200 and 7 x 400

Signature True SubWoofer 13 inch cube True Sub MKIV 11 inch cube and Junior Sub Woofer 9 inch cube -all with two drivers, to as low as 16hz, 116 SPL and 360 cu ins of air movement, 1200 or 2700 watt patented amp technology. Solid state power amps 2 channel (2 x 300 and 2 x 600) and 5 channel (5 x 220 watts and 5 x 430 watts patented amp technology (no heat sinks), Classic tube preamp and Theatre Grand III processor preamp

www.audusa.com

T: 020 8241 9826, 020 8264 0249 F: 020 8241 0999 E: sales@audusa.com



*R*

# RETRO

LINN ISOBARIK



This is the story – alright, part of the story – of one of the great high-end loudspeakers, the Linn Isobarik. Linn Product's supremo Ivor Tiefenbrun tells how the Isobarik programme got under way.

"When we started it was clear to me that turntables were worse than loudspeakers, that the task of getting information out of the groove was absolutely fundamental. When we developed the LP12, we had to go around selling it, by proving that the LP12 offered better performance in demonstrations. People would put their ears to the loudspeaker, and they would notice that when you played a triangle through it, the bass unit will go in and out, which was nothing to do with what was on the record. The system generated noise. So I asked one of our young engineers to make a loudspeaker that would work properly down to DC, without the noise and resonances. He said it was impossible. If it was possible, someone would have done it."

"But we worked on it, reasoning that a bass driver is driving a spring by compressing the air mass inside the box. To balance the force on the diaphragm, could we not use a second internal driver driven in the same way as the first to take up the load as the main one moved? The original experiments were with Lowther drive units. We machined a cabinet, put it all together – and it didn't work. There was almost no bass at all. Just a knocking sound. And then we realised that the knocking was coming from the speaker, and that it was the groove noise from the record. We soon realised it was doing what we thought it should after all, but the amplifier – a 300-watt Crown – couldn't cope. Then I was introduced to Julian Vereker of Naim Audio who had an amplifier that was only 50 watts, but with lots of current, which could drive it in a sweet and subtle way."

The early Isobariks were made with clip-on grilles, and the sides glued on. It was the first loudspeaker with solid stands, and the first to use spikes, which stood on screws that were let into the floor. Some important crossover and cabinet revisions followed, but the basic layout remained the same – two B139s for the bass, plus B110s and T27s for the mid and treble, with a combination of upward and forwards firing drivers to achieve a

**"Our engineer said it was impossible to make a speaker that would work down to DC. But we worked on it."**

widely dispersed sound. Later the tweeters were changed to SEAS, then Scanspeak, and finally SAE. After a while Linn changed the style of the enclosure to one that was thinner, narrower, and incorporating a machined wooden insert on the top like an LP12.

The Isobarik wasn't the first big, ambitious loudspeaker, but for a period it was the only big ambitious loudspeaker to own. The big KEFs, IMFs and B&Ws of the day simply weren't very rock 'n' roll. First introduced in passive form in 1972/3, the active (a term introduced with the Isobarik) version followed in 1974. When launched, you could buy a pair for £398, plus £91 for the stands. Some 15 years later, when production ceased in favour of the Keltik, the final selling price of the PMS was £2,498, and the passive four-ohm crossovers £498. By that time 3,000 pairs had been sold.

In the weird and wonderful world of seventies Linn Products, the myths often overtook reality. My favourite, possibly apocryphal, story has Ivor Tiefenbrun answering a question about why the PMS, which has no crossover, cost more than the DMS, which was the same thing with a crossover. "To pay for all the extra bullshit" was the answer. If the story is true, I suspect he was irritated by the question or the questioner, and Ivor has never been one to suffer fools gladly. But nothing can undermine the seminal influence of the Isobarik in its youth and its middle years. It defined everything that high fidelity aspired to for those with the space and the money. And of course the Isobarik helped square the circle, so that Linn Products with Naim Audio could present to the world a single, complete system of unmistakable class and mastery – a loudspeaker that *almost* made it down to DC. **HFC**

*Alvin Gold*

# Countdown to



**20 - 22 February 2004**

10am - 5pm every day  
at the Marriott City Centre  
Hotel, Lower Castle St.,  
Bristol

#### GETTING TO THE SHOW

By train: Temple Meads Station is a short distance from the Marriott and is accessible by bus, foot or taxi.

By car: from the M4 take J19 (M32 - Bristol). Follow signs for City Centre and RAC signs to the Show.



Easy local parking in Broadmead and Bond Street NCPs.

ORGANISED BY

**audio** X  
EXCELLENCE

**audio** T

in association with

**WHAT HI-FI?**  
SOUND AND VISION

# SOUND & VISION

## THE BRISTOL SHOW

NOW  
IN ITS 17<sup>TH</sup>  
YEAR

**See and hear all the latest products under one roof...**

**ACOUSTIC ENERGY:** the official launch of 4 new models!

**ARCAM:** launch of the AVR300 home cinema receiver.

**AUDIOVECTOR:** launch the Mi-series loudspeakers.

**CHORD ELECTRONICS:** the new Choral Mezzo 50 & Mezzo 150 power amplifiers.

**CYRUS:** come & learn about quality multi-room and the Cyrus Link, at the same time take a sneak peak at the forthcoming DAC X.

**DENON:** unveil their fourth Universal SACD/DVD-A Player 51; the technologically groundbreaking DVD-A11 with DVI-HDCP output; and the SD770 super slimline system.

**DYNAUDIO:** a new range of subwoofers.

**ELAC:** launch the 200 Series - 5 new JET tweeter loudspeakers.

**LIVING VOICE:** the OBX-R2 loudspeaker system making its debut.

**LOEWE:** presenting their latest LCD, Plasma and DLP televisions, and the stylish new XELOS SL flat panel TVs.

**MERIDIAN:** come and see the new G Series, their first new range in 10 years!

**MISSION:** are proud to use the Bristol Show to launch the beautifully styled, Elegante range of multi channel, multi format loudspeaker systems.

**MONITOR AUDIO:** additions to the Radius range.

**QUADRASPIRE:** the launch of some major new products.

**REGA:** the all new R9 loudspeakers and possibly more...

**REVOLVER:** 2 new loudspeaker models.

**SONUS SYSTEMS:** a new SE range of support furniture.

**TOTEM ACOUSTIC:** unveiling of the Rainmaker, a fabulous compact loudspeaker.

**WA LOUDSPEAKERS:** stunning speakers carved from Cotswold Limestone!

**WHAT HI-FI? SOUND & VISION MAGAZINE:** there in person to answer all your questions about Hi-fi, Home Cinema and more.

**YAMAHA:** unveiling the Z9 (home cinema amplifier), MXD1 (stereo digital power amp) and the RXV2100 (home cinema receiver).

**GREAT DEALS AND SPECIAL OFFERS AVAILABLE ONLY AT THE SHOW - PLUS YOUR CHANCE TO WIN SOME SUPERB PRIZES IN THE SHOW COMPETITION**

#### Admission

**Adults £7.00; Students/OAPs/UB40s £3.50; Accompanied children under 16 free**

**BRANDS ON SHOW INCLUDE:** Acoustic Energy, Allsop, Alphason, Anthony Gallo Acoustics, Apart, Apollo, Arcam, Argento, Artison, Atacama, Audionet, Audiopax, Audiophile BASE, Audioprism, Audioquest, Audiovector, Ayre Acoustics, B&W, Bاندridge, Baseplayer, Beyer Dynamic, Black Rhodium, Bryston, Cabasse, Canton, Celestion, Chapter Audio, Cherished Record Company, Chord Electronics, Clearaudio, Clearcover, Clearlight Audio, Creek, Cyrus, Dagetti, Denon, Dezorel, Diverse Vinyl, Dynaudio, Eclipse TD, Ecosse, Eichmann, Elac, Epos, Exposure, Fergushill, Focal JM Lab, Fujitsu, Future Glass, Gamut, Goldring, GPA, Grado, Graham, Hi-Fi World Magazine, Inca Design, InFocus, Invision UK, Isotek, Ixos, Ixotica, Jamo, KEF, Klegg Audio, KM Acoustics, Lafayette Electronics, Last, Lexicon, Living Voice, Loewe, Lyra, Marantz, Mark Levinson, Meitner, Meridian, Michell, Miller & Kresel, Milty, Mission, MJ Acoustics, Monitor Audio, Moon, Mordaunt Short, Multicover, Music Works, Myryad, NAD, Naim Audio, Never Connected, Niro, Nordost, One for All, Onkyo, Optimum, Opus, Ortofon, Parasound, Perfect Sound, Perigee, Pioneer, PMC, Polk, Primare, ProAc, Profigold, Project, PSB, PURE Digital, Purist, QED, Quad, Quadraspire, RDC, Rega, REL, Revel, Revolver, Ringmat, Roksan, Ruark, Runco, Russound, Sennheiser, Seventh Veil Loudspeakers, Shakti Audio Innovations, Shun Mook UK, Sim 2, Sonus Systems, Sony, SoundStyle, Spendor, Stands Unique, Stax, T+A, TAG McLaren Audio, Talon Audio, Tannoy, Teac, Technik, The Chord Company, Tivoli Audio, Totem Acoustic, Transfiguration, Trichord, Trinity Audio, True Colours Industries, Tube Technology, van Den Hul, Veda Products, Velodyne, Vertex AQ, Vibe, Vienna Acoustics, Vivadi, Vivante, Vogels, Voodoo Isolation, VPI, WA Loudspeakers, Waterfall, Wharfedale, What Hi-Fi? Sound & Vision Magazine, Wilson Benesch, Yamaha and many more.

For the very latest information on new product launches check [www.bristolshow.co.uk](http://www.bristolshow.co.uk)

# M

# MUSO

JOHN COLTRANE  
A LOVE SUPREME



When he led his quartet into legendary jazz producer Rudy Van Gelder's Englewood Cliffs, New Jersey, studio on 9 December 1964, master saxophonist John Coltrane already knew that he had a potential masterwork just waiting to be recorded. Not that he had much written for it, besides a few sketches, but the time was right, he had the right band, the right attitude and the right material – it all seemed to just fit.

Sure enough, it took just four hours for the band to lay down the album that would become one of the touchstones of modern jazz, an album that more than any other has come to define the new directions jazz began to take in the mid sixties. But *A Love Supreme* has its roots in the source, with echoes of blues, spirituals, and traditional jazz inflections, as well as pointing the way to the new, atonal 'thing' and the complete melodic, harmonic and rhythmic freedom that Coltrane and others would eventually take just about as far as it could go. Here though, he is still in transcendent mode, bestraddling the new and the old like a colossus, and encompassing the best of both worlds.

For someone known for his propensity for recording take after take, struggling for perfection from his music, the date was a revelation. The entire session consisted of little more than four hours rehearsal and recording time, with the band running through the barely familiar material and recording most of the four tracks in one take, with just one known overdub where the band accent the end of the last track, *Psalm*.

However, Coltrane did try to improve on his original vision. The following day, he returned to the studio with an expanded lineup, including free jazz prophet Archie Shepp and bass player Art Davis (along with his existing band of bassist Jimmy Garrison, pianist McCoy Tyner and drummer Elvin Jones). The recording wasn't used and the tape believed lost for many years.

The original vinyl release on Impulse with gatefold sleeve, a drawn portrait of Coltrane and his own liner notes comprising a poem to God, will for some always be the definitive version, but this iconic work has been through several phases. The rather sorry vinyl reissue in 1980 saw it emerge as a budget release,

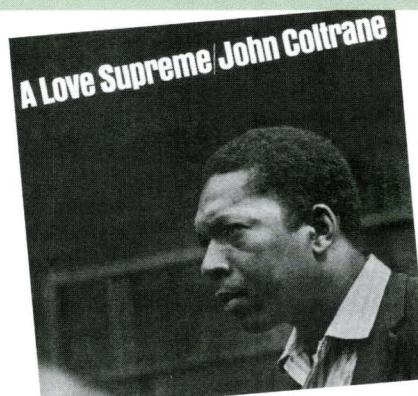

**“Rudy Van Gelder’s original tape was lost, probably wiped to be re-used, sometime in the early seventies.”**

minus the gatefold, portrait and poem, and pressed on thin, low-grade vinyl. The first CD issue in 1986 showed a similar lack of reverence, even changing the original sleeve design so that Coltrane's name took precedence over the title.

However, 1995 saw a new CD release with a remastered mix. Impulse, originally owned by ABC and later MCA, wasn't always circumspect with its treatment of master tapes, and Rudy Van Gelder's original tape was lost, probably wiped to be re-used, sometime in the early seventies. Subsequent reissues had been cut from a back-up master which featured a flaw in the left channel during the first three minutes of *Pursuance*, with some added equalisation and compression. For the 1995 remastered version, improved 20-bit-rate sampling was used to up the quality of the flawed master. It also restored the original design and liner notes – ditto for the simultaneous vinyl release.

But it wasn't until the release of the two-CD *Deluxe Edition* in October 2002 that fans were able to appreciate Coltrane's vision in a form close to his original concept. Faced with the prospect of re-using the flawed 1971 second generation master tape yet again, despairing executives realised that the original album had been released in other territories besides the US and a quick call to EMI's Abbey Road studios in London turned up an alternative, fully intact, master. It was used as the backbone for the release, which also included the recently unearthed 10 December sextet session, believed lost for many years, as well as the only ever live recording of the complete suite, at the first Festival International de Jazz in Antibes, on France's Cote d'Azur, on 26 July 1965.

To date, *A Love Supreme* is one of the very few million-selling jazz albums, and is still Coltrane's defining statement, the bridge between his traditional and visionary stages. **HFC**

Dave Oliver

# www.superfi.co.uk

## Quality hi-fi separates, multi-channel audio systems, digital recorders and lifestyle home entertainment

### Sale now on!

Featuring  
the best lifestyle,  
AV, digital and  
hi-fi technology

#### Marantz PM7200 amplifier

Black or gold finish.  
Class A or Class A/B  
operation.  
**£279.95 (Was £329.95,  
Save £50)**

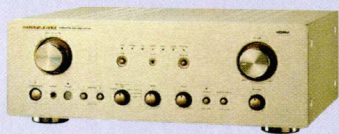

#### Project Debut II turntable



Complete, high-quality turntable  
solution with cartridge. 'Debut SB'  
option available with electronic speed  
control and pre-amplifier built in. Also  
new Goldring GR1 turntable.  
**From £109.95**

Accessories  
A wide range of  
leads, connectors,  
and headphones,  
cartridges and  
switch boxes  
available to  
buy now

#### Yamaha DVDS540 + RXV740 6.1 package



Multi-region DVD playback.  
PAL and NTSC Progressive  
Scan. Dolby Digital and DTS  
6.1 decoding. Beefy 6 x 90  
watts. Quality AV separates  
at a bargain price  
**£499.95 (was £709.95,  
save £210)**

#### Mission M5 5.1 speaker package



HiFi Choice Best Buy.  
Black, rosewood or beech  
real-wood veneers. Multi-  
channel audio system with  
active subwoofer  
**£1199.95 (Was £1449.95,  
Save £250)**

Price promise  
We beat prices,  
visit [www.  
superfi.co.uk](http://www.superfi.co.uk) for  
full details

#### Denon DVD 1400 disc player

Multi-region. DVD-Audio,  
SACD, MP3. HiFi Choice  
Best Buy. Black or silver.  
**£329.95 (Was £399.95)**



#### Pure Tempus 1 DAB radio alarm



Sophisticated alarm timer  
functionality. Ergonomic  
'Snooze Handle'. Latest  
DAB reception.  
**£129.95**

Latest technology  
DVD recorders,  
DAB radio,  
freeview, LCD  
and plasma

#### Pioneer DV360 DVD player

Multi-region. Black or silver.  
Plays recordable format DVD  
and CD, MP3, JPEG, VCD  
**£84.95 (Was £119.95)**



#### Yamaha CDRHD1300 CD and hard disk recorder

80 GB hard disk. Rip  
CD to hard disk and  
hard disk to CD.  
**£479.95 (Was £599.95,  
Save £120)**



Website regularly  
updated  
visit [www.  
superfi.co.uk](http://www.superfi.co.uk) for  
the latest offers

Extensive product specs,  
useful product guides and  
full order tracking.  
Free delivery on all orders  
to the UK mainland  
(excluding the Scottish Highlands)

Acoustic Energy, Denon,  
KEF, Marantz, Mission, NAD,  
Pioneer, QED, Sony, Yamaha,  
Wharfedale, and many more  
top brands

Buy online now at [www.  
superfi.co.uk](http://www.superfi.co.uk). You can email  
us at [sales@superfi.co.uk](mailto:sales@superfi.co.uk)  
Tel: 0115 9789347

[www.superfi.co.uk](http://www.superfi.co.uk)

# Superfi

# DIGITALIA

NEXT GENERATION DVD

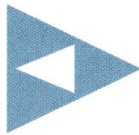

If we thought the drawn-out wait for the high definition audio in the form of SACD and DVD-A was painful, then the evolution of DVD-Video into a true High Definition picture format looks

like being a far bigger mess. Blu-ray is the technology we've heard most about, a 'next generation' DVD that uses a shorter wavelength (blue) laser to read finer pit structures on the disc. Finer pit structures mean more data per square inch with proportionally greater stress on the laser servos and error correction regimes.

Other 'HD' DVD systems under development include those that use blue lasers with double-sided discs or red lasers reading more heavily compressed data. Obviously, if more sophisticated data-reduction algorithms can be used to compress the digital video data, then there is less of an imperative to use costly blue lasers and delicate disc substrates. Either way, it really seems as if the industry has learned nothing from the VHS vs Beta debacle or, more recently, from the general confusion propagated by conflicting SACD and DVD-A formats. Frankly, until the likes of Sony, NEC, Toshiba and Warner, to name but a few, start pulling in the same direction, then the chances of a unified HD DVD format making it to market are pretty unlikely.

Fortunately, the outlook for the home cinema enthusiast is not so gloomy, for the vast majority of us have yet to realise the full potential of the MPEG-compressed digital video stored on our existing DVD movie discs. The reason for this is pretty straightforward. Up until very recently there has been no way to output a direct stream of digital video data off the disc without falling foul of copyright legislation. The moguls of Hollywood view the unprotected digital output on CD players as the thin end of the 'home copying' wedge that has plagued the music industry ever since.

Which is why all video must be passed from player to display in the analogue domain, even if it is re-converted back to digital video before it hits the screen. And it's these totally unnecessary D-to-A and A-to-D stages that have compromised DVD's potential picture quality. Until now with the launch of DVI and



## **"Hollywood moguls view unprotected digital output on CD players as the thin end of the 'home copying' wedge."**

HDMI-equipped DVD players that are licensed to output genuine digital video, albeit guarded by a parallel copy protection process called HDCP (High-bandwidth Digital Content Protection).

DVI uses Panellink from Silicon Image, a communications format based on TMDS (Transition Minimised Differential Signaling) to transmit uncompressed digital video data over four lines – red, green, blue and clock, respectively. PC users will recognise this 24-pin connection as today's universal standard for flat-panel, fixed-pixel displays but it really comes into its own with DVD video once HDCP is mixed-in. HDCP was introduced some four years ago to verify that a display device is authorised to receive protected video content, a system now ratified by the DVDCCA (DVD Copy Control Association) for home players.

The HDMI connection championed by Pioneer as the 'Digital SCART' is really a combination of HDCP-compliant DVI with potential bandwidth for some eight channels of 24-bit/192kHz linear PCM audio. Which means it's perfectly possible to connect HDMI players to DVI-equipped plasmas or projectors, and vice-versa, using simple adapters. Any remaining technical issues are not with DVI or HDMI but with the implementation of HDCP which, currently, is not overseen by any one body. Any slight 'misinterpretation' of HDCP's handshaking or timing errors between source and display will cause the recipient to block the incoming signal. The result is a screenful of sparkly noise or, most commonly, no picture at all.

Fortunately, most player/display combos work together out of the box, whether or not they are from the same manufacturer. And once you've seen DVD's uninterrupted digital video light up your screen, you'll wonder if we need HD DVD after all... **HFC**

*Paul Miller*



# P.J.hi-fi

The only **real hi-fi** shop in **Guilford**

*Do you want to choose your hifi or home cinema system, in a comfortable and relaxing environment...?*

*Do you want friendly and impartial advice ( and a cup of tea) ...?*

*Do you want to buy your system based on what you hear, and see, and not what somebody tells you...?*

## **Do you live in GUILDFORD...?**

.....or Addlestone, Aldershot, Ashford(Middx), Ashstead, Bagshot, Basingstoke, Bracknell, Bookham, Bramley, Camberley, Chertsey, Chipstead, Chobham, Cobham, Cranleigh, Crowthorne, Dorking, Epsom, Esher, Farnborough, Farnham, Fleet, Frimley, Godalming, Hartley Wintney, Hampton, Haslemere, Hook, Horsham, Kingston, Liphook, Leatherhead, Liss, Molesey (East&West), New Malden, Odiham, Petersfield, Reading, Reigate, Redhill, Richmond, Shepperton, Virginia Water, Walton-on-Thames, West Byfleet, Weybridge, Windsor, Woking, Wokingham, Yateley .

**Nobody else** in these areas carries all the following major hifi brands:

Apollo, Arcam(Diva/FMJ), Ash Design, Atacama, **Atlas** (spkr cables & interconnects) B&W, **Chord Company**, **Creek**, **Cyrus**, Denon, Epos, **Exposure**, **Genelec**, **Anthony Gallo Acoustics**, Harman Kardon, Infinity, Iso Tek, KEF (including **Reference**), Linn Products(including Knekt), **MJ Acoustics**, Meridian, Michell, **Mirage**, Mission, Musical Fidelity, NAD, **Naim**, Ortofon, Pioneer, **PMC**, **Primare**, **Proac**, Project, Pure, QED(including Systemline), Quad, Quadraspire, REL, Rotel, Sennheiser, Soundstyle, **Spendor**, Stands Unique, **Tag McLaren**, Wharfedale, Yamaha.

**Nobody else** in these areas carries all the following major Home Cinema products:

DVD players: Arcam & **FMJ**, **Cyrus**, Denon, Harman Kardon, Meridian, Rotel, **Tag McLaren**, Yamaha,

Processors: **Arcam FMJ AV8**, **Cyrus**, **Lexicon**, Linn, Meridian, Rotel, **Tag McLaren**.

Amplifiers: Arcam/FMJ, **Bryston**, **Cyrus**, Denon, Harman Kardon, **Lexicon**, **Naim**, Rotel, **Tag McLaren**, Yamaha.

Display devices: Plasma screens from Loewe, Panasonic, Pioneer and **Yamaha**. Televisions/LCD: Loewe.

Projectors: **Barco(CRT/DLP)**, **Sim (DLP)**, **Yamaha(DLP/LCD)** Screens: **Stewart/Draper/Vutec** ,

Video Processing: **Faroudja**, **I-Scan**, **Key Digital**, **Lumagen**, **Tag**. Control systems: **Crestron**, Lutron lighting.

Specialist set up services: **ISF Display Calibration**.

**Nobody else** in the area offers you a "**One Stop Solution**" to all of your home entertainment requirements, as we are also Custom Installation experts. Discuss your requirements with us and we can survey, design, install, commission, and maintain full Sound and Audio-Visual distribution, and automated lighting around your home.

**Visit us first** and you won't need to go anywhere else.

We have superb demonstration rooms for both Hifi and Home Cinema, and we will deliver and install.

We are a **Mountainsnow** dealer, and members of **BADA**, so you can trust us to look after your every need.



# P.J.hi-fi

The only **real hi-fi** shop in **Guilford**

**Guildford's only REAL Hifi and Home Cinema store**

**Open 9-6 Monday to Saturday (later by appointment)**

**3, Bridge Street, Guildford, Surrey GU1 4RY (opposite Wetherspoons)**

**01483 504801 and 01483 304756**

**[www.pjhifi.co.uk](http://www.pjhifi.co.uk) email:info@pjhifi.co.uk.**

**".....it's hifi for fun's sake....."**

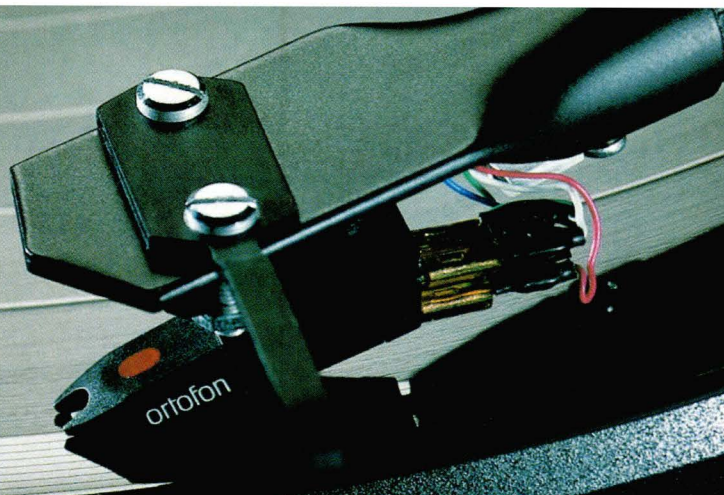

# SAVE 36% WHEN YOU SUBSCRIBE TO HI-FI CHOICE

## SUBSCRIBE AND GET ALL THIS:

- ▶ 13 issues a year delivered FREE to your door at a cost of just £2.30 each (free delivery UK only)
- ▶ Every issue hot off the press – get your copy before it's in the shops
- ▶ A satisfaction guarantee or your money back on any unmailed issues



### YOUR DETAILS (BLOCK CAPITALS)

Title \_\_\_\_\_ Initials \_\_\_\_\_ Surname \_\_\_\_\_

Address \_\_\_\_\_

Postcode \_\_\_\_\_ Country \_\_\_\_\_

Tel no. (inc. code) \_\_\_\_\_ Email address \_\_\_\_\_

We will use the contact details supplied to communicate with you about your Hi-Fi Choice subscription. We'd also like to keep you up to date with any special offers or new products/services that may be of interest. If you're happy for Hi-Fi Choice, Future Publishing and its sister companies to contact you by email, indicate here:  If you're also happy for us to pass your details on to carefully selected companies so they can send you relevant information about their products/services by email, indicate here:

**I WOULD LIKE TO SUBSCRIBE TO HI-FI CHOICE BY DIRECT DEBIT FOR ONLY £7.49 EVERY 3 MONTHS**

Simply fill out your details above and complete the form opposite.

Alternatively, if you live outside the UK or prefer not to pay by Direct Debit, select from the options below for a full year's subscription (13 issues):

- UK £29.97                       Europe £43.00  
 North America £49.99         Rest of World £62.00  
 Cheque (E's sterling drawn on a UK bank account payable to Hi-Fi Choice)  
 Mastercard    Visa    American Express  
 Switch Issue no./valid date

Card no.

Expiry date   /        Signature \_\_\_\_\_

### SEND TO:

**UK:** HI-FI CHOICE Subscriptions, FREEPOST BS4900, Somerton, Somerset, TA11 6BR

**OVERSEAS:** HI-FI CHOICE Subscriptions, Cary Court, Somerton, Somerset, TA11 6TB, UK

### Terms and Conditions

Your subscription will start with the next available issue. 13 issues are published in a year. Please indicate if you do NOT wish to receive relevant information about special offers or products/services from Hi-Fi Choice, Future Publishing or any of its sister companies by post  or telephone  Please indicate if you do NOT wish us to pass your details on to other carefully selected companies to enable them to contact you about their products/services by post  or telephone

Order code: HFPC251 Offer ends: 20/02/2004

Instruction to your Bank or Building Society to pay Direct Debits.



Future Publishing Ltd,  
Cary Court, Somerton,  
Somerset TA11 6BR



Originator's Identification Number

7 6 8 1 9 5

Please send this form to address shown

1. Name and full postal address of your Bank or Building Society branch

To: The Manager \_\_\_\_\_ Bank/Building Society

Address \_\_\_\_\_  
Postcode \_\_\_\_\_

2. Name(s) of account holder(s) \_\_\_\_\_

3. Branch sort code (from the top right-hand corner of your cheque)

4. Bank or Building Society account number

5. Instruction to your Bank or Building Society

Please pay Future Publishing Direct Debits from the account detailed on this Instruction subject to the safeguards assured by the Direct Debit Guarantee. I understand that this instruction may remain with Future Publishing and if so, details will be passed electronically to my Bank or Building Society.

Signature(s) \_\_\_\_\_ Date \_\_\_\_\_

Ref No (Office use only) \_\_\_\_\_

Banks and Building Societies may not accept Direct Debit instructions for some types of account.

# WIN! £1000 worth of Panasonic Home Cinema kit!

Got the post Christmas blues? Other half didn't get you what you wanted for the festive season? Then sit yourself down and take part in the Future Lifestyle Survey for the chance to win this...



A SC- HT1000 Home Cinema System from our friends at Panasonic Worth £1,000!

We at Future Publishing are always keen to find out as much about you, our readers, as possible. Which is why we've created the brand-new Future Lifestyle survey – offering you the chance to tell us all about your lives, your hobbies and your attitudes so we can continue to create magazines that you enjoy.

Just go to the link below and type the password 'Panasonic' for your chance to win!!

[www.surveyshop.com/futurelifestyle](http://www.surveyshop.com/futurelifestyle)

The Panasonic SC-HT1000 combines an integrated DVD recorder and Home Cinema System to produce a complete entertainment package with superb surround sound and optimum picture quality. The 600 Watt total power output system incorporates excellent video editing capabilities, innovative DVD recording features like Time Slip and also boasts decoders for the three main surround sound formats – Dolby Digital, Dolby Pro-Logic and Digital Theatre Surround (DTS). The slim, stylish SC-HT1000 plays back high quality DVD Audio, DVD RAM/-R discs as well as DVD Video, CD-R/-RW, Video CD and MP3.

For more information please call 0870 5357357 or visit [www.panasonic.co.uk](http://www.panasonic.co.uk)

#### Terms and Conditions

Open to over 16's only. Employees of Future Publishing or other involved companies are not eligible to enter the prize draw. The prize is as stated and no cash alternative will be given. No purchase is necessary to enter the prize draw. A list of prize winners may be obtained by sending an SAE to Andrea Cooper, Future Publishing, LIFESTYLE WINNERS, Freepost, 30 Monmouth Street, Bath, BA1 2XF, a month after the closing date of 01.03.2004.



# HI-FI CHOICE BUYER'S BIBLE



Welcome to the *Hi-Fi Choice Buyer's Bible* – the ultimate guide to the very best high performance hi-fi and AV gear you can buy. Here you'll find all our favourite current products listed under easy to use categories, together with useful information on what to look for and how to get the most from your components.

## Reviews you can trust

Our test results are the most reliable in the business. We employ the most experienced reviewers and use the most thorough techniques to ensure our ratings are the ones you can trust. All the equipment we rate most highly is contained within these pages, from CD and vinyl to the latest multichannel disc players. Whether hi-fi stereo or high performance surround and vision, these components will take you a step closer to reality.

## How to use this guide

The *Hi-Fi Choice Buyer's Bible* is the best way to make a shortlist of components for your system. Pick the ones that best suit your taste and budget, then use our *Dealer Classified* section to find specialist outlets where you can audition these components with your favourite discs.

Products that score more than 80 per cent overall are automatically featured in the *Hi-Fi Choice Buyer's Bible*. Any Best Buy or Editor's Choice Badges awarded are also displayed.

## SOURCE COMPONENTS

- 82 CD PLAYERS
- 84 DVD PLAYERS
- 86 VINYL
- 89 RADIO TUNERS
- 90 DIGITAL RECORDERS

## AMPLIFIERS

- 98 STEREO AMPS
- 100 MULTICHANNEL AV AMPS

## LOUDSPEAKERS

- 106 STEREO SPEAKERS
- 110 MULTICHANNEL SPEAKER PACKAGES

## ANCILLARIES

- 112 CABLES
- 113 HEADPHONES
- 114 STANDS AND SUPPORTS

- 115 GLOSSARY
- 116 CHOICE BITS ACCESSORIES SHOP
- 119 READER CLASSIFIED

## DEALER CLASSIFIED

- 120 DEALER GUIDE
- 126 DEALER DIRECTORY

# CD PLAYERS

*Audio disc players for music only*



Despite the emergence of new formats and the resurgence of an old one (vinyl), CD is still the king of formats if you require breadth of choice. And despite the fact that other sources will play CDs, if you want to hear your discs at their best there's little substitute for a dedicated CD player.

It's also the most enduring format on the market. Despite high-resolution contenders like SACD and DVD-Audio, nothing has been able to undermine this universally popular format.

CD players work by reading a stream of 1s and 0s off a disc that spins at a constantly changing speed (to counteract the increasing length of 'groove'). This bitstream is then digitally filtered before undergoing digital-to-analogue conversion in the DAC (D-to-A convertor). Thereafter, the signal is filtered



again before being amplified and sent to the output sockets.

The processes of reading the disc and converting the data are sometimes split between a CD transport and separate DAC in so-called two-box players. A popular approach with very high-end kit, this separates the electronically noisy elements from the sensitive analogue stages, but can introduce timing errors known as jitter, therefore one-box players usually offer best results where budget is a consideration.

## SUPER AUDIO CD



SACD or Super Audio CD is a relatively new audio-only format introduced by Sony and Philips. It offers higher resolution than CD in the form of considerably greater bandwidth and improved dynamic range. It also has the potential for uncompressed surround sound using up to six channels, and most new discs take advantage of this. SACD discs are usually hybrids and will play on normal CD players, but you won't be able to appreciate their highest quality or their multichannel capability without an SACD-compatible player. Some SACD players also play DVD and even DVD-Audio – these are listed in our DVD section.

## Q&A

### WHAT'S A DAC?

A DAC or digital-to-analogue convertor is a fundamental part of any CD player and converts the digits read from the disc into an analogue music waveform which is amplified to line level.

### WHY HAVE SEPARATE TRANSPORTS & DACS?

Discs are read by a transport or disc drive, which creates radio frequency 'noise'. Separating the DAC means the conversion can be done with less interference.

### CAN I USE AN OUTBOARD DAC WITH MY INTEGRATED CD PLAYER?

Yes, if it has a digital output – and most do.

### DO I NEED DIGITAL CABLES FOR A CD PLAYER?

No. All analogue cables are suitable for connecting a CD player to an amp. Digital specific cables with 75ohms impedance are useful when connecting the player to a digital recorder or DAC.

### WHAT IS OVERSAMPLING/UPSAMPLING?

Oversampling involves multiplying the sampling frequency by a whole number, usually between four and 32, but sometimes higher, and is designed let the DAC to work in a more linear fashion. Upsampling is where the data stream is stretched out by interpolation and is typically used to refer to large changes in sampling rate such as from 44.1kHz to 192kHz.

### CAN I PLAY SACDS ON A NORMAL CD PLAYER?

Yes. The vast majority of SACD discs are hybrids, with a CD layer that all CD players can read.

### CAN I PLAY DVDS ON A CD PLAYER?

No, the same applies to DVD-As. But you can play CDs and DVD-As on normal DVD players.

## TOP BUYS



**Marantz CD7300 £350**

The latest in a long line of highly successful sub-£500 CD players from Marantz is an absolute beauty. Engaging and sonically refined, there's little to touch it at the price.



**Meridian 507 £1,195**

The entry-level player from British digital audio specialist Meridian is an absolute peach – a transparent and detailed sound, and superb build quality to boot.

## Our favourite BB BEST BUY EC EDITOR'S CHOICE

# CD PLAYERS

### Audio-only CD and SACD players

BADGE?	PRODUCT	£	COMMENTS	SACD COMPATIBLE	ELEC DIG OUTPUT	OPT DIG OUTPUT	CD-RW COMPATIBLE	CD TEXT	BAL ANALOGUE OUT	HEADPHONE SOCKET	VARIABLE OUTPUT	ISSUE NUMBER
<b>UP TO £1,000</b>												
<span>BB</span>	Arcam DIVA CD73T	400	Refined and articulate, smooth and dynamic – a finely judged balance for budget to mid-price systems		●	●	●	●				247
<span>BB</span>	Arcam DIVA CD93T	950	Excellent high-resolution and transparent-sounding player in familiar DIVA clothing		●	●	●	●				247
<span>BB</span>	Cambridge Audio Azur 640C	250	This elegant little player can hold its own in very elevated company – a budget system will barely do it justice		●	●	●					249
	Cyrus CD8	1,000	Reveals the emotional and intellectual message in everything it plays and is guaranteed to keep you listening		●							247
	Exposure 2010	600	A smooth and substantial-sounding player, a little lacking in refinement but musical all the same		●	●	●	●				231
	Linn Genki	995	Explicit, rather bright-sounding player with strong multiroom appeal								●	212
	Heart CD6000 OSE LE	750	Valved-up Marantz makes an entertaining and colourful player that will inspire you to listen longer		●	●	●	●		●	●	245
<span>BB</span>	Hegel CDP2A	1,500	Norwegian player that does what every hi-fi component should – gets out of the way and lets the music shine		●		●		●			250
<span>BB</span>	Marantz CD7300	350	Astonishingly capable sub-£500 player with effortless bass, detailed mid and treble and vast soundstages		●	●	●	●		●		250
	Rotel RCD-02	375	Against some strong competition in the same price area, the new Rotel generally holds up well		●		●					231
<span>BB</span>	Sony SCD-XA3000ES	800	A revised and refined version of the SCD-XA333ES that provides an almost holographic sound	●	●	●	●	●	●			248
<span>BB</span>	Thule CD150B	775	A light but engaging and expansive-sounding player with a very quirky user interface		●		●	●	●			246
<b>ABOVE £1,000</b>												
<span>EC</span>	Audionet ART V2	2,300	Built to last forever, this CD has a dark natural sound with excellent bass and would be cheap at twice the price!		●		●					231
<span>BB</span>	Classé CDP-10	1,599	Very natural yet capable of revealing the finest of details in a coherent and engaging manner		●		●		●			238
<span>EC</span>	Copland CDA 822	1,598	Well built and carefully thought out, if you go for the more sophisticated musical forms it is superb value		●		●		●			241
	Exposure 3010	1,195	What this player lacks in immediacy and punch is offset by its sparkling sense of occasion and musical tension		●	●	●	●				246
	Exposure XXII	1,395	Natural sounding player, great with voices and acoustic instruments and makes for engaging listening		●	●	●					238
<span>EC</span>	Gamut CD1R	2,350	Natural, precise and impressively 3D sound that marries precision with emotional communication		●		●		●			240
<span>EC</span>	Krell KPS 25sc	24,998	One of the finest CD players available, this is also a state of the art preamplifier with Cast interface technology		●	●	●		●		●	236
<span>EC</span>	Mark Levinson No390S	6,495	Superbly built and comprehensively equipped with genuinely high-resolution sound		●	●	●		●		●	231
<span>BB</span>	Meridian 507	1,195	Unusually precise and considered performer that sounds as different as the discs you stick in the drawer		●		●					238
	Musical Fidelity CD-PRE <sup>24</sup>	2,000	Substantial player incorporates upsampling and extensive analogue and digital preamplification facilities		●	●					●	229
<span>EC</span>	Musical Fidelity Tri-Vista	4,000	Limited edition stereo-only SACD/CD player that is simply the best player MF has ever made	●	●	●	●	●				237
	NAD S500i	1,200	A beautifully built machine that treads the fine line between precision and musicality with aplomb		●	●	●		●			238
<span>EC</span>	Naim CDX2	2,650	Fine quality one-box CD player, but its best feature is upgradeability via outboard XPS supply				●					238
<span>BB</span>	Orelle CD10eovo	1,500	Very superior timing, a wide dynamic range, natural sweetness and fine transparency				●					248
<span>BB</span>	Primare D30.2	1,499	Superb high-resolution player gives a strong taste of musical structure and physicality		●				●			226
<span>BB</span>	Resolution Audio Opus 21	2,850	Dynamic, well timed and 3D performance with an analogue volume control and digital input for a second source				●		●		●	244
<span>BB</span>	Roksan Caspian M Series	1,100	Not CD-RW compatible, but otherwise an excellent CD that punches above its weight		●							248
<span>EC</span>	TEAC D-70/P-70	13,000	This two-box solution is one of the best CD replay systems available, with a fantastic range of facilities		●	●		●	●			239

**SPECS KEY** **SACD COMPATIBLE** Plays high-resolution SACD discs in multichannel and/or two-channel mode. **ELEC DIGITAL OUTPUT** Electrical coaxial output for digital connection to a DAC or digital recorder. **OPT DIGITAL OUTPUT** Optical Toslink output for digital connection to a DAC or digital recorder. **CD-RW COMPATIBLE** Will play CD-RW (rewritable) discs, most CD players can cope with CD-Rs. **CD TEXT** Will display album and track titles from inserted disc. **BAL ANALOGUE OUT** Balanced XLR output connections for similarly equipped amplifiers. **HEADPHONE SOCKET** Quarter inch (6.3mm) headphone jack fitted to the CD player. **VARIABLE OUTPUT** Player features both fixed level and variable, volume adjustable outputs.

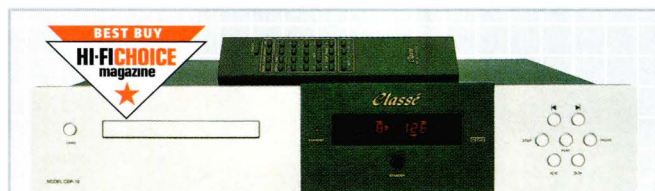

### Classé CDP-10 £1,599

An exceptional CD player from the Canadian high-end brand – its natural, detailed and engaging way with varied music types is little short of stunning.



### Naim CDX2 £2,650

A superb player that mixes rhythm and timing with precision and poise. Add the £2,300 XPS power supply (pictured) to make one of the best CD players in the world.

# DVD PLAYERS

Disc players for audio and video



DVD has proved a phenomenal success in commercial terms and has virtually extinguished the market for budget CD players – you can't really beat a multifunction player when it comes to features. Early DVD players were not particularly good CD spinners because of the enormous amount of RF interference produced by video circuits, but as this problem has been identified manufacturers have begun to tackle it. Nowadays, most DVD players are competent CD players and a few are very good – often as not they are the ones that play DVD-Audio discs as well.

The great advantage of DVD is that it offers sufficient capacity to hold a feature length movie or music concert *and* discrete multichannel sound on a disc the size of a CD. In the case of plain DVD-Video discs, the audio is encoded in either the Dolby Digital or DTS format, both of which use 'lossy' compression to fit the audio onto the disc alongside the video data. You can

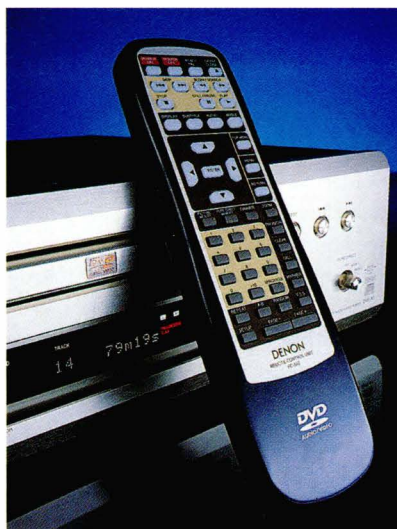

use a DVD player with your stereo system by connecting the stereo outputs, though this won't give the surround sound benefits that the format specialises in.

## Q&A

### WHICH AUDIO OUTPUTS GIVE THE BEST QUALITY?

Use the analogue outputs for CD, DVD-A and SACD, and the coaxial digital output for DTS and Dolby Digital movie soundtracks.

### WHICH VIDEO OUTPUTS GIVE THE BEST QUALITY?

The best connection is component video closely followed by RGB Scart, which is clearly superior to S-video and the basic composite video option.

### DO I NEED A MULTICHANNEL AMP TO USE A DVD PLAYER?

Only if you want to hear music and movie soundtracks in multichannel surround. DVD players can be used with stereo amps and just two speakers to great effect, but you'll only get stereo, not surround sound.

### DO I NEED PROGRESSIVE SCAN VIDEO?

It's worthwhile for the very best picture quality, but make sure your DVD player and display device support PAL progressive.

## DVD-AUDIO



DVD-Audio is a high-resolution format that offers multichannel, stereo and Dolby Digital tracks on dedicated DVD-A discs. The discs can be played on any DVD player, but the CD-beating high-fidelity sound can only be appreciated with a DVD-A player. While offering similar benefits to SACD, it has the advantage of on-screen display for information – lyrics, images and so on. To save

you having to decide which format to go for, a few brands are bringing out universal players to cover SACD *and* DVD-A, alongside CD and DVD-Video – a neat and relatively future proof route into high-resolution multichannel music. Higher-end models featuring high-bandwidth compatible digital audio links are now also appearing, enhancing DVD-A/SACD sound when used with similarly equipped amps.

## CONNECTIONS

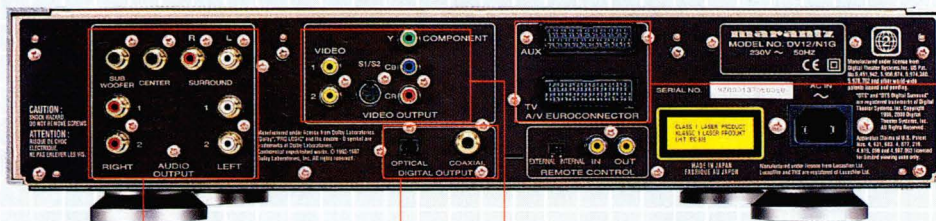

**ANALOGUE AUDIO OUTPUTS:** For stereo and multichannel connections, use these for best results with DVD-Audio, SACD and CD.

**DIGITAL OUTPUTS:** For Dolby Digital, DTS and PCM audio bitstreams.

**VIDEO CONNECTIONS:** Yellow sockets are composite; red, green and blue sockets are for component which gives best results, while the black multipin socket is S-video, which sits qualitatively between the two.

**SCART CONNECTIONS:** These are a good-quality option for video, especially ones that output RGB.

## Our favourite BEST BUY EDITOR'S CHOICE DVD PLAYERS

### Audio/Video disc players

BADGE?	PRODUCT	£	COMMENTS	DVD-A COMPATIBLE	SACD COMPATIBLE	ELEC DIG OUTPUT	OPT DIG OUTPUT	HEADPHONE SOCKET	ISSUE NUMBER
<b>UP TO £1,000</b>									
<span style="border: 1px solid black; padding: 2px;">EC</span>	Arcam DIVA DV88 Plus	1,000	The first DVD player (just) enabled to deliver progressive scan with UK-spec PAL discs. Superb picture and good sound						238
	Cambridge Audio DVD57	200	DVD-Audio replay, progressive scan pictures and a good performance at a silly-low price. Fantastic value for money.						243
	Cyrus DVD 7+	1,000	Typical Cyrus style – open, vivid and bouncy sound, with moderate picture quality to match						237
<span style="border: 1px solid black; padding: 2px;">HB</span>	Denon DVD-1400	400	Denon's entry point to universal disc playback and a remarkably good one too. Excellent CD replay for a universal player						249
<span style="border: 1px solid black; padding: 2px;">HB</span>	Denon DVD-2900	850	A beautifully built universal player that delivers a strong performance across all formats, all at a remarkable price						248
<span style="border: 1px solid black; padding: 2px;">HB</span>	Pioneer DV-565A	250	Do-it-all 'universal' player is a decent performer with all disc types, and superb value for money considering its range						248
<span style="border: 1px solid black; padding: 2px;">HB</span>	Pioneer DV-757Ai	800	State of the art universal player with iLink digital interface provides performance stretch currently unavailable to others						240
	Primare V25	1,000	Bold pictures on screen are matched to easy, likeable sound quality and a huge range of outputs						237
<b>ABOVE £1,000</b>									
	Arcam DIVA DV89	1,300	No SACD playback, but CD sounds strong, DVD-Audio is highly engaging and video performance is excellent too						248
<span style="border: 1px solid black; padding: 2px;">EC</span>	Arcam FMJ DV27A	1,900	Very accomplished, clean sounding player with CD, DVD and DVD-Audio alike. Picture quality is equally top-notch						246
	Cyrus DVD8	1,200	An impressive step up from the DVD7+, which includes component video outputs						238
<span style="border: 1px solid black; padding: 2px;">EC</span>	Denon DVD-A11	1,700	Refinement and clarity are hallmarks of this player, which is also as close to being future-proof as they come						250
<span style="border: 1px solid black; padding: 2px;">EC</span>	Denon DVD-A1	2,500	A convincing case for the DVD-A format, battleship construction combined with sonic and visual finesse						230
<span style="border: 1px solid black; padding: 2px;">EC</span>	Marantz DV-12S1	2,500	THX Ultra-progressive DVD-A player is a classy all-rounder, and absolutely top notch in legacy CD mode						229
<span style="border: 1px solid black; padding: 2px;">EC</span>	Meridian 800	10,805	The ultimate in DVD replay, modular construction, buffered ROM drive, upsampling and high-res digital outputs						230
	Roksan Caspian DVD	1,195	A good all-rounder – a solid and propulsive sounding DVD player which is also a surprisingly capable picture-making machine						237
<span style="border: 1px solid black; padding: 2px;">EC</span>	TAG McLaren DVD32R	3,995	An engineering <i>tour de force</i> . It's pricey and plays neither DVD-A nor SACD, but performance – especially video – is top notch						212

**SPECS KEY** **DVD-A COMPATIBLE** Plays high-resolution DVD-A discs in two and multichannel modes. **SACD COMPATIBLE** Plays high-resolution SACD discs in two and multichannel modes. **ELEC DIGITAL OUTPUT** Electrical coaxial output for digital connection to a multichannel amplifier or receiver. **OPT DIGITAL OUTPUT** Optical Toslink output for digital connection to a multichannel amplifier or receiver. **HEADPHONE SOCKET** Quarter inch (6.3mm) headphone jack fitted to the DVD player.

## TOP BUYS



### Pioneer DV-565A £250

A universal player with respectable performance across all formats, at a remarkable price.



### Denon DVD-2900 £850

A universal player that's good with CD and great with DVD-V, DVD-A and SACD alike.



### Denon DVD-A11 £1,700

A superb universal player, made even better with i.Link/Denon Link/DVI digital outputs.



### Arcam FMJ DV27A £1,900

No SACD playback, but DVD-Audio and CD sound are first rate, as is picture performance.

**Billy Vee** 248 Lee High Rd, London SE13 5PL (Mon - Sat 10am to 6.30pm Closed Thurs & Sun)  
**4 More Super Savers** → [www.billyvee.co.uk](http://www.billyvee.co.uk)  
 Call Sales: (020) 8318 5755 or 8852 1321 Now!  
 Web: - [www.billyvee.co.uk](http://www.billyvee.co.uk) email: [sales@billyvee.co.uk](mailto:sales@billyvee.co.uk) We deliver nationwide from £5. E&OE.

**Arcam AVR200/KEF KHT2005**  
 Save over £500 **£999**  
 Last Few only!



**AVR200 70W x 5ch - AM/FM Receiver**  
**KEF KHT 2005. 150w Sub & 5 satellites**

**Linn Klassik + B&W DM600s3**  
 Save over £200 **£999**  
 While stocks last!



Classik Only? **£799.00**  
 Silver or Black  
 Available for audition along with other fine products in our listening rooms  
 Call our helpful sales staff or check our website for more sizzling offers!

Want different speakers?

- With KEF Q1 add £45
- With DM601s3 add £45
- With DM602s3 add £95
- With Linn Kan add £169
- With Quad 11L Add £179
- With AVI NuNeutron Add £295

**Arcam CD73/A80 + B&W602.5**  
 Save over £200  
 While stocks last!  
**£1195**



Arcam & KEF Products - shop callers only

# VINYL

*Turntables, cartridges and phono stages*



Record players or turntables offer the digital revolution serious competition when it comes to sound quality. Even a modest model can turn musical tricks that most CD players struggle with. Some call it vinyl warmth, but in reality it's a lack of digital hardness that makes the format so engaging. True, the software requires a bit more care, but even a knackered LP is more playable than a scratched CD.

Record players are made of three, perhaps four, fundamental parts. The turntable is the plinth and platter, usually also containing the motor and any suspension system. A tonearm sits on the plinth and allows the cartridge to trace the vinyl groove by pivoting or parallel tracking over the record. The cartridge contains the means of turning the mechanical movement of the groove wall into an electrical signal.

A fourth element is an amp dedicated to the delicate job of amplifying and equalising the cartridge's insubstantial output. This is called a phono stage and can be found in some integrated amplifiers and preamps, but is increasingly purchased separately for use with line-only amps.

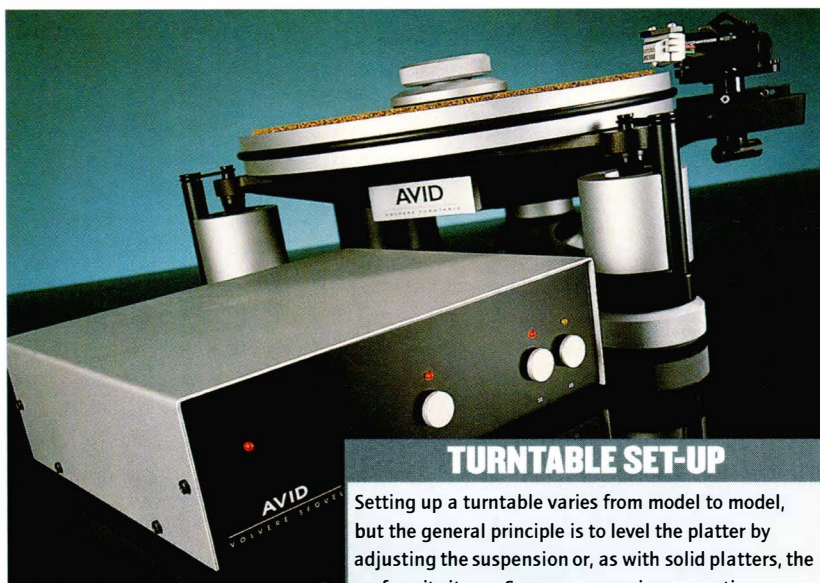

## TURNTABLE SET-UP

Setting up a turntable varies from model to model, but the general principle is to level the platter by adjusting the suspension or, as with solid platters, the surface it sits on. Sprung suspensions sometimes require a bit of fine-tuning to sound their best, but the principle is to achieve a smooth, pistonic bounce. Cartridge set-up is even more critical, as the angles at which the stylus traces the groove affects its tonal balance and levels of distortion. A good alignment protractor is essential if you are intending to set up your own cartridge, as is a degree of patience. In essence, there are two angles you need to get right: the tracing angle as the cartridge crosses the record if you are looking from above, and the vertical tracking angle (VTA), which is adjusted by raising or lowering the arm base to bring the arm parallel with the record surface.

There are two types of phono cartridge: moving magnet (MM) and moving coil (MC), and with a few exceptions the latter outperforms the former. But MCs produce a lower output and require better-quality amplification to be heard at their best. As a general rule, MCs offer a broader bandwidth, greater dynamics and more detail, but the better moving magnets do most things well enough to distract you from your CD collection.

## TOP BUYS



### Pro-Ject 1 Xpression £210

The latest model from Czech turntable specialist Pro-Ject is remarkable value for money – an Ortofon OM10 cartridge and carbon fibre arm are included in the price.



### Roksan Radius 5 £850

A beautiful mid-price turntable with an impressively well-sorted sound from low bass to high treble. Price includes matching Nima tonearm.



### Avid Diva £1,100

Superbly well engineered for the money, Avid's entry-level deck spins a highly involving musical message – solid, powerful and detailed.



### Michell Orbe SE £1,825

A fine example of the turntable art, the stripped down SE version of Michell's flagship now features a DC motor. Does justice to the best arms and cartridges.

## Our favourite BEST BUY EDITOR'S CHOICE

# TURNTABLES

### Record players

BADGE?	PRODUCT	£	COMMENTS	SPECIFICATIONS					
				SPEEDS	SUSP SUBCHASSIS	SWITCHABLE SPEED CHANGE	SUPPLIED WITH ARM	SUPPLIED WITH CART	ISSUE NUMBER
<input type="checkbox"/>	Audio Note TT1/ARM1	594	Simple and unpretentious, it delivers a real taste of true high-end performance at an affordable price	33/45	●	●	●	●	203
<input type="checkbox"/>	Avid Diva	1,100	A solid and powerful sounding deck with fine build, requires a smooth, relaxed cartridge for best results	33/45	●	●	●	●	247
<input checked="" type="checkbox"/>	Avid Volvere Sequel	3,500	Heavyweight turntable that will deliver more of what's in a vinyl groove than most of the competition	33/45	●	●	●	●	229
<input checked="" type="checkbox"/>	Avid Acutus	5,000	Extremely capable design with no apparent shortcomings. Don't sell your vinyl 'til you've heard it on this!	33/45	●	●	●	●	194
	Clearaudio Champion Level 2	1,955	Neutral balance, great looks, but only so-so detail. Benefits greatly from isolation	33/45			●	●	223
	Linn LP12 Basik	1,100	Trails the full LP12 significantly, but pace, rhythm, timing etc are still top rank	33	●		●	●	103
<input type="checkbox"/>	Michell Gyro SE	1,058	New DC motor-equipped Gyro offers great looks and even better sound. Price includes RB300 arm	33/45	●		●	●	239
<input checked="" type="checkbox"/>	Michell Orbe SE	1,825	A superb turntable, able to mix it with the best at virtually any price. Now features new DC motor.	33/45	●		●	●	235
<input type="checkbox"/>	Pro-Ject 1 Xpression	210	Well designed and executed budget deck with an entertaining and revealing sound	33/45			●	●	248
<input type="checkbox"/>	Pro-Ject RPM 6	500	Basic, very neutral turntable and arm combination that can take a very expensive cartridge. A high-end bargain	33/45			●	●	236
<input type="checkbox"/>	Rega P2	198	Updated Planar 2: just as much fun as ever and now even better value as the competition falls away	33/45			●	●	214
	Rega P3	298	Updated Planar 3, building on the strengths of the P2 with added subtlety and detail	33/45			●	●	214
	Rega P25	619	The contemporary aesthetic wins admiration, the sonic assurance turns it into your own personal music shrine	33/45			●	●	239
<input checked="" type="checkbox"/>	Rega P9	2,248	Exceptionally elegant hi-tech player with complex outboard supply, ceramic platter and wonderful RB1000 tonearm	33/45		●	●	●	228
<input type="checkbox"/>	Roksan Radius 5	850	Sophisticated design with accomplished sound quality, excellent imagery, and good isolation	33/45	●		●	●	248
<input checked="" type="checkbox"/>	Roksan TMS2	7,500	Typical Roksan sound, but better: pitch-accurate, lean, detailed and controlled, without the 'bloat' of lesser designs	33/45	●	●	●	●	246
<input checked="" type="checkbox"/>	SME Model 10A	3,411	Elegant and extremely capable design with Series V/309 hybrid arm, superbly built	33/45	●	●	●	●	195
<input checked="" type="checkbox"/>	SME Model 20.2A	5,274	Beautifully built, extremely neutral damped and suspended deck with superb sound. Inc V arm	33/45/78	●	●	●	●	186

## Our favourite BEST BUY EDITOR'S CHOICE

# PHONO CARTRIDGES

### MM and MC cartridges

BADGE?	PRODUCT	£	COMMENTS	SPECIFICATIONS			
				MM	MC	REPLACEABLE STYLUS	
	Clearaudio Aurum Beta S	270	Clear improvement over cheaper Alpha, and good sound all round by any standards	●			223
	Clearaudio Sigma	580	A nimble and revealing cartridge that is more at home in lower mass arms		●		235
	Goldring Elite	250	A remarkably subtle and persuasive design that should tempt anyone		●		235
	Grado Prestige Black	40	Offers admirable detail and treble extension, with good bass and ambience too	●		●	214
<input type="checkbox"/>	Grado Prestige Gold	110	Produces rich, open and expansive music with the minimum of fuss	●		●	235
<input checked="" type="checkbox"/>	Linn Akiva	1,800	With fine dynamic expression and a wide bandwidth, what you hear sounds very close to master tape		●	●	242
<input checked="" type="checkbox"/>	Lyra Helikon	1,095	Highly capable and highly neutral, this is a cartridge for all seasons, albeit fussy about vinyl quality	●			215
	Reson Etile	485	Plenty of life and detail, and refined with it		●		223
<input type="checkbox"/>	Sumiko Blue Point Special	250	A no-nonsense performer with engaging musical properties – one of the best around for less than £300		●		192
<input type="checkbox"/>	Van den Hul MC One Special	699	A gorgeous cartridge that's worth the price every time you hear a familiar track in a whole new light		●		235
<input checked="" type="checkbox"/>	van den Hul Colibri XGP	2,699	Phenomenal resolution, custom building to suit hard and software, but needs 500 ohm loading and is vulnerable to damage		●		244

## Our favourite BEST BUY EDITOR'S CHOICE

# PHONO STAGES

### Phono stages

BADGE?	PRODUCT	£	COMMENTS	SPECIFICATIONS				
				MM PHONO INPUTS	MC PHONO INPUTS	AUJ GAIN	AUJ IMPEDANCE	
<input type="checkbox"/>	Creek OBH-8SE	160	Neutral, relaxed and involving sound from this neat little unit	●				223
	Lehmann Black Cube	275	Creates a well balanced sound that has few limitations and plenty of good qualities. Very flexible for the price	●	●	●	●	234
	Musical Fidelity X-LPS <sup>43</sup>	249	Simple, well turned out valve-driven phono stage lacks adjustability, but sounds sweet, open and well-behaved	●	●			248
<input type="checkbox"/>	NAD PP2 phono stage	50	A fine buy for turntable users on a tight budget – open tonality and clarity is distinctly impressive for the money	●	●			245
<input type="checkbox"/>	Tom Evans Microgroove	400	For dynamics and real bass extension with good tonal colour this is the one to beat. The Plus version (£700) is even better!		●			234
<input checked="" type="checkbox"/>	Tom Evans The Groove	1,800	Plenty of detail, excellent imaging and almost flawlessly neutral: a good choice for maximum information retrieval off any LP		●			201
<input type="checkbox"/>	Trichord Dino/Dino+	498	Relaxed yet resolute with very good image depth and natural balance, not to mention great flexibility	●	●	●	●	234

**TURNTABLE SPECS KEY** **SPEEDS** Speeds offered in rpm. **SUSP SUBCHASSIS** Turntables with a sprung or suspended support for the platter and arm. **SWITCHABLE SPEED CHANGE** Some decks require manual lifting of the belt from one pulley to another to change speed, but not these ones. **SUPPLIED WITH ARM** Deck is supplied complete with tonearm – some require a separate purchase in this department, but the dealer will fit it for you.

**SUPPLIED WITH CARTRIDGE** Some decks are supplied with a starter cartridge and this is included in the price shown.

**CARTRIDGE SPECS KEY** **MM** Moving magnet cartridge – see amp and phono stage features to match this type. **MC** Moving coil cartridge – see amp and phono stage features to match this type.

**REPLACEABLE STYLUS** Some cartridges have separate styli for ease of replacement, but it compromises sound quality.

# SME

The way to play vinyl...

Model 10

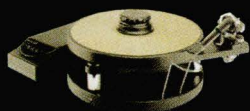

Model 20/2



Model 30/2



Series 300



Series IV



Series V



Ask for details of this superb range:

SME LTD · STEYNING · SUSSEX · BN44 3GY · ENGLAND

tel: +44 (0)1903 814321 · fax: +44 (0)1903 814269

email: sales@sme-ltd.demon.co.uk

or visit our website [www.sme.ltd.uk](http://www.sme.ltd.uk)

## Release the full potential of your system

### STEP 1: SORT OUT YOUR MAINS

Start at the beginning! The truth is that poor mains quality ruins the sound of even the best equipment. The better the equipment the bigger the difference. Our Russ Andrews Mains Blocks and Power Cables remove mains pollution effectively, giving you a deeper more extended bass and a sweeter more natural sound.



£120  
for 4 Way Block

Yellow Power Cable  
1m £29.95

Classic PowerKord™  
from £55

Phone UK Freephone 0800 373467 (quote: AC34) for a FREE catalogue or buy online at [www.russandrews.com](http://www.russandrews.com)

Russ Andrews

Russ Andrews Accessories Ltd, Windermere Road, Staveley, Kendal LA8 9PL.  
Int tel: 0044 1539 825500 Fax: 0044 1539 825540 Email: AC34@russandrews.com

FREE  
CATALOGUE

## PINEWOOD MUSIC of Winchester and Taunton

### KRELL SACD STANDARD

We invite you to hear this superb CD and SACD player in our Winchester or Taunton listening rooms - or in the comfort of your own home.

Please telephone for a demonstration.

FEATURED AWARD-WINNERS  
ON DEMONSTRATION:

Krell KAV-400xi  
Sonus faber Cremona Auditor  
Martin Logan Clarity

Pinewood Music has been a high end dealer for 16 years, specialising in two-channel music and home cinema. We cover Hampshire, Wiltshire and the South-West. Home demonstrations are always welcome, and we give the kind of personal service and after-sales support expected at this level.

Agencies include:

KRELL, SONUS FABER, MARTIN LOGAN,  
COPLAND, TRANSPARENT

**The Pinewood Music Company**

Tel: 01460 54322 Mobile: 07860 351113

e-mail: [brianriv@mac.com](mailto:brianriv@mac.com)



# RADIO TUNERS

FM and DAB hi-fi separates



Radio is a fantastic musical resource that's in danger of being taken for granted, but whatever your tastes there's someone out there catering for it. If you haven't got a decent tuner hooked up to your hi-fi already, you're missing out!

### DAB or FM?

Digital Audio Broadcasting (DAB) is said to be available to 80 per cent of the population and the long-term plan is to switch public broadcasting over to digital, but hardware prices have yet to come down to a point where this would be acceptable. Its advantages over FM include hiss-free reception, the potential for a wider range of stations and the ability to display comprehensive programming information. FM's RDS system means that station name and occasionally track titles are displayed, but the range of information is fairly limited.

Where FM scores over DAB is in the lower cost of hardware and the greater reception

area. It can also provide higher sound quality if reception conditions are favourable. Absolute sound quality judgements are muddled by the fact that you are listening to different forms of compression and processing at the studio for each station.

What is clear, however, is that there are more and more radio stations broadcasting on DAB that aren't available on FM. So if it's variety of programming you're after, they have a lot to offer.

### RECEPTION

The quality of signal you feed a tuner will dictate its sound quality. So serious FM listeners should get a decent external aerial and connect it with as few junctions and splits as possible. Every time you split the cable (ie take a feed for another tuner) you halve signal strength! With DAB the same applies but get a DAB-specific aerial. See [www.bbc.co.uk/digitalradio](http://www.bbc.co.uk/digitalradio) for details.

### TOP BUYS



#### Denon TU260L II £130

The benchmark for all other budget AM/FM tuners, with great sound and features.



#### Cambridge DAB500 £150

A low-cost DAB radio that gets very close to much more expensive digital models.



#### Rega Radio 3 £374

An excellent sound-first FM/MW tuner – low on features but big on sound.



#### Magnum Dynalab MD102 £2,200

If you're serious about radio this superb FM tuner is about as good as it gets.

## Our favourite TUNERS

BEST BUY EDITOR'S CHOICE

### FM & DAB HI-FI SEPARATES

BADGE?	PRODUCT	£	COMMENTS	WAVEBANDS	PRESETS	RDS	REMOTE CONTROL	SIG. STRENGTH METER	ROT. TUNING KNOB	ESQ. NUMBER
<b>FM TUNERS</b>										
	Cambridge Audio T500	180	Very capable tuner suited to good and less good reception conditions	FM,M,L	64					193
	Creek T43	399	Quality UK-made tuner offering classy sound in all areas at a very fair price	FM,M,L	64					193
	Denon TU-260L II	130	The return of the all-time favourite, now enhanced with RDS and sounding as fine as ever	FM,M,L	40					193
	Magnum Dynalab MD102	2,200	Unique remote control analogue FM tuner delivers a superbly transparent sound that makes radio fun	FM	5					241
	Marantz ST6000	180	Another budget killer from Marantz, with sound well above its class and useful features	FM, M, L	90					211
	NAD C422	180	Admirably free of roughness or other obvious nasties, with just a slight lack of clarity	FM,M	30					250
	NAD S400	600	One of the best around – bass and treble are both well extended and detail is excellent	FM	30					230
	Primare T21	600	Identical to NAD S400 and likewise a very fine tuner	FM	30					230
	Rega Radio 3	374	Unpretentious unit which does what it claims, very well. Unusually fine FM sound in all areas	FM,M	20					242
	Rotel RT-02	279	A highly competent tuner which always sounds appealing and fuss-free	FM,M	30					242
<b>DAB TUNERS</b>										
	Arcam DT-81	650	A very smart and polished DAB performer	DAB	16					221
	Cambridge Audio DAB500	150	Very good sound, plus optional response tweaks, and slickest operation yet	DAB	10					248
	Pure Digital DRX-701ES	250	An excellent introduction to DAB, fine value, simple to use and feature loaded	DAB	99					234
	Pure Digital DRX-702ES	330	Very flexible DAB (inc L-band) and FM tuner. DAB is good, FM a touch disappointing	DAB,FM,M	99					242
	TAG McLaren T32R+DAB	2,290	Classy hi-fi at its best: top sounds on FM and DAB, and a joy to own and use	DAB,FM,M,L	99					230

**SPECS KEY** WAVEBANDS Which bands are supported: FM, M – medium wave, L – long wave, DAB – digital audio broadcasting. PRESETS How many stations can be stored in memory. RDS Radio Data System – station names and program titles can be displayed among other facilities (FM only, DAB has more comprehensive display potential). REMOTE CONTROL For the couch potato. SIGNAL STRENGTH METER Useful for setting up an aerial. ROTARY TUNING KNOB An ergonomic alternative to buttons.

# DIGITAL AUDIO RECORDERS

CD, MiniDisc and hard drive recorders



## MiniDisc

MD's strength is versatility. You can record and then re-record many times over. Editing facilities are second to none – you can erase mistakes, name tracks and re-order a disc's contents with a few simple button pushes, making it ideal for building compilations. They're pretty robust too.

Sound quality is below that of CD-R/CD-RW. The format uses a Sony-developed compression technology called ATRAC, which discards part of the data in order to squeeze it on the disc. If you're copying from CD to MD, the result tends to sound a little cold in comparison, lacking a degree of detail and ambience. But to most people it still sounds light years ahead of cassette – clean and hiss-free.

## Recordable CD

With recordable CD you have a choice of two disc types: CD-R discs are the cheapest, but you can only record once; and CD-RW discs are a little more costly, but you can re-record on them *ad infinitum*.

Though the latest machines incorporate some useful editing facilities, CD-R/RW is not as flexible as MD. However, sound

quality is higher – if you're recording from a CD, the best models will give you a copy that is very close to the original. In terms of compatibility, most CD players will play back a CD-R disc, but older models might have trouble with CD-RW (though you can, of course, play the disc back on your own recorder). If you want to play a CD-R/RW on a DVD player, check for compatibility.

## Hard drive

The latest contender on the digital recording scene is also the most flexible. Some HDD (hard disk drive) recorders can store whole music collections if you use a compression format such as MP3. HDD recorders are taking over from multidisc CD changers as sound servers in multiroom installations, where their ability to play more than one piece of music at a time is a great boon. HDD also offers impressive editing facilities on a par with MD, and they can also record from CD (or to CD-R/RW) at high speed.

At present, sound quality isn't the driving force behind the format – flexibility and storage capacity being bigger issues – and a plain CD-R/RW machine will outperform an HDD recorder in fidelity terms.

TOP BUYS



**Philips CDR802** £300

Multidisc recorder that's slick and accomplished, albeit with a slightly flaky build.



**Marantz DR6000** £400

Quality in a box – it eschews gimmicky, but it does a simple job very well.



**Yamaha CDR-HD1300** £600

Combining hard disk with CD-R makes CD recording a whole lot more flexible.



**Imerge S2000** £1,599

Impressively flexible hard disk music server for multi-room applications.

## Our favourite DIGITAL RECORDERS

BEST BUY  EDITOR'S CHOICE

CD-R/RW, MD and HDD recorders

BADGE? PRODUCT	£	COMMENTS	SPECIFICATIONS							
			DECKS	HD CAPACITY (GB)	OPTICAL IN/OUTPUTS	ELEC IN/OUTPUTS	ISSUE NUMBER			
<b>CD-R/RW RECORDERS</b>										
	Denon CDR-1000	400	A respectable player and recorder, though some midband congestion was noted when recording	1		● ●		218		
<input type="checkbox"/>	Marantz DR6000	400	No frills, but in its fundamentals this is one of the finest CD recorders on the market	1		● ●		233		
	NAD C660	500	Audiophile twin deck offering high-speed copying, HDCD replay and notably fine recording from analogue	2		● ●		243		
<input type="checkbox"/>	Philips CDR802	300	Tacky looks and build notwithstanding, this is a well-equipped and technically sound 3-to-1 autochanger/recorder at a good price	2		● ●		233		
<input type="checkbox"/>	Philips CDR951	380	An improvement on previous models, it delivers the musical goods in some style	1		● ●		205		
<input type="checkbox"/>	Pioneer PDR-609	270	Classic CD recorder with outstandingly good sound for the money on both record and replay	1		● ●		243		
	Pioneer PDR-W839	350	Good-quality twin CD burner makes recordings that can be hard to distinguish from the original. Good value too	1		● ●		218		
<b>MD RECORDERS</b>										
	Pioneer MJ-D508	200	Well equipped, but musically sleep-inducing player that receives its Recommendation owing to the price	1		● ●		205		
	Sony MDS-JE480	130	Straightforward and effective, but the three real killer features are price, price and price	1		●		233		
<b>HDD RECORDERS</b>										
	Imerge S2000	1,599	Intended as the centrepiece of a multi-room installation, this three-output server combines flexibility with good sound	2	80	● ●		243		
<input type="checkbox"/>	Yamaha CDR-HD1300	600	Superb combination of high-speed CD-RW drive and hard disk, adding editing flexibility to CD recording	2	80	● ●		243		

**SPECS KEY** **DECKS** Amount of drive mechanisms on board – twin-deck recorders use one to play while the other records. **HD CAPACITY** Amount of gigabytes of storage capacity, for HD only. **OPTICAL IN/OUTPUTS** Optical Toslink in and outputs for digital connection to a CD player or DAC. **ELEC IN/OUTPUTS** Electrical coaxial in and outputs for digital connection to a CD player or DAC.

# Sevenoaks SOUND & VISION



Sevenoaks Sound & Vision stocks a wide range of Hi-Fi separates, DVD players, amplifiers, speakers, plasma screens, LCD televisions and projection systems from all the leading manufacturers.

From starter systems to custom designed multi-room and home cinema installations, our friendly staff are available in all stores to advise, demonstrate and guide you through the home entertainment jungle. If you're interested in home entertainment and want to avoid the confusion, contact your local Sevenoaks Sound & Vision store and **experience more.**

0% interest free option\* is available on most products.

\*Written details on request. Licensed credit brokers. Minimum balance £400. Subject to status.



## CUSTOM INSTALLATION

Are you looking to neatly and seamlessly integrate a Home Cinema or Hi-Fi System into your home? Our Custom Installation experts are fully trained in all areas and provide a prompt, reliable and professional service. Whether you're looking for lighting control systems, a dedicated home cinema installation with a retractable screen and built-in speakers or an integrated control system, Sevenoaks Sound & Vision has the solution.

**Northern  
2004  
Sound & Vision  
Hi-fi & Home Cinema show**  
Radisson SAS, Manchester Airport  
7/8 February 2004

Sevenoaks Sound & Vision Leeds will be exhibiting at the superb Northern Sound & Vision show, 7/8 February 2004. On display will be an exceptional range of audio and visual equipment from the finest companies, along with live entertainment. Sevenoaks will be working on the 'Smarthouse Showcase' which will exhibit cutting-edge home technology all in an actual home setting.

For further information on this event, contact Richard at our Leeds store - 0113 245 2775.

## Product NEWS



### SHARP INTRODUCES THE **XV-Z200** DLP HOME CINEMA PROJECTOR

Housed in a compact and stylish tungsten coloured case, the XV-Z200 is similar in design to the award-winning XV-Z91. Incorporating the industry's latest DLP 'Matterhorn' chip, the projector can display images at a resolution of 1024 x 576 pixels enabling true widescreen support in

both interlaced and progressive scan.

Packed with features, the XV-200 offers a 2D digital keystone correction, a set of six picture presets, gamma correction (which enables contrast and detail to be increased in dark conditions) and a white enhancement feature. The whisper 30db fan ensures the unit will sit unnoticed in the room leaving the user to simply enjoy the movie.



### YAMAHA RX-V1400RDS THX SELECT AV RECEIVER

A recent addition to Yamaha's range of acclaimed AV products is the THX select certified RX-V1400RDS receiver. Comprehensively equipped and effortlessly powerful, What Hi-Fi? Sound and Vision magazine (Jan 04) described the sound quality as "sensational" and concludes the '1400RDS to be "One of the most significant receivers of recent months [and may] be the new class leader."



BEDFORD  
BIRMINGHAM  
BRIGHTON  
BRISTOL  
BROMLEY  
CAMBRIDGE  
CARDIFF  
CHELSEA  
CHELTENHAM  
CRAWLEY  
CROYDON  
EDINBURGH  
EPSOM  
EXETER  
GLASGOW  
GUILDFORD  
HOLBORN  
HULL  
IPSWICH  
KINGSTON  
LEICESTER  
LEEDS  
LINCOLN  
LIVERPOOL  
MAIDSTONE  
MANCHESTER  
NEWCASTLE  
NORWICH  
NOTTINGHAM  
OXFORD  
PETERBOROUGH  
PLYMOUTH  
POOLE  
PRESTON  
READING  
SEVENOAKS  
SHEFFIELD  
SOLIHULL  
SOUTHAMPTON  
SOUTHGATE  
STAINES **NEW**  
SWANSEA  
SWINDON  
SWISS COTTAGE  
TUNBRIDGE WELLS  
WATFORD  
WEYBRIDGE **NEW**  
WITHAM (ESSEX)  
WOLVERHAMPTON

PLEASE SEE PAGE 7  
FOR ADDRESS AND TELEPHONE  
NUMBER DETAILS

# Sevenoaks

SOUND & VISION



## HI-FI SEPARATES

**MICHELL GYRO SE**  
TURNTABLE / RB300 TONEARM  
**£1049.95**



WHAT HI-FI?  
SOUND AND VISION  
**Best Buy**  
2003  
HI-FI & HOME CINEMA AWARDS

"The Gyrodec SE sounds great, combining the best sonic characteristics of rivals... Quite simply, the Michell Gyrodec SE is terrific. Nothing compares at this price point - it's well deserving another Best Buy."

**CLAIM £50**  
TOWARDS THE CARTRIDGE OF YOUR CHOICE\*



**SYSTEM PRICE**  
**£949.95**

PRICE EXCLUDES CABLES & STANDS

WHAT HI-FI?  
SOUND AND VISION  
**Best Buy**  
2002  
HI-FI & HOME CINEMA AWARDS  
AMPLIFIERS  
£751 £500

**PRO-JECT 1 XPRESSION**  
TURNTABLE (BLACK) **£209.95**



"Compared with a £200 CD player this deck sounds remarkable: dig out your vinyl and give the Xpression a spin."

WHAT HI-FI?  
SOUND AND VISION  
**Best Buy**  
2003  
HI-FI & HOME CINEMA AWARDS

**FREE GOLDRING EXSTATIC CLEANER\***

**ARCAM CD73T CD PLAYER £ CALL**



WHAT HI-FI?  
SOUND AND VISION  
**Product**  
of the year  
2003  
HI-FI & HOME CINEMA AWARDS

FANTASTIC OFFERS ON ARCAM DIVA AMPS & CDS

**HI-FI SYSTEM 1 SAVE £149**



WHAT HI-FI?  
SOUND AND VISION  
**Best Buy**  
2002  
HI-FI & HOME CINEMA AWARDS  
TURNTABLES  
Up to £150

**FREE**  
PRO-JECT DEBUT II TURNTABLE\*

**ROTEL**  
RCD-02 CD PLAYER  
RA-02 AMPLIFIER  
**B&W**  
DM601 S3 SPEAKERS

Rotel electronics and B&W speakers are natural partners for each other, giving excellent sound quality and stunning looks. So what better than this combination of class-leading detail with an even and robust sound.

But at Sevenoaks we always aim to offer you more and this means What Hi-Fi? Sound and Vision's Award-winning Project Debut II turntable is thrown in **FREE**.

HI-FI SYSTEM 1 - NOT IN CONJUNCTION WITH ANY OTHER OFFER OR PROMOTION

experience more

experience more  
experience more

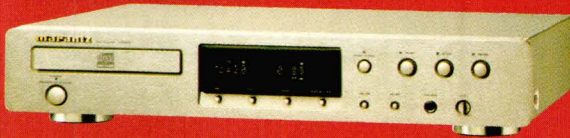

**MARANTZ**  
CD5400 CD PLAYER  
**£119.95** **SAVE £30**

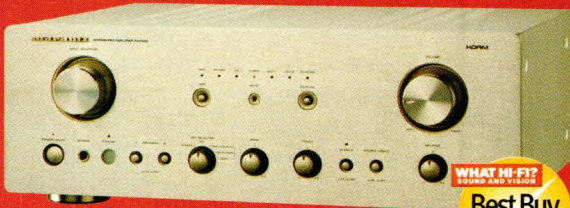

**MARANTZ**  
PM7200 AMPLIFIER  
**£249.95** **SAVE £80**



"This is one of the most powerful amps in its class, at 95w per channel, and it sounds it with anything from dance to a big orchestral work, offering a delicious combination of poise and impact. Stick with fast, dynamic speakers such as B&W DM601 S3s or KEF's equally capable Q1s and the results will amaze."

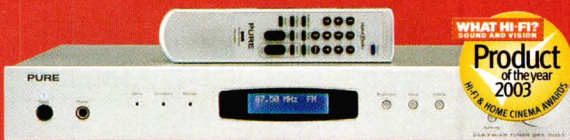

**PURE DIGITAL**  
DRX-702ES ANALOGUE/DAB TUNER  
**£299.95** **SAVE £30**



### PRICING POLICY

We always try to ensure our prices are highly competitive.

In the event you can find the same products and excellent service at a lower price, please bring it to our store managers' attention.

£

0%

### FINANCE OPTION\*

Spread the cost of buying. 0% finance option is available on the vast majority of products we stock.

\*Written details on request. Licensed credit brokers. Minimum balance £400. Subject to status.

Please Note: Some products may not be available at all stores. Please call before travelling. \*Cable Offer - From range available in-store. Not in conjunction with any other offer. Advertisement valid until at least 11/02/04, E&OE.

## HI-FI SYSTEM 2

**MUSICAL FIDELITY**  
A3 CD PLAYER & AMPLIFIER  
**MONITOR AUDIO**  
SILVER S8 SPEAKERS

One of our most popular systems at an amazing sale price. Full-scale dynamics with a lightness of touch makes this combination stand out.



**SYSTEM PRICE**  
**£2399.95**

PRICE EXCLUDES CABLES & STANDS

HI-FI SYSTEM 2  
NOT IN CONJUNCTION WITH ANY OTHER OFFER OR PROMOTION

**SAVE £379**

**MISSION**  
780 SE SPEAKERS  
**£349.95**

"The revamped Mission 780s are hugely enjoyable: anyone with up to £400 to spend should consider these standmounters. Mission's clever move has paid off."



INCLUDES **FREE**  
SPEAKER CABLE WORTH £60\*



**MISSION**  
782 SE SPEAKERS  
**£899.95**

"Well, with the exception of the alderwood-veneer finish, these floorstanders look identical to the standard model, although there's a new tweeter and crossover design. One of the advantages of the three-way configuration is that each driver deals with only a narrow section of the frequency range, and the designers optimise each unit to perform its respective task. Mission's

engineers have excelled in this area: these elegant floorstanders sound beautifully balanced and few rivals under £1000 can match their wonderful levels of clarity. The 'special edition' tag is overused but these talented floorstanders are bona fide sonic stars."



INCLUDES **FREE**  
SPEAKER CABLE WORTH £120\*

SAVE £169

## HI-FI SYSTEM 3

**ROKSAN**

KANDY KD1/III CD PLAYER

KANDY KA1/III AMPLIFIER

**QUAD**

11L SPEAKERS



WHAT HI-FI?  
SOUND AND VISION  
**Best Buy**  
2003  
HI-FI & HOME CINEMA AWARDS

WHAT HI-FI?  
SOUND AND VISION  
**Product**  
of the year  
2003  
HI-FI & HOME CINEMA AWARDS

If you're after detail and excitement in your music then this system's for you. Here we've combined the Quad 11L speakers - Product of the Year 2002/2003 - with Roksan's double Award-winning Kandy KA1/III amplifier and its ideal partner, the Kandy KD1/III CD player.

Awarded five stars in a recent What Hi-Fi? Sound and Vision group test, the Kandy KD1/III CD player was described as "offering a great array of talents - team it with its amp stablemate and you have something close to the ideal visual and sonic combination."

But don't just take our word for it; come in for a listen.

HI-FI SYSTEM 3 - NOT IN CONJUNCTION WITH ANY OTHER OFFER OR PROMOTION

SYSTEM PRICE  
**£1399.95**

PRICE EXCLUDES CABLES & STANDS

## MONITOR AUDIO

SILVER S8 SPEAKERS

£699.95

SAVE £100



## HI-FI SYSTEM 4

SAVE £399

**CYRUS** CD8 CD PLAYER & 8 AMPLIFIER

**MONITOR AUDIO** SILVER S6 SPEAKERS

Another very popular combination that's more than the sum of its already talented parts - and that's before you've examined the upgrade options. The CD8 is a magnificent player (Best Buy - What Hi-Fi? Sound and Vision Awards 2003) and like most Cyrus products its performance can be maximised with the addition of a Cyrus PSX-R power supply

The beautifully crafted Silver S6 speakers from British speaker specialists Monitor Audio complete the package.

HI-FI SYSTEM 4 - NOT IN CONJUNCTION WITH ANY OTHER OFFER OR PROMOTION



WHAT HI-FI?  
SOUND AND VISION  
**Best Buy**  
2003  
HI-FI & HOME CINEMA AWARDS

SYSTEM PRICE  
**£1999.95**

PRICE EXCLUDES CABLES & STANDS

WHAT HI-FI?  
SOUND AND VISION  
**Product**  
of the year  
2003  
HI-FI & HOME CINEMA AWARDS

Please Note: Some products may not be available at all stores.  
Please call before travelling. \*Cable Offer - From range available in-store.  
Not in conjunction with any other offer.  
Advertisement valid until at least 11/02/04. E&OE.

experience more

# experience more

# experience more



## LINN CLASSIK ▾

MUSIC SYSTEM (EX SPEAKERS)

£749.95

SAVE £100

"The Classik sounds simply marvellous. Boasting fine impact and drive, it retains its grip even as it thumps out rock and dance tracks. Ask it to



play quiet acoustic music and its smooth, liquid presentation impresses still further. The Classik offers the performance you'd expect from high quality separates in one lovely package - this is a very superior product."



## YAMAHA CDR-HD1300

CD-RW/HD RECORDER

£499.95

SAVE £30

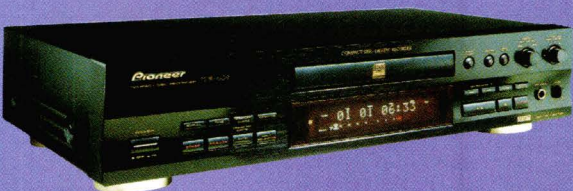

## PIONEER PDR-609

CD-RW RECORDER

£159.95

## DENON DM31 ▸

UD-M31 CD RECEIVER

£179.95

SAVE £50

"The D-M30 was exemplary, as its three What Hi-Fi? Sound and Vision Awards clearly show. The D-M31 is even better, making it phenomenal value for money."

OPTIONAL RECORDERS: DMD-M31 MINIDISC RECORDER • DRR-M31 CASSETTE DECK  
NB - PRICE EXCLUDES SPEAKERS

## HI-FI SYSTEM 5

SAVE £169

ARCAM

CD73T CD PLAYER & A65 PLUS AMPLIFIER

MONITOR AUDIO

BRONZE B2 SPEAKERS



SYSTEM PRICE  
**£799.95**  
PRICE EXCLUDES CABLES & STANDS

Arcam and Monitor Audio both have an enviable reputation for producing great sounding kit without breaking the bank. This system shows why with a well balanced sound that's both musically involving and enjoyable.

At the front of this package is Arcam's upgradeable CD73T CD player - a What Hi-Fi? Sound and Vision 'Product of the Year 2003'. We've coupled this with Arcam's complementary A65 Plus integrated amplifier and Monitor Audio's beautifully balanced 'Best Buy' Bronze B2 speakers. According to What Hi-Fi? Sound and Vision (Awards 2003), these compact speakers "Sound superb... Speakers don't get much better than the B2s."

HI-FI SYSTEM 5 - NOT IN CONJUNCTION WITH ANY OTHER OFFER OR PROMOTION



WHAT HI-FI?  
SOUND AND VISION  
Product  
of the year  
2003  
HIFI & HOME CINEMA AWARDS

# Sevenoaks

## SOUND & VISION



### PRODUCT RANGE

An outstanding selection of products are on display and available for demonstration at all Sevenoaks Sound & Vision stores. However, some products may not be available at all stores.

Please call to check availability before travelling.

### TURNTABLES

Goldring GR1	£ CALL
Michell Gyro SE/RB300 E50 TOWARDS CARTRIDGE*	£1049.95
Michell TechnoDec	£ CALL
Project Debut Phono SB	£ CALL
Project Debut II (Black)	£ CALL
Project Debut II (Colours)	£ CALL
Project 1 Xpression FREE EXSTATIC CLEANER*	£209.95
Project RPM4	£ CALL

### TUNERS

Arcam DIVA T61	£ CALL
Cyrus FM X	£ CALL
Denon TU260L MKII	£99.95
Marantz ST4000	£ CALL
Pure Evoke 1 DAB	£89.95
Pure DRX-701ES DAB	£ CALL
Pure DRX-702ES Analogue/DAB	£299.95

### CD PLAYERS

Arcam DIVA CD73T	£ CALL
Arcam DIVA CD82T	£ CALL
Arcam DIVA CD93T	£ CALL
Arcam FMJ CD33T	£ CALL
Cyrus CD6	£ CALL
Cyrus CD8	£ CALL
Denon DCD485	£119.95
Linn Genki	£ CALL
Linn Ikemi	£ CALL
Marantz CD5400	£119.95
Marantz CD17/II M	£ CALL
Meridian 507	£ CALL
Musical Fidelity A3.2	£ CALL
Musical Fidelity A308 <sup>PM</sup>	£ CALL
Musical Fidelity Tri-Vista SACD	£ CALL
Quad 99 CD-P	£ CALL
Roksan Kandy KD1 MKIII	£ CALL
Roksan Caspian M	£ CALL
Rotel RCD02	£ CALL
Rotel RCD1072	£ CALL

### RECORDERS

Pioneer PDR609 CD-RW	£159.95
Sony RCDW3 CD-RW	£169.95
Yamaha KX393 Cassette Deck	£99.95
Yamaha KX580SE Cassette Deck	£179.95
Yamaha CDR-HD1300 CD-RW	£499.95

### AMPLIFIERS

Arcam DIVA A65 Plus	£ CALL
Arcam DIVA A80	£ CALL
Arcam DIVA A85	£ CALL
Arcam DIVA A90	£ CALL
Arcam FMJ A32	£ CALL
Cyrus 6	£ CALL

Cyrus 8	£ CALL
Cyrus Pre X Pre	£ CALL
Cyrus Mono X Power (Each)	£ CALL
Denon PMA355	£189.95
Linn Kolektor Pre	£ CALL
Linn LK85 Power	£ CALL
Marantz PM4400	£ CALL
Marantz PM7200	£249.95
Musical Fidelity A3.2	£ CALL
Musical Fidelity A3.2 Pre	£ CALL
Musical Fidelity A3.2 Power	£ CALL
Musical Fidelity A308	£ CALL
Musical Fidelity Tri-Vista 300	£ CALL
Quad 99 Power	£ CALL
Roksan Kandy KA1 MKIII	£ CALL
Roksan Caspian M	£ CALL
Rotel RA-01	£ CALL
Rotel RA-02	£ CALL
Rotel RA-1062	£ CALL

### SPEAKERS

Acoustic Energy Aegis Evo One	£ CALL
Acoustic Energy Aegis Evo Three	£ CALL
Acoustic Energy AE1 MKIII (From)	£ CALL
B&W DM303	£ CALL
B&W DM301 S3	£ CALL
B&W DM602 S3	£ CALL
B&W 705	£ CALL
KEF Q1	£ CALL
KEF Q4	£ CALL
KEF XQ1	£ CALL
Linn Katan	£ CALL
Linn Ninka	£ CALL
Mission m31	£ CALL
Mission 780SE E60 FREE CABLE*	£349.95
Mission 782SE E120 FREE CABLE*	£899.95
Monitor Audio Bronze B2	£ CALL
Monitor Audio Silver S1	£ CALL
Monitor Audio Silver S6	£ CALL
Monitor Audio Silver S8	£699.95
Monitor Audio Gold Reference 10	£ CALL
Monitor Audio Gold Reference 20	£ CALL
Quad 11L	£ CALL
Quad 12L	£ CALL
Quad 22L	£ CALL
Ruark Epilogue II	£ CALL
Wharfedale Pacific Evolution 30	£ CALL

### HI-FI SYSTEMS

Denon 201 Ex Speakers	£499.95
Denon DF101 Ex Speakers	£299.95
Denon DM31 Ex Speakers	£179.95
Linn Klassik Music Ex Speakers	£749.95
Onkyo CS210 Ex Speakers	£ CALL
Teac Legacy 600 Ex Speakers	£199.95
Teac Reference 300 Ex Speakers	£449.95
Teac Reference 500 Ex Speakers	£569.95

### DVD SYSTEMS

Denon ADV-M71 Ex Speakers	£ CALL
Denon ADV1000 Ex Speakers	£ CALL
Jamo DVR50/A305PDD	£ CALL
Jamo DVR50/A355PDD	£ CALL
Linn Klassik Movie Ex Speakers	£1299.95
Linn Klassik Movie DI Ex Speakers	£ CALL
Onkyo DR-S2 2 Ex Speakers	£ CALL
Panasonic SC HT1000	£ CALL
Pioneer NS-DV99	£ CALL
Teac Legacy 700/LS-L800 Speakers	£849.95

### DVD PLAYERS

MAKE & MODEL	REGION 2	MULTI REGION
Arcam DIVA DV78	£ CALL	£ CALL
Arcam DIVA DV88 Plus	£ CALL	£ CALL
Arcam DIVA DV89	£ CALL	£ CALL
Cyrus DVD8	£ CALL	£ CALL
Denon DVD-1400 Universal	£ CALL	£ CALL
Denon DVD-2200 Universal	£ CALL	£ CALL
Denon DVD-2900 Universal	£ CALL	£ CALL
Denon DVD-A1	£ CALL	£ CALL
Harman Kardon DVD21	£ CALL	£ CALL
Harman Kardon DVD25	£ CALL	£ CALL
Marantz DV4300	£189.95	£189.95
Pioneer DV360	£89.95	£109.95
Pioneer DV464	£99.95	£119.95
Pioneer DV565A Universal	£179.95	£ CALL
Pioneer DV668Av Universal	£ CALL	£ CALL
Pioneer DV868Avi Universal	£ CALL	£ CALL
Tag McLaren DVD32FLR	£ CALL	£ CALL

Teac DV50	£ CALL
Toshiba SD330E	£79.95
Wharfedale DVD M3	£69.95
Yamaha DVD-S540	£ CALL

### DVD RECORDERS

MAKE & MODEL	REGION 2	MULTI REGION
Panasonic DMR-E50 DVD-R	£269.95	£299.95
Panasonic DMR-E60 DVD-R	£ CALL	£ CALL
Panasonic DMR-E100 DVD-R	£ CALL	£ CALL
Panasonic DMR-HS2 DVD-R	£ CALL	£ CALL
Philips DVDR70 DVD+RW	£239.95	£239.95
Philips DVDR75 DVD+RW	£ CALL	£ CALL
Philips DVDR80 DVD+RW	£ CALL	£ CALL
Pioneer DVR3100S DVD-R/RW	£ CALL	£ CALL
Pioneer DVR5100HS DVD-R/RW	£ CALL	£ CALL
Sony RDR-GX3 Recorder	£ CALL	£ CALL
Sony RDR-GX7 Recorder	£ CALL	£ CALL
Toshiba RD-XS30 DVD Recorder	£549.95	£ TBA

### A/V AMPLIFIERS RECEIVERS & PROCESSORS

Arcam AVR200 A/V Receiver	£ CALL
Arcam AV8/P7 A/V Pre/Processor/Power	£ CALL
Cyrus AV8 A/V Processor	£ CALL
Denon AVC-A1SR A/V Amplifier	£ CALL
Denon AVC-A11SR A/V Amplifier	£ CALL
Denon AVR1604 A/V Receiver	£ CALL
Denon AVR1804 A/V Receiver	£ CALL
Denon AVR2803 A/V Receiver	£ CALL
Denon AVR3803 A/V Receiver	£ CALL
Harman Kardon AVR2550 A/V Receiver	£ CALL
Harman Kardon AVR5550 A/V Receiver	£ CALL
Harman Kardon AVR8500 A/V Receiver	£1499.95
Marantz SR4400 A/V Receiver	£ CALL
Marantz SR5400 A/V Receiver	£349.95
Onkyo TX-SR501E A/V Receiver	£ CALL
Onkyo TX-SR601E A/V Receiver	£ CALL
Onkyo TX-NR900E A/V Receiver	£ CALL
Pioneer VSX-C301 A/V Receiver	£ CALL
Pioneer VSX-C501 A/V Receiver	£ CALL
Pioneer VSX-DB12 A/V Receiver	£319.95
Pioneer VSX-AX3i A/V Receiver	£649.95
Pioneer VSX-AX5i A/V Receiver	£949.95
Pioneer VSA-AX10i A/V Amplifier	£2199.95
Rotel RSX1065 A/V Receiver	£ CALL
Rotel RSP1066/RMB1075 A/V Pre/Power	£ CALL
TAG McLaren AV30R A/V Processor	£ CALL
TAG McLaren AV192R A/V Processor (From)	£ CALL
Yamaha DSP-AX640SE A/V Amplifier	£ CALL
Yamaha DSP-Z9 A/V Amplifier	£ CALL
Yamaha RX-V440RDS A/V Receiver	£ CALL
Yamaha RX-V640RDS A/V Receiver	£ CALL
Yamaha RX-V1400RDS A/V Receiver	£ CALL

### A/V SPEAKER PACKAGES

Acoustic Energy Aego P5	£399.95
Acoustic Energy Evo 3B	£699.95
B&W VM1/AS1	£ CALL
Energy Take 5.1	£ CALL
Energy Encore	£ CALL
Jamo D7 THX Ultra 2 (from)	£ CALL
KEF KHT1005	£ CALL
KEF KHT2005 2	£ CALL
KEF KHT5005	£ CALL
KEF Q7 AV £300 FREE CABLE*	£2199.95
M&K K5 £250 FREE CABLE*	£1699.95
M&K K3	£ CALL
M&K Xenon 25	£ CALL
M&K B50/CS35/V850	£ CALL
Mission m70	£399.95

Monitor Audio Bronze B4	£ CALL
Monitor Audio Radius	£ CALL
Ruark Vita 120	£ CALL

### SUBWOOFERS

B&W ASW675	£ CALL
B&W ASW750	£ CALL
MJ Acoustics Pro 50 (Black)	£ CALL
MJ Acoustics Pro 100 (Black)	£ CALL
MJ Acoustics Ref 100 (Blk) E60 FREE CABLE*	£349.95
MJ Acoustics Ref 1 (Black)	£ CALL
REL Q150E MKII (Brittix Black) £100 FREE CABLE*	£499.95
REL Q201E (Brittix Black)	£ CALL
REL Q400E (Brittix Black)	£ CALL
REL Quake (Brittix Black)	£ CALL
REL Strata III (Brittix Black)	£ CALL
REL Storm III (Brittix Black)	£ CALL

### PLASMA

Fujitsu P42HHA10 42"	£3199.95
Fujitsu P42HHA30 42"	£ CALL
Hitachi 42PD3000P 32"	£2299.95
Hitachi 42PD3000E 42"	£2999.95
Panasonic TH37PA20B 37"	£ CALL
Panasonic TH42PA20B 42"	£ CALL
Panasonic TH42PW6B 42"	£2999.95
Philips 37PF9965 37"	£ CALL
Philips 42PF9965 42"	£ CALL
Pioneer PDP433HDE 43"	£3489.95
Pioneer PDP434HDE 43"	£ CALL
Pioneer PDP503HDE 50"	£4989.95
Pioneer PDP504HDE 50"	£ CALL
Sony KE32TS2 32"	£2599.95
Toshiba 42WP36P 42"	£ CALL

### LCD TV

LG RZ17LZ10 17"	£549.95
Panasonic TX15L2 15"	£ CALL
Panasonic TX15L1 15"	£ CALL
Panasonic TX22L13 22"	£ CALL
Philips 17PF9945 17"	£ CALL
Philips 23PF9945 23"	£ CALL
Philips 30PF9975 30"	£1999.95
Relisys RL1720 17"	£ CALL
Sharp Aquos LC-13B4E 13"	£ CALL
Sharp Aquos LC-13S1E 13"	£329.95
Sharp Aquos LC-15B4E 15"	£ CALL
Sharp Aquos LC-15E1E 15"	£ CALL
Sharp Aquos LC-20B4E 20"	£ CALL
Sharp Aquos LC-20E1E 20"	£ CALL
Sharp Aquos LC-22SV2E 22"	£1099.95
Sharp Aquos LC-30HV4E 30"	£ CALL
Sharp Aquos LC-37HV4E 37"	£3699.95
Toshiba 26WL36P 26"	£ CALL
Toshiba 32WL36P 32"	£ CALL

### PROJECTORS

NEC HT1000 DLP	£ CALL
Sanyo PLV-Z1 LCD	£999.95
Sanyo PLV-Z2 LCD	£ CALL
Screenplay SP4800 DLP	£ CALL
Screenplay SP5700 DLP	£ CALL
Sharp XV-Z91E DLP	£1799.95
Sharp XV-Z200 DLP	£3499.95
Sharp XV-Z1000 DLP	£5999.95
Sim 2 Domino 20 DLP	£3599.95
Sim 2 HT300 Xtra DLP	£7499.95
ThemeScene H30 Cinema DLP	£ CALL
ThemeScene H56 Cinema DLP	£2399.95
Yamaha LPX-500 LCD	£ CALL
Yamaha DPX-1000 DLP	£ CALL

# CALL

CONTACT YOUR LOCAL STORE OR VISIT OUR WEBSITE FOR OUR UP-TO-DATE PRICES

## £ PRICING POLICY

SEVENOAKS SOUND & VISION OPERATES A PRICING POLICY  
SEE OPPOSITE PAGE FOR DETAILS

Please Note: Some products may not be available at all stores.  
Please call before travelling.

\*Cable Offer - From range available in-store. Not in conjunction with any other offer.  
Advertisement valid until at least 11/02/04, E&OE.



experience more

# experience more

# experience more



## SEVENOAKS STORES NATIONWIDE

Within the M25

- BROMLEY** 39A EAST STREET  
• 020 8290 1988
- CHELSEA** 403 KINGS ROAD  
• 020 7352 9466
- CROYDON** 369-373 LONDON ROAD  
• 020 8665 1203 *OPEN SUNDAY*
- EPSOM** 12 UPPER HIGH STREET  
• 01372 720720 *OPEN SUNDAY*
- HOLBORN** 144-148 GRAYS INN ROAD  
• 020 7837 7540
- KINGSTON** 43 FIFE ROAD  
• 020 8547 0717 *OPEN SUNDAY*

- SOUTHGATE** 79-81 CHASE SIDE  
• 020 8886 2777 *OPEN SUNDAY*
- STAINES** 4 THAMES STREET **NEW**  
• 01784 460777 *OPEN SUNDAY*
- SWISS COTTAGE** 21 NORTHWAYS PDE, FINCHLEY RD  
• 020 7722 9777 *OPEN SUNDAY*
- WATFORD** 478 ST ALBANS ROAD  
• 01923 213533 *OPEN SUNDAY*
- WEYBRIDGE** 43 CHURCH STREET, THE QUADRANT  
• 01932 828525 **NEW**



Nationwide

- BEDFORD** 29-31 ST PETERS STREET  
• 01234 272779
- BRIGHTON** 57 WESTERN ROAD, HOVE  
• 01273 733338
- BIRMINGHAM** ARCH 12, LIVERY STREET  
• 0121 233 2977
- BRISTOL** 92B WHITELADIES ROAD, CLIFTON  
• 0117 974 3727
- CAMBRIDGE** 17 BURLEIGH STREET  
• 01223 304770
- CARDIFF** 104-106 ALBANY ROAD  
• 029 2047 2899
- CHELTENHAM** 14 PITTVILLE STREET  
• 01242 241171
- CRAWLEY** 32 THE BOULEVARD  
• 01293 510777
- EDINBURGH** 5 THE GRASSMARKET  
• 0131 229 7267
- EXETER** 28 COWICK STREET  
• 01392 218895
- GLASGOW** 88 GREAT WESTERN ROAD  
• 0141 332 9655
- GUILDFORD** 73B NORTH STREET  
• 01483 536666
- HULL** 1 SAVILE ROW, SAVILE STREET  
• 01482 587171
- IPSWICH** 12-14 DOGS HEAD STREET  
• 01473 286977
- LEEDS** 62 NORTH STREET  
• 0113 245 2775 *OPEN SUNDAY*
- LEICESTER** 10 LOSEBY LANE  
• 0116 253 6567
- LINCOLN** 20-22 CORPORATION STREET  
• 01522 527397 (*OFF HIGH STREET*)
- LIVERPOOL** 16 LORD STREET  
• 0151 707 8417
- MAIDSTONE** 96 WEEK STREET  
• 01622 686366
- MANCHESTER** 69 HIGH ST, CITY CENTRE  
• 0161 831 7969
- NEWCASTLE** 19 NEWGATE STREET  
• 0191 221 2320
- NORWICH** 29-29A ST GILES STREET  
• 01603 767605
- NOTTINGHAM** 597-599 MANSFIELD ROAD  
• 0115 911 2121
- OXFORD** 41 ST CLEMENTS STREET  
• 01865 241773
- PETERBOROUGH** 36-38 PARK ROAD  
• 01733 897697 *OPEN SUNDAY*
- PLYMOUTH** 107 CORNWALL STREET  
• 01752 226011
- POOLE** LATIMER HOUSE, 44-46 HIGH STREET  
• 01202 671677
- PRESTON** 40-41 LUNE STREET  
• 01772 825777 *OPEN SUNDAY*
- READING** 3-4 KINGS WALK SHOPPING CENTRE  
• 0118 959 7768
- SEVENOAKS** 109-113 LONDON ROAD  
• 01732 459555
- SHEFFIELD** 635 QUEENS ROAD, HEELEY  
• 0114 255 5861 *OPEN SUNDAY*
- SOLIHULL** 149-151 STRATFORD ROAD  
• 0121 733 3727
- SOUTHAMPTON** 33 LONDON ROAD  
• 023 8033 7770
- SWANSEA** 24 MANSEL STREET  
• 01792 465777 *OPEN SUNDAY*
- SWINDON** 8-9 COMMERCIAL ROAD  
• 01793 610992
- TUNBRIDGE WELLS** 28-30 ST JOHNS ROAD  
• 01892 531543
- WITHAM (ESSEX)** 1 THE GROVE CENTRE  
• 01376 501733
- WOLVERHAMPTON** 29-30 CLEVELAND STREET  
• 01902 312225 *OPEN SUNDAY*

### WHO ARE SEVENOAKS?

Founded in 1972, Sevenoaks Sound & Vision is one of the largest and most successful hi-fi and home cinema retailers in the country.

Each Sevenoaks Sound & Vision store stocks a wide range of quality products, covering all categories of specialist home entertainment, from Hi-Fi separates and systems to DVD players, widescreen plasma televisions and projection systems, all at highly competitive prices.

Friendly staff are available in all stores to advise, demonstrate and guide you through the home entertainment jungle.

### NEW STORES

We are pleased to announce both the new stores in Staines and Weybridge are now open. For more information visit our website.

### CUSTOM INSTALLATION

Sevenoaks Sound & Vision's Custom Installation Service enables the integration of a home cinema or hi-fi system into your home as neatly and seamlessly as possible. All electronics can be hidden away, speakers discreetly mounted either in the wall or ceiling and the complete system operated via remote control.



Our installation experts are fully trained to the highest standards in all areas and provide a prompt, reliable and professional service. Whether you're looking for a multi-room system, a dedicated home cinema installation with a retractable screen and built-in speakers or an integrated control or lighting system, Sevenoaks Sound & Vision has a diverse range of products available to cater for all your requirements.

### SEVENOAKS WEBSITE

The Sevenoaks Sound & Vision website has news and information on the Sevenoaks group and its stores.

There are regularly updated special offer and stock clearance lists with hundreds of products available and detailed pages to help you locate your nearest store. To find out more, click on [www.sevenoakssoundandvision.co.uk](http://www.sevenoakssoundandvision.co.uk)

### DEMONSTRATION FACILITIES

Our comfortable demonstration rooms are among the finest in the country, many complying with full THX specifications.



### STOCK CLEARANCE

With 49 stores nationwide, the Sevenoaks Sound & Vision group stock and display a wide range of products. As models and product ranges are changed or superseded, the preceding models are made available at a reduced price, for clearance. Visit our Website for an up-to-date list of the clearance stock.

### PRICING POLICY

Whilst we do not claim always to be the cheapest, we try to ensure our prices are highly competitive. Take into account the expert advice, unrivalled product selection, demonstration facilities and excellent price, during and after sales service and the lower price might not look such good value.

In the event you can find the same products and excellent service at a lower price, please bring it to our store managers' attention. We will always endeavour to offer you the best deal.

**OPENING HOURS:** PLEASE TELEPHONE OR VISIT OUR WEBSITE  
**E-MAIL:** [insert store name]@sevenoakssoundandvision.co.uk

[www.sevenoakssoundandvision.co.uk](http://www.sevenoakssoundandvision.co.uk)

# STEREO AMPLIFIERS

*Integrated and pre/power amps*



Amplifiers come in two basic forms: integrated and preamplifier (pre) plus power amp combinations. Integrated simply means that both pre and power sections are in one box. There are definite advantages to separating the low level, delicate signals in the preamp from the radiations of a power amp, so the more ambitious designs come in two or more cases. In some cases, each channel has its own power amp called a monoblock.

Amplifiers use two basic technologies: transistors or valves. Transistors are popular because of their practical and technical advantages, but valves – aka tubes – live on owing to aspects of sound quality that transistors can't replicate. If you want to play your music loud, use transistors; if you appreciate acoustic music, try valves.

The fundamental of amp/speaker interfacing is power rating and speaker sensitivity. You can drive a high-sensitivity speaker with a ten watt valve amp, but it takes a 200W behemoth to get the best out of speakers which present a difficult load. As a rule, you can't have too much power.

### How to choose an amp

The main areas in which amps vary are: timing, dynamics, stereo imaging and transparency. Timing is the ability to present the attack and decay of each note precisely; amps with strong timing have a snap and coherence that is very appealing.



Dynamics is a general term for the ability to portray variations in level between individual notes and is different to dynamic range (the difference between the loudest and softest notes). Dynamically strong amps tend to have more life and energy.

Stereo imaging is how solid or three-dimensional an instrument or voice sounds. The point of having two rather than one speaker is to make it possible to recreate the soundstage of the original recording, thus amps that have strong imaging skills can create a sonic space that seems to extend the room.

Transparency of detail is the most obvious difference between amps. One amp will present more subtlety than another, but the drawback with using this as your main criterion is that a forward or 'bright' sounding amplifier will emphasise detail at the expense of overall musical coherence.

### Q&A

#### SHOULD I LEAVE MY AMP ON ALL THE TIME FOR BEST RESULTS?

All audio electronics perform better when they are warmed up, and this is particularly the case when it comes to amplifiers. If there's no way that you can leave it on all the time, make an effort to switch it on at least 20 minutes before listening.

#### WHAT IS BI-WIRING AND BI-AMPLING?

Bi-wiring is when you run separate cables to the treble and bass/mid terminals on the speaker. In most instances, this improves sound quality so long as identical cables are used. Bi-amping is using two stereo amps to drive one pair of speakers, using one amp to drive the treble and the other for the bass/mid sections of the speakers.

#### WHY DO VALVE AMPS HAVE SO LITTLE POWER?

Valve amps are inherently low powered in absolute terms – at least when you compare them to their transistor-based cousins. But when partnered with high-sensitivity loudspeakers, they are quite capable of producing perfectly adequate head-banging levels.

### HOME CINEMA STEREO

Stereo amps can be used in home cinema set-ups as well. You don't get the surround and centre channels, but well set-up stereo speakers do a remarkably good job of creating atmosphere for movies. Stereo amps

tend to be better at reproducing music as they don't have the (electrical) noise-inducing digital processing of AV amps. AV amps cost three to four times as much as stereo models of a similar quality.

### TOP BUYS



**Marantz**  
PM7200 £330

A true budget belter from Marantz – power and finesse in equal measure, plus the ability to switch between Class A and Class AB operation. Giant killing amps are back!



**Rotel**  
RA-1062 £595

Rotel's latest is an affordable taste of the high end, packed with power and detail. It'll drive virtually any speaker and embarrass a good many more costly amps.



**AVI**  
Type S21 MI £1,399

This AVI's full name is Lab Series Integrated Amplifier Type S21 MI – a lengthy moniker for such a neat little amp with a hugely accomplished sound.



**Exposure**  
XXIII/XXVIII £2,790

A beautifully natural and dynamic sounding pre/power amp combo – a transistor design with a touch of the valve amp sound.

## Our favourite 🏆 BEST BUY 👑 EDITOR'S CHOICE

# STEREO AMPLIFIERS

### Integrated amplifiers

BADGE?	PRODUCT	£	COMMENTS	SPECIFICATIONS					
				LINE INPUTS	PHONO INPUT	REMOTE CONTROL	HEADPHONE SOCKET	POWER OUTPUT (W)	ISSUE NUMBER
<b>UP TO £1,000</b>									
🏆	Arcam DIVA A65 Plus	370	Highly articulate and fluent, offers unusual insight for its price	5	●	●	●	40	232
🏆	Arcam DIVA A75 Plus	470	Quick, lively and well-presented amplifier, bass is sharper and more tuneful than its predecessor	5	●	●	●	50	224
🏆	Arcam DIVA A80	600	Affordable integrated, with sophisticated control system, and crisp, detailed sound	5	●	●	●	85	245
🏆	Arcam DIVA A90	850	Enhanced replacement for A85, convertible to 7.1 sound with the addition of an add-on module and extra P90 power amps	6	opt	●	●	90	250
	Cambridge Audio Azur 640A	250	Cambridge has a powerful weapon in the battle for budget amp supremacy, it's a lot of musical entertainment for the money	5	opt	●		65	250
	Cyrus 8	800	Impressive at low to medium volumes, and a clear improvement on its predecessor, but deteriorates at high power levels	7		●	●	70	239
	Exposure 2010	599	Neatly turned-out amplifier with mainstream appeal. Sounds musical, if a touch 'safe'	6		●		50	214
🏆	Exposure 3010	1,000	A mix of old and new, combining greater power with Exposure's traditionally sweet and enthralling sound	6	●	●	●	120	244
🏆	Marantz PM7200	330	High power, plenty of features, and remarkably clear and informative sound with lots of impact	6	●	●	●	105	248
	NAD C320BEE	220	Spirited and enthusiastic amp with slight bass hump and a sound that will suit relaxed speakers	7		●	●	50	232
	Primare A10	500	Beautifully made, smooth and easy sounding, and though not overtly detailed it is well organised musically	6		●		50	208
🏆	Primare I20	750	An amplifier with attitude: punchy fast and secure sounding, with excellent build quality for the money	4		●		70	239
🏆	Roksan Caspian M Series	1,000	Improved mid-range model from Roksan is a fine, expressive amplifier – right at the top of its class	6		●		85	248
🏆	Rotel RA-02	349	Agile and capable slimline design with an engaging sound that draws you into the music	4	●	●	●	40	232
🏆	Rotel RA-1062	595	The pick of this season's crop. Fabulous sound with the ability to drive almost any speaker in its path	5	opt	●	●	95	244
🏆	Sugden A21a	899	This single-ended, Class A transistor amp has exquisite resolving ability and presence – an authentic classic	5				25	224
<b>ABOVE £1,000</b>									
🏆	Arcam FMJ A32	1,150	Remarkably flexible and well-featured, with excellent sound quality for the price	7	●	●	●	100	228
🏆	ATC SIA2-150	2,375	Starkly revealing powerhouse that eats most integrateds for breakfast	5		●		150	228
👑	AVI Laboratory Series	1,399	Terrific power, control and resolution – effortlessly musical and fine value	6	opt	●		200	241
👑	Karan KA-i180	3,900	Lean, sharp and articulate, this impressively constructed heavyweight is almost up there with the audiophile pre/power elite	4		●		180	236
👑	Krell KAV-400xi	2,698	The best integrated Krell yet is quick, agile, solid and finely detailed	5		●		200	247
	Marantz PM-14 MkII Kl	2,000	Highly sophisticated and well equipped, with a refined and relaxed sound quality that's hard to resist	7	●	●	●	100	228
👑	Musical Fidelity Tri-Vista 300	3,999	If you audition one, you will want to be one of the handful of Tri-Vista owners	5	●	●	●	350	239
🏆	Primare A30.1	1,500	Smooth, detailed singing quality, elegant appearance and healthy power yield	6		●		100	214

## Our favourite 🏆 BEST BUY 👑 EDITOR'S CHOICE

# STEREO AMPLIFIERS

### Pre/power amplifiers

BADGE?	PRODUCT	£	COMMENTS	SPECIFICATIONS							
				PRE-AMPLIFIER	POWER AMPLIFIER	LINE INPUTS	PHONO INPUT	REMOTE CONTROL	POWER OUTPUT (W)	ISSUE NUMBER	
<b>UP TO £2,000</b>											
👑	Arcam FMJ A32/P35	1,980	One of the few correctly matched integrated/power combinations, the sound has real gravitas and sophistication	●	●	7	●	●	100	227	
👑	ATC CA2	750	Stripped-down version of ATC's range topper delivers considerable transparency and bandwidth. Excellent value	●		5		●		221	
🏆	Creek P43R/A43	900	Great value, with a particularly impressive way with dynamics	●	●	6		●		140	212
🏆	Croft Vitali/Series 5C	2,000	Oddball retro style and ergonomics, but truly magical voice coherence and projection, great transparency	●	●	3	●			30	216
	Densen Beat 200/300	1,985	Classy jet black cast boxes pack plenty of punch with good total musical coherence (remote £300 extra)	●	●	6	opt	opt		100	216
👑	Musical Fidelity A308CR	3,898	Bold-looking design with an absence of sonic signature that proves there is life after NuVista	●	●	4	●	●		250	231
	NAD Silver Series S100/S200	2,000	Beautifully built kit that sounds as good as it looks, with heaps of power	●	●	7		●		200	200
👑	Naim NAC112/NAP150	1,425	Clean, clever simplicity, plus a very well-balanced sound that's much sweeter than earlier Naims	●	●	6		●		50	213
🏆	Rothwell Indus/Rubicon	1,488	Quirky valve combo with passive pre-amp has a lovely neutrality and consistency across a wide dynamic range	●	●	6				10	216
<b>ABOVE £2,000</b>											
	Audio Note M2Phono/P2SE	2,698	Wonderfully natural and inviting sound with great warmth and drama, but limited loudness capability	●	●	4	●			18	216
👑	Audio Research LS25/VT100	12,199	This is not so much a fine valve amp, as a fine amplifier, full stop (LS25 MkII/VT100 MkII)	●	●	6	●	●		100	216
👑	AVI S2000M	2,398	This preamp/monoblock pairing does most things very well and images better than most	●	●	5		●		150	221
👑	Border Patrol P20	6,750	Muscular 300B P-P design with fluidity and dynamics to match the best	●	●					20	231
	Bryston BP25/4BSST	4,000	Extremely transparent, high-power combo, you'll listen louder and longer because you can	●	●	8	opt	●		300	241
👑	Chapter Preface/II+	9,800	Among the finest amps available, the resolution of this preamp and power amp challenges the best at any price	●	●	6		●		300	249
👑	Classé CP-35/CA-101	2,797	Very classy Canadian pre/power combo with a natural, open and no-nonsense sound	●	●	4		●		100	237

**SPECS KEY** **LINE INPUTS** Input sockets for source components with a line level output: CD players, DVD players, tape decks, tuners, phono stages etc. **PHONO INPUT** Input sockets and onboard phono stage for a cartridge. Either MM (moving magnet) or MC (moving coil), occasionally both. **REMOTE CONTROL** A remote control is supplied with the amplifier. **HEADPHONE SOCKET** To drive your cans with. **POWER OUTPUT** Manufacturer's rated output in watts per channel.

Our favourite BEST BUY EDITOR'S CHOICE

# STEREO AMPLIFIERS *continued*

## Pre/power amplifiers

BADGE?	PRODUCT	£	COMMENTS	SPECIFICATIONS					ISSUE NUMBER	
				PRE-AMPLIFIER	POWER AMPLIFIER	LINE INPUTS	PHONO INPUT	REMOTE CONTROL		POWER OUTPUT (W)
	Conrad-Johnson PV10BL/MV60SE	4,290	Gorgeous valve combo – preamp may seem a bit dated by today's standards, but both still rate as hi-fi classics	●	●	5		●	55	250
BB	Electrocompaniet EC4.7/120DMB	3,448	Bulky Norwegian combo has wonderful transparency, wide dynamic range and fine musical tension	●	●	6		●	120	216
BB	Exposure XXIII/XXVIII	2,790	Highly natural and dynamic amplifier that offers the fluidity and energy of valves via transistors	●	●	6	opt	●	70	241
EC	Gamut D200 Mk3	3,950	A great power amp that's now even better – one of the best regardless of price		●				200	247
EC	Halcro dm10/dm68	75,900	Extravagant, extreme and massive amp combo will probably polarise opinions, but delivers stunning midrange clarity	●	●	5		●	225	243
EC	Hovland HP-100/RADIA	12,745	Uncommonly musical valve/transistor hybrid transcends stereotypes, one of the genuine high achievers	●	●	9	Opt		125	250
EC	Krell FPB 700cx	14,998	Reference class amplifier may represent overkill in many systems, but when no compromise is called for, this is it		●				700	234
EC	Linn Klimax Kontrol	6,000	Beautifully executed example of Scots audio art, sounds as clean as it looks and is a lot more transparent than most	●		4		●		238
EC	Linn Klimax Twin	6,000	Super-slim stereo power amp uses advanced switch-mode power supplies to fast, engaging effect		●				125	230
	Naim NAC202/NAP200	2,720	More sophisticated than its forebears with a fleet-footed sound that draws you into the music	●	●	8		●	70	241
EC	Naim NAP500	10,995	Wonderful neutrality, bandwidth and dynamic range, plus Naim's traditional leading-edge definition		●				140	208
EC	Naim NAC552	11,750	Extremely expensive preamp, but still solid value. Magnificent sound with fine flexibility and convenience	●		6		●		23
	Primare PRE30/A30.2	2,400	Beautifully built with great selection of features and serious power delivery	●	●	7		●	120	241
EC	Steinhart DVP 2XR/Fidelio 102 DD	7,440	Brilliantly musical, making even difficult material enjoyable, but gets hot and has ergonomic foibles	●	●	7		●	100	236
EC	Sugden Masterclass AA	5,600	Yorkshire's finest class A kit. Dynamic and tonally rich, this gives even valve amps a run for their money	●	●	7		●	35	246
EC	Unison Research Unico Pre/DM	2,590	Hybrid designs with a rich powerful performance that makes a fine balance between valve and solid state sound	●	●	3		●	150	242

# AV AMPLIFIERS

*Surround sound amps for music and movies*



The multichannel, surround sound or AV amplifier is a popular option, thanks to the success of the DVD player and home cinema. Now you can buy five channels or more of amplification for the price of two. Now that multichannel music is also on the agenda, there's a lot to be said for a good AV amp or receiver (an amp with a radio tuner built in).

So if you fancy hearing what DVD-Audio, SACD or even music DVD-Video can do, then check out a multichannel amp and speaker set-up – they're stunning with movies and none too shabby with music.

AV amps are usually designed primarily for movies and come with digital processing for the various soundtrack formats – Dolby Pro-Logic (analogue), Dolby Digital and DTS, which offer discrete surround sound in 5.1 and 7.1 channel formats. More ambitious designs also offer THX post processing, designed to emulate the sound of the mixing theatre at home.

Processing in AV amps is needed because the surround formats on DVD-Vs are compressed, limiting their high-fidelity



potential. This is why new formats SACD and DVD-A, which don't use 'lossy' compression, were created for music.

All this processing power can take its toll on analogue formats. The best multichannel amps for music are often the simplest, but any that offer a complete bypass option with six-channel input are suitable. It's also worth looking at real power – five or seven channels of amplification are not easy to produce with a feeble power supply, and the cheaper amps in particular often fail to live up to the claims.

## Q&A

### HOW MANY CHANNELS?

Depends on how many speakers you want. Multichannel music discs come with six or 5.1 channels, but for new movies, 7.1 systems are where it's at. 7.1 set-ups also mean you have speakers directly behind you – preferable for music discs.

### WHAT'S THE DIFFERENCE BETWEEN A PROCESSOR AND AN AV AMP?

Processors don't have amplification on board and you need separate power amps. AV amps and receivers have processing and amps in the same box.

### WHAT DOES THE .1 IN 5.1 STAND FOR?

This is the LFE (low frequency effects) or bass channel that is reproduced by a subwoofer.

## HI-FI MEETS SURROUND SOUND

With DVD-Audio and SACD offering high-quality multichannel music, surround sound is no longer just a home cinema thing. An increasing number of people want to build a multichannel system that will do their music as well as

their movie DVDs justice, and the number of AV products delivering sufficient quality is on the increase. But most aren't cheap – building a top-quality system with five or more channels is inevitably more expensive than sticking with stereo.

There are some very decent integrated options below £1,000, though the best (and most costly) route is to buy a separate processor and power amp(s). Or you can add AV amplification to a stereo model you can't bear to part with.

## TOP BUYS



**Harman Kardon**  
AVR 5550 £900  
Here's a rarity - a sub-£1,000 AV amp that does a good job with both stereo and surround sources, and well equipped too.



**Pioneer**  
VSA-AX5i £1,200  
Trickle-down version of the VSA-AX10i is a superb performer at the price, good with both music and film soundtracks, with the added bonus of i.Link digital connection.



**Denon**  
AVC-A1SR £3,000  
Denon's AV behemoth is arguably the best integrated multichannel amp to date - superbly cinematic and one of the very few with genuine 'hi-fi' music credentials.



**Arcam**  
AV8/P7 £5,498  
A fantastic achievement from this respected UK brand - an top-ranking AV processor and seven-channel power amp.

## Our favourite BEST BUY EDITOR'S CHOICE AV AMPLIFIERS

### Multichannel amplifiers

BADGE?	PRODUCT	£	COMMENTS	RECEIVER	LINE INPUTS	7.1 COMPATIBLE	5-CHANNEL POWER (W)	ISSUE NUMBER
<b>MULTICHANNEL INTEGRATED AMPS</b>								
	Arcam AVR200	800	Upgraded AVR100 with Dolby Pro-Logic II and some bass management. Great for stereo, a bit bass-light for multichannel	●	6	●	70	229
MB	Denon AVR-3803	899	Feature packed 7.1 channel AV receiver which needs a lot of studying but does everything well	●	11	●	110	239
	Denon AVC-A11SR	1,800	Feature-packed with superb spatial processing, combined with powerful, though slightly opaque overall audio quality		11	●	235	
EC	Denon AVC-A1SR	3,000	An AV amp with genuine high-res hi-fi credentials. Includes a ground-breaking 'wide bandwidth' digital audio link		8	●	170	232
MB	Harman Kardon AVR 5550	900	The upgrade to the AVR 5500 comes with features that are actually of some use to the audiophile and a meaty sound to boot	●	9	●	85	240
MB	Pioneer VSA-AX5i	1,200	Standard setter in its price category, with i.Link digital interface and MCACC auto set-up	●	11	●	100	248
EC	Pioneer VSA-AX10i	2,700	Seven channel tour de force with automatic speaker set up and eq, excellent with music, movies and DVD-A/SACD		8	●	150	229
	Sony VA-777ES	1,500	Smart circuitry gives this model unusual precision and transparency, and it is a fine all-rounder		9	●	100	210
<b>MULTICHANNEL PREAMPS/PROCESSORS AND POWER AMPS</b>								
MB	Arcam A90/7.1 mod, P90/3	1,920	Add Arcam's multichannel module and a P90/3 power amp to the A90 stereo integrated and you've got got superb purist 5.1		8	●	90	250
EC	Arcam AV8/P7	5,498	State-of-the-art processor (£2,999) and seven-channel power amp (£2,499). An excellent fusion of stereo and surround sound		7	●	180	235
EC	Bryston SP1/9B THX	7,100	Stripped-back 5.1 channel processor/amp combo reaches genuine audiophile heights		6	opt	120	219
EC	Copland CVA306/CVA535	3,748	Tube analogue six-channel pre transforms multichannel audio from a novelty into a genuine advance for the high fidelity art		5		125	236
	Cyrus AV8/3x Smartpower	2,900	Classic Cyrus sound translated to a multichannel arena, limited features and power, but civilised sound		3		105	238
EC	EAD TheaterMaster 8000 Pro	5,200	Arguably the most 'musical' sounding AV processor to date - tested with the PowerMaster 8300 multichannel power amp		9	●		242
MB	Marantz PS-17/2 x SM-17	3,400	Classy and capable system, great steering, warm solid sound and high detail resolution, and some great gadgets		10	●	60	238
EC	Meridian 861	9,833	Powerful surround processor with flexible modular construction, marvellous versatility to drive any speaker configuration		6	●		230
	Myryad MDP500/MA240/360	3,799	Superb three-box, five-channel AV amplifier. Great with movies and beats most multichannel amps hands down with music		9	opt	120	215
	Naim AV2/NAPV175/NAP150	4,175	First truly credible multichannel system from Naim is idiosyncratic but offers excellent basic sound with modest spatial steering		5	●	50	238
EC	Parasound Halo C1/A51	8,500	Powerful and flexible processor/power amp combo with impressive sound. Excellent value - processor includes onboard screen		11	●	250	243
MB	Primare SP31.7/A30.5	4,200	Great all-round system which brings the qualities of good stereo high fidelity to a multichannel world		5	●	120	238
	Roksan DSP/5ch amp/VSU	2,440	Clean, powerful stereo expanded seamlessly, if without distinction, to 5.1 channels		4		80	210
EC	TAG McLaren AV32R EX	2,994	Flexible AV processor, unusually good with music. Excellent for multichannel systems in standard or seven-channel 'EX' form		6	●		215

**SPECS KEY:** **RECEIVER** Integrated multichannel amp with built-in radio tuner. **LINE INPUTS** Input sockets for source components with a line level output: CD players, DVD players, tape decks, tuners, phono stages etc. **7.1 CHANNEL COMPATIBLE** The amp either has seven-channel in and outputs or in some instances is equipped with seven channels of amplification. **5-CHANNEL POWER (W)** Power output in watts per channel of all channels driven by the amp.

The most complete & thoroughly integrated solution to quality vinyl replay.

- Excellent Sound
- Excellent Looks
- Excellent Price
- Excellent Finish
- Excellent Design
- Excellent Engineering

The all new DIVA is simply excellent, now everyone can enjoy the excellence of AVID

Contact us for your nearest dealer

**AVID** • Tel: 01480 457300 Fax: 01480 457057 • Email: info@avidhifi.co.uk • Web: www.avidhifi.co.uk  
Unit 52, 137 North Gate, Alconbury Airfield, Huntingdon, Cambridgeshire PE28 4WX

# SOUND & VISION

## DELIVERING A BETTER DEAL

### SONY

### DAV-S880

- INTEGRATED DVD/SACD HI-FI SYSTEM
- 100W X 5 + 100W SUBWOOFER (RMS 10%)
- 5 FULL RANGE SATELLITE SPEAKERS
- SPEAKER STANDS INCLUDED
- SACD MULTI CHANNEL PLAYBACK
- DOLBY DIGITAL 5.1 CHANNEL AMPLIFIER
- DTS DECODER
- FM/MW RDS TUNER WITH 30 PRESETS
- CD-R/CD-RW PLAYBACK

NEW PRICE



AMAZING PRICE

HSP\* £799.99 S&V > **£449.99**

### SONY

### STR-DB2000

DETAILS:

- D. DIGITAL EX & DOLBY PRO-LOGIC 2 DECODERS BUILT-IN • DTS, DTS-ES DISCRETE 6.1, MATRIX 6.1, NEO-6 DTS 96/24 DECODERS
- 100W X 6 POWER OUTPUT
- TRUE 6.1 CHANNEL AMPLIFIER
- 6.1 CHANNEL INPUT
- SACD MULTI-CHANNEL INPUT
- SUPPORTS MULTI-CHANNEL ACD (FREQUENCY RANGE UP TO 100KHZ)



AMAZING PRICE

HSP\* £499.99 S&V > **CALL FOR LATEST PRICES**

### SONY

### SONY DVP-NS930

DETAILS:

- SLIM LINE QS RANGE DVD / CD / SUPER AUDIO CD MULTI-CHANNEL COMBINATION PLAYER
- QS COMPONENTS SOUND / QUALITY / PERFORMANCE
- CD-R/RW (5) CD & MP3 PLAYBACK • 12-BIT / 108MHz NOISE SHAPED VIDEO D/A CONVERTER • NTSC PROGRESSIVE SCAN • ALUMINUM FRONT PANEL

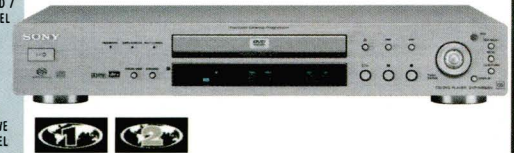

AMAZING PRICE

HSP\* £499.99 S&V > **CALL FOR LATEST PRICES**

### ARCAM

### AVR-200

DETAILS:

- 5 X 70 WPC (ALL CHANNELS DRIVEN INTO OHMS) • 2 X 90 WPC (BOTH CHANNELS DRIVEN, STEREO MODE) • D. DIGITAL AND DTS DECODING • DOLBY PRO LOGIC II DECODING • 5 X DIGITAL INPUTS (3 X CO-AXIAL AND 2 X OPTICAL) • 1 X DIG. OUTPUT (CO-AXIAL) • VIDEO SWITCHING FROM BOTH COMPOSITE AND S-VIDEO



AMAZING PRICE

HSP\* £799.99 S&V > **RETAIL OUTLET ONLY**

### ARCAM

### DV-89

DETAILS:

- DVD-VIDEO & DVD-AUDIO PLAYER
- CERTIFIED FOR PROGRESSIVE SCAN PLAYBACK
- DVD, CD-R/RW, MP3, HD/CD COMPATIBLE
- COMPONENT VIDEO, RGB & S-VIDEO
- PAL & NTSC COMPATIBLE PLAYBACK SOUND & VISION



AMAZING PRICE

HSP\* £799.99 S&V > **RETAIL OUTLET ONLY**

### YAMAHA

### RX-V740RDS

DETAILS:

- HOME CINEMA RECEIVER • HIGH POWER 6-CHANNEL DISCRETE AMPLIFIER CONFIGURATION (140W X 6 DIM; 90W X 6 RMS)
- DIGITAL TOP-ART • HIGH CURRENT AMPLIFICATION FOR HIGH SOUND QUALITY • COMPATIBILITY WITH LATEST MOVIE SOUND FORMATS INC. D. DIGITAL EX, DOLBY PRO LOGIC II, DTS-ES DISCRETE 6.1, AND DTS NEO-6



AMAZING PRICE

HSP\* £559.99 S&V > **CALL FOR LATEST PRICES**

### YAMAHA

### RX-V540RDS

DETAILS:

- HOME CINEMA RECEIVER
- 6-CHANNEL DISCRETE AMP. CONFIG. (140W X 6 DIM; 90W X 6 RMS)
- DIGITAL TOP-ART • HIGH CURRENT AMP. • COMPATIBILITY WITH D. DIGITAL EX, DOLBY PRO LOGIC II, DTS-ES DISCRETE 6.1, AND DTS NEO-6
- POWERFUL 32-BIT YAMAHA LS3 (YSS-938) CINEMA DSP PROCESSING
- FRONT PANEL VIDEO AUX INPUT



AMAZING PRICE

HSP\* £389.99 S&V > **CALL FOR LATEST PRICES**

# WWW.SOUNDANDVISIONONLINE.COM

ALL PRICES IN THIS ADVERTISEMENT ARE CORRECT AT TIME OF GOING TO PRESS AND ARE SUBJECT TO AVAILABILITY. E&OE. WHOLEST REASONABLE CARE IS TAKEN TO ENSURE THE ACCURACY OF THIS INFORMATION IN THIS ADVERTISEMENT. THE INFORMATION IS OBTAINED FROM A VARIETY OF SOURCES AND NEITHER SOUND & VISION, THE PUBLISHER OF THE PRINTERS RESPONSIBLE FOR ERRORS OR OMISSIONS. ALL DATA IS ACCEPTED BY US IN GOOD FAITH AS BEING CORRECT AT THE TIME OF GOING TO PRESS. REGISTERED IN THE UK NO. 0229 5372 VAT NO. 540 5952 32. ALL PRICES INCLUDE VAT AT 17.5% REPRODUCTION IN WHOLE OR IN PART IS FORBIDDEN WITHOUT EXPRESS PERMISSION OF S&V & SOUND & VISION. © 2003 S&V LTD. S&V SOUND & VISION REGISTERED OFFICE: 44-46 HIGHER MARKET STREET, FARNWORTH, BOLTON, BL4 9BE. REGISTERED IN THE UK NO. 0229 5372 VAT NO. 540 5952 32. ALL OUR TERMS AND CONDITIONS APPLY TO THE DISTANCE SELLING REGULATIONS 2000 WHICH CAN BE FOUND ON THE INTERNET AT WWW.DISTANCESELLINGREGS.COM. THIS NOTICE IS IN FULL OR A LETTER, FAX OR EMAIL OR A TELEPHONE CALL DOES NOT CONSTITUTE AN OFFER. ALL GOODS RESERVED FOR RETURN UNDER THE REGULATIONS MUST BE IN THEIR ORIGINAL BOX AND PACKAGING AND RETURNED VIA YOUR OWN CARRIER. COMPANY. ALL GOODS WHICH ARE NOT RETURNED IN THIS MANNER WILL BE SUBJECT TO A 25% HANDLING FEE OFF THE PURCHASE PRICE. FULL TERMS & CONDITIONS OF SALE ARE AVAILABLE AT WWW.SOUNDANDVISIONONLINE.COM/TERMS.HTML OR IN WRITING ON REQUEST.

S & V PAGE 1

# LOWEST PRICES IN THE UK?

## CALL US LAST TO FIND OUT!

TEAC

LEGACY  
700



DETAILS:

- DR-L700 DVD PLAYER & STEREO RECEIVER • SUPPORTS VCD, CD-R/RW & MP3
- 96KHZ 24-BIT AUDIO D/A CONVERTOR • 2X30W RMS POWER OUTPUT
- A-L700P 3 CHANNEL POWER AMPLIFIER • 3X30W RMS POWER OUTPUT
- SUPPORTS DOLBY DIGITAL, DTS, DOLBY P-LOGIC

HSP\* £729.98

S&V > £573.99 INC FREE DELIVERY

TEAC

LEGACY  
800



DETAILS:

- DV-L800 DVD-AUDIO & DVD VIDEO PLAYER • SUPPORTS VCD, CD-R/RW & MP3
- 96KHZ 24-BIT AUDIO D/A CONVERTOR • 1 X OPTICAL 1 X COAX
- AG-L800 HOME CINEMA RECEIVER • 5X50W RMS POWER OUTPUT
- SUPPORTS DOLBY DIGITAL, DTS, DOLBY P-LOGIC2 • 30FH & 30AM STATION MEMORY

HSP\* £929.98

S&V > £687.99 INC FREE DELIVERY

### ABOUT US

SOUND & VISION ARE ONE OF THE UK'S BIGGEST INDEPENDENT CONSUMER ELECTRONIC RETAILERS STOCKING 1000'S OF PRODUCTS IN OUR PURPOSED BUILT 80,000SQ WAREHOUSE. WE ARE NOT PART OF ANY BUYING CHAINS WHICH MEANS THAT WE GET THE BEST DEALS DIRECT FROM UK MANUFACTURERS OFFERING YOU THE LOWEST PRICES ACROSS THE UK.

### HOW 2 PURCHASE

EVERY ITEM WE STOCK CAN BE EITHER PURCHASED THROUGH OUR STORE OR VIA OUR EXPRESS MAIL ORDER SERVICE. A SELECTION OF OUR PRODUCTS ARE AVAILABLE FOR PURCHASE ON OUR WEBSITE AT WWW.SOUNDANDVISION.UK.COM YOU CAN THEN PAY BY MULTIPLE WAYS (CASH, CHEQUE BANKERS DRAFT AND ALL MAJOR CREDIT CARDS.)

### BUY NOW PAY LATER

- NO DEPOSIT\*\* NO PAYMENTS
- NO INTEREST

WE CAN OFFER YOU UP TO 6, 9 OR 12 MONTHS "BUY NOW PAY LATER" PURCHASE WHAT YOU WANT, WHEN YOU WANT. INTEREST CHARGED ON THE REMAINING BALANCE AT A RATE OF 2.2% PER MONTH. (29.8% VAR'1) \*A MINIMUM DEPOSIT ON 6 OR 9 MONTHS OF 10% AND ALL FINANCE IS SUBJECT TO STATUS, WRITTEN DETAILS AVAILABLE ON REQUEST.

**BOSE**  
Better sound through research.

### HOME ENTERTAINMENT

- 5 SPEAKER SYSTEM • CD CHANGER • 6 DISC • DOLBY DIGITAL DECODER
- FM / AM TUNER WITH RDS • MULTI-ROOM CAPABILITY STANDARD
- REMOTE CONTROL: RATIO FREQUENCY • AVAILABLE IN BLACK OR WHITE

VISIT OUR SHOWROOM FOR A FULL DEMONSTRATION

BOSE LIFESTYLE® 2B DIGITAL AUDIO WITH DVD

S&V > £2499.99 INC FREE DELIVERY



DETAILS:

- DVD-VIDEO, CD, CD-R/RW AND MP3 ON CD.
- ARTICULATED ARRAY® SPEAKER DESIGN
- ACOUSTIMASS® MODULE • AVAILABLE IN GRAPHITE GREY & WHITE

VISIT OUR SHOWROOM FOR A FULL DEMONSTRATION

BOSE 3-2-1 DVD HOME ENTERTAINMENT SYSTEM

S&V > £999.99 INC FREE DELIVERY

DETAILS:

- 5 SPEAKER SYSTEM
- DVD-VIDEO, CD, CD-R/RW AND MP3 ON CD
- TINY JEWEL CUBE SPEAKERS
- HIDEAWAY ACOUSTIMASS MODULE
- ADAPTIQ™ AUDIO CALIBRATION SYSTEM
- REMOTE CONTROL: RATIO FREQUENCY
- AVAILABLE IN BLACK OR WHITE
- INC "FREE" DELIVERY

VISIT OUR SHOWROOM FOR A FULL DEMONSTRATION

BOSE LIFESTYLE® 3D DIGITAL AUDIO HOME ENT' SYSTEM WITH DVD

S&V > £3299.99 INC FREE DELIVERY

### EXCLUSIVE DELIVERY

MORE PEOPLE PURCHASE FROM SOUND & VISION BECAUSE OF OUR EXCLUSIVE DELIVERY ARRANGEMENTS. WE USE A NEXT DAY COURIER FOR ALL SMALL ITEMS E.G. DVD PLAYERS. LARGE HEAVY ITEMS ARE SENT VIA OUR VERY OWN EXCLUSIVE BESPOKE DELIVERY COMPANY. YOUR PURCHASE WILL COME DIRECT FROM US TO YOU AND WILL ALSO BE PRE-ARRANGED 1-2 DAYS BEFOREHAND, SO YOU ARE ASSURED OF WHEN IT IS COMING.

### GUARANTEES

WE USE A DEDICATED UK SERVICE NETWORK. ALL LARGE PRODUCTS ARE SERVICED IN HOME OR AT A LOCAL SERVICE CENTRE AND SMALL PRODUCTS CAN BE SENT DIRECT TO THE SERVICE CENTRE OR BACK TO US. ALL THIS IS BACKED UP BY OUR CUSTOMER SERVICES DEPARTMENT. ANY PROBLEM CAN BE LOGGED ON TO OUR CUSTOMER SERVICES SECTION OF THE WEBSITE. OR CALL: 0845 345 3789 (LOCAL RATE CALL).

### PRICING

GREAT PRICES ARE ALWAYS AVAILABLE AT SOUND & VISION AS WE CONSTANTLY MONITOR OUR PRICES AGAINST LOCAL AND NATIONAL COMPETITION. ONE THING YOU CAN BE ASSURED IS WHEN YOU MAKE A PURCHASE FROM SOUND & VISION THAT YOU WON'T JUST BE GETTING THE BEST CHOICE OF EQUIPMENT BUT ALSO AT THE LOWEST PRICE POSSIBLE. SO PICK UP THE PHONE & ORDER TODAY...

TEL: 01204 861 861 FAX: 01204 439 024  
NOW OPEN SUNDAYS 11-6

# «SOUND & VISION»

DELIVERING A BETTER DEAL

**TOSHIBA**

42WP27B

- 42"/107CM FLAT FACE WIDESCREEN PLASMA TELEVISION
- NICAM DIGITAL STEREO
- REMOTE CONTROL COMMANDER
- TELETEXT ON BOARD • 852 X 480 PIXEL RESOLUTION
- 3000:1 CONTRAST RATIO
- 16W AUDIO AMPLIFIER OUTPUT
- COMPOSITE VIDEO INPUT
- S-VIDEO INPUT • RGB INPUT
- PC COMPATIBLE • OPTIONAL DETACHABLE SPEAKERS



AMAZING PRICE

HSP\* £4739.99 S&V > **£2499.99**



ACOUSTIC ENERGY AEGE 5P

**DETAILS:**

- 5X SATELLITE SPEAKERS + POWERED SUBWOOFER
- UNIQUE DESIGN
- FULL CABLING PROVIDED
- REMOTE CONTROL COMMANDER
- WALL BRACKETS INCLUDED



AMAZING PRICE

HSP\*£599.99 S&V > CALL FOR LATEST PRICES

**AEGIS EVO Series**

AESPRIT SERIES

**DETAILS:**

- AE300 MEDIUM SIZE BOOK SHELF SPEAKERS
- AE309 FLAGSHIP FLOOR STANDING SPEAKERS
- AE300C COMPACT BOOKSHELF SPEAKERS
- AE301 SLIM LINE WALLMOUNTABLE SPEAKERS
- AE307 CENTRE SPEAKER & AE308 SUBWOOFER



AMAZING PRICE

HSP\*£479.99 S&V > **£379.99** INC FREE DELIVERY

**Panasonic**

PTAE200



**DETAILS:**

- 0.7" (DIAGONAL) 16:9 ASPECT RATIO LCD PANEL • APPROX. 1,245,000 • MANUAL ZOOM1-1.2, F2.0-2.3 • 120W UHM • 700 ANSI LUMENS (HIGH MODE) • RGB: 858X484 PIXELS (1920 X 1080 WITH COMPRESSION) • PAL/PAL-M/PAL-N/SECAM/NTSC/M-NTSC • 700-1 (FULL ON/FULL OFF) • 40" - 200" (16:9 ASPECT RATIO) • 1016-5080MM DIAGONALLY, 16:9 ASPECT RATIO • FRONT/REAR/CEILING/DESK 2W(MONO) • S-VIDEO (MINI DIN 4 PIN), VIDEO(RCA PIN JACK) AUDIO (RCA L&R X 1, 0.5VRMS) • RGB-D-SUB HD 15-PIN FEMALE(X) • RCA PIN JACK X3, AUDIO-RCA PIN JACK X2 (L&R) • SD SLOT X1, STILL PICTURES(DCF COMPLIANT) • HUMIDITY 20%-80% (NO CONDENSATION) • DIMENSIONS (W X H X D) 280 X 85 X 280 MM • WEIGHT (KG) 2.9 • ACCESSORIES INCLUDED AC CORD (3MM), CARRYING BAG, AV CABLE (3MM), REMOTE CONTROL

AMAZING PRICE

HSP\* £1199.99 S&V **£749.99** CALL NOW: 01204 861861 FOR THE BEST DEAL IN THE UK!

**SONY**

KD-32DX40

**DETAILS:**

- INTEGRATED DIGITAL TELEVISION
- 76CM VISIBLE FD TRINITON WEGA SCREEN
- 50HZ DRCMF
- ANALOGUE DUE DIGITAL TUNERS
- NEW ELECTRONIC PROGRAMME GUIDE
- DIGITAL TURBO TEXT
- PCMCIA SLOT FOR ITV DIGITAL SMARTCARD ADAPTER
- VIRTUAL DOLBY SURROUND
- STAND



AMAZING PRICE

HSP\*£949.99 S&V > **£699.99** INC FREE DELIVERY

**HITACHI**

42 PD3000

**DETAILS:**

- 42" (106CM) PLASMA TV WITH MULTI-MEDIA BOX
- WIDESCREEN VIEWING RATIO
- INCORPORATES HITACHI'S NEW H2 PANEL AND I"
- INTELLIGENT IMAGE CHIP TECHNOLOGY
- 16.7 MILLION COLOURS FOR CLARITY AND DEPTH(256 GREY LEVELS) • DIGITAL COLOUR MANAGEMENT - TRUE COLOUR REPRODUCTION
- CONTRAST OF 1000:1 TO PRODUCE SUPERIOR BLACKS • SPLIT SCREEN FUNCTION - PICTURE AND TELETEXT, PC AND PICTURE • PC INPUT

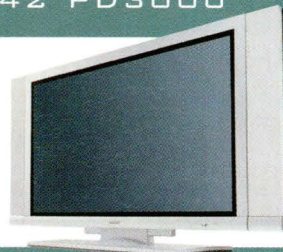

AMAZING PRICE

HSP\*£6259.99 S&V > **£3038.99** INC FREE DELIVERY

**WWW.SOUNDANDVISIONONLINE.COM**

ALL PRICES IN THIS ADVERTISEMENT ARE CORRECT AT THE TIME OF GOING TO PRESS AND ARE SUBJECT TO AVAILABILITY. PRICES WHERE READABLE HAVE BEEN TAKEN TO ENSURE THE ACCURACY OF THIS INFORMATION IN THIS ADVERTISEMENT. THE INFORMATION IS OBTAINED FROM A VARIETY OF SOURCES AND NEITHER SOUND & VISION, THE PUBLISHER OF THE PRINTERS RESPONSIBLE FOR ERRORS ON OMISSIONS. ALL DATA IS ACCEPTED BY US IN GOOD FAITH AS BEING CORRECT AT THE TIME OF GOING TO PRESS. REGISTERED IN THE UK NO. 0129 5373 VAT NO. 540 5953 31 • ALL PRICES INCLUDE VAT AT 17.5% REPRODUCTION IN WHOLE OR IN PART IS FORBIDDEN WITHOUT EXPRESS PERMISSION OF S&V • SOUND & VISION © 2003 S&V LTD TIA SOUND & VISION REGISTERED OFFICE: 44-46 HIGHER MARKET STREET, FARNWORTH, BOLTON BL4 9BB. REGISTERED IN THE UK NO. 0129 5373 VAT NO. 540 5953 31. ALL OUR TERMS AND CONDITIONS COMPLY WITH THE DISTANCE SELLING REGULATIONS 2000 WHICH GIVES YOU THE RIGHT TO CANCEL YOUR ORDER WITHIN 7 WORKING DAYS FROM RECEIPT. THIS MUST BE DONE IN A FORM OF A LETTER, FAX OR EMAIL AS A TELEPHONE CALL DOES NOT CONSTITUTE CANCELLATION. ALL GOODS ACCEPTED FOR RETURN UNDER THIS REGULATION MUST BE IN THEIR ORIGINAL BOX AND PACKAGING AND RETURNED VIA YOUR OWN CHARGE COMPANY. ALL GOODS RETURNED MUST BE KEPT IN THIS MANNER UNTIL A 25% HANDLING FEE OFF THE PURCHASE PRICE. THE TERMS & CONDITIONS OF SALE ARE AVAILABLE AT WWW.SOUNDANDVISIONONLINE.COM/TERMS/WHICH OR BY WRITING ON REQUEST.



# NEW WEBSITE NOW LAUNCHED!

**DENON** DM-31 PACKAGE



- HI-FI PACKAGE
- DM-31 CD TUNER
- DRRM-31 CASSETTE PLAYER
- DM-DM31 MINI DIS
- SCM-51 SPEAKERS

CALL US FOR NEW PRICES  
**CALL 01204 861 861**  
FOR LATEST PRICES

**DENON** AVR - 3803



- 7X105W TOTAL POWER OUTPUT
- DOLBY DIGITAL-EX, DTS-ES/NEO
- DOLBY PROLOGIC 2
- SUPPORT FOR MULTI ZONE CONFIGURATIONS

CALL US FOR NEW PRICES  
**CALL 01204 861 861**  
FOR LATEST PRICES

**DENON** DVD - 2900



- DVD & SUPER AUDIO CD WITH PUREPROGRESSIVE™ CIRCUIT
- PLAYS SUPER AUDIO CD & DVD-AUDIO DISCS
- DVD-R/RW (DVD-VIDEO RECORDING MODE) PLAYBACK
- CD-R/RW (MP3 / JPEG), PICTURE CD (KODAK & FUJICOLOUR) PLAYBACK

AMAZING PRICE  
**CALL 01204 861 861**  
FOR LATEST PRICES

**marantz** DV-8400



- DVD & SUPER AUDIO CD WITH PUREPROGRESSIVE™ CIRCUIT
- DVI-DIGITAL OUTPUT WITH COMPONENT VIDEO
- DVD-A, DVD-V, DVD-R/RW, SACD, CD-R/RW & MP3

CALL US FOR NEW PRICES  
**CALL 01204 861 861**  
FOR LATEST PRICES

**marantz** SR - 7300



- 6X110W TOTAL POWER OUTPUT
- DOLBY DIGITAL EX, DTS-ES & DOLBY PRO-LOGIC 2
- RDS FM/AM ON BOARD TUNER • AVAILABLE IN BLACK & GOLD

AMAZING PRICE  
**CALL 01204 861 861**  
FOR LATEST PRICES

**marantz** SR-8200



- 6X120W TOTAL POWER OUTPUT
- THX-SELECT DTS-ES & DOLBY PRO-LOGIC 2
- RDS FM/AM ON BOARD TUNER • AVAILABLE IN BLACK & GOLD

CALL US FOR NEW PRICES  
**CALL 01204 861 861**  
FOR LATEST PRICES

## Pioneer SOUND SYSTEMS

**PIONEER DV-7571**



- DVD-A, DVD-VIDEO, SACD, MP3, CD-R, CD-RW, DVD-R AND DVD-RW
- DOLBY DIGITAL & DTS DECODERS • PROGRESSIVE SCAN OUTPUT
- 2 X SCARTS RGB THU-PUT
- 108MHZ / 12-BIT VIDEO DAC

CALL 01204 861 861 FOR CONSTANT PRICE UPDATES

**PIONEER VSX-D812**



- DOLBY DIGITAL-EX / THX SURROUND EX • DTS / DTS-ES DISCRETE 6.1 / DTS-ES MATRIX 6.1 / DTS NEO: 6 / DTS 96/24 • DOLBY PRO-LOGIC / DOLBY PRO-LOGIC 2 • 6X100W RMS POWER OUTPUT • 2 X DIGITAL COAXIAL INPUT • 2 X DIGITAL OPTICAL INPUT • 1 X DIGITAL OPTICAL OUTPUT

CALL 01204 861 861 FOR LATEST PRICES

**PIONEER VSX-AX101**



- THX ULTRA 2 CERTIFIED MULTI-CHANNEL AMPLIFIER • DOLBY DIGITAL-EX / THX SURROUND EX
- DTS, DTS-ES DISCRETE 6.1 DTS-ES, MATRIX 6.1 • DOLBY PRO-LOGIC & DOLBY PRO-LOGIC 2
- 2 X I LINK • 8 X DIGITAL INPUT • 3 X DIGITAL COAXIAL INPUT • 5 X OPTICAL DIGITAL INPUT
- 2 X DIGITAL OPTICAL OUTPUT PRICE

CALL 01204 861 861 FOR LATEST PRICES

**SONY**



**DETAILS:**

- MULTI REGION • INTEGRATED DVD HI-FI SYSTEM • S-MASTER FULLY DIGITAL AMPLIFIER • DVD, SACD, DOLBY DIGITAL, DOLBY PRO LOGIC 2 & DTS DECODING BUILT-IN • MP3 CD-R/CD-RW PLAYBACK • NEW ON-SCREEN MENU • DVD/SACD/CD/CD-R/CD-RW/VCD PLAYBACK • WIDE FREQUENCY RANGE SPEAKERS FOR SACD AUDIO FM/AM RDS RADIO TUNER BUILT IN • 500W TOTAL POWER OUTPUT • SLIM DESIGN

HSP\* £449.00 **SONY DAV-S550**

**S&V > £269.00** INC FREE DELIVERY

**PIONEER NS-DV1000**



**DETAILS:**

- PIONEER NS-DV1000 • DVD-VIDEO & DVD AUDIO
- 5X40W RMS + 65W SUBWOOFER
- DOLBY DIGITAL & DTS DECODERS BUILT-IN
- SUPPORTS SACD, VCD, CD, CD-R/RW & MP3
- 10 BIT VIDEO D/A CONVERTER
- PAL/NTSC DUAL PLAYBACK • 96KHZ/24BIT D/A CONVERTER • ADVANCED GUI (GRAPHIC USER INTERFACE) • MAGNETICALLY SHIELDED SUBWOOFER & SATELLITE SPEAKERS
- RDS TUNER FUNCTIONS RT, PS & PTY DISPLAY • MIDNIGHT LISTENING MODE

**CALL 01204 861 861 FOR LATEST PRICES**

**TEL: 01204 861 861 FAX: 01204 439 024**  
NOW OPEN SUNDAYS 11-5

# STEREO SPEAKERS

*Speaker pairs for stereo sound*



While loudspeakers are relatively straightforward in construction, they have one of the most difficult jobs in hi-fi – turning an electrical signal into an acoustic one. Most consist of two or more drive units in a box that usually has a port in it to make life easier for the cone in your mid and/or bass driver. Alternatives to this arrangement include panel speakers, which use electrostatic or ribbon technology, and horns, which use drive units in complex cabinets that greatly improve efficiency.

Box speakers are either designed to stand on the floor (floorstanders) or on a stand (stand or shelfmounts). Floorstanders have greater internal volume which can translate into greater efficiency and/or bass extension, but less substantial designs also introduce cabinet resonance and thus distortion. But they don't need stands and therefore have the aesthetic edge. Standmounts have less cabinet to vibrate and often score in terms of imaging and timing, but need good stands to work well.

## Positioning

The closer the speaker is to a wall, the greater the reinforcement of bass. As all rooms differ, there's no simple formula for placement and experimentation will yield the best results. Altering the angle at which the speakers face the listener can also make a difference to balance and stereo image.

## Going multichannel

Many stereo speakers can be augmented with centre and surround channels from the same brand to create a multichannel system. The most important element is a centre channel, which needs to match the stereo pair as closely as possible. For the best musical results, surrounds should be as per the front left and right channels, but if space or funds don't permit, smaller designs can be used quite effectively.



## Choosing speakers

Because speakers and the rooms they are used in vary so much, choosing a pair tends to be quite subjective. To find some that will suit you, try to listen to a good variety to hear how they differ, and if possible, audition some at home. Tonal balance tends to vary the most, but is less important than more subtle factors such as timing and dynamics. Finally, listen with your ears not your eyes – great-looking speakers aren't necessarily great sounding.

## Spikes

Floorstanding speakers and stands have threaded inserts for spikes that allow rigid coupling with the floor. These have the advantage of draining resonance from the speaker and giving tighter bass, but can result in more vibration getting back to the electronics and often cause the floor to resonate as well.

## POWER

Though some speakers have a power rating, this isn't as informative as a rating for how difficult they are to drive, nor does it indicate wattage extremes for the partnering amp. In practice, an amplifier cannot be too powerful. Our listings quote ease of drive to indicate how much power

your amp needs to avoid a mismatch. An above-average (A+) speaker will work with amps rated at 25W plus, while an average (A) speaker will need 50W or more, and a below average (A-) speaker could require 100W plus to sound its best. These are guidelines rather than rules.

## Q&A

### IF SPEAKERS ARE RATED AT 75 WATTS, DOES THAT MEAN I NEED A 75 WATT AMP?

No, see the box on power for the full story.

### WHICH SPEAKERS ARE BEST FOR SMALL ROOMS?

Those designed to work close to the wall will be smoother in confined spaces. Speakers that have relatively dry, tight bass will also sound better.

### WHICH SPEAKERS ARE BEST FOR BIG ROOMS?

Big, efficient, easy-to-drive designs are more likely to be able to fill a room better than compact models.

### DO I NEED TO BUY CENTRE AND SURROUND CHANNELS FROM THE SAME BRAND AS MY STEREO SPEAKERS?

Yes, assuming that you're wanting to create a homogenous surround sound experience, where voices don't change when they move from one channel to another.

## TOP BUYS



**Tannoy**  
Sensys DC1 £449  
A new dual-concentric main driver plus super-tweeter in a solid standmount box results in a neutral yet expressive speaker at a very tempting price.



**Focal-JMLab**  
Cobalt 816 Sig S £999  
One of the best all-round performers around £1,000, combining a lively and dynamic character with an unusually smooth and neutral balance.



**B&W**  
703 £2,000  
A hi-tech, three-way floorstander sporting a 'surroundless' midrange driver. Delivers a thoroughly engaging sound with great bass and an expressive midrange.



**Living Voice**  
Avatar OBX-R2 £4,000  
Newly revised for 2003, the top model in Living Voice's Auditorium range is capable of delivering both the music's spirit and also its finest detail.

## Our favourite STEREO SPEAKERS

BEST BUY 
  EDITOR'S CHOICE

### Stereo speakers

BADGE?	PRODUCT	£	COMMENTS	SIZE (WxHxD (CM))	FLOORSTANDER	EASE OF DRIVE	BASS FROM (Hz)	FREE SPACE	CLOSE TO WALL	ISSUE NUMBER
<b>UP TO £1,000</b>										
	Acoustic Energy Aegis Evo 1	180	An unusually classy and sophisticated performer for the price; laid-back sound and good looks too	19,36,24	A	30	●			226
	ATC SCM12	999	Transparent, engaging and quick – a revealing, high-fidelity performer that's not afraid to bare all	22,39,25	A	62	●			237
	Audio Note AZ One	449	Delivers music with great gusto and enthusiasm, but also more than its fair share of coloration	23,83,29	●	A	30		●	215
	AVI Biggatron Red Spot	599	Good bass coherence and timing, but the lean and decidedly forward balance won't be to every taste	19.5,37,30	A	30			●	211
	B&W DM303	180	Chunky looking and lively sounding, with deep bass, a fine midband and a restrained top end	20,33,23	A	23			●	226
	B&W DM602 S3	300	Old-fashioned size/shape, but this timeless design has a rare combination of grip, authority and headroom	24,49,29	A	25	●			234
	B&W DM309	330	Much of the grace and punch of the smaller DM303 – a superb floorstander for the money	20,91,30	●	A	60	●		235
	B&W DM603 S3	600	Excellent all-rounder, smooth for its price with fine bass and mid, though top might be more refined	20,91,29	●	A-	25	●		231
	Blueroom Minipod	249	Wonderfully blobular styling aside, it's hard not to fall for the Minipod's openness, expression and detail	18,34,17	A	50			●	225
	Castle Durham 3	399	A very attractive near-miniature wallmount with a lively and communicative disposition – lots of fun	19,37,22	●	A	45	●		227
	Castle Conway 3	930	Lovely real wood finish and a beautifully balanced sound, fine dynamics and transients, but might have more 'air'	22,91,27	●	A+	30	●		237
	Castle Harlech S2	1,000	Improved Harlech is slightly aggressive, but lots of fun, and very good-looking too	20,96,33	●	A	50	●		219
	Dali Royal Tower	750	Cutely compact floorstander has a delightful liveliness and lightness of touch to match its luxury real wood finish	17,85,22	●	A	25		●	237
	Dynaudio Audience 42	400	An aristocrat of the vinyl-covered miniature breed. A terrific small speaker for the price	17,29,24	A	40	●			215
	Dynaudio Audience 52	557	Brilliant neutrality, though a little understated dynamically (wood veneered version, as tested – £647)	20,33,26	A-	30	●			250
	Dynaudio Audience 62	729	Pricy but cute vinyl floorstander that is a class act sonically – lightweight, but clean and dextrous	20,86,26	●	A	30			231
	Elac JET 205	650	Sweet, smooth, clean and delicate tweeter justifies hefty price tag, but a little lacking in warmth and body overall	20,33,29	A	40	●			231
	Energy Connoisseur C-5	600	Has a marvellously even and neutral overall balance, if a little too laid-back with restrained dynamic expression	20,95,37	●	A+	23	●		240
	Epos ELS3	200	Few affordable speakers sound as clean and convincing while taking up so little real estate	18,27,19	A-	60	●			241
	Epos M12	499	Retains the beguiling midband coherence that made the ES12 such a favourite. A genuine class act	20,38,26	A	40	●			215
	Focal-JMLab Chorus 716 S	550	Not the smoothest around, but combines coherent voicing with fine dynamic expression and real authority	22,95,30	●	A	20	●		250
	Focal-JMLab Cobalt 816 S	999	Great all-rounder – lively and dynamic, smooth and neutral, marred only by a slight treble 'sting'	22,98,31	●	A-	25	●		242
	Infinity Kappa 200	600	Notably artful styling. Some coloration, but good punch and drive with real dynamic propulsion and expression	22,37,36	A	25	●			250
	KEF Q1	250	Stylish if slightly small-sounding stand-mount with fine midband coherence; works well close to a wall	22,35,30	A	30			●	234
	Mission m73	199	Good-looking floorstander. Dynamics are a little limp, but it has a good overall balance. Excellent value for money	20,88,31	●	A	25	●		215
	Mission 782SE	900	Definitely one of the prettiest speakers around. Very even balance but could sound more exciting	17,80,30	●	A	35	●		242
	Monitor Audio Bronze B2	200	A lively and entertaining speaker with tight controlled bass and pronounced midband	18.5,35,25	A	42		●		238
	Monitor Audio Silver S1	300	Super-quick sonics thanks to the C-CAM metalised drivers. Resolution and speed – a great value box	18,30,24	A	45			●	236
	Monitor Audio Silver S8	800	A thoroughly impressive all-rounder, notable for its wide dynamic range, excellent imaging and fine neutrality	19,90,27	●	A	20	●		237
	Monitor Audio Silver S10	1,000	Timing might be less than the best, but the full balance and fine dynamic range deliver plenty of detail.	20,100,27	●	A+	20	●		242
	MonoPulse 32	695	Very creative style and construction with an unusually vivid and communicative if less than smooth sound	21,98,23	●	A	30	●		245
	Neat Petite III	845	The treble is peaky, but this is still one of the most coherent and communicative miniatures around	20,31,20	A	30			●	211

**SPECS KEY** SIZE (WxHxD (CM)) Width, height and depth of one cabinet in centimetres. **FLOORSTANDER** Speakers that don't require stands. **EASE OF DRIVE** How much power the amplifier needs (approximately) to drive the loudspeaker effectively. **A+** 25 watts plus **A** 50 watts plus **A-** 100 watts plus **ACT** Active – the speaker has its own in-built amplifier. **BASS FROM** How low the speaker goes – the smaller the number the deeper the bass. **FREE SPACE** The speakers work best away from wall(s). **CLOSE TO WALL** The speakers will work best when up against a wall (but avoid corners).

# AudioVenue

bespoke audio visual consultants

36 Queen St., Maidenhead, Berkshire SL6 1HZ

Tel: 01628 633 995 • 020 8707 4849

Email: [info@audiovenue.co.uk](mailto:info@audiovenue.co.uk)

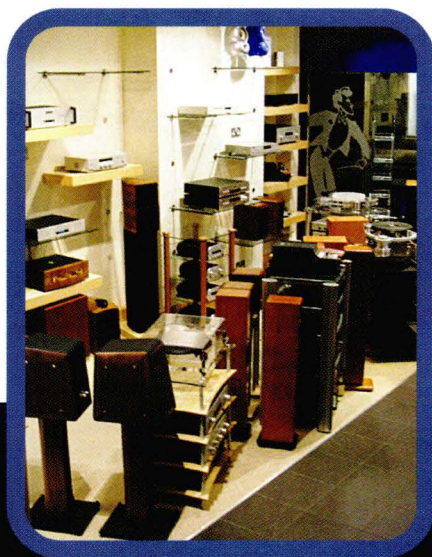

The finest showroom...

The finest products



Musical Fidelity KWP Pre-amplifier

Selection of our partners... Arcam • Artcoustic • Audio Access • Audio Analogue • Audioquest • Audio Research • BCD Engineering • Beyerdynamic • Bryston • Bose • Boston • Chord Cables • Clearaudio • Copland • Crestron • Definitive Technology • Denon • Draper Screens • Final • Fujitsu Plasma • Graaf • Krell • Harman Kardon • Integra Research • KEF • Lexicon • Linn Classic • Living Control • Loewe televisions • Michell Engineering • Miller & Kreisel • Monitor Audio • Musical Fidelity • Martin Logan • Nad • Nordost • Nakamichi • Onkyo • Opera • Ortofon • Panasonic plasma • Parasound • Pioneer plasma • PMC • Primare • Proceed • Project • QED • Quad • Quadraspire • REL • Revel • Revox Screens • Roksan • Runco • Sennhesier • SME • Sonus Faber • Spondor • Stands Unique • Stewart Screens • Straightwire • Sumiko • Tag McLaren • Townshend Audio • Theta • Transparent Audio • Unison Research • Vienna Acoustics • Vutec Screens • Wilson Audio and other leading components and accessories.

[www.audiovenue.co.uk](http://www.audiovenue.co.uk)

Our favourite  BEST BUY  EDITOR'S CHOICE

## STEREO SPEAKERS continued

### Stereo speakers

BADGE?	PRODUCT	£	COMMENTS	SPECIFICATIONS					
				SIZE (WxHxD) (CM)	FLOORSTANDER	EASE OF DRIVE	BASS FROM (Hz)	FREE SPACE	CLOSE TO WALL
<input type="checkbox"/>	PMC DB1	555	Lacks a little weight and authority, but beautifully balanced, free from boxiness, and loads of fun for a tiny	16,29,24		A	50		240
<input type="checkbox"/>	PMC TB2	700	A worthy successor to the TB1, which sets a high standard in its size/type for neutrality and transparency	20,41,31		A	30		211
<input type="checkbox"/>	Rega Ela	749	Might have more grunt, but few can match its impressive agility, delicacy, and superior musical communication	23,89,30		A	28		250
	SonusFaber Concerto Home	999	Looks good and sounds better. Great midband communication skills, well aligned for close-to-wall siting	24,36,34		A	40		233
	Spendor S3	600	Beautifully voiced, unboxy, lacks some dynamic and loudness capabilities. Best suited to small rooms	17,31,21		A-	30		223
	Spendor SR5	1,000	This wall-mount very cleverly avoids the usual colorations, delivering a very dynamic if rather dry sound	31,31,18		A+	50		240
<input type="checkbox"/>	Tannoy Mercury mX3-M	229	Beautifully balanced and voiced, with low coloration and good transparency, but could be more dynamic	19,87,25		A+	45		234
<input type="checkbox"/>	Tannoy Sensys DC1	449	Modest sensitivity but beautifully balanced with fine authority at a very realistic price	21,41,29		A	40		245
	Tannoy Eyris 1	600	Pricey but very cute standmount miniature; oddball, but has marvellous midband subtlety and delicacy	17,35,26		A+			227
	Tannoy Sensys DC2	649	Has impressive scale and weight with fine stereo imaging, but is also rather laid back, lacking easy agility	21,97,29		A	20		250
	Tannoy Eyris 2	999	This super-slim and cutely different-looking floorstander is very communicative, despite weak treble	17,91,26		A	20		231
<b>ABOVE £1,000</b>									
	ATC Active 10	1,269	Stylish, active powerhouses with plenty of subtlety when required (balanced connection only)	23,39,31		act	45		221
<input type="checkbox"/>	ATC SCM35	1,999	If you want to hear the uncoloured truth about your record collection in all its glory, this is a speaker to treasure	23,88,30		A-	48		250
<input type="checkbox"/>	ATC Active 20	2,538	30k + 300W equals resolution and bass that most amp/speaker combinations dream about – a bargain	56,28,36		act	45		240
<input type="checkbox"/>	ATC SCM50 ASL	7,255	350W of power combine with superb drive units and a 48kg cabinet to provide alarming resolution	35,72,48		A	38		218
	Audio Note AN-E/D	1,520	This classic large standmount might have throwback aesthetics, but it delivers an exceptional all-round sound	36,79,28		A+	20		204
	Audio Note AN-J/SPe	1,675	Retro styling, but a vigorous and dynamic performer that creates fine musical tension	33,59,25		A	38		219
<input type="checkbox"/>	B&O Beolab 5	10,000	Radical, environmentally independent active speaker has exceptional bass, neutrality, and imaging	49,97,49		n/a	<20		244
	B&W Nautilus 805	1,400	A small-sounding loudspeaker dynamically, but very stylish, clean and 'unboxy', delivering loads of detail	24,42,31		A	28		199
<input type="checkbox"/>	B&W 704	1,400	Sleek and stylish two-and-a-half-way with deep, lively bass, sweet treble, and rather laid-back presence	22,96,32		A-	20		248
<input type="checkbox"/>	B&W 703	2,000	Elegant floorstander with excellent bass drive and mid dynamic range, but slightly strong and obvious top end	23,101,36		A-	20		247
<input type="checkbox"/>	B&W Signature 805	2,500	Gorgeous standmount sounds delicately transparent and laid back with very superior resolution and imaging	24,42,34		A	30		247
<input type="checkbox"/>	B&W Nautilus 802	6,000	Outstanding example of the high-tech speaker builder's art. Needs real power, but gives real sound	39,111,55		A-	34		183
<input type="checkbox"/>	B&W Nautilus 801	8,500	The 801 is a magnificent loudspeaker in nearly every respect, but it is one that likes to play loud	52,111,69		A-	34		186
<input type="checkbox"/>	B&W Nautilus 800	11,000	Unequivocal challenge for world domination. One of the most revealing speakers around	45,120,65		A-	<20		231
	Beauhorn B2.2 Revelation	3,984	Magnificent midband and fine overall balance but limited bass is best with small-scale material	34,130,75		A+	80		244
	Castle Howard S3	1,350	A solid all-rounder with uniquely spacious imaging, bit pricey compared to some though	21,99,32		A+	38		229
	Dynaudio Contour 1.3 MkII	1,198	Outstanding performer among compact standmounts; neutral, with fine punch and dynamic range	20,38,29		A-	45		219
<input type="checkbox"/>	Dynaudio Audience B2	1,460	Bulky, with vinyl finish, but offers exceptional neutrality, bass extension, power handling and loudness potential	22,106,36		A	30		229
	Eclipse TD Lulét 307/316	1,250	Extraordinary satellite plus sub solution sounds a cut above other sub/sats. Can be expanded to multichannel	12,16,16.2		act	40		247
<input type="checkbox"/>	Ferguson Hill FH001	6,853	Looks and sounds wonderful, with realistic dynamic expression, but needs careful amp matching and sub(s)	90,166,80		A+	180		242
<input type="checkbox"/>	Focal-JMLab Micro Utopia	3,500	New 'Be' version is clearly an exceptional standmount, capable of revealing the innate quality of the music	25,42,5.38		A	50		245
<input type="checkbox"/>	Focal-JMLab Alto Utopia Be	11,000	Attractive and beautifully balanced, with fine bass alignment and focus, low coloration and very clean top end	37,121,53		A-	20		248
	Graves Audio Korongray	1,999	Fast and very time-coherent, but rather bass-light and aggressive higher up – valve amps preferred	25,109,36		A+	45		247
	Harbeth Super HL5	1,699	Looks old-fashioned, but classic monitor combines authority and transparency with good neutrality	33,64,31		A	30		233
<input type="checkbox"/>	Infinity Intermezzo 2.6	1,600	Bi-amp speaker sounds laid back and 'disappears' acoustically; highly enjoyable, looks and sounds great	25,38,29		A+	27		233
	KEF Reference Model 205	4,000	Great looking speaker with a smooth, neutral and slightly 'cool' sound that could be tauter and more exciting	29,116,43		A-	20		245
	Leema Xen	1,000	A true micro-mini-monitor with remarkable powers of analysis and great musical insight, if a touch forward	14,22,23		A-	50		245

### PATHOS LOGOS - THE ULTIMATE COMBINATION OF MUSIC AND ART

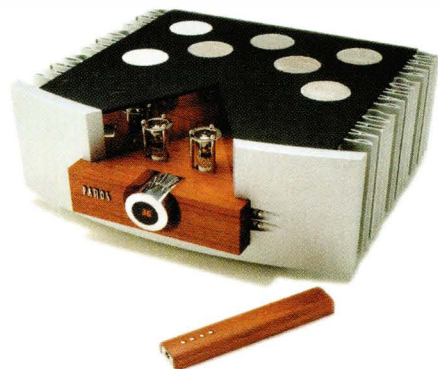

Italian design is renowned throughout the world for its sophistication and beauty. The Logos integrated amplifier from Pathos Acoustics is no exception. With its stunning looks and 110 watts per channel of smooth, detailed and controlled power, it is truly a musical work of art - and superb value for money. Don't just take our word for it, contact us for your nearest UKD dealer and find out for yourself.

You won't believe your eyes, or ears!



**UKD Ltd. 23 Richings Way,  
Iver, Bucks SLO 9DA  
Tel: 01753 652 669  
info@ukd.co.uk  
www.ukd.co.uk**

Our favourite BEST BUY EDITOR'S CHOICE

# STEREO SPEAKERS continued

## Stereo speakers

BADGE?	PRODUCT	£	COMMENTS	SPECIFICATIONS					ISSUE NUMBER
				SIZE (WxHxD) (CM)	FLOORSTANDER	EASE OF DRIVE	BASS FREQU (Hz)	FREE SPACE	
	Living Voice Auditorium	1,700	Gloriously coherent and dynamic midband, though the top end is restrained and bass was uneven in our room	21.5,86,28	● A-	30	●		247
<span style="border: 1px solid black; padding: 0 2px;">EC</span>	Living Voice Avatar	2,700	Dynamic and highly resolved, yet physically discreet design with a relaxed balance	22,104,27	● A+	40	●		218
<span style="border: 1px solid black; padding: 0 2px;">EC</span>	Living Voice Avatar OBX-R2	4,000	Has Dynamics, tonal colour, detail, space and time resolution in spades. External crossovers require extra cabling	22,100,27	● A+	35	●		244
<span style="border: 1px solid black; padding: 0 2px;">MB</span>	MartinLogan Clarity	2,498	Relatively affordable and easy to live with electrostatic hybrid with class-leading resolving power	26,135,31	● A-	46	●		245
<span style="border: 1px solid black; padding: 0 2px;">MB</span>	Meridian M33	1,560	Compact active wallmount packs remarkable dynamic vigour into a very discreet package	15,38,22	act	45	●		214
	Mirage OM7	2,000	Warm, full and laid back Omni has weak stereo focus but brings the musicians into your room	30,115,16-39	● A-	25	●		247
	Naim Allae	1,990	Chunky little floorstander has a 'cold' overall balance, but remarkable powers of musical analysis	24,94,28	● A	40	●		229
<span style="border: 1px solid black; padding: 0 2px;">EC</span>	Naim SL-2	4,995	Delivers magnificent musical analysis and communication skills in a notably discrete physical package	28,103,33	● A-	20	●		232
<span style="border: 1px solid black; padding: 0 2px;">EC</span>	Naim NBL	6,925	Elegant, large floorstander is exceptionally informative, with an awesome dynamic range and dry, forward balance	29,116,47	● A-	20	●		200
<span style="border: 1px solid black; padding: 0 2px;">EC</span>	Neat Ultimatum MFS	2,995	Wonderful five-driver standmount sounds bigger than it looks. Very spacious and informative, if a little bright	22,38,37	A+	25	●		241
<span style="border: 1px solid black; padding: 0 2px;">EC</span>	Neat Ultimatum MF9	8,500	Superb musical communicator with splendidly deep and agile bass and fine open neutrality	22,150,40	● A-	20	●		226
	PMC LB1	1,150	Still fully competitive eight years after our original review, this genuine compact monitor is now a modern classic	17.5,53,26	A-	40	●		199
<span style="border: 1px solid black; padding: 0 2px;">MB</span>	PMC FB1	1,410	Has the lively coherence of a simple two-way, alongside impressive bass weight and extension	20,105,31	● A	20	●		204
	PMC OB1	2,450	Genuinely deep bass and lovely overall neutrality, though mid could have more tension and bass more punch	20,103,33	● A	20	●		243
<span style="border: 1px solid black; padding: 0 2px;">EC</span>	PMC IB2	6,150	Stunning in an understated way, this speaker creeps up on you and hooks you with its transparency and power	33,74,47	A-	25	●		237
<span style="border: 1px solid black; padding: 0 2px;">EC</span>	Royd Revelation RR2	1,199	Pretty little floorstander delivers genuinely deep bass without 'thump'; lovely clean, open midband too	19,89,18	● A-	20	●		221
<span style="border: 1px solid black; padding: 0 2px;">EC</span>	Sonus Faber Cremona A	2,149	Standmount 'Auditor' version of the Cremona makes a soundstage bigger and better than its size suggests	19,35,32	A	48	●		246
	Spendor S8	1,700	Classic midband neutrality and transparency, the S8 has great subtlety and fine bass grunt too	23,92,32	● A+	40	●		229
<span style="border: 1px solid black; padding: 0 2px;">EC</span>	Spendor S9	2,500	Meaty three-way with superb bass and explicit mid – one for detail fans	24,99,8,38	● A+	37	●		223
<span style="border: 1px solid black; padding: 0 2px;">EC</span>	Tannoy Dimension TD8	4,000	This stylish speaker is a splendid all-rounder, with fine dynamics, precise imaging and minimal coloration	30.5,85.5,30	● A-	25	●		240
<span style="border: 1px solid black; padding: 0 2px;">EC</span>	Tannoy Dimension TD10	5,000	Extremely competent and rhythmic speaker, a futureproof supertweeter and detail to die for	35,101,37	● A-	38	●		215
<span style="border: 1px solid black; padding: 0 2px;">EC</span>	Tannoy Dimension TD12	6,500	Art Deco-inspired style, plus magnificent headroom and genuine monitoring neutrality – a tour de force	42,126,41	● A-	23	●		225
<span style="border: 1px solid black; padding: 0 2px;">MB</span>	Totem Forest	2,390	Low sensitivity but wonderfully open neutrality, at heart a beautifully communicative and musical loudspeaker	19.5,90,27	● A	25	●		247
	Triangle Zays 222	1,295	Wonderful freedom from time-smear gives invigorating and realistic dynamics, but colorations are also obvious	26,116,32	● A	22	●		242
	Triangle Naia	1,900	Exciting, vivid and communicative, but also a bit untidy and uneven, the Naia is a whole lot of fun	23,119,32	● A-	25	●		247
	Vandersteen 2Ce Sig	1,990	Very superior midband neutrality, impressive freedom from boxiness and splendid stereophony. A classic	41,109,26	● A-	30	●		229
<span style="border: 1px solid black; padding: 0 2px;">EC</span>	Wilson Benesch Chimera	15,000	Elegant with lovely sonic delicacy and plenty of weight too. Works best at low levels, but a difficult load to drive	24,145,55	● A-	20	●		234
<span style="border: 1px solid black; padding: 0 2px;">EC</span>	Wilson benesch Discovery	5,500	Innovative three-way with built-in stand, combines great subtlety with weight and headroom	23,47,38	● A-	45	●		212

# AV SPEAKERS

Speaker solutions for multichannel surround sound



Multichannel speaker systems have a front left/right (L/R) stereo pair, a centre or dialogue channel, two (5.1) or four (7.1) surround speakers and often a subwoofer. For best results, each of these speakers bar the sub should be identical. The problem is that few surround systems are dedicated to music and perform a home cinematic role as well, meaning the centre speaker has to sit above or below a

video monitor. Centre channels are usually wide and short for this reason.

This should not be a barrier to great surround for music and movies however, as many brands make centre channels with a very close sound to their L/R designs.

### Music vs movies

High-resolution SACD and DVD-A music recordings tend to be mastered with

surround speakers in the ITU standard position which is as far behind the listener as the front channels are in front. 5.1 movie soundtracks tend to place surround channels not so far behind and to the side of listeners. Usually, practical limitations will dictate a limited range of placement options, but if you are a dedicated music fan, check out the ITU set-up regulations in the booklet supplied with SACD discs.

## SET-UP

Ideally you should set up surround speakers with as much care as you would stereo systems, but practical issues tend to have a significant bearing on surround and centre speaker placement. Surround channels can be floorstanding or wallmounted, and centres usually have to perch on the TV or underneath it. Given these limitations, adjust your L/R front

speakers to give the best tonal match with the centre. If there's more than just you listening, 'toe in' the speakers so that their axis crosses in front of the listening position – this gives a wider stereo image. And if there's a subwoofer it should be placed near the front speakers. Use a sound pressure metre (available from Tandy among others) to accurately set levels.

## SUBWOOFERS

Subs start working where stereo speakers run out of steam at low frequencies. The idea is to create deeper, better-controlled bass rather than more of it. They usually have onboard amplification (active) and connect to either the LFE (Low Frequency Effects) channel in a home cinema set-up or the speaker terminals in a stereo set-up.

## TOP BUYS



**B&W**  
600 S3 package £900  
Incorporates 602s, 601s and an LCR 600 centre speaker. Great in both stereo and multichannel surround modes.



**KEF**  
Q AV7 £1,300  
With the latest Uni-Q refinements, this system is astonishingly accomplished and amazing value.



**Mission**  
m5 package £1,450  
A five-speakers-plus-sub package giving a strong performance with both music and film soundtracks. Excellent value.



**Mirage**  
Omni 2 £2,650  
Dark tonality but superb imagery makes this an excellent all-round choice for music and movies alike.

Our favourite  BEST BUY  EDITOR'S CHOICE

## AV SPEAKER PACKAGES

### Multichannel speakers

BADGE?	PRODUCT	£	COMMENTS	SPECIFICATIONS					
				EASE OF DRIVE	NUMBER OF SPEAKERS	BASS FROM (HZ)	FREE SPACE	CLOSE TO WALL	ISSUE NUMBER
	B&W 300	900	An excellent compromise between the requirements of music and those of home cinema (inc. subwoofer)	A	6	27	●		241
<input checked="" type="checkbox"/>	B&W 600 S3 package	900	Unquestionably delivers the sonic goods. High-quality drivers in standmount enclosures (uses 602 S3s at the front)	A	5	22	●		224
	Castle CAV Sterling	1,250	Lovely real wood veneers. Sound has fine dynamic drive and expression, but can sound a little hard	A	5	28		●	224
	Dynaudio Audience 42	1,142	Multichannel package for hi-fi purists with real authority and imaging, but needs subwoofer for full-bore movie sound	A-	5	53	●		241
	Focal-JMLab Cobalt	1,797	A little lean and bright, but with righteous dynamic expression and lively communication skills	A	5	22	●		224
	Focal-JMLab Electra	3,017	Bold, solid system, tremendous consistency and easy to expand with an added subwoofer	A	5	50	●		232
<input checked="" type="checkbox"/>	KEF Q AV7	1,300	With latest Uni-Q refinements, this system is astonishingly accomplished and amazing value	A+	5	35	●		232
	Mirage Omni 2	2,650	Dark tonality, but superb imagery makes this an excellent all-round choice	A	5	30	●		232
<input checked="" type="checkbox"/>	Mission m5	1,450	Main m52 is a clean, attractive full-range stereo speaker, while the m5As does big bass for movie fans	A	6	28	●		241
	Mordaunt-Short Declaration 500	1,600	Good value vinyl THX Select package with Power Towers. Good authority, but must be 5.1-connected	A	5	25		●	210
	PMC FB1/TB2	2,485	Classy, if bulky and pricey, package has good transparency, coherence and weight	A	5	20		●	210
	Rega Jura/Ara/Senta	938	Classy real wood package does a good all-round job, but sounds bright and might have more surround weight	A	5	25		●	210
	Spendor S-Series	1,650	Ultra-tinies lack some dynamic and loudness capabilities, but beautiful voicing and freedom from boxiness	A-	5	30		●	224
<input checked="" type="checkbox"/>	Tannoy mXAV4	500	Lacks some grunt, but smooth and refined with seamless surround coherence. Excellent value	A	5	20		●	210

**SPECS KEY** **EASE OF DRIVE** How much power the amplifier needs (approximately) to drive the loudspeaker effectively: **A+** 25 watts plus **A** 50 watts plus **A-** 100 watts plus.

**NUMBER OF SPEAKERS** The amount of individual loudspeakers in the package. **BASS FROM** How low the speaker goes, the smaller the number the deeper the bass.

**FREE SPACE** The speakers work best away from wall(s). **CLOSE TO WALL** The speakers will work best when up against a wall (but avoid corners).

Our favourite  BEST BUY  EDITOR'S CHOICE

## SUBWOOFERS

### Bass speakers

BADGE?	PRODUCT	£	COMMENTS	SPECIFICATIONS			
				SIZE WxHxD (CM)	POWER (W)	BASS FROM (HZ)	ISSUE NUMBER
	Acoustic Energy Aesprit 308	650	Tuneful and dynamic sound with music or movies from this compact sub, which comes with a handy remote	41,37,30	200	35	225
<input checked="" type="checkbox"/>	B&W ASW850	2,000	Does all the things subwoofers should do with music and movies alike, but transparently and seamlessly	53,56,52	1000	18	246
	Monitor Audio ASW100	300	For the price, this compact subwoofer performed well	32,32,34	120	27	225
<input checked="" type="checkbox"/>	REL Q150E	500	Great value compact 'cube' sub adds genuine weight and drive thanks to superior filtering	29,32,33	150	20	239
	REL Strata III	700	A little more bottom octave might have been preferable, but in terms of agility and coherence, this is a fine hi-fi subwoofer	42, 52, 33	100	20	210
	REL Storm III	900	Excellent sub with powerful, detailed and deep bass. Comprehensive facilities, including flexible filter adjustment	42,62,33	150	18	225
<input checked="" type="checkbox"/>	REL Stadium III	1,500	It's a bulky piece of furniture, but offers superior filtering as well as an ability to delve deep into the bass nether regions	59, 56, 39	200	16	217
<input checked="" type="checkbox"/>	Ruark CL300	2,000	Shows what a good subwoofer can do: controlled, detailed and dynamic. A delight with music and movies alike	60,52,5,40	300	30	225
	Titan Saturn	800	Very bulky sub has curious styling, but decent filtering gives good weight and headroom	72,48,72	200	20	239

**SPECS KEY** **SIZE WxHxD (CM)** Width, height and depth of one cabinet in centimetres. **POWER (W)** How many watts the onboard amplifier of active models delivers.

**BASS FROM** How low the sub goes, the smaller the number the deeper the bass

# CABLES



Wires to hook your system together



Hi-fi cables come in two varieties: interconnects and speaker cables.

Interconnects come in preset lengths, generally with RCA phono plugs attached, though some equipment uses XLR connectors for balanced connection. Speaker cable is sold by the metre and can be used without plugs or can be fitted with screw or solder-on types.

Choosing the best cables is not quite as

straightforward as it might seem. One problem is that components interact with the cables you use and this often results in audible effects, but there are few cables that are fundamentally incompatible with any components, and we recommend the advice of a good dealer. In any case, you should look to spend as much as you can afford.

Digital cables come in two flavours: electrical and optical. In most instances

electrical varieties sound better than optical, but if you are after a smoother sound the light carriers have the advantage, as they do if long lengths are needed (10m+). Optical outputs tend to have Toslink connectors (around 99 per cent), but some electrical digital outputs are of the superior BNC type, which uses a bayonet-type socket. Check which type your digital component has before buying a digital interconnect.

## Our favourite CABLES

BEST BUY EDITOR'S CHOICE

### Interconnects and speaker cables

BADGE?	PRODUCT	£	COMMENTS	SPECIFICATIONS				ISSUE NUMBER	
				STRANDED	SOLID CORE	COPPER	SILVER		DIGITAL CABLE TYPE
<b>ANALOGUE INTERCONNECTS</b>									
	Black Rhodium Illusion	77	An upfront, lively, exciting cable which still manages subtlety when needed. Slight coloration though		●	●			248
	DNM TBB75	75	Bass not always completely consistent, but sound has great clarity and insight		●	●			241
<span style="border: 1px solid black; padding: 2px;">BEST BUY</span>	Ecosse The Composer	30	A high degree of realism and delicacy, and a fantastic price (0.8m)	●		●			211
	Ecosse Reference Diva	100	Very good performance in all areas, with particularly fine, tuneful, bass (0.8m)	●		●			224
<span style="border: 1px solid black; padding: 2px;">EDITOR'S CHOICE</span>	Ixos Gamma Audition II	30	Detailed and neutral, with just a hint of pleasant mellowness	●		●			211
	Kimber Silver Streak	242	Not the cheapest around, but more than justifies itself with terrific poise and balance of virtues	●		●			241
<span style="border: 1px solid black; padding: 2px;">BEST BUY</span>	Kimber Timbre	72	Typical Kimber construction with ditto sound – clean, extended and detailed	●		●			248
<span style="border: 1px solid black; padding: 2px;">BEST BUY</span>	Monster Interlink 400 Mk2	70	Really lively and enjoyable sound	●		●			224
	PM Dragon Tails	600	Targeted at valve equipment, but its virtues, including superb imaging, apply to solid-state duties too	●			●		249
	QED Qunex 1	20	Well balanced and easily rivals more expensive cables	●		●			211
<span style="border: 1px solid black; padding: 2px;">BEST BUY</span>	Townshend DCT100	100	Unusual construction with copper strip conductors, giving very detailed sound, but just an occasional hint of hardness		●	●			241
<span style="border: 1px solid black; padding: 2px;">EDITOR'S CHOICE</span>	Townshend Isolda DCT	300	Unusual construction and cryogenically treated too: whatever the reason, a remarkably capable wire		●	●			234
<span style="border: 1px solid black; padding: 2px;">BEST BUY</span>	van den Hul The Bay C5	45	Terrific detail, nice balance – a great cable	●		●			224
<span style="border: 1px solid black; padding: 2px;">BEST BUY</span>	van den Hul The Well	65	Hybrid cable with carbon-fibre conductors added. Very slight bass coloration does little to detract from fine performance	●		●			241
<span style="border: 1px solid black; padding: 2px;">BEST BUY</span>	van den Hul D102 Mk III	79	Hybrid conductors (carbon and copper) and intelligent construction give strong bass and excellent detail	●		●			234
<b>DIGITAL INTERCONNECTS</b>									
	Audioquest Digital One	35	A neutral and capable cable that adds little or no character to the sound	●		●		E	207
<span style="border: 1px solid black; padding: 2px;">BEST BUY</span>	QED Qunex P75	25	A superbly capable interconnect that's highly detailed and well balanced			●		E	207
<span style="border: 1px solid black; padding: 2px;">BEST BUY</span>	QED Qunex SR75	50	Lots of bass and good clear midrange and treble at a sensible price	●		●		E	234
<span style="border: 1px solid black; padding: 2px;">BEST BUY</span>	Supra Trico	40	Very well made digital/video cable which noticeably improves the sound of a cheap DAC	●		●		E	241
<span style="border: 1px solid black; padding: 2px;">BEST BUY</span>	van den Hul Optocoupler II	49	Noticeably has the edge over other optical leads, but still second best to electrical types					O	234
<b>SPEAKER CABLES PRICE PER METRE</b>									
	Black Rhodium S300	18	Tight, precise and extended bass makes this a great cable for rock 'n' roll	●		●			241
	Ecosse Reference MS2.3	23	Favours excitement over refinement: can be slightly bass-shy, but plenty of life	●		●			227
<span style="border: 1px solid black; padding: 2px;">EDITOR'S CHOICE</span>	Electrofluidics 20/20	45	Excellent bass extension and very fine performance elsewhere – one of the best all-round cables available		●	●			241
<span style="border: 1px solid black; padding: 2px;">BEST BUY</span>	Kimber 4PR	5	Considering the price, this cable's very slight dryness is forgivable when everything else is so right	●		●			192
<span style="border: 1px solid black; padding: 2px;">BEST BUY</span>	Kimber 8VS	18	Beautifully full, open and transparent sound right across the board. Price for 1m terminated pair	●		●			227
	Kimber 8PR	21	Bass very full, just occasionally a touch flabby, but detailed and sweet upper frequencies make this a good value cable	●		●			241
<span style="border: 1px solid black; padding: 2px;">BEST BUY</span>	Kimber 8TC	39	Very capable in all areas, particularly good at imaging and with firm bass. Price for 5m terminated pair	●		●			203
<span style="border: 1px solid black; padding: 2px;">BEST BUY</span>	QED Silver Anniversary	5	A few minor flaws, but overall performance is very assured for this price	●		●			192
<span style="border: 1px solid black; padding: 2px;">BEST BUY</span>	QED X-Tube XT300	10	A natural and well controlled sounding cable that's cost effective for mid-priced systems			●	●		234
	QED X-Tube XT400	20	A practical cable with a liking for lively music, but slightly less assured with subtle classical grooves	●		●			248
	Supra Ply 3.4/S	8	Good in all areas, with rich bass and just a touch of treble roughness	●		●			203
<span style="border: 1px solid black; padding: 2px;">EDITOR'S CHOICE</span>	Townshend Isolda DCT	50	Cryogenically treated 'impedance matched' cable with stabilising components added: great sound all-round		●	●			241
<span style="border: 1px solid black; padding: 2px;">BEST BUY</span>	Wireworld Solstice 5	20	Unfriendly to handle, but makes up for it with very assured sound – heaps of bass and great insight	●		●			248

**SPECS KEY** **STRANDED** Cable has a number of (usually) twisted strands to conduct the signal. **SOLID CORE** Cable has one or more individually insulated strands to conduct the signal. **COPPER** Material used to form the conducting element of the cable. **SILVER** Alternative material used to form the conducting element of the cable. **DIGITAL CABLE TYPE** E – electrical, O – optical. Cables are one metre length unless otherwise stated.



# HEADPHONES

*For your ears only*



Headphones come in several varieties and some are designed for particular usage. The majority of 'cans' use dynamic cone and coil-type drive units and can be used with anything from a personal stereo to a dedicated amplifier. Other types also exist, most significantly electrostatics that use a charged panel membrane to produce a distinctly refined sound. These are supplied with their own dedicated amplifiers, which tends to increase the price.

Cans are split into several types. There are open and closed-back designs, the latter being best for noisy (or noise sensitive) environments as they minimise leakage and intrusion. Open-back types tend to have a more open, less 'in-head' sound. There are also three variants of earpad design: circumaurals

enclose the ear and press on your head, supra-aurals press on the ear and intra-aurals sit in the ear and are particularly popular with personal stereo users.

### Getting the best from your cans

Getting a good result with headphones is not quite as straightforward as it should be. Merely plugging them into the output on your CD player or amp will not give particularly engaging results unless you are very lucky. If you are planning on serious listening, invest in a dedicated amp – the increase in dynamics is not in the least bit subtle. A variety of models are made and prices start at around £80 for a QED, a little more for designs from, say, Creek or Musical Fidelity. And if you're really into cans, look up the valve-powered Earmax.

## Our favourite HEADPHONES

BEST BUY  EDITOR'S CHOICE

### Stereo headphones

BADGE?	PRODUCT	£	COMMENTS	SPECIFICATIONS							
				ELECTROSTATIC	SUPRA-AURAL	CIRCUMAURAL	OPEN BACK	CLOSED BACK	WEIGHT (g)	3.5MM JACK ADAPTOR	
<input type="checkbox"/>	AKG K44	20	Lively, enjoyable and remarkably detailed: a bargain			●	●	●	190	●	219
	AKG K100	36	Leather-clad groover with bags of power and clarity, for a respectable asking price		●		●		190	●	205
<input type="checkbox"/>	AKG K270 Studio	129	Pro oriented design which is very transparent and great with acoustic material			●		●	270		230
<input checked="" type="checkbox"/>	AKG K1000	550	Neutral, analytical and completely out of the head sound, suitable for connection to speaker outputs only					●	270		244
	Audio Technica ATH-D40fs	105	Detailed and involving sound with a professional 'studio' quality appeal				●	●	250		194
<input type="checkbox"/>	Beyerdynamic DT990	160	Impeccable balance, very extended bass and treble, and bags of detail place this model ahead of the pack			●	●		250	●	245
<input type="checkbox"/>	Grado SR60	90	For sheer musical enjoyment these are hard to beat. Retro styling may not be to everyone's taste		●		●		200	●	194
<input type="checkbox"/>	Grado SR80	110	Not perhaps as neutral as some but they communicate well and that's the point of the exercise		●		●		200	●	230
	Philips HP890	70	A remarkably sophisticated and very comfortable headphone				●	●	330	●	219
<input type="checkbox"/>	Sennheiser HD590	160	Assured and confident headphone with very low coloration and great comfort				●	●	270	●	205
	Sony MDR-CD480	40	Generally neutral and nicely detailed – comfortable too				●	●	250	●	219
<input checked="" type="checkbox"/>	Stax System II	400	Luxury option at its price, but the sound delivery is five-star quality all the way	●			●	●	295	●	205

**SPECS KEY** **ELECTROSTATIC** Uses electrostatic film instead of more common cone or dome dynamics. **SUPRA-AURAL** Earpads sit on ear rather than around it. **CIRCUMAURAL** Earpads rest on the head around the ears. **OPEN BACK** Vented capsules let sound in and out. **CLOSED BACK** Sealed capsules. **WEIGHT** In grams. **3.5MM JACK ADAPTOR** Allows connection to personal stereos, computers etc.

## looking for ultimate Hi-Fi performance?



IsoTek's multi award winning<sup>††</sup> range of mains filters and regenerators allow all audio & AV systems to function at their best. With over 100 dealers throughout the UK you should have no problems auditioning a unit. For your nearest stockist call Activ Distribution on 01635 291357.

**IsoTek**  
www.isoteksystems.com

†† Hi-Fi News Award Winner 2002 (SubStation), † What Hi-Fi? Best Buy, Editors Choice & Product Of The Year Hi-Fi Choice, Hi-Fi News Award Winner 2003 (Mini Sub)

# STANDS AND SUPPORTS

Equipment racks and speaker stands



In hi-fi there are two types of stand. One is a rack that holds turntables, amps, CD players and so on and is described as an equipment support, and the other is a speaker stand. The latter comes in three basic varieties, two for standmount speakers: lightweight, multilegged types; and heavy designs with fewer legs and the ability to be mass-loaded for extra solidity. The lighter variety is

said to have a quicker sound, while heavyweights give deeper bass and a calmer sound. The third speaker stand type is a platform that sits under floorstanding speakers or speaker/stand combinations, the pneumatic Townshend Seismic Sink being an example.

There are two speaker-to-stand interfacing options: spikes or Blu Tak in each corner of the top plate. Try both and take your pick.

## Our favourite MB BEST BUY EC EDITOR'S CHOICE EQUIPMENT SUPPORTS

### Equipment supports

BADGE?	PRODUCT	£	COMMENTS	SPECIFICATIONS					
				HEIGHT	TOP PLATE SIZE (CM)	WELDED	NUMBER OF SHELVES	SHELF TYPE	ISSUE NUMBER
	Aavik Furniture A4	350	Good sound and stylish Scandinavian looks at an affordable price	80.5	47		4	MDF	193
	Alphason A5-G	399	Nice looking, very solid and practical with a pretty well balanced sound, but lacks a little detail	80	66,46		5	Glass	247
	Atacama Equinox	280	Stable, modular design with style. Excellent bass transients and a fresh design concept	81	50,50	●	4	Glass	217
<span style="border: 1px solid black; padding: 0 2px;">MB</span>	Audiophile Furniture Base	615	Price is justified by its earth-shattering sonic abilities – a worthy upgrade	82	43		4	MDF	193
	Avid Isoschelf	1,100	An enthusiast's equipment support stand free from coloration, if a little fiddly to set up	87.5	48		5	MDF	193
<span style="border: 1px solid black; padding: 0 2px;">MB</span>	Clearlight Audio RDC Aspekt	550	Stunning neutrality and detail from a well-damped design. Its performance makes the price tag good value	75	53,5,45		4	MDF	217
	Custom Design Aspect 650	270	Smart looks and practical thanks to adjustable shelves. Sound is fair with some loss of detail	66	46	●	4	Glass	206
<span style="border: 1px solid black; padding: 0 2px;">MB</span>	Custom Design Concept 400	700	Slightly drab appearance, but good sound and efficient use of space	74	48,40		4	Metal	247
	Isoblu 'The Stand'	460	Attractive modular design that's as easy on the ear as on the eye	47	48,40		4	MDF	247
<span style="border: 1px solid black; padding: 0 2px;">EC</span>	Naim Fraim	1,825	Pricey but very classy looking and sounding, with modular flexibility	96	45,34		5	Glass	232
	Quadraspire Q4 Reference	480	Excellent performance from the school of wobbly racks. Natural sounding and plenty of detail	51.5	49,39.5		4	MDF	217
	Russ Andrews Torlyte Rack	988	Attractive modular system made of very light Torlyte: a touch of added warmth is its only vice	68	54,49		4	Torlyte	240
<span style="border: 1px solid black; padding: 0 2px;">MB</span>	Sound Organisation Z560	195	Excellent value rack, five shelves too! Well balanced and under 200 quid!	92	50,40		5	Glass	217
<span style="border: 1px solid black; padding: 0 2px;">MB</span>	Standesign Design 4	190	An all-in-one support at a budget price, with good sonic performance	88.5	50,8	●	4	Glass	193
<span style="border: 1px solid black; padding: 0 2px;">EC</span>	Townshend Seismic Stand II	1,140	multi-shelf air-suspension support which isolates like few others. Recommended	92	58,45		5	MDF	240

## Our favourite MB BEST BUY EC EDITOR'S CHOICE SPEAKER STANDS

### Speaker stands

BADGE?	PRODUCT	£	COMMENTS	SPECIFICATIONS					
				HEIGHT	TOP PLATE SIZE (CM)	FILLABLE	WELDED	NUMBER OF LEGS	ISSUE NUMBER
<span style="border: 1px solid black; padding: 0 2px;">MB</span>	Atacama Nexus 6	60	An excellent all-round performer and a genuine hi-fi bargain	60,50	14,5,18	●		3	202
	Custom Design R/S300 MkII	100	A solid stand improving on the original, with better focus and detail	61,56,51	16,5,18	●		2	202
	hne Cableway	399	Looks great, sounds great, so start saving! Clean and sweet, and neutrality is exceptional with orchestral material	63	17,20	●		1	220
<span style="border: 1px solid black; padding: 0 2px;">MB</span>	Kudos S50	115	Formidable bass with real authority, and a wide dynamic range across a broad bandwidth	61	15,20	●		1	220
	Partington ANSA 60	90	Elegant flat-packer 'disappears' sonically; restrained but neutral and coherent	62	18,15	●		4	232
<span style="border: 1px solid black; padding: 0 2px;">MB</span>	Partington Dreadnought	100	Fully welded high-class engineering gives a very clean, open sound at a sharp price	61	17,15	●	●	5	220
	Sound Organisation Z522	95	Very hefty build for the price helps to deliver a solid sound with good authority and drive	60	16	●		4	220
	Townshend Seismic Sink	499	Unique inflatable plinth that works wonders with decent floorstanders, as well as standmounted speakers	4	38,48			0	202

**EQUIPMENT SUPPORTS SPECS KEY** HEIGHT Of complete stand. TOP PLATE SIZE (CM) Width by depth of the supporting platform(s). Single figures indicate a square platform.

**WELDED** As opposed to bolt-together construction. **NUMBER OF SHELVES** To put your kit on (different configurations are often available). **SHELF TYPE** Material that shelves are made of.

**SPEAKER STANDS SPECS KEY** HEIGHT Of each stand, not including spikes. TOP PLATE SIZE (CM) Width by depth of platform. Single figures indicate a square platform. Speakers generally overhang top plates.

**FILLABLE** The stand can be mass-loaded with sand and/or lead to stop ringing. **WELDED** As opposed to bolt-together construction. **NUMBER OF LEGS** That support the stand.

# Sound Fantastic

Olson's new Sound Fantastic range of units are specifically designed for both the home and professional hi-fi audio markets.

Each unit is fitted with a 10A mains R.F.I. filter with earthline choke and transient suppressor, designed to filter mains-borne transients, switching surges, R.F. interference, intermittent spikes and other disturbances.

- ✓ Robust steel construction
- ✓ 13A Sockets
- ✓ 10A Panel Mount Fuse
- ✓ RFI 10A Mains Filter & Surge Suppressor
- ✓ External Earth Stud
- ✓ 2m x 1.5mm Screened Cable
- ✓ UK Plug - 10A Fuse Fitted
- ✓ Colour Black
- ✓ Specials to order

TYPE NO.	NO. OF SOCKETS	OVERALL LENGTH	PRICE
HF 4	4	446mm	£83.72
HF 6	6	557mm	£92.47
HF 8	8	670mm	£98.70

## Call 020 8905 7273

**POWER VERDICT**  
UP

Home Entertainment, May 2001

OLSON ELECTRONICS LIMITED  
OLSON HOUSE, 490 HONEYPT LANE,  
STAMMORIE, MIDDX HA7 7JX  
TEL: 020 8905 7273 FAX: 020 8952 1232  
email: sales@olson.co.uk www.soundfantastic.co.uk

24 HOUR SERVICE, VISA, MASTERCARD  
AND SWITCH ACCEPTED

FROM  
£83.72  
inc. VAT & p&p

# GLOSSARY

## TECHNICAL TERMS

**5.1-CHANNEL AUDIO** Six discrete channels, typically front left and right, centre, surround left and right, and LFE (Low Frequency Effects) for a subwoofer.

**BALANCE** Most loudspeakers have a characteristic frequency balance resulting from emphasising parts of the audio range and/or de-emphasising others.

**BASS** The lowest three octaves of the audio band – hence 'low bass' refers to the bottom octave (20-40Hz); 'mid-bass' the middle octave (40-80Hz); and 'upper bass' the 80-160Hz octave.

**BI-AMP** (sometimes tri-amp) Loudspeakers equipped with separate access terminals to each drive unit can be driven by separate (matching) power amplifiers for each driver.

**BI-WIRE** (sometimes tri-wire) Loudspeakers with separate access terminals to each driver can be driven by separate cable runs between the amp and each driver.

**CD-R** Recordable CD that cannot be erased, though discs that have not been completely filled can have tracks added until the disc is finalised.

**CD-RW** Re-writable or re-recordable CD, incompatible with older CD players.

**CLASS A** The operation of an amplifying stage or device in which current always flows, as opposed to Class B, where some of the devices are effectively turned off some of the time. Class A tends to have the advantage of offering lower distortion while Class B tends to generate less heat.

**CLASS AB** Most practical amps operate in Class A for the first fraction of a watt and Class B thereafter.

**CLIPPING** An amplifier's output waveform is 'clipped' if the volume is advanced too far and no more 'volts' are available to sustain ever-increasing power levels. Distortion increases dramatically at this point.

**CLOCK** Any electronic oscillator that is used to generate a timing reference signal. Used to synchronise the data being taken from a disc.

**CROSSOVER** A simple electrical network which divides the full bandwidth signal received from the power amplifier, apportioning appropriate parts of the spectrum to the various drive units.

**DAB** (digital audio broadcasting). Digital radio using frequencies in the band 217.5 - 230MHz. Broadcasters use varying degrees of compression and offer a broad range of programming.

**DAC** or Digital-to-Analogue Converter. The stage in any digital component at which incoming digital data is used to reconstruct a recognisable analogue (music) waveform.

**DOLBY DIGITAL** A compressed digital audio format that typically contains five or more entirely discrete channels, eg 7.1 EX where side and rear channels are used.

**DOLBY PRO-LOGIC, DPL** Forerunner to DD that 'steers' information to the front L/R, centre and mono surround channels via an analogue matrix.

**DRIVE UNIT/DRIVER** A transducer which converts electrical energy into acoustic energy, eg bass driver, tweeter. **DSD** (direct stream digital) The coding format used for SACD offers a frequency response of over 100kHz and a dynamic range over 120dB, it has over four times the data capacity of CD.

**DSP** or Digital Signal Processor. Integrated circuit that handles the decoding of digital audio streams. In 5.1 processors it separates the left from right and front from rear while managing the various bass options.

**DTS** or Digital Theatre Sound Competitor to Dolby Digital with a reduced 4:1 compression ratio that, ostensibly, promises higher quality.

**DVD-AUDIO** High-resolution variant on DVD offering up to 192kHz bandwidth and 24-bit dynamic range. Discs are compatible with standard DVD players.

**ELECTRICAL DIGITAL** Any digital connection that uses an electrical cable rather than optical. Includes the balanced ('AES/EBU') interface.

**FILTERS** Filters are intrinsic to digital audio, both analogue and digital. These are often very sophisticated in design, and in total they probably have rather more to do with the 'personality' of CD player sound than most other factors.

**FREQUENCY RESPONSE** The range of frequencies, from low to high, which a loudspeaker will reproduce.

**IMPEDANCE** With speakers, the complex electrical load that a loudspeaker presents to the amplifier which is driving it.

**JITTER** An inaudible distortion specific to digital audio caused by the clock, used to regulate the conversion of data into analogue audio, being imprecise.

**KBPS** (Kilobits per second) Digital data rate measurement system used primarily with highly compressed formats such as MP3, DAB etc. The higher the amount, the better the quality.

**LINE LEVEL** Practically every modern source component (except phono cartridges) gives an output in the region of 1-2V, referred to as 'line level'. It follows that all inputs labelled 'CD', 'tuner', 'aux' or 'tape' are designed for this input level and are thus interchangeable.

**LOSSLESS COMPRESSION** A method of reducing the number of data bits (density) without corrupting the original description of the musical signal.

**LOSSY COMPRESSION** Reduction in data density by recourse to a psycho-acoustical model that predicts what is, and what is not, 'audible' within a sequence of music.

**MIDRANGE** The middle three or so octaves of the audio band, where the

ear is most sensitive, covering the approximate frequency span from 160Hz up to 3kHz.

**MP3** (MPEG layer 3) Lossy compression format for digital audio that drastically reduces data content in order to squeeze music through internet connections or allow hundreds of CDs to be stored on a hard disc.

**OUTPUT IMPEDANCE** A measure of resistance to alternating current, a source with low output impedance (below 100 ohms) helps ensure compatibility with most amplifiers, even with long interconnect cables.

**PCM** (pulse code modulation) The digital coding system for analogue waveforms used for CD and DVD. Quality is limited by the oversample and bit rates used – CD is 44.1kHz/16-bit while DVD-A is capable of 192kHz/24-bit.

**PRESENCE BAND** Critical section of the audio band at the point where midrange and treble meet.

**QUANTISATION NOISE** A form of distortion or noise resulting from errors in the description of the musical signal by the digital code.

**SACD** (Super Audio CD) was launched in 1999 and is a Sony/Philips format based on DSD coding that offers high resolution stereo and multichannel sound from hybrid discs that can also be played on ordinary CD drives.

**SAMPLE RATE** The rate at which the musical waveform is sliced up into discrete chunks. For CD this is 44.1kHz or once every 0.023msec. DVD will also support 48kHz and 96kHz.

**SENSITIVITY** The relative loudness that a speaker generates for a specific voltage input. Expressed in decibels per watt (dB/W).

**THX** Standards system for home cinema set-ups which includes amplifier power and speaker dispersion characteristics. THX Ultra is more stringent than THX Select.

**TOSLINK** The proprietary name given by Toshiba to the optical fibre signal transmission system it invented for consumer applications.

**TRANSISTOR/MOSFET** The two main types of power semiconductor used in solid state amplifier output stages.

**TREBLE** High frequencies, the top end of the audio band, ie above 3kHz.

**TWEETER** Treble driver.

**TWO/THREE-WAY** Loudspeaker crossovers split the signal into two or three frequency bands, a two-way speaker can have more than two drive units.

**WATTS** (per channel) The watt is the unit of electrical power and the WPC rating is the maximum average undistorted power that an amp can deliver to a typical speaker. However, speaker sensitivity variations can make more difference than amplifier output.

## DESCRIPTIVE TERMS

**AGGRESSIVE** Forward and bright sonic character.

**AMBIENCE** The impression of an acoustical space, such as the performing hall in which a recording was made.

**ANALYTICAL** Highly detailed. **ARTICULATE** Intelligibility of voice(s) and instruments and the interactions between them.

**ATTACK** The leading edge of a note and the ability of a system to reproduce the attack transients in music.

**BALANCE** Essentially tonal balance, the degree to which one aspect of the sonic spectrum is emphasised above the rest. Also channel balance, the relative level of the left and right stereo channels.

**BODY** Fullness of sound, with particular emphasis on upper bass. Opposite of thin.

**BOXY** The sound of a loudspeaker with audible cabinet resonances.

**BRIGHT** A sound that emphasises the upper midrange/lower treble.

**DARK** A tonal balance that tilts downwards with increasing frequency. Opposite of bright.

**DECAY** The fadeout of a note, it follows the attack.

**DEFINITION** (or resolution) The ability of a component to reveal the subtle information that is fundamental to high fidelity sound.

**DEPTH** (of image) The perception of music being reproduced behind the loudspeakers and inhabiting a reproduction of the acoustic space of the original recording.

**DETAIL** The most delicate elements of the original sound and those which are the first to disappear with lesser equipment.

**DRY** A sound that is devoid of 'juice', which usually comes across as fine-grained and lean. Also a loss of reverberation as produced by a damped environment.

**DYNAMIC** The suggestion of energy and wide dynamic range. Related to perceived speed as well as contrasts in volume both large and small.

**EUPHONIC** An appealing form of distortion that generally enhances perceived fidelity, often ascribed to the harmonic elaborations of some valve amps.

**FAST** Good reproduction of rapid transients which increase the sense of realism and 'snap'.

**FOCUS** A strong, precise sense of image projection.

**FORWARD(NESS)** Similar to an aggressive sound, a sense of the image being projected in front of the speakers and of music being forced upon the listener.

**GRAINY** A slightly raw, exposed

sound which lacks finesse. **GRIP** A sense of control and sturdiness in the bass.

**GRUNT** See grip. **HARD** Uncomfortable, forward, aggressive sound with a metallic tinge.

**HARSH** Grating, abrasive. **IMAGING** (stereo) The sense that a voice or instrument is in a particular place in the room.

**JUICY** Sound that has joie de vivre, energy and life. **LOW-LEVEL DETAIL** The quietest sounds in a recording.

**MUSICAL** or musicality. A sense of cohesion and subjective 'rightness' in the sound.

**NATURALNESS** Realism. **OPAQUE** Unclear, lacking transparency.

**OPEN** Sound which has height and 'air', relates to clean upper midrange and treble.

**PACE** Often associated with rhythm, a strong sense of timing and beat.

**PRESENCE** A sense of an instrument or voice occupying a place in the listening room.

**PRESENCE RANGE** The upper midrange.

**SEISMIC** Very low bass that you feel rather than hear.

**SIBILANCE** An emphasis of the 'S' sound, often heard on radio.

**SNAP** A system with good speed and transient response can deliver the immediacy or 'snap' of live instruments.

**SPEED** A fast system with good pace gives the impression of being right on the money in its timing.

**STURDY** Solid, powerful, robust sound.

**THICK** A lack of articulation and clarity in the bass.

**THIN** Bass light.

**TIMBRE** The tonal character of an instrument.

**TIMING** A sense of precision in tempo. See speed and pace.

**TRANSIENT** The leading edge of a percussive sound. Good transient response makes the sound as a whole more live and realistic.

**TRANSPARENCY**, transparent. A hear-through quality that is akin to clarity and reveals all aspects of detail. **TWEAK** To tune a system or component in an attempt to get the best performance from it.

**TWEAKER** Someone who enjoys this process.

**VEILED** Loss of detail due to limited transparency.

**WARM** A fullness in the lower midrange/upper bass.

**WEIGHT** A sense of substance and underpinning produced by deep, controlled bass.

## Welcome to the Hi-Fi Choice accessories shop

Choice Bits the easy way to buy the best audio accessories available today. Simply pick up the phone, order online drop us an email or fill out the order form opposite and pop it in the post. It couldn't be simpler!

Featured in this issue we have a variety of some of the very finest hi-fi accessories. Whether you prefer analogue or digital, these will give your system or your music collection that added lift in performance.

In the digital corner, Bedini's MkII Clarifier may not yet be widely known in the UK, but it is the audiophile's number one choice in the USA for achieving that extra level of CD performance.

Analogue's 'timeless classic' on the other hand has to be the Milty Zerostat, which has been removing unwanted static from LP grooves for many years.

### SHOWCASE

#### U.S.H.E.R.

High-quality system test and hearing disc including system

#### Key Features

- High-quality production
- Improves hearing through filtered audio tracks
- A series of burn-in tracks
- HFC's Richard Black's favourite audio tracks



### Ultimate Stereo Hearing & Equipment Refresher CD

This disc has been compiled by acclaimed audio journalist Richard Black as a test CD not only to assist you in setting up your system optimally, but also to help you achieve

something considerably more remarkable – improving your hearing. Specially filtered music tracks require you only to listen attentively while your subconscious fiddles away at optimising the ear/brain interface to extract the most information out of a deliberately limited input. The result? Not only your hi-fi, but live music and all other sounds become more vibrant and more evidently detail-packed.

Also includes a series of burn in tracks, a series of frequency sweeps, a demagnetisation tone sequence and some of Richard's favourite test tracks.

**Introductory price £14.95**

### Clearaudio Clever Clamp



The 'Clever Clamp' is a 65mm diameter plastic disc that slides over and grips the turntable spindle, locking records into place. Its upturned edges allow for easy removal after use.

**Only £12.95**

### Eichmann RCA Phono Bullet Plugs



The Bullet Plug connector is a totally new approach to RCA/phono connection where every aspect of electron flow has been considered. The Bullet Plug is designed as a miniature cable – with high-conductive, gold-plated tellurium copper (CuTe) pins, providing a cleaner transfer of electrons to/from RCA sockets. The return pin of the Bullet Plug makes single point contact with the side wall of an RCA socket – concentrating electrons to one point, thereby reducing distortion. This is a similar approach to "star earthing", used in amplifiers.

Each set contains two red and two black plugs, enough for a complete set of interconnects.

**Only £29.95**

### Milty Zerostat static remover



Most analogue buffs are familiar with the Zerostat. If you are not, then you are missing out on the easiest and most cost-effective way of removing static from your LPs and CDs.

This unwanted static electricity can rob your playback systems of resolution and detail.

**Only £37.50**

### Clearaudio Deluxe Bubble Level



Ensuring your record deck is level is essential for high quality analogue playback.

Owners of Clearaudio turntables will recognise this high quality bubble level, as it is supplied as standard on all of their turntables. If you don't own a Master Reference fear not, Clearaudio have now made this bubble level available to the rest of us! Available in a steel finish.

**Only £21.95**

### Bedini Hand-Held Audio CD Clarifier



This new hand-held Clarifier, with enhanced beam penetration is one of the most inexpensive ways to improve the sound of your entire music collection.

Music will take on an enhanced ease and air with less background noise.

**Only £69.95**

## FEATURED PRODUCTS

Bedini Hand-Held Audio CD Clarifier	£69.95	<input type="checkbox"/>
Clearaudio Deluxe Bubble Level	£21.95	<input type="checkbox"/>
Clearaudio Record Clamp	£12.95	<input type="checkbox"/>
Eichmann RCA Bullet Plugs	£29.95	<input type="checkbox"/>
Milty Zerostat	£37.50	<input type="checkbox"/>
U.S.H.E.R. CD	£14.95	<input type="checkbox"/>

## ANALOGUE ACCESSORIES

Anniversary Ringmat	£69.95	<input type="checkbox"/>
A.R.T. Head Q-Damper	£16.95	<input type="checkbox"/>
CARA Computer Aided Room Acoustics	£49.95	<input type="checkbox"/>
Cardas 180g Frequency Sweep LP	£21.95	<input type="checkbox"/>
Clearlight Audio Record Puck	£49.95	<input type="checkbox"/>
Clearaudio Exact Stylus Gauge	£265.00	<input type="checkbox"/>
Clearaudio Record Clamp	£69.95	<input type="checkbox"/>
Clearaudio Stroboscopic Light	£69.95	<input type="checkbox"/>
Clearaudio Stroboscopic Test Record	£24.95	<input type="checkbox"/>
Electronic Needle Nose Pliers	£30.95	<input type="checkbox"/>
Express Machining Rega Stub End	£24.95	<input type="checkbox"/>
Express Machining VTA For Rega	£29.95	<input type="checkbox"/>
Goldring Strobe Disc	£3.95	<input type="checkbox"/>
Graham Bearing Cap	£259.95	<input type="checkbox"/>
Gyrascope Electronic Stroboscope	£224.95	<input type="checkbox"/>
John Michell Techno Rega Heavyweight	£67.95	<input type="checkbox"/>
Loricraft Stroboscopic Light	£49.95	<input type="checkbox"/>
Michell Engineering Record Clamp	£22.95	<input type="checkbox"/>
Michell Universal Dust Cover	£44.95	<input type="checkbox"/>
Opus3 4.1 Test Record	£17.95	<input type="checkbox"/>
Origin Live Express Heavyweight	£89.95	<input type="checkbox"/>
Origin Live Rega Tonearm Upgrade Kit	£74.95	<input type="checkbox"/>
Pebbles 'The Weight' Modification	£67.95	<input type="checkbox"/>
Polaris Plus Stylus Alignment Gauge	£9.95	<input type="checkbox"/>
Pro-Ject Bubble Level	£14.95	<input type="checkbox"/>
Ringmat Developments The Ringmat	£49.95	<input type="checkbox"/>
Ringmat's How to Set Up A Turntable	£7.50	<input type="checkbox"/>
Shure Stylus Force Gauge	£24.95	<input type="checkbox"/>
T Force Ortofon Tracking Force Gauge	£7.95	<input type="checkbox"/>
The Cartridge Man Digital Force Gauge	£199.95	<input type="checkbox"/>
The Cartridge Man Digital Level Gauge	£199.95	<input type="checkbox"/>
The Producer's Cut' Hi-Fi News Test LP	£24.95	<input type="checkbox"/>
Universal Tweezers	£6.95	<input type="checkbox"/>

## DIGITAL ACCESSORIES

Allsop DVD Optimiser/Laser Lens Cleaner	£19.95	<input type="checkbox"/>
AudioPrism CD Stoptlight	£19.95	<input type="checkbox"/>
AudioPrism CD Blacklight™	£39.95	<input type="checkbox"/>
AVIA Home Theatre Set-Up & Calibration	£39.95	<input type="checkbox"/>
A-Z CD Clips	£7.95	<input type="checkbox"/>
Chesky DVD Surround 5.1 Set-Up Disc	£24.95	<input type="checkbox"/>
Chesky Ultimate Demonstration Disc	£15.95	<input type="checkbox"/>
Compact Dynamics CD Plus	£14.95	<input type="checkbox"/>
Compact Dynamics CD UpGrade	£14.95	<input type="checkbox"/>
Densen DeMagic CD	£11.95	<input type="checkbox"/>
Furutech RD-2 Disc Demagnetiser	£349.95	<input type="checkbox"/>
Lasertrack CD2000 Set-Up Disc	£19.95	<input type="checkbox"/>
Marigo Orpheus CD Crossbow Mat	£79.95	<input type="checkbox"/>
Opus3 Showcase (HDCD)	£14.95	<input type="checkbox"/>
Ringmat CDi Blue	£37.50	<input type="checkbox"/>
Ringmat The Statmat MKII	£19.95	<input type="checkbox"/>
Sound Improvement Disc (Model 14/15)	£17.95	<input type="checkbox"/>
Tommy Larsen CD-Lift™ (Green/Grey)	£14.95	<input type="checkbox"/>
Ultra Burn-In CD3000	£24.95	<input type="checkbox"/>
XLO Reference Test & Burn-In CD	£24.95	<input type="checkbox"/>

## CD STORAGE PRODUCTS

CaseLogic Hardshell CD Case	£5.95	<input type="checkbox"/>
CaseLogic Koskin 208 CD Wallet	£34.95	<input type="checkbox"/>
CaseLogic Koskin 32 CD Wallet	£9.95	<input type="checkbox"/>
CaseLogic Koskin 64 CD Wallet	£14.95	<input type="checkbox"/>
CaseLogic Koskin 88 CD Wallet	£19.95	<input type="checkbox"/>
CaseLogic Nylon 208 CD Wallet	£29.95	<input type="checkbox"/>
CaseLogic Nylon CD Wallet 88	£17.95	<input type="checkbox"/>
CaseLogic ProSleeves®	£5.95	<input type="checkbox"/>
Tommy Larsen Multi Media Rack	£24.95	<input type="checkbox"/>

## CARE/ CLEANING PRODUCTS

Allsop Carbon Edge Laser Lens Cleaner	£14.95	<input type="checkbox"/>
Allsop CD & DVD Fast Wipes	£4.95	<input type="checkbox"/>
Allsop CD Scratch Repair Kit	£12.95	<input type="checkbox"/>
Allsop Radial CD Cleaner	£10.95	<input type="checkbox"/>
Caig OpticALL	£13.95	<input type="checkbox"/>
CD Radial Cleaner	£9.95	<input type="checkbox"/>
Clearaudio Carbon Fibre Record Brush	£13.95	<input type="checkbox"/>
DeoxiT (DeoxIT 200ml)	£13.95	<input type="checkbox"/>
Goldring Deluxe Record Brush	£14.95	<input type="checkbox"/>
Goldring Exstatic Record Sleeves	£11.95	<input type="checkbox"/>
Last All-Purpose Record Cleaner	£39.95	<input type="checkbox"/>
Last Power Cleaner	£39.95	<input type="checkbox"/>
Last Record Preservative	£39.95	<input type="checkbox"/>
Last Stylus Cleaner	£19.95	<input type="checkbox"/>
Last Stylus Treatment	£29.95	<input type="checkbox"/>
Lyra SPT Stylus Cleaner	£24.95	<input type="checkbox"/>
Me-We CD Sound Elixir	£9.95	<input type="checkbox"/>
Miniature Vacuum Cleaner	£14.95	<input type="checkbox"/>
Nagaoka Antistatic Record Inner Sleeves	£14.95	<input type="checkbox"/>
Onzow Zerodust	£29.95	<input type="checkbox"/>
Optrix CD Cleaner & Clarifier	£16.95	<input type="checkbox"/>
ProGold (ProGold 20ml)	£13.95	<input type="checkbox"/>
Ross Mini Disc Head & Lens Cleaner	£14.95	<input type="checkbox"/>
Turbo Mini Vac	£16.95	<input type="checkbox"/>
Unbranded Inner Sleeves	£24.95	<input type="checkbox"/>

## ISOLATION RACKS - CONES

A.R.T. Q-Dampers	£69.95	<input type="checkbox"/>
Atacama Audio Equinox Series (2 shelf base)	£149.95	<input type="checkbox"/>
Atacama Audio Nexus 5 Speaker Stands	£69.95	<input type="checkbox"/>
AudioPrism 2.5 Iso-Bearings	£54.95	<input type="checkbox"/>

AudioPrism 3.3 Iso-Bearings	£84.95	<input type="checkbox"/>
Clearlight Audio RDC Aspekt Rack		
Black 4 Shelf Rack Cherry Legs	£599.95	<input type="checkbox"/>
Clearlight Audio RDC Aspekt Rack		
Black 4 Shelf Rack	£549.95	<input type="checkbox"/>
Clearlight Audio RDC Aspekt Rack		
Grey 4 Shelf Rack Beech Legs	£649.95	<input type="checkbox"/>
Clearaudio Spikes (Each)	£12.95	<input type="checkbox"/>
Foculpods Support Systems (4)	£14.95	<input type="checkbox"/>
IXOS Sorbothane Feet	£19.95	<input type="checkbox"/>
Michell Tenderfeet Small	£12.95	<input type="checkbox"/>
Michell Tenderfeet Tall	£14.95	<input type="checkbox"/>
Nordost Pulsar Points (Aluminium)	£54.95	<input type="checkbox"/>
Nordost Pulsar Points (Titanium)	£294.95	<input type="checkbox"/>
Polipods Support Systems (8)	£14.95	<input type="checkbox"/>
RDC 1 Cones (Qty 4)	£39.95	<input type="checkbox"/>
RDC 2 Cones (Qty 4)	£29.95	<input type="checkbox"/>
RDC 3 Cones (Qty 4)	£44.95	<input type="checkbox"/>
RDC 4 Cones (Qty 3)	£119.95	<input type="checkbox"/>
RDC 5 Cones (Qty 4)	£119.95	<input type="checkbox"/>
RDC Cone Cups (Qty 4)	£17.95	<input type="checkbox"/>
RDP Feet	£54.95	<input type="checkbox"/>
RDC SPP Platform	£109.95	<input type="checkbox"/>
RDC Super Position T	£199.95	<input type="checkbox"/>
Ringmat Feet MKII	£74.95	<input type="checkbox"/>
Spikes M6/M8 (4x M6/M8)	£7.95	<input type="checkbox"/>
Stands Unique Carbon Fibre Isolators	£24.95	<input type="checkbox"/>
Superpods Support Systems	£24.95	<input type="checkbox"/>
3D Seismic Isolation Platform	£234.95	<input type="checkbox"/>
Townshend Audio Seismic Sink Rack Model One	£670.00	<input type="checkbox"/>
(530x400mm / Internal 430x400mm 3 Tier)		
Townshend Audio Seismic Sink Rack Model One	£810.00	<input type="checkbox"/>
(530x400mm / Internal 430x400mm 4 Tier)		
Voodoo AIRTEK (430x360mm / 20kg/oak)	£199.95	<input type="checkbox"/>
Voodoo AIRTEK (490x430mm / 45kg/oak)	£249.95	<input type="checkbox"/>
Voodoo AIRTEK (510x480mm / 75kg/oak)	£299.95	<input type="checkbox"/>

## AUDIO BOOKS

Home Theatre For Everyone	£19.95	<input type="checkbox"/>
How to Set Up And Fine Tune A Turntable	£7.50	<input type="checkbox"/>
The Classical Long Playing Record Book	£119.95	<input type="checkbox"/>
The Complete Guide To High End Audio	£24.95	<input type="checkbox"/>
The LP Is Back	£9.95	<input type="checkbox"/>
The Ringmat Support System	£7.50	<input type="checkbox"/>

## Order Form

Orders can also be placed online: [www.choicebits.co.uk](http://www.choicebits.co.uk)

Name: \_\_\_\_\_

Address: \_\_\_\_\_

Postcode: \_\_\_\_\_ Tel: \_\_\_\_\_

Cheque/postal order enclosed for £ \_\_\_\_\_ made payable to Choice Bits.

Or please charge my Visa/Mastercard/Amex/Switch Card number.

Signature \_\_\_\_\_

Valid From \_\_\_\_\_ Expires \_\_\_\_\_ Issue number (Switch) \_\_\_\_\_

### How to order:

Simply complete this order form, fill in your details and send it to: P.O. Box 5996, NEWBURY, RG20 4XH

Alternatively, give us a call on: 0870 240 7228

email: [orders@choicebits.co.uk](mailto:orders@choicebits.co.uk)

Order online: [www.choicebits.co.uk](http://www.choicebits.co.uk)

### UK postage:

Postage is £2.00 for the first item and £1.00 thereafter. All Prices include VAT at 17.5%.

### European/ International sales:

Overseas sales are welcome – please call for a postage quotation. Sales outside the EU are VAT inclusive.

This service is operated by hififorsale.com Ltd (registered address) trading as Choice Bits under licence from Future Publishing Ltd. Your order will be fulfilled by hififorsale.

# FREE Hi-Fi Upgrade

hiforsale.com Ltd's AudiophileCandy  
2004 accessories catalogue

## Our NEW Edition Features:

- A massive selection of class leading audio accessories from manufacturers throughout the world
- Overviews and advice from leading industry experts
- The latest world-wide products
- Free tips, advice & F.A.Q.
- Over 92 full colour pages featuring over 500 products

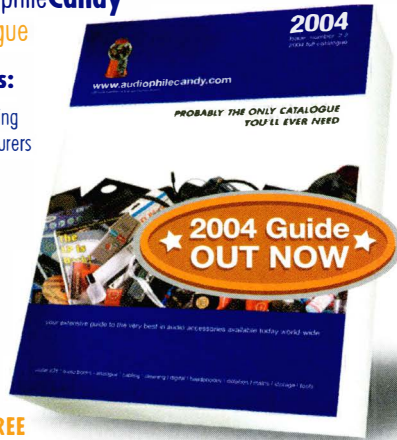

AudiophileCandy 2004 is your **FREE** essential guide to the very best in audio accessories.

## Grab Your Copy NOW

For your **FREE** copy of our latest catalogue visit [www.audiophilecandy.com](http://www.audiophilecandy.com) and fill in our contact form or call;

# 0870 241 246 9

Advertise your old Hi-Fi for **FREE** on-line at [www.hiforsale.com](http://www.hiforsale.com), or pick up an audio bargain. Every month we have over **50,000 visits** and **4.8 million hits!** - What are you waiting for?

chasing the light

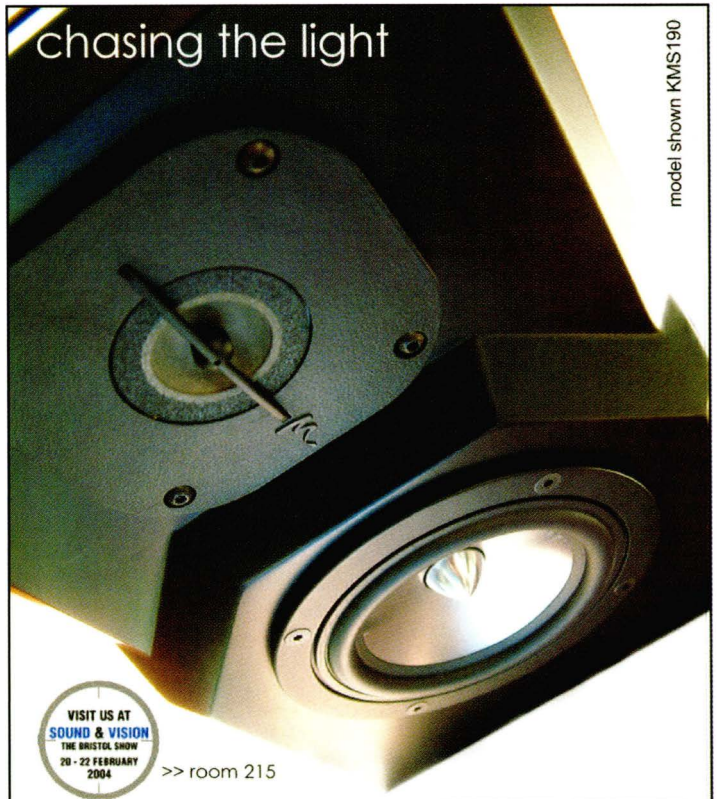

model shown KMS190



>> room 215

[www.kmacoustics.com](http://www.kmacoustics.com)  
enquiries@kmacoustics.com  
Tel... +44 (0) 1495 769492



International dealer enquiries welcome.

Agencies include:

ARCAM  
LINN  
NAIM  
MERIDIAN  
REGA  
B&W NAUTILUS  
PROCEED  
M+K  
NEAT  
PMC  
LOEWE  
SONY PRO  
FUJITSU  
STAX  
GRADO  
ORTOFON  
DYNAVECTOR  
SHAHINIAN  
XLO

## EXCEED EXPECTATIONS

If choosing your new hi-fi or home cinema in a civilised and relaxed atmosphere from a well-chosen selection of genuine performance equipment appeals, then we are for you.

See and hear the very best with us.

# Infidelity

INDECENTLY GOOD HI-FI

9 High Street, Hampton Wick,  
Kingston upon Thames, Surrey KT1 4DA

**020 8943 3530**

Full custom installation of home cinema, distributed audio/video and home automation products  
Email: [infidelity@compuserve.com](mailto:infidelity@compuserve.com)  
[www.infidelity.co.uk](http://www.infidelity.co.uk)  
Open: Tues - Fri 10.30am - 7pm, Saturday 10am - 6pm



## Stabilize any Video Source



Remove distorted horizontal and vertical sync signals - great for DVD and VCR back-ups.  
3 models now available, CP2S suitable for all composite VCR recording, Replica 1 (Scart) & Replica 2 compatible with CV and S video signals - suitable for all VCRs and DVD recorders.

**Digital Video Copy Stabilizers**  
CP-2S (Scart) £39.95  
NEW! Replica 1 (Scart) £79.95    Replica 2 (CV+SV) £79.95

## Not enough RGB Scart sockets on your TV



2 way, 3 way, 5 way Automatic RGB Scart control switches. The Trilogi range give perfect loss free switching of any AV signal - DVD, Digibox, SKY, Game console, etc. Trilogi 1 has additional feature of recording one signal whilst viewing another + Videosender + Audio output connections.

5way RGB Auto Scart Controller Trilogi 1 £89  
3way RGB Auto Trilogi 2 £59  
2way RGB Auto Trilogi 3 £39

## Turn any PC/LCD screen into a high resolution TV

Watch any RGB signal from Digibox or DVD on any LCD screen. Stunning high res VGA, SVGA or XGA images.

Scart RGB - XGA Converter Presenter 1 £129



Stand alone TV tuner/scaler plus Input switcher (Component, S video + CV + PC). 50/60Hz switch for LCD monitor. Picture in picture function - VGA, SVGA, XGA 15D output. Complete with Remote + full set of connecting cables.

**XGA Tuner Box Presenter 2 £159**

# Lektropacks

Unit 6, Metro Industrial Centre,  
St. Johns Road, Isleworth, Middx. TW7 6NJ.  
email: [info@lektropacks.com](mailto:info@lektropacks.com)

[www.lektropacks.co.uk](http://www.lektropacks.co.uk)

Call **08700 711911**  
**FREE 56 page Catalogue**  
**OVER 200 Audio, Video & PC Solutions**

# READER CLASSIFIED

Welcome to *Hi-Fi Choice Reader Classified*, the UK's premiere free service for second hand hi-fi. These pages are a must-read if you're thinking about buying used kit, and if you want to sell something it's definitely the place to be. It's FREE to place an advertisement – simply submit your ad of up to twenty words, remembering to

include your name, phone number and home town. If you can, please help us by emailing ads to: [dan.george@futurenet.co.uk](mailto:dan.george@futurenet.co.uk). Alternatively, mail to: **READER CLASSIFIED, HI-FI CHOICE, 99 BAKER STREET LONDON, W1U 6FP**. Please note that this service is open to private advertisers only.

## FOR SALE

**ACOUSTIC ENERGY** twin pillar cast iron speaker stands 23x31cm, the best available (£530) £280ono. 0115 9126424 or 07815 5194772 (Notts).

**ARCAM 7SE** CD player three years old, boxed as new £95. Arcam 7R amplifier three year old boxed as new £90. Albert 0191 5200947 (Sunderland).

**ARCAM ALPHA 10** amp with phono card excellent condition £350. Arcam Alpha 9 CD player recent upgrade by Arcam £350. Matt 07970 453611 (Berkshire).

**ARCAM CD72T** silver mint condition £190. NAD C320 amp, mint condition £70. B&W speakers DM303, mint £90. 01162 811567 (Leicester).

**AUDIOLAB 8000Q** preamp and two 8000M mono power £900. Pair Quad 111 speakers cream £200. Marantz CD85 £100. 01626 835251 (Devon).

**CAMBRIDGE AUDIO C500** remote preamp with 2xP500 power amps, all boxed, mint condition, still guaranteed. £250. 07932 330269 (Lancs)

**CDS**, Blues all varieties, all perfect condition, ten for £40 or £5 each. Will post 01278 782622 (Somerset).

**COPLAND CDA266** CD player, CSA28 amp boxed as new, black granite stand, Castle Severn, subwoofer, RA Powerchords. £2,200 may split. 01224 596076 (Aberdeen).

**CYRUS CLS50** standmount speakers in cherry veneer. Beautiful looks and sound, mint, boxed with all documents. (£550) £225. 07753 625783 (Kent).

**DENON CDRM30** CD recorder. CD-R/RW mint £150. 01785 850535 (Staffs).

**DYNAUDIO CONTOUR 1.3SE** stand mount speakers (mahogany finish) plus sound organisation stands, boxed as new £925. 01738 813140 after 6pm (Perth).

**EPOS ES11S**. Black, excellent condition, boxed. (£330) £200. Dedicated stands £85. Nick 01582 391721 (Luton)

**FARADAY TOWER** concrete cabinet speakers. Rare pair with ABR's. Fabulous sound, see [faradaysound.co.uk](http://faradaysound.co.uk) for info. £700 01603 766668. (Norwich).

**LEAK 20/ 60** floorstanding speakers with 12" bass unit £100. Also records. David 01283 517585 (Staffs).

**LEAK DELTA** FM tuner not working. Armstrong 127m tuner amplifier FM working. £20 for both (for Cancer Research charity). Mr Rowe 020 8352 1066 (London).

**LYRA CLAVIS DC** 15 months old, only two hours use only immaculate £470 ovno 01384 402938 or email [r.c.skipton@blueyonder.co.uk](mailto:r.c.skipton@blueyonder.co.uk) (Dudley).

**MERIDIAN 601** digital reference preamp, boxed as new pristine cond, (£2,800) sell £650, also Luxman L30 integrated amp, classic, valve-like sound £45, Linn 280 spark mint, £295 003531 2954076 (Dublin).

**NAIM CD3 £350, NAC72 HICAP 140** £850 Triangle Zephyr speakers £150. Heybrook HBS1 stands £30. *HFC* 1992-99

also early issues including 1-4. Offers. Gary 0151 632 3790 (Wirral)

**NAIM NAC72/ NAP140** Excellent condition will demo £700. Steve 0191 384 2954 (County Durham).

**NAIM NAIT 3 AMP, NAC 3D** CD player, NAT 03 tuner, Quad 771L speakers. (£2,700) £1,200 ono. 01225 434276 (Essex).

**NORDOST SOLAR** wind interconnects 1 metre boxed. £50 no offers. 01268 415017 (Basildon).

**PERPETUAL P3A DAC** (£800) £440. Musical Fidelity A370 power amp (£2,500) £890. XLP phono (£125) £50. Audio Research speaker cable (£650) £190. All as new boxed. 07973 220663 (Leics).

**ROTEL RX402** receiver £55. Philips CD723 £50. Thorens TD160 Shure V15/3 offers. Excellent sound at bargain prices. Will demonstrate. 01992 572098 (Essex).

**THORENS TURNTABLE** 125 turntable with SME 2009. Good working order. Offers, buyer collects. 0162 52083 (Cheshire).

## WANTED

**REL STRATA** in working condition, any reasonable price paid. Rob 01942 605587 (Wigan).

**FOR SPARES** Quad 34,44 preamps, 405 amps or boards. (Non-workers please) Mike 01758 613790 (Pwllheli, Wales).

**TOTEM MODEL 1** bi-wirable mini-monitor loudspeakers. Not Signature Series. Five years old, fantastic sound, perfect condition, box, grilles, stands, cables etc. Read *HFC* issue 247 for more details. £850 ono. Geoff 01403 254 973 or email [psynchro@dircon.co.uk](mailto:psynchro@dircon.co.uk) (Sussex).

**IMF** professional monitor speakers. Yamaha CA700 amplifier. Dual 1229 turntable. Teac A450 cassette deck. Trio KT1000A tuner. Offers. Michael 01608 686391 (Shipston On Sea).

**KEF KIT** speakers each with 1xB1775, B1475, B0475, 8 ohms. Marantz 105 stereo tuner. Offers. Mr Clarke 01752 480963 (Plymouth).

## BUYING TIPS

Buying second-hand can be a great way to pick up a bargain. A formerly expensive second-hand component might well prove a better long-term bet than a brand-new product if the price is right.

Do some research on which brands have a good service back-up, so if something does go wrong, you can get it fixed. Unless you purchase from a dealer, you're unlikely to get any warranty, so it's up to you to ensure the fitness of any gear that you buy.

Usually, speakers should be less prone to breakdown than amps, and amps should be more reliable than CD players. But any abused component could be trouble – have a proper dem, and judge the seller as well as the goods!

LOUDSPEAKERS

"...the Ultimatum is an exceptional achievement in every respect."  
Hi Fi Choice

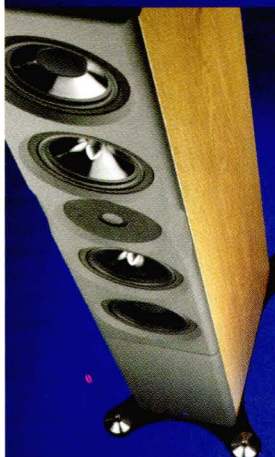

# Ultimatum

by neat acoustics

+44 (0)1833 631021 [www.neat.co.uk](http://www.neat.co.uk)

## T H E X S E R I E S



Xavier...  
Power and Finesse



[www.leema-acoustics.com](http://www.leema-acoustics.com)



Xen... Challenge your  
preconceptions



Xyp... Music,  
Pure and Simple

Loudspeakers and Subwoofers without parallel

Activ Distribution Tel: +44-(0)1635-291357 Fax: +44-(0)1635-291356

Exclusive dealer for Scotland: Kevin Galloway Audio 01563-574185



**BIRMINGHAM**

**sound cinergy**  
specialists in home entertainment

Tues - Sat 10.00am - 5.30pm  
Free Car Parking

- ACOUSTIC ENERGY • CHORD CO • CREEK • EPOS • EXPOSURE
- HARMAN KARDON • INFINITY • LINN • LOEWE • MARANTZ
- MONITOR AUDIO • MORDAUNT SHORT • NAD • ORGON
- PRO-JECT • PURE • REL • ROKSAN • VAN DEN HUL

Wide selection of HiFi furniture and accessories  
Finance Facilities

37 HIGH STREET, ALDRIDGE. 01922 457926  
www.soundcinergy.co.uk

**SALES & SERVICES**

**REVOX SERVICE**

**THE MANUFACTURERS' APPOINTED SERVICE COMPANY**

**REVOX SERVICE**

Correct Revox Spare Parts Pricing  
24 Hour Estimation procedure  
Manufacturer Upgrades and Advice  
Delivery and Collection Service  
Comprehensive Guarantees

Factory Trained Engineers  
Rapid Response Turnaround  
Full Revox range serviced  
Written Technical Reports  
Late Evening Opening

**THEAR TECHNOLOGY LIMITED**

TTL House, Sheeptick End, Near Lidlington, Bedfordshire, MK43 0SF  
Telephone 01525 841999 Facsimile 01525 841009



**MUSIC MATTERS**  
THE AUDIO SPECIALISTS



Our extensive range of products includes the very finest hi-fi and home cinema from Arcam, Audioquest, Audio Research, B&W, Castle, Celestion, Chord, Cyrus, Denon, Dynaudio, Jamo, KEF, Krell, Marantz, Martin Logan, Meridian, Michell, Mission, Monitor Audio, Musical Fidelity, Naim, Panasonic, Pioneer, Pro-Ac, Project, Quad, REL, Rotel, Ruark, Sennheiser, SME, Sonus Faber, Tag McLaren, Tannoy, TEAC, Technics, Theta and Yamaha.

INTEREST FREE CREDIT ON SELECTED ITEMS APR 0%. Written details on request. Licensed Credit Broker.

Open Tuesday to Saturday 10.30 - 5.30. Late night (not Stourbridge) Wednesday until 6.30

363 HAGLEY ROAD, EDGBASTON,  
BIRMINGHAM B17 8DL.  
TEL: 0121-429 2811 FAX: 0121-434 3298

93-95 HOBS MOAT ROAD, SOLIHULL,  
WEST MIDLANDS B92 6JL  
TEL: 0121-742 0254 FAX: 0121-742 0248

9 MARKET STREET, STOURBRIDGE,  
WEST MIDLANDS DY8 1AB  
TEL: 01384 444184 FAX: 01384 444968

10 BOLDMERE ROAD, SUTTON COLDFIELD,  
WEST MIDLANDS B73 5TD  
TEL: 0121 354 2311 FAX: 0121 354 1933

344 UXBRIDGE ROAD, HATCH END,  
MIDDLESEX HA5 4HR  
TEL: 020 8420 1925 FAX: 020 8420 1928



Naim...Meridian...Arcam...Tag McLaren...  
Teac...Mission...Stands Unique...  
and much, much more.

152a High Street, (Sharing ASDA Car Park) Bloxwich, Walsall

**01922 493499**

**0121 321 2445**

and NOW AT 111 The Parade, Sutton Coldfield, Birmingham

3 Hi-Fi Studios • Home Trials • Home Cinema Theatre •  
In House Service Department • Mail order available •  
Interest Free Credit available  
(On Selected Items, subject to 20% deposit. Written details on request)

**This Month's Hot Deals**

Acoustic Energy AEGIS Evo 3b  
5.1 speaker package

RRP £949  
Hot Deal **£749**

Pioneer VSX-AX5i  
+ KEF KHT 2005.2 + all cables

RRP £2100  
Hot Deal **£1650**

Denon AVR-3803  
+ KEF KHT 2005.2 + all cables

RRP £1775  
Hot Deal **£1375**

Arcam CD73 + Roksan Kandy amp  
+ Quad 11L speakers  
+ Partington Super Dreadnought stands  
+ Cyrus interconnect + 2x5m QED Silver  
Anniversary bi-wire cable

RRP £1700 Hot Deal **£1350**

See website for details of these and many other Hot Deals!

**www.creative-audio.co.uk**

**SOUND IMPROVEMENTS**

Is This Your Problem?



Loud



Too Loud



Way Too Loud

Here's Your Answer

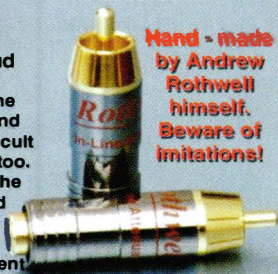

Hand-made  
by Andrew  
Rothwell  
himself.  
Beware of  
imitations!

It's a common problem. The usable range on the volume control is all down at the bottom end and fine control at low listening levels is either difficult or impossible. The noise floor may be audible too. There is now a simple and effective solution - the Rothwell In-Line Attenuators. They can be used with pre/power or integrated amps to cure the problems of excess gain and bring sonic benefits even with the most expensive equipment.

The cost is only £39 per pair delivered. To order, call

**01204 366133** or visit [www.rothwellaudioproducts.co.uk](http://www.rothwellaudioproducts.co.uk)

Excellent reviews in HI-FI Choice, HI-FI World, HI-FI Plus, What HI-FI and [www.tnt-audio.com](http://www.tnt-audio.com)

**LINCOLNSHIRE**

Lend us your ears and we'll blow your mind . . .

Arcam, ATC, B & W, Celestion, Denon, Kenwood, Kef, Marantz, Meridian, Mitchell, Mission, NAD, Pioneer, Panasonic, Quad, Rotel, Ruark, Sony, Tag McLaren, Tannoy, Teac, Technics, Yamaha and more.

Audition the very best at Lincolnshire's premier Hi-Fi dealer . . .

**MANDERS HI-FI LTD.**  
AUDIO • TV • VIDEO & SATELLITE SALES

2-4 EDWARD STREET (Off Pasture St.)  
GRIMSBY. TEL: (01472) 351391

to advertise here  
call Stuart Harris  
on 01225 442244  
or email

[stuart.harris@futurenet.co.uk](mailto:stuart.harris@futurenet.co.uk)



**HI-FI CHOICE**

BUCKS

NOTEWORTHY AUDIO



We are a new independent dealer specialising in the best hi-fi equipment available throughout the world.

Selected products from Acoustic Research, Audio Note, Avantgarde, Chord, Electrofluidics, Heart, Isotek, JM Labs, KEF, Living Voice, Merlin, Michell, Ortofon, PMC, ProAc, Project, Pure, Quad, Rega, Ringmat, Rose, Shanling, SME, Something Solid, Talk Electronics, Tannoy and many more...

We also stock a wide range of accessories, stands and cables to suit every system.

**Noteworthy Audio**  
36 Buckingham Street,  
Aylesbury,  
Buckinghamshire  
HP20 2LH  
Tel: 01296 422224  
info@noteworthyaudio.co.uk



[www.noteworthyaudio.co.uk](http://www.noteworthyaudio.co.uk)

pure music



Relax in the comfort of one of our demonstration rooms, and experience the thrill of the awesome Naim audio range.

It's just one of the great products we stock.

THE SOUND GALLERY

01494 531682

65 Castle Street, High Wycombe Bucks HP13 6RN

<http://www.soundgallery.co.uk>

or email: [home@soundgallery.co.uk](mailto:home@soundgallery.co.uk)

YORKSHIRE

Award Winning Retailers...

**Vickers Hi-Fi**

The North of England Hi-Fi Specialists

- Atacama
- Castle
- Cyrus
- KEF
- Linn
- Marantz
- Meridian
- Michell
- Mission
- Monitor Audio
- NAD
- Nordost
- Origin Live
- Ortofon
- Panθος
- Pickering
- Primare
- Pro-Ac
- Project
- QUAD
- REL
- Roksan
- Shanling
- SME
- Spendor
- Sugden
- TAG McLaren
- Tannoy
- TEAC
- Trichord
- Unison Research
- Van Den Hul
- Wharfedale
- Yamaha
- & Lots more...



- ▶ Quality Hi-Fi separates from £100 to £10,000
- ▶ Widest choice in the area ▶ Independent advice
- ▶ Consumers Choice Gold Award Winners
- ▶ Over 35yrs experience ▶ Qualified staff
- ▶ Comfortable dem rooms ▶ Superb showrooms
- ▶ Main road location ▶ Major car parks nearby
- ▶ Insurance estimates ▶ Service Dept.
- ▶ Up to 3 years Interest Free Credit\* only 20% deposit
- ▶ Carriage Free Mail Order (inc. credit) \*subject to status
- ▶ Delivery & installation
- ▶ Part Exchange
- ▶ Open 10:30am - 5:30pm 6 days: Mon. to Sat.
- ▶ Visa, Mastercard, Switch etc.

24 Gillygate, York YO31 7EQ

Tel: 01904 629659

[www.Vickers-HiFi.co.uk](http://www.Vickers-HiFi.co.uk)

**Specialists in high fidelity sound reproduction - since 1967**

HI-FI CHOICE WEB WATCH



www.HiFiBitZ.co.uk

The home entertainment specialists are just a click away



www.hifibitz.co.uk

www.avihifi.com

www.monopulse.co.uk

www.dougbradyhifi.com

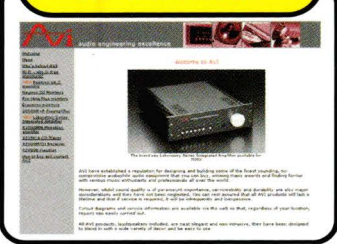
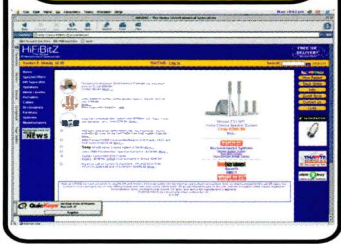

**ACROSS.**  
1. Does exactly what it says - in the tin?

- We say our synchronised-transient steel-bound speakers give startling realism.
- **Hi-Fi Choice** "delivers a coherence and timing that's positively electrifying."

**Doug Brady HiFi**

Doug Brady has been in the Hi-Fi business for 39 years, although his parents, Mr & Mrs W.A. Brady founded the family business in the 1920's.

Whether your budget is £1,000, £10,000 or £100,000 we take pride in getting it right for you.

Kingsway Studios, Kingsway North, Warrington, Cheshire WA1 3NU  
Tel: 01925 828009 Fax: 01925 825773  
E-Mail: doug.brady@dougbradyhifi.com

LONDON

**O'Brien Hi-Fi**

AUDIO NOTE • AUDIO RESEARCH • AUDIO TECHNICA • BEYER • CABLETALK • CHORD • CREEK • DIAPASON • EPOS • JAOIS • JEKLIN • MICHELL • NAO • NAIM • ONKYO • OPERA • QED • REGA • RESON • SENNHEISER • SME • SONNETEER • SONUS FABER • SUGDEN • TEAC • THORENS • TRANSPARENT CABLES • UNISON RESEARCH • ARCAIDIS • DYNAVECTOR • GOLDRING • ORIGIN LIVE • TRIANGLE • WILSON

Clearance/Secondhand/Ex Dem Equipment • Details on Request

	RRP	Our Price
Audio Analogue Maestro CD (s/h)	£1700	£850
Copland CD286CD player (Ex dem)	£1400	£995
Copland CSA28 amplifier	£1440	£995
Creek 4330/2 amplifier (new)	£320	£220
Jamo E510 speakers	£199	£99
Krell 300L (amplifier Ex dem)	£3698	£2495
Naim CD5 (Ex dem)	£1195	£849
Naim 112 (Ex dem)	£660	£460
Naim 150 (Ex dem)	£795	£575
Stands Unique Sound Support (s/h)	£275	£175
Stands Unique CD/DVD storage (s/h)	£229	£195
Sonneteer Campion (new)	£700	£595
Theta Data 11 CD (new mech)	£1500	£750
Vienna Mozart (Black) (s/h)	£1500	£595

**AUDIO ANALOGUE**      **COPLAND**      **KRELL**

**0% Instant Finance Available - Written details on request**  
**Demonstration room • Free car parking • Major Credit Cards**  
 Personal Export • Mail Order • Installation Service • Repair facilities  
 5 mins walk Raynes Park BR20 mins Waterloo •  
 5 mins from A3 (Raynes Park B282 exit) • 25 mins M25 Junc 10

**60 Durham Road, West Wimbledon, London SW20 0TW**  
 Tel: (020) 8946 1528 Fax: (020) 8946 0331  
 Email: obrienhifi@iname.com

THE INNOVATIVE HI-FI, HOME CINEMA & MULTI-ROOM RETAILER/INSTALLER

ORANGES & LEMONS

Friendly and efficient service 0% Finance available

**JUICY FRUIT FROM LONDON'S FRESHEST RETAILER**

ARCAM B&W CABLE TALK CASTLE CHORD CREEK DENON EPOS LINN MARANTZ NAD NAIM NEAT PMC QED REGA ROKSAN ROTEL RUARK STANDS UNIQUE SOUNDSTYLE YAMAHA XANTECH and many others

**020 7924 2040**  
**61/63 WEBBS ROAD, SW11**  
 website: www.oandhifi.co.uk

www.hifichoice.co.uk

**Zen**  
 Audio & Vision

25 Story Street, Hull HU1 3SA • 01482 587397

Hull's best Hi-Fi and Home Cinema store!  
 Friendly service and impartial advice.  
 3 Demonstration Rooms  
 Open Mon - Sat - 10.00 a.m. - 5.00 p.m.

Naim Audio • NAD • Dynaudio • Onkyo • Teac • Pro AC and many more

DEVON

**SPEAKER KITS FROM I.P.L. ACOUSTICS**

The IPL range now includes six superb biwired Transmission Lines using top quality drive units and components to achieve sound quality and bass extension equivalent to speakers costing in the range of £800 to £3,000. The Plus Kits include all that is required apart from the woodwork, but plain or veneered cabinet kits are available. The S31l is a new kit with advanced polyprop. custom built bass unit and excellent SEAS 1" fabric dome tweeter.

KIT	SPEAKER UNITS	CAB SIZE mm	PLUS KIT	P&P
M31l	5" Morel, 1" Seas treb	810 x 191 x 261	£219.00	£9.50
S31l	6.5" IPL PP, 1" Seas treb	903 x 230 x 350	£196.00	£10.00
S31ml	6.5" IPL metal, 1" Seas treb	903 x 230 x 350	£243.00	£10.00
S31ml Rib	6.5" IPL metal, Ribbon treb	903 x 230 x 350	£398.25	£10.00
S41l	8" Audax HDA, Seas treb	960 x 276 x 400	£268.00	£11.00
S51l	10" Audax, 5" mid, 1" treb	1080 x 320 x 400	£435.00	£12.00

Send cheque or postal order made payable to Mr I. P. Leslie at IPL ACOUSTICS, Chelsea Villa, Torrs Park, Ilfracombe, Devon EX34 8AY. 01271 867439.  
 Alternatively visit our website at [iplacoustics.co.uk](http://iplacoustics.co.uk), or send a 44p SAE for catalogue detailing Transmission line, Hi Fi, and AV kits, including: Active

ACCESSORIES

**Is This Your Problem?**

Too Loud      Way too Loud

**Here's Your Answer**

**New! Balanced version now available**

It's a common problem. The usable range on the volume control is all down at the bottom end and fine control at low listening levels is either difficult or impossible. The noise floor may be audible too. There is now a simple and effective solution - the Rothwell In-Line Attenuators. They can be used with pre/power or integrated amps to cure the problems of excess gain and bring sonic benefits, even with the most expensive equipment.

The cost is only **£39** per pair delivered. To order, call  
**Rothwell: 01204 366133** or **www.rothwell-electronics.co.uk**  
 Excellent reviews in Hi-Fi Choice, Hi-Fi World, Hi-Fi Plus, What Hi-Fi and www.tnt-audio.com

**BRISTOL**

**V'audio**

**Hi-Fi Consultants**

Home demonstrations and honest advice a speciality, using specially selected equipment from  
**AVI, ATC, AUDIO ANALOGUE, ALR JORDAN, ALON, ELECTROCOMPANET, HEYBROOK, RUARK, SHEARNE, OPERA, ORACLE, MICHELL, MARK LEVINSON** etc.

Home cinema on demonstration using:  
**SONY, NAKAMICHI, HARMAN-KARDON, DAVIS, SIM2, STEWART SCREENS, JAMBO, TRIANGLE**, etc.  
 Please ring for an appointment

**36 Druid Hill, Stoke Bishop, Bristol BS9 1EJ.**  
**Tel: 0117 968 6005**  
**www.vaudio.co.uk**



**LONDON**

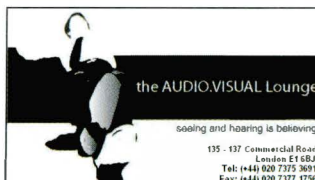

Stockists of:  
 AVID TURNTABLES  
 ANTHONY GALLO  
 AUDIOQUEST  
 BOSTON ACOUSTICS  
 CHORD ELECTRONICS  
 DALI  
 DRAPER SCREENS  
 EXPOSURE  
 FUJITSU  
 HITACHI

FOCUS PROJECTORS  
 LIVING CONTROL  
 JM LABS  
 LEXICON  
 LAT  
 MUSICAL FIDELITY  
 MONITOR AUDIO  
 NAD  
 NORDOST  
 ORTOFON  
 PROJECT

PRAC  
 PRIMARE  
 QUADRASPIRE  
 REL ACOUSTICS  
 ROKSAN  
 RUARK  
 STAND UNIQUE  
 TANNY  
 VIENNA ACOUSTICS  
 VAN DEN HUL  
 and many more

**Specialist in audio and visual entertainment systems from the world's best manufacturer's**

**the AUDIO.VISUAL lounge,** **Tel: 020 7375 3691 Fax: 020 7377 1756**  
**135-137 Commercial Street, London E1 6BL Email: info@theavloung.com**

**SUFFOLK**

atc  
 audio physic  
 bow  
 densen  
 harbeth  
 lyra  
 michell  
 primare  
 stax  
 sme + many more

**signals**

hi-fi for grown-ups

tel ipswich 01473 655171 fax 01473 655172  
 www.signals.uk.com

**DERBY**

**IAN HARRISON HIFI MASSIVE NEW YEAR SALE!!**  
**TRADE IN YOUR OLD MOVING COIL CARTRIDGE AND SAVE UP TO 60% OFF A NEW ONE**

PLEASE PHONE OR WRITE FOR SALE PRICES  
 BLACK RHODIUM, STAX, HALCRO, ALOIA, EPOS, OPTIMUM, SOUND ORGANISATION, TOM EVANS, SHUN MOOK, ASH DESIGN, SHURE, ALPHASON, TRANSPARENT, CABASSE, HADCOCK, NAD, TASCAM, MICHELL, CLEARAUDIO, DENON, TRANSFIGURATION, KOETSU, SUMIKO, ORTOFON, SOUTHER, GRAHAM, E.A.R./YOSHINO, CONVERGENT AUDIO TECHNOLOGY, HARBETH, NORDOST, SONY, SENNHEISER, GRADO, RESON, GOLDRING, QED, ARGENTO AUDIO, DECCA, MOTH, CREEK, AUDIO TECHNICA, APOLLO, SOUNDSTYLE, DYNAVECTOR, ELAC, GAMUT, BEYER, AKG, BENZ-MICRO, AUDIO VALVE, GRAAF AND ACCUSTIC ARTS

All goods are brand new and boxed with full U. K. guarantees.  
 No ex-dem or ex-display equipment. No grey imports. Delivery is free (U.K. only).  
 Goods are not supplied on approval. Sorry, no general catalogue.  
 Please phone or write for specific details.

Established in 1986

**MAIL ORDER ONLY FROM:**  
**7 MILL HILL, REPTON, DERBY, DE65 6GQ, U.K.**  
**TEL: 01283 702875 9AM-9PM INCLUDING SUNDAYS**

**SPECIALIST**

Front End Problems?  
 contact:

**The Cartridge Man**

It doesn't have to cost an arm and leg to get the best  
 - listen to my Koetsu - and - Decca - eater.  
 Also agents for Croft, Moth, Hadcock & Mitchell & E.A.R, Graham Slee projects.  
 Valve equipment re-build service available.  
 - Plus cartridge re-tipping service

**020 8688 6565**

Website: [www.thecartridgeman.com](http://www.thecartridgeman.com)

to advertise here  
 call Stuart Harris  
 on 01225 442244  
 or email

[stuart.harris@futurenet.co.uk](mailto:stuart.harris@futurenet.co.uk)

**HI-FI CHOICE**

Measurements in Nov 2003 magazine shows **£2,500 "2 way" speakers with "flat" frequency response and 5" or 6" drive units struggle with 10 watts of bass and produces a lot of distortion (1% to 3%).** Should we limit bass to 20 watts or 40 watts amplifier, to prevent damage to 6" drive units?  
**We use £350 or £650 of transformers and £50 or £160 of valves.**  
**If we could achieve the same quality of sound with £10 volume control, £10 wires, £10 capacitor, we could have saved a lot of money!!!**

**Money back guarantee (less £30 UK or £100 overseas) that you prefer :-**  
 £850 or £1,000 or £1,250 or £1,450 **"KT88 Triode Connection"** amplifiers to most transistor amplifiers, most transistor / valve hybrid amplifiers, most Single Ended valve amplifiers, most Ultra Linear valve amplifiers selling for £2,000 to £20,000

**£850 "KT88 Triode Connection" + high quality £350 "3 way" speakers** to most "ultra linear" valve amplifiers + £600 "2 way" and "2.5 way" speakers

**£700 EL34 valve amplifiers (40 watts + 40 watts)** to most transistor amplifiers and transistor / valve hybrid amplifiers costing £1,000 to £2,000

**£500 EL34 valve amplifiers (40 watts + 40 watts)** to most £700 amplifiers.

Telephone 01634 268662 anytime or 01634 373410 for Mr Andrew Everard's review in Gramophone Magazine and Summary of 21 testimonials from satisfied customers. [www.affordablevalvecompany.co.uk](http://www.affordablevalvecompany.co.uk)

**Buy direct & save £££**  
 Shop prices are expensive because of rent, rates, wages  
**Free UK delivery**  
**90% of customer keep our valve amplifiers**

**4 years of proven reliability.**  
**2 years guarantee.**

Even our "standard" transformers are **BIG** Big powerful EL34 valves

**40 watts + 40 watts** **£500**

**HUGE expensive "High End" "potted" transformers** **KT88 valves are more expensive than 6550 valves**

Unbelievably huge transformers

American 5670 valves

expensive non-magnetic stainless steel chassis

Ultra Linear **£1,050 £1,150** **Triode Connection £1,250 £1,400**

Larger transformer **huge transformer** **KT88 valves are more expensive than 6550 valves**

American 5670 valves

2 or 6 pieces of silver capacitors

Ultra Linear **£650 £750** **Triode Connection £850 £1,000**

Larger transformer **huge transformer** **Distortion matched famous Russian Svetalana EL34 valves**

American 5670 valves

Upgradeable to **£1,000** **KT88 Triode Connection + £50 for carriage + £50 for used valves** **Ultra Linear £600 £700**

**40 watts + 40 watts**

**JANIS JOPLIN** Heroin,  
hangovers and heartache

**SAMMY HAGAR** On Van  
Halen, Roth and retirement

**THE EAGLES**  
Life in the fast lane

**PLUS** Grohl,  
T.Rex, Korn...

# Classico ROCK

**AND THERE'S MORE!**  
Peter Frampton  
Iron Maiden  
Arthur Brown  
Springsteen  
Fleetwood Mac  
Skid Row

£3.60  
0 2  
FEBRUARY 2014  
9 771464 783051  
Future  
Entertainment Group

**REALITY BITES!**

# OZZY

**FROM SATANIST TO SITCOM STAR**  
The Black Sabbath years, the 80s excesses... What's next?

**On sale Friday January 23**

# DEALER DIRECTORY

**Choosing a good hi-fi dealer is the most vital step in acquiring the system that is right for you. This unique directory gives full information on dealers able to help in your area.**

## BATH/BRISTOL

**THE RIGHT NOTE**, tel: 01225 874728. Give your ears a new reference point for the best sounds at any price. Forget reviews and trying to put together a system like a patchwork quilt with the 'best' bits around. It's our job to do the assessing, you judge the results. Come here, or we'll come to you, and plan a system for the future, even if you spread the purchases. Leave "upgrade-itis" behind, save money and enjoy music. Just listen, and you'll know. CD: Accuphase, Advantage, Audio Synthesis, Balanced Audio Technology, dCS (Elgar etc), Meracus, Pass, Sugden, Wadia. Vinyl: Audio Synthesis, Basis, Clearaudio, DNM, Graham, (The) Groove, Lehmann (Black Cube), Michell, Sumiko, Transfiguration. Amps: Accuphase, Advantage, Balanced Audio Technology, CAT, DNM, Gamut, Lumley, Meracus, Michell, Nagra, Pass, Sonneteer, Spectral, Sugden. Speakers: Audio Physic, BKS, Ethos, Harbeth, Lumley, Magneplanar, NEAT, Totem, Verity Audio. Tuners: Accuphase, Magnum Dynalab. Cables: Argento, Chord Co, DNM, Hovland, Nordost, SonicLink, Siltech, Yamamura Churchill. Mains: Accuphase.

## BIRMINGHAM

**SOUND ACADEMY**, 111 The Parade, Sutton Coldfield, Birmingham B72 1PU. Tel: 0121 321 2445. Audio equipment from leading and specialist brands, with 3 demo floors, home trials, home cinema with instore demo theatre, evening demos by appointment. In house service dept. Mail order avail. Int. free credit subject to status. Open 6 days 9am - 6pm. Late night Friday. Expert advice, cable dressing and free installation. Also at 152a High Street, Bloxwich, Nr Walsall, W Midlands. Tel: 01922 493499/ 473499.



## CHESHIRE

**ACOUSTICA**, 17 Hoole Rd, Chester CH2 3NH. www.acoustica.co.uk. Tel: 01244 344227. All that's best in Hi-Fi and Home Cinema from quality manufacturers including Naim, Rega, Bowers & Wilkins, Sugden, Musical Fidelity, Rotel, Primare, Teac, Harman Kardon, JM Lab, Spendor, Quadraspire, Royd, Michell, Sonus Faber, SIM/Seleco Projectors & Yamaha. We offer friendly, helpful advice, interest-free credit and trade-in facilities, and deliver and install systems through Cheshire, Merseyside and North Wales. Open Tues. - Sat. 10-5.30, evenings by arrangement.

**DOUG BRADY HI-FI**, Kingsway Studios, Kingsway North, Warrington WA1 3NU. Tel: 01925 828009. Email: doug.brady@dougbradyhifi.com. Website: www.dougbradyhifi.com. For the widest range of high quality hi-fi in the Northwest. Family business est. 42 years. 3 demo rooms, inc. home cinema, home trials; deliveries throughout NW; Mastercard, Visa, credit facilities. Open 10.30 - 6. Send for free map.



**ACTON GATE AUDIO**, 4 Ruabon Rd., Wrexham. Tel: 01978 364500. Audio Visual specialists. AAD, Arcam, Audio Analogue, Bose, Celestion, Castle, Denon, Harman-Kardon, Jamo, JBL, Marantz, Michell, Mission, Musical Fidelity, NAD, Onkyo, Pure Digital, Quad, REL, Roksan, Ruark, Tannoy, Teac, UKD, Unico, Vibe, Yamaha. Demonstration room, installation service. Easy parking and motorway access. Mastercard, Visa etc.

**THE HI-FI SHOWROOMS**, 12A West Str, off West St Car Park, Congleton, Cheshire. Tel: 01260 280017. E-mail:

mail@hifishowrooms.co.uk. Web site: hifishowrooms.co.uk. Naim Audio, Audiolab, Rega, REL, Arcam, Technics, KEF, NAD, Harman-Kardon, Yamaha, Rotel, Lexicon, RCF, Millennium, NHT, JBL, Onkyo, Sony, Marantz, Toshiba, Panasonic, Ruark, Jamo, Celestion, Qed, Teac, Castle. Front and rear projection systems, 3 demonstration rooms, 1 A/V with 8ft screen, customer car park. The North West's Premier Audio Visual Specialist. Mastercard, Visa, Amex, JCB. 9.15-5.30, Closed Sun/Mon.

## COUNTY DURHAM

**MUSIC MATTERS**, 17 Coniscliffe Road, Darlington, County Durham DL3 7EE. Tel: 01325 481 418. Tues - Sat 10.00-5.30 Weds 10.00-6.30



## DORSET

**MOVEMENT AUDIO**, 588 Ashley Road, Parkstone, Poole. Tel: 01202 730865/380018. www.movement-audio.co.uk. Arcam, Audio Vector, B&W, Castle, Chord Electronics, Cyrus, Denon, Densen, Lavardin, Marantz, Mission (inc. FS series), NAD, Pioneer, Roksan, REL, Rotel, Tannoy (inc. Dimension), Yamaha. 3 demo rooms, Hi Fi and Home Cinema specialists, easy parking on site, high quality used equipment, massive range of audio and video leads and connectors etc. Credit facilities. Open Tues-Sat 10-5.30.



**MOVEMENT AUDIO**, 926 Wimborne Road, Moordown, Bournemouth, Dorset. Tel: 01202 529988/ 520066. www.movement-audio.co.uk. Arcam, B&W, Celestion, Denon, KEF, Marantz, Michell, Musical Fidelity, NAD, Opera, Pioneer, Project, Quad, REL, Roksan, Rotel, Tannoy, Teac, Yamaha. Home cinema and Hi Fi specialists, full demo facilities, friendly expert advice, home demo and installation, easy parking, credit facilities, Visa/Mastercard. Open Tues-Sat 9.30-5.30.



**WEYMOUTH HI-FI**, 33-35 Maiden Street, Weymouth. Tel: 01305 785729/766345. www.movement-audio.co.uk. Arcam, B&W, Castle, Celestion, Denon, KEF, Meridian, Mission, Musical Fidelity, Panasonic, Pioneer, Project, Quad, Rotel, Technics, Yamaha plus large range of P.A. and DJ audio and lighting, multi room and commercial installation specialists, Home Cinema and DVD, Projection TV and plasma, 2 demo rooms, credit facilities, Visa/ Mastercard. Open Mon-Sat 9.30-5.30



## HEREFORDSHIRE

**ENGLISH AUDIO**, 37 Whitecross Road, Hereford HR4 0DE. Tel: 01432 355081. www.englishaudio.co.uk. Acoustic Energy, Arcam, ATC, B&W, Castle, Cyrus, Denon, Elac, Exposure, JM Lab, KEF, Loewe, Marantz, Mission, Musical Fidelity, NAD, Naim, Pink Triangle, Pioneer, Primaire, Project, REL, Rotel, Ruark, Stax, Tannoy, Teac, Tivoli, Vienna Acoustics, Wharfedale, Yamaha and others. Single speaker demo room. Home trial. Free install. Service dept. Mastercard, Visa, Credit arranged. Open Mon-Sat 9.30am-5.30pm.



## LANCASHIRE

**ADVENTURES IN HI-FI**, 5 Bishopsgate, off Hallgate, Wigan WN1 1NL. Tel: 01942 234202. For the best hi-fi and home cinema products from quality manufacturers including B&W, Royd, Bryston, Neat, Michelle, Naim, Rega, Cyrus, NAD, KEF, Denon, Dynavector, Shahinian, JM Lab, PMC, Project, Quadraspire. We offer friendly advice, excellent demonstration facilities, 0% finance, free delivery and installation throughout the North West. Opening hours 10.00 - 5.30 Tuesday to Saturday, evenings by appointment.

**DOUG BRADY HI-FI**, Kingsway Studios, Kingsway North, Warrington WA1 3NU. Tel: 01925 828009. Email: doug.brady@dougbradyhifi.com. Website: www.dougbradyhifi.com. See our main entry under Cheshire.



## LEICESTERSHIRE

**LEICESTER HI-FI CO**, St Martins Square Leicester LE1 5EW. Tel: 0116 253 9753 Fax: 0116 262 6097 Website: www.leicesterhifi.co.uk Email: info@leicesterhifi.co.uk. Acoustic Energy, Arcam, Atacama, B&W/Nautilus, Bryston, Celestion, Chord Electronics, Creek, Crimson, Cyrus, Denon, Greig, IK Loudspeakers, Marantz, Michell, Mission, Mordaunt-Short, Musical Fidelity, NAD, Optimum, Pioneer, Plasma TV, Projectors, ProAc, Project, Pure, Quad, Rotel, Roksan, Tag McLaren, Yamaha, and more. 4 Listening areas/rooms over 3 floors. We can Demonstrate, Deliver and Install. Hi/A/V/Multi-room/Custom Installation/Design DAB radio specialists. Bargain Bin on Website. Open Mon-Sat 9.30-5.30



### Members of the British Audio Dealers Association are able to offer:

- Two year guarantee, transferable to another BADA dealer should the purchaser move more than 30 miles from his/her original address
- low cost five year guarantee option
- proper demonstration facilities
- seven day exchange or refund scheme if the dealer's advice is taken on product selection
- fully guaranteed service work
- customer complaints procedure in the event of problems

For more information contact BADA on

☎ 020 7226 4044



**INDICATES MEMBERSHIP OF THE BRITISH AUDIO DEALERS ASSOCIATION**



**BADA**  
BRITISH AUDIO DEALERS ASSOCIATION  
the symbol of security

**INDICATES MEMBERSHIP  
OF THE BRITISH AUDIO  
DEALERS ASSOCIATION**

**LONDON**

**CORNFLAKE.CO.UK**, 37 Windmill Street, London W1T 2JU. Tel: 020 7631 0472, fax: 020 7436 7165. E-mail: help@

cornflake.co.uk. Open Tues-Sat 10-6, Thurs 10-7. The specialists in high quality sound, be it for one room or many more. They offer friendly advice, and a full delivery and installation service is available. Two listening rooms with full A/V facilities demonstrating Arcam, ATC, AVI, Barco, Bryston, Dynaudio, Mark Levinson, Naim, Origin Live, Proceed, PMC, Rega, Royd, Yamaha and more. Service department. Amex, Mastercard, Switch, Visa and worldwide mail order service. Still the coolest Hi-Fi shop in London.  
www.cornflake.co.uk.

**GRAHAMS HI-FI**, Canonbury Yard, 190a New North Road, London N1 Tel: 020 7226 5500. www.grahams.co.uk 'One of the 5 best hi-fi shops in the world'. Arcam, Linn, Meridian, Naim, Rega, and more... Home cinema and whole house custom installed solutions. Free parking, 4 demo rooms, service dept, open Tues-Sat. Ring for appointment.



**ORANGES & LEMONS**, 61-63 Webbs Road, Battersea SW11. Tel: 020 7924 2040. Juicy fruit from London's newest, freshest hi-fi, home cinema and multi-room retailer/installer. Friendly and efficient service, home installation, credit cards, 0% finance available, plus all the very best from: Arcam, B&W, Chord, Creek, Demion, Epos, Imerge, NAD, Naim, Neat, Pmc, Quadraspire, Qed, Rega, Roksan, Rotel, Ruark, Soundstyle, Stands Unique, Xantech, Yamaha and many more...



**GREATER MANCHESTER**

**DOUG BRADY HI-FI**, Kingsway Studios, Kingsway North, Warrington WA1 3NU. Tel: 01925 828009. Email: doug.brady@dougbradyhifi.com. Website: www.dougbradyhifi.com. See our main entry under Cheshire.



**ADVENTURES IN HI-FI**, 5 Bishopsgate, off Hallgate, Wigan WN1 1NL. Tel: 01942 234202. See main entry under Lancashire.

**MERSEYSIDE**

**ACOUSTICA**, 17 Hoole Rd, Chester CH2 3NH. Tel: 01244 344227. See our main entry under Cheshire.

**DOUG BRADY HI-FI**, Kingsway Studios, Kingsway North, Warrington WA1 3NU. Tel: 01925 828009. Email: doug.brady@dougbradyhifi.com. Website: www.dougbradyhifi.com. See our main entry under Cheshire.



**MIDDLESEX**

**MUSIC MATTERS**, 344 Uxbridge Road, Hatchend, Middlesex HA5 4HR. Tel: 020 8420 1925. Arcam, Audio Research, B & W, Castle, Celestion, Chord, Cyrus, Denon, Dynaudio, Jamo, KEF, Krell, Marantz, Martin Logan, Meridan, Michel, Mission, Monitor Audio, Musical Fidelity, Naim, Panasonic, Pioneer, ProAc, Project, Quad, REL, Rotel, Ruark, Sennheiser, SME, Sonus Faber, Tag McLaren, Tannoy, TEAC, Technics, Theta, Yamaha. Excellent demonstration and home trial facilities. Free installation. Customised multi-room systems. All major credit cards accepted. Full credit facilities available. Tues - Sat 10.00-5.30, Weds 10.00-6.30.



**WEST MIDLANDS**

**SOUND ACADEMY**, 152a High Street, Bloxwich, Nr Walsall, W Midlands. Tel: 01922 493499/ 473499. Audio equipment from leading and specialist brands, with 3 demo floors, home trials, home cinema with instore demo theatre, evening demos by appointment. In house service dept. Mail order avail. Int. free credit subject to status. Open 6 days 9am - 6pm. Late night Friday. Expert advice, cable dressing and free installation. Also at 111 The Parade, Sutton Coldfield, Birmingham B72 1PU. Tel: 0121 321 2445.



**MUSIC MATTERS**, 363 Hagley Road, Edgbaston, Birmingham B17 8DL. Tel: 0121 429 2811. Arcam, Audio Research, B & W, Castle, Celestion, Chord, Cyrus, Denon, Dynaudio, Jamo, KEF, Krell, Marantz, Martin Logan, Meridan, Michel, Mission, Monitor Audio, Musical Fidelity, Panasonic, Pioneer, ProAc, Project, Quad, REL, Rotel, Ruark, Sennheiser, SME, Sonus Faber, Tag McLaren, Tannoy, TEAC, Technics, Theta, Yamaha. Excellent demonstration and home trial facilities. Free installation. Customised multi-room systems. All major credit cards accepted. Full credit facilities available. Tues - Sat 10.00-5.30, Weds 10.00-6.30.



**MUSIC MATTERS**, Hobbs Moat Road, Solihull, W. Midlands B92 8JL. Tel: 0121 742 0254. Tues - Sat 10.00-5.30 Weds 10.00-6.30



**MUSIC MATTERS**, 9 Market Street, Stourbridge, W. Midlands BY8 1AB. Tel: 01384 444184. Tues - Sat 10.00-5.30 Weds 10.00-6.30



**MUSIC MATTERS**, 10 Boldmere Road, Sutton Coldfield, W. Midlands B73 5DT. Tel: 0121 354 2311. Tues - Sat 10.00-5.30 Weds 10.00-6.30



**ACOUSTICA**, 114 Wolverhampton Road, Stafford ST17 4AH. Tel: 01785 258216. See our main entry under Cheshire.

**NORFOLK**

**BASICALLY SOUND**, The Old School, School Rd, Bracon Ash, Norwich NR14 8HG. Tel: 01508 570829. Audio Analogue, Bayer, Bryston, Cabletalk, Chord Co., Creek, Opera Speakers, Denon, Dynavector, Epos, Grado, Heybrook, Naim, Opera, ProAc, PMC, Sound Organisation, Rega, Royd, Soundstyle, Teac, etc. 2 comprehensive demo rooms. Home trial. Free installation. Visa, Mastercard, HP facilities. 0% Finance. Tues-Fri 9.30-1, 2-5.30. All day Sat.



**NOTTINGHAMSHIRE**

**DEFINITIVE AUDIO** Maybe it's time to graduate, both from the high street and from conventional hi-fi. We offer you a far more sensitive and sophisticated way of choosing a beautiful sound for your home. Our premises are located at Junction 25 on the M1 motorway where we work by appointment. Our approach is specialised and focused, as is our product range. We have been importing, exporting, designing and manufacturing high-end, 2-channel audio for the past 15 years. If you would like to move your listening experience up several gears call us for a chat. Living Voice, Vitavox, Border Patrol, Sugden, Monarchy, Kuzma, Benz-Micro, VPI, SME, Van den Hul, Avid, Nottingham Analogue, Tom Evans, Reson, Electrofluidics, & Western Electric. Tel: 0115 9733222 Fax: 0115 9733666 Email: shout@definitiveaudio.co.uk

**OXFORDSHIRE**

**ASTLEY AUDIO LTD**, 3 Marketplace, Wallingford OX10 0EG. Tel: 01491 839305, fax: 01491 825024. Founded 1975. Great deals on B&W, Denon, KEF, Marantz, Mission, Panasonic, Pioneer, Project, Sony, Technics,

Yamaha. Home trial, installation and delivery service. Service dept on site. 2 yr guarantee on most products. Interest free credit on selected items. 1 home cinema room, 2 listening rooms. Mastercard, Visa, Amex, Diners. Instant credit. Tues-Fri 9-5.30, Sat 9-5. CDs and DVDs stocked.

**OVERTURE HI-FI**, 3 Church Lane, Banbury OX16 8LR. Tel: 01295 272158. Arcam, Bose, Cura, Denon, Linn Products, Mission, Naim Audio, Quad, Yamaha. For sensible unbiased advice, call Oxfordshire's audio experts. Superb demo facilities. Home cinema, multiroom & commercial installations. No appts nec, service dept, free install, home trial. Mastercard, Visa, instant credit. Mon-Fri 10-6, Sat 9.30-5.30.



**SHROPSHIRE**

**CREATIVE AUDIO**, 9 Dogpole, Shrewsbury SY1 1EN. Tel: 01743 236055. Email sales@creative-audio.co.uk, www.creative-audio.co.uk. One of the largest ranges of quality HiFi/Audio Visual equipment outside of London. Arcam, Ash, Atacama, Cabletalk, Celestion, Chord, Cura, Cyrus, Denon, Dual, Heybrook, KEF, Mission, Onkyo, Optimum, NAD, Naim, QED, Quad, Rega, Soundstyle, Stands Unique, Teac, Wharfedale. Large selection of bargain special purchases available on most makes. Comfortable listening room, expert installation (including multiroom and DVD home cinema), free 2 & 5 year warranties, selected used equipment, part-exchange welcome, specialist workshop facilities. Mastercard/Visa/Switch/Amex and low cost finance from £250 up to £15,000.

**SOMERSET**

**MIKE MANNING AUDIO**, 110 Middle Street, Yeovil, Somerset BA20 1NE. Tel: 01935 479361. 54 Bridge Street, Taunton. Tel: 01823 326688. www.mikemanningaudio.co.uk. The HiFi and A/V specialists. The best in HiFi from: Arcam, B&W, Castle, Denon, Densen, Heybrook, JM Lab, KEF, Loewe TV & Video, Marantz, Naim Audio, NAD, Pioneer, PMC, Rega, Rotel, Royd, Shahinian, TDL, Teac. Dedicated listening lounge for relaxed and unpressured demonstrations. Home installations on most systems. Full service department. Mastercard, Visa, Instant Credit Closed Mondays



**BADA**  
BRITISH AUDIO DEALERS ASSOCIATION  
the symbol of security

**INDICATES MEMBERSHIP  
OF THE BRITISH AUDIO  
DEALERS ASSOCIATION**

**STAFFORDSHIRE**

**ACOUSTICA**, 114 Wolverhampton Road, Stafford ST17 4AH. www.acoustica.co.uk Tel: 01785 258216. All that's best in Hi-Fi and Home Cinema from quality manufacturers including Naim, Rega, Bowers & Wilkins, Sugden, Musical Fidelity, Rotel, Primare, Teac, Harman Kardon, JM Lab, Michell, Ruark, Kef, NAD, Onkyo, SIM/Seleco Projectors, NEC Plasma & Yamaha. We offer friendly, helpful advice, interest-free credit and trade-in facilities, and deliver and install systems throughout Staffordshire and the Midlands. Opening hours Tues. - Sat. 10.30-6.00, evenings by arrangement.

**SUFFOLK**

**EASTERN AUDIO**, 41 Bramford Rd, Ipswich IP1 2LU. Tel: 01473 217217. Email: HiFi@eastern-audio.com. Giving sound advice for over 25 years. Parking. Demo room. Lots of free advice. Arcam, Meridian, Denon, Quad, NAD, B&W, Celestion, Project, Kef, Castle, Technics, Top Tape, plus all the usual and unusual leads, cables, stands, racks, headphones, cartridges & styli etc.

**SURREY**

**COSMIC HI-FI SUPERSTORE**, (Est 1962) 244-256 Station Road, Addlestone, Surrey KT15 2PS, LARGO FREE CAR PARK Tel: (01932) 854522/ 832400/ 851753, Fax 01932 832432. Open 7 Days a week, Mon-Sat 9-6pm, Fri till 8pm, Sun 10-4pm. Fully equipped service department on site, Massive Showrooms. Available Brands Acoustic Energy, Alphason, Apollo, Arcam, Audio Quest, Cable Talk, Denon, Dual, Elac, Harman Kardon, Jamo, JBL, Marantz, Mission, NAD, Ortofon, Panasonic Plasma, Pioneer, Pro-Ject Turntables, Pure Digital, Quad, REL, Roksan, Sennheiser, Sonus Systems, Sony, Tannoy, Technics, Thorens, Wharfedale, Yamaha Home cinema, Wide screen TV, Projection TV, Plasma & LCD TV. Interest free credit available. All major credit cards accepted. www.cosmicuk.com

**PJ HI-FI**, 3 Bridge Street, Guildford GU1 4RY. Tel: 01483 504801/ 304756. Mon-Sat 9am-6pm. Arcam, B&W, Denon, Linn, Meridian, Mission/Cyrus, Kef, Marantz, NAD, Pioneer, Primare, Proac, Quad, REL, Rega, Rotel, Tag McLaren, Yamaha. Demo rooms for Hi-Fi/home cinema, parking, delivery & installation. Service department on premises. Call now.

**SUSSEX (EAST)**

**THE POWERPLANT**, 40 Church Rd., Hove, East Sussex, BN3 2FN. Fax: 01273 748419. E-mail email@powerplant.co.uk Whatever your

budget we can help you choose from our carefully selected range of today's finest hi-fi and home cinema equipment. Recommended agencies include Arcam, ATC, B&W, B&O, Cyrus, DEF Tech, Imerge, Linn, Living Control, M&K, PMC, ProAc, QED Systemline, Rega, Revel, Seleco, Stewart, Tag McLaren Audio, Yamaha. Excellent demonstration facilities, knowledgeable and friendly staff. Multiroom specialist, CEDIA member. Open Tues - Sat 10.30 am- 5.30 pm. Late evenings by appointment. All major credit cards. Full credit facilities.

**SUSSEX (WEST)**

**AUDIO DESIGNS**, 26 High Street, East Grinstead, West Sussex RH19 3AS. Tel: 01342 328065. www.audiodesigns.co.uk. Hi-Fi, home cinema & multiroom specialists. Authorised stockists of: Arcam (inc. FMJ, DIVA & Alpha), ASH, The Chord Company, Cyrus, Kef (inc. Reference), Linn (inc. CD12 & Klimax), Loewe (inc. Spherros), Mission, Naim (inc. CDS & NAP500), Pioneer, PMC, Primaire, ProAc, Project, QED, Quadraspire, Rel, Roksan, Rotel, Ruark, SIM2 (inc. DPL), Sennheiser, Soundstyle, Stands Unique, Tag McLaren, TEAC & more. The LARGEST display of Hi-Fi furniture in the South. Probably the largest stock in the South, with three dedicated demonstration rooms together with a friendly team of staff and service facility, Finance available. 9.30-6.00 Tues-Sat.

**BOWERS & WILKINS LTD**, (Est 1945), Littlehampton Road, Worthing, (near Thomas a Becket). Tel: 01903 264141. E-mail: sales@bowersandwilkins.co.uk. Web site: www.bowersandwilkins.co.uk. 1 minute from A24 & A27. Free local parking. Acoustic Energy, B&W, Denon, JBL, Marantz, NAD, Optimum, Philips, Tannoy, Teac, Technics, and many more in 4 demo rooms. Systems, Hi-Fi and home cinema, DVD and projection TV. Service dept, installations. Open 6 days a week. Mastercard, Visa, instant credit to £1,000 subject to status.

**AUDIO DESIGNS**, 7/9 Park Place, Horsham, West Sussex, RH12 1DF (Next to Piries Place car park). Tel 01403 267766. www.audiodesigns.co.uk. See our main entry above under Sussex (West).

**WILTSHIRE**

**SALISBURY HI-FI**, 15 Catherine Street, Salisbury. Tel: 01722 322169/330841. www.movement-audio.co.uk. Arcam, Audio Analogue, B&W, Celestion, Chord Company, Denon, Harmon Kardon, Kef, Marantz, Meridian (inc. Digital theatre), Mission, Michell, Musical Fidelity, NAD, Nordost, Opera, Project, QED, Rotel, REL, Teac, Yamaha.

Home Cinema and Hi Fi specialists, multi room and commercial installation specialists, service dept. on site, high quality used equipment, projection TV and plasma. 2 demo rooms, credit facilities, Visa/Mastercard. Open Mon-Sat 9.30-5.30.

**YORKSHIRE (EAST)**

**THE AUDIO ROOM**, 2 George Street, Hedon, Hull, HU12 8JH. tel 01482 891375. www.theaudiroom.co.uk. The North Easts premier dealer. We have three stunning showrooms with a dedicated listening room and are authorised agents for Linn Products, Naim Audio, Mark Levinson, Cyrus, Sugden, Rega, Audio Analogue, Unison Research, Graaf, Pathos, Rotel, B&W, JM Labs including Utopia, Proac, Spondor, Base, Quadraspire, Hutter, Stands Unique, The Chord Company, Townsend Isolda, QED, Sumiko, Lyra, Ortofon, Stax, Grado and Loewe television and plasma. We are open Mon-Sat 9am-6pm (later by appointment). Credit facilities and home demonstrations available. Free and easy car parking as well as a relaxed and comfortable environment assured. The North Easts friendliest and most complete dealer.

**YORKSHIRE (SOUTH)**

**DONCASTER**

**THE HI-FI STUDIOS**, The Long Barn, Wakefield Road, Hampole, Doncaster DN6 7EU. Tel: 01302 727274/ 725550, fax: 01302 727274. Email: info@thehifistudios.freeserve.co.uk. Hi-Fi, home cinema and multi-room experts. Musical Fidelity, Tag McLaren, Electrocompaniet, ProAc, Ruark, Castle, Teac, Unison Research, John Shearne, Impulse Horns, Monitor Audio, Harbeth, Alchemist, NAD, Michell Turntables, Nottingham Analogue Studios, Audio Analogue, Living Voice, Exposure, Densen, Lynwood Electronics, Celestion (A Series only), Opera, Trichord Research, Nordost, Stands Unique, Stax Electrostatics, Ortofon, Project, Goldring, REL Subwoofers, Yamaha A/V, Proceed Digital Cinema, Tag McLaren & Denon Home Cinema products, plus others. Viewing and demonstration by appointment. Home trials and free installation on hi-fi equipment. Mastercard, Credit card and finance facilities. Phone for more information. 10am-6.30pm Tues-Fri, 10am-5pm Sat. Closed Sunday & Monday.

**YORKSHIRE (WEST)**

**AUDIO REFLECTIONS**, Leeds, Tel: Simon Trickett 0113 3873609 or John Bleakley 0113 2049458, Fax: 0113 2533098, Email: info@audioreflexions.co.uk Providing the best Hi-Fi and AV products from the leading

manufacturers. Audionet, Audio Synthesis, ATC, AVI, Ayre, Bryston, Chord, Chord cables, Clearaudio, Gamut, Lexicon, Lyra, Nordost, Primare, PSAudio, PMC, Red Rose, REL, Revel, SME, Stax, TAGMcLaren, Tom Evans, Wadia, Wilson Benesch. Please ring for friendly advice and to book a demonstration. Home demonstrations welcomed. Ring day or evening, 7 days a week before 9pm. Major credit cards accepted. Part exchange available. Established 1988.

**SCOTLAND**

**LOUD & CLEAR**, now in Glasgow and Edinburgh, find out more at www.loud-clear.co.uk. Scotland's finest and friendliest Hi-Fi stores, combining knowledgeable advice with specially selected products and exceptional customer service. Comfortable hi-fi and home cinema demonstration rooms, dedicated multi-room and home cinema installation team, full service and repair facilities. Naim Audio, DNM, Crimson, Primare, Musical Fidelity, Tag McLaren, Rega, NAD, Marantz, Denon, ProAc, Kef Reference, Living Voice, Ruark, Dali, Monitor Audio, Tannoy, JM Labs, VDH, Nordost, Chord Co, Ash Design, Optimum, Quadraspire, etc. etc. Open Tues-Sat 10am-6pm. Thurs till 7pm. 520 St Vincent St, Finnieston, Glasgow. Tel: 0141 221 0221 and 26 Hamilton Place, Stockbridge, Edinburgh. Tel: 0131 226 6500.

**WALES**

**NORTH WALES**

**ACOUSTICA**, 17 Hoole Rd, Chester CH2 3NH. Tel: 01244 344227. See our main entry under Cheshire.

**ACTON GATE AUDIO**, 4 Ruabon Rd., Wrexham. Tel: 01978 364500. Demonstration room, installation service. Easy parking and motorway access. Mastercard, Visa etc. See main entry under Cheshire.

To advertise in the

**HI-FI CHOICE**

Dealer Directory

call **Stuart Harris on**

**01225 442244**

ext **2221**

**TODAY!**



# HI-FI CHOICE MAX YOUR MUSIC

## IN NEXT MONTH'S ISSUE

**In-depth reviews of the most vital kit:**

- » The world's most rigorous CD player group test
- » Naim for less – new entry-level kit rated
- » Hot flagship headphones from Sennheiser
- » Tannoy's new dual concentric Eyris speakers
- » HDMI-equipped universal players compared

**PLUS!! FREE LINN RECORDS CD!!**

**and much, much more!**

**ISSUE 252 ON SALE 20 FEBRUARY**

**PASSION FOR SOUND**

**RESERVE  
YOUR COPY  
NOW!**



DECEMBER 2003/ISSUE 248

- Ultimate Group Test: DVD-A/SACD
- Roksan Radius 5 turntable
- Sony SCD-XA3000ES SACD player
- B&W 704 loudspeaker

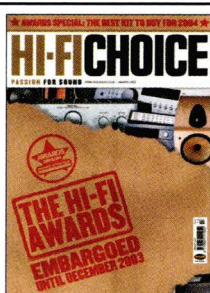

JANUARY 2004/ISSUE 249

- Special Awards Issue!
- The year's best Source Components
- The year's best Amplifiers
- The year's best Speakers... and more!



FEBRUARY 2004/ISSUE 250

- Ultimate Group Test: Loudspeakers
- Denon DVD-A11 universal player
- Arcam A90 & P90/3 amplifiers
- Marantz CD7300 CD player

## HI-FI CHOICE BACK ISSUES

Back issues from January 2000 onwards are available by mail order. They cost £4.00 (UK) or £6.95 (overseas). Both prices include p&p. You can order by phone on:

**0870 444 8650**

**ORDER A REVIEW REPRINT:** If you're interested in an HFC review of an older component and the back issue has sold out, we can usually send photocopies of individual reviews to any UK address for a flat fee (inc. p&p) of £5 per review. You must know in which issue the original review appeared; we are unable to search back issues for old reviews. Send a written request, enclosing a cheque for £5 made payable to Future Publishing Ltd, to: Hi-Fi Choice Reprint Service, Future Publishing Ltd, 99 Baker Street, London W1U 6FP. **PLEASE NOTE:** THIS SERVICE IS ONLY FOR OTHERWISE UNOBTAINABLE REVIEWS.

# HI-FI EXTREME



**“Ice hockey pucks can improve bass solidity and give better integration of highs and lows.”**

with more depth while the sound stage becomes wider and taller.

**5 The cushion that cares** Place spikes under your equipment, then put it on a piece of MDF. Place haemorrhoid cushion under the board and inflate. Don't put too much air in it – just enough to 'float' the board. Place whole thing on equipment rack. Claimed improvement: articulation, punch... all the audiophile jargon you have ever read is improved through this isolation tweak.

**6 Make it gel** Go to chemist and buy medical gel pads. Place them under hi-fi components. Claimed improvement (user): "I had one in the freezer, thawed it out and placed it under my DVD player. Before I did this, due to insane bass levels from two subs in my listening room, my DVD player was skipping like crazy. After I placed the pad under the player it has never skipped, even at the loudest and most vibrating bass volumes".

**7 Out of the box** If you have the boxes your floorstanding speakers came in, empty out the chunks of packaging polystyrene and cut them into slabs (preferably 2cm thick) the same size as the base of each speaker. Stand the speakers on polystyrene. Claimed improvement: this tweak gives a really noticeable improvement to the overall fullness and lushness of sound, especially with budget-priced floorstanding speakers.

**8 Puckering up** Pay a visit to your nearest sporting goods shop and purchase about 16 ice hockey pucks. Place them under CD player, amp etc. Claimed improvement: Sometimes improves bass solidity and gives a more relaxed presentation with better integration of highs and lows. Depends on the weight of component and type of stand/support used. Results are inconsistent – it doesn't improve sound in every situation, but it is cheap. **HFC**

## Super tweakin'

*David Vivian explores the far side of well-meaning, but frankly bizarre hi-fi tweakery*

**R**eady to go beyond the far side once more? All over the world, hi-fi lovers with too much time on their hands have been dreaming up new and yet more obscure ways of harnessing the unsuspected power of the cupboard under the stairs and the more embarrassing areas of their local chemists in the never-ending search for musical nirvana.

As ever, I submit these tweaks without modification and largely without comment. They are, as far as I'm aware, completely genuine and were devised without the help of psychotropic drugs.

**1 Marbelous** Place four common glass marbles of the same size under the four corners of your CD player or DAC. Claimed improvement: helps focus images in sound stage. (How you stop your CD player rolling away isn't explained).

**2 Like a coiled spring** Mount your speaker cabinets on three or four engine valve springs

salvaged from a scrapyard. The stiffness of the springs should suit the weight of the cabinet. The claimed improvement is that it sounds different to cones.

**3 Put a lid on it** To make your low-cost record clamp, start with any plastic screw lid from a coffee or mayonnaise jar about three to four inches in diameter. Cut out a hole in the centre with a hole maker just a bit smaller than the spindle on your turntable. Clamp down by pressing on the centre of the clamp at all points around the spindle. Claimed improvement: helps eliminate the transfer of airborne vibration and record warps.

**4 Take care of your feet** Buy two pumice stones from the chemist (Dr Scholl foot beauty stone if you're feeling flush). Break each in half, so you have four equal pieces. Place one under each foot of your CD player. Claimed improvement: acts like expensive vibration pads. Sound is much cleaner, more detailed,

## Outstanding speakers that don't stand out The new B&W FPM Series

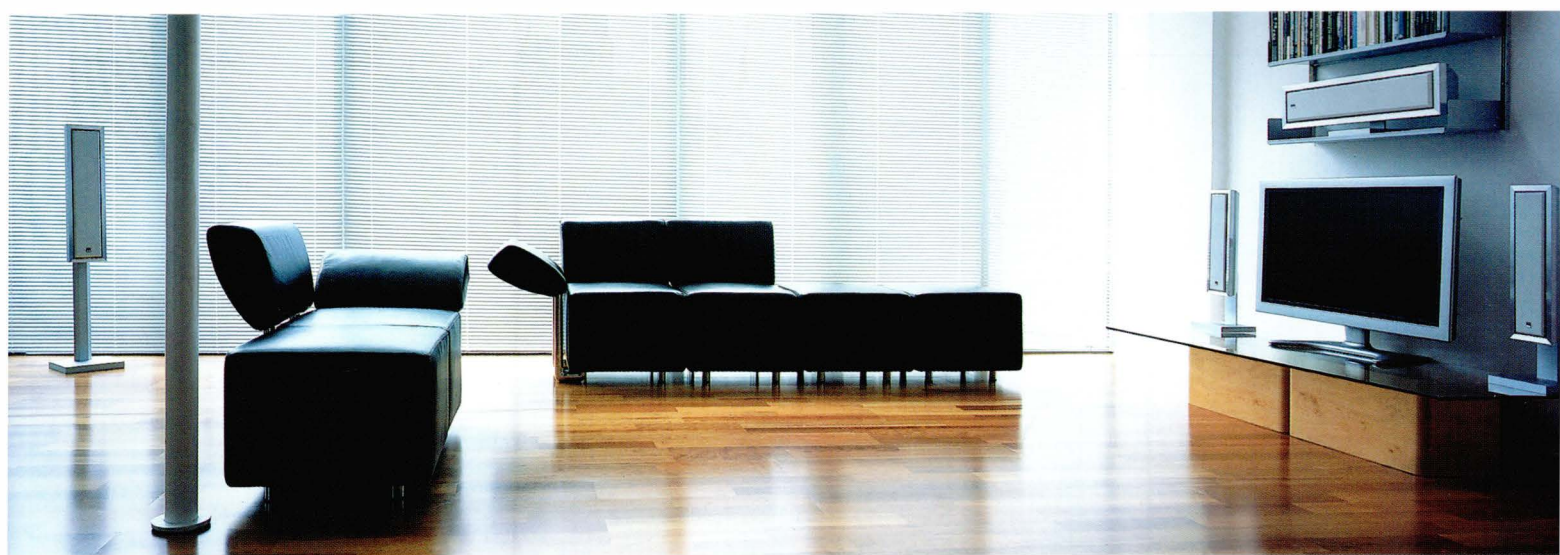

Bowers & Wilkins' new range of Flat Panel Monitors provide B&W sound quality in stunning, streamlined, contemporary cabinets. Designed to complement 42", 50" and 60" flat panel monitors, the FPM4, FPM5 and FPM6 possess a level of poise and elegance all too rare in high-end home theatre and audio components.

Hear these outstanding new speakers at your authorised B&W dealer.



[www.bwflatspeakers.com](http://www.bwflatspeakers.com)

For your virtual tour of the B&W Flat Panel Monitor Series please visit our site, or call +44 (0)1903 221 500



#### **Cyrus 8**

"A massive sonic step forward over its predecessor and most of the competition."

What Hi Fi Sound and Vision (Apr 03)

★★★★★ Group Test Winner

#### **CD6**

"The pinnacle of £600 CD replay."

What Hi Fi Sound and Vision (Sept 03)

★★★★★ Group Test Winner

#### **CD8**

"Class leading levels of detail."

What Hi Fi Sound and Vision (Sep 03)

★★★★★

#### **Pre X / Mono X**

"Worthy of true audiophile status....highly musical and satisfying performance."

Hi Fi Plus (issue 25, Aug 03)

The internationally acclaimed 8 series from Cyrus delivers stunning pictures and audiophile sound. Our elegant, hand-finished units and range of equipment racks complement the most style-conscious loft or traditional country home, concealing wires and clutter. Carefully planned upgrade options maximise your initial investment, even many years later.

Audition our exciting new 6, 8 and X series components (including the new DAC X decoder) and Cyruslink – the next generation of wireless home audio networking systems – at your local Cyrus dealership.

Further details are available on our website.

# CYRUS

**Advanced Audio and Video Systems**

Cyrus Electronics  
Huntingdon, Cambridgeshire, PE29 6XY

Tel: +44 (0)1480 435577  
Fax: +44 (0)1480 437715  
email: [info@cyrusaudio.com](mailto:info@cyrusaudio.com)

[www.cyrusaudio.com](http://www.cyrusaudio.com)