

# HI-FI CHOICE

THE WORLD'S No. 1 GUIDE  
TO BUYING HI-FI

114 CARTRIDGES  
- SUMMARISED

SYSTEM TWEAKING  
IN PERSPECTIVE

CD OFFER  
SAVE £5 ON DMP JAZZ CDs

134 LOUDSPEAKERS  
- SUMMARISED

144 AMPLIFIERS  
- SUMMARISED

SOFTWARE SELL  
- FOCUS ON RETAILING

30 CASSETTE TAPES  
- TESTED

## COMPETITION

OVER  
**£5000**  
WORTH OF  
**MARANTZ**  
**HI-FI**  
MUST BE WON!

72 CD PLAYERS  
- SUMMARISED

OVER 25 CASSETTE DECKS UNDER REVIEW  
TEST SUMMARIES ON OVER 850 HI-FI PRODUCTS

# A NEW RANGE OF SONY TAPES. WHAT YOU SEE IS WHAT YOU GET.



When you make a recording you want it to sound as close as possible to the original. A statement of the obvious? You might not think so when you listen to some tapes.

That's why Sony have launched a new range of 8 audio cassettes. Every single one, whether it's top of the range Metal-ES or the world favourite HF has been carefully designed and engineered to give you the ultimate in performance in its category, including higher levels of retentivity and coercivity so not only do your recordings capture the original but having captured it, they keep it

And it's not just the sound that sets Sony's

new range apart, they also look special. But, it's a look with a purpose. The Metal-ES, UX Pro, UX-ES and UX-S all benefit from the new Infinity Shaped shell, which, apart from looking rather nice, makes them much tougher, gives the tapes a steady even flow over the heads and reduces modulation noise to a minimum.

And not to be left out, the UX, HF-ES and the HF-S all have a new wide window so you can see exactly where you are on the tape and the HF has the widest window of the lot, because the whole cassette is clear - just like the sound. Just another way of saying 'what you see is what you get.'



**SONY**

THE WORLD'S No.1 GUIDE TO BUYING HI-FI  
**HI-FI CHOICE**  
ISSUE NUMBER 69: APRIL 1989

EDITOR:

John Bamford

CONSULTANT EDITOR

Paul Messenger

ASSISTANT EDITOR

Jane Hadley

STAFF WRITERS

Daniel Houston, Jason Kennedy

CONTRIBUTORS

Paul Miller, Alvin Gold

PHOTOGRAPHY

Chris Richardson

DESIGN CONSULTANT

David Whelan

ART EDITOR

Kerry Gormley

ADVERTISEMENT MANAGER

David Reynolds

ASSISTANT ADVERTISEMENT MANAGER

Lawrence Merritt

ADVERTISEMENT EXECUTIVE

Cindy Forde

ADVERTISEMENT PRODUCTION MANAGER

Clare Leggett

ADVERTISEMENT DIRECTOR

Alistair Ramsey

PRODUCTION MANAGER

Judith Middleton

MARKETING MANAGER

Bryan Denyer

ASSISTANT MARKETING MANAGER

Katrina Edmonson

CIRCULATION CONTROLLER

June Smith

PUBLISHING DIRECTOR

Marianne McNicholas

FINANCE DIRECTOR

Colin Crawford

MANAGING DIRECTOR

Stephen England

CHAIRMAN

Felix Dennis

PUBLISHED by Dennis Publishing Ltd,  
14 Rathbone Place, London W1P 1DE. Tel: 01-631 1433.  
Telex: 8954139 DENNIS G. Fax: 01-436 0350

Company registered in England.

REPRO: Graphic Ideas.

TYPESET by: Time Graphics Ltd.

PRINTED by: Riverside Press.

DISTRIBUTED by: SM Distribution,  
6 Leigham Court Road, Streatham, London SW16 2PG.  
Tel: 01-677 8111.

A



PUBLICATION

Enquiries regarding the content of this journal should be made in writing to *Hi-Fi Choice* Editorial, 14 Rathbone Place, London W1P 1DE. We regret enquiries cannot be dealt with by telephone. While every care has been taken in the preparation of this journal, the publishers cannot be held responsible for the accuracy of the information herein, or any consequence arising from them. Readers should note that all judgements have been made in the context of equipment available to *Hi-Fi Choice* at the time of review, and that 'value for money' comments are based on UK prices at the time of review, which are subject to fluctuation and are only applicable to the UK market. This edition © 1989, Felden productions. ISSN No. 0955 111 5.

# MENU

# W

hen you consider the convenience of the compact cassette tape, it's no wonder that it has become the most popular music storage medium worldwide. Of course, most of us realise that the sound quality of prerecorded music cassettes doesn't come close to that of LPs and CDs, but then not all consumers are hi-fi buffs. The tapes they buy can be played at home, played in the car, and played on the streets on personal stereos – which is exactly what gives the medium such mass-market appeal. Added to this, blank tapes are inexpensive and making up one's own music collection on cassettes is the cheapest way of building a library.

But you'll doubtless have noticed that the tapes you record at home often sound much worse when played on a friend's tape deck, and vice versa. People wrongly assume cassettes to be a 'universal medium', thinking that a tape is a tape and that it'll play on any cassette deck. Truth is, tape is the *least* universal medium of all; the tiniest difference in alignment between the heads of two cassette decks can cause all sorts of problems.

And then there's the complicated business of different tape Types. Some work well on some cassette decks, some don't. Tape Types are explained fully in this issue, along with Paul Miller's survey on thirty different examples. Notice we've avoided our usual 'Recommended' and 'Best Buy' flags on the tape reviews because choosing the best tape for your cassette deck is much more involved than simply choosing the tape which conforms most closely to the reference standards laid down by the IEC (International Electrotechnical Commission). However, hopefully Paul's reviews will point you in the right direction to finding the tape most suitable for your needs.

This month also sees the start of our fabulous free-to-enter Marantz competition. We've some gorgeous gear up for grabs and it has all got to go – so put your thinking caps on! Seeing as this is the April issue, one bright spark in the office suggested it might be a nice idea to run another competition to win a Finial *Laser Turntable* . . . (in-joke for keen observers of the hi-fi scene) but we thought the better of it in the end!

Next month's *Choice* is an action-packed instalment. Our main focus of attention is on CD players (new models keep coming faster than we can keep up with them), plus we've reviews on a bunch of receivers and a handful of miniature loudspeakers which come with matching subwoofers. Also, of course, our Marantz competition continues. Certainly an issue not to be missed!

*John Bamford*



Cover photograph  
by Chris Richardson.

THE WORLD'S No.1 GUIDE TO BUYING HI-FI

# HI-FI CHOICE

ISSUE NUMBER 69: APRIL 1989



*Stylish entertainment high above Chelsea Harbour; and below, over £5,000 worth of fabulous Marantz gear up for grabs in our three-part competition.*



## THE FRONT END

**6**

### UPDATE

Hot off the presses, news of the latest products, events and technological breakthroughs in the audio world.

**12**

### DMP COMPACT DISC OFFER

*Hi-Fi Choice* and distributor Absolute Sounds have teamed up to bring you the DMP audiophile range of Jazz CDs at £5 below retail price.

**19**

### CHOICE SESSIONS

The aural delight of the vacuum tube is further investigated with product from Audio Innovations and Audion under scrutiny, whilst JB checks out MF's DAC, the *Digilog*.

**38**

### READERS WRITE/CHOICE ANSWERS

Views and queries from audiophiles across the land – JK has the answers.

## COMPETITION

**14**

### THE HI-FI CHOICE/MARANTZ COMPETITION

Your chance to win over £5,000 of Marantz hi-fi. This month, part one, we have a *CD75/II* up for grabs plus your first chance for the big grand prize of a complete hi-fi system.

## ASPIRATIONS

**22**

### A WEALTH OF SOUND

Dan Houston visits the Chelsea 'Pagoda' topped tower and discovers a stylish system in one of its many tiers.

## FOCUS

26

### SOFTWARE SELL

Banbury boasts a branch of Ottakars, with a novel way of retailing both books and compact discs.

## PERSPECTIVES

30

### TWEAKING TACTICS

Richard Black steers his way through the murky canals of system fine tuning, and comes up with some tweaks.

## CASSETTE DECKS

42

### MARKET RESPONSE

Cassette players have been said to be the most unreliable of audio components. DMH finds out the best sellers and which ones keep rolling the longest.

45

### CHOOSING AND USING CASSETTE DECKS

Somewhere in that vast black bank of knob riddled cassette decks at your local store is the machine for you. AG gives some hints on finding it.

47

### CASSETTE DECK REVIEWS

Our man at the controls, Alvin Gold reports his findings on over 20 new cassette decks and a Grundig *Fine Arts* DAT machine.

91

### TECH TALK

Just what do the graphs and test results mean? Alvin explains.

93

### CONCLUSIONS, BEST BUYS AND RECOMMENDATIONS

An instant guide to the best of this month's test group plus our features comparison chart on over 50 cassette decks.

## CASSETTE TAPES

97

### CHOOSING AND USING CASSETTE TAPES

Paul Miller pauses, rewinds and plays back some hints on how to pick the right tape.

99

### CASSETTE TAPE REVIEWS

C30, C60, C90... Go! Our blank cassette tape survey starts here.

## THE DIRECTORY

126

**SELECTED DEALER DIRECTORY**  
Regional dealer listing for serious hi-fi in your area.

133

### THE CHOICE DIRECTORY

Our unique buyer's guide packed full with information on all the currently available equipment we've reviewed.

*Roll on separate CD transports – the Digilog (top) is ready and waiting. Centre, tweaking gets mighty serious; below, choosing the right tape for the job can be a tricky business.*

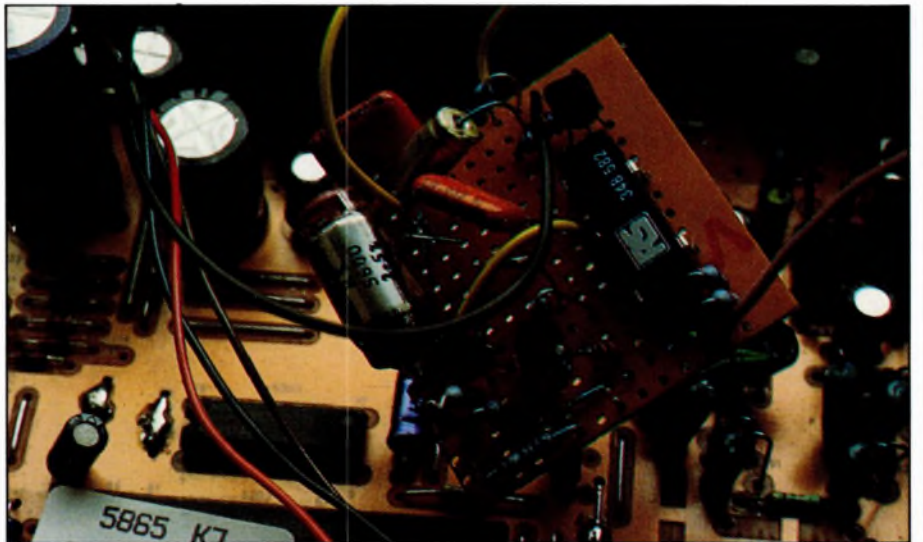

## CHOICE MATTERS

13

### COMING UP

Next month Chris Bryant checks out the latest CD players, Alvin Gold investigates the return of the receiver, JK discovers the delights of subwoofer and satellite speaker systems, and Richard Black unravels the mysteries of microelectronics. And don't forget about part two of our mega Marantz competition.

123

### BACK ISSUES

Fill in this page for back issues of the World's No. 1 Guide to buying hi-fi.

160

### PERSONAL MESSAGES

Paul Messenger bombs the bass with the Goodmans *b-max* subwoofer.



# EASTER ECSTASY!

## CLASSICS!

**FREE!** on selected classics with this coupon  
BEYER Inflatable HEADPHONES



**FREE!** BEYER HEADPHONES on this item with coupon

**£79**

**YAMAHA T09 Tuner** Crystal clear, to your ear, this sleek, highly desirable digital tuner features 2 wavebands and sixteen touch presets ●435x72x237

Full range of Yamaha stocked!



**WHAT Hi-Fi?** 1989

**FREE!** BEYER HEADPHONES on this item with coupon

**£119**

**ONKYO TA2120 Cassette deck** Computer controlled logic is at the heart of this high spec cassette deck featuring Dolby B&C NR, 7 segment peak meters and auto tape select. ●435x116x264

Full range of Onkyo stocked!



**WHAT Hi-Fi?** 1989

**BEST BUY** Hi-Fi CHOICE MAGAZINE

**FREE!** BEYER HEADPHONES on this item with coupon

**£99**

**DUAL CC8010 Cassette Deck** One of Dual's new-range components, this highly commended cassette deck is another one that speaks for itself. Featuring excellent heads and Dolby B&C NR ●440x119x245



**WHAT Hi-Fi?** 1989

**BEST BUY** Hi-Fi CHOICE MAGAZINE

**FREE!** BEYER HEADPHONES on this item with coupon

**£119**

**NAD 3020E Amplifier** The legendary 3020 in an improved 'E' form. This 20 watt stunner speaks for itself. Need we say more?? ●420x91x270

Full range of NAD stocked!



**WHAT Hi-Fi?** 1989

**BEST BUY** Hi-Fi CHOICE MAGAZINE

**FREE!** BEYER HEADPHONES on this item with coupon

**£99**

**ROTEL RA810A Amplifier** At under £100 you can't go wrong on this 20wpc classic. Impressive performance and a specially designed phono input make it a 'knock 'em dead' 'Best Buy'!

Full range of Rotel stocked!



**WHAT Hi-Fi?** 1989

**BEST BUY** Hi-Fi CHOICE MAGAZINE

**FREE!** BEYER HEADPHONES on this item with coupon

**FACTORY REPACK**

**£99**

**ARISTON Q Deck Turntable** What Hi-Fi? magazine's 'Turntable of the Year' and Hi-Fi Choice mag's 'Best Buy' the sound on this 'Q' will blow your mind with fidelity!! While stocks last... (Quality OMP10 cart only £10 extra)



**FREE!** BEYER HEADPHONES on this item with coupon

**£99**

**MARANTZ RV253 Dolby Surround Processor** Transform your lounge into an auditorium and tremendously increase the audio performance of your system with this 3D surround-sound processor. Now at a lower price than ever before. \*Connectable to most systems.

Full range of Marantz stocked!



**WHAT Hi-Fi?** 1989

**BEST BUY** Hi-Fi CHOICE MAGAZINE

**FREE!** BEYER HEADPHONES on this item with coupon

**£169**

**HITACHI FTMD5500 Tuner** Containing award-winning circuitry a mind-blowing specification and 16 touch presets this tuner's knockout performance takes care of itself! Only while stocks last. ●370x65x268

Full range of Hitachi stocked!



**FREE!** BEYER HEADPHONES on this item with coupon

**Full range of Dual stocked!**

**£114**

**DUAL CS503.1 Turntable** An old favourite, and those people at Dual keep managing to improve it. 'Virtually featureless but a great solid sound' ●440x115x363 (Cart £5 extra)



**FREE!** BEYER HEADPHONES on this item with coupon

**£169**

**MARANTZ CD883 COMPACT DISC** This fresh new addition to the Marantz range wins again, offering the same impeccable spec as the CD873, complete with FREE remote control. (also CD6511 £249.95, CD6511SE £299.95)

While you're cracking open your first Easter egg (hard boiled of course) take a peak at our fresh spring savings on a range of brilliant hi-fi deals that any self-respecting bunny would go hopping mad over.

## BARGAINS!

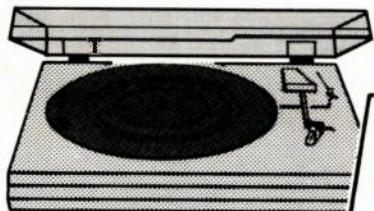

**£29**

**TENSAI TS705 Turntable** Sleek, low profile belt drive turntable featuring a DC servo motor and static balance tonearm for increased performance



**£59**

**DUAL CS410 Turntable** Brand-new to the UK, this high performance low priced Dual brings new standards to budget turntables! •(Cart £5 extra.)



**HITACHI SS28 Speakers** 50 ki/ki/kilowatts of music power - not quite, 25 watts handling sounds more realistic though, from these highly popular 2 way infinite baffle speakers!

**£19**  
Pair

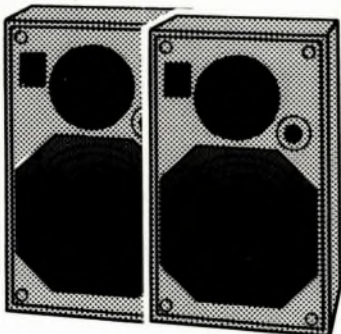

**NAD 8020E SPEAKERS** Laser-analysed computer-aided research has been utilised to produce an amazing 60 watt per channel compact classic.  
•W210xH340xD190

**£69**  
Pair

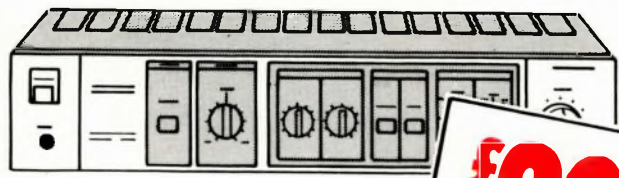

**SANYO JA220 Amplifier** 20 watts of music power! Featuring bass/treble controls, tape monitor and a respectable THD of only 0.9%, what more could one desire?? •420x80x220

**£29**

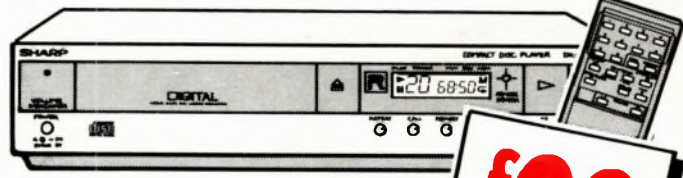

**SHARP DXR554 Compact Disc** This remarkable price isn't a misprint - our exclusive bulk-buy features 20 program memories, 16 bit technology and an infra-red remote control with variable output volume.

**£99**

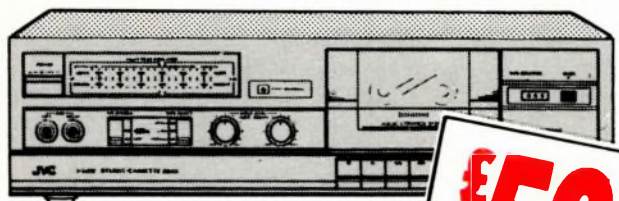

**JVC TDX102 Cassette deck** This super-value JVC deck comes equipped with Dolby B NR, metaperm heads and soft touch controls, a snip . . . but only while stocks last!

**£59**

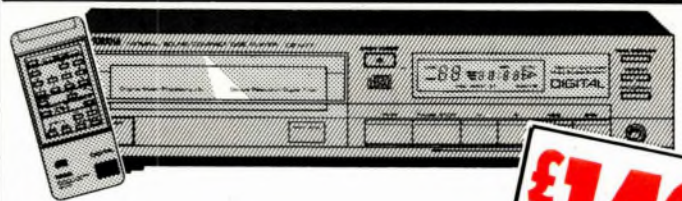

**YAMAHA CDM77 Compact Disc** Sophistication is the name of the game here. A classy, crisp sounding disc spinner that'll satisfy even Mr. Richer's ears, complete with multi-function remote control.

**£149**

**WHERE TO FIND US...**

- BIRMINGHAM:** 10 Smallbrook Queensway, B5 4EN. Tel: 021 643 1516
  - BRISTOL:** 20 Cotham Hill, BS6 6LF Tel: 0272 734397
  - CARDIFF:** 5 Central Square, CF1 1EP Tel: 0222 383311
  - EDINBURGH:** 1b Chambers Street, EH1 1HR Tel: 031 226 3544
  - LEEDS:** 55 The Headrow, LS1 6LR Tel: 0532 455717
  - LIVERPOOL:** 69B Church Street, L1 1DN Tel: 051 708 7484
  - LONDON:** 2 London Bridge Walk, SE1 2SX. Tel: 01 403 1201 (10 Lines) 01 403 4710
  - STOCKPORT:** 4 Wellington Street, SK1 3RN Tel: 061 480 1700
  - YORK:** 6 Feasegate, YO1 2SQ Tel: 0904 645535
- We are open 10-6 Mon-Fri and 10-5 Sats except London 10-7

Mon-Fri and 10-5 Sats.  
**FREE MAIL ORDER** on Classics (only) available from our Stockport branch.  
**OPEN Good Friday 24th March 12-4pm Saturday 25th Open as normal Closed Easter Sunday Easter Monday Open 12-4pm**  
 We welcome Access, Visa, Cheques and Part Exchange. Also VAT export (handling charge £2.50) All goods brand new in sealed boxes unless otherwise stated. inc. VAT and g'teard 1 year. E&OE. All stores have a clearance corner full of ex-display & secondhand bargains and browsers are definitely welcome! Please phone 061 480 1700 (24hrs) for FREE monthly 16 page price list and hi-fi guide. Don't forget: If you see our hi-fi cheaper anywhere else within 75 miles of your local branch; we'll happily beat that price on the spot by £3. (Must be in stock elsewhere at time of purchase)



# UPDATE

## PRODUCTS

### GIMME DAT

Four years' work by 35 engineers has resulted in Nakamichi's first DAT recorder – a \$5,000 two-box state-of-the-art machine designed for professional and domestic use. The launch is something of a surprise, coming at a time when informed opinion regards DAT as a white elephant as far as the consumer is concerned (not that many consumers have banks which are this sympathetic!).

However, Niro Nakamichi, who headed the design team and was in London to promote his product last month, believes his DAT player is in an altogether different class from others. Consequently he has dubbed his machine the *Nakamichi 1000 Digital Audio Recording System* conferring upon it the cachet of his original mould-breaking 3-head cassette deck of the '70s.

The new Nakamichi 1000 is a dual chassis design with one box incorporating the transport and recording functions while the other deals with the signal processing (both analogue to digital and vice versa). It is also a modular system with circuit boards which can be taken out and replaced as and when technology becomes obsolete. It comes with a remote control unit for either infra red or wired use. Other natty features justifying four years' labour include the FAST Mechanism (Fast Access Stationary Tape Guide Transport) which according to Nakamichi gives a tape loading time of just 1.9 seconds and tape rewinding of 19 seconds. Rewinding takes place in a 'half load' position reducing head and tape wear.

As a piece of flag waving for the DAT medium in general Nakamichi reckons you will get 8000 hours' worth of play from a DAT tape (on its machine) before it shows signs of wear. This is different from loss in sound quality – no-one would comment on how long DAT tapes would last before going "off



Two-box DAT – one for each of your massive pockets.

song". But the promotion team did seem confident that cleaning this machine is not like a conventional cassette deck; Nakamichi supplies a DAT cleaning cassette which you "wouldn't use very often".

The new 1000 records at 48kHz so you can't digitally interface with a CD player (some electronic whizzkids might be saying "Oh Yeah?"), but even so the loss of 3dB or so dynamic range wouldn't cause heartache from our preliminary hearing at its launch. Nakamichi plans other, cheaper, DAT machines in the future once it has established whether or not demand for DAT is going to take off in this country. There's also a CD transport in the pipeline which would hook up to the 1000 *System*, flexibility being touted as the name of the game.

### STATE OF THE ART

Audio Technica has announced the long-awaited *AT-ART1* cartridge, an \$800 flagship model, which to quote AT is 'designed to push back the boundaries of analogue reproduction'. The name *ART* stands for Audio Reference Transducer, which may sound a bit pretentious, but if the *OC-7* and *9* are considered this new beast may well be something of a giant.

The features of this moving coil design include a titanium body with a compound rubber lower half for elimination of internal resonance, *PCOCC6N* coils (which indicates a copper purity of 99.99996 per cent) in a ceramic VC mold, boron cantilever and a micro linear stylus. Combine these factors together and according to Audio Technica you have a resonance-free 9gm cartridge with a 0.35mV output that will give the established references a serious headache. The *AT-ART1* should be in specialist shops by mid April.

### BETTER MIDIS?

Aiwa is excited about a new technological development

shortly to be used in its range of midi systems. The firm has the patent on a processing system which it claims reduces distortion by ensuring a clearer signal transfer from amplifier to loudspeaker, thereby enhancing clarity and bass in domestic hi-fi. The development, named BBE after Barcus Berry Electronics Inc (of California), features on Aiwa's \$479 *X77* CD midi system available now. The remote control *X77* has an on/off switch and pot to allow fine tuning of the BBE function.

Aiwa touts BBE as being to amplifiers what Dolby *HX Pro* has been to cassette decks and hopes (of course) that it will soon be established on all amplifiers, even though the company doesn't make any amps itself. Although

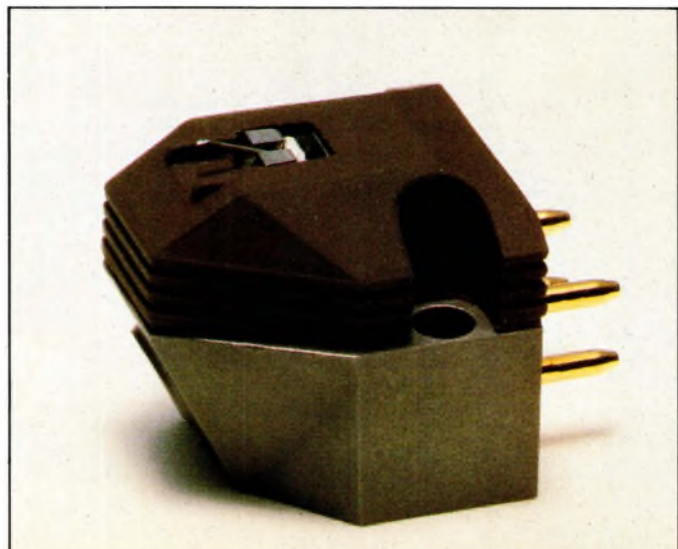



recognised in the professional side of hardware, and used by musicians at live gigs and recording sessions, this is said to be the first time BBE has been used in the domestic market. However, an Aiwa spokesperson said that BBE may be regarded as just the latest gadget or widget and commented that they "would not like to comment on where BBE stood in the more established spheres of hi-fi."

## TALL BOY

Celestion's new floor-standing three way loudspeaker has been designed for those with large or 'acoustically difficult' rooms. The £349 *DL12 Series Two* model is available from April and according to Celestion optimises the technology of the existing *DL* series. Two eight-inch bass drivers and a one-inch titanium dome tweeter have pushed the *DL12*'s sensitivity up to a claimed 90dB. The braced 18mm high-density particle board cabinet is divided internally to avoid interaction between the two bass/mid drivers which operate in separate 19 litre chambers. Other details for your money include gold-plated binding terminals for cable or 4mm plugs.

## GET PERSONAL

A trio of new Aiwa persons coming onto the market offer features unheard of a couple of years ago in their price brackets. The cheapest, £30 *HS-G34*, model offers two way auto reverse,

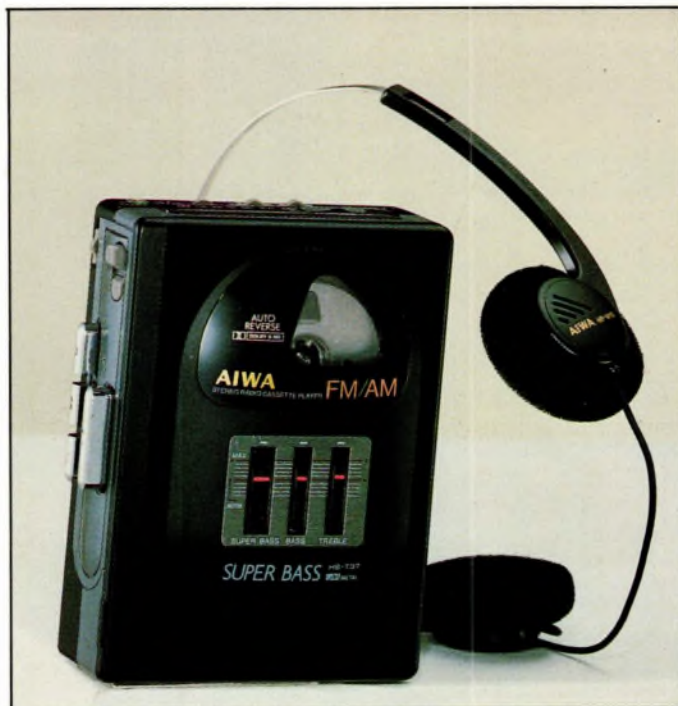

For your ears only: Aiwa's HS-T37.

super bass, and tone controls, rechargeable ni-cad batteries and an anti-rolling mechanism. For £35 you can have all this and Dolby B in the *HS-G37* while at £70 *HST37* offers higher quality sound and a built in AM/FM tuner.

## THE FINAL FRONTIER

Space Acoustics has announced the *Space Deck* turntable and *Space 50's* loudspeaker. The turntable was first spotted at last year's Penta show and bears a

strong resemblance to the Omega Point which was designed by the same person – Tom Fletcher. The *Space Deck* uses a plastic coated alloy platter, inverted bearing and a height adjustable armboard which allows VTA tweaking of fixed height arms. In other respects this £550 deck is quite simple with manual speed change and has no springs to go out of tune.

The *Space 50's* loudspeaker is a floor standing two-way design that is nearly triangular in section and primarily intended for corner placement (although it will also work in free space), it utilises a hardwired crossover that is split to allow bi-wiring. Finished in black ash veneer its sensitivity is quoted as being 89dB/W. Space Acoustics, 128 Cordy Lane, Underwood, Nottingham NG16 5FD. Telephone: (0773) 762947.

## TWO IN ONE

In keeping with a rash of receivers hitting the marketplace at the moment Teac has launched a £199 AM/FM offering. *AG-55* is a remote control 'system starter' with inputs for VCR/TV as well as the normal (CD, tape and phono) options. It also boasts a seven band graphic equaliser for those particular about their tone control.

## ANDROMEDA II ARRIVES

American high end specialist Sumo has announced two new products – the *Aria* loudspeaker (£1,950) which was first seen at last year's Penta Show and the *Andromeda II* power amplifier (£1,500). The *Aria* is unusual in as much as it is a planar speaker that acts as a virtual point source (see picture on page 9); it uses a single stretched polyester membrane which is driven over a small area at its centre. Being a full range design it requires no crossover and avoids the problems that such devices can cause. Its strengths are said to be openness, coherence and very impressive imaging whilst its only apparent drawback is relatively poor sensitivity – around 86-87dB/W.

The *Andromeda II*, as its macho name suggests, is a high powered (200watt) stereo power amplifier which is said to deliver a peak current of 200 amperes! Operating in class AB it is a balanced design that has only 10dB of negative feedback said to give inherent stability, wide bandwidth and low distortion. In a bid to attain a higher profile over here Sumo is setting up a subsidiary company, Sumo Europe, in the UK. It will be managed by its present



On the floor: the more sensitive Celestion.



Beam me up to the Space Deck Scotty!

distributor Dennis Wratten of Acoustic Gold who also handles Primare and ATC products.

## SPEND MORE

A tri-wireable loudspeaker has been launched by Spondor at a premium of £1,100.

The 70cm high *S100* reflex speaker is said to build upon the characteristics of the *SP1* but offers extended bass response and power handling. The driver complement consists of 12 and six inch units for the bass and midrange respectively while (hopping into French now) a 19mm soft-domed unit does the tweeting. Real wood veneers help to push up the price and attractiveness of this loudspeaker which is the first from the 1989 Spondor stable.

Spondor Audio Systems, Hailsham. (0323) 843474.

## ACCEPT NO SUBSTITUTES

Goldmund of Switzerland, best known for its exotic turntables, has officially announced the *Apalogue*, an equally exotic loudspeaker. This exquisitely finished black lacquered design follows the Goldmund turntable tradition of big is beautiful, each *Apalogue* being six feet tall and made up of five separate boxes, two woofers, one midrange and two tweeters held in a sloping frame. It uses two very complex 700 element (!) crossovers and offers an extraordinary efficiency of 100dB/W, which will allow the use of low powered amps.

The unusual aesthetic appearance of the *Apalogue* is due to the design input of Italian designer and painter Claudio Rotta-Loria whose signature will grace each of the 300 pairs to be made. The price is of the 'if you have to ask you can't afford it' nature but Goldmund anticipate something in the region of \$50,000. Start saving...

## SOMETHING FOR NOTHING?

While high streets become ghostly with shoppers staying home to calculate how much extra their mortgage will cost this month Philips is offering free CD mini libraries with its equipment. This incentive to buy while the market flattens out covers Philips' *Series 7* and *F8* CD midi systems and all separate CD players. System purchasers get eight discs from the Philips Audio Gallery (Phonogram) while purchasing a standalone CD

player gets you any three. A spokesman said the titles were all pukka; covering pop, jazz, soul and classics numbers from the '60s and '70s, plus Dire Straits' compilation *Money for Nothing*. "They're all major artists - it's not Japanese singing the Beatles or anything," he reassured. Better hop to it though - offer closes March 31st.

## TOBLERONE SOUND

Break off a piece of this! It's not a new concept but Stereolith believes its latest one-box stereo loudspeaker is a real breakthrough in terms of soundstaging.

Dubbed *Duetto* the speaker incorporates three pairs of drivers set either side of a triangular prism-shaped cabinet. It projects a soundstage in both horizontal and vertical planes according to its maker, Walter Shupbach, a Swiss who spent 15 years R&D on the project. It can be sited at floor level or hung from the ceiling and apparently does not create a sweet spot; you can have many favourite chairs.

*Duetto* comes in black and white finishes costing \$416 for matt and \$629 for lacquered versions. It is distributed by FWO Bauch Ltd, Borehamwood, Herts. Tel: (01) 953 0091.

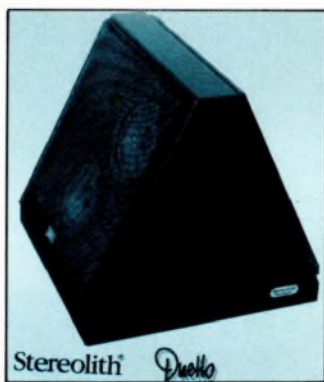

Ready to create an impression - Stereolith's *Duetto*.



Talk about decoupling. *Apalogue's* sound dispenser.

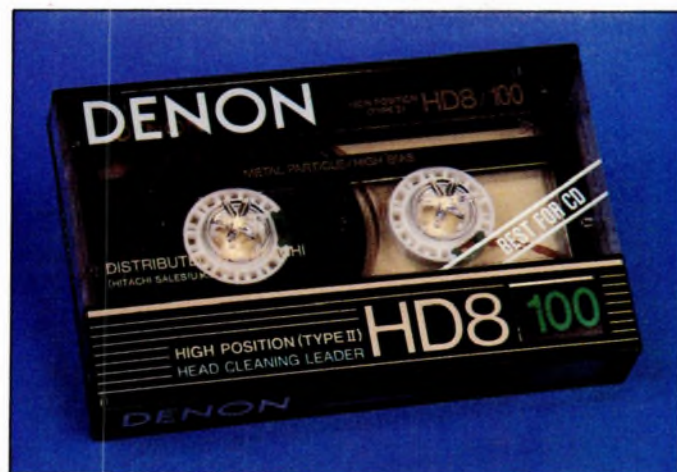

Denon and on - CD-friendly 100 minute tapes.

## GETTING IT TAPED

Readers who find it difficult cramming the contents of a CD onto a standard 90-minute cassette tape will be pleased to learn about Denon's new 100-minute cassettes. The firm has put two compact cassettes on the market, the \$3.49 metal *HD-M 100* and metal particle (high bias) *HDS-100* which retails at \$4.49 for a twin pack. Hitachi, which markets Denon tape, says *HD-M 100* is designed for professional and very high quality personal use, while the *HD 8-100* has been specifically developed to cope with the dynamic range of digital sources such as CD.

## SECOND'S OUT

A&R Cambridge has developed a second digital to analogue converter in a bid to keep ahead in this expanding field. The \$300 *Delta Black Box 2* is a more flexible version of the original *Black Box* catering for the latest CD players. It will take optical and coaxial digital inputting and contains circuitry to work at both the 44.1kHz (CD) and 48kHz (DAT) sampling frequencies. It can be hooked to DAT players and certain video disc players, and comes with 75cm lengths of *Toslink* optical fibre and copper coaxial digital interconnects. Owners of original *Black Boxes* can upgrade for \$50.

## BUSINESS

### THE NEW CAMBRIDGE

New products can be expected soon from Cambridge Audio which was recently bought out of receivership by the Hi-Fi Markets group. A 'budget' (less than £200) amplifier and a cheaper CD player are among items in the pipeline for the coming months. Andy Giles, speaking for Cambridge said the new CD

player would incorporate several functions of the acclaimed higher end models and would "represent very good value for money".

However, he added: "since takeover, the first job has been to solve the problem of long standing allegations over quality control of Cambridge product. It's all very well their (*the products*) sounding brilliant but when you twist the knob it comes off in your hand. That doesn't auger well for business so we have got to concentrate on what is out there first." This has led to changes in component sourcing for existing models, upgrading at no extra cost to the customer, he continued.

By way of correction to our news story in February we should point out that the Hi-Fi Markets bid was the highest for Cambridge Audio (some sources had said it wasn't) and therefore was the best deal from the creditors' point of view as well as that of the Cambridge workforce which mostly remained intact during the negotiations and takeover.

## LINN'S AWARD

Linn Products, maker of turntables and other audio equipment has received a Royal Institute of British Architects (RIBA) 1988 award.

The award was given for Linn's \$5m factory, designed in 1987 by Richard Rogers of Lloyds of London and the Paris Pompidou Centre fame. Occupying a 'greenfield' site eight miles south of Glasgow, it was apparently the only industrial facility chosen for an award. Flexibility in manufacturing processes plus the option of room to grow were main requirements for the factory according to Ivor Tiefenbrun, Linn's MD. He chose the Rogers partnership for their understanding of the complexity of a new kind of architecture

allowing maximum use of personnel space.

"Our aim was to be able to quadruple output with no more than 50 per cent extra staff in five years," Ivor drawled. "In one-and-a-half years here we have doubled output and only taken on ten per cent more people so we're on track to achieve our objective."

Extensive use of computers, automation systems and robotics are used at the factory which has attracted much attention from overseas businessmen. Ivor Tiefenbrun believes all future factories will be like his but so far in the British hi-fi industry only Tannoy and KEF had taken advantage of a guided tour he said.

Development of a Linn tuner and integrated amplifier, which we reported in January 1988 as on the drawing board was played down by Tiefenbrun: these products would have to be up to Linn Products' standard before a any launch date would be considered.

## AND THE SHOW GOES ON . . .

But you can't go to this one, primarily because it's a 'trade-only' show and members of the public aren't allowed in. But even if you were, you'd have to jump on a plane to Las Vegas, Nevada USA, the venue for the annual Winter Consumer Electronics Show (CES), held this year from January 7th to 10th. You don't miss out entirely, though, because *Hi-Fi Choice* asked me to have a nose around on your behalf. And what a show it was! These American CESs (there's a summer one held in Chicago every year too) attract about 100,000 visitors from all over the world and serve to promote the latest and most innovative products from over 1,400 manufacturers.

The term Consumer Electronics in the context of these shows means anything

from the most absurd and tacky electronic game to the most expensive Hollywood-shot hard-core 'adult' video tape. Hi-fi equipment, from the lowest (and I do mean lowest) to the very highest end, is included, but the serious stuff is usually demonstrated in hotel rooms, not at the gigantic Las Vegas Convention Center where the massive Japanese corporations choose to exhibit.

Broadly, although it may sound daft, there was not a great deal to see at this year's WCES, although at least one UK audio journalist came back home having had to pay excess baggage due to the amount of press-packs he'd acquired. It all comes down to whether you live in the practical world or on some esoteric planet inhabited with millionaire hi-fi buffs. The most interesting news story at the show was meant to have been the launch of the Finial Technology *LT-1 Laser Turntable*. Before the show, journalists from around the world were sent invitations to the long-awaited press launch of 'the optical turntable that employs a laser beam to play LP vinyl records'. 'The Laser Turntable is here', we were told. Well, sad to report, it wasn't and it didn't happen. Just before the show it was announced that the project had been abandoned. Spare a thought here for Dennis Wratten of Acoustic Gold, the company that was to have distributed the *LT-1* in the UK. Dennis, having spent a considerable amount of time and money promoting the turntable was clearly more than a little disappointed.

He did have one crumb of comfort, however, which came in the form of the Sumo *Aria* loudspeaker which Acoustic Gold will market in the UK.

British loudspeaker companies continue to flourish in the United States. Celestion has its own company there and was well represented at the show (the new *Celestion 3* featuring prominently), as does KEF,

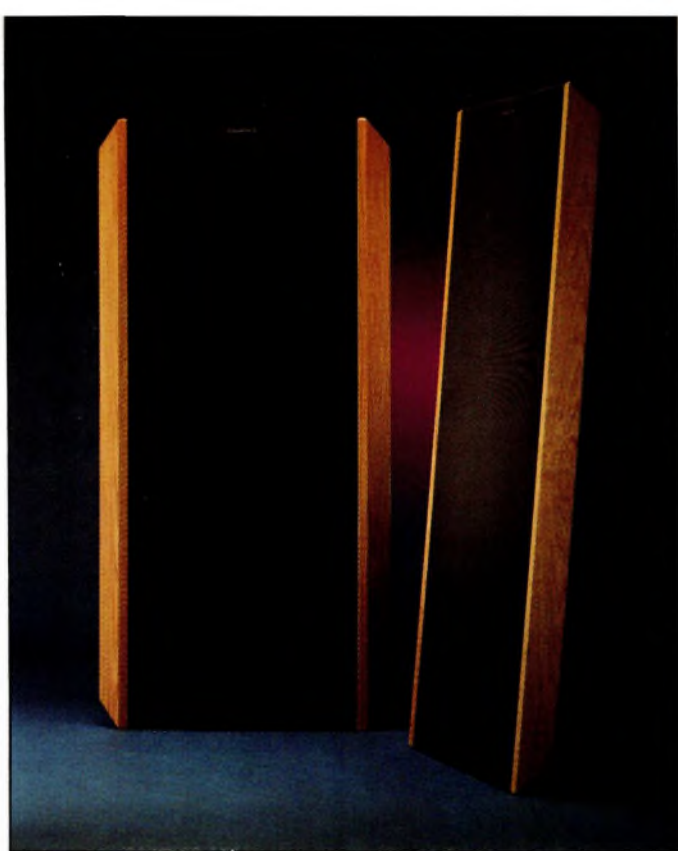

*Aria in stereo? A first from Sumo. Celestion 3 (below).*

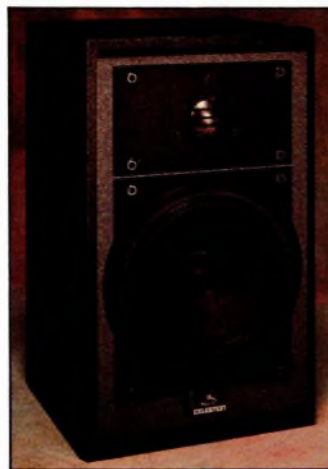

currently enjoying tremendous success with the newly launched *C-Series* in the States. Also, it was good to see Monitor Audio in Las Vegas, showing the *Reference 1200 Gold* speaker previously shown at the Penta show.

Tannoy, Mordaunt-Short, B&W, Mission, and Wharfedale were all there, flying the British flag.

At the high end, Krell proudly launched a new CD player, a two-box, top-loading affair that will set you back a cool \$10,000. That seems to be a popular price point, as Nakamichi, putting two fingers up to the record companies, were showing a remarkable product, the \$10,000 Nakamichi *1000* two-box DAT recorder which records at all sampling frequencies – making the direct recording of a compact disc relatively simple. (But it seems this version won't be made available to the general public – Ed.)

Everybody seemed to have some form of surround-sound system – it really is big in the States – and smart looking audio-visual set-ups heavily outnumbered the conventional and hi-fi purist source/amp/speaker approach to enjoying music.

Now that CD is firmly established and people are still not quite sure about what's happening with DAT, it seems likely that a major technological break-through in the world of hi-fi is not due for a number of years. Pity – that Laser Turntable would have been most welcome!

Andy Giles

## IN BRIEF

Foundation stands are down in price. The *18i2* and *21iB* stands now retail at £69 unfilled or £99 filled. Foundation's *Sir Fred* filler pack brings back those happy days at the beach for 18.95.

Woodside Electronics' Radford valve amplifiers are now distributed by Acoustic Arts of Watford. Latest product is the £1,115 *STA35*, a slimmer upgrade of the *STA25*.

Two musical evenings featuring new Absolute Sounds gear will be held by Oxford Audio Consultants in April. Krell and Apogee will play on the 17th with Audio Research and Magneplanar on the 24th. Tickets: (0865) 790879.

Grahams Hi-Fi, the well-known Pentonville Road specialist dealer has moved. Grahams' new address is Canonbury Yard, 190A New North Road, London N1 7BS. Tel: (01) 226 5500.



*Robots in the greensward: Linn's factory.*

Your ears tell you it's British, your eyes tell you it's not. Which do you trust?

A dilemma facing any discerning hi-fi buff when hearing our ES separates for the first time.



CDP 557 ES

This unnerving experience should be blamed on the team of top British audio engineers and consultants who helped us develop our ES range.

For Sony to use the best hi-fi specialists in the World (the British), to satisfy the most demanding hi-fi enthusiasts in the World (the British), is cheating you might say.

Maybe. But there's definitely no cheating on what goes into our equipment.

Both the CD player and the amplifier featured for example, have Gibraltar chassis. (Rock solid bases that keep vibration and magnetic interference to an absolute minimum.)



TCK 700 ES

Both have 18-bit linear converters with eight-times oversampling. (To save you looking through reams of competitive specifications, that's the best there is.) In fact, we've gone to extraordinary lengths to keep sound signals pure.

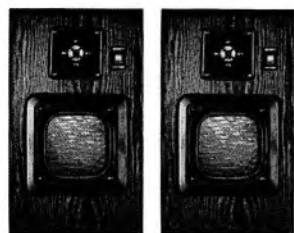

APM 12 ES

The CD player is copper shielded, its loading tray acoustically sealed. The tape deck is divided

into three compartments (all shielded), with equal weight distributed on each foot to reduce vibration. The tuner (What Hi-Fi 'Tuner of the Year' Award 1989) has AM circuitry specifically designed for the UK's medium and long wave bands.



STS 700 ES

Lastly, the loudspeakers have titanium tweeters to improve treble and a reflex design for more accurate bass.

**IF IT WASN'T FOR ONE SMALL DETAIL  
YOU'D THINK OUR  
HI-FI SEPARATES WERE BRITISH.**

All these measures would be pointless, though, if you skimped on cable. We don't.

Our phono leads have gold plated connectors to improve the flow, and we spot weld them onto the cable (instead of using 'sound tarnishing' soldering like some people).

Both phono and speaker cables are made of linear crystal, oxygen free copper. They offer a lack of resistance so negligible that unless you accidentally trip over them, you'll forget they're even there.



TAF 450 ES

To hear some pure, unadulterated sound, have a listen to Sony ES separates at one of the dealers overleaf. And remember. Their origins may be Japanese, but their pedigree is essentially British.

**SONY ES**



# DMP CD OFFER

Special offer to Hi-Fi Choice readers. Save £5 on DMP compact discs.

Digital Music Products is a CD-only jazz label imported from the USA by leading audio specialist Absolute Sounds. As an introduction to the superb quality of DMP CDs, *Hi-Fi Choice* is offering its readers DMP CDs at a special price of £13.00 each, £5 off the recommended retail price.

As part of its exclusive deal with *Hi-Fi Choice*, Absolute Sounds is offering automatic free membership of the DMP Club as soon as you place an order for a DMP CD.

Membership of the DMP Club entitles you to:

- Select any of the CDs in the DMP catalogue at special discount prices.
- First option on all new DMP releases.
- DMP's quarterly newsletter, which keeps you up to date on all the new releases, live tours, and forthcoming projects by DMP artists. The newsletter also features regular competitions in which you could stand to win any number of the hi-fi accessories distributed by Absolute Sounds.

**CD-443: TriCycle, Flim & the BB's**  
Voted best jazz CD of 1985 by readers of Digital Audio in the US, combining pop melodies and jazz improvisation. Arguably the definitive DMP album, TriCycle has become a standard demo CD for stretching hi-fi loudspeakers to their limits.

**CD-447: Tunnel, Flim & the BB's**  
Flim & the BB's second album for DMP voted best jazz CD of 1986 by readers of Digital Audio magazine. A collection of joyful, melodic songs superbly played and recorded.

**CD-451: Incredible Journey, Bob Mintzer Big Band**  
A must for all jazz and big band lovers, Incredible Journey features Mintzer supported by some of America's finest jazz musicians – including Michael and Randy Brecker, Peter Erskine, Lawrence Feldman and Marvin Stamm.

**CD-453: NY Cats Direct, John Tropea**

Brilliant New York guitarist John Tropea plays bluesy, improvisational jazz which alternates between thoughtful, melodic passages and electrifying blues solos. Supporting musicians include Steve Gadd and David Spinozza.

**CD-454: Big Notes, Flim & the BB's**

Another tour-de-force from jazz quartet Flim & the BB's. Superb sound, joyous, uplifting music – and . . . (yup, you guessed it) . . . voted best jazz CD of 1987 by readers of Digital Audio magazine.

**CD-455: Lighthouse, Billy Barber**

One of the most popular DMP recordings, and rightly so – Barber's second album for DMP is full of beautiful melodies and heartfelt tunes. Barber's piano playing is stunning, accompanied throughout by an array of imaginative keyboard and synthesizer sounds.

**CD-459: Brazilians, Manfredo Fest**

Blind-from-birth jazz legend, Manfredo Fest returns to the world of recording with this stunning CD invested with the rhythms and melodies of Brazilian jazz. Fest's piano playing throughout is inspired, as are the pure vocals of Roberta Davis.

**CD-460: Thom Rotella Band, Thom Rotella**

DMP discovery Thom Rotella combines melodic acoustic guitar with funky electric solos on this mainstream jazz CD. Great sound – the recording was a prototype for one of the first Sony R-DAT demos.

**CD-461: Spectrum, Bob Mintzer**  
Spectrum is still fired with the big band sound of Mintzer's earlier DMP albums, but also sees the acclaimed saxophonist and composer experimenting with quintet and quartet arrangements. A superb collection.

**CD-462: The Further Adventures of Flim & the BB's, Flim & the BB's**

The BB's fifth album for DMP and perhaps their best to date. Once

again the band's characteristic blend of dynamic jazz, driving rhythms and pop melodies combine to form a memorable collection of songs.



## TO ORDER DMP COMPACT DISCS

(Tick selections)

- CD-443: TriCycle, Flim & the BB's
- CD-447: Tunnel, Flim & the BB's
- CD-451: Incredible Journey, Bob Mintzer Big Band
- CD-453: NY Cats Direct, John Tropea
- CD-454: Big Notes, Flim & the BB's
- CD-455: Lighthouse, Billy Barber
- CD-459: Brazilians, Manfredo Fest
- CD-460: Thom Rotella Band, Thom Rotella
- CD-461: Spectrum, Bob Mintzer
- CD-462: The Further Adventures of Flim & the BB's, Flim & the BB's

## PAYMENT

- I enclose my cheque/PO made payable to Dennis Publishing for \_\_\_\_\_ selections at £13.00 each  
Total \_\_\_\_\_
- Please charge my Access/Barclaycard/American Express/Diners Mastercharge (delete as appropriate)

Credit card number \_\_\_\_\_

Expiry date \_\_\_\_\_

Signature \_\_\_\_\_

Name \_\_\_\_\_

Address \_\_\_\_\_

Postcode \_\_\_\_\_  
HFC 69

Please send order form with payment to:  
Hi-Fi Choice Mail Order  
PO Box 320  
London N21 2NB

DON'T MISS NEXT  
MONTH'S ISSUE OF

# HI-FI CHOICE

PACKED WITH  
IN-DEPTH REVIEWS!



## 30 CD PLAYERS ON TEST

Including the latest from  
**DENON, SONY, TEAC**  
and many others.

Our Market Survey investigates the  
dealers' views on the current state of  
the Compact Disc player market  
**PLUS . . .**

ALVIN GOLD REVIEWS RECEIVERS,  
RICHARD BLACK EXPLORES MICRO  
ELECTRONICS AND JASON KENNEDY  
LISTENS TO SATELLITES AND SUBWOOFERS  
**PLUS . . .**

**NEWS, VIEWS, AND MUCH, MUCH MORE.**

# HI-FI CHOICE

MAY ISSUE ON SALE APRIL 14th

## ES SEPARATE STOCKISTS.

**London:** Atlantic Electronics, 295-297 High Road, Willesden

Doug Brady Hi-Fi, 18 Monmouth Street, Covent Garden

Covent Garden Records, 84 Charing Cross Road

Harrods Ltd, Knightsbridge, Brompton Road

Massey Radio, 117 Chiswick High Road, Chiswick

Nicholls Hi-Fi, 430-434 Lee High Road

PNR AudioVision, 28 Tottenham Court Road

H.I. Smith, 287 Edgware Road

Sound Sense, 350 Edgware Road

Weibeck Video Plc, 26 Tottenham Court Road

**Southern England:** Absolute Sound & Video Ltd, 4 Feather Lane, Basingsloke, Hants

Esiricon Sony Centre, Unit 46, Eastgate Int Shop Ctr, Basildon, Essex

Bexleyheath Sony Centre, 118 Broacway, Bexleyheath, Kent

Bournemouth Sony Centre, Westover Road, Bournemouth, Dorset

Bowers & Wilkins Ltd, 1 Beckett Buildings, Littlehampton Road, Worthing, Sussex

Bromley Sony Centre, 32 The Mall, High Street, Bromley, Kent

Chew & Osborne Ltd, 148 High Street, Epping, Essex

W. Darby & Co, Lockey House, St. Peters Street, St. Albans, Herts

Cawson Radio Ltd, 23 Seamoor Road, Westbourne, Bournemouth, Dorset

Gerald F. Giles, 32-36 Rose Lane, Norwich, Norfolk

High Wycombe Sony Centre, 7 High Street, High Wycombe, Bucks

Hulman Radio & Television, 3 King Street, Wimborne, Dorset

Jellies Hi-Fi, 4 Albert Parade, Green Street, Eastbourne, East Sussex

Merrow Ltd, 21/22 Tunsgate, Guildford, Surrey

Merrow Sound Ltd, 34 West Street, Horsham, Sussex

Norwich Sony Centre, St. Stevens Way, Norwich, Norfolk

Sonance Ltd, 553 Ivybridge Shopping Centre, Isleworth, Middx

Spalding Electrical Ltd, 352-354 Lower Addiscombe Road, Croydon, Surrey

The Audio File, 27A Hockerill Street, Bishops Cleeve, Herts

Tri-Fi Sound & Vision Ltd, 2 Central Parade, London Road, Redhill, Surrey

Unit Products Ltd, Compton House, 35 High Street, New Malden, Surrey

**South West England:** Absolute Sound & Video Ltd, 65 Park Street, Clifton, Bristol, Avon

Absolute Sound & Video Ltd, 42 Albion Street, Cheltenham, Glos

Absolute Sound & Video Ltd, 60 Fleet Street, Swindon, Wills

Barnstable Sony Centre, Holland Walk, Barnstable, Devon

Bristol Sony Centre, 8-10 Bond Street, Broadmead, Bristol

Exeter Sony Centre, 15 Paris Street, Exeter, Devon

Paul Green Ltd, Hi-Fi, Harpers Furn, 8L, London Road, Bath, Avon

Paul Lawrence, 100 Union Street, Torquay, Devon

H. Lewis & Co. Ltd, The Green, Stonehouse, Gloucestershire

Plymouth Sony Centre, 20 Armada Centre, Armada Way, Plymouth, Devon

**Midlands:** Absolute Sound & Video Ltd, 19 Old High Street, Headington, Oxford

Absolute Sound & Video Ltd, 256 Banbury Road, Summertown, Oxford

James Beattie Ltd, Victoria Street, Wolverhampton

Birmingham Sony Centre, 160-162 Corporation Street, Birmingham

Chew & Osborne Ltd, 26 King Street, Saffron Walden, Cambridge

Derby Sony Centre, 2c Albert Street, Derby

High Grade Hi-Fi, 297 Welington Road, Northampton

Horns, 6 South Parade, Oxford, Oxon

Kings Radio (Hereford) Ltd, 35 Widemarch Street, Hereford, Herefordshire

Leamington Spa Sony Centre, 3 Regent Grove, Leamington Spa, Warwickshire

Mansfield Sony Centre, 14 Queen Street, Mansfield, Nottinghamshire

Northampton Sony Centre, 771 Abington Street, Northampton, Northants

Sounds Expensive, 12 Regent Street, Rugby, Warwickshire

University Audio, 1 & 2 Peas Hill, Cambridge, Cambs

**Northern England:** Bai Brothers Entls Ltd, 15 Bacup Road, Rawlenshaw, Lancs

Bennett Superstore, 136 Shields Road, Byker, Newcastle-upon-Tyne, Tyne & Wear

Bradford Sony Centre, Erics, Rawson Square, Bradford, W. Yorks

Doug Brady Hi-Fi, 15A Kingway, Warrington, Cheshire

R.F. Lang, 30 Knowsley Street, Bolton, Lancs

R.F. Lang, 6 Compton Street, Wigan, Lancs

Leeds Sony Centre, Jones of Oakwood, 103 Vicar Lane, Leeds, West Yorkshire

Linlone Audio Ltd, 7-11 Park Lane, Gateshead, Tyne & Wear

Manchester Sony Centre, R.N. Clearstone Ltd, 66/68 Girdle Street, Manchester

P & A Audio, 98 Liverpool Road, Crosby, Liverpool, Merseyside

Peters Electrical Ltd, 24 St. Michael's Square, Chester, Cheshire

Peters Electrical Ltd, 8 High Street, Bromborough, Wirral, Merseyside

Peters Hi-Fi of Chester, 11 St. Werburgh Square, Grange Precinct, Birkenhead, Merseyside

Preston Sony Centre, 98-100 Fishergate, Walk, St. Georges Precinct, Preston, Lancashire

Searle Audio, 223-225 Rawlinson Street, Barrow-in-Furness, Cumbria

The Transistor Centre (Wimslow), Hi-Fi Centre, Green Lane, Wimslow, Cheshire

Wakfield Sony Centre, 3-5 Cross Square, Wakfield, W. Yorkshire

**Scotland:** Dundee Sony Centre, 18 Union Street, Dundee

Edinburgh Sony Centre, 165 Bonnington Road, Edinburgh

Perth Sony Centre, 38 South Melhuon Street, Perth

Graham Robertson, 5 Fountain Road, Bridge of Alan, Stirlingshire

David Stevens Hi-Fi, 1-3 Main Street, The Village, E. Kibridge, Lanarkshire

SONY ES

# COMPETITION

Hi-Fi Choice and Marantz have got together to offer you the chance to win a selection of fabulous hi-fi and video components.

With this and the next two issues we will be giving away three CD75/II compact disc players, plus a £4,000 complete system comprising CD94/CDA94 two-box CD player, PM94 amplifier, SD55 cassette deck, ST54 AM/FM tuner, LD50 DMS bi-wireable loudspeakers . . . and a CV55 CD-Video combi player. In June there will also be a runner-up prize of another CV55 CD-V machine.

*Over £5,000 worth of Marantz separates to be won!*

1st PRIZE: Complete separates system including CD94/CDA94 two-box CD player and a separate CV55 CD-Video.

2nd PRIZE: CV55 CD-Video combi player.

PLUS: One CD75/II CD player to be won each month for three months.





## THE COMPETITION

Here's how it all works. Each month we have a simple competition consisting of five questions requiring one word answers. Fill in your answers on the entry form provided, remembering to include your full name and address, and send it to us at the address shown at the bottom of the page. The first correct entry drawn from our mailbag after the closing date wins a *CD75/III* compact disc player. It's as simple as that.

In our May and June issues we will be doing exactly the same thing, five questions to answer each time, giving you three opportunities to win a *CD75/III*. Who knows, if your luck's in you could win all three!

And there's more besides!

If you are a regular reader and save the *System Entry Forms* from this and the next two issues you have the chance to win a complete separates system. Obviously this is a little more challenging; there are two additional questions to be answered which, although one word answers, are a trifle cryptic. But get your brains into gear and you'll soon have them licked!

When you have completed the answers on all three *System Entry Forms* – this one, one in the May issue, and one in June – clip them together and send to the address at the bottom of the page, marking

your envelope 'SYSTEM'. Similar rules apply, in that the first correct set of entries pulled from the mailbag on the competition closing date wins the fabulous system complete with two-box CD player and separate *CD-V* player. We also have a runner-up prize of a *CV55 CD-V* machine for the second complete set of correct entries drawn. Good luck!

## THE QUESTIONS

1. Type I tapes are Ferric; Type IV tapes are \_ \_ \_ \_ \_
2. Fixed coil phono cartridges are more commonly referred to as moving \_ \_ \_ \_ \_ cartridges
3. The co-developers of CD were Philips and \_ \_ \_ \_ \_
4. CD-V stands for compact disc video, CD-R for compact disc R E C O R D
5. 44.1kHz is the sampling rate for recordings on CD; 48kHz is the sampling rate for recordings on \_ \_ \_ \_

And for the system . . .

6. Musical Fidelity's logical approach to D/A conversion? M F L I D L O G I C A L S
7. Boothroyd & Stuart's longitudinal product band? B S L O N G R O N G A N D



### COMPETITION RULES

- 1) All entries must be on the entry forms provided. Photocopies will not be accepted. Entrants for the system prize must submit completed entry forms for all three parts, in a single envelope. Incomplete entries will not be considered.
- 2) There is no cash or other alternative to the prize.
- 3) Employees of Dennis Publishing Ltd and associated companies, or their agents, or of the manufacturers and suppliers of the prize system components or their relatives are not

eligible to enter the competition.

- 4) The competition is not open to readers living outside the United Kingdom.
- 5) The prizes in each competition section will be awarded to the first set of correct answers opened. The Editor's decision shall be final and binding. No correspondence whatsoever will be entered into regarding the competition.
- 6) The winners will be notified by post and the results will be announced in *Hi-Fi Choice*.

Beware of imitations

**AKAI**

*Reference Master*

COMPACT DISC PLAYER CD-93

POWER

DIGITAL

OPTICAL DIGITAL OUTPUT

PHONES — LEVEL



TIMER START

OFF  PLAY



With the coming of the true digital age, new standards in product performance and quality of sound will have to be achieved.

And no-one is in a better position to meet such a challenge than Akai.

Since 1929 our belief has always been the same.

We specialise in hi-fi and are totally committed to producing the best of its kind.

We do not compromise on quality.

We welcome innovation.

We copy no-one.

The ultimate achievement in product performance and quality of sound is **grand**  
"Grand Excellence." **EXCELLENCE**

But don't take our word for it just listen to what the press have to say:

CD-93.

*"The luxury presentation extends under the glossy exterior, with the extensive use of die-castings for both the base and the substantial smooth-acting disc drive."*

*"This is undoubtedly a CD player with real class."* **HI-FI CHOICE, MAY 1988.**

CD-73.

*"Although the price is fairly high, this player showed considerable merit in our tests, and will suit the needs of many."*

**HI-FI NEWS & RECORD REVIEW, APRIL 1988.**

*"Overall I found the machine thoroughly musical. It was hard not just to sit back and listen to the music rather than keep on taking notes."*

*"For £450 the CD-73 represents excellent value for money and would make a sensible upgrade from even the best of the £250 players. Its particular strengths are its imaging and smoothness."*

**NEW HI-FI SOUND, JUNE 1988.**

You won't find Akai's Grand Excellence range in any ordinary hi-fi shop. Only the very selective hi-fi specialist will carry them.

You may have to search a bit to find one, but when you do, it'll be music to your ears.

**AKAI**  
The genuine article

For your nearest Akai audio/visual specialist, see list overleaf.



*From the perfectionists  
in sound, you could  
only expect the  
greatest names  
in sound...*

...and at Chew & Osborne, with nearly 30 years' experience in catering to our customers' discriminating requirements, we make certain that we only stock the names that will live up to these demanding criteria.



### Look at the Names

- A&R Arcam • Ariston
- Audioquest Livewire
- Bang & Olufsen • BLQ • B&W
- Cambridge Audio • Denon
- Dual • Foundation Audio
- Gale • Harman Kardon
- Harman Kardon Citation • Kef
- Kenwood • Manticore
- Marantz • Meridian
- Mission Cyrus • Mordaunt
- Short • Musical Fidelity
- NAD • Nakamichi
- Pioneer • Quad
- Rogers • Ruark
- Sansui • Spondor
- Spica • Tannoy
- Yamaha — Plus

- Accessories from**
- Audio Technica
  - DNM
  - Goldring
  - MIT
  - Nagaoka
  - PMB • QED
  - Sennheiser
  - Target Audio
  - Thats
  - TDK
  - WBT



### Look at the Music on Disc and Tape

We've got everything you could ever need, including an extensive range of compact discs at prices to suit everyone, classical and popular naturally!



### And at Saffron Walden there's ABSOLUTE SOUNDS

- As the only specialists in Essex appointed by Absolute Sounds, you'll find it well worth a visit to see and hear this truly outstanding equipment. In stock now, you'll find • Apogee Acoustics • Krell and Sonus Faber • Micro-Seiki • Sicomin — including cables and interconnects.



### Look at the Service

Professional, helpful, unbiased advice is only part of our service. For true peace of mind we back it with after-sales service which we believe is second to none.

**GO Chew & Osborne**

**EPPING, ESSEX, 148 High Street (0378) 74242**  
**SAFFRON WALDEN, ESSEX, 26 King Street (0799) 23728**  
**BISHOP'S STORTFORD, HERTS, 70 South Street (0279) 56401**

*simply perfectionists in sound*



GENUINE DEALERS

#### ENGLAND

##### AVON

Paul Roberts, 31/33 Gloucester Rd, Bristol  
0272-429642

##### BEDFORDSHIRE

Buttons, 5 Queensway Parade, Dunstable  
0582-602584

##### BERKSHIRE

Fraser's Hifi, 4 Park St, Slough  
0753-20244

##### CAMBRIDGESHIRE

Cambridge Hifi Ltd, 1 Hawthorne Way, Cambridge  
0223-67773

##### DERBYSHIRE

Baskills, London Rd, Derby  
0246-250222

##### DEVON

Jessops (Tom Molland), 110 Cornwall St, Plymouth  
0752-669282

Richlow Elec, 264 Torquay Rd, Paignton  
0803-523734

##### DORSET

HATV, 131 Barrack Rd, Christchurch  
0202-473901

Direct Vision, 41/43 Seabourne Rd, Bournemouth  
0202-432143

##### ESSEX

GSP, 46 Cranbrook Rd, Ilford  
01-553 1335

PR Noble, 11/17 Eastern Esplanade, Southend-on-Sea  
0702-63377

##### GLOUCESTERSHIRE

Smith & Roberts, 34 Castle St, Cirencester  
0285-4756

R. Lewis, 45 High St, Stroud  
0453-62485

Robbs of Cheltenham, 3 Clarence St, Cheltenham  
0242-584404

##### HAMPSHIRE

Thirwall & Allen, 29 Winchester St, Basingstoke  
0256-21228

Mr G. Electric Discount, City Commerce Centre, Southampton  
0703-222662

Southampton 37 Bedford Place, Southampton  
0703-228434

##### KENT

VJ Hifi, 29 Guildhall St, Folkestone  
0303-56860

##### LANCASHIRE

Goodlights, 3 Friargate, Preston  
0772-57528

##### LEICESTERSHIRE

Alpha Audio, 1 Guildhall Lane, Leicester  
0533-518597

##### LONDON

SoundVideo Centre, 132 Balham High St, Balham  
01-673 3398

Galaxy, 230 Tottenham Court Rd, London W1  
01-637 2624

Craig Hifi, 879 High Rd, North Finchley  
01-446 7522

GSP, 99/100 Upper Level, Woodgreen Shopping City  
01-881 3597

Hiway Hifi, 313/315 Edgware Rd, London  
01-723 5251

Desgate, 218/220 Whitechapel Rd, London E1  
01-247 0567

##### MERSEYSIDE

Beaver Radio, 20/22 Whitechapel, Liverpool  
051-709 9898

##### MIDDLESEX

Sonance/Sight & Sound, Treaty Centre, Hounslow  
01-892 3507

##### NORFOLK

BB Adams, 125/129 King St, Norwich  
0603-630311

##### NOTTINGHAMSHIRE

Baskills, 169 Chesterfield Rd Sth, Mansfield  
06223-641537

##### OXFORDSHIRE

Acoustic Engineering, Unit 3, Range Rd, Witney  
0993-703053

Haken & Bell, 7/9 High St, Abingdon  
0235-24390

##### SOMERSET

Denners, High St, Yeovil  
0935-74444

Telefringe, 2/3 King St, Frome  
0373-62598

##### STAFFORDSHIRE

T. A. Rowney, 8 Bridge St, Stafford  
0785-58284

##### SUFFOLK

Oliver Thompson, 1 St James House, Bury St Edmunds  
0284-701807

F. A. Page, 8/10 Dial Lane, Ipswich  
0473-56585

#### SURREY

Rogers Hifi, 13 Bridge St, Guildford  
0483-61049

#### SUSSEX

Tape Shop, 6 Preston Rd, Brighton  
0273-609099

#### TYNE & WEAR

Bennetts, 136/168 Shields Rd, N castle-upon-Tyne  
091-265 6021

Craig Hifi, The Metro Centre, Gateshead  
091-460 0090

#### WARWICKSHIRE

Taylor's of Nuneaton, 118/119 Abbey St, Nuneaton  
0203-382645

JVC, Unit 7, Wharf St, Warwick  
0246-250222

#### WEST MIDLANDS

Norman H. Field, 35/37 Hurst St, Birmingham  
021-622 3619

Karma Audio Visual, 26/28 School St, Wolverhampton  
0902-773338

#### WILTSHIRE

PR Sounds, 5 King St, Melksham  
0225-708045

John Holmes Music, 21/23 Faringdon Rd, Swindon  
0793-34095

Salisbury Hifi, 15 Catherine St, Salisbury  
0722-22169

#### YORKSHIRE

KTS, 50/52 Cavendish St, Keighley  
0535-662888

#### SCOTLAND

##### FIFE

A. Thomson, 6/8 Bonnar St, Dunfermline  
0383-724541

A. Thomson, 3 Whytescausway, Kirkcaldy  
0592-205997

##### GRAMPIAN

Telemach, 23 Marischal St, Aberdeen  
0224-574248

##### HIGHLANDS

Highland TV, 14/16 Greig St, Inverness  
0463-236670

##### LOTHIAN

A. Thomson, 97 Sandwick Place, Edinburgh  
031-228 3907

##### TYNSIDE

Robert Ritchie, 102/106 Murray St, Montrose  
0674-73765

##### IRELAND

##### BELFAST

LRG, 171/175 Albertbridge Rd, Belfast  
0232-51381

Zeus Audio, Hope St, Belfast  
0232-332522

Audio Times, 47/49 Fountain St, Belfast  
0232-249117

Audio Times, 83/87 Royal Avenue, Belfast  
0232-229907

##### CO. DOWN

Lisnasure Interiors, Lisnasure Rd, Dromore  
0762-881073

##### TYRONE

Zeus Audio, 18 Castlecaulfield, Dunngannon  
08687-67935

##### WALES

##### CLWYD

Gwens Hifi, 9/11 Abergale Rd, Colwyn Bay  
0492-530015

##### GLAMORGAN

Tele-Electrical, Brackla St Centre, Bridgend  
0656-59157

##### GWENT

Hifi Western, 52 Cambrian Rd, Newport  
0633-62790

##### ISLE OF MAN

Manx Audio, Glenvine Crosby, Isle Of Man  
0624-851437

And selected branches of Laskys.





## CHOICE SESSIONS

*Things we hear . . . This month the vacuum tube gets another look-in along with Musical Fidelity's D-to-A convertor, the Digilog.*

### FILLING THE VACUUM

*JK supplements his central heating with transparent glass bottles*

Shortly after Christmas I managed to satiate my longing for amplifiers that glow by borrowing an Audio Innovations *First Audio Amplifier*. This is a particularly attractive 7½watt stereo power amplifier. Yes, you read it right – and, no, this thing doesn't produce earbending levels, although with appropriately sensitive loudspeakers (90dB/W plus) it's quite adequate for most listening purposes. For small scale acoustic pieces it's more than sufficient, but if you are after the rock concert in your living room effect it falls a little short.

The design philosophy behind this and the rest of the *Audio Amplifier* range is the use of the direct heated triode, a type of valve which was first used in the 1920s and is claimed by Audio Innovations to be 'truer to the input signal than any other type of amplifier'. In this case they are run purely in Class A without negative feedback in a very simple circuit incorporating output transformers which, contrary to popular opinion, are claimed to offer greater linearity and transparency than active devices.

So what do all these claims do for the sound quality of this glass beast? The first thing that strikes you is the extraordinary sense of space that it creates, instruments achieve a likelike scale and position that make transistor amps sound positively small. As long as volume is kept at a reasonable level music is presented with a remarkably natural ease and poise, yet it can also be solid and powerful – if the information is in the interconnect. It even managed to do justice to tracks from *Tres Hombres* (old but solid ZZ Top), which one wouldn't have expected to be a great recording, and in combination with the rest of the system the *First* revealed good depth, tonal colour and dynamics on superb tracks like *La Grange* and *Sheik*. With hi-fi oriented discs like Roger Waters' *Pros And Cons Cj Hitch Hiking* it revealed extraordinary depth and nuance – you almost get the impression of the eight, sixteen or whatever tracks on the tape. This amp's ability to resolve information at different levels is quite remarkable.

Dynamic range is one of the most influential factors in the perceived loudness of a system, and it seems to be the area where the *First Audio Amplifier* scores, despite its low output. This is most obvious when listening at relatively low levels where wide dynamic range makes music more interesting and subtle. At higher levels the effect is noticeable as a layering of instruments and voices as the relative level of each element gives it its own space and position. It's almost like



*Glowing in the dark, the Audio Innovations First Audio Amplifier.*

imaging but not quite, rather it's the ability to reproduce the various parts of a piece at the correct volume, creating a series of overlapped images. Of course this only occurs when the turntable and preamp can grasp such information from the disc and present it to the amp. And in this case the system is a *Xerxes/RB300/AT-OC7* front-end, JB's Wolstenholme'd Musical Fidelity *The Preamp* as featured in February's *Sessions*, and a natural Innovations partnering speaker, the Snell *J/III* on Pirate stands.

In a practical sense this power amplifier could be described as mildly inconvenient. It has very high gain and is fussy about partnering equipment, being impractical for use with insensitive loudspeakers and not very keen on preamps with the wrong output impedance. An Orange valve preamp I tried caused the Audio Innovations to produce an unattractive midrange hum. Another factor which had a similar, but far lower level, effect was leaving a tuner (Cambridge *T55*) plugged in to the same mains extension – probably due to an earth loop. So some experimentation is required to reduce noise and maximise potential. However, that said, it does have outputs for 4, 8 and 16ohm loudspeakers and is robust and attractive (in a slightly esoteric way). It costs £999 which may seem a lot for 7½watts but in my experience you'd be hard pushed to find anything more transparent at the price.

### THE ANALOGUE ATTIC

*Fun and games experimenting with community radio in downtown Brighton.*

Listeners in Brighton have just had an opportunity to hear what neighbourhood radio might sound like. Operating under a cloak of secrecy and a press blackout, local engineers Wireless Workshop which includes our regular contributor Norman McLeod, has been testing 'the Wireless Station'.

The aim of the experiment was to find out something of the practical problems of trying to establish a community station in the abundance of enthusiasm and the absence of money. Expensive toys like compact discs, stereo and RDS encoders were OUT. Instead, they assembled the 'analogue attic' – just a mike, a gramophone, and a gadget called a 'cart' machine for the announcements.

Tony Currie, controller of programmes at the Cable Authority, read the announcements and helped with tapes of music. But only a small handful of civil servants and professional engineers knew what was happening in Brighton. The dangers of neighbourhood broadcasting falling into the hands of subversive groups are immense, and the licence was only granted on the condition that no publicity or advertising was to be allowed.

Wireless Workshop has been using the sta-

tion to check out the efficiency of one-watt wireless transmitters. It reckons that about 25,000 people in the Hanover, Preston Park, London Road and Seven Dials areas of Brighton could hear the station well. That means that for every watt of power the neighbourhood station used, it could have delivered 2,500 pairs of ears to the attic microphones.

"Because we're not from the BBC or IBA tradition, we can re-invent radio from the ground up," says the project manager. And together with his technical assistant Matt Bisson, he has set about purging a selection of ancient and modern studio equipment of needless expense and complication. The studio has been organised by Norman McLeod under his 'intermediate technology' consultancy McLeod Associates, and in conjunction with equipment manufacturers Wireless Workshop, who are the station Licensees.

The group, all former Sussex University students who are now in their thirties, also provide broadcasting facilities for sports meetings, pop festivals and other outdoor events for which they have a caravan fitted with a low-power transmitter and a pump-up mast.

Meanwhile it seems unlikely that Brighton will have a community radio station for at least two years, not until the new Radio Authority has been established.

## BITS 'N' PIECES

*Experiments with Musical Fidelity's Digilog outboard D-to-A unit leads John Bamford to ponder on the future of digital conversion.*

Regular readers of *Choice* will be aware of the disappointing results we've experienced from the latest so-called 'digital amplifiers' that have passed through our hands in recent months.

Like the majority of the more ambitious amplifiers to emanate from Japan (referring, of course, both to pre/power combos and up-market integrated models) digital amps turn out the most impressive figures on the laboratory test bench, some producing measurements which indicate that to all intents and purposes they are 'perfect'. But when it comes to sound quality, they simply don't sound quite right. Many display what can only be described as a 'monochromatic' and somewhat 'sterile' quality; when listening to music it just isn't possible to ignore the electronics and believe that you're listening to real musicians, despite the inconceivably low measured distortion of the amplifier.

A good reason for this may be the overly complicated circuitry. None of them is ever of minimalist design, expensive Japanese amplifiers almost always employing a vast selection of switches and control circuitry in the signal path. And textbook laboratory figures are often obtained by heavy use of negative feedback – and it is this feedback

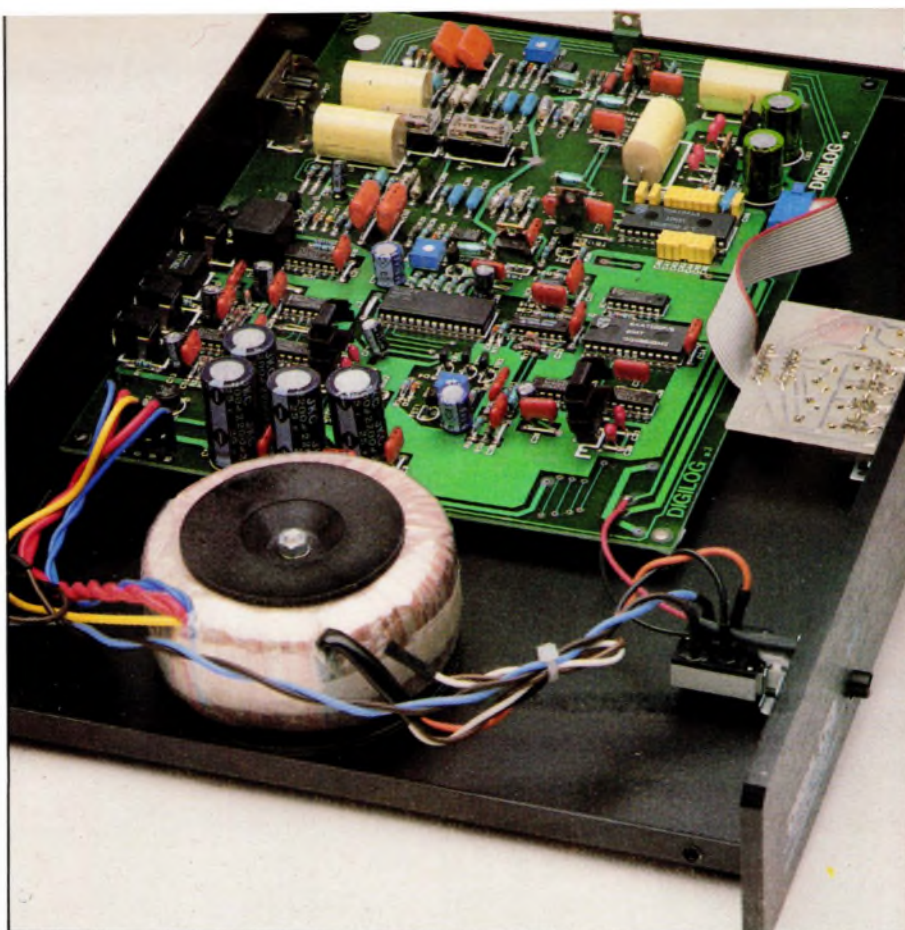

*MF's £399 Digilog caters for CD and DAT; bitstream enters via conventional or optical fibre cable. Phase invert switch is also provided.*



and other circuitry design 'tweaks' which many audiophile hi-fi amplifier designers claim corrupts the purity of the music signal and crushes natural dynamics.

We've criticised these 'digital' amplifiers because they've simply not sounded particularly good in our listening tests. What's not quite so clear cut, however, is why they've put in such a poor showing. Is it just that they're not very good amplifiers, for the classic reasons of over complication, or – as we've proposed time and time again – is the idea of removing the task of digital to analogue conversion from the CD player and passing it on to the amplifier totally misguided? Chances are it's a combination of both.

Recent listening tests with outboard digital to analogue converters (DACs) such as the Arcam *Black Box* and Musical Fidelity *Digilog* have satisfied me that fidelity is improved when the DAC is housed in a separate box. I've been experimenting with both Marantz *CD65/11SE* and *PM94* compact disc players, and although the results have varied depending on the system used for auditioning, the results overall have been beneficial – qualitatively, if not quantitatively.

I won't dwell on the differences between the two DACs too much because I suspect that much depends on partnering equipment, so there's little way of knowing whether the results I've heard will tally with your experiences at home. However, in general terms, the *Black Box* is the more 'British' sounding unit, providing a degree of weight and 'body' to lean-sounding discs, while the *Digilog* attempts to increase the clarity and focus of CDs. When it succeeds, the sound is sharper and more dynamic and is clearly providing the greatest digital upgrade – but I have heard a demonstration where the *Digilog* sounded distorted and brittle. (That was with Denon power amps driving ATC *SCM50* loudspeakers; and what that tells me about that particular system I'm not quite sure!)

Just how great are the improvements when you use an outboard DAC with your CD player? Well, if you're using a good-sounding player like the *CD65/11SE*, to my ears the improvement is not a particularly cost effective one. It's that old law of diminishing returns again; the improvement could be likened to the difference between a £100 moving coil cartridge and a \$500 model. In

other words – yes, there's an improvement, but can you really justify paying an extra £400 for it? I'm also bound to say that with the 65 the difference in performance with and without an outboard DAC is not as great as the difference you'll hear simply be reversing the polarity of the CD player's mains lead.

So where does all this leave us? Fact is, we've yet to hear what outboard digital-to-analogue conversion is really all about. There's much more to all this than we presently understand, and experiments show that even different brands of optical fibre connectors can make a difference to the sound we perceive. Already in Europe we've seen transport-only CD mechanisms from the likes of Philips and Luxman, and for the audiophile looking to get the best possible sound quality from compact disc it seems that 'component CD' is about to happen at any moment in the UK.

You can expect the first high quality CD transport on sale here to be a Kenwood model, in fact. Samples have already arrived from Japan, and all we're waiting for now is a confirmation of price. (Expect it to be around the £500 mark.)

A journalist friend who was fortunate enough to visit Japan late last year took delivery of one of these Kenwood machines just last week. And I'm told that hooked up to a *Digilog* the sound is nothing like we've heard before from any CD player. Things are just hotting up . . .

### AUDION REVISITED

*More from this new Brighton-based manufacturer of valve amplifiers. John Bamford is impressed with its wares.*

A few words on the Audion *Intro* preamp, as promised last month. News too on Audion's *Finale* monoblok power amps (£995/pair), which I've been listening to at home although we didn't have time to organise photographs before going to press. You'll have to use your imaginations . . .

The £749 *Intro* is what Audion describes as its basic 'full' preamplifier (the company also manufactures a £399 CD/Line preamp called *CDI*), the phono section using four ECC83 valves, followed by two ECC82s. The line stage has inputs for CD, tuner, tape (with full monitoring for 3-head decks) and 'aux', in a passive configuration – as with the top-of-the-range *Reference* preamplifier, although with this cheaper model you don't get the luxury of being able to route the phono signal straight to the preamp's output. The power supply is stabilised and fully regulated using high quality capacitors.

Build quality is very good, these valve amps from this recently formed Brighton-based company being extraordinarily well turned out for British products. And if that observation sounds as bad as I think it sounds . . . well, I guess it's a fact of life that the majority of our homegrown product looks

decidedly shoddy when put up against imported electronics gear. Much of it has to do with metalwork. Musical Fidelity amps are a good study case; they've been criticised in the past for lacking real 'class', but take a close look at the quality of their metalwork next time you're wandering around a hi-fi show. The company's products have improved beyond recognition during the past twelve months. The ridiculous thing is, to get better quality casework and gorgeous looking front panels MF had to go shopping overseas!

Anyway, as I was saying before getting sidetracked, these Audion amplifiers look pretty tasty – and they 'feel' right too. The controls feel positive and purposeful, and unlike many other valve amplifiers I've used at home the Audions just slot in and work. No nasty buzzes or irksome humming noises, they just work. In fact the phono stages of both the *Reference* and this *Intro* preamp are quiet enough that if you're sitting reasonably close to the loudspeakers in your system you can just about get away with feeding a moving coil cartridge straight in, without a step-up transformer. Most of my listening is done in the far field – I sit a good 18-20 feet away from the loudspeakers in my listening room in order to create a very wide and deep soundstage with extended bass response – so with the Audio Technica *OC9* cartridge I find it necessary to employ my resident Audio Innovations *Series 1000* transformer.

The sound of the *Intro* doesn't have quite the transparency of the more expensive *Reference*, but it shares much of the latter's

sense of space and naturalness. Not that it's such a bargain, mind you, as this is an £800 preamp after all. It needs to be very good at this price to survive in the marketplace.

Just as I thought the more expensive model sounded slightly more rounded and laid-back than Audio Innovations' *Series 1000* preamp, so with the *Intro*. The Audions are polite and essentially vice-free amplifiers, a trend which has been followed through even to the 24watt power amplifiers. On commenting to Audiofreaks, the company responsible for marketing the Audion range, that I found the monobloks to lack the bass extension of the Innovations triode-coupled *Second Audio Amplifiers* (which I've been using as a reference ever since reviewing them for issue 63 way back in October last year), I was told that this was a conscious design consideration. Bearing in mind the price of the amplifiers and the calibre/size of systems they were likely to partner, it was felt wiser to sacrifice the ultimate in bandwidth extension in favour of control and a 'tidy' overall behaviour.

This is only meant as a taster. Doubtless further description will be reported the next time we carry out full tests on a selection of valve amplifiers – which we really must get around to doing in the near future. But there's just one thing I must tell you about the power amps, because some of you might think it neat. (I do.) Each monoblok has two input sockets and two pairs of outputs, which is a really nice touch. How come others haven't bothered?



*Audion Intro valve preamplifier: relaxing musical performance.*



## ASPIRATIONS

*Dan Houston visits a riverside flat over Chelsea Harbour to find a hi-fi system installed for sound and symmetry. Photographs by Chris Richardson.*



# A Wealth of Sound



Getting in the lift set the tone for this month's *Aspirations* piece. It's one of those glass outside-the-building affairs that gives you a high-speed feeling of levitation over London – and a strong temptation to get back in and play Yo-yo with your breakfast. Our few seconds ride sent us whizzing to the 15th floor of the Belvedere tower – the dominant building of the new Chelsea harbour development just across the river from the Westland Heliport.

This floor, and the 12th, belong to David King, a 46-year-old Company Director who bought into the development at the building stage. One of his prestigious next-floor

neighbours is Michael Caine. He moved in last Autumn having had the whole floor decorated to provide a home for himself and his daughter. The emphasis is on space and light, with lots of monochrome giving a high-tech feel, while the plants, Kilim rugs, wooden floors and objets d'art provide a homely warmth. As you walk around the flat London crowds away on all sides – a little dirty in the breeze.

The main living area runs the length of the south side with panoramic views down-river to the City. As one enters, a huge painting by The Slade's Ron Bowen, with its juxtaposition of outlandish and everyday scenery is immediately arresting.

Bowen has also painted a kind of fresco round the walls and two lifesize murals of a man and a woman, Adam and Eve style, on the south walling. On the west side the kitchen and dining area are open plan, creating an informal atmosphere for the preparing and eating of food. A twelve seat glass-topped table designed by the architect Norman Foster stops guests playing footsie, although the original huge slab of glass had to be cut in half before it would fit in the lift!

The central area allows for reclining by the balcony on two Aram Zeev leather sofas either side of another slab of glass, this time coffee-table style, from Zeev's Covent



Garden base. There are two more glass and chrome occasional tables from a 1920s design by the architect Eileen Gray. Architects' furniture continues with a Corbusier recliner in front of the shelving which houses the hi-fi. The eastern side of the room is used for a stainless steel-topped bar above which a Sony television and video hang from a ceiling bracket. Viewers can watch TV sitting in a novel sofa made from two very comfortable leather Rover car front-seats (just like the TV ad.). However, there was no evidence of Mr. King having thrown his old chair out of the window! This two-seater was bought from *One Cff*, of Northington Street, EC1, who domesticised its famous single forebear.

The hi-fi has all been installed by KJ Leisuresound (West One), and David King explained that the equipment had been chosen for style as well as performance. The line-up fronts with the Denon *DCD 800* CD Player, Yamaha *KXW500* cassette deck and Meridian *204* tuner as sources. Meridian's *201* preamplifier and a couple of *205* monoblocks then send signal to three pairs of Bose *Acoustimass* loudspeaker systems to give all-round sound.

The diminutive *Acoustimass* mid and tweeter units are suspended from the ceiling at either end with a couple positioned in the middle of the room on their tripod stands. The three subwoofer units in their plain black ported boxes are unseen in this setting being tucked away under furniture to provide omniscient 'through-the feet' bass. Two are positioned at the system end, the other under the sideboard next to the dining table. The system itself, which can be controlled either manually or by remote, is housed in shelving by the bar and has been placed to be seen but not to be obvious. The silverware and collection of model cars detract from its minimalist black components.

The system and room sound quite bright, though one would expect that from an area with so many hard surfaces and so much glass. The rugs do soak up the echoes though so it's not by any means like an empty room. One of the surprising things is the sheer scale of sound from such diminutive speakers which manage to fill the room easily with a dynamic punchiness that carries throughout the flat. But the all-round (unconventional) nature of the sound means that stereo imaging for instance, is a bit lost.

David King describes himself as being a hi-fi buff ever since he could afford it. In the '60s he worked as a disc jockey and claims he ran the first ever mobile disco in London. Before moving to Chelsea, his Mayfair flat was home to a Tannoy *Buckingham/Quad* system which he describes as having a preferable sound to the Meridian/Bose set-up here. "I think Tannoy and Quad go really well together, they give a warm sound which is wonder-

ful. But what I have here is very competent and good visually – I needed something that would go with the decor."

KJ Leisuresound installed the system using QED speaker cable to the various outlets so that visible wiring was kept to a minimum. However, Mr King said his only regret was in not calling in KJ at an earlier stage when KJ could have done a more comprehensive set-up with a link up (operated centrally) for the flat as a whole. "There was just no time to do that and all the walls had been plastered by then," he told me. The result is a further system in his studio-come-dressing room and a Technics midi-system supporting Gale *301* loudspeakers in his daughter's room.

The studio system harks back to David King's DJ days (his vinyl collection is in shelves nearby) and is where he mixes cassette tapes for his car or cassette decks. "I don't like the gaps in records," he explained, "I like continual sound and I like to put music to my order. I either like it all loud or all quiet so I mix my own cassettes. But people always take them!"

Here a Citronic *SM450* mixer links up the two Technics direct drive *SL1200II* turntables and a pair of Yamaha *CDX810* CD players to make tapes on a Denon *DRM20* cassette deck. KJ plans to make a rack which will tidy up this system but hadn't got round to it by the time we photographed it. The Citronic also acts as a pre-amplifier then drives a pair of American Phasetech *C140* loudspeakers which are set in a void pointing ceiling-wards above the 'desk' and cannot be seen, and also power a pair of Alexander *566* loudspeakers in his bedroom. Both or either pair of speakers can be used with a QED switching box. The Alexanders would have been put on stands but for the lack of space that would have created said David King. Another of Aram Zeev's seating products, based on Dali's tribute to Mae West's lips, provides shocking colour in the bedroom giving a permanent good-morning kiss on the Alexanders' axis. And a telescope is a must from this vantage point.

KJ has run QED Systemline cable through both drawing room and bedroom



The mini studio (above) where car tapes are made up, also sources the bedroom sounds below.



to allow infra-red (remote) use of the systems from anywhere in these rooms should the need arise. At the moment the main system can be operated locally with Meridian's 209 remote control unit, but the Systemline allows future flexibility should remote control be needed at the dining end of the main room, or from the bedroom for the studio system. Extra power amplifiers could also be linked in with the Systemline to make a system which was volume controllable.

An installation like this would cost around £8,000 according to KJ's manager Paul Tam. But he pointed out that much of the kit belonged to David King already so his job had concentrated on the installation of equipment and provision of the main system. The hi-fi isn't necessarily the most esoteric but is some of the best available when one considers the constraints of style. Large loudspeakers just wouldn't fit in here. And the satellite and woofer system is a growing trend which allows living in style without compromising on sonic dynamics.

**The equipment:**

Denon DCD 800 CD Player	NA
Yamaha KX-500 Cassette Deck	£210
Meridian 204 Tuner	£495
Meridian 201 Preamplifier	£550
Meridian 205 Power Amplifier	£395 each
Bose Acoustimass Loudspeakers	£470 a pair
Yamaha CDX 810 CD players	£300 each
Phasetech CI 40 Loudspeakers	£220
Denon DRM 20 Cassette Deck	NA
Quad 405 2 Power Amplifier	£349

Installed by: KJ West One, 26 New Cavendish Street, London W1M 7LH. Tel: (01) 486 8262.



*Spot the speakers: unobtrusive subwoofers (right) thump away while the tiny Boses belt out sound.*



## FOCUS ON RETAILING

*A new concept in book and record selling led to a commission for some hi-fi from The Cornflake Shop. Dan Houston and photographer Chris Richardson went to Banbury to find out about the . . .*

# Soft Sell

WARE



**M**ost of us would associate music while shopping as an aid to the vendor rather than buyer; soporific supermarket muzak or blaring aural acid to confuse the salespeak. Even record shops embrace the time-is-money ideal, forcing one to queue for a quick snatch of the disc so that purchases are made from listening to friends' collections or the radio single. (Of course, there's always the cover artwork which is fine for those who like to look rather than listen.)

It was therefore with some anticipated pleasure that we visited a book-and-CD shop in Banbury which offers its customers hi-fi sound both as a background and through headphones. Ottakars is a new chain designed by Din Associates (designers of *Next* in Kensington) which so far has branches in Brighton and Banbury. Both have been kitted out with hi-fi by The Cornflake Shop with the genteel philoso-

phy that shoppers can sit with their potential choice of music while they muse over a book.

Crossover sales (ie you'll buy both book and CD) are the aspired aim and Ottakars felt there was a huge gap in the market to be filled in an age when both record and book shops are becoming more and more comprehensive. The development director, Peter Cheaney told me: "bookshops are getting bigger and bigger so that you walk in and get presented with 30 bays of modern novels. How can you select from 10,000 titles if you just want to browse? Our aim is to give advice, giving people a less wide choice, but hopefully making the process of buying a book more exciting and more of a discovery. The aim is to do this with discs as well; at the moment they are laid out in such a way that it's difficult to browse or discover new material."

Ottakars has also developed neat little

*The system downstairs (left) is out of sight and operated by staff.*

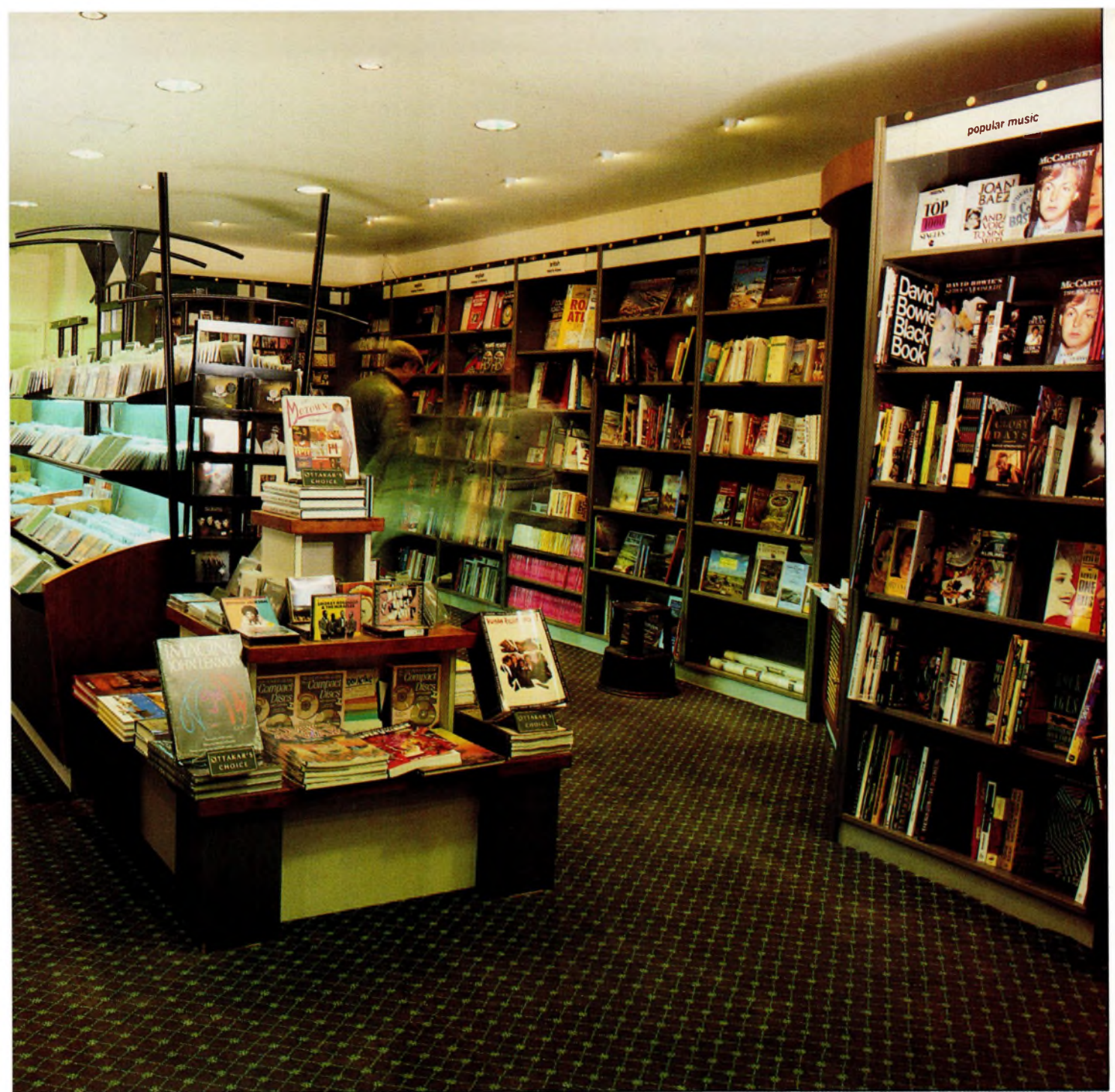

plaques (so far used with books but to be used with CDs as well) giving customers a review of some of the works on display. In the Banbury branch books and music have been arranged with contemporary material on the ground floor and classical upstairs. There are two sets of Sennheiser HD40 headphones linked to Yamaha CD29 players in each department; upstairs you can listen in the comfort of an armchair.

Angela Parker, Ottakars' operations manager, said there were around 4,000 CD titles (and the same number of tapes) in stock. Of these, around 1500 are classical and 2,500 split into contemporary, jazz and folk categories. The shop does not stock vinyl records, she said, partly because of the trend away from the medium and partly because the shop's target customer has more disposable income – which amounts to the same thing. The musical selection also reflects that: "it's not so



*Something new: proper access to music before you buy and with a hi-fi sound.*



## UNTIL NOW THERE WAS ONLY ONE WAY TO SEE MOVING PICTURES ON CD.

No disrespect to Mr Clapton, but Marantz suggest a slightly more advanced idea. CD Video.



As its name implies, you not only get perfect digital sound, but also perfect moving pictures.

"Oh no!" comes the cry, "my large and expensive collection of CDs has become obsolete."



**marantz**  
HEAR THE MUSIC

Not so. Because although the new golden Video CDs come in 5", 8" and 12" format, the

Marantz CV55 with its 16 bit four times oversampling facility, is more than capable of playing the familiar 5" silver version.

CD Video from Marantz. You've heard the ultimate in music. Now see the picture.



much Kylie Minogue as Leonard Cohen; we can't compete with *Our Price*," Angela said.

The system for both shop floors was comprehensively installed running QED speaker cable through walls and behind plaster at the decorating stage. Downstairs six pairs of American Phasetech loudspeakers are mounted into the ceiling. Steve Moore, the amiable and bearlike founding Cornflake, explained that the (circuit protected) speakers were chosen for their ability to work in cavity walls and false ceilings such as these. The Phasetechs and the Nakamichi *OMSIE* CD player are powered by a Bryston *4B* power amplifier with a QED passive preamplifier

acting as volume control. Downstairs the two listening 'bays' are run by the Yamaha CD players through Yamaha *AX300* and Rotel *RA816A* integrated amplifiers. The system is kept, and operated from, behind the sales desk although the headphones have a volume control set in the wall next to their jack socket. Both hi-fi stacks are supported on Target equipment furniture.

Upstairs, in the classical section there is much the same set-up although less power was needed for six Sonance (USA again) loudspeakers and a Bryston *2B* power amplifier. The loudspeakers all but sonically disappear in this setting, their metal grilles being painted white with a layer of white foam inside concealing the drive

units. The system is relaxing, bringing music into the room effortlessly with good clarity, though stereo imaging would be too much to hope for (and was not required) in this set-up. The two headphone sets powered by Yamaha CD players and amplifiers with their QED volume potentiometers allow browsing in the comfort of an armchair with a book in hand and a disc on the headphones. And although you're not in a 'booth' there's very little interference from the music playing 'outside'. The dedicated can thus decide whether they prefer Heimit Newton, say with Wagner or Vivaldi.

Such a luxury, even in 1989, is surely open to abuse. One imagines the town's dilettante tramps taking up residence almost, bagging the seats early and slowly working through the shop's entire repertoire without ever reaching for their wallets. However, although Ottakars says there is no time limit it reports no problems – wowsers or otherwise – and points to the skillful design of the shops as being comfortable but not too comfortable. If demand does exceed available pairs of Sennheisers there is provision for extension, the Cornflake Shop having run extra wiring for further outlets.

The inconsistency about an article like this is that it is being written at all. In an age when yuppies have their weekly shopping done for them it is amazing that such shops are not commonplace. Perhaps the Ottakars move signals a subtle High Street shift – that we are becoming more a nation of buyers than shopkeepers. The Cornflake Shop can be found in Windmill St, London W.1.





## PERSPECTIVES

*Bored with merely listening? Why not get intimate with your system? Richard Black outlines how to get the best – and more – from your hi-fi gear.*

*The innards of a CD-273 CD player. When it comes to this, you know you're serious!*

And cables connecting the equipment have a 'sonic signature' which is worth some experimentation. A tuner should have a good aerial, even in a strong signal area. And although CD players 'ought' to be impervious to tweaks, it seems this is not necessarily true, and we are seeing a few sound enhancing gadgets surface already, such as damping rings and special fibre optic cables for connecting the digital output to a decoder.

### ... THEN GET IT BETTER

In addition to the setting up of equipment, there are often simple modifications which can be made by the more dedicated enthusiast without any great expense or effort. In this category, I would put the replacement of the record deck armboard with one made of a different material, or the rewiring of the insides of a loudspeaker with special cable, or the replacement of components in an amplifier. Some of these

# Tweaking Tactics

Few things in life can be quite as satisfying as getting something just right, especially when the something is a pleasure itself. Tuning a sports car engine just so, removing the perfect soufflé from the oven at the precise second... or moving your loudspeakers by the crucial half-inch that finally crystallises the stereo image, all create a special sense of achievement. The off-tune car still drives, the soggy soufflé is still edible, and the loudspeakers plonked down at random still pump air, but the result is never quite right and you've also missed the pleasure of banishing the gremlins.

'Tweaking' hi-fi can conjure up images of strange goblin-like creatures sitting in head clamps, with sticky foils and spiked feet (only three, of course) on everything, having a thoroughly miserable time trying to enjoy themselves. Actually, I've never met any of these; most of the hi-fi tweekers I know spend at least 20 times as many hours listening happily as they do tweaking happily, and no time doing either miser-

ably. The fact is that tweaking is fun and productive.

### FIRST, GET IT RIGHT...

The greater part of tweaking consists of setting up a system when it's installed, and the importance of this can not be over-emphasised – it is vital.

Obviously, some pieces of equipment need more setting up than others. Most amplifiers, for example, can be taken out of their box, connected up to everything, switched on and left to run. Tweaks such as isolation bases and flux dumpers may have an effect, but they're not fundamental to the amplifier's performance. On the other hand, record decks simply cannot work properly if not aligned carefully in every detail. And loudspeakers should always be moved around and tried out in different areas of the room – the chance of positioning them perfectly at random is remote. Turntables and loudspeaker supports can also have a significant effect on the resultant sound.

are considered later, but first a few words of warning are in order.

Don't undertake a modification if you're not sure what you're doing, especially on equipment under guarantee (the guarantee will be automatically invalidated). Even if you only intend to replace a few coupling capacitors in a CD player, for example, make sure you are competent at soldering. By far the best way to learn such skills as soldering and miniature engineering is to arm yourself with a few hobby magazines (there are dozens on electronics), and build a few of their suggested projects for practice. If you want to try more advanced electronics tweaks, buy a good reference book such as *The Art of Electronics* by Horowitz and Hill (Cambridge, paperback).

Be logical about your tweaking order. If you've a spare hour to devote, don't replace six inches of wire in an amplifier if your speaker cable is a frayed piece of 3 amp flex, or superglue the cartridge to the headshell of an arm with slack bearings and expect a good result, or fit an electronic power supply to a turntable that is sited on a slope. And be prepared to admit



the limits of tweaking – a cheap 1970s receiver is just that, when all's said and done. Although you can improve it slightly you can not transform it by any lesser process than replacing the entire innards. Finally, don't try any tweak that involves irreversible changes unless you've double-checked with someone at least as knowledgeable as yourself that what you propose is feasible and sensible. You'd be amazed how easily one can do something really stupid.

## ELECTRONICS

Considerations of setting up do not apply to electronics-based items in the same way as with record decks and loudspeakers, and the options on modifications are usually more limited. As setting up a turntable is arguably the most involved subject of hi-fi tweaking, we've saved that 'till last. However, there are certain aspects of all hi-fi components that should not be overlooked.

Cassette decks certainly benefit from an initial set-up to match your chosen tape type and normal signal levels, and should be given a maintenance check now and then, which I described fully in *Getting it Taped* (Issue 63).

CD players are not quite as perfect as some advertisements would have us believe, and it's worth making sure that the player is sited on a dead level surface which is not directly in the firing line of the loudspeakers. CD damping rings can make a small difference, and Martin Colloms has even reported that a CD sounds different every time it's inserted in the machine due to slight differences in centring on the transport.

FM tuners require a good signal for optimum stereo decoding, and this means a signal which is not just large but clean, and not *too* large. There's only one way to achieve this, and that is to get a good aerial (preferably a four-or-more element one) and mount it as high as possible pointing directly at your nearest transmitter. This may require some experimentation if you're not sure where the transmitter is, and will require a compromise or an aerial rotator if you listen to both BBC and IBA stations. Connect it to the tuner via good coaxial cable, using the correct plugs, and use attenuators (from radio shops) if the signal is too large. This sounds silly, but the good aerial will give a signal which is clean and free from multipath interference, while the attenuators will ensure that the input to the tuner is not overloaded, which gives a noisy audio signal.

Connecting equipment to the mains is not always as simple as fitting a plug (which in fact is not that simple if done properly). Earthing equipment can be a real headache. But fortunately, the current trend is towards double-earthed equipment which does not require a safety earth. The mains lead will not include an earth wire, giving you freedom to experi-

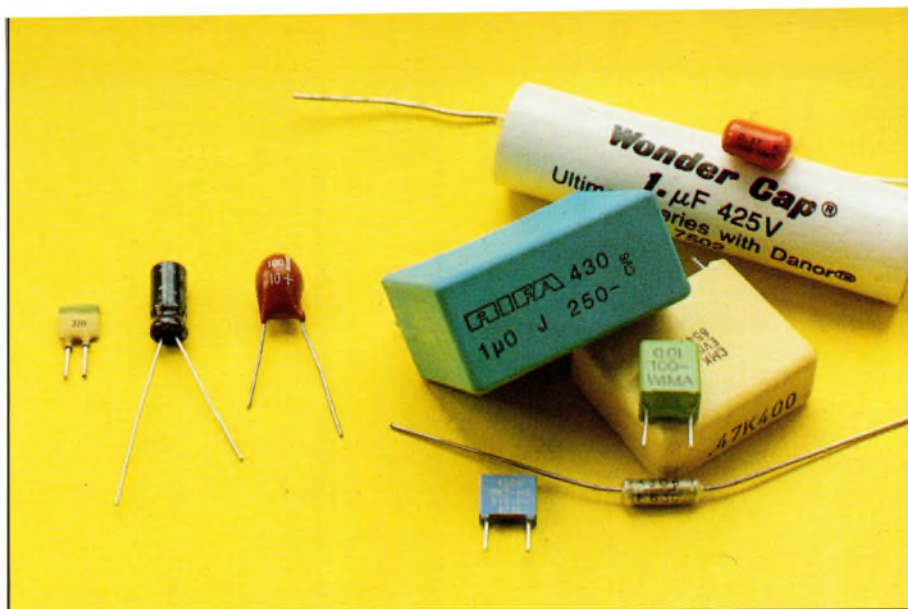

*Experimenting with passive components can be most rewarding. Shown here: ceramic capacitor (disastrous), aluminium electrolytic capacitor (not bad if correctly used), tantalum electrolytic (good if correctly used), assorted plastic film capacitors (all good, but opinions vary on the very best), and a mica capacitor (good, but only small values available).*

ment with earthing without danger. Preferably, earth the preamp to the mains, and earth everything else to that (via the signal cables, that is). Extra earth leads added in will tend to form 'hum loops'. If nothing is earthed, you'll probably also get hum.

If equipment other than the amplifier has an earth wire in the mains lead, try connecting it at the plug first. If there is no hum, leave it. If there is hum, for preference connect the earth lead at the equipment end to the case only, and disconnect the case from the electronic 'ground' (usually a short wire with a tag on it). It's not good practice to rely on signal cables to provide the safety earth. Consult a dealer if in doubt.

Sometimes it's recommended that mains cables should be changed for special types, as this makes a difference to the sound. Frankly, the difference is small and the risk of creating a potential danger is

*How it should be done: a high quality mains plug with correct colour coding, inner and outer insulation stripped to the right length, cable securely clamped, correct fuse rating.*



large, so DON'T fiddle with mains wiring. Even solid core house wiring cable, which some enthusiasts recommend, is a bit risky as it's prone to break when flexed and will not fit properly into connections in the plug and at the equipment. Remember that if someone is electrocuted it will probably not be you but someone unfamiliar with your equipment. Fit a good mains plug in accordance with instructions and leave it at that. The only permissible tweak is to reverse live and neutral wires at the plug or at the equipment, which is not dangerous if the wiring is not damaged (when it's dangerous anyway) and can sometimes give a reduction in interference.

Most electronic equipment isn't too fussy about where it lives. However, it seems even amplifiers are marginally microphonic (valve amps especially so, of course), so equipment supports can be worthwhile. Be careful to leave some ventilation for power amplifiers, or the device could overheat and cause damage or fire.

Electronic modifications involve at least an ability to recognise components and to solder properly which is not difficult (practise!) and the results can be worthwhile. Changing the internal wiring for PTFE-insulated types, and carbon resistors to precision metal film, and replacing ceramic or electrolytic capacitors with plastic film varieties, are all popular tweaks, of which I have found resistor changes to be the most effective. Unbiased electrolytic, and any sort of ceramic, capacitors in the signal path are to be avoided, but properly biased electrolytic and most plastic film capacitors are generally OK. Physically enormous polypropylene capacitors are sometimes favoured, but I find they introduce more problems than they solve, and as they are also outrageously expensive I no longer use them.

Don't 'bypass' (with small value plastic film capacitors) physically small capacitors, but do bypass large power supply capacitors as near the circuit board as possible, unless this has already been done. Other fairly simple tweaks including wiring out the tone control stages, if fitted, and replacing cheap and nasty operational

amplifiers (integrated circuits) with higher quality, faster and/or quieter, ones. But first read up on electronic tweaks, and if in doubt don't try it – you could do some expensive damage.

## CABLES AND CONNECTORS

This area is a real minefield and the main reason why there is such a variety of opinions on interconnect cable is that amplifiers are not designed to drive it. If they were, we could all standardise on one sort of cable and stop worrying. Some of the advertising propaganda for certain cables is absolute drivel – quite apart from any intrinsic merit the cables might have (which seemingly is unrelated to price and manufacturer's claims), the 'reasons' for their claimed superiority are utterly unfounded. Some of the expensive cables are excellent, some bizarre. Basically, the requirement for a typical hi-fi system signal cable is a screened cable, as fat as you can put up with, of simple coaxial construction, using polythene or PTFE dielectric (insulation) and a good dense screen.

For the price of a couple of metres of special 'hi-fi' cable, you can buy from an electronic components supplier a 100m reel of *RG 62*, *URM 70* or *URM 43* (or similar), which will wire your entire system and leave enough for a few friends. If you don't require full screening, you can get away with *URM 203* which is very good, and with luck you can use '300 ohm twin feeder', which is unscreened, for short runs. It costs about 12p a metre but is awkward to get into plugs. Loudspeaker cable uses a slightly different set of rules, but again the fatter the better; I'm not a fan of the thin cables advocated by some listeners. High capacitance cables are best but don't work with a small handful of amplifiers.

As far as connectors go, the standard phono plug is a horror from the start, but since one is generally stuck with them it's wise to get decent metal-bodied types. Gold plating is of questionable value if it also covers the solder surfaces, as you can't easily solder to gold plate without it disintegrating and giving a bad joint. Ordinary nickel-plate connectors should occasionally be inspected for corrosion. Loudspeaker cable connections should be big, and done up tightly. There are available several 'contact enhancers', for applying to connectors to improve conduction. The only one I've tried made things worse, but others have had better luck and they are at least easy to apply and remove.

## LOUDSPEAKERS

Setting up loudspeakers to sort-of work is easy; just stand them upright, roughly facing you, and connect to an amplifier as per instructions. However, setting up loudspeakers to work well is frequently time-consuming, but worthwhile.

Most loudspeakers less than a yard high will benefit from stands, which should be



*Will that disc sound the same next time you play it?*



*A HEAD phono plug, designed to be like a radio-frequency connector with excellent shielding. Note also gold plating of contact surfaces and robust construction.*

non-resonant and stable (but it's impossible to generalise further than that). As a starter, follow the manufacturer's recommendations on placement, but do move them around and try other positions; close to walls (rear and side) or away from them, near furniture or not, close together or far apart. Ideally, stand them some distance apart and do not fire them straight down the room, but point them so that their axes cross just in front of the normal listening position (this may not work if most of your records are pan-potted stereo, but is best for genuine amplitude-and-phase stereo). Unless the front of the speaker looks particularly horrible, take the grille cloth off.

Cables certainly make a difference to loudspeakers; see *Hi-Fi Choice* Issue 64 for speaker cable reviews. Bi-wiring can also improve things (often more, with cheaper cables than with fancy ones); Paul Crook reported on his experiences with this in Issue 57. If your loudspeakers don't have bi-wiring terminals fitted, you may find that it is easy to get behind the terminal panel and fit suitable connections yourself. Bi-amping is more of the same, although my feeling is that if you are going to all that trouble and expense it is worth having active crossovers built and the crossover in the loudspeaker eliminated. However, design of an active crossover is usually a

task for an experienced designer – only tackle it if you have confidence or want it to be a simple first-order type.

If you have the persistence to get inside the loudspeaker (most often done by removing the driver – and DO be careful wielding the screwdriver; remember, there's a big magnet in there), you can experiment with adding or taking away damping and bracing materials. In most budget speakers there is plenty of scope for this as the construction is often plain particle board with foam rubber lining. The best way to add bracing bars or panels is asymmetrically, whether you use struts across the cabinet or battens glued to the side walls, which break up resonances most effectively. On the outside, try adding smooth curved profiles to the corners of the baffle to improve diffraction.

There is a current fashion for removing damping materials from loudspeaker cabinets, but I don't hold with this, having tried it extensively. The sound becomes more 'lively' in some ways, but it is undoubtedly more coloured and distorted.

Drive units can often be changed, especially bass drivers as they are mostly of standard sizes. However, it's generally accepted that the cabinet is far more important than the driver in determining sound character, and most cabinets are far 'worse' than most drivers. But if you want to improve bass response, try a less efficient driver with a lower resonant frequency (and add attenuation to the tweeter section of the crossover or you'll not like the result). Changing the tweeter for a light metal dome can make a worthwhile difference, and purists could try a miniature cone unit such as the Jordan Module (watch out for limited power handling).

## RECORD DECKS

Because a record deck is basically a mechanical device, it's susceptible to transit damage and has to be dismantled before it's moved. It is generally down to the user to reassemble it, hence the need for all the setting up procedures. However, a record deck is in many ways normally the easiest, most versatile and most gratifying piece of equipment to tweak.

First tip: don't put the turntable in its final position until you've done most of the setting up, as in general its playing position will not give easy access for adjustment. Get yourself a large, clear, well-lit area to work in. Lifting a turntable a few feet across a room will not upset the alignment.

If you are fitting a new cartridge, it's often easiest and safest to remove the arm and place it upside down on a table so that you can see what you're doing. It doesn't matter that this may mean losing the overhang adjustment of the arm; ten to one you will have to reset this for the new cartridge. Leave the stylus guard on the cartridge as you fit it (or remove the stylus

# Rediscover FM-stereo

MAGNUM  
dynalab

*"The FM Specialists"*



MODEL FT-11

Distributed in the U.K. exclusively by:-  
Ion Systems Ltd. 61 Mochdre Business Park, Newtown, Powys SY16 4LE. Tel (0686) 2566 Fax (0686) 25241

assembly if it's a detachable type). Then refit the arm, setting the vertical tracking angle (ie in practical terms, the height of the arm pillar above the armboard) to something that looks sensible, and set the tracking force to about 1g.

The offset and overhang can now be set to minimise the lateral tracking distortion of the system. These should always be set first as, unlike vertical tracking angle and tracking force, you don't need to listen to check alignment. If you bought *Hi-Fi Choice* Issue 67, you already have the ideal tool for this job – the Elite Alignment Gauge. (If not, order a back copy now!) Of other alignment tools, the most common is the two-point protractor, which is extremely tricky to use correctly. If you do use one, be fastidious about aligning the cartridge with both sets of lines, or you can

retightening the bolts. It's worth checking that the cantilever on the cartridge is straight – put a handbag mirror on the platter and lower the cartridge onto this, then look towards the front of the cartridge and you will be able to see if all is well.

If your deck has a suspended subchassis, you will need to adjust the springs for the precise weight of arm and cartridge. Instructions for this should be supplied with the deck, so follow them carefully. If the instructions are lost then a simple rule of thumb is that the platter should be horizontal when the plinth is (remember to put a record on the platter to get the overall weight right), and there should be some free up-and-down movement at every point of the subchassis (it needn't be much movement, as in operation the deck

skating force) on the arm to a 'best guess' value – this will have to be properly tweaked later. The next stage is the much-feared 'Vertical Tracking Angle/Stylus Rake Angle' (VTA/SRA). To be absolutely rigorous about this, VTA refers to the angle between the line joining the stylus to the cantilever pivot position (not absolutely parallel to the cantilver, but very close) and the record surface, and SRA refers to the angle between the stylus contact patch and the record surface. VTA is a bit misleading as it is measured relative to the record, although altering the arm inclination without altering cantilever inclination (ie SRA) alters vertical tracking distortion. However, you don't need to know that to set it up!

Usually, the VTA should be about 20 degrees with the arm roughly horizontal. Unfortunately that figure is not standardised, and depends on record thickness and age (the 'standard' used to be a nominal 15 degrees), the cartridge make, individual cartridge variations, and worst of all the record itself. It is more sensitive to tracking force than to arm height adjustment, and subjectively interacts with lateral tracking error, tracking force error, bias error, and of course SRA. So arm yourself with a few favourite records and prepare to set arm height, tracking force and bias by trial and error. You may wish to leave this until the deck is finally sited, so you can listen critically.

The location of the deck is important and there are two considerations here: one is that the vibration in the arm due to stylus movement (action equals reaction, remember?) must be dumped to a mechanical ground, and the other is that sound from the loudspeakers must not be fed back to the deck. It's worth mentioning here that the smallest detectable modulation of a record groove is about one thousandth of a wavelength of light (ie one thousandth of the size of a CD 'pit'). At college I did an experiment with a 'Michelson interferometer', an optical device which measures to one tenth of a wavelength of light. The device was on a very solid concrete and brick bench, on a solid concrete floor. Kicking the base of the bench gently cause perturbations of about one tenth of a wavelength. You can't tell me that record deck siting is unimportant!

The best way to mount a deck is on a five ton slab of granite, supported by compliant mounts on a structure of steel girders set into the bedrock independently of the house foundations! Of course, every home should have one. Real people might prefer to use a wall-mounted shelf (such as those made by Appolo or Target – but make sure the wall is solid), or a good floor stand, preferably spiked and resting on the floor directly over the joists. Torlyte stands seem to suit suspended subchassis decks, while heavy stands suit solid decks better. See *Hi-Fi Choice*, Issue 57, for details of equipment supports in general.

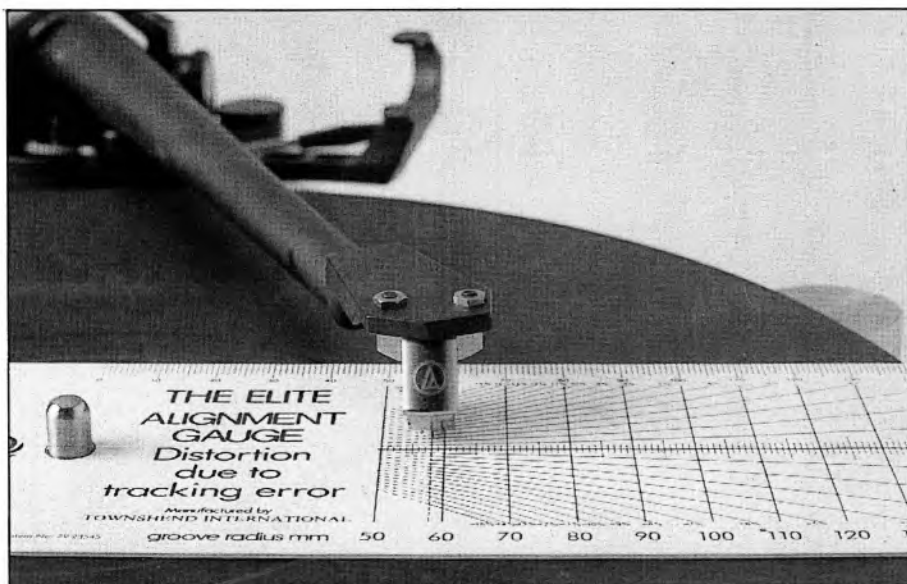

*The ideal tool for the job – The Elite Alignment Gauge. We gave you one free with Issue 67 in February.*

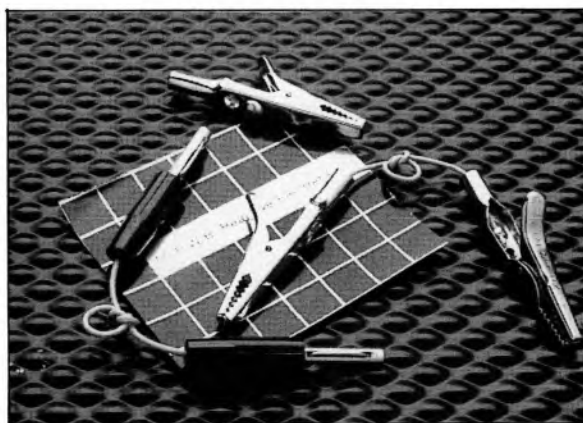

*Electret Foils and assorted 'charged' widgets from PWB Electronics. The case is far from closed...*

easily make unsuspected errors.

Follow the instructions with your alignment tool to set overhang (adjusted by moving the arm base towards or away from the spindle). If you installed the cartridge carefully, the offset angle should already be very nearly correct. The Elite protractor will let you compensate for small errors in this by means of small errors the other way in the overhang setting, leading to overall errors which are very small. You don't have this option with a two point protractor, and may have to fiddle with the cartridge, rotating it by fractions of a degree and then

shouldn't move perceptibly). Also check that the cables from the tonearm are properly dressed so as not to interfere with subchassis movement. Thick rigid cables are quite unsuitable for this job, so if you do use them, run a short but very flexible link to the tonearm base, or indeed run the arm wiring (which is very thin) right out of the arm base, as long as it doesn't pick up hum.

Now use a stylus force balance (a cheap mechanical balance from any good hi-fi shop is generally adequate), to set tracking force to the cartridge manufacturer's recommendation. Set the bias (anti-

Modification-type tweaks to record decks are plentiful. A popular one with some decks (Thorens/Linn style of construction) is replacement of the armboard with one made of a stiffer material such as Aerolam or Fibrelam. Metal platters can 'ring' and may be treated by a suitable choice of platter mat (felt or various synthetic rubber materials), or by bonding damping pads to the underneath. Don't try this unless you are prepared to go to some trouble to re-balance the platter (tilt the turntable and see where the platter wants to end up, to find the 'heavy spot'). The plinth can also be damped using bitumastic pads, lead or other materials. Be careful not to overload subchassis springs.

It is possible to get special silver wiring for use in a tonearm, but this must be regarded as a 'top level' tweak - I certainly don't rate it as cost effective. Replacing the

leads from the deck to the preamp is more likely to be beneficial and low capacitance, well screened cable usually works well. Altering the cartridge loading resistance and capacitance can make a difference, depending on the cartridge. If you are really brave, you could try filling the cartridge body with epoxy resin, bearing in mind that you will wreck it if the resin goes in the wrong places. Finally, if you want to spend a little money, fit an electronic drive to the deck (most decks use a synchronous motor, run straight off the mains). This makes a quite alarming improvement, for reasons I have never seen convincingly explained.

### ENVIRONMENTAL TWEAKS

I'm often surprised that more hi-fi enthusiasts do not spend more time tweaking their listening room. This should really go

hand in hand with loudspeaker installation, and can make amazing differences. Simply bracing (or removing to another room) a few flimsy bits of furniture can remove a good deal of muddle from the sound, and installing selected resonance control devices is well worthwhile. The American *Tube Trap* device would be highly recommendable if it were not so expensive, but its general principle of controlling resonances by putting sound absorbers (*Tube Traps* are a bit cleverer than just that, actually) in the corners of a room is very sound.

Also intended to modify the environment, in a different way altogether, are the PWB 'Electret Foils'. These little sticky things, and allied clips and widgets, are supposed to control electromagnetic fields in the room and in equipment. As far as anyone has been able to measure, they do no such thing and some of the claims made for them are quite untenable, but they have adherents. PWB says that it's not the equipment itself that is altered by the 'treatments', but listeners' perception of sound in the environment. Unfortunately, many listeners seem unable to spot the difference between a 'treated' and untreated room/system, which does tend to support the 'hysteria' explanation of their operation. And controlled listening tests organised by *Hi-Fi News & Record Review* at last autumn's Penta hi-fi show proved inconclusive. I suspect time will tell, and although I don't consider the case closed I must admit I have tried the treatments and don't use them.

Lateral tracking angle alignment, showing offset angle and overhang.

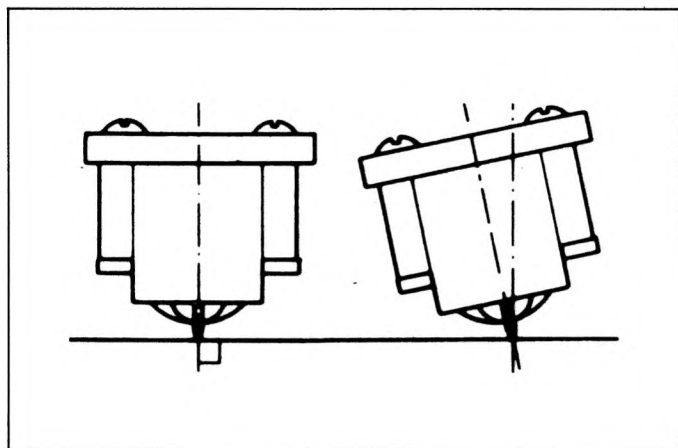
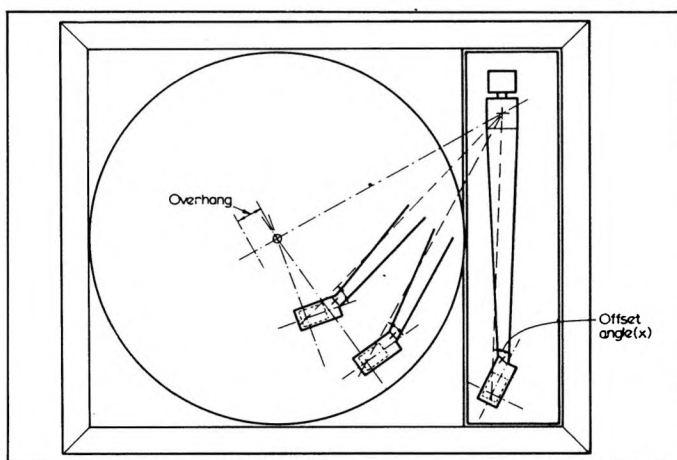

Viewed from the front, the 'tilt' angle of your phono cartridge should be zero.

Visualisation of Vertical Tracking Angle (VTA).

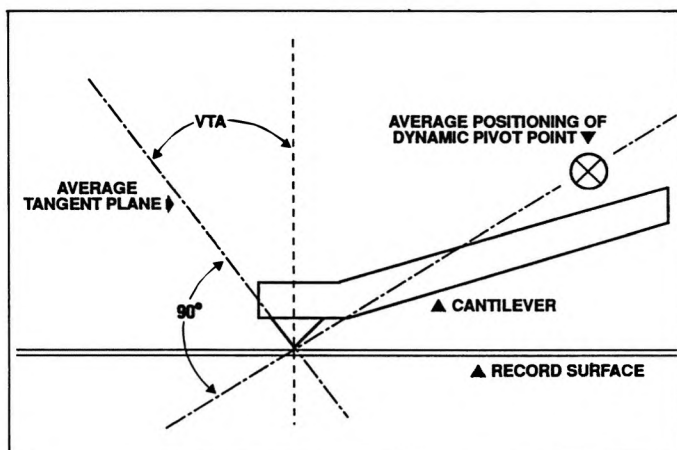

### THE END

The end of tweaking can only be defined by your patience, as the process can be carried on more or less indefinitely. But do bear in mind the law of diminishing returns; you will not improve things beyond their inherent merit, however well hidden that merit might have been in the first place. On the other hand, a certain degree of tweaking is always appropriate, and as mentioned should be an enjoyable activity in itself. You may not wish to turn into a full-blown hi-fi hobbyist, but you will get that little bit more pleasure from your music collection - which is what it's all about, isn't it?

### USEFUL CONTACTS

The following telephone numbers may be useful for DIY hobbyists needing to source high quality components.

- RATA Ltd** (0539) 83247.
- Audiokits** (0332) 674929.
- Moth Marketing** (0234) 741152.
- Wilmslow Audio** (speaker kits/drivers) (0625) 529599.
- Maplin Electronics** (catalogue from WH Smith) (0702) 554161.
- Audio Conversions** (hobbyist newsletter, £5 subscription) (0709) 873667.







# READERS WRITE CHOICE ANSWERS

## BEWILDERED IN LEEDS

With the intention of purchasing a turntable I have been to numerous hi-fi establishments in Leeds and have been given so many recommendations that I am now rather bewildered as to what to opt for. The decks that have been suggested are: AR EB101, Ariston Icon, Dual CS5000, Moth, Rega Planar 3 and the Revolver.

I listen to a wide spectrum of music (easy listening to rock) but am predominantly into Indie bands. Do you think that any of the decks mentioned are particularly good or would you suggest something else? My budget is £200-£230 and my system consists of a Technics SU-V55A amplifier and Mission 770 loudspeakers.

Once I've bought a turntable I will be looking for a cassette deck, and although I've not been recommended any particular models I have taken a liking to the Aiwa AD-WX808. Is this a competent performer? I only listen to live tapes and require a twin deck machine with excellent replay quality and a real time counter - my budget is £250. Looking forward to your expert advice.

HOWARD HOBSON,  
LEEDS, YORKSHIRE.

*Icon which could be good, or the current Moth turntable, but the Best Buy AR and Rega have consistently proved their worth and are hard to beat at the price. An important factor when considering either of them is whether you'll be able to site the deck on a proprietary wall bracket or table. If you can't do this then the AR is probably the better choice as it's less fussy about support than the Rega.*

*Cassette deck-wise, take a look at the reviews in this issue where we've tested several reasonably priced twin decks, including an old favourite, the Technics RS-T330R. We haven't as yet listened to the Aiwa you mention but its big brother the 909 fared quite well when we tried it, so the 808 is probably worth a listen.*

## RECOMMENDED POSITIONS

I enjoyed reading the January '89 edition of *Choice* and found many of the loudspeaker reviews informative. Like many other hi-fi enthusiasts I rely heavily on the information and reviews provided by your publication to help select future purchases.

However, I must take issue with you over the review of the Acoustic Research AR132 speakers. I have been in the

speakers as recommended (one foot away from the wall on stands). As an experiment I tried positioning them against the wall, as in your trials, and found that they did not sound as good.

Since your trials must take considerable time and trouble to arrange, surely it would be worth ensuring that the equipment is set up as recommended. I was impressed by your honesty in admitting that the speakers had not been set up correctly. It was also helpful of you to admit that when you later tried them in their correct position, you liked them. However, such a mistake should warrant a second trial. If this was a 'one off' it would be bad enough but on the facing page I noticed you admitted to accidentally presenting the AR112 in open space instead of against the wall as recommended. I began to wonder how many other reviews were on equipment that had not been correctly positioned.

On page 37 you point out that speaker positioning is important if they are to transmit sound to the ear efficiently and on page 50 you go so far as to say 'the site chosen for loudspeakers is often as influential as the choice of loudspeakers themselves'. Unfortunately you seem unable to take your own advice seriously.

As for your comment about one of your post-prandial panelists nodding off during the demonstration - were you serious? If he really did nod off after too good a lunch are we expected to take this as an indication of the quality or otherwise of the speakers? I suggest you give the person concerned the sack and employ somebody who is willing to take his responsibilities more seriously. I would feel a lot happier if I felt my monthly £2.95 was helping to pay the salary of a dedicated reviewer rather than feeding someone who is too bored to stay awake.

I have always felt that reviewing hi-fi equipment must be a daunting task if it is to be done honestly and fairly. I hope that in future loudspeaker reviews you will ensure that the panel is presented with equipment that has been set up

correctly. If you subsequently find that this has not been done I suggest you either repeat the review or make no comment on the equipment concerned.

ANDY ECKERS,  
TOCKWITH, YORK

*When undertaking blind listening tests on a large number of loudspeakers, it is essential to work within a defined framework. We therefore use the same room and ancillary equipment throughout, varying only the position of the loudspeakers in the room between a position 150-200mm from the rear wall and another 1m away, as far as possible according to manufacturers' recommendations (where available).*

*Unlike the wall site recommendations for the '112 and '122, AR was a little equivocal over the '132's ideal site. We went for the wall for the panel test, with subsequent free space siting, but my own feeling is that the '132 balances best when sitting rather uneasily in no man's land, betwixt and between - a position which regrettably tends to provide the worst rather than the best of both worlds. That said, the low frequency interaction of speaker and room is an unpredictable and fickle thing: it's perfectly feasible that the '132s may work better in your particular room. And if you like the sound of them in your system, who are we to argue?*

*As for one panelist starting nodding off during the presentation (after a light, cold buffet and alcohol free luncheon), I (and the editor) both regard this factual observation as of possible relevance, and it is reported as such.*

Paul Messenger

## OPEN-REEL SURGERY

What a pleasure to read the *Menu* on the contents page of your February issue. I had begun to think that the satisfaction I still derive from my LP collection must be due to old age ('cloth ears', etc)! It was even more encouraging to see that the record player still merits such

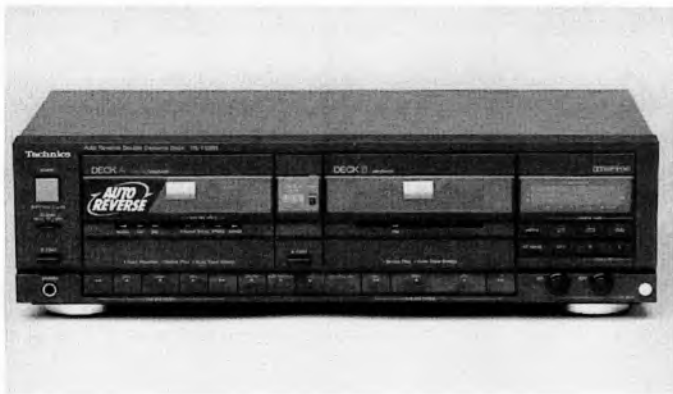

A twin with fair sound - the Technics RS-T330R.

*First, we'd suggest you buy a back copy of our February issue which dealt with turntables in some depth and includes reviews of 30 turntables and tonearms. Of those that you have been recommended both the AR and the Rega rated highly for their price when we last reviewed them. We haven't seen the Ariston*

fortunate position of being able to try out a pair of these for a few days and have been very impressed with their detail and clarity. I would have expected them to warrant at least a 'Recommendation' if not a 'Best Buy'. Perhaps my trials were not as scientific as yours but I did take the trouble to position the



keen practical attention as the Elite Alignment Gauge.

My equipment, like my LPs and tapes, was acquired over my active years but is even more valued now that I have more time to enjoy it. Some equipment could usefully be updated but I do want to keep my Ferrograph Series 7 open-reel tape recorder which needs some replacement parts. Do you know of a company that can provide them?

D. WHITE,  
OTTERY ST. MARY, DEVON.

*There's no-one we know of in Devon, I'm afraid, but if you give London Sound a call - Tel: (01) 868 9222 - they should be able to help you. Some parts are becoming difficult to source, we're told, but the experts at London Sound are most adept at improvising when it comes to getting an old Ferrograph machine back on the road.*

## POP 'N' SCRATCH

I read with interest the November edition of *Hi-Fi Choice* and am confused about the vinyl vs CD debate which appears to be in progress.

I find it practically impossible to find perfect pressings of records - mainly electronic music such as Klaus Schulze, Tangerine Dream etc. In fact I have duplicated approximately 30 albums with CDs and for the most part I am delighted with the expensive but pop'n'scratch free results. I would greatly appreciate guidance in finding superb pressings of albums such as *Sourcerer* by Tangerine Dream and *X* by Klaus Schulze, which aren't available on CD. I take great care of my LPs but still

encounter problems even with brand new so-called audiophile pressings.

DAVID GILLET,  
KINGSTON-UPON-THAMES, SURREY.

*The vinyl vs CD debate has now largely petered out but concerns the fact that CDs, despite their advertised 'perfection' are not as good in fidelity terms as LPs. This becomes more obvious as the transparency of systems increases and is most noticeable as a difference in the amount of musical information available from each medium. But some listeners would, or used to, beg to differ - hence the debate.*

*There are two possible solutions to your dilemma - the first and most economic is to wait for the albums you want to appear on CD, maybe even petition the record company, or hunt around for an importer who specialises in this area, as they may well be available in Japan, America or Europe.*

*The second is to buy yourself a top flight turntable. Contrary to the popular belief that the better your hi-fi the more perfect your LPs need to be, very high quality turntables have a wide dynamic range and present music as a separate entity above and in front of surface noise, ie the level of the music relative to noise is so great that the latter becomes all but unnoticeable. Consequently it's feasible to play quite scruffy LPs on a state-of-the-art turntable and derive great musical enjoyment from them. Of course, the catch is price, as the sort of turntables that make this grade cost close on £1,000 when equipped with an arm and cartridge. But if you want to hear your records in their full*

*splendour take a few of them down to a dealer who stocks one of the following decks:*

*Townshend Rock, Voyd Valdi, Roksan Xerxes, Pink Triangle PT Too, Linn LP12 or Alphason Sonata and have a listen.*

## BETWEEN A ROCK AND A HARD PLACE

My system consists of a Townshend Rock/Merlin turntable, Excalibur arm and Goldring Eroica L cartridge, amplification is courtesy of an Exposure VI, VII, VIII Super combination, with Exposure cable supplying the signal to Mordaunt Short MS500 Golds. I also have a Marantz CD65/IISE as a secondary source. My musical tastes are varied, anything from the Buzzcocks to Beethoven finding its way onto my deck.

I suspect that the weakest parts of my system are the speakers and the cartridge which is now two years old and ripe for replacement. Models that have crossed my mind are the Audio Technica AT-OC7, Ortofon MC30 Super and the Milltek Aurora. What are your thoughts on these and can you think of any alternatives? My budget is flexible in as much as I have time to save up for the replacement.

Could I also have your thoughts on loudspeakers? Owing to domestic constrictions the speakers have to fire across the room and one of the reasons I chose the MS500s is that they work close to a back wall and any replacement speakers will have to do the same.

Thanks for a superb magazine. When are we going to get a *Hi-Fi Choice* show?

M. P. C. ELLIOT,  
ST. AUSTELL, CORNWALL.

*The Editor uses the same front-end as you and as yet hasn't discovered a cartridge significantly better than the Audio Technica AT-OC9. There are plenty that are different and often more expensive, but to his taste (and he's not alone) the OC9 is very hard to beat. Of the cartridges you mention the OC7 is probably the most impressive, whereas the Milltek is less dynamic but quite seductive and the Ortofon a little bland.*

*At the other end of his system JB uses Townshend Glastonbury II loudspeakers situated in the corners at one end of his room, with the listening position at the opposite end creating a far field effect. The image depth and width created by this set-up can be awesome with the right software and I can think of no other speakers that would suit*

*your system and circumstance better. That is, if you've got the space for these less than dainty transducers which measure 90 x 28 x 45cm (h x w x d) and cost £1,400. If they sound too hefty then consider the Yamaha NS1000s which are smaller and less costly, and would work very well with your amplifier.*

*A Hi-Fi Choice show sounds like a good idea - next time we get a spare nano second we'll give it some thought.*



*Editor's choice - the Audio Technica AT-OC9.*

## DISTORTION MYTH

Your February issue, which included a free Elite Alignment Gauge, contained an excellent article explaining how to use the gauge to reduce stylus tracking error. However, it is misleading to state so positively that end-of-side distortion is a myth.

It is true that audible distortion caused by a misaligned arm is more obvious towards the record centre, but even when the arm is adjusted for optimum tracking there will always be some residual tracing distortion - which is worst towards the end of the side. This tracing error is inevitable because of the essential difference between record cutter and replay stylus. It is no myth and must be accepted.

Fortunately over the last decade or so the development of improved styli profiles - such as the elliptic and parabolic - has reduced the footprint of the playback stylus in the record groove to the extent that tracing distortion at the end of the side is now too small to annoy the average user.

J. WALTERS,  
POOLE, DORSET.

*Quite so. The myth is not that end-of-side distortion exists at all, but that it is necessarily far worse than anywhere else. Even with a cheap modern cartridge, painstakingly aligned, the effects due to reduced groove velocity are small, and with elliptic (etc) styli things are even better. Lateral tracking distortion should be zero at 62mm groove*



*One top flight turntable, Alphason's Sonata.*

*play it  
again  
sam  
and  
again  
and...*



... when it comes to music, nobody plays it better than Yamaha  
Sit back, relax and enjoy the dynamic, natural sound of a Yamaha  
cassette deck. Engineered to the highest standards, the Yamaha  
range of hi-fi cassette decks offers something for everyone –  
professional 3-head systems, auto-reverse decks, twin-tape  
machines plus advanced features like Play Trim and Dolby HX Pro\*  
Dynamic Bias Servo – and much more. Plus they're all RS remote  
control compatible – in harmony with the rest of your Yamaha



system. So whether you're buying your first cassette deck or  
reaching for new heights of excellence, choose a

Yamaha – they're music, naturally.

For further information and the name

of your nearest Yamaha dealer, contact us at the address below.

*music  
naturally*

**100** **YAMAHA HIFI**  
YAMAHA 1887-1987

Yamaha Electronics (UK) Limited, Yamaha House, 200 Rickmansworth Road,  
Watford, Herts WD1 7LS. Tel: Watford (0923) 33166.

\*Dolby HX Pro is a trademark of Dolby Laboratory Licensing Corporation

*radius, and this can sometimes be heard as a 'sweet spot' on a record, despite the low groove velocity there; so tracing distortion must be pretty low.*

### PAUSING IN FULL STEAM

I have recently replaced my old Sony cassette deck with a Denon DR-M24HX. I chose this because I wish to produce edited copies of some home made recordings (of steam locomotives) and thought the general recording quality, three heads and variable bias etc would produce good results. However, the machine exhibits one undesirable feature not mentioned in any of the reviews, namely that using the pause control during recording always leaves a short blank of approximately half a second. I have been in touch with my dealer and Hayden Labs who tell me that this is as per specification. Is this feature typical of modern cassette decks or have I picked the wrong one again? Either way I feel that the lack of a proper pause facility might be of interest to other potential buyers.

Finally, if you have any advice on how to overcome this problem I would be most grateful.  
P. SHUTTLEWORTH,  
WIGAN, LANCs.

*Because tape dubbing is rarely carried out in our reviews the effectiveness of the pause control is often overlooked which makes it hard to say whether the problem you have encountered is a common one. A quick experiment with a rather basic NAD deck proved that on decks with mechanical transport controls it's quite easy to make relatively seamless pauses, so perhaps the problem is due to the electronic controls on the Denon.*

*Certainly it's a problem that shouldn't arise even with powered transport controls, but unfortunately apart from replacing the machine we can't think of a way around this.*

### CRYSTAL CLEAR AND PRECISE

The core of my hi-fi system consists of a Cambridge CD2 CD player, Inca Tech Claymore amplifier and Musical Fidelity MC4 loudspeakers. All the equipment was auditioned before purchase but I still have a problem. I listen to music fairly loud and the treble is sometimes very edgy - it sounds as though the system is becoming confused and ruins vocals by making them sound completely unreal.

However, this coarseness doesn't seem to occur with classical music.

I have heard the CD2 in a different system (Quad 34/606/ESL63) and the MC4s in another (Nakamichi OMS3/NVA A50TDS) and neither of these suffered any coarseness. The sound I like is sharp, crystal clear and precise, transients must be effortless with powerful bass slam and speed; I would also like to improve depth and imaging. I have heard the Musical Fidelity Preamp 3/PI40 combination but didn't like it, as the sound seemed very slow. I've also listened to a Cambridge C50/450 and liked its solidity and speed. I intend to audition the pre/power combos from Audiolab, Quad, NVA, Cambridge (2x450) and possibly the Denon POA6600s with a passive preamp.

Would you recommend any of these in particular or are there any alternatives you could suggest?

SHAUN HASSELDEN,  
GRIMSBY, SOUTH HUMBERSIDE.

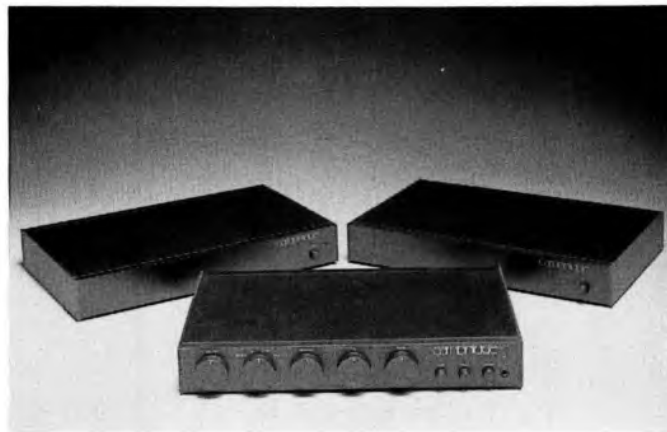

*Affordable Cambridge separates could fit the bill.*

*You are right to assume that the amplifier is the main limitation in your system - the MC4s are quite power hungry loudspeakers requiring fairly meaty amplification to give of their best. Of the amplifiers you mention the Cambridge and Denon are most appropriate to your requirements, both being suitably powerful and capable of high levels without muddling. If you wanted an alternative the Deltec DSP/DPA 50S set-up was very well received in our March tests and is well worth a listen. Paul Miller commented that "Via the CD input the sound was thrilling, so vivid and sharply etched were the images of instruments and vocalists."*

### POWER HUNGRY

I have an Ariston Q-deck turntable, NAD 3020e amplifier and AR18BX loudspeakers. Although the sound this system

produces is quite good it lacks power, and doesn't have enough bass, punch or scale. I have replaced the original Ortofon cartridge with an Audio Technica AT95E which improved this area a little but not enough. In an effort to improve things I am considering changing the speakers as I feel they are the limiting factor. Given a budget of £100-£150 do you have any suggestions for a replacement?

At present my ARs are supported by cabinets, not speaker stands. I have considered buying proper stands but don't know whether they would give me the more powerful sound that I am after.

Also, I've noticed that smaller speakers tend to give quite a punchy and powerful sound and had wondered whether I should try some in my system.

T. CLIFFE,  
NOTTINGHAM.

*Speaker stands would definitely take your system some way*

### COMPACT EXTENSION

I have two questions on loudspeakers: one of a general nature and the other specific.

Many of the smaller speakers which your reviewers have rated very highly in the mid and HF range, are inevitably compromised by obvious LF inadequacies, due to their size. What if these were used with a sub-woofer? Would this then make them comparable with the better of the larger speakers, or does a sub-woofer add its own sonic detraction/complications?

Although highly desirable it is hardly reasonable to expect every small speaker to be reviewed with and without a sub-woofer, but might I suggest this aspect be covered in the summary of *Best Buys & Conclusions* or even a review of sub-woofers and their capabilities in the small speaker field? Whilst a decent sub-woofer can cost more than many bookshelf speakers, I would suggest that to many readers it is size rather than price, which limits the possibilities.

And specifically, do you have any views as to what a quality sub-woofer would do for the Acoustic Energy AE1?

R. GREAVES,  
BEAUMONT, JERSEY.

*You're right - the subwoofer does look like the answer to every compact speaker-owning bass freaks' dreams, and if you're not obsessed with fidelity and keeping things in phase they do indeed offer some serious extension of the lower frequencies. However, unfortunately they are extremely difficult to integrate into a speaker system not designed for the purpose. The main problems seem to be in maintaining phase, ie the time at which signals are transduced, and creating seamless integration of the sub and main speakers, eg if the compact rolls off at 100Hz and the subwoofer goes up above that, muddling can occur.*

*The only subwoofers that seem to work really well are the two box types (ie one for each channel) such as the Celestion System 6000, which has its own active crossover. This latter component is undoubtedly one of the key factors in the success of this design, as it maintains phase and tailors the roll-off points of both units to give an integrated response. In fact the System 6000 could prove a suitable partner for the AE1 giving it an extended response and thus a greater sense of depth, impact and substance.*

*towards the sound you are after, but given the relaxed nature of the AR 18BX it may indeed be a good idea to find a replacement. Your desire for a big, powerful sound with good punch and bass is a little tricky to satisfy given your budget. You're right that small, well designed speakers such as Goodmans Maxims and Wharfedale Diamonds give a punchy and tight sound that can sound quite big with suitable partnering equipment, but rarely can these designs offer significant bass extension or sense of power.*

*We would suggest you consider stretching your budget to either the Wharfedale 505.2 (£159) or the Mordaunt Short MS100 (£189), the latter probably being the more punchy of the two whilst the 505.2 is the more revealing and neutral. Both are capable of a powerful, large scale sound if sited on rigid spiked stands close to a rear wall.*



# MARKET RESPONSE

*In our exclusive market survey Dan Houston talks to UK hi-fi dealers about cassette decks, investigating current trends, reliability and sales.*

Walk things, in-car set-ups, yuppie and ghetto blasters, twin-cassette machines, a Nakamichi Dragon... whatever your poison you probably come into contact with compact cassette more than any other musical software medium. And with pre-recorded cassettes selling more than LPs and CDs combined (74.4 million according to 1987 record-industry figures) it's not surprising that sales of cassette decks are leaping forward in corresponding fashion.

Market statistician Nick Parker of AGB (the Audits of Great Britain Group) put last year's sales of separate cassette decks at 174,200 units representing a market worth just over £31m. In 1987 160,000 decks were sold according to AGB, with a corresponding value of £26m. Although the volume of cassette deck sales has only risen by nine per cent, the value of the market has risen by nearly 19 per cent which is good news for the hi-fi cause since it means people are now spending more money on cassette decks.

The still relatively recent establishment of CD was given as one of the main reasons for this trend. It seems CD's 'better quality' has leavened people's expectations of what they can get from audio equipment thereby boosting the whole industry, cassette decks included. And it looks as if the longevity of the compact cassette with its plethora of applications remains assured – certainly for decades to come.

DAT (Digital Audio Tape) appears to have died a death with machines being marketed only to professional users and software limited to a mere handful of titles. Even in Japan DAT only achieved a 'bonsai' status with consumers, and consequent price slashing has done nothing to alleviate Nipponese nonchalance. The arrival of recordable CD (CD-R), with the first machines expected (for professional use only) this summer, may shake things up because CD-R has a wider and more established appeal. The £5 blank discs will be playable on any CD machine as well as CD-R

machines and if quality can be proven there will be more pressure on the manufacturers to market the machines (even at the envisaged cost of £700). The issue of copyright is holding up technology with hardware manufacturers afraid of record industry reprisals, although it's easy to see that something like CD-R is a pirate's dream. Certainly nothing will be resolved until the two industries decide on how to solve the copyright problem.

So tape will enjoy a long life. But one of the criticisms we heard from dealers this month is that the quality of most prerecorded cassettes is poor and therefore the hi-fi user would want to make his own tapes from better quality blank cassettes.

This month we have replies from 42 dealers covering 25 brands of cassette deck on the market in the UK at the moment. As yet there are no British cassette decks (apart from Pro machines made by NEAL) and from previous surveys we know this is a cause of chagrin to dealers, some of whom felt they lost sales on British hi-fi systems for this reason. A&R Cambridge has been investigating the possibility of producing a cassette deck but Mike Martindell, its Technical Manager, told *Choice* there was nothing in the pipeline... yet.

We asked dealers how important a cassette deck is in the overall hi-fi system and found that its position is number three

– after CD players and turntables. Many told us that cassette decks were only used as a 'slave' by their customers to make tapes for the car, say. The tape medium (also known as hi-fi's bastard medium) is widely regarded as inferior in terms of sound quality. The only group who appear to be buying cassette decks as a sole source are students. This makes sense when one thinks of their financial position and the fact that cassettes are an established medium to their age group.

## TERRIBLE TWINS

Twin cassette decks did not interest our dealers, many of whom describe them as "a gimmick". Suttons told us that 90 per cent of customers who asked for a twin subsequently found they had no real use for the facility. The consensus of opinion is that you are always better off putting your money into a single deck – rather than trying to buy two for the price of one. If you must have a twin deck dealers felt that Aiwa and Denon made reasonable models but that you should spend twice as much as you would on a reasonable single deck (ie at least £250).

## RELIABILITY

Although a couple of dealers felt that cassette decks were among hi-fi's less reliable components the overall feeling was that today's models are of good build quality. And if you look after your cassette deck you can expect years of service from it. The

heads are usually the first things to go and dealers felt, on average, that today's heads would last around seven years. Quality control at the factory stage is also good with only 2.3 per cent of decks arriving in a faulty condition. Merrow Sound told us it had not had a faulty machine delivered in the last year! The above figures are around the same as those in past cassette deck surveys and our reliability ratings should be seen in terms of this low figure; the standard of reliability overall is very good.

We asked dealers to name their most and least reliable brands and calculated the results on a points system. Nakamichi is top with 78 points for reliability followed by Denon (66), Yamaha (62), Marantz (26) and Technics (24). Unreliable brands were given as Teac, Aiwa and a few comments on Denon. The latter has suffered from discordant reliability ratings before and many dealers pointed out that while Denon had had a 'glitch' of unreliable product in the past those days were over now – some dealers may still be affected by these past experiences.

If and when your cassette deck does fail we found that you can expect a dealer to repair it in two weeks on average. Most dealers would repair cassette decks themselves and many told us this figure would be much shorter if they had parts in stock. Should the machine be sent back to the manufacturer then the average turnaround time seems to be just



*If you are expecting twins then Denon's DRW 750 option is popular.*

*Allsop 3: hi-fi's equivalent to a lice comb for those dirty heads.*



less than three weeks. Dealers mentioned longer waits for parts on old cassette decks and one told us: "the older it is the longer it takes."

Bearing in mind how infuriating it is to wait without music we asked dealers to name their fast and slow brands. Yamaha was mentioned by seven dealers as fast followed by Nakamichi, Denon, Technics, NAD, Kenwood and Teac. Slow brands were cited as: Aiwa (five mentions), Sony, JVC and Denon (again!).

## HEAD CLEANER

The most common cause of complaint from a cassette deck is dirty heads and pinch rollers. It seems that the GBP (Great British Public) believes that a cassette deck – perhaps like an amplifier or loudspeakers – will deliver sounds regardless of any upkeep or attention. And while all the specialist dealers we spoke to said they explained the importance of cleaning at the point of sale, dirty heads remain their biggest bugbear.

"Ninety five per cent of breakdown cases are due to dirty heads," was how Chris Coakes, of Suttons put it. The best method of cleaning is manually with a pure alcohol spirit (genuine Russian Vodka would do according to one source!) and cotton wool buds. "It's like cleaning the floor, you have to get down on your hands and knees and see what you're doing," said Mike Corrin of Island Compact Discs. Pure alcohol, or isopropanol, is the cheapest and can usually be obtained from chemists – though you may have to order it if you look a little destitute! Failing that,

proprietary fluids are sold under the Teac, Bib and QED brand names.

Hi Fi Corner, of Edinburgh and Glasgow, has put together its own cleaning kit comprising head and pinch-roller cleaning fluids, brush and buds. However, many dealers recognised that their clients may suffer from the palsy and that to manually clean a cassette deck was a fiddly and dexterous job. The other problem with cotton buds is that you cannot use them in car cassette players, so we asked dealers for their best selling cassette-type cleaners. The £4.95 *Allsop 3* kit was preferred for using pads rather than brushes and came top with an overwhelming majority followed by Trackmate and Discwasher offerings.

Dealers told us that cassette decks benefited from regular demagnetisation to keep them sounding sweet, but one should be careful to follow the manufacturer's directions on this. Nakamichi's UK Service Manager, Duncan Crimmins, explained that repeated use of cassette type kits could push the circuitry off specification in logic control decks. "The high burst of energy can alter the internal characteristics by affecting the deck's own amplifiers," he said. For this reason Nakamichi recommends hand-held demagnetisers with which you 'brush' the heads after the deck has been turned on. Nakamichi's own *DM10* is about £30, but dealers also recommended Milty's *Magnett 1X Demagnetiser* which retails for £7.99.

## THE BEST SELLERS

Our survey asked dealers for their three top-selling cassette

decks in three price brackets. The results are calculated on a points basis: five for the first, four for the second and three for the third and added up.

### Budget Best Sellers (below £120)

1) Yamaha <i>KX200</i>	73
2) Aiwa <i>ADF270</i>	41
3) Aiwa <i>ADF370</i>	30
4) Onkyo <i>TA2120</i>	30
5) Sony <i>TCFX150</i>	18

These findings are different from our previous surveys with only Aiwa maintaining its position among the best sellers.

### Mid Priced Best Sellers (£121-£300)

1) Denon <i>DRM07</i>	90
2) Denon <i>DRM10</i>	73
3) Denon <i>DRM12</i>	63
4) Yamaha <i>KX300</i>	61
5) Denon <i>DRM24</i>	49

Although Denon is stocked by more dealers than other brands it nevertheless wipes the board of competition with the above picture looking much the same as previous surveys.

### Top priced best sellers £300 plus

1) Nakamichi <i>CR1E</i>	77
2) Nakamichi <i>CR2E</i>	76
3) Nakamichi <i>CR3E</i>	72
4) Denon <i>DRM44HX</i>	53

A couple of dealers mentioned that Nakamichi's *CR* range wasn't selling as well as its previous models, but our figures show it going from strength to strength with only Denon offering to do battle.

Market Response is compiled by approaching dealers (in a fairly random fashion) nationwide. The results are then compiled in a similar way to an opinion poll – much of the material is subjectively based. We don't pretend that our list of best sellers is a totally accurate picture for the UK at the moment. The specialist dealers that we rely on mostly should be seen in the light of their specialisation; they don't, usually, sell fridges as well. The limited nature of the survey also means that only the more common brands stocked will feature. If your proposed cassette deck doesn't feature in the reliability column it does not necessarily mean it's unreliable. The survey complements the main review topic every month but concentrates on mostly different criteria to give readers a distillation of as many dealers'

opinion as possible.

## CORRECTION

In February's *Market Response* on turntables the figures given by AGB indicated a drop in turntable sales by 10,000 units from 1987 to 1988 (to 121,700), not a rise of 10,000 as was published.

## PARTICIPATING DEALERS

Our thanks to the following dealers for taking part in this survey:

Acoustic Arts, Watford, Hertfordshire  
Aerco Ltd, Woking, Surrey.  
Analog Audio, North Finchley, London.  
Aston Audio Ltd, Alderley Edge, Cheshire.  
Audio Excellence, Swansea, Wales.  
Avon Hi-Fi, Shrewsbury, Shropshire.  
Basically Sound, Bracon Ash, Norwich, Norfolk.  
Beaver Radio, Liverpool, Merseyside.  
Better Hi-Fi, Liverpool, Merseyside.  
Bridge Hi-Fi, Walsall, West Midlands.  
Cambridge Hi-Fi, Cambridge.  
Chew and Osborne Ltd, Saffron Walden, Essex.  
Cloney Audio, Blackrock, Dublin.  
Covent Garden Records, Charing Cross Rd, London W1.  
Definitive Audio, Brighton, E Sussex.  
Elite Hi-Fi, Harrogate, N Yorks.  
Erricks of Bradford, Yorkshire.  
Framptons, Plymouth, Devon.  
Gilson Audio, Middlesborough, Cleveland.  
Grahams Hi-Fi, New North Rd, London N1.  
Grange Hi-Fi, Burton on Trent, Staffs.  
Hi-Fi Corner, Edinburgh and Glasgow.  
Hi-Fi Experience, Tottenham Court Road, London.  
Holborn Hi-Fi, Aberdeen, Angus.  
Island Compact Disc Centre, Douglas, Isle of Man.  
Marrow Sound, Guildford, Surrey.  
Norman Audio, Preston, Lancashire.  
Now That's Hi-Fi, Portsmouth, Hampshire.  
Lafayette Hi-Fi, Dublin, Eire.  
O'Brien Hi-Fi, Wimbledon, London.  
Paul Green Hi-Fi, Bath, Avon.  
Radlett Audio, Radlett, Herts.  
Richer Sounds, London Bridge, London.  
Selective Audio, Otley, W Yorkshire.  
Spatial Audio, Tottenham Court Road, London W1.  
Stereo Stereo, Glasgow.  
Steve Boxshall Audio, Cambridge.  
Suttons, Bournemouth, Hampshire.  
The Audio File, Bishops Stortford, Hertfordshire.  
The Cornflake Shop, Windmill St, London W1.  
University Audio, Cambridge.  
Westwood and Mason, Oxford.

**NB Any dealer who feels aggrieved that he is not on this list, and would like to be consulted in future, either regularly or intermittently, please write to us at 14 Rathbone Place, London W1P 1DE, or telephone (01) 631 1433.**

# APPLIED TECHNOLOGY From SENNHEISER

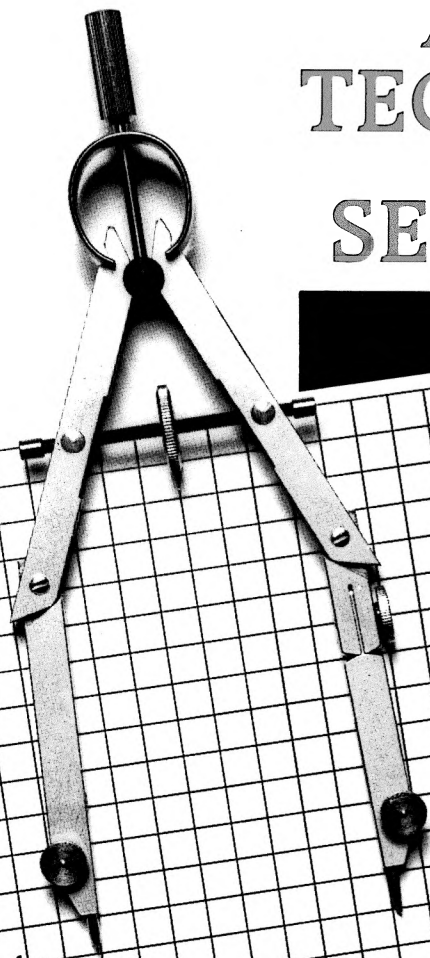

Ergonomic  
Ovoid Capsules

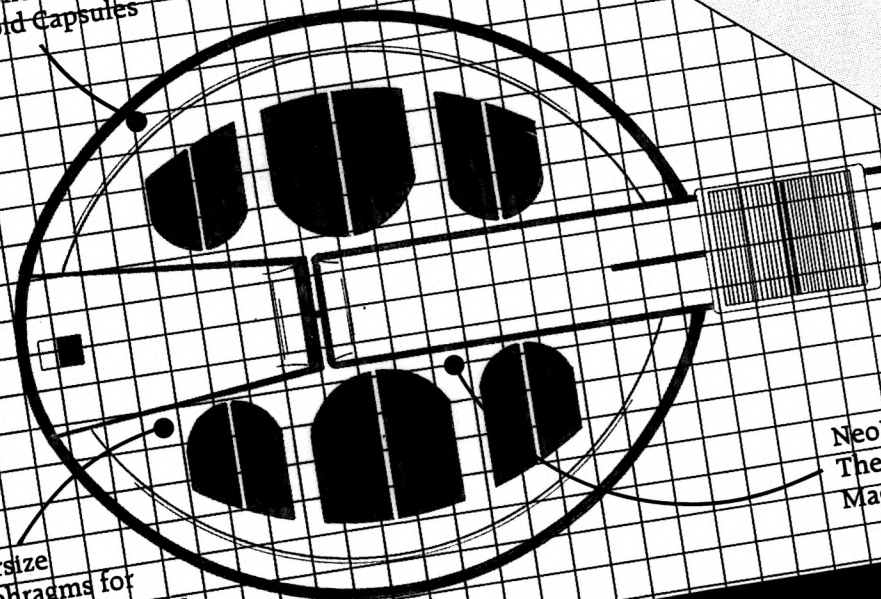

Over-size  
Diaphragms for  
Deep Powerful Bass

Neodym Iron Magnets.  
The World's most powerful  
Magnetic Material!

**HD 520. £59.95**

- Copper voice coil tuned for deepest bass · Oversize diaphragms · Neodymium Iron Magnets · Oval Circumaural Capsules · Unbreakable Headbands · Fully Modular Construction · 18 - 22'000 hz ·

**HD 530. £69.95**

- Aluminium voice coil tuned for absolute clarity · Oversize diaphragms · Neodymium Iron Magnets · Oval Circumaural Capsules · Unbreakable Headbands · Fully Modular Construction · 20 - 25'000 hz ·

**Applied technology** is not just a catch phrase. Sennheiser has invested in an ongoing R&D programme that constantly pushes at the boundaries of audio research. The results can be clearly heard in these new headphones.

For your FREE Sennheiser Colour catalogue,  
write to: Hayden Laboratories, FREEPOST, Chalfont St Peter,  
Bucks, SL9 9BS. Tel. 0753 888 447.





# CHOOSING AND USING . . . CASSETTE DECKS

The unique feature of Compact Cassette is, of course, the ability to record. But it should also be stressed that musicassettes are a major source of prerecorded music, outselling LP and CD combined. The cassette has done for the music industry what the transistor did for radio, providing 'go anywhere' flexibility in portables, personals and in-car variations.

The most obvious recent trend in domestic mains machines has been towards the double 'dubbing' deck, fitted with two transport mechanisms. In the past the prevailing standards of these decks has been very poor, but matters have improved somewhat and almost one half of the latest test group is of this type.

## REPLAY

Nowadays the best musicassettes can give very respectable quality, so the ability to get the best from musicassettes is a valid assessment for a cassette deck.

The task requires a good quality tape transport mechanism and replay head, plus careful alignment of heads and electronics. Although international tape equalisation and noise reduction standards do exist, not all manufacturers are equally good at adhering to them. The result is that many decks perform less well on replay only than they do within the 'closed loop' of record/replay, and our reviews pay attention to this.

## RECORD/REPLAY

In some ways record/replay is easier than replay only, insofar as head alignment, Dolby tracking and equalisation errors can cancel out and compensate for each other. However, any inherent transport problems are likely to be exaggerated, and there is now a still greater premium on the quality of the record head, particularly if metal tape is likely to be used. To get a decent quality recording, a deck needs to be accurately aligned electronically for a sensible range of different tape types; some machines offer variable bias for 'fine tuning' to specific tapes – a useful facility for those prepared to take the trouble.

Good quality metering set to the right sensitivity level can be a

boon, though in time and with practice a cassette deck owner will probably gradually come to learn the 'right' meter level for getting most signal without compression onto a specific type of tape.

## TAPE TYPES

Though there are three formal groups of tapes, Types I, II and IV, there are variations within each group which further confuse. In brief, the best advice is to find a tape in each group which suits the set-up of the recorder, and then stick to it. (But note that the tape manufacturers have an annoying habit of re-mixing formulations regularly without changing the brand identity.)

The very cheap ferric tapes are not hi-fi quality, so it is better to go for premium Type I ferric from a reputable brand for general purpose use. A Type II chrome or pseudochrome will give a step-up in quality, while Type IV metals can turn out to be the cat's whiskers on some decks – but may not work too convincingly on others. Perversely, the very best decks can produce stunning results on the better quality Type I ferrics.

## FEATURES

No other component fulfills a button pusher's dream like a cassette deck. The bare essentials boil down to tape selection (nowadays generally automatic), and Dolby B noise reduction (necessary for musicassette replay but optional for record/replay).

A host of imaginative inessentials will either enhance the enjoyment or baffle the user, depending upon temperament. Microphone inputs are fast disappearing, but headphone sockets remain. Most decks now include Dolby C noise reduction, and a few still have dbx. Dolby HX Pro is used by an increasing number of decks, and reduces high frequency compression with Type I and II tapes. It is *not* a noise reduction process.

Electronic logic control may supervise an almost silent transport system, giving the potential for microprocessor-controlled track search and programming systems; for auto-reverse to extend play or record

times; and for automatic or semi-automatic tape tuning in the more expensive machinery. Bias 'tweaking' enhances tape matching, while replay EQ may be trimmed for optimum replay response on some machines.

## R-DAT RECORDERS

R-DAT – more often known by its generic title, DAT – is an acronym for Rotary-head Digital Audio Tape, and was developed by a large number of mainly Japanese companies headed by Sony. At the time of writing, DAT remains stalled in a political morass, and very few machines are available through legitimate channels. Talks scheduled for the spring and summer this year may change matters, and we maintain our watching brief. . . .

Two existing technologies came together to make DAT possible. One is the helical scan method of recording signals on to tape. A fast rotating drum with heads embedded in its periphery records diagonal stripes across the width of the tape. The result is a high head writing speed to cope with the necessary 2.5MHz bandwidth combined with a slow linear tape speed (along the length of the tape) to give up to two hours recording time from a relatively short length of tape. This in turn facilitates a physically small tape and allows fast shuttling from one end of the tape to the other. To further increase practicality, the tape is wholly enclosed – it's only exposed when within the maws of the recorder itself – and it has a neat record disable switch rather than a cassette style break off tab.

The other technology is of course compact disc style digital signal processing. More than one standard of digital encoding is available. For prerecorded material, the system is identical to CD – 44.1kHz sampling and 16 bits (there are necessary differences in error correction which don't concern us here). However domestic DAT recorders are inhibited from recording at 44.1kHz to avoid the temptation of making 'perfect' recordings digitally from compact discs. Instead, recordings are allowed at a 48kHz sampling frequency which means a slightly greater

bandwidth but an unnecessary digital to analogue conversion stage followed by conversion back to digital, with the inevitable loss of sound quality when recording from compact disc.

DAT machines can also be driven in a long play, lower quality mode, but this isn't fully supported by the industry and is not usually available for recording purposes.

In common with video practice, recordings are made on one side of the tape only – there's no turning sides in the middle – but with the addition of a control track which automatically records data such as running time from the start of the recording and track numbers which are recorded automatically when the deck detects a gap between tracks or songs. The codes can be changed later if required, renumbered (important when recordings overlap so the recorder can tell where it is when the tape is inserted without having to rewind or to add skip IDs which instruct the tape to fast wind to the next start ID and resume play from there. A few minutes recording time can be skipped in a second, which is almost imperceptible, whilst a complete two-hour tape can be rewound in about 40 seconds with most recorders. When handling, the format is incredibly slick and polished by cassette standards. Only the CD player makes DAT's track access times look pedestrian.

## CHOOSING

Having weighed up the pros and cons of your own priorities and requirements, and having studied our reviews, it's not a bad idea to audition one or two likely contenders. A comparison with something really good is almost essential to establish a quality yardstick when trying to assess how much you will need to spend to achieve the desired level of performance.

The hi-fi enthusiast may not take the purchase of a tape deck as seriously as he would the selection of, say, turntable, arm and cartridge, but audible differences between machines are no less obvious.

1  
9  
8  
9

# DESIGN INTEGRITY

---

THE SAME ENGINEERS WHO  
DESIGN DENON PROFESSIONAL AUDIO  
DESIGN DENON HI FI.

THE SAME EARS THAT GUIDE  
DENON'S AWARD-WINNING RECORDING  
SESSIONS EVALUATE THE SOUND OF  
DENON'S PLAYBACK EQUIPMENT.

THE SAME TECHNOLOGY THAT  
WINS CRITICAL ACCLAIM FOR DENON'S  
TOP-OF-THE-LINE COMPONENTS APPEARS IN  
DENON'S MOST AFFORDABLE PRODUCTS.

THIS SINGLE-MINDED APPROACH  
TO SOUND QUALITY IS SUMMARIZED BY  
JUST TWO WORDS: DESIGN INTEGRITY.

# DENON

---

D E S I G N I N T E G R I T Y

For your free colour brochure on all  
Denon's Hi Fi equipment write to:  
Hayden Laboratories Ltd, FREEPOST,  
Chalfont St. Peter, Bucks SL9 9BS.



# ACOUSTIC RESEARCH RD-06

ACOUSTIC RESEARCH LTD., HIGH STREET, HOUGHTON REGIS, BEDS LU5 5QJ. TEL: (0582) 867777.



If asked to encapsulate the *RD-06* in one pithy phrase, it would have to be 'long awaited'. It must be three or four years since AR first unleashed its characteristic 'sit up and beg' style into a Rotel/NAD-dominated semi-specialist market, but the company has so far not been able to offer a coherent range. Misled perhaps by imaginative projections for the future, AR even proposed to bypass the compact cassette by going straight to a DAT recorder. Having belatedly recognised that cassette continues as the only practical universal audio recording medium, it's recanted...

... And turned out this perfectly conventional two head, unidirectional deck, which can be used as a normal standalone recorder, or linked into the remote control AR system. The cassette well is illuminated and the display area has high quality 28dB high resolution meters and an electronic tape counter, with telltales for tape group (where chrome/Type II is described as 'special') and Dolby status.

The operating controls are jammed together below the display, and it has to be said that they're not a fantastic ergonomic success in day to day use. With amplifiers and other components this kind of layout works well, but intrinsically control intensive cassette decks are better if more sparsely laid out.

Facilities are on the sparse side, though nothing serious is missing. Dolby B and C play their usual roles, and the deck also boasts Dolby *HX Pro* and an MPX defeat switch. Bias levels are adjustable using a front panel potentiometer. Track search, a counter memory and a repeat key complete the list.

Headphones can be connected - to a 3.5mm Walkman type socket rather than the usual full size jack. The deck is adequately built and finished, but loud sound effects accompany transport mode engagement.

## LAB REPORT

On the whole the lab test performance is about right for a cassette deck in the £150

price area, or at a pinch say £200 - but is perhaps a little lacking for a deck costing nearly £300. The transport is definitely implicated here. There's little measurable wow, but flutter levels are less than wholly satisfactory, the sidebands being plainly visible in the spectrum analysis.

Signal/noise performance (referred to OVU = 0dB IEC) is several decibels below normal, and the various frequency responses have incorrect equalisation, in each case showing a broad, shallow upper bass suckout and a complementary treble peak. However, this can be largely straightened out by suitable choice of tapes, and to the machine's credit the replay only response shape is first class.

## SOUND QUALITY

The *RD-06* passes muster, even though it doesn't stack up too well against the principal opposition. Like most Dolby *HX Pro* equipped decks, it treats different tape groups relatively equally, so the usual tendency for Type I ferrics to sound soft-centred when trying to deal with dynamic material is largely ameliorated.

The AR also sounds better with the least necessary noise reduction (typically Dolby B instead of C), whereas some manufacturers in this price area choose and align their Dolby circuits carefully enough to escape this criticism. As is so often the case, the most practical combination is to use Dolby B noise reduction and metal tapes, but the fact remains that other decks in similar circumstances offer a lower noise floor and greater effective headroom before head saturation sets in.

At best, the AR sounds mildly damped down compared to the best, and some loss of clarity and stereo depth information is very much part of this. At the same time, the deck sounds firm, stable and tuneful (flutter is more likely to result in loss of resolution than obvious pitch problems), and in this sense often manages to transcend some of the cassette medium's hoarier stereotypes.

## CONCLUSIONS

No timer standby is a restriction that some people won't be happy with, but the *RD-06* can otherwise be regarded as a purposeful, stripped down attempt at the middle market. On the whole it succeeds but there are a number of rough edges, perhaps inevitably for a first ever cassette deck. It is an obvious first choice for owners of the partnering AR electronics, but I cannot help concluding that AR isn't exactly giving it away.

## TEST RESULTS

Rec/replay response - 3dB ref 1kHz	
IEC Type I	24Hz - 14.5kHz
IEC Type II	26Hz - 16.5kHz
IEC Type IV	25Hz - 18kHz
Wow & Flutter - Peak DIN wtd/unwtd	0.13%/0.21%
Wow/Flutter Peak DIN wtd	0.072%/0.26%
Speed error	+0.10%
Type I signal/noise CCIR/ARM 400Hz distortion 0dB	50.5dB
Type II signal/noise CCIR/ARM 400Hz distortion 0dB	0.85%
Type IV signal/noise CCIR/ARM 400Hz distortion 0dB	51dB
Type I signal/noise CCIR/ARM 400Hz distortion 0dB	2.0%
Type IV signal/noise CCIR/ARM 400Hz distortion 0dB	52dB
Channel separation OVU/1kHz	1.7%
Line input sensitivity/overload	45dB
Mic input sensitivity/overload	61mV/>13V
Line output for 0dB/maximum	n/a
IM distortion 10kHz/11kHz 0dB peak, 1kHz product	840mV/2.2V
Azimuth check R-L phase at 10kHz	2%
VU indication at IEC 0dB	30°
Dimensions (w x h x d)	0dB
Typical Retail Price	43 x 11.5 x 31.5cms
	£280

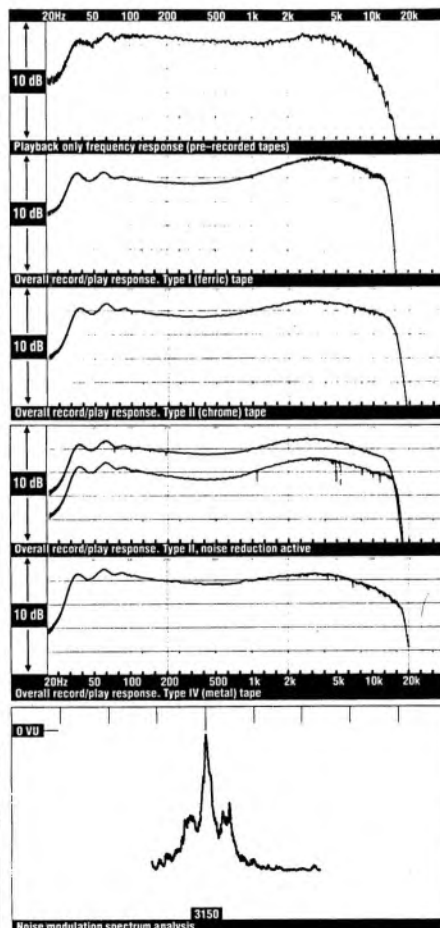

*H*ave you ever heard  
your room disappear!

OBS

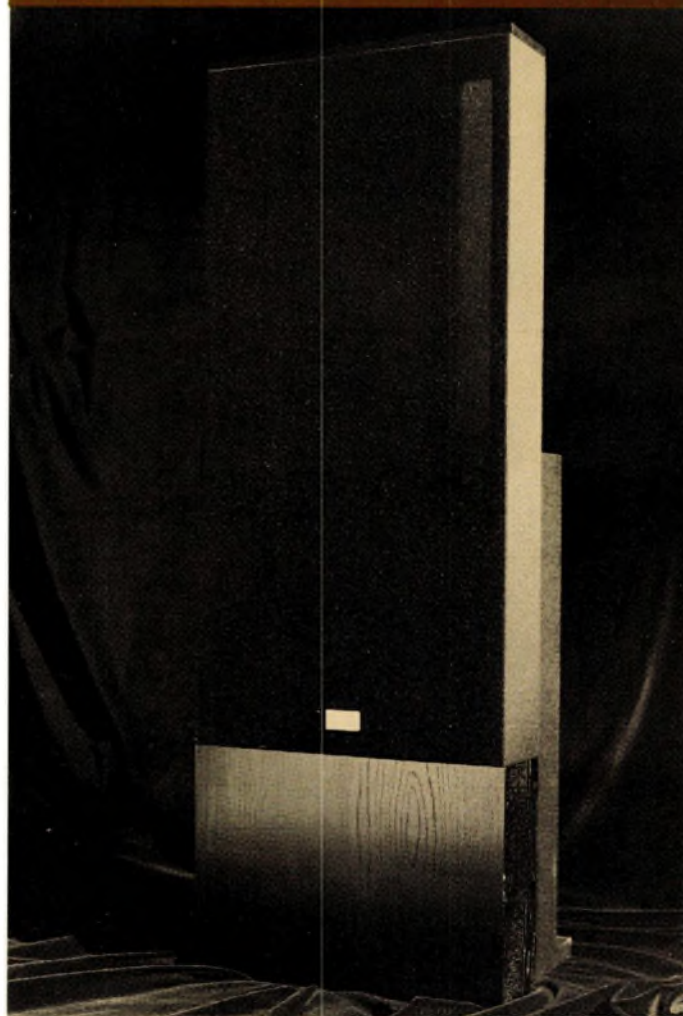

*S*ome Adventures —



ACOUSTICS

*B*egin at —

SD ACOUSTICS 39-43 HIGH STREET NEW MALDEN SURREY KT3 4BY TEL: (01) 949 1623

AUDIO EXCELLENCE: CARDIFF 0222 228565, GLOUCESTER 0452 300046 BRADY HI-FI: LONDON 01 379 4010, WARRINGTON 0925 828009 GRAHAMS HI-FI: LONDON 01 837 4412 NORMAN AUDIO: PRESTON 0772 53057 K. J. LEISURESOUND: LONDON 01-486 8262 RADLETT AUDIO: HERTS 09276 6497 LINTONE AUDIO: GATESHEAD 091 4774167 CHEW & OSBORNE SAFFRON WALDEN 0799 23728, EPPING 0378 74242 ACOUSTICS ARTS: WATFORD 0923 245250 ISLAND HI-FI: ISLE OF WIGHT 0985 65995 STANLENS: TONBRIDGE 0782 355540 PAUL GREEN HI-FI: BATH 0225 316197 BASICALLY SOUND: NORWICH 0508 70829 ZEUS AUDIO: BELFAST 0232 332522 ROBERT KING AUDIO CONSULTANTS: LONDON 01 274 8087

# AIWA AD-R470

AIWA (UK) LTD., UNIT 5, HEATHROW SUMMIT CENTRE, SKYPORT DRIVE, WEST DRAYTON, MIDDX UB7 0LY. TEL: (01) 897 7000.

BEST BUY



The £150 AD-R470 is the lowest cost auto-reverse model in Aiwa's extensive range of cassette decks. In several ways it is an impressive piece of work.

Aiwa has now dropped the split fascia presentation from all its current models, and the 470 is both blander but also in better taste than its ancestors. Functional layout is excellent, and learning how to use it to the full is unlikely to cause difficulties. The transport controls are particularly logically laid out: with separate play controls for each direction which seems somehow more intuitive than the single play control and separate direction change switch pattern widely favoured elsewhere.

The auto-reverse mechanism is the central feature of the deck of course, and in this example a very quick acting rotating head mechanism is combined with optical end of tape sensing so that less than half a second playing time is lost as tape direction is reversed.

Other transport features include audible cue and review modes when either fast wind key is held down in 'play' mode, and auto play following fast wind if the controls are jiggled just right. Noise reduction is by Dolby B and C, and HX Pro circuitry is also included.

The meters cover 30dB in 7 steps; although the scale can be hard to read in poor lighting, readings above 0VU are picked out in red. Finally, bias can be fine tuned in the case of ferric and chrome bias tapes (Type I and II), but not metal (Type IV), presumably because there's insufficient bias current available on this setting.

## LAB REPORT

The transport does its thing outstandingly well (for the price, for an auto-reverse, and in the forward direction). But things deteriorate a little in reverse, largely it seems due to capstan wow. There's an azimuth discrepancy between sides too.

At the standard bias setting, all record/playback responses were similarly in error, with a top end boost of around 2-3dB. Increasing the bias setting helps but doesn't

completely resolve matters.

The playback only trace, however, is first class - indicative of good setting up, but subject of course to the azimuth changes between sides that removes the edge from the sound when playing the 'wrong' side. IEC 0dB is at +3dB on the meters, by which point intermodulation distortion is beginning to build up, reducing effective dynamic range, or at least the range over which the deck is sonically clean.

## SOUND QUALITY

Most low cost auto-reverse cassette decks tend to be a bit grim. This one is well above average, and quite high up in the pecking order of unidirectional decks at the same price, which is an impressive achievement.

Like any musically worthwhile cassette deck, the Aiwa has particularly good speed stability and a high standard of clarity - not just in the midband, but well into both frequency extremes too. The bass end is perhaps the weakest point, but it lacks power more than resolution. The treble is clean and open, and well integrated into the sound of the player as a whole. Just a trace of grain remains, but nothing that can't be ignored in a well behaved system. Stereo resolution is also surprisingly good.

I found the 470 perfectly capable of painting a solidly three-dimensional sound picture of the source in space that detracted little from the sense of focus and perspectives available from the original. And in practical, everyday terms, matters don't deteriorate seriously when used in the reverse direction. This Aiwa, does however, appreciate expensive tapes, sounding best with metals, and with Dolby B rather than a compressed sounding Dolby C. Commercial prerecorded tapes sounded particularly clean.

## CONCLUSIONS

Aiwa's budget auto-reverse deck is well priced at just £150, and not as meanly equipped as you might expect. Yet it still provides decent engineering in relation to price, and is less compromised by the auto-reverse

mechanism than usual. A good unidirectional deck will still eat this deck for breakfast, but as auto-reverse models go it's a peach, or more precisely, a Best Buy.

## TEST RESULTS

Rec/replay response - 3dB ref 1kHz	
IEC Type I	32Hz - 15kHz
IEC Type II	32Hz - 16.5kHz
IEC Type IV	28Hz - 17kHz
Wow & Flutter - Peak DIN wtd/unwtd	
	FWD 0.09%/0.20%
	REV 0.12%/0.32%
Wow/Flutter Peak DIN wtd	
	FWD 0.07%/0.17%
	REV 0.08%/0.27%
Speed error	
	+0.15%
Type I signal/noise CCIR/ARM 400Hz	49.5dB
distortion 0dB	0.55%
Type II signal/noise CCIR/ARM 400Hz	51dB
distortion 0dB	1.1%
Type IV signal/noise CCIR/ARM 400Hz	51dB
distortion 0dB	1.2%
Channel separation 0VU/1kHz	47dB
Line input sensitivity/overload	87mV/>13V
Mic input sensitivity/overload	n/a
Line output for 0dB/maximum	600mV/2.5V
IM distortion 10kHz/1kHz 0dB peak, 1kHz product	10%
Azimuth check R-L phase at 10kHz	15°/60°
VU indication at IEC 0dB	+3dB
Dimensions (w x h x d)	43 x 12.5 x 21cms
Typical Retail Price	£150

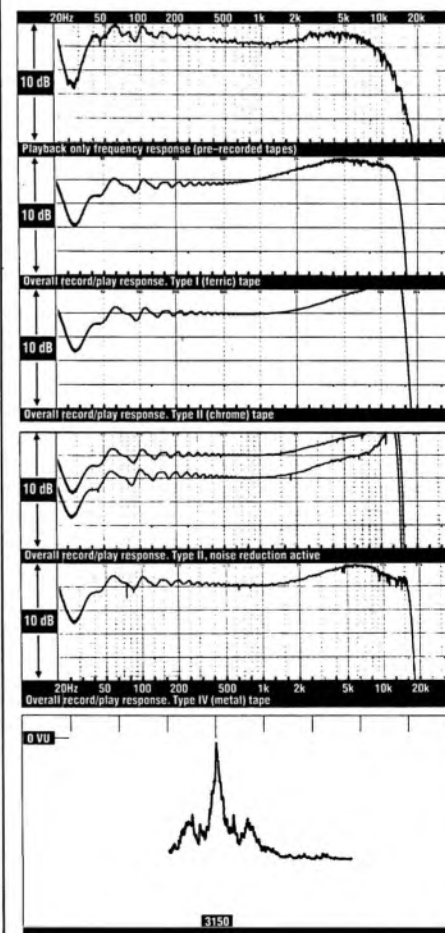



CR-3E CASSETTE DECK

PHOTO LIAM WOON

*"By anybody else's standards, these decks are stripped (CR-3E/CR-4E).  
what you get instead is superb engineering, delightful tape  
handling, sublime sound and the status that the name confers."*

HI-FI NEWS

*Head to Head*



NAKAMICHI B & W UK LTD

MARLBOROUGH ROAD LANCING WEST SUSSEX BN15 8TR TELEPHONE (0903) 750750

# AIWA AD-F880

AIWA (UK) LTD., UNIT 5, HEATHROW SUMMIT CENTRE, SKYPORT DRIVE, WEST DRAYTON, MIDDX UB7 0LY. TEL: (01) 897 7000.

RECOMMENDED

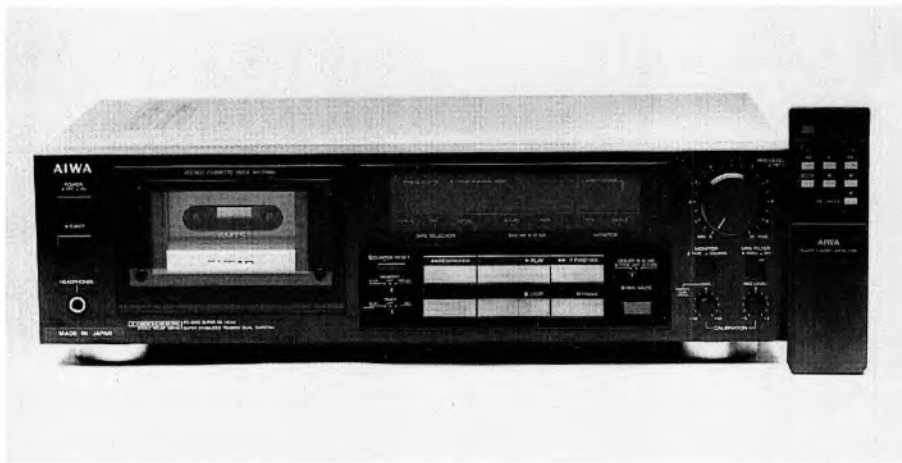

In the broadest possible terms, the *AD-F880* can be best seen as a serious minded product where value for money ranks equally with other criteria. Your £300 buys a three-head deck equipped for off-tape monitoring in real time. The *PC-OCC* wound *DX* record and playback heads are siamesed and bolted to a diecast headblock for stability. The tape itself is clamped firmly by a system spuriously legitimised by a set of initials - *AMTS*, or Anti-Modulation Tape Stabiliser. The transport system employs a closed loop, dual capstan drive, and the capstans are ground with Aiwa's proprietary micro-grain finish which I understand reduces stiction.

Naturally the Aiwa has all mod cons too, or most of them anyway. Surprisingly, tape/source monitoring is handled strictly manually where most decks switch automatically and provide a manual override switch. The *880* has the full set of Dolby circuits - B and C type noise reduction and *HX Pro* - and a switch to defeat the MPX filtering. Memory stop and play and full transport cueing are fitted, but no track, intro or blank search in this case. The meters cover 30dB with good resolution.

There are two important features not so far mentioned - one performance, the other convenience related. The first is record bias and sensitivity adjustment: this is performed manually, using interstation tuner hiss or a similar signal as source and the tape monitor switch and record level meters to perform the adjustment. The other is an infra red remote control which is usable for the key transport modes, plus record/mute and tape counter reset.

Build quality is fair to middling, but I was disappointed by the noisy transport engagement, the poor labelling of several telltales in the display area (the legends won't be visible under some lighting), and by the slide switches for timer, Dolby and memory function which don't line up quite correctly.

## LAB REPORT

The transport is as good as the description promised. Wow measures 0.048% and flutter

just 0.088% for a total weighted figure of 0.066%. The spectrum analysis confirms just how clean the mechanism really is.

The record/replay frequency responses are smooth and well extended into both frequency extremes, but rather wayward when bias and sensitivity are set by the book, at least with Type II tape. This isn't a real problem, however, since the available set-up adjustments make the published response shapes more or less arbitrary. The playback only response is well extended into the treble too.

The remaining measurements need little comment, save to note that noise is well suppressed and there's plenty of headroom in the system in practice, despite an appreciable level of IM distortion at IEC 0dB (= +3VU).

## SOUND QUALITY

On audition, there's more than a touch of the *AD-R470*s about this deck. Both models have unusually transparent and unobtrusive electronics, that are incidentally a considerable improvement over earlier generation Aiwas. The *470*'s inherent seamlessness and clarity is carried over, but is matched here to a considerably more refined basic performance. The bass in particular is much more solid and meaty, extending better into the very lowest frequency area where the *470* began to sound untidy and boomy.

High frequency quality is similar, but is assisted by both the very stable transport and also the excellent stability of the tape path across the heads. The *880* carried the slightly bright responses remarkably well, by adding a touch of crispness and attack without grain. There was never any real suggestion of dropout or unevenness, and mid and HF uniformity and dynamics alike came close to rivalling that of good vinyl or CD with some material.

Last but not least, prerecorded tapes reproduced extremely well. These seem to benefit disproportionately from the dual capstan transport, even to the extent of eliminating a dropout on one of my test tapes that

I thought was there forever!

## CONCLUSIONS

This is a high grade deck with a very clean, stable audio performance. It has few weaknesses beyond a mild build tackiness and is clearly Recommended.

## TEST RESULTS

Rec/replay response - 3dB ref 1kHz	
IEC Type I	<20Hz - 15kHz
IEC Type II	<20Hz - 19kHz
IEC Type IV	<20Hz - 21kHz
Wow & Flutter - Peak DIN wtd/unwtd	0.066%/0.094%
Wow/Flutter Peak DIN wtd	0.048%/0.08%
Speed error	+0.20%
Type I signal/noise CCIR/ARM 400Hz	49dB
distortion 0dB	0.65%
Type II signal/noise CCIR/ARM 400Hz	51dB
distortion 0dB	0.85%
Type IV signal/noise CCIR/ARM 400Hz	50dB
distortion 0dB	0.9%
Channel separation 0VU/1kHz	44.5dB
Line input sensitivity/overload	89mV/>13V
Mic input sensitivity/overload	n/a
Line output for 0dB/maximum	850mV/4V
IM distortion 10kHz/11kHz 0dB peak, 1kHz product	1.8%
Azimuth check R-L phase at 10kHz	90°
VU indication at IEC 0dB	+3dB
Dimensions (w x h x d)	43 x 12.5 x 29.5cms
Typical Retail Price	£300

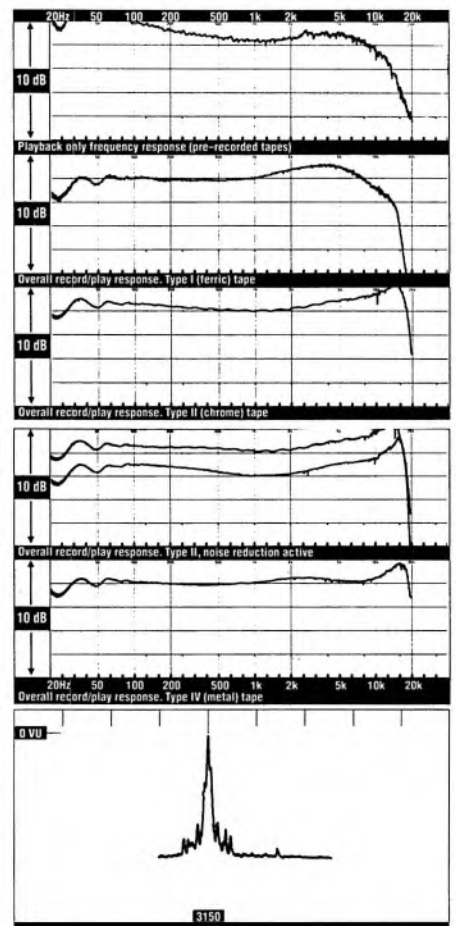

# AKAI GX-32

AKAI (UK) LTD., 12 HASLEMERE HEATHROW ESTATE, SILVER JUBILEE WAY, HOUNSLOW, MIDDLESEX. TEL: (01) 897 6388.



The £200 price break is a popular and important one which almost every significant cassette deck manufacturer (Nakamichi apart) addresses in a determined way. The Akai GX-32 will have its work cut out if it's going to compete; now read on.

First impressions are good. The GX-32 has much of the polish and elaborately engineered look of its expensive range-mates. But the rotary controls feel cheap, and the transport makes a rare selection of noises – and not just when engaging and releasing transport modes. Ergonomics, however, are excellent and the deck has fine two-colour record level meters with a 33dB dynamic range. The mechanical tape counter lacks a memory stop feature, but instead there's a track search feature. It's also possible to preselect play mode following rewind, by holding 'play' while momentarily pressing 'rewind'.

Naturally the deck is equipped with Dolby B and C noise reduction. It also has a switch allowing the MPX filter to be removed from circuit – a small but worthwhile plus point. A variable bias control, a headphone level control and timer standby switching completes the list of major features.

There are few features of particular technical interest, apart from the GX twin-gap head design. This allows Akai to sidestep the compromise inherent in combined record and playback head gaps though without the valuable off-tape monitoring capability provided by true 3-head recorders.

## LAB REPORT

The various frequency responses are smoothly extended into the treble, and can be made arbitrarily flat. The boost you see in the plots is what the player does with the bias control centred using the tape types recommended by the manufacturer (see also GX-95 review).

Each of the traces was characterised by a small-amplitude jiggling of the writing pen, which can just be seen in the reproduced plots. The only obvious explanation that presents itself is some shortcoming in the head

contact, tape guidance and/or tensioning system. By coincidence or otherwise, wow and flutter is not especially low – there are some important out-of-band flutter components, which are also plainly visible in the spectrum analysis.

The playback only response test was handled cleanly, the important midband area in particular being completely flat. The only slight oddity (and it's of no great significance) is that the Dolby C response nose-dives in the treble earlier than the Dolby B trace: outputs peak at 10kHz and 14kHz respectively, so perhaps the finding isn't so significant after all. (Naturally these tests were made with the MPX filter switched off.) The final point is that the deck appears to be a little under-specified for Type IV metal tapes, for which there is rather limited operating headroom.

## SOUND QUALITY

This deck was not a sonic success. The special qualities of metal tapes were wasted on the whole, but that's scarcely an unusual finding at this price level, and therefore not enough to condemn it out of hand. Prerecorded cassettes actually sounded surprisingly good, or at least reasonably accurate, but this isn't enough by itself to redress the other problems.

As a recorder the GX-32 came unstuck, betraying itself with some classic budget deck failings. It sounded compressed, and stereo imagery was poor, with vague lateral and depth image placing alike. Individual instruments often sounded blurred and over-size, and sharp penetrating sounds were muzzled due to lack of precision and focus at both ends of the audio spectrum. Finally, the more pungent, astringent and exotic instruments and voices were rendered less distinctive, leading to what is best described as blandness and facelessness.

## CONCLUSIONS

This deck does not make for very exciting listening. It's tempting to blame the transport, and the odd jiggling of the pen during

the response tests is surely not unrelated. The findings don't rely on that explanation, however, as fundamentally the GX-32 sounds terminally lacking in detail, dynamics and colour, and as such is unlikely to inspire enthusiasm for the music it reproduces.

## TEST RESULTS

Rec/replay response – 3dB ref 1kHz	
IEC Type I	26Hz – 15kHz
IEC Type II	26Hz – 16kHz
IEC Type IV	26Hz – 19.5kHz
Wow & Flutter – Peak DIN wtd/unwtd	0.16%/0.74%
Wow/Flutter Peak DIN wtd	0.10%/0.66%
Speed error	+0.17%
Type I signal/noise CCIR/ARM 400Hz	52dB
distortion OdB	1.0%
Type II signal/noise CCIR/ARM 400Hz	53dB
distortion OdB	2.4%
Type IV signal/noise CCIR/ARM 400Hz	54.5dB
distortion OdB	1.9%
Channel separation OUV/1kHz	37dB
Line input sensitivity/overload	125mV/>13V
Mic input sensitivity/overload	n/a
Line output for 0dB/maximum	735mV/3.5V
IM distortion 10kHz/1kHz 0dB peak, 1kHz product	0.56%
Azimuth check R-L phase at 10kHz	20°
VU indication at IEC 0dB	0dB
Dimensions (w x h x d)	42.5 x 11 x 33.5cms
Typical Retail Price	£200

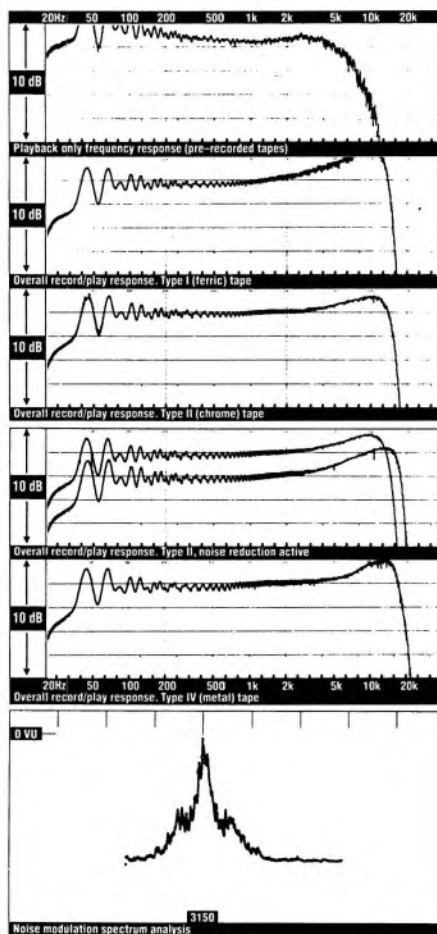

# AKAI GX-95

AKAI (UK) LTD., 12 HASLEMERE HEATHROW ESTATE, SILVER JUBILEE WAY, HOUNSLOW, MIDDLESEX. TEL: (01) 897 6388.

RECOMMENDED



For a few pence less than £400, Akai's GX-95 is an imposing 3-head cassette monster from the *Reference Master* series. Akai stresses the 'back to the roots' engineering that has gone into this product. Front panel slogans announce 'Separated Blocks/High Rigidity Construction' just in case you missed the point.

Structural engineering starts with the transport of course, and the Akai uses a high grade, dual capstan mechanism with a direct drive motor and a cassette stabiliser – the latter not brilliantly designed, but better than a kick in the teeth. Akai points to the enforced separation and screening erected around individual circuit blocks (it's true, and I cheerfully confirm I'd hate to be the service engineer). But on the 'high rigidity construction', Akai is in danger of overselling: strip away the piano gloss wood end cheeks and the lid and you discover a lack of panel damping or real structural rigidity. The gold coloured feet ('large pedestals') are strictly for show.

The electronics are more exciting. Akai's excellent proprietary *Super GX* heads are mated to a transport that boasts refinements like automatic direct lead-in and auto tape slack take-up. Dolby *HX Pro* can be switched off, and so can the status display to reduce high frequency noise from the drive electronics. This is the first time such a feature has been incorporated in a cassette deck to the best of my knowledge.

Fine control is available over bias and sensitivity using manual adjustment pots and an alternative meter display mode. Other highlights include 50dB peak hold meters, a memory time counter, track search (up to 16 tracks away in either direction), A-B repeat and erase, switchable MPX, a second line input (CD/DAT Direct), a headphone level control, a 13 key infra-red remote control...

## LAB REPORT

The record/replay response plots were all run with recommended tape types (Maxell *UD-1/TK-SAMA*), and the results show how effectively the circuitry is optimised for mid-

band linearity. All the LF responses are on a gently declining curve below 100Hz. Dolby tracking is good, and so is the standard of setting up for prerecorded tapes. (If it hadn't been, the readily accessible head tilt and azimuth adjustment points would have enabled things to be put right easily.)

The deck's electronics are blessed with a low noise floor and plenty of headroom – suitable tapes can be driven very hard. Wow and flutter is little short of exceptional. At this price level it is exceptional.

## SOUND QUALITY

The rare opportunity to switch off Dolby *HX Pro* circuitry gave interesting results. With metal tapes, the circuitry does little, but on balance seemed to slightly reduce the ability to 'hear through' the deck. With lower bias tapes, and ferric ones in particular, the same circuits were extremely effective in making these sound more like metals. It has the effect of sharpening and focusing a sound which otherwise seemed rather wayward and soft-centred. The recommendation then is to use *HX Pro* except when using metals, justifying the presence of the switch.

*HX Pro* aside, this is an impressive sounding deck. It is very sharp and clear, with a light, agile bass, a clean, penetrating treble and very good stereo focus and perspectives. It works well with all tapes – prerecorded ones too – but was unquestionably best with metals, on dynamic range grounds if for no other reason. It is electrically quiet enough to sustain use without Dolby noise reduction with some material.

Alternatively, it is sometimes possible to use Dolby B instead of C, which has a small but significant effect by improving transparency. The 'display off' switch works too – try it.

For the record, the test deck suffered a fault on one channel which affected source monitoring. This didn't affect the tests, and hopefully isn't typical of build quality.

## CONCLUSIONS

Although fairly expensive, £400 seems to be

good value for the very sophisticated audio standards of this deck, even if some of the basic engineering isn't quite as impressive as the cultured externals suggest. Recommended.

## TEST RESULTS

Rec/replay response – 3dB ref 1kHz	
IEC Type I	20Hz – 15kHz
IEC Type II	21Hz – 12kHz
IEC Type IV	<20Hz – 19kHz
Wow & Flutter – Peak DIN wtd/unwtd	0.08%/0.13%
Wow/Flutter Peak DIN wtd	0.06%/0.096%
Speed error	+0.12%
Type I signal/noise CCIR/ARM 400Hz	50dB
distortion 0dB	0.6%
Type II signal/noise CCIR/ARM 400Hz	53.5dB
distortion 0dB	1.5%
Type IV signal/noise CCIR/ARM 400Hz	54dB
distortion 0dB	1.5%
Channel separation 0VU/1kHz	43dB
Line input sensitivity/overload	111mV/>13V
Mic input sensitivity/overload	n/a
Line output for 0dB/maximum	680mV/4.9V
IM distortion 10kHz/1kHz 0dB peak, 1kHz product	0.9%
Azimuth check R-L phase at 10kHz	0°
VU indication at IEC 0dB	+1dB
Dimensions (w x h x d)	46.5 x 151.5 x 33cms
Typical Retail Price	£400

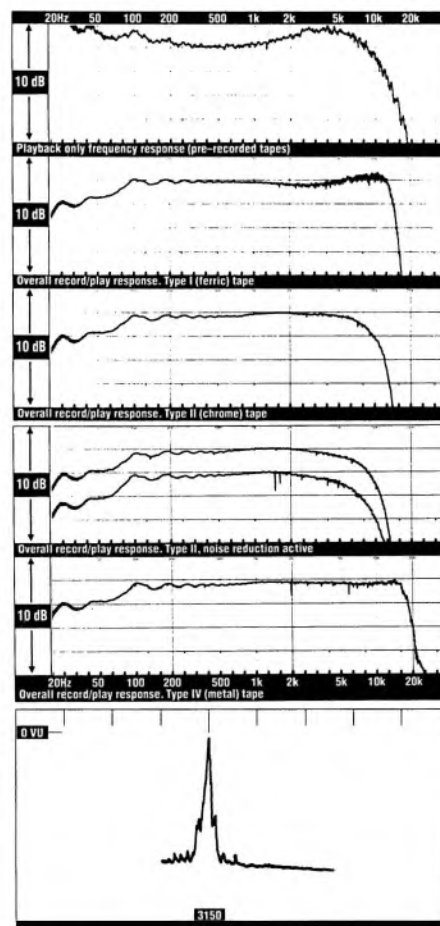

# KOSS – The word on everyone's ears

## Koss Supersonic Technology (SST)

Designed specifically for use with today's digital technology, the SST's offer the best in sound and comfort. Whether you prefer the heavy bass and isolated sound of a closed headphone or the open, airy sound of a hear-through headphone, there's an SST model for you.



## Koss Prolite

Using Neodymium magnets, the Prolites provide remarkable high magnetic flux density without adding to their lightweight portability. The high powered motor drives the diaphragm at incredibly high speeds while remaining low in distortion. Special temporal pad design redirects the pressure away from the ear to the temple.

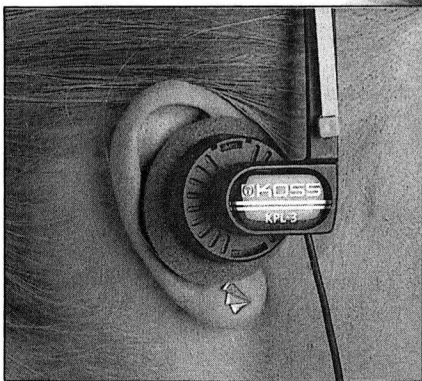

## Koss Porta Lite

A range of four headphones designed to meet the needs of the contemporary music lover whatever their budget. These models offer great portable sound with features like extra cushions, volume balance controls, even 1/4 inch adapter plugs for home use.

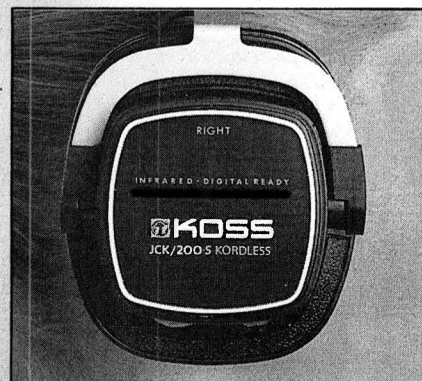

## Koss Kordless

Koss Kordless combine the finest in headphone design with the latest in infrared technology. Now, listen to your favourite CD's, audio or video tapes, even TV broadcasts with complete freedom. And because it's Koss, you get full frequency response and high-output capability.

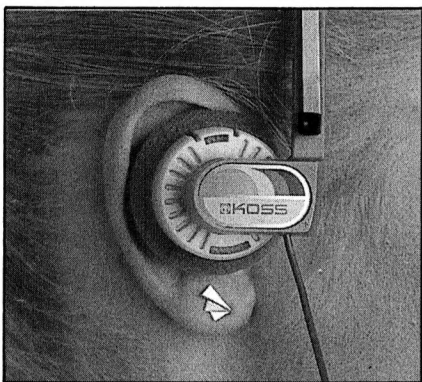

## Koss Fun 'N' Fashion

Portable listening never looked or sounded as great as the Fun 'N' Fashion headphones – the ultimate accessory for today's fashion conscious listener. And because they're Koss, you get spare cushions, volume balance controls, adapter plugs, and of course, great sound.

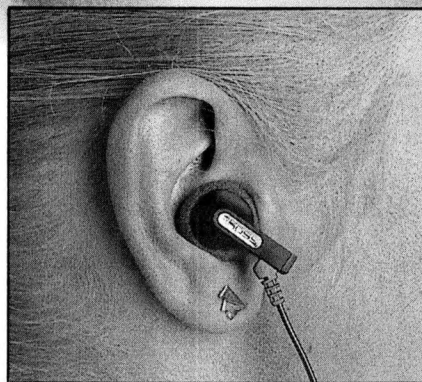

## Koss Music Pals

For today's active listener on-the-go, Koss presents the Music Pals. These ultra-lightweight models fit directly in the ear for a secure, comfortable fit that's perfect for bicyclists, joggers and other music lovers on the move. Complete with a range of accessories.

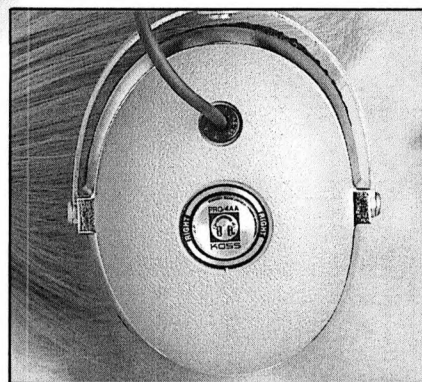

## Koss Professionals

Studio and broadcast professionals, as well as other discriminating audiophiles have long preferred the full frequency, deep bass sound of Koss' professional headphones. Foam-filled earcushions totally isolate the listener from distracting outside sounds and irritating feedback.



# KOSS

HW International, 3-5 Eden Grove, London N7 8EQ. Tel: 01-607 2717

Please send me full details on the full range of Koss headphones, to HW International, 3-5 Eden Grove, London N7 8EQ.

Name \_\_\_\_\_ Address \_\_\_\_\_ Post Code \_\_\_\_\_



# DENON DR-M07/88

HAYDEN LABORATORIES LTD., HAYDEN HOUSE, CHILTERN HILL, CHALFONT ST. PETER, BUCKS SL9 9EW. TEL: (0753) 888447.



Our regular reader will recognise the DR-M07 from previous appearances in these pages. The DR-M07/88 is a simple update of the original, introduced unsurprisingly in '88. The importer is a little equivocal about exactly what has been changed, but describes the /88 (the suffix appears only on Denon's promotional literature) as having benefitted from 'better quality components, tighter tolerances and improvements in production'. A more stable transport and improved sound quality are other specific claims. But what is beyond dispute is that the price has been improved - from £140 to £125. A modest change maybe, but in the right direction.

The DR-M07 is the baby of the Denon range, and it must be said that it is beginning to look a little dated. The display is a crude device with poor (5dB best case) resolution and a 16dB range, and the tape counter is a basic mechanical device without memory stop. Another feature that places the deck firmly in the past is manual tape type selection - a tedious procedure that this year's crop of new models seems finally to have left behind.

The rest of the story is much harder to criticise. Ranged along the bottom of the fascia are controls for Dolby switching, fine bias adjust (excluding metal/Type IV tapes here), input level and channel balance. A fixed level headphone socket is planted amidstships. The selectors are neat rotary controls rather than press buttons, and all the better for it. The logic controlled transport section uses solenoid engagement, not the quiet cam action of dearer Denon players.

The Denon has nothing that might be described as unnecessary or gimmicky. It completely lacks track search facilities, for example, and unfortunately cannot be run from a timer. But it is nevertheless decently presented and engineered on the whole.

## LAB REPORT

Our sample of this deck wasn't set up too well except in the Type I/ferric slot. Type IIs like TDK SA could be made to fit quite well with

some extra bias, but all the metals I tried (TDK, Maxell and Sony) measured much like the plot shown alongside. Furthermore, prerecorded material measured (and sounded) grim. There were severe losses of HF and gross breathing effects caused by Dolby mis-tracking. Another sample of the same deck I looked at recently was much more accurately matched to metal tapes, and prerecorded material sounded bright and edgy!

The signal/noise figures may look good, but in actuality they are referred to a level 6dB above IEC 0dB. In practice this means that it is vital to keep record levels from exceeding 0VU, beyond which point the deck sounds highly compressed or even severely distorted, according to the spectral content of the music. Wow and flutter is just satisfactory for a budget deck.

## SOUND QUALITY

Metal tapes were clearly unusable with this deck, but not with a previous sample examined. Prerecorded material also sounded quite different (see *Lab Report*), so quality control once again appears to be implicated in a review of a Denon cassette deck. Of course we could just have been very, very unlucky, several times. Ferrics sounded vaguely compressed (as they so often do), which leaves just tapes like TDK SA suitable for serious use.

Here at last the Denon begins to show some of the class it has demonstrated on previous occasions. Although the transport measures quite modestly, and there are signs of dropout with less than brand new cassettes, (especially metals), the deck is surprisingly solid and stable most of the time. The M07/88 sounds crisp and alive especially with Type II tapes. There's a wealth of detail and it's possible to 'hear through' the electronics in a way that eludes many recorders.

## CONCLUSIONS

I thought long and hard before withholding Recommended status from this deck. A well set up example is capable of a subtle alchemy that is far from common with low cost decks.

This deck is worth investigating, but only on the basis that the machine you buy is properly checked to specification. Realistically, many high street dealers will be ill-prepared to do this, and would probably be unwilling anyway on grounds of cost.

## TEST RESULTS

Rec/replay response - 3dB ref 1kHz	
IEC Type I	23Hz - 15.5kHz
IEC Type II	25Hz - 15.5kHz
IEC Type IV	26Hz - 18kHz
Wow & Flutter - Peak DIN wtd/unwtd	0.18%/0.29%
Wow/Flutter Peak DIN wtd	0.17%/0.27%
Speed error	+0.10%
Type I signal/noise CCIR/ARM 400Hz	55.5dB
distortion 0dB	>3.3%
Type II signal/noise CCIR/ARM 400Hz	56dB
distortion 0dB	>3.3%
Type IV signal/noise CCIR/ARM 400Hz	56dB
distortion 0dB	>3.3%
Channel separation 0VU/1kHz	46.5dB
Line input sensitivity/overload	117mV/>13V
Mic input sensitivity/overload	n/a
Line output for 0dB/maximum	690mV/3.6V
IM distortion 10kHz/1kHz 0dB peak, 1kHz product	5.4%
Azimuth check R-L phase at 10kHz	30°
VU indication at IEC 0dB	+6dB
Dimensions (w x h x d)	43.5 x 11 x 22cms
Typical Retail Price	£125

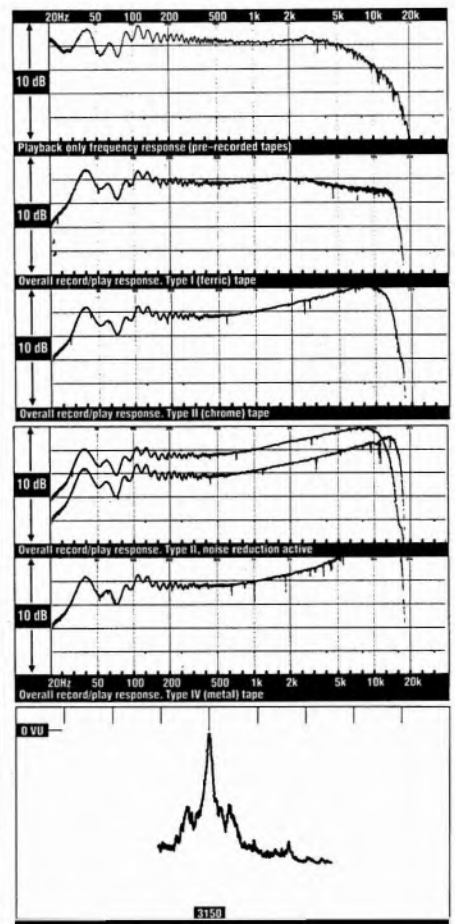



# *Fine playing deserves fine tuning*

## *At Acoustic Arts*

standards continue to improve and it gives us great pleasure to announce that our premises have been redeveloped to offer you, our customer, the finest demonstration facilities we know of. Two new studios have been added to cope with the increase in our business one of which has been specially tailored to resemble the structure of a typical domestic living room.

We feel strongly that we should recommence our own activities as the performance of new equipment has astonishingly continued to rise and our standards must rise with them. The landmarks this past year must surely be the new Krell

range. The PAM 7 pre amp and KSA-80, 200 and 160 power amps set new standards in being able to combine 'state of the art' sound quality with massive power delivery. Just put one of these amplifiers into your system and we guarantee it will transform it.

The most significant loudspeaker development must surely be the new Apogee Duetta Signature. We are all Apogee enthusiasts here but the improvement in sound quality with this model has amazed us. A true 'state of the art' product.

To take advantage of the transparency of these new products we must look at recent advances in cable and we would unhesitatingly recommend the new Symo and Siltech FT12 speaker cables. The former is expensive and the latter is very expensive but both are indispensable.

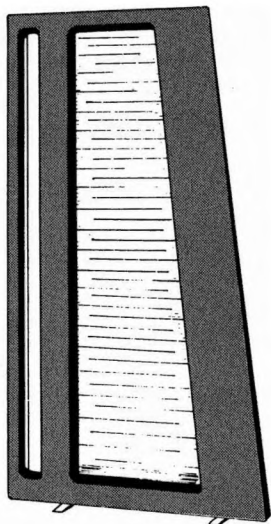

Come and hear these and many other fine new products at our new showroom.

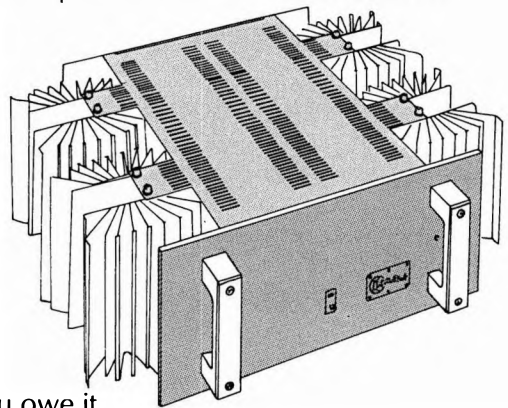

You owe it to yourself to discover why people continue to visit us from all over the country in ever increasing numbers. We think you will discover a degree of expertise and interest in your needs that you will not find elsewhere. We are located a few hundred yards from Watford Junction station with its regular train services and interconnecting bus routes and Watford is closely situated to the M25 and M1 motorways. We are probably a lot closer than you might imagine.

#### Our Agency includes:

A & R, ATC, Acoustic Energy, Air Tangent, Alexander, Alphason, Apogee, Aragon, Audiolab, Beard, Bryston, Castle, Celestion, Counterpoint, Crystal, Deltec, Denon, Dual, Ensemble, Gale, Goldmund, Heybrook, Incatech, Jadis, Koetsu, Krell, Linx, Magneplanar, Mantecore, Marantz, Meridian, Micromega, Monitor Audio, Musical Fidelity, Orell, Pink Triangle, PS Audio, Quad, Quicksilver, Revolver, Revox, Robertson, Rogers, Roksan, Rotel, SD Acoustics, SME, Sonus Fabus, Spondor, Stax, Sumo, Systemdek, Source, TDL, Tannoy, Thorens, VDH, WTA, Wharfedale, Yamaha.

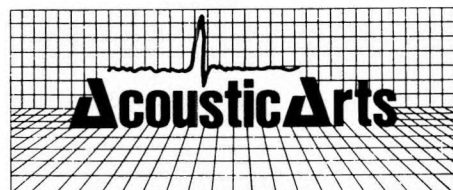

101, St. Albans Road, Watford, Hert  
Telephone: Watford 245250  
Open Monday-Saturdays 9.30am-5.30pm



# OUND OF EXPERIENCE



Memorex expertise has produced a range of quality hi-fi products to enhance every type of music, from rock to opera to a classical concerto. So whether it's the ultimate in headphones you want, or the best in audio tapes, you know Memorex has the answer. For a complete range of audio and video accessories with the level of performance you expect, choose Memorex.

## MEMOREX<sup>®</sup>

— hear the sound of experience.

# DENON DRW-750

HAYDEN LABORATORIES LTD., HAYDEN HOUSE, CHILTERN HILL, CHALFONT ST. PETER, BUCKS SL9 9EW. TEL: (0753) 888447.

RECOMMENDED



'The deck we said we'd never make, until it could be done properly' trumpets the press release for this *DRW-750*. We're currently living through the coming of age of dual cassette decks. Nearly half of the submissions to this issue are twin deck machines, and a number have a decidedly up-market slant. The £230 Denon, which is not amongst the most expensive, is pitched somewhere between the *DR-M07* and the *DR-M10HX* in quality terms.

One transport is for recording and playback and the other is for playback and of course dubbing. The ubiquitous Dolby B and C circuits are present, in addition to which there is a Dolby *HX Pro* circuit and a fine bias adjustment pot for use with all tapes groups.

The user interface (grotty phrase, but you know what I mean) is a thing of joy. Denon has achieved a rare simplicity mainly by making the controls and displays assignable, either by operating a switch or automatically when a tape is inserted. There has been some handy rationalisation of controls, for example by using a single rotary control instead of a string of buttons for Dolby selection. Tape selection is automatic.

Dubbing (another grotty word, but you know what I mean) is simply a matter of pressing the normal or high speed dub keys and sloping off to make a nice hot cup of tea. One oddity I couldn't resolve was that playing a tape in the record transport created an irresistible urge in the other transport to rewind whatever was inserted. Another oddity is that using the pause control (available only when recording) places a short gap between sections, with obvious implications when editing. By the way, Denon now offers a two year guarantee.

The level display is a very attractive but small two colour LED package with 12 steps and a 30dB operating range. The tape counter is electronic and backed by the counter memory, and the deck also has track search. The *DRW-750* is nicely built and has a good operational feel. Under the skin it features hyperbolic heads matched to a record amp circuit with 2dB improved headroom.

## LAB REPORT

The standard frequency responses show the benefit of the hyperbolic head profiles in an almost total absence of the usual low frequency peaks and troughs, except during high speed dubbing where additive effects change the picture. But despite new extended headroom electronics, metals saturated relatively early, failing to show any significant dynamic range gains over other tapes. But plots also show that Type IV tapes have a flatter, more extended response shape. Azimuth errors are small and the playback only response shape is pretty favourable. The transport is fully comparable with moderately good single transport decks. You can't ask for much more...

## SOUND QUALITY

The playback speed error is perfectly audible; so is a severe loss of detail and cloudiness in the bass and midband with pre-recorded material. The deck is also not entirely hum free, which affects pre-recorded material as well as its own recordings.

Otherwise, I have little but praise. Numbers notwithstanding, the deck sounded at its best with Type IV metals, but was not far behind with good Type II formulations. The deck is characterised by a noticeably free and open midband, a quite refined, detailed treble and a standard of bass reproduction that approximates the leanness and tunefulness expected from other programme sources, yet rarely found with cassettes.

## CONCLUSIONS

Missing from this deck is a timer facility and microphone inputs, but ergonomics are good and it's otherwise well equipped to meet standard audio requirements. As a recorder the Denon sets a high standard, but pre-recorded material can sound a touch grim. Recommended, unless you're heavily into commercially recorded tapes.

## TEST RESULTS

Rec/replay response - 3dB ref 1kHz	
IEC Type I	33Hz - 15kHz
IEC Type II	33Hz - 14.5kHz
IEC Type IV	32Hz - 19kHz
Wow & Flutter - Peak DIN wtd/unwtd	0.15%/0.32%
Wow/Flutter Peak DIN wtd	0.084%/0.024%
Speed error	+0.27%
Type I signal/noise CCIR/ARM 400Hz	53.5dB
distortion 0dB	0.7%
Type II signal/noise CCIR/ARM 400Hz	55dB
distortion 0dB	1.8%
Type IV signal/noise CCIR/ARM 400Hz	55.5dB
distortion 0dB	2.9%
Channel separation QVU/1kHz	47dB
Line input sensitivity/overload	105mV/>13V
Mic input sensitivity/overload	n/a
Line output for 0dB/maximum	958mV/4.2V
IM distortion 10kHz/11kHz 0dB peak, 1kHz product	0.74%
Azimuth check R-L phase at 10kHz	10 degrees
VU indication at IEC 0dB	0dB
Dimensions (w x h x d)	43.5 x 12.5 x 17 cms
Typical Retail Price	£230

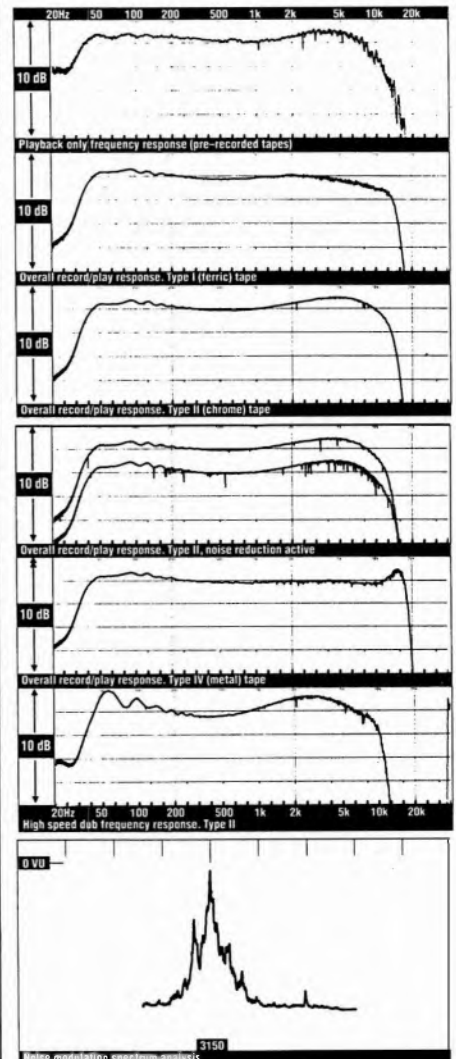

# GOODMANS GSW-5200

GOODMANS LOUDSPEAKERS LTD., 1 & 3 RIDGWAY, HAVANT, HAMPSHIRE PO9 1JS. TEL: (0705) 492777.



This low cost, twin transport deck from the fast expanding Goodmans stable also leads a clandestine existence as a rack system component. There's an old saying that if you pay peanuts, you get monkeys. So you mustn't expect £90 to buy a terrifically wonderful cassette deck – particularly one with two transports. But with a bit of luck and a following wind, £90 can buy a surprisingly reasonable one (the next best thing) if you're willing to forfeit some of the less necessary accoutrements. This is what the *GSW-5200* should be all about. But is it?

What you see is pretty much what you get. As you'd expect, both transports are unidirectional, and just one is capable of recording. There aren't many facilities to discuss, but the deck does stake some sort of claim to being worth taking seriously with its manual record level control (supported by simple 16dB stereo record level meters); some low cost decks forfeit any pretence to high fidelity by fitting automatic record level circuitry instead. Noise reduction is by Dolby B. On the record transport, tape types are selected manually using a column of three push buttons on the record transport; this is also the only deck to benefit from the simple mechanical tape counter. The replay only deck is automatically switched.

Of course tapes may be dubbed at normal or double speed in the time honoured fashion, but although this purports to be a simple enough operation (there's a 'synchro' button to oil the wheels) it actually demands a considerable amount of button pushing. You do get a microphone input, albeit mono only, but not a control to adjust record input balance. The mechanical transport controls are surprisingly slick.

One point for which Goodmans deserves some praise is the instruction leaflet. No multilingual section, no obscure footnotes to contain all the really important information. Just a straightforward, concise account. Praise be!

## LAB REPORT

Lab test performance straddles the divide

between the world of high fidelity and that of utility audio, and maybe leans a little towards the latter. All the frequency responses show high frequency emphasis, and although the metal run does show signs of good extension, it also shows some sharp HF ringing caused by underbiasing, which is the real source of the extended bandwidth. The bass also rings and lacks extension, and the prerecorded test results show significant treble loss.

The record amps are probably either clipping or close to clipping at the 0VU point, judging by the very high IM distortion at this level. The deck has rather high levels of low rate wow (<4Hz) – witness the broadening of the peak in the spectrum analysis – but flutter components are (only just) acceptable.

## SOUND QUALITY

As a cheap and ready means for copying tapes for non-critical applications, this deck may cut the mustard. Musically, however, it's a bit of a joke. Prerecorded tapes sound for all the world as though they were made inside some enormous cardboard box – hollow as well as lacking HF. The high running speed is also noticed.

As a recording tool, this Goodmans performed only a little better. Metal tapes sound thin and a little distorted, while the other tape groups are as good or better, albeit tonally they were a little brighter still.

Beneath everything, it was possible to detect the tape wandering slowly across the head by the way the treble drifted into and out of focus. Finally, the deck is seriously hum prone. I could not eliminate high levels of hum harmonics, whether recording or playing tapes, even when in pause mode and with the other test equipment ruled out as a possible source of interference.

## CONCLUSIONS

No recommendation is appropriate for a deck which is seriously under-endowed in engineering terms. Taking price into account, Goodmans hasn't done a bad job with the *5200* – but clearly hi-fi quality sound from a £90 twin-deck is simply too much to

expect. You get what you pay for.

## TEST RESULTS

Rec/replay response – 3dB ref 1kHz	
IEC Type I	48Hz – 15kHz
IEC Type II	48Hz – 15kHz
IEC Type IV	52Hz – 17kHz
Wow & Flutter – Peak DIN wtd/unwtd	0.32%/0.38%
Wow/Flutter Peak DIN wtd	0.24%/0.30%
Speed error	+0.27%
Type I signal/noise CCIR/ARM 400Hz distortion 0dB	55dB
Type II signal/noise CCIR/ARM 400Hz distortion 0dB	>3%
Type IV signal/noise CCIR/ARM 400Hz distortion 0dB	54dB
Type I signal/noise CCIR/ARM 400Hz distortion 0dB	>2.9%
Type II signal/noise CCIR/ARM 400Hz distortion 0dB	54.5dB
Type IV signal/noise CCIR/ARM 400Hz distortion 0dB	2.3%
Channel separation 0VU/1kHz	45dB
Line input sensitivity/overload	80mV/>13V
Mic input sensitivity/overload	1.15mV/30mV
Line output for 0dB/maximum	580mV/3.0V
IM distortion 10kHz/11kHz 0dB peak, 1kHz product	5.4%
Azimuth check R-L phase at 10kHz	10 degrees
VU indication at IEC 0dB	0dB
Dimensions (w x h x d)	34.5 x 12.5 x 28.5cms
Typical Retail Price	£90

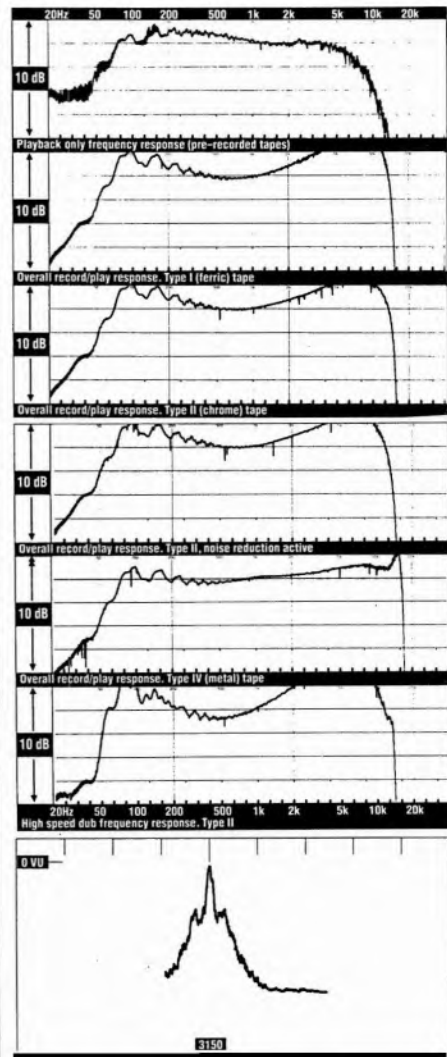

# GRUNDIG FINE ARTS CCT-903

GRUNDIG INTERNATIONAL LTD., MILL ROAD, WARWICKSHIRE CV21 1PR. TEL: (0788) 77155.

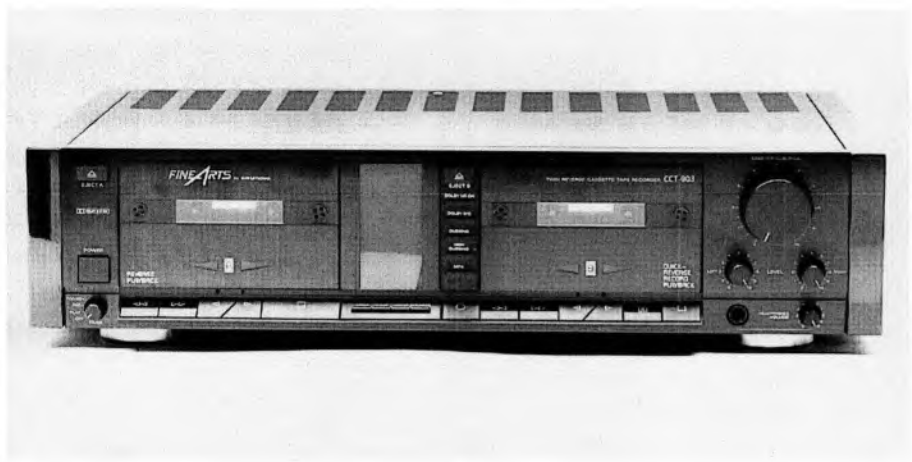

At the present time, Grundig's *Fine Arts* range consists of a prestige line of packaged systems. However, an in-depth look at a couple of elements of these systems (the DAT recorder is covered separately) is still of obvious potential interest, particularly given the company's illustrious history in tape recording. The twin transport *CCT-903* comes on strong as an audiophile design with its lacquered wood end panels and the machined high tech front panel.

This is an impressive deck, though not quite as elaborately kitted out as appears at first sight. Both transports offer full auto reverse operation, but only one records, and curiously this is also the only one with optical end of side direction change triggering. Dolby B and C noise reduction are fitted, as are all the expected features like normal and high speed dubbing. In the central area between the transports there's a control panel and display area that takes care of the secondary features, including an array of status data, 26dB range meters, the electronic memory counter, and a switch that enables it to read data from either deck.

Headphone users have a volume control, the input levels are set by a combination of a master level control and two individual channel pots. An output volume control appears on the rear panel, which is as undesirable as non-essential components of this kind always are.

## LAB REPORT

There was some indication that the Grundig transport was a little more dropout prone than some, perhaps due to inappropriate back tension on the tape or the design of the tape path itself. In other respects, however, the deck is a success: wow and flutter levels are low by auto-reverse standards, though some capstan wow is visible in the plot.

The various frequency responses all show a rather early bass rolloff, which nearly always correlates well with listening, and all three IEC test tapes reproduced with what appears to be a gentle and quite deliberate top end lift.

The playback plot shows just the opposite characteristic, however, and the test of Dolby tracking shows some mild HF error with Dolby C. Finally, the record amplifiers have insufficient headroom, judging by the clipping distortion on the intermodulation test. The meters have sluggish ballistics too, which can lead to the accidental over-recording of peaks.

## SOUND QUALITY

In practice it is in fact possible to record a little into the red even with metal tapes, but the sound has an edginess which is further exaggerated by the bright tonal balance. There is also a lack of dynamic freedom at high levels, even with metal tapes and especially so with Dolby C.

There's another problem too. This Grundig sample laid down a very low level but insistent background whistle, which meandered around in pitch quite unrelated to the music and was present even under no signal conditions. The cause could not be traced, but the accompanying system was eventually ruled blameless.

This probable sample fault aside, and within the limitations already described, the Grundig makes good recordings favouring higher bias and metal tape formulations, though a rather bright, insistent quality remains part of the package with all tapes types. Detail is good and stereo resolution is explicit, but a lean bottom end means a reduction in ambient feel and diminution of the scale of the musical performance being reproduced. High speed dubbing led to very heavy compression, but speed stability was better than usual. Bucking the trends already noted, prerecorded tapes sound a little 'wooden' and 'shut in'; the response shape is certainly partly responsible.

## CONCLUSIONS

The *CCT-903* is a hard machine to sum up. It carries more conviction than any previous Grundig assault on the ramparts of high fidelity. It also looks good – and feels wonderful, the loading door shutting with a satis-

fying clunk, and the controls operating with discreet precision. It shows promise musically too, but isn't quite there yet.

## TEST RESULTS

Rec/replay response – 3dB ref 1kHz	
IEC Type I	38Hz – 15kHz
IEC Type II	40Hz – 13.5kHz
IEC Type IV	40Hz – 20kHz
Wow & Flutter – Peak DIN wtd/unwtd	FWD 0.10%/0.24%; REV 0.15%/0.30%
Wow/Flutter Peak DIN wtd	FWD 0.09%/0.22%; REV 0.15%/0.27%
Speed error	+0.07%
Type I signal/noise CCIR/ARM 400Hz distortion 0dB	53.5dB 0.6%
Type II signal/noise CCIR/ARM 400Hz distortion 0dB	55.5dB 2.0%
Type IV signal/noise CCIR/ARM 400Hz distortion 0dB	53dB 2.4%
Channel separation 0VU/1kHz	47dB
Line input sensitivity/overload	62mV/4.2V
Mic input sensitivity/overload	n/a
Line output for 0dB/maximum	1.6mV/2.9V
M distortion 10kHz/11kHz 0dB peak, 1kHz product	30%
Azimuth check R-L phase at 10kHz	30° (A); 0° (B)
VU indication at IEC 0dB	+3dB
Dimensions (w x h x d)	47.5 x 11.5 x 34.5cm
Typical Retail Price	n/a, only available within the system

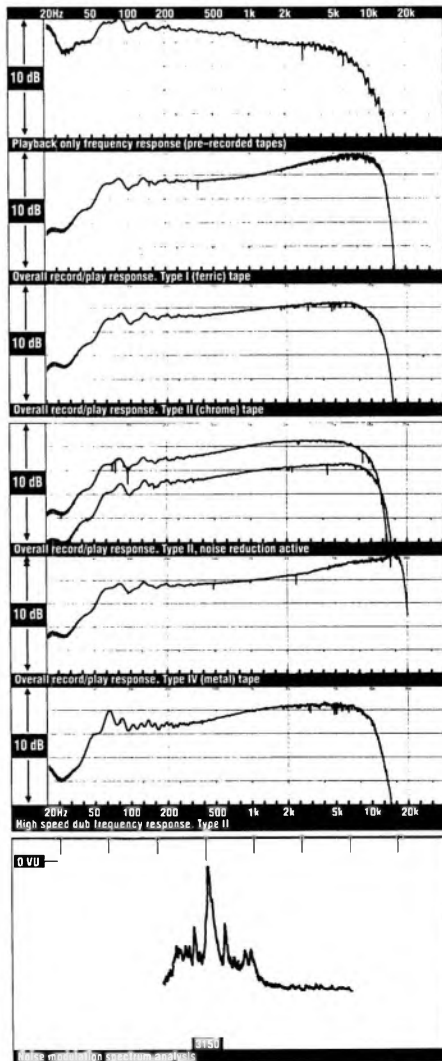

# GRUNDIG FINE ARTS DAT-9000 DAT RECORDER

GRUNDIG INTERNATIONAL LTD., MILL ROAD, WARWICKSHIRE CV21 1PR. TEL: (0788) 77155.

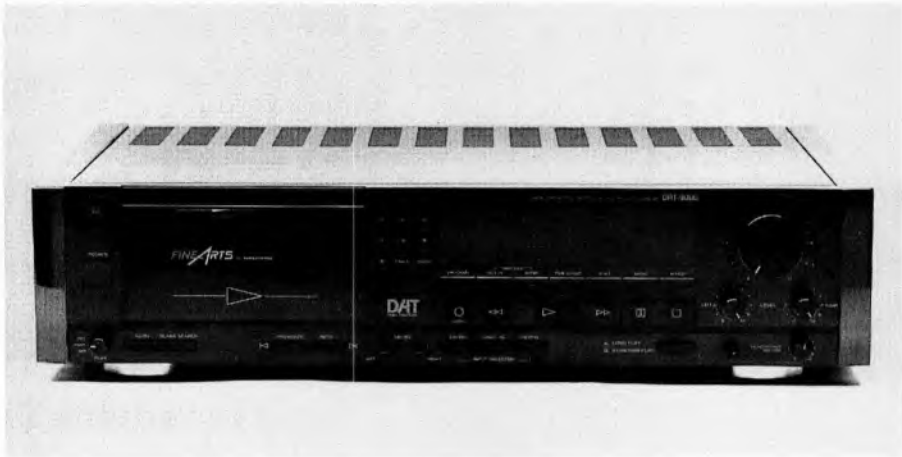

We continue our watching brief over the presently stalled market for domestic DAT with the Grundig *DAT-9000*, from the prestige *Fine Arts* series. At first sight, the only stand out features are the piano gloss wood side cheeks, and the £1,200 price tag. By present standards, the level of engineering of this deck appears quite prosaic.

The recorder itself records and plays back in standard mode with 16-bit linear quantisation and 44.1kHz sampling which gives a maximum of two hours per tape; or (unusually) 12-bit nonlinear/32kHz mode (ie reduced sound quality) to give a four hour maximum. Nonlinear quantisation minimises quality losses, but HF response is limited to 15kHz-ish.

The range of features includes direct track selection using a numeric keypad, intro search, memory programming of up to 50 steps, blank search, repeat (all/programme/A-B), memory stop and timer record and playback. The meters cover a 42dB range with 3dB resolution, with a separate section offering higher resolution near 0VU and overload warnings alongside.

The tape counter reads in arbitrary numbers or a choice of elapsed or time to go, along with other subcode information (track IDs etc). The subcode data is added automatically when recording, but can be post-edited freely. A microphone input is fitted, optimised (says Grundig) for Sennheiser *MKH-406* capacitor mikes.

## LAB REPORT

Judging by the legends on the internal boards, the unit is made by JVC. It is fairly typical of DAT recorders in containing a large number of PC boards (I lost count at ten!) interconnected by a complex wiring harness. The DAC/ADC section inhabits its own screened tray and uses timeshared Burr Brown *PCM 54HP* converter ICs run at a 2x oversampling rate, which explains the 40 degree 20kHz phase difference between channels. Extensive shielding is used in potential problem areas, and ferrite beads are in evidence to stop breakthrough. Many

of the chips come from Sony and NEC. The case is made from steel panels with some cross bracing, but there is no sign of any internal damping.

The electronic components are of broadly standard commercial quality, while layout and design follows traditional electronic practice. There's little or no special attention of the kind you'd expect from an audiophile design - high grade caps etc. The transformer and power supply are fairly small. The transport is made from pressed steel and plastic parts, and looks efficient enough. Test results are fine, if sub-CD for noise and dynamic range; low level resolution is good.

## SOUND QUALITY

The long play mode is a utility rather than to be recommended. But it sounds OK, and may well be favoured by those who record FM off air, though the sound is a touch emphatic and strained at times. Of course half speed recordings are also less 'robust', a factor that should be considered when archiving. Even with normal speed use, I noticed the odd dropout, which is what a full mute sounds like. Grundig in fact recommends that the first minute of a tape be treated as 'unstable' and ignored when recording - a previously unencountered DAT inhibition.

Taking full note of the modest electronic quality of the deck, the Grundig sounds quite good, if a touch dry and grainy when stressed, both at very low or at very high levels. And there's a very subtle masking, almost like a very mild compression, though not of course to the extent that is pandemic with the compact cassette medium. In close comparisons with various sources, it was plain that the Grundig - like other DAT recorders encountered before - sounds like nothing more nor less than a CD player, in this case a reasonably good one in the middle price range.

## CONCLUSIONS

£1,200 looks expensive, and is. But DAT prices are all but imaginary in the absence of a proper market, and the *DAT-9000* is at least officially available - theoretically on its own

and certainly as part of a complete system. Which is more than can be said of some of its alleged competitors. The Grundig does everything necessary, does it well, and sounds rather better than a glance inside may lead you to suppose. The only thing missing is a remote control.

## TEST RESULTS

Test resolution	15.5 bits
Output level dB ref 2V, source	2.18V, 0.74dB 1kohm
Effective dynamic range (0dB thd + N + dither)	95dB
Stereo separation	20Hz, 90dB; 1kHz, 76dB; 20kHz, 52dB
Stereo balance L/R	very good*
Frequency response (ref 1kHz) 20Hz - 20kHz	±0.2dB
Audible high frequency intermodulation	84dB/0.0063%
Audible electrical noise	-84dB CCR/ARM, 1kHz
Audible mechanical noise	very low
Ultrasonic noise	-97dB
Error correction	n/a
Shock/vibration resistance	very good
De-emphasis	n/a
Resolution (dB) at -90dB	L = R = 088dB
Line input sensitivity/overload	300mV/>13V
Mic input sensitivity/overload	4.13mV/650mV
Line output for 0dB/maximum	2.18mV/2.18V
Azimuth check R-L phase at 20kHz	40°
Dimensions (w x h x d)	47.2 x 11.5 x 36cms
Typical Retail Price	n/a only available within 9000 system

*All measurements are for record/replay chain.  
\*depends on record level settings (<0.3dB error mid setting)*

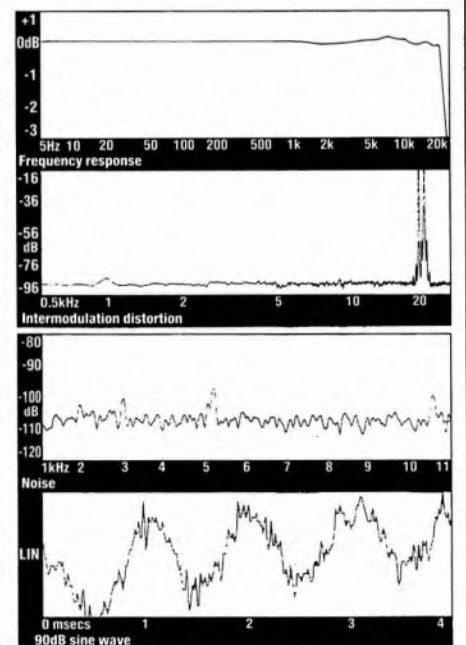

# QUART

*The wraps are off  
the Quart sound revolution!*

Times and sounds are  
changing

And Quart Loud Speakers  
are right behind the sound  
revolution — as one of the  
biggest names in Germany.

Now, here in the UK, Quart is  
set to challenge every opinion  
you have ever had about  
quality sound reproduction.

Hear the sound, appreciate  
the finish, enjoy the value —  
starting at only £299.90.

Quart — take the wraps off  
soon at your dealer.



Soundtec Marketing Limited,  
Unit 9, Belfont Trading Estate,  
Mucklow Hill, Halesowen,  
West Midlands, B62 8DR  
Telephone: 021-550-7387

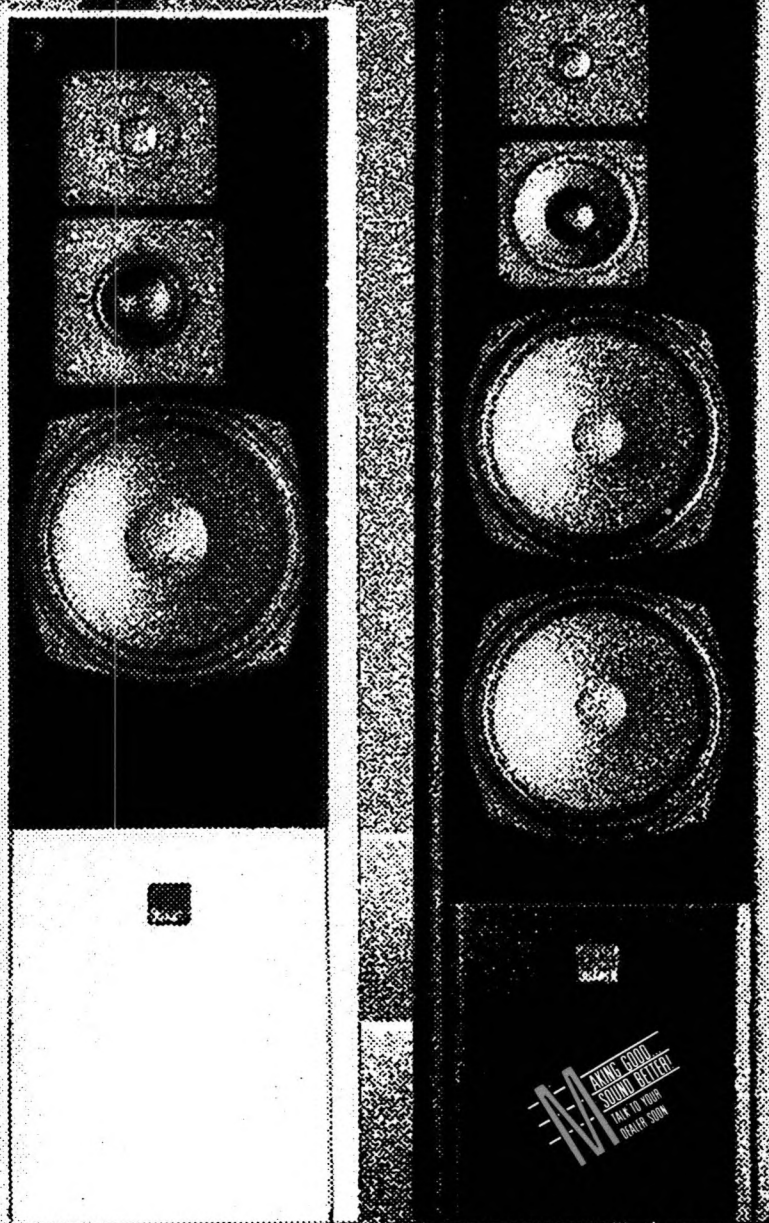

QUART 300 S  
ODER  
DER  
UNTERSCHIED  
ZWISCHEN  
BOX  
UND  
KLANGMOBEL

QUART

QUART

HEAR THE SOUND  
SOUNDTEC  
THE WAY YOU  
HEAR SOUND



# JVC TD-R411

JVC (UK) LTD., ELDONWALL TRADING ESTATE, 12 PRIESTLEY WAY, STAPLES CORNER, LONDON NW2. TEL: (01) 450 3282.



This relatively low cost auto-reverse deck has few unnecessary frills or luxuries. But the auto-reverse mechanism is a quick reverse type based on a rotating head assembly and optical end of tape sensor, which does its thing as soon as it detects the leader. The result is the shortest possible interruption in the musical flow, of the order of one second. The transport is impressive too, for the quiet way that it goes about its various duties.

And that's about it. The only feature that smacks of novelty to any degree at all is the provision of microphone inputs. The most obvious omission is of any tape search features, unless you count the primitive mechanical tape counter.

The record level meters are equally unsophisticated, consisting of only five LEDs per channel spread over a 16dB range, plus one extra per channel acting as power on indicators. Levels are set using a single large potentiometer.

Finally therefore, a toast to absent friends. The JVC has no input balance control, which in a well designed system may not be quite the shortcoming you might imagine, but which could prove an irritant if using microphones. There's no timer standby facility either, so this is not the deck to choose if you like taping radio programmes while away from home.

## LAB REPORT

The lab tests reveal only too clearly that this deck has limited capabilities in almost all areas. The various frequency responses are (almost literally) all over the place. The two consistent threads are a degree of underbiasing that leaves all the responses with a sharply rising treble, and the very erratic bass behaviour, which extends all the way up to around middle C! The solitary response that bears any relation to truth, accuracy and the American Way is the playback only one.

There are other weaknesses too I'm afraid. By far the most invidious is the poor transport performance. Wow levels (<4Hz) are not intolerable, but flutter is high in the forward

direction, and at nearly three-quarters of a percentage point grossly excessive in reverse. The spectrum analysis shows quite strong discrete sidebands, increasing the probability of audibility.

In relation to IEC 0dB, which with this deck corresponds to +3VU on the meters, signal/noise isn't as poor as a superficial first glance at the figures suggests, but the deck isn't completely clean above 0VU (-3dB IEC) or thereabouts, and effective dynamic range is therefore a little limited in practice.

## SOUND QUALITY

A slow meandering in pitch was apparent even with prerecorded material, which also often sounded muddled and dulled, acceptable response shape notwithstanding. There were signs that pitch stability improved as the deck warmed up and its circuits stabilised, but not sufficiently so as to remove an element of uncertainty with much material.

The HF lift in the record/replay response shapes gives the JVC a touch of apparent precision and detail, but it is achieved at considerable cost in areas like background hiss (higher than average) HF stability (erratic) and a lack of what is best subjectively described as 'weight' or 'body'. The deck sounds weak in the lower registers and rough and edgy in the higher ones. And lack of pitch precision is even more noticeable after recording than when simply playing back prerecorded tapes, due to the additive nature of the errors.

## CONCLUSIONS

Without question, the best feature of this deck is the superbly quiet action of the transport and the quick auto-reverse mechanism. And the greatest weakness is not a million miles removed, being found in the poor stability of the very same transport. Poor set-up of the electronics doesn't help either, while the sound quality is dynamically compressed and spatially unrealistic.

## TEST RESULTS

Rec/replay response -3dB ref 1kHz	
IEC Type I	<20Hz - 17.5kHz
IEC Type II	<20Hz - 18kHz
IEC Type IV	<20Hz - 19kHz
Wow & Flutter - Peak DIN wtd/unwtd	FWD 0.26%/0.72% REV 0.15%/0.60%
Wow/Flutter Peak DIN wtd	FWD 0.12%/0.72% REV 0.22%/0.64%
Speed error	+0.01%
Type I signal/noise CCIR/ARM 400Hz distortion 0dB	51dB 0.65%
Type II signal/noise CCIR/ARM 400Hz distortion 0dB	52dB 1.2%
Type IV signal/noise CCIR/ARM 400Hz distortion 0dB	51.5dB 0.95%
Channel separation 0VU/1kHz	46dB
Line input sensitivity/overload	137mV/>13V
Mic input sensitivity/overload	0.63mV/19mV
Line output for 0dB/maximum	515mV/3.35V
IH distortion 1kHz, ref 10kHz/11kHz 0dB	1.27%
Azimuth check R-L phase at 8kHz	22°
VU indication at IEC 0dB	+3dB
Dimensions (w x h x d)	43.5 x 11 x 26.5cms
Typical Retail Price	£180

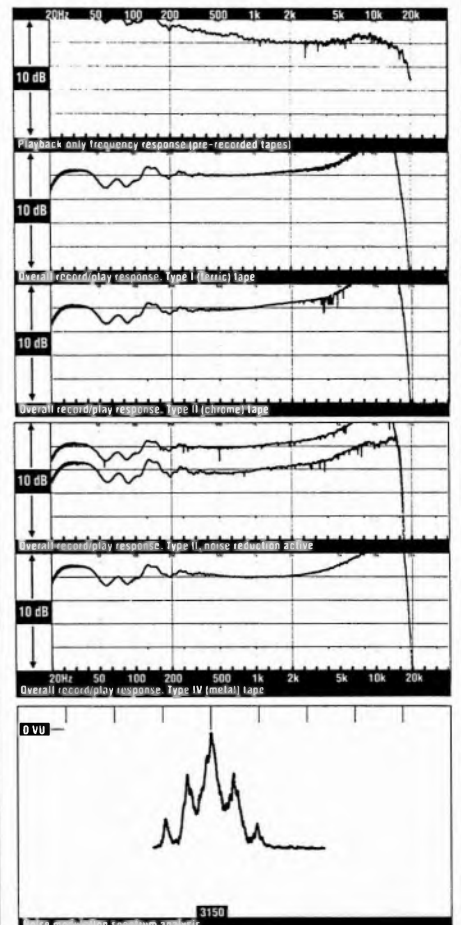

# JVC TD-W444

JVC (UK) LTD., ELDONWALL TRADING ESTATE, 12 PRIESTLEY WAY, STAPLES CORNER, LONDON NW2. TEL: (01) 450 3282.



The £190 *TD-W444* has two transports, one of which is a player only and doesn't record, the other being an auto reverse type that does record. At first I couldn't work out how to open the cassette doors to insert tapes. I finally twigged that pressing either door itself did the trick, which demonstrates an admirable directness of purpose, though the plastic windows will probably quickly become soiled by fingermarks. Wear gloves and you'll be alright . . .

I think JVC's beauticians had an off day when this model was invented. Styling is dour even on the most favourable interpretation. But the lack of aesthetic values conceals some sound basic thinking. I particularly liked the grouping of transport controls in the central area between the transports and below the record level meters.

The control keys interface via a logic chip which instructs a quiet motor-driven engagement system – one more nail in the solenoid coffin, clickety-clack. Dubbing (in real time or at double speed) is a simple one button operation, noise reduction is by Dolby B and C as usual, and the deck may be linked into remote control JVC systems.

The level meters are both tacky and somewhat impractical with their 16dB, 5-step range and almost invisible dB markings. The simple mechanical non-memory tape counter attached to the record capable transport doesn't exactly anticipate the 21st century either. For what it's worth, you can't select different noise reduction systems on the two transports, and the input level control consists of a lonely slide control – no means of adjusting balance is available. And finally, the auto reverse changeover happens somewhat tardily and at the wrong end of the leader.

## LAB REPORT

The *TD-W444* has a good sense of pitch, with little short term drift or wow, though in common with the majority of auto reverse decks, flutter is consistently on the high side. Curiously though, the figures for the reverse direction (side B with the tape inserted side

A outwards) are the better of the two.

Type IV (metal) tapes are consistently underbiased by this deck, and all IEC standard tapes are processed to give a rather bright sound. The Type II (TDK SA) plot is a classic, giving a gentle, progressive top end leg-up. With Dolby switched in the response shapes are modified as shown, which implies poor Dolby set-up and compression.

Prerecorded tapes are quite accurately aligned, though there is a broadband loss of midband output. Recordings can be driven quite hard on the record level meters, with 0dB IEC set at 0VU. But even at this level the amplifiers are beginning to produce significant intermodulation, suggesting that headroom is running out.

## SOUND QUALITY

Commercial recordings sound OK, but with rather more compression than was expected – a finding that turned out to be common to other modes of use . . .

Although rich and full, the bass is indictable on the grounds that it has a loose, floating feel at the very lowest frequencies. And our sample also showed a significant and disturbing shift in the stereo image towards the right – disturbing because the lack of balance adjustment means it cannot be compensated when recording.

These things apart, criticisms are restricted to a partial lack of absolutes – tangibility, clarity and dynamics in the main – which are difficult to achieve with cassette decks at all, particularly so at these prices. The sound sharpened up considerably with higher bias tapes, though paradoxically metal tapes were not obviously better suited than chromes.

Dolby B and C gave roughly equivalent standards of audio performance, which reflects well on the Dolby C installation.

## CONCLUSIONS

Although not quite good enough to stand being placed on a pedestal, the *TD-W444* has a competent standard of performance, veering on the side of softness and safety, plus an

attractive enough specification in a vaguely old-fashioned way. The transport section, however, is a definite strength.

## TEST RESULTS

Rec/replay response – 3dB ref 1kHz	
IEC Type I	<20Hz – 16.5kHz
IEC Type II	<20Hz – 16.5kHz
IEC Type IV	<20Hz – 17kHz
Wow & Flutter – Peak DIN wtd/unwtd	
	FWD 0.25%/0.34%;
	REV 0.11%/0.26%;
Wow/Flutter Peak DIN wtd	
	FWD 0.13%/0.27%;
	REV 0.09%/0.24%
Speed error	
	+0.12%
Type I signal/noise CCIR/ARM 400Hz	51.5dB
distortion 0dB	0.65%
Type II signal/noise CCIR/ARM 400Hz	53dB
distortion 0dB	1.2%
Type IV signal/noise CCIR/ARM 400Hz	53dB
distortion 0dB	1.2%
Channel separation 0VU/1kHz	45dB
Line input sensitivity/overload	133mV/>13V
Mic input sensitivity/overload	n/a
Line output for 0dB/maximum	480mV/3.2V
IM distortion 10kHz/1kHz 0dB peak, 1kHz product	1.4%
Azimuth check R-L phase at 10kHz	90° (A) 0° (B)
VU indication at IEC 0dB	+3dB
Dimensions (w x h x d)	43.5 x 12.5 x 26.5cms
Typical Retail Price	£190

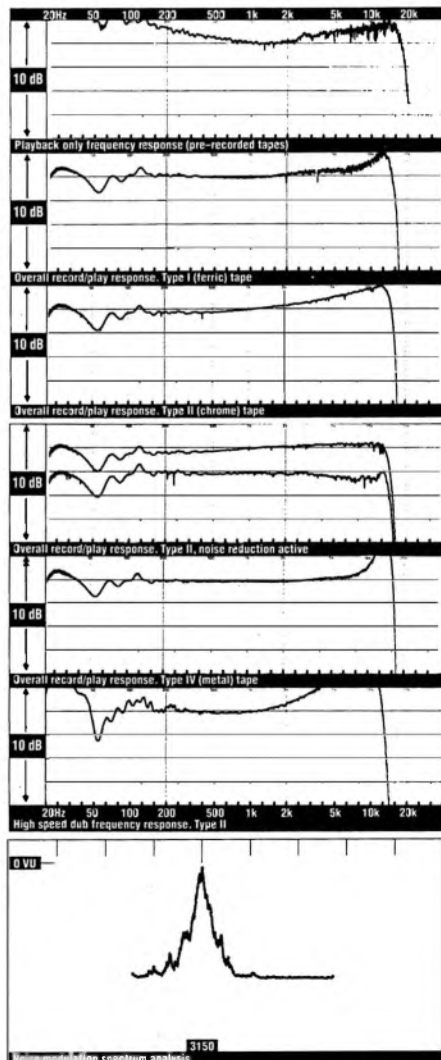

# JVC TD-V711

JVC (UK) LTD., ELDONWALL TRADING ESTATE, 12 PRIESTLEY WAY, STAPLES CORNER, LONDON NW2. TEL: (01) 450 3282.

RECOMMENDED



Only one word adequately describes this machine: wow! In a marketplace of clones, the £380 *TD-V711* benefits from some highly original thinking. One example is the total removal of the Dolby circuits from the signal path when they're not in use – usually the major part of the circuit continues to conduct the audio signal regardless. Even Dolby HX Pro can be defeated and removed in this way.

The *TD-V711* has separate dedicated record and playback heads and automatically switched tape/source monitoring. The transport has dual capstans, driven by a direct drive motor. Instead of solenoids, motor driven cams control the transport, in a near silent arrangement modelled on Nakamichi and Denon practice. Auto tape type recognition is supplemented by a fine bias adjustment facility. The range of up-market gadgets fitted include a headphone socket with volume control, 43dB meters with peak hold, a counter with remaining time readout and various memory and track search functions.

There are other points of at least equal interest to the audiophile. They include extensive remote control switching to minimise signal runs inside, the separation of control and audio signal areas, OFC circuit track and PC-OCC head windings, and a number of steps to reduce microphony and structural resonance. The deck also has no less than three line inputs so that various system components can be connected directly without passing through a system amplifier.

## LAB REPORT

The high-tech transport endows the JVC with very fine wow and flutter test results. Both wow and flutter are low individually and the spectrum analysis shows almost negligible modulation noise.

The record/replay frequency response plots were run with the bias control set to normal and using the standard test tapes. Note the way the responses hinge around 1-2kHz; this is almost completely correctable using the bias adjust feature. Not so Dolby

tracking, however. The nature of the curves shows quite strong mistracking evidently due to inappropriate Dolby level settings; this of course can't be corrected without access to the internals; the solutions are appropriate choice of tapes (see below), or re-alignment by a competent dealer.

Incidentally I ran some frequency response tests with HX Pro switched in and out, at 0VU and -15VU; both showed similar 1dB increases in output at the top end of the passband with the circuit active, which is curious since there should be little effect with simple sinewave signals at -15dB. It appears that the HX Pro circuit is in effect operating a little like a mild dynamic expansion circuit, which isn't quite the idea.

## SOUND QUALITY

I made some wonderful recordings with this deck using some of the recent high grade tapes such as TDK *MA-X* and Sony *Metal ES* Type IVs, and Sony *UX-Pro* Type II, using Dolby B or without Dolby altogether. These tapes are especially suitable for non-Dolby recording because they can take a lot of signal without compression, leaving hiss far behind. Generally I felt the deck sounded best without noise reduction but with HX Pro. However, non-Dolby recordings were often better with the more sensitive tapes simply because they side-stepped the sensitivity mismatch problem. Adjustable record sensitivity would avoid this.

Prerecorded material replays well. There's a small loss of air and detail but nothing that isn't explicable by the parallel (and mild) loss of HF output. The deck is predictably best at playing its own recordings, however, and the overriding impression after the auditioning was that this is a remarkably stable and assured performer, with pin sharp precision, a solid bass, and complete accuracy of pitch. But there is also a slight trace of 'wispi-ness', a kind of emphasis on transients to the detriment of the body and weight of the sound, even though the tonal balance is to all intents and purposes flat.

## CONCLUSIONS

It is possible to criticise the JVC *V711*, which doesn't have quite the fullness and weight of the real thing. But it does have remarkable resolving power and stability, and fundamentally doesn't sound like a tape recorder. I know of few decks so utterly free of dropout either – Recommended enthusiastically.

## TEST RESULTS

Rec/replay response -3dB ref 1kHz	
IEC Type I	30Hz - 21kHz
EC Type II	30Hz - 21kHz
IEC Type IV	30Hz - 21kHz
Wow & Flutter - Peak DIN wtd/unwtd	0.06%/0.10%
Wow/Flutter Peak DIN wtd	0.05%/0.09%
Speed error	+0.5%
Type I signal/noise CCIR/ARM 400Hz	48dB
distortion 0dB	0.48%
Type II signal/noise CCIR/ARM 400Hz	53dB
distortion 0dB	0.65%
Type IV signal/noise CCIR/ARM 400Hz	49dB
distortion 0dB	0.5%
Channel separation 0VU/1kHz	49.5dB
Line input sensitivity/overload	147mV/>7V
Line output for 0dB/maximum	510mV/4.2V
IM distortion 1kHz, ref 10kHz/11kHz 0dB	2.5%
Azimuth check R-L phase at 8kHz	0 degrees
VU indication at IEC 0dB	4dB
Dimensions (w x h x d)	47.5 x 13.5 x 33.5cms
Typical Retail Price	£380

Reprinted from issue No. 63

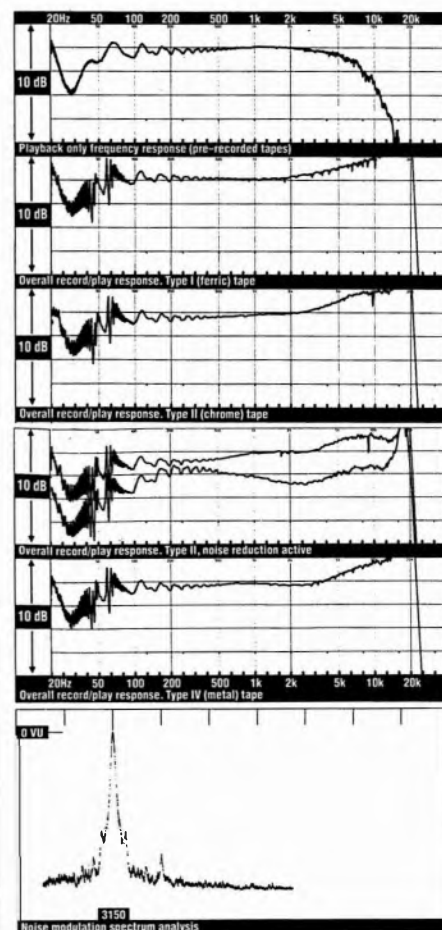

# TEAC

## Quality Comes As Standard



**V-670 Stereo Cassette Deck**



**PD-470 Compact Disc Player**

Outstanding sound quality –  
that's what you get as standard with TEAC.  
Two new models from TEAC come with even more of that quality.

The V-670 is a 3-head Cassette Deck which, with adjustable bias, guarantees optimum recording quality with all tapes. Dolby B and C with HX Pro reduces noise to a minimum with extended dynamics.

When it comes to Compact Disc players, the PD-470 offers more than most. 16 bit A/D convertors with 4 times oversampling provide an exceptional clarity of sound. Comprehensive controls allow up to 20 selections to be programmed, with a remote control to put that operational variety at your fingertips.

Check out TEAC Sound Quality today  
and hear what comes as standard.

# TEAC®

TEAC UK Limited, 5 Marlin House, The Croxley Centre, Watford, Herts. WD1 8YA  
Telephone 0923 225235

# KENWOOD KX-660HX

TRIO KENWOOD, 17 BRISTOL ROAD, THE METROPOLITAN CENTRE, GREENFORD, MIDDX UB6 8UP. TEL: (01) 575 6030.

RECOMMENDED

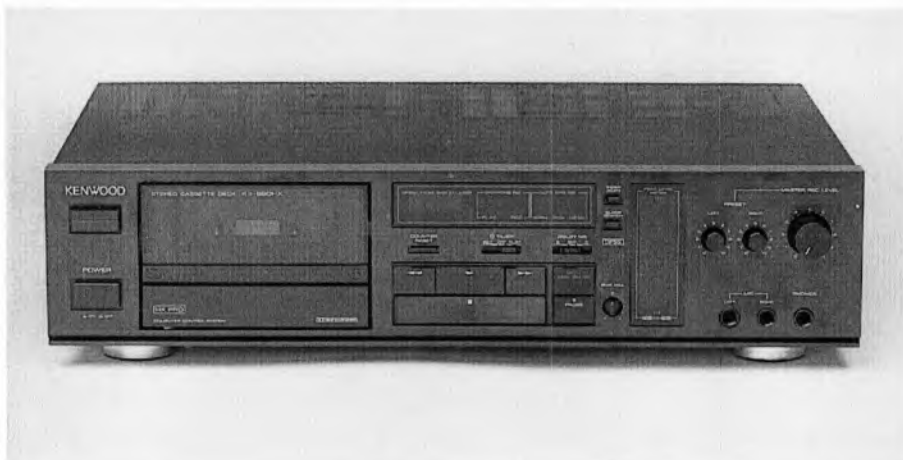

There's no shortage of choice around this price point, and Kenwood has decided to take a fairly purist view of what is desired. Some modest measures have been taken to 'rigify' (Kenwood's term) the structure against resonance and vibration, and the businesslike control system is also notable.

Like other Kenwood decks, the '660HX is equipped with Dolby HX Pro which to a first approximation has the effect of linearising (my term) the high level, high frequency performance of lower bias tapes. Noise reduction is courtesy of the ubiquitous Dolby B and C.

Twin 6.3mm microphone sockets are fitted alongside the fixed level headphone socket. Tape type recognition is automatic, and bias levels may be adjusted on all three tapes. The electronic tape counter reads in minutes and seconds, which makes searching a tape a more than usually intuitive task. There is no memory stop feature, but a number of alternative tape search facilities include track search (up to 16 tracks in either direction), blank search and index scan (which plays a few seconds from the start of each track in turn). These combine to form a powerful set of tools for this often tedious task.

The main user interface is unusually well designed. The transport controls are disposed in a block with the fast wind controls flanking 'play' and surmounting an oversize 'stop' key. One-key record starts are possible. Input level controls consist of two variable controls for each channel described as 'pre-sets', and a third large master gain control which enables fades to be easily made. The meters are excellent, high resolution, two-colour vertical columns, scaled clearly from -20dB to +12dB.

## LAB REPORT

The transport is plainly a good one. It produced some excellent figures for a sub-£200 model on test, though some fairly low level capstan wow artefacts are visible on the plot, and some high frequency components too.

The metal and ferric (Type IV and I)

record/replay frequency responses are all perfectly smooth and flat up to 5kHz, but the Type II curve is on the rise from below 2kHz. A little extra bias from the front panel control is enough to more or less correct matters, and this should be adjusted for similar perceived source and off-tape tonal balance - using FM interstation noise, for example. The Dolby plots look acceptable enough, but more detailed examination suggests mild misalignment.

Head azimuth is correct, and prerecorded tapes are accurately reproduced. IM distortion is low. Note that the IEC 0VU level is set high, at +4dB on the meters, which means that recording levels can be set a little higher than usual.

## SOUND QUALITY

Prerecorded cassettes sound coloured, with a strangely thin, hollow bass and a slightly metallic 'enclosed' mid and top - clear and detailed enough, but plainly invented and obviously synthetic.

The KX-660HX rates rather better as a recorder. Adjectives culled from the listening notes include 'good', 'tight', 'dynamic', 'forceful' and 'fairly detailed'. The precision and stability suggests that modulation noise is low, and there's little waffle or muddiness.

I found the deck varied and interesting to listen to, predictably more so with Dolby B than with C which tended to sound slightly coloured. Noise levels are generally too intrusive to allow use without noise reduction, not just because of the absolute level of hiss but also due to its character which was a little sharper than usual.

## CONCLUSIONS

The KX-660HX is one of the better decks in its market sector. It is stable and well focused and works consistently well with a wide variety of blank tapes. Recommended, except for those with a large collection of musicassettes.

## TEST RESULTS

Rec/replay response - 3dB ref 1kHz	
IEC Type I	30Hz - 17kHz
IEC Type II	30Hz - 17kHz
IEC Type IV	30Hz - 17kHz
Wow & Flutter - Peak DIN wtd/unwtd	0.08%/0.23%
Wow/Flutter Peak DIN wtd	0.06%/0.20%
Speed error	+1.0%
Type I signal/noise CCIR/ARM 400Hz	46.5dB
distortion 0dB	1.1%
Type II signal/noise CCIR/ARM 400Hz	51.5dB
distortion 0dB	0.7%
Type IV signal/noise CCIR/ARM 400Hz	50dB
distortion 0dB	0.7%
Channel separation 0VU/1kHz	49.5dB
Line input sensitivity/overload	121mV/>7V
Mic input sensitivity/overload	0.62mV/32mV
Line output for 0dB/maximum	560mV/2.6V
IM distortion 1kHz, ref 10kHz/11kHz 0dB	1.3%
Azimuth check R-L phase at 8kHz	0 degrees
VU indication at IEC 0dB	4dB
Dimensions (w x h x d)	44 x 11.5 x 32.5cms
Typical Retail Price	£170

Reprinted from issue No. 63

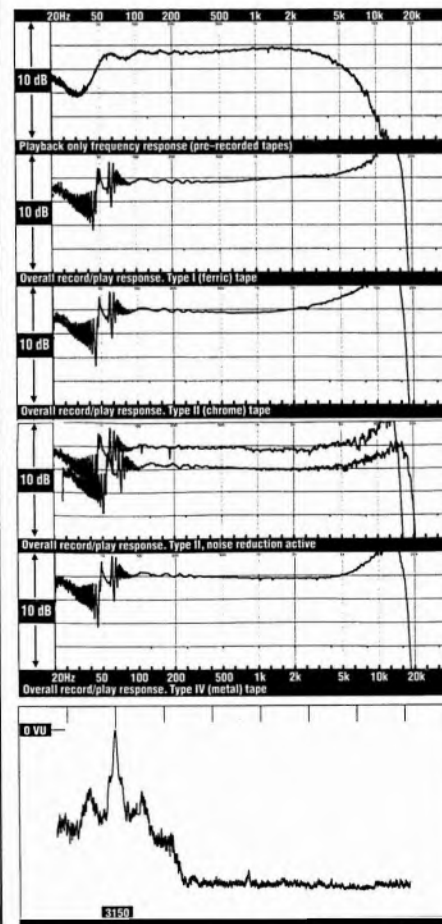

# Oxford Audio Consultants

**Our shop facilities are like no other.  
Our equipment is without peer, from  
the affordable to the very expensive.**

**Our superb service is the same,  
regardless of price.**

## **INTEREST-FREE CREDIT AVAILABLE FOR A FURTHER LIMITED PERIOD**

*Beat the interest rate rises while you can!*

### **FEATURED SYSTEM THIS MONTH ON CONTINUOUS DEMONSTRATION:**

**CRYSTELLE/REGA/KOETSU BLACK  
AUDIO RESEARCH SP9  
KRELL KSA-80  
MAGNEPLANAR MG2.5R  
MICROMEGA CD F1 CLASSIC**

**Agencies include:** Oxford Acoustics, Audio Research, Apogee, Air Tangent, Counterpoint, Koetsu, Krell, Magneplanar, PS Audio, Sonus Faber, Aragon, Micromega, Stax, Beard Audio, Cambridge Audio, Wharfedale, Linx, Marantz, Audio Technica, Goldring, Discwasher, Allsop, Target, Foundation, Sennheiser, QED, Hunt EDA, van den Hul, That's Tape, DNM, Lift, etc

**Formal opening hours 10am – 6pm,  
Tuesday to Saturday: closed Monday**  
Individual consultations bookable  
Home demonstrations a pleasure  
Custom House Installations  
Part Exchange  
Full service back-up

*PART-EXCHANGE AND EX-DEM BARGAINS —  
RING FOR DETAILS OF CURRENT LIST.*

# Oxford Audio Consultants

**Cantay House, Park End Place, Oxford OX1 1JE  
Telephone: Oxford (0865) – 790879 (24hr. service)**

*Write or telephone for appointments or our comprehensive  
information pack*

PIERE LURNE,

SNELL,

PINK T.

AUDION,

SPICA,

DELTIC,

MARANTZ,

KISEKI,

RAY LUMLEY,

KUZMA,

ORTOFON,

MOTIF,

AUDIONOTE,

INCA TECH,

TRIPLANER,

PROAC,

J.P.W.,

GYRODEK,

AUDIO INNOVATIONS,

KUZMA,

SME,

FINESTRA,

VOYD,

EMSEMBLE,

ROCK.

**18 HILLINGDON RD.,  
UXBRIDGE, MIDDX.  
OPEN – 11-7 MON-SAT.  
BY APPOINTMENT**

# Audiocraft



☎ 0895 – 53340



# KENWOOD KX-5010

TRIO KENWOOD, 17 BRISTOL ROAD, THE METROPOLITAN CENTRE, GREENFORD, MIDDX UB6 8UP. TEL: (01) 575 6030.

BEST BUY



Something of a rarity amongst modern cassette decks, the £270 *KX-5010* is a two head deck (ie without real time off-tape monitoring) which nevertheless has an automatic tape calibration system (ATCS). At the press of a single button it skips the leader, records and then plays back a series of test tones at 400Hz and 10kHz to set bias and sensitivity, and finally rewinds to a point just past the leader ready for action. The settings thus arrived at remain current until the tape is changed or power is switched off; it may be criticised for the second of these.

This Kenwood is also capable of using microphone as well as line level sources, and like other recent models from the same stable, the *5010* has Dolby *HX Pro* and MPX filter switching in addition to the usual Dolbys B and C. A large high grade ganged level control with a small balance port underneath control the input. Levels are monitored on magnificent 42dB, 16-step peak-hold meters.

Tape recognition is automatic, with front panel confirmation. Search aids include a real time counter (without memory stop), intro search, track search and blank skip. The headphone output has its own volume control.

Finish quality is above and beyond the call of duty, but there are weaknesses elsewhere. The piggyback PC board to which the record level and some other controls are attached by long shafts was poorly anchored, and rocked freely in its socket – obviously a breakdown waiting to happen. Secondly, although the power supply and audio circuits are unusually well specified, and Kenwood has taken care to screen critical areas effectively, I would have liked to have seen measures to control mechanical vibration. As it is, the large gilded mock-isolating feet are imposters. On the other hand, the 3-motor transport which includes a cassette damper is impressive enough.

## LAB REPORT

This was a hard deck to fault in the lab tests. The tape path and head geometry have been well optimised, effectively minimising head

contour effects, and the ATCS circuit adjusted for maximum linearity with fine consistency. There's a tiny HF error visible in the Dolby B tracking, but the playback only test was passed with flying wotsits.

The apparently mediocre signal/noise ratios must be seen in the context of a relatively high meter reading for IEC 0dB point on the meters. In effect most recordings can be peaked quite deeply into the red, which is helped by level meters which read up to +12VU (or +9dB ref IEC). There's no shortage of input headroom either. Finally the bench tests show that the transport system is state of the art for a non-dual-capstan design.

## SOUND QUALITY

As last I've found a cassette deck that is relatively modestly priced, yet can be discussed within a frame of reference normally reserved for considerably more expensive models – and only the best of those. Amongst several immediately notable features, one of the most persuasive is the rock like stability of the sound, assessed by output level as well as pitch stability.

Dynamics are also very good in both important meanings of the term: the *5010* goes loud without compression; when quiet, music remains articulate and intelligible. There's little of the cassette medium's traditional low level mush and vagueness, and one immediate beneficiary is excellent stereo imagery.

Dolby *HX Pro* circuitry has the effect of improving dynamics with lower bias tapes, and consequently good quality ferrics and chromes (or chrome bias Type II tapes) lose relatively little to metals. Yet it is with metal tapes that the Kenwood is at its happiest, and where it shows its true colours.

## CONCLUSIONS

At last – a serious musical tool that uses cassettes and which doesn't cost a king's ransom. The *KX-5010* sets a standard for subtlety and informativeness at the price – musical integrity no less – that is likely to stand for some time, and is therefore a clear Best Buy.

## TEST RESULTS

Rec/replay response – 3dB ref 1kHz	
IEC Type I	<20Hz – 15.5kHz
IEC Type II	<20Hz – 16kHz
IEC Type IV	<20Hz – 22kHz
Wow & Flutter – Peak DIN wtd/unwtd	0.056%/0.19%
Wow/Flutter Peak DIN wtd	0.02%/0.19%
Speed error	none
Type I signal/noise CCIR/ARM 400Hz	49.5dB
distortion 0dB	0.8%
Type II signal/noise CCIR/ARM 400Hz	51dB
distortion 0dB	0.95%
Type IV signal/noise CCIR/ARM 400Hz	51dB
distortion 0dB	0.75%
Channel separation 0VU/1kHz	47dB
Line input sensitivity/overload	110mV/10V
Mic input sensitivity/overload	0.6mV/46mV
Line output for 0dB/maximum	740mV/4.9V
IM distortion 1kHz, ref 10kHz/11kHz 0dB	0.6%
Azimuth check R-L phase at 8kHz	0°
VU indication at IEC 0dB	+3dB
Dimensions (w x h x d)	44 x 13 x 30cms
Typical Retail Price	£269

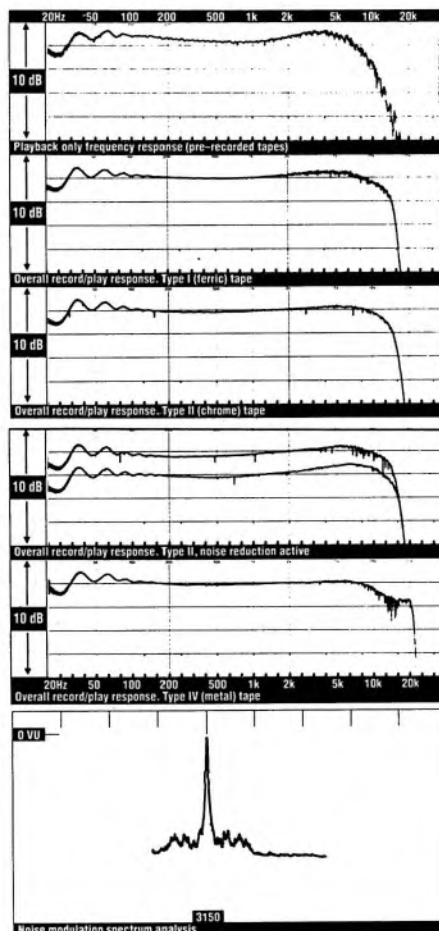

# MARANTZ SD585

MARANTZ AUDIO (UK) LTD., 15-16 SAXON WAY IND. EST., MOOR LANE, HARMONDSWORTH, MIDDX UB7 0LW. TEL: (01) 897 6633.



A step or three away from the routine twin deck, both transport sections of the £300 *SD585* are fitted with auto reverse mechanisms, and both are capable of recording. They are used to provide a veritable raft of facilities, including parallel and sequential recording and playback, using one or both sides of the two cassettes.

There are several flaws with the user interface. The assignable transport control system is sensible in reducing the number of buttons, but whereas on other similarly specified decks the selection between transports is triggered by the last tape inserted, changeover here is stubbornly at the mercy of a pair of buttons labelled *Mecha Sel* (I kid you not). Except if there's just one tape in the deck, where it has enough native intelligence to work this out for itself.

The rest is a rather uneven mixture of the contemporary and the dated. The record level meters cover just 15dB in 5 steps, which is budget deck stuff; ditto the mechanical tape counter. This is connected only to Deck B by the way despite the equal status of the two transports, and showed a minor sample fault by occasionally sticking near zero. Likewise, although the side change mechanism is optically triggered with a specified 0.8sec changeover time, on my sample one of the transports failed to trigger at the junction of tape and leader.

On the plus side, the deck has a package of electronics (with associated LED indicators) which can find an index point (equivalent to a counter memory), locate specific tracks up to 15 away from the current position, and even program random sequences of up to 16 tracks. Such programmed selections can then be dumped onto the second tape, while the Marantz will also repeat individual tracks and locate the start of a recording just completed. Auto tape sensing (without tell-tales), Dolby B/C, a headphone socket and microphone/line mixing complete the count.

## LAB REPORT

The deck's internal equalisation is not set appropriately for IEC Type I tape, but is more

accurate for the other tape groups. Note also the low frequency response variations. However, the prerecorded response shape is well engineered.

The Marantz is not wonderful mechanically. Wow levels are reasonably low, but flutter is high and varies wildly between sides, and some sharply defined capstan wow is evident in the spectrum analysis. There is also some azimuth variation between sides (a 30° phase discrepancy at 10kHz with one transport), giving some inconsistency in HF output, clarity and focus when the sides change. IEC 0dB is set at 0VU on the meters.

## SOUND QUALITY

I found the *SD585* subtly disappointing in a number of individually minor but cumulatively significant ways. The lack of response linearity was audible using the major TDK, Maxell and Sony tape types, except in the case of metals. And even here treble reproduction has a slight thinness and graininess I become aware of in direct source/tape comparisons.

At the same time, this deck imposes a degree of compression, especially at high frequencies, and a consequent lack of 'air' and openness – partly ameliorated by using Dolby B system instead of C. (No noise reduction at all sounds altogether airier and fresher, but hiss can be severe.) Prerecorded material also emerges sounding compressed and dulled. The bass end is deep and full but not very tight. Finally, the measured wow was just audible with some material, especially on the 'wrong' side of the tape.

## CONCLUSIONS

This deck is quite well made, but I find that the control system looks and feels both messy and ill considered. The *SD585* is worth considering for its ability to make timer controlled sequential recordings of up to 3 hours duration (using C90s) and so on, but musically and ergonomically the ground is less firm.

## TEST RESULTS

Rec/replay response — 3dB ref 1kHz	
IEC Type I	<20Hz – 14kHz
IEC Type II	<20Hz – 14kHz
IEC Type IV	<20Hz – 17.5kHz
Wow & Flutter — Peak DIN wtd/unwtd	
	FWD 0.17%/0.40%; REV 0.19%/0.80%
Wow/Flutter Peak DIN wtd	
	FWD 0.08%/0.36%; REV 0.12%/0.82%
Speed error	
	+0.02%
Type I signal/noise CCIR/ARM 400Hz	
distortion 0dB	54.5dB
	2.0%
Type II signal/noise CCIR/ARM 400Hz	
distortion 0dB	55.5dB
	3.0%
Type IV signal/noise CCIR/ARM 400Hz	
distortion 0dB	56dB
	>3.0%
Channel separation 0VU/1kHz	
	47dB
Line input sensitivity/overload	
	99mV/>13V
Mic input sensitivity/overload	
	0.1mV/25mV
Line output for 0dB/maximum	
	440mV/1.4V
IM distortion 10kHz/11kHz 0dB peak, 1kHz product	
	0.63%
Azimuth check R-L phase at 10kHz	
	A = 0°/30°; B = 4°/13° (FWD/REV)
VU indication at IEC 0dB	
	0dB
Dimensions (w x h x d)	
	42 x 11 x 26.5cms
Typical Retail Price	
	£300

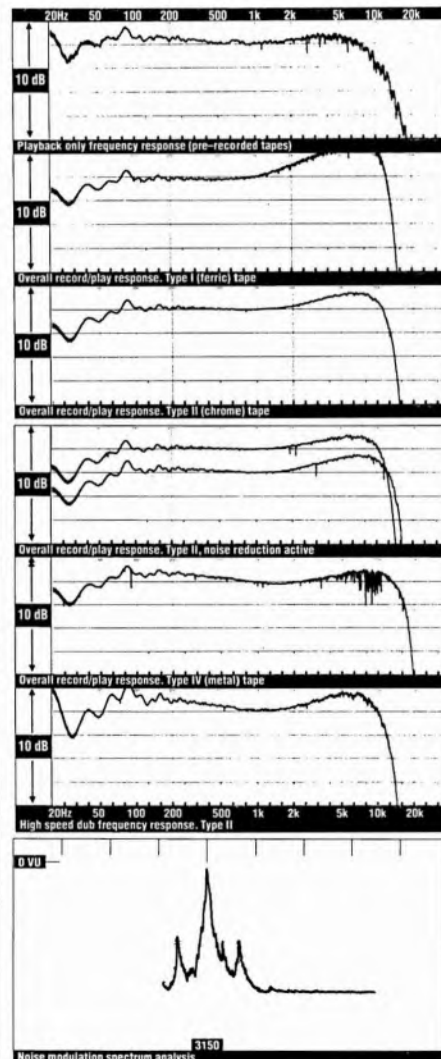



# MEMOREX SCT-84

MEMTEK PRODUCTS, UNIT 4 SUMMIT CENTRE, HATCH LANE, HARMONDSWORTH, WEST DRAYTON, MIDDX. TEL: (01) 897 7393.

RECOMMENDED

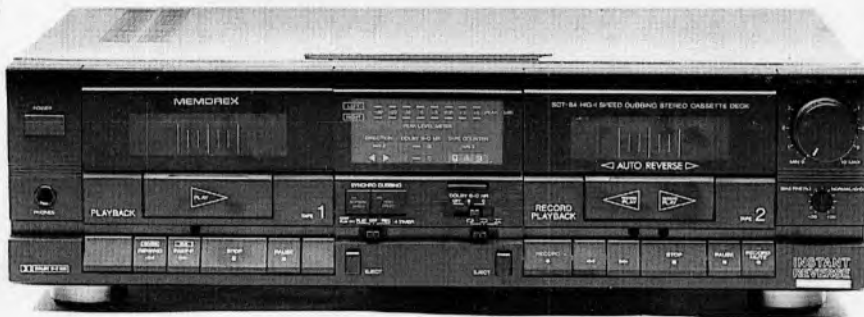

Made in Singapore and wearing a badge associated with the Tandy retail group, the *SCT-84* occupies an increasingly popular £200 sector of the twin deck market. The package combines an auto reverse recorder with rapid acting optically triggered end of side direction change, and a playback mechanism that operates in one direction only.

With strong, sculpted lines, the deck positions the main transport controls below each loading door, the play keys integrated into the doors themselves. In between are the meters (7 steps, 26dB) and switches for reverse mode, Dolby B/C and off, timer standby and finally a pair of buttons to initiate dubbing – one for normal speed use, the other for double speed. Over on the right are the input level and fine bias adjust controls. Around at the back are two 6.3mm input jacks for microphones.

Features included on an impressively long roll call include Dolby B and C noise reduction, full timer standby support, automatic tape type sensing, illuminated cassette wells (unusual this), and full audible cue and review facilities as the appropriate fast wind control is held down in play mode. The last is available on both decks, and helps make up for the lack of track search or even a simple counter memory option.

Despite the rather inelegant appearance and plasticky feel, the Memorex is easy and pleasing to use, if you can learn to forgive the great gnashings from the transport solenoids. Well at least you know something is happening, and £200 doesn't stretch to complicated features and refinements nowadays. The owner is helped in the learning task with a well conceived instruction booklet.

## LAB REPORT

The *SCT-84* is a well behaved deck on the whole. The weighted wow and flutter figures are excellent, and although the unweighted figures are less good, analysis shows that wow is negligible and flutter sidebands are well distributed, minimising audible intrusion.

The three tape groups each reproduce

with a dB or two of HF lift. Except in the case of metal tapes this can be sorted out with the bias control, and in any case the metal response showed the smallest error and therefore the least need for adjustment. The Dolby circuits are well aligned, both as shown by the figures and also assessed by ear. The signal/noise figures should be interpreted in the context that IEC OdB is set to 0VU, and that the amplifiers are already clipping at this level.

## SOUND QUALITY

The well behaved nature of this deck on the test bench was matched by its performance in use. Prerecorded cassettes were well replayed by the record capable transport, but paradoxically tended to sound rather bland and flattened when reproduced by the playback only transport. This turns out to be something of a makeaweight feature, and is clearly inferior to the rather good auto reverse transport.

So how good is good? The answer is something like five out of ten for absolute merit, and eight for value. This deck has a clean, incisive quality on the whole, with a full and clear bass if an occasionally rather raucous treble. Recordings tend to offer quite good stereo and high levels of intelligibility, though certainly not with the stature and depth you'd expect from more expensive machinery. Speed stability is clearly good.

This is one twin, auto-reverse machine where you're not paying too heavy a price for those features in musical terms. I was also intrigued to discover just how evenly the deck treats tapes from different tape groups. Good ferrics have much of the life and clarity of metal recordings, almost as though the makers have surreptitiously included Dolby *HX Pro* circuitry (of which there's no trace incidentally).

## CONCLUSIONS

This deck is closely comparable to the JVC *TD-W444*, which it just betters sonically, though I think I could live with the latter's lack of styling better than the Memorex's

positively awful styling. It does what it purports to do though, and can be Recommended.

## TEST RESULTS

Rec/replay response – 3dB ref 1kHz	
IEC Type I	22Hz – 13kHz
IEC Type II	<20Hz – 14.5kHz
IEC Type IV	<20Hz – 19.5kHz
Wow & Flutter – Peak DIN wtd/unwtd	FWD 0.10%/0.36% REV 0.12%/0.30%
Wow/Flutter Peak DIN wtd	FWD 0.07%/0.36% REV 0.13%/0.30%
Speed error	+0.17%
Type I signal/noise CCIR/ARM 400Hz	53dB
distortion OdB	0.6%
Type II signal/noise CCIR/ARM 400Hz	54.5dB
distortion OdB	2.1%
Type IV signal/noise CCIR/ARM 400Hz	55dB
distortion OdB	2.8%
Channel separation 0VU/1kHz	46.5dB
Line input sensitivity/overload	83mV/4.2V
Mic input sensitivity/overload	0.6mV/33mV
Line output for 0dB/maximum	620mV/2.8V
IM distortion 10kHz/11kHz 0dB peak, 1kHz product	3.5%
Azimuth check R-L phase at 10kHz	Deck 1 – 30/50 degrees Deck 2 – 50 degrees
VU indication at IEC 0dB	0dB
Dimensions (w x h x d)	43 x 12.5 x 30cms
Typical Retail Price	£200

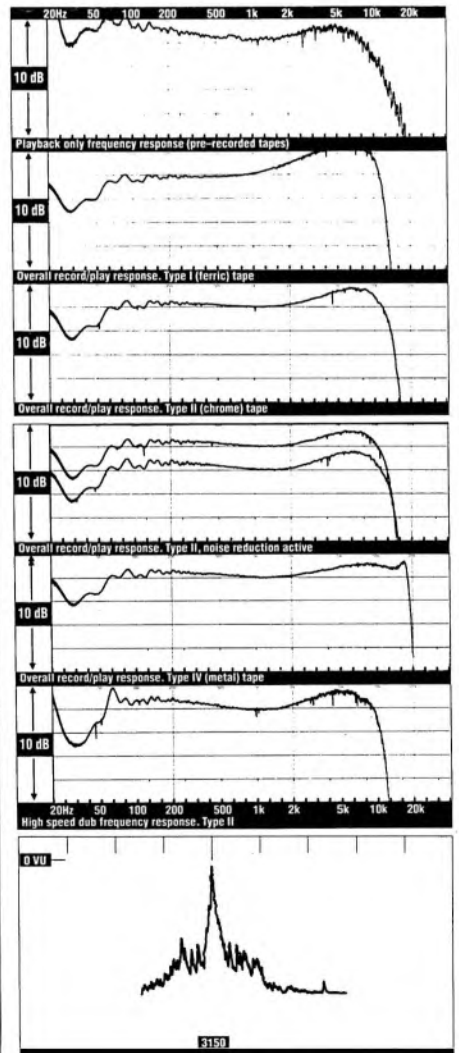

# The Kenwood KX-5010



After a review that says it all,  
a chance to hear it like it is.

It is undoubtedly welcome to read that Hi-Fi Choice has accorded the Kenwood KX-5010 the accolade of Best Buy cassette deck.



But it is better even to experience the truth for yourself.

Ring the number given below and we'll be happy to point you in the direction of the nearest Kenwood dealer.

There to trust your own senses as you sample the finer qualities of the KX-5010.

TEL: (01) 575 6030

TRIO-KENWOOD, BRISTOL ROAD, THE METROPOLITAN CENTRE, GREENFORD, MIDDX UB6 8UP



**KENWOOD**  
HOME Hi-Fi ■ CAR Hi-Fi

# NAD 6300

HI-FI MARKETS plc, AXIS 4, RHODES WAY, WATFORD, HERTS WD2 4YW. TEL: (0923) 226499.

RECOMMENDED



NAD tells me that it suffers from a 'perceived value' problem with this 3-head Dolby B/C remote control deck – there are too few controls and displays to justify the price in many people's eyes. Perhaps many people have problems with their eyesight...

General reaction to the appearance is positive: the NAD has a discreet charm and a splash of originality. It also has some surprises. Dolby *HX Pro* is combined with *Dyneq* processing to improve working dynamic range. And something called *Play Trim* can adjust the replay equalisation applied to old or incorrectly processed tapes, but does so *inside* the Dolby replay loop which reduces the processing required by a half.

*Dyneq* is a recording limiter which operates on high level HF signals to prevent them causing LF intermodulation. It does so in conjunction with Dolby *HX Pro*, and is designed to work only when the system would otherwise be in clip.

The NAD is a superb ergonomic design, my only criticisms being that the power switch should be further away from the cassette door open button, and that the (28dB high resolution) record level meters are too bright. Elsewhere NAD has managed to keep the control count as low as practical – the MPX switch is on the back panel for example. Sensible grouping and the imaginative use of colour and control style makes the deck as near intuitively obvious to use as possible.

Elsewhere, the electronic counter has a real time option, and tape and Dolby switching use sensible lever switches. But I do miss a memory counter and automatic tape recognition, not to mention the almost inevitable headphone socket. The transport accommodates 'punch-in' recording, and the cassette well is illuminated. The remote control addresses the main transport features including 'record', and a full NAD *Monitor* system remote handset is available.

For car cassette users in particular, the deck features a switchable compressor to reduce recorded dynamic range, and so make quiet passages more audible in an environment with inherently high background noise.

## LAB REPORT

The '6300 aims to offer low scrape flutter and good speed stability, and achieves these ends in some style. The transport is a dual capstan diffused resonance design (shades of Nakamichi) of a quality level that doesn't grow on trees. The wow and flutter figures are remarkably fine (0.05% DIN Wtd), and the noise modulation spectrum is sharp and clean, albeit with some discrete sidebands at very low level.

Remarkably well extended at both ends of the passband, the response curves all show a sharp, high Q lift at high frequencies which is not completely correctable by bias adjustment. The playback response shape is good at the normal setting of the play trim control, and the effect of minimum and maximum settings are also included for information.

## SOUND QUALITY

*Dyneq* works rather well. It can be treated almost like an auto-level control circuit, and is very nearly undetectable unless you know what you're listening for. It *can* be cracked if the deck is really abused, but with common sense one is free to use very high record levels without compression, tape noise virtually disappearing at the other end of the volume spectrum. This facilitates purist non-Dolby recordings which in turn help retain that much more of the life of the original.

The sound of this deck is quite distinctive. Not wholly neutral, it has a rounded kind of feel. The HF end isn't as open or as airy as the best, and the '6300 never sounds as detailed as some. But the sound picture is remarkably homogenous, with excellent dynamics and a truly 3-D quality rare from cassettes. Image stability and separation are remarkable.

## CONCLUSIONS

This is the nearest thing to a minimalist audiophile low-spec recorder this side of some of the best Nakamichis. The hefty price can only be justified by the sound; Recommended, but I feel bound to suggest it's a little expensive despite the recent price reduction.

## TEST RESULTS

Rec/replay response – 3dB ref 1kHz	
IEC Type I	<20Hz – 22kHz
IEC Type II	<20Hz – 22kHz
IEC Type IV	<20Hz – 22.5kHz
Wow & Flutter – Peak DIN wtd/unwtd	0.05%/0.09%
Wow/Flutter Peak DIN wtd	0.04%/0.08%
Speed error	+0.75%
Type I signal/noise CCIR/ARM 400Hz	52dB
distortion 0dB	0.6%
Type II signal/noise CCIR/ARM 400Hz	56dB
distortion 0dB	1.2%
Type IV signal/noise CCIR/ARM 400Hz	53dB
distortion 0dB	0.8%
Channel separation 0VU/1kHz	47.5dB
Line input sensitivity/overload	52mV/>7V
Line output for 0dB/maximum	562mV/2.3V
IM distortion 1kHz, ref 10kHz/11kHz 0dB	0.8%
Azimuth check R-L phase at 8kHz	20 degrees
VU indication at IEC 0dB	1dB
Dimensions (w x h x d)	43.5 x 12 x 28cms
Typical Retail Price	£550

Reprinted from issue No. 63

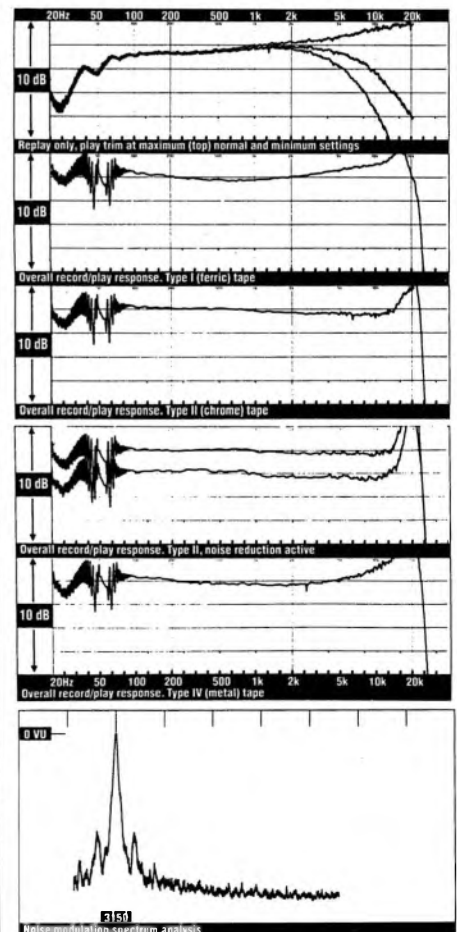

1. Louis Armstrong *West End Blues* 2. Johann Sebastian Bach *Brandenburg Concertos* 3. The Beatles *White Album* 4. Ludwig Van Beethoven *Symphony No 8 "Pathétique"* 5. Irving Berlin *Puttin' On The Ritz* 6. Chuck Berry *Sweet Little Sixteen* 7. Big Country *In A Big Country* 8. Georges Bizet *Carmen* 9. David Bowie *Space Oddity* 10. The Boys Of The Lough *Lochaber No More* 11. Benjamin Britten *Peter Grimes* 12. Big Bill Broonzy *Made A Date With An Angel* 13. Kate Bush *The Man With The Child In His Eyes* 14. Johnny Cash *A Boy Named Sue* 15. Tracy Chapman *Talkin' Bout A Revolution* 16. The Chieftains *Celtic Wedding* 17. Frederic Chopin *Piano Concerto No 1* 18. The Christians *Harvest For The World* 19. Nat King Cole *Mona Lisa* 20. Sam Cooke *Chain Gang* 21. Curiosity Killed *The Cat Ordinary Day* 22. Miles Davis *Bye Bye Blackbird* 23. Deacon Blue *Raintown* 24. Frederick Delius *A Song Of Summer* 25. Dire Straits *Brothers In Arms* 26. Bob Dylan *Highway 61 Revisited* 27. Antonin Dvorak *Symphony No 9 "From The New World"* 28. Edward Elgar *The Dream of Gerontius*

29. Duke Ellington *Mood Indigo* 30. The Eurythmics *Who's That Girl?* 31. Everything But The Girl *Each And Every One* 32. Frankie Goes To Hollywood *Relax* 33. Ella Fitzgerald *Every Time We Say Goodbye* 34. Peter Gabriel *Sledgehammer* 35. George Gershwin *Porgy And Bess* 36. Gilbert and Sullivan *H.M.S. Pinafore* 37. Philip Glass *Satyagraha* 38. Benny Goodman *Let's Dance* 39. Merle Haggard *Okie From Muskogee* 40. George Frederic Handel *Messiah* 41. Coleman Hawkins *A Strange Fact* 42. Jimi Hendrix *All Along The Watchtower* 43. Billie Holiday *That Ole Devil Called Love* 44. Buddy Holly *Peggy Sue* 45. Gustav Holst *The Planets* 46. Michael Jackson *Thriller* 47. Elmore James *Dust My Blues* 48. Jean Michel Jarre *Oxygene* 49. Waylon Jennings *This Time* 50. Louis Jordan *Choo Choo Ch'Boogie* 51. B.B.

King Sweet Sixteen 52. The Kinks *You Really Got Me* 53. Peggy Lee *Why Don't You Do It Right?* 54. Jerry Lee Lewis *Great Balls Of Fire* 55. Gustav Mahler *Symphony No 5* 56. Felix Mendelssohn *A Midsummer Night's Dream* 57. Glenn Miller *I've Got A Girl In Kalamazoo* 58. Charlie Mingus *Wednesday Night Prayer* 59. Thelonius Monk *Monk's Mood* 60. Morrissey *Every Day Is Like Sunday* 61. Wolfgang Amadeus Mozart *Don Giovanni* 62. Carl Perkins *Blue Suede Shoes* 63. The Pet Shop Boys *Actually* 64. Iggy Pop *Wild Child* 65. Cole Porter *Night And Day* 66. Bud Powell *Bouncing With Bud* 67. Elvis Presley *Jailhouse Rock* 68. The Proclaimers *Letter From America* 69. Sergei Prokofiev *Romeo And Juliet* 70. Giacomo Puccini *La Bohème* 71. Serge Rachmaninoff *Piano Concerto No 2* 72. Oris Redding *The Dock Of The Bay*

73. Django Reinhardt *Sweet Georgia Brown* 74. Little Richard *Good Golly Miss Molly* 75. The Rolling Stones *Brown Sugar* 76. Diana Ross *Mahogany* 77. Gioacchino Rossini *The Barber Of Seville* 78. Sade *Your Love Is King* 79. Franz Schubert *Death And The Maiden* 80. The Sex Pistols *Anarchy In The UK* 81. Dmitri Shostakovich *Symphony No 5* 82. Nina Simone *My Baby Just Cares For Me* 83. Simple Minds *Once Upon A Time* 84. Frank Sinatra *Nice 'n' Easy* 85. Bruce Springsteen *Born To Run* 86. Richard Strauss *Salomé* 87. Igor Stravinsky *The Right Of Spring* 88. Talking Heads *Stop Making Sense* 89. Pyotr Ilyich Tchaikovsky *1812 Overture* 90. U2 *Rattle And Hum* 91. Guiseppe Verdi *La Traviata* 92. Gene Vincent *Be-Bop-A-Lula* 93. Antonio Vivaldi *The Four Seasons* 94. Richard Wagner *Tristan and Isolde* 95. Fats Waller *You Rascal You* 96. Muddy Waters *You Can't Lose What You Ain't Never Had* 97. The Who *My Generation* 98. Jacky Wilson *Reet Petite* 99. Stevie Wonder *Uptight (Everything's Alright)* 100. Lester Young *These Foolish Things Remind Me Of You*

# 100 good reasons for coming to In Hi-fi.

Music. We can't think of a better reason for visiting us. **IN HI-FI**

IN HI-FI, 83 GEORGE STREET, EDINBURGH. TELEPHONE 031-225 8854. WE STOCK KEF, MISSION CYRUS, MERIDIAN, QED, MUSICAL FIDELITY, MARANTZ, CASTLE, HEYBROOK, DENON, AR, ARCAM.

## by **AMPLIFICATION** ION SYSTEMS



ION SYSTEMS LTD, 61 Mochdre Business Park, Newtown, Powys, SY16 4LE. Tel (0686) 25266 Fax (0686) 25241

# NAKAMICHI CR-5E

NAKAMICHI B&W (UK) LTD., MARLBOROUGH RD., CHURCHILL INDUSTRIAL ESTATE, LANCING, WEST SUSSEX. TEL: (0903) 750750.

RECOMMENDED

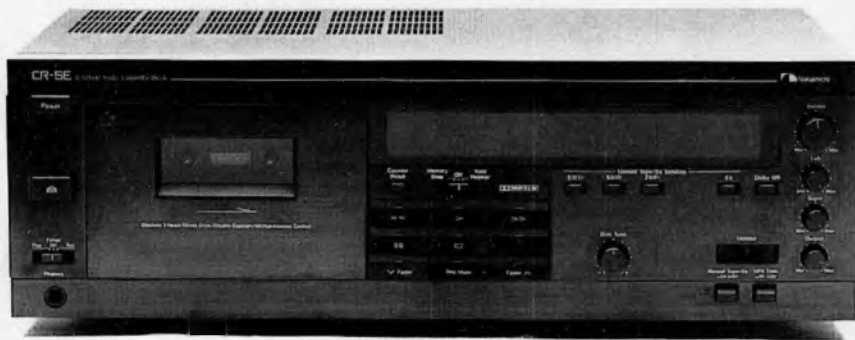

A lower cost (hah!) brother to the *CR-7E* reviewed in *Issue 60*, the £995 *CR-5E* lacks the 7's auto bias, sensitivity and playback azimuth adjustment, but retains a variable bias facility for all three tape types. Apart from a few minor detail differences, the two are almost exactly the same under the skin.

Maturity hasn't done much for the control system which remains idiosyncratically in character. Tape type selection is automatic, but rather than leave it at that, the selection can be overridden using a row of bias and equalisation keys – the former labelled with Nakamichi tape type and IEC group numbers, presupposing a degree of familiarity with the medium that some may not possess. In fairness, Nakamichi promotes the added versatility this gives, and I suppose if you're into Type II metals or ferrichromes then it might have a point. The auto fade in/out keys can add a touch of polish to your recordings. And the deck is beautifully turned out, both inside and out.

The transport is based on Nakamichi's 'diffused resonances' construction, and has a gentle cam control of transport modes instead of noisy solenoids, and a sophisticated mechanism which includes a direct drive capstan motor. The record and playback heads are totally discrete to eliminate unwanted cross-coupling, and the electronics feature multiple power supplies, FET's in the playback amp to which the playback head is directly connected, and hand matched Dolby ICs to limit mistracking. The record meters are wonderful – yards long and with a generous 50dB range.

The supplied propaganda speaks of being 'compatible' with the optional *RM200* remote control. The recorder can also be plumbed into a Nakamichi system via a rear panel socket.

## LAB REPORT

The playback response shape is near perfect, with virtually no falloff even at 20kHz, and the Type II record/replay plots are essentially flat. The other two tape types show mild and easily correctable underbiasing at the

central position of the bias control. These results are matched by excellent Dolby integrity and a wide operating range between the twin evils of noise and distortion – the latter delayed until way above 0VU on all tape types.

Wow and flutter are near state of the art, the cleanness of the flutter spectrum being apparent in the spectrum analysis. The only oddity is a measured 90° azimuth phase error at 10kHz, which has few obvious consequences elsewhere.

## SOUND QUALITY

There's not a lot of point in buying a deck like this and then using it with ferric tapes – not for serious purposes anyway. At best, ferrics sound a little 'feathery' and constrained on the *CR-5*. Type IIs make much better recordings, and the better metals add the final touch of clarity and low level resolution – but at the risk of rather higher levels of dropout, which seems to be endemic with Type IV tapes, especially if they've been used more than a few times.

Predictably the Dolby installation is better than most, although it has a small residual effect when auditioned carefully – a mild spreading and defocusing of the sound, along with a subtle diminution of detail. With many types of music Dolby makes more sense than the inevitable hiss that comes when no noise reduction is used at all. Dolby B is probably the optimum compromise, especially for music with an energy spectrum that doesn't help conceal tape hiss – chamber, instrumental, vocal etc.

These things apart, the *CR-5E* makes absolutely magnificent recordings which more than redeem the reputation of the medium. The recorder was often almost or completely undetectable when patched into the tape monitor circuit of a high resolution monitoring system.

Problems with pitch stability were left far behind, and the precision and reach at the frequency extremes were remarkable for cassette tape – especially at the low frequency end.

## CONCLUSIONS

The *CR-5E* is a *CR-7E* without the tape set-up and azimuth adjustment facilities. Stick with known tapes (you still have variable bias) and you literally can't do better.

## TEST RESULTS

Rec/replay response – 3dB ref 1kHz	
IEC Type I	<20Hz – 20.5kHz
IEC Type II	<20Hz – 19kHz
IEC Type IV	<20Hz – 22kHz
Wow & Flutter – Peak DIN wtd/unwtd	0.094%/0.14%
Wow/Flutter Peak DIN wtd	0.08%/0.11%
Speed error	+0.15%
Type I signal/noise CCIR/ARM 400Hz	50dB
distortion 0dB	0.65%
Type II signal/noise CCIR/ARM 400Hz	52dB
distortion 0dB	0.75%
Type IV signal/noise CCIR/ARM 400Hz	52.5dB
distortion 0dB	0.55%
Channel separation 0VU/1kHz	47dB
Line input sensitivity/overload	80mV/>13V
Mic input sensitivity/overload	n/a
Line output for 0dB/maximum	1400mV/7.3V
IM distortion 10kHz/11kHz 0dB peak, 1kHz product	0.08%
Azimuth check R-L phase at 10kHz	90°
VU indication at IEC 0dB	3dB
Dimensions (w x h x d)	43.5 x 14.5 x 31cms
Typical Retail Price	£995

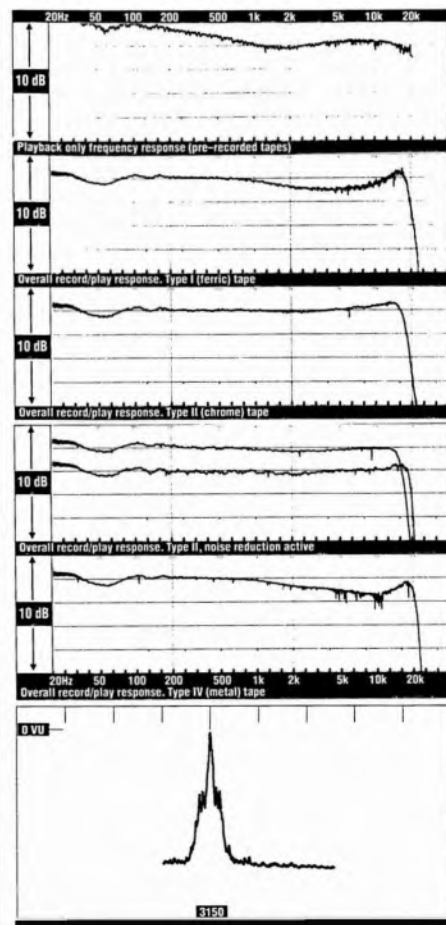

# PIONEER CT-443

PIONEER HIGH FIDELITY GB LTD., FIELD WAY, GREENFORD, MIDDX UB6 8UZ. TEL: (01) 575 5757.



This expensive looking £180 three-head deck includes rudimentary (*cf.* Aiwa *XK-009*) cassette shell damping and other anti-resonance measures designed to reduce microphony in the player itself.

The deck is Dolby B and C equipped and has non-switchable Dolby *HX Pro* headroom extension circuitry. Like other Pioneer designs, the *443* has an attractive display with a range of simple function telltales, an electronic tape counter (but no memory!), and two colour 28dB meters which are both clear and offer good resolution.

The display also shows what kind of tape has been selected and Dolby status (including Dolby *HX Pro* for some inscrutable reason). But there are some useful gadgets, to wit 'index scan', which looks for and plays the first 12 seconds of each track until overridden; 'blank search', which finds the end of a recording so that a new one can be made; and a track search feature. For recording itself the deck permits fine control over bias, and defeatable MPX filtering.

There are some nice features here then, but also some unfortunate shortcuts, probably thought necessary in the designers' (marketing department's?) desire to include some extra facilities to fill out the 'perceived value' side of the equation. Examples include unfriendly Dolby B/C switching based on dual dependent switches and badly designed manual tape type switching in place of auto tape sensing. Though logic controlled, the transport is rather noisy, but it's arguably unfair to expect much more at this price level.

## LAB REPORT

The playback test tape was reproduced adequately enough, and with the fine bias control centred, the three main record/replay frequency responses were all contained within a  $\pm 1$ dB envelope from under 50Hz to above 15kHz. In each case there's a tendency towards a slightly 'dished' shape which is probably responsible for the mild 'loudness' effect noted when listening. The two higher bias positions are most affected, and the

application of Dolby – quite well aligned in this recorder – naturally exaggerated the effect. Of course the fine bias adjustment is tailor made to ameliorate this kind of situation.

Wow and flutter is quite good, though the highish unweighted figure shows the presence of quite a bit of energy towards the outside of the weighting curve – note the 'shoulders' in the spectrum analysis. The *443*'s noise figures are between 1 and 3dB below average, and the speed error is surprisingly large.

## SOUND QUALITY

This Pioneer runs perceptibly fast, and the pitch change may well be unacceptable in certain cases. Some people are naturally sensitive to pitch, and others may want to be able to play a properly tuned live instrument alongside a commercial tape (never mind why).

Prerecorded tapes lack top end 'bite', but the underlying quality is good – bass definition is fine and there is little obvious smothering of detail.

The record/playback cycle sounds dynamically rather neutered. The Pioneer never really sounds as potent and meaningful as the source, but it does have something ultimately more important perhaps – subtlety. In comparison with similarly priced decks, the *443* has a natural expressiveness, good resolving power and a good if mildly imprecise stereo soundstage width and depth.

There was never anything obvious or pointed about a sound which instead offered a taste of quality more frequently found with considerably more expensive decks than this one. The *443* also made good use of lower bias tapes, and created the impression that the HX Pro circuitry really meant something in this case. The two noise reduction circuits are reasonably transparent, but the C circuit was predictably responsible for some added sonic damping.

## CONCLUSIONS

Prerecorded cassette enthusiasts should

beware the speed error, but in most other respects the Pioneer *CT-443* is rather more than you'd expect at the price. It offers a real touch of class, and readily justifies recommendation.

## TEST RESULTS

Rec/replay response – 3dB ref 1kHz	
IEC Type I	30Hz – 18kHz
IEC Type II	20Hz – 18kHz
IEC Type IV	20Hz – 20kHz
Wow & Flutter – Peak DIN wtd/unwtd	0.10%/0.25%
Wow/Flutter Peak DIN wtd	0.07%/0.23%
Speed error	+1.75%
Type I signal/noise CCIR/ARM 400Hz	48.5dB
distortion 0dB	1.1%
Type II signal/noise CCIR/ARM 400Hz	53dB
distortion 0dB	0.55%
Type IV signal/noise CCIR/ARM 400Hz	50.5dB
distortion 0dB	1.0%
Channel separation 0VU/1kHz	52dB
Line input sensitivity/overload	91mV/>7V
Line output for 0dB/maximum	500mV/1.9V
IM distortion 1kHz, ref 10kHz/11kHz 0dB	1.4%
Azimuth check R-L phase at 8kHz	10 degrees
VU indication at IEC 0dB	3dB
Dimensions (w x h x d)	42 x 13 x 32cms
Typical Retail Price	£180

Reprinted from issue No. 63

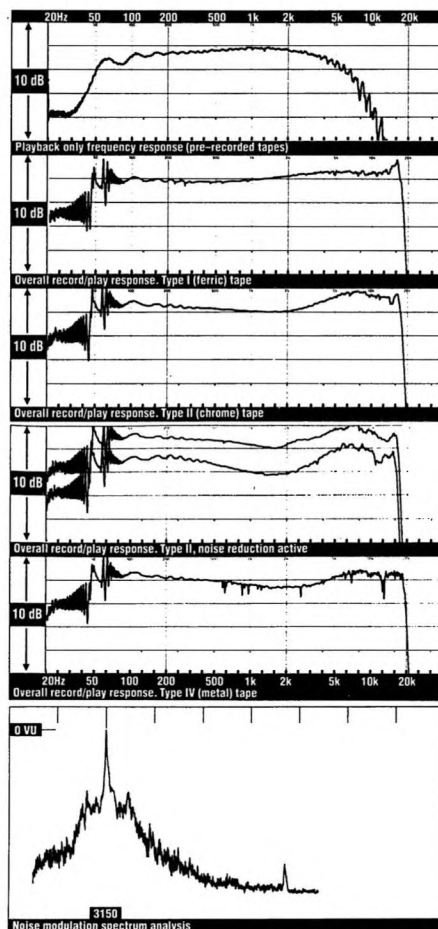

# PIONEER CT-939

PIONEER HIGH FIDELITY GB LTD., FIELD WAY, GREENFORD, MIDDX UB6 8UZ. TEL: (01) 575 5757.

RECOMMENDED



I gather that the decision to bring this three-head machine into the country hung by a thread. It was eventually made just in time for this report, which consequently had to take place without the benefit of instructions or much in the way of alternative documentation. Nevertheless, the basics are clear enough. In outline, the £450 CT-939 is an expensive and extremely well built deck that is notably short on gadgetry. All of which suggests that it is designed first and foremost to appeal to that semi-legendary anachronism, the audiophile.

Build quality, a topic properly placed top of the list in this case, is quite elaborate, making good use of non-magnetic copper panels and fixing screws, honeycomb panel stiffening, significant amounts of screening of vulnerable circuit elements, and lid damping. The power supply uses some excellent, high capacity/high grade components, and a generous transformer is enclosed in a cast alloy screening can.

The display is also very impressive. With a full range of transport and other status displays (including the automatically selected tape group) the record level strip covers a generous 47dB range using two colours and peak hold elements, and there is also an expanded 20dB range option.

This is a three-head deck with twin siamesed record and playback heads, the former using a laminated amorphous core with PC-OCC windings. The transport has twin capstans, an illuminated well and a cassette shell damper. Transport engagement is very sweet, leaving solenoid actuated rivals far behind.

On the widget side there's Dolby B and C, adjustable bias, Dolby HX Pro, a headphone socket with volume control, and track search. A memory counter (with 'return' facility rather than a simple memory stop) has an optional time display that shows time remaining once the deck has been told the length of the tape inserted - it's intelligent enough to work out how much playing time remains when presented with a tape that has not been rewound.

## LAB REPORT

On paper at least, the transport is amongst the best yet seen. Not only are the wow and flutter figures incredibly low, the spectrum analysis does a remarkably good job of approximating the shape of the source signal before it was recorded on tape!

Noise and distortion figures are low - note that the listed signal/noise figures are measured against a 0VU that is 2dB below IEC 0dB. The only fly in the ointment is that the bias pot had to be turned to its maximum setting before obtaining the still theoretically underbiased results shown. The pre-recorded test earns top marks.

## SOUND QUALITY

A very good showing on ferric tape (compared, say, to the Nakamichi CR-5 reviewed separately) is certainly attributable to the Dolby HX Pro headroom expansion circuit. On this Pioneer, TDKSA (Type II) was barely able to beat Type I AD except on residual noise levels. But that last point is important, since it is often possible to get away without noise reduction using SA, whereas the same trick isn't so practical with AD.

Using the same CR-5 point of reference, the Pioneer's electronics are not as transparent. There's a touch of the standard commercial amplifier about them: the top has a slightly jangly quality, while the bass and lower mid don't have quite the requisite level of strength and weight.

The tape section, however, is quite remarkably good, contributing very little additional deterioration to a first class aggregate result. Imaging is particularly good; the bass is tight and extremely well focused; the top practically effervesces detail - perhaps too much so for total realism in fact. Pre-recorded tapes were handled like a dream, and there were absolutely no audible effects that could be attributed to lack of pitch integrity.

## CONCLUSIONS

The Pioneer CT-939 is a very fine tape deck, blessed with a superb transport, adequate electronics (a little extra bias current is a

priority though) and a set of features notably lacking in superfluous gadgetry. The pricing is attractive for the performance on offer, so assuming regular production matches the standards set by our sample it may be highly Recommended.

## TEST RESULTS

Rec/replay response -3dB ref 1kHz	
IEC Type I	26Hz - 19kHz
IEC Type II	28Hz - 20kHz
IEC Type IV	27Hz - 22kHz
Wow & Flutter - Peak DN wtd/unwtd	0.08%/0.10%
Wow/Flutter Peak DIN wtd	0.054%/0.084%
Speed error	+0.2%
Type I signal/noise CCIR/ARM 400Hz	51.5dB
distortion 0dB	0.6%
Type II signal/noise CCIR/ARM 400Hz	52dB
distortion 0dB	1.1%
Type IV signal/noise CCIR/ARM 400Hz	52.5dB
distortion 0dB	1.0%
Channel separation 0VU/1kHz	45dB
Line input sensitivity/overload	84mV/>13V
Mic input sensitivity/overload	n/a
Line output for 0dB/maximum	460mV/5.0V
IM distortion 1kHz, ref 10kHz/11kHz 0dB	0.45%
Azimuth check R-L phase at 8kHz	45°
VU indication at IEC 0dB	+2dB
Dimensions (w x h x d)	42 x 13.5 x 35.5cms
Typical Retail Price	£450

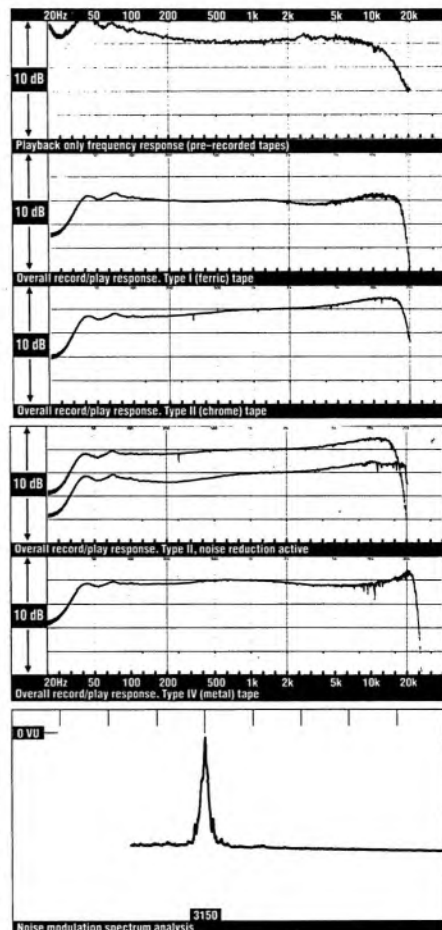

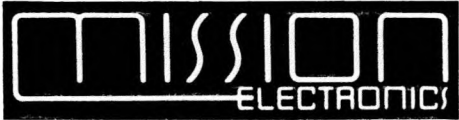

good dealer  
 good equipment  
 the foundation of a good music  
 system  
 from

# Hampshire Audio Ltd

Kingfisher House  
 2-12 Hursley Road  
 Chandlers Ford, Hants SO5 2FU  
 Tel: Southampton (0703) 252827 & 265232

We stock selected items for:  
 Aloi, Audiolab, A&R, Audio Technica, B&W, Celestion, Celet, Cliff Stone, Creek, Cyrus, Denon, Dual, Gale, Goldring, Gyrodek, Heybrook, Hunt, Infinity, Jordan, KEF, Koetsu, Linn, Marantz, Mark Levinson, Maxell, Meridian, Michell, Mission, Monitor Audio, Monitor PC, Musical Fidelity, Nagaoka, Nakamichi, Ortofon, Perreux, ProAc, QED, Quad, Revolver, Revax, Rogers, Rotel, Sennheiser, Tannoy, Target Audio, Supex, Wharfedale, and others. Active systems on demonstration.

with  
 The new **Cyrus** amps -

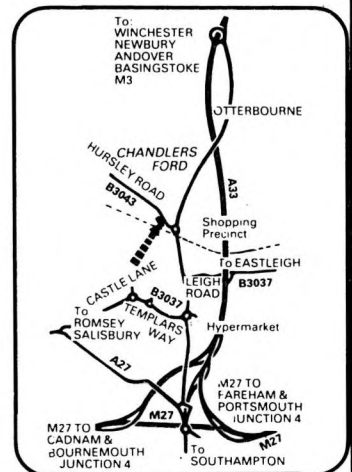
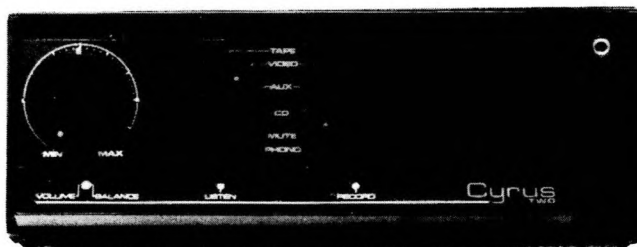

OPENING HOURS  
 TUES-SAT 10-6 THURS 10-8  
 CLOSED MONDAYS  
 (EXCEPT IN DECEMBER)



# SANSUI D-X301i

SANSUI (UK) LTD., AXIS 4, RHODES WAY, WATFORD, HERTS WD2 4YW. (0923) 226499.

RECOMMENDED

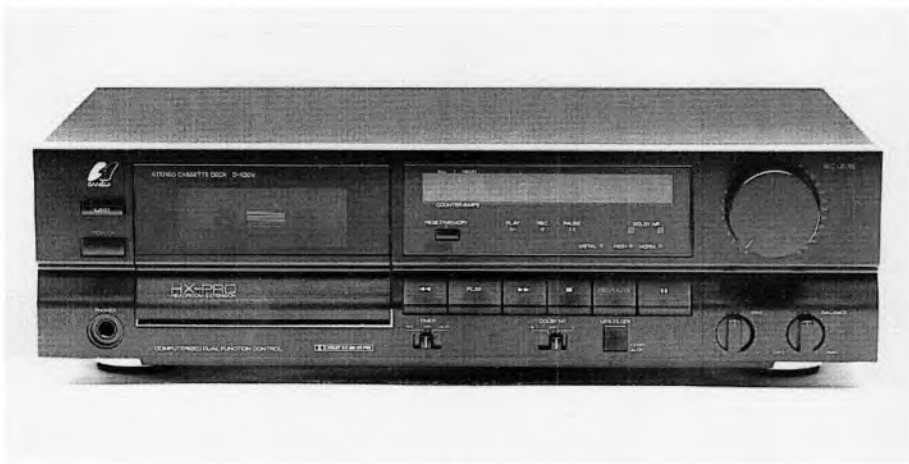

The basics of the *D-X301i* are that it has a unidirectional transport and two heads, and comes equipped with Dolby B and C type noise reduction and switchable MPX filtering – a good point in an under £200 deck. Dolby *HX Pro* circuitry is also sensibly included, as this makes particular sense in helping inexpensive decks get the most from lower cost, lower bias tapes.

The display reads over a generous 30dB range, with best case 2dB resolution around 0VU. Record and balance controls adjust input levels, and a bias potentiometer provides some measure of control over the tape/machine interface. Tape recognition is automatic, and flagged in the display.

That covers the main features, but a number of tacked-on facilities expand the Sansui's repertoire considerably, accessed mainly using the play, fast wind and counter reset keys in combination or sequence – sometimes in arrangements that are so unlikely there's a danger they will be forgotten.

These include, in no particular order: auto tape lead-in, which takes the tape past the leader when recording (press pause, then fast forward); record cancel, which reinstates record mode at the start of the previous recording (rewind from record mode); intro scan (play and fast wind together) and single track or tape repeat (successive depressions of the play key). The counter has a memory stop feature (using the counter reset key!), and a track search feature is capable of selecting tracks up to 20 away in either direction.

## LAB REPORT

Wow and flutter are a little on the high side. A little more effort expended here might well have paid real dividends. Capstan wow appears to be a major contributing factor in this case.

The electronics are a mixed bag. LF response behaviour is well optimised, whilst the standard IEC test tapes gave gently declining HF responses, amounting to a couple of dB above 10kHz in each case (with the

bias control centred and the MPX filter defeated). This is of little real significance except that Sansui supplied different tapes for which they claim the deck is aligned, two of which (TDK *AR*, *MA-X*) gave results so lacking in HF that they had to be dropped from the test programme. The third type was TDK *SA* (Type II), whose response plot is reproduced here. Signal/noise performance is particularly good, assisted no doubt by the dipping treble, but the Sansui does give a very high 0VU (= -2dB ref IEC) reading of 50 per cent in the intermodulation distortion test, which suggests something not a zillion miles removed from hard clipping.

## SOUND QUALITY

Prerecorded material is unimpressively reproduced, lacking energy or focus, though elsewhere the Sansui did much better. In fact, the *D-X301i* is a good example of a deck that gets a whole list of things wrong but which still manages to deliver the goods.

I noticed a lack of pitch integrity and control at the very lowest frequencies in a wide bandwidth system, and also that the extreme treble sounded hard or even coarse, though the effect was level dependent and mostly limited to metal tapes. Headroom limitations in the amplifiers or record head would seem implicated.

At the same time, the Sansui is eminently listenable. Although it lacks focus at the frequency extremes, it's anything but lacking where it matters most, from the upper bass, through the midband and extending into the lower treble area dominated by overtone harmonics – the 'subtlety' band. Here the deck sounds articulate and self-contained, with good stereo focus and perspectives. The bass is well proportioned too, even if it is slightly excessive when stretched.

## CONCLUSIONS

The clincher here of course is the price. Had this deck cost £200, we would have been justified in using the technical weaknesses as a stick to beat it. At £150, the *301i* is clearly one of the best available. Recommended.

## TEST RESULTS

Rec/replay response – 3dB ref 1kHz	
IEC Type I	<20Hz – 11kHz
IEC Type II	<20Hz – 13kHz
IEC Type IV	<20Hz – 11kHz
Wow & Flutter – Peak DIN wtd/unwtd	0.16%/0.24%
Wow/Flutter Peak DIN wtd	0.11%/0.21%
Speed error	+0.10%
Type I signal/noise CCIR/ARM 400Hz	54dB
distortion 0dB	0.85%
Type II signal/noise CCIR/ARM 400Hz	56dB
distortion 0dB	2.1%
Type IV signal/noise CCIR/ARM 400Hz	56dB
distortion 0dB	2.1%
Channel separation 0VU/1kHz	47dB
Line input sensitivity/overload	135mV/>13V
Mic input sensitivity/overload	n/a
Line output for 0dB/maximum	690mV/4.2V
IM distortion 1kHz, ref 10kHz/11kHz 0dB	50%
Azimuth check R-L phase at 8kHz	20°
VU indication at IEC 0dB	+2dB
Dimensions (w x h x d)	42 x 12.5 x 27cms
Typical Retail Price	£149

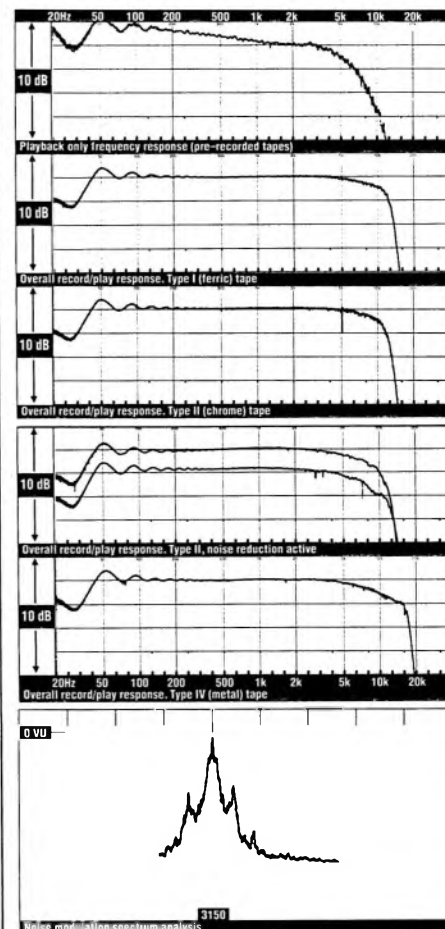

# AMPLIFICATION by ION SYSTEMS



ION SYSTEMS LTD, 61 Mochdre Business Park, Newtown, Powys, SY16 4LE. Tel (0686) 25266 Fax (0686) 25241

## A MOVING EXPERIENCE

*(with apologies to the reader)*

The well-informed enthusiast will confirm that demonstration is a fundamental element in choosing the equipment that will give you lasting pleasure playing music in your home. Indeed the quality of dealer may be judged from demonstrations — how convincingly these back up what they say they think will suit you and suggest you ought to buy. A great deal 'tho, is due to the dealer's long experience in the setting up of systems for musical felicity.

The warmth of family business plus the skills that have been added over sixty years of trading have combined for Grahams Hi-Fi to make them most respect'd in the field of specialist dealers. In premises quite unfavour'ble (a warehouse site near Kings Cross)

our happy home has operat'd for nigh on twenty years; but the traffic's getting heavier (and some would say much louder) the parking's more congested, the dem rooms aren't that perfect e'en tho' they were among the first (not quite the best) to be set up here in England.

We're proud to make th'announcement that Grahams Hi-Fi's moving not far — about ten minutes — it's quite a quiet area with lots and lots of parking and the chance in our new building to do things even better — we'll have among the finest demonstration rooms in Europe; in all, the proper premises to complement a service (not to mention installation) which has earned our reputation both at home and overseas.

Our policy will continue of carefully selecting the best of all those items that are brought to our attention, equipment that is able to reproduce the message and communicate the essence, yea, the spirit of the music. It may well be for the first time (perhaps — we might be boasting) in the whole United Kingdom that appointments can be taken for any one of five new dem rooms, acoustically unrivall'd and specially designed to provide the vital background for easy relaxation. So please do dial our number and make yourself a booking, let's show you our new building can provide the perfect context for optimal selection of your choice in sound and music.

Visit Grahams! End your searching!

GRAHAMS HI-FI



# SONY TC-WR500

SONY UK LTD., SONY HOUSE, SOUTH STREET, STAINES, MIDDLESEX TW18 4PF. TEL: (0784) 67000.



Last time out (the *October '88* issue to be precise) we looked at a budget twin deck from the Sony stable. The model concerned was the £150 *TC-W300*, which appears almost identical to the subject of this test except for one rather crucial detail. The *TC-WR500* reviewed here has two auto reverse transports, whereas the *300* has unidirectional mechanisms; the £50 cost of auto-reverse is not inconsiderable.

This Sony is aesthetically clean, with large clearly signposted controls and displays, but the level display – a miserly six steps covering a mere 16dB – is not illuminated and is therefore hard to read. Other significant ergonomic failings include manual tape selection on both decks using controls that are far too easily missed, mutually dependent Dolby B and C switching, and only a simple mechanical tape counter to assist finding one's way around, covering only tapes inserted in the record/play transport. The transport keys are also surprisingly stiff, if positive in action.

There is no track search facility, no memory stop, nothing like that. And believe it or not, there's not even an auto stop feature when in fast wind mode. You've probably already guessed that end of side changeover is not triggered optically, which means that the deck has to chunter twice through the leader tape at the end of side. That means ten seconds of blessed quiet in the middle of Iron Maiden, but a blessed nuisance if making a long recording.

## LAB REPORT

The transport is surprisingly noisy, though this shouldn't be a great intrusion in play mode, and anyway there are worse things to worry about. Most obvious are the perfectly appalling wow and flutter figures, which in all cases deteriorate further in the reverse direction.

The 3kHz spectrum analysis shows the widely spread spectrum of unwanted wow and flutter artefacts, though there are very few discrete components. The deck's electronics are also in trouble near 0VU as the inter-

modulation distortion results indicate, and head azimuth is a little out.

On a more positive note, the response shape in the prerecorded test is quite good, and the record/playback frequency responses are good too except for considerable LF variations due to head geometry limitations. The Dolby C plot shows a mild flattening effect that can be expected to be audible as compression.

## SOUND QUALITY

Prerecorded tapes show significant treble loss and consequent lack of detail and clarity, besides running fast. The latter may escape attention in some cases, but the former certainly won't.

In record mode, the Sony was marginally at its happiest with metal tapes and Dolby B not Dolby C. (The promised compression was very much in evidence with Dolby C.) Even at its best, however, the Sony suffers from rather muddled detail and a loss of stereo image focus, especially around the dead ahead position.

On the positive side, the poor speed stability figures are not reflected in particularly obvious pitch instability, and I can only surmise that the random nature of the instability helps. The Sony is also quite good at dubbing operations, making due allowance for the basic quality issues already discussed.

## CONCLUSIONS

Modest performance standards are matched to a control system that lacks some of the basic amenities such as auto-stop, decent transport controls and auto tape sensing. The price isn't that cheap, and for the bottom line, well watch my thumb.

## TEST RESULTS

<b>Rec/replay response – 3dB ref 1kHz</b>	
IEC Type I	21Hz – 13.5kHz
IEC Type II	22Hz – 13.5kHz
IEC Type IV	21Hz – 16kHz
<b>Wow &amp; Flutter – Peak DIN wtd/unwtd</b>	
	FWD 0.44%/0.70%;
	REV 0.54%/0.78%
<b>Wow/Flutter Peak DIN wtd</b>	
	FWD 0.26%/0.42%;
	REV 0.34%/0.64%
<b>Speed error</b>	
	+ 0.20%
<b>Type I signal/noise CCIR/ARM 400Hz</b>	
distortion 0dB	54dB
<b>Type II signal/noise CCIR/ARM 400Hz</b>	
distortion 0dB	56dB
<b>Type IV signal/noise CCIR/ARM 400Hz</b>	
distortion 0dB	55.5dB
<b>Channel separation 0VU/1kHz</b>	
	45.5dB
<b>Line input sensitivity/overload</b>	
	92mV/>13V
<b>Mic input sensitivity/overload</b>	
	n/a
<b>Line output for 0dB/maximum</b>	
	660mV/2.9V
<b>IM distortion 10kHz/11kHz 0dB peak, 1kHz product</b>	
	7.9%
<b>Azimuth check R-L phase at 10kHz</b>	
	20 degrees
<b>VU indication at IEC 0dB</b>	
	0dB
<b>Dimensions (w x h x d)</b>	
	43 x 11.5 x 24cms
<b>Typical Retail Price</b>	
	£200



# When Music Is Important It's Not What You Know But Where To Go.

*The advice isn't new, but it still holds true: choosing your hi-fi dealer is more important than choosing your hi-fi equipment. Find the right dealer, and he'll guide you to the equipment that's right for your needs.*

*Introducing and evaluating equipment keeps most hi-fi magazines fully occupied. There's seldom the opportunity to do a similar introduction for hi-fi retailers, which is why we at Hi-Fi Experience have decided to tell you something about our seven specialist hi-fi shops around the country. There are three in London, all wholly owned by Hi-Fi Experience plc, and franchises which we directly control in Birmingham; Bradford; West Yorkshire; Leamington Spa in Warwickshire, and Glasgow, Scotland. Each store has a highly individual character of its own if not the building, then the manager! Yet each benefits from being part of a multiple retailer.*

*From your, the customer's point-of-view, that means our shops are ready to help each other when it comes to obtaining an item of equipment you especially want to listen to. Each one stocks a range of equipment - much of it British-made - tailored to the requirements of its own customers, but there is a standard of service that's common to all.*

*The three years that Hi-Fi Experience has been operating have shown us that, with increased leisure time, people everywhere are putting a higher value on good hi-fi. In addition, we've all lately come to expect better service regardless of what we're buying, and there was an urgent need for hi-fi retailing to reflect that trend and finally move away from the 'boxes over the counter' approach of a few years ago.*

*At Hi-Fi Experience we decided to offer a new level of service, one that would apply without qualification at all our shops, regardless of where they were or how big they were. That meant stocking only equipment we were satisfied with, in terms of sound quality, construction, reliability and after-sales service. Which is why as a group we are happy to stock and sell **MISSION** products. We have to be able to demonstrate that equipment to the best of its capabilities, and that means implementing an ongoing programme to ensure our listening rooms and setting-up procedures meet our requirements.*

*There is a constant effort to improve the comfort and ambience of our demonstration rooms to make selecting and comparing equipment as relaxed and enjoyable a process as possible. Most of our stores have a purpose built **MISSION** listening room.*

*Of course, the best equipment and the best demonstration facilities would count for nothing if we didn't believe we also had the best staff. Good staff is a product of good training, and we invest heavily to ensure the people you will encounter in our shops know their equipment, and how to get the best from it. We undertake the kind of staff training courses that are far-from-commonplace in hi-fi retailing.*

*It's all part of an effort to offer you a level of service that's way above the rest, but should you find you don't get that level of service from one of our shops, let us know and we'll do something about it. We have confidence in ourselves, and we want you to have confidence in us.*

*Each of our shops will do some things slightly differently: we encourage an individual approach to customers' requirements. But the minimum we expect from each one is good demonstration facilities; comfortable, well-furnished places in which to listen; an exchange-if-not entirely satisfied procedure; and fair prices. We also hope they'll convince you that good hi-fi can look good, too, and that you don't need the likes of a Gold Visa card to obtain it! All our shops offer sound-value, inexpensive equipment which will form the basis of a reliable system for years to come.*

*It's worth adding that all Hi-Fi Experience outlets are Members of BADA (British Audio Dealers Association) and trade within the terms laid down in BADA's charter, and most often exceed them.*

*Most people enjoy the experience of recorded music and the world is a richer place for it. Our name means we can help you share that experience.*



**MISSION**  
ELECTRONICS



**MISSION**  
ELECTRONICS



**MISSION**  
ELECTRONICS



**MISSION**  
ELECTRONICS



**MISSION**  
ELECTRONICS



**MISSION**  
ELECTRONICS

**BADA**  
THE ULTIMATE IN  
SOUND VALUE  
**CYRUS**  
LOUDSPEAKERS

**MISSION**  
ELECTRONICS

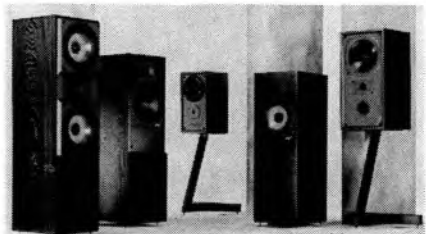

# HI-FI EXPERIENCE PLC

**Lion House W1**  
227 Tottenham Court  
Road, London, W1.  
Tel: 01-580 3535

**Camden**  
2/4 Camden High Street,  
Camden Town, NW1.  
Tel: 01-388 1300

**Alfred Pl. WC1**  
32/34 Alfred Place,  
Store Street, London,  
WC1. Tel: 01-631 4917

**Glasgow**  
145 Bath Street,  
Scotland.  
Tel: 041 226 4268

**Bradford**  
Errick's,  
Rawson Square.  
Tel: 0274 309266

**Leamington Spa**  
49 Park Street,  
Leamington Spa, Warks.  
Tel: 0926 881500

**Birmingham**  
Superfi, 67 Smallbrook,  
Queensway.  
Tel: 021-631 2875

**NEW SHOP**

# TEAC V-570

TEAC (UK) LTD., 5 MARLIN HOUSE, THE CROXLEY CENTRE, WATFORD, HERTS WD1 8YA. TEL: (0923) 225235.

RECOMMENDED

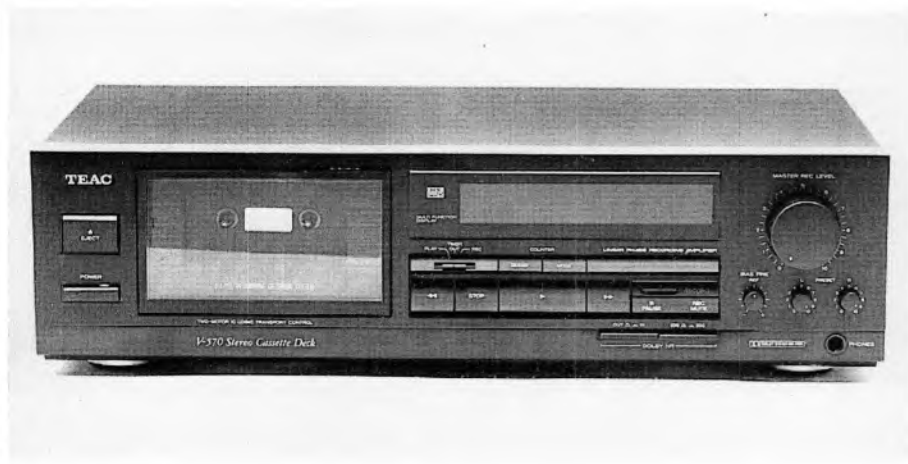

Teac's £200 middle of the range model is a conventional design in almost every respect. It offers Dolbys B and C noise reduction plus *HX Pro*, alongside a simple single capstan, two head transport.

The most attractive feature is the display area: well designed (if rather short) level meters have a 32dB range and use red display elements to show readings of 0VU and above. There is also an electronic counter readout showing simple rolling numbers or elapsed playing time. But there's no memory facility and both counters lose track of where they are the moment power is switched off. The time display also fails to register during fast wind operations, which surely makes it rather pointless.

The transport is driven by a set of logic controlled keys, an ergonomically sound arrangement which is both smooth and quiet in operation. Tape type recognition is automatic and confirmed in the display window. Headphones can be connected to a fixed level output, but the input arrangements are slightly more elaborate: a couple of individual channel 'presets' and a larger master volume control together enable both fades and channel balancing to be performed easily. The *V-570* had full timer support and a bias adjustment control. What it lacks – and this is perhaps the deck's weakest point – is any ready means of searching tapes apart from juggling the play and fast wind controls.

## LAB REPORT

The *V-570* has excellent signal/noise performance on ferric and chrome (Type I & II) tapes, but is let down with metal tapes, because the record electronics simply don't have the headroom to cope. Note the high intermodulation figure, and the high THD figure of off tape, which is partly a function of the head design.

There's nothing wrong with the basic frequency responses themselves, except for the Dolby B test run which has a peculiar stepped HF; this is certainly a sample fault as Dolby C was not similarly affected. And to judge by the figures, this Teac is equipped

with a remarkably fine transport for a deck so inexpensive.

## SOUND QUALITY

Whatever the technical quibbles over this deck's performance with metal tapes, they do not extend to sound quality, where the *570* excels. It's perfectly true that Type IV tapes fail to justify their extra cost over good Type IIs (with the emphasis on 'good'), but this is partly because Dolby *HX Pro* gives the lower bias tapes a significant leg-up. In practice all three tape groups give similarly (not identically) good performances, the high end Sony and TDK Type IIs being best suited in my view.

The key quality possessed by this cassette deck compared to its peers has nothing to do with frequency/amplitude uniformity or signal to noise ratios. It's transparency: this is a cassette deck that can be 'heard through'. It doesn't smear the music, leaving centrally placed images central and left and right images positioned unambiguously and correct in scale. Brass orchestral sections blaze with energy and tension when so called upon, and strings have that natural astringent quality without fudging or screeching. All the indications are that the rock stable transport and some well conceived electronics are amongst factors responsible for this good showing.

Prerecorded tapes, however, were disappointing. My test tapes sounded universally dull and compressed. The mild speed error was just audible too.

## CONCLUSIONS

It's only too easy to pick holes in this player, especially if approached pedantically simply on the basis of the lab test results. The poor showing with commercial tapes is a significant snag of course, though sample variation may provide you with better results than I obtained. But as a recorder, and used within its limits, this Teac is unusually effective in musical terms and is hence a viable Recommendation.

## TEST RESULTS

Rec/replay response – 3dB ref 1kHz	
IEC Type I	27Hz – 12kHz
IEC Type II	27Hz – 13kHz
IEC Type IV	29Hz – 17.5kHz
Wow & Flutter – Peak DIN wtd/unwtd	0.17%/0.24%
Wow/Flutter Peak DIN wtd	0.12%/0.20%
Speed error	+0.22%
Type I signal/noise CCIR/ARM 400Hz	54.5dB
distortion 0dB	0.46%
Type II signal/noise CCIR/ARM 400Hz	57dB
distortion 0dB	2.8%
Type IV signal/noise CCIR/ARM 400Hz	56dB
distortion 0dB	>3.0%
Channel separation 0VU/1 kHz	46.5dB
Line input sensitivity/overload	133mV/>13V
Mic input sensitivity/overload	n/a
Line output for 0dB/maximum	540mV/2.9V
IM distortion 10kHz/1 kHz 0dB peak, 1kHz product	25%
Azimuth check R-L phase at 10kHz	50°
VU indication at IEC 0dB	2dB
Dimensions (w x h x d)	43.5 x 12 x 25cms
Typical Retail Price	£199

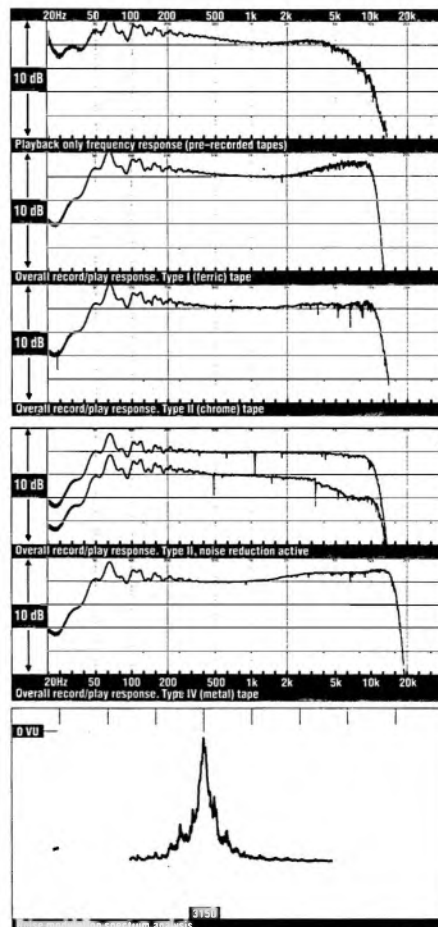

# TEAC V-670

TEAC (UK) LTD., 5 MARLIN HOUSE, THE CROXLEY CENTRE, WATFORD, HERTS WD1 8YA. TEL: (0923) 225235.

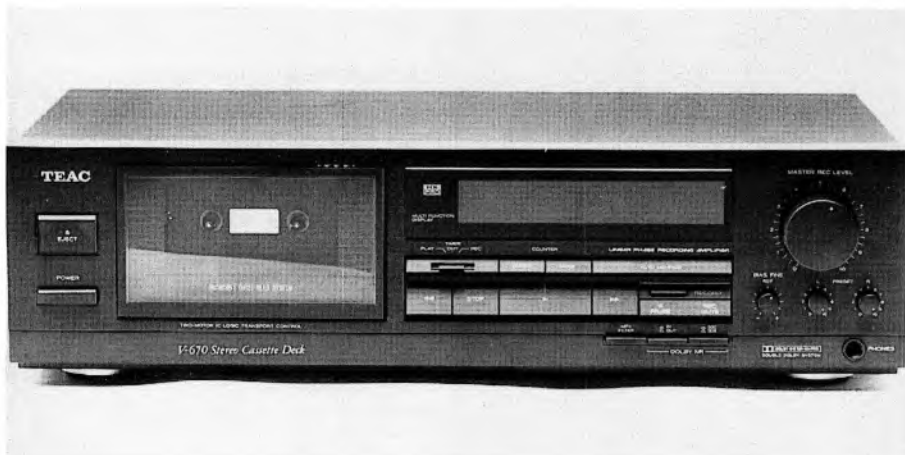

One of the least costly 3-head cassette decks currently available, the Teac V-670 is essentially a much simplified version of the V-870 (itself derived from the V-970) – a Recommended model in the £400 price area which features some basic tape alignment facilities.

The £250 V-670 is stripped down in line with its more modest pricing, but it still has Dolby HX Pro headroom expansion circuitry, plus a fine bias control which works with all three tape groups. Dolby B and C are fitted too of course, along with switchable MPX filtering.

The input arrangement consists of a master level control and two so-called 'presets' to adjust channel balance. The record level meters are physically rather short, but otherwise have a reasonable specification, running from -20dB to +12dB with 2dB resolution around and a colour change above 0VU.

One of the economies that Teac has been forced into (I don't suppose it was done out of conviction or for fun) is the virtual elimination of programme finding aids. There is a tape counter with an electronic display which can be switched to read arbitrary number or time, but the time display is pretty arbitrary too: there's no auto-zeroing when a tape is rewound, and the counter forgets where it was as soon as power is switched off. There is no counter memory, track search or any comparable feature. The transport is logic controlled and solenoid operated, and makes quite a din when in fast wind – but not, happily, when simply playing tapes.

## LAB REPORT

The transport is relatively simple with single capstan drive, and this reflected in wow and flutter figures that are just modestly good. There are no obtrusive frequency components in the spectrum analysis, however, just a degree of imprecision leading to some generalised broadening of the peak.

Frequency/amplitude behaviour isn't quite as bad as the Type II plot implies, which was run with the bias control centred. There's a residual response error even with bias optimally adjusted, but the non-linearity

is not great. Dolby tracking with Dolby B is quite good, but is a little offbeam with Dolby C, probably due to poorly selected Dolby ICs. (The best components certainly tend to find their way onto the more upmarket models.)

The playback only response is a little lacking at the high frequency end, but the LF responses are all clean. Signal/noise performance is just adequate, and tapes can't be caned quite as hard by this deck as by many others; intermodulation distortion within the record/replay electronics chain is high, which is probably not unrelated.

## SOUND QUALITY

£250 is something of a watershed cassette deck price point where the advantages of going for three heads instead of two are very much in the balance. Three heads costs, not merely because of the extra head itself, but also due to the Dolby and monitoring electronics needed in the replay chain and so on, and the money involved might well be better spent elsewhere.

This is such a case, where less might well have been more. The Teac sounded OK in a rather undistinguished kind of way, but the off-tape monitoring facility exposes differences between the on- and off-tape sound no matter which tape is used and however the bias control is set. But perhaps more important is the high level compression and loss of image specificity. Instruments tend to sound too large and are not correctly anchored in the soundstage. Finally, I have to criticise a rather mechanical treble quality which signals its presence while not really providing the window onto the performance that is expected.

## CONCLUSIONS

This really isn't a bad cassette deck, and it's an attractive one in several ways, notably for the ability to monitor recordings off tape in real time. On the other hand, sound quality is rather loose and uncoordinated. It lacks both the subtlety and consistency to stand out in the company of its peers.

## TEST RESULTS

Rec/replay response – 3dB ref 1kHz	
IEC Type I	27Hz – 17kHz
IEC Type II	29Hz – 19kHz
IEC Type IV	29Hz – 21kHz
Wow & Flutter – Peak DIN wtd/unwtd	0.18%/0.29%
Wow/Flutter Peak DIN wtd	0.12%/0.30%
Speederror	+0.27%
Type I signal/noise CCIR/ARM 400Hz	52dB
distortion 0dB	0.65%
Type II signal/noise CCIR/ARM 400Hz	53dB
distortion 0dB	1.7%
Type IV signal/noise CCIR/ARM 400Hz	54dB
distortion 0dB	1.2%
Channel separation 0VU/1kHz	46.5dB
Line input sensitivity/overload	116mV/>13V
Mic input sensitivity/overload	n/a
Line output for 0dB/maximum	550mV/3.3V
IM distortion 10kHz/11kHz 0dB peak, 1kHz product	1.5%
Azimuth check R-L phase at 10kHz	24°
VU indication at IEC 0dB	+2dB
Dimensions (w x h x d)	43.5 x 12 x 25cms
Typical Retail Price	£249

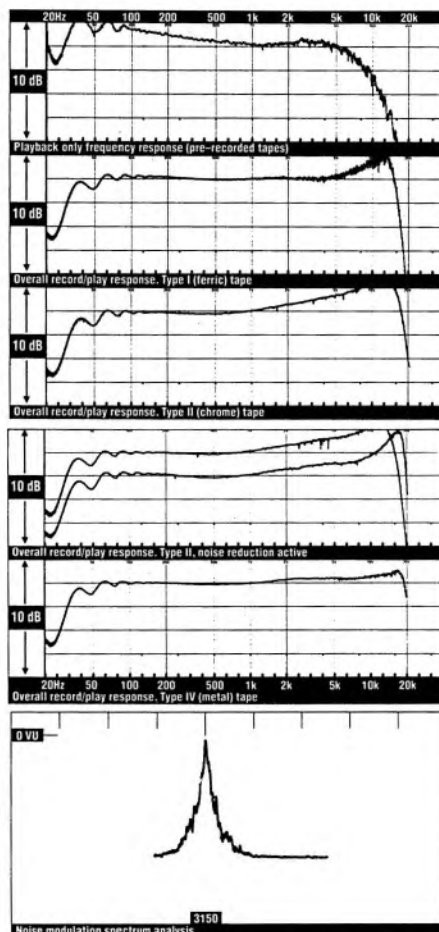

# TEAC W-460C

TEAC (UK) LTD., 5 MARLIN HOUSE, THE CROXLEY CENTRE, WATFORD, HERTS WD1 8YA. TEL: (0923) 225235.

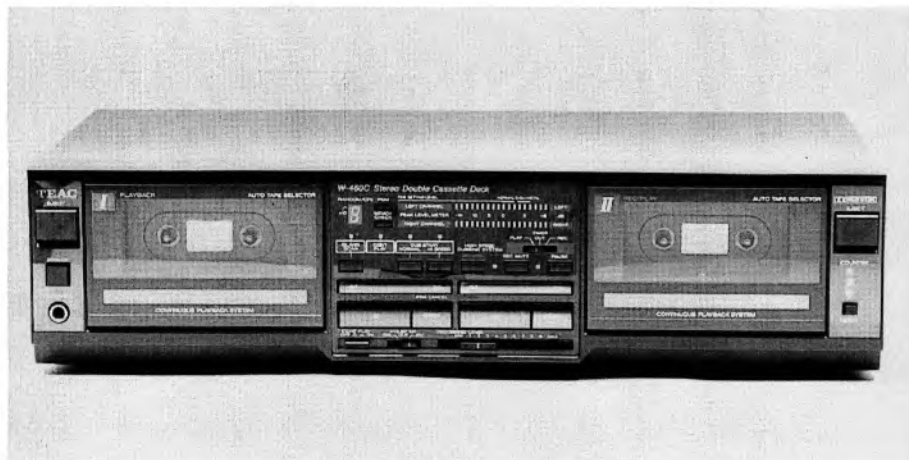

On the face of it, the £300 *W-460C* looks a little overpriced for what it offers. A dual deck designed for dubbing and sequential play operations in the time honoured fashion, this Teac manages with unidirectional mechanisms where many of its competitors have auto reverse, a feature which tends to be popular with twin deck users.

But this rather superficial analysis doesn't tell the whole story. Auto-reverse decks have an important problem: they're not as good. Azimuth variations between sides (well catalogued in our test data) result in subtly different frequency responses between sides. More important, the compromises needed for auto reverse militate against good pitch stability and related physical/mechanical parameters. This deck has a very good unidirectional transport that beats most auto-reverse models hollow.

In addition, the Teac has a number of its own unusual features that may well appeal. Based on the ability to recognise blank spaces between tracks, the machine can search out tracks numbered up to 19 away in either direction, and to programme up to 19 tracks for memory play (or dub) in random order. It can also be made to skip prolonged unrecorded passages – the 'blank skip' function. And if you're wondering about the significance of the number 19, its all that the display, which has one digit and a dot to represent the tens, can cope with.

The transport is logic controlled and has the usual Dolby B and C processing on hand, along with one-key normal and high speed dubbing. The record level meters cover a miserable 16dB in a display the length of a matchstick, and no record channel balance facility is available.

## LAB REPORT

As promised, the transport distinguishes itself with good figures, the flutter component being much lower than that achieved by reasonably priced auto-reverse transports. The spectrum analysis confirms just how clean this Teac is.

Type I and II (ferric and chrome)

responses are excellent, assisted by a well designed head profile. The very tiny amount of top end lift shown in the plots is scarcely significant here. However, with metals treble output was truncated, and the story was repeated in the ferric playback only test. Other test results were unexceptional, except that the record amplifiers seemed to be running out of headroom by 0VU. It doesn't pay to push record levels too hard with this deck.

## SOUND QUALITY

By interchanging tapes between cassette decks, it was quickly established that the *460C* sounds better playing back tapes recorded elsewhere than when making and playing back its own recordings. The *460* is perfectly capable of retaining the subtle strengths of recordings made on Teac's own *W-990RX*, say, but these same strengths are dissipated by its own record process, and recordings consequently tended to sound rather coarse and threadbare. The bass sounds a little weak too, though more than adequately defined, and the mid and treble were a tad mechanical by the standards achievable today.

That's not to say this is a bad deck, or anything like it. The transport is an obvious strength, and although the deck is musically wanting, it rarely suffers the vagueness endemic with most poor cassette decks. On the contrary, this Teac offers a good deal of precision, and quite good stereo focus and spread, laterally anyway. I detected no real advantage in the use of metal tapes, but pre-recorded material was generally satisfactory, if not exactly engaging. Finally, and this probably won't be a surprise, high speed dubs sounded even more impossibly coarse than usual.

## CONCLUSIONS

This is an individualistic middle price twin deck with unidirectional operation only. It has some powerful programming features on its side, but although musical presentation (in the cosmetic sense) is undoubtedly good

on the whole, deep down musical quality is at something of a premium.

## TEST RESULTS

Rec/replay response – 3dB ref 1kHz	
IEC Type I	34Hz – 12.5kHz
IEC Type II	35Hz – 13kHz
IEC Type IV	33Hz – 14kHz
Wow & Flutter – Peak DIN wtd/unwtd	0.11%/0.22%
Wow/Flutter Peak DIN wtd	0.10%/0.23%
Speed error	+0.15%
Type I signal/noise CCIR/ARM 400Hz distortion 0dB	54dB
Type II signal/noise CCIR/ARM 400Hz distortion 0dB	55dB
Type IV signal/noise CCIR/ARM 400Hz distortion 0dB	56dB
Channel separation 0VU/1kHz	46dB
Line input sensitivity/overload	90mV/5.7V
Mic input sensitivity/overload	n/a
Line output for 0dB/maximum	480mV/3.5V
IM distortion 10kHz/11kHz 0dB peak, 1kHz product	2.2%
Azimuth check R-L phase at 10kHz	40° (1); 80° (2)
VU indication at IEC 0dB	0dB
Dimensions (w x h x d)	43.5 x 11.5 x 28.5cms
Typical Retail Price	£300

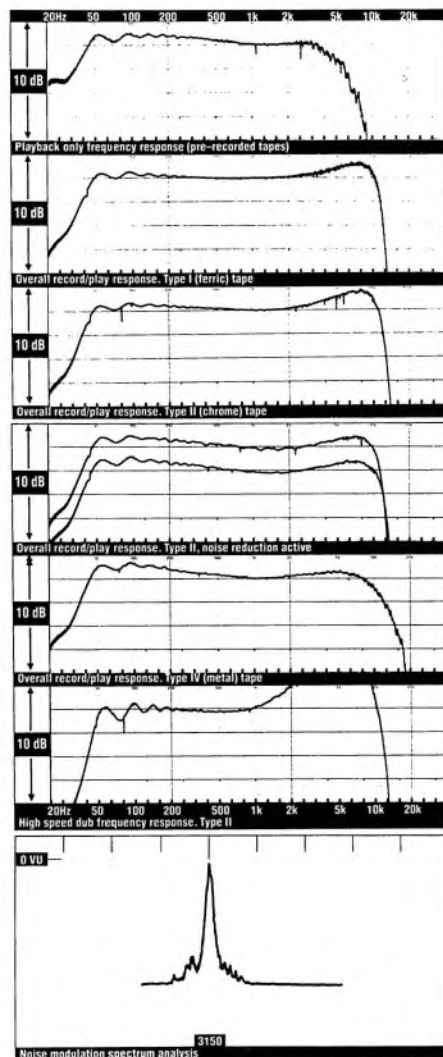

# ESSENTIAL NUMBERS.

## NEW HORIZONS IN ANALOGUE TRANSDUCING

In the constant perfection of record reproduction, Audio Technica unveil their latest numbers . . . AT-OC7 and AT-OC9. Having an almost identical 'on paper' specification, both incorporate varying elements of the newest technology in materials and micro-engineering, many of them developed originally in applications for NASA and the hi-tech aerospace industry. The result is a sound quality previously considered unattainable in the sub £500 category.

Whilst the list of technical achievements is endless, the true test is in the listening. Press comments include . . . *'the OC7 is a superb sounding cartridge; there's no other way of looking at it. It's treble articulation and dynamics are exceptional'* — *NEW HI-FI SOUND*. *'I will say with certainty that the OC9 is one of the very best cartridges I know, and can give it my strongest and most enthusiastic recommendation'* — *HI-FI REVIEW*. Please contact Audio Technica for complete reprints of these together with the reviews of Hi-Fi Answers, Gramophone and Hi-Fi News. Better still, call in for a personal audition at BADA and specialist audio retailers and find out why AT-OC7 and AT-OC9 are now essential numbers in today's top flight analogue systems.

AT-F3 and AT-F5 . . . the successful start to AT's outstanding 'mc' family.

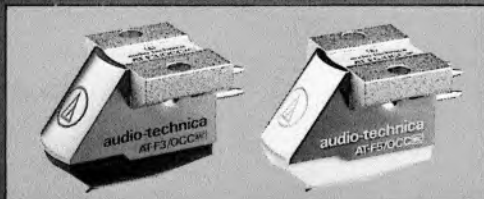

	AT-OC9	AT-OC7
Frequency Response (Hz)	15-50,000	15-50,000
Output Voltage (1 KHz, 5cm/sec)	0.4mV	0.3mV
Tracking Force (gm)	1.25-1.75	1.25-1.75
Weight (gm)	7.8	7.8
Stylus	Square shank elliptical	Square shank elliptical
Magnet Mould	Titanium-Oxide/Potassium mix	Ceramic
Yoke-Piece	Vanadium based metal	Soft Iron
Coils and Terminal Pins	PC-OCC	PC-OCC



**The only complete transducer family**

CARTRIDGE • HEADPHONE • MICROPHONE • VITAL LINKS



# audio-technica

□ INNOVATION □ PRECISION □ INTEGRITY

Technica House, Lockwood Close, LEEDS LS11 5UU. Tel: 0532 771447



# TEAC W-990RX

TEAC (UK) LTD., 5 MARLIN HOUSE, THE CROXLEY CENTRE, WATFORD, HERTS WD1 8YA. TEL: (0923) 225235.

RECOMMENDED



At the present time, the £500 W-990RX is the flagship of a five-strong Teac dual cassette deck fleet. Being a flagship of course means being called upon to be all things to all men.

The key to the power of this deck lies in the fitting of two identical auto reverse recording transports. Used together they allow extended unattended recording (or playback) of up to three hours (using C90s), but can also record in parallel or dub modes to multiply existing recordings.

And there's much, much more. To start with, this is a full remote control player, with all major and most minor facilities fully addressable, even down to switching the electronic tape counter between transports. Next, in addition to the usual Dolby B and C, dbx noise reduction is available, this very powerful system providing a raw signal/noise figure of the order of 90dB – CD country in fact. The Teac is also equipped with a range of features in software, including intro-scan, track search and programming (up to 19 tracks, or 19 tracks away), blank skip, CD level check and of course the linked recording and playback modes mentioned above. Both the transports are logic buffered and a pleasure to use.

The only fly I detected in the ointment is that the auto reverse mechanism doesn't have optical end of side changeover triggering, which means there will inevitably be a ten second gap during unattended long recordings. In practice the delay was extended further by some tardiness in the system.

## LAB REPORT

One rather surprising omission is variable bias. It is missed, not simply because it allows different types of tape to be used, but also because it is needed to achieve the greater set-up precision necessary to make sense of dbx. As a direct consequence of the way it works, dbx magnifies any residual deviation from the straight and flat. All the IEC standard tapes used for testing reproduced with an appreciable treble boost (prerecorded tapes were OK). Whereas Dolby processing

came near to maintaining the intrinsic response of the recorder, dbx processing resulted in a massive 7dB boost around 7-8kHz, using tapes which suffered a mere 2-3dB hoist without noise reduction. But there are other reasons too for not using dbx...

As auto-reverse transports go, this one is superb, with just a trace of capstan wow to distinguish it from some of the better unidirectional models. The noise floor, however, isn't quite as low as some, taking into account overload behaviour.

## SOUND QUALITY

Once again, I am left wondering if anyone bothered listening to their handiwork before unleashing that dbx circuit. The usual justification is that US buyers go for dbx. The usual finding, repeated here, is that with dbx in place, what had sounded like a very fine cassette deck instantly resembled a cheap and nasty one. Even with tapes providing an approximately flat response and where the treble isn't boosted out of proportion, there's a significant loss of detail and presence. The bass sounds flabby and imagery doesn't. The IEC standard (brighter) tapes produce a boosted treble but no real increase in precision. The loss of dynamic range and clarity were unmistakable despite the lowered noise floor.

Without noise reduction, and to a large extent also with Dolby B and C (I'm pleased to say), this Teac is revealed in all its glory as a coherent, punchy and articulate sounding deck, with particularly fine stability, both spatially and temporally. It suited all tape types, and was particularly striking with the metals which preserved dynamics best. A slightly inferior noise floor could be detected using ultra quiet tapes, but was generally not a problem.

## CONCLUSIONS

Nobody's pretending that you can't buy a better cassette deck at this price, but you will have difficulty finding a better dual cassette deck, especially one that does what this one can do. The obvious shortcomings are the

absence of a bias adjustment and an MPX filter switch, and the presence of dbx. Recommended, but only to those who must have two of everything.

## TEST RESULTS

<b>Rec/replay response – 3dB ref 1kHz</b>	
IEC Type I	38Hz – 14.5kHz
IEC Type II	38Hz – 14.5kHz
IEC Type IV	37Hz – 17kHz
<b>Wow &amp; Flutter – Peak DIN wtd/unwtd</b>	
	FWD 0.10%/0.28%;
	REV 0.09%/0.22%
<b>Wow/Flutter Peak DIN wtd</b>	
	FWD 0.072%/0.28%;
	REV 0.084%/0.20%
<b>Speed error</b>	
	+0.2%
<b>Type I signal/noise CCIR/ARM 400Hz</b>	
distortion 0dB	52dB
<b>Type II signal/noise CCIR/ARM 400Hz</b>	
distortion 0dB	0.8%
<b>Type IV signal/noise CCIR/ARM 400Hz</b>	
distortion 0dB	54dB
<b>Type I signal/noise CCIR/ARM 400Hz</b>	
distortion 0dB	2.0%
<b>Type IV signal/noise CCIR/ARM 400Hz</b>	
distortion 0dB	53dB
<b>Channel separation 0VU/1kHz</b>	
	47dB
<b>Line input sensitivity/overload</b>	
	77mV/>13V
<b>Mic input sensitivity/overload</b>	
	n/a
<b>Line output for 0dB/maximum</b>	
	490mV/3.6V
<b>IM distortion 10kHz/11kHz 0dB peak, 1kHz product</b>	
	0.28%
<b>Azimuth check R-L phase at 10kHz</b>	
	(1) 60°/20°; (2) 30°/70°
<b>VU indication at IEC 0dB</b>	
	0dB
<b>Dimensions (w x h x d)</b>	
	43.5 x 11.5 x 28.5cms
<b>Typical Retail Price</b>	
	£500

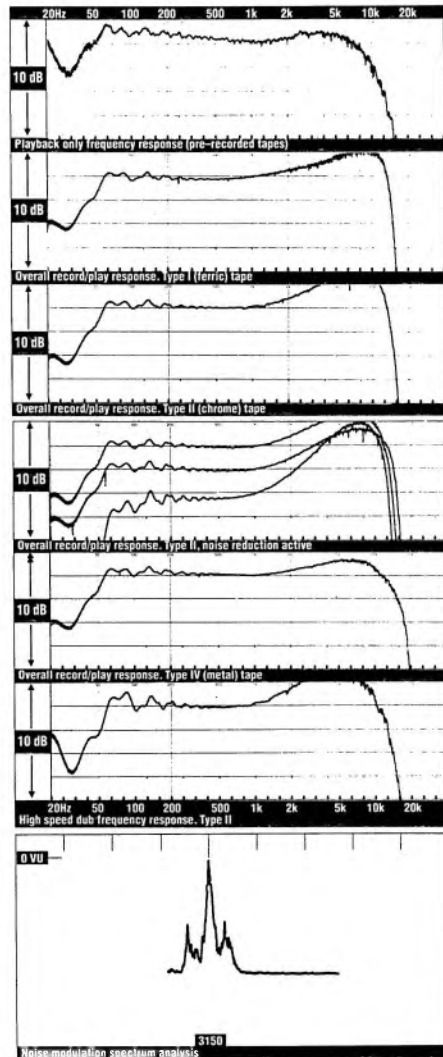

**THE SPECIALISTS**

# Rayleigh Hi-Fi

216 Moulsham Street, On-the-Parkway,

**Ghelmsford**

Tel: 0245-265245  
(3 LINES)

44a High Street,

**Rayleigh**

Tel: 0268-779762  
747571

**MISSION**  
ELECTRONICS

**Cyrus**  
by MISSION

## MY FRIEND SAID THAT YOU'D SORT ME OUT

(IN THE NICEST POSSIBLE WAY!!)

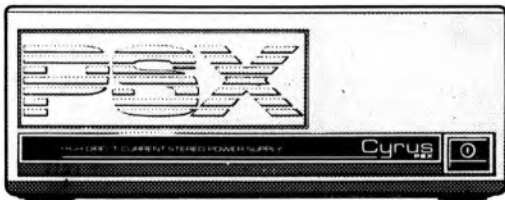
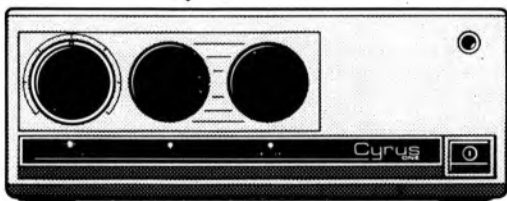

Most of our customers come to us on the recommendation of a friend. There are probably a number of reasons for this.

It may be because we stock the widest range of quality hi-fi in the area. It may be because we provide proper demonstration facilities. Unbiased professional advice by staff who are genuinely interested in music and hi-fi must be a large plus point especially as they are not motivated by how much commission they might be earning (because none of our staff receive any).

It could be the free delivery and proper in-home installation and the 3 year guarantee of systems (which means we have confidence in the products that we recommend).

However, we'd like to think that there's also an extra factor. We believe that every customer has individual musical needs and we take a pride in trying to provide the best possible solution to those needs. After all our reputation is important to us for if we take enough care, perhaps you'll soon be recommending us to your friends.

<b>Cyrus I Amplifier</b>	<b>£179.90</b>
<b>Cyrus II Amplifier</b>	<b>£299.90</b>
<b>Cyrus PSX Power Supply</b>	<b>£199.90</b>
<b>PCM II CD Player</b>	<b>£490.90</b>
<b>Cyrus Tuner</b>	<b>£199.90</b>

**NEW ARRIVALS - FULL RANGE OF NEW MISSION  
LOUDSPEAKERS ON DEMONSTRATION & IN STOCK**

HIGH QUALITY HI-FI FROM:

ACOUSTIC ENERGY A&R AUDIOLAB AUDIOTECHNICA BEYER BLQ CAMBRIDGE AUDIO CREEK  
CYRUS CELESTION DENON DNM DUAL EPOS GALE HEYBROOK INCA TECH ION SYSTEMS  
LINN PRODUCTS MANTRA MISSION MONITOR AUDIO MORDAUNT SHORT MUSICAL FIDELITY  
NAD NAIM AUDIO NAGAOKA NAKAMICHI ONKYO ORIGIN LIVE PROAC QED QUAD QUART  
REGA REVOX REVOLVER ROGERS ROKSAN ROTEL ROYD STAX YAMAHA

**0% FINANCE AVAILABLE FOR LIMITED PERIOD ONLY. DETAILS ON REQUEST**

Visit either of our superb showrooms and discuss your requirements with our enthusiastic and knowledgeable staff who will be pleased to tailor to suit **you**



**3 YEARS PARTS AND LABOUR GUARANTEE ON HI-FI SYSTEMS**

LICENCED CREDIT BROKERS - FULL FINANCE FACILITIES AVAILABLE - DETAILS ON REQUEST - APR 26.5%



**THE SPECIALISTS**

# TECHNICS RS-T330R

PANASONIC (UK) LTD., 300-318 BATH ROAD, SLOUGH, BERKS SL1 6JB. TEL: (0753) 34522.

RECOMMENDED

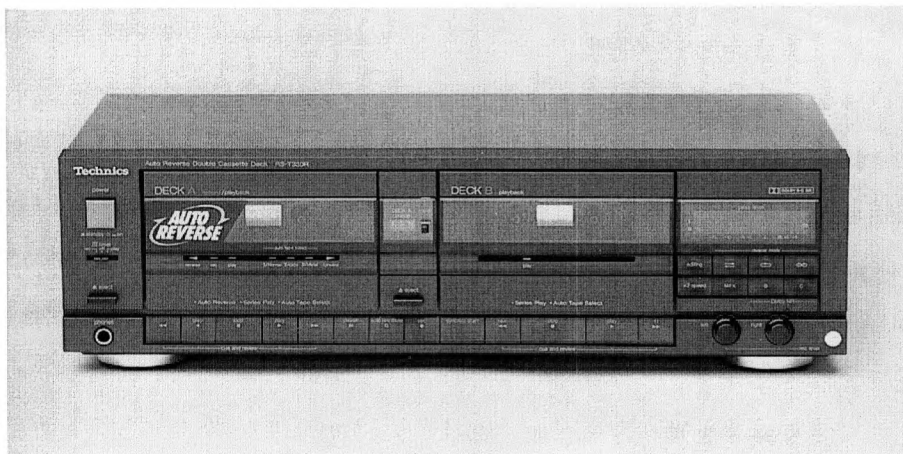

The *RS-T330R* is a twin cassette deck which fits within the £200 price break, pitched as a fairly sophisticated model. Most twins are built down to a cost rather than up to a specification; this one is in danger of doing the latter.

It is one of a small number of slightly strange twins which combine an auto-reverse deck capable of recording and playing back, and a unidirectional transport for replay only. There may be several positive things to say about this arrangement (theoretically a high quality unidirectional transport could have a narrow head for optimum replay, but see later), but on the negative side must be included the purely personal observation that I can't quite see the point. The auto reverse record feature makes sense; it facilitates long, uninterrupted recordings, for example off radio. But the prime raison d'être for twin decks, at least for most users, is the ability to dub cassettes, and the inability of the play transport to switch sides automatically means that this facility is somewhat wasted on the record side.

Be that as it may, what can the *RST330R* do, and with what style? The answer to the second of these questions is 'considerable'. There is automatic tape type selection and full logic controls on both transports (with audible cue/review in both cases), neither of which is anything like universal with twin decks. Naturally, Dolbys B and C are fitted, but in a concession to sound quality I had not expected at this price or with this type of product, the 19kHz MPX filter can be defeated independently of the noise reduction circuits.

Some of the ergonomic decisions seem to have been made with more of an eye to aesthetics than dear old aunt Flo, but owners will certainly appreciate the 2x dubbing facility, the sequential play mode, the one key synchro-start (my car's got one of those too), the repeat facility, the 26dB meters (however minuscule), and the quick reverse feature which switches sides at the tape/leader junction rather than the end of the tape.

## LAB REPORT

Despite the auto reverse record transport which is a traditional recipe for poor performance, this Technics achieves a wow and flutter performance that places it truly in the hi-fi category, alongside some unidirectional decks in the same price area. The wow and flutter spectrum plot tends to confirm this analysis.

The various frequency responses are also extremely well engineered. Note the ruler flat Type IV metal record/replay response shape which holds accurately to 15kHz before rolling off beyond audibility. The pre-recorded response shape is also quite accurate, whilst Dolby processing made little material difference, at least from the measurement point of view.

## SOUND QUALITY

The *RS-T330R* is a surprisingly strong subjective performer, and one of the best moderately priced twin deck the author has tried. Sound quality is crisp, lean and tolerably stable. There's the suggestion of a sound-stage, and a clean, light sound that suggests reduced modulation noise.

Curiously, the unidirectional playback only transport was audibly inferior to the auto reverse record/playback one and this naturally reflected in the quality of dubbed tapes, which were perceptibly less accurate and stable than others. Dubbed piano recordings were plainly shaky in tone and pitch alike. Dubbed tapes also included a degree of hum, though at low level.

## CONCLUSIONS

The *RST330R* has an exceptionally practical user interface and is consequently a pleasure to use. A good single transport deck will still beat it on music, but if the dubbing and sequential play facilities are important, this fine sounding model is an excellent purchase, and one of very few twins to deserve confident Recommendation.

## TEST RESULTS

Rec/replay response — 3dB ref 1kHz	
IEC Type I	35Hz — 17kHz
IEC Type II	35Hz — 18kHz
IEC Type IV	35Hz — 18kHz
Wow & Flutter — Peak DIN wtd/unwtd	0.10%/0.15%
Wow/Flutter Peak DIN wtd	0.06%/0.26%
Speed error	+0.5%
Type I signal/noise CCIR/ARM 400Hz	48.5dB
distortion 0dB	0.75%
Type II signal/noise CCIR/ARM 400Hz	54.5dB
distortion 0dB	0.8%
Type IV signal/noise CCIR/ARM 400Hz	51dB
distortion 0dB	1.2%
Channel separation 0VU/1kHz	48dB
Line input sensitivity/overload	130mV/>7V
Line output for 0dB/maximum	62.4mV/2.6V
IM distortion 1kHz, ref 10kHz/11kHz 0dB	3.2%
Azimuth check R-L phase at 8kHz	15 degrees
VU indication at IEC 0dB	+3dB
Dimensions (w x h x d)	43 x 12.5 x 23.5cms
Typical Retail Price	£200

Reprinted from issue No. 63

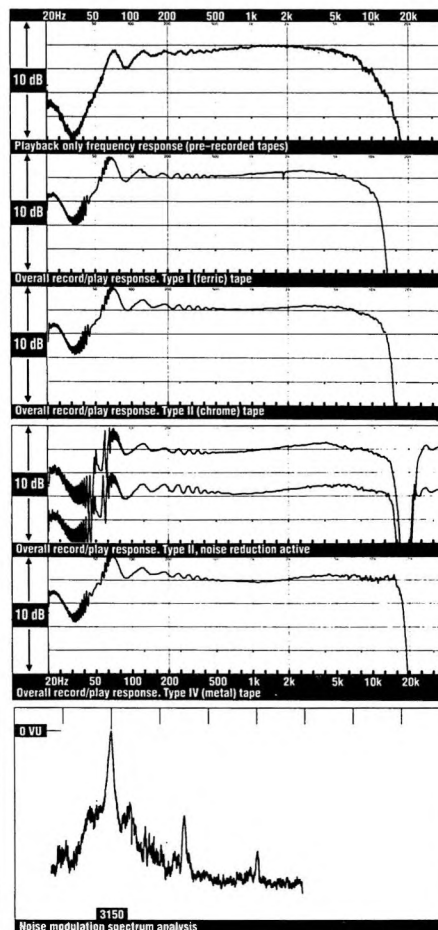

# FREE!



Your  
Very Own...

## ★ HI-FI EXPERT ★

WITH  
EVERY

HI-FI SYSTEM

PURCHASED\*

### CONDITIONS

To qualify all customers must:-

- experience our superb demonstration facilities
- take advantage of our helpful advice in all Hi-Fi matters
- be fully aware of our friendly service.

All purchasers will then be entitled to use their HI-FI EXPERT\* as and when needed for an indefinite period.

\*OFFER LIMITED TO THE FOLLOWING STORES



## AT Labs



**AT Labs**  
173-5 Station Road  
Edgware  
Middlesex  
HA8 7JX  
01 952 5535

**AT Labs**  
159 Chase Side  
Enfield  
Middlesex  
EN2 0PW  
01 367 3132

**AT Labs**  
190 West End Lane  
West Hampstead  
London  
NW6 1SQ  
01 794 7848

**AT Labs**  
442-4 Cranbrook Rd.  
Gants Hill Ilford  
Essex  
IG2 6LL  
01 518 0915

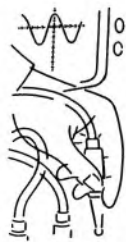

# TECH TALK

*Alvin Gold describes the how and why of the various technical tests.*

The true value of any *Hi-Fi Choice* project derives from covering a wide enough range of equipment to be fully representative of the market as a whole, and in reporting on them using common techniques and criteria, so that once the reader has learned to interpret the author's personal idiosyncrasies and prejudices, he can apply this knowledge to a large database of review information.

At the outset let me acknowledge the help I received from various sources: Robert King, an able assistant who did much measurement and donkey work; Chris Bryant, who did the sensitivity, overload, azimuth, intermodulation and VU indication at IEC 0dB measurements. All the remaining machine tests and most of the tape tests were done using the author's own facilities.

As in previous projects, the cassette decks were assessed in two distinct ways: first as hardware designed to play commercially recorded musicassettes, and secondly as recording tools. The vital distinction is that for the former the deck must correspond (in physical alignment and electrical equalisation) to the external standards applied during the duplication of prerecorded material. In the latter case, this stricture doesn't apply in quite the same way. Although a recorded tape ought still to replay accurately on other cassette decks (the owner's *Walkman* or ICE players, for example) some of the commonest errors (notably those due to head alignment) are essentially self-correcting with the same machine; they replay with the same error that was used at the record stage.

## LAB TESTING

**Rec/replay response – 3dB ref 1kHz.** The two figures given are simply the –3dB frequency extremes that define the bandwidth (referred to the arbitrary 0dB 1kHz level, and recorded at –10dB ref IEC).

These are shown separately for all three tape types.

**Wow and Flutter – Peak DIN wtd/unweighted.** Central to the task of writing to and reading from tape is that the consequence of any lack of absolute speed stability will superimpose itself on the signal, and that you will hear the effect. In an analogue system like compact cassette, the inevitable variations in speed of the tape passing over the heads appear as momentary (and sometimes longer term) pitch variations. This class of variation is known under the blanket term wow and flutter, and is shown in unweighted and weighted form. Wow and flutter are also shown separately.

**Speed error** is measured in percentage deviation from the nominal standard (4.75cms/s).

**Signal/noise** ratios are quoted with CCIR/ARM weighting. The test frequency is 315Hz, the distortion is shown at the same point (0VU on the deck's meters) for each of the three tape types.

**Channel separation** is measured with reference to a 1kHz signal at 0VU on the deck's meters.

**Line input sensitivity/overload.** Will it match your amplifier tape feed?

**Mic input sensitivity/overload.** What sort of microphones (if any) can be used?

**Line output for 0dB/maximum.** Will it drive your amplifier properly? (probably).

**IM distortion 10kHz 11kHz 0dB peak, 1kHz product.** This test gives a useful measure of how well or badly the various machines respond when asked to record two high frequency signals at 0VU level simultaneously. Real life musical signals are much more complex still of course, and an inability to deal with this test cleanly suggests an inability to cope with up-front percussion or other high energy material without sounding hard, splattery or just plain distorted.

**Azimuth check R-L phase at**

**10kHz.** Expressed in degrees (of treble phase shift), this is a measure of azimuth misalignment. The higher the error, the greater the HF loss when playing commercially recorded cassettes.

**VU indication at IEC 0dB.** In principle, the 0VU point on a deck's record level meters is arbitrary, but it is usually set around +3dB ref IEC 0dB.

**Dimensions (w x h x d).** In centimetres, of course.

## PLOTS & GRAPHS

In addition, a number of plots and graphs are included with each review. The frequency response plots were run with the highest pen writing speed available, which means that dropouts tend to show up in all their glory, and frequency response errors are not 'sanitised' as is often the case. The chart recorder was used with its greatest vertical resolution. This exaggerates response aberrations by a factor of 2.5 times compared to previous cassette deck tests but brings them into line with CD players, cartridges and amplifiers. The record/replay sweeps were also continued right up to 40kHz. All response plots were run at –10dB, which stresses the machines rather more than the traditional –20dB.

Also included are similar, comparable plots showing the effects of the noise reduction systems in the frequency domain. The playback only plots were also run in exactly the same way, giving an indication of the frequency response available with prerecorded material. There is no available sweep test tape for this, so the author made his own, calibrated against the official 120μS Abex IEC calibration test tape. The accuracy of this test tape is not absolute, but error is estimated at around 1.5dB maximum – and is constant from machine to machine.

We also performed spectrum analysis tests to investigate the mechanical behaviour of each of the decks, though space

prevented the publication of more than one of these. The noise modulation spectrogram graphically illustrates the mauling endured by a 3150Hz sinewave when recorded and replayed by the deck under test – there are close parallels with a similar analysis carried out in last year's edition. The central peak should be as fine and as thin as possible, any problem here being heard as a lack of pitch stability.

Response runs were also made using the high speed dub option, but have not been reproduced for space reasons. With auto-reverse decks, all data refers to Side 1, but the reverse side was checked in the same way, and again discrepancies are reported as they arose. In the case of decks with automatic tape alignment, the alignment procedure was followed, and where a bias adjustment facility was fitted, the setting recommended for TDK, AD, SA and MA was used if available. Otherwise the central (usually 12 o'clock) setting was adopted.

## LISTENING TESTS

The listening was divided into two sections. The first involved using each deck in turn in a system which included a Marantz *CD75SE* CD player, Arcam *Delta 60* amplifier and a pair of Stax *Lambda Pro* headphones. Much routine listening was done with this system, along with all the functional work – which button does what and so on.

Finally, and most important of all, each deck was auditioned in a high grade loudspeaker based system. Equipment used included a Musical Fidelity preamplifier (my own DNM preamplifier has no tape circuit at present), Musical Fidelity *A370* power amplifier, a Roksan *Xerxes/Rega RB-300/Koetsu Rosewood Signature* record deck, the aforementioned Marantz CD player with outboard *703 DAC* amongst others and a pair of Apogee *Caliper* loudspeakers, all wired with solid core DNM cable.

# ARJAY

## The Professional Sound Storage System Direct from the Manufacturer

**ST5**  
Holds 120 records  
price £48.00

**ST2**  
Holds 480 records  
price £154.00

**ST1**  
Holds 600 records  
price £183.00

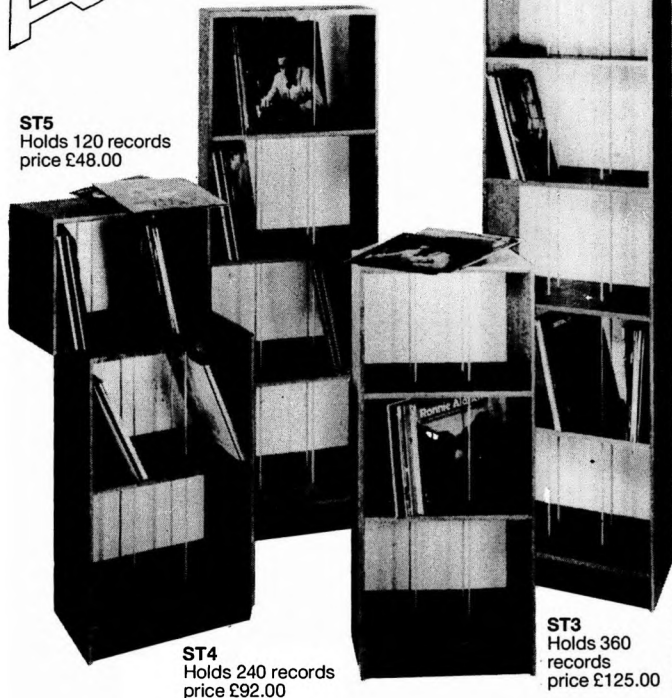

**ST4**  
Holds 240 records  
price £92.00

**ST3**  
Holds 360 records  
price £125.00

All prices are ex-works and inclusive of VAT.

Whether your collection is Records, Cassettes or CDs the **ARJAY** system is just for you. In fact, at many music studios, stores and libraries throughout the country **ARJAY** is considered essential equipment.

Its classic and original design makes the best possible use of available space to provide the ideal storage and display conditions.

You have a choice of the "Record Collection" which consists of five different sized units, designed specifically for record only collections or "The Combination" which has three different sized units, designed for a mixed collection of Records, Tapes & Compact discs. There is a unit just right for you.

The **ARJAY** System is British made and is available in a choice of five functional finishes - **Rosewood, Mahogany, Teak, Black or White** - to look good wherever you choose to keep them.

You couldn't put your music collection in better hands or units.

Contact Sandra on **01-390 2101** or send coupon below to:-

**ARJAY Ltd.**

54 Lower Marsh Lane, Kingston, Surrey KT1 3BJ

Please send me The **ARJAY** Sound Storage System brochure.

Name .....

Address .....

..... Tel No .....

- Huge selection from the world's leading names
- Comprehensive demonstration facilities
- Total aftersales care
- Best Price Promise
- Low cost credit (interest free over £500)

**NOW YOU'VE READ THE REVIEWS COME TO US FOR THE BEST DEAL**

- Largest selection of CD players and discs in the UK
- The Paul Roberts Discount card (value £50) is FREE with your Compact Disc player
- We guarantee the best deal in the UK on any CD player

Licensed credit broker, written details on request.

# PAUL ROBERTS

## There's nowhere like it for Hi-Fi

OPENING HOURS: MON-FRI 9.30am - 7.30pm. SAT 9.30am - 6.00pm

31-33 GLOUCESTER ROAD, BRISTOL (0272) 429370    203 MILTON ROAD, WESTON-SUPER-MARE (0934) 414423  
 32 NORTH STREET, TAUNTON (0823) 270000    65 HIGH STREET, BRIDGWATER (0278) 421234



# CASSETTE DECKS: CONCLUSIONS, BEST BUYS AND RECOMMENDATIONS

*Alvin Gold sums up the best from the tests.*

I and others in the media, have waged a rear guard campaign against twin cassette decks, tending to treat them as a trivialisation and a diversion from the real goal of the cassette designer – achieving high quality sound from a very slow running narrow strip of iron oxide coated plastic. We – I – have dealt with the subject of sound quality as something that was quite indivisible, except that is by price. But perhaps we have been guilty of ignoring the real reasons people buy cassette decks.

Taking the most severe, cynical view, if sound quality was

it's impossible to sell systems without twin decks, and very few are brave or bone-headed enough to try. The most notable exception I know of is Bang & Olufsen who makes its own rules, but by and large, low cost decks used to be designed by marketing people, not engineers.

Over the years, twin cassette decks really have tended to be very grim indeed, but that's largely because they were very cheap, and two into cheap simply doesn't go. But there's nothing intrinsically wrong with dual cassette decks, and certainly nothing that throwing a bit of

decks, not far short of half our test group was of this type – nine twins from a total of 22 recorders and 1 DAT machine. If they seem slightly under-represented in the list of recommendations, it's because they still tend to be under-achievers. But there's no doubt that they are looking up.

Three models caught my attention as being wholly viable and recommendable products. At £200, there's the Memorex *STC-84*. Key features are cue and review, and microphone inputs. Sensibly engineered it offers quite fair performance standards on the whole. There is an obvious competitor in the Technics *RS-T330* (also £200, and Recommended) which is carried over from the last cassette test issue. The Technics betters the Memorex significantly all round, although the Memorex remains a highly acceptable deck and honest value for money, chintzy exterior decorations notwithstanding.

One step up the ladder and we come to the £230 Denon *DRW-750* which like the Technics and Memorex has one record capable transport and one dedicated to playback only. Unlike the other two it also boasts Dolby *HX Pro*, but it sacrifices auto-reverse operation on the record transport fitted to the two cheaper recommendations in favour of improved transport integrity. It's perfectly true that the *DRW-750* is not entirely free of problems. Behaviour with prerecorded material was suspect on the review sample, and the deck

wasn't hum free. But it remains an excellent recorder despite the latter, and quite a bit better than the cheaper models described above.

Also recommended from our twin deck selection is the £500 Teac *W990RX*. This is powerfully kitted out with two record capable, auto return mechanisms plus remote control and dbx. The last of these facilities turns out to be not worth having, and the transports lack optical end of side detection, a remarkable oversight at this price level. But audio performance is good by all but the most exacting (single transport) standards.

Our single transport models continue to show slow but steady progress when compared to previous groups. This takes several forms. One small but significant step has been the almost total elimination of manual tape type switching. One deck – the Nakamichi – even had selectable automatic or manual tape switching, for reasons that would take longer to explain than the topic deserves. Anyway, three cheers are in order. dbx is also becoming rarer, whilst many decks are now available with Dolby *HX Pro*.

There's an intriguing tendency for up-market decks to include *HX Pro* switching, and whilst this must make Dolby Labs cringe (as have some comments in these pages on Dolby B and C, which I continue to see as necessary evils at the very best), it is notable that whilst *HX Pro* benefits low bias tapes, and especially Type I



*The Best Buy Aiwa AD-R470 – an impressive and uncompromised cheapie.*

of such overriding importance, nobody would buy cassette decks at all. They are purchased because they do things that other sources can't get close to, and for the hi-fi freak, this is much more likely to be connected with the ability to record than it is the ability to play prerecorded cassettes which we are rightly entitled to hold in disdain. Making copies of tapes is a facility that many people find attractive, and it therefore strikes of burying heads in the sand to rule out all double decks as being unworthy of attention.

However, I'm not relenting on the quality issues involved. It's perfectly true for example that twin decks were popularised by the makers of cheap midi systems, and that in many cases they were included to fill out the specification sheet rather than to fulfil a particularly arduous technical brief. In fact conventional wisdom has it that

money at the problem won't help cure. By and large, you can count on having to spend in the region of 50-80 per cent more than the cost of a single deck for roughly comparable quality in a twin, so all things being equal a £200 twin deck can be expected to perform roughly like a £125 single.

Twin decks have inherited one rather nasty facility from the time when they were not meant to be taken seriously. That is high speed dubbing, the facility available on all twin mechanism decks that allows a tape to be dubbed in half the usual time. The only deck I know where this facility was engineered on something like a no-compromise basis was (a) very expensive and (b) never made available in this country. High speed dubbing is as sure a recipe for disaster as can be had, and the x2 button should be ignored at all costs.

In line with our slightly more positive stance on dual cassette



*Well engineered for the price the Kenwood KX-5010 merits a Best Buy.*

ferrics, there is a slight but detectable degradation when used with Type IV metals. This justifies having the circuit switchable. Equally, I'd like to see the ability to switch the status and level displays off being made more common, especially in the case of expensive decks with more complex displays. At present only Akai has taken the plunge.

As usual, some of our tessees have auto-reverse transports, and as before they are rarely anything like as stable as the best unidirectional models. But just like the ability to dub from cassette to cassette, the ability to make long continuous (perhaps absentee) recordings depends on auto-reverse operation, and models of this type have been included in our recommended list wherever practical.

## RECOMMENDED MODELS

In ascending order of price, the following single transport models are recommended on the basis of their performance on test in this issue.

Although basically conventional, the £149 Sansui *D-X301i* has a very well endowed set of electronics, even if some of the more abstruse features can be difficult to find. It also has Dolby *HX Pro*, and works well, albeit with some minor faults in areas not crucial to musical integrity.

Next comes the Teac *V-570*, at £200 which unfortunately lacks almost any of the multitudinous varieties of tape search, but a high standard of under the skin engineering more than ensures its recommended status. Except with prerecorded material, that is.

The £300 price break is represented by the Aiwa *AD-F880*. This is a 3-head recorder with off-tape monitoring and a sophisticated dual capstan mechanism, plus Dolby *HX Pro*, cue and review and manual adjustment facilities for record bias and sensitivity. The Aiwa has unusually transparent sounding electronics and an ultra-stable transport. Predictably, audio performance benefits from both these things.

Another 3-head deck suitable for off-tape monitoring in real time, the £400 Akai *GX-95* is equipped with a high tech dual capstan transport with a direct drive capstan motor and switchable MPX filtering. The display can be switched off too (see above). Bias and sensitivity are fully adjustable, and the Akai includes a range of search and

other facilities, not least a remote control handset. This is a very impressive deck from all angles.

For £50 more, that is £450, the Pioneer *CT-939* offers less gadgetry than you might expect, but a good deal of straight, solid and in some respects quite adventurous engineering, missing from too many cassette decks. Highlights include a low resonance, largely non-magnetic construction and an elaborate power supply stage. The transport is real state of the art stuff, and if the electronics are now wholly invisible, musical performance is as good as we have heard from a deck at this price level making it highly recommended.

The most expensive non-digital deck in our test is the £995 Nakamichi *CR-5E*. As usual with this marque the range of features is unimpressive and in any case quite beside the point. The *CR-5* is patterned closely on the well known *CR-7E*, but omits the auto tape set-up facilities, not to mention the auto playback azimuth adjustment, and manages instead with a simple variable bias facility. The money has been sunk into a no-compromise structure and circuit design, and features totally discrete heads. Sound quality is state of the art with metals and with prerecorded material, but less impressive with other tape types, which obviously weren't high on the priority list when the deck was designed.

## BEST BUYS

Finally, two models have been elected for our ultimate accolade: Best Buy. One is the Aiwa *AD-R470* (£150), a rather impressive and surprisingly uncompromised cheapie with auto reverse operation and optically triggered side change for minimum intrusion. The other is the Kenwood *KX-5010*. This one costs £269, and is equipped with an auto tape calibration system, but is otherwise conventional. It is exceptionally well engineered for the price though, and as good a candidate for Best Buy as we have had for some time.

The following models, recommended in the previous cassette deck issue, have been reprinted along with the new tests:

NAD 6300	£550
Kenwood <i>KX-660HX</i>	£170
Pioneer <i>CT-443</i>	£180
Technics <i>RS-T330</i>	£200
JVC <i>TD-V711</i>	£380

	Single deck	Dual deck/ single record	Dual deck/ dual record	High speed dub	Real-time counter	Counter memory
Acoustic Research RD-06	●					●
Aiwa AD-R470	●					
Aiwa AD-F880	●					●
Akai GX-32	●					
Akai GX-95	●				●	●
Denon DR-M07	●					
Denon DRW-750		●		●		●
Goodmans GSW-5200		●		●		
Grundig Fine Arts CCT-903		●		●		●
JVC TD-R411	●					
JVC TD-W444		●		●		
Kenwood KX-5010	●				●	
Marantz SD-585			●	●		‡
Memorex SCT-84		●		●		
Nakamichi CR-5E	●					●
Pioneer CT-939	●				●	●
Sansui DX301i	●			●		●
Sony TC-WR500		●		●		
Teac V-570	●				●	
Teac V-670	●				●	
Teac W460C		●		●		
Teac W-990RX			●	●		

Aiwa AD-WX909		●		●		
Aiwa XK-009 Excelia					●	●
Akai GX-52	●				●	●
Akai GX-6	●				●	
Denon DR-M10HX	●					●
Denon DR-M12HX	●					●
Denon DR-M24HX	●					●
Denon DR-M44HX	●				●	●
Dual CC8010	●					
Harman Kardon CD491	●				●	●
JVC TD-V711	●				●	●
Kenwood KX-660HX	●				●	
Marantz SD-35	●					
Marantz SD-45II	●					●
Marantz CP230	●					●
Marantz SD-55	●				●	●
NAD 6300	●				●	
Nakamichi CR-2E	●					●
Nakamichi RX-202E	●					●
Nakamichi CR-3E	●					●
Nakamichi CR-4E	●					●
Nakamichi CR-7E	●				●	●
Onkyo TA-2120	●					
Pioneer CT-443	●					
Sony (WMD6C) ProWalkman	●					
Sony TC-RX80ES	●				●	●
Sony TC-K700ES	●					
Teac V-250	●				●	
Teac V-870	●				●	●
Teac V-970X	●				●	●
Technics RS-B355	●					
Technics RS-T330R		●		●		
Yamaha KX-200	●					
Yamaha KX-400	●					
Yamaha KX-500	●				●	●

\* Remote control via AR system only

‡ Wire link connections for Denon systems

‡ See text



# FACILITIES CHART

Auto reverse play	Auto reverse record	Track (music) search	Dolby C	dbx	Dolby HX Pro	Auto tape sensing	Tape alignment adjust	Tape azimuth adjust	Record bias adjust	Remote control	Auto repeat	Microphone Input	Headphone Output	
			•		•	•			•	*	•		•	Acoustic Research RD-06
•	•		•		•	•			•				•	Aiwa AD-R470
			•		•	•	•		•	•	•		•	Aiwa AD-F880
		•	•			•			•				•	Akai GX-32
		•	•		•	•	•	•	•	•	•		•	Akai GX-95
			•			•			•				•	Denon DR-M07
		•	•		•	•			•	†			•	Denon DRW-750
												•	•	Goodmans GSW-5200
•	•		•			•					•		•	Grundig Fine Arts CCT-903
•	•		•			•					•		•	JVC TD-R411
•	•		•			•					•		•	JVC TD-W444
		•	•		•	•	•					•	•	Kenwood KX-5010
•	•	•	•			•					•	•	•	Marantz SD-585
•	•		•			•			•		•	•	•	Memorex SCT-84
			•			•			•		•		•	Nakamichi CR-5E
		•	•		•	•			•		•		•	Pioneer CT-939
		•	•		•	•			•		•		•	Sansui DX301i
•	•		•			•							•	Sony TC-WR500
			•		•	•			•				•	Teac V-570
			•		•	•			•				•	Teac V-670
		•	•			•					•		•	Teac W460C
•	•	•	•	•		•				•	•		•	Teac W-990RX

# RECOMMENDED MODELS FROM PREVIOUS TESTS

•		•	•		•	•			•		•		•	Aiwa AD-WX909
			•	•	•	•	•		•		•		•	Aiwa XK-009 Excelia
•		•	•		•	•			•	•	•		•	Akai GX-52
		•	•			•			•				•	Akai GX-6
		•	•		•	•			•				•	Denon DR-M10HX
		•	•		•	•			•				•	Denon DR-M12HX
		•	•		•	•			•				•	Denon DR-M24HX
		•	•		•	•	•	•	•	•			•	Denon DR-M44HX
			•			•						•	•	Dual CC8010
		•	•		•	•			•		•		•	Harman Kardon CD491
		•	•		•	•			•		•		•	JVC TD-V711
		•	•		•	•			•		•		•	Kenwood KX-660HX
		•	•			•			•				•	Marantz SD-35
		•	•			•			•				•	Marantz SD-45II
		•	•		•	•			•		•	•	•	Marantz CP230
		•	•		•	•			•		•		•	Marantz SD-55
		•	•		•	•			•	•	•		•	NAD 6300
		•	•			•			•	•	•		•	Nakamichi CR-2E
•	•		•			•			•	•	•		•	Nakamichi RX-202E
		•	•			•			•	•	•		•	Nakamichi CR-3E
		•	•			•			•	•	•		•	Nakamichi CR-4E
		•	•			•	•	•	•	•	•		•	Nakamichi CR-7E
		•	•			•			•		•		•	Onkyo TA-2120
		•	•		•	•			•				•	Pioneer CT-443
		•	•			•						•	•	Sony (WMD6C) ProWalkman
•	•	•	•		•	•	•		•				•	Sony TC-RX80ES
•		•	•			•	•	•					•	Sony TC-K700ES
			•		•	•							•	Teac V-250
			•		•	•			•	•	•		•	Teac V-870
		•	•	•	•	•			•	•	•		•	Teac V-970X
		•	•			•						•	•	Technics RS-B355
•	•		•			•					•		•	Technics RS-T330R
		•	•			•				•			•	Yamaha KX-200
•	•	•	•		•	•			•	•	•		•	Yamaha KX-400
		•	•		•	•	•	•	•	•	•		•	Yamaha KX-500

# Aylesbury Hi-Fidelity



The real Hi-Fi specialists in Buckinghamshire

MONITOR AUDIO R852 MDs  
R352 MD/R300 MD  
NOW IN STOCK.  
CAMBRIDGE P40/CD2  
DISC PLAYER IN STOCK  
ARCAM RANGE OF  
AMPS IN STOCK  
AR EB101 IN  
STOCK.  
DUAL CS 503-1  
IN STOCK.  
NVA RANGE OF  
AMPS STOCKED.

7 DAY EXCHANGE  
PART EXCHANGE  
HOME DEMONSTRATIONS  
SERVICE FACILITIES.  
EXPERT INSTALLATIONS.

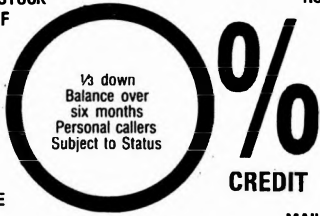

1/2 down  
Balance over  
six months  
Personal callers  
Subject to Status

%  
CREDIT

MICHELL GYRODECK  
ON DEM.  
QED RANGE OF AMPS  
IN STOCK.  
ROTEL RANGE OF AMPS  
STOCK D.  
ARISTON 'Q' DECK  
STOCKED.  
DENON RANGE OF  
CASSETTE DECKS  
IN STOCK.  
AUDIO TECHNICA  
ATF3/ATFS/007/  
OCD IN STOCK.

MAIL ORDER AVAILABLE.  
EXPORT SERVICES.  
TURNTABLE SET  
UP FACILITY

Arwa, AKG, Alphason, Audio Technica (CD Players also) ADC, AR, A&R, Beard, Briston, BLO, Castle, Celestion, Denon, Dressis, Dual, Exposure, Gale, Goldring, Goldring, Grado, Gyrodeck, Heybrook, Harmon Kardon, KEI, Logic, Linn, Amis, Monitor Audio, Michell, Magnum, Mantra, Musical Fidelity, Meridian, Mission, Mordaunt, Short, Marantz, Monster, Myst, Nakamichi, Nagaoka, NVA, NAD, Ortofon, Paragon, Philips (CD only), P.S. Audio, Proac, Protone, Quid, QED, Rata, Rotel, Revox, Revolver, Rogers, Sennheiser, Something Solid, Sonitex, Stand & Deliver, Spendor, Systemdek, Tannoy, Target, Teac, CD, Thorens, Trio CD, Walker, Wharfedale, Yamaha, Zeta



MasterCard



Visa

98 Cambridge Street, Aylesbury, Bucks

HI-FI MARKETS (0296) 28790

TOP TAPE

OPEN 10am-6pm Monday-Friday, 9.30am-5.30 Saturday

# 1st choice in East Anglia for Quality hi-fi . . .



By Roksan



QUAD  
SME

ROGERS  
ROYD  
QUAD  
GALE  
ROKSAN  
NAD  
DUAL  
DENON  
TDL  
A&R  
ORACLE  
SME  
ROTEL  
ONKYO  
QED  
AR  
SPENDOR

AUDIOLAB  
MICHELL GYRODECK  
PINK TRIANGLE  
MISSION  
FOUNDATION  
AUDIO INNOVATIONS  
SYSTEMDEK  
SNELL  
WHARFEDALE  
SONY ES  
GOLDRING  
TANNOY  
AUDIO-TECHNICA  
CELESTION  
BEARD  
MARANTZ  
SOUND ORG NISATION

• OPEN 9am to 6pm  
MONDAY TO SATURDAY  
(or by appointment)

• PROFESSIONAL INSTALLATIONS

• FULL DEMONSTRATION  
FACILITIES AVAILABLE  
• FREE CUSTOMER  
CAR PARK OUTSIDE

# Lyon Audio

Hi-Fi Sound & Design Specialists



16 PEARTREE BUSINESS CENTRE  
PEARTREE ROAD, STANWAY, ESSEX

Tel: COLCHESTER (0206) 560259

Credit Arranged - details on request

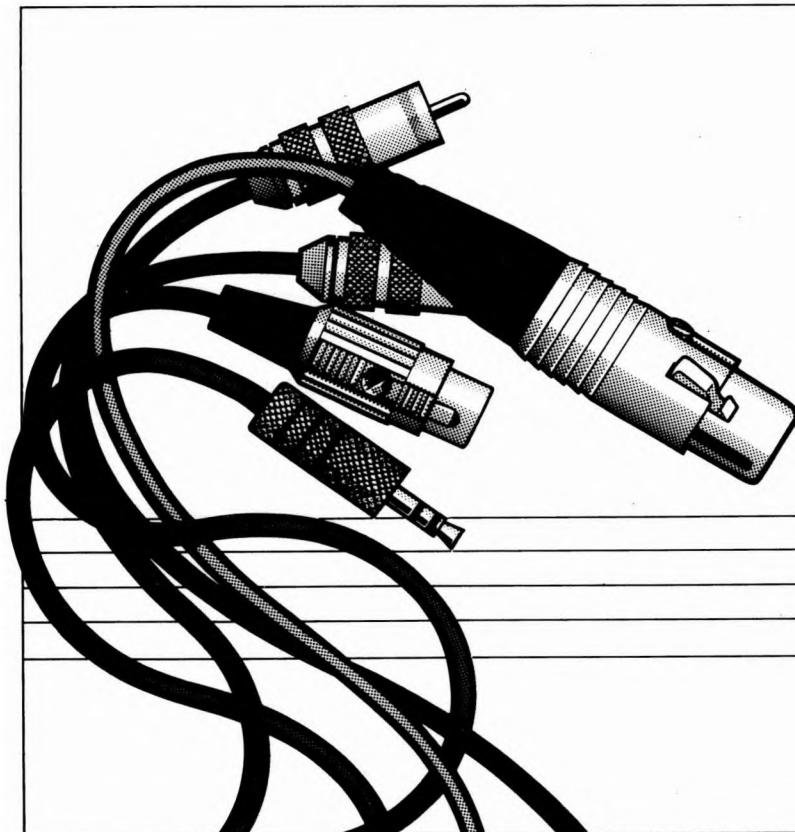

The best leads  
come from having  
the best  
connections.



CHORD

COMPANY

19 St Marks Road Salisbury Wiltshire SP1 3AY

Telephone (0722) 331674



# CHOOSING AND USING . . . CASSETTE TAPES

*Paul Miller explains tape types and outlines the test procedures in these latest reviews.*

Magnetic tape has long come of age since BASF introduced the first commercial samples over 55 years ago. It had to wait until 1962 for Philips and the advent of the compact cassette before the prospect of home recording en masse could become a reality, but even then few people could have predicted the blossoming popularity of this pocket-sized medium. Of course, new inventions like the Sony *Walkman* may have capitalised on the flexibility and convenience of tape but they also served to revitalise the medium, just as modern in-car entertainment was launched off the back of tape many years before.

Tape has diversified into several categories or types, each tape type employing a different magnetic coating which responds to the bias and equalisation of its category. Ferric, or Type I tapes are the most popular group and use a coating of iron oxide crystals which require the least applied bias current to achieve a reasonably flat frequency response. This bias signal operates way above the audio range (100kHz+) and cycles the tape through its hysteresis loop to ensure the residual (audio) magnetism is applied in the most linear fashion.

Chrome or pseudochrome tapes fall into the Type II category and employ a richer magnetic formulation that is either based on a true chromium dioxide pigment or, more commonly, a fine-grained iron-oxide that is infused with a highly active Group VIII element such as cobalt. Type II tapes require 70 $\mu$ sec equalisation to redress the treble boost applied upon recording, in addition to a higher bias current to ensure minimum distortion. Type II tapes should offer lower hiss and a wider dynamic range than Type I (ferric) tapes.

Finally, we come to the Metal or Type IV category which includes a restricted number of expensive tapes formulated with crystals of elemental metal,

either pure or as an alloy. Metal tapes can accept very high recording levels but place considerable stress on the performance of the record heads themselves. As a result the Type II category remains the most important for high quality recording.

Depending on their formulation (or chemistry), different tapes residing in the same category will require slightly different levels of applied bias to achieve a flat response (uniform sensitivity characteristic). This is desirable because an uneven sensitivity trend will only be exaggerated by the action of proprietary noise reduction (NR) circuits. However, even with a flat sensitivity response any deviations in the absolute sensitivity of the tape will still precipitate errors in the encode/decode process of a NR system.

Increasing the applied bias will reduce a tape's high frequency sensitivity but will also decrease the headroom available for treble music peaks. Adjusting the bias level will always be something of a juggling act but is probably most useful with ferric (Type I) tapes which, conventionally, suffer a higher hiss (and lower dynamic range) than either the Type II or IV formulations. Ferric's 120 $\mu$ sec equalisation time constant also highlights treble noise in comparison with the 70 $\mu$ secs chosen for the higher bias tapes.

## TEST STANDARDS AND PROCEDURE

In contrast with earlier blank tape reports, this survey conforms to the recommendations of IEC94 and so utilises the IEC Primary Reference Standards for the Type I, II and IV categories. The use of alternative, arbitrary standards are of little practical benefit if the results are also to be interpreted by the engineers and chemists that formulate the tapes for our consumption.

IEC-aligned Nakamichi *Dragon*, *CR-7E* and *CR-4E*

cassette machines were employed for the objective and subjective tests, the applied bias current being adjusted to yield a +3dB MOL (maximum output level) for Type I and II and a +4dB MOL for the Type IV Primary Reference Tapes. Apart from the sensitivity readings all dB values quoted in the text refer to a nominal IEC 0dB = 250nW/m which is a measure of magnetic flux some 1.9dB higher than the 200nWb/m Dolby level.

## Sensitivity, Relative Sensitivity and the Frequency Response:

All sensitivity values were measured at 400Hz relative to a level -20dB below the IEC 0dB flux and refer to a deviation in sensitivity either side of the appropriate IEC Primary Reference Tape. The relative sensitivity is the difference in overall level through 400Hz-10kHz between the blank tape under test and the appropriate IEC Primary Reference. A

employed and a ratio established between the blank tape's response and that of the IEC Reference Tape at -20dB. The difference between the two is the relative response of the tape itself, measured here between 20Hz-20kHz and subject to extensive computer processing to yield the published sensitivity response.

## MOL/SAT balance

MOL stands for maximum output level and refers to the level in dB relative to 250nWb/m at which point the tape under test achieves a THD (mostly 3rd harmonic) of 3 per cent at 315Hz. The SAT figure is the maximum level the tape will accommodate at 10kHz before compression or self-erasure is precipitated. The higher both values are the better, though there is little point in having bags of headroom at 315Hz if for instance, the tape saturates with the merest whiff of treble.



positive value denotes an increasing sensitivity trend which will yield a bright (treble) response on an IEC-aligned cassette machine.

Contrary to popular belief a blank tape cannot have a frequency response, only a response that is relative to the appropriate IEC Reference Tape. If a tape's response is measured directly then it will show various irregularities at both low and high frequencies that *are due to the cassette deck*, not the blank tape.

For these *Choice* tests a periodic noise source was

## Hiss, Dynamic Range and Modulation Noise

Hiss or Bias Noise is a true-RMS reading obtained by extensive averaging followed by A-wtn to remove any hum contribution. The difference between this hiss figure and the MOL 315Hz represents the dynamic range of the tape. Modulation noise is a measure of the band noise accompanying a 3150Hz driving signal recorded at the Dolby flux of 200nWb/m and includes contributions from scrape flutter, shell resonances and variations in polish of the tape's surface.

# TOP 50

## FROM STEVE BOXSHALL AUDIO

Dual, Denon, Rotel, Creek, QED, Yamaha, KEF, Wharfedale, Monitor Audio, Target, Mordaunt-Short, Systemdek, Sennheiser, Cambridge Audio, Celestion, JPL, JPW, Mantra, Audio Technica, Tannoy, Sumo, Gale, Quad, Rogers, Nakamichi, Roksan, Meridian, Helius, Marantz, Audiolab, Musical Fidelity, Ruark, Lynx, Beard, Inca Tech, Acoustic Energy, Gyrodek, Orell, Revox, Source, VDH, Oxford Acoustics, Stax, SME, Clear Audio, Oracle, Sonus Faber, P.S. Audio, Air Tangent, Koetsu, Magneplanar, Krell, Audio Research.

*Steve  
Boxshall*  
**AUDIO**

A MEMBER OF BADA

**41 VICTORIA ROAD, CAMBRIDGE (0223) 68305**



## JOIN THE CROWD

Join the crowd now going to Doug Brady Hi-Fi. An increasing number of people are discovering that at Doug Brady Hi-Fi you can listen in comfort to a very wide range of products from the inexpensive to the esoteric.

The staff are as pleasant as they are knowledgeable and will help you select what is right for your system and your budget.

Since opening the London shop last year

there have been so many customers listening and buying we have had to double the number of staff. We have also quadrupled our stock and to fit it all in we've almost doubled our size by taking over the shop next door.

If you are looking for the best in hi-fi, and the best place to buy it, phone us to book a demonstration.



## Doug Brady Hi-Fi

**Kingsway Studios,  
Kingsway North,  
Warrington, Cheshire.  
(0925) 828009.  
Open six days.**

**401 Smithdown Road,  
Liverpool L15 3JJ,  
Merseyside.  
(051) 733 6859  
Closed on Wednesday.**

**14/18 Monmouth Street,  
Covent Garden,  
London WC2H 9HB.  
(01) 379 4010.  
Open seven days.**

We stock AE • AR • Alphason • Apogee • Apollo Arcam • Aris on • Audiolab • Audioplan • Audio Research • Audio Technica • Beyer • B+W Cambridge • Castle • Celestion • Chord • Creek Cyrus • Denon • DNM • Dual • Elite • Epos Foundation • Gale • Goldring • Goodmans • Heybrook Infinity • Jecklin • JPW • KEF • Koetsu • Krell • Linn Linx • Magnapan • MAP • Marantz • Meridian Michell • Mission • MA • Mordaunt Short • Moth Musical Fidelity • NAD • Nagaoka • Naim Nakamichi • Oracle • Ortofon • Oxford • Philips Pink Triangle • QED • Quad • Rata • Revolver Revox • SD • Sennheiser • Slate • SME • Sonus Faber Sony ES • Spica • Stax • Systemdeck • Tannoy Target • TDK • Thats • Technics • Van Den Hull Veda • WBT • Wharfedale • Yamaha • among others.

**BRADY'S THE MUSICAL EXPERIENCE!**



# BASF FERRO SUPER I

BASF UK LTD., BASF HOUSE, 151 WEMBLEY PARK DRIVE, WEMBLEY, MIDDX HA9 8JG. TEL: (01) 908 3188.



Commercial audio tape was being developed long before Philips launched the compact cassette in 1962 and BASF was undoubtedly at the forefront in those early days. Its latest *Ferro Super I* ferric is a world apart from the crude formulations used as far back as 1934 and takes the current complement of Type I tapes to three. Underneath the metallic blue wrapping the actual cassette shell looks rather old-fashioned, even if the graduations on the small tape window have been picked out in gold for improved visibility.

## LAB REPORT

BASF makes play of its proprietary 'Megadium' iron-oxide formulation though, judging by the response rise of +1.3dB at 5kHz and +3dB at 20kHz (rel. 1kHz), this would appear to involve some Group VIII doping. Its 400Hz sensitivity was slightly down at -

0.6dB but the increasing relative sensitivity suggests that the applied bias should also be elevated to flatten out the HF response. Anyway, the MOL/SAT balance is fairly typical of a medium-grade ferric, as is its 56.8dB dynamic range. Only the fine -41.2dB mod noise stands out as unusual at this price point, testament to the small crystal size and good surface polish of the tape.

## SOUND QUALITY

As expected, *FSI* sounded bright and punchy though it was more likely to sound grainy or sharp at HF if the bias was increased. In this case the SAT level was reduced and the tape more easily overloaded by strong vocals or vigorous percussion for instance. The potential clarity and transparency offered is probably best realised with a smooth rather than 'sharp' sounding player, so *FSI* is not universally compatible.

## CONCLUSIONS

BASF's new mid-range ferric tape is certainly less compatible than the cheaper *FEI* formulation but, in subjective terms, it's certainly a step-up from most 'cooking' ferrics and is consequently recommended.

## TEST RESULTS

Formulation	Type I, Doped-ferric
Sensitivity	-0.6dB
Relative sensitivity	+1.8dB
MOL315Hz	+2.2dB
SAT10kHz	-2.3dB
Hiss	-54.6dB
Dynamic range	56.8dB
Modulation noise	-41.2dB
Consistency	80%
Typical Retail Price	£1.33

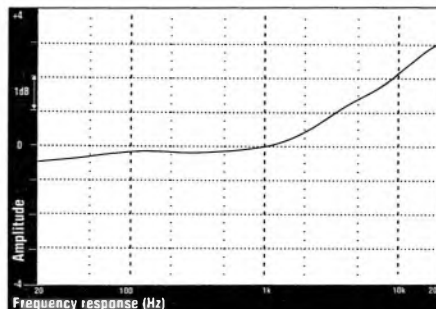

# BASF FERRO MAXIMA I

BASF UK LTD., BASF HOUSE, 151 WEMBLEY PARK DRIVE, WEMBLEY, MIDDX HA9 8JG. TEL: (01) 908 3188.



Although BASF is responsible for producing both Type I and II IEC Primary Reference tapes its premium ferric tape demonstrates scant regard for compatibility. It employs a double layer of the same 'Megadium' formulation used for *FSI* even though BASF seems to be targeting this tape at the portable and in-car markets. A further reflection of this is in the high temperature stability of the cassette shell, the 'frying pan' test apparently being a feature of some German reviews. Still, it's gratifying to know that while most of us would have shuffled off our mortal coil, BASF's *FMI* will still be going strong at 85°C!

## LAB REPORT

Compared to the cheaper *FSI*, *FMI* benefits from an improved maximum output of +3.2dB together with an increased tolerance of abuse in the treble region. In fact, the

SAT10k figure of -1.8dB means that *FMI* will accept more treble energy than most ferrics even if this has gone hand-in-hand with an increase in HF sensitivity; compared to the IEC reference, *FMI* is some +3.8dB up at 20kHz. Hiss is some 1dB worse than *FSI* but when this is traded against the improved MOL, the overall dynamic range still levels out at 56.7dB - a good figure.

## SOUND QUALITY

Once again a generally bright but sharp and clear sound ensued, the boost given to treble notes cutting through the vague and soft sound generally associated with ferric tapes. I felt that hiss was slightly more audible but individual instruments possessed a better sense of solidity and stereo focus than they had with *FSI*, as a rule this kind of see-through transparency being rare amongst ferrics.

## CONCLUSIONS

I would certainly fight shy of using Dolby noise reduction with BASF's *FMI*, especially if your deck is not equipped with a fine bias or tape-tuning facility. Nevertheless the tape is capable of very fine results, especially with up-tempo pop recordings.

## TEST RESULTS

Formulation	Type I, Doped-ferric
Sensitivity	-0.3dB
Relative sensitivity	+2.0dB
MOL315Hz	+3.2dB
SAT10kHz	-1.8dB
Hiss	-53.5dB
Dynamic range	56.7dB
Modulation noise	-41.7dB
Consistency	80%
Typical Retail Price	£1.49

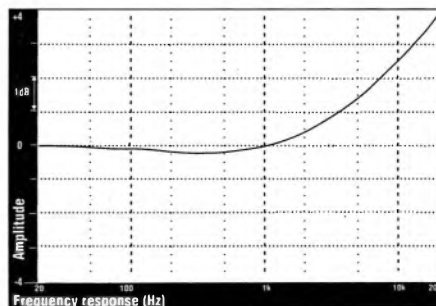

# BASF CHROME SUPER II

BASF UK LTD., BASF HOUSE, 151 WEMBLEY PARK DRIVE, WEMBLEY, MIDDX HA9 8JG. TEL: (01) 908 3188.



In the battle for higher MOLs and increased sensitivity most tape manufacturers have opted for pseudo-chrome formulations to satisfy the Type II slot. BASF, along with Philips and Agfa, is one of the few companies still utilising a true chromium dioxide pigment. *Chrome Super II* is the mid-runner in BASF's line-up though it shares the same unadventurous, high-temperature shell as the cheaper tapes in the range.

## LAB REPORT

BASF's dual-layer chrome formulation offers an alternative set of compromises when pitched against a conventional pseudochrome. Its high frequency performance is hampered by a low SAT10k ceiling of -6.2dB but the +3.9dB MOL and exceptionally low -59.7dB hiss result in a superb 63.6dB dynamic range. This wide operating

'window' is a match for the most advanced, and expensive, formulations currently available. The 400Hz sensitivity is nearly spot-on but its peculiar HF sensitivity trend (-0.76dB at 5kHz and +3.7dB at 20kHz, rel. 1kHz) will still upset Dolby or dbx NR systems. However, with a mod noise of just -43dB coupled with a vanishingly low hiss level, who needs noise reduction?

## SOUND QUALITY

Suited to rich classical works rather than synth-ridden pop tracks, BASF's *CSII* provided a very transparent, detailed and sharply focused copy of the original. There was a hint of extra warmth added to the sound but this was counterpointed by a similar emphasis of sharp, high frequency transients. Those characteristic harmonics associated with a metal-stringed guitar were also subtly modified, for example lending the instrument an icier cutting edge.

## CONCLUSIONS

With care taken over recording levels *CSII* can offer a near-silent background with the minimum compression of treble dynamics. With this excellent performance it's a wonder that the Far-Eastern competition have not persevered with true chrome pigments.

## TEST RESULTS

Formulation	Type II, Chrome
Sensitivity	-0.3dB
Relative sensitivity	-0.8dB
MOL315Hz	+3.9dB
SAT10kHz	-6.2dB
Hiss	-59.7dB
Dynamic range	63.6dB
Modulation noise	-43.0dB
Consistency	94%
Typical Retail Price	£1.99

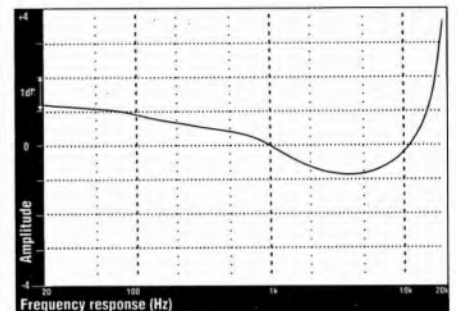

# FUJI FR-I SUPER

FUJI PHOTO FILM UK, 125 FINCHLEY ROAD, LONDON NW3 6JH. TEL: (01) 586 5900.



Fuji may have a fairly comprehensive range of domestic and in-car tapes but they still remain a trifle thin on the ground. *FR-I Super* has recently been re-packaged in a transparent shell that may not boast the same temperature stability of the tough black plastic version but it certainly looks a lot better! This attempt to bolster the aesthetic appeal of the tape is understandable but such clear shells are more commonly associated with the budget ferrics from TDK, Maxell and Thats to name but a few. Conversely, *FR-IS* with its cobalt-doped Beridox ferric particles, is a high sensitivity tape configured for use at the lower Type I bias.

## LAB REPORT

In common with That's FX, this enriched ferric will exhibit a strongly rising treble (+5.3dB at 20kHz, rel. 1kHz) unless the bias

level is increased accordingly. To Fuji's credit the -0.8dB SAT10k enables *FR-IS* to accept plenty of treble though the high -53dB hiss has restricted its dynamic range to 56.7dB - not bad but wasted in view of the tape's healthy overload margins. This poses a problem: to employ any sort of noise reduction the applied bias must be increased; this flattens out the HF sensitivity but then its SAT10k performance is compromised.

## SOUND QUALITY

Most recordings sounded brighter and sharper than the original while its low distortion helped prevent any added sibilance with strong vocals. *FR-IS* proved to be delightfully transparent and 'open' throughout the mid-band and preserved a good sense of rhythm throughout the upper bass. However some tape hiss was audible in the quieter moments.

## CONCLUSIONS

Without tape tuning *FR-IS* needs to be pushed hard if bias noise (hiss) is to be kept at bay, but watch you don't overload the tape heads first! It's worth investigating if you record a lot of potent jazz or synth music but otherwise its application is a little restricted.

## TEST RESULTS

Formulation	Type I, Doped-ferric
Sensitivity	-0.3dB
Relative sensitivity	+2.5dB
MOL315Hz	+3.7dB
SAT10kHz	-0.8dB
Hiss	-53.0dB
Dynamic range	56.7dB
Modulation noise	-40.8dB
Consistency	88%
Typical Retail Price	£1.49

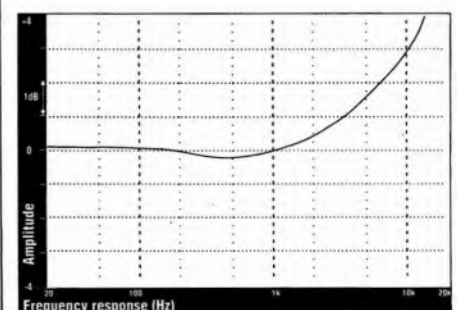

# FUJI FR-II

FUJI PHOTO FILM UK, 125 FINCHLEY ROAD, LONDON NW3 6JH. TEL: (01) 586 5900.



In many respects this tape is very similar to the lower bias *FR-IS*, from its new transparent housing, special slip sheet, guide rollers and pressure pad to the cobalt-infused iron oxide crystals that go to make up the magnetic layer. Of course the 70 $\mu$ sec equalisation time constant helps to reduce the perceived hiss level of the tape but while this enriched ferric formulation did seem a trifle 'lively' for the Type I slot, it is hardly matched to the higher bias Type II position either.

## LAB REPORT

Fuji claims to be employing a 'Super Smooth' surface treatment to reduce modulation noise while a proprietary dispersion binder increases MOLs and reduces hiss. In truth *FR-II*'s modulation noise was poor at -37.4dB, though shell resonances will also

play a part here. Its treble headroom was very low at only -6.3dB so compression or even self-erasure may result if you try to record brassy tracks at too high a level. This lack of headroom goes hand-in-hand with a declining sensitivity trend, *FR-II* is actually over-biased in the Type II position! The relative sensitivity fell to -1.6dB with an unusual -0.75dB loss at 20Hz (rel. 1kHz).

## SOUND QUALITY

Instead of proffering the kind of forward and aggressive sound that characterises many modern tape formulations, *FR-II* was very laid-back and inherently smooth in presentation. However, it also sounded a trifle 'slow' and lacklustre, qualities that robbed some forms of music of their zest and vitality. Rhythmic security was not exactly the strong suit of this tape either which erred on the soft side of neutral. On the other hand, reducing the applied bias and avoiding any sort of noise reduction did improve the tape's sense of sparkle and clarity.

## CONCLUSIONS

Fuji's Co-Beridox formulation seems to fall between two stools and is perhaps better suited to the Type I slot than for duty at higher bias levels.

## TEST RESULTS

Formulation	Type II, Doped-ferric
Sensitivity	-0.1dB
Relative sensitivity	-1.6dB
MOL315Hz	+2.3dB
SAT10kHz	-6.3dB
Hiss	-58.5dB
Dynamic range	60.8dB
Modulation noise	-37.4dB
Consistency	95%
Typical Retail Price	£1.56

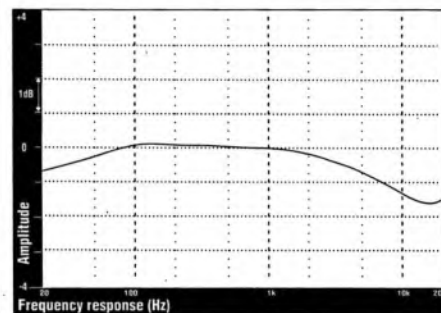

# FUJI FR-METAL

FUJI PHOTO FILM UK, 125 FINCHLEY ROAD, LONDON NW3 6JH. TEL: (01) 586 5900.



If Fuji is somewhat at odds with the IEC sensitivity trend with its cheaper tapes then the company seems to have hit the nail on the head with its *FR-Metal* Type IV derivative. This tape employs the older style, though more robust black shell of earlier Fuji tapes and apparently benefits from a monocrystalline dispersion process that ensures a very uniform coating of its 'Metalix' particles. These thin crystals are also aligned in a longitudinal fashion so as to optimise MOLs and hiss. Either way this tape does offer a very high retentivity of 3300Gauss, typical of a good metal and about double that available from ferric or pseudochrome formulations.

## LAB REPORT

Despite an odd -0.2dB sag at 150Hz, the +0.7dB 400Hz sensitivity and +1dB treble level should ensure reasonable compati-

bility. The maximum output levels are usefully high at +5.2dB (315Hz) and +0.5dB (10kHz) but the tape will have to be pushed very hard in order to accommodate the 60.6dB dynamic range. So, if you pull back on the recording level to prevent overloading the deck's heads then the -55.4dB hiss floor might become apparent.

## SOUND QUALITY

Now that the metal tape scene is contracting, *FR-Metal* is just about the only Type IV formulation that sounds obviously rich and smooth. It's not as dull as *FR-II* but I did notice a slight loss of sparkle and 'air' at high frequencies. Nevertheless, *FR-Metal* maintained a high degree of resolution and stereo focus regardless of the type of music involved, its high overload ceiling being ideal for classical works as much as pop recordings with a strong treble content.

## CONCLUSIONS

All metal tapes are expensive and Fuji's *FR-Metal* is no exception; it is a tolerant and IEC compatible formulation but just lacks that refreshing sparkle of the better Type IVs. Tentatively Recommended.

## TEST RESULTS

Formulation	Type IV, Metal Crystal
Sensitivity	+0.7dB
Relative sensitivity	+1.0dB
MOL315Hz	+5.2dB
SAT10kHz	+0.5dB
Hiss	-55.4dB
Dynamic range	60.6dB
Modulation noise	-39.2dB
Consistency	93%
Typical Retail Price	£2.99

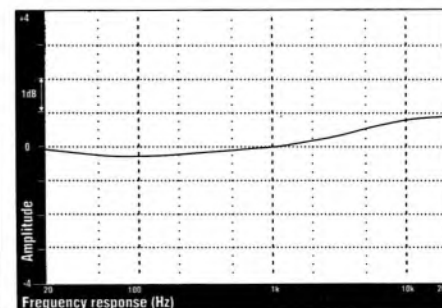

# WESTWOOD & MASON OXFORD

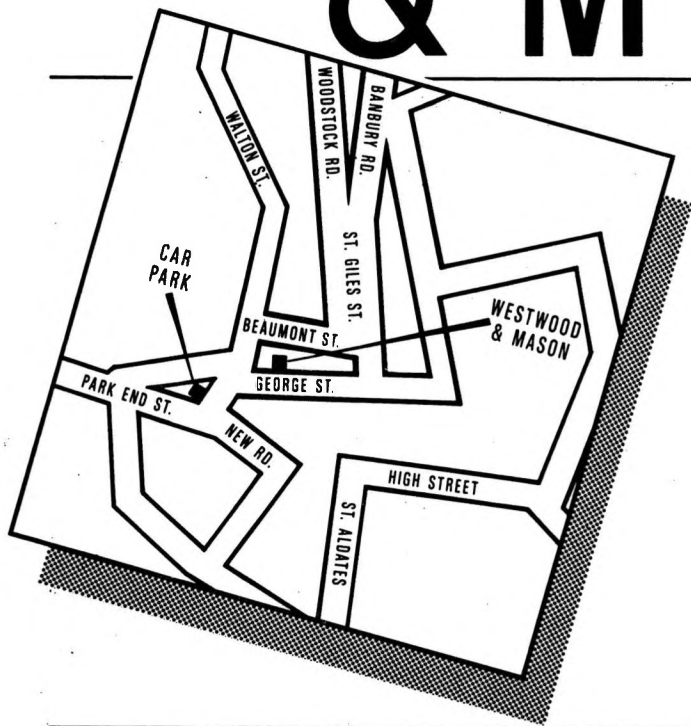

THE FINEST EQUIPMENT PLUS THE BEST SERVICE MEANS YOU ACHIEVE THE MOST MUSICAL RESULTS.

WE STOCK EQUIPMENT FROM:

A&R, AUDIO TECHNICA, BEYER, CREEK, DENON, DUAL, EPOS, GOODMAN'S, HARBETH, HEYBROOK, INCATECH, KEF, LINN, MARANTZ, MONITOR AUDIO, MORDAUNT-SHORT, NAIM, NAKAMICHI, ORTOFON, QUAD, QED, REGA, ROTEL, SENNHEISER, SPENDOR, TANNOY, TEAC, YAMAHA.



LINN

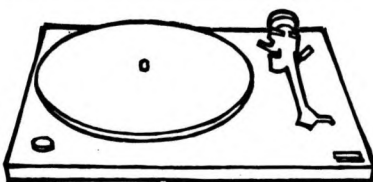

REGA

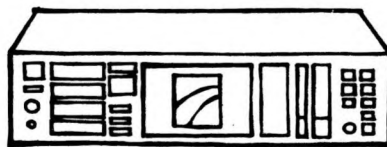

NAKAMICHI



LINN

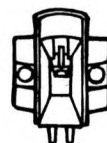

A.T.

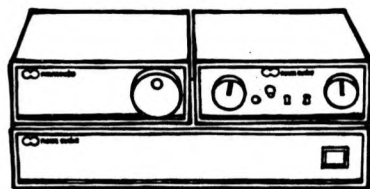

NAIM

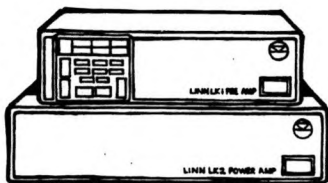

LINN

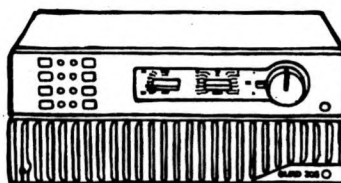

QUAD

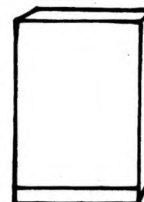

MORDAUNT-SHORT

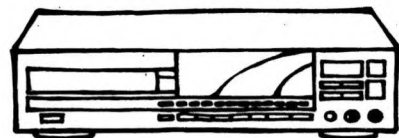
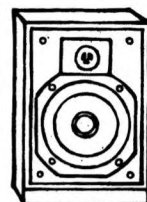

DENON

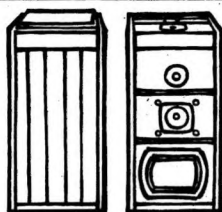

LINN



BEYER

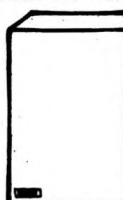

GOODMANS

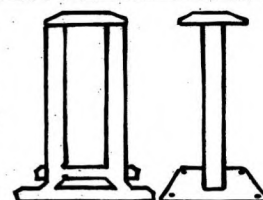

VARIOUS STANDS

WESTWOOD & MASON (OXFORD) LTD.  
46 GEORGE STREET,  
OXFORD OX1 2AN.  
TEL: 0865-247783

- ▶ PART EXCHANGE.
- ▶ DEMONSTRATIONS BY APPOINTMENT.
- ▶ CLOSED ON THURSDAYS.



# JVC UFI

JVC (UK) LTD., ELDONWALL TRADING ESTATE, 12 PRIESTLEY WAY, STAPLES CORNER, LONDON NW2. TEL: (01) 450 3282.

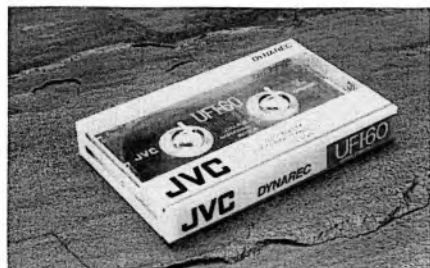

Adhering to the current trend of hi-tech aesthetics, JVC's premium ferric is now housed within a heat-resistant smoked plastic shell. In this respect it matches the *UFI* pseudochrome while the 'cooking' ferric and MR-Pro metal derivatives are still waiting to be repackaged and subsequently relaunched. Modulation noise and azimuth errors are apparently reduced in the *UFI* with JVC using a proprietary TP slip sheet, oblique hubs, low friction guide rollers and a precision pressure pad. Ho hum, it looks pretty anyway.

## LAB REPORT

This is a fairly well-balanced tape with a +1.1dB relative sensitivity that is followed by a slight kick to +2.3dB at 20kHz (rel. 1kHz). This might cause trouble with Dolby C, for instance, but the +2.3dB MOL and -55dB bias noise do endow the tape with an

appreciable 57.3dB dynamic range so you may not actually require any noise reduction in practice. The -2.7dB SAT10kHz ceiling is equally impressive but the -38.3dB modulation noise less so, particularly in view of JVC's literature on the matter.

## SOUND QUALITY

Subjectively *UFI* also proved to be a good all-rounder. It provided a punchy and lively version of the original without sounding splashy or vague in the manner of cheaper 'cooking' ferrics. It also revealed a pleasant sense of ambient depth while avoiding the tendency to 'close-in' or compress when asked to handle momentary peaks that were above the MOL/SAT levels. This expressive character was muted with the application of Dolby B noise reduction but *UFI*'s hiss was only really a problem when recording instruments like solo flute or guitar; with raunchy pop tracks noise reduction can be switched out.

## CONCLUSIONS

JVC has hit on the right formula with this tape which appears to be the most successful in its current range. It's not as adventurous as the new premium ferrics from Maxell or TDK but as a traditional ferric is certainly Recommended.

## TEST RESULTS

Formulation	Type I, Ferric
Sensitivity	-0.5dB
Relative sensitivity	+1.1dB
MOL315Hz	+2.3dB
SAT10kHz	-2.7dB
Hiss	-55.0dB
Dynamic range	57.3dB
Modulation noise	-38.3dB
Consistency	85%
Typical Retail Price	99p

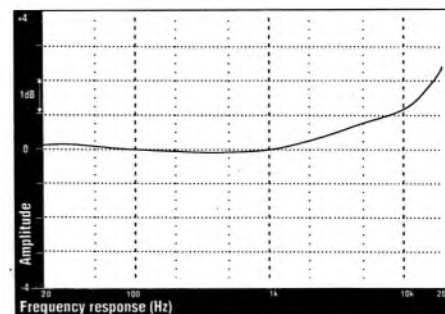

# MAXELL UDI-S

MAXELL UK, 3a HIGH STREET, RICKMANSWORTH, HERTS WD3 1HR. TEL: (0923) 777171.

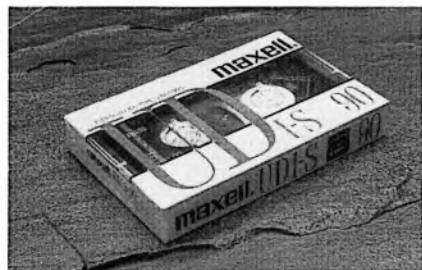

Maxell has recently consolidated its range by offering three distinct styles of tape in both the Type I and Type II categories. *UDI-S* has been launched as a replacement for the stalwart *UDI* and features the same black, arrow-window shell as the partnering *UDI-S* pseudochrome tape. Similarly, it also features Maxell's STA (Silent Tri-Arch) slip sheets which ensure a uniform, friction-free delivery of tape. The formulation itself appears to be an un-doped gamma ferric though Maxell's 'poreless Ferricrystals' are claimed to improve the tape's coercivity.

## LAB REPORT

The conventional formulation of this tape has endowed it with a fair IEC correlation, its +0.9dB relative sensitivity should not pose any matching problems despite the +1.1dB kink above 15kHz. *UDI-S*'s SAT10k figure of

-2.8dB is acceptable but the +2.6dB MOL is exceeded by the best premium ferrics currently available. Consequently, with an A-wtd hiss of -54.4dB, the 57dB dynamic range is also slightly short of the best ferrics. Nevertheless, this must be traded against relative frequency response of *UDI-S* which is flatter than most premium ferrics...

## SOUND QUALITY

Used without noise reduction and with care taken not to over-record the tape, *UDI-S* fared extremely well. Recordings were essentially neutral, in that they accurately reflected the balance of the original, and enjoyed an unusually high degree of stability, clarity and poise - a real boon when it came to recording subtle, delicate sounds. It retained the solidity and rhythmic urgency of the source where appropriate and far from sounding bright at very high frequencies it actually appeared a little damped or 'dark'.

## CONCLUSIONS

One of the best conventional ferrics on the market, *UDI-S* is a widely compatible tape that will yield equally good results regardless of your taste in music.

## TEST RESULTS

Formulation	Type I, Ferric
Sensitivity	-0.4dB
Relative sensitivity	+0.9dB
MOL315Hz	+2.6dB
SAT10kHz	-2.8dB
Hiss	-54.4dB
Dynamic range	57.0dB
Modulation noise	-38.5dB
Consistency	75%
Typical Retail Price	£1.38

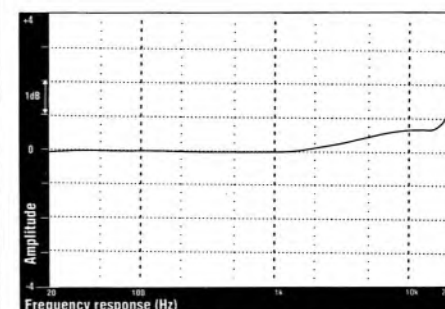

# COVENT GARDEN RECORDS

AT

# 84

**CHARING CROSS ROAD  
LONDON WC2H 0JA**

Tel: 01-379 7635/7427

Fax: 01-836 1345

Open Mon - Sat 10.00 am - 7.30 pm 2 mins from Leicester Sq Tube

**THE COMPLETE SERVICE TO ALL MUSIC LOVERS**

**AT LONDON'S FINEST COMPACT DISC CENTRE**

#### NEW RELEASES

Classical full price new releases only £9.95 and mid price £6.95 per CD for the first 30 days after issue: Decca, DG, Philips, EMI, CBS, RCA and selected others.

#### LISTENING FACILITIES

Not only the cheapest new releases in town but also full individual listening facilities - listen before you buy.

#### 7,000 CDs IN STOCK

A continually updated and growing stock of the best classical, jazz and popular compact discs.

#### SECONDHAND

Secondhand CDs bought and sold, on sale from £5.99.

#### TOKEN SCHEME

Unique scheme of one token for each CD you buy (value £10.95 and over) entitles you to a free CD when you have collected ten to the value of £10.95.

#### SPECIALISTS IN CD PLAYERS

Over 45 CD Players in stock and on demonstration. From £149 to £2,000.

#### QUALITY AUDIO

We stock an excellent range of some of the best audio equipment and loudspeakers available from famous names such as B&W, Quad, Meridian, Mission, Cyrus, Arcam, Rogers, Sony, Nakamichi, Sennheiser, Denon, Rotel, Marantz, Pioneer, Revox, Monster Cable, Yamaha, Technics, Celestion and more.

#### DELIVERY AND INSTALLATION

Free delivery in the London area on selected Hi-Fi systems. Installation service provided. Orders actioned within 24 hours subject to stock availability.

#### DEMONSTRATION

Two private demonstration rooms to audition your future purchase. Demonstration room can be prebooked. Just phone to make an appointment.

#### SERVICING

Full up-to-date department for servicing and CD Player up-grading by qualified technicians.

#### DAT

Digital Audio Tape on demonstration.

# CDV

**COMPACT DISC VIDEO NOW ON SALE AND DEMONSTRATION  
PHILIPS, MARANTZ AND PIONEER IN STOCK  
FULL RANGE OF 5", 8", AND 12" CDV FROM £4.99**

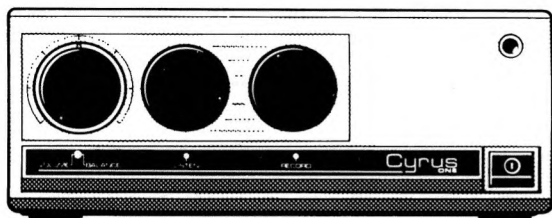

**COVENT GARDEN RECORDS  
PRESENT**

**NOW IN STOCK AND ON DEMONSTRATION**

# MISSION ELECTRONICS

New range of Mission loudspeakers now in stock and on demonstration. Also stockists of full range of Mission speakers from the 761 to 765.

PCM 2 CD Player  
Cyrus 1  
Cyrus 2  
PSX Power Supply

£499.00  
£199.00  
£299.00  
£229.00

The superb new CD Player, the PCM2 and the improved Cyrus 1 and 2 amplifiers. These outstanding products set new standards for reproducing music as it was performed.

**£50  
OFF**

#### WHEN YOU BUY A CD PLAYER

Bring this coupon in during FEB/MAR and get £1 off your next 50 CDs over £6.99 this year. Also available on Audio Components over £500.

HFC 04/89

**£6  
OFF**

#### ON PURCHASE OF 5 CDs OVER £9.95

84 Charing Cross Road, London WC2  
No Tokens Given  
Valid to end of Apr 1989

**£1  
OFF**

#### ON PURCHASE OF 1 CD OVER £9.95

84 Charing Cross Road, London WC2  
No Tokens Given  
Valid to end of Apr 1989

Sale & Special offer goods excluded Valid until end of Apr 1989

HFC 04/89

HFC 04/89

# MAXELL UDII-S

MAXELL UK, 3a HIGH STREET, RICKMANSWORTH, HERTS WD3 1HR. TEL: (0923) 777171.

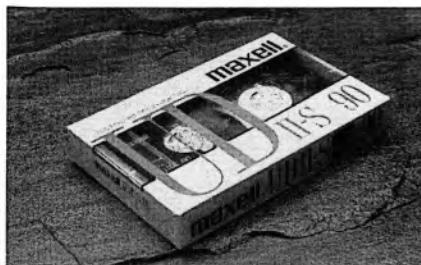

Accompanying the release of the fabulous *UDI-S*, Maxell's *UDII-S* pseudochrome effectively replaces the older *UDII* formulation. It shares the same modern-looking shell as *UDI-S* with its arrow-shaped window but may easily be distinguished by its bold red and silver packaging. Maxell appears to have based the magnetic coating of *UDII-S* on larger particles of the cobalt-doped Epitaxial ferric crystals used for the lower bias *XLI-S* tape. As a consequence of the higher Type II bias, *UDII-S* enjoys a near ruler-flat response ensuring all-round compatibility with IEC-aligned cassette machines.

## LAB REPORT

A very even sensitivity trend is one thing but this must be traded against a +2.6dB MOL and - more importantly - a -5.3dB SAT10k which is below par for a premium

pseudochrome of this type. Bias noise is suitably low at -57.5dB and this helps to stretch the final working dynamic range of 60.1dB but you should still fight shy of recording high treble levels with *UDII-S*. In its favour the -45.6dB modulation noise is a fitting tribute to the smooth operation of the tape mechanism and polished surface of the tape surface - well done Maxell!

## SOUND QUALITY

This undoubtedly helped *UDII-S* to convincingly recreate very subtle, filigree musical details. In particular, complex classical works generally sounded 'busy' without appearing muddled or diffuse. Its overall character was smooth and neutral but perhaps lacking a touch of sparkle at very high frequencies. However, many tapes can sound a trifle muted or dead with noise reduction and I have to say that *UDII-S* fared very consistently whether subject to Dolby B/C or left untouched.

## CONCLUSIONS

I cannot be as enthusiastic about *UDII-S* as *UDI-S* because the former is not quite the balanced all-rounder in its own, higher bias category. Nevertheless it is a highly compatible pseudochrome that warrants Recommendation.

## TEST RESULTS

Formulation	Type II, Doped-ferric
Sensitivity	-0.1dB
Relative sensitivity	-0.3dB
MOL315Hz	+2.6dB
SAT10kHz	-5.3dB
Hiss	-57.5dB
Dynamic range	60.1dB
Modulation noise	-45.6dB
Consistency	93%
Typical Retail Price	£1.55

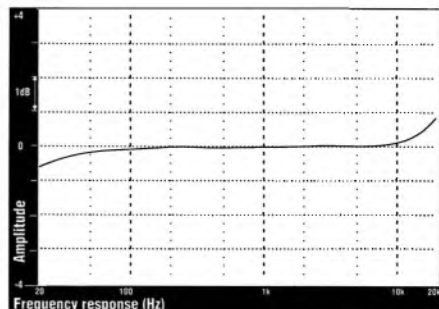

# MAXELL XLI-S

MAXELL UK, 3a HIGH STREET, RICKMANSWORTH, HERTS WD3 1HR. TEL: (0923) 777171.



This premium ferric was launched before *UDI-S* and incorporates a very attractive and highly damped black plastic housing. The viewing window has also been enlarged for improved visibility. Dubbed SS-PA or Super Silent Phase Accuracy, the cassette mechanism attempts to reduce any azimuth (phase) error while also curtailing modulation noise. Both the novel shell material and proprietary tape smoothing process have a part to play in this latter process of course.

## LAB REPORT

For once the claims for low modulation noise were borne out in the tests, -41.7dB is a fine result. *XLI-S*'s formulation is based on 'Super Fine' cobalt-doped Epitaxial ferric particles which enhance its high frequency sensitivity. Consequently the 400Hz sensitivity is not far off that recorded for *UDI-S* but its treble level

is higher at +2.3dB, in fact its relative response rises to +5.7dB at 20kHz (rel. 1kHz) indicating that *XLI-S* is under-biased in the Type I slot. Tape tuning is a must if any sort of noise modulation is to be used, for though the HF ceiling clocks in at -1.9dB, the reduced +1.7dB MOL coupled with the -55.2dB hiss level leaves *XLI-S* with only a moderate 56.9dB dynamic range. Other premium ferrics exceed this working range by a few dBs.

## SOUND QUALITY

Without any tape tuning *XLI-S* clearly sounded very light and bright, a quality that also tended to exacerbate any hiss during quiet moments. Increasing the applied bias also decreases the treble headroom but as *XLI-S* has plenty to spare this did not pose a problem - record as high as you dare and the tape should retain much of its dynamic punch and fizz. However, *XLI-S* remains a trifle mixed-up at present and can only be made to 'calm down' with technically advanced tape machines.

## CONCLUSIONS

In my view *XLI-S* is due for further re-tweaking, especially if it is to compete with the cheaper and evidently superior *UDI-S*!

## TEST RESULTS

Formulation	Type I, Doped-ferric
Sensitivity	-0.8dB
Relative sensitivity	+2.3dB
MOL315Hz	+1.7dB
SAT10kHz	-1.9dB
Hiss	-55.2dB
Dynamic range	56.9dB
Modulation noise	-41.7dB
Consistency	91%
Typical Retail Price	£1.79

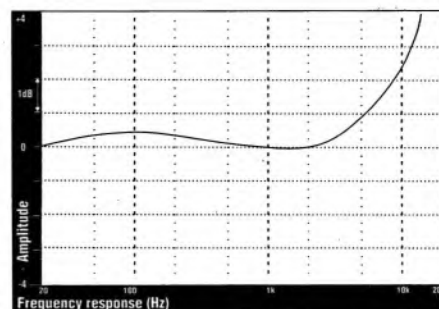

Royd audio

# The Eden Loudspeaker

"The Edens have confirmed my belief that you shouldn't have to mortgage your house to listen to records with insight and enjoyment - a David among Goliaths."

ADAM MEREDITH HI-FI REVIEW  
August 1988

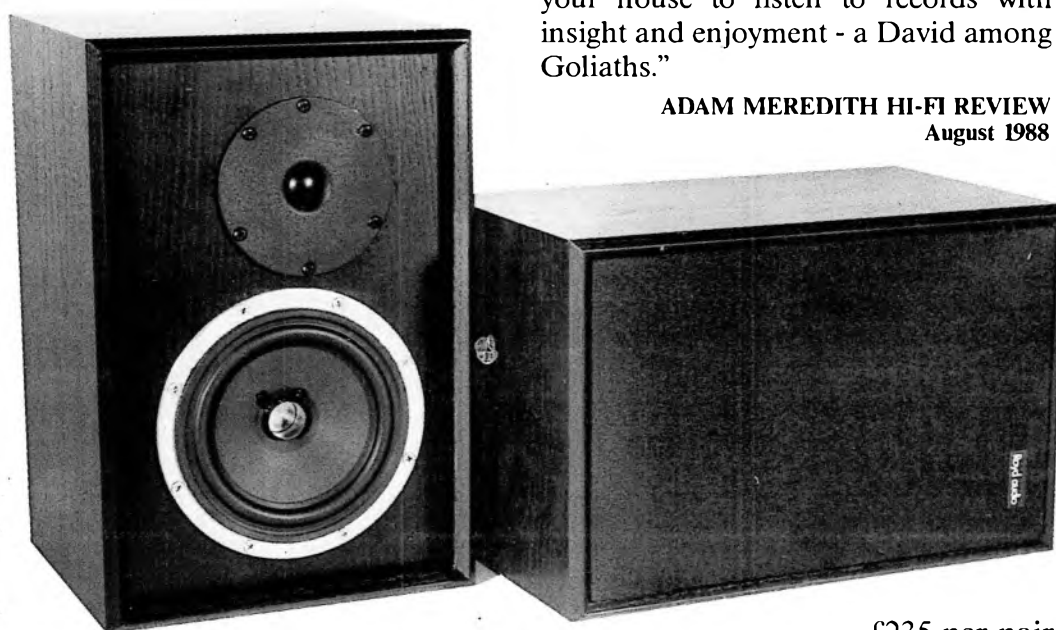

£235 per pair

AUDIO COUNSEL. OLDHAM	061-633 2602	MUSICAL APPROACH STAFFORD	0785 55145
THE AUDIO FILE. BISHOPS STORTFORD	0279 506576	MURRAY HI-FI. STOCKPORT	061-429 7666
AUDIO INSIGHT MILTON KEYNES	0908 561551	MURRAY HI-FI. HULL	0482 227867
AUDIO PROJECTS. LEEDS	0532 304565	O'BRIEN HI-FI. LONDON SW19	01-946 0331
AUDIO VENUE. LONDON SE19	01-771 7787	PHOTOCRAFT HI-FI. ASHFORD	0223 24441
BETTER HI-FI. LIVERPOOL	051-227 5007	PJ EQUIPMENT. GUILDFORD	0483 504801
CHRIS BROOKS AUDIO. WARRINGTON	0925 61212	PRACTICAL HI-FI. BLACKPOOL	0253 27703
DOUG BRADY HI-FI. WARRINGTON	0925 828009	PRO MUSICA. COLCHESTER	0206 577519
DOUG BRADY HI-FI. LONDON WC2	01-379 4010	ROBERT RITCHIE HI-FI. MONTROSE	0674 73765
WA BRADY & SON. LIVERPOOL	051-733 6859	RUSS ANDREWS HI-FI. EDINBURGH	031-557 1672
BASICALLY SOUND. NORWICH	0508 70829	RAYLEIGH HI-FI. RAYLEIGH	0268 779762
CHICHESTER HIFI. CHICHESTER	0243 776402	RAYLEIGH HI-FI. CHELMSFORD	0245 265245
THE CORNFLAKE SHOP. LONDON W1	01-631 0472	SOUND ADVICE. LOUGHBOROUGH	0509 218254
CREATIVE AUDIO. SHREWSBURY	0743 241924	SOUND ADVICE. BIRMINGHAM	021-449 3328
DF CLARK. RUSHDEN	0933 313805	THE SOUND ORGANISATION. LONDON SE1	01-403 2255
FARNBOROUGH HI-FI. FARNBOROUGH	0252 520146	THE SOUND ORGANISATION. YORK	0904 627108
GRAHAMS HI-FI. LONDON N1	01-837 4412	SOUNDWAVES. HOLBURY HANTS.	0703 899133
GRIFFIN AUDIO. BIRMINGHAM	021-692 1359	STUDIO 99. LONDON NW6	01-624 8855
LYON AUDIO. COLCHESTER	0206 560259	SHROPSHIRE HI-FI. SHREWSBURY	0743 232317
LYRIC HI-FI. BELFAST	0232 381296	TONBRIDGE HI-FI. TUNBRIDGE WELLS	0892 24677
MIKE MANNING AUDIO. YEOVIL	0935 79361		

**Royd Loudspeaker Co. Ltd.,  
Unit B2, Stafford Park 15,  
Telford, Shropshire TF3 3BB.  
Telephone: Telford (0952) 290700**

# MAXELL XLII-S

MAXELL UK, 3a HIGH STREET, RICKMANSWORTH, HERTS WD3 1HR. TEL: (0923) 777171.



Fashioned from the same high-density and acoustically 'dead' plastic as *XLI-S*, the matching cassette shell of *XLII-S* also houses Maxell's proprietary 'Super Silent' cassette mechanism. In addition to the heavily damped shell, *XLII-S* features two Silent Tri-Arch slip sheets, precision two-piece hubs and smooth running guide rollers which also help cut down on unwanted vibrations. Furthermore, the felt pressure pad has been increased in area by some 25 per cent while also allowing it to conform most accurately to the contours of the record/replay heads.

## LAB REPORT

With this high bias tape Maxell has pressed similar doped-Epitaxial ferric particles into service as those used in *XLI-S*, this accounting for its fair IEC correlation ( $\pm 0.7$ dB) from 20Hz to 10kHz. However, more recent sam-

ples of *XLII-S* have demonstrated an abrupt increase in sensitivity above 10kHz, attaining +3.9dB at 20kHz (rel. 1kHz). The +0.7dB boost around 100Hz is also rather unusual. As expected, modulation noise is suitably suppressed at -43.3dB but the 62dB dynamic range has only been arrived at courtesy of the low -59.5dB hiss floor. The LF and HF maximum output levels of +2.4dB and -5.6dB are no great shakes and indicate that *XLII-S* will be intolerant of strong treble levels.

## SOUND QUALITY

With care taken not to push the tape too hard it proffered a slightly warm but essentially faithful copy of the original. It was certainly more open and transparent through the mid-band than *UDII-S* while the sudden treble lift was only really apparent when listening to some percussive or brass instruments. There was a slight timbral modification, some added steel or 'edge' but nothing that obstructed the natural rhythm of the music.

## CONCLUSIONS

The wobbly sensitivity curve for *XLII-S* can be a little misleading as this Type II formulation actually sounded very coherent and well balanced. It's certainly worth trying out.

## TEST RESULTS

Formulation	Type II, Doped-ferric
Sensitivity	+0.1dB
Relative sensitivity	-0.2dB
MOL315Hz	+2.4dB
SAT10kHz	-5.6dB
Hiss	-59.5dB
Dynamic range	61.9dB
Modulation noise	-43.3dB
Consistency	85%
Typical Retail Price	£2.36

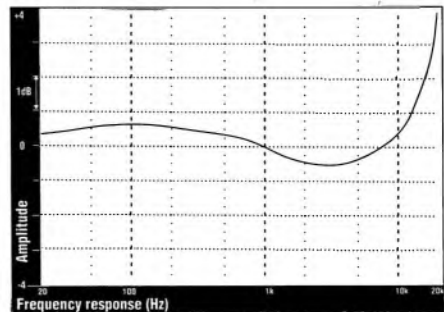

# MEMOREX HBXII

MEMTEK PRODUCTS, UNIT 4, SUMMIT CENTRE, HATCH LANE, HARMONDSWORTH, WEST DRAYTON, MIDDX UB7 0LJ. TEL: (01) 897 3939.



Memtek was formed in 1982 to maintain the manufacture and distribution of Memorex tapes in the UK and Europe subsequent to the Tandy Corporation acquiring sole rights to the Memorex brandname. This also explains the uncanny similarity between some of the cheaper Memorex tapes and Tandy's own 'Supertape' formulations. However, we shall concentrate on the two upmarket Memorex tapes, the first being *HBXII* which is a gamma ferric formulation with cobalt oxide to improve its compatibility with the Type II slot. The shell looks fairly ordinary despite featuring what Memorex euphemistically refers to as its 'new' Permanent Reference Cassette Mechanism.

## LAB REPORT

*HBXII* falls into that rare group of premium pseudochromes that suffer a falling relative

sensitivity, its irregular and drooping HF response (-1.2dB at 20kHz, rel. 1kHz) only being exaggerated by noise reduction systems. Its modulation noise is fairly low at -40dB and the useful +3.2dB MOL helps bump up the dynamic range to 61dB but a SAT10k ceiling of -5.4dB suggests that recordings of sax or trumpet should be avoided. Reducing the applied bias will help redress the response while also improving the SAT figure by a dB or so.

## SOUND QUALITY

Without recourse to tape-tuning *HBXII* sounded darkly-lit without appearing overly muffled or 'slow'. In fact it provided a surprisingly dynamic and weighty bass that urged strong rhythms across with great conviction even if this same lucidity and sense of articulation was lost to the mid and treble registers. This tape will not impress with a falsely aggressive sound but neither will it astound you with musical insight and transparency.

## CONCLUSIONS

*CRXII* is a safe pseudochrome that offers an inherently smooth balance if one that lacks a modicum of pizzazz or sparkle. Best suited to bright-sounding machines it is tentatively Recommended for reggae fans.

## TEST RESULTS

Formulation	Type II, Doped-ferric
Sensitivity	-0.1dB
Relative sensitivity	-1.6dB
MOL315Hz	+3.2dB
SAT10kHz	-5.4dB
Hiss	-57.8dB
Dynamic range	61.0dB
Modulation noise	-40.0dB
Consistency	92%
Typical Retail Price	£2.49

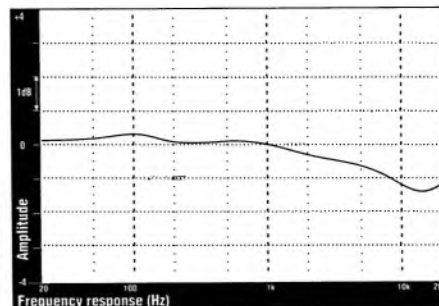

## \*\*TONICS FOR TIRED TRANSDUCERS\*\*

Cost-effective speaker upgrade kits from Wilmslow Audio.....

### AUDAX TITANIUM TWEETER UPGRADE.

Change your 1" dome tweeters for these Titanium units and enjoy crisper, cleaner response. Suitable for replacing tweeters up to 91dB sensitivity. Kit includes constant impedance level controls so that you can adjust for optimum results without any crossover modifications.

order TITANIUM 100 (100mm round plate) £43.50 pair.  
or TITANIUM 12x9 (120x90mm) +p&p £2.50

### ELAC METAL DOME TWEETER UPGRADE.

As kit above but using the Elac tweeter which has had such rave reviews. To replace units up to 89dB sensitivity.

order METAL 25DT30 (104mm round plate) £63.50 pair.  
or METAL 25DT29 (120x90mm plate) +p&p £2.50

### CONCERTO UPGRADE CROSSOVER.

Replacing the DN12 network in speakers employing the Kef B139, B110, T27 combination, this crossover greatly improves detail and definition. (Screw terminal connections) £48.95 pair+p&p £2.50

**WACOUSTIC PANELS** inhibit panel resonance and limit cabinet-induced colouration. (Foam sandwiched between two layers of bitumin.) Self adhesive. Size: 270x200x16mm. Set of 8 (will treat pair of small/med. speakers) £16 +p&p £2.50



Telephone credit card orders



**WILMSLOW AUDIO LTD.**

35/39 Church Street, Wilmslow, Cheshire  
SK9 1AS Tel: 0625 529599

Call and see us for a great deal on HiFi  
(Closed all day Mondays)

DIY Speaker catalogue £1.50 post free (export \$6)

# Audio Projects

WHEN ONLY THE BEST WILL DO...

## ARCAM ALPHA 2

WE STOCK A RANGE OF SELECTED  
COMPONENTS FROM:

A&R (CAMBRIDGE). AUDIOLAB. CREEK.  
DENON. EPOS. EXPOSURE. HEYBROOK.  
INCA TECH. LINN PRODUCTS. MUSI-  
CAL FIDELITY. NAIM AUDIO. QUAD. REGA.  
ROGERS. ROYD. TANNOY. CELEF.  
BEYER. STAX, QED.

Home trials our speciality.

Open 9.30 - 6.00 Tues - Friday. 2.30 - 5.30 Saturday.

45 Headingley Lane. Leeds. LS6 1 DP. Tel (0532) 304565

The Specialists  
in Hi-Fi  
Equipment

•  
Home/Shop  
Demonstrations

•  
Installation

•  
Mail Order

•  
Export Orders  
Welcome

The  
Sound  
Shop

for

conrad-johnson *motif*

58 THE BROADWAY,  
MILL HILL,  
LONDON NW7 3TE

**Tel: 01-906-3364**

Instant Credit Available



# MEMOREX CDXII

MEMTEK PRODUCTS, UNIT 4, SUMMIT CENTRE, HATCH LANE, HARMONDSWORTH, WEST DRAYTON, MIDDX UB7 0LJ. TEL: (01) 897 3939.



Whereas the lightly doped ferric of *HBXII* rendered it less sensitive than the most recent IEC Type II Reference tape (which is now a pseudochrome), Memorex has attempted to redress the situation with *CDXII* by employing a metal pigment designed to operate at the lower chrome bias. I imagine Memorex has coated the fine iron crystals with a passivating oxide layer to ensure the formulation does not 'age' too quickly. Either way the metal pigment does offer over twice the retentivity of a standard pseudochrome formulation.

## LAB REPORT

*CDXII* does not really offer Type IV performance in the Type II position because the limited maximum output of +2dB and higher-than-average -56.4dB hiss, squash the dynamic range down to 58.4dB. The HF

ceiling of -2.9dB is more in keeping with the better pseudochromes available, but the -37.9dB modulation noise is distinctly below par. The sensitivity trend of *CDXII* is weird and accounts for much of its distinctive sonic character: on paper it has a relative sensitivity of -1.8dB but the tape still sounds bright because of the +2.5dB rise at 20kHz (rel. 1kHz). Between 7kHz and 20kHz the sensitivity actually increases by 4dB!

## SOUND QUALITY

*CDXII* does not furnish terribly neutral recordings but it does offer a particular sharpness and vivid clarity that will appeal to pop or rock enthusiasts. In keeping with its sensitivity trend, *CDXII* also provides plenty of 'welly' at very low frequencies but this superficially impressive 'thudding' quality is wrought at the expense of some delicacy and refinement. Percussion can often sound a little hard, incisive and tiring while any sort of noise reduction should be avoided unless a powerful tape-tuning facility is on hand.

## CONCLUSIONS

*CDXII* is not a widely compatible tape and so cannot be universally recommended. It is not 'So Superior' but as Memorex also maintains, it most certainly is a 'Sound Experience'!

## TEST RESULTS

Formulation	Type II, Iron Crystals
Sensitivity	+1.4dB
Relative sensitivity	-1.8dB
MOL315Hz	+2.0dB
SAT10kHz	-2.9dB
Hiss	-56.4dB
Dynamic range	58.4dB
Modulation noise	-37.9dB
Consistency	84%
Typical Retail Price	£3.99

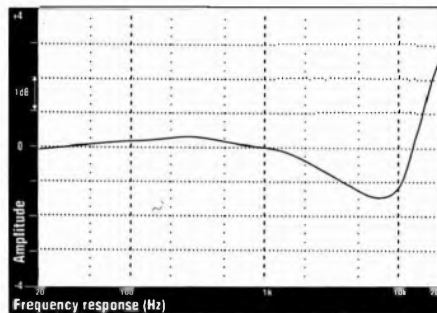

# PHILIPS FS

PHILIPS ELECTRICAL LTD., CITY HOUSE, 420-430 LONDON RD., CROYDON, SURREY CR9 3QR. TEL: (01) 689 2166.

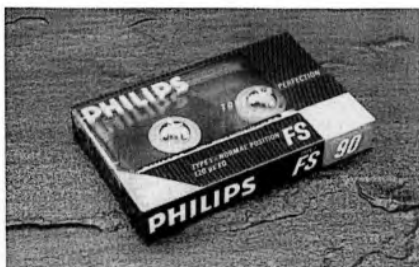

Trendy, or fashion-oriented ferric tapes began to appear in Japan a few years back and have gradually filtered their way Westwards, Philips, who introduced the compact cassette format in 1962/63 is probably the only company to produce such a tape from a European plant. *FS* is a high quality ferric tape that features a fairly rudimentary cassette see-through shell and decorated with zebra-stripes to give it a distinctive appearance. The tape mechanism is not so hot, several samples adding their own high rate speed fluctuations (flutter) to that already suffered by the deck.

## LAB REPORT

*FS* is a trifle mixed up. It offers a superb treble headroom of -1.9dB but this is linked to an increase in tape sensitivity at progressively higher frequencies, the 400Hz sensitiv-

ity may be low at -0.7dB but at 20kHz *FS* is some +3.5dB up on the IEC Reference. Hiss is high at -52.3dB but if mistracking is to be avoided then a dramatic increase in applied bias will have to be sought before any noise reduction system is applied. Consequently, the dynamic range is also restricted (55.6dB).

## SOUND QUALITY

Without tape-tuning or Dolby noise reduction Philips' *FS* ferric did suffer from audible hiss and a thin almost fuzzy treble quality that could hardly have been helped by the mechanism's own speed instability. Furthermore, the resolution of strong bass lines was diluted compared to the original, *FS* sounded tight and coherent at low frequencies but it simply lacked the impetus and warmth of the better ferrics. Nevertheless in the context of a portable stereo with miniature headphones *FS*'s bright and forward sound might be considered a bonus.

## CONCLUSIONS

A step in the right direction for Philips, *FS* ferric is a good-looking tape ideally suited to duty with *Walkmans* even if its high hiss level precludes its use with high quality cassette machines.

## TEST RESULTS

Formulation	Type I, Ferric
Sensitivity	-0.7dB
Relative sensitivity	+2.3dB
MOL315Hz	+3.3dB
SAT10kHz	-1.9dB
Hiss	-52.3dB
Dynamic range	55.6dB
Modulation noise	-39.7dB
Consistency	81%
Typical Retail Price	99p

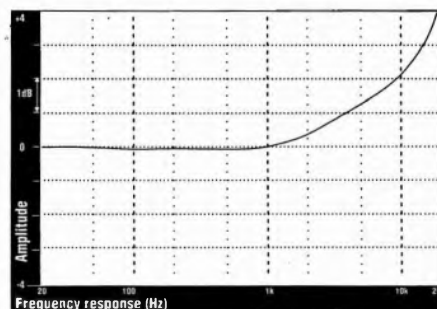

# SONY WHAT'S UP?

SONY UK LTD., SONY HOUSE, SOUTH STREET, STAINES, MIDDLESEX. TEL: (0784) 67000.



Launched to complement Sony's brightly coloured Pop-Art ferrics, *What's Up?* is a peculiar mix of the old and new. Its tough blue shell (or red, or yellow) features a broad and graduated window that appears to have been culled from earlier Sony tapes while the magnetic coating itself is of a higher quality than its current HF 'cooking' ferric! As such it's difficult to place *What's Up?* in the current Sony range, except to say that it effectively bridges the gap between the fashion ferrics and hi-tech ES formulations.

## LAB REPORT

The maximum output levels of +2.9dB (315Hz) and -2.1dB (10kHz) represent a slight improvement over Sony HF while the lower -54.4dB noise floor also gives *What's Up?* an appreciably wider 57.3dB dynamic range. More importantly perhaps is its fairly

even sensitivity trend, spot-on at 400Hz the rise at HF is gentle rather than abrupt in the manner of other 'tweaked' ferrics. It is possible to get away from using any sort of noise reduction with this ferric tape, otherwise increase the bias by 1dB before switching in Dolby B or C.

## SOUND QUALITY

In spite of its rather daft name and fashion image *What's Up?* is capable of very faithful recordings. Treble notes possessed a natural sparkle and zest that offset the inherent featheriness of the Type I format without sounding in any way bright or aggressive. Similarly the mid and upper bass were pleasantly transparent while also revealing much of the stage width and stereo depth captured by the original. *What's Up?* is no TDK AR beater and neither is it superior to Sony's own premium ferrics but it will certainly give HF a run for its money.

## CONCLUSIONS

*What's up* with this high quality ferric? Nothing at all, so buy it.

## TEST RESULTS

Formulation	Type I, Ferric
Sensitivity	-0.1dB
Relative sensitivity	+1.4dB
MOL315Hz	+2.9dB
SAT10kHz	-2.1dB
Hiss	-54.4dB
Dynamic range	57.3dB
Modulation noise	-37.8dB
Consistency	87%
Typical Retail Price	(46 mins) 99p

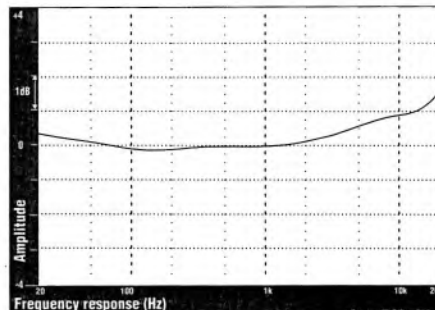

# SONY HF

SONY UK LTD., SONY HOUSE, SOUTH STREET, STAINES, MIDDLESEX. TEL: (0784) 67000.



Imitation is the sincerest form of flattery and is shown here by the transparent shells used by TDK, Maxell, That's and Fuji in addition to Sony for all its competing budget ferrics. Either that or everyone is using the same market research team . . . Anyway, Sony HF has recently been reformulated with new, lower-density ferric particles that offer a lower hiss threshold as well as a smoother tape surface to reduce modulation noise. The shell has also been tinted with an attractive grey while the internal guide rollers have been picked out in red.

## LAB REPORT

HF enjoys a very even sensitivity trend below 1kHz (-0.8dB at 400Hz) but steadily increases at higher frequencies to yield a relative sensitivity of +1.5dB and a 20kHz point of +2.55dB (rel. 1kHz). The MOL/SAT

balance is adequate but the -53.4dB hiss can only be aggravated by the brightly-lit response of the tape; as a result some increase in the applied bias level may be necessary. On a more positive note, HF's -42dB modulation noise is a fine result that betters Sony's costlier ferrics.

## SOUND QUALITY

Listening to this tape immediately after Sony's *What's Up?* ferric proved slightly disappointing for the latter was obviously the more coherent and better balanced of the two. HF did err on the light and bright side of neutral, a trait which was made all the more pointed by Dolby noise reduction. Unfortunately, without noise reduction this ferric was compromised by audible hiss and a peculiar veiled quality that pervaded the upper octaves. Low bass notes were also a little vague, lacking the tighter, punchier sound of *What's Up?*

## CONCLUSIONS

The uneven balance of this tape may not be so obvious with budget portables but, when compared to compatible tapes like That's EX and TDK D, will restrict its applications with hi-fi cassette machines.

## TEST RESULTS

Formulation	Type I, Ferric
Sensitivity	-0.8dB
Relative sensitivity	+1.5dB
MOL315Hz	+2.4dB
SAT10kHz	-2.4dB
Hiss	-53.4dB
Dynamic range	55.8dB
Modulation noise	-42.1dB
Consistency	74%
Typical Retail Price	£1.09

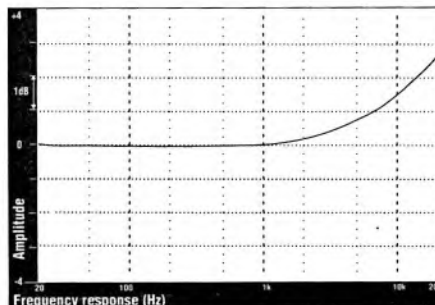



# SONY HF-ES

SONY UK LTD., SONY HOUSE, SOUTH STREET, STAINES, MIDDLESEX. TEL: (0784) 67000.



Sony's premium ferric tape has been reformulated and repackaged in a smart new shell featuring a distinctive and very wide viewing window. The 'Single Crystal Gamma' ferric particles are uniformly dispersed across the tape surface by a new binding polymer that coordinates with the metal atoms and so prevents localised clusters from appearing. Sony does not appear to have turbo-charged *HF-ES* with cobalt so the improvements in retentivity and hiss witnessed over *HF* must boil down to the minute crystal size and excellent uniformity of the magnetic coating.

## LAB REPORT

*HF-ES*'s sensitivity trend is remarkably similar to that obtained for *HF* though in overall terms the premium ferric has a +1.2dB advantage. More importantly the MOL has been boosted to +4.2dB and the bias noise

reduced to -54dB, together yielding a substantial 58.2dB dynamic range. The -38.6dB modulation noise is not quite so clever but with a -1dB HF ceiling (SAT) *HF-ES* should prove quite capable of handling high treble inputs.

## SOUND QUALITY

On audition *HF-ES* impressed with its vivid clarity and up-tempo presentation. It was not as outwardly aggressive as Memorex's *CLXII* for instance but cymbals and powerful brass wind instruments were tinged with some added 'steel' near the top of their range. Fortunately *HF-ES* can withstand the onslaught of a jazz quintet without sounding muffled or compressed in the upper octaves. Background hiss was rarely a problem so tape-tuning and noise reduction can be happily switched out. Vocal articulation was particularly well-preserved with male singers though, depending on the tape machine employed. Some users might find an increase in acid sibilance with female vocalists.

## CONCLUSIONS

This premium ferric is not a truly compatible tape but when pushed hard it delivers a clear and dynamic sound that must surely earn it a firm Recommendation.

## TEST RESULTS

Formulation	Type I, Ferric
Sensitivity	+0.4dB
Relative sensitivity	+2.0dB
MOL315Hz	+4.2dB
SAT10kHz	-1.0dB
Hiss	-54.0dB
Dynamic range	58.2dB
Modulation noise	-38.6dB
Consistency	94%
Typical Retail Price	£1.69

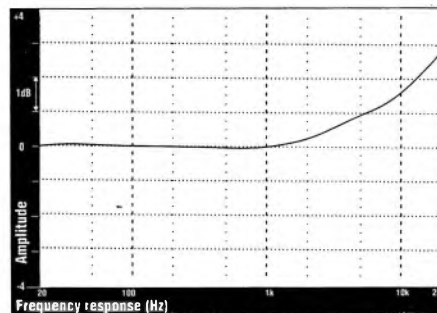

# SONY UX-S

SONY UK LTD., SONY HOUSE, SOUTH STREET, STAINES, MIDDLESEX. TEL: (0784) 67000.



Billed as Sony's 'star' tape, *UX-S* is destined to compete alongside other Type II favourites such as TDK *SA* and Maxell *XLII*. It benefits from the same tough shell construction and low-friction mechanism as the *UX* pseudochrome but Sony has managed to reduce the Uniaxial particles down from 0.43µm to 0.29µm which increases the surface specific area and retentivity while also reducing hiss. The magnetic coating is composed of a gamma ferric compound similar to that used for the Type I tapes but with a surface coating of cobalt hydroxide to pep up its sensitivity in the high bias position.

## LAB REPORT

Apart from *UX-S*'s +0.3dB relative sensitivity and +2.9dB 20kHz level (rel. 1kHz), the measured parameters bear a striking resemblance to those obtained for TDK *SA*.

The MOL is suitably high at +3.4dB and hiss exceptionally low at -59.7dB (though not quite as low as Sony would have you believe...). All this combines to give a super 63.1dB dynamic range which will allow you to record into the red and forget any notion of noise reduction. Its only weak point is the -4.1dB SAT limit which is reduced further if tape tuning is employed. Still, even with a flat response *UX-S*'s SAT level is only reduced to that of TDK *SA*'s!

## SOUND QUALITY

Subjectively too, *UX-S* mirrored those positive qualities of TDK *SA*. Bass was deep and firm, the mid pleasantly open and transparent but the very highest frequencies were just slightly muted or 'damped'. Other Sony tapes offer a more incisive view of events, but *UX-S* simply requires a little extra sparkle. However, the very balanced and faithful recordings available from this tape certainly placed it in the top league, alongside if not ahead of TDK *SA*.

## CONCLUSIONS

Sony is justifiably proud of new *UX-S* - it's a technically advanced and fine sounding product that deserves very strong Recommendation.

## TEST RESULTS

Formulation	Type II, Doped-ferric
Sensitivity	-0.3dB
Relative sensitivity	+0.7dB
MOL315Hz	+3.4dB
SAT10kHz	-4.1dB
Hiss	-59.7dB
Dynamic range	63.1dB
Modulation noise	-40.3dB
Consistency	96%
Typical Retail Price	£1.79

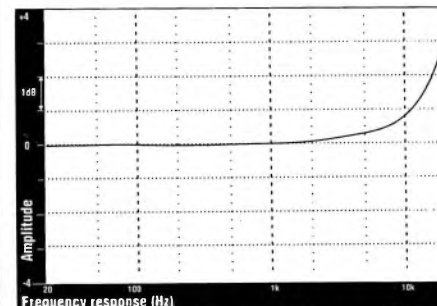

# Uxbridge Audio

Dear Sir

The EXCELLENT service, personal attention and professionalism I found with your staff, compels me to write this letter.

Having embarked on the daunting task of looking for the right music system I visited many Stores and purchased a lot of literature. I was attracted by your advertisement in What Hi-fi magazine. First class sound quality was my top priority and from another article in the same magazine I had made up my mind to purchase a system recommended therein.

A quick phone call to your Shop to find out whether you had them in stock and I was lectured on how a Music System should be purchased . . . "Have you listened to it? How do you know you will like it's sound? It isn't the same as buying a washing machine, when it has to be taken on faith that it will do the job as you want it. It is more like buying a musical instrument, where personal preference dictates. You do not need to be an expert, you only need to listen to it and decide for yourself . . ."

Not too keen on the lecture, I was, none the less, taken up by what he said, and decided to pay you a visit. This turned out to be QUITE AN EXPERIENCE! After listening to a few systems I had already decided I would be buying my own combination and not the one recommended in the magazine. A music system should, indeed, be listened to, before purchasing. In addition, the personal attention, friendly, untiring and "non pushy" attitude of your sales assistant, Jas, turned the daunting prospect of choosing the right hi-fi into a most pleasant experience.

When I first read the letter from a satisfied customer in your advert I didn't think it genuine. But after my experience I know just what he meant. I echo him in commanding you and your staff and I will not hesitate to recommend you. I, once again, thank you for the help in choosing my system and the excellent service and attention I have received at and since it's installation.

Wishing your Company every success

Mrs. F. Monteiro

**BADA**  
THE ULTIMATE IN  
SOUND ADVICE

TWO DEMONSTRATION ROOMS • 7 DAY EQUIPMENT EXCHANGE OR REFUND • UNBIASED ADVICE

MAIL ORDER ANYWHERE • 2 YEARS GUARANTEE PARTS AND LABOUR • FULL INSTALLATION SERVICE

0% INTEREST FREE CREDIT • TURNTABLES SET UP AND FULL REPAIR FACILITIES

**UXBRIDGE AUDIO**  
**278 HIGH ST. UXBRIDGE**  
**MIDDX. Tel: 0895-30404**  
**OPEN 10 TILL 6 - 6 DAYS A WEEK**

*Music from the best  
equipment at all  
price levels*

ACOUSTIC ENERGY • A&R CAMBRIDGE • AR • ARISTON • AUDIOLAB • BLQ  
CAMBRIDGE AUDIO • CANTON • CREEK • CYRUS • DENON • DUAL • EPOS  
EXPOSURE • GALE • HEYBROOK • JPW • KEF • LINN PRODUCTS •  
MANTICORE • MARANTZ • MERIDIAN • MICHELL • MISSION • NAD • NAIM  
NAKAMICHI • ONIX • QED • QUAD • REVOLVER • ROGERS • ROTEL  
RUARK • STAX • TANNOY • WHARFEDALE • YAMAHA



# SONY METAL-ES

SONY UK LTD., SONY HOUSE, SOUTH STREET, STAINES, MIDDLESEX. TEL: (0784) 67000.

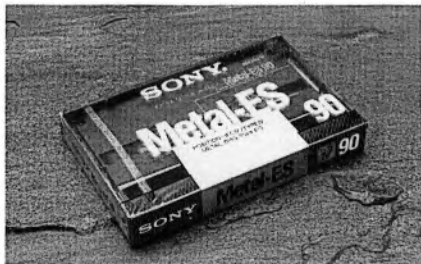

As Sony's flagship tape, *Metal-ES* is something of a misnomer. It is packaged in a bright gold wrapper, benefits from Sony's ultra-rigid Infinity shell and utilises a double layer of its new Extralloy metal pigment. Composed of iron, nickel and cobalt this formulation uses a sandwich of large and small crystals to yield an incredibly high retentivity of 3600Gauss, huge overload margins and a massive dynamic range. *Metal-ES* is the kind of tape to stretch your machine to its limits, most record heads will begin saturation long before the tape suffers >3% THD.

## LAB REPORT

Looking on the bright side, *Metal-ES* offers a vast 64.3dB dynamic range with a maximum output of +6.1dB at 315Hz, equivalent to a magnetic flux of 505nWb/m or double that available from the IEC Type IV Reference

tape! Hiss is very low so Dolby can be switched out. However, turning to the dim side, *M-ES*'s +1.2dB sensitivity and +2.4dB treble level would send any noise reduction system into fits. The sound is totally dominated by its meteoric rise at HF (+6.2dB at 20kHz) and a similar increase in sensitivity at LF (+2.3dB at 20Hz), both rel. 1kHz.

## SOUND QUALITY

I have to say that I found it impossible to obtain a wholly neutral, faithful recording with *Metal-ES* despite its incredible detail resolution and immense dynamic range. It simply sounded too hard and unforgiving for recordings to be musically enjoyable.

All the sweetness and warmth of the original was leached away to be replaced with an uncomfortable, steely coloration. In my view the cheaper pseudochromes in Sony's range do a far better job.

## CONCLUSIONS

As an academic exercise in metal tape formulation Sony *ES* is working at the limits of current technology. As a consequence its rather limited appeal as a recording medium comes as something of a disappointment.

## TEST RESULTS

Formulation	Type IV, Alloy Crystals
Sensitivity	+1.2dB
Relative sensitivity	+2.4dB
MOL315Hz	+6.1dB
SAT10kHz	+1.2dB
Hiss	-58.2dB
Dynamic range	64.3dB
Modulation noise	-40.9dB
Consistency	96%
Typical Retail Price	£4.49

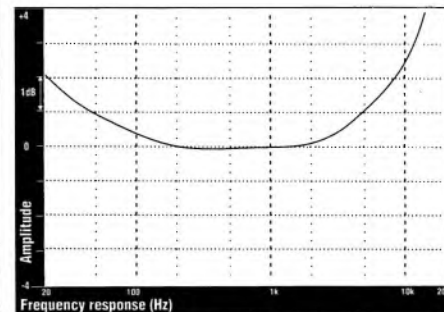

# TDK D

TDK (UK) LTD., PEMBROKE HOUSE, WELLESLEY ROAD, CROYDON, SURREY CR0 9XW. TEL: (01) 680 0023.



In an effort to retain its dominance over the blank tape market, TDK has reformulated and repackaged its most popular formulations in addition to adding a couple of replacements. TDK *D* or *Dynamic* is still the budget ferric of the range but now features a slightly tinted transparent shell in addition to the 'reliable' RC-II mechanism. Fine grained ferric particles are used to improve the MOL/SAT balance of new *D* over the older formulation but this has not been achieved at the expense of compatibility.

## LAB REPORT

Despite the slightly low -1dB 400Hz sensitivity, *D* experiences an increase in sensitivity of +0.7dB at 50Hz and +0.95dB at 20kHz (rel. 1kHz) though these errors are not likely to cause any trouble if Dolby is employed. Some form of noise reduction is required

with *D* for its hiss level, though average for a budget ferric, is still audible at -53.3dB. Of greater concern is the poor -36.6dB modulation noise and discrepancies observed in the MOL/SAT and relative sensitivity figures between different samples of TDK *D*. Hence the low 75 per cent consistency rating.

## SOUND QUALITY

Choosing the best sample of TDK *D*, I was rewarded with a basically faithful copy of the original but one that sounded a little veiled or indistinct. It certainly did not deteriorate to the point of sounding thick or unpleasant but *D*'s slightly soft treble character did vary according to the sample chosen. All 'cooking' ferrics display this innocuous fuzzy quality to some degree but TDK *D* was perhaps that much more transparent and musically convincing compared to much of the competition.

## CONCLUSIONS

TDK *D* is as compatible and user-friendly as ever while matching the modern see-through aesthetics of the other popular Type I brands. The variations from sample to sample are a little worrying but even this cannot prevent a very warm Recommendation.

## TEST RESULTS

Formulation	Type I, Ferric
Sensitivity	-1.0dB
Relative sensitivity	-0.2dB
MOL315Hz	+2.3dB
SAT10kHz	-3.7dB
Hiss	-53.3dB
Dynamic range	55.6dB
Modulation noise	-36.6dB
Consistency	75%
Typical Retail Price	£1.20

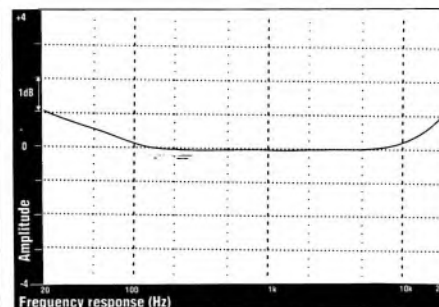

# HI-FI-CORNER



*At the original Hi-Fi-Corner*

**We Offer:**

- ★ **FRIENDLY SERVICE**
- ★ **14 DAY EXCHANGE IF NOT ENTIRELY HAPPY**
- ★ **TWO YEAR GUARANTEE**
- ★ **QUALITY BRANDS —**
  - Alexander, Gale, Spendor, Ruark, Celestion,
  - YBA, A&R, Rotel, EAR, NAD,
  - Pink Triangle, Alphason, Revolver
  - + More.
- ★ **CREDIT FACILITIES —**  
**WRITTEN DETAILS ON REQUEST: APR VARIABLE**
- ★ **SEPARATE DEMONSTRATION AREA**



# HI-FI-CORNER

**1, Haddington Place, Edinburgh  
(Off Leith Walk)**

**Tel: 031-556-7901**

**Branches At:**

**FALKIRK**  
44, Cow Wynd  
Tel: 0324 29011

**GLASGOW**  
52, Gordon Street  
Tel: 041 248 2840

**EDINBURGH**  
Rose St Precinct  
Tel: (031) 220 1535

*James  
Kerr*  
..... a touch of class

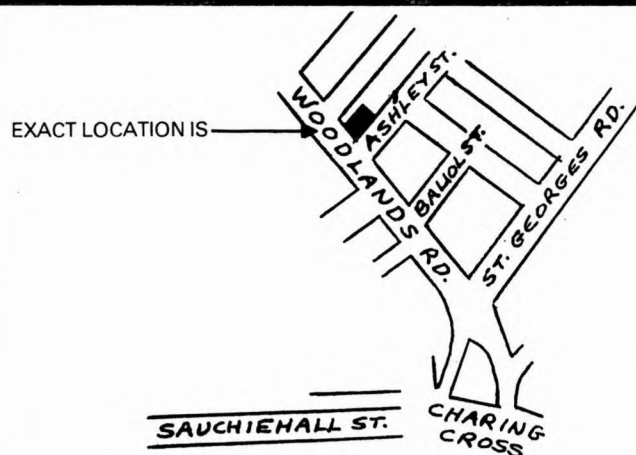

A warm welcome awaits you at Scotland's oldest established hi-fi specialist.

If you haven't visited us recently you may not be aware of our refurbishment programme.

We have recently completed our new listening room where you can listen to equipment from Acoustic Energy, Source, Elite, Spendor, Pink Triangle, SME, Denon, Luxman, Quad and many other selected products.

Our classical record department offers free advice to those wishing to venture into classical music but didn't "know the number of that tune".

We're also happy to offer advice on upgrading your existing equipment or help you if you're buying your first.

*We Look Forward To Seeing You Soon.*

98/110 WOODLANDS ROAD

# GLASGOW

Tel: 041-332-0988

Closed Mondays

Open 9.30-5.30 Tues-Sat

# TDK AD

TDK (UK) LTD., PEMBROKE HOUSE, WELLESLEY ROAD, CROYDON, SURREY CR0 9XW. TEL: (01) 680 0023.

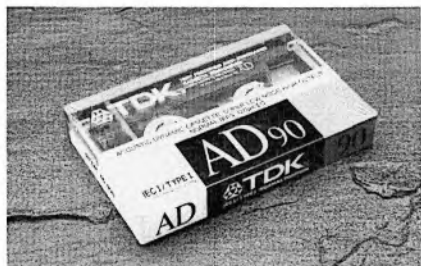

TDK rightfully claims that its longstanding *AD* is one of the quietest ferrics currently available, though even *AD* is bettered by the costlier *XLIS* from Maxell. Ultra-fine ferric particles are employed with a special binder that ensures a uniform dispersion of the pigment, improving on TDK *D* in almost every area of performance. Aesthetically too, TDK *AD* is a step in the right direction with its new High Precision Anti-Resonant (HP-AR) mechanism and stylish H-shaped viewing window – ordinary ferrics look positively old-fashioned!

## LAB REPORT

Hiss is suitably low at  $-54.6\text{dB}$  (A-wtd) and this together with its useful  $+3.5\text{dB}$  MOL ensures a wide  $58.1\text{dB}$  dynamic range. The HF ceiling is also impressively high at  $-1.1\text{dB}$  but this is inevitably linked to the

crazy increase in sensitivity above  $1\text{kHz}$ . Under-biased in the Type I slot, *AD* rockets to  $+4.95\text{dB}$  at  $20\text{kHz}$  (rel.  $1\text{kHz}$ ) which is sufficient to knock most noise reduction systems senseless. My advice would be to avoid noise reduction and push the tape as hard as possible to make the most of its available dynamic range.

## SOUND QUALITY

Without any prior tape-tuning *AD* sounded very bright and clear without appearing objectionably coarse or edgy. It certainly avoided the slightly vague fuzziness of TDK *D* but also lacked a similar impetus at very low frequencies. *AD* is a sparkling articulate and 'fast' sounding tape ideally suited to rock or pop program. It is not entirely faithful but it is very exciting without appearing overly aggressive or forward – a difficult line to tread, this.

## CONCLUSIONS

If your deck is already a trifle under-biased and has the tendency to sound bright then *AD* is probably not such a good choice. If tape tuning is available however, then *AD* represents a fine buy.

## TEST RESULTS

Formulation	Type I, Ferric
Sensitivity	$-0.2\text{dB}$
Relative sensitivity	$+2.2\text{dB}$
MOL315Hz	$+3.5\text{dB}$
SAT10kHz	$-1.1\text{dB}$
Hiss	$-54.6\text{dB}$
Dynamic range	$58.1\text{dB}$
Modulation noise	$-38.2\text{dB}$
Consistency	95%
Typical Retail Price	£1.50

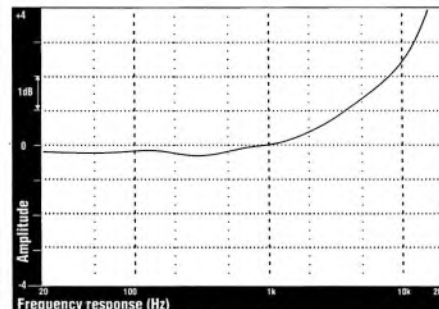

# TDK AR

TDK (UK) LTD., PEMBROKE HOUSE, WELLESLEY ROAD, CROYDON, SURREY CR0 9XW. TEL: (01) 680 0023.



Developed to replace the older *AD-X* formulation, TDK has released two new formulations called *AR* and *AR-X*. The cheaper (*AR*) version is apparently available in C46, 54, 60, 80, 90 and C100 minute lengths! *AR* is actually something of a technical marvel. It uses the same newly-developed HP-AR mechanism as *AD* but its magnetic coating is based on very new non-porous iron-oxide particles that are densely and uniformly packed using a proprietary binder system. It's clothed in TDK's revised packaging and may easily be distinguished by its gold and maroon wrapper.

## LAB REPORT

Technically, *AR* offers a glimpse of the future while still being hampered by the restraints of today. For example, *AR*'s MOL is a truly massive  $+6.2\text{dB}$  (higher than any other tape in existence, including the metals) while at

higher frequencies its equivalent SAT figure is reduced to just  $-2.1\text{dB}$ . There's little point having bags of headroom midband if the tape is going to overload far quicker in the treble. This may endow *AR* with a fabulous  $59.1\text{dB}$  dynamic range but with tape-tuning to redress the  $+3\text{dB}$  rise at  $20\text{kHz}$  its SAT ceiling will be squashed down further.

## SOUND QUALITY

This tape possesses an odd MOL/SAT balance that makes it uniquely suited to recording heavyweight orchestral works, lovers of jazz or synth-pop beware. Bearing this in mind *AR* provided a quite unfettered and wholly transparent account of the original – there was little or no muddling of instruments during complex sequences while the sensation of stage width and stereo depth was quite uncanny. Bass notes were rich and firm, vocals highly expressive without suffering any additional sibilance but push *AR* too hard with percussion, for instance, and the treble will 'glaze' rapidly over.

## CONCLUSIONS

*AR* is a remarkable if slightly unblanced formulation that still points the way for other premium ferrics to follow. Buy it and try it.

## TEST RESULTS

Formulation	Type I, Ferric
Sensitivity	$+0.9\text{dB}$
Relative sensitivity	$+1.2\text{dB}$
MOL315Hz	$+6.2\text{dB}$
SAT10kHz	$-2.1\text{dB}$
Hiss	$-52.9\text{dB}$
Dynamic range	$59.1\text{dB}$
Modulation noise	$-41.5\text{dB}$
Consistency	80%
Typical Retail Price	£1.55

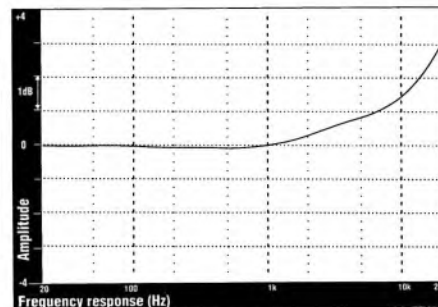

# TDK SF

TDK (UK) LTD., PEMBROKE HOUSE, WELLESLEY ROAD, CROYDON, SURREY CR0 9XW. TEL: (01) 680 0023.



Kicking off on the bottom rung of TDK's Type II category, *SF* or *Super Fidelity* has its work cut out if it's to make any impact in the shadow of the new *AR* and *AR-X* ferrics. *SF*, like all TDK's tapes, has been modified to subtly uprate its performance, in this case using carefully oriented needle-shaped Avilyn particles to increase the pigment density. *SF* features the HP-AR mechanism and H-shaped viewing window used with the cheaper ferrics in addition to the ST slip sheet which ensures a smooth tape delivery. Once out of its case there is little to distinguish *SF*, but while clothed in its dull gold wrapper it looks quite different from any of the other tapes.

## LAB REPORT

Whereas the Avilyn formulation gave a bright response with the lower bias *AR-X* tape, in

the higher bias Type II position it lends *SF* a sensitivity which actually falls with increasing frequency ( $-1.6\text{dB}$  at  $20\text{kHz}$  rel to  $1\text{kHz}$ ). This will tend to make the tape sound even duller if used with noise reduction but with a hiss floor of  $-59.1\text{dB}$  and a dynamic range of  $61.2\text{dB}$  such action is unlikely to be necessary. By reducing the bias slightly not only will the HF response be lifted but the  $-5.9\text{dB}$  SAT level will also be improved.

## SOUND QUALITY

Fortunately *SF* did not sound dim or lacklustre, its gently tilting response yielding a rich and smooth sound that was detailed without being incisive or tiring. In many respects it sounded like TDK *D* but with added resolution and 'presence' – not a bad result overall.

## CONCLUSIONS

Sandwiched between the excellence of TDK's *AR-X* and *SA* formulations *SF* could easily have paled into insignificance. It is neither as immediate or transparent as these two star performers but as a bargain-basement pseudochrome it puts in a creditable performance.

## TEST RESULTS

Formulation	Type II, Doped-Ferric
Sensitivity	$-0.3\text{dB}$
Relative sensitivity	$-1.0\text{dB}$
MOL315Hz	$+2.1\text{dB}$
SAT10kHz	$-5.9\text{dB}$
Hiss	$-59.1\text{dB}$
Dynamic range	$61.2\text{dB}$
Modulation noise	$-40.1\text{dB}$
Consistency	89%
Typical Retail Price	£1.60

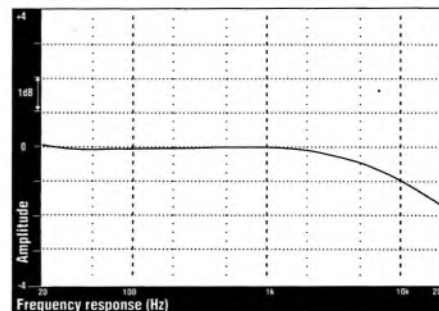

# TDK AR-X

TDK (UK) LTD., PEMBROKE HOUSE, WELLESLEY ROAD, CROYDON, SURREY CR0 9XW. TEL: (01) 680 0023.



*AR-X* is TDK's premium ferric tape and most closely reflects the enriched ferric formulation used earlier for *AD-X*. It employs a dual-layer of TDK's famous Avilyn particles that are graded to obtain a very high packing density and therefore increase the retentivity of the tape. TDK has used its Super Precision Anti-Resonance (SP-AR) mechanism for this top ferric which comprises a sandwich of materials to help reduce unwanted tape and shell vibrations. The H-shaped window has also been replaced with a rectangular affair that looks rather similar to those employed by Sony.

## LAB REPORT

Typical of a pseudochrome designed to operate at the lower Type I bias, *AR-X* displays an alarming rise in sensitivity at HF ( $+6.3\text{dB}$  at  $20\text{kHz}$ , rel.  $1\text{kHz}$ ) that can only be quashed

by judicious application of the fine bias control. Compared to *AR* though, *AR-X* possesses a superior MOL/SAT balance that offers bags of headroom at all frequencies. The level of hiss is also lower but the overall dynamic range remains fairly constant at  $59\text{dB}$ , as does the  $-41\text{dB}$  modulation noise.

## SOUND QUALITY

The subjective performance of *AR-X* is strongly influenced by its rising top end which yields a bright and often very icy, piercing balance if not rectified with tape tuning. Either way, noise reduction is a certain 'no-no'. Once tuned-in *AR-X* afforded a solid and highly tactile sound that had more in common with a fine Type II tape than a premium ferric. With the right ancillaries *AR-X* offers an unbeatable performance.

## CONCLUSIONS

*AR-X* is not as music-dependent as *AR* but its success is partially governed by the sophistication of the partnering cassette machine; if yours lacks a fine bias control then *AR-X* is not going to be suitable. Otherwise it joins *AR* as a Reference quality tape at this price point.

## TEST RESULTS

Formulation	Type I, Doped-Ferric
Sensitivity	$+0.7\text{dB}$
Relative sensitivity	$+2.8\text{dB}$
MOL315Hz	$+4.8\text{dB}$
SAT10kHz	$+0.1\text{dB}$
Hiss	$-54.2\text{dB}$
Dynamic range	$59.0\text{dB}$
Modulation noise	$-41.2\text{dB}$
Consistency	85%
Typical Retail Price	£1.85

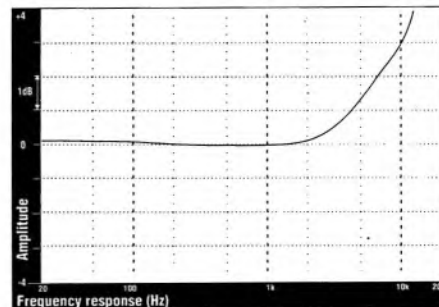

# TDK SA

TDK (UK) LTD., PEMBROKE HOUSE, WELLESLEY ROAD, CROYDON, SURREY CR0 9XW. TEL: (01) 680 0023.



Whenever a tape manufacturer decides to revamp an existing and very popular formulation there is always the danger that it may end up sounding worse. Fortunately this is not the case with the new SA which benefits from the further miniaturisation of TDK's renowned Super Avilyn particles. SA was first launched in 1975 and started a trend towards the pseudochrome formulations that have all but ousted the true chrome tapes that are available today. New SA bears little technical similarity with its forebear just as its mechanical construction and aesthetics have also come on in leaps and bounds.

## LAB REPORT

New SA offers an uncanny sensitivity match with the IEC Type II Reference from 20Hz-10kHz, rising slightly thereafter to peak at +1.1dB at 20kHz (rel to 1kHz). Its A-wtd

hiss figure of  $-59.7\text{dB}$  is exceptionally good for a middle-market pseudochrome and this, together with its  $+3.8\text{dB}$  MOL results in an overall dynamic range of  $63.5\text{dB}$ . Impressive stuff. Only the  $-4.9\text{dB}$  SAT ceiling need give any cause for concern but avoid powerful treble peaks and SA will be in the clear.

## SOUND QUALITY

Inherently neutral and strictly faithful to the original source, TDK SA is one of the very few tapes that preserves the fluidity and complex timbral structure of music in a convincing fashion. There is no extra warmth, bloom or brightness but there is no fuzziness or sense of 'processing' either. It is, quite simply, the closest thing yet to the sound of 'no tape'!

## CONCLUSIONS

TDK SA is my favourite all-round tape. It is just about the only ultra-high performance formulation that does not require tuning-in while offering a level of fidelity that is unmatched by virtually any tape at any price. Highly Recommended.

## TEST RESULTS

Formulation	Type II, Doped-Ferric
Sensitivity	+0.3dB
Relative sensitivity	-0.2dB
MOL315Hz	+3.8dB
SAT10kHz	-4.9dB
Hiss	-59.7dB
Dynamic range	63.5dB
Modulation noise	-40.2dB
Consistency	94%
Typical Retail Price	£2.05

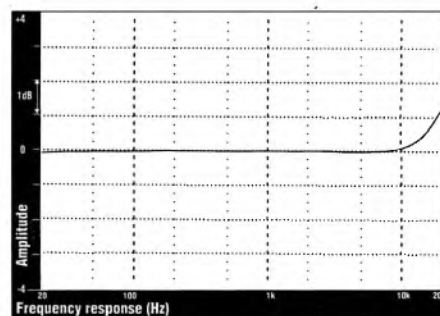

# TDK MA-X

TDK (UK) LTD., PEMBROKE HOUSE, WELLESLEY ROAD, CROYDON, SURREY CR0 9XW. TEL: (01) 680 0023.



The cheaper of TDK's two metal tapes, new MA-X is now built into the luxurious 'Unified Two-Layer' shell which sports a glossy top layer and black plastic lower housing, which combine to minimise unwanted resonances. This is all part and parcel of the SP-ARII mechanism that is also utilised by the cheaper SA-X pseudochrome tape. MA-X, being a metal tape, uses a pure metal (alloy) crystal pigment for operation at high bias, though its  $4\mu\text{m}$  coating thickness has resulted in a slightly lower retentivity than for example Sony Metal-ES.

## LAB REPORT

Early samples of MA-X suffered from a degree of inconsistency, particularly with respect to the HF sensitivity and relative sensitivity level, the latter now settling out at  $+1.4\text{dB}$ . Compared to some other metals, MA-X is now

a reasonably compatible formulation though the problem of Dolby errors is hardly likely to arise bearing in mind the tape's  $63.1\text{dB}$  dynamic range. The real problem arises in accommodating this dynamic range (which is still exceeded by TDK SA) because the  $+5.9\text{dB}$  MOL will place considerable stress on the quality of the deck's own record heads.

## SOUND QUALITY

Subjectively MA-X is an unflappable tape that affords a faintly lightweight but thoroughly consistent sonic 'character' with all types of music. I do not mean to say the tape always sounds the same, simply that it captures the essence of an awesome orchestral movement with the same dexterity and poise that it would reveal an undemanding solo instrument. On balance it is not as neutral and therefore as faithful as TDK SA but it is able to withstand punishingly high treble levels without audible compression.

## CONCLUSIONS

If you record a lot of jazz then MA-X could be just the ticket, otherwise the cheaper pseudochromes will provide a comparable fidelity.

## TEST RESULTS

Formulation	Type IV, Alloy Crystals
Sensitivity	+1.2dB
Relative sensitivity	+1.4dB
MOL315Hz	+5.9dB
SAT10kHz	+1.2dB
Hiss	-57.2dB
Dynamic range	63.1dB
Modulation noise	-41.2dB
Consistency	92%
Typical Retail Price	£3.80

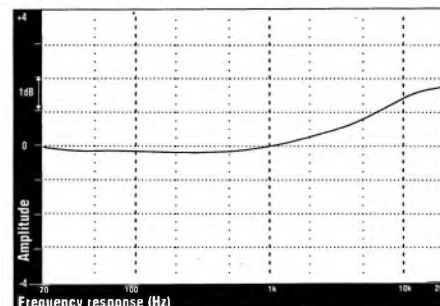

# STILTON AUDIO SYSTEMS

*Simply better hi-fi*

## STILTON AT-F3 & AT-F5 CARTRIDGES

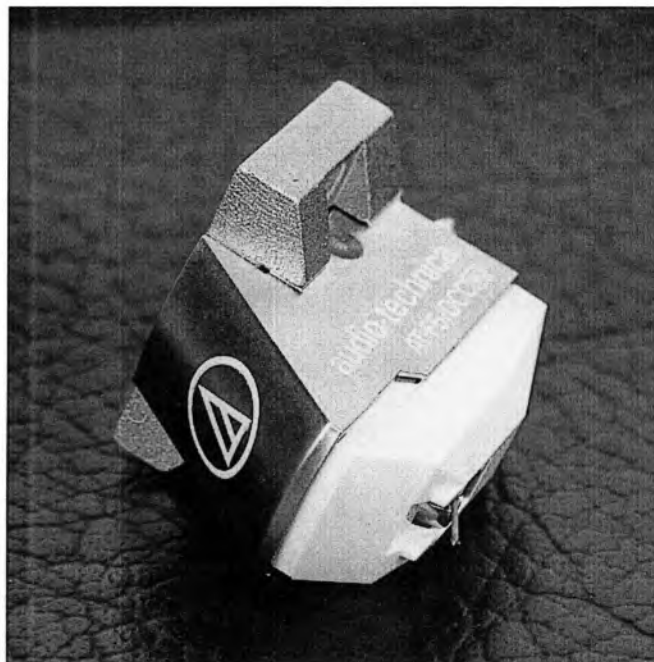
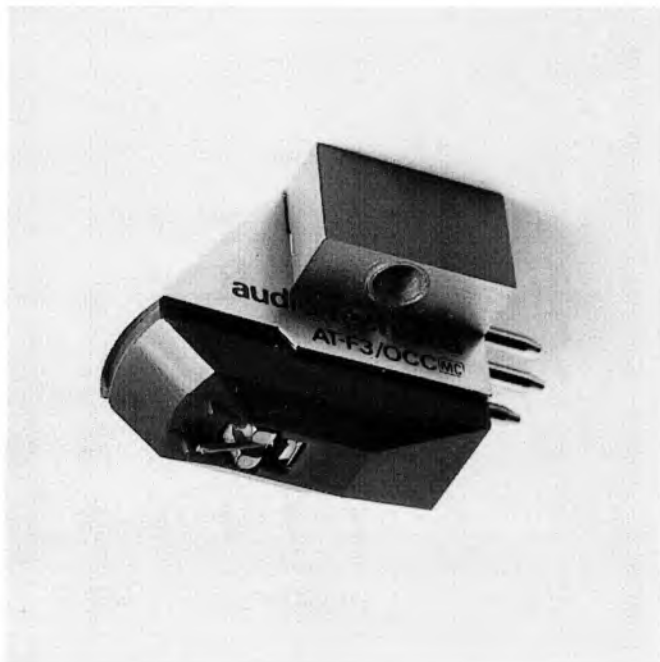

"There isn't a cartridge below £200 that can take on either of these bruisers and win!

**MALCOLM STEWARD HI- I REVIEW AUGUST 1988**

"The transformation of the ATF5 is little less than magical"

**ALVIN GOLD HI-FI ANSWERS DECEMBER 1988**

"The ATF5SB proved to be significantly better than the standard version"

**ALVIN GOLD HI-FI ANSWERS DECEMBER 1988**

**Have your AT-F5 upgraded for £35 + VAT**

**Modified AT-F3 £109.95 AT-F5 £139.95**

**489 Lincoln Road, Peterborough PE1 2PE.  
Tel: (0733) 558838**

We are also stockists of : A&R — Audio Technica — Celestion — Cyrus — Dual — Exposure — Inca Tech — JBL  
Linn Products — Mantra — Meridian — Mission — Mordaunt Short — Musical Fidelity — NVA — Revolver  
Roksan — Ruark — QED — Stax — Wharfdale — Yamaha



# THAT'S RX

HARMAN (AUDIO) UK LTD., MILL STREET, SLOUGH, BERKS SL2 5DD. TEL: (0753) 76911.



Taiyo Yuden, the parent company responsible for That's tapes, has produced a number of weird and wonderful formulations in recent years so the excellent IEC correlation of *RX* is something of a departure for this Japanese giant. That's *RX* is the latest tape to emerge from this company, its status as a budget ferric being reinforced by the lightly tinted transparent shell that provides all-round visibility. In this respect *RX* parallels competing Type I tapes from Sony, TDK and Maxell even though its 'Close-Spinelic' gamma ferric formulation is fairly individual.

## LAB REPORT

Earlier samples were a little variable but the most recent *RX* ferrics have demonstrated a superb match with the IEC Primary Reference. This tape is entirely compatible with all noise reduction systems as a result of its

highly uniform sensitivity. However, the low  $-54.3\text{dB}$  hiss and fine  $+3.8\text{dB}$  MOL endows *RX* with a most impressive ( $+58.1\text{dB}$ ) dynamic range for a ferric tape, so in many cases Dolby noise reduction may not be required. *RX* will tolerate roughly the same levels of treble as TDK *D* for instance but its SAT figure of  $-3.7\text{dB}$  is  $1\text{dB}$  or so worse than other budget ferrics.

## SOUND QUALITY

As befits a highly compatible tape, *RX* sounded both neutral and faithful to the source though the limitations of the budget magnetic coating were manifest as a slight warming or thickening effect with complex classical works. The tape sounded very much in control at higher frequencies but this was also part-and-parcel of its articulate and slightly reserved delivery. Still, in general terms this was preferable to the vague or clothly sound of inferior budget ferrics.

## CONCLUSIONS

*RX* is certainly That's most compatible and well-balanced tape to date while its magnetic technology leads the budget field by a considerable margin.

## TEST RESULTS

Formulation	Type I, Ferric
Sensitivity	$-0.1\text{dB}$
Relative sensitivity	$-0.1\text{dB}$
MOL315Hz	$+3.8\text{dB}$
SAT10kHz	$-3.7\text{dB}$
Hiss	$-54.3\text{dB}$
Dynamic range	$58.1\text{dB}$
Modulation noise	$-38.4\text{dB}$
Consistency	89%
Typical Retail Price	£1.09

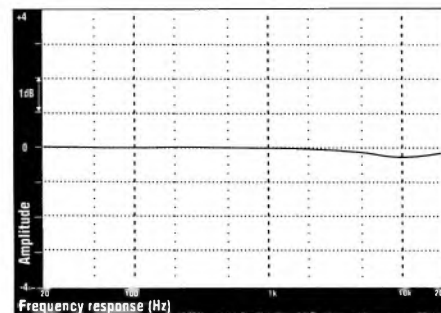

# THAT'S VX

HARMAN (AUDIO) UK LTD., MILL STREET, SLOUGH, BERKS SL2 5DD. TEL: (0753) 76911.



Packaged in an attractive emerald green wrapper, *VX* is another relatively new tape from That's. Technically it appears to be based on a very similar doped-ferric formulation to the *RX* tape, though in the case of *VX* the pseudochrome pigment has been more correctly targeted at the Type II slot. Once more, *VX* benefits from That's proprietary Delta shell with two very broad slip sheets used to ensure the smooth running of the tape in addition to reducing unwanted vibrations. The tape in any cassette has only to move aslant very slightly for a large phase error to become apparent.

## LAB REPORT

Up to  $4\text{kHz}$  or so *VX* seems to be a fairly compatible formulation though above this there is a slight, but nonetheless unwarranted, increase in sensitivity ( $+1.2\text{dB}$  at

$5\text{kHz}$  and  $+3.6\text{dB}$  at  $20\text{kHz}$  rel. to  $1\text{kHz}$ ). Its  $10\text{kHz}$  SAT output level of  $-3.8\text{dB}$  is pretty good though the  $+2.5\text{dB}$  MOL is less impressive. In fact, coupled with the  $-58.7\text{dB}$  A-wtd hiss, *VX*'s dynamic range is on a par with TDK *SF* for instance. Modulation noise was gratifyingly low at  $-42\text{dB}$ , a testament both to the polish of the tape and mechanical rigidity of the Delta shell.

## SOUND QUALITY

I found *VX* sounded similar to *RX* with its slightly damped, restrained delivery but it was also capable of retrieving far more musical detail. It lacked the ability to project a broad and deep soundstage in the manner of TDK *SA* because dynamics were always slightly held-back or fettered. However, its increasing sensitivity trend was not translated into a bright or aggressive sound so the tape's general compatibility would seem to be assured.

## CONCLUSIONS

*VX* is no star performer but neither is it a peculiar tape that demands specialist attention. A little extra transparency would not go amiss but otherwise the tape is recommended.

## TEST RESULTS

Formulation	Type II, Doped-ferric
Sensitivity	$-0.6\text{dB}$
Relative sensitivity	$+0.9\text{dB}$
MOL315Hz	$+2.5\text{dB}$
SAT10kHz	$-3.8\text{dB}$
Hiss	$-58.7\text{dB}$
Dynamic range	$61.2\text{dB}$
Modulation noise	$-42.0\text{dB}$
Consistency	92%
Typical Retail Price	£1.59

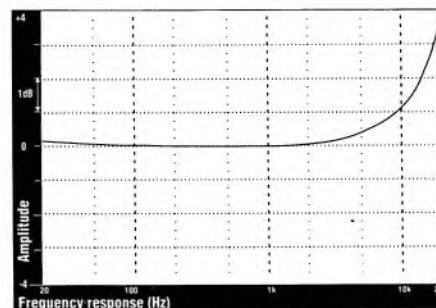

MISSION

**ROKSAN**

**-exposure-**

**AR**

**audio-technica**  
ENJOY ADVANCED TECHNOLOGY

CAMBRIDGE AUDIO

DENON

**ROTEL**

**CELESTION**

**NAD**

**B&W**

*Sussex Audio*

**Nakamichi**

163/165 Church Road

Burgess Hill

Sussex

**04446 42336**

Interest Free Credit available

**Dual**

**TANNOY**

**NI**

**Gale**

ONIX

**Goodmans**

**Target**

**Linx**

PROTON

**marantz**

**MANTRA**

**INCA TECH**

**ONIX**  
INTEGRATED

# THAT'S FX

HARMAN (AUDIO) UK LTD., MILL STREET, SLOUGH, BERKS SL2 5DD. TEL: (0753) 76911.



Back in Japan That's has a vast range of cassettes including the trendy 'Pas de Deux' ferrics and Suono high-end formulations. *FX* is also available in Japan and features the same characteristic Delta shell, so-called because of the triangular-shaped viewing window, though it is known as the 'Xiphoid' or sword mechanism back East! *FX* falls into that very rare category of Type I formulations that actually employ a high sensitivity Type II pigment, in this case a Maghemite ferric treated with FSC (Flush Surface Cobalt).

## LAB REPORT

As a result *FX* is still obviously under-biased in the Type I slot, note the good +0.3dB 400Hz sensitivity but crazy 20kHz level of +4.5dB (rel to 1kHz). The applied bias will have to be increased if any sort of noise reduction is to be used, especially as the hiss

floor is only at -53.2dB. The MOL and SAT figures are very good (due to the enriched magnetic coating) but the final dynamic range is still bettered by That's *RX*. Furthermore, you should remember that tape-tuning to 'flatten' *FX*'s response will also degrade its SAT performance, increasing the chance of overload at high frequencies.

## SOUND QUALITY

Auditioned in an IEC-calibrated deck, *FX* sounded very clear but also very bright and incisive. This had the effect of blowing the cobwebs away from stuffy classical recordings but also rendered many forward and boppy pop tracks unbearably sharp and aggressive. *FX* is about as far removed from the classic 'fuzzy ferric' as you can possibly imagine but its qualities render it best suited to dull and very laid-back machines. Otherwise its lack of richness and warmth will impart all recordings with a tiring acidity.

## CONCLUSIONS

*FX* is not recommended for general consumption but its particular, and almost unique, set of attributes make it an ideal 'party' tape!

## TEST RESULTS

Formulation	Type I, Doped-ferric
Sensitivity	+0.3dB
Relative sensitivity	+2.3dB
MOL315Hz	+4.6dB
SAT10kHz	-1.2dB
Hiss	-53.2dB
Dynamic range	57.8dB
Modulation noise	-39.7dB
Consistency	78%
Typical Retail Price	£1.99

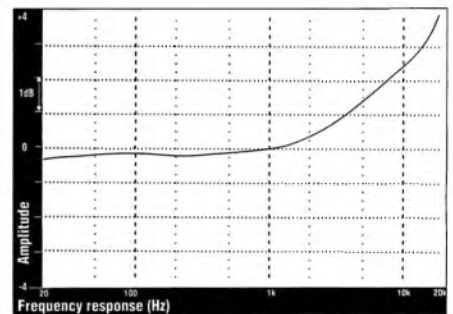

# THAT'S MR-X PRO

HARMAN (AUDIO) UK LTD., MILL STREET, SLOUGH, BERKS SL2 5DD. TEL: (0753) 76911.



Currently the top dog in the That's range of blank tapes, *MR-X Pro* seems prone to constant - if subtle - reformulation exercises. This is a true metal (Type IV) tape and employs minute 'Topo' iron crystals in conjunction with its proprietary UMD binder system to yield a very high retentivity and low modulation noise. At first glance the Delta shell looks no different from that employed by other That's tapes but *MR-X Pro* may be distinguished up close by virtue of its buff-coloured legends - an improved shell design would not be out of place at this price, so how about it That's?

## LAB REPORT

New *MR-X Pro* displays a peculiar sensitivity trend that steadily increases from low to very high frequencies. At 20kHz the sensitivity is -0.5dB down compared to 1kHz while it

rises to +2.5dB at 5kHz and +3.8dB at 20kHz. Earlier samples demonstrated a more linear LF trend but proved far too sensitive at 20kHz. Anyway, *MR-X Pro* does benefit from vast MOLs at 315Hz (+5.2dB) and 10kHz (+1.6dB) which means the tape will be perfectly happy if pushed continuously into the red. The state of the deck's heads is another matter of course!

## SOUND QUALITY

*MR-X Pro* offered a slightly bright and two-dimensional picture of events but it was quite unruffled by the mass of detail contained within an orchestral recording. Similarly, it accepted the brash forwardness of a close-miked trumpet without collapsing into a muffled heap even if the mellifluous character of an accompanying double bass was slightly glazed-over in comparison.

## CONCLUSIONS

That's reformulations have not necessarily transformed *MR-X Pro* into a better tape than a couple of years ago but it's still a state-of-the-art metal and deserves the appropriate recognition.

## TEST RESULTS

Formulation	Type IV, Metal Crystals
Sensitivity	+0.7dB
Relative sensitivity	+2.5dB
MOL315Hz	+5.2dB
SAT10kHz	+1.6dB
Hiss	-57.4dB
Dynamic range	62.6dB
Modulation noise	-42.0dB
Consistency	91%
Typical Retail Price	£3.99

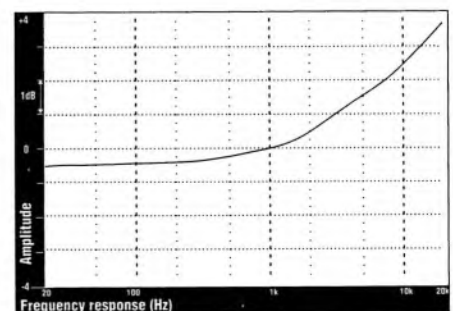

# THE SWEETEST SOUNDS ARE JUST OFF THE M25



ALPHASON SONATA  
"THE No. 1 TURNTABLE"

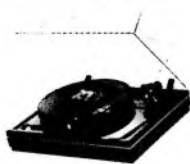

TOWNSHEND  
"THE ROCK"  
TURNTABLE

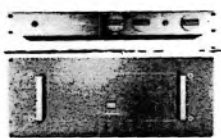

MUSICAL FIDELITY  
& MVT PRE-AMP  
P270 POWER AMP



NAKAMICHI CR5E  
CASSETTE DECK



INFINITY  
8 KAPPA  
LOUDSPEAKERS



MORDAUNT-SHORT  
SYSTEM 442  
LOUDSPEAKERS



LUXMAN KD117  
DAT PLAYER  
*In stock NOW!*



CAMBRIDGE AUDIO CD2  
COMPACT DISC PLAYER



MARANTZ CD94/CD494  
COMPACT DISC PLAYER &  
D/A CONVERTER



QUAD FM4  
TUNER  
34 PRE-AMP  
306 POWER AMP



SPENDOR SPI  
LOUDSPEAKERS



TOWNSHEND  
GLASTONBURY II  
LOUDSPEAKERS

IN STOCK — OVER 300 SEPARATES PLUS ACCESSORIES



MANTICORE MANTRA



KENWOOD  
DP-1100SG Remote Controlled  
CD Player with Optical Output



HARMAN KARDON



DENON DR-M44HX  
CASSETTE DECK



B & W MATRIX 1



TANNOY M20 GOLD

Shop & Home demonstrations given

ADC, AKG, Alphason, AR, Ariston, Audio Technica, Avance, B&W, Beyer, British Loudspeakers (BLQ), Bose, Cambridge Audio, Castle, Cemac, Chord, Citation, Decca, Denon, DNM, Dual, Foundation, Gale, Glanz, Goldring, Goodmans, Grado, Harman/Kardon, Hunt, Infinity, JBL, Jecklin, Kenwood, Kiseki, Koss, Logic, Luxman, Manticore, Marantz, MDM, Milltek, Mordaunt-Short, Musical Fidelity, NAD, Nagaoka, Nakamichi, Onkyo, Ortofon, Philips (CD), Proton, QED, Quad, Rata, Revolver, Rotel, Ruark, Sansui, Sennheiser, Shure, Spendor, Tannoy, Target, Thorens, Torlyte, Townshend 'The Rock' turntable & Glastonbury II loudspeakers, Trio, Van den Hul, Vecteur, Wharfedale, Yamaha, etc.

## NOT ONLY HI-FI IN BRENTWOOD

### BUT ALSO COMPACT DISCS, RECORDS & CASSETTES

"THOUSANDS OF CDs — THOUSANDS OF RECORDS — THOUSANDS OF CASSETTES"

★★★ IN STOCK ★★★

Most importantly we offer: *FIRST-CLASS PRODUCT CHOICE*  
*ATTRACTIVE PRICES*  
*FRIENDLY, HELPFUL SERVICE*

We stock all types of music and spoken word, but concentrate mainly on classical music. Not only will you find a choice of performance on mainstream repertoire but also you will discover recordings of many lesser-known works. We have musically knowledgeable staff to help you as well as the *Penguin Record Guides*, back issues of *Gramophone*, catalogues, etc., for reference in the shop.

All products are keenly priced (including our vast back catalogue!) with many bargains and sale items at all times. There is also a voucher scheme.

#### HAVE YOU HEARD ABOUT OUR VOUCHER SCHEME?

You will receive one voucher for every £10 spent at our normal selling price (but every £5 in respect of CDs, records & cassettes). 12 vouchers collected will entitle you to one compact disc from stock at HALF PRICE (6 vouchers for a record or cassette).

WHAT MORE COULD YOU WANT?

So we look forward to seeing you soon!

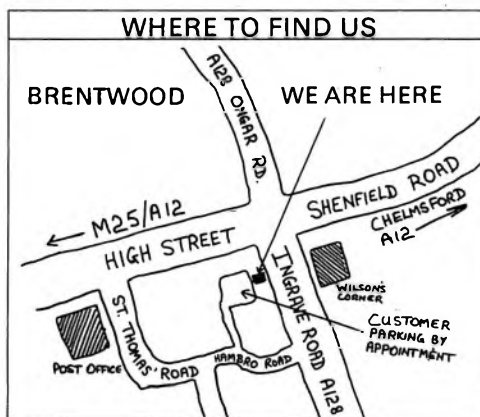

# BRENTWOOD MUSIC & HI-FI CENTRE

Ground &  
First Floor

2 INGRAVE ROAD, BRENTWOOD, ESSEX

Tel: (0277)  
221210

Corner of Brentwood High Street and Ingrave Road (A128)

On-site customer parking by appointment.

Easy to reach — 5 mins. from M25.

FOR  
25 YEARS  
WE'VE BEEN  
MIXING  
WITH THE  
RIGHT  
COMPANY

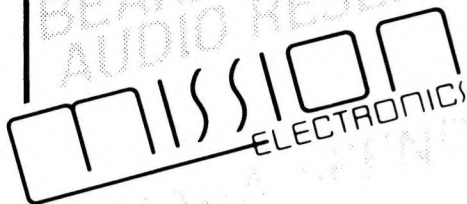

Without doubt — we require the same standards of service you have come to expect from us over the years. But don't just take our word for it, come in and experience the confidence we have in recommending and demonstrating **Mission Cyrus** only the very best in High Fidelity Equipment will do.

**Spaldings**  
ESTABLISHED IN SOUND  
01 654 1231/2040 - 352/4 LOWER ADDISCOMBE ROAD, CROYDON, SURREY.  
BADA VISA

# BACK ISSUES HI-FI CHOICE

## TO ORDER BACK ISSUES:

Please tick issues you require

CD Midi Systems (Special Ed.)	Nov 86 <input type="checkbox"/>
Turntables, Arms, Cartridges (48)	Dec 86 <input type="checkbox"/>
The Best Buy Guide (Special Ed.)	Oct 87 <input type="checkbox"/>
Amplifiers & Tuners (50)	April 87 <input type="checkbox"/>
Compact Disc Players (51)	June 87 <input type="checkbox"/>
Cassette Decks & Tapes (52)	Aug 87 <input type="checkbox"/>
Loudspeakers (53)	Dec 87 <input type="checkbox"/>
CD Based Midi Systems (54)	Jan 88 <input type="checkbox"/>
Turntables & Arms (55)	Feb 88 <input type="checkbox"/>
Amplifiers (56)	March 88 <input type="checkbox"/>
Cassette Decks (57)	April 88 <input type="checkbox"/>
CD Players (58)	May 88 <input type="checkbox"/>
Loudspeakers (59)	June 88 <input type="checkbox"/>
The Collection (60)	July 88 <input type="checkbox"/>
One-Name Systems (61)	Aug 88 <input type="checkbox"/>
Amplifiers (62)	Sept 88 <input type="checkbox"/>
Cassette Decks (63)	Oct 88 <input type="checkbox"/>
Compact Disc Players (64) (inc. free CD)	Nov 88 <input type="checkbox"/>
CD Midi Systems (65)	Dec 88 <input type="checkbox"/>
Loudspeakers (66)	Jan 89 <input type="checkbox"/>
Turntables & Arms (67) (inc. free Elite Gauge)	Feb 89 <input type="checkbox"/>
Amplifiers (68)	March 89 <input type="checkbox"/>

Individual issues including postage and packing: UK £3.50, rest of the world £4.25 (air service)

## PAYMENT

- I enclose my cheque/Post Order made payable to *Dennis Publishing Ltd.*
- Please charge my Access/Barclaycard/American Express/Diners Mastercharge (delete as appropriate)

Credit card number \_\_\_\_\_

Expiry date \_\_\_\_\_

Signature \_\_\_\_\_

Name \_\_\_\_\_

Address \_\_\_\_\_

\_\_\_\_\_

Postcode \_\_\_\_\_

(69)

**Please send order form and payment to:**

Hi-Fi Choice, Mail Order, P.O. Box 320, London N21 2NB.

# DEALER GUIDE

## Hastings Hi-Fi

CONSULTANTS

32 WESTERN ROAD, ST. LEONARDS. (0424) 442975

Selected Hi-Fi  
from -

EXPOSURE, MUSICAL FIDELITY,  
QUAD, NAKAMICHI, HARMAN KARDON,  
MONITOR AUDIO, ROGERS, TANNOY, CYRUS,  
NAD, REVOLVER, MANTICORE, GALE,  
MARANTZ, ROKSAN, ELITE, AUDIOLAB,  
CELESTION, HEYBROOK,  
& Many more.

- OPEN TUES-SAT 9.00-6.00
- FULL DEMONSTRATIONS - IN STORE & IN HOME



AKG, AR, AIWA, A&R, AVANCE, ARISTON, ALPHASON, BEARD, B&W, BOSE, BEYER, CASTLE, CELESTION, CAMBRIDGE, DENON, DUAL, dbx, ELITE ROCK, HARMON KARDON, HEYBROOK, INCA TECH, INFINITY, KEF, KENWOOD, LUXMAN, MARANTZ, MONITOR AUDIO, MICHELL, MONSTER CABLE, MORDAUNT-SHORT, MUSICAL FIDELITY, MYST, NAD, NAKAMICHI, NAGAOKA, PMB, ONKYO, PIONEER, PHILIPS (CD), QED, QUAD, REVOLVER, REVOX, ROKSAN, ROTEL, RUARK, SOUNDEX, SPENDOR, SANSUI, STAX, SENNHEISER, TANNOY, TARGET, TEAC, THORENS, VdH, WHARFEDALE, YAMAHA.

- LATE NIGHT THURSDAY • INSTANT CREDIT UP TO £1,000
- MAIL AND TELEPHONE ORDERS WELCOME
- ACCESS, BARCLAYCARD, AMEX, DINERS CLUB.

45 HIGH STREET, HOUNSLOW, MIDDLESEX  
TEL: 01-570 7512



Appointed Stockists of A & R Cambridge, Denon, Castle, Creek Audio, Goldring, Linn, Naim, Quad, Rega, Rogers, SME, Monitor Audio, Nakamichi, Roksan, Royd, Spondor, Tannoy

40 Little London, Chichester, W. Sussex  
Telephone 0243 776402  
(Closed all day Monday)



Hi-Fi Specialists

- A&R
- Castle
- Dual
- Mordaunt-Short
- Musical Fidelity
- Pioneer
- Sony
- Trio/Kenwood
- B&W
- Denon
- Marantz
- Monitor Audio
- Nakamichi
- Philips CD
- Quad
- Rogers
- Rotel
- Revox
- Spendor
- Tannoy
- Technics
- Thorens
- Yamaha
- Ariston etc.

Two-year guarantee  
Private listening room  
Excellent comparator demonstrations

54 Chapel St., Chorley, Lancs.

Telephone (02572) 71935

## MURRAY HI FI FOR REAL SOUND



REGA, DUAL, REVOX, ROTEL, ROYD, MONITOR AUDIO AND MANY OTHERS.

103a BEVERLEY ROAD, HULL  
HUMBERSIDE HU3 1RX  
EL: 0482 227867

19 MIDDLE HILLGATE, STOCKPORT  
CHESHIRE SK1 3AY  
TEL: 061 429 7666

## ASHTON AUDIO VISUAL SPECIALISTS

TARGET, RUARK, THORENS, ARISTON, WHARFEDALE, TDK, THAT'S, SONY, ROBERTS, CELESTION, MORDAUNT-SHORT, TANNOY, KENWOOD/JVC, TOSHIBA, JBL, LINX, MONSTER CABLE, VAN DEN HUL, DENON, MARANTZ, PROTON, NAD, ROTEL, AR, NAKAMICHI, INCATACH, QUAD

6 HIGH STREET SOUTH, DUNSTABLE, BEDFORDSHIRE.  
TEL: 0582 608003

Diner's Club - American Express - Visa - and Credit Brokers  
Open Monday to Saturday 9.00am - 5.30pm (6 on Fridays)

## SHROPSHIRE'S HI-FI CENTRE!

Quad  
B&W  
Kenwood  
JVC  
Celestion  
NAD  
Onkyo  
A&R  
Nakamichi  
Beyer Dynamic  
Dual

AVON Hi-Fi Limited

12 Barker Street, Shrewsbury (0743) 55166

## BUY! SELL! EXCHANGE!

We accept for cash or exchange ALL 2nd hand Audio & Video equipment.

Everything accepted in ANY condition - absolutely NOTHING refused!

MUSIC & VIDEO EXCHANGE  
56 Notting Hill Gate, London W11  
Open 7 days 10am-8pm  
Tel: 01-727 0424

# DEALER GUIDE

## MANDERS HI-FI LTD

For Nakamichi, Quad, Dual, Hafler, Luxman, Denon, Revox, Sansui, Harman-Kardon, A+R, Thorens, QED, Spendor, Monitor Audio, Rotel, Ariston, Revolver, Technics etc.

2 Edward St, Grimsby,  
Humberside  
0472-351391

## Analog Audio

First Class Separates from  
AR, Denon, Dual, Harmon/Kardon,  
Jamo, Kenwood, Luxman, Marantz,  
Mordaunt Short, NAD, Onkyo, Proton,  
Rotel, Teac, Thorens, Tannoy, Yamaha

FULL DEMONSTATION  
FACILITIES AVAILABLE

Access and Barclaycard Welcome.

**ANALOG AUDIO**  
849 HIGH RD., LONDON N12. 01-445 3267

**Peter TYSON**  
The NAME you can TRUST

6 ABBEY ST, CARLISLE. TEL: 0228 46756  
(Hi-Fi & Service Centre)

Products we stock include:-

Linn-Acoustic Research-Mission-Cyrus-Technics  
-Marantz-Kenwood-Aiwa-Denon-Dual-Pioneer-Akai-  
Ariston and Philips.

"Demonstration Facilities" "Part Exchange Welcome"  
"Free Delivery & Installation" Access & Visa accepted  
"Cumbria's Premiere Hi-Fi Centre"

**BUY, SELL, EXCHANGE  
& REPAIR CENTRE**

**FOR TV, VIDEO & HI-FI**

- \* NEW & RECONDITIONED EQUIPMENT
- \* FULLY GUARANTEED
- \* COMPETITIVE PRICES
- \* TECHNICAL ADVICE GIVEN
- \* EXPORT ORDERS WELCOME
- \* FULL BACK UP AND REPAIR SERVICE
- \* FOR PERSONAL & PROFESSIONAL SERVICE



**01-837-8741**

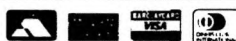

**CANAL BRIDGE  
AUDIO VISUAL**  
172 CALEDONIAN ROAD  
LONDON N1 0SG

## The Reference Studio

If your quest is absolute perfection and truth to the original then look no further.

**British Audio Specialist**

E.A.R., Townshend, A.T.C., Pink Triangle, Ortofon,  
Clear Audio, etc.

And introducing the new DAI reference monitors. Plus  
other high end products.

**Hadlow Down, East Sussex.**

By appointment only please Phone 082 585327 any time.

## SHROPSHIRE HI-FI THE HI-FI SPECIALIST

ARISTON, AUDIO TECHNICA, CAMBRIDGE AUDIO, CELEF,  
DENON, DUAL, HEYBROOK, INFINITY, ION, MANTRA,  
MORDAUNT SHORT, MUSICAL FIDELITY, MONITOR AUDIO,  
MARANTZ, NVA, PROAC, QED, ROTEL, TARGET, TEAC, ETC.  
TANNOY, ROKSAN

Demonstration Room, Free Parking, Free Installation, Repairs

CLOSED THURSDAY

**SHROPSHIRE HI-FI, ST. MICHAEL'S STREET,  
SHREWSBURY 0743 232317**

SMC GROUP

**B&W**  
SPEAKERS

STOCKISTS OF JVC,  
ARISTON, CASTLE,  
STUDIO POWER SPEAKERS

**Dual**

**PP Soundr**

5 KING STREET, MELKSHAM, WILTSHIRE  
TELEPHONE: 0225 708045

**AKAI**

**PIONEER**  
The future of sound and vision.

**DENON**

**Active  
Audio**

sound systems

- Aiwa ■ AR ■ A&R Cambridge ■ Ariston ■ Bose ■ Celestion
- Denon ■ Elite ■ Heybrook ■ KEF ■ Marantz ■ Mission Cyrus
- Monitor Audio ■ Musical Fidelity ■ NAD ■ Onkyo ■ Pioneer
- Rotel ■ Revox ■ Rogers ■ Sansui ■ Wharfedale ■ Yamaha

**BRANCHES IN DERBY & TAMWORTH**

Active Audio  
12 Osmaston Rd  
The Spot  
Derby  
☎ 0332-380385

**BADA**

Active Audio  
29 Market St  
Tamworth  
Staffs  
☎ 0827 53355

# SELECTED DEALER DIRECTORY

Choosing a good hi-fi dealer is the most vital step in acquiring the system that is right for you. This unique directory gives full information on dealers in your area.

## AVON

ABSOLUTE SOUND AND VIDEO, 65 Park St, Clifton, Bristol. (0272) 264975. A&R, Apogee, Denon, Dual, Krell, Linn, Magneplanar, Mission, NAD, Quad, Roksan, Rotel, Yamaha, etc. (closed Weds). Customer car park. BADA MEMBER   
RICHER SOUNDS, 20 Cotham Hill, Bristol BS6 6LF. (0272) 734397. City-centre budget hi-fi discounts; most popular 'majors' from A to Z and all points in between; monthly 'specials'. Facilities: expert advice; free 48 page Hi-Fi Guide and monthly Newsletters; mail order; part exchange. Mon-Fri 10-6, Sats 10-5. Access, Visa, Richer ChargeCard.

## BEDFORDSHIRE

ASHTON AUDIO, 6 High Street, Dunstable. (0582) 608003. AR, Cambridge Audio, Denon, JVC, Monster, NAD, Nakamichi, Quad, Rotel, Sony, etc. Credit to £1,000. Access, Amex, Diners, Visa. Service dept. Open 9-5.30, 6p.m. Friday.  
CAMBRIDGE HI-FI, 31 Cuthbert St, Bedford. (0234) 325035. Mission-Cyrus, Rotel, Kenwood, Pioneer, Manticore, Revolver, Ariston, ITL, KEF, Monitor Audio. Single speaker dem room. 9.30-5.30 6 days. Free installation. Service Dept. Visa, Access. Credit facilities.

## BERKSHIRE

NEWBURY AUDIO, 2 Weavers Walk, Northbrooke Street, Newbury, Berkshire RG13 1A1 (0635) 33929. 6 days 9.30-6.00. Linn, Naim, Roksan, Exposure, A&R Cambridge, Ion Systems, Revolver, Ruark, SD Acoustics, Monitor Audio, Manticore, Nakamichi, Dual, Rotel, Royd. Dem room. Home trial facilities. Free installation. Late appointments. Interest free credit. Access, Visa.  
READING HI-FI CENTRE, 4-6 Harris Arcade, Friar St, Reading. (0734) 585463. 'The best equipment, advice and service from Berkshire's premier Hi-Fi emporium'. BADA MEMBER 



## BUCKINGHAMSHIRE

AUDIO INSIGHT LTD, 53 Wolverton Rd, Stony Stratford, Milton Keynes. (0908) 561551. A&R, Audiolab, Heybrook, KEF, Linn, Mission Cyrus, Musical Fidelity, Nakamichi, Nytech, Rotel. BADA MEMBER   
AYLESBURY HI FIDELITY, 98 Cambridge St, Aylesbury. (0296) 28790. Dual, Heybrook, Linn arms, Musical Fidelity, Mission, NAD, Nakamichi, Quad, Rotel, ITL. 2 Dem rooms, appointment reqd. Mon-Fri 10-6, Sat 9.30-5.30. Home trial, free installation, credit to £1,000. Access, Amex, Diner, Visa. Service dept.

## CAMBRIDGESHIRE

CAMBRIDGE HI-FI, 1 Hawthorn Way, Cambridge. (0223) 67773. Ariston, ITL, KEF, Mission Cyrus, Monitor Audio, Pioneer, Revolver, Technics, Thorens, Kenwood. All credit cards.  
STEVE BOXSHALL AUDIO, 41 Victoria Rd, Cambridge CB4 3BW. (0223) 68305. 10-6 - 6 days. Denon, Rotel, Dual, Monitor Audio, Tannoy, Quad, KEF, Roksan, Nakamichi, Revox, SME, Audio Research, Krell, Magneplanar. 3 dem rooms, home trial, appointment preferred. Free installation and service dept. Access, Visa and credit facilities. BADA MEMBER 

## CHESHIRE

ASTON AUDIO, 4 West St, Alderley Edge. (0625) 582704. Wide selection of equipment in N.W. 2-year guarantee. 3 dem rooms. Tues-Sat 10-6. BADA MEMBER   
DOUG BRADY HI-FI, Kingsway Studios, Kingsway North, Warrington. (Padgate 0925) 828009. 'Largest choice of specialist Hi-Fi in N.W.'. All credit cards. 3 Dem rooms. Open 6 days. BADA MEMBER   
NEW DAWN HI-FI, 1-3 Castle St, Lower Bridge St, Chester. (0244) 24179. Linn, Quad, Technics, National Panasonic, Denon, Rotel, Dual, Meridian, Aiwa, Philips. BADA MEMBER   
SWIFT OF WILMSLOW, 4-8 St Annes Parade, Wilmslow. (0625) 526213. A&R, Aiwa, Denon, Marantz, Mission, Monitor-Audio, Pioneer, Trio, Yamaha, NAD. Dem facilities. Tues-Sat. BADA MEMBER   
RICHER SOUNDS, 4 Wellington St, Stockport SK1 3RN. (061) 480 1700. Cheerfully small store by BR station with virtually all major 'budget' names; many on special offer. Facilities: expert advice; free 48 page Hi-Fi Guide and monthly Newsletters; part exchange. Mon-Fri 10-6, Sats 10-5. Access, Visa, Richer ChargeCard. Mail Order for all Richer Sounds stores from this branch.  
CHRIS BROOKS HI-FI, 29 Gaskell St, Stockton Heath, Warrington. 0925 61212/3. Tues-Sat 10-6. 2 dem rooms. Credit facilities. All credit cards. Total absence of bull\*\*\*\*. BADA MEMBER 

## CORNWALL

N.C.E. HI-FI, The Bridge, Boscastle, N. Cornwall (08405) 248. Ariston, Arcam, Creek, Denon, Dual, Gale, Heybrook, Incatech, Marantz, QED, etc. Dem room. Full credit facilities including interest free. Access, Visa.  
TRURO HI-FI & E.T.S. Ltd, 25 King St, Truro (0872) 79809. A&R, Denon, Dual, Heybrook, Linn, Mission Cyrus, NAD, Quad, Rotel, Thorens. Dem and home trial facilities. Mon-Sat 8.45-5.30. Credit to £1,000. Access, ETS Visa. Service dept.



## DERBYSHIRE

ACTIVE AUDIO, 12 Osmaston Rd, The Spot, Derby. (0332) 380385. Meridian, Mission, Denon, Yamaha, Rotel, A&R Cambridge, Monitor Audio, Trio, Marantz. Dem and home trial facilities. Open 9.30-6 - early closing Wed. Credit to £1,000. Access, Visa, Diners, American Express. Service dept.



## ESSEX

A.T. LABS, 442/4 Cranbrook Rd, Gants Hill, Ilford. (01) 518 0915. Mon-Sat, 10-6. Two single speaker dem rooms. Access, Amex, Visa. BADA MEMBER   
RAYLEIGH HI-FI, 44a High Street, Rayleigh, Essex. (0268) 779762/747571. 216 Moulsham St, On-the-Parkway, Chelmsford, Essex. (0245) 265242. A&R, Audiolab, Beyer, BLQ, Cyrus, Celestion, Denon, DNM, Epos, Gale. Access, Visa. 3 years parts and labour guarantee on hi-fi systems. BADA MEMBER   
BRENTWOOD MUSIC & HI-FI CENTRE, 2 Ingrave Rd, Brentwood. (0277) 221210. Alphason, B&W, Cambridge Audio, Denon, Harman Kardon, Marantz, QED, Quad, Yamaha. Dem and home trial facilities. Mon-Sat 9.30-5.30 (Thurs from 10am, Sat from 9am). Free installation, credit facilities. Access, Visa, Hi-Fi Markets. Service dept.  
LYON AUDIO, 16 Peartree Business Centre, Peartree Road, Stanway, Essex CO3 5JN. (0206) 560259. Audiolab, Beard, Celestion, Oracle, Rogers, Denon, NAD, Rotel, J.A. Michell, Roksan, Marantz, Quad. Dem facilities. Mon-Sat 9-6. Installations. Credit facilities up to £1000. Access, Visa, Hi-Fi Markets, Eurocheque. Service dept available.



## GLOUCESTERSHIRE

ABSOLUTE SOUND AND VIDEO, 40/42 Albion St, Cheltenham. (0242) 583960. A-R, Denon, Dual, Linn, Meridian, Mission, NAD, Rotel, Technics, Yamaha, etc. (Closed Wed). BADA MEMBER   
AUDIO EXCELLENCE, 58 Bristol Road, Gloucester. (0452) 30046. Audio Research, Dual, Krell, Linn, Magneplanar, Naim, NAD, Yamaha and lots more. Closed Mon. BADA MEMBER 

## HAMPSHIRE

ABSOLUTE SOUND AND VIDEO, 4 Feathers Lane, Basingstoke, Hants RG21 1AS. (0256) 24311. A&R, Audiolab, Denon, Dual, Linn, Mission, NAD, Rotel, Technics, Yamaha. Dem and home trial facilities. Mon, Tues, Thurs, Fri 9.30-6, Sat 9.30-5.30. Closed Wed. Free installation. Credit facilities. Access, Visa, Connect, Amex, Diners. Service dept. BADA MEMBER   
HAMPSHIRE AUDIO Ltd, 2-12 Hurley Rd, Chandlers Ford. (0703) 252827/265232. Quality CD and analogue agencies. 5 dem studios. Large free car park. BADA MEMBER   
TRUE-FI SOUND AND VISION, 10/12 Grosvenor Rd, Aldershot. (0252) 26390. Akai, Aiwa, B&W, Nakamichi, Hitachi, J.P.W., Mission, Mordaunt-Short, Nagaoka, Sony, etc. Dem facilities. Mon-Sat 9.30-6.00. Free installation, credit to £1,200. Access, Visa. Service dept.  
HOPKINS HI-FI, 38/40 Fratton Rd, Portsmouth PO1 5BX. (822155) 830753. Technics, Quad, Monitor Audio, Tannoy, Denon, Nad, Heybrook, Ariston, Onkyo, plus others. Dem facilities, appointments necessary. Access, Visa. 9-5.30. Open to 6 Thurs. Closed Wed. Service dept.

## HERTFORDSHIRE

ACOUSTIC ARTS Ltd, 101 St Albans Rd, Watford, Herts. (0923) 45250. A&R, Audiolab, Denon, Magneplanar, Quad, Rogers, Meridian, TDL, Jadis, Krell. Mon-Sat 9.30-5.30. BADA MEMBER   
THE AUDIO FILE, 40 Hockerill St, Bishops Stortford, Herts CM23 2DW. (0279) 506576. 9.30-5.30 6 days. Linn, Roksan, Rega, Naim, Denon, Mission, Cyrus, Marantz, Quad, Tannoy, Sony. 2 dem rooms. Home trial, free installation service dept. Interest free. Bada Charge Card. BADA MEMBER 

## ISLE OF MAN

ISLAND COMPACT DISC CENTRE, Parliament Square, Ramsey. (0624) 815521. Musical Fidelity, Sugden, Celes-

tion, Harman Kardon, Teac, Castle Acoustics, Philips, A&R, JBL, Luxman, Bose, Sansui. Mon-Sat. 9-5.00. Dem and home trial facilities. Free installation. Full credit, no limit. Access, Elite. Service dept.





## KENT

JOHN MARLEY HI-FI CENTRES, 2 Station Rd West, Canterbury. (Canterbury) 69329. Also at Dover - (0304) 207562. B&W, Heybrook, Magnum, M.Y.S.T., Nakamichi, Pink Triangle, Rotel, Sansui, Technics, Quad. Dem and home trial facilities. Mon-Sat 9-5.30 closed Thurs. Free installation. Credit to £1,000. Access, Visa, Creditcharge. Service dept.  
VJ HI-FI, 29 Guildhall St, Folkestone. (0303) 56860. Mon-Sat 9-6. NAD, Yamaha, Marantz, Cambridge Audio, Denon, Kenwood, Tannoy, Rogers, Mordaunt Short, Dual. Dem and home trial facilities, free installation, credit to £1000. Amex, Diners, Visa, Access. Service dept.

## LEICESTERSHIRE

SOUND ADVICE, The Sound Factory, Duke St, Loughborough LE11 1ED. (0509) 218254. A&R, Creek, Linn, Epos, Mission, Cyrus, Naim, Rega, Roksan, Rotel, Yamaha. Dem facilities, appointment reqd. Mon-Sat 9.30-6. Free installation. Credit facilities. Access, Visa, Amex. Service dept. BADA MEMBER   
ALPHA AUDIO, 1-3 Guildhall Lane, Leicester, LE1 5FQ. (0533) 518597 or 530330. Aiwa, Akai, Ariston, Bose, Cambridge, Celestion, Denon, Harman Kardon, Musical Fidelity, Rotel, etc. Mon-Sat 9.30-5.30. Free installation. Credit to £1,000. Dem facilities. Access, Visa.  
MJS HI-FI, 80 Stapleton Lane, Barwell, Leicester LE9 8HE. (0455) 46977. The Rock, Audio Innovations, Kelvin Labs, Snell, Helius, Sugden, Ruark, Concordant, Valdi, J.P.W. Our main aim is for our customers to enjoy music. Dem and home trial facilities. Mon-Sat 9.30-7.00. Free installation and service dept. Visa, Access.  
THE LEICESTER HI-FI CO, 6 Silver Walk, St. Martins Square, Leicester LE1 5EW. (0533) 539753. 6 days 9.30-5.30. A&R Cambridge, Heybrook, Marantz, Mission, Musical Fidelity, Nakamichi, QED Hi-Fi, Quad, Revox, Roksan "and noddes more". Largest selection in Leicestershire. 2 dem rooms. Home trial arranged + free installation. Credit facilities. Hi-Fi Markets, Access, Visa, Am. Exp. Service dept.

## LONDON

A.T.LABS, 159 Chase Side, Enfield, Middlesex. (01) 367 3132. Mon-Sat 10-6. Two single speaker dem rooms. Service dept, car park. Amex, Visa, Access.  
BADA MEMBER   
AUDIO T, 190 West End Lane, London NW6. (01) 794 7848. Mon-Sat, 10-6. Two single speaker dem rooms. Access, Amex, Visa. BADA MEMBER   
CORNFLAKE SHOP, 37 Windmill Street (just off Tottenham Court Road), London W1. (01) 631 0472. Mon-Sat 10-7. DNM, Epos, Koetsu, Marantz, Naim, PS Audio, Rega, Roksan, SME, Yamaha. 2 dem rooms, full delivery and installation. Credit facilities. Access, Visa.  
COVENT GARDEN RECORDS, 84 Charing Cross Road. (01) 379 7635/7427. Quad, B&W, Meridian, Mission, Yamaha, Sony, A&R Cambridge, Nakamichi, Rotel, etc. Dem facilities - no appointment reqd. Mon-Sat 10-7.30. Home trial facilities, free installation. Access, Visa, American Express, Diners Club. Service dept. BADA MEMBER   
DOUG BRADY HI-FI, 14-18 Monmouth St, London WC2H 9HB. (01) 379 4010. Wide range of top specialist hi-fi from Britain, America and Japan. 3 Dem rooms. BADA MEMBER   
GRAHAM'S HI-FI, Canonbury Yard, 190a New North Rd, London N1 7BS. (01) 226 5500. 'FBA Dealer of the year 1985'. Linn, Naim, Rega etc. £300-£3,000-£13,000. BADA MEMBER   
H.L. SMITH & Co Ltd, 287-289 Edgware Rd, London W2 1BE. (01) 723 5891. Aiwa, B&W, Denon, Dual, KEF, Ortofon, Panasonic, Sony, Technics, Yamaha. Dem facilities. Mon-Sat 9-5.30, Thurs 9-1. Credit to £1,000. Access, Visa, Diners. Service dept.  
K.J WEST ONE, 26 New Cavendish St, London W1M 7LH. (01) 486 8262. A&R, Aiwa, Audio Lab, B&W Audio Res - Krell, Rogers, Gale, Musical Fidelity, Linn, Nakamichi, etc.  
THE SOUND ORGANISATION Ltd, No. 1, Cathedral St, London Bridge, London SE1 9DE. (01) 403 2255/3088. Counterpoint, Denon, Exposure, Koetsu, Linn, Naim, PS Audio, Roksan, Rega, SME etc. Dem facilities, appointment reqd. Tues-Sat 10-7. Free installation. Access, Visa. Service dept.  
RICHER SOUNDS 2, 6 London Bridge Walk, London SE1. (01) 403 1988. Major names in esoteric hi-fi, unusually



matched to discount offers and special end-of-line purchases. Dem facilities, expert advice, free local delivery & installation (\$500+), plus 2 Yr G'tee, Hi-Fi Guide and monthly Newsletters; part exchange. Mon-Fri 10-7, Sat 10-5. Access, Visa, Richer ChargeCard. Service Department.

**RICHER SOUNDS**, 2 London Bridge Walk, London SE1 2SX. (01) 403 1201/4710. The original bargain hi-fi store, now refitted; 100s of regular and special discounts on most budget/mid price major names. By London Bridge. Facilities: expert advice; free 48 page Hi-Fi Guide and monthly Newsletters; mail order; part exchange. Open Mon-Fri 10-7, Sat 10-5. Access, Visa, Richer ChargeCard. Service Department.

## MIDDLESEX

**A.T. LABS**, 173-175 Station Rd, Edgware, Middx. (01) 952 5535. Mon-Sat 10-6. 2 single speaker dem rooms. Access, Visa, Amex. **BADA MEMBER**   
**UXBRIDGE AUDIO LTD**, 278 High St, Uxbridge, Middx UB8 1LZ. (0895) 33474/31993. A&R, AR, Ariston, Creek, Cyrus, Denon, Dual, JPW, KEF, Manticores, Meridian, NAD, Nakamichi, Quad, Rotel, Wharfedale, Yamaha, etc. 2 dem rooms. Mon-Sat 10-6. **BADA MEMBER** 

## MERSEYDIE

**W.A. BRADY & SON**, 401 Smithdown Rd, Liverpool L15 3JJ. (051) 733 6859. 'Largest choice of specialist Hi-Fi in N.W. £100-£20K'. All credit cards. 3 dem rooms. Closed Monday.

**BADA MEMBER** 

**PURE SOUND** - Birkenhead 051 645 6690 24hrs. Acoustic Energy, Aragon, Audio Technica, Beard, Celestion, Deltac, Denon, Michel, Cyrodec, Ortofon, SME. Home demonstration a pleasure, plus evenings and weekends (Sundays by appointment).

**RICHER SOUNDS**, 69B Church St, Liverpool L1 1DN. (051) 708 7484. Virtually every major 'budget' name - small store with big discounts and special offers. Facilities: expert advice; free 48 page Hi-Fi Guide and monthly Newsletters; mail order; part exchange. Mon-Fri 10-6, Sat 10-5. Access, Visa, Richer ChargeCard.

## NORFOLK

**SOUND APPROACH**, 161 Unithank Road, Norwich. (0603) 622833. Ariston, AR, Claymore, Castle, Elite Rock, Heybrook, Mantra, Musical Fidelity, Revolver, Yamaha. Dem and home trial facilities. Mon-Sat 9-6.30. Free installation. Credit to £1,500. Visa, Access, Diners Club. Service dept.

## NORTHAMPTONSHIRE

**CLASSIC HI-FI + VIDEO**, School Lane, Kettering, Northants. (0536) 515766. ADC, Marantz, Onkyo, Sansui, Teac, Harman Kardon, Pioneer, Proton, Ariston, Thorens, Mantra, Goodmans, Castle, JPL, Mordaunt Short, Seleco TV, Monitor Cable + others.

**THE AUDIO SHOP**, Coffee Tavern Court, High St, Rushden. (0933) 56651. Tannoy, Mordaunt Short, Castle, Royd, B&W, Goodmans, Ion Systems, Audio Technica, QED, Rotel. Dem room. Ring for opening times.

## WEST MIDLANDS

**ALTERNATIVE AUDIO LTD**, 93-95 Hobs Moat Rd, Solihull. (021) 742 0254 (sales), 0248 (service). A&R, Audiolab, Denon, KEF, Marantz, Meridian, Mission, M.A., The Source, Philips. Tues-Sat 10-6, closed Mon. Home trial facilities, 3 dem rooms, free installation, instant credit. Access, Visa, Amex. Service dept. **BADA MEMBER** 

**GRIFFIN AUDIO LTD**, 94 Bristol St, Birmingham. (021) 692 1359. Linn, Naim, Audio, Rega, Creek, Denon, Nakamichi, Quad, Mission, Monitor Audio, Rotel. **BADA MEMBER** 

**HI-FI EXCELLENCE**, 163 Medieval Spon St, Coventry. (0203) 525200. Linn, Musical Fidelity, Quad, Mission, Cyrus, Denon, A&R Cambridge, Rotel, NAD, Nakamichi etc. Three floors of carefully selected hi-fi amidst the eloquence of our 14th century showroom. Dem, home trial and credit facilities. Access, Visa, Diners, Am. Exp. Mon-Sat 9.30-5.30. Closed Thurs. **BADA MEMBER** 

**HORTON ELECTRONICS (1987) LTD**, 8-9 Lower Temple St, Birmingham B2 4JD. (021) 643 0972. Aiwa, Dual, Marantz, Goodmans, JVC, Mission, Sony, Technics, Wharfedale, Sennheisser. Dem facilities. Credit to £1000. Access, Visa. 9-5.30 Mon-Sat. Service dept.

**RICHER SOUNDS** 2, 12 Smallbrook Queensway, Birmingham B5 4EN. (021) 643 6664. Popular esoteric hi-fi for upgrades, monthly special offers. Dem facilities, expert advice, free local delivery/installation (\$500+), 2 Yr G'tee. Hi-Fi Guide and monthly Newsletters; part exchange. Mon-Fri 10-6, Sat 10-5. Access, Visa, Richer ChargeCard. Service Dept.

**RICHER SOUNDS**, 10 Smallbrook Queensway, Birmingham B5 4EN. (021) 643 1516. An A-Z of affordable, popular hi-fi; no-frills environment. Facilities: expert advice; free 48 page Hi-Fi Guide and monthly Newsletters; part exchange. Mon-Fri 10-6, Sat 10-5. Access, Visa, Richer ChargeCard. Service Dept.

## OXFORDSHIRE

**ABSOLUTE SOUND AND VIDEO**, 19 Old High St, Headington, Oxford. (0865) 65961. A&R, Denon, Linn, Mission, NAD, Rotel, Yamaha. Also 256, Banbury Rd,

Summertown. **BADA MEMBER** 

**ASTLEY AUDIO LTD**, 3 Marketplace, Wallingford. (0491) 39305/34349. AR, Dual, Kenwood, Mordaunt-Short, Mission, Monitor Audio, Philips, Technics, Tannoy, Yamaha. Tues-Fri 9-5.30, Sat 9-5. Records, tapes, 1000+ CDs. Service Dept. Access, Visa, Diners.

**WESTWOOD AND MASON**, 46 George St, Oxford. (0865) 247783. Linn, Naim, Rega, A&R, Heybrook, Dual, Mordaunt-Short, Mission, Tannoy, Quad, etc. **BADA MEMBER** 

**WITNEY AUDIO & VIDEO**, 28 High St, Witney, Oxford. (0993) 2414. A&R, Aiwa, Akai, Bose, Denon, Dual, Goldstar, JBL, Mordaunt Short, NAD, Pioneer, Sony, Yamaha. Dem facilities. Mon-Sat 9-5.30. Free installation, credit to £1,000. Access, Visa. Service dept.

**OXFORD AUDIO CONSULTANTS LTD**, Cantay Hse, Park End Place, Oxford OX1 1JE (0865) 790879. Oxford Acoustics, Audio Research, Krell, Magneplanar, Apogee, Aragon, Stax, Marantz, Wharfedale, Cambridge Audio. Home trial and free installation. Instant Credit. Access, Amex, Visa. 10-6 Tues-Sat. Service dept.

## SHROPSHIRE

**AVON HI-FI LTD**, 12 Barker St, Shrewsbury. (0743) 55166. A&R, B&W, JBL, Dual, NAD, Nakamichi, Revolver, Trio, Quad, Yamaha. Dem and home trial facilities. Mon-Sat 9-5.30, closed Thur. Free installation, credit to £1,000. Access, Visa. Service dept.

**MID SHROPSHIRE AUDIO**, 24 Peverill Bank, Dawley, Telford. (0952) 502828. Agencies include Ariston, Ortofon, Helius, Ion Systems (full range), SME, Goldring, Ruark, Sansui. Guaranteed ex-dem and used hi-fi equipment available. Home trial and free installation. 7 days a week. Access.

**CREATIVE AUDIO**, 9 Dogpole Lane, Shrewsbury (0743) 241924. Marantz, Meridian, Linn, Naim, A&R, Mission, Nakamichi, Revolver, Castle, Audio Technica. Dem room. Home trial and free installation. Credit to £1000. Access, Visa. Tues-Sat 9.30-5.30. Service dept.

## SOMERSET

**WATTS RADIO - THE ENGINEERS**, Jim Badman, 1 West Street, Somerton. (0458) 72440. Castle, Dual, Denon, KEF, Mordaunt-Short, Ortofon, Quad, Rogers, Thorens, Yamaha. Dem and home trial facilities. Mon-Sat 9.1, 2-5.30, Wed 9-1. Free installation. Credit to £1,000. Access, Visa. Service dept.

## STAFFORDSHIRE

**GRANGE HI-FI LTD**, 153 Branston Road, Burton-on-Trent. (0283) 33655. Pink Triangle, Voyd Valdi, Marantz, Audio File, Systemdek, Audio Innovations, Cambridge, Quad, Rotel, Snell, etc. 2 dem rooms - no appointment reqd. Mon, Tues, Thurs, Fri, Sat. 9-6 Wed 9-1. Free installation. Credit facilities. Visa, Access. Service dept.

## SUFFOLK

**EASTERN AUDIO**, 41 Bramford Rd, Ipswich. (0473) 212717. Quad, Audio Lab, Denon, Dual, Marantz, Mission, NAD, Nakamichi, Technics, Arcam. Mon-Sat 9.30-6. **BADA MEMBER** 

## SURREY

**AERCO LTD**, 11 The Broadway, Woking. (04862) 4667. A&R, Ariston, Exposure, HK, A.R., Heybrook, JBL, KEF, Magnum, NAD, Pt. Quad, Revox. **BADA MEMBER** 

**ROGERS HI-FI**, 13 Bridge Street, Guildford (0483) 61049. Ariston, Acoustic Research, Akai, Denon, JPW, Mordaunt-Short, Marantz, Onkyo, QED, Tannoy etc. Mon-Sat 9.30-6. Dem. facilities. Instant Credit. Access, Visa. Service dept.

**SURBITON PARK RADIO**, 48 Surbiton Rd, Kingston-Upon-Thames, Surrey (01) 546 5549. Quad, Dual, Denon, Kenwood, Nakamichi, Rotel, Pioneer, QED, B&W, Tannoy, Mordaunt Short, Castle, KBL. Dem and home trial facilities. Access, Visa. 9.30-5.00 Tues-Sat. Service dept.

**TRU-FI SOUND AND VISION**, 2 Cromwell Rd, Redhill, Surrey. (0737) 66128. Akai, Aiwa, Band W. Nakamichi, JPW, Mission, Mordaunt-Short, Nagaoka, Sony, Technics. Dem. facilities. Mon-Sat 9-6. Free installation, credit to £1,200. Access, Visa. Service dept.

**UNILET PRODUCTS LTD**, 35 High St, New Malden, Surrey KT3 4BY. (01) 942 9567. Mon-Sat 9-6. Thurs 9-7. Dem facilities. Large stock. Amex, Access, Diners, Visa.

## SUSSEX (EAST)

**DEFINITIVE AUDIO**, 30 Islingwood Street, Brighton, East Sussex BN2 2UR. (0273) 672796. Voyd, Systemdek, Helius, Audio Note, Sugden, JPW, Snell, Marantz, Denon, Rotel, etc. Wed-Sat 11-7. Home dems throughout Sussex. Credit facilities. Visa.

**JEFFRIES HI-FI**, 69 London Rd, Brighton, East Sussex. (0273) 609431. 2 dem rooms, closed Mon, late night Wed. Parking, bus route. Credit facilities.

**BADA MEMBER**   
**JEFFRIES HI-FI**, 4 Albert Parade, Green St, Eastbourne, East Sussex. (0323) 31336. 2 dem rooms, closed Mon. Late night Wed. Parking, bus route. Credit facilities.

**BADA MEMBER**   
**HASTINGS HI-FI**, 31-32 Western Rd, St Leonards On Sea. (0424) 442975. A&R, B&W, Mission/Cyrus, NAD, Nakamichi, Quad, Rotel, Systemdek, Tannoy, Yamaha. 2 dem rooms. Mon-Sat 9-6. Home trial facilities. Free installa-

tion. Credit facilities. Access, Amex, Visa. Service dept.

## SUSSEX (WEST)

**BOWERS AND WILKINS LTD**, 1 Becket Buildings, Littlehampton Rd, Worthing (0903) 64141. B&W, Cambridge, Dual, JVC, Mordaunt-Short, Nakamichi, Philips, Shure, Quad, Sony, Technics. 2 dem rooms. Mon-Sat 9-5.30, Weds 9-1. Home trial facilities, free installation, credit to £1,000. Access, Visa. Service dept.

**CHICHESTER HI-FI**, 40 Little London, Chichester PO19 1PL. Tel: (0243) 776402. Linn, Naim, Rega, Creek, Nakamichi, A&R, Denon, Roksan etc. Tues-Sat, 10-1, 2-5.15 (closed Mon). **BADA MEMBER** 

## TYNE & WEAR

**RED RADIO SHOP AND HI-FI CENTRE**, 11 Olive St, (Off Park Lane) Sunderland (Sunderland) 5672087. Bose, Castle, Denon, JVC (Hi-Fi and Portable TV), Luxman, Michell, Mordaunt-Short, Pickering, Tannoy. Dem facilities. Mon-Sat 9-5.30. Free installation, interest free credit. Visa. Service dept.  
**LINTONE AUDIO LTD**, 7-11 Park Lane, Gateshead (091) 477 4167. Linn, Naim, Rega, Musical Fidelity, Audio Lab, Quad, Cyrus, Denon, NAD, plus all leading Japanese manufacturers. Dem and home trial facilities. Free installation. Access, Visa, Amex, Diners. Credit to £1000. 9-6 Mon-Sat. Service dept. **BADA MEMBER** 

## WILTSHIRE

**ABSOLUTE SOUND AND VIDEO**, 60 Fleet Street, Swindon. (0793) 38222. A&R, Denon, Dual, Linn, Meridian, NAD, Rotel, Technics, Yamaha. (Closed Wed).

**BADA MEMBER** 

**PR SOUNDS**, 5 King St, Melksham. (0225) 708045. Pioneer, Akai, JVC, Dual, Ortofon, Philips, Toshiba, B&W, Celestion. Mon-Sat 9-6. Dem and home trial facilities, free installation. Credit to £1,000. Access. Service dept.

## YORKSHIRE (NORTH)

**ELITE HI-FI**, 178 Kings Road, Harrogate HG1 5JG (0423) 521 831. Voyd, Valdi, Avalon, Systemdek, Helius, Audionote, Goldring, Audio Innovations, Sugden, Marantz, Mordaunt-Short, JPW, Infinity, Snell. Mon-Sat 9-5.30. Free installation. Service dept.

**THE AUDIO CLINIC**, 2A Brunswick St, Bishopthorpe Rd, York YO2 1ED. (0904) 646309. ADC, Allison, Hafler, JPW, Luxman, Proton, Quart, Studio Power, Systemdek, Thorens and more. Second hand hi-fi available. Appt's reqd, home trial and dem facilities. Free installation. Access and Visa. 10-5 Mon-Sat. Service dept.

**THE SOUND ORGANISATION**, 36 Gillygate, York. (0904) 27108. Linn, Naim, Rega, Roksan, Epos, Ruark, Gale, Denon, Rotel, Mantra. Tues-Sat 10-6.

**BADA MEMBER** 

**RICHER SOUNDS**, 6 Feasegate, York YO1 2SQ. (0904) 645535. Probably the smallest hi-fi store in York; but stocks the A-Z of popular budget hi-fi at special discount prices. Facilities: expert advice; free 48 page Hi-Fi Guide and monthly Newsletters; mail order; part exchange. Mon-Fri 10-6, Sat 10-5. Access, Visa, Richer ChargeCard.

## YORKSHIRE (SOUTH)

**MOORGATE ACOUSTICS LTD**, 2 Westgate, Rotherham S60 1AP. (0709) 370666. South Yorkshire's leading specialist hi-fi dealer Roksan, Meridian, Mission, Quad, Musical Fidelity, Rogers, Beard, Bryston etc. Single speaker dem facilities. **BADA MEMBER** 

## YORKSHIRE (WEST)

**AUDIO PROJECTS**, 45 Headingley Lane, Leeds. (0532) 304565. A&R, Audiolab, Creek, Heybrook, Linn, Musical Fidelity, Naim, Quad, Rega, etc. Tues-Fri 9.30-6, Sat 2.30-5.30. **BADA MEMBER** 

**ERRICKS**, Hi-Fi Experience, Fotosonic House, Rawson Square, Bradford (0274) 309266. Dem facilities. Sales/service agents for A&R, Linn, Quad, Naim, Nakamichi, Mission etc. **BADA MEMBER** 

**HUDDERSFIELD HI-FI CENTRE**, 4 Cross Church St, Huddersfield. (0484) 544668. B&W Loudspeakers, Kenwood, Denon, Dual, A&R Cambridge, Musical Fidelity, Quad, NVA, Audio Lab, Philips, etc. Dem facilities - appointment reqd. Mon-Sat 9-5.30, Thurs 9-8. Closed Wed. Free installation, credit facilities. Access, Visa.

**IMAGE HI-FI LTD**, 8-10 St Annes Rd, Headingley, Leeds. (0532) 789374. AR, Audio Lab, Denon, Linn, Marantz, Meridian, Mission, Monitor Audio, NAD, Quad. **BADA MEMBER** 

**RICHER SOUNDS**, 55 The Headrow, Leeds LS1 6LR. (0532) 455717. Affordable special deals on every big budget line from Akai to Yamaha; separates & systems. City centre store opposite Lewis's. Facilities: expert advice; free 48 page Hi-Fi Guide and monthly Newsletters; mail order; part exchange. Mon-Fri 10-6, Sat 10-5. Access, Visa, Richer ChargeCard.

**SELECTIVE AUDIO**, The Forge Cottage, 19 Crossgate, Otley. (0943) 467689. Exclusively handles Alphonson, Roksan, NVA, ProAc in the area and other minimalist British designer products for the discerning listener. Dem facility. Member of the Cognoscenti. Mon-Sat 10-6.

# SELECTED DEALER DIRECTORY

## IRELAND

CLONEY AUDIO, 34 Main St, Blackrock, Co. Dublin. 0001 889449. Linn, Naim, Roksan, Rega, Rogers, Spendor, Musical Fidelity, Cambridge Audio, Accoustat. Tues-Sat 10-6, Thurs & Fri til 9. Free installation. Visa, Access. Service dept.

## SCOTLAND

### EDINBURGH

RICHER SOUNDS, 1B Chambers St, Edinburgh EH1 1HR. (031) 226 3544. Discount hi-fi near the Royal Scottish Museum: affordable culture with monthly special offers on major names. Facilities: expert advice; free 48 page Hi-fi Guide and monthly Newsletters; mail order; part exchange. Mon-Fri 10-6, Sat 10-5. Access, Visa, Richer ChargeCard.

BILL HUTCHINSON Ltd, 43 Clarke St, Edinburgh. (031) 667 2877. AR, Aiwa, Denon, Dual, JVC, Mission, Mordaunt-Short, Omar, Technics, Yamaha. Dem facilities. Mon-Sat 10-6. Free installation. Instant credit. Credit cards: Access, Visa. Service dept.

### GLASGOW

RICHER SOUNDS, 24 Gordon St, Glasgow G1 3PU. (041) 221 9147. The affordable hi-fi alphabet in an unpreten-

tious atmosphere; regular special offers. Facilities: expert advice; free 48 page Hi-fi Guide and monthly Newsletters; mail order; part exchange. Mon-Fri 10-6, Sat 10-5. Access, Visa, Richer ChargeCard.

STEREO STEREO, 278 St. Vincent St, Glasgow G2 5RL. (041) 248 4079. Linn, Naim, Rega, A&R, Aiwa, Denon, Dual, Epos, Heybrook, Mission, QED, Rotel, etc. BADA MEMBER 

BILL HUTCHINSON Ltd, 43 Hope Street, Glasgow. (041) 248 2857. A.R., Aiwa, Denon, Dual, JVC, Mission, Mordaunt-Short, Omar, Technics, Yamaha etc. Dem facilities. Mon-Sat 10-6. Free installation, instant credit. Access, Visa. Service dept.

## GRAMPIAN

HOLBURN HI FI Ltd, 441 Holburn St, Aberdeen (0224) 585713. Linn, Rega, Quad, Audiolab, Mission Cyrus, Rotel, QED, NAD, Krell, Nakamichi, Denon, Sony, KEF, Wharfedale, Monitor Audio, Kenwood, etc. 9.30-5.30 Mon-Sat. BADA MEMBER 

## WALES

### CLWYD

ACTON GATE AUDIO, 4 Ruabon Road, Wrexham. (0978) 364500. Quad, Rotel, NAD, Onkyo, AR, B&W, Sansui, Revolver, Castle, Target. Mon-Sat 9.30-5.30, closed Wed. Dem and home trial facilities. Free installation. Full credit. Access, Amex. Service dept.

## GLAMORGAN

AUDIO EXCELLENCE, 134 Crwys Road, Cardiff. (0222) 28565. Audio Research, Dual, Krell, Linn, Magneplanar, Naim, NAD, Yamaha, etc. Closed Mon.

BADA MEMBER   
AUDIO EXCELLENCE, 9 High St, Swansea. (0792) 474608. Audio Research, Dual, Krell, Linn, Magneplanar, Naim, NAD, Yamaha, etc. Closed Mon.

BADA MEMBER   
RICHER SOUNDS, 5 Central Square, Cardiff CF1 1EP. (0222) 383311. From Akai to Yamaha on a budget - regular end of line special offers. Facilities: expert advice; free 48 page Hi-fi Guide and monthly Newsletters; mail order; part exchange. Mon-Fri 10-6, Sat 10-5. Access, Visa, Richer ChargeCard.

## GWENT

A. E. HUGHES & SONSLTD, 28 Clarence Place, Newport. (10633) 58851. Bang & Olufsen, Kenwood, Mordaunt-Short, Roberts Radio, Dynatron, Mitsubishi, Sheraton. Cabinets plus audio accessories. Dem and home facilities. Free installation. Access and Visa. 9-12.45, 2.15-5.30 Mon-Sat. Service dept.



**g**  
the  
sound  
gallery

ALL CONSULTANTS ARE THE SAME. AREN'T THEY?

THE SOUND GALLERY HAS ESTABLISHED AN ENVIABLE REPUTATION FOR ITS PROFESSIONALISM IN THE RECOMMENDATION AND DEMONSTRATION OF DOMESTIC HI-FI. WHATEVER YOUR BUDGET, WE CAN PROVIDE YOU WITH THE HIGHEST LEVEL OF MUSICALITY.

SO WHY COME TO US? FOR SERVICE. IT'S FRIENDLY YET INFORMATIVE. PROFESSIONAL YET COST-EFFECTIVE. TRY IT!

65 CASTLE STREET  
HIGH WYCOMBE BUCKINGHAMSHIRE HP13 6RN  
TELEPHONE (0494) 3682

- ACOUSTIC ENERGY ■
- AUDIO AB ■
- A + R ■
- B & W ■
- CAMBRIDGE ■
- CREEK ■
- CELESTION ■
- DENON ■
- EPOS ■
- GOODMANS ■
- HEYBROOKS ■
- KEF ■
- LINN PRODUCTS ■
- MORDAUNT SHORT ■
- MARANTZ ■
- NAD ■
- NAIM ■
- NAKAMICHI ■
- REGA ■
- ROTEL ■
- SENNHEISER ■
- TANNOY ■
- WHARFEDALE ■
- YAMAHA ■

# PROGRESSIVE AUDIO

Lessons in music...

Systemdek IIX/Helius Scorpio/Goldring 1010  
Sugden A25 + JPW P1

Rock/Excalibur/ATF-5

Kelvin Labs Junior Pre/Power + Proac Super Tablettes

Valdi/Kuzma Stogi/Goldring Eroica

Audio Innovations Series 500 + Snell Type JII

Kuzma Stabi/Kuzma Stogi/Audio Technica OC-7

Kelvin Labs MC1/M30 + Proac Mini Towers

Michell Gyrodek/SME IV/Koetsu

Kelvin Labs MC1/M60 + Proac EBS

Voyd/Helius Cyalene/Audio Note

Audio Innovations 1000/2nd Audio Triodes + Snell Type C

**We give you six of the best!**

Progressive Audio is situated 5 mins. off the M2 at Rainham, Kent.

First class, no obligation demonstrations of these systems or of the superb equipment listed below, with pleasure, either here or in the comfort of your own home.

MICHELL VOYD SYSTEMDEK ROCK KUZMA STABI VALDI  
REGA ARMS EXCALIBUR HELIUS SME KUZMA STOGI  
AUDIO NOTE GOLDRING KOETSU ORTOFON AUDIO TECH. MILLTEK  
ARIA ROSE AUDION AUDIO INNOVATIONS QUICKSILVER  
SUGDEN ALBARRY INCA TECH MYST KELVIN LABS  
TOWNSHEND GLASTONBURY'S PROAC SNELL SPICA JPW CELEF  
MARANTZ CD PLAYERS KIMBER SUPRA VECTEUR PIRATES  
**COMING SOON!** LATEST MODELS FROM CROFT AND TDL

PHONE: DAVE on (0634) 389004 or STEVE on (0634) 366216

## PETER ELLIS AUDIO

Akai, Denon, Goodmans, Kenwood, Marantz, Teac, Aiwa, Technics, Maxell, TDK, That's and many more.

SINGLE SPEAKER DEMONSTRATION ROOM AVAILABLE.

PLEASE PHONE FOR AN APPOINTMENT

29 Kirkgate, Newark, Nottingham  
(0636) 704571

## THE Hi-Fi MECHANIK

Specialist Suppliers & Installers of Multi-Room Systems

Head Office: Unit 16, Downham Business Centre, Boundfield Road, London SE6 Tel: 01-695 5032

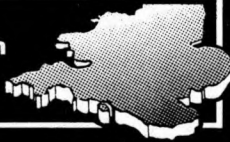

## Bill Hutchinson

HI-FI, AUDIO & C.D. Centre

★ Sales ★ Service ★

**ROTEL** **KENWOOD**

**marantz** **Technics**

**CRISTON**

**Dual**

**KFF**

**AIWA**

**DENON** **TANNOY** **JVC**

**Mordaunt-Short**

**AR**  
ACOUSTIC RESEARCH

**PIONEER**

**YAMAHA**

**TISSOT**

*Leading loudspeakers. Plus all leading brands. Our aim is to provide the highest level of service and value available in Scotland*

43 SOUTH CLERK ST EDINBURGH

031 667 2877

43 HOPE ST GLASGOW

041 248 2857



NO 1 FOR SERVICE AND VALUE



## The Sound Room of Norbury

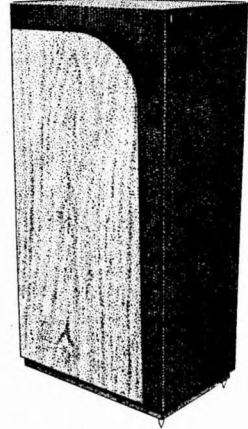
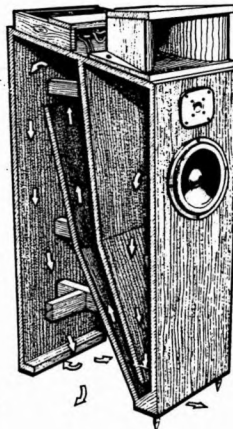

SIMPLY MADE FOR EACH OTHER ABSOLUTE CLARITY



Townsend Rock

Custom built State of the Art Horns. Introducing the awesome new Impulse H1 full range horn loaded loudspeakers. Lows that go down to the bowels of the earth. Highs that sing sweetly and a midrange that flows with an effortless freedom.

### AGENCIES INCLUDE:

ORACLE · BEARD AUDIO · ESOTERIC AUDIO  
RESEARCH · KISEKI-MILLTEK · AUDIO  
INNOVATIONS · ZETA · SNELL · MICHELL  
GYRODEC · THE VOYD · VALDI · HIGHPHONIC  
MCA 3 · IMPULSE H4 · AUDIO NOTE · HELIUS  
AUDIO · STATIC · MDM · SPICA · VECTEUR  
JECKLIN · DECCA · GARROTT P-77 · GOLDRING  
GRANT · SAE COMPACT DISC · ALPHASON  
VAN DEN HUL · INFINITY · KUZMA · COPLAND  
FOUNDATION · ELITE ROCK · AUDIO TECHNICA  
GLANZ · GRADO · NAGAOKA · ORTOFON  
SHURE · STAX · TARGET · DNM

### SOUND ROOM SPECIALS

#### EX DEMONSTRATION

	Retail Price	Sale Price
LINN LK1-LK2	£900	£550
SONUS FABER	£1200	£995
AUDIO RESEARCH SP11	£5250	£2950
AUDIO RESEARCH SP8	£1988	£825
AUDIO RESEARCH D115 MKII NEWVALVES	£3331	£1950
DIARIE SPEAKERS NEW	£865	£695
REVOX SYMBOLS LOUD SPKS	£1500	£695
INCATECH CLAYMORE	£300	£225
REGAR B300 SILVER WIRED	£195	£125
AUDIO INNOVATIONS 500	£750	£550
KRELL KSA50	£2550	£1100
SNELL TYDEK	£450	£275

#### PREVIOUSLY OWNED

SD1 LOUDSPEAKERS £850  
COUNTERPOINT SA7 £450  
ROBERTSON 4010 £450  
SNELL TYPE E £725

OPEN 7 DAYS AND EVENINGS  
DEMONSTRATIONS BY APPOINTMENT ONLY



PHONE 01-764-9295



# THE DIRECTORY

The *Hi-Fi Choice Directory* was conceived as a reference guide to all the audio products reviewed by *Choice* that are currently available. At present this runs to some 700 plus products split into suitable categories, each with its own introduction containing information about the product type and its applications. They are particularly relevant to the uninitiated first time buyer and help sort out the order of priorities when buying a piece of equipment.

Each product along with its retail price is placed in its respective category in alphabetical order. For instance the Acoustic Research *EB101* is presently at the beginning of the Turntables and Tonearms section; however, the Ariston *RD90 Superior* heads the Motor Units section as it is sold and was reviewed as a separate component – requiring a separate arm. Where there are several products with the same name but different model numbers these are in price ascending order.

Then come the ratings for the standard achieved in laboratory and listening tests, with the exception of certain product groups where lab tests were not carried out. One important point to remember is that they cannot be used to compare products from different categories – ie a cassette deck rated 'excellent' in sound quality will not usually offer

the same standard of fidelity as a similarly rated turntable or CD player (unless you can get hold of first generation copies of the master tape!).

The Comments column contains a potted summary based on the original review, emphasising the salient points of a product's character and sonic performance. The space available doesn't allow for great detail but in the 20 or so words we have attempted to put across the essence of the review, in some cases using quotes from the review itself. Obviously, important information on compatibility or auxiliary equipment used in the test cannot be included, and it is best to refer to the original review for this, of which more later.

The next column(s) varies from category to category but is usually either features or specifications, the former being facilities available on a cassette deck or amplifier or the type of drive system on a turntable.

Specifications vary with product type but usually relate to suitability or capability, for instance arm matching figures are given with the cartridges which tie in with the mass figures for the tonearms themselves, making it easier to avoid compliance/mass mismatches.

Perhaps the most influential letters in the Directory are those found in the Value column, the *Rs* and *Bs* denoting the Recommended and Best Buy ratings that are appended to products we consider meritorious. The Best Buy tag means that a product not only offers good sound quality but is reasonably priced as well. With source components a price

limit of approximately £300 is usually used as a guide. Recommended means that either the performance of a product is particularly good irrespective of price or, alternatively that a good value standard is achieved but overall attainment falls short of Best Buy classification. An ideal situation would be to choose suitably priced Best Buy or Recommended products from relevant categories and create a Best Buy system, but, due to the variety in tonal balance that exists in much audio equipment (especially the electromechanical elements – ie cartridge and speaker) system building is not quite that simple. These ratings make a useful guideline for shortlisting components, but only experiencing the actual combination will tell you whether it works for you.

The final column contains a reference to the issue of *Hi-Fi Choice* which featured the complete review. If you wish to get a better idea of a product by reading the complete review it is possible to order a copy (if still in print) through our back issues department. Every *Choice* issue contains a Back Issues page for this purpose.

The Directory is constantly updated with the latest reviews and price changes as well as having discontinued products removed. If a listed product is updated to a 'mark two' form and the alterations are purely cosmetic or not too extensive we sometimes leave the product in with its current model number and an asterisk to denote that it has changed since our original review was published.

## SYSTEM BUILDING

Pre-packaged one-make systems have been commercially very successful, with advantages like cosmetic consistency, competitive pricing, and (assumed) technical compatibility. However, despite the mass market clout of the consumer electronics giants, the hi-fi tradition of specialised separate components seems as strong as ever, and certainly represents the route taken by those who place sound quality ahead of other criteria.

Yet those who choose the separates route still have lingering doubts – usually completely unjustified – over the compatibility of components from different manufacturers. Gross incompatibilities are very rare nowadays, only likely to rear their heads amongst the most exotic components. Here the delicate art of 'supercompatibility' really takes over the major role and might be regarded as the key to 'real' hi-fi.

There are now three different pre-recorded music media competing for the attention of the hi-fi user, and to go for all three will either cost a lot of money or involve substantial compromises in the sound quality of each. For this reason many separates purchasers may start with just one source, adding others or a tuner when funds permit.

There will always be controversy over the relative qualities of LP, CD and cassette. LP is still the choice for ultimate sound quality – particularly for those prepared to spend a substantial sum on a good quality turntable system. Furthermore the vinyl repertoire is still the cheapest, largest and most varied.

Cassette has never really challenged vinyl's superior quality, but it is a multiple role format, offering 'go anywhere' flexibility, a uniquely useful recording capability, plus a broad catalogue of pre-recorded music cassette material. As a hi-fi medium cassette suffers from pre-recorded material which has been improving but is still patchy in quality, and can usually be bettered by a home recording. There is also the worry that a tape made on a specific machine usually replays best on that machine, which may cause aggravation when upgrading a few years hence. It is worth remembering that though such opportunities are rarely possible or practical, a live recording onto cassette using good quality microphones can be the hi-fi equal of any other source.

CD is the latest challenger to these two established media, using a digital instead of analogue storage format. The sound quality remains controversial, hailed as near perfect by its fans but derided by vinyl freaks, so it is probably fairest to say that CD is fine for most listeners, but may not suit everyone; certainly the lack of background noise, defects and deterioration over time are major strengths.

While there will always be arguments about the different music storage and transmission formats available to the hi-fi listener, there is also controversy over the relative importance of the different components which make up the system chain – by which is meant the source, the amplification, and the loudspeakers (and for the pedantic the room itself, though there's often little that can be done here).

For many years the 'weakest link' theory proposed that the loudspeakers needed the most attention, that amplifiers merely had to have sufficient power, and that turntables were pretty well perfect. However, this perspective has become steadily discredited by an alternative 'theory of precedence', which stresses that no subsequent component can make up for the inadequacies of its predecessors – all it can do is supply its own additional degradations. In such a context it is not uncommon to find more than half the system budget allocated to the record player, with scrimping and saving made on amplifiers and loudspeakers, even though these are used all the time whatever the source.

Choosing the components of a system is only part of the task of getting the system as a whole working as well as possible. Good turntables and loudspeakers both benefit to a surprising degree from proper support – from stands that enable them to give their best performance, whether floor-standing or wall mounted.

Siting of components within a room can play a significant role, as can the room itself. Some people may prefer an acoustically more 'live' room than others, but most will agree that the larger it is the better, because this tends to provide smoother and better extended bass reproduction. All rooms create reflections and standing waves, and the effects of these are more severe if all opposing walls are parallel, similar distances apart, and with hard reflective surfaces. Provided that the loudspeakers can be placed fairly symmetrically, slight asymmetry elsewhere in the room is usually helpful.

The loudspeakers are most critical of placement, because it is their job to create the stereo image, and it will be impossible to do this if the sound from each is not roughly similar at the listening position. Each loudspeaker should operate in a similar immediate acoustic environment, unencumbered by other furnishings and structure, and a similar distance from listener, nearby walls, and corners. Some loudspeakers are designed to operate close to a rear wall, others a metre or so out into the room, but all loudspeakers benefit from being closely mechanically coupled via proper stands to the floor.

There is some debate about the best form of fixing, however, adjustable spikes through to the

floor proper or seated into the tops of cross-head screws are generally regarded as the best solution in most circumstances. There is no need for paranoia about using spikes through normal pile carpets because the holes will be almost impossible to find when the stands are removed.

Most decent quality turntables are fairly immune to feedback from loudspeakers, so it should not matter too much if these items are sited fairly close to each other. Indeed it is debatable whether any advantages gained from keeping the turntable well away are not lost through the need to use longer connecting cables.

Mixing and matching the components of a record player to get optimum results can be something of a black art, over and beyond the fairly simple business of choosing a cartridge of roughly the right compliance to suit the arm effective mass. Certainly the combining of turntables and tonearms is not a simple matter, and this is where a good specialist dealer will come into his own, both in terms of recommending good combinations from the models he holds in stock, and then in correctly carrying out the sometimes tricky set up procedures which are often required to get the best results.

The key to getting the best results from a separates system lies in finding an experienced and skilled dealer in the first place, one who takes the trouble to find out what you really want and then demonstrate some likely alternatives, without trying to cram his own particular prejudices down your throat. To some extent the customer's task must be to discover for himself whether the dealer in question is competent or not. Membership of trade organisations like BADA can be a worthwhile pointer to a degree of professionalism, but the bottom line is whether the dealer in question can create a good sound in his own shop. If he can't, there is precious little chance of him doing so in your home. The best dealers should lay on demonstrations so you can hear the differences between components for yourself, and hear the sort of improvements which can be had at different price strata. You can then establish the sort of performance you are prepared to accept within whatever budgetary constraints you have set.

The Directory has been compiled so that it can be used by *Choice* readers as a buying guide. A guide in the sense that you should use the information in it to make a shortlist of equipment suited to your needs and budget, and then audition it at a dealer before taking the plunge. Because tastes inevitably differ it would be unwise to buy purely on the basis of our recommendation and dealers are the most experienced people around when it comes to making systems work as a whole.

# THE DIRECTORY

## TURNTABLES & TONEARMS

The schizophrenic split between consumer electronics and 'real hi-fi' is most obvious amongst turntables. The former are supplied simply as a means of playing vinyl in a system context. Cheaply manufactured in the Far East, these are complete players with a variety of automatic facilities, sometimes tied into system remote control. But engineering compromises severely limit sound quality, cartridge choice may be P-mount restricted, and such machines are rarely stocked by specialist hi-fi dealers these days.

Specialist turntables offer big sound quality

improvements, but lack so-called convenience features (that practised users often find irksome). Such turntables at the cheaper end of the market (sub-£350) tend to be supplied with matching tonearm, and often include a 'starter' cartridge. Still better quality is found at higher prices amongst the separate motor units and tonearms. Careful partnering and set-up is essential for these individual components, but 'naturally sympathetic' combinations do exist, and the good dealer can help.

Listed separately as integrated players and as turntable motor units and tonearms, our **sound**

**quality rating** is based on results achieved using a high quality system – but in point of fact the turntable is usually the limiting factor soundwise in any system. **Lab performance** summarises the speed stability, vibration generation and environmental isolation of turntables, along with the friction, alignment and adjustment of tonearms. The tonearm's physical characteristics also define a range of mechanically compatible cartridges (see cartridge listings).

### INTEGRATED TURNTABLES

NAME PRICE	LAB SOUND	COMMENTS	FEATURES ARM EFF. MASS	VALUE	BACK ISSUE FULL REVIEW
<b>Acoustic Research EB101</b> £230	Good Good	This genuine high fidelity product offers an impressive package at a competitive price	Subchassis, manual, 13.5g	BB	48
<b>Alphason Solo/Xenon MCS</b> £365/£262	Average + Good	The deck is warm and euphonious with high levels of clarity. Wow artefacts occasionally just audible.	3 point suspended motor unit, optional quartz PSU/speed change 13g		67
<b>Alphason Sonata/HR-100S-MCS</b> £695/£412	Excellent Very Good	Highly capable audiophile system with real resolution and control. Bass is powerful and dynamic ability unbridled.	Manual, subchassis, belt drive,	R	60
<b>Ariston Q-Deck</b> £150	Good Average +	Well engineered and good sounding low cost package which is both easy to set up and to use.	Semi-auto, belt drive, solid	BB	This
<b>Ariston RD60</b> £219	Good Good	With the Enigma arm, this balanced and communicative turntable falls only slightly short of the RD90 on sound quality.	Manual, belt drive, subchassis, 11.5g	BB	48
<b>Ariston Forte</b> £350	Below Average Average	Heavy on engineering, short of soul? The Forte almost makes it, losing out only because of some residual pitch variations and a lack of bass power. The arm is modestly good.	Manual 2-speed belt drive player and detachable arm, 10g		67
<b>Dual CS430</b> £89	Average Below Average	Ragged, sometimes unpleasant cartridge mixes with a modest pleasing player in a very sharply priced package.	Belt drive, with cartridge, auto return, 5g	R	67
<b>Dual CS503-1</b> £114	Poor Average	Slated as a replacement for the CS505, the 503-1 needs careful system matching to mask rumble and microphony, but is good enough to benefit from a better cartridge.	Semi auto, belt drive, low mass arm	R	55
<b>Dual CS505-3</b> £139	Very Good Good	Continuous steady improvements have kept this model at the forefront of the budget market. Practical is excellent and the deck has excellent timing bass/mid and stereo imaging.	Semi-auto belt-drive, 8g	BB	67
<b>Dual CS5000</b> £200	Average Average +	The rare 78 facility may give grandma's collection a new lease of life but the player did not merit recommendation on price vs sound.	Electronic, belt drive, subchassis, 10g		48
<b>Goldmund ST4</b> £4,000	Very Good Excellent	The Studio turntable takes on a cheaper tonearm than the T3F, yet provides a similar reference standard objective and subjective performance at £2,000 less, in a neatly integrated though bulky package.	Solid subchassis, direct drive, parallel arm, detachable headshell	R	60
<b>Heybrook IT2 turntable &amp; arm</b> £349/£249	Average Good +	A gradual process of informed evolution and a sensibly designed arm combine to make this a good sounding middle of the road package. Well supported dealers.	Manual subchassis motor with arm, belt drive,	R	67
<b>JVC AL-FQ555</b> £170	Below Average Poor	Clear midband sound but woolly bass and crude treble. Ease of use however ranks highly, and there's little to out of adjustment.	Auto, direct drive, 5.5g		67
<b>Kenwood OP-990</b> £300	Average Average	Smart, slick and massive player suitable for low compliance cartridges only. A good but not inspired performer.	Semi-auto 2 speed direct drive, 16g		67
<b>Kuzma Stabi/Stogi</b> £575/£349	Average + Stabi: Good; Stogi: Excellent	Stabi is powerful, spacious but not sufficiently subtle. Stogi is an excellent all rounder with even spread of abilities.	Manual, belt drive, subchassis, 12.5g	Stogi: R	60
<b>Linn Axis</b> £379	Good + Good +	Setting new performance-for-price standards this cleverly engineered and competent deck has many of the qualities of the Sondek LP12.	Electronic, belt drive, semi subchassis,	BB	48/Coil
<b>Linn Sondek/Ittok (Troika)</b> £509/£429 (£669)	Excellent Excellent	Superb sound – the best LP12 combination yet. The Troika gives the system real solidity and strength, stretching the deck and arm qualities to the full.	Manual subchassis player, belt drive, 14g	R	60
<b>Manticore Mantra</b> £300/£330 (Arm)	Good + Good +	Fitted with a Rega RB250 arm variant and AT95E cartridge the Mantra fared very well indeed with a fine midrange and good focus.	Subchassis, 12g, manual	BB	48/Coil
<b>NAD5120</b> £89	Average Average	A number of running improvements have given this player a range and tautness denied its lazier sounding antecedents.	Semi-auto belt drive, detachable arm/tube/weight,	BB	67
<b>Omega Point Silver/Black</b> £895/£295	Good Good +	An avowedly stripped down turntable that lacks even an on/off switch, the Omega Point Silver offers fine midrange clarity and good stereo, but some HF compression and a lack of 'wellie'.	Manual, solid, belt drive, unipivot, 11g		55
<b>Opus 3/Decca London International (Revised)</b> £399/£99	Poor Good	Heavyweight motor unit with many fine properties, but which needs further development. The idiosyncratic arm is a suitable (though not ideal) platform for the Decca cartridge. For all its faults though, the whole transcends the sum of the parts.	Belt-drive manual, damped unipivot arm, 12g		67
<b>Rega Planar 2</b> £135	Average + Good	A remarkable product at the price, surprisingly articulate and confident.	Integrated turntable, manual, 11.5g	BB	48
<b>Rega Planar 3</b> £188	Good Good	A long time leader in its price category, the '3' (with its excellent RB300 arm) sounded nicely 'musical' in a balanced and coherent manner.	Integrated turntable, manual, 11.5g	BB	48
<b>Revolver Rebel</b> £160	Below Average Below Average	Fat, assured and forward presentation, but ragged and subjective speed stability problems. With a little further development, it will be a winner.	Manual, 2-speed belt drive inc cartridge,		67
<b>Revox B291</b> £660	Average – Average –	Sound quality ranks as below average. Subjective bandwidth is narrow and the music lacks grace and energy. Ease of use however is unrivalled.	Automatic, remote controllable, direct drive parallel arm, prefitted cartridge		55
<b>Sansui SR-222 Mk V</b> £159	Average – Average	More than acceptable in most areas, the Sansui is detailed and positive, though a little muddled when stressed. Best suited to low compliance cartridges.	Manual 2-speed belt drive,		67
<b>Source/Odyssey RP1</b> £849/£695	Very Good	Mixed. The turntable has tremendous power and authority, but as tested suffered pitch imprecision. The arm is rather ill controlled and lacks resolution and focus.	Manual, belt drive, subchassis, motor, outboard PSU, 15g		55
<b>Systemdek IIX</b> £248	Good Average +	Poised, clear sounding deck, forward and explicit in character. A good value deck under £250, and a relatively cheap and satisfactory suspended model.	2 speed belt drive manual turntable and arm,	R	67
<b>Technics SLBD-22</b> £90	Average – Average –	Not bad for the price and a great improvement on the L20, it performs reasonably when not stretched.	Semi automatic, solid plinth, electronic, 6g P-mount	R	48
<b>Technics SL-DD33</b> £110	Average Average	As with the DD33 though better value.	Automatic, direct drive, solid plinth, 7.5g, P-mount	BB	48

TO ORDER BACK ISSUES OF HI-FI CHOICE SEE PAGE 123



NEW CAVENDISH STREET W1

CITY OF WESTMINSTER

The choice is yours!

Most equipment featured here has received a "Best Buy" or "Recommended" rating when reviewed in this magazine.

EXPORT Worldwide

Send for our Tax FREE price list and general information on how to order.

MULTIROOM SYSTEMS

Stereo in as many rooms as you want. Contact Paul Tam for more information about this service.

HI-FI CHOICE BEST BUYS



B200

SPEAKERS

Apart from having the best selling range of amplifiers the MF range of speakers is fast establishing itself as a best selling brand.

MODELS/PRICES

Table with 2 columns: Model, Price. Includes Reference 2, Reference 4, MC 2, MC 4.

AMPLIFIERS MODELS/PRICES

Table with 2 columns: Model, Price. Includes A1, B200, A100, PR3A, P140, P172, P170, MVT, P270, MA50, MVX, A370.

ASK ABOUT OUR INTEREST FREE CREDIT

TANNOY

Two models in the Tannoy range have received 'Best Buy' awards in this magazine and it is not difficult to realise why. Their all-round versatility on a wide range of music means they integrate well into most systems. Good dynamics, clarity and firm bass sum up their best characteristics.

MODELS/PRICES

Table with 2 columns: Model, Price. Includes Eclipse, Mercury 'S', M20 Gold Mk 2.



CD65 Mk 2 Special Edition

The current Marantz range of CD players keeps winning accolades from the press. The 'special edition' versions of the CD65 and CD75 have been 'tweaked' for extra refined performance. Indeed the CD65 Mk 2 SE was recently voted CD player of the year by What Hi-Fi magazine and enjoys a 'Best Buy' rating in this magazine. Through the range they are excellent machines and to be fully recommended.

MODELS/PRICES

Table with 2 columns: Model, Price. Includes CD65 Mk 2 SE, CD75 Mk 2 SE, CD 85, CD94, CDA94 D to A converter.

HI-FI CHOICE RECOMMENDED

INTERCONNECTS Stereo pairs terminated gold plated RCA phono plugs

Table with columns: Description, 0.5m, 0.75m, 1.00m, 1.5m, 2.0m, 3.0m, Cable per metre. Lists various cable models like QED INCON, DNM Solid Core, etc.

SPEAKER CABLES Stereo pairs terminated 4mm plugs (state if other termination required)

Table with columns: Description, 2m, 3m, 4m, 5m, 7m, 10m, Cable per metre. Lists various speaker cable models like AQ Livewire, DNM Solid Core, etc.

BRANDS STOCKED: Air Tangent, Albarry, Alphason, Arcam, Apogee, Audioplan, Audiolab, Audio Research, Avance, Beard, B & W, Cambridge, Croft, Celestion, DNM, Denon, Dual, Epos, EAR, Foundation, Goldmund, Harbeth, Heybrook, Jadis, KEF, Koetsu, Kiseki, Kinergetics, Krell, Kuzma, Linn, Linx, Magneplanar, Martin Logan, Mantecore, Marantz, Meridian, Michell, Milltek, Mod Squad, Musical Fidelity, NAD, Naim, Nakamichi, Nitty Gritty, Oracle, Pink Triangle, PS Audio, Quad, QED, Rata, Revox, Revolver, Rotel, Rogers, Stax, SD Acoustics, Sonus Faber, Spica, SME, Sumo, Slate Audio, Systemdek, Tannoy, Voyd, Wharfedale, Yamaha, Zeta.

kj K.J. WEST ONE Dept. HC2 26 NEW CAVENDISH STREET, LONDON W1M 7LH Telephone: 01-486 8262/8263 Fax: 01-487 3452 Open: Monday-Saturday 10am-6pm Thurs until 7pm

MAIL ORDER - Post/Packing/Carriage £1.65 per order (over £35 Post Free) UK mainland only. Overseas and off-shore by quotation. Telephone orders are welcomed if customers are paying by credit card.



# THE DIRECTORY

## INTEGRATED TURNTABLES

NAME PRICE	LAB SOUND	COMMENTS	FEATURES ARM EFF. MASS	VALUE	BACK ISSUE FULL REVIEW
Technics SL-L20 £115	Poor Average -	A rather lightweight parallel tracker achieving a poor overall rating, with little to recommend it unless you dig facilities	Electronic, solid plinth, 5g, P-mount		48
Technics SL-QD33 £140	Average Average	The quartz speed controlled version of the DD is short on sound quality but not features. But it did have fair focus and some depth	Automatic, Quartz, direct drive, solid plinth, 7.5g, P-mount	R	48
Thorens TD280 £150	Average Average	Extremely competitively priced package with a trace of lower-mid overhang, but it's very well behaved elsewhere	Semi-auto belt-drive 2-speed, 13g	BB	67
Thorens TD166 Mk II £179	Average Average +	A polished and professional design consisting of a first rate budget suspended subchassis turntable and a mildly disappointing arm	Manual 2-speed, 13g	BB	67
Thorens 160S Mk IV £249	Average + Average +	Fine, familiar suspended player and arm. Faults are few, but include poor arm bearing adjustment. The arm can sound a little messy	Manual 2-speed, 7g	R	67
Thorens TD320 Mk II £349	Good Good	Good, consistent sounding deck with much improved (but not ideal) arm. A little expensive for performance offered	Semi-auto two speed belt drive, 14g		67
Well Tempered Turntable & Arm £1690	Average Very Good	Intriguing and challenging design. Musically it is not ideal, but it has a limpid quality and a lack of artificiality that sets standards as well as turning the ear, though it's not completely uncoloured. A charmer yet mainstream enough in its virtues to be viable	Manual 2-speed, damped suspended arm, 7.5g	R	67

## MOTOR UNITS

NAME PRICE	LAB SOUND	COMMENTS	FEATURES	VALUE	BACK ISSUE FULL REVIEW
Ariston RD90 Superior £900	Good + Good	Good but slightly damped sound quality, with powerful and stable bass. The pro quo is a certain lack of pace, energy and resolution	Belt drive, subchassis, electronic		55
Audio Labor Konstant £2,560	Good + + Very Good	The space-station-like solid alloy frame needs a substantial shelf, but absolute stability renders a confident, neutral sound	Belt drive, subchassis	R	48/Coll
Goldmund Studio £2,350	Very Good Excellent	A reference point for high end audio, only exceeded by the even more extravagant Reference. Currently being reworked into a more competitive (!) package	Electronic, direct drive, solid subchassis	R	60
Michell Synchro £265	Good Good	A particularly happy blend of qualities endows the Synchro with a blend of subtlety and force - the mailed fist in the velvet glove. Easy on the ear in the best sense	Manual, belt drive, suspended motor unit	R	67
Michell Gyrodec £595	Good Good	Sweet and natural sounding player, well exploited by the Rega RB300 arm. Aesthetics, and the acres of acrylic, are unique	Manual, belt drive, suspended motor unit		55
NVA Turntable £499	Average Good	A surprisingly fast and assured performer, but with lightweight bass and a little aggressive. Easy to set up, the price (necessarily) includes stand	Manual, belt drive subchassis, stand, 33 $\frac{1}{3}$ rpm		60
Oracle Alexandria Mk III £825 - £995	Very Good Very Good	One of the most beautifully presented players made, and fully supported by superb separation, dynamics and a euphonious style of delivery	Manual 2-speed belt drive	R	67
Oracle Delphi III £1450	Very Good Very Good	Stable imaging, good bass and refined detail, it's well made and consistent in service - but very expensive	Manual, belt drive, subchassis	R	60
Oxford Acoustics Crystal Reference £1955	Very Good Excellent	This big, open and powerful sounding turntable works beautifully with Airtangent arm to give superb 3-D imagery	Manual, belt drive, subchassis, stand	R	60
Pink Triangle PT TOD £650	Good Excellent	A state of the art player, easy to set up but extremely fussy about partnering equipment and state of tune. The test sample suffered flutter derived roughness (presumed not typical)	Manual 2-speed, outboard PSU	R	67
Rega Split Slab Modification Kit £74	Good Good	Clever and cheap upgrade kit that protects the initial investment and which adds clarity and environmental isolation to a fine but microphonic original	Conversion suspended chassis kit for Rega 2/3		67
Roksan Xerxes £655	Excellent Excellent	This unique design cuts a swathe through the conventions of turntable design, providing superb resolution and stereo. Setting is critical, and for experts only	Manual, belt drive, solid/decoupled	R	67
SEE Revolver £135	Average Average	Nicely balanced, but unimpressive timing and lightweight bass made this deck rather average for the price. Manufacturer has since made several changes, but not re-submitted for review	Manual, belt drive, solid plinth		48
Source So £675	Good Good +	Now an extremely tidy sounding deck, the So has a grip and range at low frequencies that knows few peers, and is at least sufficiently good elsewhere. A successfully refined version of a promising original that didn't quite deliver	Manual belt-drive 2-speed, outboard PSU	R	67
Systemdek IXE £248	Good Good	Fine, honestly specified and well built player which easily betters its closest stablemate, the IIX	Manual 2-speed, external PSU	R	67
Systemdek IV £495	Good Very Good	The level of wow is a theoretical concern at least, but elsewhere this player shines, combining euphony, information and imaging in a polished, untemperamental package	Two-speed manual belt drive	R	67
Thorens TD521 £629	Average Average +	Nice product. Unexciting, rather undynamic and insubstantial sound quality, but facilities such as ability to accommodate 12 inch arm compensate	Manual, belt, suspended motor unit, 78rpm pitch control		55
Townshend Avalon £299	Good Good	Some smear and coloration, probably due to structural shortcomings of the plinth, take the edge off this otherwise well turned out and well priced machine. Worth trying if you can't afford the full-blown Rock	Manual 2-speed belt drive	R	67
Townshend Rock £450	Good Good + +	Tight, tidy sounding player which works with a wide variety of (non-tangential) arms, giving almost CD like precision and clarity. Good bass depth, dry balance - our Editor's favourite deck, in fact	Manual, belt drive, solid, arm damping, various optional extras	R	55

## TONEARMS

NAME PRICE	LAB SOUND	COMMENTS	ARM EFF. MAS	VALUE	BACK ISSUE FULL REVIEW
Airtangent II £1998	n/a Excellent	A complex but superbly built arm for high quality systems, giving excellent stereo and resolution	7.5g (vertical)	R	60
Alphason Opal £110	Good Average	This is a straightforward adequate sounding low cost arm, priced just above where it rightly belongs	10g		55
Alphason Delta £165	Good Average +	A highly competent design from Alphason gives good sound quality but with slight blurring and treble fizz	16g	R	48
Alphason Xenon £210	Good Good +	A trimmed down HR100S, the Xenon has inferior bearings and a simpler finish, but sounds crisp and coherent. Fits any Linn cutout	127.5g	R	55
Alphason HR100S £395	Good + + Very Good	This S-shaped arm sounds smooth, but nevertheless reproduces transients with fine attack	10g	R	48/Coll
Ariston Enigma £99	Average Average +	Good but not the best in its class: mid-band sounds a little uneven; treble a trifle "brash"	11.5g		48
Audio Technica AT1130 £186	Good Good	Well suited to most cartridges including high compliance ones, the AT is smooth and tonally neutral, if slightly lacking in 'balls'	8.5g	R	67
Decca International £49	Average + Average +	This uni-pivot design gives a rather rich tonal balance and some bass muddling. Could be good with Decca cartridges, but not well built	12g		48/Summary
Eminent Technology £960	Good + Good + +	One of the best sounding tonearms around, the linear tracking Eminent delivers impressive stereo imagery, focus and transparent sound	9g (vertical)	R	48/Coll

THE WORLD'S NO 1 GUIDE TO BUYING HI-FI

# THE DIRECTORY

## TONEARMS

NAME PRICE	LAB SOUND	COMMENTS	ARM EFF. MAS	VALUE	BACK ISSUE FULL REVIEW
Goldmund T3F arm £3950	Excellent Excellent	This complex parallel tracker created an "ear-opening" experience when tested with a (since updated) Goldmund Studio turntable	16.5g	R	Coll 2
Grace G707 £299	Good Good+	This venerable is still capable, if not competitive with modern alternatives	7g		48
Helius Orion 2 £490	Very Good Very Good	Very expensive but with a performance that merits recommendation	12g	R	48
Linn LV Plus £129	Good+ Good	The fixed headshell provides an improvement over the LVX resulting in better clarity, detail and punch	13g	BB	48
Linn Ittok LVII £429	Very Good Very Good	Suitable for many turntables this top-quality arm performs best with the LP12, the combination exceeding the sum of both parts	13.5g	R	48/Coll
Linn Ekos £895	Very Good Very Good	Superb, state of the art design which builds significantly on Ittok's strengths	9g	R	67
Manticore (Logic) Datum 2 £140	Very Good Good++	Rated sonically very good with fine depth focus and transparency, good air and life, albeit slightly 'untidy'	15g	R*	48/Coll
Mission Mechanic £700	Good Good+	Nearly right, but inconsistency with level and vague imagery spoil what is otherwise a firm, powerful advocate for black vinyl	11g		55
Moth Arm £65	Good Good+	The ultimate budget arm? Refined, detailed, sweet and natural – performance improves in line with the rest of the system	12g	BB	60
Rega RB300 £90	Good++ Good++	Despite its modest price this sets exceptional performance standards and could be used on a number of high-quality turntables	10-11g	BB	60
Roksan Artemiz £350	Average Good	Excellent but flawed arm which needs some development and refinement before it can be wholeheartedly endorsed. Watch this space. Fits Rega cutout	8g		67
SME 3009 Series IIS £165	Good Average+	A simplified less flexible (as regards adjustment) Series III with a similarly 'soft' sonic character	5g		48
SME 3009 Series III £229	Good Average+	Comprehensively adjustable and very well made, suited to MM and high compliance MC cartridges	5g		48
SME 3009R £291	Average+ Average+	A higher mass version of the Series III designed for low compliance MC cartridges	12g		48
SME Series IV £810	Excellent Very Good	Superb engineering and finish with a finely balanced sound giving impressive stereo focus and low coloration	10.5g	R	60
SME Series V £1206	Excellent Very Good	Excellent in terms of design engineering and sound quality, this arm arguably sets a new reference standard regardless of price	10.5g	R	60
Souther Tri-Quartz £895	Average Good	A unique parallel tracking arm that makes up for what it lacks sonically in its unusual appearance	3-4g		48

## CARTRIDGES

Very much the 'slave' of turntable and tonearm and to some extent undermined by the supply of free 'starter' cartridges on many turntable systems, the cartridge is still worth taking seriously. The quality of both the stylus itself and the cartridge's tracking performance are important in preserving that most important part of the hi-fi system – the record collection – and the cartridge also plays a significant role in determining the overall balance of a system.

Cartridges fall into two groups: high output models, capable of working directly into any amplifier, and more expensive low output models. Stereotypically, low output cartridges use the moving coil principle of operation, have better mechanical integrity and tighter tolerances, and give better performance but at much higher cost. Most under-£150 amplifiers and many valve designs need either an extra head amp or transformer to cope with the low output. **Cartridge/amplifier**

interfacing can be very subtle, but even basic high output moving magnet designs benefit in overall balance from optimised amplifier capacitance loading. Still more important, the mechanical cartridge characteristic of cantilever compliance ('springiness') needs to be considered in the light of the effective mass of the tonearm which will be used (see Turntable & Tonearm entries).

NAME PRICE	LAB SOUND	COMMENTS	ARM OUTPUT/TYPE	VALUE	BACK ISSUE FULL REVIEW
A&R C77 £20	Average+ Average+	A sensible moving magnet package with good bounce at a competitive price	6-16g Normal, MM	BB	48
A&R C77Mg £30	Average- Average	Punchy sound quality with plenty of extra energy to liven things up. The solid body seems well worth the extra £10	4-8g Normal, MM	BB	67
A&R E77Mg £47.50	Average Average	Our sample had a disappointing stylus, but gave a coherent, rich and laid back sound, with good 'scale'	3-8g Normal, MM	R	48
A&R P77Mg £60	Average+ Average+	Cautiously recommended, the P77Mg was preferred to its cheaper partner by virtue of a better tip. Channel balance could have been better	4-9g Normal, MM	R	48
AudioNote ID2VDH £795	Good Very Good	One of the best, giving 'an extraordinarily relaxing midrange clarity'. But it picked up a bit of surface noise and dust and needs a transformer	8-18g Very low (transformer), MC		43
Audioquest MC5 £200	Average Average	Offers high-output benefits but the drooping frequency response and severe VTA error preclude recommendation	10-20g Normal, MC		54
Audio Technica AT95E £17	Average- Average	Clear, dynamic if richly balanced, the magnetic '95E is a definite Best Buy	8-14g Normal, MM	BB	48
Audio Technica AT-420E OCC £30	Average Average	Better suited to pop recordings this MM bears some of the sonic hallmarks of the Linn K5	7-14g (damp) Normal, MM	R	67
Audio Technica AT-430E OCC £42	Average+ Average	A rising high frequency response yields something of a treble sting, not a good all-rounder	3-7g Normal, MM		67
Audio Technica AT-F3/OCC LE £70	Average+ Good	Though the 'limited edition' badge is a trifle tongue-in-cheek the 'F3 still offers excellent value	8-15g Low, MC	BB	67
Audio Technica AT-F5OCC £100	Average+ Good	Decent output, good channel balance and a thoroughly refined sound sets the standard at £100	9-20g Low, MC	BB	54
Audio Technica AT-F5/OCC LE £100	Average Good+	This latest sample demonstrated some technical weaknesses but its spacious, fluid sound quality still represents a benchmark at this price	4-10g Low, MC	BB	67
Audio Technica ATOC7 £250	Good+ Good+	Technically and subjectively this cartridge represents a new dawn for AT, in the twilight of analogue audio	6-13g Low, MC	R	54
Audio Technica ATOC9 £400	Average+ Very Good	Tonal colours were reproduced faithfully while stereo images were clearly isolated and focused despite contributing to a thoroughly integrated whole. Slightly less transparent than more costly MCs	6-14g Low, MC	R	60
Azden YMT0VE £12.50	Average Average-	A good tracker. Sounds rather bunched-up but not totally incoherent – for very basic systems only	5-15g Normal, MM		54
Azden GM1E £30	Average- Average-	Of academic interest only, this high o/p MC is seriously flawed in sonic terms	8-18g Low/normal, MC		54

TO ORDER BACK ISSUES OF HI-FI CHOICE SEE PAGE 123



# THE DIRECTORY

## CARTRIDGES

NAME PRICE	LAB SOUND	COMMENTS	ARM OUTPUT/TYPE	VALUE	BACK ISSUE FULL REVIEW
<b>Azden GMP5L</b> £108	Average+ Average+	Although no P-mount system will do this cartridge justice, it can still be enjoyed in its universal mode. The subtle balance may prove irresistible to some.	4-10g Low, MC	R	54
<b>B&amp;O MMC5</b> £24	Average+ Average	Cheapest in the family – smooth treble and good focus, but the bass was left in the wings.	5-15g Normal, MM		38 (Summary)
<b>B&amp;O MMC4</b> £43	Good Average+	Solid and well balanced in the midrange, the '4 lacks bass impact.	5-15g Normal, MM		48
<b>B&amp;O MMC3</b> £57	Good Average	Slightly "laid back" sound quality but a good performer for the price. Best suited to B&O equipment.	5-15g Normal, MM		48
<b>B&amp;O MMC2</b> £87	Good Average+	Only a modest improvement on its cheaper brothers (and sisters).	5-15g Normal, MM		48
<b>B&amp;O MMC1</b> £112	Very Good Good	Great clarity and detail at high frequencies but a slightly plodding bass. It may appeal more to the classical enthusiast.	5-13g Normal, MM		48
<b>Cello Chorale</b> £799	Good Very Good	Looking like a piece of NASA gadgetry the Chorale's transparent treble delicacy was without equal. A serious audiophile choice.	4-10g Low, MC	R	48/Coll
<b>Clear Audio Gamma</b> £295	Average Average+	Brimming over with enthusiasm, the unusual-looking Gamma is more than an audio oddity, but it lacks a little subtlety at times.	4-11g Low, MC		54
<b>Clear Audio Delta</b> £450	Average+ Good	Midway between the Gamma and exotic Pradikat, the Delta sounds like neither! Nevertheless, it delivers the goods.	6-17g Low, MC	R	54
<b>Clear Audio Pradikat</b> £1225	Average+ Very Good	Sounded absolutely glorious, creating a full sense of scale and a large well-focused soundstage – but watch for record wear.	8-18g MC		Coll
<b>Clear Audio Accurate</b> £2,000	Good Excellent	A remarkable cartridge, not only by virtue of its effortless and highly neutral sound quality but also because this has been achieved with the same basic design as Clearaudio's cheapest MCs.	4-11g Low, MC	R	60
<b>Denon DL110</b> £69	Good Good	Firmly recommended as a fine all-rounder, this high-output moving coil model is likely to perform well in nearly all circumstances.	6-16g Normal, MC	BB	48
<b>Denon DL160</b> £89	Average+ Good	Although listeners just preferred the 110 its brother here proved a twin in lab tests and is still "thoroughly competent".	6-16g Normal, MC		43
<b>Denon DL 103</b> £99	Average Good	This classic spherical stylus model gives a lively sound with powerful bass, and is popular in broadcast studios.	6-16g Low, MC	R	48
<b>Dynavector DV-50X</b> £60	Good Average	A high-output MC model with impressive lab performance, but whose tip and sound quality both disappointed.	6-14g Normal, MC		48
<b>Dynavector DV10X IV</b> £60	Average Average+	Fine sounding and realistically priced, damping is recommended to ensure successful tracking ability.	8-18g Normal, MC	R	48
<b>Dynavector DV23RS</b> £150	Average+ Good	Sound quality was described as "shut-in", lacking energy and sparkle but with some "edginess" in high frequencies.	10-22g Low, MC		28
<b>Dynavector DV XX-1</b> £360	Good Good+	The XX-1 embodies a power and solidity rarely encountered amongst the breed, nevertheless it did exhibit a peculiarly suppressed character that will suit lively rather than wholly neutral systems.	7-17g Normal, MC		60
<b>Empire 800 Mk II</b> £33	Good Average	This very high output MM appears to be based on the classic Ortofon VMS series. A trifle uninspiring overall.	7-17g Normal, MM		67
<b>Empire MC-5M</b> £110	Average+ Good	A very low compliance renders this MC best suited to heavy tonearms while its sweet, non-aggressive sound quality earns it a recommendation.	13-20g Low, MC	R	67
<b>Glanz MFG 110EX</b> £24	Average Average	A little bright but giving detailed bass and clear treble this was competitive at the price.	6-16g Normal, MM	R	Systems
<b>Glanz GMC-10EH</b> £49	Good Good	The rising HF trend of this high o/p MC may cause problems in certain systems but with a favourable wind its seductive qualities will win out.	8-14g Normal, MC	R	67
<b>Glanz GMC-10LX</b> £79	Average+ Average+	Bearing some of the hallmarks of the '10EH, the '10LX is still less competitive in the sonic stakes.	7-15g Low, MC		67
<b>Glanz GMC20E</b> £129	Average Average	You could try haggling but we thought the makers of this number were demanding too much lucre for their product.	3-6g Low, MC		48
<b>Goldmund Clearaudio</b> £1500	Average+	Something of a mixed bag overall, its sonic character bears a strong resemblance to the Pradikat though it shares some of the hallmarks of the more expensive Accurate.	5-12g Low, MC		60
<b>Goldring Elan</b> £15	Average+ Average	A lightweight and frisky-sounding MM that appears to be based upon the same body as the Nagaoka mm4.	7-15g Normal, MM	R	67
<b>Goldring Epic II</b> £23	Average Average+	An excellent budget choice though the limitations of the stylus are rather obvious at higher frequencies.	5-12g Normal, MM	R	67
<b>Goldring G1010</b> £36	Average Average	A bit fiddly to set-up but rewarding once accomplished. The big and bouncy sound belies its price. Sensitive to amp loading.	10-20g Normal, MM	BB	54
<b>Goldring G1020</b> £53	Average+ Average-	This one strutted finely onto stage but couldn't project to the "gods".	8-16g Normal, MM		43
<b>Goldring G1040</b> £79	Average+ Average-	High frequency extension was improved by the van den Hul tip, nice looking model – no great actress.	8-16g Normal, MM		48
<b>Goldring Eroica L</b> £95	Average Average+	Open and relaxed sounding, the L version is just that bit more refined than its high output brother.	7-18g Low, MC	R	54
<b>Goldring Electro II</b> £149 complete	Average Average+	A pretty decent all-rounder that did not excel sufficiently to warrant recommendation.	8-16g Normal, MC		43
<b>Grace F9E II</b> £240	Good Good	For lively presentation, excellent separation and generally satisfactory sonic delivery – consider this model.	5-10g Normal, MM		48
<b>Grado XTE +1</b> £20	Average- Average	Bass and treble are a trifle coloured but the midband proved highly enjoyable. Ideal for budget systems.	6-13g (damping) Normal, MM	R	54
<b>Grado XF3E +</b> £43	Average- Average	Downtilting balance disguises the brightness of this cartridge, bit of a mixed bag at this price.	9-20g (damping) Normal, MM		54
<b>Highphonic MCA3</b> £360	Very Good Good+	Exquisitely crafted by a group of ex-Denon engineers, this superb tracker had a sweet and seductive (if rather bright) treble.	5-12g Low, MC		43
<b>Kiseki Blue Silver Spot</b> £395	Average+ Good	Solid performance from a very solid cartridge but lacks some of the magic of other Kisekis. Compliance too high.	5-12g Low, MC		54
<b>Kiseki Purpleheart Sapphire</b> £695	Good+ Good+	Rare, beautiful to look at and sweet to listen to, our review of this high-flyer conjured up images of Japanese art.	5-14g Low, MC		Collection
<b>Kiseki Blackheart</b> £1595	Good Good	This cartridge demonstrated refined poise and a delicate but at once potent security, however, the price did seem a little on the high side compared to other Kisekis.	6-16g Low, MC		60
<b>Kiseki Lapis Lazuli</b> £3500	Good Very Good	Combining very sensible design concepts at a silly price, the Lapis Lazuli is best thought of as combining the detail of the MC300C and the fluidity of the Clearaudics.	4-12g Low, MC		60
<b>Koetsu Black K</b> £577	Good+ Good+	Impressive in scale and dynamics but with some criticism of bass muddling and high treble fizz. Listen before deciding.	6-18g Low, MC	R	48/Coll

THE WORLD'S NO 1 GUIDE TO BUYING HI-FI

## THE DIRECTORY

## CARTRIDGES

NAME PRICE	LAB SOUND	COMMENTS	FEATURES	VALUE	BACK ISSUE FULL REVIEW
<b>Koetsu Red</b> £896	Good+ Very Good	Named like a rare, and perhaps dangerous, little oriental fish this famous cartridge sounded "almost larger than life"	10-25g Low, MC	R	48/Coll
<b>Koetsu Red Signature</b> £1298	Good Excellent	Technically this cartridge suffers no faults whilst on a subjective level it offers rare musical insight	10-21g Low, MC	R	60
<b>Linn K5</b> £30	Average Average+	Not as crisply focused as the costlier Linn magnetics, the K5 offers a smoother presentation	7-16g Normal, MM	R	67
<b>Linn K9</b> £69	Average Good	Linn threw this model into the leading pack by beefing up the Basik's bodywork, adding a super stylus, and keeping the price fair	6-15g Normal, MM	BB	48/Coll
<b>Linn Asaka</b> £299	Good+ Good+	Disciples of Linn who are trying to realise their true "Karma" may find that saving money is not a short cut to heaven	9-18g Low, MC	R	48/Coll
<b>Linn Karma</b> £435	Very Good Very Good	A specialist which is strongly recommended for Linn-based systems; results may be less predictable in more general application	9-18g Low, MC	R	48/Coll
<b>Linn Troika</b> £669	N/A Very Good	Ex-Karma users have been seen with glazed expressions indicating smug self-indulgence the morning after fitting a Troika	8-18g Low, MC		Coll
<b>London Maroon</b> £109	Average Average+	Now manufactured under the London brandname this Decca cartridge is as iconoclastic as ever	9-20g (damp) Normal, MM		67
<b>London Super Gold</b> £248	Average- Good+	Sometimes a bit fierce in emphasising record surface faults, it is perhaps best at revealing the excitement and tension in music	8-20g + damping Normal, MM	R	48/Coll
<b>Madrigal Carnegie One</b> £685	Average+ Good	Looks like a duck but sounds much better, certainly worth auditioning. Compliance too high	5-11g Low, MC		54
<b>Militek Aurora</b> £198	Good+ Good+	An overall feeling of relaxed ease characterised this clear and atmospheric Kiseki-built cartridge	8-16g Normal, MC	R	48/Coll
<b>Militek Olympia</b> £298	Average+ Good+	Warm and detailed sound - packs the punch of the best MCs with high output as a bonus	12-20g (damping) Normal, MC	R	54
<b>Mission 773HC</b> £150	Good Good	A sufficiently well-balanced and competitively priced "old-timer" which still warrants recommendation	6-16g Low, MC	R	38
<b>Monster Alpha 2</b> £479	Good Good+	In the final analysis this fine allrounder is insufficiently exceptional in any specific respect to justify fully its high price	6-14g Low, MC		Collection
<b>Nagaoka MM4</b> £8	Average- Average-	Clear punchy sound that delivers the rudiments of a good performance	6-16g Normal, MM	R	54
<b>Nagaoka MP10</b> £17	Average Average	High frequencies sounded "shut-in" with this spherical-stylus model, but mid and mass were energetic, bouncy and punchy	5-13g Normal, MM	R	48
<b>Nagaoka MP11 Boron</b> £38	Average Average+	Responding well overall in PM's equipment and listening room, this model was mildly criticised for low level and dynamic limitations	5-13g Normal, MM	BB	48
<b>Nagaoka MP10SB</b> £40	Average Average+	Stillton's mods have improved the fine detail resolution of this popular budget model	5-15g Normal, MM	R	54
<b>Nagaoka MP11 Gold</b> £45	Average- Average+	There were mild criticisms directed at most areas, but in general the sound was clear, open and even	3-8g Normal, MM	R	48
<b>Nagaoka MP11 Gold SB</b> £70	Average- Average	Excessive price loading for a blob of aluminium	2-6g Normal, MM		54
<b>Ortofon DM5E</b> £15	Average- Average-	The DM10 is a hi-fi cartridge - the DM5E is not	5-16g Normal, MM		43
<b>Ortofon VMS5E II</b> £14	Average Average	Sound quality was thought fair for the price, though a little 'untidy'	8-18g Normal, MM		38 (Summary)
<b>Ortofon DM10</b> £20	Average Average	One of the leading "cheapies", this gives a fine level of sound quality for the price, with good matching compatibility	5-15g Normal, MM	BB	48
<b>Ortofon VMS 10E II</b> £21	Average- Average-	Some of its stablemates fared rather better, and showed less evidence of tracking problems to boot	Normal, MM		38
<b>Ortofon VMS20E II</b> £35	Average Average	One of the most popular cartridges ever, sound quality was a bit laid-back and tracking could have been better	3-10g Normal, MM		48
<b>Ortofon DM20</b> £40	Average Average+	This turned out to be the listening panel's favourite among Ortofon's moving magnet models	5-16g Normal, MM	R	48
<b>Ortofon 520</b> £50	Average Average+	Very sensitive to load capacitance this new Ortofon maintains the company tradition for a lively, effervescent SQ	7-16g Normal, MM	R	67
<b>Ortofon X1</b> £50	Average Average	The cheaper X1 scored higher marks with our listening panel than the X3, but both were a disappointment	6-15g Normal, MC		48
<b>Ortofon VMS30E II</b> £52	Average+ Average	Rather an old soldier in relation to turntable technology, it will perform undemandingly in demanding circumstances	5-13g Normal, MM		38
<b>Ortofon MC10 Super</b> £70	Average Good	"What a delightfully sweet-sounding cartridge this is..." we said	5-15g Low, MC	BB	48
<b>Ortofon X3</b> £70	Average Average	A lack of bass power, definition and a "zitty" top end makes this competent but uninvolving	5-15g Normal, MC		48
<b>Ortofon OM40</b> £80	Average Average+	Highly competent engineering, secure tracking and decent sound quality are major strengths. But it's a little cold, a little polite	3-8g Normal, MM		48
<b>Ortofon 540</b> £100	Average- Average	Graced with an advanced FG11 stylus our sample possessed too high a compliance for broad arm matching. It could also sound a little unforgiving	3-8g Normal, MM		67
<b>Ortofon MC20 Super</b> £170	Average+ Good+	An "inviting" sound quality; polite rather than exciting it approaches much more expensive models, but does not better them	6-15g Low, MC	R	48/Coll
<b>Ortofon MC30 Super</b> £250	Very Good Good+	Beautifully engineered and well-balanced, it was slightly criticised as bland, though some may appreciate the lack of rough edges	5-14g Low, MC		Coll
<b>Ortofon MC3000</b> £800	Good Excellent	Quite simply, the most accurate transcription device yet created - not one for the faint hearted	6-16g V Low, MC	R	60
<b>RATA RP20</b> £22	Average- Average	Good integration, a clear dynamic midrange and the beginnings of fine stereo imagery merits clear recommendation	6-14g Normal, MM	R	48
<b>RATA RP40</b> £44	Average Average+	The '40 did a good job of sorting out the layers and complexity of the mix, with good focus, excellent stereo spread and fine scale	6-15g Normal, MM	R	48
<b>RATA RP70</b> £77*	Average Average+	Clearer and sweeter than the '40 this also seemed heavier and less lively. For £99 you can have a van den Hul stylus	6-14g Normal, MM		43
<b>RATA RP70vdH</b> £99	Average+ Good	Able to retrieve bags of musical detail (thanks to the vdH stylus), RATA's top cartridge ranks as one of the most articulate MM's available	11-18g Normal, MM	R	67
<b>Rega Bias</b> £34	Average Average+	Difficult to mount in some arms due to its shallow build, the bias offers a gentle, refined SQ that certainly makes it worthy of audition	4-10g Normal, MM		67

TO ORDER BACK ISSUES OF HI-FI CHOICE SEE PAGE 123

# THE DIRECTORY

## CARTRIDGES

NAME PRICE	LAB SOUND	COMMENTS	ARM OUTPUT-TYPE	VALUE	BACK ISSUE FULL REVIEW
Rega RB100 £38	Average Average +	Remarkable mechanical performance in the right system context, but "try before you buy"	5-12g Normal, MM	R	48
Rega Elys £74	Good Good	Clearly superior to the Bias, despite their common heritage, the Elys is both more detailed, accurate and musically convincing	8-15g Normal, MM	R	67
Revolver £20	Average + Average	This modified AT-95E enjoys a very lively mid and treble even if the bass is somewhat 'slower' in protection. A firm budget!	8-16g Normal, MM	BB	67
Shure M92E £15	Average - Average	Though lacking depth, the overall sound quality was competent, but treble was not its forte	10-15g Normal, MM		43
Shure M99E £26	Average - Average -	Sister to the 92E this is a solid but not particularly exciting cartridge	5-10g Normal, MM		38 (Summary)
Shure ME75ED £24	Average Average -	Rather bright and splashy in the high frequencies but nevertheless a competent model	5-10g Normal, MM		38
Shure M104E £32	Average - Average	Capable in many ways, but giving no substantial improvement over the 92E in our view	5-15g Normal, MM		38
Shure ME97HE £44	Average Average +	It won't turn a sow's ear of a turntable into a silk purse, but will at least keep going and produce an acceptable result	8-20g Normal, MM	R	48
Shure M105E £45	Average Average -	A slightly 'spitty' sound lacking deep bass and dynamic contrast, but can be used in virtually every system where it will perform "inoffensively"	5-12g Normal, MM		38 (Summary)
Shure M110HE £55	Average Average	Sound quality was thought eminently presentable, but not exciting, smooth clear high frequencies, but a loss of bass definition	5-10g Normal, MM		38 (Summary)
Shure M111HE £67	Average Average	Early reviews of this cartridge complained principally of the price - which has since come down	5-10g Normal, MM		38 (Summary)
Shure ML120HE £95	Average + Average +	Quite decent sound quality and a generally fine balanced performance	6-18g Normal, MM		48
Shure ML140HE £120	Average + Good	Qualitatively the treble of this well-balanced moving magnet model was a match for many moving coil cartridges	6-16g Normal, MM		43
Shure V15 VMR £195	Good Average +	Initial listening gave promising results, but extended familiarity gave the feeling of a lack of energy and a "shut-in" sound	5-12g Normal, MM		38
Shure Ultra 500 £452	Good Good	There was no doubting the accomplishments of what could well be the finest moving magnet cartridge around	6-14g Normal, MM		48
Stilton/AT-F3 £110	Good + Good +	At a premium of some £40 this modified AT-F3 offers a startlingly refined performance and is strongly recommended	8-18g Low, MC	R	67
Supex SM100E £115	Average Average +	Delivers as much musical information as many moving coils - the bass in particular having an attractive bounce	6-15g Normal, MM		38
Supex SD900IV £350	Average + Good +	The 900 is an inherently fine cartridge, but despite a recent update it is beginning to show its age	10-18g Low, MC		48/Col
Supex SD90 IIV £375	Average + Good +	This high output model delivered sufficient subjective and objective performance, plus good compatibility, to justify its price	8-18g Normal, MC	R	48
Supex SDX2000 £651 L £721 H	Good Good +	The high-o/p 2000 was preferred on listening tests to the low-o/p model, which even so has a unique place among the designs	6-16g Either, MC		48
Van den Hul MC10 £699	Good Good +	A neutral balanced performer giving transparent midrange, fine depth and focus with firm extended bass. Gosh!	5-10g Low, MC	R	60
Van den Hul MC One £799	Good Very Good	This extended all the positive qualities of the '10 but added greater authority and scale - worth it for the extra money	6-12g Low, MC	R	60

## AMPLIFIERS

The amplifier sits at the heart of the system, processing the outputs from all the various music sources as necessary and then driving the loudspeakers. These two (quite separate) functions are integrated into a single box at the low-to-middle price points; separated pre- and power amplifiers become increasingly common as one moves upmarket. At the upper end of the specialist market, valve amplifiers provide a popular alternative to the transistor types amongst enthusiasts.

There is a substantial difference between specialist (sound quality oriented) amplifiers and the consumer electronics style models. The former

are bleakly simple, avoiding all unnecessary features to provide the most direct signal path in the interests of best sound quality. The latter range from models with just basic tone controls and tape recorder switching, to those with elaborate facilities such as graphic equalisers, remote control (including volume), surround sound options etc. etc.

Lab measurement provides some useful data, particularly in regard to an amplifier's ability to drive a wide range of different types of loudspeakers, but this is only obliquely related to sound quality. We also include our measured power output (RMS, 8ohm load, 1 channel driven) - but

again, paradoxically, this doesn't necessarily correspond to the loudness capability of the amplifier, which has as much to do with the elegance of the overload characteristics within a given system (valve amplifiers invariably sound more powerful than their rating would suggest). The listing of features provides some indication to the complexity of an amplifier; many users prefer to retain the option of tone controls to 'shape' the overall sound according to taste; many others have found living without tone controls surprisingly easy, with additional benefits in terms of transparency

NAME PRICE	LAB SOUND	COMMENTS	FEATURES	VALUE	BACK ISSUE FULL REVIEW
Acoustic Research A07 £280	Very Good Average +	Relatively smooth but ineffectual sound quality that lacks some weight and impetus at very low frequencies	75W, 4 line, 2AV and MM/MC inputs		68
ADC A-2080E £400	Good + Average +	Clean and neutral sound but one that lacked depth and spaciousness; MM input favoured above MC or CD	108W, logic sw. for 5 line and MM/MC inputs		68
Akai AM-93 £550	Average Average -	Unfortunately Akai's on-board D/A converters were less successful than its conventional analogue CD input	112W, coax and optical dig inputs MM/MC		68
A&R Arcam Alpha II £160	Good Good +	Very confident, convincingly musical and punchy sound that sets the standard for other budget amps	41W, 4 line and MM inputs	BB	68
A&R Arcam Delta 60 £250	Good Good +	Very refined and highly detailed sound via MM and CD without any of the hardness noted via the MC stage	59W, 4 line, MM/MC inputs, no tone controls	R	68
A&R Arcam Delta 90 £350	Good Fair	Well balanced and sweet-natured in any given system with MC capability, but pricey	70W MM/MC 5 inputs tone controls		50
Albarray M408 II £649 pr.	Good + Good +	Unusually styled transistor monoblok power amplifiers reintroduced with improved performance and sound quality. Needs good warm-up for best sweetness and clarity	40W Power amp only	R	56
Albarray M1008 II £899	Very Good Good	A larger version of the similarly styled M408II, fairly good all round but only of average quality for the price	80W, monoblok		62
Aria Acoustics Aria 12 £299	Poor Very Good	A plain looking valve power amp that's something of a wolf in sheep's clothing giving many dearer amps a run for their money	12W	BB	63

# THE WORLD'S NO 1 GUIDE TO BUYING HI-FI

## THE DIRECTORY

## AMPLIFIERS

NAME PRICE	LAB SOUND	COMMENTS	FEATURES	VALUE	BACK ISSUE FULL REVIEW
<b>Ariston Amp</b> £130-200	Average Average+	Slightly veiled and thin sound but proved suitably attractive in the listening tests	32W, full logic control, MM and 4 line inputs	R	68
<b>Audio Innovations Series 300</b> £389	Poor Good+ +	Something of an anomaly the 300 is an integrated valve amp that looks awful in the lab but sounds remarkable in a system	10W, MM, 6 inputs	BB	63
<b>Audio Innovations Series 1000/2nd Audio Amplifier</b> £1139/1399	Poor Excellent	This valve combination offered awesome dynamic range with superb transparency and power to match. Compatibility with other brands is unpredictable	15W, MM, 6 inputs, monobloks	R	63
<b>Audio Research SP9</b> £1700	Very Good Very Good	This new high performance valve/FET hybrid preamplifier sets a high standard for versatility, build quality and sound	5 inputs, MM/MC	R	60
<b>Audio Research SP11 II</b> £5250	Very Good Excellent	Current state of the valve preamp art. A reference point	Straight line MM/MC Disc + phase invert	R	60
<b>Audiolab 8000C</b> £325	Excellent Good	A well established preamp with a highly controlled sound, though it could do with more life and depth	MM/MC, 5 inputs, hdph, tone controls	R	62
<b>Audiolab 8000A</b> £350	Very Good Good	A long running and high dependable classic, versatile and consistent via all inputs	50W, MM/MC, 5 inputs, hdph, tone controls	R	62
<b>Audiolab 8000P</b> £495	Excellent Very Good	A dynamic powerhouse, load tolerant and sonically reliable	100W	R	62
<b>Beard Audio CA35/P35mkII</b> £535/£795	Fair+ Very Good	Good build quality and a very smart finish combine with a characteristic valve sound to make a first class amplifier capable of giving hours of musical enjoyment	35W, MM/MC, 4 inputs	R	63
<b>Beard 506</b> £1195	Good+ Good+	A versatile valve preamp – the bass sounded lively if a touch softened while the treble was detailed but lacked a little sparkle and air	4 inputs MM/MC		50
<b>Beard M70</b> £1995 pair	Good Good+	A substantial British monoblok power amplifier, but not a great deal more impressive than the P35 at half the price	70W		50
<b>Bryston 12B/4B Pre/Power</b> £995/£1395	Good+ Good	Bryston's massive 4B power amp stood out as the backbone of this combo, the preamp sounding a trifle unbalanced between MM and MC inputs	272W, bridgeable to 800W, 6 line, 2 disc inputs, subsonic filter		68
<b>Burmester 838</b> £1490	Very Good Good	A disc-only minimalist preamp, strong points include excellent build, extreme neutrality, dry clean bass and notably sharp stereo focusing	MC only, MM option		Collection
<b>Burmester 846</b> £1599	Very Good Good+	Usually coupled with the 838 this high-level preamp provides many and versatile input facilities	6 inputs		Collection
<b>Burmester 850</b> £3995	Good+ Good	Each of these mono power amplifiers contains separate high current 25W amps giving a refined coherent sound over most of the frequency range	100W		Collection
<b>Cambridge Audio P40</b> £200	Good Good+	A very fine sounding integrated amplifier with simple facilities and MC cartridge capability	5 inputs 40W MM/MC straight line	BB	50
<b>Cambridge Audio C75</b> £279	Good+ Good+	Whilst not quite on par with its A75 companion this preamp provided excellent stereo imagery but was a touch "heavy" in character	MM/MC disc	R	50
<b>Cambridge Audio P55</b> £290	Very Good Very Good	A grown up P40, the P55 suffers slight noise on the moving coil input but offers great sound for the money	55W, MM/MC, 5 inputs, hdph	BB	62
<b>Cambridge Audio A75</b> £299	Very Good Very Good	This strong power amplifier sounded open and effortless, with fine bass drive and dynamics, albeit a touch grainy and harsh at high frequencies	100W	R	50
<b>Cello Audio Suite</b> £5290	Excellent V Good/Excellent	Cello's preamp represents a whole new ball game in flexibility and sound quality (or war of attrition on your wallet)	Optional inputs MC etc	R	50
<b>Conrad Johnson PV7</b> £735	Very Good Good	This beautifully finished quality preamplifier performed well, delivering a musically relaxed sound though not offering especial value for money	5 inputs MM disc		57
<b>Conrad Johnson MV50</b> £1699	Good+ Good+	Coupled with the PV5, this CJ power amp performed well on audition	50W		Collection
<b>Conrad Johnson Motif MC-8</b> £1395	Very Good Very Good	A cheaper alternative to the '7, this preamp is an undoubted success in maintaining the Motif sound but does not compare on sound quality	MM/MC	R	50
<b>Copland Pre and power amps</b> £649 each	Good+ Fair	At £649 each this simple Danish valve pre/power combination is expensive, though the power amplifier sounds very easy on the ear	3 inputs MM, 12W		50
<b>Counterpoint SA7</b> £747	Average+ Good	Simple valve Californian preamp offering inspiring transparency for the price	4 inputs straight line MM/MC		Collection
<b>Counterpoint SA12</b> £1250	Good+ Good+	A real power-house power amp, beefy and load-tolerant although like the SA7 a trifle untidy at frequency extremes	100W		Collection
<b>Creek CAS 4040 II</b> £179	Good Good	The Mk II has no problems and is a fine all rounder	30W, MM, 4 inputs, tone controls	BB	62
<b>Creek CAS 4140 S2</b> £219	Good+ Good	Redesigned for '88, this is a fine allrounder with good moving coil input, plain presentation	40W MM/MC 3 line inputs	BB	62
<b>Croft Micro</b> £150	Average+ Good	A real upsetter, this excellent valve preamp put the cat among the pigeons proving good sounds can be made at budget price levels	4 inputs MM straight line	R	Collection
<b>Croft Super Micro A</b> £500	Average+ Very Good	The locks are somewhat improved, while this 'hot rod' version with tuned components performed very well indeed. There is still no gain on the line inputs	4 inputs, MM, straight line	R	57
<b>Croft Series IV(S)</b> £730	Good Good	The original IV is still available now supplemented by the higher price and power (S), both are fine performers	40(60)W channel	R	57
<b>Croft Series IVSA</b> £1000	Good Very Good	Featuring tuned components chosen for their sound quality, the 'A' variant is an impressive example of Croft's technique in valve design	60W special supply regulation	R	57
<b>Deltec DSP-50S DPA-50S Pre/Power</b> £675/£825	Excellent Excellent	Remarkable pre/power combo based around the highly linear DH-0A32 hybrid op-amp. Unmatched detail resolution, control and transparency	63W, external feedback wiring, 3 line, MM/MC no tone controls	R	68
<b>Deltec DPA 100S</b> £2200	Very Good Very Good	A top-quality transistor power amp, sounding fast, articulate and well controlled, though maybe a touch clinical for some tastes	80W	R	50
<b>Denon PMA 250 II</b> £125	Good Fair	Despite a claimed increase in power this competent model now slips behind the competition on sound quality grounds	30W, MM, hdph, tone controls		62
<b>Denon DAP-2500 PDA-4400A Pre/Power</b> £549/£599 pair	Very Good Good	Denon's fully-fledged preamp also incorporates D/A converters that did not improve the sound of our £299 CD player. The power amps are brilliant	172W, monobloks Opt/Coax dig + 2 tape, 4 line and MM/MC inputs		68
<b>Denon PDA-6600</b> £1,000/pair	Excellent Excellent	Delivers abundant high quality sound, solid engineering expertise and content clearly compensating for any compromising of purist audiophile principles	250W monoblok, remote power	R	60
<b>DNM 3A</b> From £1000	Good+ Very Good	The DNM3 in its acrylic case is a remarkably revealing and neutral state of the art preamp	5 inputs MM/MC twin vol controls	R*	44
<b>E.A.R. 802/509mkII</b> £920/£1550	Average Very Good	Extremely well made and combining the sonic strengths of both transistors and valves this EAR combo warrants attention	100W, MM, 6 inputs, monobloks	R	63
<b>E.A.R. 549</b> £3,000/pair	Very Good Very Good	A valve monoblok that measures like a solid state amp is itself an achievement, but exceptional power delivery and bass 'slam' is not fully matched by delicacy and transparency elsewhere	200W monoblok, bias setting		60

TO ORDER BACK ISSUES OF HI-FI CHOICE SEE PAGE 123

# THE DIRECTORY

## AMPLIFIERS

NAME PRICE	LAB SOUND	COMMENTS	FEATURES	VALUE	BACK ISSUE FULL REVIEW
Exposure VII/VIII £360/£340	Very Good Good	Supplied as a combination without the separate preamp power supply, this pre power combination performed satisfactorily especially on the moving coil input	50W, MM/MC, 3 inputs, straight line		62
Exposure VI/VII Dual/VIII Pre/Power £449/£219/£379	Good Very Good	An established company like Exposure could do more to improve the 'look' of these amps which, nevertheless, sounded confident, dry and musical	63W, Super mod 4 line and 2 disc inputs with full rec-out switching	R	68
Goldmund Mimesis 6 £2,500	Very Good Very Good	Small and discrete for those who'd rather not flaunt it, this is no powerhouse but sounds subtle, delicate and refined	80W stereo power amp		60
Grant 60AMS £948 pr	Good Very Good	This neat and compact 60W valve monoblok gave good sound on the 8ohm tap, better still on 4ohms. The midrange was particularly natural	60W monoblocks 4) 8ohms	R	57
Hafler DH120 kit form £295	Fair	We didn't build one, see below	60W		44
Hafler DH120 assembled £360	Very Good Fair	Sound quality results were decent enough, but this power amp won't set the world on fire at this price	60W		44
Harman Kardon PM635i £159	Good Good	An improved version of the classic PM635 amp which sounds typically dry and articulate. Price is frozen	49W, 4 line and MM inputs A/B speaker o/p	R	68
Harman Kardon 640 Vxi £225	Good + + Good	Moderately priced but built to HK's high standards, good value and good load tolerance	50W MM, 5 line inputs tone controls		56
Harman Kardon PM645VXi £300	Very Good Good	Fits in well with the Harman Kardon series, giving a competent all round performance at a fair price	75W, MM/MC, 5 inputs, hdph, tone controls		62
Harman Kardon PM650vxi £369	Average + Good	A tight and slightly over-damped sound lacks any essential warmth or richness. Reduced headroom on MC	71W, 6 line, MM/MC and true A/V inputs		68
Harman Kardon 655 Vxi £449	Very Good Good	Plenty of well built integrated amplifier for the money, with lots of power to drive almost anything, plus versatile inputs	100W MM/MC 6 line inputs tone controls		56
Harman Kardon PM665Vxi £699	Good Good	A versatile and meaty amplifier with high current capability, but sound quality lags behind certain home grown alternatives	150W MM/MC tone controls (switchable)		60
Inca Tech Dirk £215	Good + Good +	This tiny, minimalist model is effectively a power amplifier with volume control, providing inputs for CD player and tape recorder but not tuner!	50W, 2 line inputs, straight line		56
Inca Tech Claymore £396	Good + Good +	Limited facilities but a strong, clear, well-focused sound results in auspicious Choice debut for this relatively young company	50W MM/MC 3 line inputs straight line	R	56
Inca Tech Claymore S £415	Fair Very Good	Rich, deep and captivatingly musical this amp prompted a very favourable reaction. Disc sens too high	60W, CMOS logic controls 7 line and MM/MC inputs	R	68
Inca Tech Claymore 2 £515	Good Average +	Very similar to the well-received 'S' wa CD our Claymore 2 had a dodgy disc input which ruined its showing	100W, CMOS logic, as 'S' but with more Mosfets!		68
ITL MA-80 £150	Good Good	A promising start for this young company, the MA-80 gave a fine sound with CD but was less wonderful on the moving coil input	30W, MM/MC, 5 inputs	R	62
Jadis JP30/JA30 £6,790	Fair Excellent	Two-box preamp plus monoblok power amps, classic valve design gives stereotype valve sound. Beautiful build, nostalgic styling and delightful sounding midrange transcend limitations at frequency extremes, in lab, and re cartridge matching	30W 2-box pre-, monoblok power, MM-only, 4 line inputs	R	60
JVC AX-222 £110	Good Fair	Not very impressive, JVC need to pull their socks up if their budget amplifiers are to score	35W, MM, 4 inputs, hdph, tone controls		62
Kelvin Labs Junior/J30 £295/£295	Good Good	Their heart is in the right place but the class A Junior combination is a bit expensive for what you get	20W, MM/MC, 5 inputs		62
Kenwood KA-5500 £130	Very Good Fair	Having dropped its moving coil input, this latest version has British style dynamics and rhythm but is not first grade	35W, MM, 4 inputs, hdph, tone controls	R	62
Le Tube £585	Good + Good	If moving coil sensitivity is not required then this preamplifier will offer a clean view with very good stereo	3 inputs MM	R	44
LFD £2,995 +	Very Good Excellent	Can set the subjective standards that others merely aspire to, but this outstanding if unconventional multi-box preamp needs careful matching to ancillary components (cartridge, power amp)	MC (with care), passive line extra	R	60
Linn LK1/LK280 Pre/Power £459/£595	Good Good —	A very modern, logic-controlled amp with distinctive and inoffensive sound quality. Its restrained sound could do with extra insight and	84W, compact amp CMOS sw for 2 tape, 2 line and MM/MC, XLR sockets.		68
Luxman LV100 £205	Good Fair	Nicely finished modern integrated amplifier, generally competent though not exceptional	45W MM 4 line inputs tone controls		56
Luxman LV105u £685	Very Good Good	This very well equipped and beautifully finished Japanese integrated amplifier has two valves in the early section of the power amplifier. Pleasant and musical it sets no value for money record here	9 inputs 80W, MM/MC tone controls		57
Magnum A100 £1995 pair	Good + + Good +	Given their massive power rating a pair of A100's make a fine stereo power amp; ideal for high levels and with a wide dynamic range for digital programme	320W		50
Marantz PM25 £125	Good Fair	Soft and sweet like the rest of the range, the PM25 is inoffensive and undemanding	25W, MM, 5 inputs, hdph, tone controls		62
Marantz PM35 £170	Very Good Good	This new generation Marantz is a good allrounder, and shows that extra care is being taken over sound quality, well equipped and versatile	45W MM/MC 3 line inputs tone controls		56
Marantz PM45 £200	Good + Fair	Generally pleasant and polite with above average clarity; there was some softening in the bass, restricting dynamic output somewhat	40W MM/MC tone controls		50
Marantz PM-75 £400	Good Average	More successful than most amps with on-board DACs but still not as balanced as other Marantz products	136W, opt/coax dig inputs, 6 line + MM/MC		68
Marantz PM94 £1,000	Very Good Good	At 23kg the PM94 is no lightweight in either physical or sonic respects. A very powerful and comprehensively equipped amplifier	140W MM/MC tone controls (switchable)		60
Meridian 201/205 £599/£425 each	Very Good Good +	A fine preamp with additional luxury option of full system remote, plus competent and attractive monoblok power amplifiers with generally good performance	100W MM/MC 6 line inputs remote capable straight line	R/—	62
Mission Cyrus One £180	Very Good Good	A red hot class winner, which caused the whole issue to be re-rated! It's even well built - however, the headphone socket will only take a 3.5mm jack	30W, MM/MC, 5 inputs, hdph, straight line	BB	62
Mission Cyrus PSX £230	Very Good Very Good	The PSX does make the Cyrus Two sound better, and also improves the PCM II CD player giving more wallop and clarity	Auxiliary power supply	R	62
Mission Cyrus Two £300	Very Good Very Good	Also a top performer in its group with fine moving coil and compact disc sound. Again, only 3.5mm headphone socket	50W, MM/MC, 5 inputs, hdph, straight line	R	62
Mordaunt Short MS-A5000 £350	Very Good Good	With a recognisable pedigree, Mordaunt Short engineers have made a good job of this one. A musical all rounder	50W, MM/MC, 6 inputs, hdph, tone controls	R	62
Musical Fidelity A1 £269	Good Good +	Fine-ranking in terms of overall sound quality for money, the excessive heat output could be hazardous to your vinyl if you're careless	20W MM/MC 4 inputs straight line	BB	56
Musical Fidelity B200 £299	Very Good Good +	Running cooler than other MF's, the B200 delivered fine musical and dynamic sounds with plenty of power	80W MM/MC 4 line inputs straight line	BB	62
Musical Fidelity Pre 3/P140 £379/£349	Very Good Very Good	Delivering true audiophile sound quality well ahead of their price, both components shine in their own right	70W MM/MC 4 line inputs straight line	R	56

THE WORLD'S NO 1 GUIDE TO BUYING HI-FI

## THE DIRECTORY

NAME PRICE	LAB SOUND	COMMENTS	FEATURES	VALUE	BACK ISSUE FULL REVIEW
<b>Musical Fidelity A100</b> £459	Good + Very Good	This is another one recommended for fine sound with which you could keep your Chinese carry-outs warm	50W MM/MC 5 inputs straight line	R	62
<b>Musical Fidelity P170</b> £599	Very Good Very Good	Acquitted itself well, later samples showing steadily increasing refinements	85W	R	50
<b>Musical Fidelity MA-50</b> £875 pair	Good Excellent	An audiophile bargain. One of the best sounding power amplifiers made	50W, monoblok	R	62
<b>Musical Fidelity MVT Mk 3</b> £1199	Very Good Very Good	The MVT preamp was "strong in its class", providing competition for £1500-plus amplifier systems, now rivalled by the MF3B	MM/MC 5 inputs	R	50
<b>Musical Fidelity P270</b> £1299	Very Good Excellent	If the hot-box aspect is not a deterrent, this is something of a bargain. A big amplifier scale of sound which is just a little rough-edged	135W	R	50
<b>Musical Fidelity MXV</b> £2229	Very Good Excellent	Soundwise this preamp puts Musical Fidelity on terms with much more expensive exotics, with top class transparency, focus and dynamics	MM/MC, phase invert	R	60
<b>Musical Fidelity A370</b> £2229	Very Good Excellent	Arguably the finest sounding power-amplifier manufactured in the UK	185W	R	50
<b>NAD 3020e</b> £120	Good Fair	A little light in balance and "weight" but superior to run-of-the-mill budget amplifiers	20W MM/MC 4 inputs	R	50
<b>NAD 3220PE</b> £140	Good Fair	Like the 3020E but with more peak power and loudness thanks to the "power envelope"	20W, MM, 5 inputs, hdph		62
<b>NAD 3225PE</b> £150	Average + Average +	Light and detailed if not as rich or weighty sounding as others. MM input sounds warmer than CD	42W + 70W dyn. headroom; soft-clipping, MM only	R	68
<b>Naim NAIT 2</b> £322	Average + Fair	Well built with good load tolerance the NAIT delivered a fully competitive sound in spite of its modest measured power output. Recent modifications as yet unchecked	15W pc MM 3 inputs	R*	50
<b>Naim Separates</b> £560-c£8,000	Very Good Good	A consistent and coherent series of 'building blocks' for conventional passive or active operation. Sound quality ignores conventional audiophile standards of presentation, but achieves fine musical communication	40-70W MM/MC etc	R	60
<b>Nakamichi CA-5E</b> £750	Very Good Good	A fine lab performance and high build quality but rather disappointing sound quality for a preamp of this price	MM/MC, 6 inputs, hdph, tone controls		62
<b>Nakamichi PA-5E</b> £1150	Very Good Good	A strong sound in several respects but one which ultimately failed to satisfy	100W		62
<b>Nakamichi CA7E/PA7E</b> £2500/£1700	Very good Good/Good +	Exceptional build and finish, plus good general performance, remote control and versatility, but expensive	200W MM/MC 6 line inputs, remote, tone controls		56
<b>Nuance</b> £795	Very Good Good	A subtle civilised pre-amp though a little lacking in resolution and detail; suited to some tastes but not top-drawer	4 inputs MC		50
<b>NVA AP30mc</b> £290	Average + Good	Utilitarian in appearance but offers a very refined and beguilingly musical sound quality on MC and line	22W only, MC or MM options, 3 line inputs	R	68
<b>Oakley Image</b> £425	Poor Very Good	An interesting valve preamp from Yugoslavia, the Image on first impression needs a bit of tweaking to warrant <i>Choice</i> commendation but is a nice product nonetheless	MM, 5 inputs straight line		63
<b>Orell SA-040</b> £359	Good Good +	This promising newcomer from a brand new company sounded pretty good and should improve as production settles	45W MM/MC, 4 line inputs, straight line	R	56
<b>Philips FA860</b> £249	Very Good Fair	Well balanced model from Philips' Japanese factory, with versatility, good build and finish	70W MM/MC 5 line inputs tone controls		56
<b>Philips FA960 MkII</b> £299	Good + Average	The MkII '960 still failed to grasp our listeners' attention but it remains a competent amp nonetheless	122W, 6 line & 2 disc inputs + tone controls		68
<b>Pink Triangle PIP</b> £2670	Excellent Excellent	This state-of-the-art preamp is one of the few truly high end products to come out of this country this year. It will most certainly worry the competition	MM/MC, 4 inputs, battery supply	R	62
<b>Pioneer A333</b> £149	Very Good Fair	A rather average but nonetheless competent performer that is pleasant enough	55W, MM, 5 inputs, hdph, tone controls		62
<b>Pioneer A-616 MkII</b> £180	Good + Average	The disc inputs sounded a trifle smoother than the CD stage which was harder and more aggressive	95W, 3 tape, 3 line and 2 disc inputs Heavy		68
<b>QED A240 CD II</b> £169	Good + Good	Latest 240CD is fine value for CD and has competent MM disc input as well	45W MM 5 line inputs straight line	BB	62
<b>QED A240 SA II</b> £219	Good + + Good +	Redesigned 240SA represents a significant allround improvement over its predecessor, and provides a good moving-coil disc input in a competitive price	45W MM/MC 5 line inputs straight line	BB	62
<b>QED A270</b> £329	Good - Good +	Building on the strengths of the '240' the '270' sounds weighty, fast and dynamic. A bit 'lumpy' via MC	51W, 5 line and 2 disc inputs, pre-out	R	68
<b>Quad 34</b> £285	Very Good Fair	This well-built durable preamp has useful filtering and above average tone controls but was found lacking in sound quality (viz: detail/dynamics)	4 inputs MM/MC tone controls		44
<b>Quad 405</b> £349	Very Good Fair	Not an impressive power amp but easy on the ear if not pushed and very reliable	100W		44
<b>Quicksilver Mono</b> £1495	Good Good +	Moderately improved for '88 the Quicksilver still rates well despite up and coming competition	60W monoblok 4/8ohms		57
<b>Radford SC25</b> £862	Very Good Very Good	A very fair price for a solid, well built valve preamp, combining good allround performance and a neutral sound	5 inputs, MM, straight line	R	57
<b>Radford MA75</b> £977	Good Very Good	A fine quality valve monoblok with good load tolerance and a neutral accurate sound, offering significant gains in power and focus over the STA25	75W monobloks	R	57
<b>Radford STA25 Renaissance</b> £1115	Good Good +	Offering superb midrange performance if not quite as good at the extremes, the Renaissance valve power amp is a genuine audiophile product	25W	R	50
<b>Revox B150</b> £875	Very Good Average +	Beautifully constructed but hampered by Revox's convoluted logic control. Open and smooth sound. Still costly.	117W, CMOS sw. for 3 line, 2 tape and MM		68
<b>Revox B250</b> £1188	Very Good Good	With much improved sound over its predecessors plus amazing remote control facilities, this could form the heart of a round-the-dream-house system	150W MM/MC system/house remote tone controls		56
<b>Robertson Forty Ten</b> £987	Very Good Good	Here is a neat little power amp (60W) you can fit and forget; it proved most satisfying over long listening sessions	60W		Collection
<b>Rose RV-23</b> £370	Average Very Good	A very attractive little British valve preamp with a sound that was rich, colourful and reasonably sharp via the CD input but was less impressive on disc	MM, 4 inputs, straight line		63
<b>Rotel RA810A</b> £100	Very Good Fair	As a cut price RA820AII this is a very successful little amp that loses little in sound quality to its predecessor. Excellent value	20W, MM, 5 inputs, hdph, tone controls	BB	62
<b>Rotel RA820A</b> £130	Good + + Good	This A version of an established budget favourite delivers the goods sonically and is fine value for money	35W MM 4 line inputs tone controls	BB	56
<b>Rotel RB/RC850</b> £145/£125	Good + + Good +	Quality separate pre and power amplifiers at near budget integrated amplifier prices. A notable achievement	60W MM/MC 4 line inputs tone controls	BB	62
<b>Rotel RA820BX3</b> £165	Very Good Good	The latest upgrade is not that impressive, but the BX remains a fine amplifier and now has a moving coil disc input	30W, MM/MC, 5 inputs, hdph, straight line	BB	62
<b>Rotel RC-870BX/RB-870BX</b> Pre/Power £190/£210	Excellent Good +	Reduced price makes the 870 combo better value but despite mods to the preamp, it is the power amp that must take the lion's share of credit	128W or 208W in bridged mode CD direct, 4 line, 2 tape and MM/MC	R	68

# THE DIRECTORY

## AMPLIFIERS

NAME PRICE	LAB SOUND	COMMENTS	FEATURES	VALUE	BACK ISSUE FULL REVIEW
Rotel RA840BX3 £220	Very Good Good+	Requires a very long warm-up period but rewards with a refined sound that should suit 'lively' systems	59W, 2 tape, 2 line, MM/MC and A/V inputs	R	68
Rotel RA870BX £300	Very Good Good+	A powerful blockbuster with solid and well focused sound, good versatility and fine load tolerance	85W MM/MC 7 line inputs tone controls	R	56
Sony TA-F200 £130	Average— Average	Over-ambitious protection circuit is hardly in keeping with modern amp design. Lean but 'dead' sound quality	74W, 2 tape, 3 line and MM/MC inputs		68
Sony TA-F400 £200	Good Average+	Some lack of integration across the frequency range but still offers a more open and detailed sound than the F200	76W, 2 tape, 3 line and MM/MC inputs Rec-out		68
Sony TAF 500ES £349	Good+ Fair	Not too hot at the price, lacking in bass action, rating poorly on vinyl and only marginally improving on CD	75W hdp tone controls MM/MC		50
Sony TAF 700ES £500	Good+ + Fair	Scoring higher than the 500 but still not offering the sort of standards set by the competition. But many buttons to push	100W MM/MC tone controls		50
Sumo Nine + £1200	Very Good Excellent	Macho styling of this class. A stereo power amp conceals a sonic subtlety that is exceptional for the price, limited by lots of waste heat and a noisy fan on our sample (being improved)	65W	R	60
Tannoy SR-840 £1713	Very Good Good	A "muscle" power amp, capable of impressive levels into difficult loads while remaining quite subtle and revealing	250W		50
Vacuum State FVP £999	Good Very Good	This well thought out valve preamplifier is designed for optimum musicality and transparency, a goal which is handsomely achieved	5 inputs, MM, straight line	R	57
Yamaha AX-300 £100	Good Fair	A lively and dynamic performer, offering a credible if bright sound at a competitive price	30W hdp tone controls (MM)		50
Yamaha AX500 £200	Very Good Good	A well built versatile performer with generous power, decent sound	90W MM/MC 5 line inputs tone, var loudness		56
YBA 2 pre & pwr £1395/£1695	Good+ + V Good/Excellent	Superbly finished French audiophile separates, with very good space and transparency, slightly softened bass. Needs extra transformer (£300) for MC cartridges	70W MM (MC extra) straight line	R	56
YBA 1 preamp £2895	Very Good Excellent	A front line French audiophile product. Great stereo and a fine Krell style finish	MM/MC, 3 inputs, straight line	R	62
YBA 1 power amp £2995	Good Excellent	This equally well finished power amp offers front rank stereo staging and transparency, and is capable of driving the most difficult loads	85W	R	62

## LOUDSPEAKERS

Last item in the hi-fi chain, to some extent the loudspeaker is merely the slave of what has gone before, capable only of reproducing a signal as good as it is fed. Nevertheless the distortions (colorations and stereo effects) introduced by loudspeakers (and rooms) tend to be more immediately obvious than those anywhere else in the chain, so careful choosing according to taste is very important.

The average loudspeaker consists of a smallish enclosure, much of which may have begun life as

part of a tree, plus a couple of drive units hidden behind a removable grille. Inside the box lurks a simple electrical circuit known as a crossover, which divides the incoming (full range) signal into the right bits for the drivers to handle. Variations on the above formula are specifically identified in the entries. The designer's primary task is to balance the sensitivity of the loudspeaker (how loud it goes for a given electrical input) against the bass extension (how low does it go) for the given box size. After that such subtleties as coloration and

dispersion come into the equation.

Careful placement of the loudspeakers within the room is as important as the initial choice of model. For good stereo they need to be more or less the same distance from nearby walls, and preferably on similar rigid stands. The listener should be about the same distance from and listening angle to each loudspeaker. The ideal placement depends on the way a particular model has been balanced (not to mention a number of other factors), and our recommendation is given in the entries.

MODEL PRICE	LAB SOUND	COMMENTS	SIZE PLACEMENT	SENSITIVITY BASS FROM	VALUE	BACK ISSUE FULL REVIEW
Acoustic Energy AE1 £700	Good Very Good	To the author's knowledge, the most awesomely dynamic and articulate miniature ever made	29.5 x 18 x 25cm semi-open space	88dB/W 60Hz	R	59
Acoustic Energy AE2 £1138	Good Very Good	Dynamic, solid and lively, a great allrounder if a bit small considering the price. AE proves that metal cone/dome drivers really work	39 x 23.5 x 29.5cm heavy stands in free space	88.5dB/W 45Hz	R	66
Acoustic Research AR122 £140	Average Average	Despite a promising enough list of ingredients, the 122 failed to excite real enthusiasm amongst the listening panel	38.5 x 19 x 22cm stands near rear wall	87dB/W 68Hz		68
Alexander Aurora £350	Average Good—	The unusual metal case and slim shape of this grown up miniature provide welcome diversity. It sounds pretty good too	42.5 x 14 x 19cm matching stands in free space	85dB/W 55Hz		66
Apogee Caliper £2550	n/a Very Good	Near state of the art performance, not materially worse than bigger Apogees, just less bass. Rich, subtle and slightly dull, with a clear, articulate midband, but uncommonly system fussy	122.5 x 71 x 10cm ex rear foot, free standing, away from walls	n/a n/a	R	60
Apogee Scintilla £4990	Good Very Good	These take-me-to-your-leader speakers gave exceptional transparency and can achieve excellent results in a true audiophile system	145 x 88 x 9cm free space on floor	79dB/W 20Hz	R	46/Colt
Q&R Arcam Three £150	Average+ Average—	Arcam's baby speaker did not delight our listeners, but it might do better in less expensive systems	34 x 18 x 23cm close to wall at head height	88.5dB/W 95Hz		53
Q&R Arcam Two £260	Good Average	Most things to most men this compact is unlikely to disappoint with its lively "balsy" character though lacking weight a bit	38 x 23 x 28cm near wall shelf or 40cm stands	88dB/W 55Hz		59
Q&R Arcam One Plus £359	Good Average	Provides a solid, weighty and rich sound, but is a little raw in the treble and indefinite in the midband	22.3 x 28.1 x 37.8cm open space, on stands	88.5dB/W 60Hz		59
AR 112 £120	Average Average—	Nicely presented and engineered, but sounds a bit small and boxy without true coherence	36 x 19 x 18.5cm stands near rear wall	87dB/W 75Hz		66
AR 132 £180	Average+ Average—	Good presentation and detail engineering was not sufficient to counter bass heavy balance problems on auditioning	44.5 x 23 x 25.5cm stands 1ft from rear wall	87dB/W 50Hz		66
Ariston Image £185	Good Average	Good engineering content at a reasonable price, the Image delivers fine stereo with low coloration, but sounded too bassy under our listening conditions	42 x 22 x 27cm stands in free space	87dB/W 55Hz		66
Ariston QLNI Mk 2 £350	Very Good Good+	This very sophisticated loudspeaker has much of the euphony of a LS3/5A but with rather more "oomph". A little "romantic" for some tastes — Schubert and Sting rather than Stockhausen or the Stones perhaps?	35 x 25 x 26.5cm free space, 24 inch stands	84.5dB/W 65Hz	R	59
Audiostatic ES200 £1495	Average Average+	Sounding forward and unbalanced with limited bass power, these excelled in transparency and detail, and might suit some tastes	150 x 53 x 23cm low stands, free space	79dB/W 45Hz		46
Audiostatic ES300 £1995	Average+ Good	Marred by similar problems to its cheaper ES200 stablemate, this line source electrostatic was superb in the upper-mid and treble but lumpy in the bass	44 x 5 x 93cm free standing	82.5dB/W 30Hz		46
Audio Electronics TC10 II £599	Good— Good+	Oddball appearance is rescued by a respectable technical performance, interesting and impressive engineering and fine sound quality at a realistic price	70 x 33.5 x 33.5cm low stands in free space	87.5dB/W 40Hz	R	68
Avance 120 £279	Average+ Average+	This unusual "after eighties" looking speaker has the recipe for success, but not quite the right seasoning yet	42 x 30 x 30cm 30cm from wall on 40cm stands	86.5dB/W 60Hz		53

TO ORDER BACK ISSUES OF HI-FI CHOICE SEE PAGE 123

## THE DIRECTORY

## LOUDSPEAKERS

MODEL PRICE	LAB SOUND	COMMENTS	SIZE PLACEMENT	SENSITIVITY BASS FROM	VALUE	BACK ISSUE FULL REVIEW
<b>Avance Concrete 2000</b> £970	Below Average Below Average	Very low cabinet talk, but the system sounds terminally uneven – lumpy bass and over-forward midband dominate	86.5 x 29.2 x 43cm clear of walls	94dB/W 40Hz		60
<b>B&amp;W DM560</b> £200	Average + Average –	Fine cosmetic presentation and good engineering for the price; overload protection may be handy but listening panel was underwhelmed	49 x 23.5 x 30cm stands in free space	88dB/W 55Hz		66
<b>B&amp;W LM1 Mk II</b> £249	Average + Average	Probably one of the best 'micros' ever made, worth considering for special applications (boats or vehicles). Upgraded since our review	24 x 15.5 x 20cm shell or flush mount	86.5dB/W 80Hz		31
<b>B&amp;W DM1600</b> £399	Good Good	Crisp, dynamic loudspeaker with tight but not especially deep bass and a tweeter that sometimes sounds overcooked	49 x 23.6 x 30cm free space, open stands	87.5dB/W 60Hz	R	59
<b>BLQ Q2</b> £275	Average – Average	Nearly a good loudspeaker, the basic balance is good, but the midband is very uneven and there are severe losses of resolution, 'space' and dynamics	43 x 25.1 x 24.5 semi open on stands	87.5dB/W 70Hz		59
<b>Bose 6.2</b> £570	Average – Average –	Wishy-washy (but not unpleasant) sound and vague imagery are the hallmarks of this unusual design	25.4 x 50.8 x 24.4cm free space, on stands	87.5dB/W 55Hz		59
<b>Boston A4011</b> £110	Average Average –	Competent performance for size and price but below average relative to the UK competition	34 x 21 x 20cm on stands near wall	88.5dB/W 63Hz		41
<b>Canton 60 Karat</b> £600	Average + Good	Looks a bit of a throwback designwise, but is nicely presented and has a lively dynamic and generous sound	58 x 31.5 x 31cm stands in open space	90dB/W 48Hz	R	66
<b>Castle Clyde</b> £149	Average + Average	A tidy little performer packing punch, but beginning to show its age in the light of new competition	37 x 21.5 x 22cm open space on stands	89.5dB/W 64Hz	R	46
<b>Castle Durham</b> £199	Average + Average	Listening results were encouraging, well engineered and finished, but lean on treble and a bit weak on bass; still recommended	41 x 21.5 x 25cm near rear wall	89dB/W 67Hz	R	46
<b>Castle Pembroke</b> £309	Good Average +	Comfortably recommended, a sweet smooth sound with good overall balance of engineering-based performance	55 x 37.5 x 30.5cm open space on stands	88dB/W 46Hz	R	31
<b>Castle Warwick</b> £169	Good Average –	Excellent presentation and fine engineering with overload protection, but a sonic disappointment in bass and dynamic qualities	46.5 x 25 x 23cm stands 1ft from rear wall	88dB/W 50Hz		66
<b>Celef Cirrus</b> £180	Average Good	It's nice to see Celef back in the UK, with this decent sounding small reflex box that seems unusually tolerant of siting	39 x 20.5 x 23cm stands in free space	84dB/W 60Hz	R	66
<b>Celestion DL6 Series Two</b> £149	Good Average	Good tonal colouring and plenty of bass for the enclosure size; the metal dome tweeter is excellent, but bass and mid lack clarity and bite	45.4 x 24.5 x 26.2cm near wall, on stands	87dB/W 65Hz		59
<b>Celestion DL8 Series Two</b> £199	Very Good Good	A refined middle market speaker has a smooth but slightly dull quality, with good definition and deep, if slightly boxy bass	50 x 27.5 x 27.8cm open stands	87.5dB/W 60Hz	R	59
<b>Celestion SL12Si</b> £580	Average Average	Careful setting up does reveal elements of fine sound quality, but this 'grown up' SL6 variation has a lumpy response alongside its improved power handling	53 x 20 x 27cm matching stands clear of walls	85dB/W 50Hz		66
<b>Celestion SL600Si</b> £780	Good + Good	This Aerolam high tech miniature has certain remarkable qualities that some will find irresistible, and which go a long way towards justifying the high price. Needs careful system and room matching.	27 x 20 x 23cm matching stands in free space	82dB/W 52Hz		68
<b>Celestion SL700</b> £1349 inc stands	Good Good	Very sophisticated, mostly smooth and accurate transducer, with fast but not very deep bass and a rather bright treble	37.5 x 20 x 23.5cm free air on tall stands	83dB/W 45Hz		60
<b>Celestion 6000</b> £1470	Very Good Very Good	A genuine fullrange audiophile quality speaker system – with Star Wars styling to suit a high tech environment	Complex, on floor in free space	82.5dB/W	R	60
<b>Chameleon 500</b> £349	Average – Average –	Sounding badly coloured, dull and compressed, it is also amateurishly constructed, despite using good quality materials	38 x 25.3 x 31.3cm free stands	89.5dB/W 75Hz		59
<b>dbx 1000</b> £450	Average – Average –	This system sounds soft and woolly, with an effusive bass, an occasionally sharp treble, and a recessed midband. Stereo positioning is poor	78.7 x 35.6 x 27.9cm against rear wall	91dB/W 60Hz		59
<b>Energy 22 Pro Monitor</b> £600	Good Good	Presentation is a bit rough for the price, but this Canadian entrant is an impressive sonic allrounder that will appeal to most listeners	62.5 x 27 x 30cm stands in free space	87dB/W 40Hz	R	66
<b>Gale 301</b> £280	Average Average +	Of unusual distinctive appearance, this produced a mixed response, being lively but lacking depth	44 x 23.5 x 22cm on stands quite near wall	86.5dB/W 63Hz		46
<b>Gale GS402</b> £700	Average + Average +	Clean but rich and powerful bass; stereo focus was not a strong point, but it is worth considering. (Recent revisions not checked)	61 x 35.5 x 28cm on matching stands near wall	88dB/W 48Hz	*	46
<b>Goodmans Maxim Two</b> £80	Average + Average	More wham-bam-thankyou-mam sound that imitates much bigger speakers when you let these babies yell. (A well-controlled yell)	26 x 17 x 19cm near wall on shell or stand	86dB/W 85Hz	BB	59
<b>Goodmans Point 3</b> £90	Average + Average –	Recommended as good value for money, but our listeners' differing opinions mean your ears should judge for themselves	47 x 25 x 20cm shell/high stand near wall	90dB/W 80Hz	R	53
<b>Goodmans Point 7</b> £170	Average + Average	Basically competent performance, mix and a lot of speaker for the money, but a certain lack of refinement nonetheless	69 x 33 x 26cm free space on 35cm stand	89dB/W 47Hz		53
<b>Harbeth LS3/5A</b> £300	Good Average	Still a classic miniature, though not to every taste, and none the better for the recent update under our listening conditions. Limited dynamic range	30.5 x 19 x 16cm stands in free space	81dB/W 60Hz		66
<b>Harbeth HL Compact</b> From £455	Very Good Average	The clean and neutral sound lacks resolution and gives rather unobtrusive though well differentiated stereo. Can be bi-wired to advantage	52 x 27.2 x 28.1cm open space, on high stands	87.5dB/W 65Hz		59
<b>Heybrook Point Five</b> £129	Average Average	Disappointingly prosaic performance on listening tests; wooden and hollow, with restricted dynamics and 'space'. Earlier samples sounded better	37.5 x 23 x 23cm near wall, on matching stands	86dB/W 65Hz		59
<b>Heybrook Point 7</b> £170	Average Average	Physically an attractive package, but not entirely convincing in lab or listening panel test; interesting for all that	40.5 x 23 x 23cm stands against rear wall	85dB/W 60Hz		68
<b>Heybrook HB1</b> £189	Good Average +	No longer an over-bright character, a strikingly clear sound and fine transient performance now merits recommendation	47 x 29 x 23cm on stands near wall	88dB/W 61Hz	R	46
<b>Heybrook HB100</b> £250	Average + Good	Well matched for wall siting, the HB100 is a lively and informative performer in the tradition of the popular HB1	47 x 26 x 28cm stands near rear wall	86dB/W 50Hz	BB	66
<b>Heybrook HB200</b> £369	Average Average	This luxury successor to the HB2 is lively and informative, but sounded insufficiently balanced to convince our listening panel	46 x 23 x 26cm stands against rear wall	87dB/W 55Hz		66
<b>Infinity RS2000</b> £140	Good Good +	Fast, detailed and assured miniature with quick but not very deep bass. The top end is detailed but sometimes jangly	36.2 x 22.5 x 20cm near rear wall, high stands	91.5dB/W 70Hz	BB	59
<b>Infinity 6 Kappa</b> £650	Good Good	Interestingly styled US loudspeaker has unusual high tech drivers and good neutral, but the sound seriously lacks excitement	63 x 38 x 24cm stands, free space	85dB/W 35Hz		66
<b>Jamo Concert 2</b> £240	Good Average –	A thoroughly respectable 'bookshelf' performer that needs free space siting but includes attractive cabinetwork and a neat grille	41 x 24 x 25cm stands in free space	85dB/W 48Hz		66
<b>JBL L 60T</b> £399	Good + Good	Well balanced and offering realistic value for money, the fine treble and extended bass make it suitable for larger rooms	78 x 30.5 x 26.5cm low stands or floor	88dB/W 40Hz	R	46
<b>JBL L80T</b> £559	Good Average	Large scale, dynamic if rather unwieldy sounding, this is a performer of integrity, if not much subtlety	85.1 x 35.6 x 30.3cm floorstanding, open space	89.5dB/W 55Hz		59
<b>JBL 18Ti</b> £599	Good + Good	Beautifully engineered, well finished miniature with many good points, but unexceptional overall. Try the cheaper L20T	34 x 24 x 22.5cm 50cm from wall on rigid stands	85.5dB/W 53Hz		46



# THE DIRECTORY

## LOUDSPEAKERS

MODEL PRICE	LAB SOUND	COMMENTS	SIZE PLACEMENT	SENSITIVITY BASS FROM	VALUE	BACK ISSUE FULL REVIEW
<b>JBL 250Ti</b> £3599	Good+ Good+	In general this speaker did not show the required level of dynamic presentation transparency and stereo depth expected of a pricey flagship model	132 x 57 x 36cm free space on floor	89dB/W 53Hz		46
<b>JPW P1</b> £125	Good Average+	Honest and basically articulate if not very sophisticated resolution is good but it can sound a little wearing in bright systems or with rough sounding material	44 x 25.9 x 26.1cm free space on stands	89dB/W 60Hz	R	59
<b>JPW AP2</b> £145	Good Average+	Few grounds for criticism but purchasers should check out the treble qualities to avoid hammering the ear anvils	46 x 26 x 25cm 40cm from wall on 45cm stands	89dB/W 65Hz	R	53
<b>JPW AP3</b> £210	Good Average+	Pretty good stereo and well balanced overall it had its own character which is well suited to vinyl replay	52 x 25 x 29.5cm near wall on stands	90dB/W 57Hz	R	46
<b>KEF R102</b> £335	Very Good Very Good	High class near-miniature with expressive, articulate midband and clean, accurate bass and top. The sound quality of the Kube circuitry, however, is suspect, what would an audiophile Kube sound like?	33 x 20.7 x 26.3cm near wall or open on stands	89.5dB/W 60Hz	R	59
<b>KEF 103/3</b> £630	Good+ Good	Technically impressive, excellent bass power handling for size but not for the audiophile system. Better among cheaper components, and good in a large room	56 x 27 x 30cm supplied stands free space	90-95dB/W 35Hz		53
<b>KEF 104/2 (inc KUBE equaliser)</b> £849 (£948)	Very Good Good+ +	A reference point for dynamics, preferred without KUBE suited to many rooms. Good stereo, high sound levels	90 x 28 x 41.5cm floor standing in free space	92dB/W 50Hz	R	60
<b>KEF 107</b> £1890	Very Good Good+	A welcome sense of ease and lack of strain at most normal levels. Minor criticisms included a dulling in the extreme treble. Excellent bass extension	116.5 x 33 x 45cm on floor in free space	87.5dB/W 20Hz	R	60
<b>Linn Helix</b> £259	Average+ Good	Attractive presentation is coupled with an attractively lively sound which is more neutral if less committed than earlier Linn loudspeakers	51 x 25.5 x 28cm stands 11cm from rear wall	88dB/W 53Hz	R	66
<b>Linn Nexus</b> £379	Good Average	Good features include a solid, meaty bass plus good imagery and tonal balance. The catch is that Nexus lacks resolution and timing	49 x 23.5 x 30.4cm near rear wall supplied stands	89dB/W 60Hz		59
<b>Linn Sara</b> £749	Good Very Good	The new Sara is now much smoother and sweeter with much better imaging. Bass power and dynamics are as good as ever, and the system is no longer as fussy as before	43 x 34.4 x 26.5cm stand mounting near wall	88dB/W 50Hz	R	60
<b>Magneplanar SMGa</b> £675	Average- Average	Tonally 'rich', in the right room it proved a satisfactory musical experience	122 x 48 x 4.5cm on floor clear of wall	85dB/W 56Hz		46
<b>Magneplanar MG2.5R</b> £1897		Offers the low coloration and profound musical insight of better electrostatic loudspeakers but without loss of low frequency extension	183 x 56 x 4.5cm Open space	83-85dB/W 35Hz	R	60
<b>Magneplanar MGIIIa</b> £2650	Good Very Good	Another excellent true-audiophile loudspeaker this American panel speaker helps to convey much of the original character of the music	180 x 62 x 38cm well clear of walls	84-86dB/W 35Hz	R	46
<b>Marantz LD20 DMS</b> £150	Average Average	Recommended more for CD users than vinyl keepers, soundly engineered and built but should be heard before bought	36 x 23 x 24cm free space on 45cm stands	86.5dB/W 55Hz		53
<b>MB Quart 390</b> £499	Below Average Poor	An aggressive, messy sounding design whose uncouthness undermines the positive level of detail	52 x 31 x 30.5cm open space, on stands	89.5dB/W 60Hz		59
<b>Meridian M30</b> £725	Average+ Average	Pricy but easy on the ears and worth considering especially where space is at a premium	38.5 x 18 x 32cm free space on stands	Active 40Hz		46
<b>Mission 70 II</b> £100	Good Average	Lively and transparent, the 70 II was favoured for its speed though the sound had a mildly 'thin' tonal balance	35 x 21 x 21cm on stands or shelf near wall	89dB/W 68Hz	BB	46
<b>Mission 761</b> £120	Average Good	One helluva speaker for the price, if a shade small and short of subtlety and refinement - should prove a worthy successor to the 70 and 700	38 x 21 x 21cm stands near rear wall	87dB/W 60Hz	BB	66
<b>Mission 700LE</b> £140	Good Average	Mission re-submitted this popular model and again got positive review - which proclaims their (and our) consistency	38 x 21 x 21cm straight ahead stand near wall	89dB/W 66Hz	R	59
<b>Mission 762</b> £180	Average Average-	Mission's 'bookshelf middleweight' offers high sensitivity and loudness capability but at the expense of a somewhat untidy and rather 'heavy' sound	50 x 25 x 27cm stand experiment advised	91dB/W 55Hz		66
<b>Mission R737 Renaissance</b> £250	Average Average	Effusive, over-the-top bass and obtrusive treble get in the way of a marvellously lucid and transparent midband. Inconsistent on audition - wonderful piano, bloated orchestras etc	54 x 25 x 27cm near wall on dedicated low stands	88.5dB/W 60Hz		59
<b>Mission 763</b> £280	Average+ Average+	A very artful combination of generous volume and good bass extension at a surprisingly modest price that works well in the listening room despite a few rough edges	77 x 25 x 32cm near rear wall	86dB 40Hz	BB	68
<b>Mission Argonaut</b> £500	Good Good	Perhaps not the most subtle or sweet these were recommended for their excitement, drama, power handling and good looks	95 x 23 x 31cm floor-standing near wall	91dB/W 40Hz	R	60
<b>Monitor Audio R100</b> £159	Average+ Average-	Tonally quite neutral, but with small box character, negligible low bass and a rather 'hard' midrange	40.5 x 25 x 21cm free space on stands	87.5dB/W 70Hz		46
<b>Monitor Audio R352/MD</b> £300	Average+ Good	A good value large box that sounds more engaging than subtle, providing a good compromise between bandwidth and sensitivity	64 x 25 x 32cm stands in free space	89dB/W 45Hz	R	66
<b>Monitor Audio R452/MD</b> £399	Average Average	This big, efficient, dynamic sounding loudspeaker has a clean, open treble but a pinched, two-dimensional midband. Can be tiring in the long run	64 x 25 x 31.8cm open space, low stands	89dB/W 55Hz		59
<b>Monitor Audio R852/MD</b> £399	Good+ Good	This finely crafted design has a sharp and clear if occasionally rather rough sound quality. Bass is light but qualitatively very good - an intriguing performer	45 x 25 x 27.5cm open space or near rear wall, high stands	89dB/W 68Hz	R	59
<b>Monitor Audio R852/Gold MD</b> £450	Good Good	Luxury build and 'high tech' tweeter or not, this compact model offers good refinement and detail on an open soundstage	45 x 25 x 26cm stands in free space	86dB/W 50Hz	R	66
<b>Monitor Audio I200 Gold MD</b> £800	Average Average+	This smooth and civilised slimline floorstanding loudspeaker is well built and nicely presented. But it is also expensive	94 x 20 x 26cm in free space	85dB/W 48Hz		68
<b>Mordaunt Short MS10 II</b> £90	Average Average-	One of the best miniatures around. A borderline Best Buy because of the bass limitations, which may depend on your taste	29 x 20 x 17cm wall bracket	86dB/W 75Hz	R	53
<b>Mordaunt Short MS100</b> £189	Average+ Average+	A 'mid forward' tonal balance is its main drawback but other aspects such as ambience, transparency and stereo depth compensate	32.5 x 22.5 x 21.5cm stands near wall	85dB/W 80Hz	R	46
<b>Mordaunt Short 45Ti</b> £230	Good Average	A sensitive tandem-bass number that can be driven loud but loses its balance a bit and can be unsuitable	63 x 26 x 30cm low (20cm) stand near wall	90.5dB/W 52Hz		53
<b>Mordaunt Short MS300</b> £319	Average+ Average+	Not considered particularly competitive in its class, though it has good power handling and stereo focus	54 x 22.5 x 25cm on stands near wall	89dB/W 65Hz		46
<b>Mordaunt Short 442</b> £1150	Good+ Good+ +	A resounding success with the listening panels. Make sure your room can accommodate the bass	95 x 26 x 38cm floor standing in free space	87.5dB/W 40Hz	R	60
<b>Musical Fidelity MC-2</b> £300	Very Good Very Good	This exceptionally clean and clear design offers real subtlety and finesse. Bass quality is light but exceptionally clear; the treble is smooth if slightly shallow	48.5 x 25.5 x 16.5cm open space and stands	87.5dB/W 65Hz	BB	66
<b>Musical Fidelity MC-4</b> £499	Very Good+ Very Good	Achieving a very high standard, the MC-4 sounds detailed and coherent like the MC-2, but with more bass depth and solidity, and large image scale	56.5 x 26.9 x 29cm open space on stands	87.5dB/W 60Hz	R	59
<b>Opus 3 Capella</b> £495	Good Good	The sound of this Scandinavian curiosity certainly benefits from the crushed marble enclosure, though presentation is strictly DIY	32 x 40.5 x 26(ave)cm amongst books in bookcase	86.5dB/W 45Hz		66

TO ORDER BACK ISSUES OF HI-FI CHOICE SEE PAGE 123

## THE DIRECTORY

## LOUDSPEAKERS

MODEL PRICE	LAB SOUND	COMMENTS	SIZE PLACEMENT	SENSITIVITY BASS FROM	VALUE	BACK ISSUE FULL REVIEW
Quad ESL-63 £1538	Good+ Good++	With its unusual but subtle characteristics this classic electrostatic may not be punchy in the bass, but has strengths that some cannot live without	92 x 66 x 27cm open stand well clear of wall	84dB/W 34Hz	R	60
Richard Allan C05 £242	Average— Average—	This neatly presented small reflex design can sound engagingly communicative, but is flawed sonically and technical and quite expensive too	38 x 19 x 23cm on rigid stands	88dB/W 80Hz		68
Rogers LS7t £399	Good+ Good+	A fine combination of classic qualities at reasonable price produces the "R" tag, but try to get a pair home on approval to check for bass 'heaviness'	56 x 27 x 28cm free space on 40cm stands	88.5dB/W 48Hz	R	59
Rogers Studio 1a £565	Very Good Good—	The classic BBC monitor style sound sensitively updated – transparent and natural with fine stereo, but a touch 'heavy' in balance	63.5 x 30.5 x 30.5cm stands in free space	87dB/W 36Hz	R	66
Roksan Darius £1265	Average Poor/V Good	A controversial speaker which when set up right can deliver impressive performance, but with a far from neutral balance	98 x 31 x 51cm integral stands near side walls	88dB/W 50Hz		53
Rotel RL850 II £130	Average+ Average+	Strongly recommended. Well-balanced, clear, with decent focus and fine stereo, but tendency to 'heaviness' needs decent stands and space	44 x 25 x 24cm free space on 40cm stands	86.5dB/W 50Hz	BB	59
Royd A7 Series 11 £99	Average+ Average	Lively clear sound, good upper bass and dynamics, but treble "ramp" made vocals sound shut in before	31 x 20 x 17cm shelf or 50cm stands near wall	86dB/W 75Hz	R	53
Royd A25 £100	Average+ Average—	Receiving mixed reactions on audition, the A25 is flawed but offers a lot of speaker for the money	51 x 29.5 x 24cm, stands near wall	87dB/W 52Hz	R	46
Royd Eden £235	Average Average+	Delightful mid/treble speed and transparency but determinedly bass light, this oddball miniature threatens cult status but could use a sweeter tweeter	31 x 20.5 x 18.5cm stands close to rear wall	87dB/W 85Hz	R	66
SD Acoustics SD1 £1050	Average Very Good	A large scale, airy and unusually detailed system with excellent dynamics. Balance is light and bright and the original model could upset some systems/listeners. Current model has more civilised top-end and warmer overall balance	123.5 x 38.2 x 31.9cm free standing, away from walls	90dB/W 50Hz	R	60
Sony APM 10ES £100	— Average	An obvious Best Buy at its highly competitive price point, it can do justice to a good hi-fi system of Sony or specialist origins	40 x 25 x 20cm, 40cm stands 40cm from wall	87dB/W 55Hz	BB	59
Sony APM 22ES £249	Good+ Good	Sounding notably clear, the 22ES scored well on listening tests, was easy to drive and achieved high sound levels	51.5 x 29 x 30cm free space on 40cm stands	88.5dB/W 46Hz	R	46
Sony APM 66ES £700	Average+ Average+	Powerful heavyweight sound with a brilliant midband – clear articulate and transparent. But the bass is on the boomy side and the treble can sound grainy	66 x 38 x 36.5cm open space, low stands	89dB/W 60Hz		59
Spendor Prelude II £345	Good+ Good	Good clarity and detail were evident everywhere in this speaker. Though a little boxy or muddy in the midrange it is strongly recommended	50 x 26 x 28cm open stands in free space	88dB/W 52Hz	R*	46
Spendor SP2 £450	Very Good Good+	Conceding little to the SP1, this 30 litre model displayed good tonal balance with a highly articulate midrange, only slightly marred at frequency extremes	50 x 25 x 30cm free space, stands	87dB/W 45Hz	R	59
Spendor SP1 £680	Very Good Good	A very subtle and musical performer that works particularly well with digital material. An exceptional allrounder	63.5 x 29.5 x 30.5cm stands in open space	87dB/W 41Hz	R	60
Spendor SA3 Passive £1400	— Good+	Same as Spendor SA3 active	85 x 38 x 46cm low	89dB/W 32Hz	R	46
Spendor SA3 Active £2708	Good+ Very Good	Substantial speakers designed to deliver high sound levels and killer bass. Suited to larger rooms and power hungry ears	85 x 38 x 46cm low rigid stands in free space	89dB/W 32Hz	R	46
Spica TC-50 £595	Average+ Good	These American wedge-shaped-cabinet speakers were detailed and clear. However, we've not heard the current version with new drive units	40 x 33 x 28cm free space on 50-60cm stands	85dB/W 48Hz	R*	59
Spica Angelus £1195	Good Average	A little bass shy and soft in the bass and lower mid, the Angelus is otherwise tidy, extremely lively and fluid, if uneven overall	116.8 x 53.3 x 26cm free standing away from walls	86.5dB/W 50Hz		60
Studio Power Sapphire £130	Poor Average—	Balance difficulties are improving, though still prevent the potential of this interesting metal-cone new miniature from being fully realised	30 x 20 x 19.5cm stands near rear wall	85dB/W 70Hz		66
Tannoy Eclipse £120	Average+ Good	Although a little bright, the essentials are right: hear-through clarity at all frequencies, good dynamics, firm bass	38.8 x 22.6 x 21cm semi open on stands	87dB/W 65Hz	BB	59
Tannoy Mercury S £160	Good Good	A fine budget allrounder in the now established Mercury tradition; good balance and reasonable refinement will ensure wide appeal	49.5 x 25 x 21.5cm stands in free space	87dB/W 50Hz	BB	66
Tannoy M20 Gold £200	Good Average+	Luxury version of Mercury S with real wood and bi-wire frills doesn't necessarily sound better overall, but still fine value	49.5 x 25 x 21.5cm stands in free space	87dB/W 50Hz	R	68
Tannoy DC2000 £300	Good Good	Remarkably high sensitivity from unique dual concentric driver that has an involving but characteristic sound. Bass could be better	68.5 x 26 x 27cm floor in free space	93dB/W 55Hz	R	66
Tannoy Westminster £3400	n/a Good+	These awesome horn loaded speakers are remarkably controlled and impressive, if only suited to a few pockets and rooms	Huge, flat against rear wall, away from corners	96dB/W (manuf.)	R	Cott
TDL Monitor £1600	Very Good Very Good	Fine solidity and good accuracy, with enough bass extension to satisfy even organ freaks. Needs a room and can sound a bit lazy and a shade tinkly	118.5 x 30 x 47cm 0.5m from walls	85dB/W 28Hz	R	66
Technics SBC 250 £130	Average+ Average—	Despite a fairly even tonal balance, the 250EK sounded muddled in the midrange and dull in character	36.5 x 23.5 x 20.5cm free space, stands	86dB/W 60Hz		46
Technics SB-RX50 £500	Very Good Average+	With its unique coaxial drive unit the RX50 proved a smooth and well balanced loudspeaker, its minor weakness being a mild excessive low bass	48 x 30 x 26cm free space on 40cm stands	86dB/W 40Hz	R	46
Toshiba S33-M £90	Average Average	Providing a benchmark for budget loudspeakers, this Toshiba-inspired but UK designed and manufactured model is a lot of loudspeaker for the money, if a shade on the cheap	40 x 26 x 21.5cm stands in free space	86dB/W 55Hz		68
Wharfedale Delta 30 £79	Good Average	Very clear and surprisingly neutral for the price, with good dynamics and stereo within limited volume ceiling	37.9 x 20 x 16.9cm near wall on high stands	88.5dB/W 80Hz	BB	59
Wharfedale Delta 50 £99	Average+ Average—	"There's nothing obviously wrong, but it seems a bit mundane," is what we said when the Delta 50 was £129. But since then the price has dropped by 30 per cent, making it great value	48 x 27 x 19cm near wall on 40cm stands	88dB/W 55Hz		53
Wharfedale Diamond 111 £99	Below Average Average—	This latest version of the long running Diamond sports a better tweeter, but bass, though deep, is soft, and the midband is indistinct and uneven	24 x 18.5 x 20.5cm near wall, stands	86.5dB/W 75Hz		59
Wharfedale Super Diamond £139	Average Average—	Although there are improvements on the basic "legendary" model, listening panelists did not get airborne about this upgrade	24 x 19 x 19cm close to wall at head height	88dB/W 57Hz		53
Wharfedale 504/2 £140	Average Average	Not strictly accurate, this musically involving miniature sounds unusually coherent and well integrated, if a shade dull in balance	29 x 18.5 x 19cm stands against rear wall	84dB/W 60Hz	R	68
Wharfedale 505/2 £169	Average Good	This lively Wharfedale provides plenty of speaker with unusual refinement for the money and should be fairly tolerant of room siting	44 x 25.5 x 24cm stands 1ft from wall	86dB/W 55Hz	BB	66
Wharfedale 510.2 £299	Average Average—	Even in its latest guise, this loudspeaker still sounds hard, cluttered and lacking innate clarity. The bass is uneven and midband coloured	61.5 x 28 x 29.6cm near wall, high stands	89dB/W 50Hz		59
Yamaha NS 1000M £900	Good Good+	Living up to its monitor label, and tonally well suited to digital material, the NS 1000M is superbly crafted and capable of high levels	67.5 x 37.5 x 32.5cm 30cm from wall, stands	90dB/W 40Hz	R	46

\* rating refers to original, tested model

THE WORLD'S NO 1 GUIDE TO BUYING HI-FI

# THE DIRECTORY

## CASSETTE DECKS

The bad odour of copyright theft hangs around the compact cassette, but there is no doubt it is the world's most versatile and ubiquitous music storage medium. Hi-fi buffs may wrinkle their noses pointedly, but are still happy to use cassette decks to make up tapes for the car or personal – at the same time complaining loudly about the quality of pre-recorded material. (In fact the very best decks can do a surprisingly good job with musicassettes.)

There is no problem in connecting a cassette deck to any normal amplifier, but some care needs

to be taken in choosing the best tapes for a specific machine. (Trial and error is one effective technique, but many decks have manual bias adjustment and some match up to the tape automatically.) Lab performance and sound quality often go hand in hand, and are frequently somewhat dependent upon factory alignment. The mechanical integrity of the mechanism itself is another crucial factor, that is often reflected in the asking price.

All modern hi-fi decks have Dolby B and the majority have Dolby C besides; the very worthwhile

HX Pro system is becoming steadily more widespread. Remote control remains rare, though sometimes it is available as a system option. Three-head recorders allow simultaneous checking of the recording being made. Auto-reverse is a useful convenience feature, but usually with some mechanical compromise, while double-mechanism 'dubbing' decks of dubious quality are fashionable at the bottom end of the market. The welter of different 'music search' systems available is some indication of their frequent ineffectiveness.

NAME PRICE	LAB SOUND	COMMENTS	FEATURES	VALUE	BACK ISSUE FULL REVIEW
Acoustic Research RD-06 £280	Average Average+	Acceptable middle market player with very simple facilities and cramped control section, but unusually good looks	Dolby B/C HX Pro, fine bias, counter memory, repeat		This
Aiwa AD-F370 £130	Average Average	Adequate but uninspiring recorder with detail shortcomings but good control layout and successful sounding with recorded musicassettes	Dolby B, C, HX Pro, bias adjust		63
Aiwa AD-R470 £150	Average Good	For once, an auto-reverse deck with the performance of a decent unidirectional one at a similar price. The Aiwa is modern in concept and execution, and has good, transparent electronics	Dolby B/C/HX Pro, auto reverse, cue & review, bias adjust	BB	This
Aiwa AD-WX707 £180	Poor Average	Not bad value for a twin deck, but marginal from the high fidelity viewpoint. The review sample was poorly set up	Dual deck, auto-reverse, Dolby B & C, bias adjust		57
Aiwa AD-F880 £300	Good Very Good	Modern sophisticated deck which manages to include some very sound under the skin development work in a rather ordinary (if well polished) exterior	Dolby B/C/HX Pro, 3 head, remote, manual tape calibration	R	This
Aiwa XK-007 Excelia £400	Good Good	Downmarket version of XK-009 with simplified bias/equalisation adjustment section and more forgiving but less informative sound. Still good, but less exciting than XK-009	Dolby B, C, dbx, HX Pro, 3 Head, tape alignment		63
Aiwa AD-WX909 £400	Good Good	Convenience meets sound quality, and both win. An essentially clean, positive recorder which works alongside an auto-reverse player of lower standard – a sensible compromise	Dual deck, auto-reverse, track search, Dolby B/C/HX Pro, bias adjust, 3 Head	R	57
Aiwa XK-009 Excelia £550	Very Good Very Good	Excellent detail, stable articulate midband and slightly obvious treble. The most interesting Aiwa for yonks	Dolby B, C, dbx, HX Pro, 3 Head, tape alignment, CD direct	R	63
Akai CX-32 £200	Average Poor	Constrained and smeared sum this deck well. It has poor bass and treble definition alike, though it proved well aligned for prerecorded cassettes	Dolby B/C, variable bias, headphone out, track search		This
Akai CX-52 £249	Very Good Very Good	Well finished and a pleasure to use this well specified deck sounds clean and defined with all tape groups, with or without Dolby	Dolby B, C, HX Pro, track locate features	BB	57
Akai CX-6 £350	Good Good	There is a strong sense that someone has really thought this one through, it has an indefinable 'specialness'	Real-time counter, track search, Dolby B, C, bias adjust	R	52
Akai CX-95 £400	Good Very Good	Well designed and finished cassette deck with features well judged to please the audiophile – especially switchable Dolby HX Pro and switchable panel display. The calibration system is simple and effective, and the deck sounds great	Dolby B/C/HX Pro, 3 head, manual tape set-up	R	This
Denon DR-M07 £125	Poor+ Average	There were several problems with the test player that render it an unsafe purchase. This is a pity since despite the antiquated control system, the deck is capable of refined sound quality	Dolby B/C, fine bias adjust		This
Denon DR-M10HX £180	Good Good	Very well laid out, a sensible range of features and smooth cam-operated transport. Replay-only sound quality suspect, but the deck is successful as a recorder – clean, precise but slightly 'grainy'	Dolby B, C HX Pro, memory counter, bias adjust	R	63
Denon DR-M12HX £220	Good Good+	Well constructed and pleasant to use, a lack of true pitch constancy kept it from sounding superb	Track search, Dolby B, C, HX Pro, bias adjust	R	57
Denon DRW-750 £229	Good Good	Polished and articulate, the only significant shortcoming is poor performance with prerecorded material	Dolby B/C/HX Pro, twin unidirectional, one records	R	This
Denon DR-M24HX £290	Good Good+	This deck will slot into many high grade systems without disgracing itself – or the cassette medium. Very presentable high resolution sound with good stereo with or without Dolby	Dolby B, C, HX Pro, bias adjust, 3 Head	R	60
Denon DR-M34HR £320	Very Good Good+	Prerecorded cassettes sounded grey and dull, but this may have been a sample fault. As a recorder, the DR-M34 is refined and detailed – and good value	Dolby B, C, HX Pro, 3 Head, manual tape calibration, memory counter		63
Denon DR-M44HX £400	Excellent Excellent	A well designed deck that also performed fine sonically, working very well with ferric and metal tapes	Real-time counter, Dolby B, C, HX Pro, tape alignment adjust, remote control, 3 Head	R	60
Dual CC8010 £110	Average Average+	The only limitation worth noting is a slight opaqueness, the Dual otherwise sounds stable and effective. An excellent low-cost design	Dolby B & C, microphone input	BB	63
Goodmans GSW-5200 £90	Poor Poor	Musically unimpressive but at least it's cheap!	Dolby B, twin, one records		This
Grundig Fine Arts CCT-903 n/a (system component)	Good Good-	(Competent part of complete Grundig system) Solid and well engineered deck with small but significant problems preventing it scoring highly. Basic design generally – and transport specifically – are excellent	Dolby B/C, twin auto reverse, one records		This
Harman Kardon CD491 £695	Good Good+	Excellent audio engineering and tremendous flexibility make this an audiophile cassette deck 'par excellence'	Real-time counter, auto reverse, track search, Dolby B, C, HX Pro, bias adjust	R	52
JVC TD-R411 £180	Poor Poor	Transport irregularity, especially flutter, and poor set-up lead to a sound that although sharp is lacking in body and detail. However, the quick auto-reverse mechanism is nice to use	Dolby B/C, auto reverse		This
JVC TD-W444 £190	Average Average	The 444 offers a satisfying blend of cost and facilities, but musically it is lacklustre, lacking detail, dynamics and grip. Fair value though	Dolby B/C, twin deck, unidirectional play deck, auto-reverse record deck		This
JVC TD-V711 £380	Very Good Excellent	This is a complex recorder which is built on the back of some important ideas with audiophile roots. It has a (mostly) superb technical performance and is very capable, if not always strictly accurate	Dolby B, C, HX Pro, 3 Head, variable bias, track search, 3 line inputs	R	63
JVC TD-W222 £150	Below Average Below Average	Well endowed but somewhat user-hostile twin deck. Sound quality is very tape dependent, but offers tolerable stability with considerable loss of resolution and scrappy musical presentation	Dual deck, auto reverse, Dolby B/C		63
Kenwood KX-440HX £140	Average+ Poor	Uneven, unstable sounding player with limited resolving power, but good control layout and finish	Dolby B, C, HX Pro, intro scan		63
Kenwood KX-660HX £170	Good Good	Well designed control system with useful search aids. Sound quality is positive and detailed	Dolby B, C, HX Pro, track & blank search, intro-scan, bias adjust	R	63
Kenwood KX-5010 £269	Very Good Excellent	This important new middle price deck is a well thought through and thoroughly developed design which eschews gimmicks for the sake of musical excellence	Dolby B/C/HX Pro, auto tape calibration, track/intro search	BB	This
Luxman K-105 £349	Average Average	Rating quite well for an auto reverse deck, and featuring complex track search facilities, it was not sonically competitive on price	Auto reverse, track search, Dolby B & C, remote control		52
Luxman K-112 £349	Average Average	Build quality is not truly consistent with the price. Nor is sound, which veers on the warm, lossy side of neutral	Dolby B, C, HX Pro, bias adjust, 3 Head		57
Marantz SD-35 £150	Good Good+	Rock steady tape transport gives very competitive sound quality for the price, but the slightly bright replay may not appeal to some	Dolby B & C, bias adjust	R	52

## THE DIRECTORY

## CASSETTE DECKS

NAME PRICE	LAB SOUND	COMMENTS	FEATURES	VALUE	BACK ISSUE FULL REVIEW
Marantz SD-45II £200	Good+ Good+	Well built and dynamic sounding player, working better as a recorder than with musicassettes	Dolby B & C, bias adjust Auto selection	R	52
Marantz CP230 £300	Average Average	This is a competitively priced portable recorder though not suited to replay of musicassettes	Dolby B, bias adjust	R	52
Marantz SD585 £300	Average Average-	Sound quality is a little sat upon, and control ergonomics are somewhat opaque, though the twin auto-reverse/recording capability makes this a powerful machine	Dolby B/C, twin auto-reverse & record, parallel recording etc		This
Marantz SD-55 £349	Good Very Good	Slightly tacky feel and restricted signal/noise performance are the main shortcomings of an excellent sounding piece of kit	Real-time counter, track search, Dolby B/C/HX Pro, bias adjust, 3 Head	R	57
Memorex SCT-84 £200	Average+ Average+	The playback only transport is a little disappointing, but the record one is a quality item and the deck works well. Ergonomics are good, but styling and control feel are decidedly tacky	Dolby B/C, fine bias, twin with auto- reverse record, unidirectional play	R	This
NAD 6300 £550	Very Good Very Good	Solid and homogeneous sound quality and very good replay compatibility thanks to 'play trim' distinctive, musical - and costly	Dolby B, C, HX Pro, 3 Head, bias adjust	R	63
Nakamichi CR-1E £345	Very Good Good	Modestly equipped by any standards, the CR-1E stands or falls by its build quality, which is high, and sound which is highly competent	Dolby B & C		57
Nakamichi CR-2E £395	Very Good Good+	Ordinary to look at, in some respects rather awkward to use (tape switching especially), the CR-2E sounds very slightly better than the CR-1E, and therefore ranks well. But it doesn't come cheap	Dolby B & C, bias adjust, remote control	R	57
Nakamichi RX-202E £545	Good V Good+	Fine, clear and articulate sounding player. Excellent with prerecorded material, but idiosyncratic and sometimes obstructive control system	Auto reverse, Dolby B, C, 2 Head	R	63
Nakamichi CR-3E £595	Very Good Very Good	The user interface is a little clumsy, though conceptually straightforward. Sound quality approaches the CR-4E, and is amongst the best at the price	Dolby B & C, bias adjust, remote control	R	57
Nakamichi CR-4E £745	Very Good+ V Good+	High class deck with a reasonably full range of features and superb sound at a slightly unlikely price	Dolby B & C, bias adjust, remote control, 3 Head	R	57
Nakamichi CR-5E £995	Excellent Excellent	A slightly simplified version of the all-conquering CR-7, the CR-5 has a very similar standard of audio performance - the best	Dolby B/C, fine bias, 3-head	R	This
Nakamichi CR-7E £1500	Excellent Excellent	Remarkably this deck is not only ergonomically but also sonically superior to the Dragon, particularly on record/replay	Real-time counter, track search, Dolby B & C, tape alignment adjust, bias adjust, remote control, 3 Head	R	60
Nakamichi Dragon £1750	Excellent Excellent	Previous to the birth of the CR-7E, this machine stood head and shoulders above the rest. It is still the ultimate for music cassette replay	Auto reverse, Dolby B & C, tape alignment adjust, bias adjust, remote		60
Onkyo TA-2120 £130	Average+ Good	Clear, vivid sound with good timing and resolution when using Type II tapes without Dolby. The controls are less inspiring - the meters in particular are plainly inadequate	Dolby B/C, auto tape sensing, block/ side repeat	R	63
Onkyo TA 2130 £160	Average+ Average+	Rating fairly well on both pre-recorded and record/playback, ergonomics were a little poor but overall performance was generally consistent	Track search, Dolby B & C, bias adjust		52
Philips FC566 £179	Average+ Average+	Mostly well equipped, though some tape search facilities fail to exploit the auto-reverse capability. Sounds clean and stable - with prerecorded tapes too	Auto reverse, track search, Dolby B & C		57
Philips FC567 £279	Average Poor	Well equipped but ergonomically substandard, sound quality is messy and lacking in clarity and dynamics	Dual deck, auto reverse, track search, Dolby B & C		57
Pioneer CT-443 £180	Average Good	Structurally sound and subtly musical recorder. Sophisticated, mildly damped sound quality	Dolby B & C, fine bias adjust, track search	R	63
Pioneer CT-737 £300	Average- Average-	Interesting design and a pleasure to use with rather too many rough edges to really work properly	Dolby B, C, HX Pro, 3 Head, bias adjust, memory counter		63
Pioneer CT-939 £450	Excellent Excellent	High grade and easy to use cassette deck featuring a state of the art transport. The audio amplifiers are not quite in the same class, but fail to seriously damp enthusiasm for an excellent package	Dolby B/C/HX Pro, 3 head, real time counter, variable bias	R	This
Proton AD-200 £140	Poor Poor	Sound quality is essentially on a par with many portables, and has nothing to do with high fidelity. The main problems are an unrelenting hardness and an almost total lack of detail	Dolby B & C		57
Proton AD-300 £200	Average- Poor	High levels of flutter give sound a roughness and coarseness that rules it out for high quality work. The record and replay electronics certainly deserve better	Auto reverse, Dolby B & C		57
Revox B215 £1461	Good Average+	Superb engineering and good sound, but lacking the subjective qualities that characterise the very best hi-fi equipment	Real-time counter, Dolby B & C, tape alignment adjust, remote control		52
SAE C102 £549	Average+ Good	Looking most unlike a cassette deck designed in the States and proving competitive in its price group. Not sonically that outstanding, however	Real-time counter, track search, Dolby B & C		52
Sansui D-X301i £150	Average+ Good	Lively, informative and well equipped basic deck, if rather obscure operationally	Dolby B/C/HX Pro, variable bias, track search	R	This
Sony TC-FX 150 £90	Average+ Average+	Recording and playing back on this deck itself gave acceptable results, whereas prerecorded stuff was a joke. But it's a good £90 worth	Dolby B & C		52
Sony TC-W300 £150	Poor Poor	Deeply unimpressive and messy sounding deck with bloated quality and poor pitch integrity. Dubbing performance substandard	Dual deck, Dolby B & C		63
Sony TC-RX50 £180	Average- Poor	Terminal inability to play at a steady pitch, or (on prerecorded material) in tune spoiled this simple but otherwise attractive design	Auto-reverse, Dolby B/C/HX Pro		63
Sony TC-WR500 £200	Poor Poor	In many ways a curiously old-fashioned package which lives up (down?) to stereotypes about twin cassette decks	Twin Dolby B & C, 1 records, both auto-reverse		This
Sony (WMD6C) ProWalkman £249	Good+ Excellent	"One of the finest sounding cassette decks on the market today. A mandatory Best Buy, which also fits in your pocket"	Dolby B, & C	BB	60
Sony TC-RX60ES £250	Average Average	For once a stable sounding auto-reverse deck but sound quality is rather 'dirty' and compressed, especially with Dolby C	Auto-reverse, Dolby B/C/HX Pro, auto tape recognition		63
Sony TC-RX80ES £350	Average+ Good	Clean, powerful and detailed sound, especially without Dolby C. Stable pitch - but prerecorded cassettes sounded disappointing	Auto reverse, Dolby B/C/HX Pro, bias/ level adjust	R	63
Sony TC-K700ES £499	Excellent Excellent	Firmly in the esoteric league, this is easy both to operate and to listen to. Best points: first class imagery, focus and stability	Auto reverse, track search, Dolby B & C, tape alignment adjust	R	60
Teac V-250 £89	Average Average	Ultra-basic design which works quite well. Lack of pitch integrity is the main shortcoming, but it wasn't always noticeable	Dolby B		63
Teac V-270C £109	Average- Average-	Not quite cheap enough to compete solely on price, the V-270C is a rather messy and unstable sounding deck	Dolby B & C, bias adjust		63
Teac V-570 £199	Average+ Good	Metal tapes are not exploited well by this deck, and prerecorded tapes sounded very disappointing. But the underlying sound quality sets a very high standard, assisted by clean electronics and an excellent transport	Dolby B/C/HX Pro, fine bias adjust	R	This
Teac V-670 £249	Average Average	This deck is worth considering, but much has been sacrificed for the third head, both musically and in the range and type of features included. Worth considering	Dolby B/C/HX Pro, fine bias, 3 head/off tape monitoring		This

TO ORDER BACK ISSUES OF HI-FI CHOICE SEE PAGE 123

# THE DIRECTORY

## CASSETTE DECKS

MODEL PRICE	LAB SOUND	COMMENTS	FEATURES	VALUE	BACK ISSUE FULL REVIEW
Teac R-515 £299	Average+ Average+	Expensive, this deck is basically a competent but pedestrian performer which will not fully satisfy the critical user	Real-time counter, auto reverse, Dolby B & C, bias adjust		57
Teac W-460C £299	Good Average	Musically this deck is a little lacking, given the price and despite a notably fine transport section. Nevertheless well worth considering if the programming options appeal.	Dolby B/C, twin unidirectional, one records. Programme memory		This
Teac V-870 £399	Good+ Good	Cut-down V-970X for the proletariat. Expensive and carefully engineered with mostly very good but slightly cold sound quality	Dolby B, C, HX Pro, 3 Head, manual tape calibration	R	63
Teac V-970X £499	Very Good Very Good	An excellent sounding deck with useful features (tape calibration etc) that fully justifies the price	Real-time counter, track search, Dolby B/C/dbx & Dolby HX Pro, bias adjust, remote control, 3 Head	R	57
Teac W-990RX £499	Good Good	A mess with dbx, but taut and articulate otherwise. The 990, though expensive, has a powerful range of features, making it one of the few really ambitious decks to successfully straddle both sets of requirements	Dolby B/C & dbx, dual auto-reverse/record, parallel & sequential recording, remote	R	This
Technics RS-T230 £160	Average— Average	Satisfactory with prerecorded material but otherwise unexceptional, the main features of this deck are its excellent user interface and value for money	Dual deck, Dolby B/C		63
Technics RS-B355 £140	Good Good	Good sound let down by inadequate meters and poor prerecorded replay only sound quality	Dolby B, C, microphone inputs, cue and review	R	63
Technics RS-B505 £160	Average+ Average+	Neatly made recorder with Dolby HX Pro that sounds precise and stable, though sometimes a little processed and grainy too	Track search, Dolby B/C/HX Pro		57
Technics RS-B605 £180	Good Average+	Mixed but generally good sound. Weakest points are dbx and prerecorded sound, best are Type IV (metal) recordings which sound sharp and precise	Track search, Dolby B/C/HX Pro & dbx		57
Technics RS-T330R £200	Average+ Average+	One of the very few dual cassette decks with any real pretensions to audio quality, the RS-T330 is a considerable success musically as well as being a pleasure to use	Dual deck, Dolby B & C	R	63
Technics RS-B705 £250	Average Average—	3 heads for the price of two, but not the sound quality to go with them	Track search, Dolby B, C, HX Pro, bias adjust, 3 Head		52
Technics RS-B905 £350	Good Good	Good, well set up cassette deck with a clean, accurate sound but some compression, dbx circuit sounds poor	Dolby B, C, HX Pro, dbx, bias adjust, 3 Head		57
Technics RS-T80R £400	Poor Poor	Flexible and pleasant to use but poor transports led to poor sound on our latest sample	Dual deck, auto reverse, track search, Dolby B, C, dbx		52
Yamaha KX-200 £120	Good— Good	Cheap, well-equipped and workmanlike with the sound quality less obviously processed than most – the whole is more than the sum of the parts	Track search, Dolby B & C, remote control	R	52
Yamaha KX-300 £150	Average+ Average—	Uncommonly well equipped and adequately made and presented, this model turned out to be a disappointingly uncertain proposition on audition	Track search, Dolby B, C, HX Pro with 'play trim', bias adjust, remote control		57
Yamaha KX-400 £200	Good Good+	A highly commercial package with every widget under the sun. Happily it sounds good too	Auto reverse, track search, Dolby B, C, HX Pro, remote control	R	52
Yamaha KX-500 £210	Very Good Very Good	An accomplished performer, strongest in the areas of pitch and spatial stability, but slightly rough around the edges	Real-time counter, track search, Dolby B/C/HX Pro with play trim, bias adjust, remote control	R	57
Yamaha KX-800 £330	Good Average	The present Yamaha range seems oddly inconsistent. This sophisticated model sounds fine (almost) but came a clear second best to the KX-500	Real-time counter, track search, Dolby B, C, HX Pro with play trim, bias adjust, 3 Head		57
Yamaha KX-1200 £500	Excellent Average+	A veritable rats' nest of buttons and dials, albeit well laid-out. This is nearly a great recorder, but lacks simplicity of sound	Real-time counter, track search, Dolby B, C, dbx, HX Pro, bias adjust, remote control		52

## DAT RECORDERS

NAME PRICE	LAB SOUND	COMMENTS	FEATURES	VALUE	BACK ISSUE FULL REVIEW
Aiwa Excelia XD-001 £1300	Very Good Very Good	Clear and very listenable recorder roughly comparable to but slightly sweeter sounding than the Sony DCT-1000ES – but with an inferior front panel design	Track ID and search, remote	R	63
Grundig Fine Arts DAT-9000 n/a (system component)	Good Good	Conventional DAT recorder offering standard facilities. The deck is well made and equipped, and is engineered to a satisfactory quality standard. It performs to an acceptable standard, though it is not state of the art	2/4 hour recording, mic inputs, digital in/out		This
Luxman KD-117 £1499	Good Good	Slightly soggy, earth-bound sound quality, this model trails the other DAT decks tested so far	Two analogue inputs, remote twin address		63
Pioneer D-1000 n/a	Excellent Excellent	Fine, clear, colourful and consistent sounding deck. The Pioneer is lavishly (uneconomically?) constructed and equipped. It shows what is possible, but will probably never go on sale	Many search and memory facilities	R	63
Sony DTC-M100 £799	Very Good Very Good	Clean, clear sounding 2nd generation model with most of the features and sound of the DTC-1000ES	Mid-width, alpha-numeric display, remote, optical interfaces	R	63
Sony DTC-1000ES £1299	Very Good Very Good	Fine, consistent performer with accomplished tape handling and good build quality	Standard track D and search, remote	R	63

## CD PLAYERS

This all-digital music source is well established, despite still high disc prices and the opposition of many hi-fi enthusiasts. Compact Disc's strengths over conventional vinyl are complete freedom from surface noise with automatic and programmable play, plus track skip and fast music scan – frequently under full remote control. However, many vinyl enthusiasts find CDs sound less involving than

top quality vinyl replay

Introduced five years ago at around £500, CD players now average less than half that price, and for the main offer improved performance besides. Even cheaper players may have the latest decoding chips and the most useful play features; extra money can buy remote control, remote volume control, audio 'tweaks', plus improved build and component

quality control.

Compared with many hi-fi components, CD players give impressive lab performance, though there are differences between players, nonetheless. Sound quality variations are even more marked, particularly in a good quality system. As it behaves very like a preamp, there are no problems connecting a player to a normal amplifier.

MODEL PRICE	LAB SOUND	COMMENTS	FEATURES	VALUE	BACK ISSUE FULL REVIEW
Acoustic Research CD-D4 £290	Good Fair	Stylish but basic player, based on Philips 14-bit 4 x oversampling with respectable sound and remote control	Remote Control, headphones		51
ADC CD-250X £230	Good+ Fair	Well made and engineered, and average soundwise; trumpets could sound 'thin' though violins were liked so it may prefer Stephan Grappelli to Miles Davis	Skip and search, manual, repeat and 16-track programming		58
ADC CD 2000E £330	Good+ Fair+	One of the slimmest players in the business but nothing special inside. Nice ergonomics but overpriced	Remote, timeshared 16 bit		64
Aiwa DX-M45 £149	Fair Fair	Cutdown Philips technology, but results are quite good for this British made machine	Manual	R	64
Aiwa CD-001 £300	Good Good	Pretty close to Recommendation, delivering a respectable sound quality and lab performance from an ergonomically attractive package, but ultimately failed to excel in any particular respect	Track entry/volume remote, direct recorder connection etc		58

## THE DIRECTORY

## CD PLAYERS

MODEL PRICE	LAB SOUND	COMMENTS	FEATURES	VALUE	BACK ISSUE FULL REVIEW
<b>Aiwa XC-007</b> £499	Very Good Good	Creditable sound despite inverted output, high tech engineering with very good lab performance. A worthy contender but not cheap	Remote, keypad, timer, digital output, pseudo 20 bit, dual DAC		64
<b>Akai CD-52</b> £249	Good Good	A nice surprise from Akai, genuinely good sound from this mid-priced model. Better linearity will help further	Remote, digital output, headphone socket	BB	64
<b>Akai CD-73</b> £450	Good Average	A little uneven musically, the Akai tends to smother fine detail, but has first class dynamics and stereo imagery. Worth auditioning	Track entry keypad remote, menu display (switchable)		62
<b>Akai CD93</b> £700	Good Very Good	Undoubtedly a CD player of real class in build, presentation, lab performance and sound quality, but also a shade expensive for formal Recommendation – though that's not to dissuade lovers of black lacquer wood finish	Track entry remote, menu display etc		58
<b>Arcom Delta Black Box</b> £249	n/a Very Good	This rich, powerful and articulate sounding DAC transforms the majority of medium price CD players	Needs D-out CD players	R	60
<b>Arcom Delta 70</b> £500	Good Very Good	This solidly built British player has attractively understated presentation with straightforward, simple ergonomics. The very good sound quality shows a steady improvement over earlier samples	Simple remote, headphone socket etc.	R	58
<b>Cambridge Audio CD2</b> £650	Fair Very Good	The finest midrange in digital audio is sufficient grounds for Recommendation, though there remains a tinge of disappointment that the CD2 didn't get closer to big brother elsewhere, notably in the bass	16x oversampling, remote control	R	58
<b>dbx DX5</b> £640	Good Poor	Sound quality proved a single disappointment, though it's refreshingly unique in providing semi-pro post-production facilities that some users will undoubtedly relish	Track entry/volume remote, compression, impact recovery, ambience etc.		58
<b>Denon DCD 610</b> £200	Good+ Fair+	Lots of Denon player for the money, well equipped with good all round performance	Remote, versatile programming 2x 0/S	BB	64
<b>Denon DCD 810</b> £250	Very Good Fair+	A good value allrounder bettered on sheet value by the 610 and 910, power volume could sound better	Remote, 4x oversampling, programming	R	64
<b>Denon DCD 910</b> £300	Very Good Fair+	A well equipped deck of impressive appearance and solid sonic and lab performance	Remote volume, programming, 8x 0/S digital output	BB	64
<b>Denon DCD-1500II</b> £500	Very Good Very Good	The extra build quality over cheaper Denons is justified in terms of sound quality and lab performance, while the feature list is comprehensive and quite nicely presented	Track entry/volume remote, menu display etc.	R	60
<b>Denon DCD 1700</b> £650	Good+ Very Good	The overall sound was strong and coherent approaching reference standards. Fine build quality and facilities make this a firm contender	Remote, skip, scan, headphone socket, programmable	R	58
<b>Denon DCD-3300</b> £1200	Good++ Very Good	Sounding tight and coherent though not significantly better than the cheaper 1700. Very well built and comprehensively equipped	Remote control, with volume, keypad programme, scan, search, headphone		51
<b>Dual CD 1030 RC</b> £170	Fair Fair	An up and down performance on test but it is hard to deny the overall value for a machine that includes remote control at this price	Remote, headphone socket, 2x 0/S, timeshared 16 bit	R	64
<b>Ferguson CD007</b> £130	Good Fair	The cheapest recommendation in the test group, don't expect the earth but the value is good	Manual, digital output, headphone socket	R	64
<b>Ferguson CD008</b> £150	Fair Fair	Not as strong as its relatives, sample fault perhaps? Though performance is fair enough overall	Remote, midi digital output, 2x 0/S, timeshare 16 bit		64
<b>Goodmans GCD550</b> £199	Average+ Fair+	A slow autochanger with a weakish lab performance but the sound is fair enough, the features good and the price is low	Remote, 6 disc autochanger, 2x 0/S	BB	64
<b>Hitachi DA-7000</b> £150	Good Fair	Generally competent, especially considering the price, this was well built and styled if lacking in some facilities – a good budget starter	Memory and repeat, plus the basics		58
<b>JVC XL-Z444</b> £255	Good Fair+	An average performer, unremarkable though well equipped and fair value for money	Full feature remote, digital output, headphone socket		64
<b>Kenwood DP-660SG</b> £180	Below Average Below Average	Build quality and ergonomics are good, and the range of features far exceeds the price norm. However, sound quality is messy with a soft bass, recessed mid and sometimes spiky top.	Remote control, calendar/menu display, keypad, 20 track memory		62
<b>Kenwood DP-880SG</b> £250	Very good+ Fair+	A fine CD transport for the price, fine sound, very good lab results, good for a decoder?	Remote volume, programming, headphone socket	BB	64
<b>Kenwood DP-990SG</b> £400	Very Good Good	Falling just short of the required subjective standard for Recommendation at this price level, this is a doughty player nonetheless, with a build quality and technical performance that arguably justifies its premium price.	Track entry remote, menu display, sprung feet etc.		58
<b>Kenwood DP-1100SG</b> £450	Very Good Good	Something of a high tech flagship, this model doesn't quite make the grade on sonic grounds but is well built	Full remote, optical and coax digital outputs, headphones		64
<b>Kinergetics KCD-30</b> £1700	Very Good Very Good	Definitely a technical oddball with its distortion-cancelling circuits, the pricey KCD-30 nevertheless does sound very good, and also noticeably 'different' – not necessarily to our collective tastes, but possibly to your's	Favourite track selection, remote, high output (vol. bal)		60
<b>Luxman D-90</b> £300	Fair Good	Despite technical ingredients that do not seem particularly inspiring, this is a nicely judged package that is ergonomically neater than most, with decent sound quality for the price and distinctive finish and presentation	Track entry remote, programming etc.	R	58
<b>Marantz CD65IISE</b> £300	Very Good Very Good	Scorching sound quality from a competitively priced player, which is the new middle market reference	Remote, programming, digital output	BB	64
<b>Marantz CD94</b> £800	Good++ Very Good	Clearly the best Marantz CD player, with high build quality and good objective and subjective performance	10 digit keypad, headphone socket, favourite track selection, remote	R	58
<b>Marantz CD94/CDA94</b> £1600	Very Good Excellent	Taking its logical place at the top of the Marantz CD hierarchy, this two-box combination delivers reference standard lab and listening test results, albeit at a price which seems a little steep. Very refined	Favourite track selection, remote, balanced output etc	R	60
<b>Meridian 207</b> £950(+)	Very Good Excellent	Not only arguably the prettiest model around, but also one of the best sounding and most versatile – on-board preamp now accepts vinyl disc for an extra £100, and Meridian plans round-the-house future-readiness	On-board preamp, remote (inc volume)	R	64
<b>Mission PCM2</b> £500	Good+ Good	A matured design with good features it is the best sounding power volume player available, it even tests well. It accepts the £200 PSX power supply option	Remote volume, display and phase invert	R	64
<b>NAD 5220</b> £230	Average- Poor	Conforms sonically to a stereotype of the medium that most players have grown out of. Hard, thin and raw sound with poor stereo and resolution.	Time/track display, memory		62
<b>Nakamichi OMS-1E</b> £395	Good Good	This neat enough player doesn't really follow the Nakamichi tradition of providing exceptional sound quality while at the same time perpetuates that of selling at an above average price	Simple remote etc.		58
<b>Nakamichi OMS-3E</b> £995	Good Good	Superbly built and presented this expensive machine was a bit of a "stuffed shirt" when it came to sound quality	Remote control, skip and scan, headphone socket		51
<b>Nakamichi OMS-4E</b> £1200	Very Good Very Good	Solidly controlled and comparatively simple this clearly represents one of the major benchmarks for CD sound quality, though the midrange sounded a touch thin	Skip and scan, headphone socket		51
<b>Nakamichi OMS-5EII</b> £1500	Good+ Very Good	"... delivers near state of the art performance and build quality in a deliberately starkly functional package, but at a very high price"	Skip and scan, simple track programming, manual control		51
<b>Nakamichi OMS-7EII</b> £2000	Good+ Good	The only serious criticism here is of the price. And in our not always humble opinion you can get better sound quality for less elsewhere in Nakamichi's range	10 digit track entry keypad programming, headphones		51

THE WORLD'S NO 1 GUIDE TO BUYING HI-FI

# THE DIRECTORY

## CD PLAYERS

NAME PRICE	LAB SOUND	COMMENTS	FEATURES	VALUE	BACK ISSUE FULL REVIEW
Onkyo DX-1500 £170	Average Fair	Ruled out on the grounds of its poor DAC filter, but it's not so bad really given the price	Manual, 2x 0/S, timeshared 16 bit		64
Philips CD473 £229	Good Good	In the forefront as regards sound quality, this is one of the best sounding Philips players yet; we were unable to catch it out on classical through jazz program	Favourite track selection, remote control with volume, headphones etc	BB	58
Philips CD880 £500	Very Good Very Good	The '880 is an impressive blend of luxury build quality and features at a far from extravagant price, and also delivers the subjective goods.	Volume remote, FTS, menu display etc	R	60
Pioneer PD-6100 £249	Good Good	A budget audiophile player; fine sound even if its lab performance seems a little uneven	Full feature remote, digital output, variable hdph	BB	64
Pioneer PD-M500 £269	Good Good	A high performance autochanger for the money, good value all round and generously featured specification	Full remote, digital output, variable hdph	BB	64
Pioneer PD-M700 £400	Very Good Fair+	Top class autochanger, surprisingly fast, high specification and a good allrounder	Remote, optical digital output, headphone socket		64
Pioneer PD-91 £800	Excellent Excellent	Close to state of the art in nearly all areas - soundstaging, clarity and simple lack of artificiality. A well made and sophisticated player	Track entry remote, calendar display, index search, etc.	R	64
Revox B226 £658	Good+ Good	The traditional Revox house style is combined with the fine Philips 16 bit chip set, but this player doesn't really offer sound quality to match the price	Infra-red remote control, full search, scan, programming		51/Coil
Rotel RCD820B £210	Good+ Fair+	A budget Philips based player of dependable sound quality and offering very good value. Build is a touch lightweight	Remote, basic facilities	BB	64
Rotel RCD820BX2 £250	Good Very Good	Start with a good base and then make it sound better, the '820BX2 CD player maintains the reputation established by its namesakes, and comfortably deserves Recommendation	Direct track entry remote etc.	R	58
SAE D102 £700	Good Good	Considering the high price of this player, most of the innards seem fairly prosaic. Sound quality and lab performance are both respectable enough, but hardly justify the price premium involved, though styling is unusual.	Remote (inc volume), skip, scan etc.		58
Sansui CD-X501i £300	Fair Fair	Weak dynamic range for an upmarket player which shows in both lab and listening tests	Remote, programmable, digital output, headphones		64
Sharp DX-620 £199	Good Good	A surprising achievement but it shows what can be done. Another high value budget package	Remote, headphone output, 2x 0/S, timeshare 16 bit	BB	64
Sharp DX-R700H £225	Average - Poor	A workmanlike player that does not offer exemplary lab or sound quality but which is well-built with good facilities and should perform well in use	Remote control, track selection keypad, skip, scan repeat programming		53
Shure Ultra D6000 £495	Average+ Fair	Ergonomically well thought out with full function remote control, but not really scoring sonically considering its price	Remote control (full function inc volume)		51
Sonographe SD1 (by CJ) £799	Good Very Good	Distinctive with oak end-cheeks, using Philips based 14 bit x 4 oversampling, Conrad Johnson electronics make this a musically rewarding player	Full search programme and timing	R	51/Coil
Sony CDP-M35 £170	Fair Fair	There is no disguising the lightweight plastic construction of this player, but the technical performance, sound quality, aesthetics and ergonomics all deliver more than one has the right to expect for £170.	Skip, scan, programming etc.	R	58
Sony CDP-M55 £190	Fair Fair	£20 buys a remote control handset to operate your M35. Sony call it an M55 (see CDP-M35 review).	Simple remote, skip, scan, programming etc.	R	58
Sony CDP-550 £200	Good+ Fair+	Another dependable Sony, it doesn't have a digital output but at the price who's complaining? Fit and forget	Full remote/headphone output, 4x 0/S	BB	64
Sony CDP-M75 £230	Good Good	This midi version of the '750 saves £20 on the price (see CDP-750 review)	Track entry remote, menu display ect	BB	58
Sony CDP-750 £250	Good Good	A seductive blend of fine presentation and solid performance, all at a very realistic price that should ensure its success.	Track entry remote, menu display etc.	BB	58
Sony CDP-M95 £280	Very Good Fair+	Very well equipped mid sized player fine build and finish, incorporating Sony's custom file disc labelling	Remote, programmable, variable hdph output	R	64
Sony CDP-337ESD £550	Good V Good+	Well built, high grade player with excellent if undemonstrative sound. Excellent resolution, dynamics and bass weight, though arguably not control	Random access remote, calendar display, FTS, memory	R	61
Sony 557ESD £1000	Excellent Good+	Superbly built flagship model that produced excellent lab results and very good sound. Many luxury features though not that good value	Full remote, disc directory, digital output, power volume, 8x 0/S, 18 bit		64
Teac PD135 £180	Fair Fair	Particularly easy to use, this lags a little behind the pack when it comes to sound quality, but it still represents a valid alternative for those who find the presentation attractive.	Skip, scan, programming, repeat		58
Technics SL-P350 £250	Very Good+ Good	Nicely built, good features and fine sound, what more do you want for £250?	Remote, digital output, variable hdph output	BB	64
Technics SL-P770 £350	Excellent Good	Sophisticated, high resolution player, but inconsistent with level with some coarseness and compression during loud passages	Remote, 18 bit, rotary cue wheel, comprehensive display	R	61
Technics SL-P990 £450	Excellent Good	An obvious technical tour de force, with ample engineering and build quality to justify the price, but some subjective reservations nonetheless.	Track entry remote, menu display, search dial etc.		58
Technics SL-P1200 £800	Good+ + Good	Looking more like a desk workstation than a stackable component, this will appeal to the creative recordist and semi user. Sounded pretty good	Headphones, remote control, search dial cueing, etc		51
Toshiba XR-9318 £150	Good Fair+	A basic Philips based player perhaps but just look at the price/performance equation	Remote via system, manual, non oversampled, 16 bit	BB	64
Toshiba XR-9128 £200	Very Good Good	A well equipped Philips clone with a very good performance for the price	Remote, programmable, digital output, hdph	BB	64

## CD MIDI SYSTEMS

So you want a hi-fi, but you don't want to make a fuss about it. A pre-packaged system with everything matching up and no aggravation may not rank with carefully chosen separates on sound quality, but there's no denying the attractiveness or popularity of this approach - the market for pre-packaged component hi-fi systems is at least as big as that for separate items, even ignoring the vast numbers of low-cost single unit stacker systems.

The arrival of compact disc led to a new fashion for shelf-standing compact systems, or 'midis' as

they are known in the trade, as a replacement for earlier floor-standing rack systems (themselves the upmarket development from music centres). Only some 330mm wide, midis can more or less match full-size (430mm) rack components for performance, and are certainly cheaper to make, ship, sell and buy.

Whereas specialist hi-fi is moving steadily towards ultra-simple 'no frills' components, midi systems tend to be sold on a feature count at a price point, usually with little opportunity for

demonstration and comparison. Our test programme includes extensive auditioning and lab testing, while making allowance for the different aspirations of designers and expectations of users. Key features valued highly by customers include system remote control, automatic switching, double 'dubbing' cassette decks, and elaborate equaliser tone controls. And the top end of the market is developing with surround sound audio/video-ready packages.

NAME PRICE	LAB SOUND	COMMENTS	FEATURES	VALUE	BACK ISSUE FULL REVIEW
Aiwa X-55 £380	Average Average-	The turntable was slightly better than usual, the cassette deck highly limited, but the dreadful loudspeakers are the clincher	Combined cassette tuner-timer/amp, dedicated I/T speakers, & optional CD		65
Aiwa X-78 £550	Average+ Good	Good. The loudspeakers are disappointing and the turntable is excessively microphonic, but the rest of the system works well.	Auto reverse cassette/tuner/amp & timer, I/T and CD	R	65

## THE DIRECTORY

## CD MIDI SYSTEMS

NAME PRICE	LAB SOUND	COMMENTS	FEATURES	VALUE	BACK ISSUE FULL REVIEW
<b>Aiwa V1500DX</b> £999	Good Good	Remarkable features level even includes independent record feeds to each cassette. High class build, satisfying sound, but best without loudspeakers	Separates system, twin auto-reverse cassette, full remote, timer	R	54
<b>Akai M.50CD</b> £550	Poor Poor	Cassette lacks Type II compatibility, general sonics mediocre or less	Devolved from M.80 but simplified, part remote		65
<b>Akai M.80CD</b> £800	Good Good	Good all rounder with minor ergonomic shortcomings but generally practical layout	Separates based, twin auto-reverse cassette	R	65
<b>Goodmans 5300CDM</b> £400	Average— Average+	Crisply styled system with gutsy amplifier and sophisticated speakers. CD player works well, other sources are variously mediocre	Combined cassette/tuner/amp, plus T/T and CD with remote	R	65
<b>Goodmans Maxim-Midi System</b> £520	Average Average+	De-luxe version of 5200 system — very good value for money and readily upgradeable. Sonics rough but OK and speakers good; CD crude	All separates with twin cassette	R	54
<b>JVC Midi-W900CD</b> £1000	Good Good+	A competent allrounder, with important convenience related features, and powerful linked recording facilities. Less strident speakers would be appreciated	Separates system, equaliser, auto-reverse cassette	R	65
<b>Marantz MX583</b> £750	Below Average Poor	The system has potential in an A/V context, but is patently lacking in a purely audio one. Only the CD excels	Component system with A/V amp, no speakers		65
<b>Marantz MX673CD System</b> £900	Average+ Average	Tremendously flexible audio/visual system. Sound quality is satisfactory at best and ergonomics a mess	Various A/V inputs, remote, speakers optional		54
<b>Philips F777</b> £850	Good Good	Excellent CD player, tuner and amplifier, offset partly by poor cassette deck and turntable	Separates system, optional remote, no speakers		65
<b>Pioneer System 300</b> £1000	Very Good Very Good	Sharp, articulate and powerful system that works. The turntable is a weakness as usual, but the only real weakness in an uncommonly sophisticated package.	Remote separates system, optional multi-disc CD	R	65
<b>Proton AI-3000</b> £550	Good Good	There are a host of minor problems, including no LW, but the unit is attractively packaged and can be made to sound very good despite a woolly sounding amplifier	One piece CD, cassette, tuner and amp, remote	R	65
<b>Sanyo System 22</b> £350	Average Average+	Some careful detail design has given this system sound quality out of keeping with ordinary appearance. More than the sum of its parts	Single piece, plus speakers	BB	65
<b>Sanyo W40CD</b> £380	Average Average	Low cost, no options package with attractive displays, cassette had high wow and flutter, but the rest worked OK	Semi auto T/T, auto record start, twin cassette	R	54
<b>Sanyo System 33</b> £400	Average Average+	Similar to the 22, and better when extended, but the price (and value) advantage is dissipated.	As 22, separate T/T, remote	R	65
<b>Sharp SA-CD800H</b> £700	Average Average—	A superficially high grade, high spec system, the SA-CD800H actually sounds clean but a little 'synthetic'	One-piece, 6-disc CD, no T/T		54
<b>Sony Compact 350CD</b> £480	Average— Average—	Visually stunning appearance hides very basic audio attributes, the turntable and cassette deck suffering severe pitch related shortcomings. CD is too expensive in this company.	Integrated one piece, (ex CD), 5 disc non-cartridge player		65
<b>Sony Compact 500CD</b> £550	Average+ Average+	Impressive visuals are matched to electronics which in audio terms lack inspiration. The speakers are particularly poor	Combined amp/cassette, 36 preset tuner, T/T component CD		65
<b>Sony Compact 700CD</b> £700	Average+ Good	Loudspeakers and (to a lesser extent) turntable spoil a fine sounding and stylish — if rather costly — package	Separates system, auto reverse cassette, 36 preset tuner		65
<b>Sony Series 1000CD</b> £1500	Very Good Excellent	Very sharp, articulate sounding system from CD and FM. Cassette deck good and flexible, turntable as usual is not in keeping	Separates system, twin auto-reverse cassette, amp with DAC	R	65
<b>Technics X900CD</b> £470	Average Average—	Good build and mostly good sound is offset by mediocre amplifier and loudspeaker and some operational oddities	Main cassette/tuner/amp, separate T/T and CD		65
<b>Technics X950 System</b> £850	Good Good	Fine sound from CD, FM and AM radio and cassette. The record deck is a little better than normal too, but the loudspeakers are disappointing	Component based, CD, twin auto-reverse cassette, tuner, auto T/T, amp and speakers	R	65
<b>Technics X990D System</b> £1250	Good Very Good	Powerful, flexible and well built system — loudspeakers apart. Even the turntable is on the rough side and the loudspeakers should be changed if possible. The rest of the system is A1	Twin deck, programmable T/T, amp, CD, speakers	R	65
<b>Toshiba V17CD</b> £370	Average Average+	Loudspeakers are the weak link, with cassette and turntable also indifferent. Tuner and CD worked well though, so reasonable value for money	Twin cassette, semi-auto T/T	R	54
<b>Toshiba V18CD</b> £400	Poor Poor	Neat and simple to use basic system with good CD but poor elsewhere and abysmal loudspeakers	Integrated amp/cassette deck, other components separate but dedicated		65

## TUNERS

The radio medium operates at a much lower profile than TV, but in areas outside pop music the BBC service is the envy of the world. Live Prom concerts can rival all other sources from a hi-fi perspective. Only the FM (VHF) bands give stereo hi-fi sound, though AM (MW & LW) are useful for receiving certain transmissions in the UK.

Something of a hi-fi afterthought, tuners are often selected merely to match a chosen amplifier

cosmetically. However, the task they carry out is far from simple (or cheap), combining the skills of RF (reception) and audio (signal processing) engineering. The importance of the former will depend on local reception conditions, but money invested in a high quality outside aerial system is well spent.

Tuners come in two basic types. Analogue models tune gradually (and usually manually) across

the bands, and can have analogue or digital displays; they are often preferred for sound quality, and are certainly best for AM bands. Digital tuners offer convenient automatic tune facilities and hold many station positions in pre-set memories.

(The Lab and Sound results for models tested in issue No. 65 refer to FM only. For AM results see under Comments.)

NAME PRICE	LAB SOUND	COMMENTS	FEATURES	VALUE	BACK ISSUE FULL REVIEW
<b>Akai AT-52L</b> £150	Very Good Very Good	Holds its own on FM against many much more expensive tuners, but AM is very poor	All bands	BB	65
<b>Akai AT-93L</b> £250	Good+ Good+	By AM standards presentable (good) while FM delivers the goods	All bands, aerial switch	R	65
<b>A&amp;R Arcam Alpha</b> £149	Good Average+ +	Attractively classic British analogue tuner with sound quality comfortably better than most	FM/AM Analogue	BB*	50
<b>A&amp;R Arcam Delta</b> £270	Very Good Very Good	Hi-fi sound on FM, good on AM, a dependable British all-rounder	6AM, 6FM presets FM/MW LW display manual tune	BB	55
<b>Denon TU 450L</b> £130	Average+ Average+	Poor AM sound quality may be a deterrent but the FM performance fully merits recommendation	FM/AM Digital MW/LW	R	50
<b>Harman Kardon TU920</b> £299	Good Average	Rather weak sound quality for the price despite good lab test results	16 presets, AM/FM, digital auto scan, active tracking		55
<b>Harman Kardon Citation 23</b> £559	Good Very Good	Fine performance, interesting features and ease of use are this tuner's forte, and the sound quality is top notch	FM/AM seek/manual adjustment muting 16 presets remote control	R	60
<b>Hitachi FT-MD 5500</b> £200	Excellent Good+ +	A powerful, good sounding tuner with versatile facilities	16 presets, FM, AM, MW auto scan digital, signal meter	BB	55
<b>Hitachi FT5500 II</b> £200	Very Good Good+	Soundwise highly rated on FM, and on AM basically satisfactory — a versatile all-rounder	Auto and manual tuning, 16 presets	R	44

## THE WORLD'S NO 1 GUIDE TO BUYING HI-FI



# THE DIRECTORY

## TUNERS

NAME PRICE	LAB SOUND	COMMENTS	FEATURES	VALUE	BACK ISSUE FULL REVIEW
Kenwood KT-66DL £130	Fairly Good Fairly Good	You get your money's worth of gadgets and the radio's basically sound although programming is complicated. AM – fairly good	Timer, clock, all bands	R	65
Kenwood KT-1100D £300	Good+ Good+	Behind a gaudy and rather useless display the radio is much better than you might first think. AM – good	Firework display, FM/MW bands only	R	65
Marantz ST35L £125	Good+ Average–	It works well enough but the sound could be better for the money	16 presets, AM/FM, digital auto scan, active tracking		55
Meridian 204 £525	Good+ Good	Pleasant sounding with a fine finish but does not make the grade at this price	FM only, auto scan, digital, remote, clock timer		55
Musical Fidelity T1 £300	Good+ Very Good	Top class FM stereo sound on good signal strengths from this audiophile model. Watch out for local CB!	FM only, analogue box dial, manual tune, signal meter	R	55
NAD 4020B £139	Good Average+	Not the quietest or most sensitive tuner tested, it still provided good sound for the money, being "musical and ambient"	Analogue FM/AM	BB	50
Naim NAT 01 £1098	Very Good Very Good	There may be better sounding tuners in the world, but we have yet to hear one	No presets. Two box, flywheel tuning. FM only, Analogue	R	50
Nakamichi ST-7E £750	Good+ + Good+	Exceptionally good for weak-signal areas, and good all round	16 AM/FM presets, Schotz enhanced sensitivity, auto time digital		55
Pioneer F551L £100	Good+ Good+	High value budget tuner, very little to argue about (includes long wave)	12 FM, 12 AM presets, auto scan, digital and signal strength meter	BB	55
Pioneer FT 443L £130	Poor Poor	The pretentious 'computer controlled' features don't amount to much. AM – very poor	All bands		65
Pioneer F-737 £230	Good+ Good+	Terrific separation and selectivity on FM, but AM still lacking. AM – fair	FM/MW only	R	65
Pioneer F91 £350	Excellent Good+ +	Easy to use, this model has excellent RF performance and scored very high ratings on the listening tests	FM/AM 24 presets	R	60
Proton AT-300 £199	Good Good	The AT-300 is pretty on the outside, orthodox on the inside and rather dear. AM – poor	FM/MW only	R	65
Quad FM4 £289	Very Good Good+	Fine sound, excellent ease of use, good build and finish and a more than satisfactory technical performance	7 presets, Digital	R	50
Revox B260 £918	Excellent Very Good	Sophisticated and expensive, the B260 is ideally suited to the rest of the Revox range and should also work well in other systems	FM – virtually everything	R	60
Rotel RT-830AL £110	Good+ Good	Fine sounding budget audiophile material, no frills, no fuss	Manual dial analogue, FM, MW, LW	BB	55
Rotel RT-850AL £160	Good+ Good+	Scoring well on listening tests and one of the best sounding tuners at its price level, it was a bit let down on AM but RF performance was good	FM/AM, digital	BB	50
SAE T-102 £449	Good+ Good+	Expensive for all the radio you get, but sounds interesting. AM – Poor	FM/MW only	R	65
Sansui TU-D99XL £249	Very Good Good+	This slimline compact model gave good FM sound quality and strong RF performance. But the AM sounded unpleasant	FM/AM, 16 presets	R	50
Sony ST-S300L/ ST-S100L £140/£100	Good Good	A reasonable entry point, not for difficult areas. AM – Poor	All bands	R	65
Sony ST 500ES £200	Good+ + Average–	Disappointing sound quality but good lab performance. (Includes long wave)	10 AM/FM presets, auto scan digital		55
Sony ST-S 700ES £299	Very Good Very Good	First class in every respect including FM sound quality. Even AM was well above average	FM/AM, 10 presets, digital scan	BB	60
Yamaha TX-L400 £130	Good+ + Good+	Good FM sound, let down by poor AM but otherwise good value	16 presets, auto scan, digital, FM, MW, LW	BB	55
Yamaha TX-500 £150	Average+ Average	Under a gaudy coat, this sensitive tuner gave reasonable stereo results. However, the AM had again been thrown down a well	20 presets (10 buttons) digital		50

## HEADPHONES

There are a variety of different approaches to headphone design, and examples of each turn up in this group. Amongst the more expensive esoteric models, electrostatic drivers are used in square open-backed phones such as the Jeklin and Stax models. The majority of these come with some form of transformer which takes the signal initially from the speaker terminals on the amplifier. The actual speaker cables then travel from this unit via a

bypass switch to the loudspeakers.

The more down to earth models feature dynamic drivers in circular open-backed designs. The advantage of open backs seems to be a correspondingly open sound and a less claustrophobic feel to the music. One can also of course hear external noises and irritate people on public transport.

The third category are closed-back designs,

which are useful in situations where it is necessary to block out background noise.

Another means of distinguishing different types is the way they sit on your head or ears. There are three styles: circumaural models enclose the ear and rest on the side of the head; supra-aural designs press on the outer ear (pinna); and intra-aural types rest inside the ear and are popular amongst users of personal stereos.

NAME PRICE	SOUND COMFORT	COMMENTS	TYPE	VALUE	BACK ISSUE FULL REVIEW
Aiwa HP-X8 £49	Good Very Good	Very slick Walkman oriented phones which are tonally well balanced and go loud without becoming painful	Supra-aural, closed-back, dynamic	R	63
Aiwa HPEX-200 £90	Good Good	Modern looking and well finished the Excellas, as they are dubbed, had meaty bass and sounded reasonably open for the type	Circumaural, closed-back, dynamic		63
AKG K135 £35	Fair Poor	Despite a very appealing design the K135s don't live up to the usual AKG standards, though they do have the ability to reproduce rhythm well	Supra-aural, semi-open, dynamic		63
AKG K240 Monitor £60	Good Very Good	Something of a classic these AKGs are very user friendly in all respects; sonically on the warm side of neutral	Circumaural, semi-open, dynamic	R	63
AKG K280 Parabolic £110	Very Good Good	A very revealing and unusual twin driver design that uses the same principle as a satellite dish to beam sound into the ear	Circumaural, open-backed, dynamic	R	63
Audio Technica ATH 909 £55	Average Average	Quite impressive in the treble though a bit bass shy, the 909s worked well at highish levels	Circumaural, semi-open, dynamic		55
Audio Technica ATH 910 £65	Good Average	The closed-back 910s are an improvement on the 909s with a nice rhythmic quality rarely found with headphones	Circumaural, closed-back, dynamic	R	55
Audio Technica ATH-911 £75	Very Good Very Good	Nicely finished dynamic headphones with all the trimmings, plus a very clean and subtle sound	Circumaural, open-backed, dynamic	R	63
Beyer DT 325 £30	Fair Very Good	Lightweight in more ways than one, the 325s may be a little bright for some systems and tastes but will suit duller sources	Supra-aural, open-back, dynamic	R	63
Beyer DT330 Mk II £45	Poor Good	Not the most revealing 'phones encountered, the 330s were nevertheless enjoyable and rarely offended	Circumaural, semi-open, dynamic		55
Beyer DT550 £69	Good Good	On their own the 550s sound articulate with a slightly 'gritty' treble and 'keen' midrange; not suitable for headbangers!	Circumaural, semi-open, dynamic		55

# THE DIRECTORY

## HEADPHONES

NAME PRICE	SOUND COMFORT	COMMENTS	TYPE	VALUE	BACK ISSUE FULL REVIEW
<b>Beyer DT880</b> £90	Good Good	Well made cans with a warmish sound but fairly solid midrange, though they're not that informative for the price	Circumaural, semi-open, dynamic		63
<b>Beyer DT990</b> £119	Very Good Very Good	The 990s are definitely a significant pair of dynamic headphones; they have a smooth and yet revealing, neutral sound that is hard to criticise	Circumaural, open-back, dynamic	R	55
<b>Jecklin Float Model One</b> £79	Very Good Good	Whilst very unusual in appearance the Floats give remarkable sound quality and openness at a reasonable price	Circumaural-ish, open-back, dynamic	BB	55
<b>Jecklin Float Model Two</b> £99	Very Good Good	Helmet shaped and pretty unflattering but open sounding and comfortable in the long term. Note lack of adjustment means should be before	Circumaural-ish, open-backed, dynamic	R	63
<b>Jecklin Float Electrostatic</b> £399	Excellent Good	One version of the state-of-the-art, these electrostatics have an openness of sound rarely found in the breed, with good dynamic range to boot	Circumaural-ish, open-back, electrostatic	R	55
<b>Koss K/6X Plus</b> £30	Poor Fair	'Sixties-style' phones from the good ole US of A, their sonic style is unique and can make a system sound quite different	Supra-aural, closed-backed, dynamic		63
<b>Quart Phone 30</b> £40	Fair Good	Whilst not as seductive as their PMB25 predecessor the 30s are reasonably neutral and do improve on some of the competition – though not stunning	Circumaural, semi-open, dynamic		63
<b>Quart PMB 25II</b> £40	Good Good	Despite a somewhat unconventional suspension system the 25s put in a convincing and enjoyable performance with warm yet lively balance	Circumaural, open-back, dynamic	BB	55
<b>Quart Phone 70</b> £70	Good Good	Competent performers that were hard to criticise but lacked the life and sparkle of which some of the competition are capable	Circumaural, closed-back, dynamic		63
<b>Quart PMB 65</b> £70	Good Good	Quite revealing and neutral albeit with the usual closed back sound, this competes well with more established models	Circumaural, closed-back, dynamic	R	55
<b>Quart PMB 85</b> £90	Very Good Fair	These more expensive Quarts bear a striking resemblance to the Jecklin Float models and use two drivers – ear. Sound is a bit bass heavy but not bad overall	Circumaural, open-backed, dynamic		63
<b>Ross RE-2760</b> £35	Fair Poor	Stylish white cans from the only British firm in the business. Unfortunately sound quality is not to match this price range	Supra-aural, closed-back, dynamic		63
<b>Sennheiser HD30</b> £13.50	Poor Good	Built specifically for the personal stereo market these small and light Sennheisers have a slightly synthetic sound, but are an upgrade on the average Walkphones	Supra-aural, semi-open back, dynamic		55
<b>Sennheiser HD450</b> £27	Fair Good	Modern, simple and lightweight phones that are remarkably robust and which turned in a relaxed if weighty performance that was at worst pleasant	Supra-aural, semi-open, dynamic	R	63
<b>Sennheiser HD480</b> £37	Fair Good	Using the same shell as the 450s, the 480s were a little softened and unrevealing by comparison with their competitors	Supra-aural, semi-open, dynamic		63
<b>Sennheiser HD420SL</b> £47	Good Good	The 420s gave a full and tangible quality to instruments and voices; whilst not the most revealing headphones around they would suit slightly trash sources	Supra-aural, open-back, dynamic		55
<b>Sennheiser HD540 Ref Gold</b> £160	Very Good Good	The 540 Golds prove that dynamic headphones can be subtle, informative and capable of creating a remarkable sense of space	Circumaural, open-back, dynamic	R	55
<b>Sony MDR V3</b> £30	Good Fair	Portable stereo oriented phones that are very nicely made and combine clarity with a pleasant lack of distortion	Supra-aural, closed-back, dynamic	BB	63
<b>Sony MDR V6</b> £70	Good Very Good	A lot more civilised and dynamic than the V4s, these were pretty good for their type and fold up to boot	Circumaural, closed-back, dynamic	R	55
<b>Sony MDR V7</b> £70	Very Good Very Good	Classy sounding cans that are very slick and work well with all types of music, setting the standard in their price range	Circumaural, closed-back, dynamic	R	63
<b>Stax SR34</b> £140	Very Good Fair	The least expensive Stax headphones around, the SR34s are lively and rhythmic with good tight bass and a sweet midrange	Supra-aural, open-back, electret		55
<b>Stax SR84</b> £210	Very Good Very Good	The stepping stone between dynamics and full electrostatics, these electret phones are revealing, open and highly enjoyable	Supra-aural, open-backed, electret	R	63
<b>Stax Gamma pro/SRD-X pro</b> £296/£230	Excellent Very Good	The Gamma pros are like a stethoscope for your hi-fi, revealing subtleties that many loudspeakers fail to resolve	Circumaural, open-backed, electrostatic	R	63
<b>Stax SR Gamma</b> £299 (inc. SRD-6 Adaptor at £100)	Very Good Very Good	The next model down the Stax range from the Lambda, the Gamma is an excellent headphone with little to criticise but the price	Circumaural, open-back, electrostatic	R	55
<b>Stax SR Lambda Pro</b> £545 (inc. SRD-7SB Mk 2 Adaptor at £185)	Excellent Very Good	A bit of an industry reference the Pros are frighteningly revealing, bringing across more information than loudspeakers costing twice as much	Circumaural, open-back, electrostatic	R	55

## PERSONAL STEREO

Whilst not exactly hi-fi components, personal stereos probably play more music to more ears than all manner of domestic systems and as such demand some attention. Now that personal CD players have joined the ubiquitous Walkman in the market, the variety and standard of sound quality is huge, with obscurely named cassette players practically falling out of your cornflakes packet and Discmen going for £300.

Despite their diminutive size personals attempt to incorporate as many gimmicks and features as

possible, cassette players often incorporating tuners, graphic equalisers and Dolby noise reduction. CD players are still relatively expensive and don't tend to vary that much on the features front, rather the amount and quality of accessories differs. Most models come with a mains adaptor and some include remote control.

Sound quality on the cassette front seems to have a proportional relationship to price and integrity of construction – wow and flutter being quite obvious on the cheaper models. CD players

become less noisy as they get dearer and also reduce in size; one drawback of the latter seems to be that immunity to shock suffers as a consequence. Cassette players do, on the whole, seem better suited to the outdoor life than their digital counterparts, as does the software. Bear in mind that the sound and lab ratings given below cannot realistically be compared to those in other categories or between cassette and CD personals.

## PERSONAL CASSETTES

MODEL NAME PRICE	LAB SOUND	COMMENTS	FEATURES	VALUE	BACK ISSUE FULL REVIEW
<b>Aiwa HS-G35 MkII</b> £30	Poor Fair	A reasonable player for the price but not well suited to classical material and let down by the headphones	Autoreverse, graphic EQ, types I & II		56
<b>Aiwa HS-J36</b> £89	Good – Average	Comprehensive facilities and reasonable sound are no mean feat for the price	Dolby, autoreverse, types I, II & IV, AM/FM, recorder	R	56
<b>Aiwa HS-PX101</b> £149	Average – Good	A very slick little number with soft touch controls and remote control headphones	Dolby B, C, autoreverse, types I, II & IV	R	56
<b>Ferguson 3T46</b> £35	Very Poor Poor	Not particularly subtle but having reasonable speed constancy, it's OK with most material but can get painful	Autoreverse, AM/FM		56
<b>Philips D6658</b> £30	Very Poor Poor	The low price limits sound quality, and this is not a spectacular machine, but it does a reasonable job nonetheless	Graphic EQ, AM/FM		56
<b>Saisho PS90R</b> £40	Poor Poor	A bit of a jumble of features and gadgets, the PS90R has on-board speakers, an extending aerial and even records, but sound quality is dubious	Graphic EQ, types I, II & IV, AM/FM, recorder		56
<b>Sanyo MGR-77</b> £35	Very Poor Very Poor	Rather a basic machine with a raw edgy sound, not helped by poor speed stability	Graphic EQ, AM/FM		56

# THE DIRECTORY

## PERSONAL CASSETTES

MODEL NAME PRICE	LAB SOUND	COMMENTS	FEATURES	VALUE	BACK ISSUE FULL REVIEW
Sony MGR-87 £50	Very Poor Fair	The 87 came up with a slightly fast but rhythmic sound. Although lacking in finesse, it worked OK with pop material.	Autoreverse, graphic EQ, AM/FM		56
Sony MGP 600D £50	Average+ Average-	With styling aimed at the fairer sex the 600D sounded a little better than the similarly priced MGR-87. Lacking in clarity, it was still quite endurable.	Dolby, autoreverse, graphic EQ, types I, II & IV		56
Sony JJ-P4 £100	Poor Good	Claimed by its makers to be the world's smallest personal stereo the JJ-P4 is a tasty looking object that's capable of good sounds to boot.	Dolby, autoreverse, tape types I, II & IV, rechargeable		56
Sony WM-34 £40	Poor Average	This straightforward no frills Walkman makes pretty plausible sounds at a reasonable price and apart from the Walkman Pro was the only model to earn a Best rating.	Dolby, types I, II & IV	BB	56
Sony WM-F63 £100	Average- Average-	This attractive Sports Walkman is nicely built but sonically flawed by rather hissy intra-aural headphones.	Dolby, autoreverse, types I, II & IV		56
Sony Walkman Pro £249-£289	Good+ Excellent	One of the finest sounding cassette decks on the market today. A mandatory Best Buy, it takes other personals to the cleaners (except on weight and power consumption).	Dolby B, C, types I, II & IV, record, line in/out, varispeed	BB	52/56
Toshiba KT-4027 £35	Very Poor Very Poor	Not a very wonderful machine, the 4027 sounded pretty appalling with all but the most unobtrusive music.	Graphic EQ, AM/FM		56
Toshiba KT-4047 £60	Average Average	This model proved capable of making the most of better recordings, and sounds reasonably tuneful.	Dolby, autoreverse, graphic EQ, types I, II, AM/FM	R	56

## PERSONAL CDs

MODEL NAME PRICE	LAB SOUND	COMMENTS	FEATURES	VALUE	BACK ISSUE FULL REVIEW
Goodmans GCD-10 £120	Average- Poor	Cheap, flashy and not short on accessories the GCD-10 is a rather noisy player that left a lot to be desired on the sound quality front.	13.5 x 3.7 x 18cm, 478g, mains adaptor		66
Kenwood DPC-77 £270	Good+ Very Good	Very chunky and well made, the DPC-77 is the only player to include a digital output and sounds very good through its analogue output - a suitable domestic alternative.	12.8 x 3.5 x 14.5cm, 750g, digital output, mains & in-car adaptors	R	66
Philips D6800 £130	Average Average-	A competitively priced and reasonably attractive looking player whose sonic performance is somewhat marred - a rather grainy end.	13 x 4 x 17.5cm, 516g, 3" ready, twin high sockets		66
Sony CP-12 £260	Fair Good+	Sonically amongst the more enjoyable personal CD players and capable of revealing the musical aspects of a disc in an interesting and entertaining fashion.	12.5 x 2 x 12.7cm, 380g, wired remote, mains adaptor	R	66
Sony D-20 £150	Average+ Fair	Not bad for a machine at this price, it's nicely designed and reasonably robust, with reasonable sound quality.	13.8 x 3.8 x 15cm, 450g, mains adaptor	R	66
Sony D-40 £200	Fair Good	A 'largish' but attractive player that works well as a Discman being fairly immune to shock and capable of making a good job of reproducing the discs it's given.	13.6 x 3.7 x 14.7cm, 480g, mains adaptor, slinky case	R	66
Sony D-88 £300	Average- Fair+	A stylish and 'cultish' object, the D-88 is very small and has an adjustable disc drive for three and five inch discs. Sound quality doesn't quite match appearance.	9.4 x 3 x 9.8cm, 300g, 3" ready, mains adaptor, no line out		66
Sony D-150 £300	Fair+ Very Good	One of the most enjoyable machines encountered, sounding informative and sweet and looking very tasty to boot. Comes complete with a tough carrying case.	12.6 x 2.1 x 13.5cm, 420g, 3" ready, R mains adaptor	R	66
Toshiba XR-9458 £250	Average+ Good-	Accompanied by a plethora of accessories including a meaty plinth and infra red remote, the Toshiba didn't quite make it on the sound quality front but is worth considering.	12.6 x 2.4 x 12.9cm, 460g, 2 remotes, mains adaptor, 3" ready etc		66
Xenon CDP-03 £180	Average- Fair+	A well made and competitively priced machine that is ergonomically spoilt by flat slightly unresponsive buttons. Sound quality ain't too bad but a trifle boring.	12.6 x 2.7 x 12.6cm, 560g, high frequency filter, key lock		66

## CD PORTABLES

CD Portables or Yuppie Blasters as we classified them are basically portable stereos gone digital, ie a compact disc player is included alongside the usual AM/FM radio and single or double cassette deck. Compact disc is a novelty that seems to add a fairly hefty premium onto the price of the standard ghetto blaster, but the improved sound quality over standard cassettes may justify this for some.

In virtually every case a CD output socket is

fitted which means that it's possible to play silver discs through a domestic amplifier and loudspeakers, thus they are some sort of substitute for standalone mains machines (as are the personal CD players). One drawback with having a CD player on board is that batteries are gobbled up even quicker than usual, up to ten batteries being required in some cases. Neither are the units particularly light, the heaviest weighing eight kilos!

However they do all run off the mains too, and come with an appropriate lead for this purpose. Other useful features common to most are spare input sockets to record from an external line source such as a preamplified vinyl disc signal, and microphone sockets for recording live events (although the usual lack of record level adjustment is a nuisance).

MODEL PRICE	SOUND	COMMENTS	FEATURES	VALUE	BACK ISSUE FULL REVIEW
Ferguson RCDD2 £300	Poor	A large, slightly tinny midi system-esque unit with removable speakers and a slightly brash sounding CD player.	Twin cassette, graphic equaliser, spare input (DIN)		53
Fisher PH-D473F £300	Average	The Fisher is quite a neat and compact player which is nice to use but doesn't offer particularly great sound quality.	Autoreverse, AFC		53
Hitachi CX-W800 £300	Average+	This meaty Hitachi lives up to Blaster expectations, its super woofer bass speaker giving maximum street credibility.	Twin cassette, graphic equaliser, phono input	R	53
Memorex CD-3300 £280	Average	A little bit tacky, the Memorex put in a plausible if unenthralling performance, and will work with external speakers.	Spare input		53

# DAT FROM PLAYBACK

## THE WORLD'S SMALLEST DAT RECORDER

**THE COMPLETE  
PLAYBACK PACKAGE  
THE CASIO DAI  
THE AFFORDABLE  
PORTABLE AT  
£645 + VAT**



**CASIO DAI**

- \* 4 hour rechargeable battery pack
- \* AC adaptor \* Fixed angle stand
- \* Free tapes and carrying case worth £60

PLAYBACK

15 Percy Street, London W1P 9FD. Tel: 01-631 0939  
Fax: 01- 636 5011

# THE DIRECTORY

## CD PORTABLES

MODEL PRICE	SOUND	COMMENTS	FEATURES	VALUE	BACK ISSUE FULL REVIEW
Panasonic RX-FD80L £300	Average—	Shiny in a glitzy way, this Panasonic features a reasonable cassette deck but a below par CD player with tiny transport controls	Autoreverse, spare input		53
Sharp WQ-CD15 £250	Good	A reasonably compact machine with a quite impressive CD player and a novel twin cassette mechanism	Twin cassette, graphic equaliser, spare input	R	53
Sony CFD-66L £350	Good	A very attractive player in the true yuppie mould of white plastic with silver details, it even sounds OK	Spare input, shuffle play, AMS (tape search system)	R	53
Toshiba RT-7096 £250	Poor	Quite a large box for the money, the Toshiba isn't too special when it comes to sound quality but does have partly wooden detachable speakers	Twin cassette, graphic equaliser, spare input		53

## STANDS AND SUPPORTS

It's becoming more and more apparent that all the components in a hi-fi system benefit from being placed on the right kind of support. It is already acknowledged that performance of electro-mechanical transducers, such as turntables and loudspeakers, can be greatly improved by using highly rigid supports. This notion has been expanded to include electronics such as amplifiers and compact disc players, and inevitably a broad range of stands and supports have been produced to cater for this requirement.

With loudspeaker stands there seems to be two

broad schools of design. The most common is the open frame type which uses square section steel tubing (usually less than an inch square) made up to form a tripod or quadropod stand usually fitted with spikes top and bottom to ensure good coupling to both floor and cabinet. However, for reasons of domestic harmony this latter option is often not pursued as eagerly as perhaps it should be. The alternative approach is to use mass. Larger section (approximately 3 inch x 2 inch) tubing is welded between square top and bottom plates and filled with sand and/or lead shot. Again, this type uses

spikes at the base but Blu-tack or the like for coupling with the speaker cabinet.

Equipment supports generally place isolation quite high on the list of priorities and usually use a lightweight steel frame to support an MDF platform. Once again spikes are used to minimise contact with the platform and ensure good coupling to the floor. Minimising weight without compromising rigidity seems to be the aim with turntable supports but those designed for electronics often employ some form of damping to kill vibration, sometimes in the form of mass.

## LOUDSPEAKER STANDS

MODEL PRICE	TYPE FINISH	COMMENTS	TOP PLATE SIZE HEIGHT	VALUE	BACK ISSUE FULL REVIEW
Appolo A820 £40	4 leg Fair	A light open-framed budget design slightly lacking in rigidity and subjectively superceded by other stands costing £10 more.	19 x 19cm 53cm		58
Appolo A10 £47.25	4 leg Fair	A robust and lightweight model, it would make an ideal upgrade for those still happy with the big boxes of old.	19 x 19cm 44cm	R	58
Foundation Fred £65	2 leg Average	With sand filling the Freds made speakers sound tight and coherent with a more even balance.	19 x 19cm 36/43/59cm		58
Foundation Maggi £159	Pair Very Good	Made for Magneplanar and other similar panel speakers they seem to have a healthy effect on the sound quality thereof.	50 x 2cm 2cm	R	58
Foundation Pi £250	2 leg Very Good	Overpriced in material terms the Pi nevertheless has a very positive effect on the low frequency performance of conventional speakers.	20 x 20cm 25/38/46/53cm	R	58
Heybrook Point 5 £50	3 leg Very Good	An unusual triangulated open frame stand that can help certain speakers sound more transparent and fluent — a good value stand.	23 x 21.5cm 47cm	BB	58
Heybrook HBS1 £75	4 leg Very Good	With its new aluminium base frame the HBS1 fared very well in the listening tests. It allowed much of the speakers own 'sound' to remain intact.	23 x 21cm 47cm	R	58
Linn Kan II £79	4 leg Very Good	Built to support Linn's Kan speaker this stand is well suited to the task, but is less successful with other loudspeakers.	19 x 16cm 59cm		58
Linn Sara £85	4 leg Very Good	The Sara exhibits some odd properties so its use other than with the Sara loudspeaker should be viewed with caution.	25 x 21cm 53cm		58
Monotrak Engineering M1 £58	1 leg Good	The M1 gave the mid and treble a commendably smooth and detailed presentation but bass sounded rather lacklustre and muddy.	19 x 18.5cm 48cm		58
Monotrak Engineering M4 £58	4 leg Very Good	Begging comparison with Heybrook's HBS1 the M4 maintained much of the openness and forthright detail of that model.	23 x 21.5cm 53cm	R	58
Monotrak Engineering M4S £58	4 leg Very Good	Its stature and stability would seem to mark it out as most suitable for smaller, lighter cabinets. The M4S possessed an open midband and clear treble.	20 x 17.5cm 53cm		58
Mordaunt-Short IS1 II £45	3 leg Good	Suited to low mass speakers, preferably using spikes to effect coupling, they sounded slightly jazzed but the overall sound was quite unmuddled.	18 x 15cm 56cm	R	58
Origin Live £117	3 leg Good	An unusual tripod stand devoid of top plate and taking up more floor space than normal, subjective and technical performance was exemplary.	(support area) 22 x 17.5cm 52cm	R	58
Partington PP4 £50	1 leg Good	The PP4 offers a rather mixed performance, though when damped with sand in fill it was less ready to embellish the overall sound and low frequencies became tauter and quicker.	18 x 16.5cm 48cm		58
Partington Dreadnought II £120 (filled)	1 leg Very Good	Ideal for systems on the light/bright side of neutral, the Dreadnought II's nevertheless still need some careful re-examination. Partington.	17.5 x 16.5cm 63cm		58
QED TS22 Tristand £50	3 leg Very Good	Most tracks sounded uplifted or buoyant, never thick nor coloured. It worked well with most of the speakers tried and encouraged a fluid and revealing midband.	19 x 17cm 45/50/58cm	BB	58
RATA Torlyte £190	2 panel Excellent	Suited to low mass speakers, these unusual stands are hardly discreet but offer transparent and clean sound — much like the Torlyte table!	25 x 21cm 48cm	R	58
Target HS20 £53	1 leg Excellent	This monopod stand can be used either filled or unfilled and encourages different characteristics in the sound accordingly.	19 x 16.5cm 53cm		58
Target HI15/3 £83	3 leg Very Good	Sound quality was basically very good though without the sand in fill some loudspeakers may sound a little unbalanced as both bass and treble regions are subjectively exaggerated.	28 x 28cm 40cm	R	58

To Advertise in this space  
ring Cindy Forde  
on 01-631 1433

# THE DIRECTORY

## EQUIPMENT SUPPORTS

MODEL PRICE	TYPE FINISH	COMMENTS	SIZE (H x W x D)	VALUE	BACK ISSUE FULL REVIEW
Audioquest Sorbothane Feet £10 each	Feet Good	These large gumdrops are very useful for damping vibrations in amplifiers and especially CD players.	6.5 x 2.5cm (circular)	R	57
Cornflake TCS5 £50	Table Very Good	A little too close to the ground for comfort, perhaps, but this novel and stylish little table is certainly worth seeking out.	29 x 43 x 33cm	R	57
Cornflake TCS6 £50	Shelf Good	A squat and rigid frame supports a Medite top board with four adjustable spikes, better suited to suspended sub-chassis turntables.	43 x 23 x 33cm	R	57
Delttec Isolation Base £135	Platform Good	Designed for all CD players, amplifiers and separates, but not suspended sub-chassis turntables, the isolation is second to none.	50.5 x 40cm	R	57
RATA Model A £125	Table Very Good	A three-legged Torlyte turntable support that has become something of an industry reference.	46 x 46.5 x 38.5cm	R	57
RATA Amplat £40.25	Platform Very Good	A lightweight and rigid Torlyte slat with spikes for floor or shelf mounting, it works well in conjunction with the Target TT2.	4 x 44.5 x 35cm	R	57
Sound Organisation Table £55	Table Very Good	A deceptively simple structure that just happens to be engineered in a thoughtful, and ultimately successful manner.	37 x 45 x 35cm	BB	57
Sound Organisation Wall Stand £40	Shelf Very Good	The first of its ilk and still amongst the best, this simple framework represents a vast improvement over standard furniture shelves.	27.5 x 43 x 35cm	BB	57
Target TT1 £46.50	Shelf Excellent	This rigidly braced shelf offers both good sound quality and material value for money.	26 x 46.5 x 35.5cm	BB	57
Target TT2 £47.50	Table Very Good	Standing up to the best in most areas, the TT2's only real foible concerns a slight loss of bass 'slam'.	52 x 46.5 x 35.5cm	BB	57
Townshend Suspension Base £145	Platform Fair	Designed to complement the Rock turntable, this platform will bring subjective improvement to a wide range of electronics.	43 x 36cm	R	57

## CABLES AND CONNECTIONS

Although cables and connections are sometimes thought to be the least important items in an audio system there has been a growing awareness in recent years that they have a significant effect on sound quality. To this end there is now a vast array of exotic cables and interconnects available to those interested in experimentation. The key observation on cables is that they are much more than mere accessories. Carrying the audio signal, just as any amplifier does, it's really not too surprising that they can influence the quality of that

signal. The characteristics of any cable are determined by the materials and topologies utilised in its construction. The purity of the conductor, nature of the insulator dielectric, mechanical construction, physical geometry, RF characteristics, efficiency of screening and finally the connectors themselves, all play vital roles in the sonic character. These factors tend to vary more with interconnect cables which are used to carry the signal between active components like pre and power amplifiers. The

interconnects summarised here were tested in 1m terminated lengths and therefore the results and prices relate to that length - some cables may well perform differently when used in longer lengths. The features column contains information on the material make-up of the different cables with the following abbreviations: OFC - oxygen free copper, OFHC - oxygen free high conductivity (Audionote define the HC as high crystal), PC-OCC - pure copper by ohno continuous casting, LC-OFC - linear crystal oxygen free copper.

## INTERCONNECT CABLES

MODEL PRICE (per metre)	LAB SOUND	COMMENTS	FEATURES	VALUE	BACK ISSUE FULL REVIEW
Apature LSD N/A in UK	Poor Fair	Faint resonant boom was audible at very low frequencies, but otherwise this cable sounded remarkably neutral.	Silver plated copper, PTFE dielectric	R	59
Audioquest Reference 2 £29	Good Fair	Ultimately Reference 2 simply damped much of the atmosphere and emotional charge of a musical performance.	OFC copper	R	59
Audioquest Livewire Topaz £29	Good Fair	Sounding 'bigger' and faintly richer than Reference 2, Topaz was also slightly grainy at the top end.	Gold-plated plugs, OFHC copper	R	59
Audioquest Livewire Ruby £45	Fair Good	Smoother sounding than the Topaz, the extended crystal Ruby is less grainy and coarse, better able to resolve complex passages.	FCL copper twin axial	R	59
Audioquest Livewire Quartz £65	Good Good	Quartz has an ideal, neutral balance that embodies sparkling clarity without the drawbacks of harshness or compression.	3 piece plugs, PTFE dielectric	R	59
Audio Technica AT6115 £50	Very Good Fair	This cable sounds somewhat 'quieter' than the original LC-OFC interconnect, but is also less transparent and three dimensional.	PC-OCC copper coaxial	R	59
Audionote Copper ANC £35	Fair Good	ANC sounded punchy with a faintly lean but tightly-focused bass character. This crystalline precision waned slightly at higher frequencies.	OFHC copper twin-axial	R	59
Audionote Flexible Silver ANS £85	Fair Good	ANS scored a hit with its transparent midband and revealing but quite unforced treble quality. Bass transients were slightly softened.	Silver signal & Copper screen	R	59
Audionote Silver ANV £140	Poor Fair	Fair weightier-sounding than the flexible ANS, ANV interconnect also possesses a fair degree of treble clarity and sparkle.	21 strand silver Litz	R	59
Aural Symphonics N/A in UK	Poor Good	This cable enjoyed an open and transparent midband and sounded remarkably neutral and faithful to the source.	OFC copper PTFE dielectric	R	59
Budget Patch Cords see text	Fair Poor	As thrown in gratis with cassette decks and the like - frequency extremes were restricted and performances were veiled.	Thin coaxial	R	59
Budget OFC circa £7	Fair Fair	Subjectively, this cable did lift much of the aural fog experienced with scrawny standard hook-up leads.	OFC	R	59
Delttec Slink £32	Good Very Good	Ideally used in lengths of under 4 metres, it errs on the lean side of neutral but has an uncommon transparency in the midrange.	4 silver plated OFC strands PTFE dielectric	BB	59
Delttec Black Slink £152	Excellent Excellent	Inherently neutral the cable faithfully reproduced broad and deep stereo soundstages with precise focus and a sense of tactility.	8 silver plated OFC strands PTFE dielectric	R	59
Denon LC-OFC N/A separately	Very Good Fair	Supplied with Denon's dearer CD players this cable introduced a peculiar 'twangy' coloration at high frequencies, and a slightly soft bass.	LC-OFC, non-magnetic gold plated plugs	R	59
DNM Solid-core £15-£25	Fair Good	Transparent in the midband and full of sparkling detail in the treble, low bass was slightly curtailed (unterminated price £4.60 per m).	Single strand nickel-plated copper. Unshielded	R	59
Kimber Kable PSB £32	Very Good Very Good	An exceedingly transparent midband but slightly 'clanky' treble. It always managed to sound remarkably uncluttered and open.	OFC, PTFE dielectric	BB	59
Kimber Kable KC-1 £47	Very Good Fair	Tonally faintly leaner and brighter than the more open-weave PSB, KC-1's treble detail was just too sharp and grainy.	Multi-gauge PTFE dielectric	R	59
Kimber Kable KC-AG £375	Good Very Good	Treble detail resolution was perceived in a slightly abrupt if wholly controlled fashion. Depth re-creation and lateral separation were excellent.	Multi-gauge silver, PTFE dielectric	R	59
MDM Interconnect £14.95	Good Fair	The subjective performance of MDM did appear a little imprecise at the frequency extremes, but a worthwhile upgrade on budget interconnect.	Coaxial, solid core, gold plated plugs	R	59

# THE WORLD'S NO 1 GUIDE TO BUYING HI-FI

# THE DIRECTORY

## INTERCONNECT CABLES

MODEL PRICE (per metre)	LAB SOUND	COMMENTS	FEATURES	VALUE	BACK ISSUE FULL REVIEW
Van den Hul MC-D3001 £59	Poor Good	It tended to highlight some upper mid detail, but a generally open and spacious acoustic proved its saving grace. Slightly soft at LF.	Silver plated single strand VdH plugs	R	59
MIT PC-Squared £75	Fair Good	This multi-gauge cable produced a very open and buoyant midband but sounded slightly 'peculiar' at frequency extremes	OFC, multi-gauge	R	59
MIT Spectral M1330 £193	Poor Fair	M1330 displays a marvellously open and enticing midband quality, bass is warm and rich but this character has a tendency to dominate.	Multi-gauge balanced bandwidth		59
Monitor PC 0100381 £17	Good Fair	There is more than a hint of instrumental muddling and bass is slightly soft, however, the slightly 'shut-in' sound is for the course at the price	OFC, coaxial	R	59
Monster Interlink 400 £30	Good Good	Bass is solid and punchy, counterpointed by a slightly overblown midband which tends to make vocalists sound larger-than-life.	Multi-gauge	R	59
Monster Interlink CD £44	Fair Fair	Low frequency is commendably weighty, but the top-end sounds vague and lacking in image focus. Suited to some systems better than others.	Multi-gauge		59
Monster Interlink Reference £88	Good Fair	Protracted listening indicated a lack of dynamic speed – a subjective sluggishness. It may prove well suited to up-front systems.	Multi-gauge Balanced bandwidth Gold plated plugs		59
Myst Tm £15.60	Fair Good	Fairly neutral with a pleasantly open and transparent midband. Some deep bass detail is lost but treble is sharply focused	Solid-silver PTFE dielectric	BB	59
Origin Live Soli-Core Super £60	Good Fair	Improves over previous Soli-core samples in stereo depth and bass weight, but a 'loud' treble presentation remains.	Solid-core gold-plated AT plugs		59
QED Incon P1-Gold £14.95	Good Good	A lively open presentation that just borders on the lean side of neutral, the quick and lucid delivery affording considerable musical insight	OFHC, gold plated Deltron plugs	BB	59
QED Incon Graphite GPI Gold £18.95	Fair Fair	A shielded version of Incon P1, it sounded thicker at the frequency extremes, the top end being coarser and more out of focus. Good for long runs though.	OFHC Graphite shielding	R	59
Sony RK-C310ES £40	Excellent Good	Possessing deep firm bass and a sparkling top end it offers a balanced perspective with negligible coloration	Coaxial LC-OFC	R	59
Sterling £250	Fair Good	Possessing a neutral if faintly rich overall balance it supplies a pleasantly open and transparent perspective. (Reviewed in pre-production form.)	2 silver strands per conductor		59
Thorens SAC 100 £50	Good Fair	Performance is undermined by a slightly coarse and splashy treble, not necessarily bright, simply rather confused – and fine detail lacks resolution.	Silver-plated OFC, coaxial		59
Van den Hul MC-102111 £69	Good Good	Possessing the same endearing qualities as the D300 it presented open and transparent soundstages and improved timbral resolution	Twin axial silver plated copper	R	59
Van den Hul MC-D502 £77	Fair Fair	The tonal balance was 'tilted' by a strong and authoritative bass line, which had the knock-on effect of muting treble detail. A bit dear.	Twin axial silver plated copper, teflon dielectric		59
Van den Hul Thunderline £147	Good Fair	Thunderline essentially parallels the sonic performance of the cheaper D102. HF is occasionally tainted by a 'tizzy' coarseness, bass is tight and dry.	Silver plated 'matched copper'		59
Van den Hul MC-Gold £247	Fair Good	It possesses a rich and beguiling treble balance that matches a weighty, slightly warm bass character. Seductive balance may prove worthwhile in some circumstances.	Silver & gold plated copper		59
Van den Hul MC-Silver £747	Good Good	Although remarkably transparent for an asymmetric design this costly cable was not considered to be of 'state-of-the-art' standard, and is bettered by cheaper models.	19 silver plated copper strands		59
Vecteur 8045 £49	Very Good Good	Sounding solid and forthright it might seem slightly cold in some systems but the treble 'edge' is mercifully clean. Very low frequencies were a little lacking in 'slam'.	LC-OFC signal & screen	R	59

## LOUDSPEAKER CABLES

MODEL PRICE	LAB SOUND	COMMENTS	FEATURES	VALUE	BACK ISSUE FULL REVIEW
Absolute Wire Force 4 £4.50 metre	Good Fair+	By current standards there was a loss of fine, sharp detail at the frequency extremes, but it has a and friendly sound	744 OFC strands, PVC dielectric		64
Audionote DR-200 £16 per metre	Fair+ Fair+	Open and detailed throughout the midband but a grainy coloration tended to corrupt subtle timbral information at very high frequencies	200 LC strands, polyurethane and cotton dielectric		64
Audionote AN-SP £100 metre	Average+ Good	A clean and open sounding cable that offered a deep and pleasantly detailed perspective. Bass was slightly restricted, but seemed tight and coherent nonetheless	15 silver strands, polyethylene dielectric		64
Audioquest BC-4 £2 metre	Average+ Good+	There was a slowing of fast transient edges to contend with but in general BC-4 offered a delightful clarity and sparkle throughout the highest octaves	4 OFHC strands, PVC dielectric	BB	64
Audioquest Livewire Black £15 metre	Good Good	It proved clear and punchy but with some grain across the treble. Nevertheless Black remains an interesting concept and proved better than Livewire Green	OFHC, surface only – foam core construction	R	64
Audioquest Livewire Green £30 metre	Good Fair+	Green proved more overtly dynamic and forward than BC-4 with simple music, but complex passages tended towards a mushy and ill-defined perspective. FCL – functionally crystal less	FCL, surface only – foam core construction		64
Audio Technica AT6120 £95 – 10m	Fair+ Fair	Compared to earlier LC-OFC cables this PC-OCC derivative sounded smoother and less aggressive	PC-OCC, PVC dielectric		64
Bellwire metre	Poor Average+	Broadly speaking it delivered a bright and tizzy sounding treble with a fairly open and detailed mid with little or no bass resolution	0.5mm single strand, PVC dielectric		64
Deltec 8S £144 – 5m pair	Good Good+	The unerring transparency and detail resolution of 8S throughout the midband makes it a far cleaner and more spacious sounding cable than others at the price	4 silver plated OF copper strands, PTFE	R	64
Deltec Black Sixteen £456 – 4.5m pair	Very Good Excellent	Bass was deep and rhythmically secure, the mid tonally pure and free of additional sibilance while the treble was both relaxed, sweet and highly detailed	16 silver plated OF copper strands, PTFE dielectric	R	64
DNM Solid core £2.30 per metre	Average Fair	DNM cable seems too unbalanced for general consumption but excellent results have been obtained in sympathetic systems	0.54mm single strand, webbed PVC dielectric	R	64
Exposure £2 per metre	Good Good	It could sound a trifle matter of fact but this emotive flattening was also somewhat dependent on the music program. It is also highly suited to long runs	56 OFC strands, webbed PVC dielectric	R	64
Kimber Kable 4PR £49.45 – 5m pair	Fair Fair+	This directionally marked cable benefitted from an open and airy treble quality but seemed notably leaner than 4TC. Bass was well round and satisfyingly taut	4 x 7 copper strands per conductor, PVC dielectric		64
Kimber Kable 4TC £16 per metre	Good Good+	4TC made a great impression in the listening tests with an open midband, a smooth and unfatiguing treble with slightly rich but suitably weighty bass	OF copper, PTFE dielectric	R	64
Linn K20 £2 metre	Good Fair	Subjectively it erred on the forward and bright side of neutral but enjoyed an essentially clear and punchy delivery	56 OFC strands, webbed PVC dielectric		64
Marantz ML-55S £24.90 – 10m	Fair Fair	Subjectively this cable offered a loose and splashy treble which, though not overtly bright, did compromise both tonal and timbral accuracy	30 OFC strands, 3 conductors PVC dielectric		64
Mission Cyrus £2.50 per metre	Average+ Good	Because of its impedance characteristic this cable will deliver a smooth and unfatiguing treble balance with loudspeakers offering an easy load	0.8mm single strand, PVC dielectric	BB	64
Monitor PC Silverline PC4 £5.75 per metre	Good Average	Somewhat it laboured under a heavy and claustrophobic balance, lacking the see through transparency and lucidity of the better solid core cables	2072 x 0.07mm silver plated copper strands		64

TO ORDER BACK ISSUES OF HI-FI CHOICE SEE PAGE 123

# THE DIRECTORY

## LOUDSPEAKER CABLES

MODEL PRICE	LAB SOUND	COMMENTS	FEATURES	VALUE	BACK ISSUE FULL REVIEW
<b>Monster Superflex</b> £2.50 metre	Fair+ Fair+	Treble detail was both reserved and confused though there was little in the way of harshness and grain. Deep bass notes were also found to be lacking.	OFC, multistrand, Duralex dielectric		64
<b>Monster Original</b> £4 metre	Good Fair+	Original scurred relatively congested and murky at higher frequencies but possessed weight and conviction in the bass.	Multistrand		64
<b>Monster Powerline 2</b> £12 metre	Good Good-	Powerline stamped its own hallmark on the scurd with a strong taut bass and an essentially clear midband giving tactile stereo images.	Multistrand, helical construction		64
<b>Musical Fidelity Lifeline</b> £11.50 metre	Fair Good-	Lifeline did demonstrate a strong directional inclination, affording a laid back but fairly neutral balance when correctly oriented.	4 x 0.8mm PC-OCC strands	R	64
<b>Naim NAC-A4</b> £2.25 metre	Good Fair+	Tinged with brightness while the deep bass response seemed both over heavy and poorly integrated compared to the immediate competition.	Multistrand, webbed PVC dielectric		64
<b>NVA</b> £6 metre	Average+ Good	A light and breezy sounding cable best suited to short lengths, NVA benefitted from a clear and transparent outlook.	7 x 0.25mm silver alloy strands, PTFE	R	64
<b>Origin Live Soli-Core Ordinary</b> £1.80 metre	Good Fair+	Subjectively it bettered the performance of the costlier Super version, affording a pleasantly detailed and spacious soundstage with firm bass but slightly coarse treble.	1.8mm and 0.5mm single strands	R	64
<b>QED 79-Strand</b> £0.99 metre	Good Fair	For much of the last decade QED 79-Strand has been the first port of call for enthusiasts on the upgrading ladder, a tradition that should still hold true today.	79 strand, PVC dielectric	R	64
<b>QED Incon Graphite</b> £1.75 metre	Fair+ Fair+	This graphite version of Incon sounded cruder and generally more heavy handed than the cheaper unshielded type. Overall presentation was mildly restricted and cloaked in a faint aural	OFHC, polymeric screen		64
<b>QED Flat 200</b> £1.95 per metre	Good Good	I detected a degree of confusion at low frequencies but this did not stifle the acoustic atmosphere which remained open and positive.	200 strands, flat webbed PVC dielectric	R	64
<b>Rotel Supra 4</b> £2.49 per metre	Good+ Good	Ideal for both long and short runs, it furnishes a big sound that benefits further from a smooth, unfatiguing treble.	1,036 OFC strands, webbed PVC dielectric	R	64
<b>Rotel Supra 10</b> £6.49 per metre	Good+ Good	Supra 10 provided a very free and open sound that was unhindered by any excess at low frequencies. Worth its weight in scrap copper!	2,562 OFC strands, webbed PVC dielectric	R	64
<b>Sony RK-SSES</b> £59.95 - 5m	Fair+ Fair+	The sound of this cable was also somewhat controlled and over damped. The treble was relatively free and airy but lower octaves, including the midband, were constrained.	350 x 0.08mm OFC strands, heat shrink dielectric		64
<b>Solid core mains cable</b> 36p per metre	Fair+ Good	It enjoys much of the smooth treble and articulate midrange usually associated with the better solid core derivatives. Lean but taut and rhythmically coherent.	1.5mm square, 3 cores, PVC dielectric	BB	64
<b>Sterling</b> £499 - 5m pair	Fair Fair	This pre-production sample possessed a strangely muddled and reserved sound quality. It suffered from a progressive instrument modulation that totally confused more complex orchestral passages.	Pure Silver, PTFE dielectric		64
<b>Townshend Isolda</b> £400 - 5m pair	Fair+ Good	Isolda possessed a truly dark background out of which rose a very solid and extended bass together with an excellent sense of transparency through the upper octaves.	8 coax cables per conductor - very thick	R	64
<b>van den Hul CS-122</b> £5.50 per metre	Fair+ Good-	Characterised by a driving and powerful bass, CS-122 proved to be a heavy sounding cable. Mid treble detail was refreshingly clear but there was a slightly muted air about the extreme treble.	19 x 0.45mm silver plated strands, webbed rubberised dielectric	R	64
<b>van den Hul CS-352</b> £12.95 per metre	Good Fair+	Subjectively it scurred like CS-122 only more so, the deep rumbling bass tending to overwhelm subtle musical details. It also appeared a trifle peaky in the treble.	7 x 0.76mm + 168 x 0.125mm silver plated strands, rubberised dielectric		64
<b>van den Hul SCS-12</b> £29.95 per linear metre	Good+ Good+	SCS-12 set a high standard with a tight and well focused soundstage populated with tactile stereo images. Bass wasn't as extended or resolved as some other cables.	19 silver plated strands of 12 different gauges, PTFE dielectric	R	64
<b>van den Hul SCS-2</b> £99.95 per linear metre	Good+ Good+	Overall it was commendably neutral and transparent but nothing less would be acceptable bearing in mind the tremendous cost of a stereo pair.	665 silver plated matched crystal copper strands, PTFE dielectric	R	64
<b>Vecteur R-CV30</b> £4.99 metre	Fair Good	Subjectively the better of Vecteur's three-strong cable line-up offering a neutral overall perspective but with a slight loss of detail resolution at both frequency extremes.	4 x 0.8mm LC-OFC PTFE insulated strands	BB	64
<b>Vecteur S-CV90</b> £1.99 - 5m pair	Fair+ Fair+	It seemed both less transparent and integrated throughout the midband than R-CV30, though both frequency extremes were spruced up with a tighter sharper delivery.	6 x 0.7mm LC-OFC strands		64

To Advertise in this space  
ring Cindy Forde  
on 01-631 1433

# O'BRIEN hi-fi

QUALITY EQUIPMENT ON DEMONSTRATION ON MOST OF THE BEST BUYS

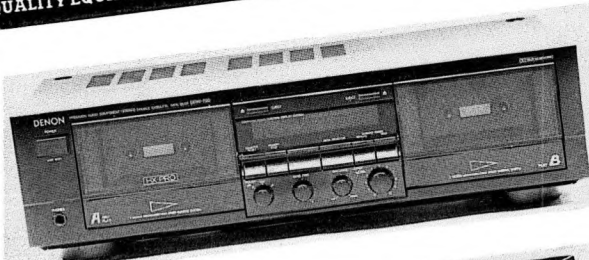

DENON 750

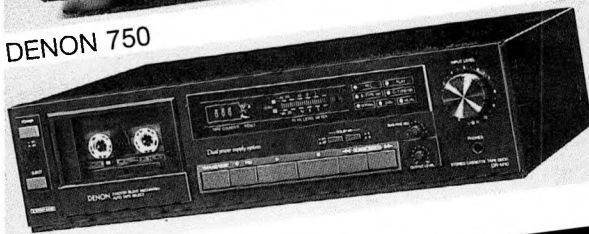

DENON DRM10

FAMOUS NAMES IN HIGH FIDELITY EQUIPMENT  
 FROM A&R (CAMBRIDGE) • AR • BEARD • CAMBRIDGE  
 AUDIO • CELESTION • DENON • DUAL • GLANZ •  
 HADCOCK • HARMON • KARDON • HELIUS •  
 HEYBROOK • HITACHI • KEF • LINN • LOGIC •  
 MARANTZ • MICHELL • MORDAUNT-SHORT •  
 MERIDIAN • MISSION • MONROSE • MYST •  
 NAKAMICHI • NYTECH • OAK • ORTOFON • PINK  
 TRIANGLE • QUAD • QED • REVOLVER • REVOX •  
 ROOPERS • ROTEL • SONY • SUPEX • SYRINX •  
 TECHNICS • THORENS • YAMAHA

95 HIGH STREET, WIMBLEDON VILLAGE, LONDON, SW19. 01-946 0331  
 • CREDIT FACILITIES (Trinity Finance APR. 36.4%. Written details on request)  
 • SERVICE FACILITIES • ACCESS/BARCLAYCARD  
 • FULL ORDER & EXPORT SERVICE • Opening Hours: Tues-Sat 9-5.30.

**HI-FI MARKETS**

## LISTEN TO MUSIC IN BEDS AT CAMBRIDGE HI FI

STOCKISTS FOR: MERIDIAN, ROTEL, NAKAMICHI,  
 ROCK, JPW, RUARK, MISSION-CYRUS,  
 MONTIOR AUDIO, ION SYSTEMS, REVOLVER,  
 KENWOOD, KEF REFERENCE, PIONEER,

\* SINGLE SPEAKER DEM. ROOM

31 ST CUTHBERTS STREET  
 BEDFORD O234 325035

ALSO AT  
 1-3 HAWTHORN WAY  
 CAMBRIDGE O223 67773

## ADVERTISERS INDEX

ACOUSTIC ARTS	56	KOSS	54
ADC SOUNDTEK	62	LYON AUDIO	96
AKAI	16,17,18	MAGNUM	33
ARJAY INTERIORS	92	MARANTZ	28
AT LABS	90	NAKAMICHI	50
AUDIOCRAFT	112	MEMTEC PRODUCTS	58
AUDIO PROJECTS	108	O'BRIEN HI-FI	112
AUDIO TECHNICA	86	PIONEER	IBC
AYLESBURY HI-FI	96	PROGRESSIVE AUDIO	128
BOXSHALL, STEVE AUDIO	98	RAYLEIGH HI-FI	88
BRADY, W&A	98	RICHER SOUNDS	4&5
CAMBRIDGE HI-FI	112	ROBERTS, PAUL HI-FI	92
CHEW & OSBOURNE	18	ROKSAN	OBC
CHORD COMPANY	96	ROYD	106
COVENT GARDEN RECORDS	104	SD ACOUSTICS	48
GRAHAMS HI-FI	68	SEVENOAKS HI-FI	36&37
HAMPSHIRE AUDIO	78	SONY TAPES	IFC
HAYDEN LABS	44,46	SONY UK	10,11,13
HI-FI EXPERIENCE	82	SOUND GALLERY	128
HUTCHINSON, BILL HI-FI	129	SPALDINGS HI-FI	123
IN HI-FI	74	TEAC	66
ION SYSTEMS	68,74	UXBRIDGE AUDIO	80
KENWOOD/TRIO	72	WILMSLOW AUDIO	108
KJ LEISURE SOUND	132	YAMAHA	40



# THE DIRECTORY

## IN-CAR ENTERTAINMENT

In-car entertainment is an area not usually associated with the esoteric world of domestic hi-fi. However, it represents a source of musical entertainment that many of us are exposed to every day. The majority of new cars are fitted with some form of radio before they leave the showroom and in many cases this usually very basic player is taken for granted and accepted as representative of in-car audio standards.

For the price of a budget amplifier or more, there is a wide variety of in-car machines to choose from

including cassette, CD and even DAT players. The majority of sub-£300 players are integrated units featuring a cassette player, AM/FM tuner and amplifier, all in one remarkably compact standard sized box. At this price level the cassette players tend to be fairly basic affairs, although autoreverse and noise reduction systems are both fairly common. Tuners are usually of the digital variety with varying degrees of sophistication in signal tuning and presetting, with some machines featuring as many as 18 FM presets. The emphasis is on the frequency

modulated band and AM often suffers as a consequence, but fortunately for radio enthusiasts there are some exceptions.

The amplifier is usually designed to drive two pairs of speakers mounted fore and aft of the vehicle, and a fader is fitted to adjust the balance between the two. The dearer machines feature separate bass and treble controls which can be quite handy given the unusual acoustic of the car environment and the variety in balance and presentation to be had from car speakers.

MODEL PRICE	LAB SOUND	COMMENTS	FEATURES	VALUE	BACK ISSUE FULL REVIEW
Alpine 7282L £250	Good Very Good	A very attractive and seductive sounding player. The matt surfaced transparent preset keys are especially sexy.	Bass/treble controls, 12 FM 6 AM presets, chrome eq., clock, 8W	R	61
Alpine 7905M/3539 £650/£350	Excellent Excellent	An easy to use and attractive CD/tuner, partnered with a powerful and flexible amplifier to give an effortless source of in-car entertainment.	Bass/treble controls, 12 FM, 12 AM presets, slide-out, 150W	R	68
Aiwa CT-23500YL £199	Fair Fair	A nicely designed machine with a flip up lid for disguise purposes. Sound quality from cassette is a bit poor but the radio is exemplary especially on AM.	Bass/Treble controls, 6 FM, 12 AM presets, Dolby, chrome eq., 8.4W	R	62
Blaupunkt Paris SQM 48 £253	Average Average	A powerful and sensibly designed player but let down by a very dull sounding cassette. The radio is a bit better.	Bass/treble controls, 5 FM, 10 AM presets, uni-directional, 11.5W		62
Blaupunkt Windsor SQR 38 £275	Good Average	Not very enthralling sonically, the Windsor is rather low powered but does have a reasonably stable tape transport.	5 FM, 10 AM presets, 3.1W		62
Clarion 916HP £160	Good Average	With its rubbery buttons and touches of white this is a modest looking player let down by a weak cassette.	Bass/treble controls, 5 FM, 5 AM presets, 9W		61
Clarion 946HP £250	Very Good Very Good	A good FM side let down slightly by AM performance. This Clarion is particularly nice to use with its nifty SAM tuning system.	Bass/treble controls, 12 FM/6 AM presets, Slot-in, 15.1W	R	61
Clarion C0C7000/10028HA £650/£250	Very Good Excellent	Despite a slightly off-beat cartridge system the Clarion combo put in a performance that had the sonic edge over other CD/tuners in its test group.	Bass/treble controls, 12 FM, 12 AM presets, security code, 80W	R	68
Goodmans GCE229 £150	Fair Average	If knobs, switches and legends are your bag then the GCE229 is the one for you - a lot of gizmos for the price and it even sounds OK.	Bass/treble controls, 6 FM/6 AM presets, Chrome eq., clock, MSS, 10.1W	BB	61
Hitachi CSK-402E £250	Good Good	An attractively designed little player that for once doesn't disappoint when it comes to playing music, and it even has a security system.	Bass/treble controls, 6 FM, 12 AM presets, Dolby, chrome eq., music search, 7.4W	R	62
JVC RX-318 £200	Average Average	This JVC sounded quite enjoyable and turned in an impressive performance on FM. It even looks quite nice.	Bass/treble controls, 5 FM, 10 AM presets, slot-in, 8.8W	R	62
JVC RX-418 £250	Average Fair	An attractively designed machine with a fair selection of features - even an aux socket for a portable CD player.	Bass/treble controls, 10 FM, 10 AM presets, Dolby, chrome eq., slot-in, aux socket, 7.7W		62
JVC XL-C30E/KS-A102 £499/£130	Very Good Very Good	Not sonically as impressive as the other CD cartridge players in its group, the C30/A102 combo is, however, a versatile and fast sounding player.	Bass/treble controls, 10 FM, 10 AM presets, direct track access, 30W		68
JVC KS-D1 £1000	n/a Excellent	The only in-car DAT player we've tested proved musically quite impressive and if software ever becomes prolific it will be able to offer CD a run for its money.	Bass/treble controls, no tuner, direct track access	R	68
Nakamichi TD-400E/PA-300 II £450/£275	Very Good Excellent	If you want your in-car entertainment to compete on sound quality grounds with your domestic system, this combo offers a very strong challenge.	Bass/treble controls, 5 FM, 10 AM presets, uni-directional, chrome eq., Dolby B, C, 75W	R	62
Nakamichi TD-700E/PA-300II £795/£299	Very Good Excellent	For those who appreciate the wonders of analogue there are few in-car players to really compete with this superb cassette/radio. You can even adjust azimuth.	Bass/treble controls, 6 FM, 6 AM presets, music search, Dolby, 75W	R	68
Panasonic CQ-497 £117	Fair Poor	The CQ-497 has a traditional style analogue tuning system making it easy to use. AM reception was good but the other sources are less encouraging.	Bass/treble controls, chrome, NR, 7W		62
Philips 553 £120	Average Average	Not the most ergonomic player on test but sound quality was quite refined for the price. Presets are a bit gauche.	4 FM, 4 AM presets uni-direction cassette 3.1W		61
Philips DC680 £180	Average Good	A colourful and musically competent player that despite a gammy volume knob is well worth checking out.	8 FM, 4 AM presets 3.5W	R	61
Pioneer KE-3030 £150	Poor Fair	A tasty looking, if sonically bass heavy, little box well suited to blasting out rock or dub.	18 FM, 6 AM presets 4.2W		61
Pioneer KEH-5080B £230	Fair Good	A chunky and neatly styled player with healthy power output and an easy relaxed sound. Just the thing for pumping the volume.	Bass/treble controls, 18 FM, 6 AM presets, anti-theft device, slot-in, 9W	R	61
Pioneer OEX-M300/COX-M100/ GM-3000 £300/£450/£280	n/a Very Good	Separate control unit and boot mounted multi play autochanger make this a bit of a hefty installation but it uses the same magazines as their domestic players and sounds fine.	Bass/treble controls, 18 FM, 6 AM presets, 80W, removable fascia		68
Proton 214CD/D275 £300/£175	Very Good Very Good	This Proton cassette/tuner offers good power and a level of fidelity appropriate to its price. Musically it has a Decca-like charm that is very appealing, plus a sensitive radio.	Bass/treble controls, 8 FM, 8 AM presets, Dolby B/C NR, chrome eq., 85W	R	68
Sansui RX-3100L £180	Poor Fair	Quite flash looking with a reasonable feature count but FM sound and cassette replay quality could be a bit stronger at the price.	Bass/treble controls, 12 FM, 12 AM presets, chrome eq., 8W		61
Sansui RX-5100L £250	Good Very Good	One of the cleaner machines around the 5100 has an excellent AM section and a reasonable cassette player.	Bass/treble controls, 12 FM, 6 AM presets, chrome eq., slot-in, 12.5W	R	61
Sharp RG-F816E £200	Poor Average	Nothing if not novel the 816, with its unusual anti-theft system is custom built for the furry dice brigade, but is sonically a bit lacklustre.	Four band graphic, 8 FM, 16 AM presets, ASP, Dolby, MSS, 10.9W		62
Sharp RG-F882E £220	Average Average	Again a glitzy full feature machine with a flip out control panel and plenty of lights. However, sound quality is a bit disappointing.	Seven band graphic, 5 FM, 10 AM presets, ASP, chrome eq., Dolby, 8.5W		62

To Advertise in this space  
ring Cindy Forde on 01-631 1433



# PERSONAL MESSAGES

Paul Messenger gets wired up with a £100 subwoofer.

As promised, it's back to loudspeakers again this month, for a play with Goodmans' new *Subwoofer*, which has now been additionally christened *b-max* or some such unprincipled abuse of the mother tongue. The 'max' bit of course is clever word association to persuade all you people out there with *Maxim 2s* to go forth and add £100 worth of extra bass. (I'm sure Goodmans must have been sorely tempted to call it the *b-diamond*, and pick up even more sales.)

What your £100 buys is a sort of 'large bookshelf' size enclosure which contains two identical 165mm bass units – one for each channel – some crossover circuitry and oodles of terminals. The whole thing is quite heavy, partly because it isn't just a simple box. Internal partitioning and a rear port provide '1/4 wave resonator' loading to give good efficiency across a limited bandwidth.

This bass loading technique was quite popular twenty years ago, but is now rarely encountered, for no particularly obvious reason. In analogy, the enclosure acts a little like an organ pipe resonator, as distinct (but not that different in practice) from the Helmholtz resonator used in reflex loading. There are some transmission line analogies too.

The subwoofer itself rolls off naturally above 150Hz, and the feed to the existing stereo 'satellite' speakers is via a simple first order filter. Simply connect the *b-max* to both channels of a stereo amplifier, and then wire your existing two conventional small loudspeakers on from the *b-max*.

This is a beer budget product with purist undertones, so there's no means of adjusting the relative balance of *b-max* and satellites. The lack of volume pots not only saves money but should assist the sound quality too. However, the only way of adjusting the balance is therefore to move the subwoofer itself with respect to the room boundaries.

Tuck it into a corner and you'll get lots more bass than if you bring it out into free space or even stick it up on a stand. There appear to be two minor disadvantages of an approach which is otherwise refreshingly simple. First, the location of the



subwoofer will effectively be predetermined by the rest of the system, and probably be restricted to quite limited range of options, and these could easily clash with room aesthetics or convenience. Rather less important perhaps, it is also unlikely (though not impossible) that those options will successfully 'time align' the sub and satellites with respect to each other.

Goodmans' *Subwoofer* guru Geoff Hill sent us a batch of curves which show just how dramatically the siting can influence the effective sensitivity. On his figures – which seem to tally pretty closely with my subjective experience – the 'equivalent sensitivity' of *b-max* ranges from 75dB/W on a stand in free space; 83dB/W when floor loaded; 88.5dB/W at a wall/floor boundary; and 92dB in the corner. Such figures are only an approximation of course, and will be modified in practice by a number of factors, but they do show that Goodmans has got its sums right – the 'most convenient' site against a rear wall corresponds closely to the 'market average' speaker sensitivity of 88dB/W or so.

I tried it with *Maxim 2* (of course), plus Royd *Eden* and even with the very upmarket Celestion *SL600Si*, and in no case

did *b-max* disgrace itself. On balance I would say it performs admirably as advertised, and makes a ready partner for speakers costing up to £200 the pair.

Minatures above that price tend to be minatures out of choice rather than price necessity, making a positive virtue out of the low cabinet 'signature' and fine stereo properties that go hand in hand with miniaturisation. And here *b-max* does start to get a little out of its depth. It will still provide enhanced bass extension and power handling, but its own limitations start to smear some of the subtleties that can be achieved with top quality conventional stereo.

As might be expected, the *b-max/Maxim* combination is a natural, although the *Maxim* itself is, ultimately, on the margin of hi-fi and audio. Enhancing its bass and power handling is all positive stuff, but doesn't disguise the comparative mid and treble crudity of any loudspeaker that costs £80 a pair. *B-max* is good enough to partner speakers costing £120-£140 per pair – and as a threesome deliver performance equivalent to the typical model costing £250/pair.

Whether it is quite up to the £240 Royd *Eden* is harder to answer. The *Eden* has some

wonderful qualities but desperately needs a subwoofer, and *b-max* obliges by providing an impressive 'fill in' for the lowest octaves. But the threesome doesn't quite retain the midrange speed and lightness of touch – the uncanny approximation to perfect timing – that the *Edens* possess on their own.

The *600Si* experience was different, though not unexpectedly so. Again the balance could be tuned without difficulty, but again some of the particular character of the original was lost, added warmth and richness rendering the *600Si* more like a *6Si* or *12Si*, and lacking the holographic stereo precision of the straight stereo pair.

Goodmans has an interesting niche product here that has been cleverly conceived and executed. But to my mind there is one exasperating flaw that could halve its sales potential. The problem lies in the unshielded powerful magnets used in the bass drivers, which in my experience are able to interfere with a colour TV tube from as much as 4ft away. Given that there is already little flexibility in siting *b-max*, this is only going to make matters worse, for anyone whose hi-fi shares living space with the TV.

In fact I'd go so far as to suggest that Goodmans is missing a golden opportunity here, to cash in on the imminent arrival of stereo TV and the trend towards integrated audio and video. (The IBA should have started up NICAM stereo sound transmissions in London and Yorkshire by the time this appears in print.) The £170 *b-max/Maxim* combination is an obvious upgrade for any stereo TV – a full bandwidth, genuine hi-fi sound in a pretty compact package. Or it would be if the magnets were shielded.

Indeed, placed on its side, the *Subwoofer* is almost exactly the right width to support a 59cm TV set, and would then be centrally placed for inconspicuous interconnection and optimum sound. Given the dramatic improvement a decent pair (or threesome) of loudspeakers can do for television sound, a magnetically shielded *b-max Subwoofer* could create a whole new market.

# Clever deck.

The Pioneer CT-737 cassette deck is a smart looking machine.

It's also a very clever one.

Because instead of two heads, it has three (one each for play, record and erase). Which means it can produce a far superior frequency response and signal-to-noise ratio.

Add to that a logic-controlled transport mechanism with a cassette stabilizer to soak up vibrations, plus a host of other high performance features, and you have the only intelligent choice:

- Honeycomb anti-resonance construction
- Dolby B, C and HX-Pro (Improves high frequency performance)
- New tape transport mechanism (offshoot of DAT technology)
- Fine bias control.

Call Teledata on 01-200 0200 for further information.



Wait 'til you hear Pioneer



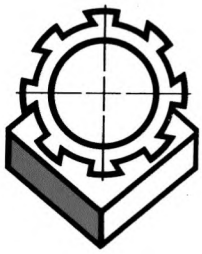

ROKSAN



XERXES

ARTEMIZ

SHIRAZ

DARIUS

HOTCAKES

TABLES

# HI-FI CHOICE

**Special Subscription Discount Offer!**

**SAVE 25%\***  
**ON NEWS STAND PRICES!**

**NEWS STAND PRICE ~~£35.40~~**  
12 Issues UK

**SUBSCRIPTION PRICE – ONLY **£24.95!**** 12 Issues UK

Hi-Fi Choice is the world's number 1 guide to buying Hi-Fi. Packed with reviews, news and features in a brand new colour section, Hi-Fi Choice is the magazine if you are serious about Hi-Fi.

Take advantage of our special Charter Subscription Offer and Hi-Fi Choice can be yours for just **£24.95\*** a year (a saving of over **25%** on news stand prices!) – including priority despatch to your home.

\*UK

#### What you get

- 12 monthly issues of the world's finest hi-fi magazine
- Priority despatch to your door (this means that you will always get Hi-Fi Choice before it appears in the shops)
- Special reader offers
- Low cost renewals offers
- Full lab and listening tests on over 700 products.

**Hi-Fi Choice Subscription Hotline**  
For credit card orders and subscription enquiries  
Telephone 01-580 8908  
Fax 01-636 5668  
Telex 8954139 DENNIS G

**Yes! I want to save over £10 by subscribing to Hi-Fi Choice, the world's number 1 guide to buying Hi-Fi.**

Please start my subscription from the next available issue.

Please tick the appropriate boxes:

- UK £ 24.95  
 Europe/Eire £ 29.95  
 Rest Of The World £ 39.95

I enclose my cheque/Postal Order made payable to **Dennis Publishing Ltd\***

Please charge my **Access\*/Visa\*/American Express\*/Diners Club\***

account number \_\_\_\_\_

Expiry Date \_\_\_\_\_

Signed \_\_\_\_\_

\*Please delete as appropriate

Unless paying by credit card, all payments must be drawn in sterling on a UK bank. Using your credit card ensures that your subscription will start without delay!

Please send my copies of Hi-Fi Choice to-

Name \_\_\_\_\_

Company \_\_\_\_\_

Address \_\_\_\_\_  
\_\_\_\_\_  
\_\_\_\_\_

Postcode \_\_\_\_\_

Telephone \_\_\_\_\_

If you are paying by credit card, simply detach this card and pop it in the post. If paying by cheque or Postal Order, send this card with your payment to the FREEPOST address overleaf (UK Only) or to the Subscriptions Department, Hi-Fi Choice, 120-126, Lavender Avenue, Mitcham, Surrey CR4 3HP

This information will be added to our mailing list. If you would prefer not to receive details of special offers and promotions, please let us know

# HI-FI CHOICE

**SAVE! SAVE! SAVE!**

12 MONTHS

HI-FI CHOICE

FOR ONLY  
**£24.95**

*Subscribe Today  
and Save £10!*

\*UK

HI-FI CHOICE

Discount  
Subscription Offer

No stamp  
required  
if posted  
in the  
UK.

Subscriptions Department DPL/C,  
Hi-Fi Choice,  
**FREEPOST,**  
Mitcham,  
Surrey CR4 9AR.