

20

A Permanent and Up-to-date Reference Work

1^s/₃^d

HARMSWORTH'S WIRELESS ENCYCLOPEDIA

For Amateur & Experimenter

SEL—STA

CONSULTATIVE EDITOR
SIR OLIVER LODGE, F.R.S.

THIS PART CONTAINS
214 New Photos and Diagrams with 116
'How-to-Make' & Other Articles

SHARP TUNING
SHORT WAVE
SINGLE-VALVE SET
SOLDERING
SOUND : SPARK GAP

SPECIAL PHOTOGRAVURE PLATE:
SHORT-WAVE RECEIVER

*J. LAURENCE PRITCHARD, F.R.Ae.S., Technical
Editor, with expert editorial and contributing staff*

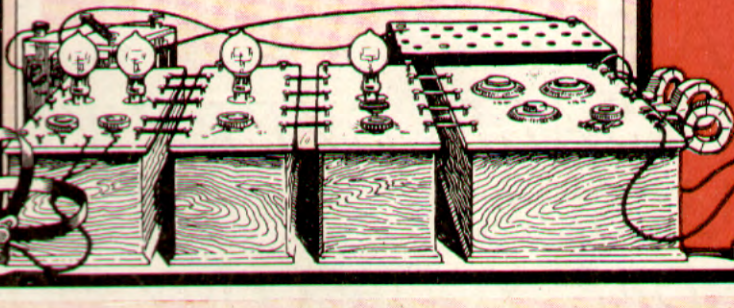

The Only ABC Guide to a Fascinating Science-Hobby

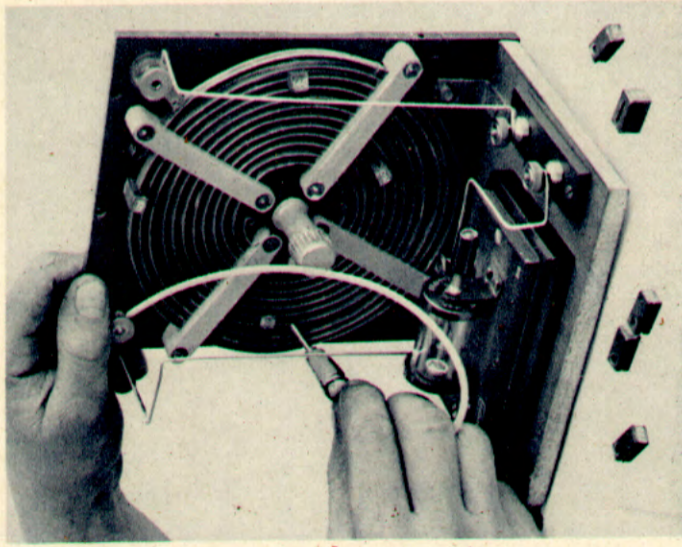

Fig. 1. Here the short-wave receiver is seen completed. Different wave-lengths are obtained by the plugging-in of an aerial clip

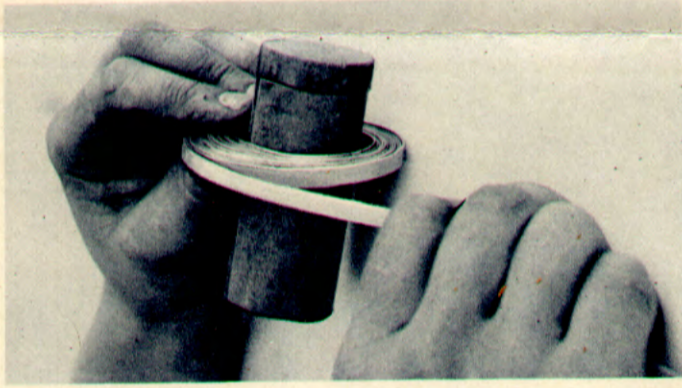

Fig. 2. A round former is used for winding the spiral, which should be kept on this till required

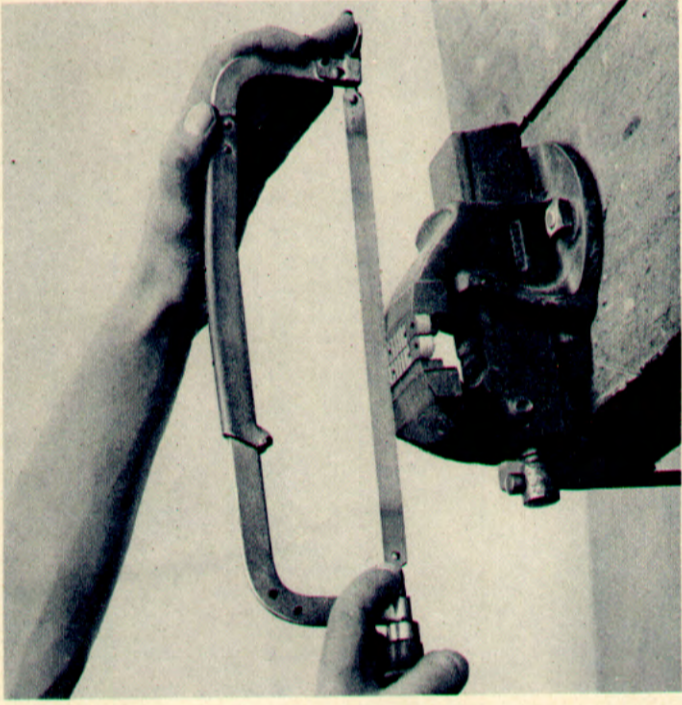

Fig. 3. How a hack-saw is used to cut slots in the ebonite strips; two of these are cut together to ensure absolute registering of the slots

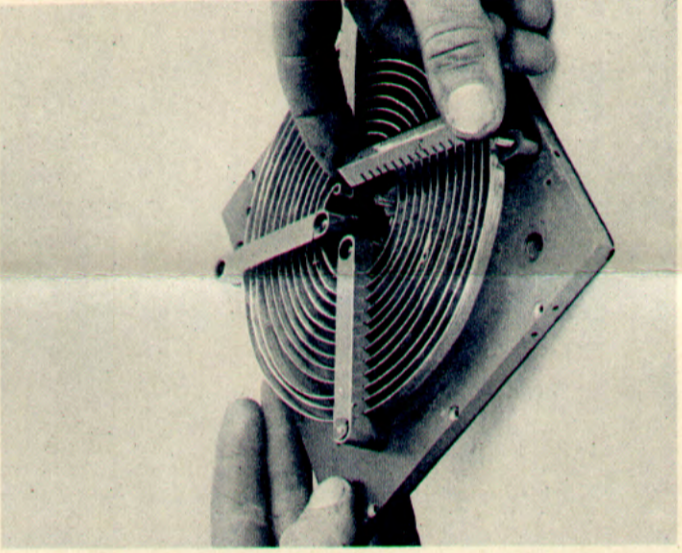

Fig. 4. Here is shown the fitting of the strips to the back board. These are used to keep the spiral in its correct fixed position

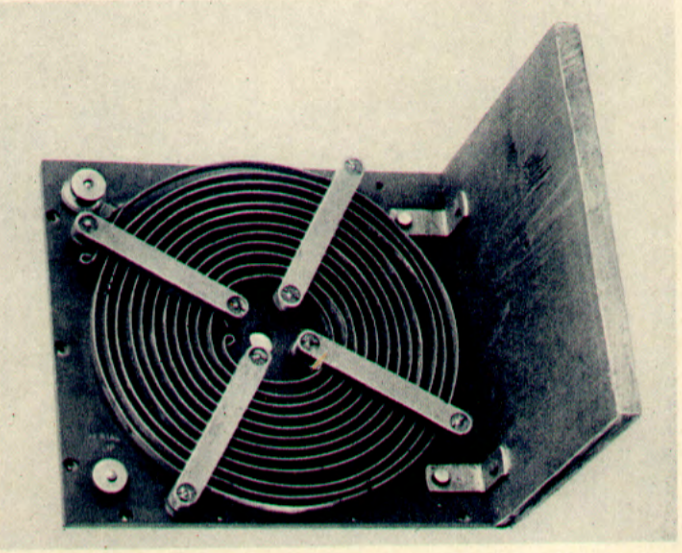

Fig. 5. Brackets of metal support the vertical panel, on which the spiral has been fixed, in its position on the platform

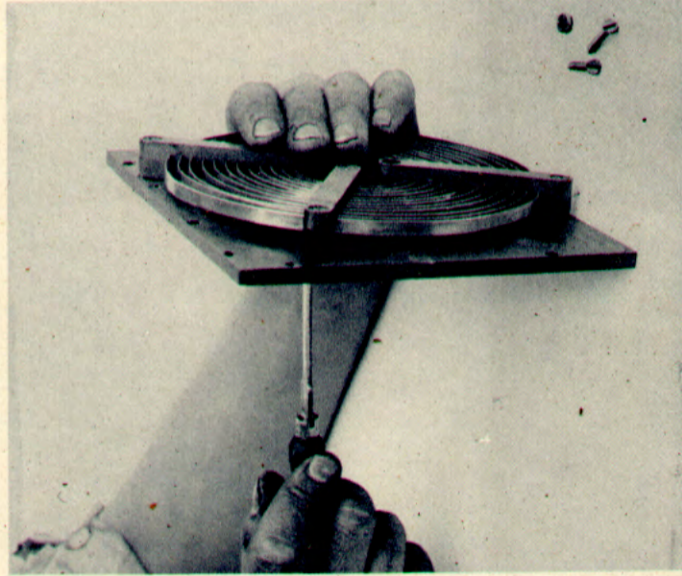

Fig. 6. A close-up view showing how the spiral is mounted in position upon the vertical panel

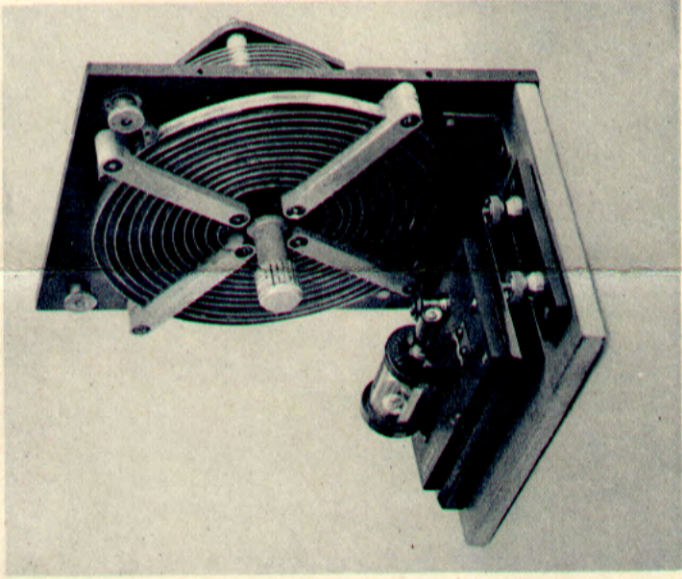

Fig. 7. Now the set is ready for wiring. Notice the positions of the detector, telephone block, and A.T.I.

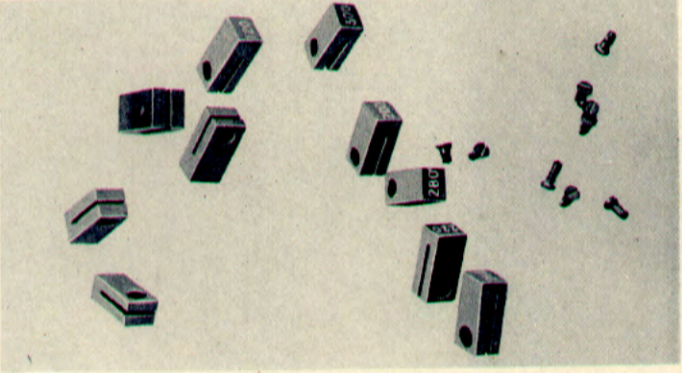

Fig. 8. Here is shown a collection of ebonite wave-length clips

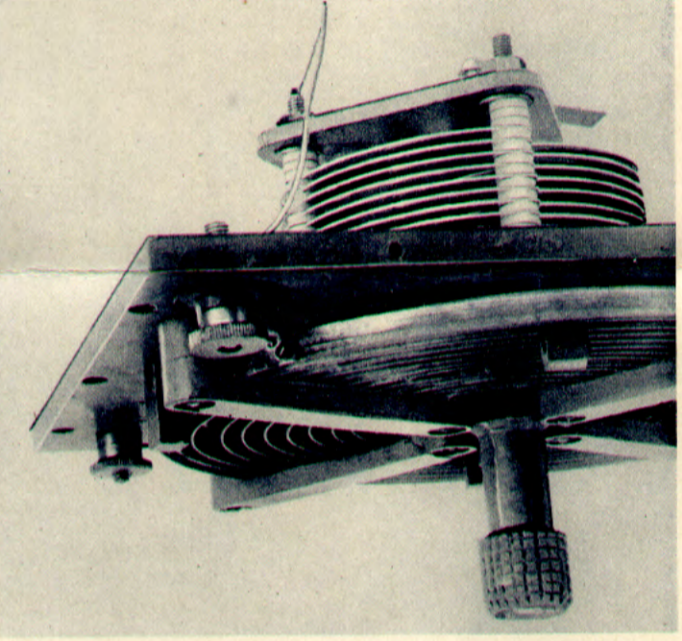

Fig. 9. A side view of the short-wave receiver presenting detail of the condenser and its control knob

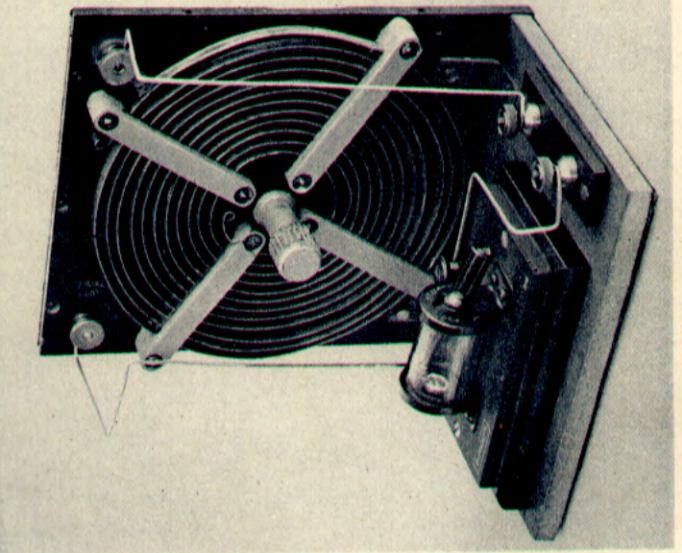
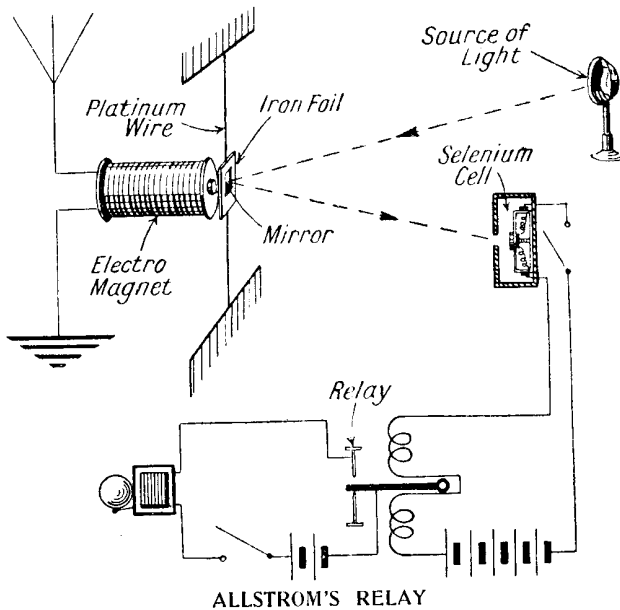

Fig. 10. Here is illustrated the completed short-wave set receiving at a wave-length of 200 metres

CONSTRUCTIONAL DETAILS IN THE BUILDING UP OF THE AMATEUR'S SHORT-WAVE RECEIVER, AN EFFICIENT SET GIVING RESULTS AT TWO HUNDRED METRES



ALLSTROM'S RELAY

Fig. 2. No more sensitive relay than this exists, as it responds to a hundred-billionth of an ampere

When a small current, as from a wireless wave, passes through the windings of the electro-magnet the core is magnetized sufficiently to move the iron foil and consequently the direction of the beam of light from the mirror, and the ray falls on the selenium cell, altering its resistance and actuating the relay. A suitable means is provided to damp the oscillations of the iron foil so that the foil becomes stationary immediately the impulse of current has passed.

A suitable coil for the purpose has a soft iron core of 1 in. diameter and 5 in. in length. This core is insulated with two layers of heavily waxed paper, and is then wound round with about three-quarters of a pound of fine gauge (about 36) enamelled copper wire. A permanent steel magnet placed a few inches away from the iron foil will serve to bring it into a position of rest. The whole room in which the relay is working is, of course, in darkness, so that the beam of light is all that affects the selenium cell.

SELF-CAPACITY. The inherent capacity of a circuit or part of a circuit. Practically all electrical circuits possess capacity, and this capacity may become extremely important. Thus in an electric cable the conductor, *i.e.* the standard wire, forms one plate of a condenser, the insulation forms the dielectric, and the earth in

which the cable is laid, or the outer lead casing by which it is protected, forms the other plate of the condenser. So two wires which are close to one another have a definite capacity, the air or intervening medium acting as the dielectric.

This last capacity effect is appreciable in an ordinary receiving set in many ways. In a coil, for example, there is a capacity effect between every adjacent turn, and the whole coil has a definite self-capacity. A suspended wire, too, has a capacity to earth, the latter acting as one plate of a condenser, the wire as the other, and the intervening air as the dielectric.

Self-capacity in a circuit, and especially in coils, is to be avoided wherever possible. With certain types of circuits,

as reflex and regenerative circuits, any self-capacity in the set as a whole due to the positions of various components and their construction may prevent the set receiving properly, although all the components may be correct as far as regards their sizes or functions.

The self-capacity of coils is avoided largely by special methods of winding. Bank winding reduces the self-capacity of coils, as do honeycomb windings and the like. In wiring up a set the amateur should, as far as possible, avoid wires running closely parallel to one another. Wires should cross as nearly as possible at right angles, and the farther apart they are the better. See Bank-wound Coil; Basket Coil; Capacity; Electrostatic Capacity; Honeycomb Coil.

SELF-EXCITED DYNAMO. A dynamo machine in which part of the current generated by the armature is used to excite the field magnets. A photograph of a small shunt-wound, self-excited dynamo is shown. This machine is designed for the use of amateurs who desire to charge their own accumulators, either from the mains by means of a motor generator (of which this machine may be the generator) or by a small gas engine.

It is an overtype machine, and is fitted with an eight-pole armature. Copper gauze bushes are fitted, these being

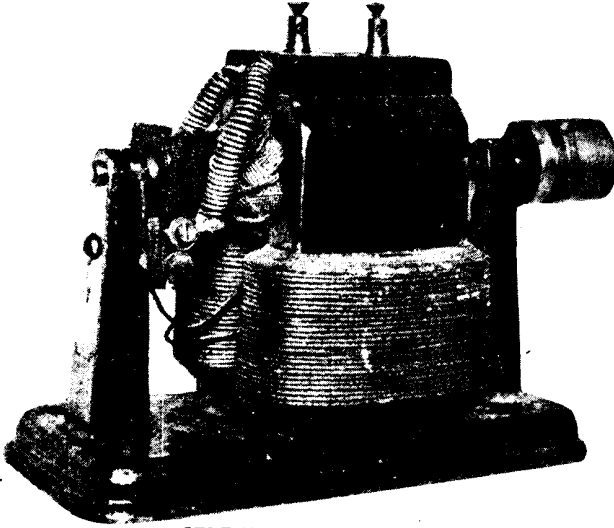

SELF-EXCITED DYNAMO

This is a shunt-wound machine in which part of the current generated by the armature is used to excite the field magnet

Courtesy Economic Electric Co., Ltd.

attached to a very simple type of rocker situated below the commutator. The pulley is made for either a V or flat belt drive. See Accumulator; Charging Board; Generator; Rotary Converter.

SENSE INDICATOR. Device used with a direction finder to indicate the actual direction of a station. In the ordinary direction finder only the plane in which the station lies is indicated, so that if the direction of the incoming wave is exactly reversed the radiogoniometer does not have to be readjusted in any way. The sense indicator is used to find out which of the two exactly opposite directions is the true one. On pages 698-699 the way the sense indicator works is explained. See Direction Finder; Frame Aerial; Goniometer.

SENSITIVE SPOTS. Places on a crystal which more readily respond to the incoming oscillations than others. Every crystal has spots on it which are more sensitive than others, and usually there is nothing to indicate why one place should be more sensitive than another. Often a crystal which displays feeble sensitivity may be found to be full of sensitive spots when fractured. These sensitive spots are often enfeebled by dust and damp, and the crystal should be protected. See Crystal.

SEPARATORS. Name used to describe narrow slips of wood or other materials employed between the plates of an accumulator to keep them the proper

distance apart. Various materials are used for this purpose, including grooved strips of wood, corrugated pieces of perforated celluloid, glass rods and the like. The essential purpose is to keep the positive and negative plates from touching each other. Separators should be good insulators, especially when subjected, as they are constantly, to the action of the electrolyte in the cell. See Accumulator; Celluloid; Glass Rods; Storage Battery.

SERIES. Term used in electricity to denote the way various parts of a circuit are joined together. Two or more conductors are connected in series when they are so joined that a current can flow from one to the next without either being increased

or decreased in amount. If a current passes through several resistances as shown in Fig. 2, the resistances are said to be joined in series. Joining resistances in this way is equivalent to making a resistance equal to the sum of the separate resistances. If R is the total resistance, then this fact may be expressed by the equation $R = R_1 + R_2 + R_3$.

Fig. 1 shows how cells are joined in series to form a battery, and on page 215 appears a photograph showing the practical arrangement of this method of wiring.

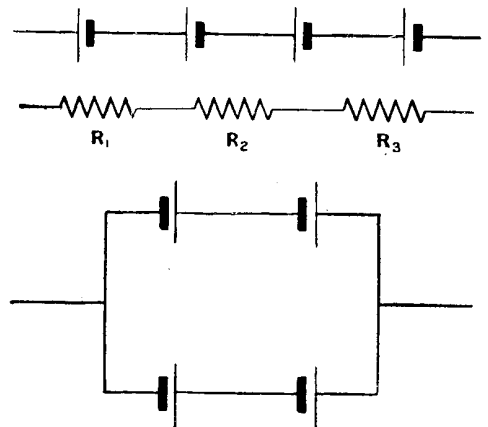

SERIES CONNEXIONS

Fig. 1 (above). Cells in series. Fig. 2 (middle). Resistances, R_1 , R_2 , R_3 , in series. Fig. 3. (below). Cells in series-parallel

It will be noticed that the negative element of one cell is joined to the positive of the next and so on. When all the negative elements are wired together and all the positive elements the cells are said to be joined in parallel.

Fig. 3 shows a combination of these two methods, and is known as a series-parallel arrangement. When cells are joined in series the total E.M.F. is equal to the sum of the separate E.M.F.'s, and the total internal resistance of the battery is equal to the sum of the separate internal resistances of each cell. In a parallel arrangement the total E.M.F. is the E.M.F. of one cell, and the total internal resistance is equal to the internal resistance of one cell divided by the number of cells in parallel.

By a series arrangement a greater E.M.F. is obtained and by a parallel arrangement a greater current.

The capacity of a number of condensers arranged in series is given by the reciprocal of the sum of the reciprocals of the separate capacities. This is explained, together with a diagram showing how condensers are wired up in series, in page 359. See Battery; Capacity; Parallel; Resistance.

SERIES COIL. Name given to that part of the field windings of a compound-wound dynamo which is in series with the armature.

The term is also used to describe any tapped inductance or other coil used in series in a circuit. A common application is in the aerial circuit of a wireless receiving set, where a condenser and coil are often placed in series. This is pictorially illustrated in Fig. 1, which shows a variable condenser with one terminal connected to the aerial lead-in represented by the conventional aerial sign, one wire also being shown from the same terminal

for connexion to the grid side of the valve or to a crystal detector. From the other terminal of the condenser a wire is taken from one side of the coil holder carrying an ordinary plug-in inductance coil. The opposite terminal of this coil holder is connected to earth and also to the earth side of the receiving set in the usual way.

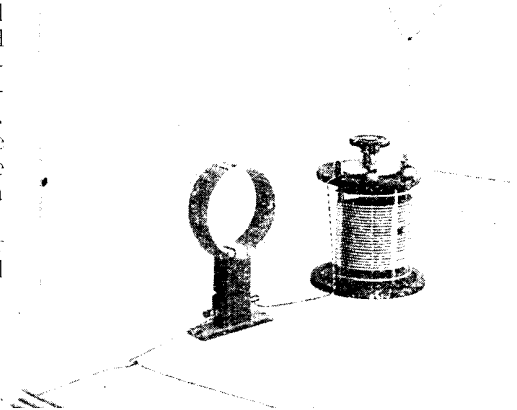

COIL AND CONDENSER IN SERIES

Fig. 1. An illustration of an aerial tuning condenser and a coil connected in series, giving direct aerial-earth circuit

The conventional manner of showing this arrangement of a series coil is illustrated in Fig. 2. See Condenser; Dynamo; Generator; Parallel; Series; Shunt.

SERIES-MULTIPLE. This is another name for series-parallel, multiple being the American synonym for parallel. See Parallel; Series.

SERIES-PARALLEL. Method of joining up parts of an electrical circuit so that it is partly in series and partly in parallel. Series-parallel connexions for cells are shown photographically on page 215, and diagrammatically in page 1794.

SERIES-PARALLEL SWITCH. Expression used to name a particular type of switch. Most series-parallel switches are of the multi-stud variety, actuated by means of a small handle which moves two or more contact blades. One simple variety of this character is illustrated in Fig. 1, and comprises a small ebonite base with five contact studs attached to it and also two small stop pegs. On the opposite side of the base is mounted two pillars, each of which acts as a bearing for the brass contact blades, the opposite ends of which make contact with one of the studs.

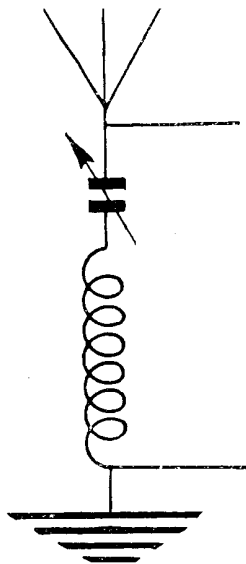

SERIES DIAGRAM

Fig. 2. Coil and condenser in series

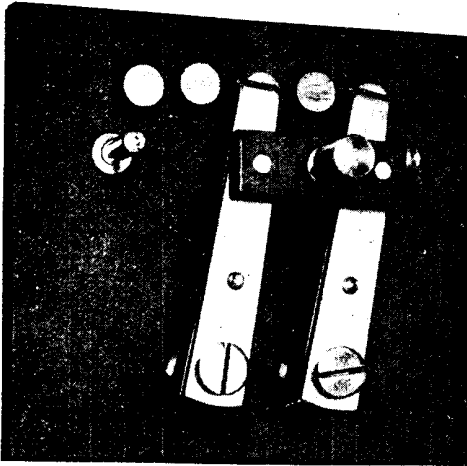

SERIES-PARALLEL SWITCH

Fig. 1. It is a simple matter for the amateur to construct this five-stud series-parallel switch, which mounts very neatly on the panel

Connexions can be made between these studs and also to the nuts on the underside of the panel, which are screwed on to the shanks of the pivots. These contact arms can be moved simultaneously, as they are united by an ebonite link provided with a small knob.

A rotary pattern of series-parallel switch is illustrated in Fig. 2, which shows the underside of the panel. In this case the rotary contact is turned from the exterior by means of a small knob. On the rim of the ebonite disk are two brass contact pieces situated diametrically. A series of six studs is disposed radially, and their extremities can press upon the brass contact plates on the disk when the latter is moved into a certain position. Normally, four of the contacts are in use and two of them are out of connexion, so

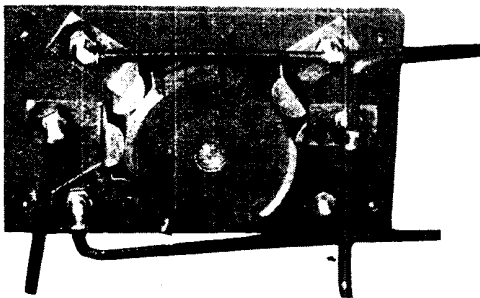

ROTARY SERIES-PARALLEL SWITCH

Fig. 2. An underside view of the contacts in the rotary switch for series or parallel connexions

Courtesy Radio Instruments Co., Ltd.

that when the switch is turned to the right one set of four connexions is completed, and when turned to the left another set of connexions is made and the rest broken.

Still another type of series-parallel switch is illustrated in Fig. 3, and is known as the domino connector. It consists of an ebonite base pierced with a number of holes and provided with suitable contact plates. Four "kwikpin" spring contacts are provided, and these can be plugged into any of the holes, so that by properly placing them either in series or parallel, connexions can be effected in a moment. This type of switch is particularly useful to the experimenter, and has the advantage that very firm and good contacts are necessarily made with it.

The principle of the connexions between the studs of a series-parallel switch is illustrated in Figs. 4 and 5, the former showing the studs and connexions which come into operation when the rotary switch is turned for the series connexions, and Fig. 5 showing how, by moving the same switch to the right, the connexions between the coil and condenser are then in parallel. The example illustrated shows the use of the switch in the aerial circuit for quickly changing from series to parallel connexion between the condenser and inductance.

The studs are numbered similarly in both these diagrams, and the contact arms are illustrated by dotted lines. This system of connexion can be used

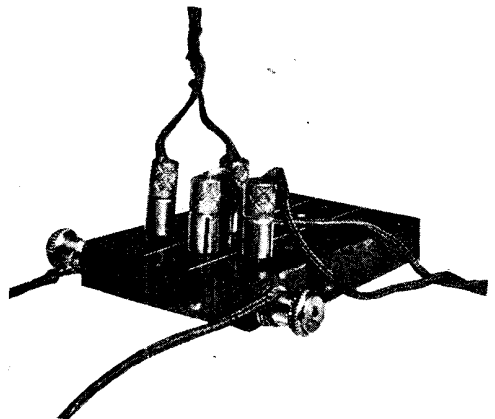

DOMINO TYPE OF SWITCH

Fig. 3. The domino series-parallel switch works on the plug-in principle, and is quick and certain in action

Courtesy Wates Bros

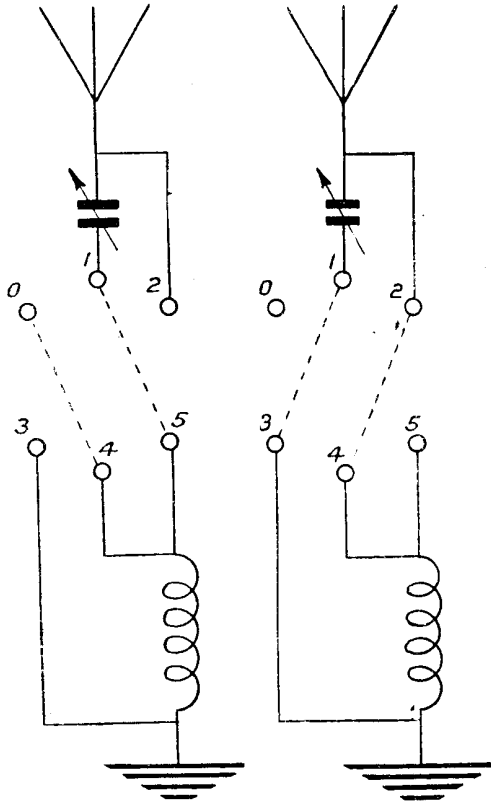

PRINCIPLE OF CONNEXIONS

Fig. 4 (left). Studs and connexions operating for series connexions. Fig. 5 (left). When moved to the right coil and condensers are in parallel

in conjunction with a home-made series-parallel switch such as that illustrated in Figs. 6 to 10. This is designed for experimental use, and takes the form of a small unit with a sloping panel.

The panel is made from ebonite, and measures 5 1/4 in. in height and 4 1/2 in. in width, and is simply mounted in a quickly made wooden case, illustrated in Fig. 7; the leading dimensions of the case given here will enable it to be quickly made up from deal or mahogany about 1/4 in. in thickness. The ebonite panel is simply screwed to the front or sloping part. A strip of ebonite, about 1 in. in width, is screwed to the lower

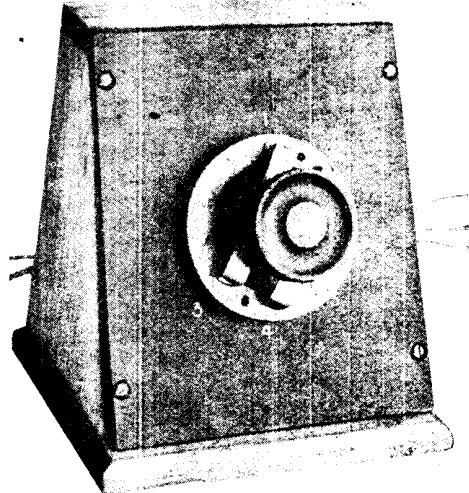

HOME-MADE SERIES-PARALLEL SWITCH

Fig. 6. This switch will fulfil all the amateur's requirements. It is self-contained, and may be easily connected to any experimental circuit

bottom portion at the back of the case, and is provided with terminals for easy connexion. This detail is clearly shown in Fig. 8, which shows the inner side of the panel, the six studs fixed to it and also the terminals.

The central hole for the switch spindle should be lashed, and the studs are

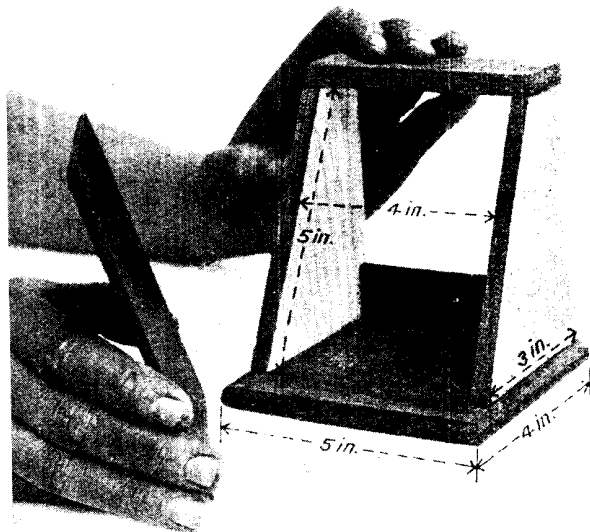

CASE FOR THE HOME-MADE SWITCH

Fig. 7. Dimensions of the cabinet are given here. It is of the sloping pattern, and is quickly made

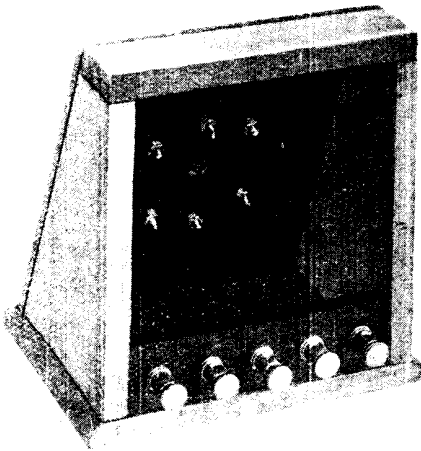

REAR VIEW OF CASE

Fig. 8. Here are seen the terminal board and positions of the stud contacts as seen from behind the panel

set concentric with this hole. They should be placed on a diameter with a radius of about 1 in. If ordinary contact studs

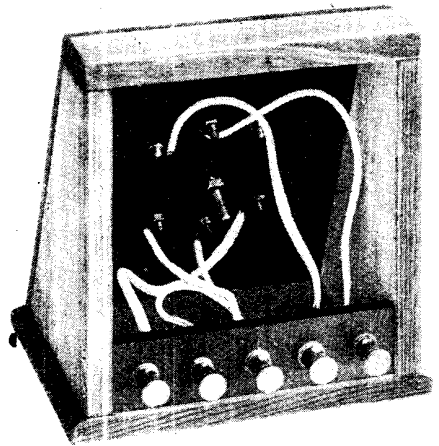

HOW THE SWITCH IS WIRED

Fig. 9. Heavy insulated wire is used here to connect the contacts with the terminal board. Notice the one blank stud

are to be used, a ring of ebonite, about $2\frac{1}{2}$ in. outside diameter and $1\frac{1}{2}$ in. internal diameter, should be cut and drilled to slip over the studs, and the whole turned or filed perfectly flat so that the face of the stud is flush with the face of the ebonite ring. The latter may be screwed to the panel by two small screws filed off flush on both sides.

The knob may be the ordinary ebonite pattern, such as is used for filament resistances and the like, and has attached on its underside a disk of ebonite with two contact arms made of brass or phosphor-bronze strip riveted to its underside. These strips are best laminated, and consist of three superimposed leaves. These contact blades should be so placed on the underside of the knob that when they are parallel they make contact with opposite pairs of studs, as may be seen from Fig. 10. The ebonite disk and contact arms are secured to the underside of the knob by small brass screws. The knob is then firmly attached to the spindle provided with a spring washer and lock nuts of the ordinary type.

The wiring is simple. If the studs be numbered in accordance with the diagrams in Figs. 4 and 5, the top left-hand side when viewed from the front will be marked No. 0, the remaining two top studs Nos. 1 and 2, and the three studs at the bottom are numbered from left to right respectively, 3, 4 and 5. The terminals on the ebonite

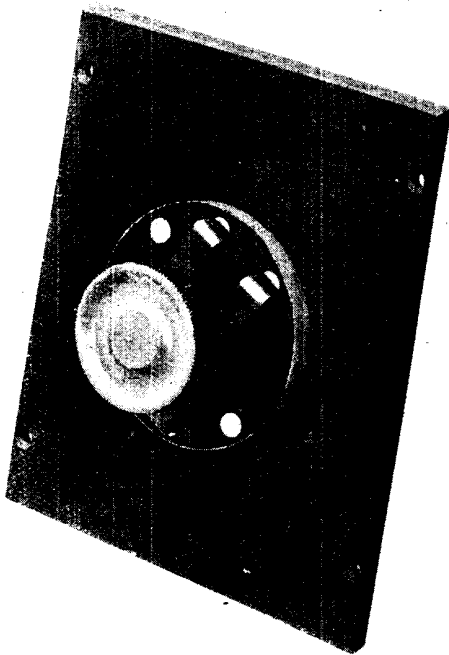

SWITCH ARM MOUNTED ON PANEL

Fig. 10. The studs are embedded in an ebonite ring to prevent the contact blades from sticking as they move from stud to stud

terminal strip at the back should be numbered similarly. Insulated wires are then attached to the contact studs and the corresponding numbered studs connected to the terminal strip.

Each contact should then be separately tested for continuity, and when all is correct the instrument is ready for use, a back view of it being given in Fig. 10 which should make the details of construction clear. The time expended in making such a device is well worth while, as a good and reliable series-parallel switch has many uses for the wireless experimenter, particularly when it is desired to change the wave-length range of a tuner or other piece of apparatus. See Coil; Knife Switch; Switch; Tapping.

SERIES WOUND. Name given to a particular form of winding of the magnet coils in a dynamo or other electrical generating machine. In the series-wound machine the armature is connected directly in series with the fields, so that all the current produced by the machine flows through them: The diagram shows the method of winding. The series-wound type of machine has many drawbacks in actual practice and has been largely superseded by the shunt and compound-wound types. See Shunt Wound.

SET SQUARE. Name applied to a type of scientific instrument used for testing or setting out right or other angles. It is used in wireless work in the preparation of plans and designs, particularly for the plan of a panel and the corners of a case. See Drawing Instruments; Square; T-Square.

SHACKLE. In wireless work the word usually refers to a particular form of fastening device, whereby pieces of rope, or chain, or the like can be fastened together in a secure yet easily detachable

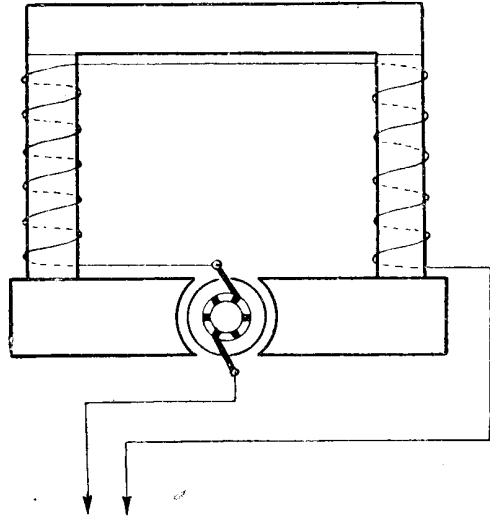

To main external circuit
SERIES WINDING IN THEORY

Dynamo magnet coils are wound thus, the armature being connected in series with the fields, so that all the current passes through them

manner. Two examples of shackle employed in wireless work are illustrated, and these will make the appearance of a commonly used type of this fitting quite clear. In the examples illustrated the shackle consists of a shaped piece of wrought iron, galvanized to protect it in some degree from the weather.

The pattern on the right of the illustration consists of a rounded U-shaped piece of galvanized metal with the upper ends enlarged and holes formed through them. One of the holes is threaded to suit a pin which passes through a clearance hole in one end and screws into the threaded hole in the other. This pin also has a small hole formed in its outer end, through which a bar, nail or other convenient object can be passed, enabling the pin to be screwed up tightly. This pattern is of convenience when the object to be fastened is of fairly large diameter, such as a thick rope.

The other pattern, illustrated on the left, consists of a straight-sided U-shaped piece of metal with a pin passed through holes in the ends in a similar manner to the first. This pattern is of convenience when a smaller-sectioned rope or a chain is to be fastened.

Such fittings are practically restricted in wireless work to the use of supporting

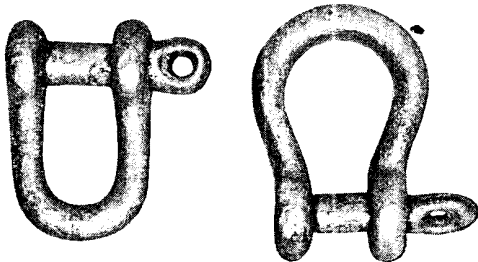

SHACKLES FOR WIRELESS USE

Two types that are very serviceable in the erection of an aerial mast for guy wires to the mast or to the ground post

**BROAD TUNING**

Fig. 1. B gives the tuning part of the coil in which the wave-length of 365 metres can be heard or tuned in

guy wires and stays for steadying an aerial mast and fastening the ends of different lengths of rope or wire together. The care and attention that should be given to such fittings is chiefly a matter of periodical examination and occasional oiling, to prevent serious damage by rust when the rope, chain or other object fastened has worn away the protective covering of the galvanizing. See Aerial; Guy; Halyard; Insulator.

SHARP TUNING. Tuning is said to be sharp when accurate adjustment is necessary to secure the required result.

Tuning is to a large extent relative, in that a set is said to be sharply tuned relatively to some other set that is less sharply tunable. The underlying scientific aspects of sharp tuning are dealt with under the separate headings of subjects that bear on the matter, as, for instance, Inductance, Capacity-resistance, and under the heading Tuning.

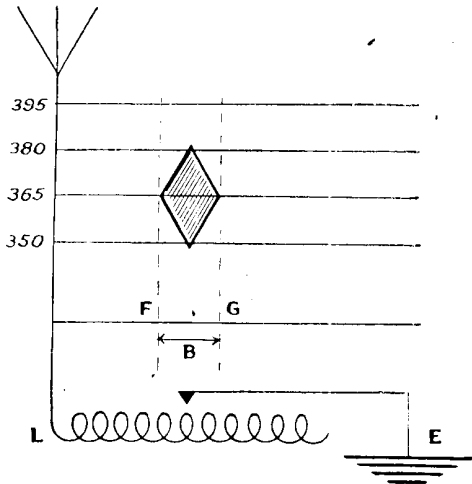
The user or purchaser of a set for wireless reception is more concerned with the practical aspects of the matter, as upon the quality of the tuning depends to a large extent the purity of reception and freedom from interference.

Consider first the simplest tuning system comprising an inductance with a sliding contact. This is represented purely in a diagrammatical manner by Fig. 1, where L represents the inductance and E the earth connexion. The horizontal lines represent wave-lengths, and

the dotted vertical lines what may be called the tuning zone, the breadth of which is designated by the distance B.

All users of such tuning systems are familiar with the fact that the slider can be adjusted for a considerable distance along the coil before all sounds of a particular station are lost.

Suppose these limits to be indicated by the letters F, G, and that maximum signal strength is found between these points as indicated by the peak of the shaded portion. Suppose also that the wave-length it is desired to tune is of 365 metres, although the same arguments and principles apply to any other wave-length.

Now it should be apparent that as the base of the tuning zone, represented by the distance B, is comparatively broad, and the peak of the tuning curve reaches a maximum height above or below the base line at some position between the lines F, G, in Fig. 1, stations transmitting on wave-lengths near to 365, or whatever other the set is tuned to, will obtrude on the tuning zone, and signals could be heard from those stations in addition to those from the 365 station.

In the diagram signals on any wave-length between 350 and 380 would be heard, and it would be difficult to eliminate one of them without increasing the strength of the other unwanted station.

**SHARP TUNING**

Fig. 2. From this diagram it will be understood how the broad tuning is made sharper by the use of a condenser



DIAGRAMMATIC LAY-OUT FOR SHARP TUNING

Fig. 3. Two circuits are shown here in a pictorial lay-out that will give very sharp tuning. This illustration corresponds with the diagrams in Figs. 4, 5 and 6

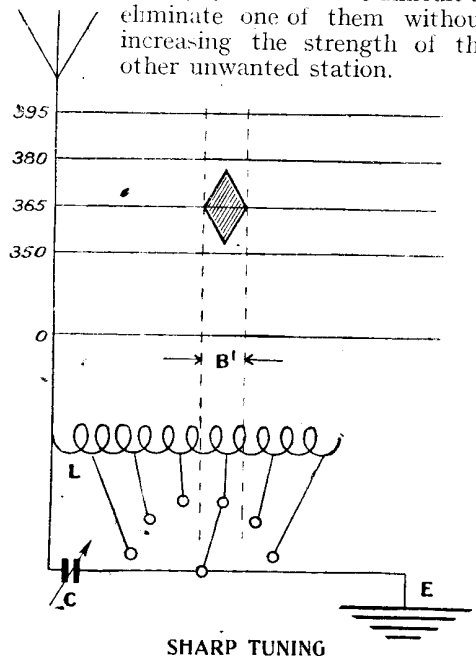
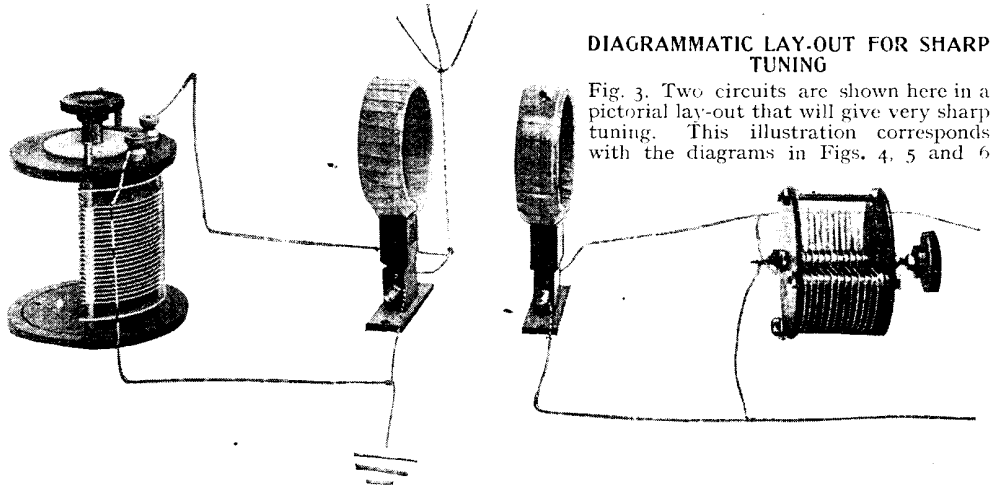
To minimise this defect a variable condenser can be added to the inductance, and this has the effect of providing a finer adjustment of the tuning curve and reducing the breadth of the base of the tuning zone. This is shown in Fig. 2, where the condenser C is shown as shunted across the tapped inductance L. The breadth of the base is represented by B^1 , which is less than B, and the height of the tuning curve becomes less, receptive wave-length range is reduced, and tuning becomes much sharper.

The arrangement of the tuning elements as usually disposed in a receiving set that is termed a sharp tuner is shown pictorially in Fig. 3, from which it will be seen that the aerial tuning system consists of an inductance coil of the plug-in variety tuned by a shunted variable condenser. A secondary circuit includes an inductance tuned by a variable condenser, the two wires from which are connected to the detector in the usual way. The two inductance coils can be moved towards each other, or may be further separated to allow a variable coupling between them. Details of such arrangements vary naturally with the design of a particular set, and other forms of coils and condensers can be employed, but the principles remain the same throughout.

The diagrammatic representation of such a circuit is shown in Fig. 4, and also the corresponding tuning zone, which remains similar to the previous example shown in Fig. 2. Now, if the two inductance coils be brought near each other a transfer of energy will take place from the aerial coil to the secondary coil,

and, further, if the aerial coil be tuned to a particular wave-length, say 365 metres the energy that is transferred to the secondary will be a maximum on this wave-length. There is, therefore, an induced current or energy flow through the secondary circuit which will tend to exhibit the characteristics of the wave-length to which the aerial circuit is tuned. In other words, the only energy that will effectively be transferred from the aerial coil to the secondary coil will be that covered by the tuning zone, as shown graphically in Fig. 4.

The moment, however, that there is a current flow in the secondary circuit, it becomes possible to tune it also, on exactly the same principles as the foregoing, although the values of the required components may be different from those of the aerial circuit.

This circuit has, however, only to deal with the signals that come in on the tuning zone as handed to it by the aerial circuit, consequently it operates over a smaller wave-length band and is capable of finer tuning, as it virtually tunes an already partly tuned circuit. The maximum signal strength and purity of reception is attained when the coupling between the coils is correctly adjusted, and when both circuits are in harmony or resonance with each other.

The latter condition is represented by the diagram Fig. 5, which shows that this condition is only met when the peaks of both tuning curves are in line or superimposed. One of the reasons for this is that to obtain any signals at all on such a receiver requires that there be a transfer

of energy from the aerial to the secondary circuit. In the conditions shown in

Fig. 5 both circuits are properly tuned, but there will be no transfer of energy from the aerial

and consequently the risk of unwanted signal reception. Too loose a coupling fails to transfer sufficient energy and signal strength is lost. The ideal conditions are shown in Fig. 6, and this should also make it possible to visualize the meaning of the term sharp tuning.—*E. W. Hobbs.*

See Tuning.

SHEARS. Term commonly applied to a cutting tool with a general appearance and method of use akin to a large pair of scissors. Shears proper are quite large instruments, and may be used for cutting thick plates of metal, bars, rods and so forth. The pattern of most interest to the wireless experimenter is the ordinary hand shears, or tinman's snips.

These are made in a variety of lengths ranging from about 9 in. to about 24 in., and one or two pairs are practically indispensable to the experimenter who

makes up wireless apparatus. The great utility of shears is the facility they afford for cutting sheet copper, brass, tinplate and the like, an operation which is clearly illustrated in Fig. 1. The implement is perfectly simple to use. A line is first drawn on the surface of the metal, the metal held in the left hand and the shears being operated as if using a pair of scissors. This method is possible on sheet metal up to about $\frac{3}{32}$ in. in thickness.

Above that thickness two hands may

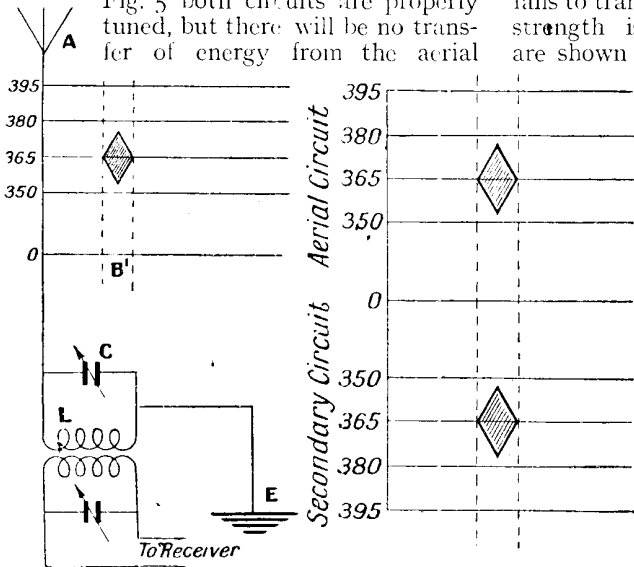

APPLICATIONS OF SHARP TUNING

Fig. 4 (left). A secondary coil and variable condenser help the tuning. Fig. 5 (right). The secondary and aerial circuits here are in tune with one another

tuning zone to the secondary zone because the coupling is too loose. When, however, the coils are brought together sufficiently these zones can be considered as overlapping with the peak of one touching, or slightly overlapping, the peak of the other, as shown in Fig. 6. When this happens the set is said to be sharply tuned, and little or no interference will be experienced. At the same time it should be appreciated that the peaks of these two zones are relatively small, and it is therefore a difficult matter to obtain a perfect result.

The diagram should make it clear that too close a coupling tends to increase the breadth of the zone of tuning

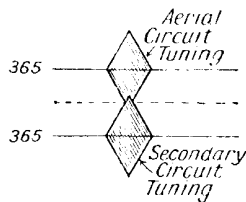

OVERLAPPING CIRCUITS

Fig. 6. Diagrammatic representation of the slight overlapping of the aerial and secondary circuit tunings, giving sharp tuning

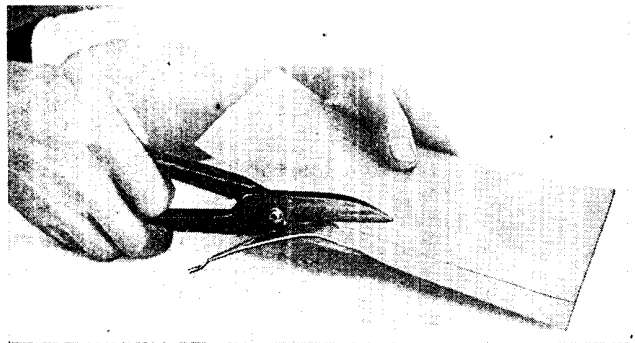

CUTTING SHEET METAL

Fig. 1. Tinman's snips will be found invaluable for cutting sheet metal. The method is illustrated here

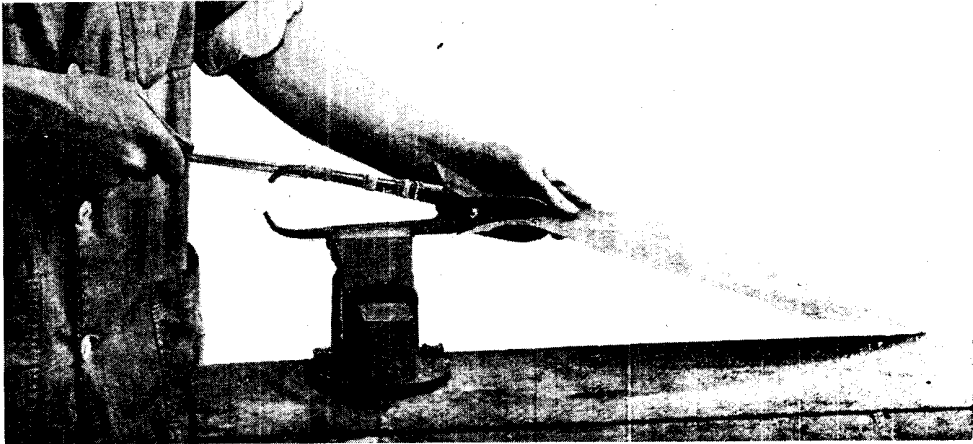

HOW THICK SHEET METAL IS CUT WITH TINMAN'S SHEARS

Fig. 2. By using an extension arm lashed to one handle of the shears, the other being firmly grasped in a vice, greater leverage is obtained, and this enables thick metal to be cut easily.

be needed to cut the metal. When the metal is tough, or rather too thick to be cut conveniently by hand, a simple and practical plan is illustrated in Fig. 2, and consists of grasping one of the handles in the vice and attaching to the other an extension arm. This may be secured by wiring it thereon with copper wire, or even binding it securely with string. One hand is then free to hold and direct the metal, while the other works the lever up and down, thus easily cutting the metal.

The edges should be ground from time to time when the instrument becomes too blunt to cut cleanly, and occasionally the pivot pin may require tightening, either by tightening a nut or by riveting a simple through pin, which is often employed on this class of tool. A little oil should be used on the moving parts, as this reduces the labour of cutting.

It should be noted that the ends of the two handles are turned inwards, and when the shears are shut these two ends touch each other. The novice should

be particularly careful, when using this pattern of shears, to avoid nipping the palm of the hand between these two ends, especially when making the last cut on a piece of metal, as the handles close up very rapidly under these conditions, and a serious bruise will result should any part of the hand be caught between the ends of the handles.

SHEATH. This is a term which is sometimes used for the metal cylinder or anode or plate of a three-electrode valve. The sheath is usually a cylinder of metal, but may vary considerably in shape and still function. The sheath shown in the photograph is that of the Cossor valve, and is dome-shaped, practically enclosing the grid. See Anode. See also under the names of the various valves; Valves for Reception; Valves for Transmission.

SHELLAC. Name given to a material of a resinous character prepared from lac. Shellac is obtainable in several different forms. It may either be obtained in the solid form, in lumps about the size of a large walnut, or in the form of a solution. One advantage of obtaining the shellac in the lump form is that it can be stored in a closed tin or other airtight receptacle, and used as required. In the solution form the shellac is dissolved in methylated spirit or some other solvent, and is then in the form of a liquid, varying in consistency from a watery fluid to one that is almost as thick as cream.

The former is useful as an adhesive for sticking cardboard and other materials together, and can also be used as shown

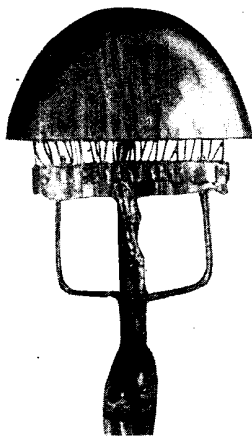

ANODE SHEATH

This sheath or anode is of the type used in Cossor valves; it is notable for its dome-like appearance

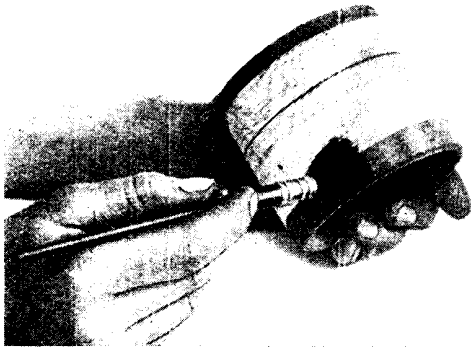

VARNISHING WITH SHELLAC

Applied to such parts as the windings of an inductance coil, shellac assists insulation, and also keeps the wiring secure

in the illustration by brushing it on to an inductance coil to keep the turns of wire in position. Two or three coats may be given, as desired. It may be used for brushing over cardboard tubes which are to be used for formers, and for other purposes. It can also be employed as a kind of varnish for applying to woodwork, and may, in many cases, take the place of other adhesives, although it is not properly such.

The thicker varieties are often known as stick varnish, and can be employed either as an adhesive or insulating varnish. The two kinds of shellac mostly employed are those known as the white and the brown. The former makes a practically colourless varnish; the latter is the form most usually employed in wireless work, and imparts a fairly rich colour to the work. When lump shellac is used, it should be dissolved in methylated spirit, alcohol or other solvent, to the desired consistency, and applied in the ordinary way with a brush.

Shellac is best kept in bottles, and to prevent the cork sticking



and closing the neck of the bottle a good plan is to use a plug made by tightly rolled-up newspaper, or alternatively to place a piece of lincn around the outside of the cork. A loose end is left projecting, so as to give a firm hold for removing the cork.

SHELL TRANSFORMER.

Expression applied to some forms of inter-valve, and also to telephone, transformers characterized by the fact that a large portion of the core is outside the coil windings.

One example of a telephone transformer is illustrated as made on this plan. In essence, such a transformer is composed of a bobbin wound with the customary primary and secondary windings, with the usual precautions as regards insulation.

The bobbin has a central hole, and through this is passed a bundle of soft iron wire rods, of such length that the ends that project can be bent around the outside of the windings and arranged to meet or overlap a little. There is thus an outer case of iron wires, and these can be secured with a few turns of binding wire or tape, and the whole thus completed. This type is, perhaps, the most suited to amateur constructors, as it avoids the necessity for punchings wherewith to make the laminated iron closed core. See Amplifier; Transformer.

SHIELDED TRANSFORMER. A type of transformer surrounded by, or incorporating in its construction, a metallic exterior. Both high- and low-frequency

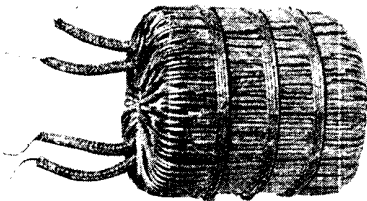

SHELL TRANSFORMER

In this transformer is a bobbin wound with the primary and secondary coils. The core is of iron wire, and is bent over the outside of the windings

Courtesy Economic Electric Co., Ltd.

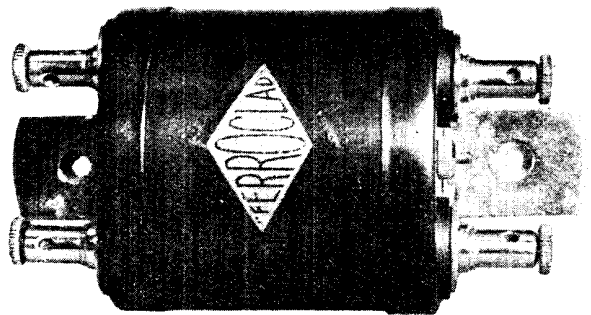

SHIELDED TRANSFORMER

A typical shielded transformer having an earthing terminal situated between a pair of large terminals

Courtesy Economic Electric Co., Ltd.

transformers may be of the shielded variety, although the reasons for shielding them are not necessarily the same.

Shielding a H.F. transformer with a metal casing prevents to a large extent the influence of a neighbouring body, such as the hand, from affecting the tuning of the apparatus. It is common practice to connect a lead from the transformer shielding to a terminal on the receiving set which is connected to earth. This is applicable to transformers of both the high- and low-frequency variety. Earthing the low-frequency transformer enables the eddy currents created during its operation to run to earth, and thus prevents the parasitic noises often traceable to the presence of eddy currents.

A low-frequency transformer is illustrated in which the earthing terminal is seen between one pair of terminals. This transformer is entirely shielded, two iron end pieces being fitted and the terminals insulated from them by means of insulated washers.

The primary reason for shielding low-frequency transformers is to prevent interaction with other parts of the apparatus caused by the magnetic lines of force from the transformer cutting the adjoining apparatus, and thus affecting their correct functioning. For this reason the metal used in shielding low-frequency transformers is usually made of soft iron, which readily absorbs the magnetism emanating from the transformer. *See Transformer.*

SHORT CIRCUIT. Expression used for the cutting out of resistance in any part of an electrical circuit, or for the cutting down of the resistance to such a point that it becomes for the purposes of the particular circuit concerned of no value.

The term is generally used in the sense of an accidental cutting out of the resistance rather than an intentional one, though, of course, there are many cases where a part of a circuit is deliberately short-circuited. The word "shorted" is commonly used for short-circuited.

Short circuit is a fruitful cause of trouble to the wireless experimenter. One of the many common causes of a short circuit is the breakdown of insulation. Many single- and double-slide tuners, for example, are wound with enamel-covered wire. During the winding this enamel, if of poor quality, may crack, with the result that the turns of wire are not properly insulated from one another.

The crossing over of battery leads is the cause of a short which generally results in a burnt-out valve. Alternatively, if connexions are badly made to terminals which are close together, a short may come from leads touching. Such a circuit is common, for example, when wiring up a valve. The lead from the plate, if not kept short and close under the holding nut, assuming it is not soldered, may touch one of the filament leads, with the resulting ruin of the valve when the batteries are connected.

The use of uninsulated wire may lead to shorts through the wires sagging and touching after the set has been in use some time. If uninsulated wire is used in wiring up a set, it should be as stiff as possible and kept far away from other leads. It is always better to use insulated wire, or to put an insulating sleeving over the leads if the wire used is not of a heavy gauge, such as 16 or 18 S.W.G.

Often a receiving set that has been working well suddenly fails without any apparent cause. When every other part of the set has been examined, look at the transformer or transformers. These may have burnt out and become short-circuited. One cause of transformer windings burning out is over-oscillation of the valves, which induces a very high voltage in the secondary windings. Alternatively too high a voltage may be used on the high-tension battery. The trouble usually occurs in the middle of the winding, which is, of course, the hottest part when the windings become heated. The insulation becomes charred or burnt away, resulting in the short circuit.

Short circuits may take place through accidentally earthing a wire, and the part of the circuit to which this happens is said to be earthed. The prevention of short circuits by passing too high a voltage through any part of the set, as, for example, the filaments, is easily arranged for by the use of fuses which immediately break down and prevent the high-tension current from doing any damage. A search for a short circuit in a transformer or in the coils may be carried out in the way described in the article *Faults*. *See Conductor; Current; Earth.*

SHORT-CIRCUITING DEVICE. A means by which a circuit, or apparatus forming a part of a circuit, may be cut out or prevented from performing its usual function in the circuit. There are numerous applications of short-circuiting devices

used in wireless, but as a rule they depend upon the current choosing the path of lesser resistance. For this reason it is important to ensure that the conductor forming the short-circuiting device has a minimum of resistance, which must in any case be considerably lower than that part of a circuit it is desired to short.

A common application of a short-circuiting device is in connexion with the majority of motor starters where direct current is used. An electro-magnet is situated in the starter, and retains the switch arm by virtue of its magnetic influence over the latter.

Another electro-magnet fitted to the starter has an armature to which are attached contact pieces. When the load of the motor increases beyond a point consistent with its safety, the armature bearing the contact pieces is raised and short-circuits the magnet retaining the switch arm. As the arm is spring loaded, it flies back and the motor is stopped. A somewhat similar device is often used with dynamos used for charging accumulators and other purposes, and it is important to see that the device is functioning correctly, as the contacts tend to become dirty, and if they fail to operate considerable damage may be done to the plant or accumulators.

In wireless, the short-circuiting device is sometimes used for cutting out the

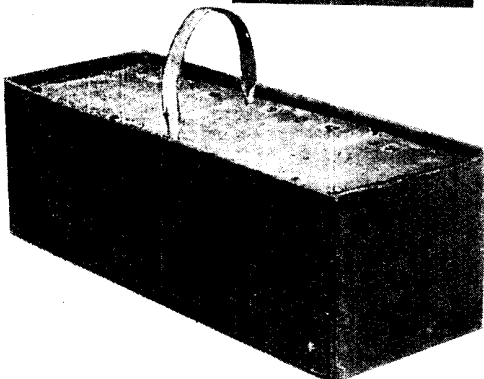
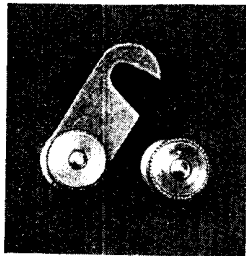

SHORT-CIRCUITING DEVICE

Fig. 1 (below). How faulty cells in an H.T. battery are short-circuited. Fig. 2 (above). A convenient short-circuiting device for mounting on a panel

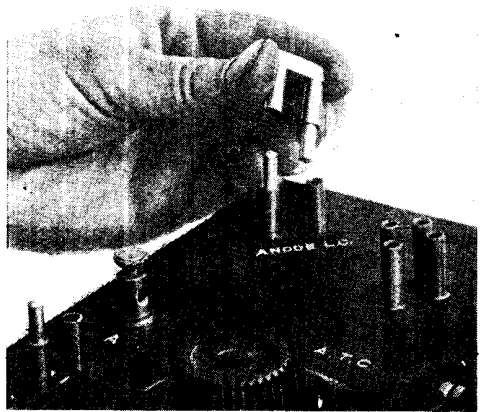

SHORT-CIRCUITING PLUG

Fig. 3 Shorting may be obtained by using this neat device, made for use in conjunction with plug-in coils

effect of a series condenser in a tuning circuit, and the same use may be applied to a loading coil.

It happens occasionally that a receiving set develops parasitic noises due to a faulty high-tension battery. It is not always necessary to scrap the whole battery, as the trouble is often limited to one or two cells, and those that are faulty may be traced with a voltmeter. A strip of springy brass rounded at the ends is prepared and the ends inserted into the sockets to short-circuit the faulty cell. This application of the short-circuiting strip is shown in Fig. 1.

A useful form of short-circuiting device is shown in Fig. 2, where a strip of brass is hinged on one terminal and is capable of engaging on to an adjacent terminal by means of a slot cut in the strip. Such an application is often used on a set for the purpose of cutting out the reaction coil leads when it is not desired to make use of this feature.

Another useful type is shown in Fig. 3, which illustrates a plug-in type of short-circuit device particularly applicable to plug-in coil holders. One common application is to short-circuit a pair of connexions which may have been added in a circuit so that the wave-length range could be increased by the removal of the shorting strip and the substitution of another coil of suitable value. See Lightning Arrester; Switch.

SHORT SPARK. This is another expression for quenched spark. See Quenched Spark.

SHORT-WAVE TRANSMISSION & RECEPTION

The Use of Wave-lengths of from 1 to 200 Metres in Wireless

Here is described one of the most valuable developments of wireless—the Marconi parallel beam with a wave-length of only a few metres—and one of great future possibilities. Detailed instructions are also given for the best methods for the amateur reception of short waves. See also Short-wave Receiver

Short wave is a general comparative term denoting any wave-lengths below about 500 metres, and it may therefore be said to apply to those wave-lengths on which the bulk of wireless telephony is transmitted. It is impossible to state definitely that a certain dividing line between short and long waves exists, for the terms frequently overlap, and wireless engineers are divided in their opinions on this point.

As an instance of this, the Mark IV receiver, used extensively during the war, was universally referred to as "the short-wave tuner," but its ranges were limited to wave-lengths of from approximately 300 to 500 metres.

Amateurs, when speaking of short waves, usually refer to those of from 100 to 200 metres, *i.e.* the wave-lengths which the G.P.O. allotted to amateur transmitters in 1923 onwards.

Considerable attention has been directed to waves of exceedingly short lengths, upon which Senator Marconi has experimented largely with reflected directional transmission. These are of the order of from 1 to 40 metres.

It is interesting to note that the very earliest experiments in wireless telegraphy, which were carried out by Hertz, and later by Marconi, were concerned with the propagation of very short waves, by the use of reflectors. As far back as 1896, Marconi demonstrated in England, to the British Post Office, the transmission of signals over a distance of more than $1\frac{3}{4}$ miles, using very short reflected waves. Soon after this, however, enormous strides were made in transmission over great distances by long waves, and the subject of short waves was dropped for a considerable time.

Since that date the development of wireless communication has been so rapid, both in the number of transmitting and receiving stations, and the sensitivity of the latter, that of necessity means of secret, or at least semi-secret, communication have become essential. The normal transmitters radiate equally in all directions, so that anyone in possession of a sufficiently sensitive receiver is at

liberty to pick up any signals, even on an indoor, concealed aerial. The use of coded messages to some extent ensures secrecy, but as no absolutely unsoivable code is in existence, the deduction of the essentials of a message is usually only a matter of time.

In view of these facts, wireless research engineers have devoted much attention to the development of short reflected waves. By this system the waves are propagated in the form of a beam, very similar to the beam of a searchlight; and thus only a receiver situated in the actual path of the beam is able to pick up the signals.

It becomes a simple matter, then, to ensure secrecy, for it is extremely unlikely that anybody, except those in possession of the details of the direction of the transmitting reflector, would be situated exactly in the beam. Apart from that, reflection means concentration, and experiments show that far less power is required to transmit over a given distance and with a given receiver than with the unidirectional method.

From the fact that the reflected wireless waves travel in a beam, it follows that real directional wireless becomes a possibility. For some considerable period commercial short-wave beam transmitters have been made and fitted to various ships for the purpose of taking bearings by wireless. The latter use of beam transmission is effected by means of a rotating reflector mounted on a turn-table, and driven automatically at a constant number of revolutions per minute. Thus a continuously rotating beam is transmitted. The turn-table is synchronized with a Morse transmitting mechanism, which causes a certain definite signal to be transmitted at every few degrees of the rotation of the turn-table.

These signals are standard for all transmitters of this type, and a chart showing the transmitted signal at every point of the compass is issued with every receiving set. This is illustrated in Fig. 1. It will be seen, therefore, that when a receiving operator hears a signal on his

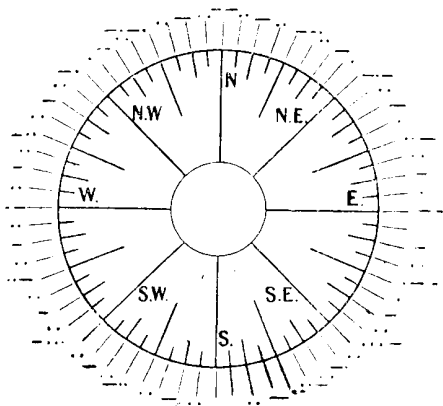

SHORT-WAVE CHART

Fig. 1. Chart showing the transmitted signals at all points of the compass made by a short-wave transmitter for ships at sea

beam receiver, he has merely to note the particular Morse character and look on his chart to see what point of the compass it represents. From this he may immediately know his precise bearings in relation to the ship which is transmitting.

In foggy weather, and in congested waters, this equipment is of inestimable value to the navigating officer or pilot, for the information of bearings is obtained without any appreciable delay. The application of such a device to every light-house is only a question of time, and will prove of enormous utility to all wireless-equipped vessels.

Referring now to the actual construction of the aerial and reflector systems for the transmitter, the illustration, Fig. 2, will clearly indicate the general construction of the apparatus.

The particular reflector illustrated is that of a special experimental station at

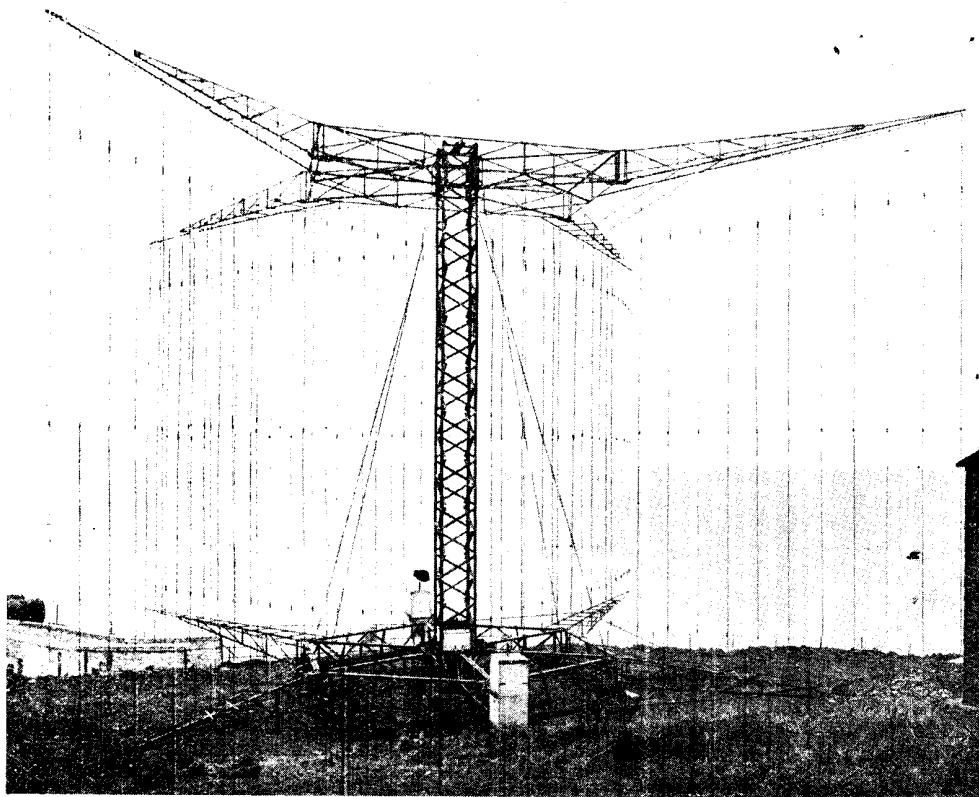

AERIAL AND REFLECTOR SYSTEMS OF A SHORT-WAVE TRANSMITTER

Fig. 2. On Inchkeith Island in the Firth of Forth this large short-wave transmitter has been erected for the transmission of signals to vessels at sea. A very short wave-length is used

Courtesy Marconi's Wireless Telegraph Co., Ltd.

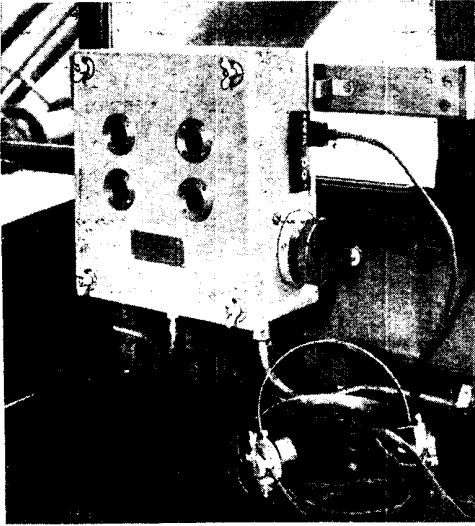

MARCONI BEAM RECEIVER

Fig. 3. Totally enclosed in a damp-proof cabinet this four-valve receiver, on the s.s. "Royal Scot," is used in conjunction with the experimental reflector shown in Fig. 2

Courtesy Marconi's Wireless Telegraph Co., Ltd.

Inchkeith. It will be seen that there are two frameworks, one at the top and the other at the bottom, between which the wires composing the reflector are strung. The curve of this framework is in the form of a parabola. Careful examination of the picture will reveal the fact that there is a short length of fairly stout rod situated in front of the reflector, at the centre. This is the aerial, and it is placed in the point of focus of the parabola.

Waves radiated from the aerial are, of course, transmitted in all directions, but, situated where it is, the waves are all caught by the reflector wires and projected forwards in a perfectly parallel beam. In the case of the apparatus illustrated the wave-length is 4 metres, and the aperture of the reflector is 8 metres. The reflector makes a complete revolution every two minutes, and a special distinctive signal is transmitted at every half point of the compass. By the particular receiving apparatus used in conjunction with this set the bearing of the transmitter may be accurately determined within a quarter point of the compass, or within 2.8 degrees.

The receiving set used in conjunction with the Inchkeith experimental reflector is located on the s.s. "Royal Scot." An illustration of this set is given in Fig. 3. This is a four-valve instrument,

totally enclosed in a stout wooden cabinet, which is water- and damp-proof. Peep-holes for each valve are provided, and the valves are of the V24 type. Tuning is simplicity itself, being entirely operated by rotation of the large knob shown on the right of the set.

This control causes two single loops of copper strip to move towards or away from two small coils. Its movement is in a series of "jerks," this being controlled by a number of spring stops, which retard the natural rotation of the knob. At each point of retardation a pointer attached to the knob spindle comes opposite a line on the dial behind the knob, thus giving the operator a guide to the range on which he is working. The set is placed in the ship's chart-room, near one of the walls, and a lead-in wire runs straight out to the aerial. It is essential that the lead-in be as short as possible.

Fig. 4 is a close-up view of the receiving aerial. Like the transmitter, this is a single length of copper rod. It is attached in a vertical position to a light triangular framework projecting from one corner of the chart-room. An ebonite block is used to insulate the aerial from the framework.

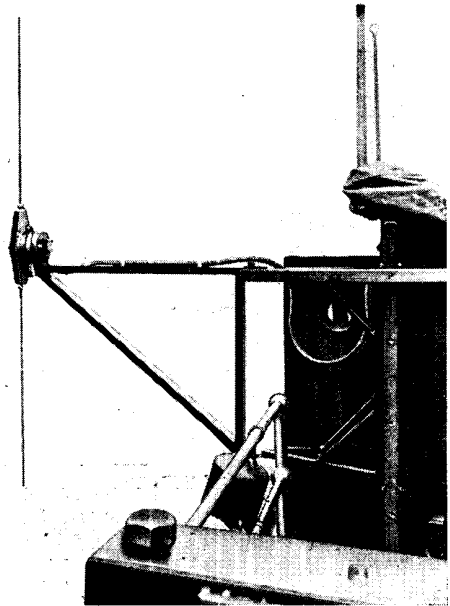

RECEIVING AERIAL

Fig. 4. The aerial receiving the beam transmissions consists of a vertical copper rod attached to a triangular framework outside the chart-room of the "Royal Scot"

Courtesy Marconi's Wireless Telegraph Co., Ltd.

This piece of ebonite is centrally situated with respect to the aerial. The lead-in wire can be clearly seen running along the top piece of the framework.

Recent experiments with reflected transmission systems on short waves prove conclusively that the reflectors cause a very considerable increase in efficiency. For instance, an experimental transmitter was erected at Hendon, London, and worked in conjunction with a suitable receiver at Birmingham. The power used was 700 watts, and with the receiver used very good speech was heard. It was found that the speech was approximately 200 times stronger when using reflectors than without.

as, for instance, between parallel conductors in the set, form actual couplings for the high-frequency currents, and very often form a prolific cause of distortion.

As high-frequency currents tend to travel on the surface of a wire rather than in the body of the metal, it follows that a large gauge of wire should be adopted throughout. Where cost is not of great importance, Litzendraht wire should be used freely, but where this is done the utmost care must be taken to ensure that no one conductor is left unattached, and that the inter-conductor insulation is absolutely unimpaired. Should either of the above faults ensue, it is possible that

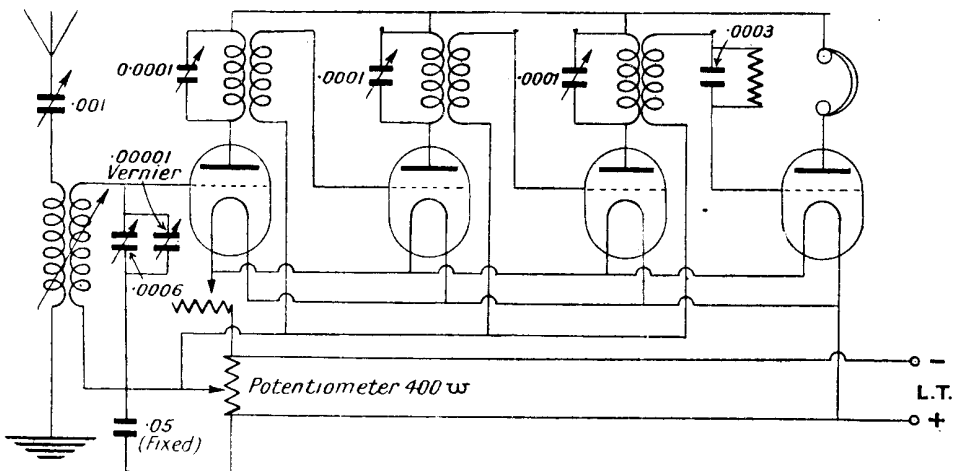

CIRCUIT DIAGRAM OF A SHORT-WAVE AMPLIFYING RECEIVER

Fig. 5. There are here three stages of radio-frequency amplification followed by a detector, and stages of low frequency may be added as desired. Inter-valve coupling is carried out by transformers, and all valves are potentiometer-controlled

An enormous field of utility exists for the beam system of transmission, and there is very little doubt that great developments will be made in that direction, for Marconi has demonstrated that perfect directional transmission and reception on very short waves is possible, even at 2,000 miles.

Reference must now be made to the methods which must be adopted for the successful reception of short wave-lengths by amateurs. The enormously high frequencies at which the short-wave transmission is effected results in extreme care having to be taken in the receiving apparatus to remove all stray capacities. The reason for this is that at these high frequencies all small stray capacities, such

a reduction of efficiency rather than an increase will result.

Again, all coils used should have the smallest physical dimensions possible in order to increase the concentration of the resultant fields. This will give much sharper tuning and will considerably reduce body capacity.

The inter-electrode capacity of valves probably presents by far the greatest problem, and on very short wave-lengths the use of valves of the V24 type is practically an essential. In these valves practically the only capacity exists between the actual electrodes themselves, for the leads to the electrodes are all spaced as far apart as possible. Further, the contacts to the electrodes are also

widely spaced. In the ordinary valve fitted with a four-pin cap the inter-electrode capacity is in the neighbourhood of .000031 mfd., but in the V24 valve it is reduced to .000001 mfd. The enormous difference between these two figures is noticeable. The amplification factor of the V24 valve is approximately 12, and it requires a filament voltage of from $4\frac{1}{2}$ to 5, and an anode potential of from 60 to 70.

Radio-frequency amplification on short waves is probably best carried out by means of transformer coupling. This system is to be preferred to the tuned anode system, because it is usually more stable and capable of more sensitive grid potential control. Transformers should have a ratio of 1 : 1, and two small basket coils of equal dimensions and electrical characteristics will probably give the best results.

On no account should the four-pin plug-in type of transformer be used, on account of the capacity between the pins and sockets. Where condenser tuning across the primaries of the transformers is considered desirable, this winding may, with advantage, be about two-thirds the size of the secondaries. The variable condenser should have a maximum capacity not exceeding .0001 mfd. Further, the end-plates of the condensers should be of ebonite or other high grade insulating material, for the metal-ended instruments possess a relatively high minimum capacity.

A suitable circuit for an amplifying receiver for very short waves is given in Fig. 5. This has three stages of radio-frequency amplification, followed by a detector. Low-frequency amplification may be added as desired. The inter-valve coupling on the radio-frequency amplifier is by means of transformers.

Marconi V24 valves should be used for amplifying, and a Q type for rectifying. The use and disposition of the potentiometer should be noted. It should have a resistance of 400 0. ms. The values of all the condensers are given, and in no case should the figure be exceeded.

For reception of the American transmissions from K D K A on 100 metres, suitable windings for the transformers would be as follow : Use basket windings with an external diameter of 2 in. and a bore of $\frac{3}{8}$ in. If the primary is to be tuned by a .0001 mfd. variable condenser, then the latter should have 25 turns, while if it

is to be untuned it should be of 40 turns. In either case the secondaries should be wound with 40 turns. The gauge of the wire should be No. 28 S.W.G., and it could, with advantage, be double silk covered. The use of shellac is to be avoided, for it considerably increases the self-capacity.—R. B. Hurton.

SHORT-WAVE CONDENSER. Condenser used in series with an aerial to decrease the wave-length of the latter.

The wave-length of a radiating circuit may be varied by altering the value of either the inductance or capacity, or both, in it. By increasing the inductance, by means of a variable inductance, for example, the wave-length can be increased as desired. But it cannot be decreased by the same means below the value which depends upon the inductance of the aerial itself and the minimum number of turns in the variable inductance. So if the natural wave-length of the radiating circuit is, say, 600 metres, other means must be adopted to reduce it to 400 or 300 metres. This is necessary, since a radiating circuit is most efficient on its natural wave-length.

By suitable choice of the value of the condenser the natural wave-length of the aerial may be reduced as required. The figure shows how the condenser is inserted in the aerial-earth circuit, a switch being shown which is used for cutting in the condenser or cutting it out as may be required. If it is wished to radiate on, say, a 300 metre wave when the natural wave-length of the aerial is 600 metres, a condenser of the same capacity as that of the aerial is connected as shown, and the total capacity of the system as a whole is reduced.

Short-wave condensers are used on ships' transmitters. The construction of such condensers follows the lines of the main condensers, consisting of alternate plates of glass and zinc. There are at least three glass plates between each two zinc plates to act as an efficient dielectric, since the short wave condenser has to withstand considerable voltages. See Main Condenser.

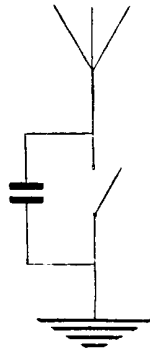

SHORT-WAVE CONDENSER
Here a condenser is used in series with aerial for short-wave transmission

SHORT-WAVE RECEIVER AND HOW TO MAKE IT

A Set which Overcomes the Difficulties in Reception on 100 to 300 Metres

With ordinary tuning apparatus and valves it is not possible to receive efficiently wave-lengths much below 300 metres. The receiver here described will function efficiently on all wave-lengths between 100 and 300 metres and will be found of considerable service to the experimenter. It is illustrated with a special photogravure plate. See also Short Wave ; Valves for Reception

The short-wave receiver, either crystal or valve, should be capable of reception on wave-lengths of about 200 metres and less. The short-wave receiver has come into prominence since the advent of British broadcasting, as the amateur transmitter is restricted largely to lower wave-lengths in order to avoid interference with official broadcasting.

Particular care must be taken with the design of short-wave receivers if the same efficiency as that of the higher wave-length instruments is to be maintained. To this end, dead ends on inductances should be reduced to a minimum and the effects of stray capacities eliminated as far as possible.

Probably the biggest obstacle in the way of an efficient short-wave receiver lies in the reaction coil, which is usually made with too large a value. The effect of this is to limit the decrease of wave-length to that of the fundamental wave-length of the reaction coil. It is obviously not possible to receive a wave-length below that to which the receiving set itself is oscillating. If it is found, therefore, that the receiving set does not respond to an adjustment of the aerial tuning circuit beyond a certain point, the reaction coil value should be reduced. If this is found to have a beneficial effect in obtaining a lower wave-length, the operation should be repeated until the correct value for the wave-length desired is obtained.

Wire for the Aerial Tuning Coil

Another common fault in the design of short-wave receivers lies in the winding of the aerial tuning coil with too fine a wire. Any gauge over 20 S.W.G. should be considered too fine. Dead-end effects may be eliminated by the use of plug-in coils capable of obtaining the desired wave-length, using as small a condenser as possible for tuning. A suitable aerial inductance coil of the spiral pattern is described below in the construction of a short-wave crystal receiver.

The completed receiver shown in Fig. 1 is designed to operate on wave-lengths

from 100 to 300 metres, the greatest efficiency being found on the higher wave-lengths.

The aerial tuning coil consists of $12\frac{1}{2}$ ft. of $\frac{1}{4}$ in. strip brass or copper of about 20 or 22 gauge. Its helical shape is obtained by winding the complete length around a small cylindrical former, and, when the spiral is completed, it is retained in this position by tying a piece of wire tightly round it. This operation is shown in Fig. 2. The spiral may be left in this condition until required.

How the Cross-pieces are Made

As shown in Fig. 1, four cross-pieces are used to space the spiral and to fix it in position to the back. These pieces are made from strips of $\frac{1}{4}$ in. ebonite having a length of $3\frac{1}{4}$ in. and a width of $\frac{1}{2}$ in. Each cross-piece consists of two pieces of ebonite of the above dimensions and slotted on their adjacent faces, the depth in each case being half that of the width of the spiral. The cross-pieces are rounded at the ends, and should be kept in pairs so that each pair will present flush edges when assembled. A hole is required at each end through which a screw serves to secure the spiral to the back. The saw cuts which constitute the slots are spaced $\frac{3}{16}$ in. apart. When cutting the slots, the two halves forming one cross-piece are sawn together to ensure the slots in the opposing sides registering correctly. The method of doing this is shown in Fig. 3.

The flat ribbon is now released from its condition of tension and will be found to have assumed a spiral very similar to that required.

The cross-pieces are fitted next, as shown in Fig. 4. The back is a $\frac{1}{4}$ in. ebonite panel measuring $7\frac{1}{2}$ in. high and $6\frac{1}{4}$ in. in width. A central hole is drilled through which the spindle of a low value condenser is passed. A .00025 mfd. variable condenser may be used, and is fixed to the back of the panel. This condenser is not absolutely essential, sufficiently fine tuning being accomplished by sliding the aerial clip along the spiral.

If the tuning part of the set is applied to a valve set, a reaction coil can be fitted in place of the variable condenser, a variable coupling being obtained by sliding the coil forwards or backwards.

A wooden platform, $\frac{3}{8}$ in. thick and 5 in. from back to front, is secured to one of the shorter sides of the vertical panel by means of two brass brackets, this platform being of the same width as the back. This feature is shown in Fig. 5. The spiral is now mounted centrally by means of the screw holes drilled at the ends of the cross-pieces. The operation of fitting the spiral is shown in Fig. 6.

Terminals for connexion to aerial and earth are attached to the top left and right sides of the panel, the latter terminal being connected direct to the outer end of the spiral.

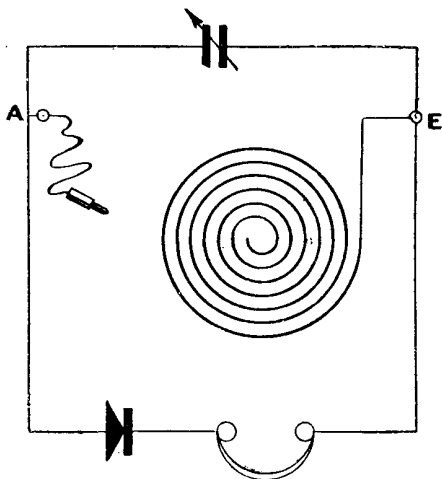

THEORETICAL CIRCUIT

Fig. 11. Nothing could be simpler than the wiring of the short-wave receiver, as shown here

Any good quality crystal detector may be used, and is mounted in the centre of the platform. To the right of the detector a strip of ebonite bearing two telephone terminals is attached. These positions are made clear in Fig. 7, which gives a lay-out of the components.

The wave-length of the set is varied by means of a plug connected to the aerial terminal by a short length of flexible wire. A suitable plug for the purpose may be made from a split valve leg to which is attached an ebonite handle. Details of the clip are shown in Fig. 1, where it is seen being fitted to the spiral. The tuning condenser is seen in side view

in Fig. 9. It should have ebonite and not metal end plates.

The wiring of the receiver is extremely simple, a diagram being shown in Fig. 11, while the completed wiring is illustrated in Fig. 10. A useful feature of the receiver is a means of calibrating the inductance. A number of small ebonite blocks are made and cut in the centre to enable them to clip on to the spiral, the front face being marked with the wave-length corresponding to the position the block occupies on the spiral. The correct positions can only be found by actual test with the set in operation. A number of wave-length clips is shown in Fig. 8.—*W. W. Whiffin.*

SHUNT. In circuits this is equivalent to parallel. For example, a fixed condenser is said to be shunted across the telephones when it is wired up in parallel. In this case one side of the condenser is connected to one telephone terminal, and the other side to the other telephone terminal. In a similar way, when one part of a circuit is wired up in parallel with another it is said to be shunted across it. A condenser placed in parallel or shunt with part of a circuit is often known as a shunt condenser.

For the purpose of decreasing the sensibility of a galvanometer and preventing damage to the instrument it is often necessary to allow only a portion of the current to pass through it. This is arranged for by connecting the terminals of the galvanometer by a wire which is known as a shunt. If, for example, it is required to send only one-tenth of the current through a galvanometer, the terminals are connected by a wire which has a resistance one-ninth of the total resistance of the galvanometer. If one-hundredth of the current only is required to pass, the shunt wire should have a resistance equal to one ninety-ninth of the galvanometer resistance, and so on.

In the same way, to increase the range of an ammeter and enable large currents to be measured a shunt is used with the ammeter. An ammeter which is normally rated for a maximum of a fifth of an ampere, for example, may be made to measure currents up to two amperes by shunting it with a wire which has a resistance equal to one-ninth that of the ammeter. In this case one-tenth of the current only goes through the ammeter, and the other nine-tenths through the

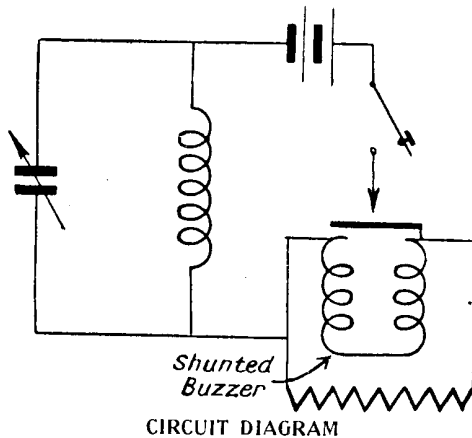

CIRCUIT DIAGRAM

Fig. 1. By means of a resistance the buzzer coils are shunted to prevent sparking at the interrupter

shunt. So generally a shunt circuit is a divided circuit, *i.e.* the current has two paths along which it may travel. See Parallel; Series.

SHUNTED BUZZER. Name given to a type of buzzer in which the coils are shunted by a resistance to prevent sparking at the interrupter. The diagram, Fig. 1, shows the connexions of a shunted buzzer in a closed oscillating circuit. In such a circuit when the interrupter breaks it, there is induced a large electro-motive force of induction in the buzzer coils, and this tends to make the current spark across the interrupter.

The oscillations would be damped out, as the energy stored up in the oscillating coil would flow via the interrupter rather than through the condenser, since the break at the interrupter is not completed. When the coils are shunted as shown, however, the induced voltage flows through the shunt instead of sparking across the interrupter, and the energy of the oscillating coil must go through the condenser. The resistance of this shunt across the coils is

comparatively small, from 10 to 14 ohms. It has to be suitably chosen with the battery, for if it is too low a value the buzzer will not act, the battery current travelling through the resistance instead of through the coils. Nor should the resistance be too high, or it will not allow the induced electro-motive force to pass through it, and sparking will occur at the interrupter. Fig. 2 shows two types of shunted buzzers made by Marconi's Wireless Telegraph Company.

The resistance used in a shunted buzzer usually consists of a small bobbin of silk-covered platinoid or german silver wire. See Buzzer.

SHUNTED CONNEXIONS.

The expression shunted condenser, or references such as a condenser shunted across a coil,

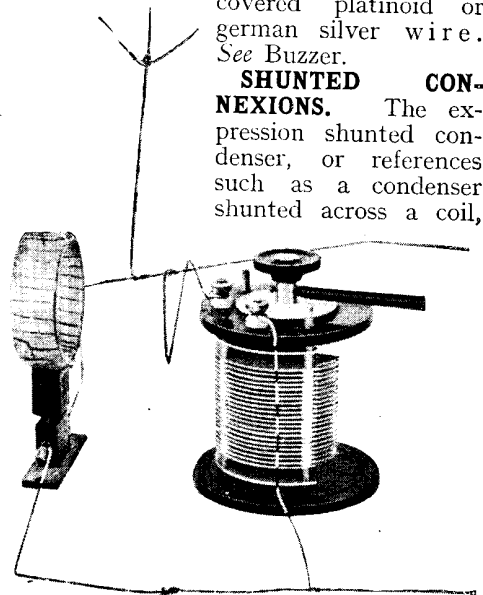

SHUNTED CONNEXIONS

Fig. 1. The mode of connecting coil and condenser in shunt is clearly shown here

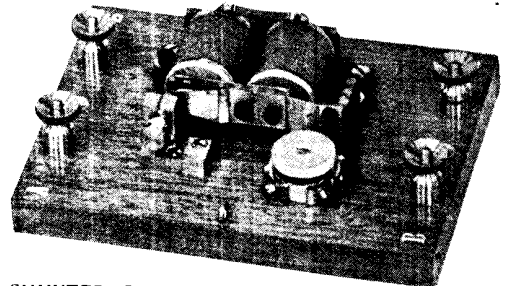
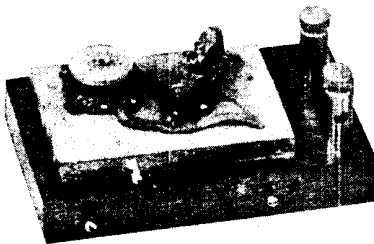

SPECIAL TYPES OF SHUNTED BUZZERS

Fig. 2. In these particular types of buzzers the coils are shunted by a resistance of silk-covered wire, either of platinoid or german silver, to prevent sparking at the interrupter

Courtesy Marconi's Wireless Telegraph Co. Ltd.

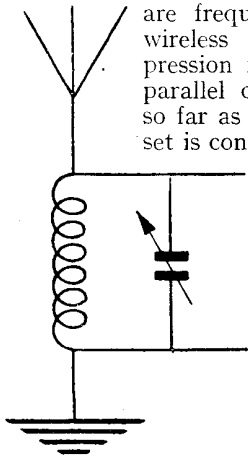

SHUNT CIRCUIT

Fig. 2. Theoretical circuit of pictorial lay-out in Fig. 1

are frequently met with in wireless literature. The expression is synonymous with parallel connexions, at least so far as the average wireless set is concerned.

A pictorial lay-out of a simple aerial tuning circuit is illustrated in Fig. 1, and shows graphically what is meant by these expressions; the theoretical diagram given in Fig. 2 corresponds with Fig. 1.

It will be observed that a wire connects from the aerial lead-in, shown by the characteristic symbol, and branches to a terminal on one side of the condenser and also to one side of the inductance coil. A third wire connects to the detector, not shown in the illustration. The remainder of the shunt connexions consist of a wire from the other side of the coil, and another from the second terminal of the condenser, these being joined together, and both are thus connected by a single wire to the earth lead, shown by the usual symbol. See Parallel; Series; Shunt.

SHUNT WOUND. Name given to a form of winding of the magnet coils in a dynamo or other electrical generating machine. In a shunt-wound dynamo only a small part of the current in the armature passes through the field winding.

The diagram shows the way the field windings are arranged in shunt with the armature. The field magnets are wound with a large number of turns of thin wire, so offering a large resistance. Only a small part of the induced current taken from the armature is used to excite them, therefore, the greater part of the current being delivered to the main external circuit. See Dynamo; Generator.

S.I.C. This is the standard abbreviation for specific inductive capacity. See Dielectric Constant.

SIEMENS. Name that is well known in wireless work in connexion with a large variety of products supplied by the firm of Siemens Brothers & Co., Ltd., of Woolwich, England.

These range from a large and complete transmitting and receiving set to the smaller components such as connecting tags, switches and the like. Dry batteries for supply of electrical energy for the filament circuit and the high-tension circuits are other well-known items used by most amateurs.



SIR WILLIAM SIEMENS, D.C.L.

Dr. Siemens, along with his brothers Werner and Carl, founded the famous firm of Siemens Brothers. The business was at once distinguished by its being able to give practical fruit to its eminent founders' researches

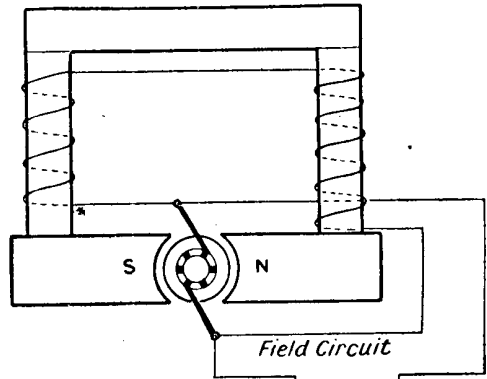

SHUNT WOUND

How the shunt winding of the magnet coils of a dynamo is carried out

To Main External Circuit

Many of the Siemens products are dealt with in this Encyclopedia under their respective headings, to which reference should be made.

SIEMENS DYNAMOMETER. Instrument for measuring alternating currents. It is a moving coil instrument, and the indicating pointer shows the force required to keep the moving part in equilibrium. In the Siemens dynamometer the displacement of the moving coil is limited actually to a few degrees each side of the position of balance. See *Electro-dynamometer*.

SILENCER. In wireless this is the name given to any arrangement for enclosing the spark gap to lessen the noise due to the sparking. One form of silencer consists of a glass tube fitted with wooden ends through which the discharge rods of an induction coil are passed, so totally enclosing the gap. Another form of silencer as used by Professor J. A. Fleming consists of a cast-iron case with thick walls. In this case is a peep-hole of thick plate glass. Through stuffing boxes or glands are passed ebonite rods, down the centre of which go the metal rods at the ends of which are the spark balls. The diagram shows a section of the Fleming silencer and makes the construction clear.

The silencer, it will be noticed, is fitted with a pressure gauge and pipe. It is only perfectly silent if the iron casing is thick and the casing is gas-tight. The pressure gauge indicates the pressure when compressed carbonic acid gas or nitrogen is used in the silencer, or compressed air. As is well known, for any given voltage the length of the spark varies inversely as the total pressure.

SILENT POINT. In beat reception of continuous waves that point where the generated and received oscillations are exactly in tune and there is no beat to be heard. See *Beat Reception*.

SILICON. One of the non-metallic chemical elements. Its chemical symbol is Si and atomic weight 28.3. Though it does not occur in a free state in nature it is, in its compound silica, one of the most abundant of all the elements.

Silicon is a greyish metallic-looking

substance, and in its compounds is important. It is the main component of sandstone, felspar and many other rocks. White sand is nearly pure silica and rock crystal is another nearly pure form.

Silicon carbide is carborundum, which is widely used not only as an abrasive, but also as a well known and efficient crystal detector. Silicon makes a good crystal in contact with zincite or tellurium, though it may also be used with copper, antimony, bismuth, gold or steel. The usual silicon detector consists of a gold or brass point resting lightly on a crystal of silicon. A silicon crystal is very uneven in its sensitiveness, that is to say it has one or two highly sensitive spots while the rest of the surface is unresponsive. For this reason it has been largely superseded by such crystals as galena, for the amateur. Its compound carborundum, however, is

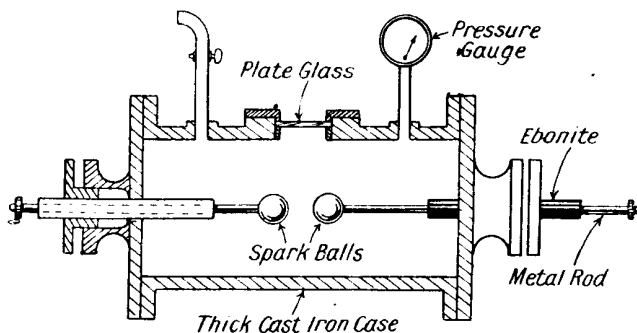

FLEMING'S SILENCER

The spark balls are enclosed in a thick cast-iron casing having a glass peep-hole. Ebonite insulation covers the current-bearing metal rods

one of the best crystals when used with a suitable battery. A carborundum-steel contact is one of the most sensitive and stable of all crystal contacts. The silicon detector was one of the first to be used and for many years was very popular.

In Austin's interference preventer, a double crystal arrangement similar to that described in this Encyclopedia under the heading *Balanced Crystals*, a silicon-arsenic contact is used. This is very sensitive, and has properties analogous to a self-restoring coherer. Loud atmospheric cause a momentary cohesion and lowering of the resistance of the contact, shunting these extraneous signals to earth. There is also a momentary weakening of the received signals which is rather a disadvantage of this form of detector.

As is the case with many other substances used as crystal detectors, silicon is also used in the T.Y.K. arc as one of the electrodes. An alloy of silicon and copper, or silicon, copper and tin, forms silicon bronze, a metal of great tensile strength used largely in wireless work for aeri-als. See Carborundum ; Crystal.

SILICON BRONZE. Name of a metallic alloy composed of silicon, copper and sometimes tin. It has considerable tensile strength and is used chiefly in wireless work for aerial wires, overhead conductors and other purposes where a wire is needed to carry electric current and to resist considerable mechanical tension.

The electrical conductivity decreases as the tensile strength increases ; for example, a wire having a tensile strength of 55,000 lb. per square inch has an electrical conductivity in the neighbourhood of 95 per cent of that of pure copper. When the tensile strength is increased by alteration of the proportions of the alloy to say 100,000 lb. per square inch, the conductivity will have dropped to about 42 per cent of that of copper.

Silicon bronze resists oxidation to a considerable extent, and this is another reason for its extensive use for telegraph wires and for aerial wires.

SILVER. Metallic chemical element. The symbol of silver is Ag, an abbreviation of the Latin name of the metal, argentum. It is whitish in colour and has a notably high metallic lustre. It is the most malleable and ductile of all metals other than gold. The specific gravity varies from 10.47 to 10.62, and the weight per cubic inch is .38 lb. The melting point of silver is 961° C. (1762° F.).

Silver plays a very important part in electrical matters, as it is the standard as regards conductivity both of heat and of electricity. In both cases silver is taken as 100 and all other metals are compared by it.

Silver is also used in computing the ampere, the unit of electrical current, as the constant and steady current which, when passed through a neutral solution of nitrate of silver deposits in one second .01118 gramme of silver on the cathode, is known as one ampere.

Silver can be electrically deposited on other metals under the proper conditions, and thus a film of silver can be built up on an irregularly shaped object as readily as on a smooth or flat surface. This method

is adopted with some wireless apparatus to improve the conductivity or to enhance the finished appearance, as, for instance, on the dials and knobs of the control devices.

Silver having a somewhat lower melting point than brass or copper, is often used in a hard-soldering process for uniting small metallic parts.

The presence of impurities in silver tends to make it brittle, consequently only pure silver is used when the metal is to be drawn into thin wires or otherwise worked mechanically.

SILVER SOLDERING. Method of uniting small metal objects by means of a heat treatment and the application in a molten state of another metal to the surfaces to be united. More particularly, silver soldering is a specific method of hard-soldering brass, copper, iron, steel, silver and german silver, and is so named from the fact that the solder is largely composed of silver.

Essentially the process consists in cleaning the surfaces to be united, applying a suitable flux, raising the temperature of the parts to a red heat and applying the solder, which melts and flows into the joints, thus making a sound and solid piece of work.

There are many applications of silver soldering to wireless work, especially when a special piece of apparatus is needed that is composed chiefly of brass, copper or iron, and the shape is such that it cannot conveniently be made from the solid. The strength of the joint made by the silver-soldering process is almost equal to that of a well brazed joint, and on brasswork can be taken as being as strong as the metal itself, at least from the practical point of view.

Generally speaking all joints are made in the same way, whatever their shape or purpose, consequently a simple example will suffice to illustrate the steps in the process. There is nothing difficult about the work, but success is only attained when certain essential points are observed and adhered to. The chief items are first to have the joint faces perfectly clean, secondly to apply the flux properly, to use a suitable grade of silver solder and place it properly over the joint. The most important is to use the proper kind of flame to heat the work, and to use the clean part of the flame. Finally the joints must fit closely, or be held together

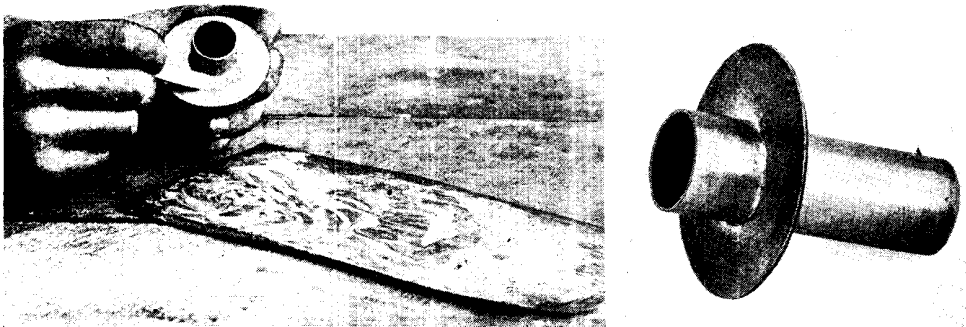

HOW SILVER SOLDERING IS CARRIED OUT

Fig. 1 (left). Borax is rubbed on a clean slate moistened with water and used as a soldering flux. Fig. 2 (right). A well-finished joint; note the single line of silver round the joint face

mechanically, by means of pegs, or binding wires, while the soldering is in progress.

Suppose, for example, it is desired to solder a flange to a brass tube such as might be required for a socket for a frame aerial.

The first step is thoroughly to clean the metal by means of emery paper, filing or dipping in diluted nitric acid and finishing by boiling in clean water. The important thing is to get rid of the least trace of grease or dirt of any kind, and having done so not to touch the parts to be joined.

Next prepare the flux. This may be boracic acid applied in powder form, or more conveniently a piece of lump borax prepared by rubbing it on a piece of clean slate moistened with water.

This, as shown in Fig. 1, works up a sort of lather, which should be stiffened until it is about as thick as ordinary paint, by continuing the rubbing process. This being done, some of the flux is taken up on a piece of clean wood shaped to a chisel point at one end and deposited all round the joint surfaces, pressing the flange home afterwards so that the flux is well down between the joint faces. The silver solder may be that as used by jewellers and composed of something like 70 per cent silver and 30 per cent copper.

This is obtainable in thin sheets about 3 in. square, and has to be cut with stout

scissors or snips into narrow slips and applied to the angle between the tube and the flange, as shown in Fig. 3. The solder has to be cleaned, before applying it to the work, by gently rubbing with fine emery paper. For the sake of economy only clean as much as is needed at the moment, as it soon oxidizes.

The silver is applied to the work with a pair of tweezers to avoid the grease of the fingers. The solder will adhere to the face of the joint, as the flux, being damp, acts as an adhesive. The solder has to be covered with additional flux to preserve it from oxidation when the heat is applied.

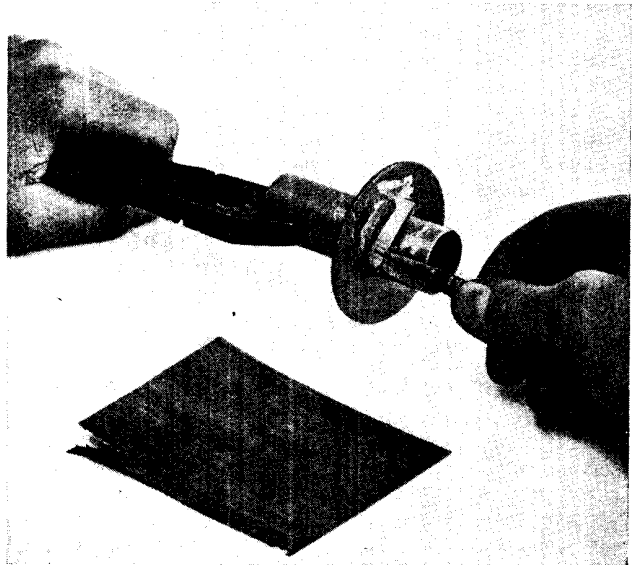

LAYING ON THE SILVER

Fig. 3. Placing the strip of silver solder on the joint. Note the tweezers holding the silver; the borax flux is already laid on

Different compositions of silver solder are used for various metals. For example, if soft brass is to be soldered the "Easy" silver solder, as it is called, should be used when available, and is composed of about 22 per cent copper, 68 per cent silver and 10 per cent spelter.

For use on copper wires and general electrical work a silver solder composed of about 35 per cent copper, 49 per cent silver and 16 per cent zinc gives good results. The jeweller's silver solder as obtainable from most watch and clock sundriesmen is serviceable for all-round work and for steel and iron. In emergency a good joint is obtainable by using a silver coin.

The next requirement is a means of heating the work and shielding it from draughts of cold air. Probably the ideal is a medium-sized gas-heated blow-pipe using the ordinary house gas and having a foot bellows for supplying the necessary air blast to ensure perfect combustion. For very small work a mouth blow-pipe and a Bunsen flame can be used, but most amateurs will have to fall back on an ordinary petrol or paraffin blow-lamp. Whatever the source of heat it must be arranged so that it can play on to a backing or wall of fire-brick, coke blocks, asbestos cubes or some similar device to that shown in the illustration (Fig. 4), so that the heat will not be wasted. The work must be packed up so that the joint is vertical, be well supported so that it will not shift when it gets hot, and so that the flame from the lamp can play on all sides of it.

The blow-lamp is then lighted and the flame worked up to a clean solid shape, when it will be noted that there are two separate portions one within the other. The inner cone-shaped part is relatively bright blue, and is known as the clean flame; the outer is rather more yellow. The part to use is the point of the inner blue cone; the outer part can thus exclude the air from the joint face, and assist the flux in preventing oxidation of the surfaces, as this would prevent a perfect joint. For the first few moments the

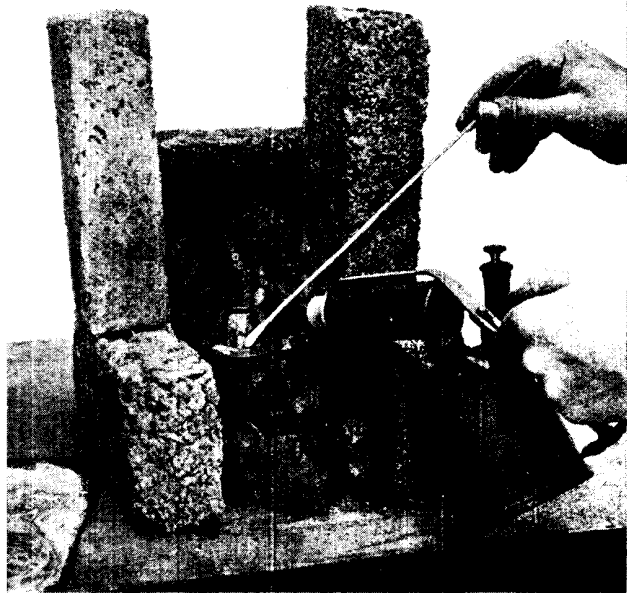

APPLYING THE HEAT

Fig. 4. A blow-lamp is employed to melt the solder used in effecting the completed joint

flame should be swept across the work slightly until the water is dried out of the flux, which will appear to boil up and then turn white. At this moment concentrate the point of the clean flame on the joint, and do not let it be removed until the work is glowing red hot.

Watch the solder all the while to see that it does not get blown away by the force of the flame. It will be seen to soften at about the same time as the work gets red hot. This is the crucial moment, and the clean flame must be kept on the solder until it melts and flows into the joint. Directly this happens withdraw the flame and allow the work to cool off slowly until it is almost cold, when it may be dipped into cold water, which will crack off most of the scale that remains from the flux. Should there not be sufficient flux it can be added during the heating process by applying it on the end of a heated piece of iron rod, as shown in Fig. 4, and additional solder can be added in the same way.

When finished the surplus flux is cleaned off by filing or with the aid of emery paper, and the result should be as shown in Fig. 2, with a film of silver showing on both sides of the joint as evidence that it has flowed right through. Quite a small piece of the solder will answer

for an average joint, as all the silver should go into the joint; any on the exterior is so much waste, as it does no good at all to the joint. Should a blue flame appear on the brasswork while soldering, immediately reduce the temperature, as it is evidence that the brass is being burnt and spoiled.—*E. W. Hobbs.*

See Soldering.

SILVERTOWN. Name given to the products of a well known firm of electrical and wireless manufacturers known as the India Rubber, Gutta Percha and Telegraph Works Company, Limited, and frequently referred to as the Silvertown Company. Their products include electrical generating machinery, electrical motors, instruments and primary batteries.

General insulating material, including insulating tapes, insulated wire and cables, and insulators are a feature of Silvertown manufactures. Two Silvertown insulators, known as Featherweight insulators, are illustrated. A feature of these insulators

stand how it is obtained, and how it shows graphically the regular rise and fall in volts or amperes of the current.

The sine curve can be used in all cases of periodic motion to represent the regular rise and fall of certain factors as the time elapses. Suppose a point P moves round a circle at a uniform speed anti-clockwise, as indicated by the arrow in the diagram. At any particular instant the line OP will make an angle θ with a fixed line X_2OX_1 through the centre O of the circle. As the point P moves round the circle, it is clear that the angle X_1OP increases regularly from 0 degrees to 360 degrees, and begins the cycle of movements all over again.

Now if PM is drawn perpendicular to X_2OX_1 the ratio PM/OP is called the sine of the angle X_1OP , or θ , and is usually written $\sin \theta$. Since OP is constant, and equal to the radius of the circle, the sine of θ is proportional to the length of PM. This length varies from zero when the angle is zero to a maximum equal to the length

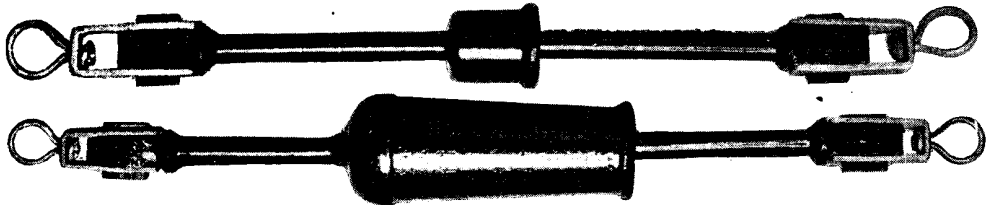

COMMON TYPES OF SILVERTOWN INSULATORS

Fig. 1 (above). The Silvertown Featherweight insulator, a most useful type in aerial construction. Fig. 2 (below). Made by the same company, the Everdry insulator is provided with a hood to prevent leakage from water on the surface of the insulator

is their lightness, which makes them especially suitable for the insulation of wireless aeriels. Fig. 1 gives an illustration of this type of insulator, which consists of a round rod enlarged at its ends to an oblong shape, projections on which are used to hold a metal eye. The eye is provided with a swivel, which allows a twisted aerial wire to unwind itself.

In the centre of the rod an insulated hood or cover is provided to prevent electrical leakage from the surface wetted with rain or moisture. A similar insulator, but having a larger tapered cylindrical cover in its centre, is shown in Fig. 2.

SINE CURVE. An important curve which is used to represent any oscillatory movement. This curve appears so regularly in wireless diagrams in connexion with alternating current and high-frequency currents that it is important that the wireless experimenter should under-

stand how it is obtained, and how it shows graphically the regular rise and fall in volts or amperes of the current. The sine curve can be used in all cases of periodic motion to represent the regular rise and fall of certain factors as the time elapses. Suppose a point P moves round a circle at a uniform speed anti-clockwise, as indicated by the arrow in the diagram. At any particular instant the line OP will make an angle θ with a fixed line X_2OX_1 through the centre O of the circle. As the point P moves round the circle, it is clear that the angle X_1OP increases regularly from 0 degrees to 360 degrees, and begins the cycle of movements all over again. Now if PM is drawn perpendicular to X_2OX_1 the ratio PM/OP is called the sine of the angle X_1OP , or θ , and is usually written $\sin \theta$. Since OP is constant, and equal to the radius of the circle, the sine of θ is proportional to the length of PM. This length varies from zero when the angle is zero to a maximum equal to the length of the radius of the circle when the sine of the angle is unity. This is when the angle is 90° . When the angle has become 180° the length of PM has again become zero and the sine of the angle is zero. At 270° the ratio between PM and OP has again become unity, but it is customary to distinguish between the lengths above X_2OX_1 and below them by calling those above positive and those below negative, so that the sine of 270° is -1 and the sine of all the angles between 180° and 360° is negative, the sine of the angles between 0° and 180° being positive.

Though the point P is moving at a uniform rate round the circle, the length of PM is not varying uniformly. It increases rapidly from 0° and then more slowly as it approaches 90° , then decreases slowly and more and more rapidly afterwards as it approaches 180° , and so on throughout the motion of P round the circle.

Supposing now we draw a straight line AB and divide it off into equal intervals each representing so many degrees. These intervals also represent equal intervals of

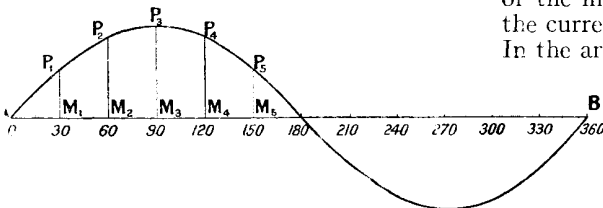
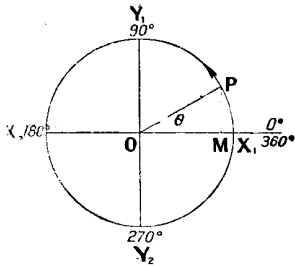

HOW A SINE CURVE IS OBTAINED

An understanding of the principle of the sine curve is of great importance in wireless and electrical work generally

time, since as P is moving uniformly round the circle it takes the same time to describe the same number of degrees. To fix ideas, suppose it takes one second to describe 30°. Then the points on AB conveniently represent either 30° intervals or intervals of one second.

At these degree points draw lines perpendicular to AB and let their lengths be those of PM when the angle θ is 30°, 60° and so on, remembering the perpendicular must be drawn above the line for angles between 0° and 180° and below for angles between 180° and 360°. We then get a series of perpendiculars P₁M₁, P₂M₂, P₃M₃ and so on, and through the points P₁P₂P₃, etc., we can draw a curve. This curve is the sine curve.

The maximum height of this curve above AB is called its amplitude, and the variations of the curve from zero to a maximum, to zero, to a maximum below AB and back again to zero again, is called a cycle. The number of times per second a cycle is repeated is called the frequency, and the duration of a cycle in seconds is called the period.

The terms cycle, frequency, period, etc., will be familiar to the wireless experimenter in connexion with high-frequency alternating currents, and it is now easy to see

how high-frequency currents may be represented by a sine curve. In the case of an alternating current the voltage varies regularly from zero to a maximum, from this maximum to zero again, and then, as the current flows in the opposite direction, from zero to a negative maximum and from this negative maximum to zero again, when the whole cycle of events repeat themselves.

Instead, therefore, of erecting perpendiculars at intervals of so many seconds to represent the line PM, if we erect perpendiculars which represent the voltage at equal intervals of time we obtain a sine curve which is a graphical representation of the increase and decrease of voltage of the current over a given interval of time.

In the article on Alternating Current it is further explained how the sine curve comes to represent alternating currents. See Phase ; Phase Angle.

SINGING ARC. This is an alternative name sometimes given to Duddell's musical arc (q.v.).

SINGLE-FLUID CELL. Name given to a simple primary cell in which only one liquid is used as an electrolyte. The best-known type of single-fluid cell is the

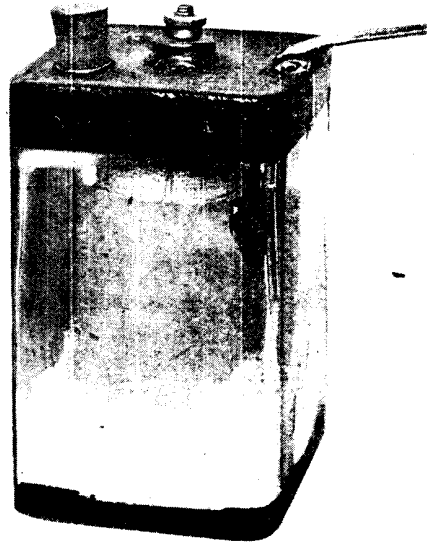

SINGLE-FLUID CELL

Sal-ammoniac is used as the electrolyte in this Leclanché type of single-fluid cell

Courtesy Economic Electric Co., Ltd.

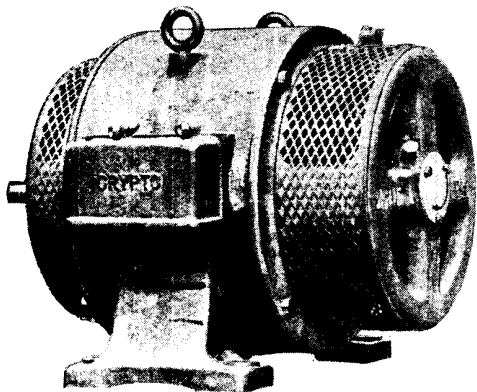

SINGLE-PHASE ALTERNATOR

A semi-enclosed type of single-phase alternator running on ball bearings. Protection and ventilation are afforded by the perforated metal casing at each end

Courtesy Crypto Electrical Co., Ltd.

Leclanché cell (*q.v.*). Cells in which two electrolytes are used are known as double-fluid cells, of which the best-known example is the Daniell cell (*q.v.*). A type of single-fluid cell is illustrated which belongs to the Leclanché type, but is modified to reduce polarization. The two elements are carbon and zinc, the former being enclosed in a sack and surrounded by the depolarizer, while the latter is circular and surrounds the sack. Sal-ammoniac is used for the electrolyte.

The jar in this case is square, and is sealed at the top with pitch. This construction prevents loss of electrolyte by splashing and evaporation, while it also prevents dust from entering. Renewal of electrolyte is provided for by having an opening in the pitch in which a rubber stopper is normally inserted. A screwed-on terminal is attached to the carbon, while the zinc is provided with a heavily insulated tinned copper lead. *See Cell; Dry Cell; Primary Cell.*

SINGLE-PHASE ALTERNATOR. Term applied to an electric generator characterized by the fact that the armature windings are so arranged that the various electro-motive forces set up in the machine are combined to give to the machine an electro-motive force equivalent to a single function of all the windings. Only two slip-ring collectors are needed on machines of this type.

The illustration shows a small single-phase alternator by the Crypto Electrical Co., Ltd. This machine is of the semi-enclosed type and runs on ball bearings. The small space taken by the latter will be noted. The brush gear and slip-rings are fitted within the expanded metal casing and are easily seen whilst running. Further, the expanded metal forms a good protection against mechanical injury, and allows of the circulation of an ample air supply for cooling. *See Alternator; Generator.*

SINGLE-VALVE SETS: CHOICE AND CONSTRUCTION

Economical and Easily Made Receivers with One Valve for Local Broadcast Reception

The commercial and amateur-made sets described in this section are confined to the simplest types for short-range reception. For long-range single-valve receivers the reader is referred to Armstrong Regenerative Receivers; Flewelling Circuit; Reactance; Reaction Set; Regenerative Set and cognate headings. *See also Amplifier; Crystal Receivers; High-frequency Amplifier*

This is a wireless receiving set characterized by the use of one valve and containing within itself a means of tuning, together with the necessary controls. There are innumerable types of single-valve sets in existence differing in their circuit arrangements, their general design, methods of tuning and the purpose for which they are primarily intended.

For instance, the set may be intended as the first of a series of units. On the other hand it may be designed as a complete self-contained device with its own source of energy in the form of batteries concealed in some part of a cabinet or container. Usually, however, a single-valve set comprises a tuning inductance

and condenser for the aerial tuning, grid leak and condenser, a filament resistance for controlling the temperature of the valve filament, and the necessary connexions between these components and their connexions to the high- and low-tension batteries.

One example of a single-valve set is illustrated in Fig. 2 and shows a standard Tingey receiving set comprising a tapped inductance and condenser for aerial tuning purposes, a series-parallel switch for varying the range of reception and a simple switch for switching on the battery current. The telephones are connected in the ordinary way to terminals, as are the different battery connexions and the

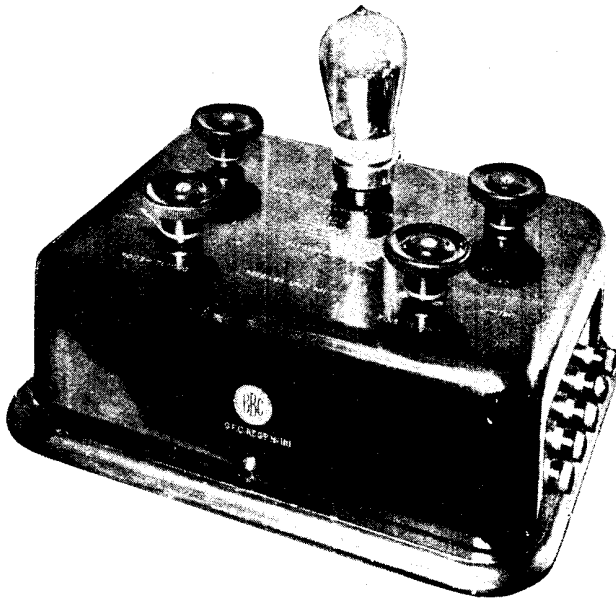

STERLING ONE-VALVE SET

Fig. 1. Many novel features are embodied in the Sterling single-valve receiver. Note the neat stamped metal case

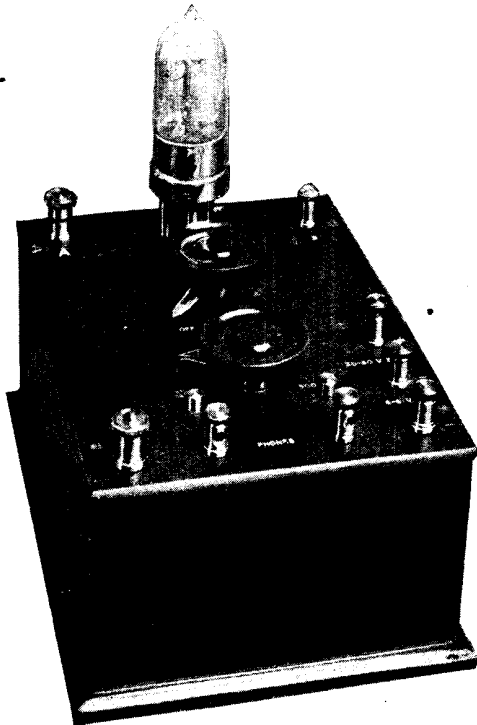

FOR USE SEPARATELY OR IN A BUILT-UP SET

Fig. 3. This Peto-Scott receiver presents a neat and compact appearance; it can be used as a unit in building up a larger set

leads to aerial and earth, the whole set being mounted in a polished wood case.

A small self-contained single-valve receiver is illustrated in Fig. 3. This set comprises a variable inductance (ranging from 300 to 500 metres), a filament resistance and the usual grid leak and condenser. Terminals for all battery connexions and aerial and earth are provided. This set is made uniform in size, shape and terminal disposition with other Peto-Scott units so that L.F. amplifiers and other units of the latter variety may be added as desired. No reaction is fitted in the circuit.

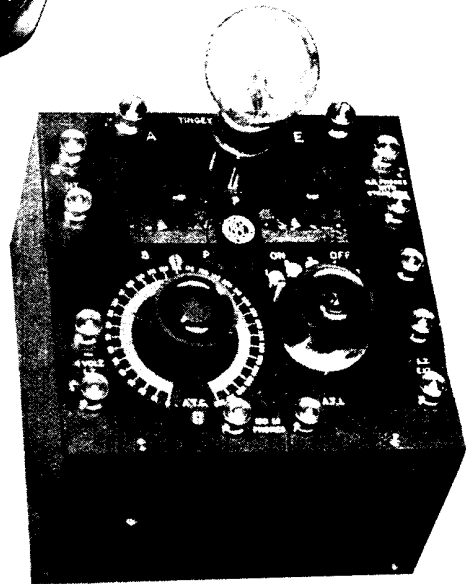

TINGEY SINGLE-VALVE RECEIVER

Fig. 2. This contains a tapped inductance and condenser for aerial tuning, a series-parallel switch for varying range, and a single switch to control the battery circuit

A Sterling unit single-valve receiver is shown in Fig. 1. The most striking feature of this instrument is the case, which is of heavy gauge stamped brass, which provides a substantial and handsome case and at the same time forms a shield against strong magnetic fields. On the outside of the case are the valve holder (containing a dull emitter valve) and the controlling knobs.

The tuning arrangements comprise a variometer for fine tuning, a tapped inductance for coarse tuning, and a series or parallel fixed condenser. A filament resistance is also fitted. Wave-length adjustment of from 280 to 2,800 metres is provided, thus allowing nearly all the telephonic transmissions to be received. The connexions to the set are made through the terminals mounted upon an inlaid ebonite strip. These are identical in disposition and size throughout.

Building a One-Valve Set at Home

A single-valve set may comprise a very simple circuit or may be elaborated to an extraordinary degree. A high-grade set with a suitable circuit will receive over long distances and give very clear and good reception. Usually, however, the single-valve set is looked upon as taking the place of a crystal set and being the stepping stone towards a multi-valve set.

The construction of a simple single-valve receiver does not present any grave difficulties, even to the novice. An amateur-made set is illustrated in Fig. 4, and is constructed from quite ordinary material. The base is composed of an ordinary gas or wall plate in turned wood, such as may be obtained from any ironmonger's, and measures about 6 in. in diameter. Upon it is mounted an outer casing made from a piece of cardboard tube, $4\frac{3}{4}$ in. in diameter and 6 in. long.

To ensure a perfect fit between the base and the bottom part of the tube, a sheet of sandpaper should be placed on the bench as shown in Fig. 5 and secured by means of a couple of wires or tacks to the bench. The piece of cardboard is then moved over its surface with a circular motion, which, if carefully done so that the tube does not rock about, will result in a nice smooth surface. The upper end is similarly treated, and to ensure parallelism it is as well to measure at two or three different places along the tube and mark a line around it, and then to wrap a piece of paper to the line indicated by the pencil marks. This should be done after the bottom end has been finished.

The next step is illustrated in Fig. 6, and that is to fit the tube to the base, for which purpose the edge of it should be filed to form a little groove or rim, so that the cardboard tube can fit firmly against it. It can be ultimately secured in

position with glue or shellac, with a further fixing of a few pins. The next requirement is an ordinary inductance, together with a suitable slider, such as that illustrated in Fig. 7. This inductance may consist of about 60 turns of No. 22 gauge enamelled copper wire, wound on a cardboard tube former about 3 in. in diameter. The slider and slider-bar can be obtained from any wireless dealer, and are mounted on to this inductance by means of two pillars of ebonite, which are screwed to the cardboard tube by passing the screw from the underside of the tube into a hole tapped in the ebonite. To prevent the head of the screw pulling through the tube a washer is introduced between the head of the screw and the tube.

The slider-bar is secured by a screw to the upper pillar and by a telephone terminal to the lower one. One end of the winding is connected to this terminal, the other end is left free, as is visible in Fig. 7. The insulation on the winding should be scraped or filed away to form a bared path for the plunger on the slider so that contact is made on any part of the winding. Various ways of doing this are described under the heading Contacts (*q.v.*).

Details in the Construction of the Inductance

The slider should be carefully adjusted and tested to see that it makes contact over the whole of its range of movement along the bar, and that contact is made both between the plunger and the bared path on the inductance winding, and also to the slider-bar itself. This may be tested by connecting a dry battery and a pair of telephones in series with the terminal on the slider-bar and the loose end of the winding. If the contact is perfect, clicks will be heard in the telephones when the slider is moved along the path, any blind spots being indicated by the absence of sound in the telephones.

When the inductance has been made a hole is cut through the outer face of the cardboard case to permit of the passage of the slider of the inductance as illustrated in Fig. 8. The inductance is held to the base by means of screws passed through a piece of ebonite which rests on the top of the inductance former and is held to the base by means of a long piece of screwed rod with a nut on its upper end, the lower end of the rod being screwed into the wooden base, the work at this stage in the proceedings being illustrated in Fig. 8.

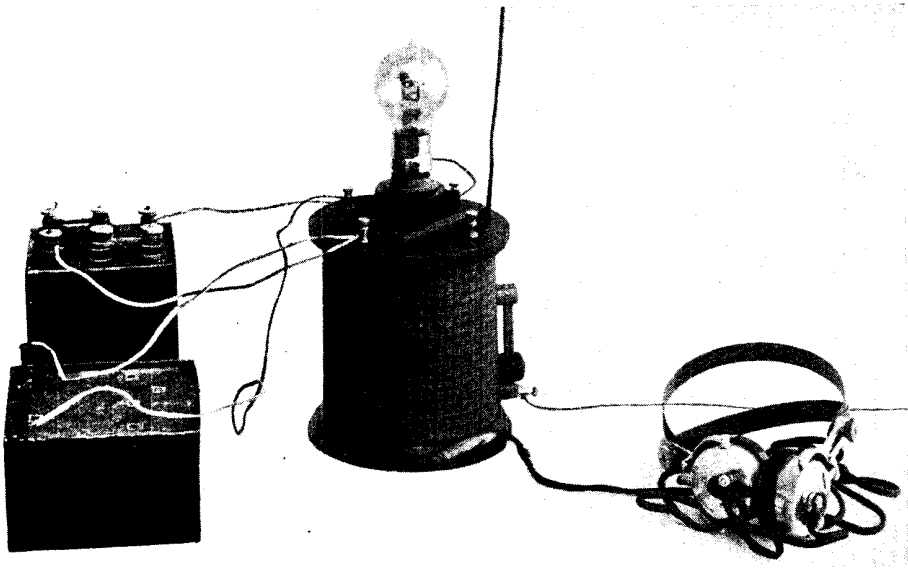

Fig. 4. Here is illustrated the completed amateur one-valve set; it is shown connected ready for the reception of broadcast concerts



Fig. 5. The process of flattening the end of the outer case. This is necessary to ensure perfect fitting, and is accomplished by rubbing on sandpaper



Fig. 6. Fixing the case to its base, an ordinary circular gas plate as used in incandescent and other burners

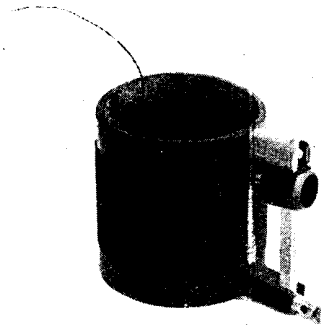

Fig. 7. The slider fitted on the inductance, which consists of a coil having sixty turns of 22 gauge enamelled copper wire

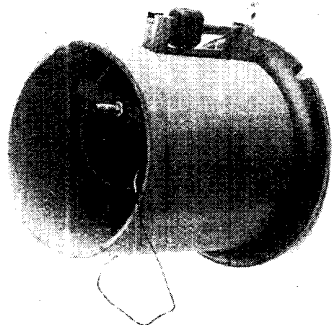
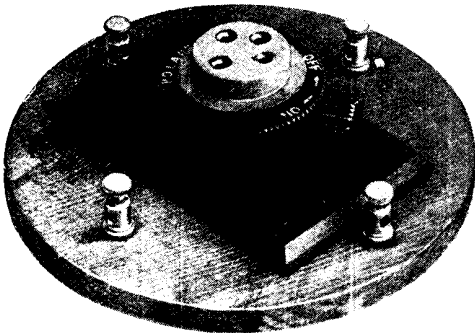

Fig. 8. Here the inductance is shown fitted. A long hole in the case allows the slider to move along the coil

HOW THE HOME-MADE SINGLE-VALVE SET IS CONSTRUCTED



PANEL AND FILAMENT RESISTANCE

Fig. 9. A Polar filament rheostat and valve platform combined is mounted on the terminal board

The next part of the work is to prepare a disk of wood about 6 in. in diameter and $\frac{3}{8}$ in. in thickness, or if preferred a disk of ebonite may be employed. A hole is cut in the centre of the disk about $1\frac{1}{2}$ in. in diameter to permit of the passage of the four terminals on the underside of the valve holder. A convenient type to use is that shown in the illustrations and known as the Polar Blok Holderstat. This comprises a flat ebonite plate having mounted upon it a valve holder, and suspended around the outside of the valve holder a movable ebonite ring, which governs the filament resistance. This ring, when rotated, serves to switch on the low-tension current, and to control the heating of the filament through the medium of the resistance wire that is incorporated in the device.

This is simply screwed to the upper part of the disk, as shown in Fig. 9, by means of

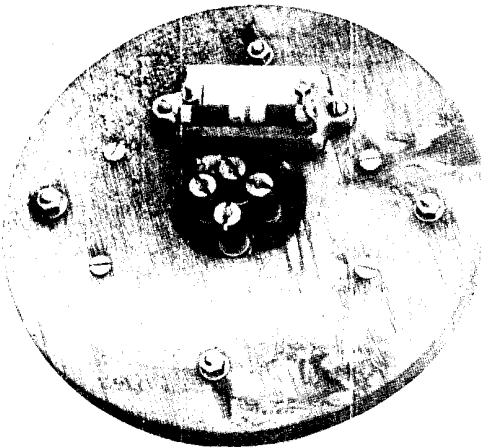

UNDERSIDE OF THE PANEL

Fig. 10. Here is clearly shown the situation of the valve legs, also the grid leak and condenser.

four screws passed through the disk into holes already provided in the container. Four telephone terminals are then fitted, one near the centre of each of the four sides of the Polar unit.

Unless very dry wood be used, these holes should be carefully bushed with ebonite to prevent any possible leakage. An underside view of this part of the apparatus is shown in Fig. 10, which also shows the whereabouts of the grid leak and condenser. These may be of any reliable components, those illustrated being by the Edison Bell Co. and having a value of $1\frac{1}{2}$ megohms and .00025 mfd. respectively.

The next operation is the wiring, and this is perfectly simple. The theoretical circuit diagram is given in Fig. 11, and this

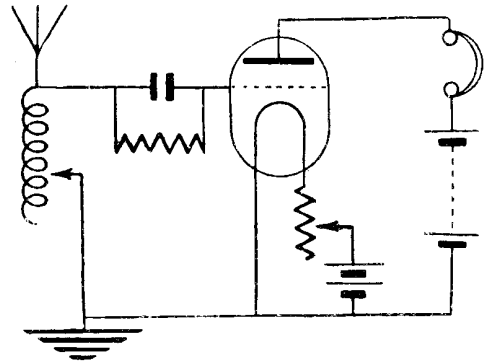

THEORETICAL CIRCUIT

Fig. 11. Circuit diagram of the set; this corresponds with the circuit in the first broadcast map in the plate facing page 282

corresponds with that given in the broadcast map facing page 282. The method of connexion is to commence from the end one of the four telephone terminals on the upper plate and connect this to the aerial terminal. A wire is then taken from this to one side of the grid leak and condenser, and the wire from the inductance attached to the aerial terminal. As the disk is to be fitted on the top of the casing, these wires should be left sufficiently long to permit of connexion to the underside of the disk.

From the other side of the grid leak and condenser a wire is taken to the grid terminal of the valve holder. The remaining two terminals on the disk should be marked respectively, L.T.—H.T.—; and L.T.±. One wire is taken from the low-tension positive terminal to one of the filament terminals on the valve holder. Another wire is taken from the other

filament terminal of the valve holder to the low-tension minus and high-tension minus terminal. A wire is connected from this (L.T. — H.T. —) terminal to the telephone terminal on the slider, this practically being the earth terminal. This completes the wiring.

The disk is then placed on the top of the case and secured with four pins or with some fine screws. The wires used should be sufficiently flexible and also well insulated so that they can be pushed down into the case without fear of short-circuiting. The telephone cords should be passed through the hole in the centre of the base and rested in the groove which is cut through it on the upper edge thereof, this groove originally being needed for the reception of the gas pipe. The underside of the disk may then be covered with a disk of cloth or baize secured with glue.

To impart a good finish to the work, the base and disk can be stained and polished,

the slider-bar until the signals are heard. It should then be very carefully adjusted until the signal strength is at a maximum, finally getting the best result by trying various positions of the filament resistance and also various anode voltages by plugging in the high-tension positive connexion at various points.

Such a set has the advantage that when not required it can be simply switched off by movement of the Polar filament resistance knob. There is no need to disturb the setting of the slider, as practically the set is only suitable for the reception of signals from the local broadcast station. The signal strength can be increased by means of an ordinary low-frequency or note magnifier. See Amplifier; Crystal Sets; High-frequency Amplifier; Low-frequency Amplifier.

SKINDERVIKEN MICROPHONE. Name applied to a type of small microphone named after the inventor. It is applicable

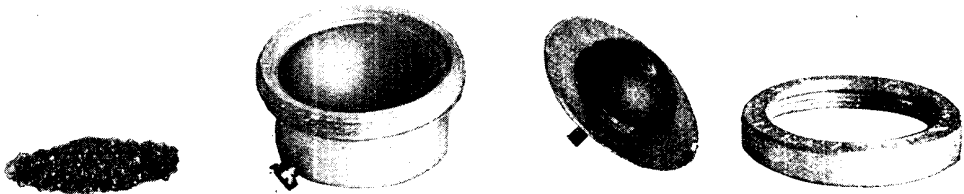

SKINDERVIKEN MICROPHONE

Fig. 1. Disassembled components of this small but most efficient microphone. Left, carbon granules; centre, casing and back plate with carbon half-sphere; right, screwed connecting ring

and the cardboard case covered with a basket pattern or other type of wallpaper, thus making the set quite presentable. The valve is then placed in the valve holder, the aerial and earth connexions made respectively to the aerial lead-in and the earth connexion, the H.T. — and the L.T. — terminals connected to the negative side of the high- and low-tension batteries respectively, the high-tension positive terminal connected to the opposite side of the high-tension battery, and the remaining terminal, marked L.T. positive, to the low-tension positive terminal. The voltage of the accumulator and the high-tension battery should be suitable for the valve in use.

The telephones should be of high resistance, not less than 2,000 ohms. To use this simple little set, which should have a range of anything up to 25 to 30 miles, the filament resistance is operated until the valve is glowing properly, which is dependent upon the make and style of the valve. The slider is carefully moved along

to a number of purposes in wireless experimental work, for the amplification of sound waves and in transmission circuits.

The component parts of the Skinderviken microphone are shown separated in Fig. 1. On the extreme left are the carbon granules. To the right of these is the case and carbon back plate, the latter being a half sphere. Another half sphere of carbon is attached to the diaphragm. This is shown to the right of the exterior casing. It will be seen that the diaphragm is of mica and is about twice the diameter of the central button.

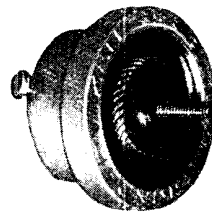

COMPLETE INSTRUMENT

Fig. 2. The photograph presents a slightly magnified view of the complete Skinderviken microphone

The space between the latter and the back plate is filled with the granules shown. On the extreme right

of the picture is the screwed ring which holds all the components together.

Fig. 2 shows the complete microphone assembled. A peculiar feature is the small stylus bar projecting from the centre of the diaphragm. It is to this that one connexion is made. The other passes straight to the case, where it is attached by the small screw shown. See Microphone.

SKIN EFFECT. Term used in connexion with the peculiar property of high-frequency currents, as used in wireless, of wanting to flow only on the surface of conductors.

The skin effect is one of great importance in wireless, and one which is often overlooked by the wireless experimenter when constructing a receiving set. Often by the mere substitution of thicker wires in certain circuits a set may be found to work which has been giving very indifferent signals previously.

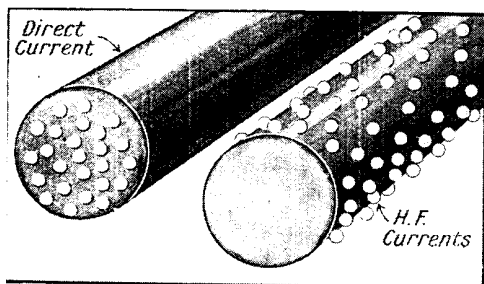

SKIN EFFECT

A symbolical representation of the different ways high-frequency and direct currents travel. H.F. currents travel on the surface and D.C. right through the material

In any conductor carrying a high-frequency current, eddy currents are induced which tend to neutralize any of the flux cutting the conductor itself. For this reason, in a wire all the current tends to flow on the outer surface of the wire and none in the centre, as diagrammatically represented in the illustration. In an ordinary direct-current-carrying conductor the whole of the wire is used for carrying the current, so that it is clear that with high-frequency current for a given wire the resistance is greater than for direct or low-frequency currents. A metal tube offers to high-frequency currents no more resistance than does a wire of equal surface.

This is one reason why it is best to use stranded cable for an aerial. Each strand, however, should for the best results be insulated by a silk, enamel or other

insulating covering, so presenting the largest possible surface for a given size of cable and allowing the currents to flow in the centre of the conductor as well as on the particular strands which come on the outer surface. This type of stranded cable offers considerably less resistance than does the ordinary single wire. Litzendraht wire is such a built-up wire, and on account of its exceedingly low high-frequency resistance is commonly used in transmitting and receiving circuits. To lessen their high-frequency resistances, transmitter inductances are wound with thin copper strip of large surface, with Litzendraht, or with large copper tubing.

Flat copper or phosphor-bronze strip is often used as an aerial on account of the large surface it presents for the high-frequency currents to travel upon. In all high-frequency circuits the wireless experimenter should make a point of using wires having the greatest possible surface area if the damping of the circuit is not to be excessive. As a specific example, a copper rod of half an inch or so in diameter has a high-frequency resistance (for currents of a frequency of a million) of about fifty times as much as the steady current resistance.

The skin effect is greater in a coil of wire than it is in a straight length of the same wire, owing to the proximity of the turns of wire in the coil to one another. See High Frequency; Resistance.

SLAB COIL. A plain wound inductance coil taking the form of a flat disk. In the most common types, the windings of the slab coil are held together with paraffin wax or other insulating medium, so that the completed coil is, in effect, a solid slab which can be handled with safety. The slab inductance has rather a high self-capacity, but its absence of dead-end effect, and the ease with which it can be constructed to suit the wave-length of any particular transmitting station that it is desired to receive, enable its efficiency to rank with other more elaborate and expensive inductance coils.

Varieties of commercially made slab coils are shown in Fig. 2, and illustrate one method of securing the ends of the wires, where a few turns of adhesive insulating tape are bound round the coil at the point where the ends of the wires project.

The slab coil can easily and cheaply be constructed by the experimenter, a home-made coil being shown in Fig. 1.

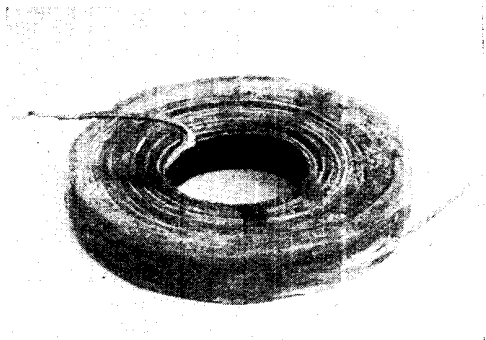

AMATEUR-MADE SLAB COIL

Fig. 1. This slab coil may easily be constructed by the amateur; it gives very efficient tuning

wire to be used may be left to fill the particular requirements for which the coil or coils are intended. For purposes of aerial tuning inductances No. 30 double silk covered or enamelled wire may be used to advantage.

In winding the coil a short length of the beginning of the wire is retained by taking a few turns round the bolt, or a hole may be drilled in one side of the former through which the end of the wire is passed. The wire is wound round the former, taking care to keep it fairly tight. When a few turns have been put on they are brushed over with paraffin wax, and this process is continued until the coil is completed. The coil in process of winding, with the paraffin wax being applied, is shown in Fig. 4.

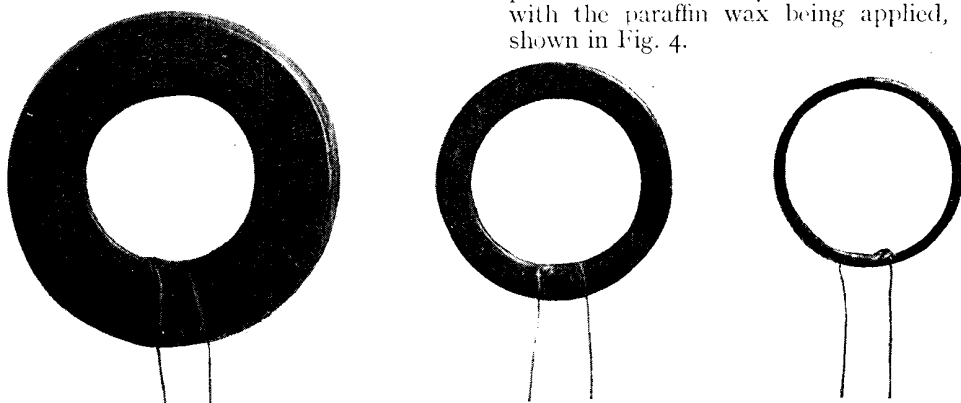

COMMERCIALY BUILT SLAB INDUCTANCES

Fig. 2. In these three types of slab inductance coils, shown in varying sizes, the leads of the wires are firmly secured by insulated tape

Two thin ebonite or fibre disks are required having a diameter of 3 in. and a centre hole in each of $\frac{3}{16}$ in. An ebonite washer, which determines the thickness of the completed coil, has a diameter of $1\frac{3}{4}$ in. A central hole is drilled through this washer and permits a bolt to be inserted which clamps one of the disks to either side of the central washer. The set of parts forming the complete former is shown in Fig. 3. In the parts illustrated, a short length of 2 B.A. screwed rod is used having a flat washer and nut on either end. The former is now ready for winding. A quantity of paraffin wax is melted in a small saucepan or tin, and a small brush obtained with which the wax is applied to the windings. The gauge of

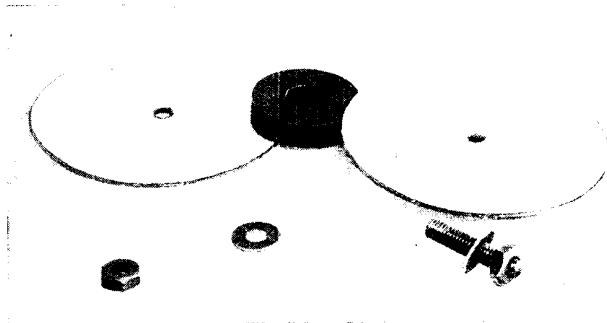

FORMER COMPONENTS OF THE SLAB COIL

Fig. 3. The set of parts used in constructing the former on which is wound the slab coil shown in Fig. 1

The former on which the slab coil is wound may be kept in position permanently, but if a number of coils are required it may be removed for making other coils. The bolt is removed when time has allowed the wax to become solid and the sides removed as in Fig. 5.

No. of turns of wire approx.	Sizes of former in in. Diameter			Wave-length using 1000 mfd. variable condenser.	
	Outside	Inside	Width	In series	Parallel
95	2	1 3/4	3/4	500-900	1100-2300
100	2	1 3/4	3/4	600-1050	1200-2500
180	2 1/8	1 3/4	3/4	1300-1700	2000-4000
300	2 1/8	1 3/4	3/4	1550-2200	2750-6000
450	2 1/2	1 3/4	3/4	2000-4000	4800-9800

SLEDGE COIL. Term sometimes used to describe a type of loose coupler in which a fixed coil is so disposed that a movable secondary coil can slide along the fixed primary

The washer is now removed, when the completed coil may receive another coat of wax to improve the appearance of the exterior.

The mounting of the coil must be arranged according to the uses to which it will be put, many methods being shown in the Encyclopedia.

The above table will form a guide to the amount of wire required in the winding of a coil to any desired wave-length. See Basket Coil; Coil; Honeycomb Coil; Igranic Coil; Inductance.

SLAB INDUCTANCE. Name applied to any form of inductance coil that is so wound that the shape is relatively thin but deep. See Slab Coil.

coil in such a way as to permit of variations in the amount of energy that can be transferred from one to another.

SLEE, COMMANDER J. A. British naval wireless expert. Born May, 1878, at Wimbledon, he joined the navy in 1894,



PUTTING THE FINISHING TOUCHES ON THE HOME-MADE COIL

Fig. 4 (lower photograph). After each layer of wire has been wound paraffin wax is brushed on to solidify the coil. Fig. 5 (upper photograph). When this wax has set hard the former may be removed in this manner



COMMANDER J. A. SLEE

This well known wireless authority is the superintendent of the Marconi International Marine Communication Company. During the Great War he held the responsible position of chief of all shore wireless stations

and took up wireless in 1901. He served as a wireless telegraph experimental officer for some years, and in 1908 was appointed in charge of all shore stations for wireless, a post he held until 1919. On the formation of the Wireless Board, Slee was appointed its chief, and in 1920 he joined the Marconi International Marine Communication Company as technical superintendent. Slee has written many articles on wireless for various technical journals.

SLEEVING. Term commonly applied to a variety of different kinds of tube used for insulating purposes. Commonly the tubing is made of indiarubber, linen or other material impregnated with an insulating compound. It is used to slip over ordinary bare wire,

which may be used for connexion on a wireless receiving set, the purpose being to protect the wire from any chance of a casual short circuit. This method of protecting the wire by means of sleeving is of particular importance when there is some moving part in the vicinity of the wire which may possibly come in contact with it and thereby cause a short circuit.

The method of using the sleeving is shown in the illustration. In this example the conducting wire from the top of the inductance coil has been cut to suitable length for connexion to the variable condenser. Before the eye is turned on the end of the wire for connexion purposes, a short piece of sleeving, which in this case is a piece of small diameter indiarubber tubing, is slipped over the conductor. The eye is then turned in the end of the wire and the connexion completed. The result is a well-insulated piece of apparatus.

Sleeving can be obtained in various colours. This is sometimes of convenience, as one colour might be restricted to, say, the positive side of the high-tension circuit, and some other colour perhaps to the aerial or grid circuit, and so on, thus simplifying the wiring and making it more easy to trace it out at some subsequent time.

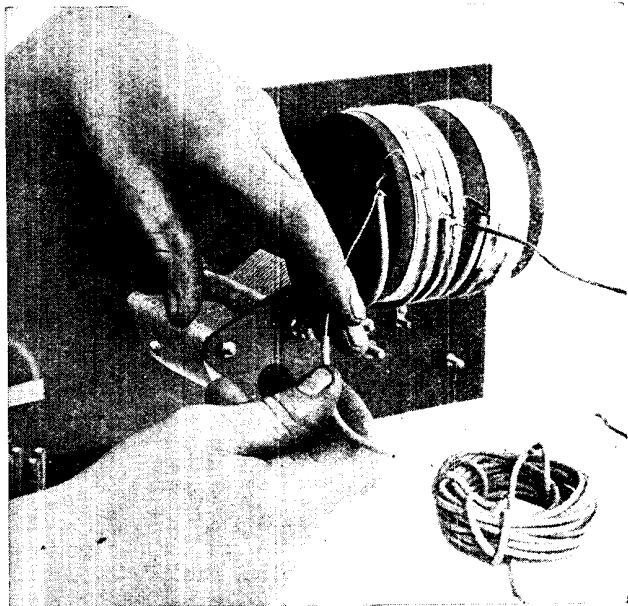

INSULATING BY MEANS OF SLEEVING

Rubber tubing, known as sleeving, is fitted over bare wires as an insulation and protection. It is extremely useful for the wireless experimenter

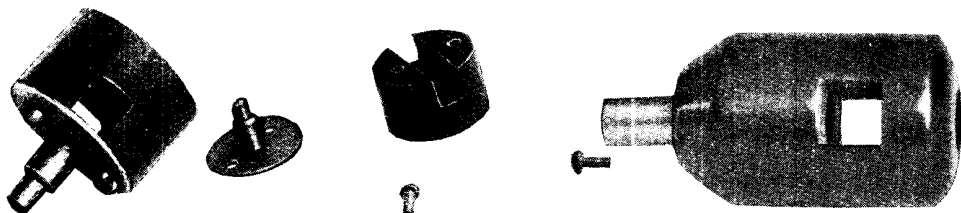

USEFUL TYPES OF INDUCTANCE COIL SLIDERS

Fig. 1 (left). Easily made from odds and ends of material, this slider gives quite good results. The group in the centre (Fig. 2) shows the slider before the brass disk is fitted to the ebonite bush. Fig. 3 (right). Another type in which the plunger fits in a hole drilled in the knob

SLIDER. A small device arranged to move along a straight rod running parallel with an inductance coil for the purpose of collecting current at any desired point on the coil. The slider usually consists of a small ebonite knob fitting on the slider-bar and having a spring-loaded plunger which makes contact with the wire of the inductance, the insulation of which is removed from the path of the slider plunger.

A typical slider is illustrated in Fig. 1, and may be easily constructed by the experimenter. It consists of a $\frac{3}{4}$ in. length of ebonite rod 1 in. in diameter, having a square slot $\frac{1}{4}$ in. wide and $\frac{1}{4}$ in. deep, cut centrally through one of its end faces. A 1 in. diameter disk is cut from sheet brass and a $\frac{1}{8}$ in. hole drilled in the centre of it. A piece of brass tube $\frac{1}{2}$ in. long, having an internal diameter of $\frac{1}{8}$ in., is soldered over the central hole in the brass disk.

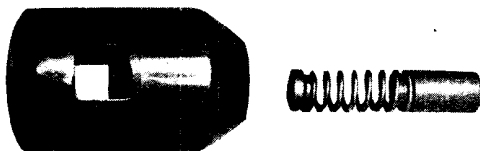

SPRING AND PLUNGER REMOVED

Fig. 4. The small cap fitting the end of the spring makes contact with the slider-bar and facilitates movement of the slider over the bar

On either side of this hole two small holes are drilled and form a means for screwing the brass disk to the knob, corresponding holes being made in the latter for the purpose. A small spring of steel or brass wire $\frac{3}{8}$ in. long is fitted inside the tube already made. The plunger, which should be a good sliding fit inside the

tube, is $\frac{3}{8}$ in. long, and is rounded at its outside end to provide a smooth movement when drawn over the wires forming the inductance. The parts forming the slider are shown in Fig. 2.

Another type of slider is illustrated in

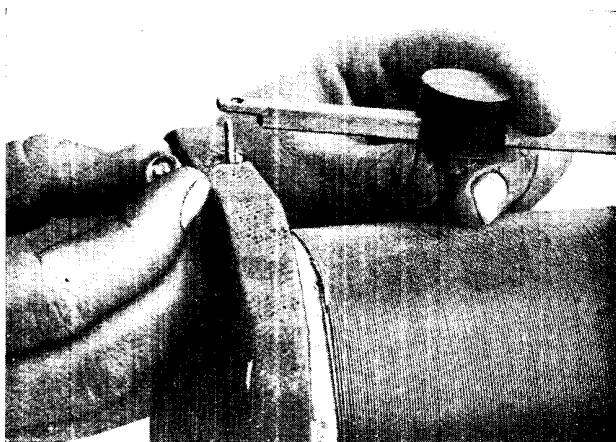

SLIDER-BAR DETAIL

A convenient method of fitting a terminal to the end of a slider-bar is shown in this illustration

Fig. 3. This is of similar construction, the details of the spring and plunger being shown in Fig. 4. Other and more elaborate sliders have a vernier arrangement, with which a very small movement is obtainable. See Coil; Inductance Coil.

SLIDER-BAR. A straight length of rod arranged parallel to the former of an inductance, and at right angles to the direction of the wire, bearing a slider capable of movement along the length of the slider-bar, with which connexion is made to the wires of the inductance. In the most common patterns the slider-rod is of square section, with sides of $\frac{1}{4}$ in. Another form of slider-bar has a triangular section, in which case sides of $\frac{3}{8}$ in. are usual. Various methods are employed for attaching the slider-bar rigidly in

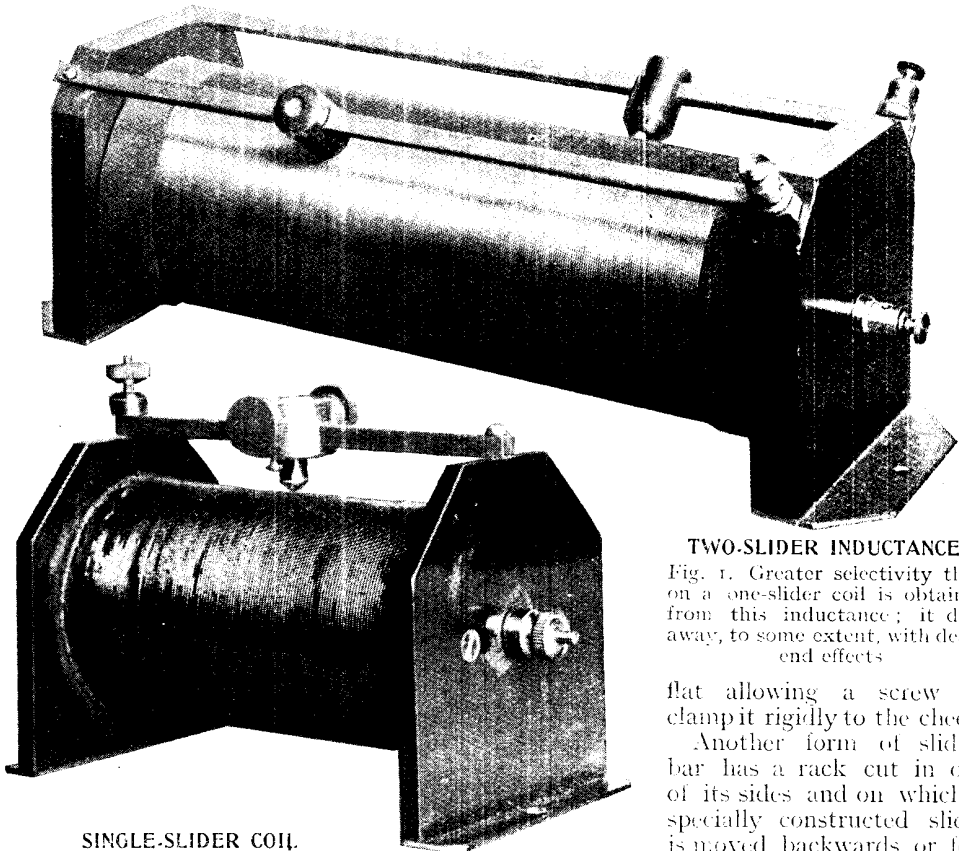

SINGLE-SLIDER COIL.

Fig. 2. A common type of single-slide inductance having a micrometer adjustment to the slider
Courtesy Economic Electric Co., Ltd.

relation to the inductance. A common method, where the inductance is supported on ebonite or wooden end checks, is to cut a slot corresponding to the section of the slider-rod, into which the latter is screwed.

Where it is desired to take an electrical connexion from the slider-rod, a piece of 4 B.A. rod is screwed into a drilled and tapped hole in the centre of the slot previously cut to receive the slider-rod. A hole $\frac{1}{8}$ in. diameter is drilled at the end of the slider-bar, when it may be fitted over the screwed rod and into position over the slot. A terminal nut is now added, which clamps the slider-rod rigidly, and under which a connecting wire may be fastened.

This method of obtaining connexion from the slider-bar is illustrated. Where a slider-bar of triangular section is used, the easiest method of securing it to the end checks is to file a flat parallel with one of the faces, a hole in the centre of this

TWO-SLIDER INDUCTANCE

Fig. 1. Greater selectivity than on a one-slider coil is obtained from this inductance; it does away, to some extent, with dead-end effects

flat allowing a screw to clamp it rigidly to the check.

Another form of slider-bar has a rack cut in one of its sides and on which a specially constructed slider is moved backwards or forwards by a geared mechanism. Unless care is taken with inductances employing a slider-bar, difficulty may be experienced with faulty or intermittent contact. It is essential that the slider-bar be kept perfectly clean and free from oxidation and that good contact be made to it by the spring arrangement of the plunger. See *Coil; Crystal Receivers.*

SLIDING INDUCTANCE. Name given to a type of variable inductance coil. The amount of inductance required is varied by moving a contact arm or other device across the coils of the inductance. Where insulated wire is used the insulation is removed from that part of the inductance on which the contact piece presses. The contact piece, usually called the slider, is supported by a straight bar, often square in section, which is rigidly fixed a short distance from the wires forming the inductance and parallel to its length.

The slider has a springy contact which presses on the wire, and by making contact with it gives a varying inductance when

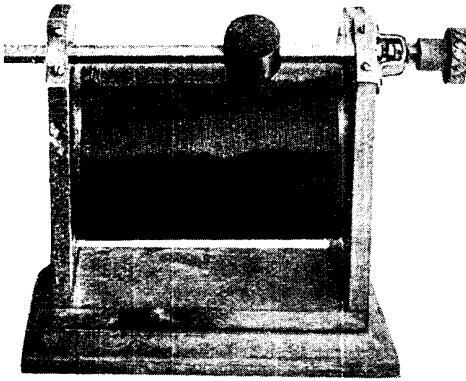

ANOTHER TYPE OF SLIDING INDUCTANCE

Fig. 3. In this illustration is shown a single-slider coil fitted with a device for obtaining a vernier movement

moved. A typical sliding inductance is illustrated in Fig. 2, where connexion to the slider rod is made by the terminal mounted on the top of it. One end of the inductance is connected to the terminal seen in the centre of the right-hand end cheek of the illustration.

A disadvantage with the sliding inductance is that due to dead-end effects, *i.e.* the large amount of inductance not in the tuning circuit yet electrically connected to it. This is overcome to some degree in the double-slider inductance shown in Fig. 1. A greater measure of selectivity is obtainable with this type than with the single-slider variety.

The single-slider inductance shown in Fig. 2 has a vernier control fitted to the

slider, which permits of finer movement than with the ordinary form of single-slider inductance.

A very easily constructed type of vernier movement which can be adapted to many forms of existing sets using the slider method of wave-length regulation is illustrated in Fig. 3. This illustration shows the principle of the movement, where it is seen that the slider-rod itself is capable of a certain amount of movement in the direction of its length. Any form of slider may be used, but it should be a fairly tight fit on the slider-rod, or alternatively have a spring attached to it for securing a fairly stiff movement on the slider-rod. One end of the slider-rod is tapped out, into which a length of screwed rod is inserted.

A U-shaped bracket is made and a central hole drilled through which the screwed rod is capable of passing. The bracket is attached to the side of the instrument, as shown in Fig. 3. Two lock nuts are tightened up together on the screwed rod to the inside of the bracket, and on the outside an ebonite knob is added and fixed in position with a lock nut, which operation is shown in Fig. 5. The position of the lock nuts should allow a free turning movement to the screwed rod without any backward or forward play. With this contrivance the slider-rod is very slowly moved on turning the knob. A close-up view of this feature is shown in Fig. 4. See Coil; Crystal Receiver; Inductance Coil; Tuning.

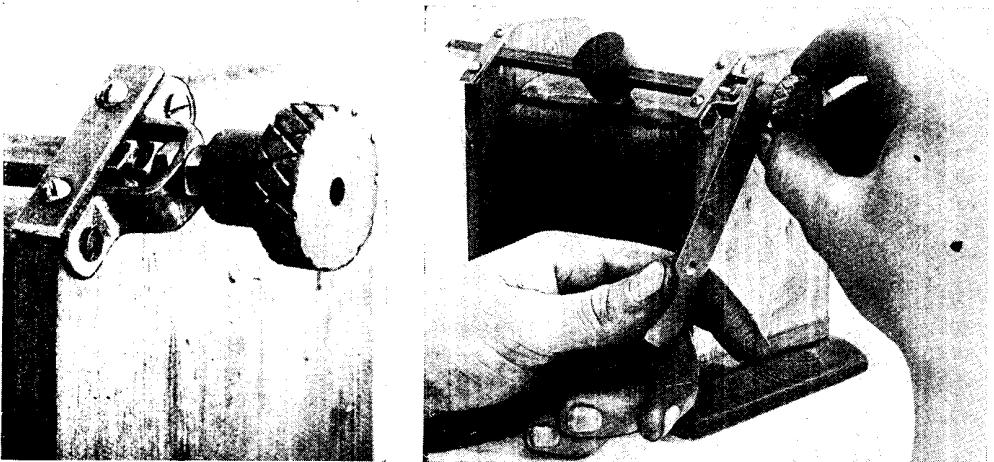

CLOSE-UP VIEWS OF THE VERNIER ATTACHMENT

Fig. 4 (left). Lock nuts are seen inside the bracket which control the movement of the slider.
Fig. 5 (right). A thin spanner, which may easily be made specially for this purpose, is used to grip the lock nut while the knob is being tightened up as shown here

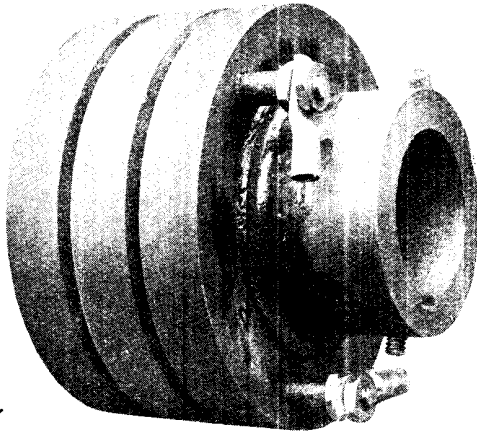

MOUNTED SLIP-RINGS

Fig. 1. Three slip-rings are shown here, mounted on their base; notice the prominent tags for the connecting wires

Courtesy Crypto Electric Co., Ltd.

SLIP-RINGS. Name given to sliding contacts from which the collecting brushes pick up the current generated by an alternator. They are equivalent to the commutator on a direct current generator.

The armature of a generator is necessarily kept revolving to generate an electro-motive force; it is clear that some sliding contact is necessary to connect the windings of the armature to any required outside circuit. The slip-rings are usually two brass rings carried on the shaft of the armature and insulated from each other and from the shaft. The rings rotate with the armature, and there lightly rest on them the collecting brushes. These brushes consist of copper gauze or carbon.

One slip-ring is connected to one end of the armature winding and the other end of the winding is connected to the other slip-ring. The two brushes making contact with the slip-rings are connected up to the outside circuit.

Three slip-rings mounted on one boss are shown in Fig. 1. The boss is insulated from the rings, connexion to the latter being made via the rods and terminal tags shown, there being one to each slip-ring. A metal sleeve of massive design is fitted in the centre, and this is arranged to be keyed on to the generator or motor spindle.

Slip-rings, together with the brush gear attached to a small wireless generator, are illustrated in Fig. 2. Carbon brushes are fitted, being arranged in adjustable sliding arms. See Commutator; Dynamo; Generator.

SLOPEMETER. Arrangement for measuring the slopes of the characteristic curves of a thermionic valve. The arrangement for measuring these slopes is due to Dr. E. V. Appleton, who also suggested the name. He described his method of measuring the slopes in the "Wireless World" for November, 1918. The circuits employed by Appleton enable the slope

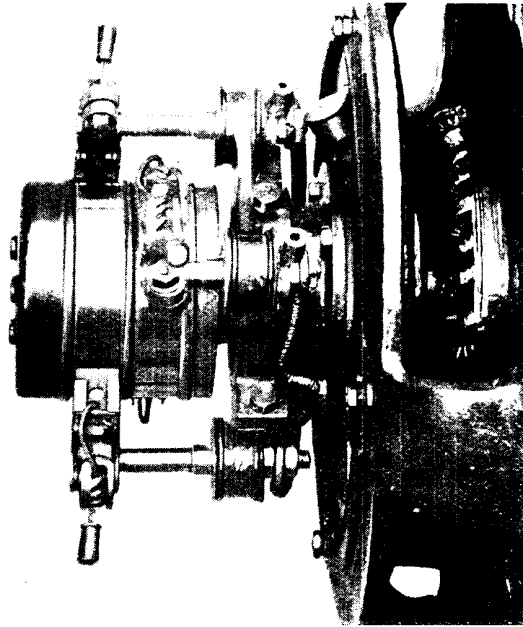

SLIP-RINGS IN POSITION

Fig. 2. Here the slip-rings are seen with the brush gear on a small generator of alternating current for wireless work.

Courtesy Marconi's Wireless Telegraph Co., Ltd.

of the anode current-anode potential curve and the slope of the anode current-grid potential curve to be determined at any point.

Fig. 1 shows the circuit used by Appleton in his slope-meter. The measurements by this circuit are carried out for differences of current and voltage supplied entirely by the batteries. It is a static test, and is the one usually taken to obtain the necessary curves. Fig. 2 shows how the same slopes may be obtained directly when the valve is being acted upon by an

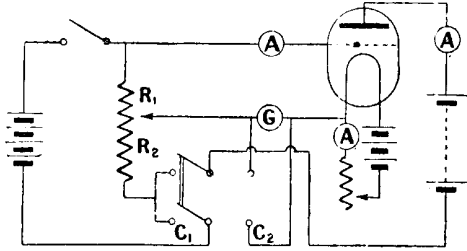

D.C. CURVE-MEASURING CIRCUIT

Fig. 1. The characteristic curves for differences of current and voltages supplied by batteries from D.C. may be measured by using this circuit

alternating current. This latter must be of audible frequency.

In Fig. 1 two measurements are made. The first is with the change-over switch making contact with the two studs C_1 , and the switch key open, when the normal plate current may be read at G . If the ratio of the two parts of the resistance R_1 , R_2 is varied until the deflection of the needle of the galvanometer is unaltered when the switch is closed, then the ratio of the slopes of the anode current-anode potential and anode current-grid potential curves is equal to the ratio of R_2 to R_1 . Expressed as an equation, if S_1 and S_2 are these slopes, then $S_1/S_2 = R_2/R_1$.

The change-over switch is now connected to the studs C_2 and the switch key is left open and, as before, the reading of G is taken. The resistance R_1 is clearly the only part of the resistance which comes into play, and this is so adjusted that there is no alteration in the galvanometer reading when the switch key is closed. We then have $S_1 = 1/R_1$, which gives a direct value of the slope of one curve, and from the first reading the value of the slope of the other curve may be obtained.

In the circuit A, A, A are ammeters in the filament, anode and grid circuits to read the currents and ensure the accuracy of the measurements. The battery on the right supplies the potential difference between the anode and the filament, that on the left is the grid battery, and the centre one the filament battery. These batteries necessarily vary with the type of valve being tested. For the ordinary receiving valve the anode battery is anything up to 250 volts or so, though for the transmitting valves an anode voltage up to 10,000 may be required.

The slopes of the curves are obtained by first taking the grid potential at some fixed value and increasing the anode current in regular steps. The anode

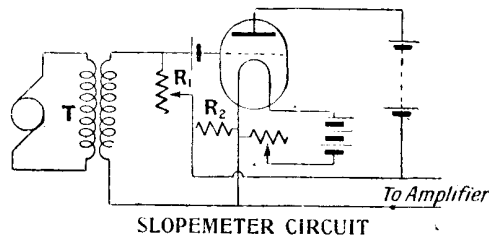

SLOPEMETER CIRCUIT

Fig. 2. The theoretical circuit diagram for the slope meter which enables the characteristic curves of valves to be obtained when alternating currents are the source of supply

potential is then kept constant and the grid potential is varied regularly.

In Fig. 2 the grid is coupled to the source of alternating current supply by a transformer T . R_1 is a variable resistance and R_2 a non-inductive resistance. The resistance R_1 is adjusted until the alternating potential across R_2 is zero, and the slope of the curve is then given by $S_1 = 1/R_1$. Connexion is made to an amplifier and telephones to assist in getting this state of affairs accurately. The impedance of the transformer winding should be small compared with R_1 to ensure an accurate result. See Characteristic Curve; Q Valve; QX Valve; Valve.

SMITH-ROSE, REGINALD.

British wireless authority. Born in 1894, he was educated at the Imperial College of Science and Technology, and immediately took up the study of wireless telegraphy, for which he was awarded the diploma of the Imperial College for research work. Smith-Rose made a special study of thermionic valve amplifiers, and was appointed assistant at the National Physical Laboratory for general wireless research. He is a member of the Committee on Directional Wireless, and physicist in charge of directional wireless research under the Radio Research Board. He is on the committee of the wireless section of the Institution of Electrical Engineers, a fellow of the Physical Society, and a member of the Radio Society of Great Britain.

SMOOTHING CIRCUIT. A circuit introduced into either a transmitter or receiver to smooth out the "ripple" due to commutation in D.C. machines or incomplete rectification where A.C. is used, in order to make the current suitable for use in connexion with valves, either for high- or low-tension supply. Were no steps taken to remove this "ripple," a continuous humming noise would either be transmitted or heard in the telephones.

The smoothing of low-tension supply is very simple, and may generally be accomplished by connecting a small accumulator of correct voltage across the supply mains. Not only will this remove the ripple caused by commutation, but it will compensate for voltage fluctuations on the part of the generator due to speed variation. This system is used in aircraft sets, where the generator is driven by an air-screw, and the speed is largely dependent on the air speed of the machine.

Where a D.C. lighting supply is available smoothing may usually be entirely accomplished by the use of condensers connected across the mains. These should be of from 4 to 8 mfd. capacity. Some engineers are in favour of adding chokes, and this system has been applied to the Sterling smoothing unit, illustrated in Fig. 1. This instrument contains 3 condensers and 4 chokes. The case is of stamped sheet brass, the connecting lugs being fitted on to pieces of ebonite let into rectangular slots cut in the side of the case.

A two-push button switch is fitted to the top of the case. One button is pressed for the "on" position, while the other is for "off." A mechanical device is incorporated in this switch which ensures that when one

button is depressed the other automatically returns to the upper position.

The lamps, which are carbon filament, are used as pilot lamps only, and merely indicate the presence of a short circuit, should one occur. When wiring this instrument up with any wireless apparatus, the input side of the smoothing unit is connected to the lighting or power supply, and the output to the H.T. terminals of the transmitter or receiver.

Where rectified alternating current is used for high-tension supply to the anodes of valves, the circuit shown in Fig. 2 is useful. Rectification by means of two electrode valves is here employed, current from the mains being obtained through the transformers A and B. Filament current for the rectifying valves may be either obtained from the mains through another (step-down) transformer, or from an accumulator. Smoothing is accomplished by the condensers C_1 and C_2 and the iron-cored choke L_1 . Another choke of the air-core type is inserted before

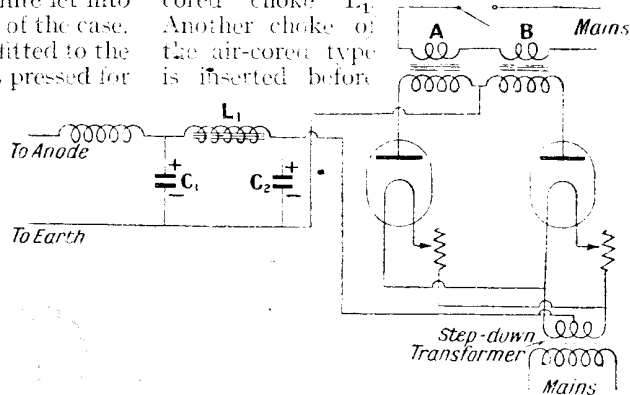

SMOOTHING CIRCUIT

Fig. 2. Where rectified A.C. is used for H.T. supply to the valve anodes this circuit will be found most useful.

the anode of the valve which is being supplied. A circuit such as this will be found efficient for either transmitting or receiving, or for power amplifiers. The choke should have a value of about 10 henries, and the condensers 4 mfd. capacity. See Broadcasting; Transmission.

Sn. This is the chemical symbol for the metallic element tin. It is an abbreviation of the Latin name, stannum, for the metal. See Tin.

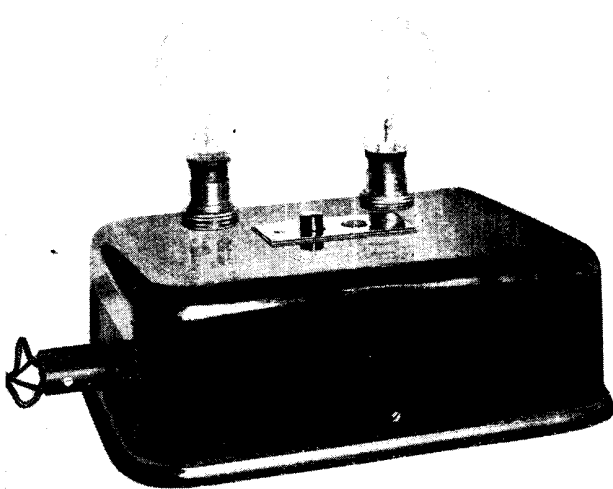

STERLING SMOOTHING UNIT

Fig. 1. Ripples in transmission and reception are eliminated by this smoothing unit; it contains three condensers and four choke coils

Courtesy Sterling Telephone & Electric Co., Ltd.

SOCKET. Name given to a component of a wireless set having a cavity formed in it for the purpose of receiving a correspondingly shaped member. In wireless work sockets are usually provided for the reception of a plug, and are sometimes known as jacks, when they incorporate some form of switching device. One useful type of socket, illustrated in Fig. 1, takes the form of an ebonite rod, having embedded in one end a brass bushing, to which the ebonite is securely fixed. The bore of the bushing is adapted to receive a slightly tapered peg formed on some other part of the apparatus. A flexible wire with a protective covering is securely attached, either by means of a screw, or by soldering to the inner end of the socket.

The plug may either be attached to a receiving set or other piece of apparatus, or may be attached to the end of another piece of flexible wire. One typical application is in the use of a flexible connector attached to the aerial lead-in, so that it can be plugged on to a peg at the back of the receiving set, or detached from it and connected to the plug on the earth lead when the set is not in use. It will be appreciated that the plug and socket should make perfect electrical contact, and generally, to some extent, act as a switch.

The amateur will find that for many purposes small sockets may often take the place of the more usual terminals. These are usually of the single-pole variety, such as those illustrated in Fig. 2, and consist of a hollow, cylindrical brass member embedded in an ebonite bushing, which in its turn can be fitted tightly into the hole in the case.

The plugs, which are separately dealt with under that title in this Encyclopedia, are also shown in Fig. 2. The component parts of the socket are illustrated in Fig. 4, and can be quickly made up by the experimenter. All that is needed is a standard valve socket, a small angle piece of brass measuring about $\frac{5}{16}$ in. in width and $\frac{3}{4}$ in. from the angle to the ends; a small ebonite bush which should fit tightly on the outside of the socket and a single lock nut.

The angle piece should have two holes drilled in it, one in each face, one being plain and the other tapped to receive the screwed shank of the socket, which should be cut off short, so that when in place it is long enough to take the nut but will not

have any excess. The ebonite bushes can be obtained from most wireless dealers, or can be quickly turned up from rod about $\frac{1}{2}$ in. diameter and drilled out to fit on to the socket.

The method of securing the sockets to a case is illustrated in Fig. 3, from which it will be seen that a strip of ebonite, about 1 in. in width and $\frac{1}{4}$ in. in thickness, is screwed to the bottom of the case. Holes are drilled through the case to receive the two ebonite bushes, the sockets passed

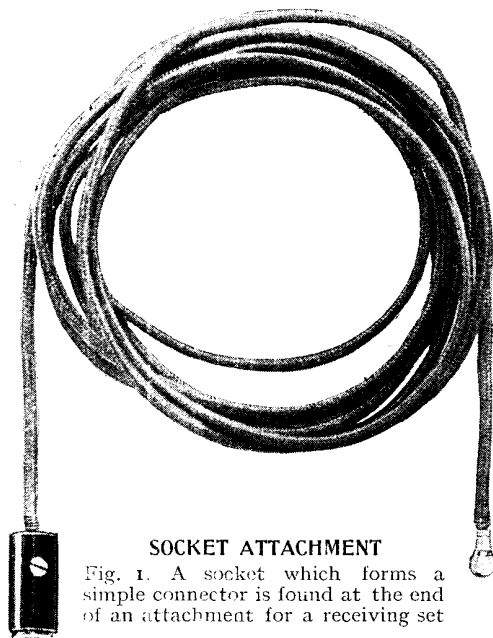

SOCKET ATTACHMENT

Fig. 1. A socket which forms a simple connector is found at the end of an attachment for a receiving set

through them and the angle piece attached, this being accomplished by pushing the socket through from the underside. The angle pieces are then secured by countersunk screws to the ebonite plate. Connexions should be made either by soldering or by pinching the wire under the nut.

Another type of easily made socket is shown in sectional form in Fig. 5, and is suitable for use on ebonite panels. It will be seen that a standard valve socket is used, but a small brass disk or ring has been soldered to the outer end. A plain piece of ebonite tube is then slipped over the socket, and should be slightly longer than the distance from the back of the panel to the shoulder of the socket. A plain washer and a nut are screwed on to the screwed part of the socket, and when tightened up, hold the whole tightly together.

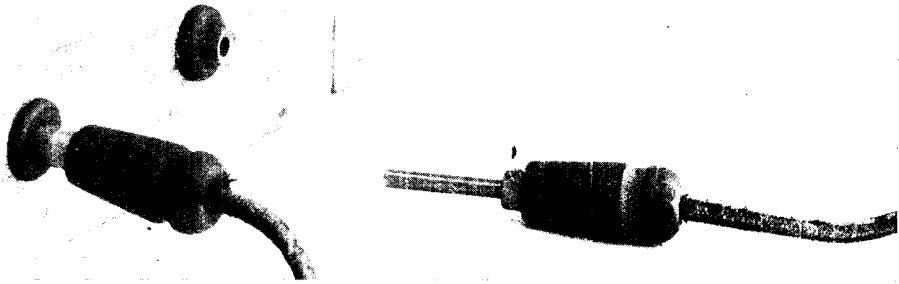

Fig. 2. Two bushed sockets are inserted in the woodwork of the cabinet. The plugs used with this type of socket are also shown in the photograph

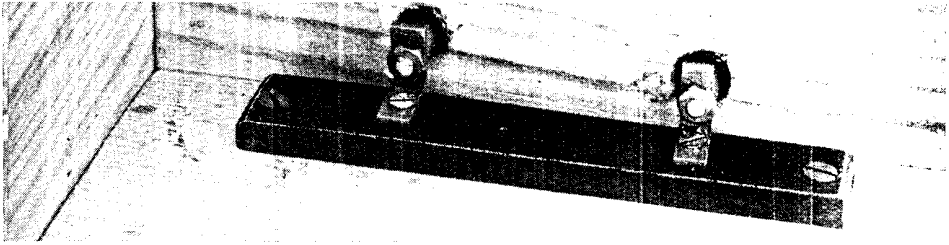

Fig. 3. Inside the cabinet may be seen the ebonite base plate and mode of supporting the socket in Fig. 2. Wiring may also be carried out by soldering leads to the brass angle pieces

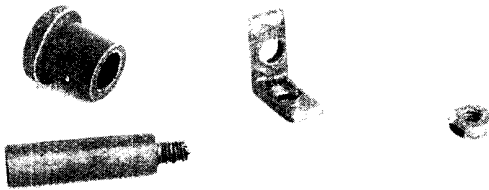

Fig. 4. Here are shown the components of the socket seen in Fig. 2. Note the flange on the bush

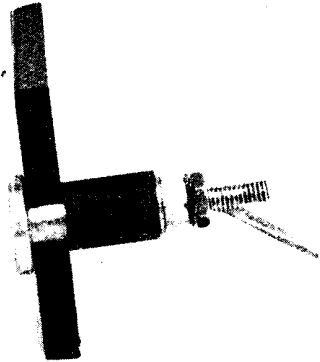

Fig. 5. Sectional view of how the socket is fitted to a panel

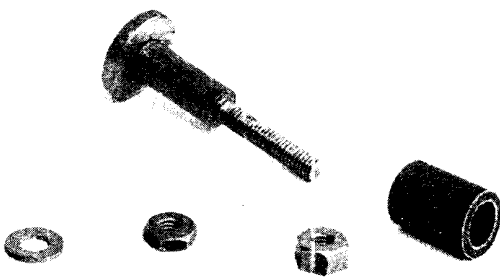

Fig. 6. Details are shown in this photograph of a socket simple in design and easily made by the wireless experimenter

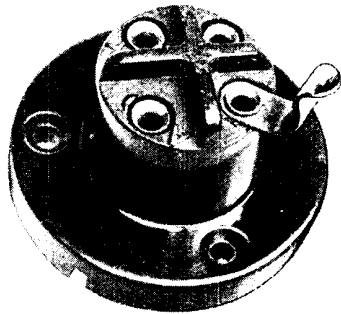

Fig. 7. This is a valve socket made by the Fullers Electrical Co., Ltd., having a clip to earth the metal valve cap

WIRELESS SOCKETS OF VARIOUS TYPES

Connexions are made by means of lock nuts or soldering as desired.

The component parts for this type of socket are shown in Fig. 6. The ring or disk on the end of the socket can be quickly made up from a brass washer of the appropriate diameter. This may need enlarging slightly so that it will fit tightly on to the end of the socket, to which it is secured by soldering, care being taken to keep it secure while doing so. This is most easily effected by placing the socket in a vertical position on a piece of warmed metal, and pressing the washer downwards so that it is flat on it. Steady the socket with a pair of pliers while the soldering is in progress.

This type of socket is very quickly made, and occupies little space on the panel, and being practically entirely insulated, except for the connecting nut, offers little chance

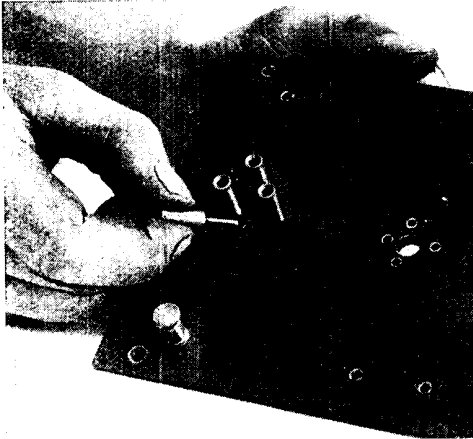

VALVE SOCKETS ASSEMBLY

Fig. 8. Four valve sockets are arranged to register exactly with the legs of a valve, and form the connexions for the valve legs

of an accidental short circuit with other apparatus.

Probably one of the most useful little fittings for the wireless experimenter is the ordinary standard valve socket already referred to. These are turned from brass rod, and have a hole in one end of a size to suit the ordinary valve legs. The other end is reduced in diameter and threaded, usually No. 4 B.A. They are fixed to the valve panel in the manner illustrated in Fig. 8, by drilling holes through the panel and tapping them with a proper size tap. The sockets are screwed through from the front and held firmly by means of a washer and nut on the underside.

In fixing sockets for the reception of valves it is very important to drill the holes exactly in the right place, an operation which can be best carried out by using a standard template or jig. Similar types of sockets are found on various pieces of apparatus, such, for example, as the tubular sockets on high-tension batteries. Another type of socket is often used for some forms of frame aerial for directional purposes. These are generally used as a bearing or support for the frame, and sometimes incorporate a simple switching device for effecting connexion between the frame aerial wires and the connexions within the set. Such sockets may also comprise means for rotating a frame aerial, as, for example, by means of belt gearing.

The valve socket shown in Fig. 7 is moulded in one piece out of ebonite. A special feature is the cross ribs between the brass contacts, which, by increasing the surface of the insulating medium between the contacts, reduce the surface leakage. A further special feature is the small plated brass clip attached to one of the filament leads. This is of such a size and shape that it makes a tight contact upon the metal cap surrounding the base of the valve. If the side of the filament to which this clip is attached is connected to the negative lead of the battery (as it should be), the metal cap of the valve is earthed. See Jack; Plug.

SODA. Term commonly applied to sodium carbonate or ordinary washing soda. One of the most common applications of soda in wireless constructional work is its use for cleaning purposes. If small pieces of brass or other metal apparatus are to be cleaned, as, for instance, before being lacquered, a method very extensively adopted is to put them in very hot solution of soda in water.

This will remove any grease, as the presence of the slightest trace of grease on the object to be lacquered is fatal to a satisfactory result. Once the objects have been cleaned in this way, they should not be touched by the fingers until after the lacquer has been applied and has dried. A good plan is to thread the objects on a wire, if possible, and dip them in the soda water until clean, and then, having allowed them to dry, place them into a vessel containing the lacquer. When coated, the objects should be hung up to dry as described in the article on lacquering.

SODIUM. Name given to one of the metallic elements. Its chemical symbol is Na and its atomic weight 23. In a pure state sodium is a soft, silvery-white substance differing from the better-known metals in that it is lighter than water, melts at a low temperature (97° C.) and forms with water caustic soda. In the latter case the action is so strong as to cause the released hydrogen to burst into flame. Sodium exists in combination with other elements to a very large extent, among the compounds being common salt, Chili saltpetre and the mineral glauberite. These three compounds occur naturally, but there are also a great many compounds which are manufactured.

One application of sodium in wireless work is in the form of an experimental photo-electric receiver. It has been found that a liquid alloy of sodium and potassium emits negative electrons when it is illuminated. It is particularly adapted for use with the ultra-violet light. An alloy of sodium and potassium when exposed to the air is spontaneously inflammable, and it is therefore kept in an hermetically sealed and exhausted tube with insulated electrodes fitted to it.

SOFT VALVE.

A type of valve which has a comparatively low vacuum, and which is peculiarly efficient as a rectifier of wireless signals. Such valves work on a low anode potential, the usual value of this being in the neighbourhood of 22 volts. It will be found that many valves of this type work quite well as rectifiers without the use of a grid leak, *i.e.* they are self-rectifying.

Soft valves are generally very sensitive to filament control, and it is frequently possible to tune out an interfering station by judicious use of

the filament resistance. Valves of this type are useless as low-frequency amplifiers.

A typical soft valve of Dutch manufacture is shown. In appearance it is very similar to any English valve, except that the bulb is of a different shape. A four-pin cap of standard size and shape is fitted, enabling the valve to be placed in the ordinary standard type of socket.

The soft type of valve is gradually going out of use, for it is much more satisfactory to have a valve capable of being used for any purpose. In conjunction with a leak, the hard valve is quite as good for rectification as the soft type, and the advantage of a common filament and H.T. supply for rectifiers or amplifiers is obtained. *See* Round Valve; Valves for Reception, etc.

SOLARI, MARQUIS LUIGI. Italian wireless authority. Born in Turin, he joined the Italian navy in 1890, and took up the study of electricity, receiving his degree in electrical engineering at Turin University, 1908. He specialized in wireless communication problems, and in 1900 was appointed in charge of the laboratory of wireless telegraphy at the Royal Dockyard of Spezia. In 1902 he had charge of the wireless on board the warship Carlo Alberto and carried out a series of important experiments with Marconi, and in 1903 he was the Italian delegate to the Berlin wireless conference. In 1904-5 he was appointed in charge of the wireless telegraph department of the Italian Post Office. Solari has written much on wireless, and is the inventor, with Professor Lori, of a magnetic relay.

SOLDER. Name applied to a variety of fusible alloys used for uniting metallic surfaces. There are two chief classes of solder: first, those known as soft solders, and, secondly, those known as hard solders. The former class includes all those that are capable of being melted by means of the heat transmitted from a heated iron. Hard solders are employed when the temperature required to effect a sufficiently strong joint would be greater than that needed to melt the soft solders. In addition, hard solder is used when the strength of the joint itself is up to a maximum and considerably in excess of that which it is possible to obtain with ordinary soft solder.

For convenience it is better to think of the soft-soldering processes as being those employing ordinary tinman's solder, work which can be carried out with a soldering

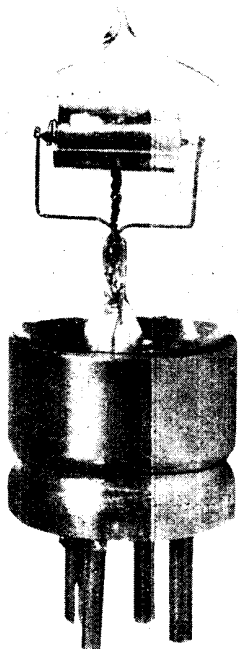

LOW-VACUUM VALVE

Above is a Dutch low-vacuum valve which is a good example of the "soft" type

iron or bit ; to think of the hard soldering as brazing, which is, in fact, another name for it ; and of the intermediate grade as silver soldering. Solder, whether of the hard or soft varieties, consists essentially of a fusible metal, usually an alloy of two or more metals, which will melt at a temperature less than the melting point of the metals to be united by it.

The essential difference between the hard and soft solders is the different temperatures at which they will melt. Soft solders are generally obtainable in two forms, at least so far as they apply to the requirements of the wireless experimenter. The ordinary soft, or blow-pipe, solder is obtainable in thin strips about $\frac{3}{16}$ in. wide and $\frac{1}{8}$ in. in thickness. It is generally obtainable in lengths which are sold by weight.

Lead and Tin Solders

Solders of this class are generally composed chiefly of lead and tin in varying proportions. Solder formed of these two metals generally increases in the temperature of the melting point with the greater proportion of tin up to about two-thirds of the whole, after which the melting point of the solder gradually works up to the melting point of the tin. In some cases other metals such as bismuth and cadmium are added, and as these metals have a very low melting point the melting point of the solder is also reduced to a lower temperature. By forming the solder from two parts of bismuth and one part each of lead and tin, the melting point of the alloy can be brought down to a temperature several degrees below the temperature at which water boils.

As a general rule, however, a solder consisting of lead and tin in about equal proportions will answer for most purposes where the soft solder is required. This is generally known as tinman's solder and melts at a slightly higher temperature (about 370° F.). It is as a rule, obtainable in strips about $\frac{1}{2}$ in. in width and $\frac{3}{8}$ in. in thickness and, as in the case of the previous variety, is almost always sold by weight.

The best qualities of this solder are made of pure lead and pure tin. Impurities, such as zinc or antimony, tend to make the solder run sluggishly and also do not allow of the perfect adhesion of the surfaces which is desirable in all soldering operations.

Another variety of soft solder sometimes obtainable is in the form of a long rod about $\frac{1}{8}$ in. in diameter with a hollow centre, this cavity being filled with a specially prepared flux, the idea being to avoid the necessity of using an independent flux during the soldering operations.

Next in order of hardness comes silver solder, which is employed for uniting small pieces and for fine work generally. Silver solder has to be melted with the aid of a blow-pipe or blow-lamp, or other source of considerable heat. Its composition and method of use is described under the heading silver soldering.

Of the hard solders, those in a granular form, often known as spelter, are chiefly used. These are generally composed of copper and zinc in varying proportions, the melting point rising with the larger proportion of copper and falling when a larger proportion of zinc than copper is used. As a rule, however, the proportion of copper is slightly higher than that of the zinc.

A somewhat similar alloy is used in the form of rectangular strip, generally known as brazing wire. Both these varieties are obtainable in various degrees of hardness, that is, some will melt at a higher temperature than others. The mode of using these is dealt with in the article on brazing.

Other Solders for Specific Purposes

In general, the foregoing solders are useful on brass, copper, tinplate and mild steel. Silver solder can be employed on the foregoing metals and, in addition, on silver. Hard solders are not used on silver, but the softer grades can be used for uniting brass or copper, though they are more generally employed for uniting articles made of iron or steel. Cast iron is not as a rule brazed, or hard-soldered, but should be auto-genous-welded.

Among special solders which are prepared for use on specific materials may be mentioned aluminium solder. This is described in detail in the article on aluminium.

Solder would be practically useless for joining purposes without the aid of a flux. The purpose of the flux is twofold. First it must exclude air from the surfaces to be united so as to prevent oxidation. Secondly it must pave the way for the solder and enable it to flow over the surfaces to be joined. If a piece of ordinary clean metal were to have solder

iron or bit ; to think of the hard soldering as brazing, which is, in fact, another name for it ; and of the intermediate grade as silver soldering. Solder, whether of the hard or soft varieties, consists essentially of a fusible metal, usually an alloy of two or more metals, which will melt at a temperature less than the melting point of the metals to be united by it.

The essential difference between the hard and soft solders is the different temperatures at which they will melt. Soft solders are generally obtainable in two forms, at least so far as they apply to the requirements of the wireless experimenter. The ordinary soft, or blow-pipe, solder is obtainable in thin strips about $\frac{3}{16}$ in. wide and $\frac{1}{8}$ in. in thickness. It is generally obtainable in lengths which are sold by weight.

Lead and Tin Solders

Solders of this class are generally composed chiefly of lead and tin in varying proportions. Solder formed of these two metals generally increases in the temperature of the melting point with the greater proportion of tin up to about two-thirds of the whole, after which the melting point of the solder gradually works up to the melting point of the tin. In some cases other metals such as bismuth and cadmium are added, and as these metals have a very low melting point the melting point of the solder is also reduced to a lower temperature. By forming the solder from two parts of bismuth and one part each of lead and tin, the melting point of the alloy can be brought down to a temperature several degrees below the temperature at which water boils.

As a general rule, however, a solder consisting of lead and tin in about equal proportions will answer for most purposes where the soft solder is required. This is generally known as tinman's solder and melts at a slightly higher temperature (about 370° F.). It is as a rule, obtainable in strips about $\frac{1}{2}$ in. in width and $\frac{3}{8}$ in. in thickness and, as in the case of the previous variety, is almost always sold by weight.

The best qualities of this solder are made of pure lead and pure tin. Impurities, such as zinc or antimony, tend to make the solder run sluggishly and also do not allow of the perfect adhesion of the surfaces which is desirable in all soldering operations.

Another variety of soft solder sometimes obtainable is in the form of a long rod about $\frac{1}{8}$ in. in diameter with a hollow centre, this cavity being filled with a specially prepared flux, the idea being to avoid the necessity of using an independent flux during the soldering operations.

Next in order of hardness comes silver solder, which is employed for uniting small pieces and for fine work generally. Silver solder has to be melted with the aid of a blow-pipe or blow-lamp, or other source of considerable heat. Its composition and method of use is described under the heading silver soldering.

Of the hard solders, those in a granular form, often known as spelter, are chiefly used. These are generally composed of copper and zinc in varying proportions, the melting point rising with the larger proportion of copper and falling when a larger proportion of zinc than copper is used. As a rule, however, the proportion of copper is slightly higher than that of the zinc.

A somewhat similar alloy is used in the form of rectangular strip, generally known as brazing wire. Both these varieties are obtainable in various degrees of hardness, that is, some will melt at a higher temperature than others. The mode of using these is dealt with in the article on brazing.

Other Solders for Specific Purposes

In general, the foregoing solders are useful on brass, copper, tinplate and mild steel. Silver solder can be employed on the foregoing metals and, in addition, on silver. Hard solders are not used on silver, but the softer grades can be used for uniting brass or copper, though they are more generally employed for uniting articles made of iron or steel. Cast iron is not as a rule brazed, or hard-soldered, but should be auto-genous-welded.

Among special solders which are prepared for use on specific materials may be mentioned aluminium solder. This is described in detail in the article on aluminium.

Solder would be practically useless for joining purposes without the aid of a flux. The purpose of the flux is twofold. First it must exclude air from the surfaces to be united so as to prevent oxidation. Secondly it must pave the way for the solder and enable it to flow over the surfaces to be joined. If a piece of ordinary clean metal were to have solder

applied to it by means of a soldering iron, it would be found that the solder would form into globular shapes and would not adhere to the surface of the metal, or if it adhered at all could be brushed off with the slightest perceptible effort.

If, however, the experiment be repeated with a suitable flux lightly spread over the surface of the metal, the melted solder will flow over the metal in a similar manner to oil over water, and it is this property of the flux that causes the solder to spread and flow which makes it of paramount importance in all soldering operations.

Many materials are available and can be successfully used as fluxes. Some are better suited for one purpose than another, but among those which may be specifically mentioned as serviceable to the wireless experimenter is the well-known preparation sold as Fluxite, which is a paste composition dark brown in colour and obtainable in conveniently sized tins. In use it is simply spread on the surfaces to be soldered. Another preparation is known as Baker's soldering fluid. This is a clear liquid, and is applied with a brush or from the end of a small pointed stick, the work to be united being moistened with the composition and the soldering carried out as usual.

Making Killed Spirit Flux

Either of these fluxes appears to give good results on most metals likely to be used by the amateur wireless experimenter with the exception of aluminium. Another flux which may be used for soldering copper, tinfoil, brass or steel is known as killed spirit. This is made by placing some hydrochloric acid in a glass vessel, taking some small pieces of clean zinc plate, cutting them into small pieces about the size of an ordinary postage stamp and dropping them into the acid.

The acid will speedily dissolve the zinc, and further pieces of zinc can be added until the acid will no longer dissolve it. It should then be poured off into another clean glass vessel and diluted with about an equal portion of water, when it is ready for use. This solution is zinc chloride. It should not be used for soldering any articles that are likely to contain food-stuffs, as it is poisonous. Killed spirit has the advantage that it is efficient and quickly made, but it has the disadvantage that it is particularly liable to splutter and make a mess unless skilfully used.

Solid fluxes can be used for ordinary soft soldering, as, for instance, resin. These are generally ordinary commercial productions crushed to a powder form and applied to the work, the heat of the iron melting the resin, which then provides the necessary flow for the solder. For soldering galvanized iron, a flux composed of hydrochloric acid and water in equal proportions can be used. The foregoing fluxes are used for soft solder.

Uses of Borax or Boracic Acid

For hard soldering the most extensively used flux is borax or boracic acid, which can either be applied in the form of a fine powder or can be moistened with water and worked in a moist form of paste. The lump borax can be rubbed on a clean slate moistened with water until it works up into a cream-like paste, which is used as a flux. For fine brazing or hard soldering the moist borax is preferable, while for large work it is generally more convenient to use it in a dry state.

An excellent composition for brazing iron or steel is known as boron compo. It is obtainable in powder form in tins, and applied in a similar way to borax. After soldering operations where soft solder is employed the metal in the vicinity of the joint will be discoloured or disfigured by traces of the flux. This must be removed immediately, either by wiping, cleansing with petrol or boiling in soda water, whichever way may be the most convenient. It is not much use attempting to remove it by rubbing with emery paper or any similar abrasive, as this only works it up into a paste, which mixes with the emery paper and makes a grinding compound.

After the brazing or hard-soldering operation the flux and some of the surface of the metal itself becomes oxidized and scales, that is, it exhibits a glassy, hard film which is very difficult to remove. In the case of the boron compo, when this is used as a flux the work can be immersed in cold water as soon as the metal has cooled to below black heat. This will cause the scale to crack and fly off, leaving the metal perfectly clean.

A plan which is often followed is to brush the work with a wire brush as soon as it is black hot. This, however, is liable to displace small parts. The only other remedy for a badly scaled job is to immerse it in a pickling acid composed of dilute sulphuric acid or nitric acid.

Although this removes the scale it easily pits the surface of the work, which will require to be resurfaced or polished. A palliative is to use anti-scale composition, of which several branded varieties are on the market. This is usually manufactured in paste form, and is brushed on to the surface of the metal in the vicinity of the

joint so that only those parts which are to be affected by the solder are exposed. The mixture prevents the formation of the scale, hence the work is finished with a minimum of trouble in cleaning it up.—*E. W. Hobbs.*

See Aluminium; Brazing; Silver Soldering.

SOLDERING: METHODS AND APPLICATIONS FULLY EXPLAINED

The Important Art of Soldering Set Out for the Wireless Experimenter

A knowledge of how to solder properly is one of the most important and necessary things for the wireless constructor. Here the processes are clearly and simply explained, so that the experimenter can make the most efficient electrical joints. He should also consult the previous article on Solder, and such cognate articles as Aluminium; Brazing and Silver Soldering. See also Wiring

Soldering is the art or process of uniting metallic articles by means of a fusible metallic alloy. There are three general methods of soldering, which are conveniently classed as soft soldering, silver soldering, and hard soldering or brazing. The wireless experimenter is chiefly concerned with the first category, that is, soft soldering, and the following notes are devoted to that aspect of the subject. Silver soldering is a distinct process, and is dealt with under that heading in this Encyclopedia. Hard soldering, often known as brazing, is described under that heading.



COMMON SOLDERING IRON

Fig. 1. Soldering irons of the common pattern frequently used in wireless work and illustrated above weigh about one pound. The soldering end is of copper

Soft soldering is carried out by making use of a relatively low-temperature source of heat supply wherewith to melt the solder. This is most usually obtained from a simple soldering iron such as that shown in Fig. 1. This instrument is variously known under such titles as soldering iron, bolt or bit, or simply as the iron. In the elementary form it consists merely of a rectangular-shaped piece of copper, known as a bolt, which is pointed at one end and tapered at the other, and is attached to a shank made of wrought iron by means of a rivet or bolt.

The iron shank usually measures from 8 to 15 in. in length, according to the size and weight of the tool, and terminates in a hardwood handle. The size of the iron has an important bearing on the soldering. For very small work an iron weighing only a few ounces is sufficient, while for general work one weighing about 1 lb. will be satisfactory.

If a large number of joints are to be made of any considerable size, a heavier iron will be preferable. The amount of heat held by the iron is roughly proportional to its weight. Consequently, a small iron cools much more rapidly than a

large one, also, the large iron takes much longer to heat up than a small one. A self-heating soldering iron is very convenient for many purposes, and a small but effective pattern of such an iron is illustrated in Fig. 2, and is known as the Lamb.

It consists of a brass container with a screw cap on one end and an outlet tube on the other, the body of the container being wound with cord to provide a grip

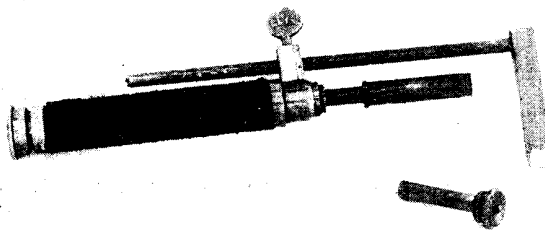

SELF-HEATING SOLDERING DEVICE

Fig. 2. Self-heating soldering irons are very useful for wireless work, especially when a number of small connexions are to be made, as in wiring apparatus. This device is light and very efficient in use

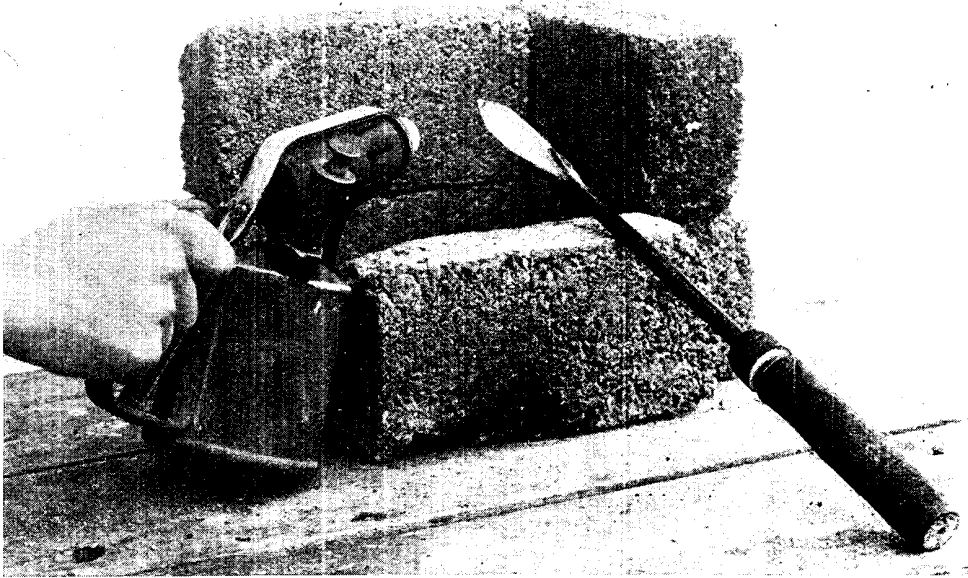

HEATING A SOLDERING IRON WITH A BLOW-LAMP

Fig. 3. When a blow-lamp is used for heating a soldering iron a few breeze blocks are very useful for conserving the heat, to form a safe rest for the iron, and to protect surrounding material, such as the woodwork of the bench, from the naked flame

and to insulate the hand from the heat. The outlet tube finishes with a small nipple and Bunsen tube. Attached to the outer end is a brass plug, provided with a thumb screw in which is adjustably fixed a plain iron rod supporting the copper bolt, which in this case is set at right angles to the rod.

When not in use the burner and nipple are closed by means of a screw cap, shown in the foreground in Fig. 2. To use such an implement, the screw cap at the bottom of the container is unfastened and the container itself filled with petrol. This soaks into an absorbent material with which the container is fitted, and after shaking out any surplus petrol the screw cap is replaced tightly. The burner is then heated, after removing the safety cap, by holding the burner over a flame of a gas stove or other sufficient heat.

When it is warm the petrol issues from the cap in the form of a spray or gas, which, when mixed with the air in the burner tube, ignites and burns with a long, blue flame. This plays on the end of the bolt and speedily heats it up to a working temperature, and will maintain that temperature until the container is exhausted. The bolt can be removed from

the container, and the latter used in conjunction with the burner as a small blow-lamp, with sufficient power for the silver soldering of small articles.

The usual way of heating a soldering iron of the ordinary type is to place it in the kitchen fire, if the experimenter is working indoors, otherwise it can be heated in any convenient stove, gas ring, or, in the absence of any such arrangement, by erecting a few bricks as shown in Fig. 3 and heating the iron by means of a paraffin blow-lamp. This is the first operation of soldering.

All soft-soldering operations are performed in a similar manner. There is nothing difficult in the work, but it requires some amount of knack, and is generally a matter of careful observation of a few simple rules. First, the iron should be at the proper temperature. This is usually judged by holding it near the cheek, when the heat given out by the iron can readily be judged. Until some experience has been obtained, the best judgment of the correct temperature is obtained by attempting to melt a piece of solder with the iron.

The temperature will be about right when the solder melts immediately it is

touched by the iron. Naturally, its temperature is somewhat less than red heat. On no account should the iron be heated to redness, as this tends to burn away the copper, and also destroys the tinned surface on the end or point. It is most important in soldering that the bolt should have a well tinned bit.

Suppose that the soldering iron were new, or for some reason had to be re-tinned, the following operations should be performed. First the iron should be well heated, and this should be followed by lightly filing or scraping the end of the iron to clean it and remove all traces of oxide. A piece of clean tinplate should be placed on the work-bench, a little flux placed upon it and a few drops of solder.

The iron is then quickly placed in the centre of the flux and pressed against the blobs of solder, which will immediately flow over the surface of the tin. The point of the iron is then rolled about in the solder and flux until the end of the iron is covered with solder, which is clearly visible in the form of a silvery film. This operation is illustrated in Fig. 5. When this is present, the bit is said to be tinned, and it is only in this condition that it is possible to solder.

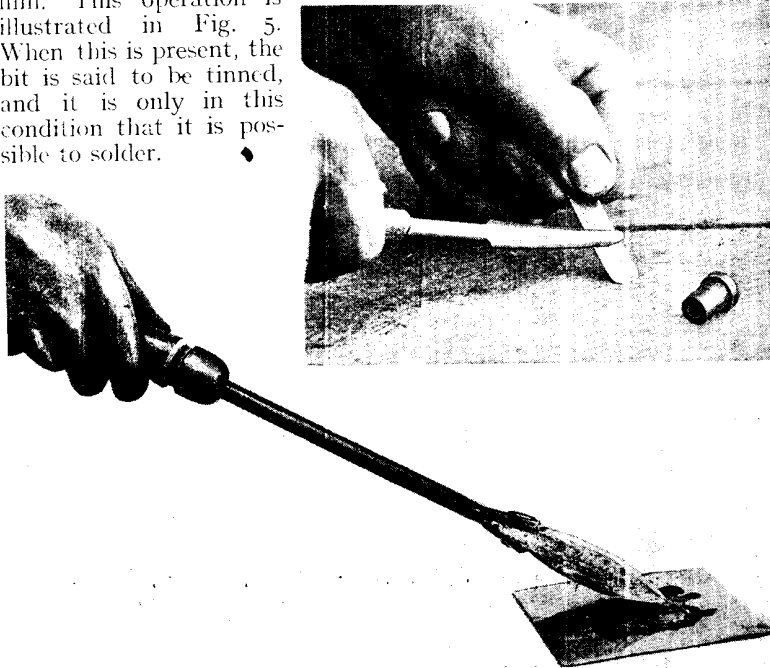

PRELIMINARY STAGES IN SOLDERING

Fig. 5 (lower photograph). Before the actual soldering is commenced, it is necessary that the bit of the soldering iron should be tinned. This is done as illustrated by mixing a little flux and a few pieces of solder and rubbing the point of the bit in it until it is covered with a film of solder. Fig. 6 (above). The work is scraped before soldering to ensure cleanliness, which is essential



APPLYING FLUX BEFORE SOLDERING

Fig. 4. Flux is best applied by means of a clean strip of wood. Both articles being soldered together should have flux applied to make the solder run easily.

The third item of importance is always thoroughly to clean the work to be joined. A simple and effective way of doing this is shown in Fig. 6, where a contact arm is to be soldered to a brass bushing. The end of the contact arm should be scraped with a small scraper, as shown in Fig. 6, or may be cleaned with a smooth file, a piece of clean emery paper, or by immersion in a pickle which is made up of dilute sulphuric acid. This must be followed by boiling in clean water. The most convenient method, as well as the most effective, is to scrape the metal thoroughly.

The next step in soldering is to apply a suitable flux, this operation being illustrated in Fig. 4. The flux should be applied with a clean strip of wood. The nature of the flux should be appropriate to the materials to be soldered, a matter which is dealt with in the article on solder. Both of the surfaces to be joined should be coated with the

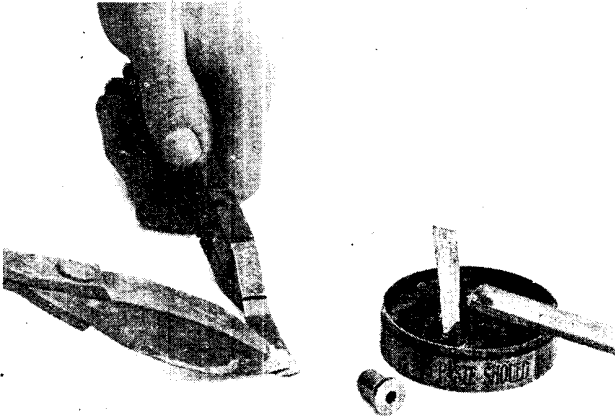

TINNING A FLAT SURFACE

Fig. 7. Tinning is absolutely necessary before two flat surfaces are soldered together, and this operation is illustrated above. The tin on the right contains the flux

flux. A minimum of flux should be applied, and this should be placed where the solder is to flow.

The next step, which is pictured in Fig. 7, is to tin the surfaces to be joined, assuming, as in this example, that they are of brass, copper or steel. Any soldering operations can be performed on tinplate without previously tinning the

surface, as this material is already coated with a film of tin. To tin the surfaces prior to the actual soldering the iron is first applied to the work to warm it. A stick of solder is then pressed against the end of the bolt so that it becomes well covered with the molten solder, which is immediately transferred to the surfaces to be tinned, a film of tin being formed by pressing the iron on the work and moving it slightly to and fro. Any excess of solder can be wiped off with a pad of clean cloth. To effect a soldered joint, the two parts are held together with a pair of pliers, or in any other convenient manner,

and a well-heated soldering iron run around the joint to warm the metal.

The end of the iron is then dipped into the flux and pressed, preferably into an angle of the joint. The stick of solder is held against the tip of the bolt, which will then melt the end of the stick of solder, and by manipulation of the iron the solder is again run into the joint.

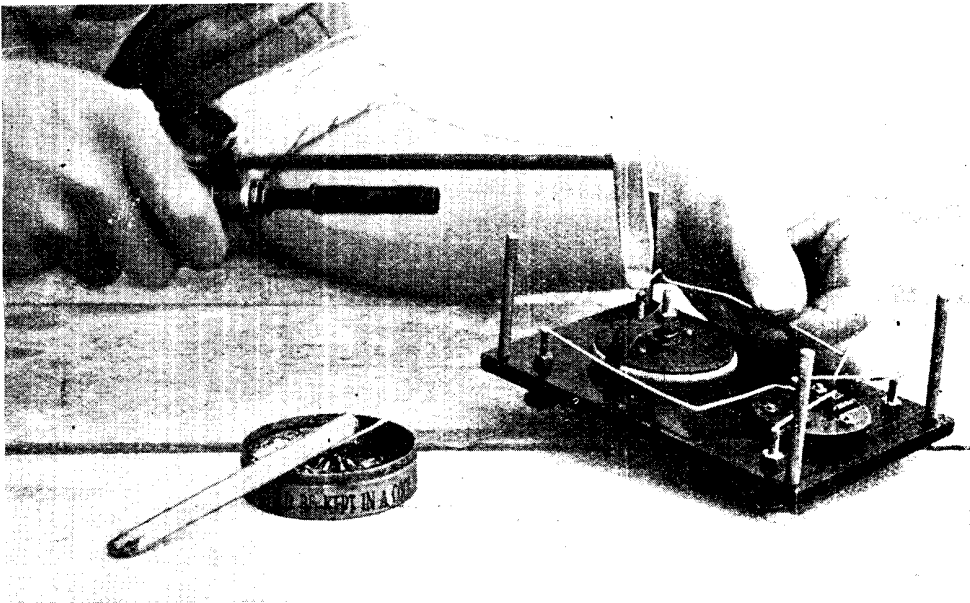

SOLDERING CONNEXIONS OF A WIRELESS PANEL

Fig. 8. One of the most common tasks in which the wireless amateur uses a soldering iron is in wiring connexions. The above photograph shows how the self-heating iron is operated. Note that the operator is holding the iron in his right hand for demonstration purposes; the iron is generally held in the left hand, the right being used to grasp the solder or steady the work

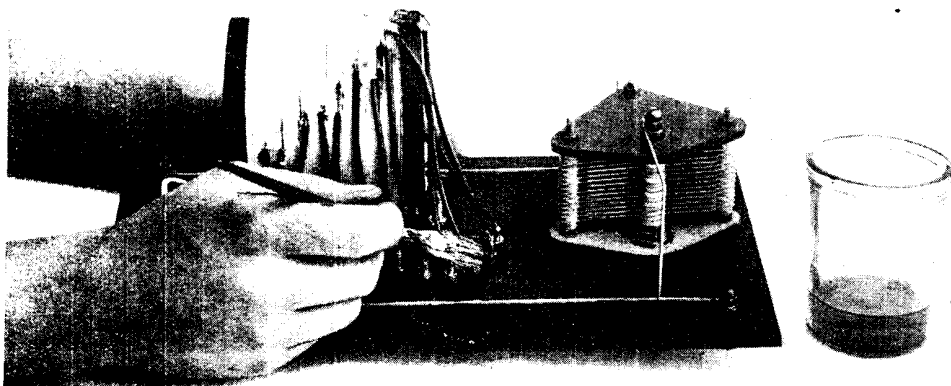

REMOVING FLUX AT THE COMPLETION OF THE SOLDERING

Fig. 9. This is an important stage in the process of soldering, and the flux must be cleaned off immediately the job is completed. Petrol is used for preference, and, as in a case of the kind here illustrated, a paint brush is very often useful for the purpose.

It should be remembered that the solder will flow towards the heat, and consequently, as soon as the solder commences to flow, the iron should be traversed steadily and regularly around the joint faces, when it will be observed that the melted solder will flow over it, and will run into and over the joint as the tinned surface becomes molten and draws additional solder into the joint.

When properly done the whole of the joint surface should be uniformly covered with a film of solder. The joint is held firmly together because the solder makes good mechanical contact with the surface of the metal. The strength of a soldered joint is equal to that of the solder, unless it be otherwise secured, as by means of pegs, screws or the like.

Many of the soldering operations in wireless work are connected with the wiring up of the panel, an operation which is shown in Fig. 8. For this class of work it is often possible to use a self-heated iron, and thereby save delays consequent upon the periodical reheating of the iron. The previous remarks as to the use of the iron apply, but in this example there is the additional necessity of keeping the iron from coming too close to the ebonite, as the heat of the iron may soften it.

It is also absolutely necessary to use the minimum of flux. A method of soldering which is often known as sweating is pictured in Fig. 10, and shows a contact arm and bush such as previously illustrated. In this case, however, after the tinning operation, the two parts are

held together with a pair of pliers or the like, and held in the flame of a gas ring, blow-pipe or other sufficiently hot flame. As soon as the metal is heated sufficiently, the tinned surfaces will commence to unite as the solder melts. At this stage a stick of solder is dipped in the flux, and the end immediately applied to the tinned joint faces, when the additional solder will melt and flow into place.

A most important stage in soldering is depicted in Fig. 9, which shows the removal of the flux when the soldering operation is complete. On a wireless panel it is a practicable plan to brush off the flux with a small brush dipped in petrol. This will wash away all traces of the flux and leave the work clean.

Soldering can be performed in a very quick and efficient manner by means of an electrically heated iron. This is simply

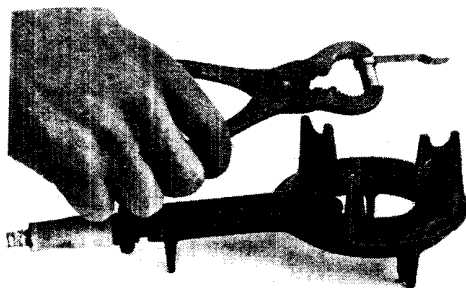

SWEATING A JOINT

Fig. 10. Two parts after being tinned are here shown being held over the flame of a gas ring in order that the joint may be sweated.



SOLENOID RULE

Fig. 1. How the polarity of a solenoid is determined is shown in this diagram

a self-heated iron, the heat being obtained from a resistance coil. Its only disadvantage is that it is only available when current is at hand from the house supply or other service.—*E. W. Hobbs.*

SOLENOID. Coil of wire through which an electric current is passing. It is sometimes called a helix, from the way the wire is wound. When a current is passed through such a coil of wire, the coil acts very much in the same way as an ordinary bar magnet. If the coil is suspended horizontally so that it is free to swing round in any direction, then while the current is passing it will take up a position pointing north and south, exactly like a compass needle.

Which end of the solenoid points north and which south depends, of course, upon the direction of the current through the coil. The north and south polarity of the ends is determined by a very simple rule, which is as follows:

Look at the end of the coil. If the current appears to be flowing round the wire in a clockwise direction, whether towards the observer or away from him is immaterial, then that end will be of south polarity. If the current is flowing anti-clockwise, the north polarity end of the magnet is indicated. The diagram in Fig. 1 will make this clear.

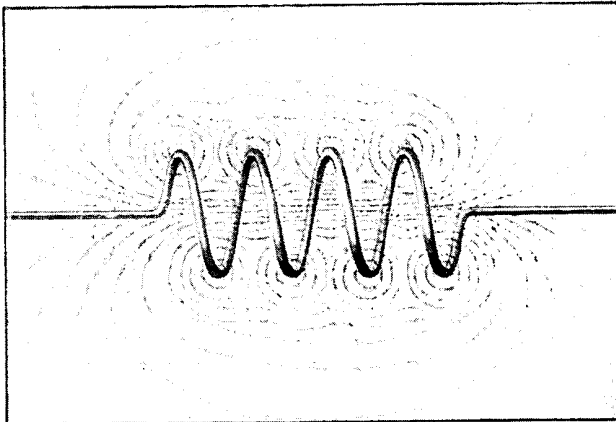

MAGNETIC FIELD OF SOLENOID

Fig. 2. The lines of force represented in the above diagram illustrate the magnetic field of a solenoid coil

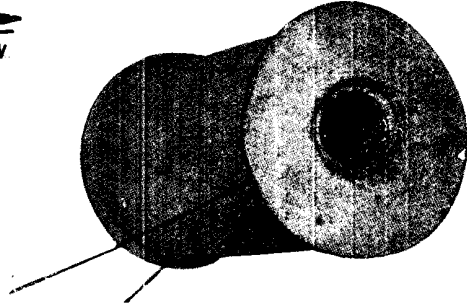

SOLENOID WITHOUT IRON CORE

Fig. 3. A coil of wire is wound on a bobbin or tube with cardboard disks at the ends. This solenoid is quickly made by the experimenter. It is afterwards covered with insulating material

The magnetic field of the solenoid is shown in Fig. 2. Lines of force are produced in a lengthwise direction through the coil, coming out at the ends, and completing the magnetic circuits through the surrounding medium. The strength of the magnetic field depends upon the strength of the current and the number of turns of wire. This is generally known as the ampere-turns. With a given solenoid in which the number of turns is constant, the flux is proportional to the current. The more closely the turns are wound together the more concentrated is the magnetic field at each turn of the coil.

When a bar or rod of iron is placed in the centre of the solenoid, it becomes an electro-magnet, and the number of lines of force is greatly increased. When there is no iron core within the solenoid, as in the type shown in Fig. 3, some of the lines of force leak out of its sides between the turns and do not extend from end to end. The iron core decreases this leakage, and also, as explained, increases the number of lines in the magnetic circuit. See *Electro-magnet; Magnetism.*

S.O.S. The international distress signal for ships at sea. The distress call is . . . --- . . . All stations must give absolute priority to the distress signals, and any ship transmitting at the time the distress signal is heard must cease until the S.O.S. call has been answered. See *International Code; Morse Code.*

SOUND : ITS IMPORTANCE IN WIRELESS EXPLAINED

Theory and Principles Simply Set Out for the Wireless Experimenter

A proper understanding of the theory of sound is necessary to every wireless enthusiast. Here the phenomena are simply explained, and the reader should also refer to such cognate headings as Amplifier ; Amplification ; Broadcasting ; Microphone ; Relay, and Transmission. Such articles as Atmospherics should also be consulted

Sound may be simply defined as the sensation resulting from the action of an external stimulus on the sensitive nerve apparatus of the ear. The nature of sound is one which should be thoroughly understood by the wireless experimenter. The science of acoustics, the theoretical study of sound, is a large one, which would take many pages of this Encyclopedia to outline. Here are dealt with only those facts and problems which concern sound from a wireless point of view. Before any of these are discussed, however, some conception of sound in general should be obtained.

First of all, sound is caused by the vibrations of some body, which in turn ultimately set up waves in the air, and these waves act upon the ear and so to the brain. When a bell is struck, for example, it is set in vibration at a rate which depends upon the material of which it is made, its mass and its shape.

How Sound Waves are Propagated

The vibrating bell moves the air in contact with its surface, and the motion is communicated from molecule to molecule of air in all directions, causing wave motions in the atmosphere. These wave motions consist of alternate states of compression or rarefaction, or to-and-fro movements, and the importance of this will be realized when the problem comes to be studied how sound waves are made to affect a piece of electrical apparatus.

A better and more obvious example of the vibrating body which produces sound is the case of a violin string or a piano wire. When a piano wire is struck by the hammer from the keyboard, for example, it is easy to see it actually vibrating and, if the finger is lightly held near it, to feel it vibrating.

Sound waves, from whatever source they may be propagated, or through whatever medium they travel, gradually diminish in strength, *i.e.* in amplitude, until finally they become so feeble they cannot be detected. Like waves of ether and any other waves, indeed, sound waves have frequency, and go through a cycle of movement. The frequency of sound waves is often termed the pitch of the sound.

The pitch or frequency of the middle C of a piano, for example, is 256 cycles per second, and that of the octave C above 512 cycles per second, and of the octave C below 128 cycles per second. The pitch of the lowest sound which can be detected by the human ear is about 16 cycles per second, and of the highest sound 20,000 to 30,000 cycles per second, and these are the usual limits of audibility. Dogs and some other animals can certainly hear sounds of a higher or lower frequency or pitch than human beings can, and the "silent" dog whistle is well known. It is inaudible, when blown, to human beings, but any dog within hearing distance will immediately prick up its ears.

The pipe organ among musical instruments has the lowest pitch generally, varying from 16 to 4,138. The piano has a range of pitch from 27.2 to 4,224, and the pitch of the human voice ranges from 60 cycles per second to 1,300, for a low bass voice to a high soprano respectively.

Speed at which Sound Travels

Sound waves move through air with a speed which is fairly constant, but which depends upon the altitude and the temperature. At sea level and normal temperature, 70° F., sound travels through air at 1,132 feet per second. The velocity of sound through water is higher than through air, since the speed of travel varies with the density and elasticity of the medium. Through fresh water sound travels at the rate of 4,700 feet per second, and through salt water at 4,900 feet per second, about four and a half times as fast as through air.

A property of any particular sound which must be understood is the tone. If the note corresponding to the middle C of a piano is played in turn by a violin, a flute, a cornet, etc., it will be found that, though the pitch is the same in every case, the tone is different. This is due to the fact that no note sounded by a musical instrument is a pure note, but is in reality a combination of notes which blend with the principal one. The separate component tones are called partial tones, that having

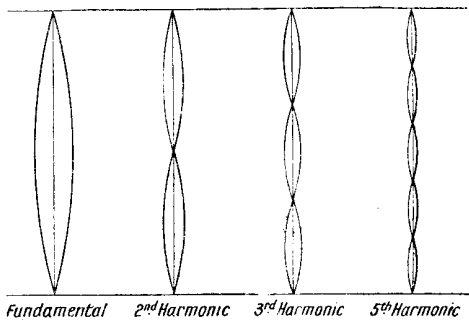

Fig. 1. How a string vibrates when plucked to give a musical note. On the left the string is vibrating at its fundamental frequency, and the remaining three instances show the second, third and fifth harmonics

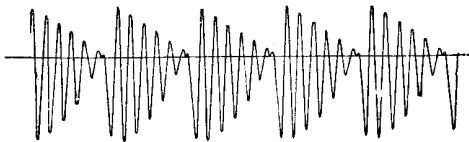

Fig. 3. This diagram represents the sound wave produced by the simple sound "ah" sustained for a moment. It gives some idea of how complicated are the sound waves of common words

DIAGRAMMATIC REPRESENTATIONS OF SOUND WAVE THEORY

the lowest frequency being called the fundamental frequency, and the others overtones. When the overtones have frequencies which are exact multiples of the fundamental frequency they are referred to as harmonics.

Fig. 1 shows how a string is vibrating at its fundamental frequency and at its second, third and fifth harmonics. Fig. 2 shows the harmonic components A, B, C of the sound wave as produced when the E string of a violin is played. The three simple curves, it will be noticed, are added together algebraically to produce the somewhat complicated-looking curve shown at D in the illustration.

The sounds dealt with up to the present are simple ones, but those produced by the human voice in the form of speech are extremely complicated. Take the apparently simple sound "ah," for example. The curve representing this sound sustained for a moment is shown in Fig. 3, so it is clear how complicated even the curve representing a simple word may be. Yet complicated as the sound-wave form becomes, its complicated form may be impressed through electrical devices upon another simple wave to modulate the latter and enable speech and other sounds to be transmitted by wireless.

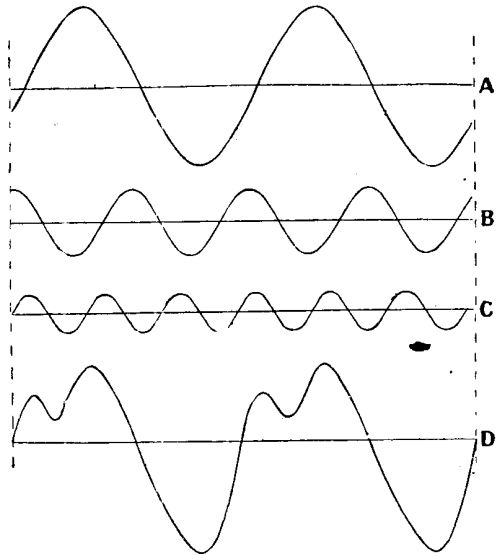

Fig. 2. In this diagram the figure at D shows pictorially the sound-wave form when the E string of a violin is plucked, and A, B, C the separate harmonic components which go to make the final wave form

The best-known electrical device for suitably transforming the sound wave into electrical impulses is the microphone. This is, in effect, an electrical ear, and, stripped of all its complications, it is shown diagrammatically in Fig. 4. Here A is the mouthpiece, corresponding to the outer shell of the ear, and acting as a collector and concentrator of the sound, as it were. This sound collector concentrates the vibrations set up in the air, by the speaking voice and other means, upon a diaphragm, D. The vibrations of the air, the alternate compressions and rarefactions already noted, cause this diaphragm to vibrate in unison.

Attached to the centre of the diaphragm is a plunger arrangement, which can move in a small cylinder packed with carbon granules, C. This arrangement is only to indicate the principle of the mechanism, and in actual practice the carbon granules may be arranged in a number of different ways. The main thing to remember is that the movement of the diaphragm, D, backwards and forwards by some mechanical means or other compresses the granules in the space in which they are confined or releases the pressure.

A current from a battery, B, is so arranged that it must pass through the

carbon granules, and a voltmeter or other electrical measuring instrument is placed in the circuit to record the change in resistance.

Fig. 4 shows the diaphragm, the plunger and the carbon granules all in their normal position. Now, the current from the battery, B, passes through the carbon granules, and the resistance these granules offer to the passage of the current depends upon the closeness with which the grains are together. When they are tightly packed together a large current will flow through them, and when loosely packed only a small one. Now, as the diaphragm vibrates it increases or decreases the closeness with which the carbon granules are packed.

In Fig. 5 the diaphragm is bent towards

carrier wave. The frequency of this wave depends upon the tuning of the transmitting circuit, and the receiving circuit is tuned to this frequency so that the signals may be received at their maximum strength. In exactly the same way as the overtones modulate a fundamental, as already explained, the amplitude of the carrier wave is varied or modulated, as it is generally called, at audible frequency by means of the microphone. This modulated wave is radiated through the ether from the transmitting aerial and influences a receiving aerial, and by means of a suitable detector the wave is transformed back again into sounds, through the telephones or a loud speaker, which are reproductions of the original sounds.

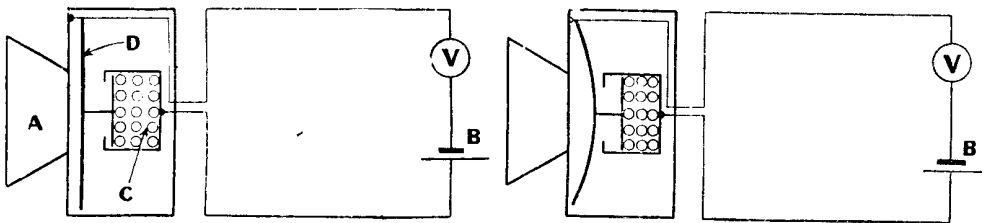

TRANSFORMATION OF SOUND WAVES INTO ELECTRICAL IMPULSES

Fig. 4 (left). The means of transforming sound waves into variations of electrical current by means of the microphone is shown. Carbon granules are compressed or loosened by the vibrations of a diaphragm. The granules are here shown in their normal position. Fig. 5 (right). In this case the granules are being packed tightly together by the movement of the diaphragm, thus enabling a greater amount of current to pass

the right of the figure, compressing the carbon grains and allowing a greater current to pass. In Fig. 6 the grains are separated and are only loosely packed, as the diaphragm has vibrated towards the left, so increasing the resistance and allowing only a small amount of current to pass.

In other words, the sound waves have been converted, via the diaphragm they cause to vibrate, into corresponding changes in an electric current.

Now, in all transmitting systems a continuous wave is sent out, known as the

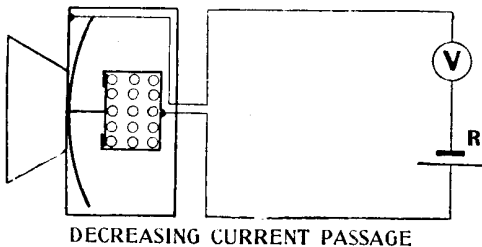

DECREASING CURRENT PASSAGE

Fig. 6. Carbon granules are here shown loosely packed, and the amount of current which can pass is accordingly decreased

Fig. 7 shows a diagrammatic section of a telephone earpiece. The ordinary telephone receiver consists essentially of a diaphragm, D, and an electro-magnet, E. The diaphragm is a disk of thin sheet iron, which rests on the case of the telephone so that its surface is as close as possible to the poles of the magnet without actually touching them. The distance is pur-



RETURN TO SOUND WAVES

Fig. 7. How the variations of electric current are transformed back again into sound waves by the vibrations of the disk D is shown

posedly greatly exaggerated in the illustration. The diaphragm is normally strained slightly towards the magnet, as shown by the thick line, since the steel core of the electric magnet is always strongly magnetized. Now, if a current passes through the coils of the electro-magnet in such a direction that the lines of force help those of the steel core, the strength of the magnet

is increased and the bulge of the diaphragm is increased. If the current passes through the coils in the opposite direction, however, the strength of the magnet is decreased and the diaphragm tends to straighten out its normal inward bending.

When the diaphragm vibrates backwards and forwards rapidly enough, owing to the fluctuations of current, it acts on the air and creates sound waves, as any vibrating body does, as explained at the beginning of the article. And the rate at which it vibrates alters the sound which is produced. Moreover, the rate at which the diaphragm vibrates depends entirely upon the fluctuations of the current, which in turn depend, through the detecting circuit, etc., upon the way the current has been modified by sounds impressed upon the microphone. So sound is converted into fluctuations of current and reconverted, after passing through the ether and suitable rectifying and detecting devices, as crystals and valve circuits, into sound again.

See Crystal Detector; Distortion; Microphone; Modulation; Transmission; Valve, etc.

SOUND-BOX MICROPHONE. A special form of gramophone sound-box which, instead of producing sound vibrations, produces electrical impulses. Fundamentally, the only difference between a gramophone sound-box and a microphone is that in the former the diaphragm is agitated by a stylus bar to which the needle is attached, and in the latter it is agitated by air waves. Thus, if carbon granules were put at the back of a gramophone sound-box diaphragm, a microphone actuated by the action of the needle on the record would result.

This is, in effect, practically the construction of the instrument shown in the illustration. At the end of an appliance which looks like an ordinary gramophone tone arm is the microphone. This is a special model peculiarly adapted to meet the requirements of this application. The

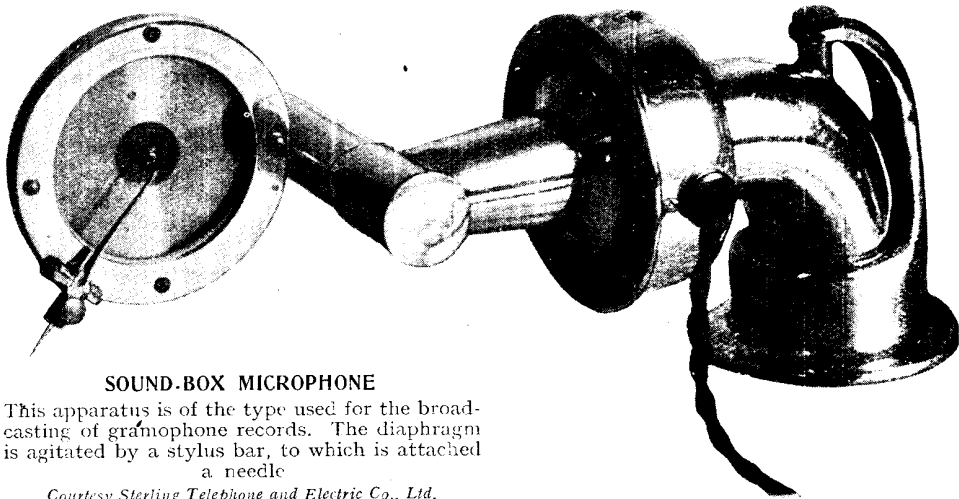

SOUND-BOX MICROPHONE

This apparatus is of the type used for the broadcasting of gramophone records. The diaphragm is agitated by a stylus bar, to which is attached a needle

Courtesy Sterling Telephone and Electric Co., Ltd.

Unfortunately, though the theory of the conversion and reconversion of sounds in this way is simple, in practice sounds are not reproduced so easily. Many things step in to prevent the absolutely perfect reproduction of speech and music. For example, certain sounds, as S, produce much higher frequency overtones than others. The inefficiency of both the transmitting and detecting apparatus leads to sound distortion, which cannot always be overcome even with the greatest care in arranging of circuits.—*J. L. Pritchard.*

leads from the microphone are conveyed to the goose-neck swivel, where a switch is concealed. This is automatic in operation and opens circuit when the sound-box is lifted off the record. It is therefore only possible for current to pass when the needle is on the record.

An instrument of this type may be connected straight to the input terminals of a telephony transmitter for radiating gramophone music. Another use is for public demonstration work where great volume is desired. In this case the

microphone is connected to a power amplifier, and the latter to one or more loud speakers. See Gramophone Attachment.

SOUNDER. An electric telegraph instrument adapted for receiving messages. It consists essentially of a pivoted armature free to move under the action of a passing electric current which is caused to flow in accordance with the making and breaking of a key operated at the sending station. The action of the moving armature as it strikes the stops on the apparatus causes a clicking noise, the frequency and spacing of which enables a practised operator to decipher messages at a considerable speed. See Morse Sounder; Telegraph.

SOUTH POLE. Term used in several ways. Usually it refers to the south geographical pole of the earth. The south magnetic pole is not in the same position, but lies approximately in lat. 70° S. and long. 102° E. It is to this point that the south pole of a magnet or a compass needle points when the magnet or needle is freely suspended. See Magnetism.

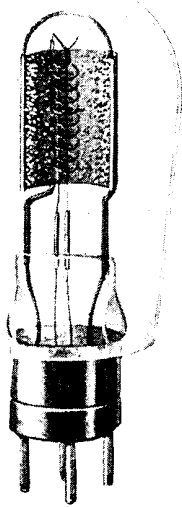

FORMATION OF SPACE CHARGE

Electrons fill up the space between the filament and the anode, so forming the space charge

with a cloud of electrons emitted by the heated filament. The illustration shows a valve with the internal structure partly cut away, showing diagrammatically these electrons flowing towards the positively charged anode.

Those electrons nearest the anode are not only attracted towards it naturally, but are also being repelled towards it by the electrons behind, as it were. The electrons nearest the filament are not moving

so fast towards the anode as those which are nearer to the latter, for two reasons. The first is that the attraction of the anode is not so great, and the second that these electrons are being repelled by those in front of them, *i.e.* between them and the anode. This is known as the space-charge effect, and it has the tendency to choke back the stream of electrons which is proceeding from the filament to the positively charged anode.

The function of the grid is to regulate this space charge, as it were, and encourage the electrons to flow steadily in one direction. If the grid is positively charged, for example, it shields the filament from the effects of the space charge, and the electronic flow is thereby increased. When the grid is made negative relative to the filament, the flow of electrons from the filament is decreased, so the grid acts as a control for the electronic current. See Valves for Reception; Valves for Transmission.

SPACER WASHERS. Small metallic washers used for obtaining equal spacing between the vanes of variable air condensers. The spacer washer is made in two main sizes, two thicknesses being common in each size.

Those washers commonly known as large spacer washers or large spacers have an internal diameter of a size to permit a good fit over $\frac{1}{4}$ in. square rod, and are used to space the moving plates of the variable condenser. The square rod forms the spindle of the condenser. The small spacers are used in connexion with the fixed plates. The fixed plates are provided with three holes spaced around their outside edges and are slipped over three lengths of 2 B.A. screwed rod rigidly attached to an end plate.

In assembling the fixed plates, a small spacer washer is slipped over each supporting rod before the next plate is added, as shown in Fig. 1, and in this way equal spacing between adjacent plates is provided.

This method of variable condenser construction is more or less standard, although occasionally smaller spacer washers, having an internal diameter of $\frac{1}{8}$ in., are met with, and these are designed for use with 4 B.A. rod. The screwed rod is not essential, pillars of $\frac{1}{16}$ in. rod being used, screwed at their ends to provide for tightening up the set of fixed plates securely. The screwed rod forms a very

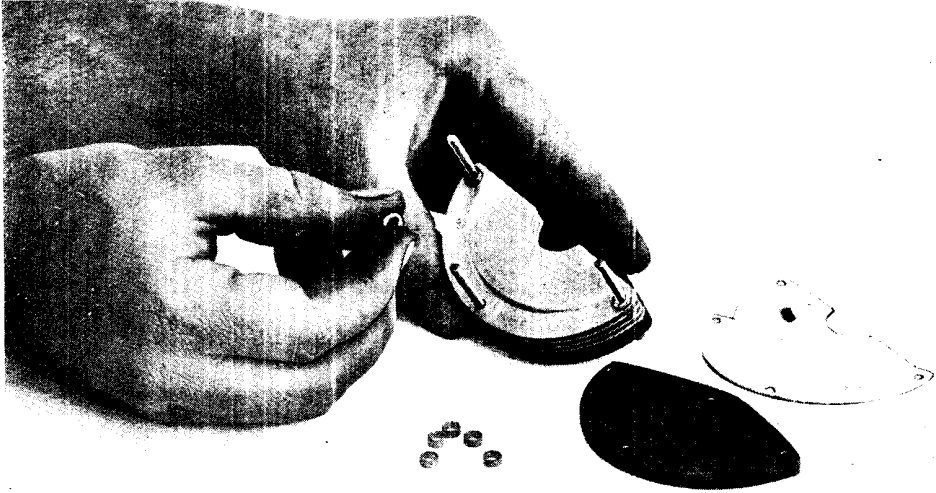

FITTING A SPACER WASHER TO A VARIABLE CONDENSER

Fig. 1. One of the most common uses in wireless of spacer washers is in separating the fixed plates of variable condensers. This illustration shows one of the spacer washers for this purpose being fitted

convenient method of construction, and is largely used.

It is important in constructing a condenser to ensure that the spacer washers, both large and small, are of equal thickness. They are manufactured in large quantities, and faulty ones are not uncommon, and if not rejected may give rise to considerable difficulty in assembling the condenser. The two general thicknesses for spacer washers are $\frac{3}{32}$ in. and $\frac{1}{8}$ in., although smaller spacers are sometimes used. The smaller the thickness of the spacer, the greater is the difficulty

in preventing the fixed and moving plates from touching.

The best way of testing spacer washers for thickness is by means of a micrometer set to the correct gauge. With this instrument any of incorrect thickness may be quickly rejected. This test is shown in Fig. 2. Another method applicable either to large or small spacers is shown in Fig. 3, where the spacer washer is applied to a wire gauge.

In purchasing spacer washers, three times the number of small to large are required for condenser construction.

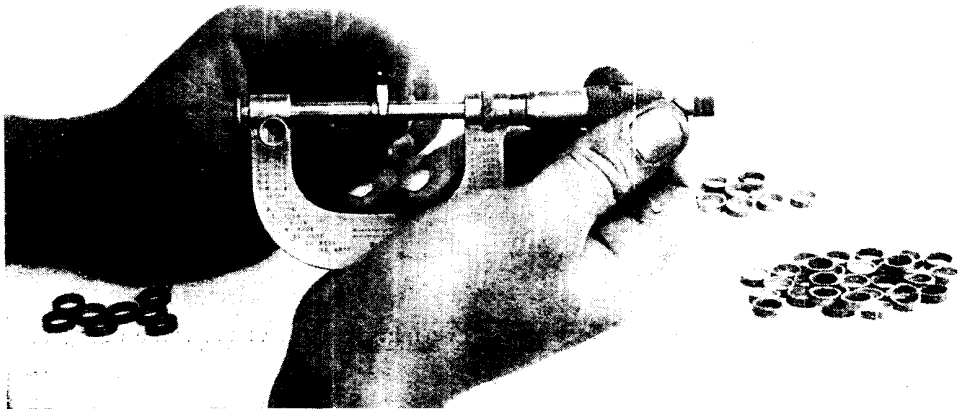

TESTING THE THICKNESS OF SPACER WASHERS WITH A MICROMETER

Fig. 2. Spacer washers vary in thickness, and when used for the purpose illustrated in Fig. 1 it is very important that they should be exactly of the same dimension. A micrometer, as shown above, is of great assistance in testing the washers for thickness



Fig. 3. Spacer washers may be tested for dimension with a wire gauge, as seen in the above photograph

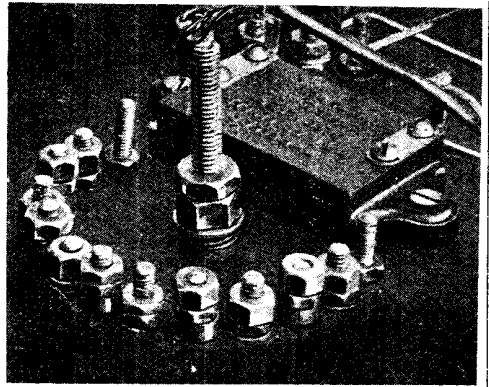

Fig. 4. Connexions of a stud switch are sometimes more efficiently made by using spacer washers to elevate the nuts

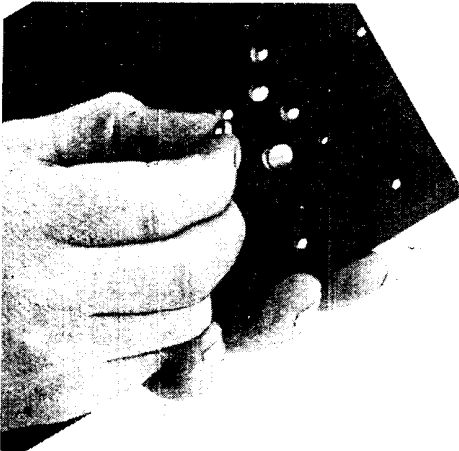

Fig. 5. Another use for spacer washers is here shown. The washer being placed in the hole in the panel is to form a brass bearing

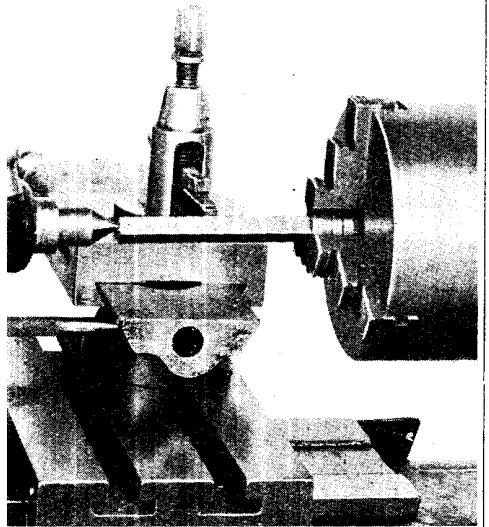

Fig. 6. Large spacer washers may often be used, as shown in this illustration, for chucking a square rod in a lathe

COMMON USES AND AN EFFICIENT TEST FOR SPACER WASHERS

A useful application of the spacer washer is shown in Fig. 4, where the spacing between the studs of a multi-stud switch is small. The nut clamping the stud to the panel is of larger diameter than a small spacer washer, and if small spacer washers are added to alternate studs the nut may be built up, thus increasing the length of the dielectric between adjacent studs. This distance may be further increased by nipping the spacer washers with pliers into an oval shape and placing them in line with the contact arm.

Another use for small spacers is to act as a metal bush set in ebonite to form a bearing for a spindle. This is of advantage, as a bearing formed in this way will offer less resistance to a rotating spindle and will also wear longer than an ebonite bearing. A hole of the same diameter as the external diameter of the spacer washer is drilled in the ebonite panel, and spacer washers pushed tightly in to fit the length of the hole. This use for the spacer washer is shown in Fig. 5, where a washer is being fitted to a hole in the panel.

Large spacers may often be used for chucking a $\frac{1}{4}$ in. square rod used in condenser spindles and slider bars, where it is desired to turn a portion of the rod round. Two or three large spacers are slipped over the end of the rod and are then tightened up in a three-jaw chuck. This operation is shown in Fig. 6. Too many spacers must not be used or they will not

yield to the tightening effect of the chuck jaws. See Air Condenser; Condenser; Spindle.

SPACE WINDING. The winding of an inductance or coil of wire so that adjacent wires do not touch each other. The common method of winding a coil of wire for an inductance or other purpose is to wind the wires side by side, using the insulation on the wires to keep them from making electrical contact. In space winding the wires need not be insulated.

In one method of space winding, illustrated in Fig. 1, twine or silk or other insulating medium is wound on at the same time as the wire, so that a turn of the insulating material exists between adjacent turns of wire. This type of winding may best be performed by rotating the former

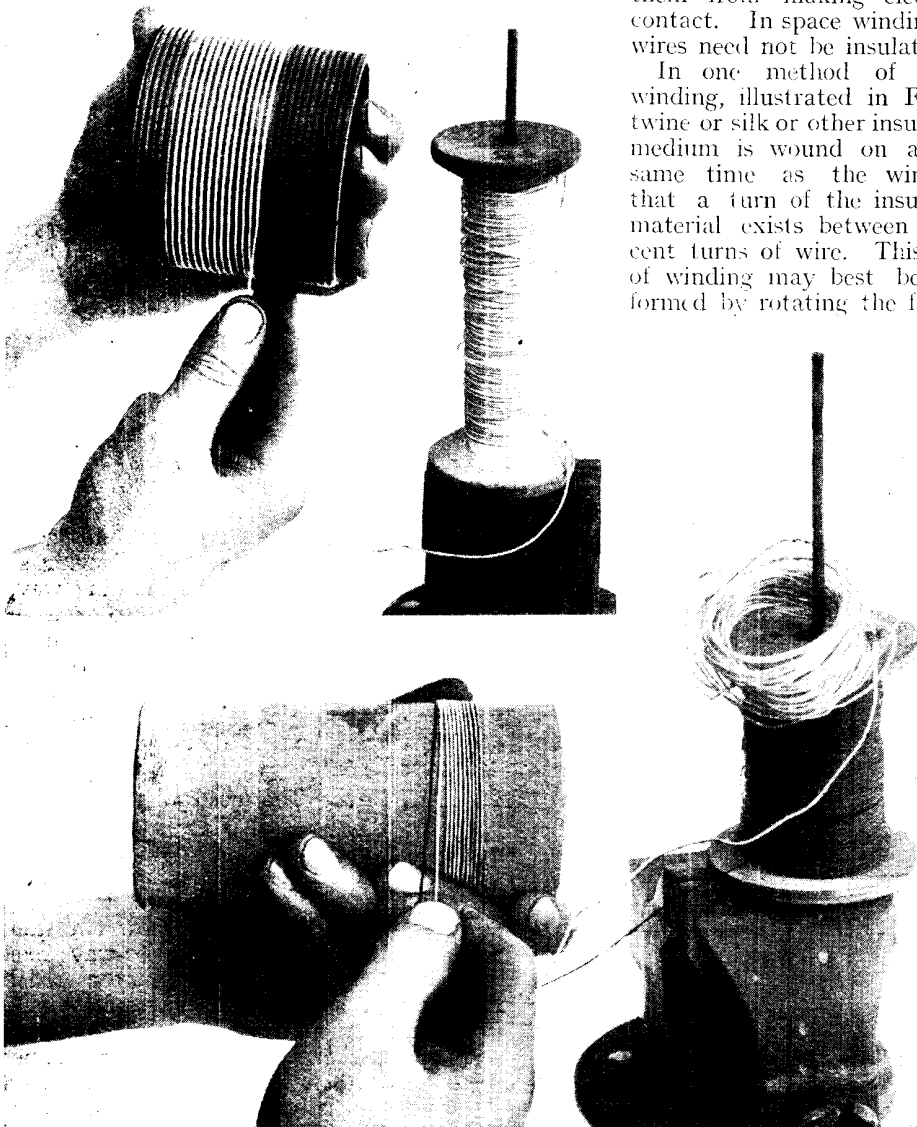

TWO METHODS OF MAKING SPACE-WOUND COILS

Fig. 1 (below). Twine or silk is being wound on to the former at the same time as the wire, so that a turn of insulating material is always between adjacent turns of wire. Fig. 2 (above). In this form of space winding a groove is cut in the former, and the wire fits into the groove to keep the turns apart from each other

in which the wire and twine are to be wound in a lathe. The reel of wire and twine should be conveniently placed to the rear of the operator and a good command of the wire and twine obtained with the right hand. A certain amount of experience and knack is required before the operation can be successfully performed.

Another method of space winding employs a former having a spiral groove or thread cut along its exterior, forming a trough, into which the wire is wound. In this type of winding it is essential that the wire be kept under constant tension, as, if allowed to get loose, the wire will mount over its trough and loosen the other turns.

This method of space winding is illustrated in Fig. 2. The most common method of space winding employs a spring of wire kept under constant tension. This method is largely used in electrical resistances, as the air space around the coils assists in cooling the wire.

Resistance coils used in motor starters and for other general electrical purposes are often wound on threaded porcelain or heat-resisting formers, which are frequently fluted throughout their length to assist in the dissipation of heat.

The aerial tuning inductances, or helices, are frequently space wound, and this method of winding is commonly employed on short-wave transmitters and receivers. See Coil; Helix; Honeycomb Coil; Inductance Coil; Lap Wound; Tuner.

SPACING COIL.

Inductance used in the aerial circuit of an arc transmission set. The

purpose of the spacing coil in a typical Poulsen arc circuit is to enable the transmitter to signal by sending out alternate variations in the wave-length radiated from the aerial. A typical arrangement of a simplified form of such a transmission device is illustrated and shows at A the aerial inductance coil; B, the variometer; C, the spacing coil, which is controlled by means of a selector switch with tapping points and a key shown at D. The arc is shown at E, the arc starter at F, and a source of electrical energy on the right.

With this arrangement it is impracticable to make-and-break the circuit in order to signal, because the arc would go out every time the circuit was broken. To overcome this difficulty the marking and spacing wave system is used. By this method the aerial is kept in a state of continuous oscillation. When, however, the key D is depressed it short-circuits a portion of the spacing coil, thus altering the length of the radiated wave. By this means one wave, termed the spacing wave, is sent out when the key is open. When the key is closed a shorter wave, termed the marking wave, is sent out.

In the receiving instrument for operating on this system means are provided for correct tuning, so that when in proper operation, that is, when the receiving set is tuned correctly to the marking wave, only these waves will be heard, and the spacing wave will not be heard. On the Poulsen system a difference in the frequency between the marking and spacing wave of 2,000 cycles is adequate to guard against confusion. See Arc Transmitter; Poulsen Arc.

SPANNER. Tool used for grasping and adjusting nuts and bolts. Those of most use to the wireless experimenter are the smaller varieties. A selection of spanners of general utility is shown in Fig. 3. From left to right these show two small adjustable spanners, a three-way fixed spanner, a large adjustable motor wrench, a ratchet spanner and a simple single-ended spanner.

The smaller class of adjustable spanner, of which there are many patterns, comprises essentially one fixed portion or body having a jaw formed at one end of it, and a movable portion, comprising the other jaw, attached to a rod or bar provided with a screw thread. A third element comprises a knurled nut, which, when rotated

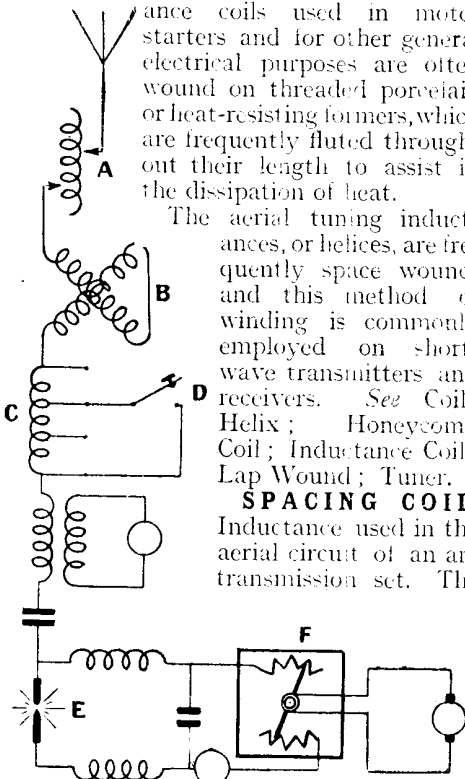

CIRCUIT EMPLOYING A SPACING COIL

An inductance known as a spacing coil is used in the aerial circuit of an arc transmitting set to enable the wave-length to be altered at regular intervals

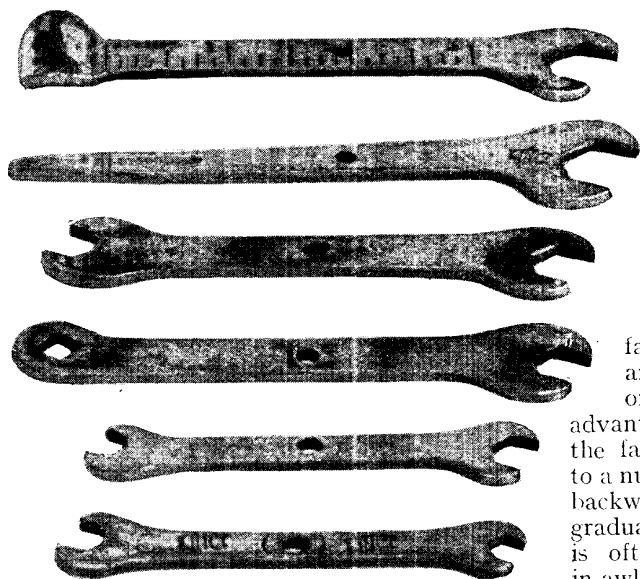

SELECTION OF DOUBLE-HEADED SPANNERS

Fig. 1. On the right of the six spanners above is a bolt or pivot, which joins the nest together in the centre

on the screw thread, propels the movable jaw. By varying the distance between the

movable and fixed jaws nuts of varying size may be gripped and rotated.

The fixed spanners are most serviceable when a considerable number of nuts of uniform size has to be unfastened or fastened. A large motor wrench, 10 in. to 12 in. in length, of the adjustable type, is very handy for



fastening down small machines and also for various purposes on a wireless mast. The general advantage of a ratchet spanner is the fact that it may be placed on to a nut, and by swinging the spanner backwards and forwards the nut is gradually unfastened or fastened. It is often serviceable when working in awkward positions.

Box spanners are those which entirely embrace the nut—that is, in this example, all four sides of the hole of the spanner bear on the four flats on an ordinary nut. In places where hexagonal nuts are to be used, hexagonal-shaped holes are formed in the spanner. A suitable selection of spanners for wireless use and for the general needs of the home worker should include a

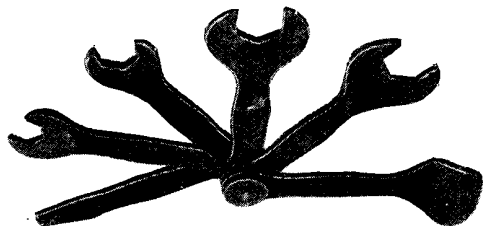

THIN FLAT SPANNERS

Fig. 2. These spanners are connected together at one end, and a screwdriver is incorporated in the nest, which is made to fit the pocket

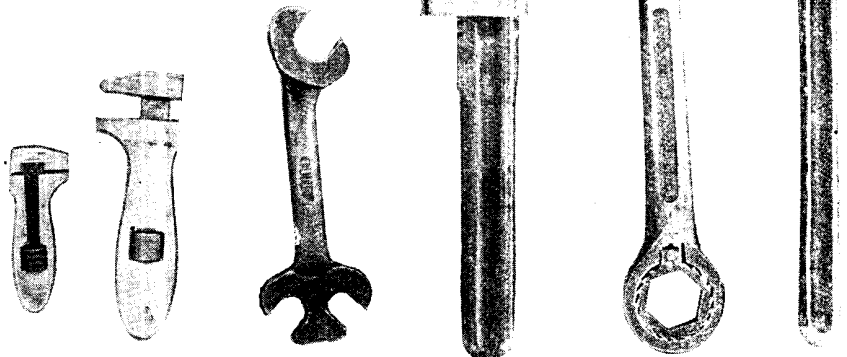

USEFUL SPANNERS EMPLOYED IN WIRELESS WORK

Fig. 3. Six examples of spanners useful for the wireless experimenter are illustrated. Some of these are designed for special purposes. On the left are two adjustable spanners of the small type, and between them and the large adjustable spanner in the centre is a tool with three jaws. On the right are a double-headed ratchet spanner and a simple spanner for fitting square nuts

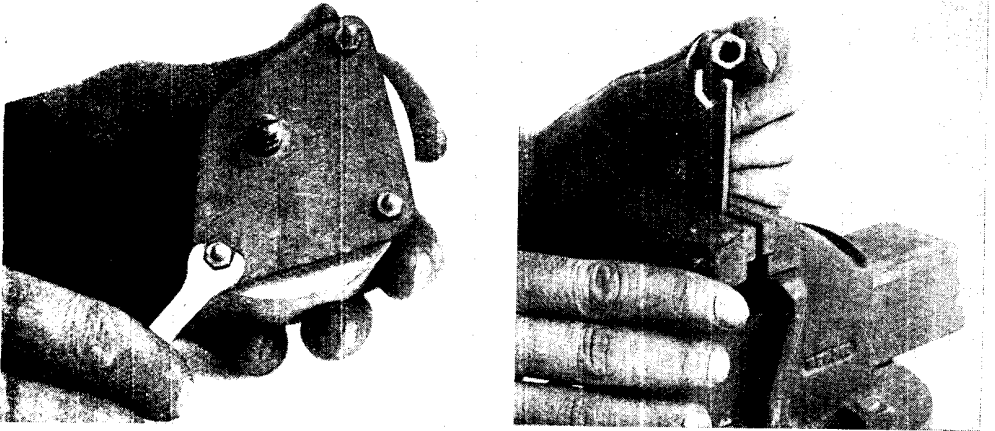

FLAT SPANNERS THAT ARE SUITABLE FOR USE WITH SMALL NUTS

Fig. 4 (left). Small flat spanners used as here shown save much damage to nuts such as is often caused by using pliers. Fig. 5 (right). This flat spanner which is easily made by filing to shape a piece of steel held in a vice, is being tested with a nut of the size it is intended to span.

large adjustable spanner about 10 in. to 12 in. in length, a medium-size adjustable spanner of the King Dick pattern measuring about $4\frac{1}{2}$ in. in length, and a very small pattern measuring about $2\frac{1}{2}$ in. in length. A few fixed spanners of sizes to fit the nuts generally used, as, for example those ranging from $\frac{1}{4}$ to 1 in., are also handy.

Particularly useful are the small nests of spanners such as those illustrated in Fig. 2. These are made from thin steel, and each has a notch cut in the end, of a suitable size for the nut. Frequently,

as in the case illustrated, a screwdriver and lever are incorporated with the set, the whole of the leaves being united by means of a pivot pin, so that any desired spanner can be used and the others folded up out of the way. When not in use the whole folds up into a small space.

Another arrangement of somewhat similar spanners rather smaller in size is illustrated in Fig. 1. In this case the spanners are of the double-ended variety, each end being notched or pierced for the different sizes of nut, one of the largest spanners having one end in the form of a

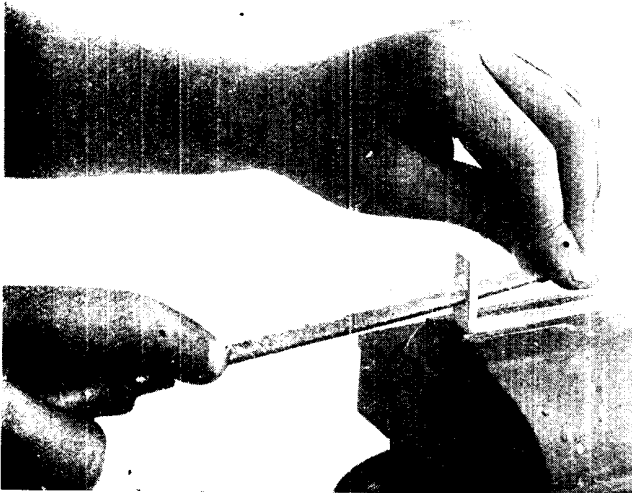

HOW TO CONSTRUCT AN L-SHAPED SPANNER AT HOME

Fig. 6. An L-shaped spanner is very useful in parts of a set which are inaccessible with the ordinary type of spanner. After the metal has been bent to shape the hexagonal hole is commenced by drilling, and finished with a triangle-section file.

lever and one face divided in inches; another has a screwdriver end, thus making the spanner extremely serviceable for wireless work. The lever end can be of service for bending connexion wires and for other similar purposes.

One of these spanners is shown in use in Fig. 4, which emphasizes the importance in wireless work of a thin, narrow spanner. This type of spanner, however, should fit accurately on the nut. This is vitally important with all spanners, as if the flats on the nut are not closely in contact with the walls of the spanner, the latter is liable to slip and round off the corners of the nut. The result is not only a slovenly appearance, but also the loss of any chance of properly tightening up the nut other than by the use of pliers or a hammer and punch.

The experimenter will soon find that the spanners commercially available do not always meet the requirements of a particular set, or perhaps a spanner may not be available at the moment. In this case an expedient is to take a piece of strip steel about $\frac{3}{32}$ in. in thickness and of a width about half as wide again as the distance across the flats of the nut. A notch should be filed in the end of the strip and the bottom of the notch filed out to an angle to fit that of the nut. To ensure a good fit on the nut the latter should be tried in the hole from time to time (Fig. 5).

A problem that often arises in the construction of a wireless set is to turn a nut in some remote part of the set where the ordinary type of spanner would be useless. This difficulty can often be overcome by making up a special spanner such as that shown in Fig. 6. This consists of a long strip of steel or brass at least half as wide again as the width across the flats of the nut and about $\frac{3}{32}$ in. in thickness. This is first bent over at one end to an L shape and a hole drilled in this short end. The whole is then filed out as shown in Fig. 6 and shaped to fit accurately on the nut, thus completing the spanner.

By reason of the length of the strip it is usually possible to work with such a spanner even if the nut to

be tightened is at the bottom of the case or in some other difficult position.

Spanners should be kept together in a drawer or box so that they are easily available whenever needed. Those made of steel are preferably wiped over with a rag steeped in lubricating oil to prevent them rusting. An excellent plan when it can be followed is to have all the spanners nickel plated. The cost is not high, and the cleanliness which results from this treatment is well worth the expense incurred.

SPARK. The sudden breaking down of the air between the points, balls, etc., forming a spark gap, is termed a disruptive discharge, electric spark, or, generally, spark.

The length of a spark depends upon the shape and size of the terminals forming the gap and the dielectric. Many observers have carried out experiments on the length of the spark in air and the voltage required to produce it between metal balls of various diameters. As a result of these experiments an average value of 4,600 volts has been obtained to produce a spark 1 mm. in length between metal balls about 1 in. in diameter in air at normal pressure and temperature. Lord Kelvin, with slightly curved metal plates, produced a spark with 4,000 volts; while Mascart, using metal balls 22 mm. in diameter, required 5,490 volts for the same result. The results are those obtained before the sparking terminals get overheated, as overheating lessens the spark voltage for a given length of spark.

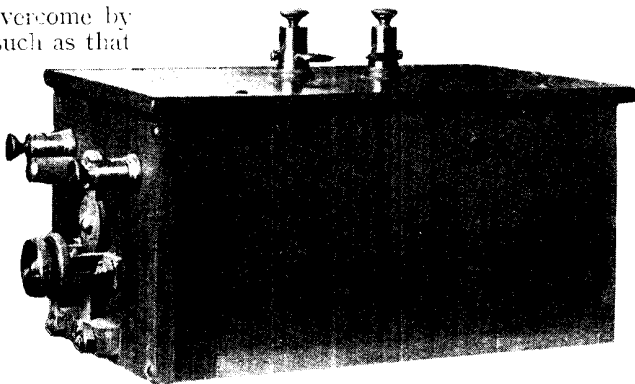

COMPLETE SPARK COIL

Fig. 1. Spark coils are frequently used by experimenters. The apparatus is completely enclosed in sheet ebonite to render it immune from dust and damp, and to protect it from the danger of mechanical injury

Courtesy X-Rays, Ltd.

For a spark 6 mm. in length some 20,000 volts are required, but this figure may be exceeded or lessened according to the size of the terminals, and can only be taken as an average of many results. Ultra-violet light falling on the terminals, for example, will decrease the voltage required for a given spark length, so that in making the measurements the spark balls must be shielded from the light from other sparks or electric arcs. See Arc; Spark Gap.

SPARK: In Transmission. Name for the signals which are heard from spark transmitters on board ships, etc. These signals are given out over a wide range of wave-lengths, and often cause consider-

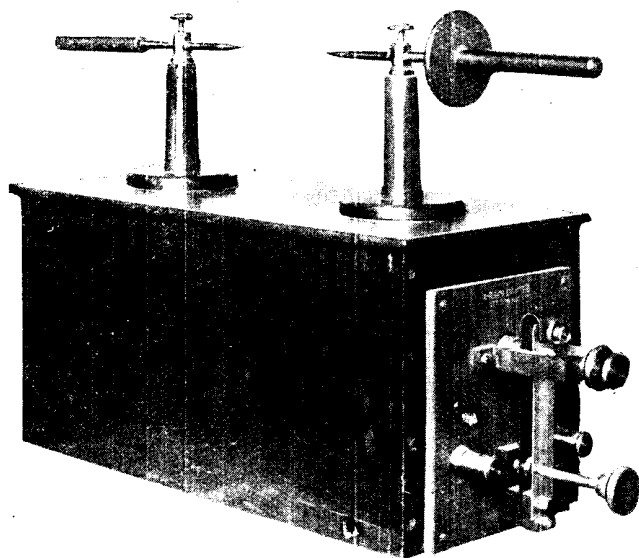

LONG SPARK COIL

Fig. 2. This coil will produce a spark approximately three times as long as the one shown in Fig. 1. The discharge rods are heavily insulated, permitting adjustment while the sparking is taking place

Courtesy X-Ray, Ltd.

able interference with broadcast reception. The elimination or the lessening of spark is dealt with under various headings in this Encyclopedia. See Interference Preventers; Tuning.

SPARK COIL. Coil with a spark gap, also known as an induction coil. A type of spark coil for experimental purposes is illustrated in Fig. 1. This instrument is completely enclosed in sheet ebonite, thus rendering it immune from the effects of dust and damp and protecting it from mechanical injury.

At the left-hand end is the interrupter,

which, by vibrating and causing contact to be made and broken, allows of the use of an accumulator for working the coil. The two large milled screws shown are for adjusting the contact breaker to suit different voltages and different sparking characteristics.

An iron armature is fitted in the centre of the blade of the interrupter, which is attracted to the core of the coil and thus breaks contact. Immediately contact is broken, however, the core becomes de-energized and the armature released, with the result that contact is again made. This cycle of operations is continued so long as the battery voltage is applied. On top of the coil are the high-tension terminals, which are shown with two pointed discharge rods fitted to them, across which the spark is allowed to jump.

A similar but larger coil is shown in Fig. 2. The design of this is substantially the same as that shown in Fig. 1, but it will deliver approximately three times the length of spark. The interrupter of this coil is of different design, and allows of a greater range of adjustment. Special discharge rods are attached to the high-tension terminals, which are insulated sufficiently heavily to permit of adjustment while the coil is in operation.

Either of the above coils may be made to work on alternating current of suitable voltage and periodicity. See Induction Coil.

SPARK DETECTOR.

Device for detecting the presence of electromagnetic waves. The simplest form of spark detector consists of two wires or strips of tinfoil attached to a glass plate placed in line with one another, and their inner ends terminated in spark balls or sharp points placed close together. Such a spark detector is an insensitive instrument, and is useful to determine approximately the direction of the electric force in the wave. The coherer, crystal detector, and thermionic valve are the practical detectors of spark signals. See Crystal; Hertzian Oscillator; Oscillator; Valve.



SPARK GAP DISCHARGE WITH HIGH AND LOW RESISTANCE

Fig. 1 (left). S is the condenser discharge across a spark gap. Here the wires R_1, R_2 , are of high resistance and the discharge is unidirectional. Fig. 2 (right). Low resistance here takes the place of the high resistance shown on the left, and the inductance, L , is high. The discharge in this case becomes oscillatory

SPARK FREQUENCY. The number of discharges per second of a condenser across its spark gap. Suppose, for example, a condenser is being charged from an A.C. supply of 60 cycles. The alternations occur at the rate of 120 per second, each side of the condenser being charged 60 times a second. Each of these 120 charges discharges or oscillates across the spark gap, and there may be many sparks for each discharge. The number of sparks which go to make up each discharge is known as the spark train frequency.

The rate of the spark frequency depends upon the alternations from the charging source. The spark train frequency depends upon the capacity and inductance of the condenser circuit, and may be at the rate of several hundred thousand or millions per second. This is the rate or frequency, it must be remembered, not the actual number of sparks which take place at each discharge. See Frequency.

SPARK GAP. A piece of apparatus designed for repeated disruptive discharges between its electrodes.

The best way for the amateur to understand the function of the spark gap is to consider first the discharge of an ordinary two-plate condenser under different conditions.

Fig. 1 shows diagrammatically the two plates of a condenser, C , which have connected to them fine wires, R_1, R_2 , of high

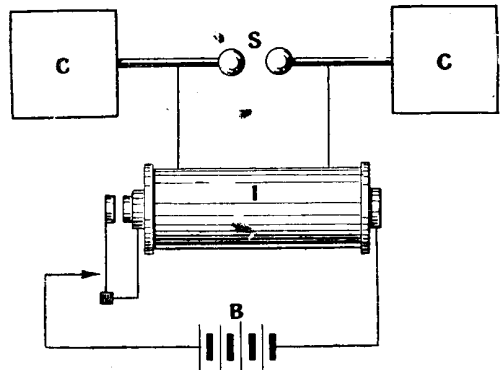

HERTZ OSCILLATORY SPARK GAP

Fig. 3. Connected to an inductance coil, I , is a spark gap, S . The condenser plates are at C , and B is the actuating battery. This is the simple oscillator as used by Hertz

resistance. Suppose the condenser is charged so that one plate is at a high positive potential and the other at a high negative potential, as shown. Now, if the ends of the wires connecting the two plates are gradually brought together as at S , there will come a moment when the condenser will discharge itself across the gap S .

Now, it is well known, and is explained under various headings in this Encyclopedia, that the nature of the discharge depends upon the relationship between the resistance of the circuit and its capacity and inductance. If R is the resistance, C the capacity, and L the inductance, the discharge will be oscillatory if R is less than the square root of $4L/C$, and will be non-oscillatory if R is greater than the square root of $4L/C$.

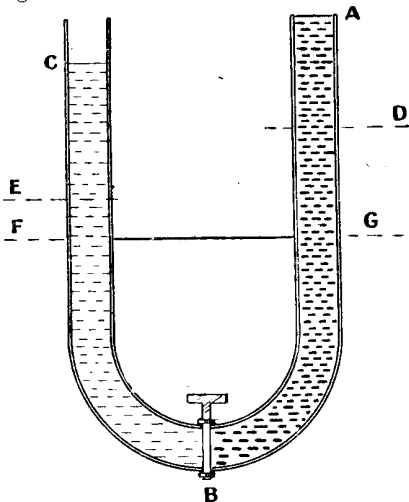

OSCILLATORY DISCHARGE OF A CONDENSER

Fig. 4. In this diagram is given a water analogy explaining the oscillatory discharge of a condenser across a spark gap

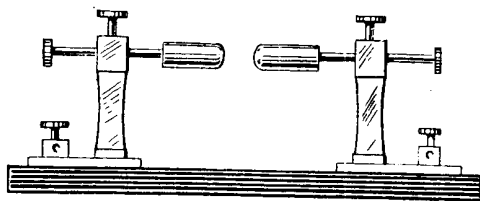

SPARK GAP FOR LOW POWER

Fig. 5. Suitable for low power this adjustable spark gap is very simple in design

Now, in Fig. 1 the resistance is high and the inductance is very small, so that the resistance is certainly greater than the square root of $4L/C$, so that the discharge is non-oscillatory. The discharge, in fact, is unidirectional, that is, the electron flow, which is actually seen as spark, passes from the positively charged plate to the negatively charged plate until each plate has come to a neutral electrical state and the condenser is discharged.

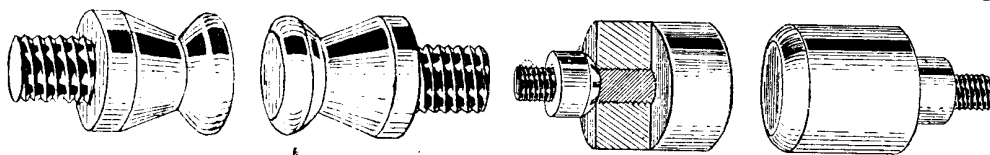

COMPARISON OF ELECTRODES FOR SPARK GAPS

Fig. 6 (left). This pair of electrodes is known as semi-cone, and its principal characteristic is its flat surfaces. Fig. 7 (right). Cylindrically shaped spark gap electrodes are here shown; the one on the left is illustrated sectionally to give an idea of the construction

Suppose, instead of the high-resistance wires in Fig. 1, we have low-resistance wires as in Fig. 2, and also place in the circuit an inductance coil L . Further, let the ends of the wires terminate in two metal balls, as shown at S .

In this second case the resistance is low, the inductance is high, and the resistance is less than the square root of $4L/C$. Instead of a comparatively slow leakage of current across the gap, as in Fig. 1, there is a quick rush of current when the spark balls are brought sufficiently near to one another, so that discharge takes place. The object of replacing the pointed ends of the wires by spark balls is to prevent the gradual leaking discharge which is always a tendency at pointed terminals.

The resistance of the spark gap, S , is high until the moment of discharge, *i.e.* until the moment the first spark passes. It then instantly drops to a very low value, due to the ionization of the air between the balls. The electrons surge backwards and forwards across the gap, so

that the sparks pass first in one direction and then in the opposite. The discharge, in other words, oscillates backwards and forwards before a position of electrical equilibrium is obtained.

The actual process can be better understood by considering the analogy of the U tube in Fig. 4). The leg $A B$ of the tube is originally full of water, and there is a tap at B which prevents the water flowing into the leg $B C$. The tap is now suddenly opened to its fullest extent. The water rushes up the leg $B C$ to some point, C , which is above the final level, $F G$, of the water. It has overshot the mark, as it were, due to its potential energy, and it flows back again up the leg $B A$ to some point, D , which is less than C , then back to a point, E , less than D , and so on until finally the oscillating flow stops and the water in the two arms of the tube finds its natural common level at $F G$. If the tap

at B had been opened only a very little so that the water could just trickle through, there would have been no such oscillating backwards and forwards. The water would have flown in one direction only until the common level, $F G$, was reached.

The first case, with the tap full open, corresponds to the oscillatory discharge in Fig. 2, where the resistance to the flow of the electrons is low, and the second case to Fig. 1, where the resistance to the flow is high.

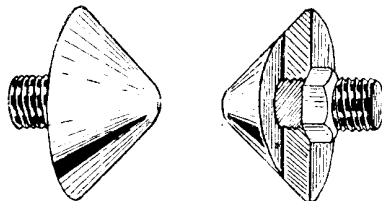

CONICAL ELECTRODES

Fig. 8. Electrodes for spark gaps are of various shapes and designs, but always in pairs. Here is a pair of conically shaped electrodes



BEDSTEAD KNOBS AS SPARK GAP

Fig. 9. Bedstead brass knobs can be converted into a simple spark gap, as illustrated, merely by fixing them to brass rods.

The sparks in the oscillatory circuit pass with such rapidity during the discharge that the gap does not regain its original resistance until the losses due to the radiation of the electro-magnetic waves and the expenditure of energy in the form of heat and light at the gap cause a sufficient drop in the potential difference between the condenser plates. When this point is reached the resistance of the gap becomes normal again, and if the condenser is connected to some charging source it is not broken down again until the potential difference has once more become sufficiently great. It is explained under the heading *Electro-lines* in this Encyclopedia how the discharge causes electro-magnetic waves to be propagated in every direction.

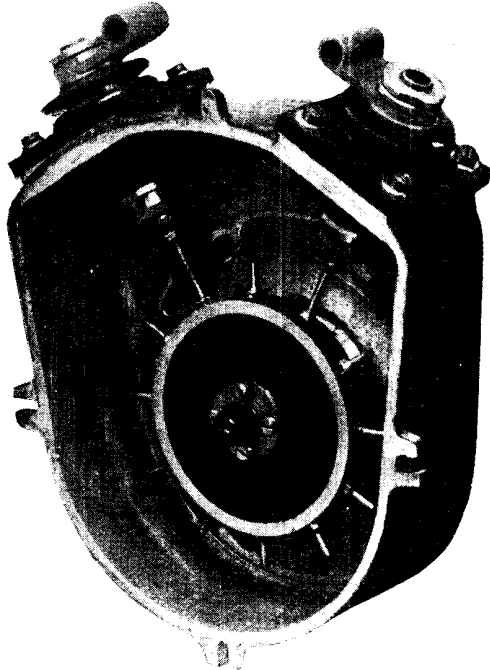

ROTARY SPARK GAP

Fig. 10. Rotary spark gaps are fitted on board ship. This is an enclosed pattern. There is one sparking point for every pair of poles on the alternator.

Courtesy Marconi's Wireless Telegraph Co., Ltd.

The length of the spark gap in practice is made shorter than the maximum to increase the number of discharges or alternations. The balls of the gap must not be too close together, however, since in that case an arc would be formed and there would be no oscillations set up except those due to the frequency of the changing current. A method of adjustment of the length of the spark gap is always provided with fixed spark gaps. Figs. 5, 6, 7, 8, 9 and 11 show various shapes of fixed gaps in use, and these are quite suitable for low power. In Fig. 9 two ordinary bedstead knobs attached to metal rods may be used for the spark balls. Fig. 11 shows a micrometer-adjusted spark gap with aluminium electrodes and fitted with cooling fins.

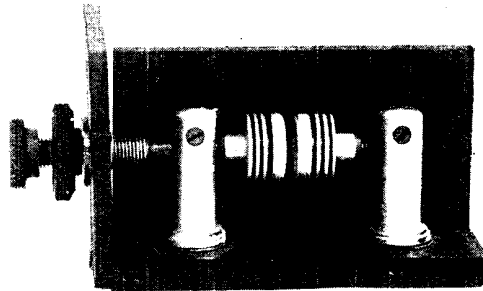

SPARK GAP FOR TRANSMITTER

Fig. 11. Micrometer adjustment and air cooling fins are features of this small power transmitting spark gap.

Fig. 3 shows the simplest method of ensuring the regular charge and discharge of the condenser. The condenser plates C are connected by metal rods to the spark gap S, and these rods are connected in turn to an induction coil I, connected in the usual way to a battery. This is the simple oscillator used by Hertz.

One of the first obvious disadvantages of the spark gap shown in Fig. 3 is that the electrodes become overheated after a short while, and many modifications of spark gaps are merely to overcome this defect. The electrodes may be hollow, for example, and kept cool by the internal circulation of water or other liquid. In some forms of gap an air blast is forced through the electrodes, and this not only helps to keep them cool but drives away the air between the electrodes, which normally has a tendency to remain conducting to some extent after discharge has taken place, so lowering the potential at which the condenser will discharge.

A further disadvantage of the stationary electrodes lies in the fact that the heat generated pits their surfaces or burns them away unevenly, so that the length of the gap does not remain constant, and this alters the potential at which the condenser discharges.

The introduction of the rotary spark gap has overcome many of these defects. In the rotary spark gap one or both the electrodes are movable, and the number of electrodes may be greatly increased. The charging of the condenser is so arranged that the electrodes are moving apart while charging is taking place, so making the resistance as great as possible, and the electrodes then come to their minimum distance apart, so making the resistance a minimum for discharge. The electrodes continuing their movement apart, the discharge is quenched rapidly.

The ordinary rotary gap consists of a small, high-speed electric motor carrying on its shaft a metal disk or ring on which are mounted a number of electrodes which pass between stationary electrodes directly connected in the closed oscillation circuit. If the speed of the motor bears no relation to the frequency of the charging current, the gap is said to be a non-synchronous discharger or an asynchronous rotary gap.

If the rotating disk is fitted with the same number of electrodes as there are poles in the alternator, the gap may then be so adjusted that the discharge takes place at the maximum amplitude of each alternation, and this is called a synchronous rotary spark gap.

A close-up view of an enclosed pattern synchronous rotary discharger is given in Fig. 10. This is part of a marine installation by Marconi's Wireless Telegraph Co., Ltd., and is fitted to the end of the spindle of a high-frequency alternator. By this means it is impossible for the speeds of the two portions of the machine to get out of synchronism.

The rotary portion of the discharger has a number of projecting rods radiating out from a central boss. These are the discharge rods, and the spark from them passes to the two fixed rods attached to the interior of the surrounding casting. The latter may be seen projecting from the insulated bushings near the top of the case.

An adjustment of relationship between the outer case, which carries the fixed points, and the alternator body, is pro-

vided in the slotted holes shown at the rear of the main casting. By loosening the bolts projecting through these slots it is possible to rotate the whole casting around its centre. This adjustment would be permanent were it not for the fact that the sparking causes the points to become misshapen at their tips, and subsequently makes the point of sparking rather late with respect to the phase of the current. There is one sparking point for every pair of poles in the alternator.

The materials used for spark gap electrodes vary as much as their shapes. The Telefunken spark gap uses flat copper disks, for example; the Lepel, hollow water-cooled brass, copper or delta metal electrodes; the Peukert gap is completely

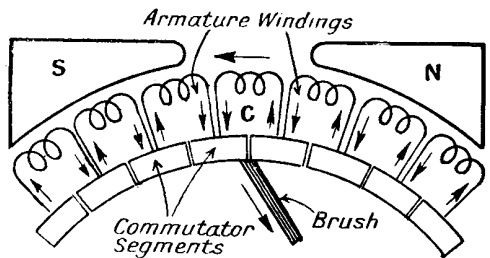

DYNAMO SPARKING

How sparking occurs at the brush of a dynamo is illustrated. Gaps occur between the commutator segments

immersed in oil, which is also the dielectric instead of air; Chaffee's electrodes are copper and aluminium, and the dielectric hydrogen gas, etc. See Arc Oscillations; Colin-Jeanne; Dubilier Arc; Fixed Discharger; Moretti's Arc; Poulsen Arc, Rotary Spark Gap; Ruhmer's Arc, etc.

SPARKING. Term used to describe the occurrence of an electrical discharge between two conductors, and usually an unwanted discharge. The same word is employed to describe the electric discharge or arc between two spark balls or the like, but in the ordinary sense sparking means the presence of an unwanted discharge due to faulty adjustment of the parts concerned or to some inherent defect in design.

One commonly experienced form of sparking is that between the brush and the commutator segments of a dynamo of small size. This can be explained by consideration of the diagram, where S and N are the poles of a field magnet. The armature windings are shown conventionally and the brush and commutator

segments shown diagrammatically. Suppose the machine to be running in the direction of the arrow, and that the brush is at the point between the two adjacent segments. The coil or winding, C, is now short-circuited by the brush. Immediately before this the winding was carrying current, and as soon as it has left the brush it will have a reverse current forced through it.

But it takes a perceptible time for the first current to die down to zero, consequently there will be an induced electromotive force set up in it momentarily which will tend to maintain the current in the original direction. If the original current is still existing at the moment the brush leaves the segment, the induced electro-motive force will cause a current to flow over the insulation to the brush, thence across the brush, and so back to the armature coil.

The current will then appear as a spark during its passage over the segment and brush, consequently unless such sparking be eliminated or minimised the commutator and brushes will speedily be worn away. One remedy that may be tried is to use brushes made of carbon or some suitable composition, which by virtue of their high resistance minimise the trouble.

A palliative is to set the brushes slightly ahead of the actual neutral line, thereby short-circuiting the armature coil at a later stage, and whilst it is under the influence of the next winding ahead.

Sparking is also frequently caused by dirty or uneven commutator segments or brushes. The remedies are in this case obvious.

Sparking between switch contacts at the moment of breaking is often encountered unless overcome by some quick break device or other feature in the design. On all small switches this sparking is seldom serious, and a quick break will generally deal with the trouble. The amateur must be careful to guard against sparking between two conductors while attending to the wiring of a set, as this is not only imposing a short circuit on the battery or other source of supply of current, but is liable to ignite any inflammable material in contact with it.

SPARKING BUZZER. Name applied to a type of interrupter used for test purposes. One of the principal applications of a sparking buzzer is for the

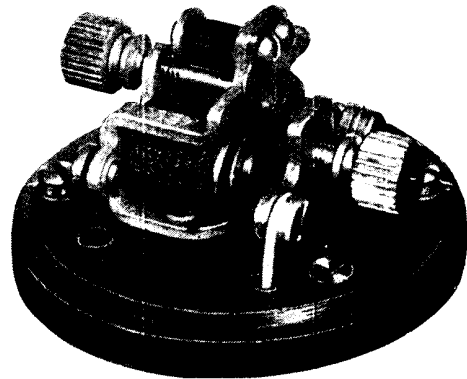

COMMERCIAL SPARKING BUZZER

Fig. 1. Buzzers of this kind are used for test purposes in receiving circuits, particularly those intended for the reception of spark signals

testing of the receiving circuit of a wireless set, more particularly those which are intended for spark reception.

The sparking buzzer is in essence similar to the ordinary buzzers as described in the article, on buzzers, and is similar to the customary electric bell mechanism. It is, however, wired on a different system.

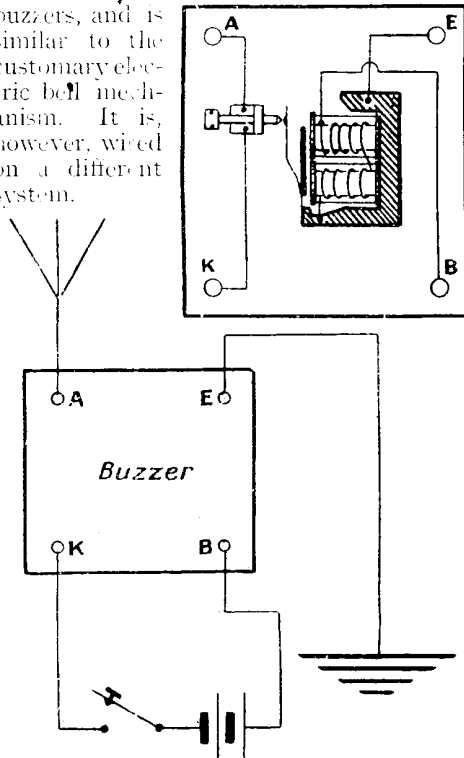

CONNEXIONS FOR A SPARKING BUZZER

Fig. 2 (top). This diagram shows the wiring of a sparking buzzer. Fig. 3 (bottom). Circuit connexions of a sparking buzzer for test purposes are shown

The appearance of one type of commercial spark buzzer is shown in Fig. 1. This comprises a circular ebonite base with a pair of electro-magnets mounted on it. These are located between the metallic framework which serves to hold the magnets and to act as one part of the connexions. Attached to an upturned part of the frame above the magnets is an armature of springy metal with a soft iron pole-piece attached to the lower part.

The pole-piece is normally located at a small distance from the ends of the magnet cores, but is capable of fine adjustment by the screwed rod which, when rotated by the knurled knob, forces the armature further away from the magnet cores. Located at a small distance away from the end of the armature on the outer side is a small bracket which supports a contact point adjustable by a small screw with a knurled head.

The wiring of a typical sparking buzzer is shown in Fig. 2, from which it will be seen that the wires terminate at four terminals marked A, E, B, K. The circuit connexions are shown in Fig. 3, where it will be seen that the terminal marked B on the buzzer is connected to the positive side of a small battery. Another wire from this battery is connected to a tapping key, and thence a connexion is made to the terminal K.

From the terminal A on the buzzer is set up a miniature aerial, which may be a length of stiff wire about 3 ft. to 4 ft. long.

The remaining terminal on the buzzer is marked E, and is connected to the earth. The action of the spark buzzer when thus connected is that when the key is depressed a current flows through the magnet windings, and thus actuates the buzzer armature. This then emits the customary humming noise, but, as the current is intermittent due to the automatic action of the vibrating armature, a series of small sparks occur between the points of the contacts. Now, as the spark is in the aerial circuit, the whole arrangement becomes a small transmitter capable of setting up oscillations in the receiver if the latter be properly connected up. When the buzzer is wired as shown in Fig. 2, the waves that are radiated from the miniature aerial would be of a length determined by the buzzer aerial.

This is of no material moment when the buzzer is used as a test for continuity of the receiver circuits. See Buzzer.

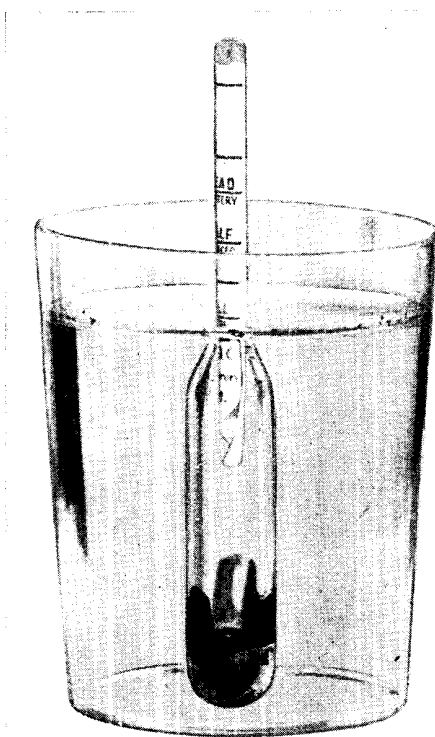

TESTING ACCUMULATOR ACID

Specific gravity of the electrolyte used in accumulators is tested by the hydrometer, shown in use above

SPECIFIC GRAVITY. Ratio between the weights of equal volumes of any substance and of some other substance that has been chosen as a standard of comparison. The substance chosen for comparison as the standard for gases is hydrogen or air, and for liquids and solids water. The specific gravity of a substance is usually determined at some standard air pressure and temperature. Water, for example, is at its maximum density at 4° C., and specific gravities of solids and liquids, therefore, are usually taken at this temperature.

Specific gravities of liquids and solids are generally determined by making use of the fact that a solid floating or immersed in a liquid loses weight equal to the weight of the liquid displaced. The solid is weighed in air and water by means of special balances, and from this the specific gravity may be obtained. A hydrometer may be used to find out the specific gravity of a liquid. The hydrometer consists essentially of a glass bulb

at the upper end of which is a graduated glass tube. On this tube the depth to which the hydrometer sinks may be read off quickly. These graduations are often arranged so that the specific gravity of the liquid under test may be read off directly without any conversion. Many special hydrometers are made for finding out the specific gravities of certain groups of liquids, as milk, alcohol, etc., as it is impossible in practice to make one hydrometer sensitive enough to give the specific gravity of any liquid.

The table below gives the specific gravities of most substances used by the wireless experimenter.

Aluminium	2.7
Antimony	6.7
Brass	8.1
Copper	8.79
Glass	2.89
Iron (cast)	7.5
Iron (wrought)	7.74
Lead	11.35
Mercury	13.6
Nickel	8.9
Platinum	21.5
Silver	10.47
Steel	7.29
Zinc	7.19
Graphite	2.35
Accumulator acid	1.25

SPECIFIC INDUCTIVE CAPACITY. The ratio of the inductive capacity of a medium to that of air, or, more strictly, a vacuum. It is, practically speaking, another name for dielectric constant, the specific inductive capacity of air being taken as unity. See Dielectric; Dielectric Constant.

SPECIFIC RESISTANCE. Resistance of an inch or centimetre cubed of a conductor between opposite faces. The specific resistances of substances are tabulated usually at 0° C., since resistance changes with temperature. When the specific resistance of a conductor is known, its total resistance can be calculated from the formula $R = \rho l/a$, where R is the resistance required, ρ is the specific resistance, l the length of the conductor, and a its cross-sectional area.

Since wires are circular as a general rule in cross-section, the formula may be written $R = \rho l \cdot 7854/d^2$, where d is the diameter.

The resistance R is measured in ohms per inch or centimetre cubed, l is the length in inches or centimetres, and a the cross-sectional area in square inches or square centimetres.

The following table gives the specific resistance in microhms per centimetre

cubed at 0° C. for metals which may be used in wireless.

Silver (annealed)	1.468
„ (hard-drawn)	1.620
Copper (annealed)	1.561
„ (hard-drawn)	1.621
Aluminium (annealed)	2.665
Iron (annealed)	9.065
Steel	15-20
Lead (annealed)	20.38
Mercury	94.07
Magnesium	4.355
Platinum	10.917
Brass	7.0 to 8.0
Phosphor-bronze	8.5
Platinoid	41.7
Manganin	42.0
Rheo-tan	52.5
Rheo-tenc	77.07

Resistance varies with temperature, and the specific resistances of pure metals increases with increase of temperature. For general purposes the resistance with increase of temperature may be calculated from the formula $R_1 = R(1 + at)$ where R_1 = required resistance.

R = resistance at 0° C. as given by the table,

t = temperature above 0° C. in degrees,

a = coefficient depending upon the metal, and assumed constant for each degree of temperature between the temperatures for which the calculation is made.

The constant a for silver is .004, and for copper .00428. For alloys it is very much smaller. For platinoid it is .00022, for manganin zero for all practical purposes, and for rheostan .00041 and rheostene .00116. See Resistance.

SPEECH AMPLIFIER. Term used for a low-frequency amplifier adapted especially for the amplification of the spoken word, and more particularly when the speech is to be heard over a wide area.

A special type of power speech amplifier by the Sterling Telephone and Electric Co., Ltd., is illustrated. This instrument is made particularly for use with public address apparatus, whereby the use of loud speakers distributed over a large area it is possible for one speaker to address an almost unlimited number of listeners. Transformer coupling is used, the transformers being able to withstand an anode voltage of anything up to 750 volts continuously without fear of breakdown.

The panel is of heavy gauge sheet brass, dull black enamelled and bushed with

ebonite at every point where any of the electrical conductors are attached. The terminals are ebonite-capped to prevent risk of shock to the operator. Three switches are fitted, which, being inserted in the anode and filament circuits of each valve, allow any number of valves to be used at will without delay. The valves are of the Marconi-Osram L.S.5 type, dull emitter power-amplifying valves having a loop filament and oval-sectioned grid and anode. A separate filament resistance is fitted to each valve. See Amplifiers; High-frequency Amplifier; Loud Speaker; Low-frequency Amplifier.

SPELTER. Spelter is a form of zinc, but the term is more usually applied in wireless work to the spelters used in soldering operations.

The base of a spelter used in this way is brass, that is, an alloy of copper and zinc. The greater the percentage of zinc, within limits, the more readily does the spelter melt, hence its usefulness for uniting brass and other low melting-point metals. There must not be too much zinc, however, or the resulting joint will be weakened owing to the brittleness of the alloy. The mixture commonly used contains about 45 per cent to 50 per cent of zinc in the composition of the brass, and is used in a granulated or powdered form. This spelter is quite yellow in appearance, and when such colour is detrimental, a white alloy can often be employed containing

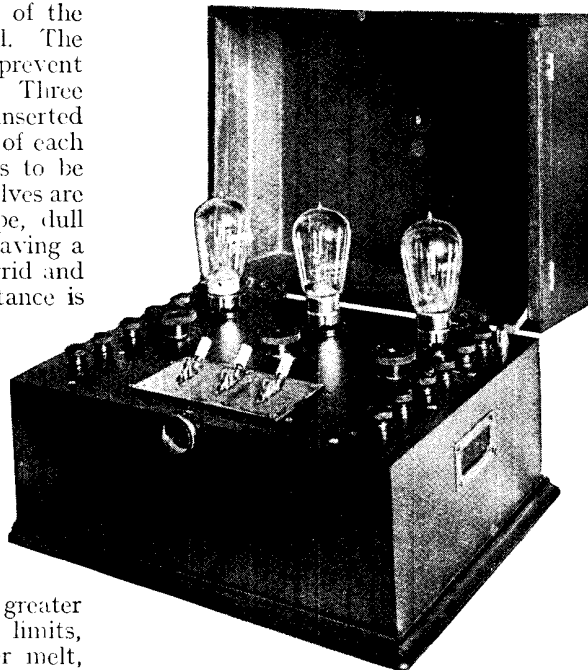

SPEECH AMPLIFIER

Amplifiers of this kind are made for use where great power is needed, as when demonstrating at public meetings

Courtesy Sterling Telephone and Electric Co., Ltd.

some such mixture as copper, 44 per cent; zinc, 6 per cent; tin, 50 per cent. This melts at a low temperature, and is suitable for small parts such as those on wireless sets. A spelter for use on nickel silver or iron may contain copper, 35 per cent; zinc 57 per cent; nickel, 8 per cent; the proportions varying somewhat.

The use of spelter is described under the heading *Brazing*. See also *Soldering*.

SPIDER-WEB COIL. Type of coil resembling a spider's web in appearance. The name is often given to basket coils. A very easily constructed spider-web coil inductance is shown in Fig. 1, and consists of two pieces of ebonite joined to form a cross and having a series of holes equally spaced from the centre and to the outer ends, through which the wires forming the inductance are threaded.

Two ebonite strips are required measuring 5 in. in length, $\frac{1}{2}$ in. in width, and $\frac{1}{4}$ in. in thickness. At the centre of each strip a slot $\frac{1}{4}$ in. in width and $\frac{1}{4}$ in. deep is cut so that the two strips may be halved together. The positions of the various holes for the wires are

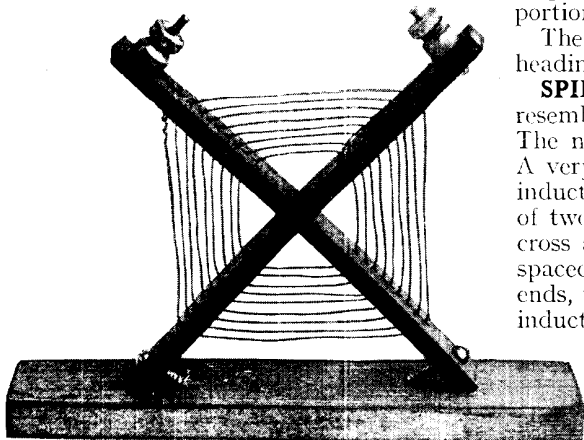

SPIDER-WEB INDUCTANCE

Fig. 1. Inductance coils of the spider-web pattern are easily made, and possess very low self-capacity. The cross members consist of ebonite strips

marked out as shown in Fig. 2, with a pair of dividers, one leg being set to the centre of the strip, while the other marks the position for the holes on either side of the strip. These holes should be $\frac{1}{8}$ in. apart.

Before winding is commenced two terminal holes are drilled for the terminals shown in Fig. 1, and two holes on the lower arms are required through which wood screws secure the inductance to a suitable wooden base. Winding is effected from the middle, the beginning end being threaded through the holes progressively

wireless spindles. Two sizes are generally used, 4 B.A. and 2 B.A., the latter being the more useful size owing to its larger diameter. The majority of ebonite knobs and dials used in wireless work are either drilled or drilled and tapped 2 B.A. for use with the large size of spindle. Spindles made from 2 B.A. screwed rod may be cut to any desired length with a sharp pair of top-cutters, and thus accurate measurement of the spindle is unnecessary.

Spindles of the screwed rod variety are not always satisfactory when the bearing

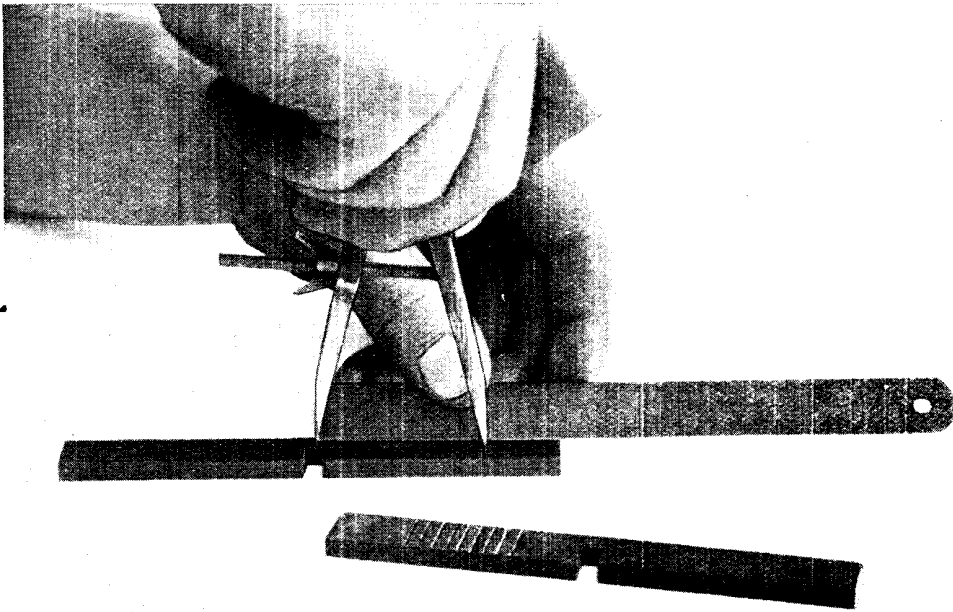

MARKING OUT THE EBONITE CROSS-PIECES FOR THE SPIDER-WEB COIL

Fig. 2. Positions for the holes in the cross members of the spider-web inductance coil are here shown being marked out. Dividers are used for this purpose.

until the outside is reached, when the two ends are connected to the terminals secured to the top of the inductance. See Basket Coil; Co2.

SPINDLE. A straight rod capable of rotation in a bearing and used for altering the position of a component or a part of the apparatus. Spindles play an important part in wireless apparatus, being incorporated in practically every moving mechanism. Iron or steel should be avoided as far as possible where its proximity to magnetic influence affects the operation of the instrument. Screwed rod is very largely used for the construction of

is formed by the ebonite panel, as the screwing action of the spindle tends to enlarge the hole forming the bearing. Brass bushes having a $\frac{1}{8}$ in. hole, which fits 2 B.A. screwed rod, may be readily purchased for the purpose. Small spacer washers also form a cheap and convenient bushing for spindles. Slackness in spindles is often overcome by the use of a spring washer, which forms a friction fit between the panel and the locking nut which secures the moving part on one side, while a similar nut is used on the other side.

An example of this is found in Fig. 1, which illustrates a spindle spring washer

and nuts necessary for supporting a variometer rotor. This application of the spindle is largely used also in filament resistances and other forms of mechanism used in wireless. Electrical connexions are often made to the spindle, and various methods are adopted for collecting current from the spindle. One method is to use a small length of strip brass having a $\frac{1}{8}$ in. hole at one end, which is slipped over the spindle after the spring washer connexion is made, in this case from the other end of the brass strip. Continual pressure is brought to bear upon the strip by means of the spring washer.

Probably, however, the best method of obtaining connexion from a spindle capable of rotation is to solder a flexible insulated lead to the end of the spindle. Spindles for variable air condensers are usually of $\frac{1}{4}$ in. square brass rod, which are turned round into $\frac{1}{8}$ in. diameter at their ends, where they form bearings for the condenser. This operation is formed with a square collet chuck, which enables the turning operation to be made. This is illustrated in Fig. 2.

Another method of chucking the square rod is described under the heading Spacer

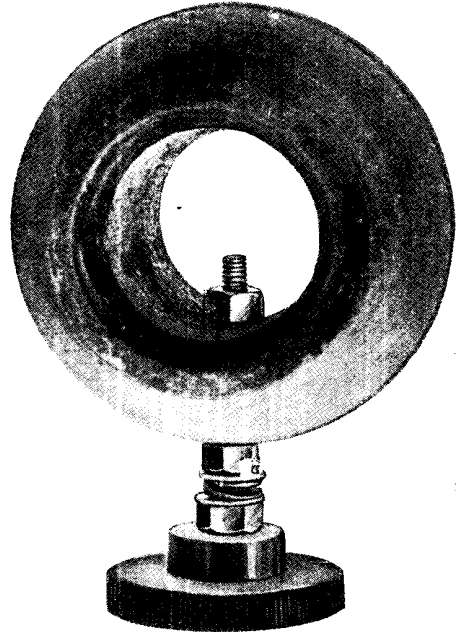

VARIOMETER, SHOWING SPINDLE

Fig. 1. How the spindle of a variometer is held tight is illustrated. Two nuts are placed one on each side of the spring washer

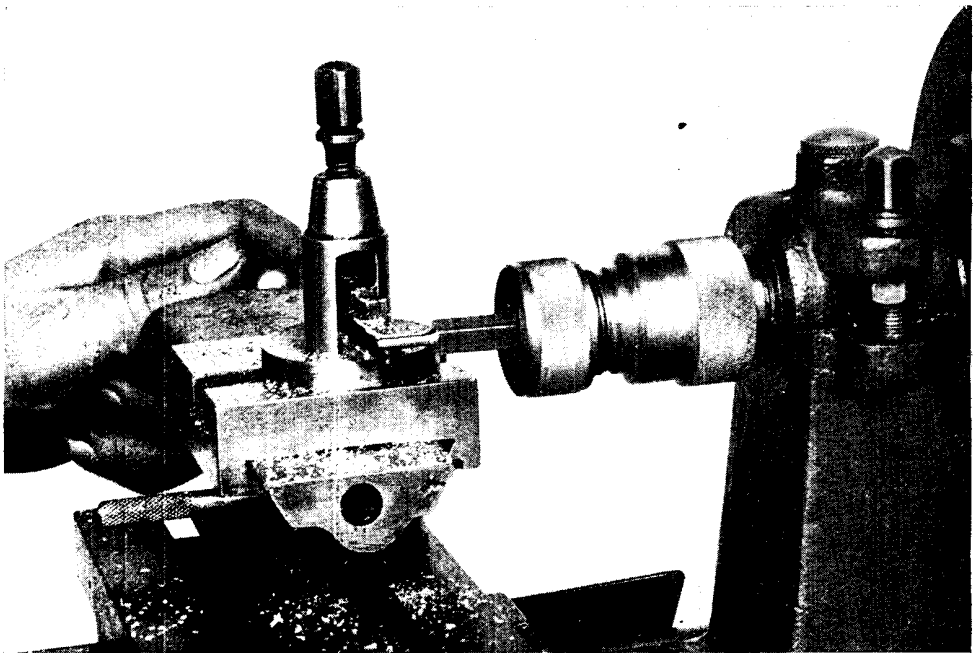

TURNING SQUARE RODS IN A LATHE FOR USE AS SPINDLES

Fig. 2. In the above photograph is shown a special collet chuck in use for turning the ends of square rods for spindles. Spindles of this kind are very commonly used in wireless for variable air condensers, screw threads being cut in the turned portions

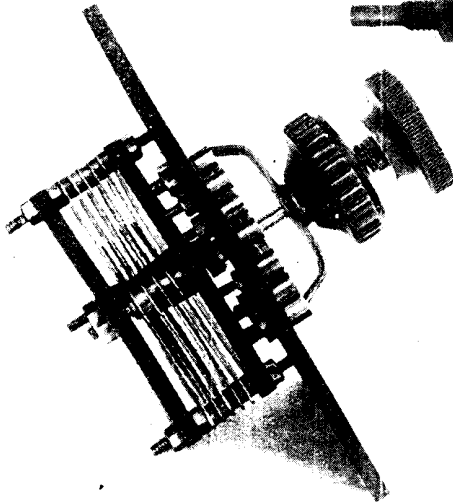

NOVEL CONDENSER SPINDLE

Fig. 4. Two purposes are served by the spindle in this condenser. The moving vanes are operated and a stud switch is engaged at the same time on the one spindle

Washer. A typical condenser spindle is illustrated in Fig. 3, the screw portion to the right of this illustration being used for attachment of the control knob of the dial. The short portion of screwed rod on the spindle on the left of the illustration has a locking nut for straightening up the moving vanes of the condenser. A rather novel type of spindle, particularly useful where space is limited, is illustrated in Fig. 4. From this illustration it will be seen that the condenser spindle serves the double purpose of operating moving vanes and also forms the bearing for the switch arm of a multi-stud switch. The switch arm makes electrical connexion with the condenser spindle, the former being capable of rotation without moving the latter.

The combination of stud switch and variable condenser is useful in aerial tuning systems, and for tuned anode circuits.

Another type of spindle occasionally used in wireless, serving a similar purpose, has a solid spindle surrounded by a hollow or tubular spindle, and is shown in Fig. 5. To each of these is attached a control knob, thus making possible the movement of independent condenser vanes on one spindle for the purpose of a vernier control. See Air Condenser; Condenser; Knob; Spacer Washer.

SPIRAL INDUCTANCE. Name given to a spiral-shaped coil, usually of copper strip, largely used in transmitting. A



VARIABLE CONDENSER SPINDLE

Fig. 3. To show details this variable condenser spindle, which has been turned out of square-section brass rod, is shown dismounted

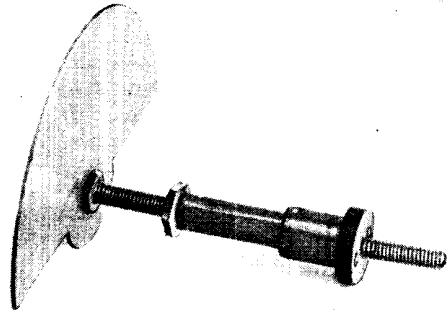

VERNIER CONDENSER SPINDLE

Fig. 5. Surrounding the spindle shown above is a hollow tube, which enables the vernier plate to be moved while the main condenser plates are stationary

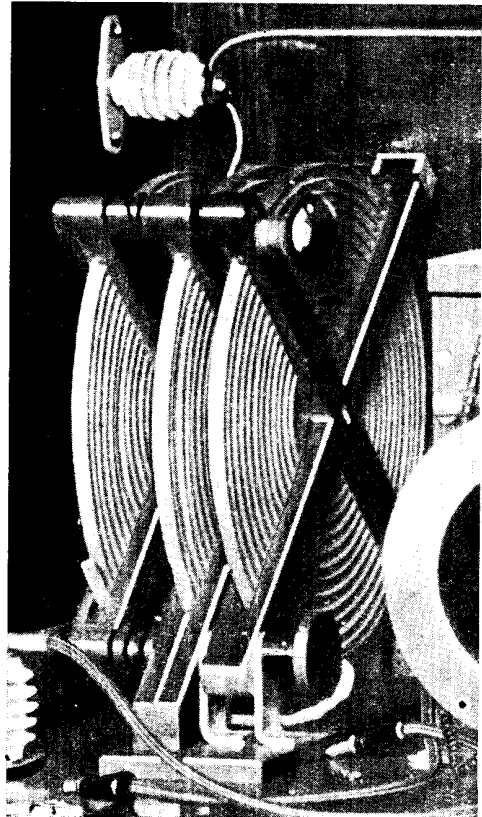

COPPER STRIP SPIRAL INDUCTANCES

Transmitting variometers of this type consist of three spiral inductances made of heavy-gauge copper strip without insulation

Courtesy Siemens Bros. & Co., Ltd.

transmitting variometer composed of three spiral inductances is illustrated. The inductances are composed of copper strip supported in a cross-shaped framework of ebonite. The latter has a number of slots cut in it, in which the strip is held in correct position. As the particular inductances are for a ship's installation, the wave-length range over which they may be varied is above and below a mean of 600 metres. This variation is effected by altering the relative positions of the coils in a vertical plane, and may be accomplished while actually transmitting if desired. See Short Wave Receiver.

SPLASH BOARD. Name applied to a wooden cover used in accumulators to prevent spraying and spilling of the acid during the charging processes.

The splash board may be of wood or other non-conducting material, and usually rests on the lugs of the accumulator plates. See Accumulator.

SPLICE. Term used to describe the act of uniting the ends of stranded ropes or cords by intertwining the strands. The wireless experimenter usually finds it necessary to splice a rope when needing a long halyard for the aerial, or to make an eye on the end of a wire or other rope. There is a certain knack in making splices, but the method consists of first separating the strands at the end of the cord to be spliced, and supposing that an eye-splice were needed, such unlaying or untwisting should extend for about 5 in. on ordinary rope, such as that used for a 30 ft. mast. The next step in the process is to double over the end of the rope to form an eye of the required size, with the unlay part overlapping the standing part.

The next proceeding is to unlay the standing part of the rope at the place where the splice is to start, and, if necessary, raise the lays or strands with a marlinspike or blunt-pointed steel spike. The purpose is to make room for the passage of the

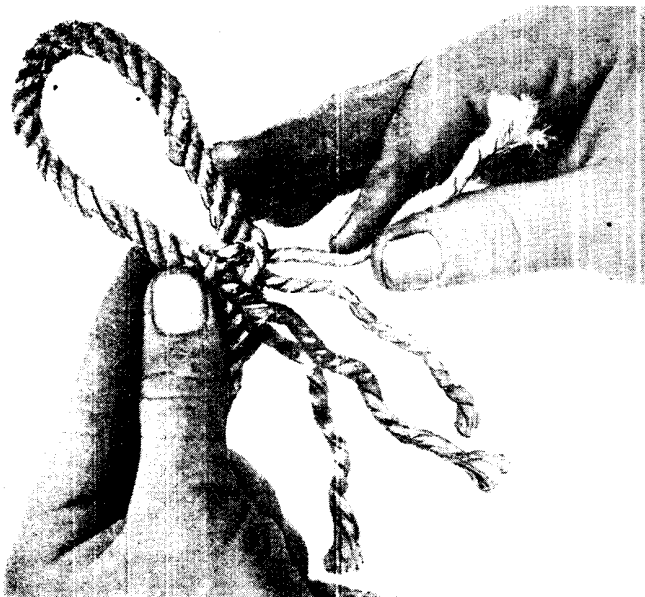

MAKING AN EYE-SPLICE

Fig. 1. Splicing is frequently called for in wireless experimenting. An early stage in making an eye-splice is illustrated. An unlay strand is being tucked under a raised one

The next proceeding is to unlay the standing part of the rope at the place where the splice is to start, and, if necessary, raise the lays or strands with a marlinspike or blunt-pointed steel spike. The purpose is to make room for the passage of the



HOW AN EYE IS MADE IN A ROPE BY SPLICING

Fig. 2. In order to show how the splice is made the strands of the rope have been left loose. The splice is shown complete, forming an eye in the rope. This is a safe and convenient method of providing a means of attachment for a rope

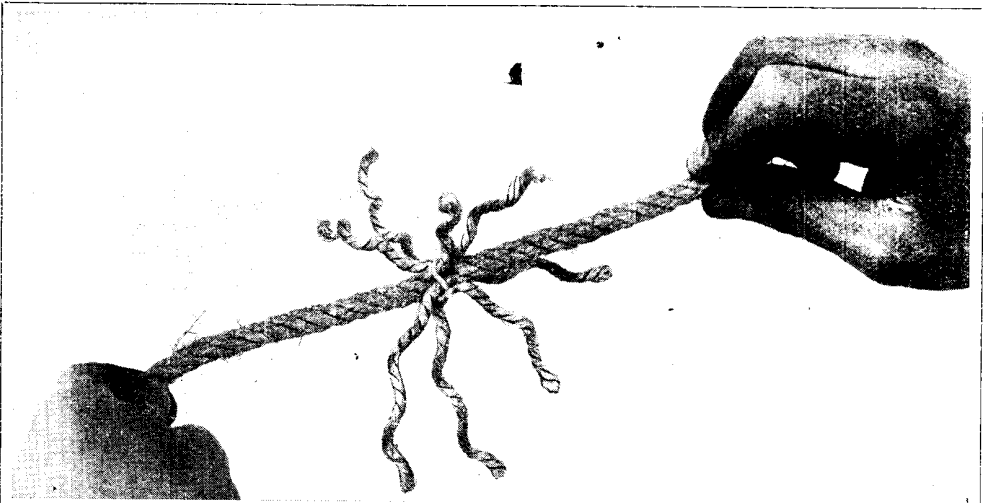

Fig. 3. After the strands of the rope have been frayed or separated they are held together in the way shown in this photograph by a small piece of twine until they are twisted together or interlaced to form the final splice

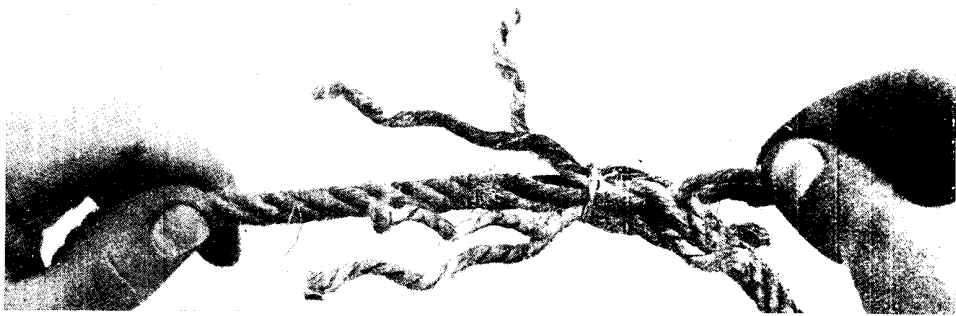

Fig. 4. Each of the unlaidd strands is passed under one of the strands of the rope which is not unlaidd. The operator is holding one of the strands which has just been interlaced in this way. Note the holding piece of twine

FIRST AND SECOND STAGES IN MAKING A SHORT SPLICE

unlaidd end of the rope. The untwisted strands are then arranged around the standing part, and one of them tucked under the raised strand as shown in Fig. 1. The under strand is then passed over the first strand already tucked in, and passes under the next raised strand on the standing part. The same proceeding is continued until the whole of the unlaidd strands are worked into the standing part.

The object at the start is to get one of the unlaidd strands under different strands of the standing part. Once this is done, and the end drawn tight so that the unlaidd part presses tightly against the standing part, the splicing is simply a matter of working the strands under and over, taking

care to have the unlaidd strand pass over the same strand which it last passed under. Two strands of the unlaidd end should never pass under or over the same strand of the standing part unless there be another unlaidd strand between them.

The method of splicing the ends of two ropes is shown in Figs. 3 to 6, the latter illustrating the finished splice, but somewhat loose to enable the location of the strands to be seen more readily.

With this class of splicing the ends of both ropes have to be unlaidd and the two pressed up against each other so that the separated strands come between one another, as shown in Fig. 3, and to prevent their separating during the splicing



Fig. 5. Both ends of the unlaied rope are being passed into the standing portions to make the splice; the ends of the strands are still loose at this stage



Fig. 6. In this photograph the short splice is complete, but left loose to show how the strands are placed. When the rope is pulled tight the loose ends are trimmed off

MAKING A SHORT SPLICE: THIRD AND FOURTH STAGES

operations they should be tied with a piece of twine, as is also visible in Fig. 3.

The next proceeding is shown in Fig. 4, and consists of raising the strands of the standing part as before and tucking those of the end under and over as previously, taking care that at the start a strand passes the strand ahead of the raised one and under this raised strand. When the one half is completed the rope is turned so that the finished portion comes to the left hand and the other half completed in the same way. Some workers prefer to work on both halves simultaneously, as shown in Fig. 5, a method that is serviceable on small ropes not liable to great strain.

During the whole of the work the strands have to be drawn up closely to make a sound joint. They are shown loosely in the photographs to reveal the turns more clearly, and in Fig. 6 one strand has been coloured black and one dotted to make their paths more clear.

To taper the ends of a splice the separate unlaied strands are divided into several smaller strands, say three, and these are each dealt with as if they are actual strands, except that for the first tuck all three are tucked under, and then only two of the strands, and finally only one. The surplus ends are cut off and the whole rolled under foot or gently hammered with a mallet until the rope is as smooth and tight as possible. See Knot.

SPOKESHAVE. Name given to a wood-worker's tool specially adapted for the

finishing of curved surfaces. It consists essentially of a cutting blade set in a body with two handles arranged one on either side of the blade. The wireless experimenter will find such a tool very handy in imparting a workmanlike appearance to finished work. The spokeshave can be obtained at low cost in two general patterns: one in which the handles and body are composed of wood, and the other in which the handles and body are made in metal, generally iron.

Its use in finishing off curved work such as is often requisite in wireless cabinet making is clearly illustrated in the accompanying photograph, this showing the general application of the tool. In use, the handles are grasped one in each hand, the tool rested on the work and the blade pulled or pushed along the surface to be finished, always working in the direction of the grain.

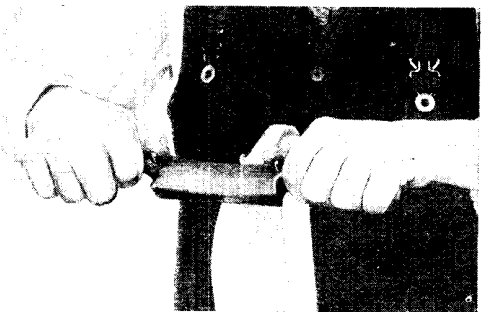

HOW TO USE A SPOKESHAVE

Spokeshaves used as here illustrated are chiefly employed for finishing off curved woodwork



Fig. 1. Owing to its slight but strong construction this commercial type of spreader offers very little resistance to the wind



Fig. 2. Constructed of two main members and fitted with distance pieces this spreader has a very distinctive appearance, and is very light considering its strength

SPREADERS USED FOR WIRELESS AERIALS

Such a tool, being a cutting tool, should be kept with a very keen edge, which can be accomplished by grinding and sharpening on an oilstone in the usual way.

SPOOL. Term used to describe a drum or cylinder with deep flanges at each end and used chiefly for the storage of wire. In wireless work it is always advisable to obtain the various sizes of wire ready wound on to spools, as this saves a considerable risk of the wire becoming tangled and wasting a great deal of time while it is unraveled. Not only is this the case, but the size of the wire is conveniently marked on the flanges of the spool, thus facilitating identification, and the wire is kept smooth and free from those small kinks that are such a trouble to deal with when winding a coil. See Coil.

SPRAYING. Expression applied to a state of affairs found in an accumulator, when the latter is gassing, where the gas given off by the plates rises to the surface in the form of bubbles, which then burst, giving a spraying effect. See Accumulator.

SPREADER.

The spreader, in its appli-

cation to wireless, is a rigid member used for separating the wires in a twin or multi-wire aerial. The spreader is usually made of wood and creosoted or painted to withstand the weather, and should be as light as possible to avoid undue strain on the aerial masts and rigging. For this reason the spreader should offer a minimum of resistance to the wind. The type of spreader illustrated in Fig. 1, which shows a commercial pattern, is particularly efficient in this respect. Two eyes are provided at the back of the insulator support for attachment of the bridle connecting the spreader to the halyard.

A spreader constructed from commercial fittings is shown in Fig. 3, and forms a very light and efficient structure, with special hooks for quick attachment of the aerial wires. An extremely light yet strong spreader is illustrated in Fig. 2, and consists of two lengths of spruce or ash screwed at their ends to two V-shaped wood blocks, and separated by wooden distance pieces attached to the longitudinal members at an equal distance from either end. Strips of

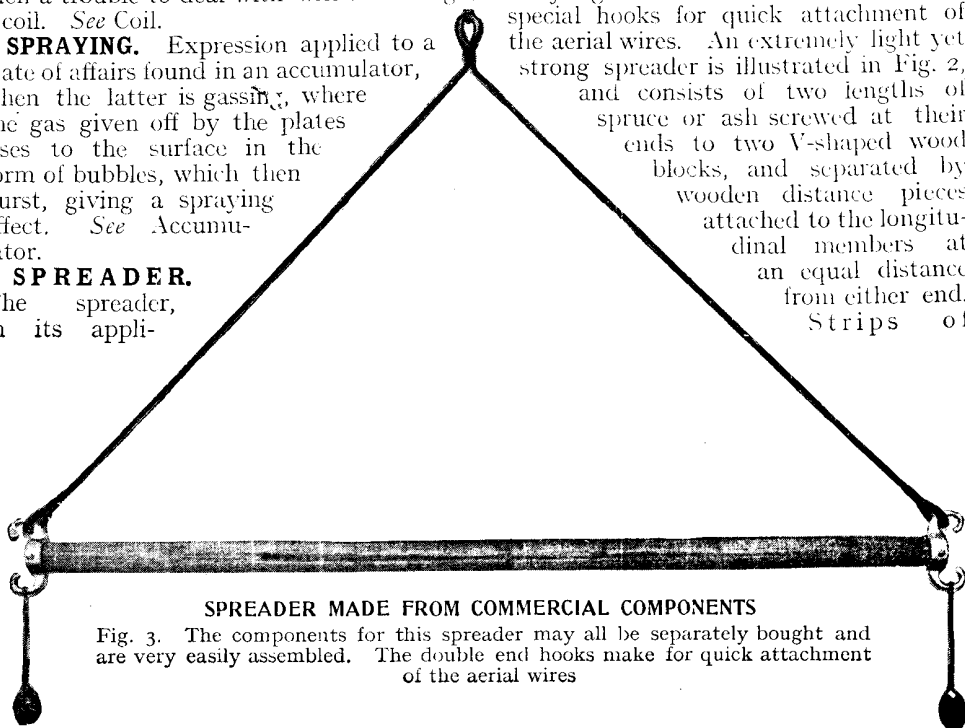

SPREADER MADE FROM COMMERCIAL COMPONENTS

Fig. 3. The components for this spreader may all be separately bought and are very easily assembled. The double end hooks make for quick attachment of the aerial wires

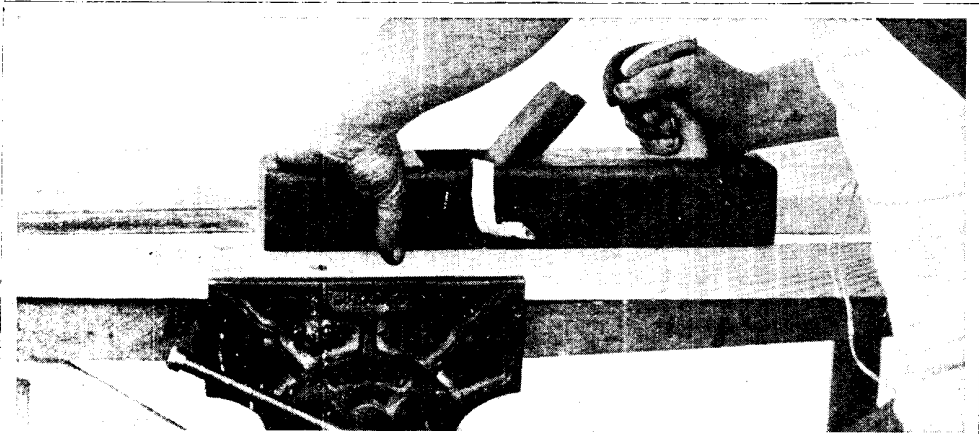

Fig. 4. One of the first stages in making the spreader is the construction of the wooden bar, which is seen here being planed to the correct size

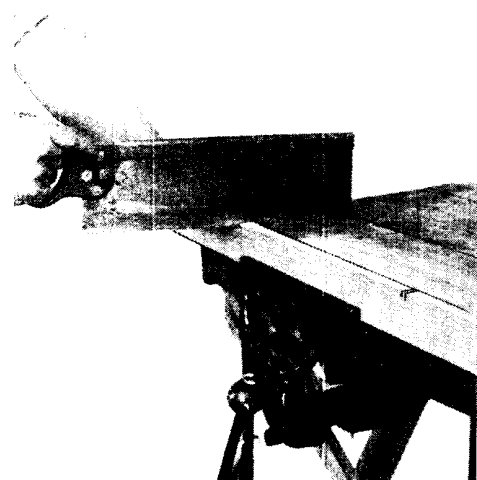

Fig. 5. Cords for the insulators are kept in their relative positions by slots which are cut in the wooden bar as shown

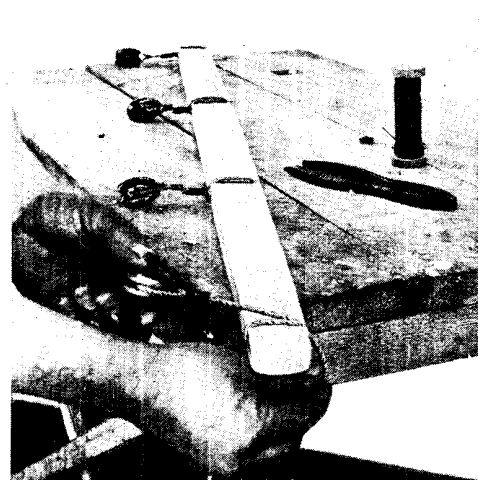

Fig. 6. Here the cords holding the insulators are shown being fixed in position on the wood-work of the spreader



Fig. 7. This illustration shows the method of tying the suspending cord to the wooden bar of the spreader, and this operation completes the construction

OPERATIONS IN MAKING A FOUR-WIRE SPREADER

zinc bent over the longitudinal members and attached to the distance pieces may be used, and give considerable strength to the spreader. Holes for attachment of the insulator cords are provided as shown at each end.

A spreader suitable for a sausage or cage aerial is illustrated in Fig. 8, and consists of three wooden members halved together and screwed to form six radial arms of equal length and spacing. The cords for connexion to the halyard are threaded through holes at the end of each

for sawing the slots, the centre of which is then knocked out with a wood chisel.

In connecting the insulators to the spreader, a length of cord is first attached to the insulator and securely bound with stout string or wire. The free end of the cord is now bound twice round each slot in the spreader, as shown in Fig. 6, and secured with string or wire. To preserve a neat appearance, the insulators should all be equidistant from the spreader. The cord or bridle for connecting the spreader to the halyard is shown in Fig. 7, where it

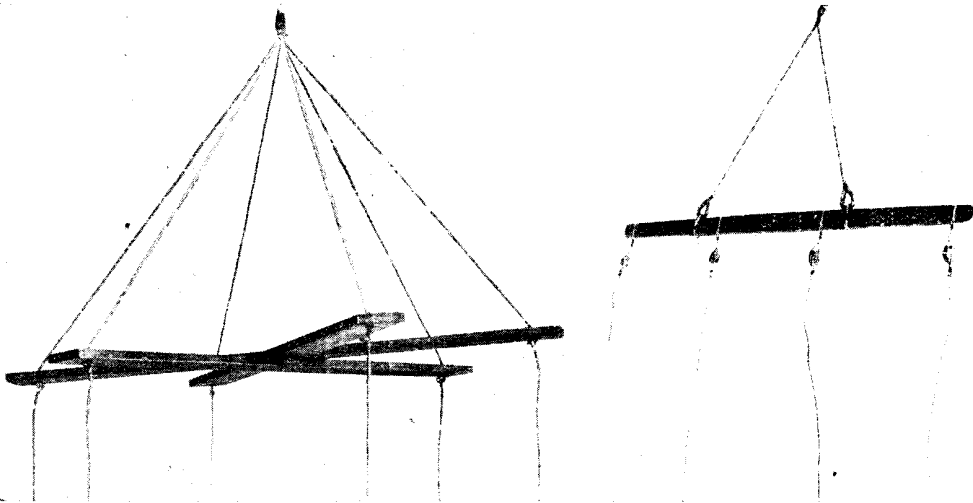

SPREADERS FOR MULTI-WIRE AERIALS

Fig. 8 (left). Cage aerials can be suspended by means of a simple spreader of this kind. Three wooden cross-pieces are used to keep the wires apart. Fig. 9 (right). An easily constructed spreader employed to hold four wires is shown

arm, and are prevented from being pulled through the arm by a stout knot which is tied on the other side of the arm. A short length of cord is left, to which an insulator is attached.

An easily constructed spreader for four aerial wires is illustrated in Fig. 9. Spruce is recommended for the construction of the spreader, but a length of straight-grained deal, free from knots or splits, may be used if care be taken in its selection. The wood should be about 2 in. in width and $\frac{3}{4}$ in. in thickness.

Having cut it to the length desired, it should be well planed, which operation is shown in Fig. 4. With the exception of a short distance from either end, the spreader now has four slots cut at equal distances to receive two turns of the cord used for attachment of the insulators. The operation of cutting the slots is shown in Fig. 5, where a brass-backed saw is used

is being fastened in position towards the centre aerial wires and between those and the two outside wires.

It is often found advisable to attach cords to the ends of the spreaders to prevent them from being blown about in the wind. A swinging aerial often gives rise to a fading effect in signal strength owing to its capacity altering with its varying relationship to still objects. This alteration of capacity affects the tuning of the aerial circuit, and thus brings about the phenomenon of fading. *See Aerial.*

SPRING. An elastic device capable of exerting tensile and compressive strains or of resisting such strains. In wireless work the springs used are mostly small and limited to the control of some detailed part of the apparatus. A selection of several small springs is illustrated in Fig. 1, and shows the varieties usually found in wireless. The long, thin, circular

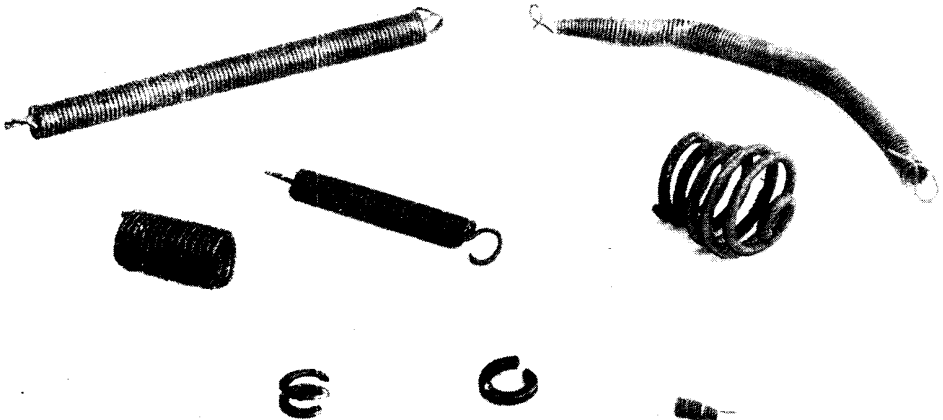

SPRING COMPONENTS USED IN WIRELESS APPARATUS

Fig. 1. Some useful specimens of small springs used in wireless apparatus are shown. Springs of this kind are mostly employed for purposes of control. In the foreground are two spring washers such as are frequently used for the spindles of control knobs

springs known as coil springs exert a tensile strain when extended; those which are wound with their coils some distance apart exert compression strains when any attempt is made to close them. A spring can only be effective when its normal or unloaded length is either extended or compressed.

One form of spring that is very extensively used is the flat type consisting of one or two turns only, and often spoken of as a spring washer. Its purpose is to retain a nut or other part on a spindle or

some moving member, or to prevent movement of a nut or other part.

This results from the friction that is set up between the parts by the pressure of the spring washer. On some experimental apparatus the use of short, thick springs under a baseboard is sometimes advocated as a means of reducing the effects of vibration.

Another commonly used example of a spring is that of a filament resistance wire which is coiled as a spring, and when extended around the edge of the resistance former is thereby held firmly by the tendency of the spring to contract. Coiled springs can be quickly made with the simple home-made apparatus shown in Fig. 2, consisting of a base and two uprights. Between them is stretched a rod with a cranked handle. The wire to be coiled is passed through a hole in one end of the rod and the latter revolved with one hand, while the other steadies the rod and guides the wire from the spool held in the same hand. Springs are usually made of spring steel wire, although hard brass or phosphor-bronze can be used for light springs when it is feasible, and always when the spring is in a damp place and liable to corrosion.

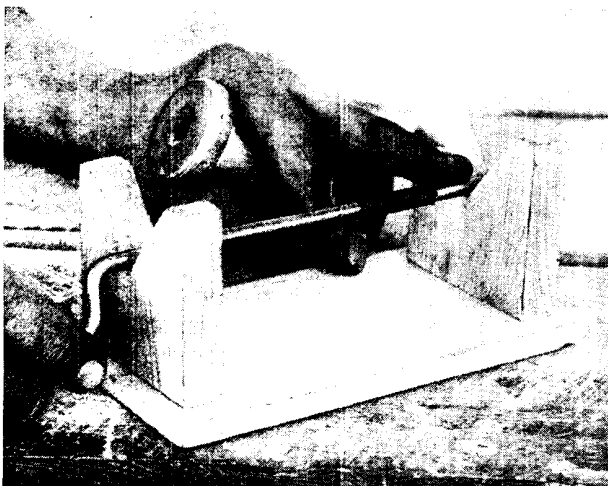

SIMPLE DEVICE FOR MAKING SPRINGS

Fig. 2: Small springs may easily be made by winding steel or hard brass wire on to a rotating bar resting on simply constructed wooden saddles in this manner

Other springs are made of indiarubber and such elastic materials.

SQUARE. Name given to a measuring instrument. There are several kinds of squares, and three of those of most interest to the wireless experimenter are illustrated in Fig. 1. These are known respectively as the carpenter's and engineer's try squares and the draughtsman's set square. In the case of the carpenter's try square, the instrument consists of a hardwood stock and a hard steel blade. The stock is usually faced with a strip of brass, and the steel blade fixed to the stock by riveting.

The essential feature of a try square is that the angle between the faced edge of the stock and the working edge of the blade be exactly 90° . The blade is generally parallel and the stock also parallel, so that either side can be used, but the proper working faces are the two which together form the inner angle of the square.

The engineer's try square, which is sometimes known as a steel square, is of similar construction, but made throughout of hard steel. The whole of the surfaces are accurately machined so that either the inner or outer angles can be used.

Draughtsman's set squares are made in different patterns, some from transparent celluloid, others from ebonite, but the most durable pattern is that

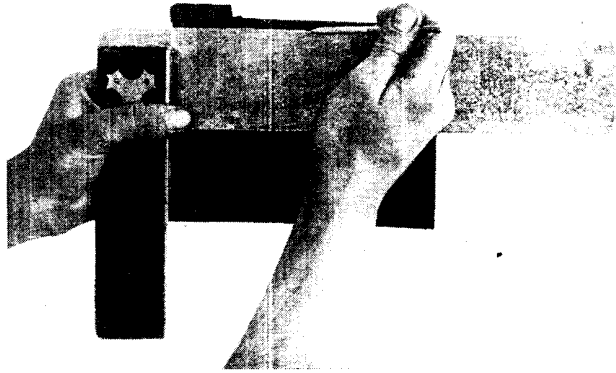

Fig. 2. Above is shown a carpenter's square in use for marking out a piece of ebonite for a panel

HOW A SET SQUARE IS USED

framed up from strips of mahogany with the edges faced with ebony. Draughtsman's squares are triangular in shape, the angles on the long side being usually 45° or 60° . The former is illustrated in Fig. 1 and has one angle of 90° and two angles of 45° . In the 60° squares the angles are one of 90° , one of 60° and one of 30° . These instruments are used by resting them against the edge of a T-square or straight edge on the drawing board, either of the latter instruments being usually used in a horizontal position. The square is moved along to any position, and angles of 90° , 45° and 135° to the horizontal can be drawn directly, the edge of the square being used to guide the pencil or ruling point.

As squares are really instruments of precision they should be treated as such, and carefully stored when not in use in some position where they are not liable to be strained or bruised, particularly in the case of draughtsman's set squares. If the edge is bruised or indented these indentations will be faithfully reproduced by the pencil or scriber. Steel squares can either be nickel-plated, to prevent them from rusting, or wiped over with an oily rag for the same purpose.

Many set squares have their edges marked in inches or millimetres, so that direct readings of ordinary dimensions can be taken with them. Try squares of the carpenter's or steel type are used by applying the stock to one working edge, or the working face of the job, as in Fig. 2, sliding it along to the desired position, and then marking a line with a pencil or scriber in exact register with

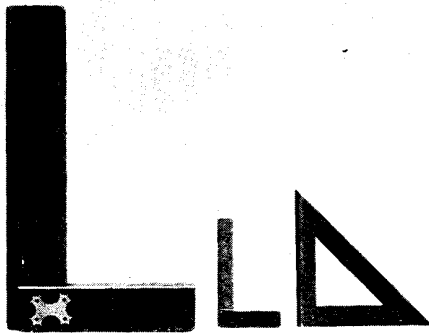

SQUARES FOR CONSTRUCTIONAL WORK

Fig. 1. Three useful squares for the wireless experimenter are the carpenter's square (left), small steel square (centre) and the draughtsman's square (right)

the working edge of the blade. See Drawing Instruments; T-square.

SQUARED PAPER. Paper which is printed with equidistant horizontal and vertical lines. The distances between the horizontal lines and that between the vertical lines are not necessarily equal, though they generally are. As a general rule every tenth horizontal and every tenth vertical line are printed more distinctly than the others.

Squared paper is very useful to any experimenter who wishes to draw curves showing the results of any of his experiments. Since the paper is divided regularly into tenths either vertically or horizontally, it becomes extremely easy to measure off any particular set of numbers to scale.

As a simple example of the use of squared paper suppose the experimenter has been carrying out some tests on a carborundum crystal, to find what current passes through the detector for different voltages from a battery. Suppose he obtains the following results:

Applied Voltage	Current in Microamperes
0.25	25
0.50	100
0.75	220
I	325

The diagram shows part of a sheet of squared paper. Suppose the distance between each vertical line is taken to represent a quarter of a volt and the distance between each horizontal line represents 50 microamperes. Then, with an applied voltage of a quarter of a volt the current is 25 microamperes. This last point is half-way between the zero horizontal line and the 50 line, and it is, of course, on the vertical quarter-volt line. The point is marked A in the diagram; so the point B, representing .50 volts and 100 amperes, and the other points C and D are obtained and marked with a cross. Now, if a curve, as shown by the dotted line, is drawn through these points, A, B, C, D, the experimenter is able to say what current should pass for voltages other than that for which he has tested. For example, at a voltage half-way between Band C, that is, a voltage of .625, the current passing should be approximately 150 microamperes.

The importance of curve plotting is explained under the headings Curve and

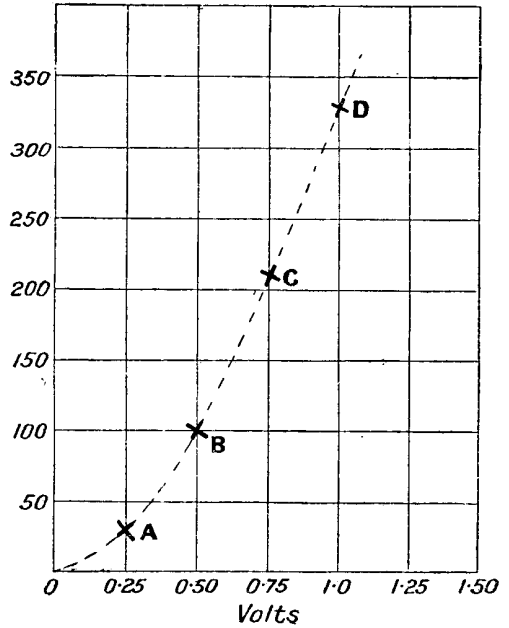

UTILITY OF SQUARED PAPER

Squared paper saves considerable time and work when diagrams and curves are to be drawn. The plotting of such a curve as the above becomes a matter of simplicity

Graph in this Encyclopedia, and squared paper is only a very convenient way of plotting such curves rapidly. See Curve; Graph.

SQUIER, MAJOR-GENERAL SIR GEORGE OWEN. American wireless authority. Educated at the Johns Hopkins University, Baltimore, he became research student under Professor Rowland and under Sir William Preece at the British General Post Office. In 1904 he published his famous paper on the absorption of electro-magnetic waves by living vegetable organisms and showed how trees could be used as a method of receiving wireless messages. In 1911 he read a paper on multiplex telephony and telegraphy before the American Institute of Electrical Engineers. In 1912 he was awarded the Elliott Cresson Gold Medal for his researches in multiplex telephony, and in 1919 the Franklin medal of the Franklin Institute. Major-General Squier was awarded the K.C.M.G. for distinguished services on the Western Front during the Great War. He is a member of the National Academy of Sciences and the International Electro-technical Commission. General Squier has written many articles on wireless, including tree

telephony and telegraphy, and multiplex telephony and telegraphy over open-circuit bare wires laid in the earth and sea.

SQUIRREL-CAGE MOTOR. Name given to a particularly shaped electrical motor. A typical 10 h.p. squirrel-cage induction motor by the Crypto Electrical Co., Ltd. is illustrated in the photograph. The machine is of the ventilated type, air being allowed access to the interior through the expanded metal shields fitted at either end.

An important feature of all squirrel-cage motors is the type of bearing employed, for owing to the extremely small air gap permissible to ensure efficiency, a bearing without any shake and wear is essential. To secure this end, ball or roller bearings are almost universally adopted, which give the added advantage of decreased starting and running friction. Small, screw-down grease-cups are fitted, one of which may be seen in the photograph. No pulley is shown attached to this motor, but the rotor spindle is keyed for this purpose.

SQUIRREL-CAGE ROTOR. Type of rotor used on electric motors. The photograph shows a standard type of squirrel-cage rotor for a comparatively small motor of 20 h.p. It consists essentially of a number of copper strips arranged side by side and insulated throughout their length, but short-circuited at both ends by copper rings of heavy section. The strips are not parallel to the spindle, but are slightly helical in disposition, as will be seen from the illustration.

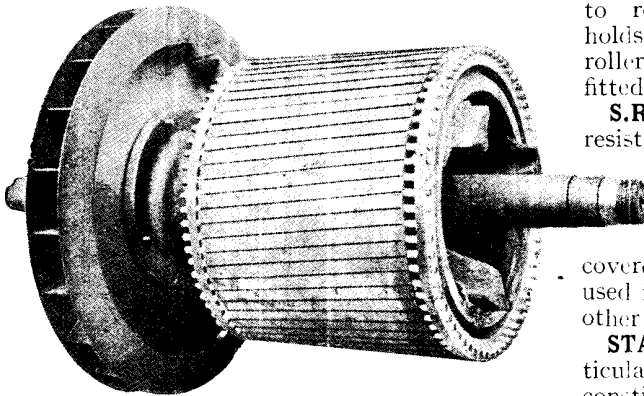

STANDARD SQUIRREL-CAGE ROTOR

This is a type of rotor used on a 20 h.p. motor. It has to be most accurately constructed, since the air gap is extremely small. A large cooling fan is fitted on the left-hand end.

Courtesy Crypto Electrical Co., Ltd.

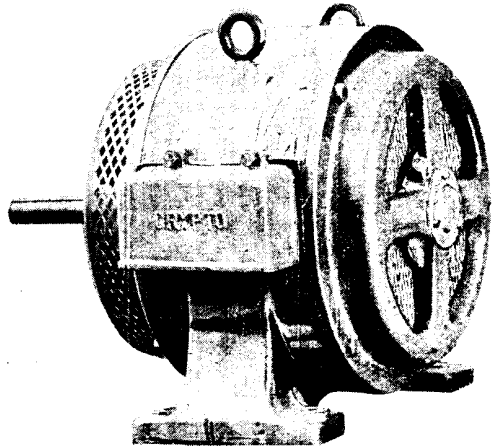

SQUIRREL-CAGE INDUCTION MOTOR

An important feature of all squirrel-cage motors is the bearing, which is always of the ball or roller type, decreasing friction to a minimum. Air is allowed to enter by the expanded metal shields shown at either hand.

Courtesy Crypto Electrical Co., Ltd.

Extreme care is taken in building these rotors, for very heavy currents with consequent high temperatures are generated, and solder must not be used for any connexion. Further, the whole construction must be carried out with great accuracy, on account of the minute air gap permissible.

In order to assist cooling a large circulating fan is fitted to the pulley end of the spindle. The rotor proper is supported on the shaft by a heavy three-legged spider, the ends of which are clearly shown.

The end of the spindle is threaded to receive the lock nut which holds the inner race of the ball or roller bearing, whichever is to be fitted. See Rotor.

S.R. Abbreviation for specific resistance. See Dielectric Constant ; Resistance ; Specific Resistance.

S.S.C. This is the usual abbreviation for single silk covered wire, a form of insulated wire used in winding inductance coils and other coils used in wireless. See Wire.

STALLOY. Name given to a particular type of steel, the predominant constituents of which are iron and silicon. Other constituents include sulphur, manganese and carbon. A greater proportion of silicon has the effect of raising the specific resistance, but also decreases the losses due to

hysteresis. Stalloy is used in wireless work in diaphragms of telephones, and also as laminac in the cores of some transformers. See Diaphragm.

STANDARD CELL. Name given to a primary cell used for standard test work. Such a cell is designed to give a constant and reliable electro-motive force irrespective of all local conditions, and it is only affected by temperature. Such a cell is the Clark cell, and this is adopted by the Board of Trade as a standard in test work. The Weston cell is also a standard cell. See Clark Cell; Weston Cell.

STAND-BY SWITCH. A type of switch of the double-throw double-pole variety used for varying the tuning arrangements of an aerial tuning system. The stand-by switch is used for switching over from a primary or open circuit to a closed or secondary circuit, or vice versa. Tuning

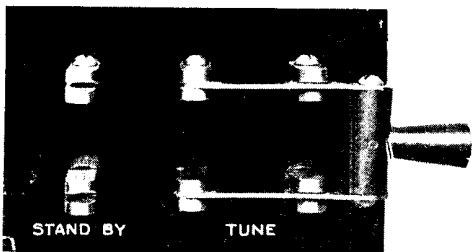

DOUBLE-POLE STAND-BY SWITCH

Fig. 1. Known as a stand-by switch, this consists of a double-throw, double-pole knife switch, and is used for varying tuning arrangements of an aerial tuning system.

with an open circuit has the advantage of ease in picking up a required station, but has the drawback of lack of selectivity. Good selectivity is obtained by using a closed circuit, tuned and coupled to the open circuit. The advantages of both systems are utilized by employing the stand-by switch, with which the station may be found on the primary tuning system and switched over to the secondary coil for the elimination of interference from other stations.

A common type of stand-by switch is illustrated in Fig. 1, and is of the usual double-throw double-pole variety.

A compact home-constructed switch suitable for stand-by and tuning purposes is shown in Fig. 2. A small ebonite panel is required, and is cut and drilled as shown in Fig. 3. The centre holes are brass-bushed and permit an easy turning motion to two spindles of 2 B.A. screwed rod.

Two springy brass arms are cut and bent

to make contact with opposing contact studs, as shown in Fig. 2, of the completed switch. The contact arms are drilled centrally and mounted to the spindles by means of a round nut on the lower side of the spindle and a locking nut to the top side, which detail is also clearly seen in Fig. 2. Having ascertained that the arms make good contact and are free to move in the bearings, they may be taken down and fitted with an ebonite cross-bar, which enables both arms to operate at once. A $\frac{1}{4}$ in. square ebonite rod is suitable for the purpose, and is attached to the contact arms by short screws fixed from the underside. These screws should not be dead tight, as they allow a pivoting motion to the arms. An ebonite knob is turned up and attached to the centre of the cross strip, as is shown in Fig. 4. The moving parts are now assembled, the operation of fitting the lock nuts to the tops of the spindles being shown in Fig. 5.

Connecting wires are attached to the stems of the contact studs by the addition of another nut to each stem, under which the connecting wire is tightened. This operation is shown in Fig. 6, where a pair of small-nosed pliers is used for gripping the outer nut. A wiring diagram for the stand-by switch is given in Fig. 7. See Knife Switch; Switch.

STANLEY, RUPERT. Irish wireless expert. Born in Ireland, 1876, and educated in Ireland, he joined, in 1899, the technical staff of the Isle of Thanet Electrical Light and Power Company, and in 1901 was appointed lecturer in physics and electrical engineering at the Brighton School of Science and Technology. In 1903 he was appointed professor of physics

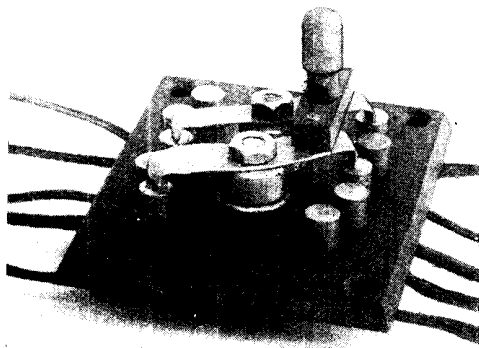

HOME-MADE STAND-BY SWITCH

Fig. 2. Contact studs are connected to a number of wires and a double contact arm makes connexion between any two pairs

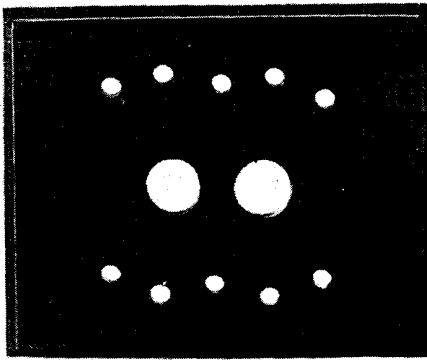

Fig. 3. An ebonite panel is drilled with stud holes, and the two spindle holes in the centre are bushed to take a 2 B.A. screw rod

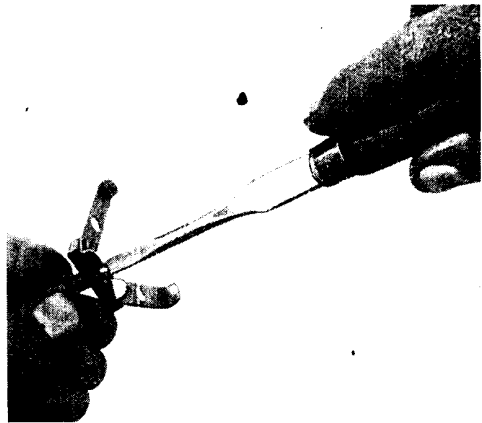

Fig. 4. Attached to the cross-piece are two contact arms, and on the other side is fitted the knob, which is shown here being attached

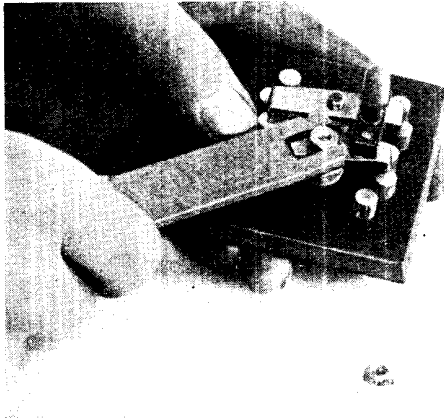

Fig. 5. After the contact arms and spindles are placed in position the lock nuts are tightened up as shown in this illustration

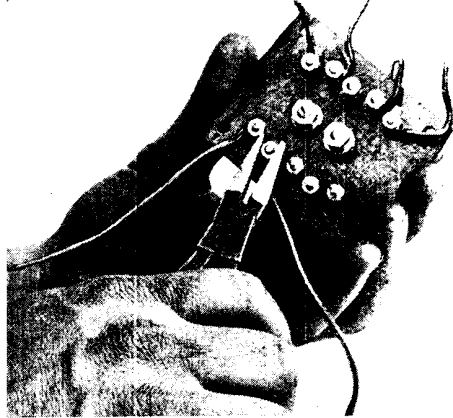
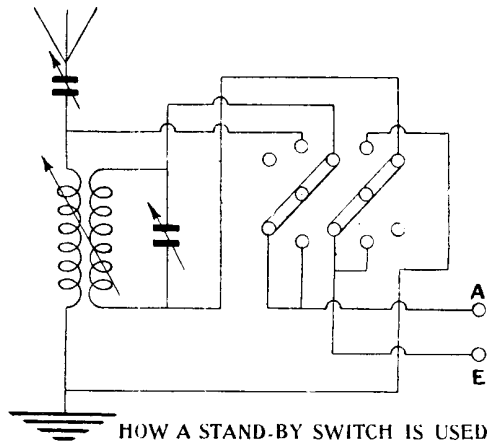

Fig. 6. Connecting wires are secured under additional lock nuts screwed to the stems of the ten contact studs

CONSTRUCTIONAL DETAILS OF STAND-BY SWITCH

and electricity at Belfast Municipal Institute, and afterwards professor of electro-technics at Queen's University, Belfast. He has written a standard textbook in two volumes on wireless telegraphy.

STAPLE. Name applied to a U-shaped fixing device employed for holding insulated conductors to a baseboard or wall, or for some similar purpose. Staples are generally made of wire or flat metal, and may either be driven into the base or secured to it by screws. In the latter case staples are provided with feet having holes for the passage of fixing screws or nails. For electrical and wireless work insulated staples are preferable, as these have a little piece of fibre, ebonite or some similar material attached to the inside of



HOW A STAND-BY SWITCH IS USED
 Fig. 7. Here are given the connexions of a stand-by switch in a double circuit tuner

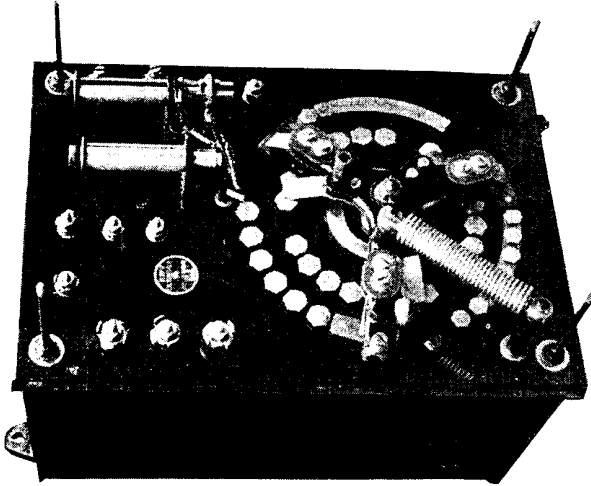

STARTER FOR ALTERNATING CURRENT MOTOR

Fig. 1. This illustration depicts a starter used for an alternating current motor. The studs, it will be observed, are of hexagonal shape and large in size

Courtesy Crypto Electrical Co., Ltd.

the U part of the staple, thereby minimizing the risk of damage to the insulation of the conductor and generally improving the insulation value of the whole system.

The expression staple is applied to a variety of differently shaped details found in many mechanical constructions. The characteristic is usually that it is an adjustable part employed for the fixing of some other part.

STAR GROUPING. A system of connecting up the three coils of an alternating current generator. See Delta Connexions; Mesh Grouping.

STARTER. A variable resistance included in the circuit of electric motors for obtaining a gradually increasing current necessary in starting a motor of any size. Considerably more current is required to begin the running of a motor than is required to maintain its speed once acquired. This excess of current would result in damage to the motor windings if a motor-starter were not fitted.

Essentially the starter consists of a number of resistances which are cut out of the circuit as the starter handle is advanced over a number of radial studs. Other features incorporated in the majority of starters are a no-volt and overload release, which are protective devices working on magnetic principles for the safety of the motor.

The direct current motor-starter illustrated in Fig. 2 is of the semi-enclosed

type, and is shown with the cover removed. A slate base is fitted to the lower cast-iron casing.

It is a form of variable resistance in which the resistance value is varied by causing the handle to slide over the studs. The handle is fitted with a spring blade, which ensures good electrical contact being maintained. The studs are connected to a number of coils of resistance wire concealed within the base casting. This starter is fitted with overload and no-volt releases. The former is shown on the left-hand side of the apparatus, and the latter to the right, situated in such a position that the handle is attracted to it when current is flowing. Three terminals of the screw-down type are fitted near the lower edge of the starter. The pillars shown on either side of the base are for supporting the cover.

A typical A.C. motor-starter is illustrated in Fig. 1. This is mounted upon a slate base, the contact studs being arranged in a circular formation. These studs in this instance are hexagonal in shape. No-volt and overload releases are fitted near the top on the left-hand side.

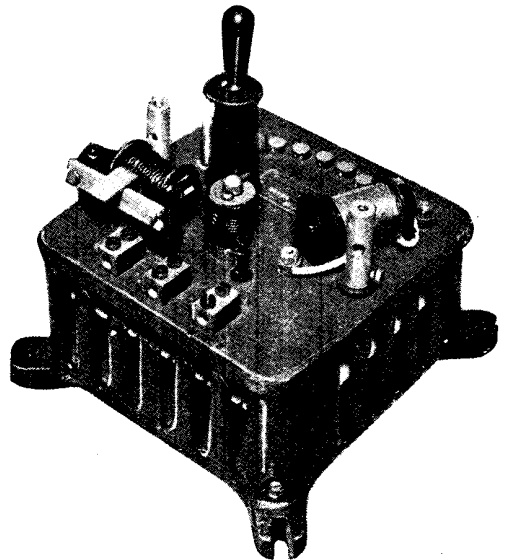

MOTOR STARTER

Fig. 2. A no-volt and overload release is fitted to this starter. Note the open construction of the case to assist in cooling the resistances

Courtesy General Electric Co., Ltd.

The resistances are contained in the hollow iron casting at the rear of the starter. Lugs are provided on the latter to enable it to be conveniently fitted to any framework or fire-protected wall. Four stud-bolts are attached to the front for the cover, which is not shown in the illustration.

STATIC LEAK. Name given to a coil of wire shunted across a condenser in the aerial circuit of a tuner to allow weak atmospherics to leak to earth instead of gradually charging up the condenser. The static leak illustrated is simply made from the secondary winding of an old $\frac{1}{2}$ in. spark coil. The wire from this is re-wound on the bobbin shown, which is made of shellacked paper and cardboard. The bobbin is 4 in. in length and $\frac{5}{8}$ in. in diameter over the cheeks. Its diameter

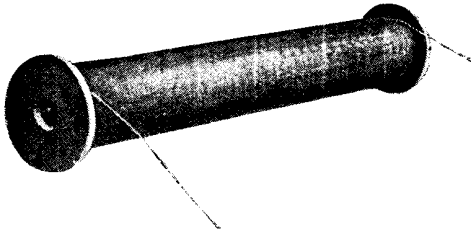

LEAK FOR WEAK ATMOSPHERICS

A coil of wire is wound on a bobbin, and this is shunted across a condenser in the aerial circuit to lessen the effect of atmospherics

over the central portion is $\frac{5}{16}$ in., while the hole is approximately $\frac{1}{4}$ in. The requisite amount of wire is wound in the lathe, and when finished the final layer is covered with empire cloth and finally varnished with shellac to prevent the entry of damp.

STATICS. Name given to stray ether waves due largely to atmospheric disturbances. Statics are one of the annoyances with which the amateur has to contend, and give rise to many kinds of irregular noises in the telephones which it is not possible to eliminate entirely. A very great amount of statics may be eliminated by using an underground aerial, and with such an aerial perfectly clear signals have been received while a thunderstorm has been raging overhead, a result not possible with an ordinary overhead aerial.

Such an aerial must be considerably longer than the overhead type. It should, indeed, be at least 200 ft. in length to get fairly good results. The aerial should be of heavily insulated wire—a rubber-

covered cable, for example—and it should be enclosed in a pipe of some kind to prevent it rotting or being destroyed by insects, etc. The free end should be thoroughly insulated, and the whole should be buried in a straight trench about two to three feet in depth. The other end of the aerial is brought out of the ground and led to the receiving instrument in the usual way.

Statics are of two main classes, those due to atmospheric disturbances, as thunderstorms, and the general electrical conditions of the atmosphere. When the atmosphere round the aerial is in a highly electrical state there is a steady hissing sound in the telephones. Stray clicks in the telephones are usually caused by the long electric waves set up by lightning discharges, which may or may not be visible, but are usually present in thundery weather. This type of static is, of course, more common in the summer months than in the winter ones.

Under the headings Atmospherics and Interference Preventers in this Encyclopedia several methods are described of reducing, if not altogether eliminating, the effects of strays. The problem is also dealt with to some extent under the heading Balanced Crystals. Fig. 1 shows a method due to Marconi and often known as the Marconi X stopper. It was one of the earliest methods of reducing the interference due to statics. A variable inductance coil, C_1 , has one end connected to earth and the other to a fixed condenser. The other side of the fixed condenser is connected to the primary coil of a loose coupler, C_2 . The other end of the primary coil goes to earth, and the secondary of the loose coupler is joined to the detector circuit. The lead-in wire

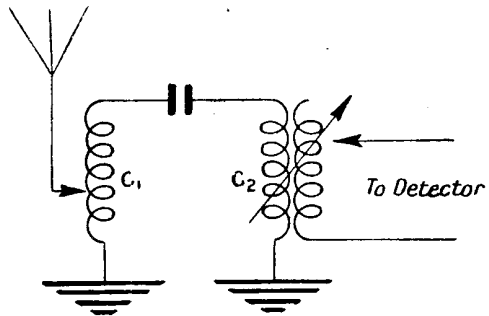
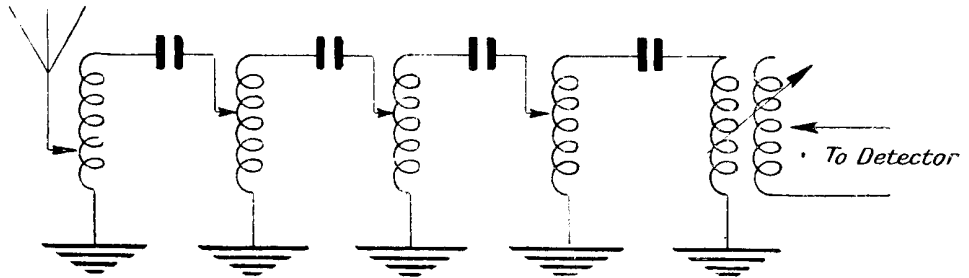
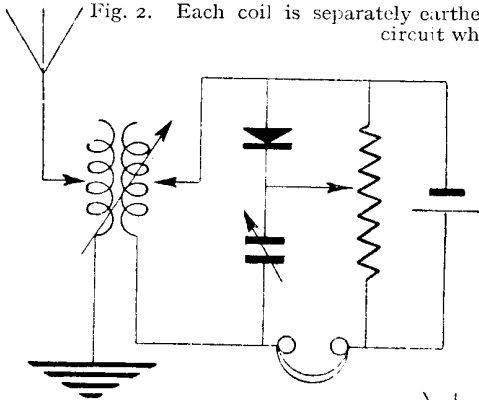

Fig. 1. Interference due to statics is reduced by the use of the above circuit



MODIFIED FORM OF X STOPPER CIRCUIT

Fig. 2. Each coil is separately earthed in this modification of the Marconi X stopper circuit which is shown in Fig. 1



DE GROOT CIRCUIT

Fig. 3. Interference due to statics is reduced by a system invented by De Groot and shown in this diagram

of the aerial is connected to the sliding contact of the variable inductance coil C_1 . When the detector circuit is tuned to a particular wave-length any signals received on that wave-length by the circuit C_1, C_2 are passed on in the usual way through the secondary of the loose coupler. But signals which are of any other wave-length pass direct to earth. Fig. 2 shows a modification of the system, in which each coil is earthed, so making it easier for any untuned signal to find its way to earth.

The balanced crystal or valve receiver arrangement of Marconi, described under that heading, involved the use of two crystals or valves working in opposition to one another. The De Groot balanced

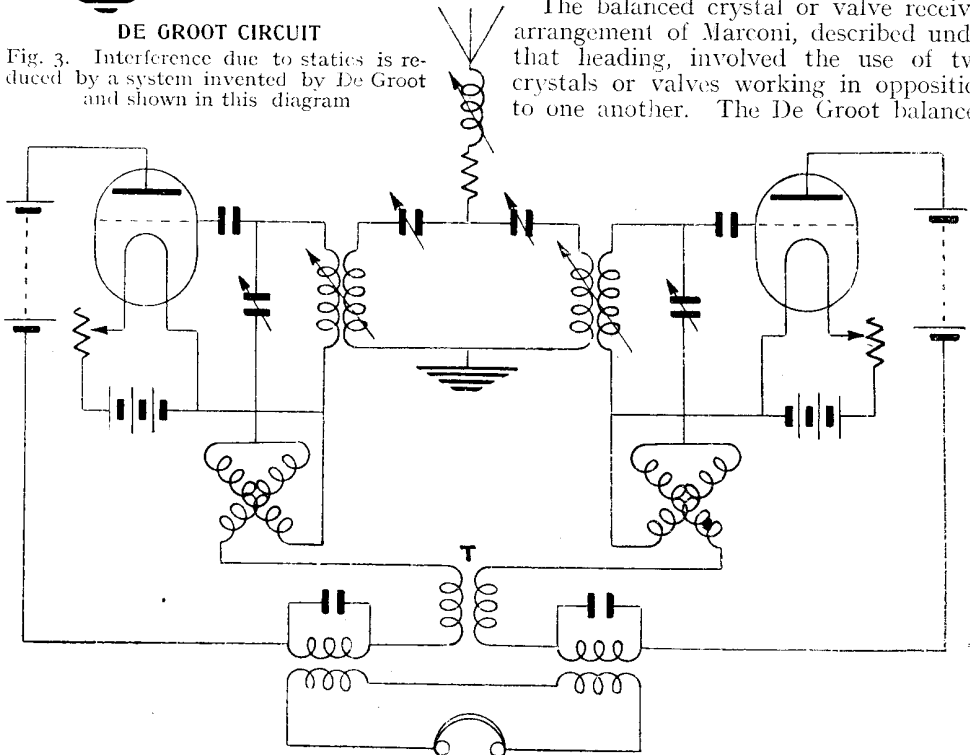

REDUCING STATIC INTERFERENCE BY BALANCED VALVES

Fig. 4. By using a circuit with balanced valves, as in this diagram, interference due to statics is reduced. It will be noticed that there is a small resistance in the aerial circuit

SELECTED PROGRAMMES FOR THE AMATEUR

British and Continental Wireless Transmissions

Below is given a list of some of the principal stations whose transmissions can be tuned in on apparatus described in this Encyclopedia. These include public stations in Great Britain and the Continent; but the list is not intended to be complete. Times of transmission by the British Broadcasting Company vary, but these may be found in the daily press. Post Office, Marconi and Aviation transmissions take place at all hours

BRITISH BROADCASTING COMPANY

CALL	STATION	WAVE-LENGTH	CALL	STATION	WAVE-LENGTH
2 LO	LONDON	365	6 FL	SHEFFIELD	303
6 BM	BOURNEMOUTH	385	5 NO	NEWCASTLE	400
5 PY	PLYMOUTH	330	5 SC	GLASGOW	420
5 WA	CARDIFF	353	2 EH	EDINBURGH	325
2 ZY	MANCHESTER	375	2 BD	ABERDEEN	495
5 IT	BIRMINGHAM	475	6 LV	LIVERPOOL	318

CONTINENTAL STATIONS

Transmissions from these stations are chiefly of popular interest, but time signals, commercial information and financial intelligence are included. Times are given in British Summer Time

CALL	STATION	WAVE-LENGTH	TIME	SERVICE	CALL	STATION	WAVE-LENGTH	TIME	SERVICE
PCFF	Amsterdam	2,000	07.50	Daily	POZ	Nauen	4,700	00.57	Time Signals
—	Berlin (Vox Haus)	430	13.55	Time Signals	FL	Paris (Eiffel Tower)	2,600	12.57	Weather
BAV	Brussels	1,100	17.40	Music	—	—	—	10.58	Time Signals
—	—	—	14.00	Reports	—	—	—	11.05	—
—	(Radio Elect.)	285	18.50	Music	—	—	—	11.34	—
—	—	—	21.00	—	—	—	—	12.15	Weather
—	Eberswalde	2,930	13.00	—	—	—	—	20.00	—
HB 1	Geneva	1,100	20.00	—	—	—	—	22.58	Time Signals
PCGG	Hague	1,070	19.00	Irregular ; Music	—	Paris (Radiola)	1,780	23.20	Weather
PCKK	—	—	21.40	Fri. Music	—	—	—	23.44	Time Signals
PCMM	—	1,050	21.10	Sat. Music	—	—	—	13.00	Markets
PCUU	—	—	20.45	Thurs.	—	—	—	13.45	Financial News
—	—	—	21.40	Irregular Sun.	—	—	—	17.30	—
LP	Königswusterhausen	3,700	08.00	Irregular Financial News	—	—	—	17.45	Music
—	—	—	09.00	Reports	—	—	—	18.45	Racing News
—	—	—	10.00	—	—	—	—	22.30	Reports ; Music
—	—	2,700	11.00	Not Sun. Music	—	Paris (Ecole Supérieure)	450	15.30	Thurs. and Sat. Music
—	—	4,000	12.00	Music	—	—	—	20.45	Daily ; Music
HB 2	Lausanne	2,700	16.00	Irreg. Music	PRG	Prague	1,800	08.00	News
—	—	1,000	19.00	Wed & Fri. Music	—	—	—	18.00	Irregular ; Music
—	—	780	16.00	Irregular ; Music	KBEL	—	1,150	22.00	Music
OXE	Lyngby	2,400	20.30	Not Sun. Music	ICD	Rome	3,200	12.00	—
YN	Lyons	470	11.45	Music	—	—	1,800	18.00	—
—	Madrid	392	19.00	Irregular ; Music	—	—	—	20.30	—
PPT	—	400-700	17.00	—	—	—	—	—	—

AVIATION AND OTHER SERVICE TRANSMISSIONS

CALL	STATION	WAVE-LENGTH	SERVICE	CALL	STATION	WAVE-LENGTH	SERVICE
GFA	Air Ministry (London)	900-4,100	—	GCS	Caister-on-Sea	1,750	Post Office
BYB	Cleethorpes (Radio)	3,000-5,200	Aviation, Gale Warnings	GCO	Crookhaven	—	—
GED	Croydon	900	Civil Aviation	GCC	Cullercoats	600	—
GEM	Didsbury	—	—	GRL	Fishguard	600	—
GEP	Fulham	—	—	GBL	Leafeld	8,750	—
GER	Renfrew Radio	—	—	GKB	Northolt Radio	8,400	—
BYP	Plymouth	220	Aircraft	GBL	Oxford Radio	8,890	—
MUU	Carnarvon	14,200	Marconi	—	—	8,750-12,300	—
MZX	Chelmsford	3,800	—	GPK	Port - Patrick Radio	600	—
GLA	North Weald Essex	3,800	—	GLV	Seaforth Radio	—	—
GLB	—	2,900	—	GSW	Stonehaven	3,000-5,000	—
GLO	—	4,350	—	GCA	Tobermory Radio	300	—
GLA	Ongar Radio	2,400	—	GCK	Valentia	600	—
GLB	—	3,950	—	GKR	Wick	600	—
GLO	—	4,350	—	—	—	—	—
2 MT	Writtle	400	Marconi Scientific Inst. Co.	—	—	—	—

POPULAR WIRELESS is the oldest established broadcasting journal, and its efforts to popularise wireless—long before a single broadcasting station was erected in this country—have made the letters “P.W.” familiar to thousands of people through Great Britain.

POPULAR WIRELESS never “lets a reader down.” Its technical staff is unrivalled. Every wireless enthusiast has heard of the famous “P.W.” Combination Set, which has proved the most effective and popular amateur receiver of the year.

No constructional article appears in **POPULAR WIRELESS** until the set described has been built and exhaustively tested. That is one reason why thousands of amateurs have learned to rely on “P.W.” above all other journals.

A special feature of **POPULAR WIRELESS** includes the brightly written notes and news by “Ariel,” and the excellent queries department, which answers readers’ questions by post, free of charge. Over 2,000 queries are dealt with every week.

Buy a copy of **POPULAR WIRELESS** to-day. You will find it the best and brightest wireless paper in the world. It is on sale every Friday, price 3d.