

1

To be Completed in about 20 Fortnightly Parts

1^s/₃^d

HARMSWORTH'S WIRELESS ENCYCLOPEDIA

For Amateur & Experimenter

A—ALU

CONSULTATIVE EDITOR

SIR OLIVER LODGE, F.R.S.

LEADING CONTRIBUTORS

PROF. J. A. FLEMING, F.R.S.
INVENTOR OF THE FLEMING VALVE

PROF. W. H. ECCLES, F.R.S.
PRESIDENT, RADIO SOC. OF GT. BRITAIN

E. V. APPLETON, M.A., D.Sc.
OF THE CAVENDISH LABORATORY, CAMBRIDGE

N. W. McLACHLAN, D.Sc.
RESEARCH ENGINEER, MARCONI CO.

CAPT. P. P. ECKERSLEY,
CHIEF ENGINEER, BRITISH BROADCASTING CO.

E. BLAKE, A.M.I.E.E.
WIRELESS EXPERT TO THE "DAILY MAIL"

MAJ. RAYMOND PHILLIPS, I.O.M.
INVENTOR OF WIRELESS CONTROL METHODS

*J. LAURENCE PRITCHARD, F.R.Ae.S., Technical
Editor, with expert editorial and contributing staff*

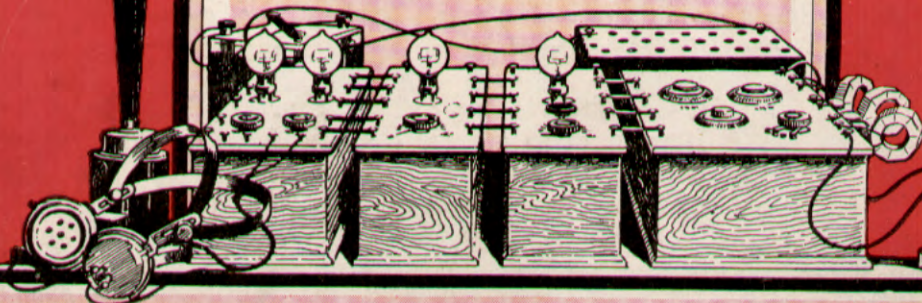

The Only A B C Guide to a Fascinating Science-Hobby



35 Setting up the guy wire with block and tackle on the strainer

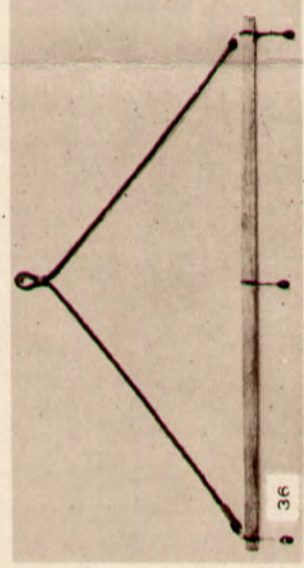

36 Details of the spreader for the three-wire aerial

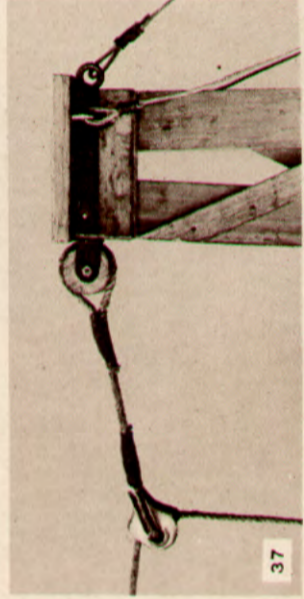

37 Fittings at the top of the lattice mast, showing aerial halyard and pulley

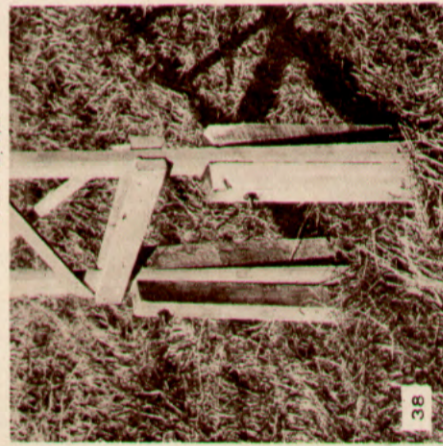

38 Stakes which support the bottom of the lattice mast

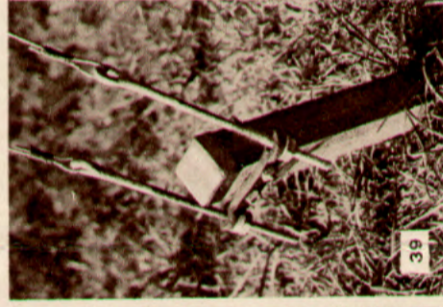

39 Fixing guy wires to the strainers on the ground stake

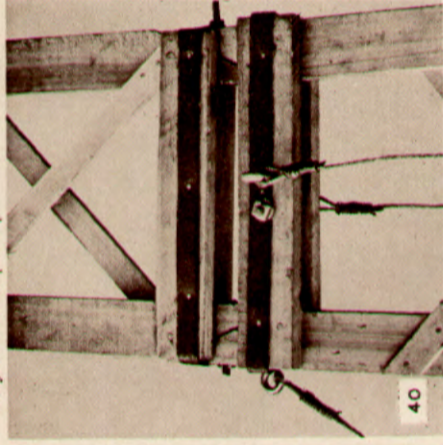

40 How the joint between the sections of the mast is made



42 The three-wire aerial complete, running from the lattice mast to the house chimney with lead-in wires

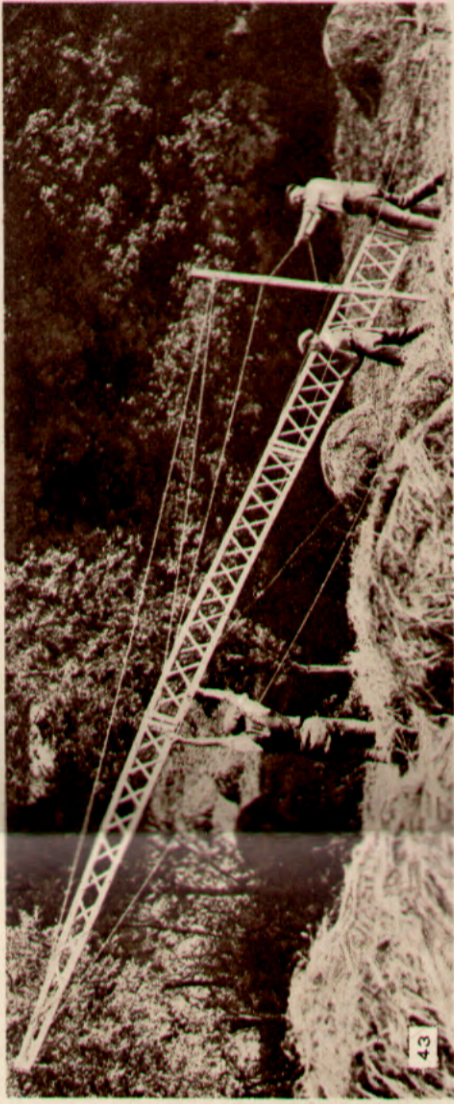

43 The complete lattice mast is assembled and bolted together on the ground, and then erected by pulling on the guy ropes as seen in the photograph



44 The mast almost erected and well supported by the guy ropes

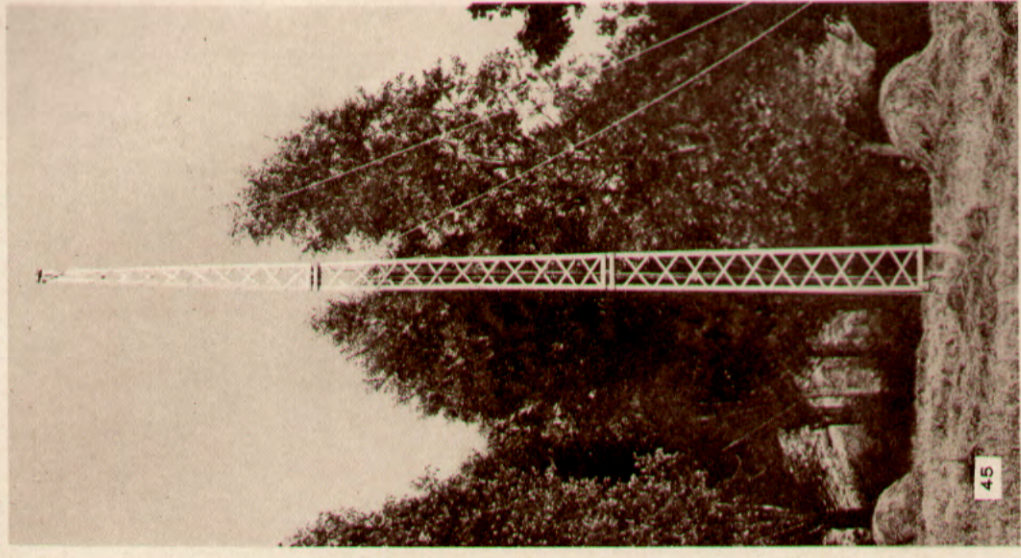

45 The complete lattice mast in position. Aerial wires are hanging behind

AERIAL: COMPLETE SET OF PHOTOGRAPHS SHOWING DETAILS OF CONSTRUCTION OF A LATTICE MAST 36 FEET HIGH, SIMPLY AND CHEAPLY MADE OF DEAL BATTENS

From photographs specially taken for HARRISWORTH'S WIRELESS ENCYCLOPEDIA

To face page 44

To Our Readers

IN offering this entirely new work to the very large and rapidly increasing public that is interested in the popularization of the science of Wireless, the publishers may be permitted to point out that not only is HARMSWORTH'S WIRELESS ENCYCLOPEDIA unique in being the very first effort to provide a complete and exhaustive work of reference in a highly specialized field of study, but that the thousands of photographs and drawings which its pages will contain have, with few exceptions, been expressly made for this work.

THE WIRELESS ENCYCLOPEDIA is one of a series of educational works issued by the same publishers, in which the instructional value of the photograph has been demonstrated to the full. Every item of Wireless equipment photographed for the pages of this work has been prepared and tested by experts. Where details of mechanism are illustrated, and the varying stages of their assembling shown, the mechanism has in every case been actually tried, as to its working accuracy, before the taking of the photograph, so that it might be claimed for the illustrations in the WIRELESS ENCYCLOPEDIA that they are not merely theoretical, but are photographic reproductions of "practical" pieces of mechanism.

IN this way, the Wireless experimenter who makes use of the literary and pictorial matter here provided for his guidance can be assured that at every turn such advice as he is given and such hints as he may derive from the information provided are soundly based upon actual practice and not merely upon theory. Every care has been taken to acknowledge proprietary circuits.

READERS will notice that the arrangement of the contents in the WIRELESS ENCYCLOPEDIA is strictly alphabetical, thus facilitating reference to the particular detail in which the reader may be for the moment most interested. In Part 1 a group of introductory articles of a general kind appears, and the pages devoted to the Encyclopedia proper are consequently fewer than will be given in the succeeding parts, each of which will contain a pictorial supplement either in colours or in photogravure.

**Order Part 2 to-day, and ask Your
Newsagent to reserve a copy of
every succeeding fortnightly part,
and so avoid disappointment**

Harmsworth's Wireless Encyclopedia

THE marked popularity of Wireless, since modern improvements enabled speech and music to be transmitted by means of ether waves, has brought into existence a great mass of publications, and has led to the dissemination of a variety of miscellaneous information connected with the subject, about both principles of theory and details of practice. The time has come when a comprehensive work of reference is required, so that special points can be looked up with a minimum of trouble. Fortunately, the amateurs who have taken up Wireless as a hobby are not content with merely listening-in and making demonstrations to their friends and relatives; they want to understand more seriously the principles underlying this great and remarkable development of human powers of communication.

SPEECH used to be limited to persons within audible range. Now it can be distributed broadcast over an Empire. This constitutes a new responsibility, like every other newly acquired power; but it is difficult to foresee any base uses to which it can be applied. It is one of the few inventions which seem wholly beneficial; and the amount of interest in it is to be heartily welcomed.

CONSEQUENTLY, when asked to contribute and to be consulted about HARMSWORTH'S WIRELESS ENCYCLOPEDIA, I felt, after seeing some proof-sheets and the wealth of illustration contemplated, and the general completeness with which it was being prepared, that I could legitimately devote some portion of my very limited time to assist in some minor degree, in a consultative capacity, those whose practical knowledge makes them familiar with the most recent developments, and who had been asked to join in producing a book which aimed at giving a widespread knowledge, to some extent of the principles, and to a still larger extent of the details, of its many branches. It must be understood that I am not responsible for all the contents of the different articles; that responsibility must rest upon the writers.

I HOPE that the publication will meet with the circulation it deserves; and in this broadcast manner I convey to my unknown friends who are enthusiastic about Wireless my cordial good wishes, accompanied by an expression of admiration for the scientific and technical skill which has developed this modern outcome of physics and engineering from what it was in 1897—when, in supplement to Mr. Marconi's initial enterprise, I took out my fundamental Patent for Tuned or Selective Wireless Telegraphy—to what it is now in 1923, the interval being surely one of the most prolific quarter-centuries, both for good and for evil, in the entire history of mankind.

Oliver Lodge

Sir Oliver Lodge in His Laboratory



From a camera portrait by E. O. Hoppe

Wireless and Other Waves

by SIR OLIVER LODGE, F.R.S., D.Sc.

Author of "Modern Views of Electricity," "The Ether of Space," etc., inventor and pioneer in wireless telegraphy

Our distinguished contributor and Consultative Editor explains concisely in this contribution the extraordinarily interesting relations between all types of ether waves, of which light, X-ray and wireless waves are similar in character, differing but in length

WAVES and the vibrations which give rise to them, and by which we are enabled to perceive them, contribute a great deal to our knowledge of the world and of the universe. It is through waves of light that we gain a knowledge of the stars, even of their chemical composition and velocities, and of the existence of other worlds in space. Without the information thus acquired our universe would shrink to the small planet which we occupy.

It is through waves of sound, also, that we are able to communicate with each other, and to hear events which are occurring at a distance. Without these two sources of information we should be limited to what we could touch and smell and taste. The two main senses of man are dependent on waves or tremors—that is, on vibrations of some kind.

But now we have to consider in what sense the term "wave" can be applied to sound or to light. The term wave was originally used, no doubt, to signify the travelling humps on the sea and the ripples on smaller pieces of water. And it was by no means obvious—it had to be discovered—that there was any analogy between them and the apparently quite distinct phenomena of sound and light.

Simple Mathematics of Waves

AS a matter of fact the waves are very different; and it is chiefly because they can all be represented by the same mathematical equation that the same term is applicable to such very different phenomena.

Ask a mathematician what he understands by a wave, and he will probably reply $\frac{d^2y}{dt^2} = v^2 \frac{d^2x^2}{dx^2}$. And if asked to put this into words, he would say: Something periodic both in space and time, travelling in the direction x with the velocity v . Let us illustrate this.

By "periodic" is meant repetition at regular intervals. A row of railings is periodic in space, if the railings are all exactly alike. The swing of a pendulum is periodic in time. And if you had a row of pendulums swinging in regular succession, not all swinging together but started one after the other, the arrangement would be periodic in both space and time; and if you watched the pendulum bobs you would see a wave form running along them, coming in apparently at one end and going out at the other. There is no real progressive motion of anything material, but there is a form which progresses.

One might take another analogy. The turns of a corkscrew are periodic in space. If you make it revolve it is periodic in time, too; and accordingly you see the waves advancing.

How the Wave Form Progresses

SO it is on the open sea. The wave advances, but the particles do not. The particles heave up and down. But because they do it in regular and periodic order the result is an apparent progression, which anyone can see by throwing a pebble into a pond. Near the shore the waves get more complicated. The bottom part is held back by the beach, the top part travels forward, and the wave topples over and breaks upon the shore. These also are popularly called waves, but they are more complicated than true waves.

They are breaking waves, and represent absorption or destruction of the wave motion, and its conversion into the irregular vibration which appeals to our senses as heat; though indeed the heat thus generated hardly raises the temperature of the water appreciably unless the waves are exceedingly violent. Nevertheless, that is the way we get heat from the sun. The energy does not come to us as heat. It comes to us as some form of

Wireless and Other Waves

wave motion, and only when absorbed or quenched by matter does it turn into what we speak of as radiant heat. It is those waves which keep the earth warm, and make vegetation, and life generally, possible. We are *not* dependent on the interior heat of the earth.

Waves are often generated by the molecular agitation we call heat; and they excite the same kind of agitation when they are received and quenched.

Sound Waves Change to Heat Waves

WAVES of sound also turn into heat when they are absorbed. But if either of these two classes of wave fall upon appropriate receiving organs, they excite the nerves with which those organs are supplied, and thereby give us the sense of sound or of light. How they do this is partly understood and partly still mysterious. The translation of a tremor into a sensation has to be interpreted, as far as it can be interpreted at present, by the science of Psychology.

The eye and the ear only respond to a certain range of tremor. They will not respond to vibrations which are too slow, nor, again, to those which are too quick. The ear has the greater range of the two. The range of the eye is very limited; the most rapid vibrations which the eye can perceive are only double as quick as the slowest which it can perceive. The slowest excite the sensation that we call red, the most rapid excite the sensation that we call violet.

The Immense Range of Unseen Rays

BUT beyond the violet there is an immense range of ultra-violet, right away up to the X-rays, and, even higher than those, the gamma rays of radium, thousands of times more rapid than anything that can affect the eye. Fortunately, however, they are able to affect certain chemicals, and therefore can be photographed. Below the red, again, there is a great range, which is called infra-red; and, very much slower than that series of other pulsations, the waves which are used in wireless telegraphy. These can neither be seen nor photographed; we require special instruments for their detection. They are big things, they require a big collecting apparatus, well known as "the aerial,"

and that has to be associated with either a coherer or a crystal or a vacuum valve, which has the property of rectifying them and enabling them to produce electric or magnetic effects, so that they can deflect a galvanometer or be heard in a telephone.

So far we have dealt with the analogy between the different forms of wave. We must now say a word about their differences. Waves of the sea and ripples only occur on the surface of a liquid. They are a very special, though a familiar, type.

No Sound Waves Without Air

WAVES of sound are not really appreciable as waves at all. They consist of compressions and rarefactions of the air, periodic variations of pressure, such as might cause vibrations in a drum-skin or any other flexible instrument susceptible to rapid changes of pressure. Such a drum-skin is provided in the ear, and, by what we must call ingenious mechanism, is transmuted into forcible though minute vibrations which can affect the endings of the auditory nerve.

Without air there would be no sound; it is conveyed by matter, and the ear is specially contrived to pick up vibrations from a gaseous medium. Sound can be transmitted by solids and liquids also, but always by some form of matter. In that it differs entirely from light. The air is no assistance to light; it can travel perfectly well in a vacuum. Air, and aqueous particles suspended in the air, are obstructive to light rather than helpful.

How Light Waves Travel in Space

IF light is not conveyed, then, but rather obstructed by matter—which is liable to absorb and quench it and turn it into heat—if it is able to travel quite freely and unobstructively through vacuum, what is there in that vacuum to convey it? There clearly must be something: we cannot imagine vibrations in empty space. We have every reason to know that space is not empty, but is filled with a subtle impalpable medium, which used to be called the luminiferous ether—that is to say, a substance which had the power of conveying light. This fact was known more than a century ago; but since then many other functions of the ether have been discovered, especially those

Wireless and Other Waves

associated with the terms electricity and magnetism.

But we have no sense organ for their appreciation, we can only investigate those things by instruments. And we have thus learnt that what we call "light" is not a material but an electrical vibration, and that the ether is able to transmit every kind of vibration at the same rate, a rate which has been measured, and amounts to about 186,000 miles per second.

Light and Radio Waves at Same Speed

THE rate at which light travels carries it a distance equal to seven times round the world in a second. A thread wrapped nine times round the world, and then stretched out straight, would reach to the moon, and $1\frac{1}{4}$ seconds is the time taken to cover that distance. This is the rate at which wireless waves travel, for they, too, travel through the ether; and consequently reach every part of the earth that they reach at all in a very minute fraction of a second. So that when it is said that a speaker whose utterances is being broadcasted can be heard by the listeners-in before his voice can reach other people at the back of the same hall as himself, the statement is quite true, and would be true even if the listener-in was a thousand miles away.

In contrasting sound-waves with water-waves, we realise that the motions are very different, and that the rapidity of vibration is different, too. The up-and-down motion on the sea may take several seconds to complete each period. The vibrations of an ordinary voice may be two or three hundred per second, or for a soprano might run up to two or three thousand a second. Indeed, the highest audible squeak is estimated at about forty thousand.

750,000 Vibrations per Second

BUT wireless oscillations are usually more rapid than that, unless the sending station is a gigantic one emitting waves several miles in length. The most usual waves employed in broadcasting are, let us say, about 400 metres, about a quarter of a mile, and the aerial at such a station has to vibrate electrically three-quarters of a million times a second. No form of matter is able to transmit waves at this rate. We are dependent wholly on

the properties of the ether for all optical and wireless phenomena. And were it not for the fact that the speed of transmission for every length of wave—whether they be twelve miles, or the millionth of an inch, in length—is accurately the same, there would be great confusion, and the transmission of wireless telephonic speech would be impossible.

The question must now be asked: If waves on water and waves of sound, though both conveyed by matter, differ so entirely in their details—one being a heave up and down, while the other is a to-and-fro compression—what sort of motion is it which occurs in the ether, and what kind of waves are light-waves?

How Does the Ether Transmit Waves?

THE answer at present is that we do not precisely know. We know that they are not like water-waves, nor are they the least like sound-waves. They are purely electric or electro-magnetic. There is something in the structure of the ether which enables it to transmit these peculiar waves, but what the structure of the ether is has not yet been worked out. The remarkable thing is that these electric or ether waves, even if very intense—and they may easily be emitted with the strength of some horse-power—do not affect any of our senses, and do not appear to affect the human organism at all.

Immersed in Speech and Music

WE can live in the midst of them and know nothing about them. As a matter of fact, we are living in the midst of them now, and we can only detect their presence if we provide ourselves with a suitable "medium" for their detection—that is, a suitable receiving instrument. Then we find that we are immersed in speech and music and Morse code, without the least knowledge on the part of ordinary humanity. Only the enlightened experimenter has learnt how to receive these ethereal pulsations and interpret them in the way intended by the sender. There may be many other things in the universe of which we are equally unconscious, and until our eyes are opened, figuratively, or until we are provided with the necessary receiver, we may live and die in complete ignorance of much that is going on round us.

The Pleasures of Wireless

by E. BLAKE, A.M.I.E.E.

Of the staff of the Marconi Company
and Wireless Expert to the "Daily Mail"

Most of the pages of our Encyclopedia are devoted to articles which, though of great practical and theoretical interest, necessarily have a somewhat utilitarian character. Here is one which possesses the fascination of real enthusiasm and the imaginative outlook of intelligent anticipation

NOT long ago, in an attempt to stimulate inventors, a number of men well known in their own particular professions were asked to give their opinions as to "what is wanted" nowadays, and one of them, with greater wisdom than may at first be apparent, answered, "A new game of skill." Directly I read this it occurred to me that pending the invention of some new game requiring skill, patience, and intelligence, the game of wireless will do very well to go on with.

There never was quite such a wonderful game as wireless, and there can be none cleaner, more educational, more fascinating, or fuller of useful possibilities. By many people amateur wireless is regarded simply as a matter of buying a "listening-in" set and intercepting the excellent programmes of the British Broadcasting Company's stations. The person who confines himself to that will probably know no more about wireless after a year of "listening" than the average telephone-user does of the principles of line telephony or the gramophonist of the physics of sound. Wireless, that is to say, the transference of electrical power across space at the speed of light and its detection at a distance, is the outstanding scientific marvel of our generation; yet it may be dabbled in at a moderate cost, and in the parlour, by anyone of ordinary intelligence.

The Real Pleasures of Wireless

A GREAT deal of the pleasure of amateur wireless springs from a knowledge of its possibilities, which, in its turn, depends upon an understanding of the scientific principles upon which the art is based and the agencies through which it is made possible. Of the mere rule of thumb reception of "broadcasting" by means of one of those compact "touch-the-button-and-we-do-the-rest" instruments designed in such profusion by wireless engineers, I

have little to say here; they are the means of bringing a new joy into many lives, and, no doubt, most of them are quite good wireless receivers, but it is not with them we are concerned. What are the real pleasures of wireless?

First of all there is, I think, the lure of the wirelessness of wireless. I am fairly seasoned at the game as played professionally, yet though it is a long time since I dropped the telegraph key and shut off the power, I recall that I never worked long-distance wireless without a thrill.

"No Wires on Silly Poles"

I ALWAYS had a queer kind of sensation on thinking, "Every time that spark of mine shoots across the gap, there is a buzz in that fellow's telephones"—the "fellow" being distant from me across leagues and leagues of ocean, forest, and plain. "He might be just round the corner," I used to think as his answering buzz sounded in my receiving telephones. "No wires strung on silly poles, no cables laboriously laid on the bed of the ocean; just a tap or so upon the telegraphing key and my thought is reacting on the brain of a man a thousand miles away."

Not so many months hence, the British station of the Empire Wireless Chain will be exchanging messages with Sydney, Australia. I wish I could be the first to operate that service; a few depressions of the key and I should be "through" to the Antipodes—five weeks or more of hard steamer travel traversed in the twinkling of an eye, and no wires or cables in the way. Before you can blink thrice, the reply is being written down on my pad. That makes space look small, doesn't it?

Now consider wireless transmission for amateurs in this country. The wirelessness of wireless is a great lark, or "horrid fun," as R. L. Stevenson would have said. For instance, you may sit in Surbiton or

The Pleasures of Wireless

Sutton, and in the space of an hour exchange messages with friends living in Birmingham, York, Exeter, or Paris. You may say, "But I have no friends in those places." That is where you make a mistake! All wireless transmitter owners are friends. You have but to refer to the list of station owners and send a card to which you please, asking him to listen for you at such-and-such an hour. He will be there, you may depend on it, provided it is within the bounds of possibility. You may even be ambitious enough to try for places as far distant as Aberdeen or Nice; and at night, with good conditions prevailing in the atmosphere and a well-adjusted apparatus, it is quite possible to "get through" to places as far distant as those.

Lure of Long Distances

ONE could write a small book on the subject of wireless transmission for amateurs, the laws and regulations governing it, the different methods by which it can be done, the problems to which it gives rise, and so on. But all these things will be dealt with in the following pages.

Next in order of charm comes the lure of the long distance. In wireless we do not think of distances as long until the 2,000 mile mark is passed; and 2,000 miles is, of course, a small step as wireless distances go. The amateur of to-day cannot normally hope to indulge in long-distance sending. What he will be able to do in twenty-five years' time we cannot guess, for ether-wave communication may be revolutionised during that period. Signals from American amateur stations have been heard in this country, but actual communication across the Atlantic by amateurs has not been accomplished yet.

Across the Seas to the Antipodes

IN the matter of reception, however, the amateur is quite free, and there are no regulations or physical obstacles to prevent his receiving signals from stations at the Antipodes, provided these are designed to communicate with Europe.

It is quite an easy matter to receive from European high-power stations, but somewhat more difficult to receive American stations, though it is chiefly a matter of possessing skill, patience, and the right sort of apparatus. We

usually proceed from simple feats of reception by means of simple apparatus until, fired by growing ambition, there is a slow evolution from the simple to the complex, and we are manipulating very powerful amplifying sets and reaching out right round the globe, much in the same way as the amateur photographer begins with a simple hand camera and ends with the most wonderful of lenses and processes.

I know of no sensation quite so strange as that which is experienced by the beginner when he begins to pick up his first long-distance signals. To sit in Peckham and listen to Moscow or New York speaking, even though it be in code, is an experience novel enough to attract anyone who is not bored beyond redemption. Yet it is within the bounds of achievement, and it is not necessary to go to Peckham to hear those stations, either—you can do it from any part of these islands, so far as I am aware. Though you must understand that manipulative skill, a great deal of patience, a certain amount of theoretical knowledge, and good instruments are necessary.

Crystal Receivers not Child's Toys

II MAY say that it is well within the scope of the amateur enthusiast to sit at home here and tune in most of the high-power stations in the world, most of the medium-power stations of Europe, from Scandinavia to Cadiz, not to mention ships galore as they proceed on their lawful occasions, aeroplanes, aerodromes, and the broadcasting stations of Great Britain, France, and Holland.

But you will not be able to do all this at once. "Link by link is chain armour made," as the old saying has it. You will find plenty of problems to engage your mind in getting the best out of a simple crystal receiver. You *must* learn all you can about crystal reception, because it is employed in combination with some of the most effective modern valve amplifiers. So do not disdain the crystal as a child's toy, for it has occupied the attention of some of the best-known men in the history of wireless and its tale is not yet over.

Yet another pleasure of amateur wireless is the scope it affords for the exercise

The Pleasures of Wireless

of mechanical constructive ability, and delicate operations of skill such as the winding of coils of fine wire. The instruments of wireless are characterised by their delicacy and precision. A coil must have such and such a diameter, it must be just so long, and it must be wound with just so many turns or wire of such and such a gauge in order to serve a certain purpose. A condenser needs so many vanes or plates, interleaved with a certain clearance, which must be exact to a hair's breadth.

If you love working in wood and metal, if you love to produce *exact* instruments, you could try your skill on nothing better than wireless apparatus. It is clean, healthy work in delightful media—wood, ebonite, brass, copper, nickel, aluminium, mica and wires of numerous sizes and kinds. The fitting up of a really good station calls for no mere rule-of-thumb work, but for design, calculation, and much ingenuity; the process is interesting and instructive, the result is useful, permanent, and, if you like, ornamental as well.

Joys of Making a Receiving Set

THOSE who enjoy manipulating instruments of precision will find plenty of scope for such work in the pursuit of amateur wireless, such as the adjustment of sliding contacts, of calibrated condensers, of potentiometers which control voltages, and of rheostats which control the rate of flow of electricity; then there is the use of electrical measuring instruments like voltmeters, ampere meters, and wave meters, the connecting up of electric batteries, and the care and charging of storage batteries, all of which is occupation of a most fascinating nature to the person who is handy with his hands and nimble of brain.

Perhaps the crowning pleasure, after the station is complete, is the exciting period of trying-out the receiver. Imagine, that we have been engaged each evening for a week in designing and making a set. First came the weighty consideration of what circuit should be used. All the best books were consulted, deep researches were conducted amongst the various radio publications and, after selecting the best points of several dozen designs, we settled the circuit at last. Then came the question

of wave-length; should the set be an example of an attempt at designing the great universal receiver capable of tuning from 200 metres to 25,000 metres, or should it be more or less specialised to work over a narrow band of waves, say from 300 metres to 3,000 metres? We chose the latter, for reasons we had learned during our apprenticeship to amateur wireless.

The Exciting Point—Will it Work?

NEXT came a short exercise in simple "figuring," in order to arrive at the electrical and mechanical dimensions of the various components—the coils, condensers, resistances, and so forth. Then bit by bit the station was built and wired up and trimmed and polished, and now we are assembling the batteries round it and connecting the aerial, filled with the pleasurable excitement of wondering whether, and how, it will work. On go the headgear telephones. It is 8.15 p.m. and the London station will be in full swing; let us try for them first.

Horrors, the second valve won't light up! Ah, no wonder! We forgot to solder just one tiny scrap of wire underneath the valve socket. We remedy the omission, and with all three valves shining out proudly, again don the telephones. Dead silence! A rush of doubts and fears sweep over us. Was the circuit wrong? We seize the working drawing. No, it is quite right! Then we begin systematically to look for the fault. Dolts! Blockheads! How can the set work without its high-tension battery—*which we forgot to switch on*. A snap of a switch and—ah, there is the unmistakable crackle in the telephones.

A few deft turns of the condenser handles, and lo, London itself, loud and clear, playing the exquisite Unfinished Symphony. So that's that. We jog up the wave-length to 600 metres. There's North Forland, there's Ushant, there are the ships, all busy as bees—and with our own hands we did it. Let's call the folk and switch on the loud speaker.

Unlimited Possibilities for the Amateur

WHEN I come to write of the possibilities of amateur wireless I am severely tempted to use the word unlimited, a word of which a sedate writer on scientific

The Pleasures of Wireless

subjects must, as a rule, fight very shy. Nevertheless, I will let it pass this once, because the ether is unlimited, and the ether is the medium in which wireless works. There is no end to the study and experiments possible in ether-wave science.

In telegraphy and telephony alone there are the two great divisions—transmission, or the production and control of the waves, and reception, or the interception and utilisation of the wave-energy. Then there are numerous problems in connection with the wireless transmission of photographs, wireless vision (or television), wireless control of mechanism (a particularly fascinating subject for amateurs), the wireless distribution of power, and wireless communication in one direction.

Life Study in Wireless Problems

YET if we take only those two subjects, wireless telegraphy and telephony, we find a superabundance of things to be done and of questions to be investigated and answered. Just as in zoology a man may devote his life to the study of one animal, so there is a life's study in the elucidation of the problems of one or other of the branches of wireless. No expensively equipped laboratory is essential, and much of the necessary apparatus can be made at home, yet fame and fortune may be the result of some amateur's patient, intelligent research.

We are just at the beginning of the ether age. Wireless, as a practical, commercial art, is only a quarter of a century old. Great discoveries, wonderful secrets, are lying like buried diamonds in the new territory. Who are going to find these treasures, to the enhancement of civilised life, and possibly the enrichment of the discoverers? Commercial wireless is still seeking certain things which it is willing to pay for, and is waiting for certain devices which, when invented, will be needed on every wireless station in the world—and there are many thousands of them.

Natural Obstacles to Wireless

THE study of "atmospherics," or X's, as we call them generally, their origin, nature, habits, and their elimination or side-tracking, with a view to reducing the natural obstacles to wireless signalling,

especially in the tropics, is well within the range of a skilled amateur. "Atmospherics" are electrical or electro-magnetic disturbances in the atmosphere, and probably in the earth as well, which manifest themselves in wireless receiving devices, sometimes badly interrupting communication and often rendering it slow and difficult. A modern transmitting station is fitted with very complicated apparatus for dealing with X's, which are thereby largely avoided; but there is still a need for an efficient X-stopper, and it may well be some amateur who will be the lucky inventor.

Then there is the question of the overcrowding of the ether—what I may call the ether traffic problem. Two stations working on the same wave-length are liable to "jam" each other; their signals arrive at the receiver of a third station mixed, and therefore probably unintelligible. Hence all the available wave-lengths have to be divided amongst the different stations or classes of station. For example, ships have several wave-lengths allotted to them, coast stations have others, aircraft others; direction-finding has its own waves also; military, naval, air force, and long-distance commercial stations are also sorted out and allotted special waves, so that each kind of telegraphic traffic may have a chance in accordance with its importance.

How the Ether is "Jammed"

BUT wireless stations are many and there are many nations using them, the result being that there is always a certain amount of "jamming" going on. The trouble is that, although modern tuning apparatus is extremely "selective," it is still not sufficiently so to tune in one station to the exclusion of others unless there is a certain minimum difference in wave-length between the desired station and the undesired. So that a super-selective receiver must be found, enabling that minimum difference to be made smaller, thus making room for more stations to work in the ether.

Again, although the modern valve detector is a very sensitive instrument, there is no reason why an improvement should not be made in receivers. The valve is expensive and fragile; it is like

The Pleasures of Wireless

an ordinary electric lamp in that it has a "life" of only so many hours, and it uses up electricity, which is money. We need a "cold" valve, that is, an electron device which will deliver up electrons from a filament which remains at atmospheric temperature, or practically so.

A splendid advance towards the low-temperature valve has been made already, and valves may now be obtained which work from dry cells and only require their filaments to be raised to a dull-red heat with consequent increase in their life and considerable economy in current consumption.

Re-discovery of the Crystal

THESE valves are, however, more expensive than the ordinary kind. We need a new receiving device which shall be cheap and durable, which shall not consume energy, and which may be used as an amplifier, as well as a simple detector, of signals.

Crystal detectors, which only about ten years ago were very widely used and which are as sensitive as the two-electrode valves of those days, were largely superseded by the wonderful three-electrode valves which we use nowadays. The three-electrode valve offers such enormous advantages over the crystal that the latter was neglected before its possibilities were exhausted, but with the growth of amateur wireless the crystal has been re-discovered, thousands of crystal detectors are now in use, and the crystal has even crept back into use in conjunction with valves, for as a simple and distortionless rectifier it excels.

Enormous Power Waste in Transmission

HERE, then, is a field for exploration open to amateurs. Who will present us with a crystal, either natural or artificial, which shall be stable in action, cheap, non-deteriorating, and more sensitive than all the others known at present?

On the transmission side, too, there are plenty of interesting problems. Wireless transmission is a wasteful process. Many units of electrical power are employed in order to achieve a result which amounts to the delivery of a very tiny fraction of one unit to the receiving aerial; all the rest of the power is utterly wasted, except in broadcasting, where many receivers are served by one transmitter. The power

of the waves decreases proportionately to the square of the distance they travel. Is there no way of getting round this natural law?

Marconi has developed his wonderful wireless beam, whereby the power is concentrated, so to speak, in a straight line, and the propagation of the waves, instead of being radial, is in one direction. Nevertheless, we are still needing the long-distance, *low-power* wireless station.

One could multiply instances by the dozen. We need a non-resonant loud speaker, one which will give perfect reproduction, without those jarring, gramophone-like noises we so often suffer from, particularly in over-loaded loud speakers,

We need a microphone which will handle the human voice and all musical instruments equally well. We want to know more about "blind spots," and how wireless waves travel long distances round the globe. And of course we want to know a great deal more about the ether.

Patient Work and Scientific Achievement

NOW, although from time to time men stumble upon fine discoveries, like men groping in the dark, the bulk of useful scientific work has been done by men with knowledge of their subject, patiently working along logical, reasoned lines, not in a desultory, haphazard fashion. That truth runs like a golden thread all through the great fabric of scientific achievement. Research is really work for trained experimenters and observers; it is out of the question for people who have not their subject at their finger-tips and possess a sound grasp of its fundamental principles.

The Encyclopedia yet to be Written

SUCH a work as has been conceived and produced by those who are responsible for this Encyclopedia brings together the knowledge and experience of hundreds of scientific men, men who laboured in the laboratory or on the big wireless stations; it concentrates the essentials of many textbooks and lectures. It is a wireless library, full of practical wisdom, fruitful, suggestive, and inspiring to those who have eyes to read, the wit to understand, and the energy and courage to use it and go forward, to sketch out by their work the chapters of the Encyclopedia which is yet to be written.

Wireless Theory for Amateurs

by Dr. J. A. Fleming, F.R.S.

Inventor of the Fleming Thermionic Valve, Author of "The Principles of Electric Wave Telegraphy and Telephony"

Here one of the pioneers in the science of radio-communication explains in simple but exact terms for the amateur in wireless work the theories that underlie the reception of messages sent on waves through the ether. He thus supplies an introduction of prime importance to the theoretical articles in later pages of our Encyclopedia, such as Electricity, Electrons, Waves, and many others, which should be read in conjunction with it

IN setting out for the benefit of the general reader or amateur in wireless telephony the broad general principles and mode of operation of the apparatus used for reception in wireless telephony and telegraphy, we shall assume that the elementary facts of electric science are familiar to him, or at least are expounded in another section of this Encyclopedia.

It must also be taken for granted he is aware that from the transmitting or broadcasting station are sent out into all surrounding space operative agencies which are called electro-magnetic, or, shortly, electric waves. Into the nature of these waves we shall not here enter, as they are discussed in another section, except to say that they are produced by very powerful electric currents or motions of electricity to and fro in a wire or collection of wires elevated into the air and called a transmitting aerial. These electric currents are repeated in the same direction in the aerial at intervals called the periodic time, and the number of such periods per second is called the frequency. These waves travel through space with the speed of light, viz., 300,000,000 metres or about 186,500 miles per second.

A Rule of Fundamental Importance

THE wave advances through a distance called the wave-length in the periodic time, and hence the product of the wave-length reckoned in metres and the frequency must always be equal to 300 million, which is the speed of the wave in metres per second. It is essential to bear this rule in mind in the adjustment of the receiving apparatus as below described.

It must also be assumed that the reader knows that the agency we call electricity exists in extremely small units or particles, which are called electrons and protons. According to modern and present-day views the chemical atoms of which material objects are built up are each composed of

a nucleus, which is itself a compact of protons or particles of positive electricity, and electrons, which are particles of negative electricity, and around this nucleus are grouped and revolve a certain family of electrons, like planets revolving round the sun. In certain materials, such as copper and the metals generally, the atoms easily lose one or more of their electrons, and these free electrons move with high velocity and irregular motion between the atoms or from atom to atom of the solid mass.

Electrons and Electric Currents

IF these free electrons are caused to drift or move as a whole in one direction in the metal, which we may suppose to be a copper wire, this constitutes an electric current, which is called a direct current (D.C.) when the electrons move steadily in one direction, and an alternating current (A.C.) if they move alternately backwards and forwards, and a high-frequency (H.F.) current or electric oscillation if the electrons jump backwards and forwards very rapidly.

Materials in which the free electrons can so move are called good conductors. On the other hand, in materials such as glass, ebonite, mica, or paper, called insulators, there are very few free electrons; but certain electrons in the atom can be displaced from their positions and spring back when the displacing force is withdrawn. This is called an electric strain or displacement in the insulator. With the aid of the above physical ideas we can next attempt to make plain the actions taking place in various parts of the receiving apparatus.

But before considering the apparatus as a whole, it will be best to explain the functions of certain elements of it which enter into the construction of receivers.

One of these is called a condenser. It consists, in simplest form, of a pair of metal

plates separated by a layer of insulator, such as ebonite, glass, mica, or even air.

The familiar Leyden jar is an example of a condenser, and in wireless apparatus the condenser generally takes the form of a number of semicircular metal plates fixed apart at regular intervals to a metal frame, and of an axis with similar plates threaded on it, so that by rotating the axis, more or less, the plates fixed to it can be sandwiched in between the fixed plates in such fashion as to alter the area of metal plates opposed to each other.

All the plates on the frame form one "coating" of the condenser, and all those on the axis the other, whilst the layer of air between is the insulator. In diagrams of wireless apparatus a condenser is conventionally denoted by a pair of parallel thick black lines; and if it is a variable capacity condenser an arrow is drawn across it, as shown in Fig. 1.

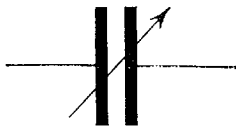

CONVENTIONAL SIGN FOR A CONDENSER

Fig. 1. The thick black lines are supposed to denote two metal plates separated by an insulator and the arrow that the plates can be varied as regards the area of opposed surface

Any two metal or conducting surfaces separated by an insulator, such as the air, form a condenser of a certain type. The function or use of a condenser is to store up energy in the form of electric strain or displacement in the dielectric. It possesses a certain capacity, which means that under a unit electric pressure the plates are capable of taking a certain charge of electrons or deficit of electrons. Thus, if we apply the poles of a battery of dry cells—which is, in fact, a sort of electron pump delivering electrons at its negative pole and absorbing or taking them in at its positive pole—to the plates of a condenser, then one plate acquires an excess of electrons and the other a deficit. In the intermediate insulator the electrons are displaced. (See Fig. 2.)

Suppose we then remove the battery and connect the plates of the condenser by a metallic wire. The result is that the

excess of electrons on one plate work their way through the wire to supply the deficit in the other plate, and the strained or displaced electrons in the insulator come back to their original positions.

This movement of electrons in the wire is called the discharge current of the condenser. If the connecting wire of the discharge circuit is rather short and thick, and if it is also coiled into a spiral, then the discharge current does not consist simply in a movement of electrons in one direction, but of a rush backwards and forwards, gradually dying away and forming a train of electric oscillations.

The reason is as follows: An electron possesses *mass* or *inertia*. This is only another way of saying that when in motion it has a store of energy due to this motion. Hence, it takes time to

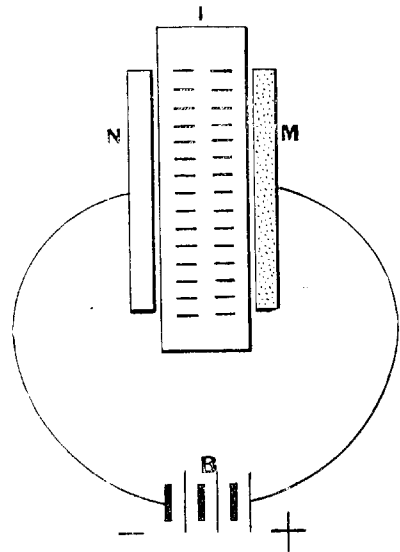

HOW A CONDENSER IS CHARGED.

Fig. 2. Conventional representation of a condenser being charged by a battery, B. The plate M acquires an excess of electrons and the plate N a deficit, whilst in the insulator plate, I, the electrons are displaced against an elastic resistance

start it in motion and, when in motion, it cannot be stopped instantly. Then, again, the electrons in the insulator which are displaced when the condenser is charged are being pulled back to their original positions; when displaced, they are like stretched springs, and when

released from constraint fly back. If, then, we discharge the condenser through a wire of small electrical resistance, the rush of electrons which takes place at the first movement goes too far, and the result is not merely to remove the excess of electrons from the plate, A, but to remove too many, and leave the plate positively electrified. Then a smaller rush of electrons takes place in the opposite direction, and the electrical equilibrium of the two condenser plates is only established after a series of to-and-fro movements of electrons in the wire called electric oscillations. These are, in fact, feeble alternating electric currents.

We may illustrate the action by a mechanical model. Suppose we attach one end of a spiral spring to a fixed point and hang a heavy weight on the other end. (See Fig 3.) This system

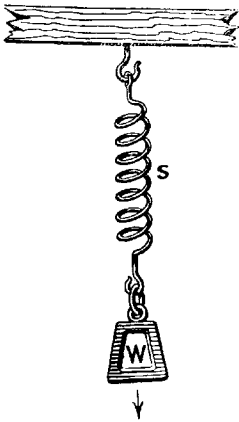

Fig. 3. Mechanical analogy of electric oscillations. A weight, W, is suspended by a spiral spring, S, which can be set in periodic vibration

possesses mass or inertia in the heavy weight and elastic extensibility in the spring. If we pull the weight down and then let it go it will bob up and down a certain number of times in a minute. The time—say in fractions of a second—between two consecutive upward movements is called the natural periodic time, and the number of complete periods per second is called the frequency of the oscillations. The frequency is greater the stiffer the spring. It is also greater the less the mass. Hence, it depends on two factors, and the periodic time is proportional not merely to the product of the mass and extensibility of the spring, but to the square root of that product.

It will be clear, then, that we might construct two such spring bobs which, when displaced, would bob up and down

at the same rate, or have the same frequency. This could be done by making one bob much heavier than the other, but suspending the heavier bob by a proportionately stiffer or more elastic spiral spring. Two systems capable of vibration which have equal periodic times are said to be in tune with each other.

One other point of great importance must be noted with respect to such a spring bob. If we were to give the suspended weight a little feeble blow, say, with a feather, it would have very little effect in starting the oscillations of the bob. If, however, we repeat these feeble blows at intervals exactly equal to the natural time period of oscillation of the system, the effect will be cumulative, and we shall soon create vibrations of great extent in the suspended mass. We can illustrate this same effect by standing on a plank supported at the two ends and gently jumping up and down on it. If we time our jumps "in tune" with the natural period of oscillation of the plank we shall soon produce very great, and, perhaps, dangerous, deflections or bending in the plank.

Condenser Action Simply Illustrated

THESE facts with regard to a heavy bob or mass suspended by an elastic extensible spring have their exact analogues in the case of electric circuits which comprise a condenser whose plates are connected by a conducting wire. The capacity of the condenser corresponds to the elastic extensibility of the spring, and the mass of the bob to the electric inertia or inductance, as it is called, of the wire in which the electrons can move. When the electrons in the insulator of the condenser are displaced and then released they rush to and fro at a certain rate, determined by the capacity of the condenser and the inductance of the wire.

The time period depends on the product of the capacity of the condenser and the inductance of the discharge wire, and hence two circuits can be constructed "in tune" with each other, one having a larger capacity and a lesser inductance than the other.

We have used in the above paragraph the term *inductance*, and it is important

Wireless Theory for Amateurs

at this stage that the reader should have a clear idea of the meaning of this term.

We have said that electrons possess mass or inertia and cannot be started into motion or stopped instantly. This property is partly dependent on the nature of the circuit in which the electron is moving. If it is in a wire coiled into a spiral, then the electric momentum of the current is greater than if the wire were laid straight out. Accordingly, a coil of insulated wire—say copper covered with enamel and wound on a cylinder—is called an inductance coil. It corresponds, so to speak, with the heavy bob in our mechanical illustration, and the condenser corresponds to the elastic spring. If we connect the plates of a condenser to the ends of an inductance coil, we make what is called an oscillation circuit.

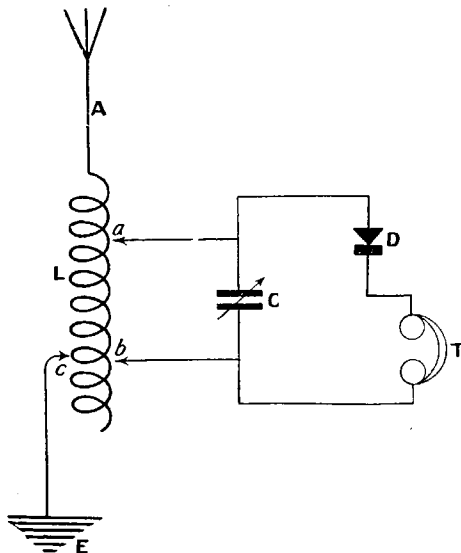

SIMPLE WIRELESS RECEIVING CIRCUIT

Fig. 4. A receiving circuit for telephony comprises an aerial wire, A, for catching the electric waves; an inductance coil, L, with sliding contacts, a, b, c on it; a condenser, C, of variable capacity; a rectifying detector or crystal, D, and a pair of head telephones, T; also an earth connexion, E, which may be the house water pipes

We are now prepared to trace out in broad outline the course of events in a wireless telephone receiving circuit of a simple kind. This apparatus comprises four elements in its most simple form—viz. a receiving aerial, A, an oscillation

circuit, L, C, a detector, D, or rectifier, and a telephone, T. (Fig. 4.)

The aerial is a wire extending up into the air, against which the electric waves from the distant transmitting station strike. The result is to produce feeble high-frequency electric currents in it, or to-and-fro motions of its free electrons, which movements are an exact copy on a greatly reduced scale of the movements of the electrons in the transmitting wire, and pulsating in sympathy with them.

The bottom end of this aerial is connected to one terminal of an inductance coil, which, in general, consists of a number of turns of enamel-covered copper wire wound in a single layer on an ebonite or card cylinder. The second terminal of this coil is connected to the earth or to the water pipes of the house. (Fig. 4.)

In this coil there are then produced oscillations of electricity, or a high-frequency current, which is the same in its mode of variation as that in the aerial wire. A condenser then has its two plates connected to two points, a and b, on this coil, and either the condenser must be one of variable capacity or else one of the contacts between it and the inductance coil must be capable of being shifted so as to vary the inductance. The reason for this is that the oscillation circuit formed of the condenser and part of the inductance coil must be "tuned" so as to have the same frequency as the waves falling on the aerial. Also, the effective length of the coil, L, in series with the aerial, A, must be tuned to the frequency of the incident waves by shifting the contact point, c.

Adjusting, or Tuning, the Circuit

THUS, suppose we are listening-in to the London Broadcasting Station, 2 L O, and that the waves sent out have a wavelength of, say, 360 metres. Then the frequency of those waves is 300 million divided by 360, viz. 833,000 (nearly). Hence the condenser-inductance circuit must have its capacity and inductance adjusted to such values that this circuit has a natural frequency of oscillation of 833,000. Also the aerial and inductance, L, must be tuned to the same frequency.

When this is the case the feeble electrical impulses given to this aerial circuit by the electric waves will set it in vigorous

electric oscillations in the circuit composed of the capacity C and the effective inductance between the points a and b on the spiral, just as the spring and weight in our mechanical illustration could be set in vibration by feeble blows administered at a rate equal to its own natural rate of vibration.

These electric oscillations in the condenser circuit are, however, alternating currents, and the function of the third element, viz., the detector, D , is to enable these very feeble oscillations to set in action some signal or sound-producing instrument such as a telephone receiver.

How the Telephone Reproduces Sounds

THE details of a telephone receiver are described more fully elsewhere, but it may here be mentioned that it consists of a magnet having pieces of soft iron on its poles, around which are wound coils of insulated wire. In front of these pole pieces is a disk of thin steel called the diaphragm, which is attracted and slightly cupped in by the magnetic attraction of the pole pieces.

If an electric current passes through the coils it either strengthens or weakens this attraction, according to its direction. The sudden release or greater attraction of the diaphragm causes it to strike a blow to the adjacent air and starts an air wave, to which our ears are sensitive as a sound.

If, then, these currents circulating through the telephone coils are low-frequency or audio-frequency currents (that means having a frequency, say, between 100 and 10,000), the vibrating diaphragm will emit an audible sound. But our ears are not sensitive to aerial vibrations lying beyond about 20,000 in frequency, and, moreover, the inductance of the telephone coils offers a serious obstruction to the passage through them of currents of this very high frequency.

The Office of the Detector

THE telephone receiver does not emit any sound, moreover, when its coils are traversed by a direct unvarying current, but only when the current rather suddenly changes in strength.

Now, the object of the instrument called a detector is to convert the extremely rapid alternating currents or electric

oscillations in the condenser-inductance circuit of the wireless receiver into the kind of circuit which can be detected by a telephone.

For this purpose we require some apparatus which will convert very rapid to and fro, or alternating, electric currents into currents flowing in one direction. Such appliances are called rectifiers, and one commonly used form is called a crystal detector. Certain crystals and other conductors and contacts between different substances possess the curious property of allowing electricity to move through them more easily in one direction than in the opposite. They act like valves in a pipe to air or liquids. One such conductor is a crystal of carborundum, which is a carbide of silicon made in electric furnaces. Another is a contact between a copper or gold wire tip and a piece of galena or sulphide of lead. A third is a device called a thermionic valve.

Let us suppose a simple galena crystal and cat's-whisker copper or gold wire is employed. This is joined in series with the telephone receiver, and the two are connected to the terminals of the condenser of the oscillation circuit (see Fig. 4). When the electric oscillations take place in the condenser circuit the plates of the latter become charged alternately positive and negative. This means that each plate has alternately a deficit and an excess of electrons.

Speech Transmission through the Crystal

WHEN one plate is charged, say, with an excess of electrons, the crystal permits some to flow through the telephone coils, but when it is charged in the opposite way the crystal does not allow the electrons to return through the telephone coil. The latter is then traversed by gushes of unidirectional electric current.

To understand the manner in which speech is transmitted the reader should bear in mind that at the transmitting station there are arrangements (elsewhere described) for producing in the transmitting aerial, in the first place, a steady flow of high-frequency electric oscillations which causes the emission of a steady stream of electric waves of constant wave-length and amplitude or height or intensity. These are called the carrier waves.

Wireless Theory for Amateurs

In addition, there are special means by which the voice of a speaker or the sound of musical instruments alters the height or amplitude of these waves in accordance with the changes in air pressure of the sound waves made.

Consider, then, the result upon the receiving apparatus. As long as the transmitter is sending out the unaltered carrier waves of constant amplitude, these will produce corresponding steady electric oscillations in every co-tuned receiving aerial and receiving circuit, and the rectifying crystal or detector will therefore pass through the receiving telephone merely a unidirectional electric current of unvarying strength. This will produce no sound in the telephone.

If, however, by speech or music at the transmitting station the amplitude or height of the carrier waves is altered correspondingly to the air pressure of the sound waves, then the unidirectional

current through the receiving telephone will alter or change in the same manner, and the receiving telephone will therefore reproduce the sounds made at the transmitter station.

It will be seen that when a simple crystal detector is used or a plain rectifying thermionic valve (*see Fleming Valve*), the energy which is conveyed to the telephone is only the equivalent of that which is given up by the electric waves falling on the receiving aerial. There are, however, many forms of so-called amplifying thermionic valves in use in which additional energy is supplied by a local battery so that the energy is increased (*see Thermionic Valve*). The important and master-tool for this purpose is the appliance called a three-electrode thermionic valve, which can act not only as a detector or rectifier of electric oscillations, but also as a magnifier or amplifier of electric oscillations or varying electric currents.

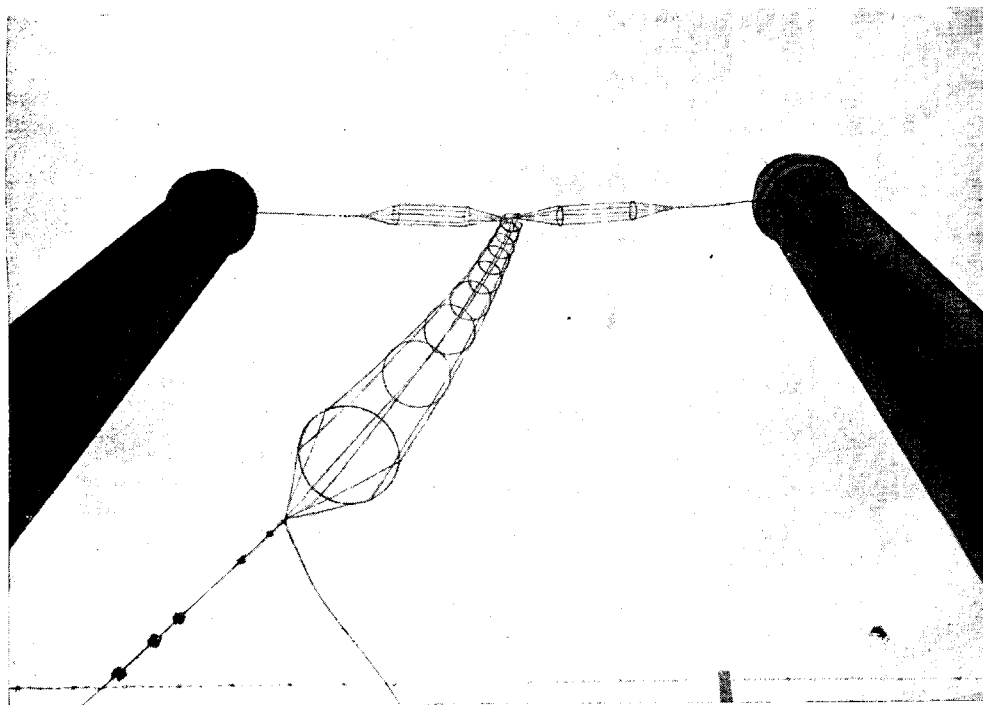

THE AERIAL BY MEANS OF WHICH MUSIC AND SPEECH IS BROADCASTED

This great aerial, known as the T type of cage aerial, sends out the messages from the Birmingham broadcasting station. It is strung between the chimney stacks of the electric generation station, whence the Birmingham wireless waves are transmitted

Photo Gilbert A. R. Palmer

The Story of Broadcasting

by Rex F. PALMER, B.Sc.

Director of the London Station, 2 LO, of the British Broadcasting Co., Ltd.,
Known to all children as "Uncle Rex"

This study gives clear, simple explanations which enable listeners-in to follow every stage of the working of a broadcasting station from the building up of the programme to the moment when the music or speech is heard in the telephones of their receiving sets

OWING to the bewildering rapidity with which broadcasting has developed since the discovery of the principles of wireless telephony, even those most intimately connected with the practical side of the science may well wonder at the beginning of each week what discoveries will have been made before it comes to an end.

In a short article such as this it would be impossible to deal in detail with the technique of a science of which the data change so rapidly, but there are certain fundamental facts, such as the methods of transmission employed in a broadcasting station, of which the principles are easily understood and permanent as far as the listener-in is concerned.

The work of transmission has two distinct sides :

(i) The stage management side, including the provision and the transmission of the programmes, which may be distinguished as the art of broadcasting.

(ii) The technical side, including the actual transmission of the items composing the programme, which may be described as the science of broadcasting.

The Station Director's Difficult Task

OBVIOUSLY the first duty of the director of a broadcasting station is to provide a programme which will interest the largest possible number of listeners-in. This is by no means an easy task, for the director has to bear in mind that he is catering for the largest audience in the world, which is composed of persons of very diverse tastes. He is, therefore, confronted by problems which do not enter into the calculations of the provider of any other kind of entertainment, and during the initial period of experiment it has been necessary to learn by experience.

Of course, it is not to be expected that every item in any programme that can ever be arranged will prove equally interesting

to every listener-in ; but the letters which reach the station—and they are to the director of a wireless station what the applause of an assembled audience is to the organiser of an ordinary entertainment—show the degree of success that has been achieved.

If the majority of the items are favourably commented upon by a large number of correspondents, while the remaining items are appreciated in various degrees, the director may conclude that the programme under discussion was well balanced—and that is the ideal at which he must aim.

A Universal and Democratic Entertainment

TO continue the comparison between an entertainment which is broadcast and one which takes place in a hall, it must be borne in mind that the broadcast entertainment is brought into the homes of all sorts and conditions of people, of all ages and both sexes, whereas the ordinary entertainment is attended only by those who, knowing what they will see and hear, feel that they will enjoy the fare which is provided.

In other words, the broadcast entertainment, which is more truly universal and democratic than any other kind of entertainment, must be composed to suit all tastes. And in addition to this paramount consideration—so that the minorities may not be ignored, even though most of the items are designed to appeal to the majority—there are other decisive factors claiming the director's attention.

On the stage or on the concert platform the performer is seen as well as heard, and on the screen the action of the story is seen ; but the broadcasting performer is not seen—it is only the sound, be it of voice or of instrument, that is heard by the listener at a distance. There is none of the atmosphere of a place of entertainment to help the broadcaster ; there is no mass magnetism, and the

The Story of Broadcasting

predisposition to be pleased which pervades an assembled audience is absent.

Thus very special qualifications are required in the broadcasting speaker, vocalist, or instrumentalist. Apart from technical considerations, it has always to be remembered that broadcasters are submitted to an ordeal which is a severe test of their powers. A performer who might be very successful in a place of entertainment may be a complete failure in the broadcasting studio; but the reverse is not correct, for, except in rare instances such as will occur to everybody, the successful broadcaster would certainly be successful on stage or on platform.

Owing to the fact that a long programme is broadcast every day in the year—not excepting Sundays—it is necessary to find a very large number of vocalists, instrumentalists, lecturers, entertainers, orchestras, and bands whose services can be invoked. This is an absolute necessity, because, however good a performer might be, variety is essential, and, consequently, an immense number of searching auditions take place.

The Raw Material of a Programme

FULL particulars concerning every suitable performer are entered on cards—which are of various colours in order to distinguish between the different classes of entertainment that the performers can give—and classified in a very extensive card-index. In this way the raw material, or ingredients, of a programme can be collected, and so time be saved when the actual arranging has to be done for any special date.

But even by this system there are often difficulties which cannot be eliminated, and there are often unavoidable and serious obstacles to be surmounted before the programme can be completed. Indeed, it may truly be said that the anxiety of the director as regards the actual delivery of each item at each performance is not at an end until the performer is face-to-face with the microphone in the studio; and then, before he can feel quite at ease, he has to await the arrival of the postbag with the criticisms of the immense audience by whom the items have been heard.

As regards the work which has to be done in the studio, while the broadcasting

is actually taking place, there are several points which are of special interest to listeners-in. Smooth running can only be ensured by the most careful attention to every detail; and it may be said that the announcer, who introduces the performers before each item is broadcast, has to be a most efficient stage-manager.

In the studio, owing to absence of resonance, which is secured by the heavily draped and padded walls and ceiling, it is impossible to judge the real quality of any performance as it will reach the listeners-in. But, as this is an indispensable precaution, checking for correction has to be done in an adjoining control room from which the studio can be seen through a sound-proof window.

Checking the Quality of Transmission

IF the checker detects any defect, such as the predominance of any instrument in an orchestra, a slight correction may have to be made, either by changing the position of the performer or by moving the microphone while the performance is taking place. Sometimes listeners-in comment upon the improvement made while a certain item was being performed, after the first few bars had been played or the first few words spoken or sung; and the director knows that it was at that moment that he made the necessary change.

It is often, too, possible to improve the effect by mechanical means while transmission is taking place. During the process of amplification, about which more will be said in due course, resonance can be eliminated, and the broadcasting defects of the voices of singers or speakers can be neutralised to an appreciable extent, just as the undesirable tone of an instrument can be rectified. For example, all sibilant sounds can be very much softened, and resonant notes can be eliminated.

Improvements Day by Day

EXPERIENCE is being gained daily in the manipulation of the apparatus employed, and to the increased skill of the operators in the transmitting station, as well as to the improvements which have been made in the apparatus, the listeners-in owe a great deal. The extraordinarily faithful, or exact, reproduction of sounds which is now possible, whether vocal or

The Story of Broadcasting

instrumental, is due to three causes—namely, the ability and suitability of the actual broadcaster, the skill of the operators in charge of the various parts of the apparatus, and the improvements made in the devices employed.

As every listener-in knows, there is a great difference between the quality of the reception when the items of a programme are being broadcast. As the same methods of transmission are employed throughout, this variation must be due to the suitability, or the reverse, of the performers. In the case of singers and speakers, the explanation is that certain voices are better for broadcasting than others—they possess natural qualities



TESTS AT THE BROADCASTING STATION

It is essential that the quality of the transmission should be checked during performances. Each station, therefore, has a listening-in set, and in the top photograph a London assistant is seen signalling through a glass partition that all is correct. At Birmingham a system of coloured signal lights is used, as seen in the bottom photograph

which enable them to "get over" more clearly than others of the same class. And, of course, the method of production is an important factor. As regards instruments, the method of the player counts for a great deal; and it is also a well-known fact that there is a great difference between the carrying power of several instruments of the same kind.

It is not easy to analyse the essential qualities which ensure good transmission in broadcasting. Pure, natural voices "go over" very well, but in this case "natural" must not be taken as a synonym for "untrained." Quite the reverse is the case. The singer or speaker who knows how to produce his voice properly is always more audible and more agreeable to listen to than one who is inexperienced; and a natural

The Story of Broadcasting

voice, in the broadcasting sense of the term, means a voice that is pure in tone, not artificial in sound, and devoid of all mannerisms.

Good enunciation is of vital importance; every word should be clearly pronounced, and the last syllables must not be slurred or clipped, nor must the voice be allowed to drop towards the end of sentences. It is not necessary to speak loudly—pitch is far more important than volume—nor should the delivery be very rapid. When the performer cannot be seen, the hearers require more time to grasp the meaning of what is being said, or sung, than when they can both see and hear the speaker or the singer.

Another interesting point to which a reference must be made is the effect of the broadcasting environment upon the broadcaster. In many cases, the "stage-fright" produced by the silence and loneliness of the studio is very noticeable when the performer is facing the microphone for the first time.

"Stage Fright" in the Silent Studio

IT is quite a common experience for the performers to be overcome by a feeling of isolation. They wonder where the hearers are; and when they suddenly realize that many of the listeners are hundreds of miles away the almost irresistible inclination is to shout, in order to make their voices heard. Shouting is quite unnecessary; in fact, it is worse than unnecessary, for trouble will be caused in the transmitting set, owing to the fact that the volume of sound may produce a minor thunderstorm accompanied by flashes of lightning, and at the same time the listener will receive anything but a pleasing impression of the performance.

At one time listeners-in were inclined to resent the intervals that occur between the items. As a matter of fact, it is doubtful whether an absolutely continuous programme would be appreciated, or whether it is desirable. It could, of course, be given by the use of two studios; but while it is necessary to arrange for the exit of one performer, or set of performers, and for the entrance of another, short intervals are inevitable. They are, however, as brief as can be reasonably expected, and, in reality, they give the hearers only

a minute or two during which to comment upon, or to think over, what has just been heard.

Sometimes the switch of the microphone is not moved after a performance, so that the listeners are in direct communication with the studio during the intervals. The sounds of what is taking place "go over," and apparently, just as a variation, the listeners like to hear them. But, except on rare occasions, the connexion is broken.

"Good Night, Everybody!"

THEN it must be remembered, when arranging a programme, that every performance must be timed most accurately, in order that listeners-in may know when they must be ready if they want to hear any special item on the programme without listening to the whole performance. Much careful calculation is necessary in order that this timing of the items can be accurately worked out.

These are only a few of the almost innumerable details of management which claim the attention of the director of a big broadcasting station. In order to ensure smooth running, constant and close supervision must be given to everything.

Despite every effort that can be made to complete the programme in advance, it very rarely happens that a performance can be broadcast exactly as it was originally planned. This is due to a variety of reasons which it would be tedious to enumerate; but the fact that such is the case shows that the organizer cannot congratulate himself until the last "Good night, everybody!" has been said after each performance, and not until a few days later, when the letters have arrived from the critical listeners-in, can he be certain that his efforts have been successful.

From the Studio to the Telephones

HAVING very briefly described how the programmes are arranged, and given some idea of the endless routine work which they entail, it is now necessary to deal with the technical side of the transmission. This can be done most simply and most clearly by giving a quite untechnical description of the journey of a performance from the transmitting studio to the headphone or to the loud speaker

The Story of Broadcasting

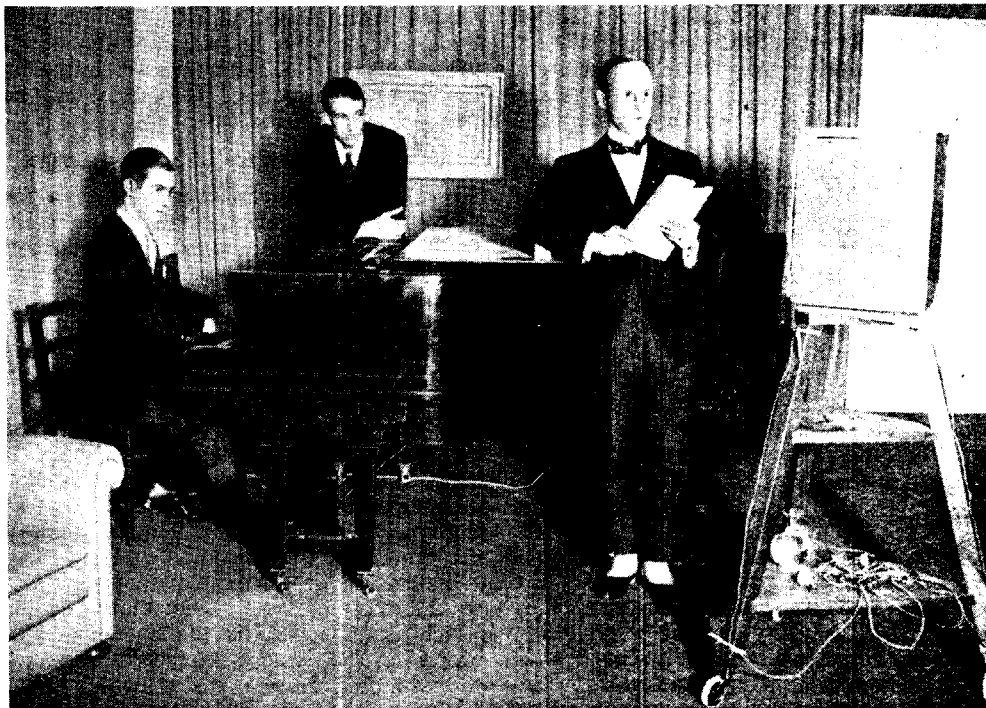

IN THE STUDIO OF THE LONDON BROADCASTING STATION

To eliminate resonance effects which would spoil the qualities of the reproduction in the telephones of the listener-in, particularly in the case of music, the room is hung with six thicknesses of canvas. "Uncle Rex" Palmer, writer of this account of broadcasting, is seen speaking into the microphone.

attached to the receiving-set of the listener-in. Exact scientific information must be sought for elsewhere in the body of this Encyclopedia.

The method employed, it may be added, is practically the same at all broadcasting stations; but for the sake of conciseness the procedure at the London Station, at No. 2, Savoy Hill, near the Thames Embankment, will be described.

When 2 LO is calling, the signal comes from the large studio on the third floor of the building occupied by the British Broadcasting Company, Limited. This is a long room, the walls and ceiling of which are hung with six thicknesses of canvas, while the floor is thickly carpeted. The heavy draperies are of gold and blue material, and so successfully has the padding been done that all room resonance has been eliminated.

The microphone is mounted on a carriage which can be easily moved from place to place on its rubber-tired wheels.

It is connected by electric wires, or leads, which pass under the floor, with a neighbouring room in which the amplifying apparatus has been established. When the instrument is temporarily installed in a theatre or concert hall, the amplifier can be quite close to the microphone, each being an indispensable part of the most important unit of the broadcasting apparatus.

The performer who is broadcasting stands or sits at a convenient distance from the microphone, in front of the instrument. When everything is ready the switch is closed, and thus the whole mechanism by which the broadcasting will be done is connected and put into motion. For the purpose of this description, it does not matter what is being broadcast at the moment. We will therefore take one specific example when describing the actual process of broadcasting. Let it be the familiar signal which precedes every performance.

The Story of Broadcasting

"Hello! Hello! Hello, everybody!
2 LO—the London Station calling!"

Now, what happens from the moment at which these words leave the lips of the speaker until they reach the ears of the listeners-in?

The sound enters the microphone, where it is transformed into an electrical current of a wave-form similar to that of the voice of the speaker. It is important to note here that every sound has a distinctive, or characteristic, wave-form. As the microphone is of such delicacy that the currents are very minute, and of what is known as audio-frequency—that is, a low frequency which can be detected by the human ear—they must be magnified as much as possible without distorting or losing the quality of the original sound.

No Current between Transmitter & Receiver

THIS magnification is done by the amplifier, and the process produces what is known as a modulating current. This amplified modulating current passes along electrical wires to the broadcasting installation, where it is superimposed upon the high-frequency current, the pulsations or oscillations of which determine the wave-length of the station. The high-frequency current in its simple form sets in motion, from the antennae of the station aerial, ether waves of unvarying length; but when the modulating current has been superimposed, the ether waves which are set in motion are of a wave-form similar to the sound which is being broadcast. That is to say, the oscillations, or pulsations, are not uniform.

It is not necessary to go fully into questions of velocity or wave-length or frequency, for they are discussed elsewhere in this Encyclopedia. Suffice it to say that the ether waves which are radiated in all directions are received by all the aeriels within range.

It is most important to bear in mind that there is no connexion, except the ether waves, between the transmitting station and the receiving aerial; that is to say, no actual electric current flows between the transmitter and the receiver, as is the case in an ordinary wire telephone, in which the land line is the continuous connecting link. In radio-telephony—that is to say, in broadcasting—the energy is

passed from the broadcaster to the listener-in simply by the high-frequency vibrations of the ether waves set in motion by the oscillations of the aerial of the transmitting station.

Why Crystal Sets are Limited in Range

WHEN the ether waves fall upon the receiving aerial, currents are set in motion in the circuit which are a reduced replica of the currents that produce the waves at the transmitting station. In other words, a much weakened high-frequency current is produced; and in order that the sound-forms which the ether waves bear may become audible, the current must be rectified and amplified so that it shall be transformed into a low-frequency current that will affect the receiving apparatus. Hence it will be seen that the process at the receiving end is exactly the reverse of the process at the transmitting end.

Throughout the journey the distinctive, or characteristic wave-form of the sound which is broadcast is maintained; and, therefore, the listener-in receives an exact reproduction of the words which were spoken or sung, or of the notes which were played, in the studio at the station from which the transmission was made.

Obviously the degree of audibility is dependent upon the power of the receiving apparatus to rectify and to amplify the tiny currents set up in the aerial. This explains the limited range of a small apparatus, such as a crystal set; while valve sets can receive from greater distances, in ratio to their power, which is determined by the number of the valves employed.

Broadcasting Still in its Infancy

IT will, however, probably surprise many people to learn that it is a very simple matter to construct at home a thoroughly efficient receiving set. Indeed, it may be stated that the very simplicity of the apparatus, and the ease with which it can be constructed—contingencies which were not foreseen at the outset—was one of the principal causes of the early difficulties in the administration of wireless matters.

In conclusion, it is only necessary to repeat that broadcasting is still in its infancy. Amazingly rapid progress has

The Story of Broadcasting

been made since it became a possibility, and many very notable developments have taken place. But only a very bold, or a very unwise, prophet would venture to predict all the changes and the improvements which will be made in the near future. Some of them, however, may be indicated without the least hesitation.

In the first place, it is already evident that broadcasting is destined to play a very important part as a means of self-improvement. Its educational value has been realised; and already it is quite clear that it is a method of acquiring knowledge which will rob the period of learning of many of its old terrors.

A New Era in Communication

THERE is no country place which is so remote that it cannot be reached by the broadcaster; and this significant fact simply means that all the advantages of the town can be brought into the remotest and the humblest home in the land, for receiving sets will be so inexpensive that they will be within the reach of everybody.

Before long it is probable that the restrictions which at present hamper broadcasting will be removed. For example, when the restrictions as regards the hours during which broadcasting is permissible are removed, a continuous broadcasting service throughout the twenty-four hours will be possible. Some people may regard this as a rather terrifying prospect, but they need not feel uneasy. Unrestricted liberty, as regards times, will simply mean that many more interests can be served, and that fuller use will be made of this wonderful discovery, which marks the beginning of a new era in the history of communication.

Already simultaneous broadcasting is being done regularly. A news bulletin from London is being sent out to all the provincial stations every night, and there it is relayed for the benefit of listeners-in who are too far away to be able to receive from London direct. Few people yet realize what the development of simultaneous

broadcasting will mean. Very briefly it may be explained that close inter-relationship will be established between all parts of the country; and this means that anything of interest which is taking place in any part of the country can be broadcast from the nearest station to all the other stations. And as it will be relayed at each of the receiving stations, every listener-in can hear whatever is taking place in any remote district.

There is now installed in the London station a complete system of inter-communication, by means of which London can speak to all, or to any, of the provincial stations; and by the same system each of the provincial stations can speak to any of the others, or to all of them.

This development is of special interest to the owners of small sets. In future, when simultaneous broadcasting becomes general, there will be very few places so far from a station as to be beyond the receiving range of the humble crystal set.

One other development for which it will not be necessary to wait long may be cited. Probably the day is not far distant when several programmes will be simultaneously broadcast from the big stations. This can quite easily be done by increasing the number of studios, and by employing a different wave-length for the transmission of each programme; and when several programmes are being transmitted simultaneously, instead of only one, it will be much easier to provide fare that will suit the tastes of all listeners.

The Beginning of the Wireless Age

THESE are just a few of the developments which are imminent. Greater and more far-reaching changes are not far off; but about these even the most daring will hardly venture to speculate. Enough has been said, however, to show that the birth of broadcasting, the youngest and most remarkable member of the wonderful wireless family, marks the beginning of what will be known to history as the wireless age.

Mr. Palmer's simple and non-technical account of the principles and processes of concert broadcasting is supplemented in later pages of our Encyclopedia by articles of greater technical detail, which will be found under such headings as Broadcasting; Transmission, etc. Separate entries are also devoted to particular Broadcasting Stations describing and illustrating their apparatus and methods

Simple Arrangements for Wireless Mechanics

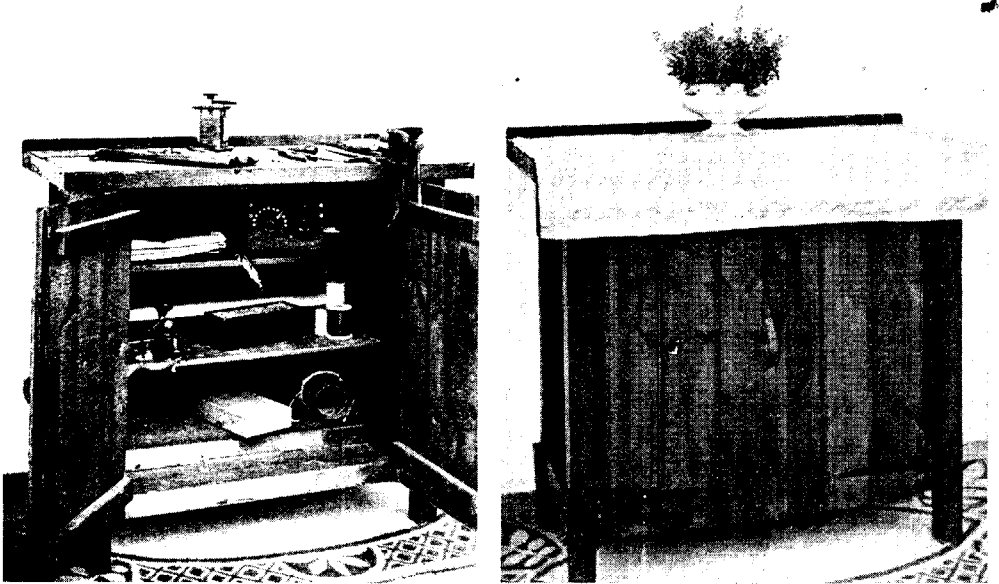

The small cupboard with folding doors seen in these photographs gives the wireless mechanic opportunities for work without disturbing domestic arrangements. When work is over tools and apparatus are stored away in a very few minutes, as seen on the right



One of the fascinating features of amateur wireless work is that a great deal of the simpler mechanical tasks of constructing and assembling sets, where soldering is not required, can be done on a table in the corner of any living room

Mechanics for Wireless Amateurs

by EDWARD W. HOBBS, A.I.N.A.

Vickers Gold Medallist, Author of many
Technical and Practical Handbooks

Outlining briefly the workshop equipment required by the wireless experimenter who wishes to make all or most of his own apparatus, our contributor also shows that much can be done with the simplest appliances in the ordinary home

THE wireless experimenter gathers all the world's news from the silent spaces of the ether, listens to the songs of the world's most famous artistes, and perchance hears the heartrending dot dot dot, dash dash dash, dot dot dot, of the S.O.S.

Borne on the invisible waves of the ether, that message calls for aid, and it is never sent in vain. By means of the invisible bond that we know as wireless, aid is found for the afflicted, and pleasure for the joyous. All these "messages" may be intercepted by apparatus that is essentially simple, constructed in many cases in the home and without the use of elaborate tools.

The simple crystal set that can be made by anyone is quite effective within a range of 15 to 20 miles of a broadcasting station, and there is no necessity for an amplifier or a valve. The only parts that need be purchased are the telephones and the crystal, and even the former can be constructed by anyone fortunate enough to possess an efficient workshop and the requisite skill and patience for the work.

A Hobby for Youth and Age

THE equipment of a wireless workshop can be supplied from the contents of the ordinary household tool-chest, as with the aid of little more than a screwdriver, pliers, and hammer, any of the commercial components now available in great profusion can be built up on the dining table. The work requires very little exertion, and so may form a most fascinating hobby for the middle-aged. The more advanced sets are not beyond the skill of a lad of twelve or so.

When more serious constructive work is to be undertaken it is highly desirable to make a start with a certain number of tools, and also to have, or acquire, the necessary dexterity in their use, in which connexion this Encyclopedia will be of

the greatest aid, as it tells just how to do the hundred and one little jobs that are different from the ordinary run of work undertaken in the home.

Not that the work in itself is different, for, after all, a chisel is a chisel and is used in the same way, no matter if the wood it cuts is intended for the cabinet of a wireless set or for the frame of a window. The important point is that this Encyclopedia explains the functioning of all the wireless parts and how they can be made by the inexperienced, and by the expert worker in another industry, who may be fully capable of excellent handcraft, but is otherwise at a loss how to apply that knowledge and ability to the construction of wireless parts, and is thus practically on a level with the amateur.

Starting With a Simple Set

FOR the amateur who is near to a broadcasting station it is quite the best plan to start with the making of a simple crystal set. The work is simple, and the results are sufficiently good to arouse the desire to hear and do more, with the inevitable result that interest, once awakened to the fascination of listening-in, stimulates latent powers of construction and the amateur feels compelled to have a three or four valve set, and to make up the principal parts.

This will call for such tools as the ordinary pliers, a pair of round-nose pliers, hammers, screwdriver, and so forth, such as are found in every well-ordered home. In addition, some means of soldering is essential. Probably the simplest arrangement is the ordinary copper soldering bit, although more convenient tools for the amateur worker are the self-heating gas soldering irons, which are connected by a flexible tube to a convenient point in the gas service pipes. Another soldering iron is made to be electrically heated and plugs into the ordinary electric light lamp

Mechanics for Wireless Amateurs

holder. When neither of these conveniences is available, a small iron can be used which is heated by a petrol or methylated spirit burner forming a part of the iron itself.

A medium-sized hand drill and a set of bits to use with it, some files, and a good firm bench; together with a small but strong bench vice, a hack saw, a few wood-working tools, and some small spanners for tightening up nuts, should enable almost anyone to make up a very satisfactory set. Numerous little devices can be made by the amateur to facilitate the winding of coils and the carrying out of the various other constructive processes, and these are fully dealt with in this Encyclopedia.

Amateurs of limited leisure and those who may be unable to devote a separate room to the pursuit of their hobby should provide themselves with a small work bench with folding doors on the front, so that when the work is over for the evening, the doors can be closed, and all the tools and the work stored away beneath the bench. From the illustration of this arrangement it will be seen that, when closed up, the top covered with a neat cloth, and decorated with a bowl of flowers, there is nothing to suggest that constructive work has been carried on, although it is but the work of a few minutes to move these and set the vice up on the bench and proceed with the work.

The Ideal Wireless Equipment

WHEN it is desired to go in for the construction of a complete transmitting and receiving set, a more elaborate workshop is needed, and, practically speaking, the equipment should commence with a turning lathe. This is undoubtedly the most useful and adaptable of all tools, and as patterns ranging in price from a few shillings upwards are available there is no reason for being without this very adaptable tool.

An ideal equipment would comprise a large lathe about 6 in. centres, a smaller one about $3\frac{1}{2}$ in. centres, shaping or milling machine, vertical drilling machine, a good strong bench, and gas-heated forge with separate blowpipe for brazing and soldering, together with such miscellaneous small tools as precision measuring instruments, files, drills, and the like. Such a

workshop should be well lighted, preferably from the north, have a good solid floor, and be well equipped with cupboards and shelves for the storage of parts, work in progress, and so forth. In addition, a grindstone, or bench grinder and oil stone, for sharpening the tools, should be included.

Knowledge Gained of Many Materials

WIRELESS work is not by any means confined to the use of one or two materials, but calls for knowledge of many, most of them with different physical properties. For example, some parts are made of the hardest steel, such as a permanent magnet; others require the use of a special grade of soft annealed iron, this being used for the construction of such pieces of apparatus as the cores of a spark coil or the flat plates from which the coils of the transformer are made. Brass is used extensively, and has to be patterned and shaped in many ways. Aluminium is another metal which has often to be handled.

A great deal of work is done with ebonite and various compositions made by a vulcanising process, and this calls for a different shape of turning tool, and for treatment different from the processes followed in the machining of metals. Such special compositions as Bakelite, Micarta, and the various forms of impregnated compound papers have to be sawn to shape, machined and polished, drilled, engraved, and so on, according to the purpose for which they are used.

Right Methods Mean Good Results

TO those unfamiliar with it, ebonite appears to be a most objectionable material; it is easily split and scratched, and by no means so easy to work as brass. But when the physical properties are appreciated the material loses its forbidding character, and it appears in its true light as a valuable product that assists in the success of the wireless set. The subject has particularly detailed attention in the pages of this Encyclopedia, and when the correct tools are used in the right way the results are entirely satisfactory.

There is a considerable group of materials that may be classed under the

general heading of ebonite, but they vary considerably in the mode of handling. For instance, good ebonite is a hard and durable material, close in grain and even of texture; but some of the so-called substitutes are almost spongy and differ a good deal in composition. As a general rule, however, they are all cut with a saw, can be turned in an ordinary type of amateur lathe, and finished with a file.

Accuracy and Care, But Simple Tools

THE differences in working are more a matter of the correct shape of the cutting edge and the speed of turning and drilling than of special equipment. The commonest operation on ebonite is in the construction of a panel or baseboard for the set, and this is, as a rule, a matter of cutting the sheet to the correct size and, after it is so far prepared, of drilling holes for the passage of the screws and bolts for the attachment of the various fittings.

The first step is to mark out accurately the panel, and to do this calls for care and some knowledge of the right way to set to work. There are two principal ways of marking out a panel. By one method a previously drawn or printed sheet of paper is attached to the face of the panel, and the holes are drilled accordingly, or a centre line is drawn and all measurements are taken from it in one direction, and another centre line at right angles to the first is used as the starting point for the other set of lines.

By always measuring from a centre nothing but carelessness will prevent a successful result. The use of good measuring instruments is therefore necessary at the start, but fortunately the ordinary engineer's steel rule will suffice, together with a good quality pair of dividers and a centre punch.

Where a Pencil Line Gives Trouble

AS an example of the little differences that crop up in wireless work, in the ordinary way a panel could be marked out with a pencil, but in wireless work the pencil line would set up a small leakage of high-tension current; and in the case of a valve set this would cause a certain amount of noise to be heard in the telephones, the sound being occasioned by the passage of the very small current

over the traces of the pencil lines on the face of the panel. The reason is, briefly, that blacklead is composed to some extent of graphite or a form of carbon, and this is a conductor of electricity; hence it is necessary to refrain from using a pencil on ebonite in any place where a current could possibly leak.

Wood work enters largely into the construction of many parts of the average amateur installation. The work may commence with the aerial mast, which is largely made of wood. Such things as a baseboard or a container for the set are frequently made of the harder woods, such as mahogany, teak, or oak. There is, however, no reason why any intelligent person should not make a thoroughly satisfactory wireless receiving set, although to make and mount the set in a case calls for a knowledge of cabinet-making and some command over ordinary wood-working tools, as well as the finishing processes, such as staining, polishing, and varnishing.

Anyone Can Make a Wireless Set

FURTHERMORE, a great deal of work calls for the handling of comparatively thin copper wire, some varieties of which are plain, others coated with enamel, and in other cases covered with an insulating material, such as cotton or silk. These are coiled in various ways on different-shaped tubes or blocks, known as formers.

Finally, there is the assembly of the work, which comprises the collecting together of components often made of all these materials and their wiring, which is in some cases quite intricate and calls for the exhibition of considerable skill, as well as the exercise of ability with the soldering iron.

Fortunately, it is possible to receive broadcast concerts with quite simple apparatus, as well as by elaborate sets, and the construction of wireless parts can therefore be modified to meet constructive ability, or may be limited by financial considerations. It is, however, possible for anyone to make up at least the major portion of the apparatus and enjoy the benefits of broadcasting.

Of the mental qualities that are especially valuable in the pursuit of wireless

Mechanics for Wireless Amateurs

construction, common-sense and patience are probably the most essential. To wind a large and elaborate bank-wound coil properly will tax the patience, and so will such a thing as making up a multi-way switch and connecting it up in some inaccessible position. Common-sense is highly desirable in the attempt to follow written descriptions of construction of apparatus, for it is impossible for the author to anticipate the difficulties of every reader.

Mechanical aptitude is an intangible quality, but one that is very real in those who possess it. It simply means that, somehow or other, they are able to accomplish, with the aid of odds and ends of material, assisted often with nothing but the simplest of tools, the turning out of an elaborate piece of apparatus; and also entice a refractory appliance to function in a satisfactory and effective manner.

In design work, knowledge of mathematics is almost essential. Many of the calculations in wireless work are extremely intricate, and based upon theoretical considerations that necessitate the use

of higher mathematics. When the set has been finished it has to be tuned, and for fine tuning, especially with multi-circuit sets and regenerative receivers, a quickness of perception is highly desirable. At the best of times, when tuning a new instrument to an unknown wave-length, it is only by the little changes in the sound on the telephones, a few words from a song, or the dots and dashes of Morse which may only be heard for a moment, that the waves and their significance can be appreciated and adjustments made accordingly. Similarly, with a simple crystal set, to get the best results a quickness of perception is desirable.

From whatever point of view the subject be approached, it is obvious that the greater the mechanical ability and theoretical knowledge possessed by the experimenter, the more likely will be the success of the apparatus constructed. On the other hand, absence of such knowledge need not deter the amateur from following one of the most fascinating hobbies known to exist at the present time.



LIGHT AND AIRY WORKSHOP FOR THE AMATEUR WIRELESS MECHANIC

In a well but simply constructed workshop of this kind the advanced amateur can carry out all kinds of work. It includes a treadle lathe for turning, coil winding and other tasks, a good bench and ample storage and shelf room

Radio Wonders of the Future

by N. W. McLACHLAN, D.Sc., M.I.E.E.

Research Engineer to the Marconi Company and author of many technical papers on wireless subjects

In this valuable and authoritative chapter our contributor sets forth clearly and dispassionately what Radio has accomplished and what it may reasonably be expected to accomplish. While warning his readers against the fallacies of random scientific prophecy, he sets out a vision of the future sufficiently striking to appeal to the most dormant imagination

AT a time like the present, when scientific activities are paramount in every walk of life, it would appear a comparatively simple matter to predict the future of radio telegraphy and telephony. This, however, is by no means the case. Witness, for example, the lightning strides that have been made in British broadcasting during the past ten months. To have predicted this extraordinary scientific activity in, say, 1910, would have been pure guesswork; for the thermionic valve as we know it to-day, and to which we are indebted for the rapid progress of radio, had not matured. Moreover, the lines of development of the art may be radically altered either by some epoch-making discovery, or by the same cause that gave birth to many war-time inventions—*necessity*.

Factors in Successful Invention

IN the application of a natural phenomenon to commercial or other purposes, one of the dominating factors is finance. But, assuming that the desired result can be achieved, there are other factors which have to be taken into account. One of these factors is simplicity—that is, the easy manipulation of a device. Although the performance of certain operations can be accomplished by automatic appliances, the apparatus may be so bulky, so apt to get out of order, and so complex in action, that the complete assemblage constitutes a potential nuisance.

The substitution of an automatic machine for human control must be viewed from a utilitarian standpoint. It is easy to suggest uses for radio which in the light of current scientific knowledge are frankly absurd, but which may be rendered feasible at some future date by an important discovery. For example, there is the direct transmission of power by radio over large distances. Considering the enormous attenuation attendant upon present-day

methods of propagation, the problem is surely beyond the bounds of immediate possibility.

Again, consider the multifarious duties of the crew of a modern Atlantic liner, and imagine that their duties are conducted entirely by radio. The complexity of the controlling mechanisms, both on the boat and on shore, would be stupendous and truly fantastic, if at all practicable. For instance, it is almost impossible to imagine apparatus for automatically performing the complete round of culinary duties on the boat.

Perhaps it will be well to indicate the fallacious side of random scientific prophecy. Could the future be accurately foretold, surely there would be an end to the necessity for discovery. And, therefore, our great scientific goal, namely, to solve the riddle of the universe, would be, on this hypothesis, gained. But the absurdity of this is too patent for comment, and we shall therefore have to be content with a picture of the immediate possibilities of radio as based on hypotheses which can be formulated from existing knowledge and commercial conditions.

World-Wide Spread of Radio

DURING the post-war period, radio work has been taken up by all kinds and conditions of the populace of various countries. This is a good sign, for the propagation of scientific knowledge is one of the fundamental assets of higher civilization. A race of people which understands the why and wherefore of the apparently commonplace occurrences of life is one which is likely to be more stable and of greater cosmopolitan value than one steeped merely in the annals of the ancients.

The general trend of modern science has been to accelerate the various operations of life in all its ramifications. The railway provides a more rapid mode of transport than the stage coach, and the aeroplane far

Radio Wonders of the Future

exceeds the former in considerations of speed. The ordinary line telegraph and telephone have brought distant places into speedy communication, whereas formerly messages were days old when delivered at their destination. Thus we may say that modern appliances annihilate distance and time. We are able, therefore, to carry out more business and deal with a greater number of the affairs of life with less physical effort than before.

When an epoch-making discovery is announced, it is usually acclaimed enthusiastically, and rash prophecies are made concerning the wonderful part it is destined to play in the immediate future. Sometimes these prophecies are well fulfilled; at other times the fulfilment is delayed for many years. In 1873 Clerk Maxwell showed from mathematical computations based on observed physical phenomena that radio was possible. In 1886 Hertz carried out radio communication in his laboratory. But it was not until 1896, 23 years after Clerk Maxwell, that Senatore Marconi effected the first experiments in practical radio; and it was not until 1901 that he first obtained signals across the Atlantic.

New Principles in Practice

WHERE the commercial application of a new principle is involved, it is necessary to bear in mind that in general a large amount of experimental work has to be conducted before the apparatus finally appears in practical form. The employment of the novel principle is likely to be speedier if there is no alternative means of obtaining the same result. In cases where another method is already in existence, the new principle must be considerably superior, so that its introduction will ensure financial success. As a case in point, communication between Britain and America was conducted solely by cables before the era of long-distance radio.

Dealing now with concrete cases, to-day we pick up our telephone receiver, ask for a certain number in the same city, and are almost immediately in conversation with the other party. Figuratively speaking, the telephone has brought both parties to the same room, so far as pure conversation is concerned.

Then there are the long overhead and

underground lines, by means of which we are enabled to converse with other people at a considerable distance. In the future we might expect that by merely asking for Moscow or Bombay our call would come through after a short wait. Here we would have a combination of wire and radio telephony. The latter might be conducted in relay stages where very long distances are covered. Thus people in the remote corners of the earth would be brought virtually to our doors.

When We Can See to New York

THE next link in the chain of events is not merely to converse over thousands of miles, but also to see what is taking place at the other end. This involves the problem of television. At the moment of writing, television has not been accomplished. Whether it is commercially possible with the natural phenomena, manufacturing processes, and materials of construction at our disposal, time alone will show. It may be that some radically new piece of apparatus is required, which bears a similar relation to television that the thermionic valve does to present-day radio. Once television and long-distance radio telephony have been accomplished, one could safely say that, so far as conversation and vision were involved, distance had vanished and was merely a mythical reminiscence.

Radio Control from a Distance

IN recent years an extensive amount of experimental work has been directed to securing reliable remote control by radio. It is obvious to anyone who has followed modern scientific progress that the tendency has always been to introduce automatic appliances. The fewer the number of mechanical operations which are conducted by human beings, the more economical and precise do these operations become. For example, the automatic electric signalling on the Underground Railways gives economy in labour and safety in transport. Moreover, there are many instances where man-controlled devices could conveniently be operated by distant or remote control using radio. There are battle aeroplanes and seaplanes and various types of warship, and with weapons of this type the control would be

Radio Wonders of the Future

effected by an officer under cover, and the number of men required would be reduced.

Wireless in Warfare

IN fact, it is not beyond the bounds of possibility that later scientific developments on the lines of distant control may lead to types of fighting units totally different from those in vogue at present. Warfare would then be less costly in men's lives, because the more mechanical bellicose operations become, the less the loss of life. Although war would still be a struggle for supremacy, its weapons would be almost entirely of an inanimate nature, while their actions would be governed purely by the invisible waves of radio. With a satisfactory system of television, combined with remote control, one may speculate on the battles of the future being controlled from a central station hundreds, or perhaps thousands of miles away, just as a battleship is controlled from the turret.

Increasing Communication at Sea

RADIO telegraphic apparatus on ships above 1,600 tons is now compulsory, and the day is not far distant when passenger boats may have their own radio telephone service. In this respect, of course, one must not overlook the great possibilities of jamming, since there are a restricted number of wave-lengths on which such communication can be comfortably conducted. Progress in radio work on board ship will continue. Use is being made of directional methods of reception, and soon we may expect a number of the larger vessels to be equipped with their own automatic transmitting and receiving apparatus. In fact, several are equipped thus to-day.

This means that instead of handling messages at a hand speed of about twenty words per minute, everything will be done automatically at speeds from 60 to 100 words per minute, and with special directional appliances it will be possible for a ship crossing the Atlantic to be in direct communication with either one side or the other.

Since the Great War devices have been invented for use at sea in case of emergency. Some of these actually responded only to the signals S O S sent in the Morse code, but the marking and spacing had to

be regular and more clearly defined than one would expect from an operator sending a message from a boat in distress. In actual practice all ships would have to be fitted with standard receiving apparatus which, in the absence of an operator, was set to ring an alarm bell on the receipt of a distress signal.

Turning to another aspect of the subject : it is known that an aerial situated under the ground or under the sea is capable of receiving radio signals. Thus it would be feasible to hold communication with entombed miners. The difficulty would be for the miners to reply, because there is the possibility of their transmitting apparatus being put out of action when an accident occurs.

Wireless Sets in the Pocket

IT is with great hesitation that we predict the time when each individual will possess his own pocket wireless set. This is almost precluded in the present state of the radio art owing to the enormous amount of jamming which would occur, since with a given range of wave-lengths, say, 10 to 50 metres, only a limited number of sets can work in any particular locality. But who knows what the future will furnish to obviate the jamming troubles of the present ?

In bygone days, when the propagation of radiation over the surface of the globe was very imperfectly understood, it was the general opinion that since electric waves travelled practically in straight lines, the signal strength at a station 3,000 miles distant from the transmitter would, owing to the curvature of the earth, be extremely weak and inaudible. But Senatore Marconi disproved this fallacy, and we now know that, owing to the action of an electrically conducting layer in the upper atmosphere, the radiation is compelled to follow the curvature of the earth, although it does so in a peculiar manner.

Thus signals which, in the absence of this wonderful electrical reflecting ceiling, would be aurally insignificant are augmented manifold. In face of the auxiliary arms of Nature, we can neither sagely predict nor preclude the possibility of communication with another planet, should it prove to be inhabited by intelligent beings.

Radio Wonders of the Future

To every listener-in—especially those at some distance from the transmitter—the existence of a perturbed electrical state of the atmosphere, particularly during thunder weather, is patent. The nasty bangs and clicks in the telephone headpieces or loud speaker, which periodically wipe out a spoken word or a musical phrase, are the bugbear of the radio engineer. In Great Britain these disturbances are usually termed “atmospherics.”

A large number of observations upon the number, type, and direction of these electrical discharges have been made by the meteorological office of the Air Ministry during the past few years, and this work is being continued. Such observations will eventually be of great assistance in the prediction of weather, and already it has been possible to correlate them with rain and thunderstorms.

Using Natural Radio Energy

ATTEMPTS have been made to adapt this natural radio energy—which, we may remark, is generally evinced on very long wave-lengths—to the use of mankind. A collecting device in the form of a specially designed balloon is sent aloft, and the energy collected is conveyed by cable to a station on the ground.

It is the strength of the atmospheric disturbances which necessitates large power output from a transmitting station. In the absence of such disturbances the power required for trans-Atlantic communication could be reduced enormously. This would enable the speed of transmission to be augmented, and the rate per word to be reduced very appreciably. If energy were radiated in one direction only when transmitting from one station to another, instead of being sent to all corners of the earth, the energy input, in spite of atmospherics, would be a fraction of that used in present-day long-distance, long-wave transmission, say from Europe to America.

Moreover, apart from improvements in transmitters and receivers which could be effected by better materials of construction, e.g. very high conductivity metal, directional transmission prevents the jamming of stations other than those in the path of the radio beam. This problem is being studied in great detail by the

Marconi Company. By merely revolving a special form of reflector, a radio beam is sent out just as a beam of light is emitted by a moving searchlight. The radiation from these two sources is similar, and merely differs in wave-length.

The Wireless Beam

THIS apparatus is used at Inchkeith, and by means of a special signalling arrangement any vessel within a prescribed radius can, if fitted with an appropriate receiver, ascertain her bearing rapidly and accurately by the simple process of listening to the signal code, irrespective of the nature of the weather. In this apparatus we have a potential safeguard for life, and it will doubtless replace the ordinary lighthouse, which is of little use in foggy weather.

Every radio amateur or expert knows the great nuisance of anode and filament batteries for running valves. The latter are especially troublesome. Much research work has been done on what is known as the thoriated filament, that is to say the ordinary tungsten filament coated with a special substance known as thoria, which enables electrons to be emitted very much more freely. The filament current required for such valves is only a fraction of that required for ordinary tungsten. Future research may endow us with special valves which require little or no filament current.

High Power Valves

THE development of large power valves, capable of dealing individually with 25 kilowatts of high-frequency power and upwards, is making rapid progress. By connecting a number of these valves in parallel, the power obtained may reach hundreds of kilowatts. The anode of such a valve is either of steel or copper. It forms the upper part of the envelope, the lower end being completed by glass, into which are sealed the other electrodes. The anode is placed in a water tank for cooling purposes.

One might expect eventually to obtain a valve whose vitals can easily be replaced *in situ* in the case of a burnt-out filament. Power valves will soon be used on an extensive scale for the generation of hundreds of kilowatts for the large trans-oceanic stations of the Imperial Chain.

HARMSWORTH'S WIRELESS ENCYCLOPEDIA

For Amateur & Experimenter

A BATTERY. Alternative name for the low-tension battery used for heating the filament of a thermionic valve. It usually consists of a 4 to 6 volt storage battery or accumulator. The A battery circuit should include a rheostat or variable resistance, by means of which the current to the filament may be changed, so causing variations in the temperature of the filament and a consequent increase or decrease in the flow of electrons to the anode or plate. Although a 4 to 6 volt accumulator is used for most valves, certain types of valve require a considerably lower voltage. With the dull-burning filament of the Mullard type L.F. Ora valve a single dry cell of about 1.4 volts is sufficient for heating the filament, the electrons being given off at a lower temperature than with ordinary valves.

Fig 2 shows the practical arrangement of the A battery circuit for heating the filament, one wire running from the accumulator to the resistance coil of the rheostat and the other direct to the filament. A third wire connects the filament with the contact arm of the rheostat. Fig. 1 shows the same arrangement in the form of the usual theoretical diagram.

See Accumulator; Amplifier; B Battery; Filament; Valve.

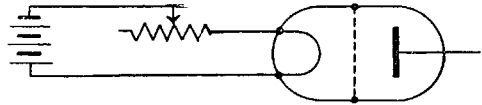

**A BATTERY.
THEORETICAL WIRING DIAGRAM**

Fig. 1. Showing connexions for the low-tension battery used for heating the filament of the ordinary detecting or amplifying valve

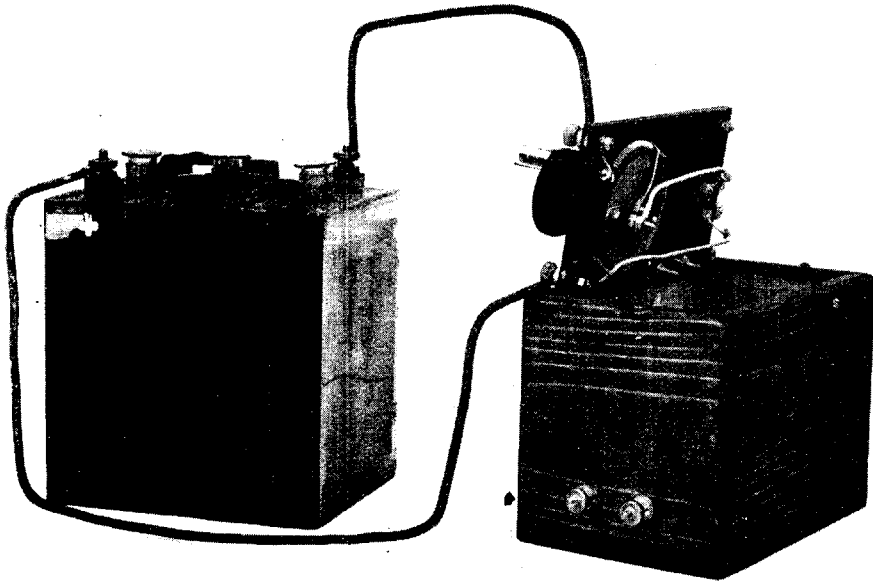

A BATTERY : CONNEXIONS TO THE ACCUMULATOR AND VALVE

Fig. 2. From the positive terminal of the accumulator connexion is made through a terminal on the panel (seen raised) to the filament of the valve. The return circuit is through a rheostat, or variable resistance, regulating the current in the filament and therefore its temperature

ABBREVIATIONS AND SYMBOLS USED IN WIRELESS

The Standard Contractions and Signs Explained and Illustrated

Here, conveniently placed for reference at the beginning of our Encyclopedia, are given complete lists and tables of the abbreviations and pictorial signs generally used in wireless work. The use of these contractions and symbols is adhered to throughout the Encyclopedia. See also Call Signs; Morse Code

In the following pages are given the chief abbreviations and symbols used in wireless telegraphy and telephony, and in all electrical and other related subjects. The symbols, which represent the various pieces of apparatus which go to make up any wireless set, should be studied carefully and memorised, since they are necessary to understand the numerous circuit diagrams which appear throughout the Encyclopedia.

This also applies to the abbreviations, which are in common use in most standard books. A separate explanation is also given of every abbreviation, and the symbols are all repeated under their appropriate headings.

For those experimenters who wish to be familiar with Morse and wireless telegraphic communication generally, a complete table of abbreviations used in Amateur and Commercial radio telegraphic transmission is added.

Electrical and Chemical Abbreviations.

ABBREVIATION.	MEANING.
A.C. . . .	Alternating current.
A.F. . . .	Audio frequency.
Ag	Argentum. Latin name for silver.
A.G. . . .	American wire gauge.
Al	Aluminium.
A.T.C. . .	Aerial tuning condenser.
A.T.I. . .	Aerial tuning inductance.
Au	Aurum. Latin name for gold.
Ba	Barium.
B.C. . . .	Bayonet cap.
B.E.M.F. .	Back electromotive force.
B.H.P. . .	Brake horse-power.
Bi	Bismuth.
B.O.T. . .	Board of Trade Unit.
B.S.W.G. .	Birmingham standard wire gauge.
C.	Capacity (in formulae).
C	Carbon.
Ca	Calcium.
C.C. . . .	Cubic centimetre.
C.G.S. . .	Centimetre, gramme, second.
Cl	Chlorine.
Co	Cobalt.
Cs	Caesium.
Cu	Cuprum. Latin name for copper.
C.W. . . .	Continuous waves.
D.C. . . .	Direct current.
D.C.C. . .	Double cotton covered.
D.F. . . .	Direction finder.
D.S.C. . .	Double silk covered.
E.	E.M.F. (in formulae).
E.M.F. . .	Electromotive force.
E.S.C. . .	Edison screw cap.
E.S.U. . .	Electrostatic units.
Fe	Ferrum. Latin name for iron.
F.P.S. . .	Foot, pound, second.
H	Hydrogen.
H.F. . . .	High frequency.
H.F.C. . .	High frequency current.
Hg	Hydrargyrum. Latin for mercury.
H.P. . . .	Horse-power.
H.T. . . .	High tension.
Hy	Henry, unit of inductance.
I	Iodine.
I.C.W. . .	Interrupted continuous waves.
I.E.C. . .	International Electrotechnical Commission.
I.H.P. . .	Indicated horse-power.
I.P. . . .	In primary.
I.R.E. . .	Institute of Radio Engineers.
I.R.V.B. .	India-rubber, vulcanised, braided.
I.S. . . .	In secondary.
L.	Inductance (in formulae).
λ	Wave-length.
L.F. . . .	Low frequency.
L.F.C. . .	Low frequency current.
L.F.I.C.I. .	Low frequency iron core inductance.
Li	Lithium.
L.T. . . .	Low tension.
M.	Metre.
M.A. . . .	Milliamperes.
M.E.S. . .	Miniature electric screw.
Mfd. . . .	Microfarad.
Mg	Magnesium.
MHO. . . .	Unit of conductivity.
Mhy. . . .	Microhenry.
M.M.F. . .	Magneto motive force.
Mn	Manganese.
N	Nitrogen.
Na	Sodium. Latin name for sodium.
Ni	Nickel.
O	Oxygen.
O.P. . . .	Out primary.
O.S. . . .	Out secondary.
P.	Phosphorus.
Pb	Lead.
P.D. . . .	Potential difference.
Pt	Platinum.
R	Electrical resistance.
R.F. . . .	Radio frequency.
R.C. . . .	Reaction coupling.
R.M.S. . .	Root mean square.
R.P.M. . .	Revolutions per minute.
R.P.S. . .	Revolutions per second.
R.T. . . .	Radio telephony.
Sb	Antimony.
S.B.C. . .	Small bayonet cap.
S.C. . . .	Silk covered.
Se	Selenium.
S.G. . . .	Specific gravity.
S.H.M. . .	Simple harmonic motion.
Si	Silicon.
S.I.C. . .	Specific inductance capacity.
Sn	Tin.
S.R. . . .	Specific resistance.
S.S.C. . .	Single silk covered.
S.W.G. . .	Standard wire gauge.

ABBREVIATION. QUESTION. ANSWER.

Q R D Where are you I am bound for . . .

Q R F Where are you com- I am coming from bound?

Q R G To what company I belong to . . . or line of naviga- tion do you belong?

Q R H What is your wave-length is length? My wave-length is metres.

Q R J How many words I have words

How are you re- I am receiving well. How are you receiving? ceiving?

Q R L Are you receiving I am receiving badly. Shall I transmit so times so so times? Transmit so times badly?

Q R M Are your apparatus? I am disturbed. Are the atmospher-ics very strong? I am disturbed.

Q R N Shall I increase my power? Increase your power. Shall I decrease my power? Decrease your power.

Q R P Shall I transmit faster? Transmit faster. Shall I transmit more slowly. Transmit more slowly. Shall I stop trans- mitting? Stop transmitting.

Q R T Shall I stop trans- mitting? I have nothing to transmit.

Q R V Are you ready? I am ready. All is in order. I am busy with an- other station (or not interrupt). Wait. I will call you when I want you). at . . . o'clock (or Your turn is No. Your turn is my turn? Are my signals are weak? Your signals are weak?

Q S A Are my signals strong? Your signals are strong.

Q S B Is my tone bad? The tone is bad. Is my spark bad? The spark is bad.

Q S C Is the spacing bad? The spacing is bad.

Q S D Let us compare watches. My time is What is your time? Are the radiotele-grams to be trans- mitted alternately or in series?

Q S G Transmission will be in series of five radiotelegrams. Transmission will be in series of ten radiotelegrams. What is the charge to collect for The last radiotele-gram is cancelled. Please give a re- ceipt?

Q S I Have you got the gram cancelled? The last radiotele-gram is cancelled.

Q R A What is the name of your station? This station is

Q R B How far are you from my station? The distance be- tween our stations is nautical miles. What are your true bearings? My true bearings are degrees.

Q R C What are your true bearings? My true bearings are degrees.

Q R A What is the name of your station? This station is

Q R B Do you wish to communicate with my station by means of the Inter-national Signal Code? I wish to commu- nicate with your sta- tion by means of the Inter-national Sig- nal Code.

Q R C What are your true bearings? My true bearings are degrees.

Q R D Where are you I am bound for . . .

ABBREVIATION. QUESTION. ANSWER.

L Length

A Flux density, electrostatic

H Capacity

P Dielectric constant

C Energy

W Work

E Efficiency

T Temperature (Cent)

M Mutual inductance

X Reactance

Z Impedance

S Frequency

F Phase displacement

Φ Electromotive force

E Current

R Resistance

H Intensity of magnetic field

I Intensity of magnetic field

G Conductance

J Quantity of electricity

Q Susceptibility

V Volt-ampere

W Watt-hour

A Volt-ohm

O or **Ω** Volt-ampere

C Ampere-hour

Ah Milliampere

mA Kiloampere

kVA Kiloampere

F Kilovolt-ampere

kVA Kiloampere

W Kilowatt

H Kilowatt-hour

kWh Henry

H Farad

F Joule

J Coulomb

C Ohm

Ω Volt

V Ampere

A Permeability

μ Susceptibility

K Permeability

K for kilo, **M** for mega or micr, **μ** for micro or micr, in general radiotelegraph transmissions. **k** for kilo, **M** for mega or meg, and **μ** for microhenry.

Radiolegraph Abbreviations. The following are the abbreviations to be used in general radiotelegraph transmissions.

ABBREVIATION. QUESTION. ANSWER.

(C) Q Inquiry signal employed by a station not necessarily needing reply.

(IR) Signal announcing the sending of indi- cations concerning a ship station.

(S) Signal indicating that a station is about to send with high power.

(P) Do you wish to communicate with my station by means of the Inter-national Signal Code? I wish to commu- nicate with your sta- tion by means of the Inter-national Sig- nal Code.

(T) What is the name of your station? This station is

(B) How far are you from my station? The distance be- tween our stations is nautical miles. What are your true bearings? My true bearings are degrees.

(C) What are your true bearings? My true bearings are degrees.

(A) What is the name of your station? This station is

Electrotechnical Symbols. The following are the abbreviations or symbols used in electricity and magnetism as set forth by the International Electrotechnical Commission.

Ta Tantalum.

W/L Wave-length.

W/T Wireless telegraphy.

X's Atmospheres.

ABBREVIATION.	QUESTION.	ANSWER.
Q S M	What is your true course?	My true course is... degrees.
Q S N	Are you communicating with land?	I am not communicating with land.
Q S O	Are you in communication with another station (or with)?	I am in communication with (through the medium of).
Q S P	Shall I signal to that you are calling him?	Inform that I am calling him.
Q S Q	Am I being called by?	You are being called by
Q S R	Will you despatch the radiotelegram?	I will forward the radiotelegram.
Q S T	Have you received a general call?	General call to all stations.
Q S U	Please call me when you have finished (or at o'clock)	I will call you when I have finished.
Q S V	Is public correspondence engaged?	Public correspondence is engaged. Please do not interrupt.
Q S W	Must I increase the frequency of my spark?	Increase the frequency of your spark.

ABBREVIATION.	QUESTION.	ANSWER.
Q S X	Must I diminish the frequency of my spark?	Diminish the frequency of your spark.
Q S Y	Shall I transmit with a wave-length of metres?	Let us transfer to the wave-length of metres.
Q S Z	Transmit each word twice. I have difficulty in receiving your signals.
Q T A	Transmit each radiotelegram twice. I have difficulty in receiving your signals or.... Repeat the radiotelegram you have just sent. Reception doubtful.
Q T B	Number of words not agreed; I will repeat first letter of each word and first figure of each group.
Q T C	Have you anything to transmit?	I have something to transmit. I have one (or several) radiotelegrams for

In addition to these signals, which are uniform in construction, the signals given in the next column of the International Telegraph Code may be used.

- — — — — “Repeat” sign (as well as mark of interrogation).
- Understood.
- Wait.

STATION.

EXAMPLES OF ABBREVIATED MESSAGES

A QRA ? What is the name of your station?
 B QRA Campania This is the Campania.
 A QRG ? To what company or line do you belong?
 B QRG Cunard QRZ I belong to the Cunard Line. Your signals are weak.
 Station A then increases the power of its transmitter and sends:
 A QRK ? How are you receiving?
 B QRK I am receiving well.

Symbols. These are diagrams which are used in wireless to represent the various apparatus, as aerial, variometer, inductance coil, and so on. These symbols

are not yet fully standardized, and the ones given are those which are in most general use. Those illustrated have been adopted throughout the encyclopedia.

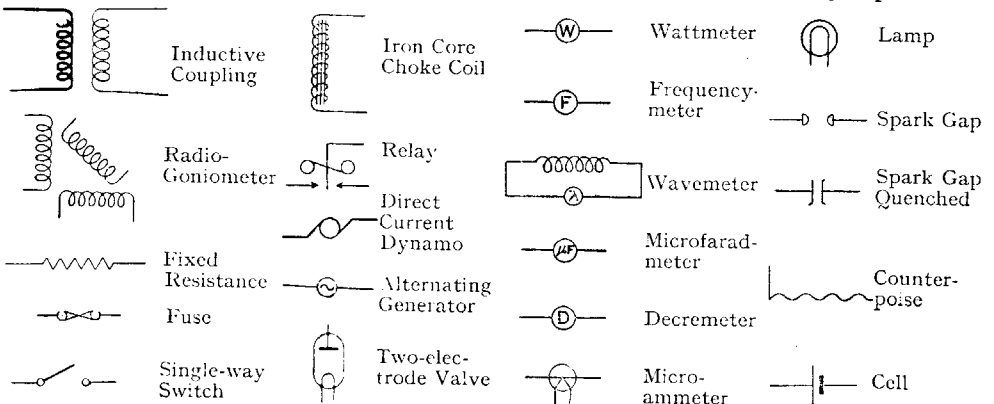

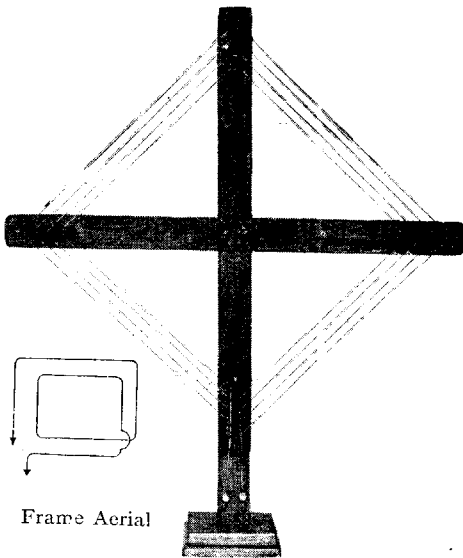

Frame Aerial

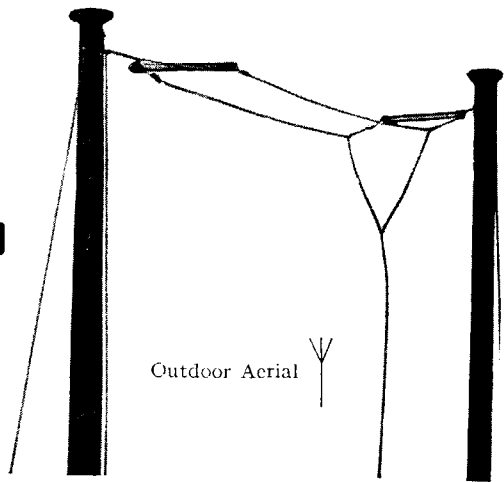
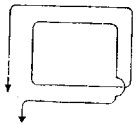

Outdoor Aerial

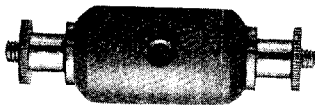

Lightning Arrester

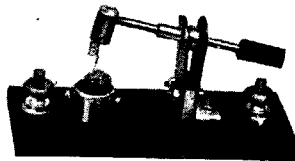
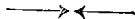

Crystal Detector



Three Electrode Valve

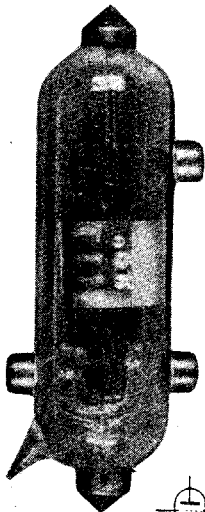

Four Electrode Valve

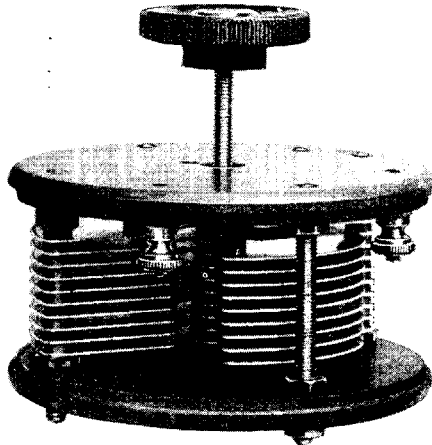

Variable Condenser

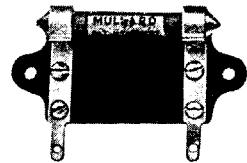

Grid Leak with Fixed Condenser



Fixed Condenser

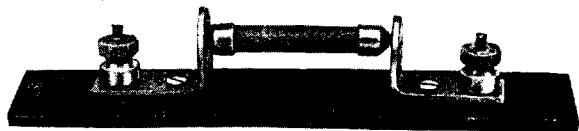
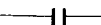

Fixed Grid Leak



ABBREVIATIONS AND SYMBOLS : STANDARD SIGNS WITH APPROPRIATE APPARATUS
Four-electrode valve by courtesy Marconi Wireless Telegraph Co., Ltd.

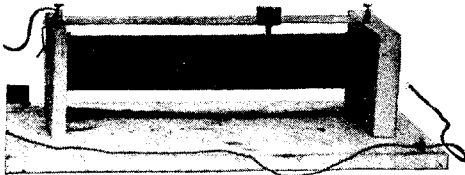

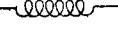
Variable inductance coil, single slider 

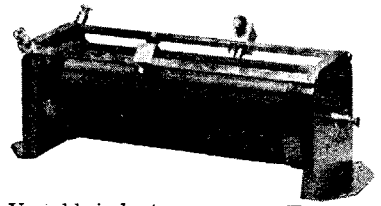

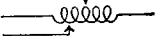
Variable inductance coil, double slider 

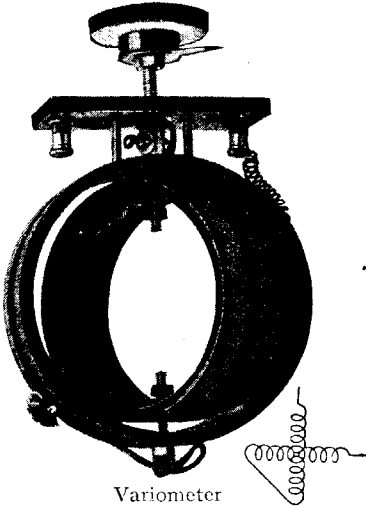

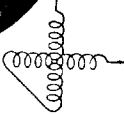
Variometer 

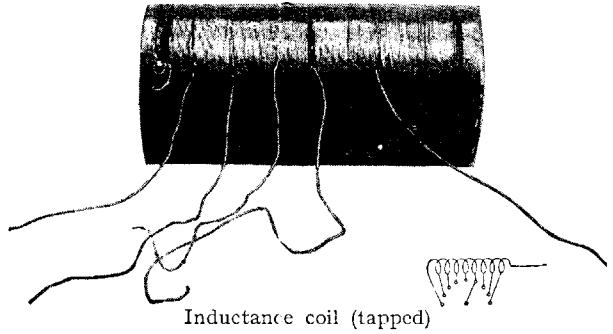

Inductance coil (tapped) 



Tuning inductance plug-in coils 

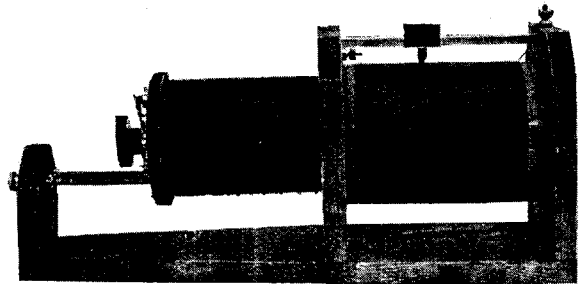

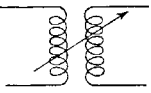
Loose coupler or variable coupled inductance 

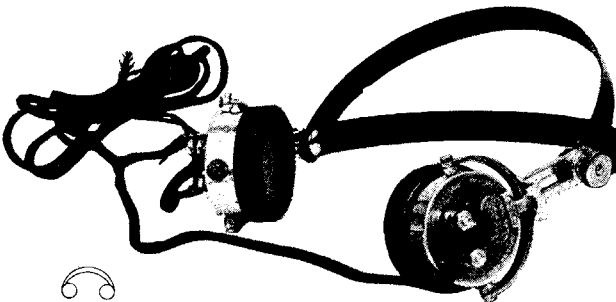

Telephones or headphones 

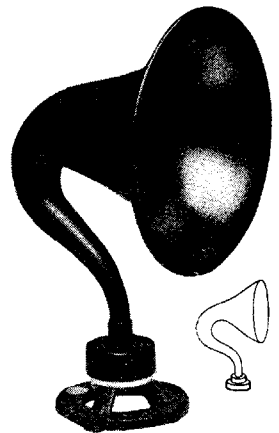

Loud speaker 

ABBREVIATIONS AND SYMBOLS: STANDARD SIGNS WITH APPROPRIATE APPARATUS

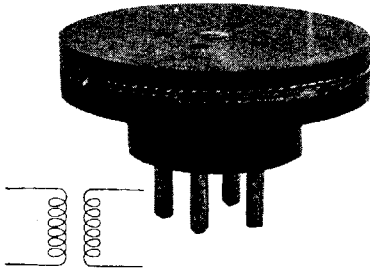

High-frequency transformer

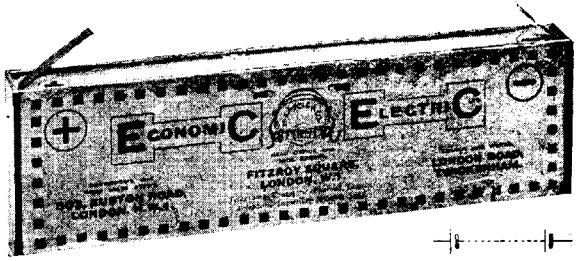

High-tension battery

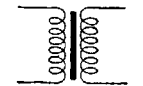

Iron core low-frequency transformer

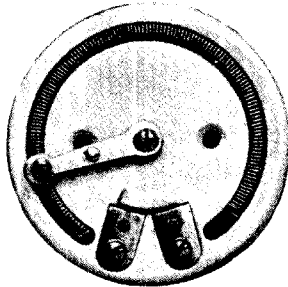

Variable resistance (rheostat). Symbol as for potentiometer, given below.

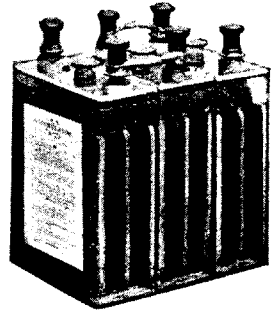

Low tension battery or accumulator

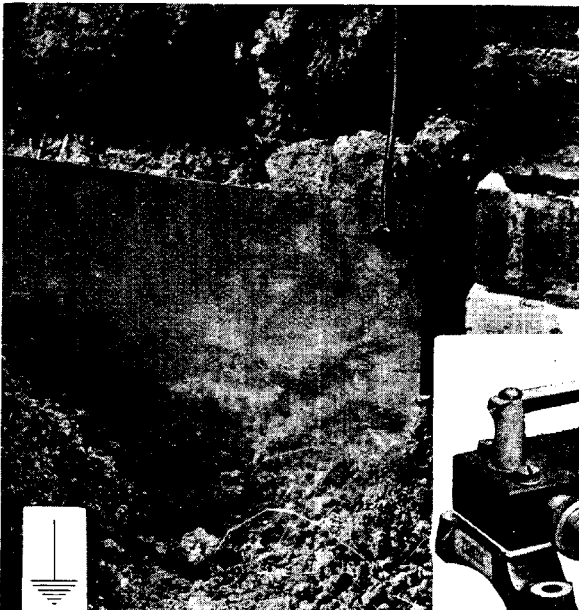

Earth



Buzzer

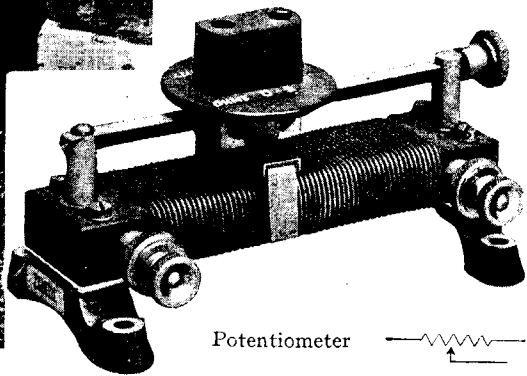
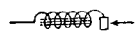

Potentiometer

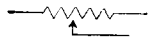

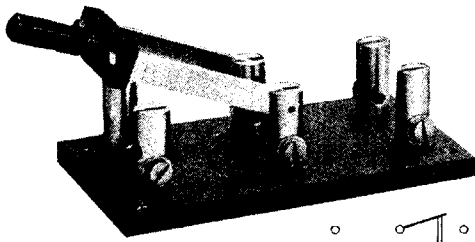

Double-Pole Two-Position Switch

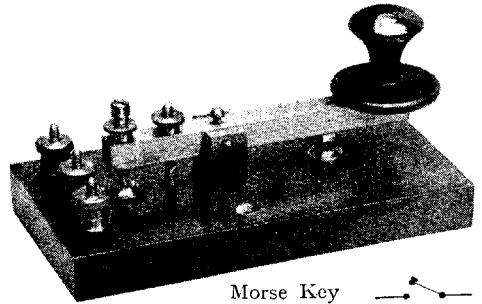
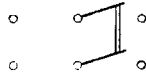

Morse Key

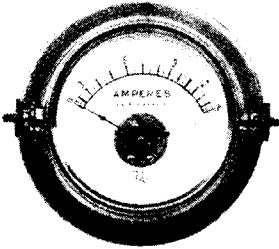

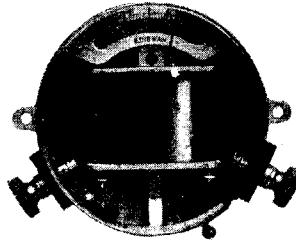

Ammeter

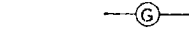

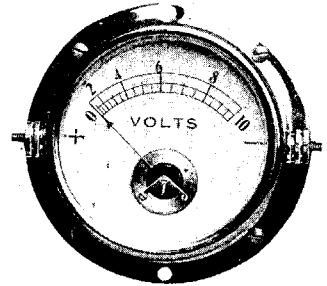

Galvanometer, cover removed

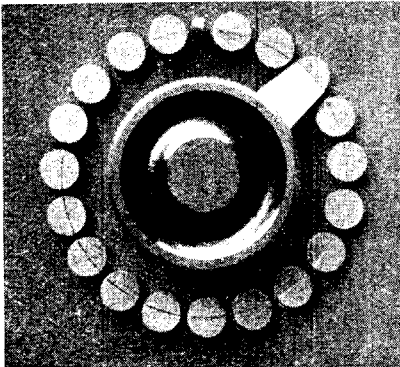



Voltmeter



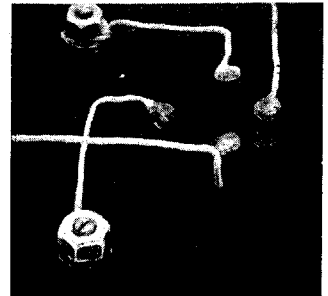

Multi-way Switch

Wires Crossing

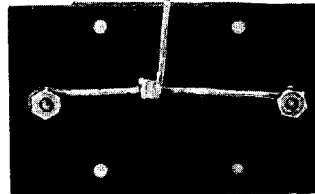

Wires Joined (below)



Microphone

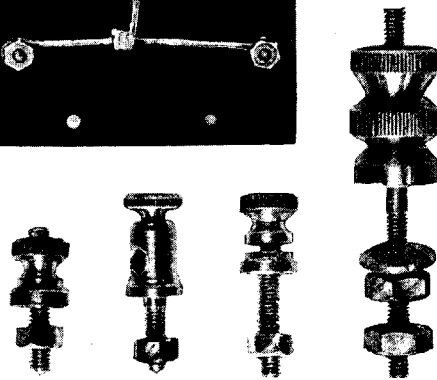
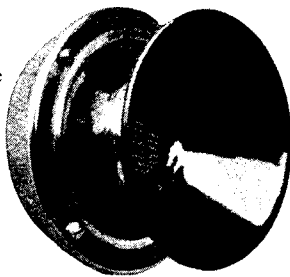

Terminals 

ABBREVIATIONS AND SYMBOLS : STANDARD SIGNS WITH APPROPRIATE APPARATUS

ABSCISSA. The distance of any point from the axis of ordinates. Usually the abscissa is measured in the direction of the x -axis in geometry, and the ordinates along the y -axis. In the diagram OX, OY are two axes at right angles, P any point in their plane, PN, PM, parallels to OX, OY respectively. Then PN is the abscissa of the point P, OX the x -axis and OY the y -axis of coordinates. In the construction of curves a series of points are plotted

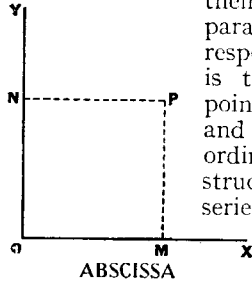

Method of plotting points as for constructing curves required in many wireless calculations

from known abscissae and ordinates and a curve drawn through them. See Curve; Ordinate.

ABSOLUTE UNITS. An absolute unit is one independent of any varying factor. Such units are derived from considerations of length, mass, and time only. In the C.G.S. or centimetre-gramme-second system of units the unit of force is called the dyne, and is that force which, acting for one second on a mass of one gramme, produces an acceleration of one centimetre per second per second. The dyne is an absolute unit.

The absolute unit of electric current is defined as that current which, flowing in a circular arc one centimetre long and of one centimetre radius, produces a magnetic field of unit strength at the centre of that arc. It is ten times as large as the practical unit, the ampere. It may also be defined by the mass of silver it can liberate per second when passed through a neutral solution of silver nitrate. Absolute units are scientific and in practice are replaced by such units as the ampere, ohm, volt and so on. All the units are separately defined and discussed in this work. See Units.

ABSORPTION. The reduction in amplitude of an ether wave due to causes other than the geometrical attenuation. It may also be said to be that portion of the total loss of radiated energy due to atmospheric conductivity.

ABSORPTION MODULATION. The production of speech-modulated waves of radio frequency involves in the first place a generator of undamped waves of radio-frequency upon which are superimposed other waves of audio-frequency. Such

waves can be caused by varying the current output of the generator by some speech-controlled device, in the form of a microphone inserted in the aerial circuit at the transmitting station, whose resistance will accurately follow the vibrations of the voice or other musical instrument.

In early experiments it was customary to make the microphone of a sufficiently low resistance to compare with that of the aerial, and in such cases the radio-frequency power output is shared between the aerial resistance and the microphone. This method is known as absorption modulation at audio-frequencies of the radio-frequency output. A better method of modulation is to insert the microphone in the direct current power supply of the transmitting system, so that the direct current input, and consequently the radio-frequency output, will be varied. All the radio output of the generator is thus available for transmission, and for a given range a smaller equipment can be used than in the earlier arrangement.

A. C. This is the standard abbreviation for Alternating Current (*q.v.*).

ACCELERATION. Rate of change of velocity, measured by the amount of increase in a given time. A decrease corresponds to a negative acceleration. If V_1, V_2 be the velocities of a body, t the time between the two instants at which they are measured, a the acceleration, then $a = (V_2 - V_1)/t$. If the acceleration is variable, the time t chosen is so small that the change in the acceleration during that time is inappreciable. See Velocity; Frequency.

ACCEPTOR CIRCUIT. Any circuit which comprises an inductance and capacity in series, which is in resonance with the frequency applied to it, is said to be an acceptor circuit for that frequency.

Since the frequency equals $\frac{1}{2\pi\sqrt{LC}}$, where L is the inductance in henries and C the capacity in farads, it follows that all circuits of the same LC value are acceptor circuits for the same frequency. Double the capacity and halve the inductance of a given circuit, for example, and it remains an acceptor circuit as before.

Two acceptor circuits may be joined in series. This does not alter the tuning of the circuit, but the ratio L/C is increased, though the LC of the whole circuit equals that of either acceptor circuit.

See Rejector Circuit.

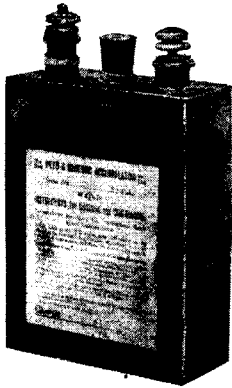

Fig. 1. A 2-volt cell with two positive plates and three negative, enclosed in a celluloid container

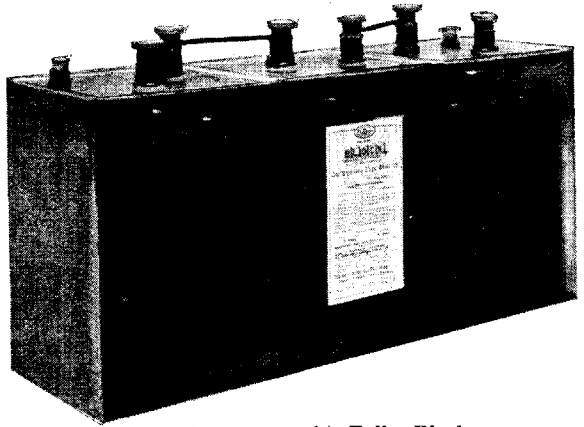

Fig. 4. The elements in this Fuller Block accumulator are composed of segmental blocks of active material separated by small gratings



Fig. 2. Two C.A.V. cells combined to form a 4-volt battery

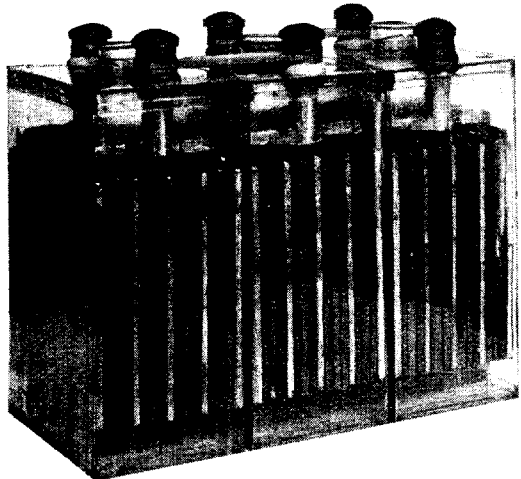

Fig. 5. Each cell in this 6-volt "Exide" accumulator has separate terminals



Fig. 3. This 6-volt accumulator has five plates per cell and capacity of 20 ampere-hours for filament heating

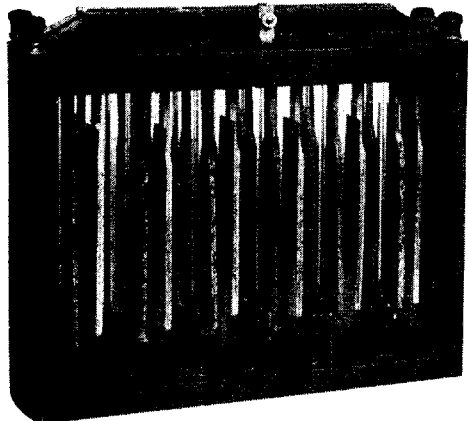

Fig. 6. An "Exide" 24-volt high-tension accumulator is shown with circular elements; each cell has a capacity of 2 volts

PORTABLE ACCUMULATORS SUITABLE FOR VARIOUS TYPES OF WIRELESS WORK

ACCUMULATORS : HOW TO CHOOSE, CHARGE AND REPAIR

By E. W. Hobbs, A.I.N.A., and A. H. Avery, A.M.I.E.E.

Beginning with a short account of the theory of accumulator action this article describes and illustrates all types of secondary cells, how to use and charge them from both direct and alternating current supplies, and how to preserve them from damage. It further describes simple practical methods of repair. See also A Battery ; Accumulator Charging Set ; Charging Board ; Low Tension Battery ; Sulphuric Acid, etc.

An accumulator (symbol $\text{---}||||||||\text{---}$) is an appliance used for the storage of electrical energy. Accumulators take the form of cells in which a chemical change is brought about by the passage of an electric current through them. The change is such that the cells are capable of giving back the electrical energy, and while doing so returning to their original chemical condition.

In the normal accumulator cell there are two metal plates, the anode or positive plate, and the cathode or negative plate, suspended in a liquid called the electrolyte. The two plates of the original Planté cell consisted of metallic lead and the electrolyte of dilute sulphuric acid. The plates were connected to a source of E.M.F., decomposing the electrolyte and oxidising the anode plate. The cell was then discharged and recharged, the process being continued a number of times to allow the oxidation of the anode to penetrate deeper each time and so increase the storage capacity of the accumulator. The substances which undergo these changes are known as the active material of the cell:

Theory of Accumulator Action

The exact nature of these chemical changes is not as yet fully understood, but the formation of lead sulphate appears to play an important part in the chemical actions and reactions.

In the charged state the conditions of affairs is represented chemically thus: $\text{PbO}_2 + 2\text{H}_2\text{SO}_4 + \text{Pb}$ for the positive plate, electrolyte and negative plate respectively. The charging current enters by the positive plate and leaves by the negative. The discharging current, however, leaves by the positive plate and returns by the negative. In the fully discharged state the chemical state can be expressed thus $\text{PbSO}_4 + 2\text{H}_2\text{O} + \text{PbSO}_4$, hence the active material (*g.v.*) on both plates is converted to lead sulphate. A simple test for the polarity of the ordinary type of accumulator such as is used in wireless work is that the positive plates are always brown in colour, while the negative plates are the familiar lead colour.

If the difference in potential of the two plates is tested with an instrument known as a voltmeter, it will be found that it is invariably in the neighbourhood of two volts, slightly over or under. The electrical pressure, therefore, to be obtained from any individual cell can only be considered as two volts. It may be a little more than this when the cell is fully charged, and somewhat less (1.85 volts) if the cell has been discharged to the practical limits of ordinary usage. The quantity of electrical energy that may be obtained from any accumulator in the form of a single cell depends, practically speaking, upon the surface area and number of plates, and in some instances upon individual variations in manufacture, and also upon the quality and purity of the materials used in their construction.

Capacity of a Lead Accumulator

The capacity of a lead accumulator as expressed in amper-hours depends primarily on the amount of active material in it. This takes the form of peroxide of lead, spongy lead, and the electrolyte. The arrangement and weight of the active material is another factor influencing capacity.

Faraday's laws of electro-chemical action state:

(1) The chemical action in a cell is proportional to the current that passes through it ;

(2) The weight of any material disengaged from an electrolyte solution may be expressed as

$$W = ZIt$$

where W = weight in grammes.

Z = electro-chemical equivalent.

t = time in seconds.

I = current flowing.

The chemical action appears to be greatest at or near the surface, and practice shows that with a low discharge rate, less weight of active material is needed than is the case when the discharge rate is high. Under these conditions a thick plate will be satisfactory, as the low discharge rate allows time for the fullest

chemical action from the diffusion of the electrolyte in the porous material.

When the discharge rate is high a greater number of thin plates are needed. The filament heating battery for a three or four valve set will therefore have to be of ample size to realise the benefits of a low discharge rate, and so get the full advantage from a thick plate.

The current density, or the number of amperes per square inch of plate surface, varies considerably. At a normal or 8-hour discharge rate a positive plate surface area of 2.5 to 3 square inches ought to be provided.

As an example:—A cell with five plates, three being negative and two positive, and all measuring 4×3 in., gives a positive plate surface area of $4 \times 3 \times 2 \times 2 = 48$ square inches, since both sides of the plates must be taken into account. It therefore has a capacity of about 16 ampere-hours at the 8-hour rate—that is, it will yield up 2 amperes per hour for 8 hours before the voltage drops to the lowest limit for safe working, that is 1.8 volts.

Small accumulators are often rated commercially at the ignition rate, that is, an intermittent discharge rate, which is generally double that of the actual, and in the foregoing example would rate as a 30 ampere-hour cell.

This is somewhat misleading for wireless work, as the discharge rate for heating a filament may be say .5 to 1.0 ampere and is a continuous discharge. The actual rate is therefore the one to work by and not the ignition rate.

Types of Commercial Cells. A typical commercial cell, suitable for wireless work, is illustrated in Fig. 1. This has two positive plates and three negative enclosed in a celluloid container or case. Each of the groups of plates are connected together at the top by a bridge piece made of lead, with an upstanding portion which projects out of the top of the case and finishes with a brass terminal and a knurled nut. In the centre of the top of the case is a celluloid tube about $\frac{3}{8}$ inch in diameter for introduction of the acid. This is closed by a rubber vent plug. Such a cell has an electro-motive force of about 2.2 volts, and has a capacity of about 20 ampere-hours (*q.v.*).

The plates, which are separated, or kept from coming into contact with each other, by sheets of perforated and corrugated celluloid, are kept from the bottom of the

cell by angle pieces of celluloid and also because the terminals are attached to the top of the case, so that the plates hang from it. In this type of lead-plate cell, the plates are generally of the pasted type. These are made with a cast lead framework or grating, having horizontal and vertical ribs, and between these are little projections of lead. The space between the ribs is then filled with soft lead paste, the projecting portion keeping it from falling out. The paste is composed of lead peroxide and sulphuric acid, and is subsequently allowed to harden.

The positive plates are thicker, as they have to withstand a greater chemical reaction than the negative ones, and are generally of the formed type. In this case, the plate is moulded in lead, with horizontal and vertical bars, and the spaces filled in with lead, the surface of which is often roughened to form pockets to assist in holding the lead peroxide which will be formed upon its surface. There is also another reason for such a construction, in that the surface area exposed to the electrolyte is very much greater than would be the case if the plate were perfectly smooth.

Forming the Plates

The process called forming the plates is carried out by the makers; it consists in repeatedly charging and discharging until the formation of lead peroxide upon the surface of the plate itself has been increased and the surface of the plate becomes more or less spongy in appearance. This process of forming is not entirely completed when the accumulator leaves the manufacturers, and it is for this reason that the first charge must be longer than the subsequent charges, and also that the capacity will gradually increase for a time, until the cell reaches its best working condition.

In wireless reception apparatus, the ordinary accumulator is generally in the form of a 4-volt (Fig. 2) or 6-volt (Fig. 3) battery. These are composed of merely two or three individual 2-volt cells assembled into one container or case, partitioned off to form separate receptacles, each with its own filling plug, and its terminals suitably connected together. The voltage given off by the battery is dependent upon the way in which the cells are connected together. If the positive terminal of the first is connected

to the negative of the second, and the positive of the second with the negative of the third cell, each of which gives off two volts, the result will be that the voltage on the first and last terminals will be six. Such an arrangement is shown in Fig. 3, and is known as connecting them in series.

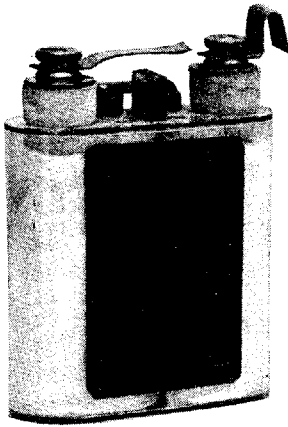

SMALL ACCUMULATOR

Fig. 8. Flashlight type, giving 4 volts

On the other hand, if the positive terminals are all connected together and the negatives connected together the voltage of the cell will only be two while the amperage will be trebled.

Usually an accumulator is bought with the required number of cells for the required voltage, each cell having sufficient plates to give the required amperage. All accumulators are not made in the same way, but the construction described is typical of those which will ordinarily be used by the wireless amateur. Other well-known types are the Fuller Block and the Exide, both of which are made on somewhat different lines, and for each of which special claims are made.

In the case of the Fuller Block type accumulator, Fig. 4, the electrodes are in the form of thin plates which are composed of segmented blocks of active material, separated by small gratings. The exterior of each positive block is wrapped in porous material. It is claimed that electrodes constructed in this manner are

free from the risk of injury owing to vibration, short circuits, or sulphating, and that they will hold their charge from 9 to 12 months or more without the electro-motive force falling below 2 volts. They have a capacity of about 20 ampere-hours. The cell is composed of two or more segments, is enclosed in a case, and provided with terminals more or less of the ordinary form.

The Exide accumulator, shown in Fig. 5, is a good type of low-tension battery with nine plates in each cell. Separate terminals are fitted to each cell so that taps or connexions can be made to any desired number of cells. This is a convenience when experimenting with valves of differing filament voltages, as, if required, a 4-volt and a 6-volt valve can be energized separately by using independent + leads.

Another type of Exide accumulator is made for high-tension purposes, and consists of a number of small circular elements, each with a capacity of 2 volts (Fig. 6). These are then put up into an openwork frame or case, and connected together to get the required voltage (Fig. 7). They have the power of retaining their charge for lengthy periods and are most convenient and economical for use on high-tension circuits, as they obviate the expense incurred in purchasing dry batteries,

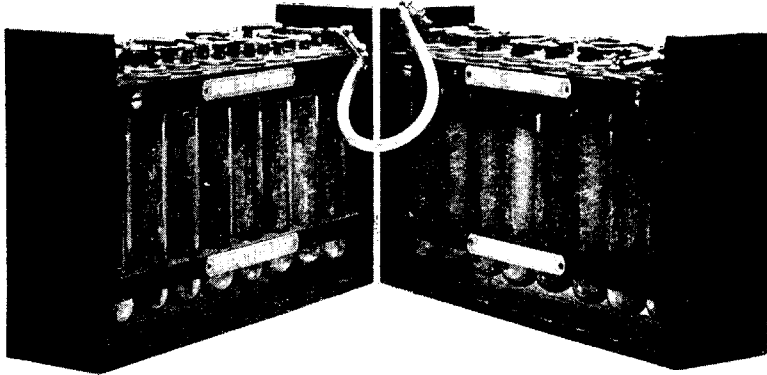

ACCUMULATOR FOR HIGH-TENSION CIRCUITS

Fig. 7. A set of Exide secondary cells cased and connected together to make a 60-volt high-tension battery

especially in those cases where convenience for recharging exists.

Small accumulators, equal in size to the familiar pocket flash-lamp type of dry battery, as in Fig. 8, are also available at low cost, and a battery of them can readily be constructed by obtaining a

sufficient number and connecting them together to get the desired voltage. They are usually packed with spun glass.

For supplying heavy current for filament lighting, a large accumulator should be chosen, and among these are those normally supplied for the starting batteries of a motor-car. Some of these are made with an ebonite case and the top filled in with pitch or some similar material. Others are made in lead-lined wooden boxes similarly enclosed at the top, and as they are of considerable weight are frequently provided with carrying handles. In the case of large installations, either for transmission or reception, a convenient type of cell is that known as the open top. These have glass containers, generally rectangular in shape, and open at the top. The plates are similar to those first described, and are separated partly by means of glass pieces at the bottom and partly by means of vertical bars of glass. Projecting ears or lugs formed on the plates and the terminal connexion pieces rest upon the edges of the glass container and support the plates, details varying with different makers' practice.

A common and convenient arrangement is to mount up a battery of these cells in a strong wooden framework, connecting the cells in series to give the maximum voltage called for (Fig. 9).

Choosing Accumulators. It is wise to purchase an accumulator larger than appears necessary. It is better practice to fit an accumulator of ample size than

one which has to be drawn on to its utmost limits of capacity. The former can be kept in perfect condition by numerous small charges, whereas the under-powered accumulator will always have to be re-charged to its full capacity and with great frequency. So far as the types of accumulator are concerned, for household use, intended for broadcast reception, or the general run of experimental apparatus, any of the reputable makes of portable or enclosed accumulator, with a celluloid case or those with a hard rubber or wooden case, should be suitable. For single-valve sets, a 4 or 6 volt accumulator with a minimum capacity of 30 ampere-hours is needed, and will run a set for about a week under normal conditions. A two-valve set should have an amperage capacity of at least 60 hours, and a three-valve set at least 100 hours. For use with a power amplifier, this allowance should be increased. For example, a two-valve power amplifier should have an accumulator with a capacity of 100 ampere-hours, the voltage varying according to the type of valve used.

A high-tension accumulator for broadcast reception work can be of quite small capacity as regards the ampere hours rating. Its voltage may vary from 15 to 100 or more, according to the design and type of apparatus in use. For transmitting apparatus it may vary from 8 or 10 ampere-hours to 750 or more, and this will have to be determined by the range of the station and the work which will be brought upon the battery.

Accumulator Charging.

Accumulator charging can be carried out in a variety of ways, according to the nature of the source of supply. Whatever the origin of the supply current may be, it always falls into one or other of two classes — direct or alternating current. As direct current alone is serviceable for charging purposes, alternating currents have to be rectified before they can be used.

Accumulators can be charged from primary batteries if no better means is available, but it is a slow and expensive

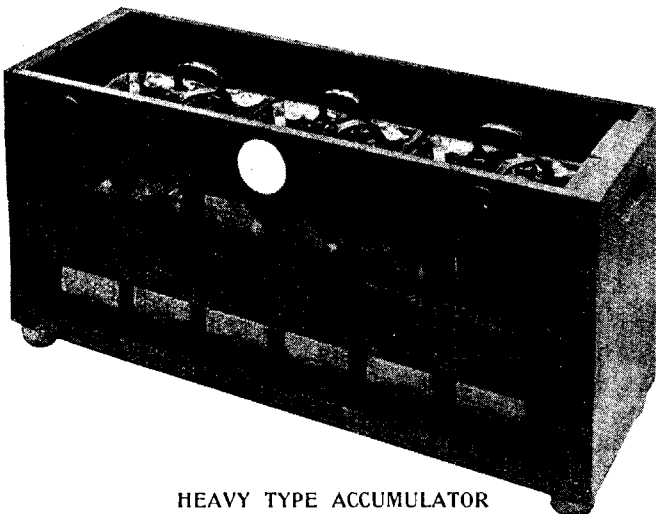

HEAVY TYPE ACCUMULATOR

Fig. 9. Storage battery in closed glass cells, mounted in strong wooden framework, for supplying heavy filament currents

process, as it is difficult to make a primary battery that will give a steady current for any length of time, owing to internal polarisation. The arrangement for charging is given in Fig. 10, the circuit including an ammeter and a small series variable resistance to regulate the charging rate.

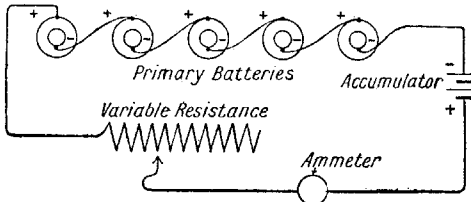

CHARGING FROM PRIMARY BATTERIES

Fig. 10. Method of arranging the circuit, showing the connexions of the batteries and the ammeter

Charging from a direct-current dynamo is shown in Fig. 11. The dynamo must give about 25 per cent higher voltage than the battery, the exact charging rate being adjusted by variable resistance in the shunt-field circuit. Series-wound or compound-wound dynamos must not be used for charging purposes, owing to their liability to reversal of polarity, and it is essential

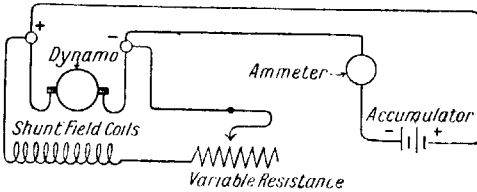

STANDARD METHOD OF CHARGING

Fig. 11. A shunt-wound dynamo, which obviates the risk of polarity reversing, is used with a resistance in the shunt field to regulate charging

always that the positive pole of the charging source should be connected to the positive terminal of the battery on charge; to reverse the poles of an accumulator when charging is highly injurious.

When direct-current public supply is available it is the most economical method of charging, but cells must never be connected to the mains without a suitable resistance in circuit to limit the current to the correct amount. Either a wire resistance or a lamp resistance can be employed, as indicated in Fig. 12.

The wire resistance must be of such a gauge that it will carry the normal charging current without overheating and yet possess sufficient resistance in ohms to prevent more than the correct amount of current passing. When lamps are used

they are wired up in parallel, and are of the same voltage as the mains, the charging rate in amperes being governed by the candle-power and number of lamps used.

Accumulator charging from alternating current sources necessitates the supply being converted to direct current. The mechanical rectifier effects this conversion by causing a permanent magnet situated in an alternating magnetic field to oscillate in step with the frequency of the current reversals, and at the same time to make connexion alternately with terminals connected with the positive and negative ends of the battery. It is, in fact, an automatic oscillating two-way switch (Fig. 13).

The motor-generator method of rectifying consists of employing an alternating-current motor coupled to a direct-current

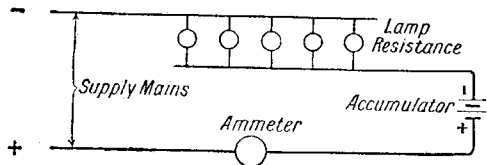

CHARGING FROM DIRECT CURRENT SUPPLY

Fig. 12. The most economical method provided suitable resistance is employed

generator, the former wound to suit the supply circuit, the latter wound suitably for the accumulators on charge. Control of the charging rate is made as in Fig. 11.

In these diagrams the symbol for the accumulator on charge is reversed. The + and - signs represent the terminals of the accumulator, and the polarity of the plates is shown reversed since the charging current flows in at the positive terminal during the charging process and out at the negative, whereas when the accumulator is discharging, the current leaves by the positive terminal. Charging is only possible when the charging voltage is higher than that of the accumulator.

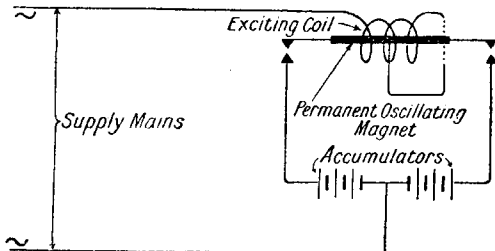

CHARGING BY ALTERNATING CURRENT

Fig. 13. A mechanical rectifier converts the alternating current to direct current. Resistance control of the charging rate will also be required

Commutating rectifiers consist of a synchronous alternating current motor driving a rotary commutator which changes the circuit connexions to the battery at the same instant the current wave reverses, maintaining the correct charging polarity.

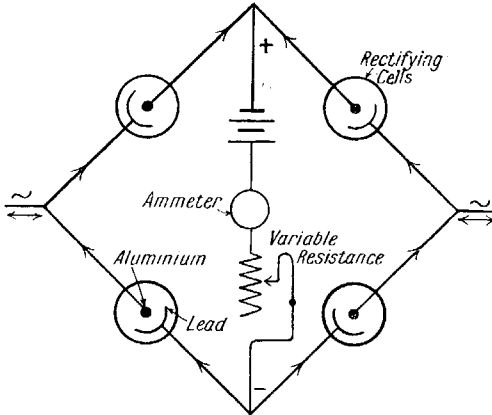

CHEMICAL RECTIFIER FOR CHARGING

Fig. 14. The Noden valve method, showing the four cells coupled. The arrows indicate the direction of the current, the A.C. supply being seen at the right and left terminals, and rectified D.C. charging current at top and bottom

Chemical rectifiers depend upon the property which certain metals in solutions of various chemicals possess of only allowing current to pass in one direction. In the form known as the Noden valve aluminium is used for one pole of the rectifier and pure lead for the other, both being immersed in a saturated neutral solution of ammonium phosphate. The usual arrangement of rectifier contains

four cells, coupled as in Fig. 14. At one of the alternating terminals there are two paths open to the current, one highly obstructive and one otherwise, consequently current passes by the route offering least resistance. A moment after the conditions are reversed and current passes by the other path, but in either case arrives at the accumulator terminals with the same polarity.

The mercury arc rectifier consists of an exhausted glass bulb, Fig. 15, with carbon electrodes sealed in, and a small quantity of mercury in the base. On starting an arc by tilting the bulb the latter becomes

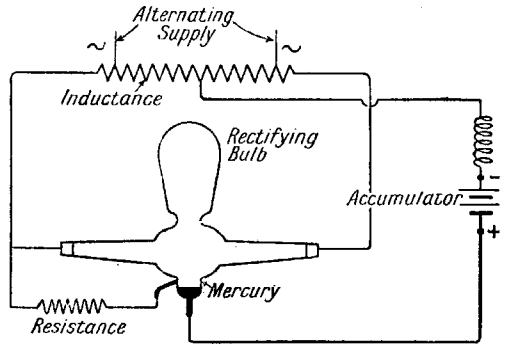

CHARGING WITH MERCURY ARC RECTIFIER

Fig. 15. Showing position of the inductance coil, which furnishes the negative charging terminal and is connected direct across the alternating mains. The mercury vapour bulb acts as a rectifier, and is connected to the positive terminal

filled with mercury vapour, which has the property of allowing current to pass in one direction only. The inductance coil shown in the diagram is connected direct across the alternating mains and furnishes the

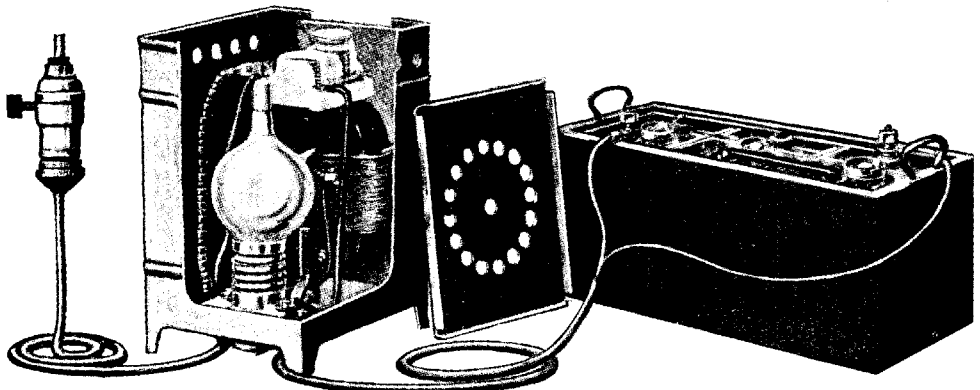

TUNGAR RECTIFYING OUTFIT FOR CHARGING WITH ALTERNATING CURRENT

Fig. 16. A bulb filled with argon gas contains a low-voltage tungsten filament and a graphite electrode. A transformer and reactance are also included in the circuit, which operates in a manner similar to the action of the ordinary thermionic detecting valve

negative terminal for the charging circuit, the alternating current waves being deviated alternately right and left to the carbon electrodes in the bulb.

The Tungar rectifier, Fig. 16, operates in the same way as the thermionic valve used in wireless signalling, and is simply a check valve which permits current to flow in one direction only. It contains a rectifying bulb filled with argon gas, a transformer, and a reactance. In addition to the low-voltage tungsten filament in the bulb (the cathode), there is also a graphite electrode (the anode), and when the filament is heated a discharge of electrons takes place between these two; the gas provides the valve action, and current can only flow from anode to cathode, hence there is no danger of batteries becoming discharged if the supply current is interrupted.

As an example of the actual charging process, take the case of charging a battery from the house electric lighting supply when the latter is direct current, or has been appropriately rectified from an alternating current. The accumulator will probably be purchased in an empty state.

The first step is to fill it with accumulator acid of the correct density. The acid can be purchased through the firm supplying the accumulator, or the sulphuric acid can be bought from a chemist's shop. In this case get the best quality, with a known density of about 1.830. This should be diluted with distilled water. The solution should be prepared with great care in an earthenware vessel in the open air. The acid is added to the water very gradually and the density tested by means of a hydrometer. This instrument is calibrated and shows at a glance the exact density of the solution. The solution, when of the approximate density, should be left for a time to cool down, as the action of dilution is to raise the temperature of the mixture. It is advisable to wear

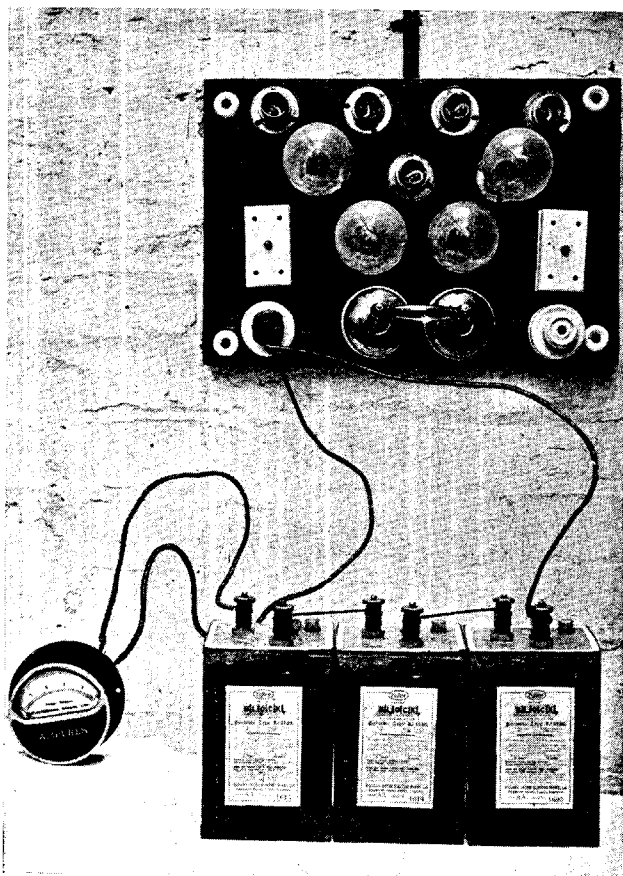

ACCUMULATOR CHARGING BOARD IN USE

Fig. 17. High candle-power lamps are used for the resistance in this standard arrangement, the number of lamps used being governed by the charging rate required. The double-pole switch breaks both circuits simultaneously. Current passes from lamps to plug shown by way of a fuse

rubber gloves and goggles, and to have the antidote, bicarbonate of soda, ready to hand in case of splashing the acid.

Everything being in readiness for the charging, the next step is to remove the filler plugs or stoppers from the top of the case, and, with the aid of an acid funnel, to introduce gently and gradually the solution into the cell, until the level is just above the top of the plates. All the cells are filled in like manner. Examine the level a little later to see that there has been no diminution due to the absorption in the plates. If necessary, add a little more to raise the level again. The exact specific gravity or density of the solution is indicated on the maker's instruction tablet attached to the case, and should be adhered to rigidly.

This tablet will state the charging rate and duration of the first charge. Suppose this to be 4 amperes for 8 hours. The next thing is to place sufficient electric lamps into the sockets on the charging board (*q.v.*), so that their combined current consumption in amperes is the same as that called for on the instruction tablet, in this case 4 amperes. The number of lamps required will be governed by the size of the lamps. The older-fashioned carbon filament lamps consumed something like $1\frac{1}{2}$ watts per candle power. This means that, say, a 30 c.p. lamp would consume nearly 40 watts. Dividing this by the voltage of the circuit gives the current consumption in amperes. For example, if the supply voltage be 100, the amperage of one lamp would be .4, or nearly half an ampere. Consequently nine of them would have to be inserted to consume the required amperes. It is more practical to use lamps of a higher candle power, say 60, as fewer are then needed. This has been done in the set illustrated in Fig. 17, which shows the lamps in position on a board.

The Charging Board Controls

The switch at the bottom controls the current and is a double pole, breaking the current through both circuits simultaneously. If this were not done and the batteries were left connected to the circuit, there would be a tendency for them to discharge through the lamps.

If carbon lamps are unobtainable, metal filament lamps can be used. These generally consume about 1 watt per candle power.

After the current has passed through the lamps its voltage is reduced, and it passes to a fuse and thence to a plug, from whence it passes to the battery terminals by flexible wires. The polarity of the circuit has to be determined, as by the use of pole-finding paper (*q.v.*), and the terminals on the plug marked accordingly. It is imperative that the + or positive sign be connected to the positive terminal on the battery. This terminal is always indicated by the plus sign, or by painting the terminal bright red.

The fuse wire used in the fuse box should not exceed $4\frac{1}{2}$ amp. in the present case, or not much over the maximum charging rate in any case. The next step is to grease the terminals slightly and connect the wires to their appropriate terminals.

Then remove the plugs or fillers and switch on the current. Once started, the current must not be switched off until the charge is complete. It is therefore preferable to start first thing in the morning, as this gives time to watch progress.

After a time the plates will begin to gas—that is show bubbles of gas on the surface, and the temperature may rise. In no case should this exceed about 105° F. Should it do so, reduce the charging current by removing one of the lamps or by introducing more resistance. After the first few hours the charging current should be reduced, and again reduced at a later time.

Testing the Charging Current

As a test an ammeter can be connected as shown in various illustrations, and its reading watched to see that the current consumption is appropriate. The voltage can be tested with a voltmeter, as in Fig. 18, while the charging current is switched off. When fully charged each cell should have a voltage of about 2.5, and the hydrometer (*q.v.*) reading should be correct. The positive plates ought to be a deep chocolate colour, and all of them should gas freely.

If more than one battery is to be charged, they can be connected in series—that is, the positive of one cell to the negative of the next, and so on—the end terminals being connected to the plus and minus signs of the plug-in wires respectively. Three four-volt batteries are shown connected in this way in Fig. 17.

The batteries should always be charged immediately after pouring in the acid, consequently do not put it into the battery unless it can go "on charge" at once.

Care of Accumulators. An important item in the practical use of an accumulator is to keep the outside of the case quite dry and free from any trace of acid, as it gives off fumes which are corrosive to many metals, it has a destructive effect on wood, and speedily ruins the clothing. The only antidote is to use soda, ammonia, or any similar alkaline substance. Consequently, if the batteries are to be used in the drawing-room, for example, it will be a good plan to put them into a properly made metal or wooden case, with a hinged lid, or otherwise encased so that their presence is not objectionable. Whatever the form of the case, ventilation is essential, as the accumulator gives off gas which must be dissipated.

Sometimes the terminal ends or nuts show a tendency to stick to the terminals, due to the formation of sulphate upon them. To prevent this, a good plan is to grease the terminals and the nuts with a trace of ordinary vaseline. Accumulators should always be stored in a cool place, and should not be exposed to the direct heat from a fire or lamp, and lighted matches should not be brought near them, especially if a celluloid container is used, as if they catch fire, they will burn with astonishing rapidity.

Their condition should be watched by observing the plates, if these are directly visible, because the colour of the positive plate turns from a deep chocolate brown, indicative of the fully charged plate, to a light colour, showing that the battery is practically discharged, which means that it should be recharged immediately.

The electrolyte should always cover the top of the plates, and as it is gradually evaporated it should be made up by the addition of a little distilled water. It is a great mistake to use ordinary water, as the impurities in it may cause a chemical action detrimental to the accumulator. When distilled water is not available, a substitute may be found in clean, filtered water.

When the plates are not visible, as is the case when they are enclosed in an ebonite or other similar form of container, their condition is tested with a voltmeter, ammeter, and hygrometer.

Other important items in the use of accumulators are to see that they are properly charged, not repeatedly overcharged, operated at too high a temperature, or left standing discharged. The connexion between terminals and contact wires must be sound, for which a regular pattern terminal is recommended. Bad connexions sometimes lead to peculiar noises in the telephones, and, in any case, it is merely increasing the resistance of the circuit and is a loss of energy. Further, the contact surfaces should always be

clean and the connexion made by means of a tag or metal fitting on the end of the contact wire. A very slight trace of vaseline will not affect, materially, the electrical value of the connexion, but it must not be used in excess.

The condition of the electrolyte is a matter of greatest importance. It is necessary that it be kept to the correct specific gravity, 1.200, generally known

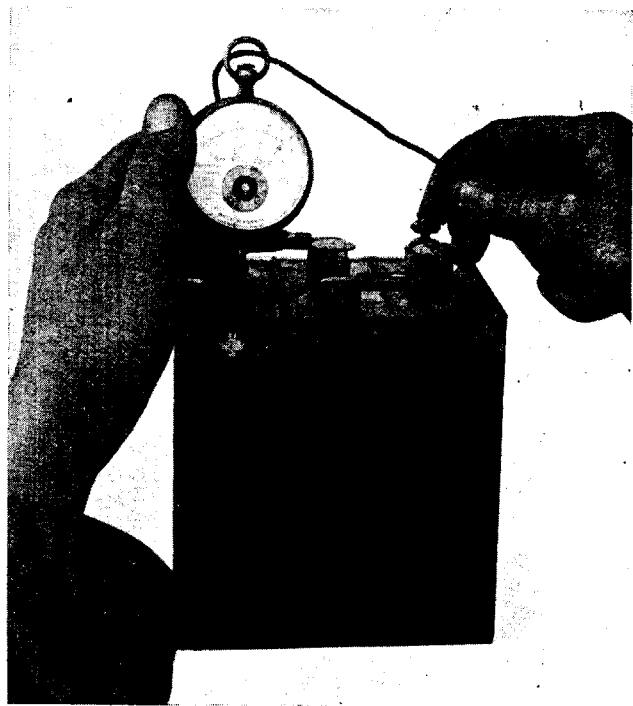

ACCUMULATOR VOLTAGE TEST

Fig. 18. A voltmeter in use with the charging current switched off. A maximum voltage of 2.5 should be shown for one cell. The six volts shown on the instrument in the photograph indicate the total of three cells not fully charged

as density. An important item is that the sulphuric acid used should be made from pure sulphur and diluted to the desired extent by distilled water—usually 1 part of commercial 1.835 acid to $4\frac{1}{2}$ parts by volume of distilled water. The acid should be added very carefully, as great heat is produced, and only a small quantity of the acid should be added at a time. The solution should be allowed to cool before being placed in the accumulator. The impurities contained in the sulphuric acid must be extremely limited, otherwise the value of the cell will be considerably diminished.

Accumulator Troubles. An accumulator, being dependent upon chemical action, is susceptible to a number of troubles, or diseases, and if any of them be allowed to persist, sulphation of the plates and other troubles will follow, with the result that the negative plate may harden and become worthless, while the accumulation of the sulphate, in the form of white powder, on the surface of the plate will seriously diminish its capacity. The electrolyte must be maintained at its correct level, as if it is allowed to fall and expose the surface of the plates to the action of the atmosphere, the spongy lead, of which they are composed, will harden. Loss of electrolyte may be due to a leaky container or excessive evaporation. Leaks from a celluloid container can generally be stopped by applying a little patch of celluloid over the hole, securing it with celluloid cement or acetone (*q.v.*). With other constructions it will probably be necessary to obtain a new container.

Density Loss Due to Sulphation

The specific gravity of the electrolyte should be about 1.25, but this may be reduced below the normal either by excessive sulphating, internal discharging, or acid losses due to spraying, that is, loss of acid due to its being given off in the form of spray when the battery is in action. When the loss of density is caused by sulphation, the cell voltage is high when charging, and below the normal when discharging, and the sulphate will often appear on the plates in the form of a greyish-white patch. If this is not very serious, it can generally be removed by several cycles of charging and discharging. When the sulphate is patchy, charging up at a high rate will often crack it off.

Another method is to drain off the electrolyte from the cells, and then place in the cells a mixture of 7 oz. of Glauber's salts to one quart of distilled water. Charge the cells at normal rates, drain off the Glauber's salts solution, wash the plates in clean water, and then refill the accumulator with the electrolyte of the normal specific gravity, discharge, and recharge at normal rates, following each other as rapidly as possible. In the case of the loss of density of the electrolyte being occasioned by internal discharge, the cell voltage on charge may have quite normal value, but exhibits a loss of capacity. It may be due to impurities in the electrolyte, short

circuits of active material from one plate to another, or contact of the plates with each other. The accumulation of sediment in the bottom of the jar is another contributory cause.

Occasionally, if the accumulators have been in use for some considerable time, the material of which they are composed may break away and fall out. This is sometimes found after sulphation has been corrected with a high rate of charge. A common cause is due to over-charging, this softening the material. The violent action which is set up by the high charging rate tends also to separate the particles of the paste. Remedies are to charge at the correct rate, and to use close-fitting separators.

Another trouble that is met with is the warping, or buckling, of the plates, generally occasioned by excessive charging, or more usually by too heavy a discharge. This trouble is more often found in cells of cheap quality, and especially those with very thin plates. It is sometimes possible to correct it by taking the plates out of the case and straightening them. This must not be attempted in the usual way as by hammering, but it should be accomplished by placing the plates separately between two or more pieces of smooth wood, putting a heavy weight on the upper one, and leaving it there until the plates are more or less flattened.

Sometimes the negative plates harden excessively, and a method of restoration is to remove them from the cell, connect up as positive, and charge and discharge several times, thus the negative material begins to be exposed and its surface softens. It may then be discharged and restored to the cell.

Causes of Loss of Voltage

Loss of voltage may be caused by a low temperature, sulphating, impurities in the electrolyte, the lowering of the specific gravity of the electrolyte, and by short circuits. A common trouble with small cells is that due to erosion of the lugs connecting the plates to the terminals. This generally takes place at the spot defined by the level of the electrolyte, and in bad cases may result in the lugs being broken. Accumulators in glass jars should not be exposed to serious variations in temperature, as they are very likely to be broken by the action of frost. A typical example of the repair and overhaul of

a small accumulator with a celluloid case is illustrated in Figs. 19 to 26, and may be carried out as follows.

First remove the terminal nuts and the conductors joining the terminal of one cell to that on the other. Take out the vent plug or stopper, and pour out the contents of the accumulator into a clean earthenware jar, and set this aside in a safe place for future use. The next step is to remove the top of the case. The example in Fig. 19 shows a 4-volt accumulator with a celluloid case. The top of this can be unfastened by brushing the joints with acetone (*q.v.*), which has the effect of softening the celluloid and partly dissolving the cement which fixes the top plate to the sides of the case. Then, with the aid of a pen-knife or similar implement prise open the joints and carefully lift up the top. If the lug joining the terminal to the plates is broken, as in Fig. 19, this will present no difficulty, but if the lug is intact, the whole of the plates must be coaxed out of the case. They will fit very tightly, as the plates will probably have buckled slightly, but with care and persistence they will be persuaded to come out. They should then be washed in clean water to rid them of any surplus acid. Rubber gloves may be worn to protect the hands, otherwise they should be frequently washed in soda water.

The next step is carefully to coax the top plate off the terminal lugs. The method by which these are fixed varies

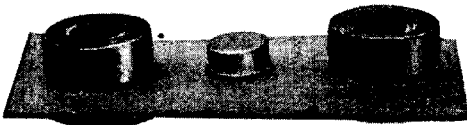

TOP PLATE REMOVED

Fig. 20. These rubber collars fit into the case top and bind round the plate lugs

a good deal with different makes, but many of them use a large rubber collar which simply fits tightly into the top of the case and binds around the lugs on the plates.

These collars can be removed by greasing the lug with vaseline and carefully working the rubber over it. It is simply a question of care and patience; any attempts at undue forcing will result in breaking the lugs.

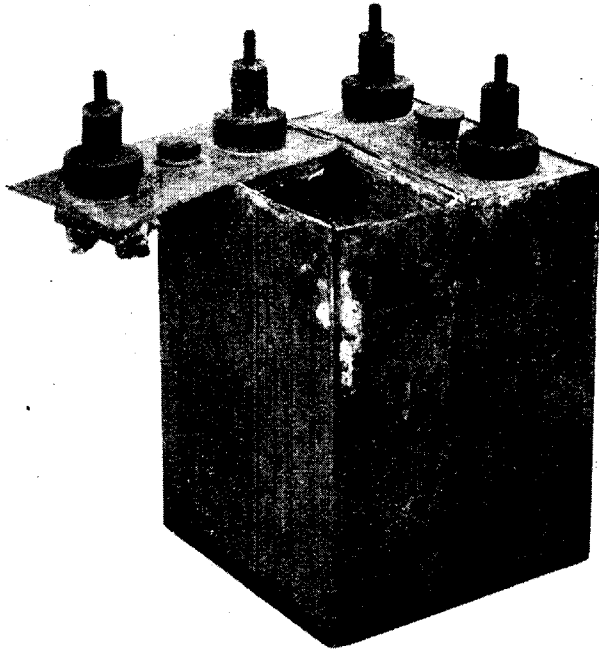

OPENING AN ACCUMULATOR FOR REPAIR

Fig. 19. Top of a cell partly removed during repair of a 4-volt accumulator, showing broken lug

The appearance of the top plate when it has been removed is shown in Fig. 20. If this is in good order, and the rubber collars are still reasonably soft and flexible and not badly cracked, they may be left in place. Otherwise, they should be pushed or cut out of the top plate and replaced by new ones.

In many accumulators it will be found that the plates are separated by perforated, corrugated celluloid sheets, known as separators, such as are shown in Fig. 21. These should be carefully withdrawn from between the plates, washed in soda water, rinsed in clean water, and then set aside to dry. The case itself (Fig. 22) should then be thoroughly washed and scoured with hot soda water, and then rinsed with clean cold water. If any of the joints are broken they can be repaired with accumulator cement (*q.v.*), or the

meeting joints may be moistened with concentrated acetic acid, acetone, or amyl acetate, and pressed together for a minute or two until they have firmly united. In bad cases it will be best to reinforce the

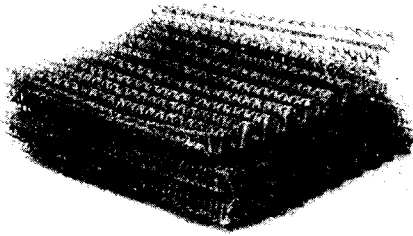

PLATE SEPARATORS

Fig. 21. Perforated, corrugated celluloid sheets or separators which are inserted between plates in some accumulators

outside edges with an angular piece of celluloid, having first thoroughly cleaned the sides of the case with sandpaper, or by scraping with a knife, and then fastening the angle strips with celluloid cement.

The joints upon the top of the case should be scraped clean, as should the edges of the top plate, in readiness for their replacement. The condition of the plates will determine what is to be done with them. Fig. 23 is a particularly bad

example and shows one of the positive plates entirely broken up and disintegrated, another broken away from its terminal, while the remainder have lost a good deal of their paste filling. Such plates are practically beyond repair. If only one or two of the cells in the plates are affected, it may suffice to leave them, but, generally speaking, it is better to obtain the requisite number of new plates, and use them instead. In such cases the whole of the plates in the cell must be replaced by new. Sometimes it will be found that only one set of plates is affected in a multi-cell accumulator. These should be replaced by new plates which should be charged and recharged before the cell is joined up with the others. Even then, the resulting job will not be so good as a new accumulator repair.

In some cases the plates will be found to have broken from the lugs, but otherwise are sufficiently sound to warrant their

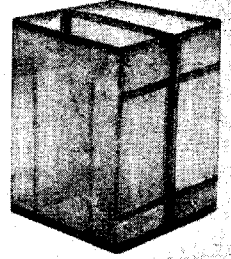
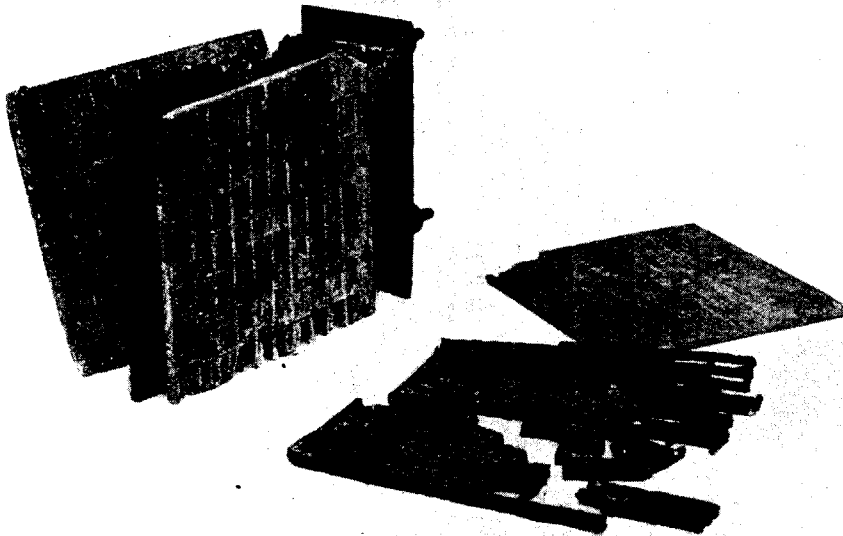

Fig. 22. Celluloid accumulator case after removal of plates



SERIOUS RESULTS OF ACCUMULATOR NEGLECT

Fig. 23. What happens when an accumulator is allowed to deteriorate by neglect is shown in this example. The terminal has parted from one plate, and the paste filling has fallen away in a number of cases. The plates are beyond practical repair and should be replaced



MENDING ACCUMULATOR PLATES

Fig. 24. Plate being fitted with new lugs by lead burning. The plate is supported on breeze blocks to retain the heat and prevent the surface of the bench from being burnt

continued use. Fig. 24 shows one method by which they may be jointed to the lugs. With quite small plates it will suffice to solder them on with a hot iron, otherwise the process known as lead burning should be adopted. Briefly, this consists of cleaning up the surfaces to be united, and making a "V" shaped groove in them. With the aid of a blow lamp, or gas heated blow-pipe, or any other source of intense heat, the parts are raised to such a temperature that they are on the verge of the melting point. Meanwhile a stick of pure lead is similarly heated, and as soon as the lugs are sufficiently hot, the flame from the blow lamp is turned on to the lead strip, with the result that a drop of lead will fall on to the grooves on the lugs.

At this instant, the flame of the blow lamp should be turned aside, so that the lead drop is not oxidized. The flame is again turned on and the whole fused together. The operation requires considerable skill and knack, as a slight increase of heat at this stage will imperil the whole work and possibly melt the metal. Too little heat, or improper use of the blow lamp, will result in an imperfect joint, generally due to the oxidation of the new lead. If properly done, however, the joint is as good as new.

Each plate has to be separately jointed to the bridge on the bottom of the terminal lug. When all the plates are prepared and in order they must be replaced in the case. Fig. 25 shows this operation in progress. First of all the top plate is fixed to the terminals and the separators



REPLACING ACCUMULATOR PLATES

Fig. 25. The position of the plate separators is shown, and the method of holding the plates to coax them into the case

placed between the plates, and in small accumulators, such as that illustrated in Fig. 25, the whole assembly is grasped between the fingers and thumb, and carefully coaxed into the case, working it gradually down into position. It only then remains to work the top into position, and the case may be jointed up with celluloid cement or acetone. This can be done by moistening the edges with the acetone, applying it with a wisp of paper or a small brush, and working the top into

to the lead type, and there are excellent mechanical qualities in the Edison cell. It requires comparatively little attention beyond adding water to compensate the loss on the electrolyte, and there is not the danger of damaging adjacent objects should the electrolyte be spilled as is likely to happen with the lead cells. In cells of the Reynier type the negative plates are made of zinc. Another cell of the same type has negative plates of copper coated with an amalgam of zinc.

ACCUMULATOR CEMENT.

An expression somewhat loosely applied to a number of different mixtures intended as a cement for joining the parts of an accumulator case, enclosing the top or otherwise, and so rendering it acid tight.

One such mixture is made by dissolving scrap celluloid in acetone or amyl acetate (*q.v.*).

As much of the scrap celluloid should be dissolved as is needed to make a thick syrup-like liquid. This must be used soon after preparation, as the acetone quickly evaporates. Both acetone and celluloid are highly inflammable, and they should only be handled in daylight.

Another mixture is composed of scrap celluloid dissolved in camphorated spirit. For cementing the tops of a closed case type of accumu-

lator, pitch can be used. It is applied warm enough to flow, but not enough to run down into the interior. See Acetone; Amylacetate.

ACCUMULATOR-CHARGING DYNAMO.

Dynamos that are used for accumulator charging possess certain features. In the first place, they must give continuous or direct current, that is, they must pass current steadily in one direction through the accumulator in order to bring about that change in the chemical condition of its plates known as a "charge." If an attempt were made to charge an accumulator with alternating current, the only result would be to destroy such chemical changes as were caused by the flow of current in one direction with the reverse direction of current which immediately followed, and the final condition of the accumulator would be "uncharged," however long this went on,

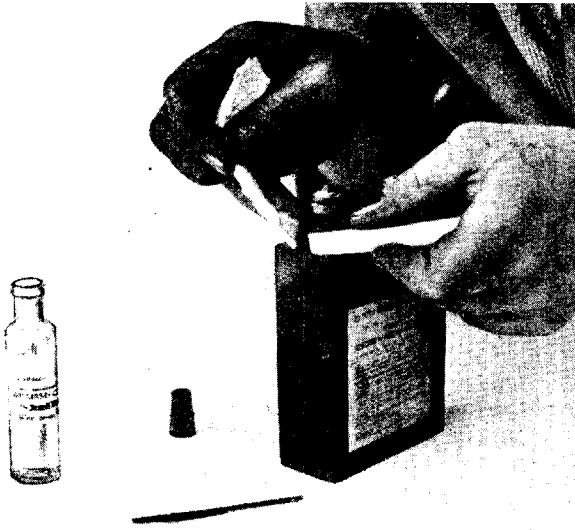

INSERTING ACCUMULATOR TOP

Fig. 26. Acetone is applied to the edge of the top as it is worked into place with a wooden stick. As the celluloid is softened the top is gently pressed into position

place with a little wooden stick. The joint is then completed by cementing narrow strips of celluloid into the angle of the joint (Fig. 26).

The accumulator is then refilled, either with the old acid, if clean and of the requisite density, or with fresh acid, which should have been allowed to stand for a few days to thoroughly cool and temper. It can then be recharged in the usual way.

In addition to the ordinary type of lead cells there are a number that employ other methods. Of these the Edison is a well-known example. The active materials are nickel on the positive plates and iron or iron oxide on the negative; the electrolyte is an aqueous solution of potash, consisting of 21 p.c. of potassium hydroxide. Here again the chemical reactions are not definitely known. The length of life of the Edison cell is generally considered superior

because the effect of every successive wave of current would be wiped out by the succeeding one.

It is very necessary, therefore, that in accumulator charging the current is not allowed to reverse, or all its previous effects will be undone. For this reason charging dynamos must not only give continuous current, but they must also be shunt wound, because this largely excludes any risk of reversing the polarity

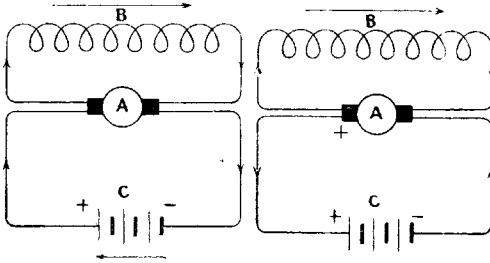

SHUNT-WOUND CHARGING DYNAMO

Diagrams explaining use of shunt-wound dynamo in charging. Fig. 1 (left). Current flow when accumulator is driving dynamo. Fig. 2 (right). Current flow when dynamo is charging accumulator. Polarity of the field remains constant

of the terminals. To explain why, it is necessary to refer to two simple diagrams, one showing a dynamo charging a battery of accumulators, and the other showing the latter "motoring" the former.

A is the conventional way of showing the armature and brushes, B is the shunt coil which excites the dynamo field magnet, and C is the accumulator. The signs + and - denote positive and negative poles. Under normal charging conditions the dynamo volts would be higher than the accumulator volts, hence current would be forced through the latter in the direction shown by arrows in Fig. 1. If the dynamo volts dropped below the accumulator, the latter would immediately discharge, reversing current direction through the armature, but not through the fields (Fig. 2).

The polarity of the field magnet remains unaltered, therefore, whether the dynamo is charging or motoring, and ensures that the terminal polarity will also remain unchanged, so avoiding any possible reversal of the accumulator when normal charging conditions are restored. Since accumulator charging is a lengthy process, dynamos designed for that purpose must be able to run for long periods without excessive temperature rise. They should also be provided with a variable resistance in the shunt field circuit, which will

enable the charging rate to be adjusted without altering the speed. See Accumulator; Charging Board; Dynamo.

ACCUMULATOR CHARGING SET.

This expression is applied to a number of self-contained sets adapted for the charging of accumulators such as those needed in wireless work. The type illustrated is known as the Triumph, and is intended for use on any direct current supply of electricity. The set consists of a metal framework with perforated sides, and the front is a slate panel. A resistance with a sliding roller contact is fitted within the case and protected with an insulating material. The front panel is equipped with an ammeter to indicate the rate at which the accumulator is being charged. On the left are terminals for connexions to the house supply mains, which can be connected with a suitable size flexible wire, terminating with a plug-in adaptor for attachment to the nearest available lamp point. The terminals at the top right hand of the photograph are for the fuse wire, while those at the bottom right hand are to take the leads to the accumulator to be charged. The double pole change-over switch has a central off position so that

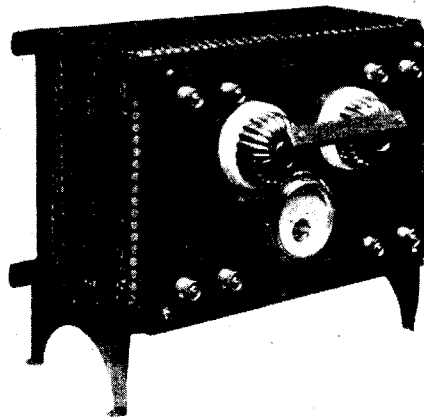

COMPLETE HOME CHARGING SET

The Triumph set, designed for charging wireless accumulators at home. The switch connects the accumulator to the house supply in one position and to the wireless set in the other position

the current can flow through the accumulator to charge it from the house supply, or by throwing over this switch the accumulator is connected to the wireless set which is thereby supplied with the desired energy from it. This arrangement

avoids the need of touching the accumulator. The ammeter indicates the charging current and also the current being taken by the valve filaments automatically. Once installed and wired up the appliance needs no further attention.

ACCUMULATOR CONNECTOR. Metal bars or wires for joining the terminals of one cell to another, or for attachments to the bus bar or other terminal of the electrical circuit. On small portable accumulators, such as are extensively employed for wireless purposes, the connectors often take the form of flat strips of metal, as lead or brass, which are drilled at the ends and secured by terminal nuts. Alternatively such bars are soldered or burned on to the terminal lugs. The former is the more convenient method because it facilitates tappings, the separate cells being readily cut out of the circuit, or connected in series or parallel as is most convenient. Other types include small ebonite strips with a brass or copper contact bar attached which is arranged to connect to terminals or push-in contacts attached to the lugs on the accumulator. The details are necessarily arranged to suit the construction and arrangement of the individual accumulators being dealt with at the time. Another form is the push-in single connector wire, one end of which is attached to an insulated plug or handle with a contact piece of metal which plugs into a hollow in the terminal lug on the accumulator. Such fittings are sometimes known as wander plugs, owing to their mobility. See Bus Bar; Flex; Plug-in Connector; Wander Plug.

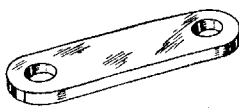

Connector for accumulator cells

ACCUMULATOR COLLAR. A device used to effect the joint between the terminal lug and the top of the case of an enclosed type of accumulator. A common method is to employ tubular rubber pieces, which grasp the lug and expand into the hole in the case top. More elaborate devices are applied to some accumulators, and include means to check the corrosion of the terminal nuts, as by the filling of a hollow part with an oil or some other solution.

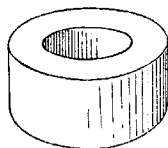

Collar for accumulator lug

cc. Accumulator

ACCUMULATOR CONTAINER. The name given to any type of box or casing that houses an accumulator. When a valve set is installed in the home for reception of broadcast concerts the receiver is often placed in the reception-rooms, and the presence of an exposed accumulator is unsightly. This is overcome in some high-priced sets by providing a special compartment for the accumulator, but in many cases this is not done, and the amateur could well equip the set by making

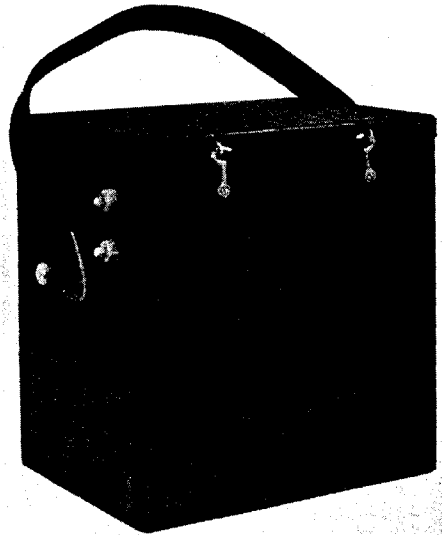

HOME-MADE ACCUMULATOR CONTAINER

Fig. 1. A strong accumulator case of wood. The corners are tongued and grooved. The case is treated inside with anti-sulphuric paint

up a wooden case for the accumulator of the kind shown in Figs. 1 and 2. This can be made from sound, dry timber about $\frac{3}{8}$ in. thick, the corners tongued and grooved together as shown in the diagram Fig. 3, and glued and pinned together with fine panel pins or very thin screws about $\frac{1}{4}$ in. long, and about No. 000 gauge. The bottom is simply screwed to the sides with fine wood screws about 1 in. long. The lid, or cover, is clamped at the ends as shown in Fig. 3, this being necessary to prevent the wood warping.

It is hinged at the back with two small brass butt hinges affixed with brass screws. A leather carrying-handle is supported on two metal studs riveted to a base plate, which is screwed to the sides of the case as shown in Fig. 1. Two hooks and eyes

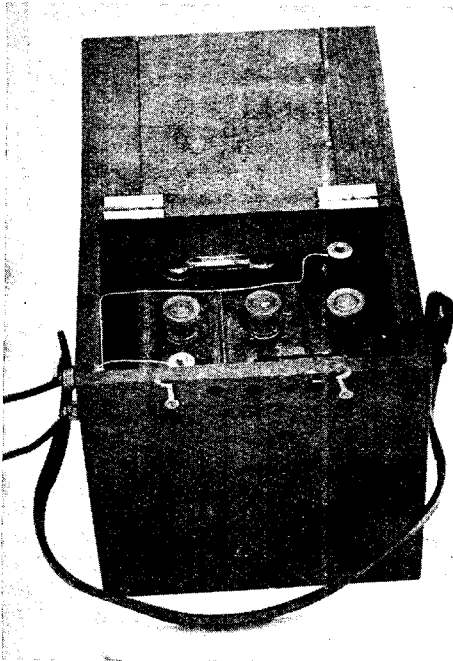

ACCUMULATOR IN ITS CONTAINER

Fig. 2. The container shown is made with terminals on the outside, and ventilation holes

are fitted to the front to keep the lid closed. A few small holes are drilled through the front of the case for ventilation purposes. Two terminals are fitted to the left-hand side, and the inner ends attached to the terminals of the accumulator as shown in Fig. 2. By this method it is unnecessary to open the case and make connexions, as all that has to be done is to attach the leads to the outside of the terminals and take care to connect the plus side to the plus on the receiving set. The size of the container will be arranged to suit the accumulator to be enclosed, or two or more separate cells could be housed in one container and the requisite number of terminals provided to permit of connecting a

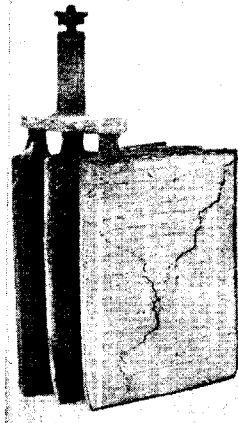

ACCUMULATOR PLATES
Assembly of three negative plates suitable for a portable accumulator

supply at, say, 4 volts to the detector valve and a separate set of wires, carrying a 6-volt current, to the amplifying valve.

Commercially made containers are available, with stud contact switches on the exterior, and serve a similar purpose.

A container such as illustrated is also serviceable for transporting the accumulator to the charging station. The interior of all such cases should be well painted with some anti-sulphuric paint, as the presence of the accumulator has a deleterious effect on wood and other objects due to discharge of acid fumes.

ACCUMULATOR PLATES. The name given to the metallic elements of an accumulator. In the ordinary type of lead plate

the lead is perforated or made up in a cellular form, the nature of which depends upon the method of manufacture. Some are spun or worked up into a finely corru-

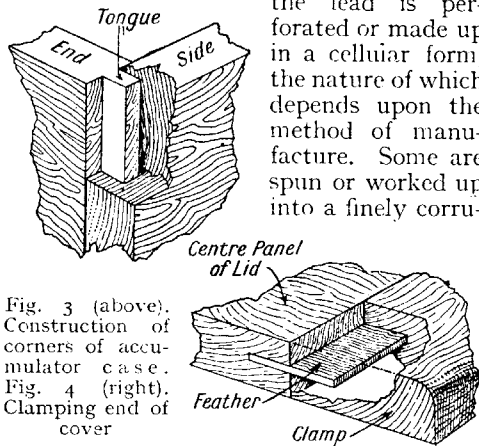

Fig. 3 (above). Construction of corners of accumulator case.
Fig. 4 (right). Clamping end of cover

gated or incised form, others are cast. This construction employs a number of fine thin ribs spanning the openings between the grid, or framework, of the plate. Another construction is in the form of a sheet of lead which is perforated with a number of closely spaced holes with slightly tapering sides into which a pellet or disk of a soft lead is forced. This, after the forming process, is converted into spongy lead firmly embedded in the holes. Most of the accumulators in wireless work are of the pasted type—that is to say, the plate is first prepared in the form of a grid, the spaces between the bars are then filled with a plastic mixture such as red lead mixed with diluted sulphuric acid to the consistency of putty, and then the whole is carefully dried and treated with sulphuric acid.

Negative plates are prepared on the same lines, but the paste has a different composition, such as litharge mixed with

sulphuric acid. The active materials have then to be formed by immersing in a bath of electrolyte and passing a charging current through them in a certain cycle of charging and discharging. Plates are generally connected together in sets of three or more, and generally one more negative plate than positive, as the negatives should be arranged so that the positives are situated between two of them. Connexions are usually made by joining a lead strip or lug to the tops of the plates. This is done by a process known as lead burning, by which the parts are virtually fused together. A convenient upward projection or lug is provided and finishes with a terminal nut, or a connector may be burned on to it. See Buckling.

ACCUMULATOR STOPPERS AND VENTS.

Small rubber or other plugs inserted into the top of the accumulator case to close the filling orifice and to permit ingress of air. They are found on wireless accumulators in various forms,



Types of plugs or vents

and three are illustrated. One type is in the form of a hollow celluloid plug, made of a tapered tube, with end pieces cemented to it. A similar arrangement has the end plates drilled with a fine hole allowing air to pass, but retarding passage of the electrolyte. Another type is made of vulcanized rubber in the form of a tapering plug with a fine hole through the centre. This is sometimes fitted with a glass pipe, the inner end open and the outer in the form of a hollow ball. A hole is made through it near to one side, and this allows air to escape, but checks the passage of the acid, as it is easier for it to run down the pipe into the case than it is to escape through the little hole. On larger enclosed types of accumulators the vents are in the form of a trapped plug consisting of a cup fixed below the vertical vent pipe which terminates on the exterior in a cowl or hollow ball, with fine holes for passage of the air. Another type of stopper is in the form of an ebonite or other screw plug which has to be removed for insertion of the acid. There are numerous patented and other devices, but all have the same objects in view, the retention of the spray while the accumulator is being charged, and admission of air to permit a breathing effect.

ACETIC ACID. Colourless, pungent liquid obtained from the destructive distillation of wood. It is used as a cleansing solution and as a cement for celluloid, and so can be employed for repairing cracks in a sheet of celluloid. Acetic acid will dissolve lead when in contact with the air, and should, therefore, not be employed on external joints in proximity to any lead work. Its specific inductive capacity is 9.7. Chemical symbol, $C_2H_4O_2$. Specific gravity, 1.06. Specific heat at constant pressure, 0.412.

ACETONE. A distillate of various organic substances and acetates; has an acrid taste, is very inflammable, and has a toxic effect if the fumes are inhaled for any length of time.

Acetone is used in the manufacture of chloroform, and is a solvent of many animal fats, camphor, celluloid, and resins. Acetone is also used in certain forms of acetylene gas containers, as one of the properties of acetone is that of absorbing great quantities of acetylene gas. In wireless work its chief uses are in the preparation of celluloid varnishes, and in various processes connected with work on celluloid. When employed in this way by the amateur, it is generally purchased in small quantities from a chemist. In colour it resembles water, has a pleasant smell, and is extremely inflammable. On no account should the bottle be uncorked anywhere near a naked light of any kind.

When used on celluloid sheet work, as, for example, in the repair of accumulator cases, the acetone is applied with a brush, and the sheet is quickly rendered pliable. The acetone must not be applied for too long, or the sheet will be dissolved. When it has dried the sheet will be as stiff as before, but while it is moist it can be bent to any desired shape in reason.

A useful cement is made by dissolving scrap celluloid in acetone, and employing it to carry out repairs to cracked and broken articles made of celluloid. If further dissolved and strained it can be used as a varnish.

The chemical symbol is C_3H_6O ; S.G., 0.819; dielectric constant, 21.85.

ACID. Chemically an acid is a substance containing hydrogen which may be replaced by metals with the formation of salts. An acid, therefore, may be regarded as a salt of hydrogen. Commonly the name is applied to any liquid that is sour and biting to the palate.

The greater number of acids have the property of changing blue litmus, a vegetable salt, to a red tint. Acids are important in electrical work for use in solutions in electric batteries and accumulators.

Sulphuric acid, also known as vitriol, is the most commonly used acid. It is employed as an electrolyte in accumulators. An important point to remember in connexion with its use is that it has a great affinity for water. So violent is the affinity, indeed, that it is dangerous to pour water into it, or the mixture will boil up and splash both person and clothing. In diluting, the acid should be poured gradually into the water, and the heat generated in the process should be allowed to dissipate before more acid is put in. Sulphuric acid is also useful for cleaning purposes.

Hydrochloric acid is used in the preparation of soldering flux. The proper soldering of all connexions in wires is of great importance in wireless. The actual flux used is formed by pouring hydrochloric acid on zinc cuttings to form zinc chloride, to which is added a little sal ammoniac.

In bichromate batteries sulphuric acid is used with a solution of 6 oz. of bichromate of potash in one pint of water in equal quantities. In the Fuller type of cell the outer jar has the bichromate solution mixed with sulphuric, and the inner porous pot has an electrolyte of diluted sulphuric.

All acids should be handled carefully, and kept in bottles or other containers conspicuously labelled. They should be used with caution and splashing avoided, for that may lead to ruin of clothes and carpets, etc., a burnt skin, or the discoloration of parts of any apparatus with which it comes in contact.

The antidotes to poisoning by acids are the alkalis. Magnesia, chalk, whitening, or even plaster from the walls or ceilings, mixed with water, should be taken at once. With a burn from acid apply common washing soda. Promptness of application is of the greatest importance. See Acetic acid; Hydrochloric acid; Sulphuric acid, etc.

ACID FUNNEL. A funnel used to facilitate the pouring of acid into a receptacle, as when filling an accumulator of the enclosed type. The material employed must not be affected by the acid, and the amateur will find that a small glass funnel of the type illustrated is as good as any. These

are usually cast in glass, ribbed to give extra strength to them and to cause the liquid to flow with a slightly rotary motion, thereby reducing the tendency for it to adhere to the glass.

The funnel should be well washed in soda water, and rinsed clean in warm, clear water after using.

One type of acid funnel is calibrated to enable approximations to be made to the quantity of acid to be added to the receptacle. It is used by closing the aperture with a rubber pad, pouring in the desired amount, and then removing the pad to release the contents.

ACIDOMETER. An instrument used to determine the acidity of a solution or its specific gravity. It is similar in form to the hydrometer, and is used in a similar manner. See Hydrometer.

ACLINIC LINES. Lines on the earth's surface where there is no inclination or dip of the compass needle. It is the isoclinal (*q.v.*) of 0° and coincides roughly with the geographical equator, lying slightly to the north of it in Asia and Africa and to the south of it in South America. See Agonic lines; Isoclinal; Isogonal; Isomagnetic.

ACOUSTIC WAVE. Alternative name for sound wave. See Sound.

ACTIVE MATERIAL. In an accumulator plate the active material is only that portion which is actually acted upon during the chemical changes which take place during charging and discharging. After one or two charges or discharges some material from the plates may be found at the bottom of the case, generally in the corners. If such material happens to touch any two plates, positive and negative, during charging or discharging, the accumulator may be ruined. Such sediment should be cleared out at once. It is chiefly caused by excessive rate of charging or discharging.

To clean out this sediment, drill a $\frac{1}{8}$ in. or $\frac{1}{4}$ in. hole in the corner of the

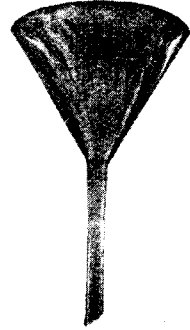

ACID FUNNEL.

Glass funnel used for filling accumulator with acid. It is ribbed to prevent acid clinging to the sides.

lids of each cell, take out the vents, and empty the acid into a clean jar. Wash out the cells with clean water until all the sediment has been removed through the holes. A bone knitting needle will help to remove any sediment that has become solid. When the accumulator has been filled afresh with acid, plug the drilled holes with celluloid cement or rubber plugs, and immediately recharge the accumulator. See Accumulator.

ADAPTOR. An expression used in wireless work to describe a variety of devices intended to modify one piece of apparatus by its application so that some other device may be attached or used in conjunction with it, generally without the need of altering the existing appliance. Examples are the use of a plug-in adaptor applied to an electric lamp holder so that the conductors wired to the plug can be taken to some other spot and the current delivered there. Another example is the Ducon (Fig. 1), which is used to adapt an existing electric light circuit as a wire-

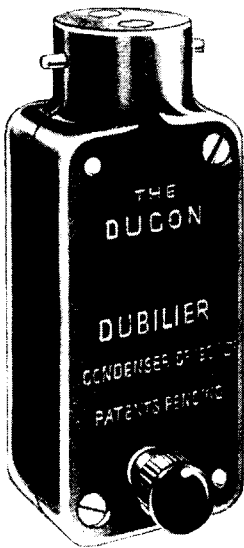

ADAPTOR FOR AERIAL
Fig. 1. Ducon adaptor for using electric light circuit as wireless aerial

less aerial. When it is desired to use a low voltage valve in an ordinary valve holder an adaptor is used, and this avoids the need of altering the existing apparatus, and is especially useful to the experimenter.

Many of the commercial adaptors as used for electric lighting are available for the wireless worker. These can be obtained in various

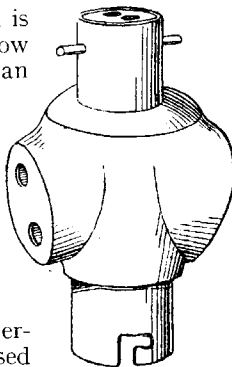

ADAPTOR
Fig. 2. Adaptor for charging accumulator from direct current

forms. The type in which the lamp can be inserted and a pair of conductors taken from it in parallel with the lighting circuit enables the lamp to be lighted although current is still flowing to the apparatus to which the additional leads have been taken (Fig. 2). A second variety is wired in series, and is valuable for the charging of small accumulators when direct current is employed. A useful adaptor is one that can be plugged into the standard valve holders, and is wired to a small pocket flash lamp bulb. This is to enable the filament circuit to be tested without endangering an expensive valve. A form of crystal detector adaptor to plug into an ordinary valve holder (Fig. 3) is useful for emergency tuning and the like.

ADHESIVE TAPE. The name of an impregnated strip of linen or similar material used to protect and insulate the bared part of a conductor. The appearance is a dirty black, as the insulating material is often of the nature of pitch, the composition varying with different makes. It has many practical uses. After a time the tape dries, and should, therefore, be preserved in an air-tight case, or wrapped in tinfoil. It is chiefly useful in wireless work for covering exposed terminals and conductors, increasing insulating value, and minimising risk of short circuits. It may be used for keeping connexions sound. See Black Tape; Insulation.

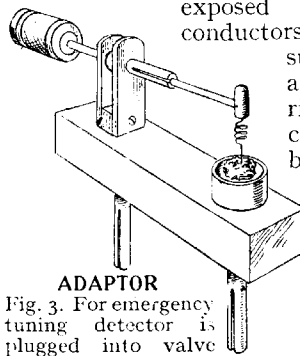

ADAPTOR
Fig. 3. For emergency tuning detector is plugged into valve holder

ADIT. An electric insulating material manufactured from papier maché impregnated with an insulating compound. It is pliable, and can be moulded into various forms. It is made in various grades, and will withstand heats of 140° to 250° F. The tensile strength is about 1,700 lb. per square inch, and it is free from detrimental effects.

As an electrical insulator a sheet 3-32 in. thick will withstand a voltage of 900, thicker sheets withstanding greater voltages, 4,000 volts being needed to puncture a sheet 7-32 in. thick. See Insulation; Insulator.

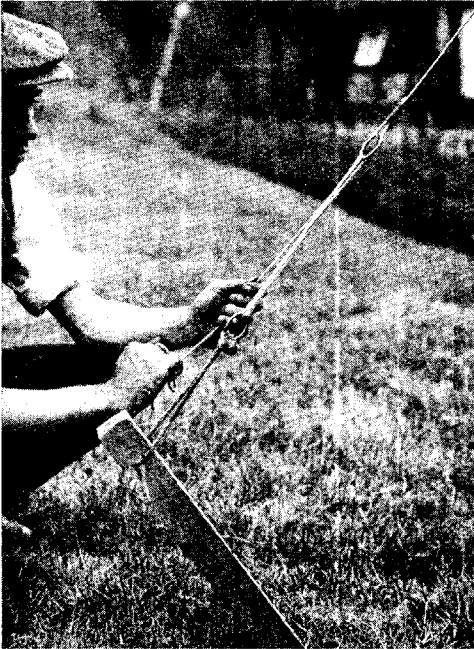

LANYARD STRAINER

Fig. 1. A simple method of adjusting the strain of guy wire

ADJUSTABLE STRAINER. An expression used to describe a variety of appliances for tensioning a wire or cord. They are used in wireless to a large extent in the erection of aerials, and particularly in tensioning the guy wires for supporting the mast. The simplest method is to use a lanyard or cord passed through rings attached to the end of the guy and the ground stake respectively. One end of the lanyard is knotted to the standing ring—that is, the one attached to the stake—the cord is then taken through the other ring back through the first, and so on until three complete turns have been taken. If the free end of the lanyard be hauled on, it will be found that there is a considerable mechanical advantage, and the wire can be drawn up taut. The lanyard is made fast by taking several turns around itself, and whipping the end to the lower ring. The system is suitable for masts of moderate height, say about 35 ft. to 40 ft. in height, and Fig. 1 shows the use of the parts referred to.

Another type consists of a screwed rod, the outer end of which is fashioned into an eye. This is to take the guy wire, which should be spliced or securely whipped at the ends. The lower end of

the bar is furnished with a well-fitting nut which bears against the under side of a long U-shaped strip of iron. The lower end is bolted to the top part of the ground stake, as can be seen in Fig. 2. To increase tension on the wire the nut is turned with a tubular spanner.

A commercial strainer is shown in Fig. 3 attached at the lower end to an eye-bolt in the top part of the stake. The top end of the strainer is connected to the guy wire, the screwed shank turns in the cage, which has a swivel device at the lower end to permit of turning it around to draw the eye-bolt down, thus tightening the wire. A lock nut is located beneath the top part of the cage, and when the wire is taut this nut should be tightened up to prevent the eye-bolt unscrewing. Whatever type of strainer is used, it should be of adequate strength, well made throughout; the screwed parts especially should be accurately fitted together. See Aerial; Guy; Strainer.

ADMIRALTY UNIT. A term for the Jar unit of capacity. One admiralty unit equals $1/900$ microfarads. See Farad.

ADMITTANCE. In the same way that conductance in a direct-current circuit is the opposite or reciprocal of resistance, admittance in a periodic or alternating circuit signifies the reciprocal of impedance, or opposition to the flow of current.

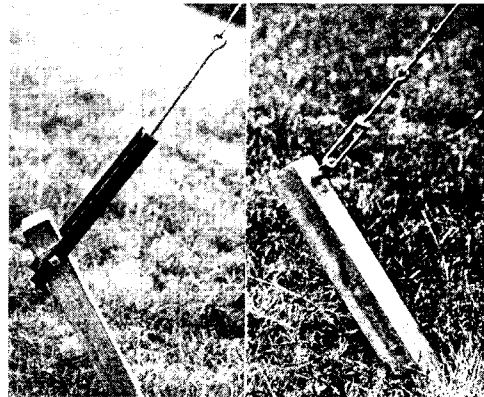

ADJUSTABLE STRAINERS

Fig. 2 (left). A screwed eye-rod with an iron U-bar. Fig. 3 (right). Standard commercial type of strainer with eye-bolt

Beside the ordinary ohmic resistance another factor, termed self-induction, comes into account with pulsating currents, and the latter may oppose the flow of current even more than the mere ohmic resistance. See Impedance.

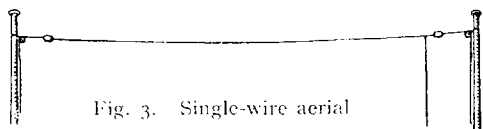

Fig. 3. Single-wire aerial

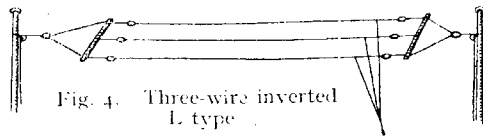

Fig. 4. Three-wire inverted L type

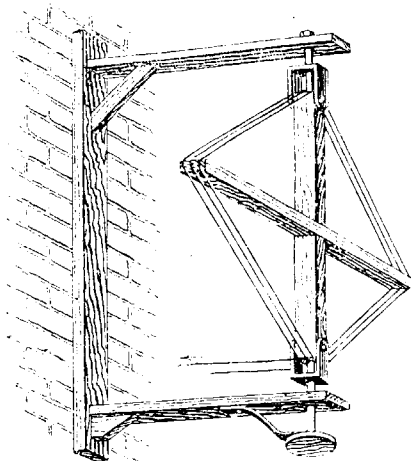

Fig. 6. A type of frame aerial

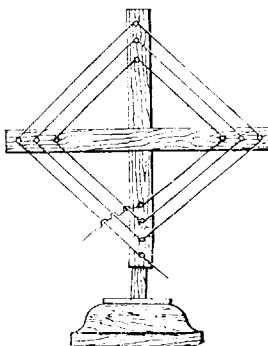

Fig. 9. Frame aerial

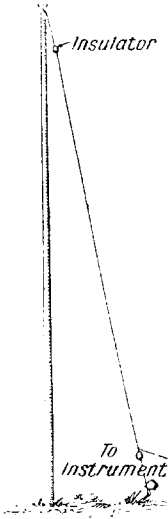

Fig. 10. Single vertical wire

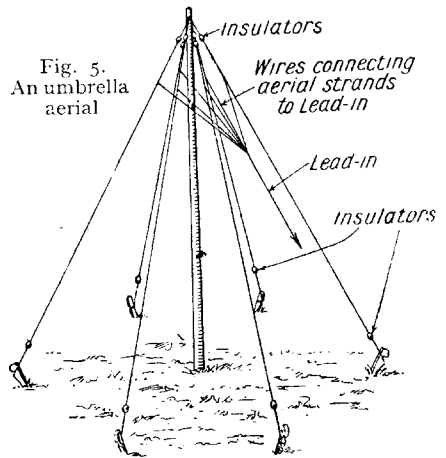

Fig. 5. An umbrella aerial

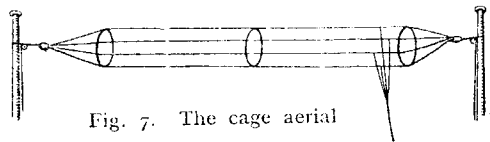

Fig. 7. The cage aerial

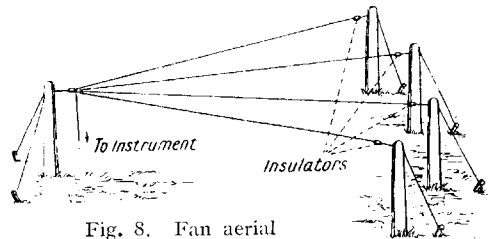

Fig. 8. Fan aerial

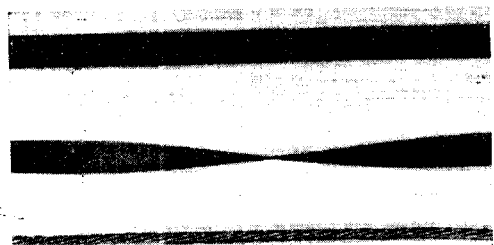

Fig. 11. Types of wire for aerials



Fig. 12. How two single-wire aerials are connected in the middle

COMMON TYPES OF RECEIVING AND TRANSMITTING AERIALS

AERIALS: TYPES, THEORY AND CONSTRUCTION

An Important Part of the Receiving Circuit Fully Described

This article describes briefly the different kinds of aerial and the construction of a number of aerial masts for aerial wires for broadcast receiving. It should be read in conjunction with the more detailed information and descriptive articles on particular forms of aerial, e.g. Cage Aerial, Frame Aerial, Ground Aerial, and with such cognate articles as Capacity; Inductance; Transmitting; Tuning. See also Guy; Spreader; Tubular Mast; and other articles of a similar nature

The aerial (symbol Ψ) or antenna is the system of conductors established at a radio station for the purpose of radiating or absorbing other waves. This expression does not include the connexion to earth or its equivalent, or the tuning arrangements.

All wireless services are under the control of the Postmaster General in Great Britain. Details of the issue of experimental and broadcast licences are given under the heading of Licence in this Encyclopedia. Here are given only the regulations concerning aerials. Under these regulations the combined height and length must not exceed 100 feet for transmitting or receiving aerials. This length is irrespective of the number of wires employed. By the length is meant the horizontal or main aerial span, and by the height the vertical height above the leading-in point. The regulations allow of the use of a four-wire or any other multi-wire aerial of, say, 75 feet in length, and a down lead of a number of wires 25 feet in length, so that the actual length of wire used in an aerial may considerably exceed 100 feet. The leading-in point is that point at which the wires enter the house. Figs. 1 and 2 make the measurements clear for two typical examples of aerial. There are no regulations limiting the size of frame aerials and the like or the length of wire which may be used.

The regulations may be varied from time to time at the discretion of the Postmaster General.

There are a great many types and methods of arrangement of the aerial. All manner of arrangements of the wires, apart from using the electric light service in the building and such things as the

metal framework of a bedstead, have been tried, and have been made to work in some sort of fashion as receiving aerials. The simplest and generally the most efficient, however, is a simple single length of wire as shown in Fig. 3. Best results are obtained by the use of stranded wire comprising, for example, 7 strands of No. 22 gauge copper or phosphor-bronze wire. Another useful and practical material is a strip of phosphor bronze or silicon bronze, measuring about $\frac{1}{2}$ in. wide

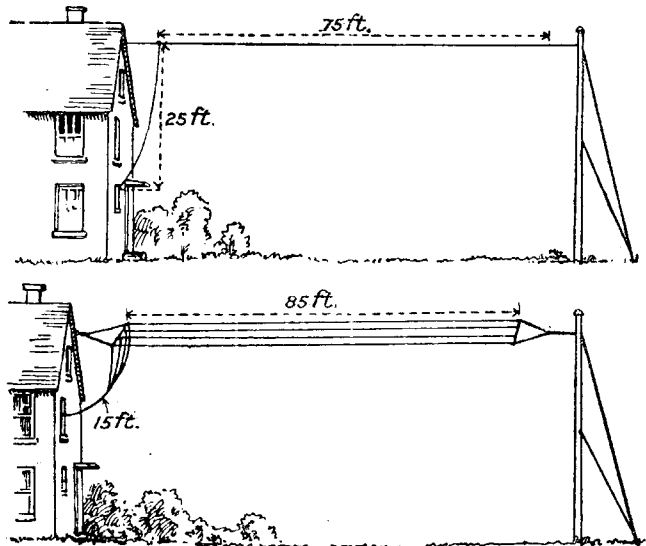

REGULATION LENGTH FOR THE AERIAL

Fig. 1 (above). Single wire aerial with lead-in showing how lengths allowed by P.M.G. are measured. Fig. 2 (below). Four-wire aerial with lead-in showing measurements allowed by P.M.G.

and rather less than $\frac{1}{2}$ in. thick. This is sometimes put up flat, while by another system it is twisted. Fig. 11 shows these types of aerial wire. Fig. 12 shows how two such single wires may be connected by insulators and cords to provide separate aerials on one set of poles or supports.

With the usual type of twin aerial two wires run parallel to each other and are separated by short wooden or other non-conductive bars, located at each end of the aerial, and known as spreaders. The

natural development of the twin aerial is the use of three, four, or even more wires parallel with each other and separated by spreaders, and all in the same plane, as in Fig. 4. When the down lead or leads are taken from the centre of such an aerial it is known as the T type. When all the down leads are at one end, as illustrated, it is known as the inverted L type.

The umbrella aerial consists of a single pole, with a number of insulated wires which serve the purpose both of supporting the poles and the aerial wires. They are connected together and conducted to the receiving apparatus by a single lead-in wire, as shown in Fig. 5. The fan aerial is one in which a number of wires are stretched between poles fanwise, as shown in Fig. 8, and the lead-in is taken from the point of the fan.

The cage aerial, Fig. 7, is somewhat differently arranged, and is separately considered under that heading. The frame, Fig. 9, or loop aerial, Fig. 6, owing to its small size and limited capabilities for collecting energy, requires a very sensitive receiving apparatus, and the requisite conditions as well as the construction of such types of aerial are dealt with under the heading Frame Aerial.

It should be pointed out here that the terms loop and frame aerial are often treated as interchangeable. The term loop is better confined, however, to an aerial having only a single convolution; and the term frame to an aerial consisting of two or more turns, usually round a frame. Fig. 10 shows the single vertical wire aerial.

Tree and Ground Aerials

Among the types of aerial which may be mentioned are tree aerials and ground aerials. By a tree aerial is meant one in which the trunk of a tree forms part of the system. In one form of such an aerial a stout nail is driven in the trunk of the tree as high as possible, and another low down. The aerial lead-in to the receiving instrument is fastened to the upper nail and the earth wire to the lower nail. From experiments which have been carried out with this type of aerial, it is found that the greater the distance between the two nails the better the reception. Ground aerials are described under that heading in this Encyclopedia. They are aerials laid on or near the surface of the ground.

The foregoing types are chiefly used for reception purposes. The single wire is efficient and collects nearly as much energy as several parallel or radial wires, and is less affected by atmospheric electricity, generally known as statics; and induction, or magnetic influence from adjacent wires carrying electrical current, is also less than with a multi-wire aerial. For transmitting, however, better results are obtained from a multi-wire aerial, as by increasing the number of wires the resistance of the aerial is lowered. It also provides a greater amount of surface for the purpose of radiation.

Aerials for Dual Working

The counterpoise aerial, chiefly used in transmission, is separately described under the heading Counterpoise Aerial. When a compromise has to be made and one aerial used both for reception and transmission, a multiple wire aerial of the T or inverted L types is used. Virtually, there is little difference between the constructive work in the erection of a single or multiple wire aerial of the T or inverted L types, as all of them will usually have to terminate in a single support.

In general, the amateur who desires to listen in to the broadcast concerts from either Great Britain or elsewhere will, in most cases, find the elevated outdoor aerial meet most requirements, and this is the general form in most cases. In providing such an arrangement several factors have to be considered. First of all, there is the design of the aerial itself. This is a matter that the technician will undertake on mathematical lines, while the practical man will be more concerned with the everyday difficulties of making attachments to chimney-stack tops or erecting an elevated pole or mast. Both, however, have one common object in view, and that is the reception of signals from the greatest number of stations with the greatest volume and strength.

As the definition of aerial implies, they may be divided into two broad classes, receiving aerials and transmitting aerials; but in actual practice the same aerial may be used in many cases for transmitting as well as for receiving.

The best type of receiving aerial, as has already been pointed out, is the single stranded wire, height and length being taken into consideration with other factors. But most amateurs prefer to have the double wire aerial with spreaders.

Rules for Outdoor Aerials. The following are some general points which should be noted before the actual construction of any outside aerial is attempted.

With an outdoor aerial the total length and height should be, as far as possible, consistent with local conditions, as great as the Postmaster-General's regulations allow. The height of the aerial should be, for the ordinary inverted L or T type, at least 20 feet above the instrument and 30 to 40 feet is preferable for receiving aerials.

Stranded wires are preferable to single wires. If a single wire is used, then 14 to 16-gauge hard-drawn copper or phosphor or silicon bronze wire is best. Galvanized iron wire may be used, but does not give such good results as copper. The aerial wires may be enamelled or insulated or bare. In any case it is preferable to use enamelled or insulated wire, especially near the sea, to prevent corrosion. Both the aerial wires and the down-lead wires must be kept as clear as possible of trees, buildings, and other obstructions. Where there are railway lines, telephone and telegraph wires, tram lines and overhead power wires and the like, the aerial should be placed at right angles to their general direction. But aerial wires should never be allowed to cross above high-power transmission wires, and it is wise to avoid their neighbourhood altogether.

Leading-in wires should not come nearer than four to six inches to electric light or power wires unless separated therefrom by a continuous and firmly fixed non-conductor additional to the normal insulation of the wire, if any. Lead-in wires should enter buildings through a non-combustible, non-absorptive insulating



**SINGLE-STRAND
LEAD-IN**

Fig. 14. Method of joining a single-strand lead-in wire to aerial wire

bushing of some kind. (See Lead-in Tube.) All sharp angles in the down lead and all kinks in this or the aerial wires should be avoided. Twin-wire aerials should have the wires spaced not less than four feet apart to obtain the best results, and in cage and other multiple-wire aerials the

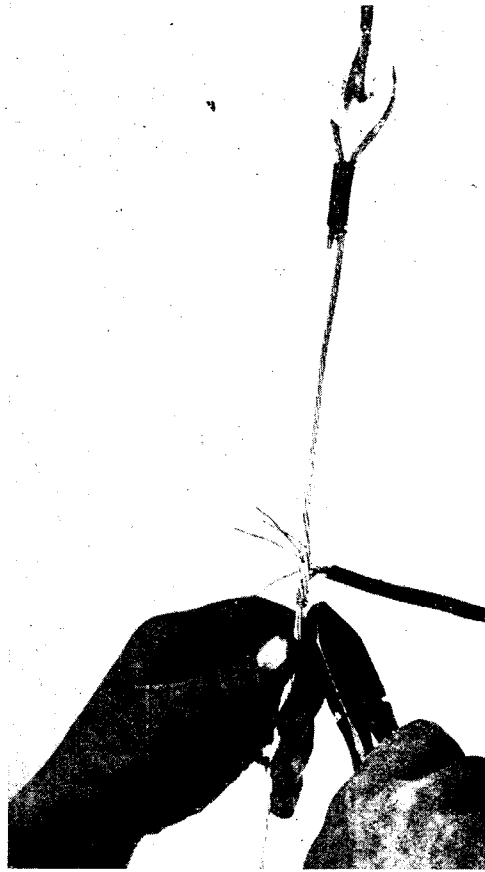

JOINING AERIAL AND LEAD-IN WIRES

Fig. 13. Showing method of joining stranded aerial wire to stranded lead-in wire

wires should be spaced not closer than two feet.

The inverted L type of aerial is to be preferred to the T aerial, as it gives a greater effective length for the same amount of wire used. The effective electrical length of the aerial is the distance from the farthest point of the wire to the place where the lead-in is attached plus the length of the lead-in itself. With the T type of aerial the lead-in wire should be attached to the centre of the aerial wire or wires, and with the inverted L type a few inches from the end.

All joints should be soldered. If it is not possible to solder the joints, then they should be cleaned and wound round with insulating tape to keep them free from moisture. Stranded wire should be jointed, as shown in Fig. 13, by separating the strands at the end of the lead-in wire and splicing with those of the aerial, and

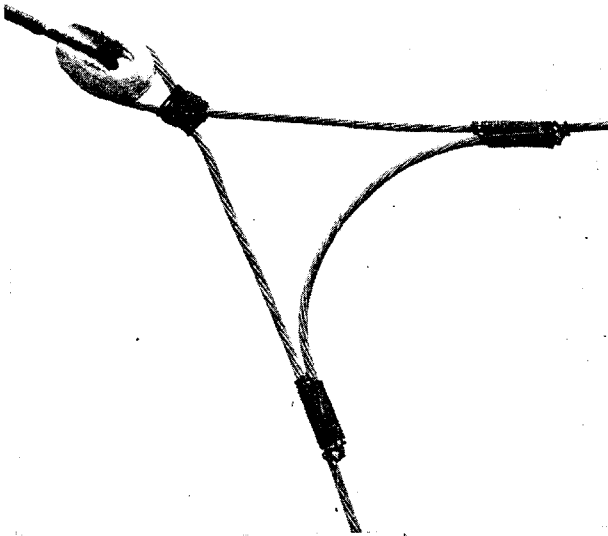

SINGLE-WIRE AERIAL

Fig. 15. How the bight of a single-wire aerial and lead-in should be wired and bridged

the ends twisted neatly round. A single-strand wire is jointed as shown in Fig. 14, being twisted evenly round. When the aerial wire is brought through an insulator and then down to the leading-in tube, the bight should be wired and bridged as shown in Fig. 15 to ease the strain on the aerial and provide a better electrical path. The insulation for aerials must be the highest possible. Over-insulate rather than under-insulate. A number of small insulators in series is better than one large insulator. One of the chief troubles of receiving and transmitting is caused by inattention to the insulation. The mast itself and its supporting guy ropes may be insulated to add to the general efficiency of the receiving or transmitting system. Glazed porcelain makes one of the best and cheapest insulators. Fig. 16 shows the proper method of attaching the halyard used for hauling up the aerial wire to a barrel insulator.

As large a contact as possible with the earth should be made, and the earth lead should be as short as possible. Connections to the earth may be made through a water pipe by attachment of the earth lead to an iron pipe or metal plate em-

bedded well into damp ground. Fig. 17 shows an earth plate connexion. Gas pipes do not make a good connexion for the earth. Fig. 18 shows the chief component parts which are required for the aerial, and also some of the



AERIAL WIRE SUPPORT

Fig. 16. Proper method of attaching halyard to barrel insulator

various types of insulators which may be used.

The aerial wires and the earth act as two plates of a condenser, and the air between them is electrically stressed whenever currents surge up and down the aerial. If the earth connexion is poor, therefore, little energy is absorbed from the wireless waves. Where the soil is usually dry the aerial may be earthed to a network of wires laid on the ground directly beneath the aerial wires or a network insulated from the ground known as a counterpoise aerial (*q.v.*).

Greater care must be taken with indoor aerials to see they are not fitted too close to gas or water pipes, electric wires, metal roof, radiators, etc.

A lightning arrester (*q.v.*) should form part of every aerial system.

For transmitting aerials the cage type is one of the best for the amateur who is limited in the power he may use. A

flat-top inverted L or T aerial with four 19-gauge copper wires will give good results. The aerial should be so constructed that the wires do not sway about. A counterpoise aerial will add to the efficiency of the transmission. For a given aerial current the range of transmission depends, other factors being equal, upon the square of the height. In transmitting, efficiency depends, even more than in receiving, on insulation. For spark coil sets, for example, a four-wire aerial should have two porcelain cleats in series at the ends of each wire, and two in series at each end of the entire aerial. Lead-in insulation is important. Quarter-inch H.T. cable passed through a porcelain tube gives enough protection for spark coils.

The insulation may be tested by means of any of the Megger or other testing sets used for measuring the insulation of electric house wiring. The insulation is greatest in dry, frosty weather, and worst in wet weather, so the tests should be tried in various kinds of weather.

High-frequency or oscillating currents are not uniformly distributed over the cross-section of a wire, but are most dense on the surface. Therefore, to keep the H.F. resistance low the wires should be stranded and the surface ample. The Marconi Company use bronze wires woven over a flexible core of non-conducting material. This increase of surface area



AERIAL : EARTH PLATE

Fig. 17. The aerial system is incomplete without the earth connexion, since the aerial wires and the earth beneath act as two plates of a condenser. Earth connexion, therefore, should be as large as possible.

also decreases any losses which may be caused by brush discharge.

Wave-length of an Aerial. The natural wave-length of an aerial depends upon the total length of the aerial circuit. This length is measured from the farthest end of the longest aerial wire to the point where the grounding system enters the earth. This natural wave-

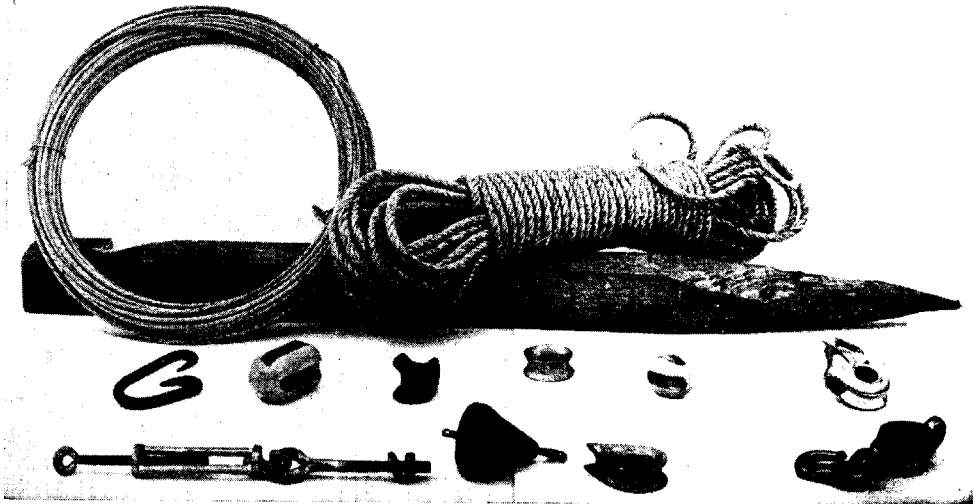

COMPONENTS OF AN AERIAL SYSTEM

Fig. 18. Parts of an aerial before erection are shown. These include a selection of parts, all of which may be varied according to local conditions and type of aerial to be constructed

length is never found in practice. Local conditions—as proximity of trees, houses, telegraphic or telephonic lines, materials of aerial mast constructions, lie of the land, and so on—all affect the natural wave-length to such an extent that it is impossible to do more than make an approximate calculation as to a suitable length. The natural wave-length of an aerial often works out, however, to be about 4.5 times its aerial length. In a T aerial, for example, this latter length is the length from one end to the centre of the aerial plus the length of the lead-in.

The wave-length of an aerial depends upon two things, its capacity and its inductance. The capacity should be as open as possible, so that, from that point of view, the aerial should be as high as possible. As, however, the wave-length depends upon the product of the capacity and inductance, it is clear that for a given wave-length the capacity and inductance must be varied with one another to conform to practical considerations.

Aerial Capacity and Inductance

As far as possible the capacity of an aerial system should be confined to the aerial wires and the earth below them, and the inductance coil should have as little capacity as possible. Capacity in the inductance coils does not allow of sharp tuning. To draw an analogy, capacity and inductance are like oil and water. They are both excellent separately, but mixing them has a deleterious effect on both. As little wire as possible should be used in the inductance part of an aerial, to lessen the capacity and the resistance, and the coil should be wound to give the maximum inductance for its length.

The effectiveness of an aerial as a receiver depends upon four things: (1) Resistance, (2) Capacity, (3) Fundamental wave-length, (4) Inductance.

The resistance should be as low as possible. High-frequency or radio-frequency currents flow on the surface of a conductor largely, and therefore the surface area of the aerial wires should be as large as possible. Therefore use stranded cable in preference to single wire. The resistance of an aerial system cannot be calculated theoretically, though it may be approximated to. In electrical work, and even more specially in wireless work, it is best to measure the resistance with a Wheatstone bridge or an ohmmeter.

The fundamental wave-length of an aerial is that wave-length to which it will respond when directly connected to the earth. Thus if an aerial has a fundamental wave-length of 200 metres, a transmitting station sending out waves of this length will cause electrical vibrations or oscillations to be set up in the receiving aerial.

The capacity of an aerial may be calculated, due allowance being made for local conditions, and it may also be measured. The same statement applies to inductance.

Capacity of Aerial Wires. Professor Howe has given a formula for the capacity of a number of parallel wires such as are used in aerial construction. For two parallel wires the capacity, in electrostatic units, is:

$$\frac{l}{2 \log_e (l/d) + \log_e (d/r) - 0.618}$$

where l is the length of each wire, d the distance between them, and r their semi-diameter.

For three wires:

$$\frac{3l}{2 \{ 3 \log_e (l/d) + \log_e (d/r) - 1.387 \}}$$

and for four wires:

$$\frac{2l}{4 \log_e (l/d) + \log_e (d/r) - 2.526}$$

All lengths are in centimetres. The capacity of a number of parallel wires, if they are all close, is considerably less than the sum of the capacities of each wire taken separately.

Finding the Wave-Length

The basic formula for the wave-length is:

$$\lambda_m = 1885 \sqrt{LC}$$

where λ_m is the wave-length in metres, L the inductance in microhenries, and C the capacity in microfarads. This formula lends itself to an alignment chart or a series of curves. Under the heading Alignment Chart the particular chart for this wave-length formula is given.

It will be observed that for any given wave-length there are a series of capacities and inductances which may be chosen to obtain it. For example, an inductance of 750 microhenries and a capacity of .0001 microfarad give the same wave-length as an inductance of 250 microhenries and a capacity of .0003 microfarad.

In an aerial system the inductance and capacity are partly localized and partly

distributed, and the calculations for the wave-length must take this into account.

The following formula, due to Dr. L. Cohen, determines the wave-length of an aerial with an inductance in series for uniformly distributed inductance and capacity. The formula is:

$$\lambda_m = \frac{1885 \sqrt{L_0 C_0}}{Q}$$

where $\cot Q = QL_1/L_0$

$$Q = \frac{1}{2} \pi \lambda_0/\lambda_1$$

and

L_1 = added inductance in microhenries.

L_0 = inductance of the aerial.

C_0 = capacity of the aerial.

λ_0 = natural wave-length of the aerial in metres.

λ_1 = wave-length of the aerial when the inductance L is in series.

The plotting of curves from the equations

$$y_1 = \cot Q$$

$$y_2 = L_1 Q / L_0$$

gives points of intersection for the values of Q . The first intersection only is required and gives the fundamental wave-length.

A similar formula applies for the case of an aerial tuned to another wave-length by a series condenser. Then

$$\lambda_m = \frac{1885 \sqrt{L_0 C_1}}{S}$$

where $\tan S = -S C_1 / C_0$

and $S = \frac{1}{2} \pi \lambda_0 / \lambda_1$

where the symbols have corresponding meanings to those given for the inductance formula above.—*J. L. Pritchard, F.R.Ae.S.*

Aerial Construction. There are many ways of actually erecting the aerial, and the final choice will depend entirely upon local conditions. A pair of tall trees may naturally supply obviously ideal supports for an aerial in one instance, whereas in another the amateur will find considerable difficulty in erecting even a single pole,

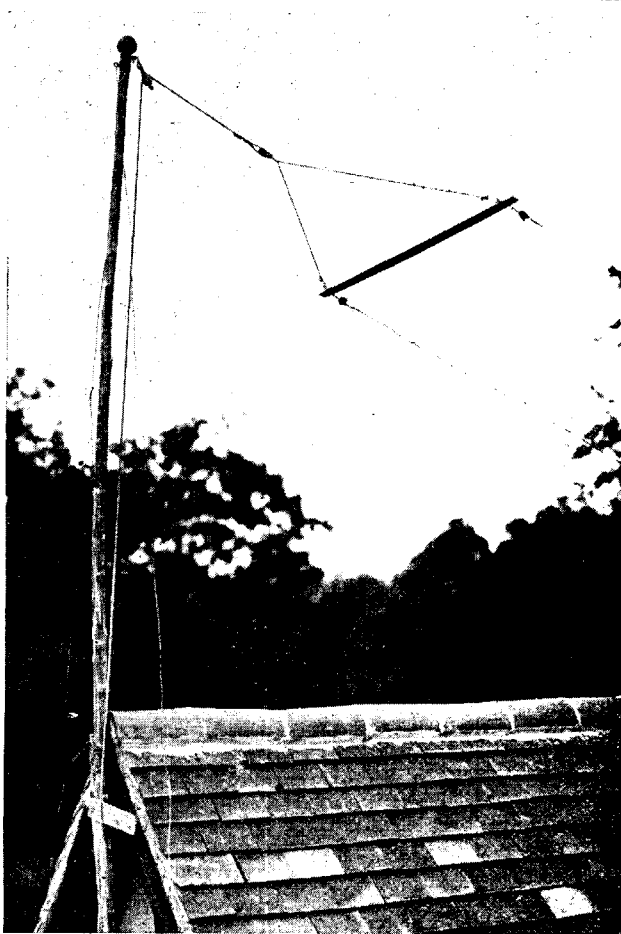

ROOF AERIAL ERECTION

Fig. 19. A simple method of erecting an aerial mast on the gable end of a roof

there not being enough room to stay it properly with the usual guy ropes. Of the available means of supporting the aerial, however, the use of a single pole or mast is perhaps the simplest. The simplest way of attachment is to the gable end of a roof, as shown in Fig. 19. If the amateur is able to obtain a pair of old telegraph poles he will find that he has a support for his aerial wire or wires which cannot be bettered. If he wishes to have more than one wire—say, three or four—he can fasten each to a cross-piece on the pole. This cross-piece should be notched and bolted to the pole. By this form of construction the use of spreaders may be avoided, and the swaying of the aerial in a wind considerably lessened, if not entirely eliminated. The wires will have to be

insulated on the cross-pieces. The method is shown in Fig. 20, and the method of staying and erecting the poles is similar to that described below.

In the absence of telegraph poles all that is required is a long, straight, sound scaffold pole, about 6 in. in diameter at the bottom and tapering to 2 in. or so at the top. It should first be cleaned upon the surface, the bark removed, and the whole well creosoted, or painted with other preservative paint, such as white enamel. The latter looks very well directly after the pole has been erected, but soon gets discoloured, and when it has to be re-enamelled it generally means taking down the pole. Consequently, the most durable finish is to creosote it thoroughly. The pole, if possible, should be obtained properly creosoted under pressure, as, so treated, its life is considerably lengthened.

When required to stand alone, a sufficiently deep hole, Fig. 21, must be dug in the ground to receive the foot of the mast, and the depth of this hole will have to be determined from the condition of soil, as if it is soft and shifting like sand, the hole must be much deeper than would be necessary if it were stiff clay or any heavy soil. Roughly speaking, for every 10 ft. of mast that is above the ground, there should be at least 1 ft. beneath the ground, so that an ordinary pole 40 ft. high



FOUNDATION FOR AERIAL MAST

Fig. 21. Showing the base of an aerial mast placed in the hole close to the side on which the aerial wires are supported

would require a hole about 4 ft. deep. As the chief pull on a pole mast is in the direction of the aerial, it follows that the hole should be dug with this side vertical, so that the mast pulls against the solid and undisturbed ground, as in Fig. 21. The ground behind the pole may be dug away to a slope to facilitate the work of erection. A piece of stone or some solid durable

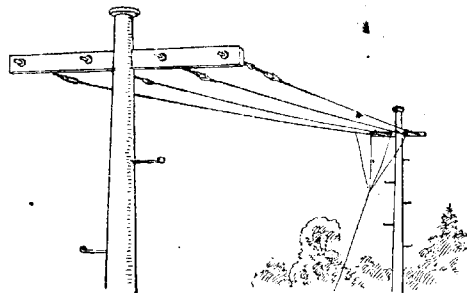

AERIAL MASTS

Fig. 20. Old telegraph posts used to support an aerial. The cross-pieces are notched and bolted to the poles

material is then placed at the bottom of the hole, the pole rested upon it and extended along the ground in line with the line of the aerial. The requisite number of stays, or guy ropes, are then obtained and fitted to the mast, as detailed later, and good, sound stakes driven into the ground to which they will be connected. The pole can then be lifted up by two men, while two others haul upon the guy ropes towards the front and sides of the pole. If a ladder, or long, straight piece of timber with a forked piece at the end of it, is available, this can be propped up under the pole while it is being elevated, and will considerably lighten the load. Just as the pole is reaching its vertical position, all must take care that it is not pulled over too far, as the pull of the pole on the ropes is small when it is nearly vertical, and unless this point is watched, the pole may easily be pulled down again.

Having got it more or less vertical, three persons should be detailed to hold the three stay wires, so that there should be no fear of the mast toppling over. Meanwhile, the earth is shovelled into the hole, and thoroughly well rammed and consolidated with a rammer as much as possible. After about a foot of the earth has been rammed into the hole, the mast can be straightened up by hauling on the guy ropes, which can then be fixed to

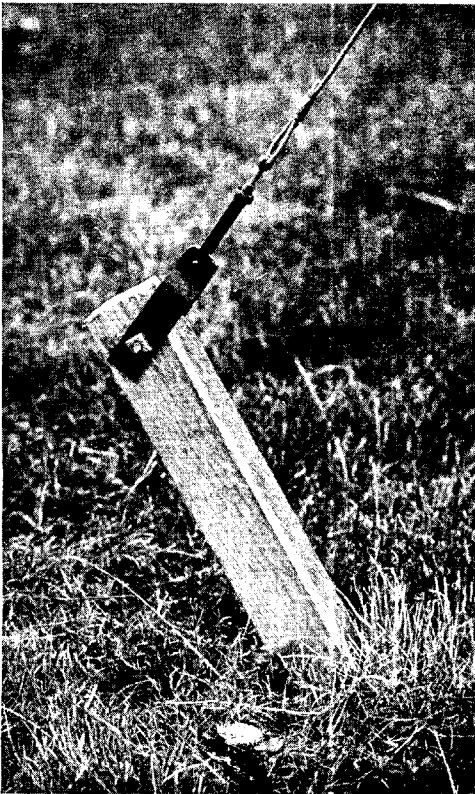

AERIAL GUY STRAINER

Fig. 22. An adjustable strainer for tightening the guy ropes supporting an aerial mast is attached to the ground stake

adjustable strainers, as in Fig. 22, in the stakes and the wires tightened up and adjusted until the pole is quite upright. The rest of the earth may then be filled in, and the whole thoroughly well rammed and consolidated.

If preferred, the mast may be embedded in concrete, which can be poured around its foot. Alternatively, the concrete may be prepared beforehand, and a hole formed in the centre of it, into which the foot of the mast will ultimately be placed. This hole can be made by putting a piece of round wood in position and pouring the concrete around it, afterwards withdrawing the wood, to do which it should be previously saturated in paraffin or creosote to prevent the concrete from adhering to it. This has the advantage that the concrete can be allowed to set hard before it has to withstand the pull of the mast.

A very secure anchorage for the guy wires is illustrated in Fig. 23, and consists

of digging a hole in the ground, and in the bottom placing a mass of concrete. While this is still wet, a stout iron bar, with the lower end turned over at an angle, is forced well down into the concrete, which should then be rammed and consolidated as much as possible. When the concrete has set, the earth is shovelled into the hole and rammed tightly. It should be prepared at least a fortnight before the guy wires are to be fitted, so that the concrete can set fairly hard before it is called upon to resist the strain. In many of the big transmission and receiving aerials all the strainers for the guys are embedded in concrete blocks, each weighing several tons. Such an anchorage is much more secure than a ground anchorage and is not affected by the changing character of the soil due to weather conditions.

Two-Part Aerial Pole Mast. The construction of a two-part pole mast shown in Fig. 24 can be carried out along the following lines. The lower mast should be longer than the top as well as larger



GUY ROPE ANCHOR

Fig. 23. Aerial guy ropes are sometimes anchored in the manner here shown

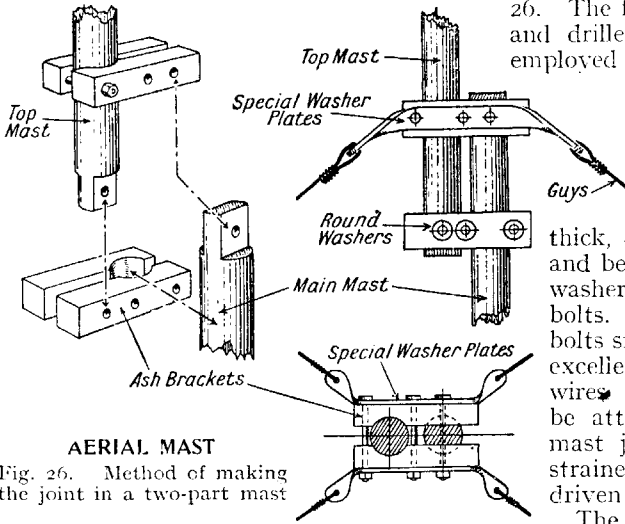

AERIAL MAST

Fig. 26. Method of making the joint in a two-part mast

26. The free end of each mast is notched and drilled, and coach bolts should be employed to bolt the clips into position, as they have heads with square necks suitable for wooden constructions. Bolts $\frac{3}{8}$ in. in diameter for 2 in. masts are of ample size. Strips of iron, about 1 in. wide and $\frac{3}{16}$ in. thick, drilled with three holes in each, and bent as shown, should be used as washer plates for the upper set of bolts. These will not only prevent the bolts sinking into the wood, but make excellent attachments for the guy wires. Four such stay wires should be attached star fashion to the top mast joint, and terminate with wire strainers shackled to stout posts driven well into the ground.

in diameter. To join them together, two pairs of metal or wooden clips will be required, as shown in Fig. 25. The distance between the upper and lower clips should be not less than three times the diameter of the mast, i.e. 6 in. for a 2 in. mast. The method of making the joint with ash strips is shown in Fig.

The upper masthead, Fig. 27, should be fitted with a cap and pulley. A wire rope (galvanized) passes over it long enough to allow the aerial to be lowered for subsequent attention to the insulator. The pulley, if of iron, should be thoroughly covered with vaseline before the mast is erected, and should be firmly attached to the masthead. The method of fixing



AERIAL SUSPENDED FROM CHIMNEY STACK

Fig. 29. How a galvanized iron strap should be fixed round a chimney to take the aerial wire. This method is adopted to avoid wall hooks, which have to be driven into the mortar

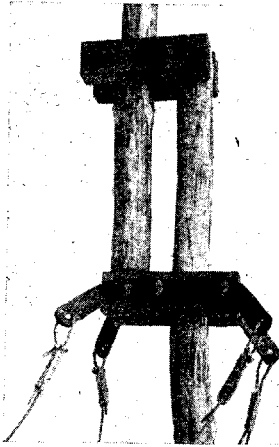

Fig. 25. How the two poles are joined

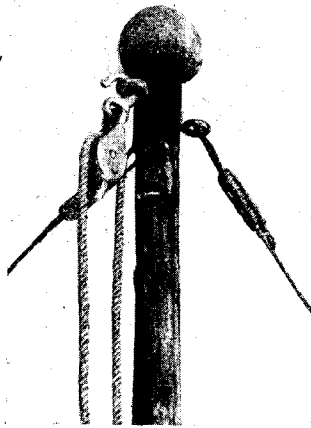

Fig. 27. Cap and pulley on masthead

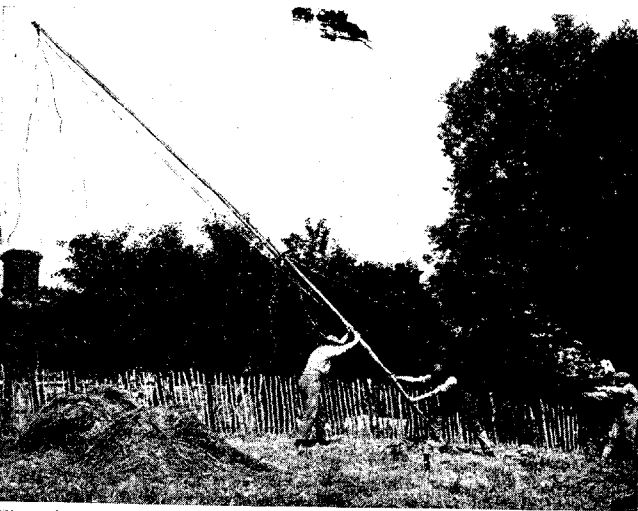

Fig. 28. Guy ropes being used as aids during erection of the two-part aerial mast

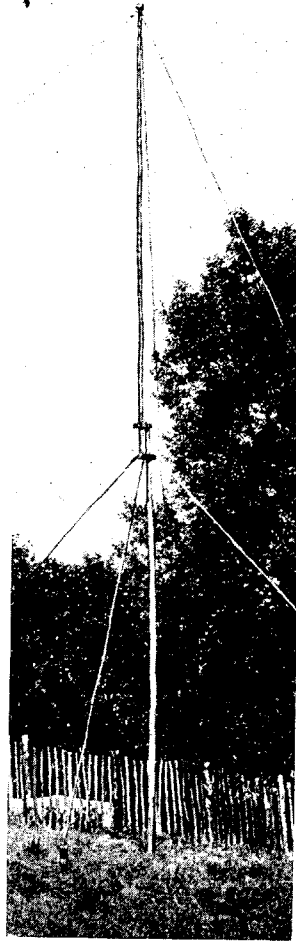

Fig. 24. The two-part mast completed and erected

CONSTRUCTION AND ERECTION OF A TWO-POLE AERIAL MAST

will depend upon the type of pulley purchased, but a reliable type hooks into the mast band with a narrow eye through it. Fig. 28 shows how such a mast is erected by three men as already described, two being engaged on the actual lifting and one taking charge of the guy ropes ready to fix them when the pole is erect.

To fix the other end of the aerial to a wall of the house or a chimney-pot requires careful consideration. It is better to rely on a galvanized iron strap round the stack than to trust to a wall hook driven into the mortar joints. Such a

construction is shown in Fig. 29. If the house end of the aerial is attached to woodwork, the latter should be examined and tested to see if it is strong enough to resist the outward pull of the wire.

The lead-in wire should be wound round and soldered to the aerial at a point 3 ft. from the insulator next to the house, where it passes through the wall to the instruments. Rubber-covered cable should be employed, such as is used for the high-tension wiring of a motor-car. A proper leading-in tube should be fitted through the wall or through any convenient woodwork.

Lattice Mast. The construction of a lattice mast in wood is not at all a difficult matter. The example illustrated on the folding plate facing this page (Figs. 35 to 45), measures some 36 ft. in height, and is made of ordinary deal. The side pieces are 2 in. wide and 1 in. thick, and the lattices are 1 in. wide and $\frac{1}{4}$ in. thick. These are nailed securely to the side pieces with 1 in. wire nails. The cross-ties are 2 in. wide and 1 in. thick, and well screwed together. The joints between the sections are effected by scarfing, that is, the two ends are cut off at an angle and the two faces brought together and secured by a bolt passed through them, while the two ends are bound together with copper or soft galvanized iron wire, and are further supported by the cross-ties. At the bottom the side pieces are supported by two pairs of stout stakes driven into the ground side by side, Fig. 38, leaving a gap wide enough to insert the side pieces of the mast. The top of the mast is completed by a cross piece and capping as seen in Fig. 37.

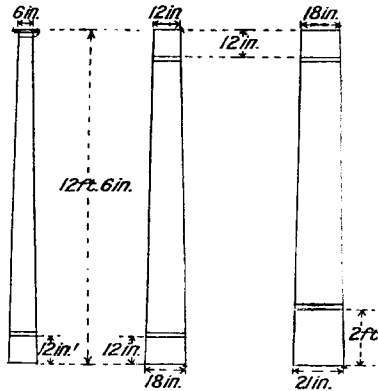

AERIAL LATTICE MAST

Fig. 30. Dimensions of three side members for the mast illustrated on the folding plate

In the construction of such a mast the best way is to prepare the separate side members first, and lay them on the ground or on some convenient and flat surface. The sections can be made up one at a time if the overall dimensions be carefully adhered to and the side members be laid out to the dimensions given in Fig. 30. They may then be temporarily fixed in place with pegs driven into the ground and the cross pieces cut to length and screwed in place, as shown in the outline diagram.

The foot of the mast is shown in Fig. 31, where the lower pieces are seen in place at a distance of 24 in. from the bottom. The scarfed joint between the sections of the mast is shown in Fig. 32, where the cross pieces are shown attached to the upper side pieces and the bolt in position through the scarfed joint. Parts of the lower cross pieces are shown cut away to make the arrangement of the joint clearer.

A similar joint is made between the upper and the top sections of the mast, and all the cross pieces are reinforced with a band of stout hoop iron. The top section of the mast is shown in detail in Fig. 33, with a plan of the ironwork. The cap is a piece of 1 in. wood screwed to the top of the side pieces, and the iron band is attached beneath it with screws or nails. The projecting ears are for the support of the aerial pulley.

When all the cross pieces have been fixed in one section the lattices are cut to size and nailed in place, an operation that is most conveniently performed when the mast rests on the workbench. Should the mast section be much longer than the bench, as is often the case, the overhanging part of the mast is easily supported on a temporary pair of trestles or on a tall box.

To ensure the best results place a solid block under the part where the lattices are being nailed, as unless the mast side rests firmly it will spring, and the nails will work out again.

Strong eye-bolts are then passed through the lattice work to support the ends of the stays, which, in this case, need only be arranged at right angles to the lattice,

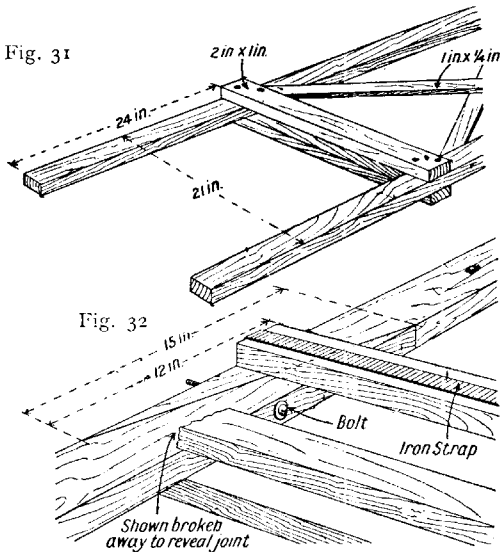

CONSTRUCTIONAL DETAILS OF THE MAST

Fig. 31. Foot with cross pieces. Fig. 32. How the scarfed joint between two sections is made

as the pull of the aerial is largely resisted by the structure of the lattice work. Two back stays are necessary to resist this load.

Strong stakes are driven into the ground, one on each side of the mast and in line with the bottom of it, and a third is driven into the ground at the back of the mast. The stay wires are attached to it, and the strainers to the stakes.

The three sections of the mast are then laid out upon the ground, and the lower one bolted loosely to the front pair of stakes in such a position that when it is turned on this bolt, as on a hinge, the feet of the lattice will bear upon the surface of the ground. This can be tested by placing the lowest section in position. Another hole is then drilled through the back pair of stakes in readiness, and the bolt left on the ground so that it will be ready to put into the hole as soon as the mast is erected.

Having prepared the bottom support in this way, lay the three sections on the ground in an upright position, and bolt the scarfed joints together, finishing them off by binding as previously described. Tie a separate piece of timber, about 4 in. wide and 1 in. or so in thickness, in

an upright position in the middle part of the lower section, as shown in Fig. 43, and to this attach a rope, which is led to the top of the mast, around beneath one of the lattices, back to

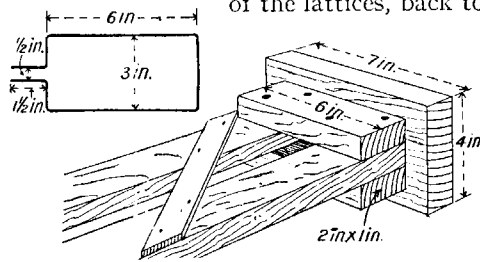

DETAILS OF THE MAST TOP

Fig. 33. Top of the mast with wooden cap and (above) plan of the iron band screwed beneath the cap to take the aerial pulley

the centre part of the pole, up again to the connexion between the middle and top parts of the mast, and then to the bottom. Also arrange another pair of wires from the top of the mast so that this can be pulled upon and used as back stays.

Fig. 43 shows the preliminary stage of lifting the mast, and Fig. 44 the mast almost erect and well supported by the stay ropes.

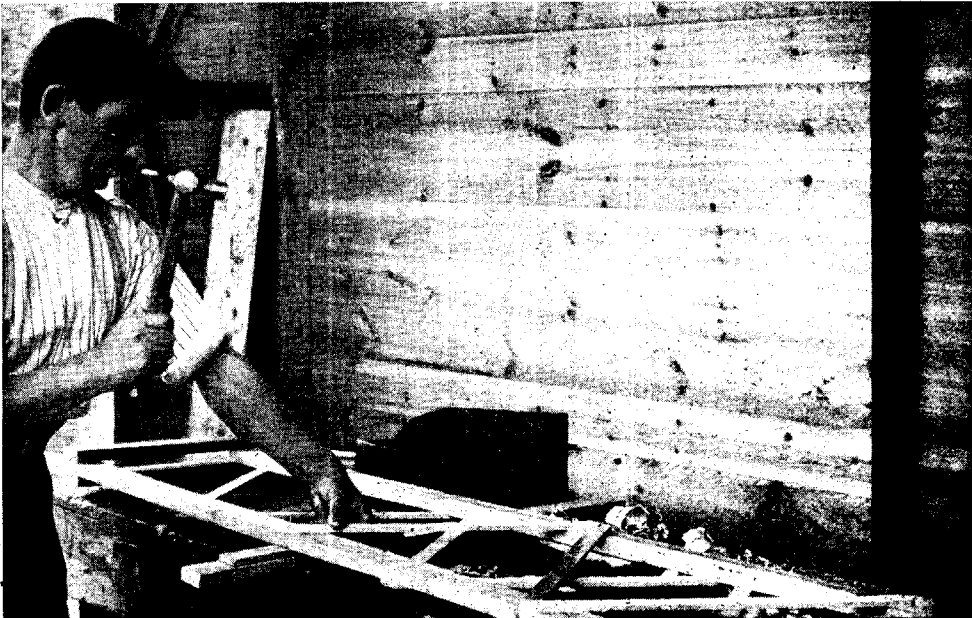

MAKING THE SIMPLE AERIAL LATTICE MAST

Fig. 34. Putting together one of the sections of the mast in the workshop, showing its essential simplicity and soundness of construction. Building and erecting the mast are fully illustrated on the plate facing page 44

Steel tubular masts are dealt with in this Encyclopedia under the heading of Tubular Mast, and other forms of construction are dealt with under the headings Bamboo Pole and Box Mast. Fig 46 shows a simple method of erecting an aerial on a roof by means of wooden uprights fixed to a wooden base, that for the ridge being Λ -shaped and simply resting upon it, the others being fixed to the wall. An insulated wire is passed through holes in the supports, and one end taken to the lead-in tube.

Temporary Outdoor Aerials. A temporary outdoor aerial can often be rigged up anywhere in the country within reasonable distance of a broadcast station, to enable the members of a picnic party to enjoy the pleasures of wireless music. Practically speaking, any method by which the aerial is raised sufficiently above the ground and insulated and earthed will do. All that is necessary is to take a coil of suitable wire of, say, 100 ft. in length, and cast it up into the topmost branches of a

tall tree, taking care that the end of the wire is insulated by means of a good plug of rubber, held in place with a wrapping of tape or some similarly effective method. It may be necessary to make one or two attempts before the wire will stay up in the tree, and the other end will then be connected to the apparatus. A cord may be thrown up, the wire attached, and then hauled over the branches. The earth connexion should be made, where water is available, by running the wire to it, and attaching to the end of the wire a tin can or any other metallic object and immersing it in the water. Otherwise, attach the earth to a stout iron bar, if such a thing can be found on the site of the picnic, or any metallic object may be used which can be laid upon the ground, as a roll of galvanised iron wire netting.

When all else fails, lay out the coil of bare wire on the ground and press it down firmly. If there is any choice in the matter, set it in the wettest part of the field. Another method is to attach the lead-in

wire to a wire or iron fence, Fig. 47, making a good metallic connexion by filing off the paint or other covering until the bare metal is visible, and winding a piece of copper wire tightly around it for an inch or so. This will make a very good connexion. The earth connexion should be made with a separate coil of bare wire laid upon the ground.

With such an arrangement tuning difficulties will be apparent, as really the wire-fence aerial may be much too large, or possibly may be much too small. In which case the correct wave-length can be found by fitting two or three fixed condensers of different values, setting these in series or parallel, or shunting them according to the conditions. Another method is to use a large capacity variable air condenser. A little experiment will soon show the best adjustment. If it is possible to pick up Morse without much tuning, and if the code can be read, it is often the means of ascertaining the wave-length

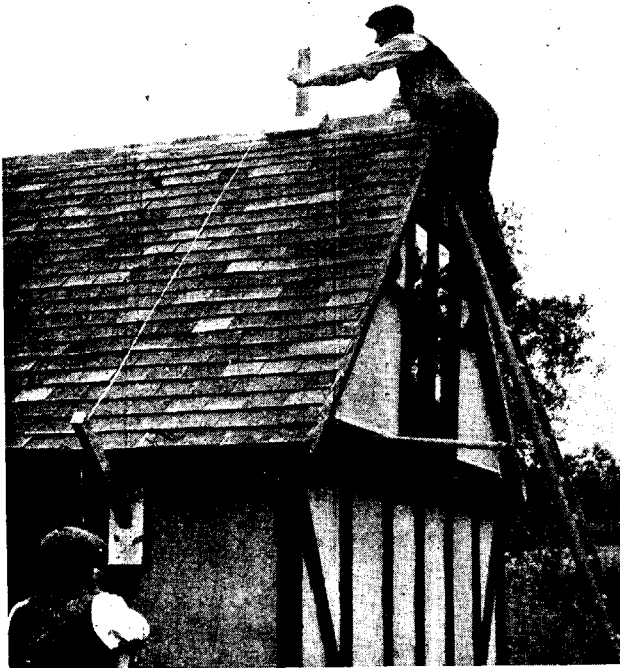

SIMPLE FORM OF AERIAL ON ROOF

Fig. 46. A wooden upright is fixed to a wooden base and placed on the ridge of the Λ -shaped roof saddlewise. An insulated wire is passed through a hole in the upright and then through a hole in a similar support attached to the wall

that is being received, assuming that a wave-meter is not available.

A directional aerial may be rigged up very quickly between two trees, and will give good reception under suitable conditions. The most important item is that the aerial should point in the direction of the nearest broadcast station. A simple way to fix up the aerial wire is shown in Fig. 50, and consists of tying insulators to a short length of cord, and tying the other end of the cord around the tree trunk. Four of these sets of cords are needed, and are tied at the top and bottom of the tree trunk. The aerial wire is then threaded through the holes in the insulators, and the two ends brought down to the receiving set and connected in the usual way. To take the pull of the leading-in wires, they should be fixed to the insulators and tied to two small stakes driven into the ground. The ends of the wire can be provided with insulators, and the two pressed together with the cord. Separate, short leading-in wires should be taken from the aerial to the receiving set. The nature of the signals, and the reception length of the set, will depend to a large extent upon the instrument in use.

Naturally, a valve set with amplifiers is more likely to give satisfactory results, but when reasonably near to the broadcasting station, a simple crystal set will give quite satisfactory results. But the distance for clear reception will, in any case, be less than that which will give a corresponding reception on a twin aerial thirty or forty feet high.

Another form of aerial suitable for use when a receiving set is taken on a short trip is that known as the ground aerial. This is simply two long lengths of bare copper wire, which are laid out on the ground and pressed down to firm contact. The receiving set is wired to one end of each of the wires so that it is in the centre of them. Tuning difficulties will have to be met by the use of a tuning system with a wide selectivity covering a long range of



WIRE FENCE AS A TEMPORARY AERIAL

Fig. 47. The four wires shown are part of a wire fence. The lead-in wire is connected to the top wire and if tuning is carried out carefully fairly good results can be obtained on a dry day

wave-lengths, or by the use of loading coils or condensers. Each individual rig-up will have to be tuned and adjusted to meet local conditions. When a powerful valve set is available, such as can often be carried on a motor-car, reception can be obtained by the use of a small frame or loop aerial, or, with some regenerative systems, without the use of an aerial at all.

Indoor Aerial Construction. Indoor aeri-als can be rigged up in all manner of ways, limited mostly by the ingenuity of the owner. Among the various methods that have been tried and found successful are the use of the wire springs or mattress of the bedstead, a length of copper wire wound around the legs of a table, a galvanised iron or other metal roof, or even the use of galvanised iron wire netting laid under the carpet; but all such arrangements are in the nature of makeshifts.

A better arrangement is to run a bare single copper wire around the cornice or picture rail of the room, supporting this on little insulated brackets, which can

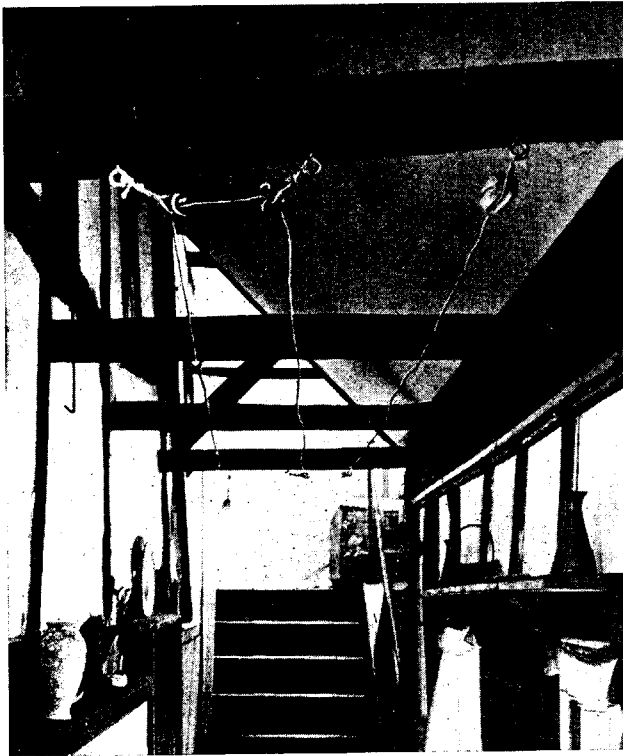

INDOOR AERIAL

Fig. 48. A three-wire aerial supported from screw-eyes by cords and insulators. The position is over a stairway and sufficiently high to avoid contact when walking up the stairs

either be purchased ready for use or rigged up in the manner illustrated in Fig. 49. The exact details of construction will have to be modified according to the facilities available in the room. Generally, however, a picture rail is present, and the brackets can be made up by fixing a rod of ebonite to an ordinary picture hanger. Part of the rod is notched by sawing it half-way across and at a small angle. Another notch is cut three or four inches nearer the wall for securing the wire, thus supporting the wire and keeping it up in a tidy manner.

The wire is then merely rested in the slots cut in the rods and worked around carefully so that it is not too tight, and the wire connected in the usual way to a leading-in wire and thence to the receiving set. Unless the wire is arranged in the form of a loop aerial, the ends are both brought to the receiving set in the manner shown in many of the diagrams in this Encyclopedia.

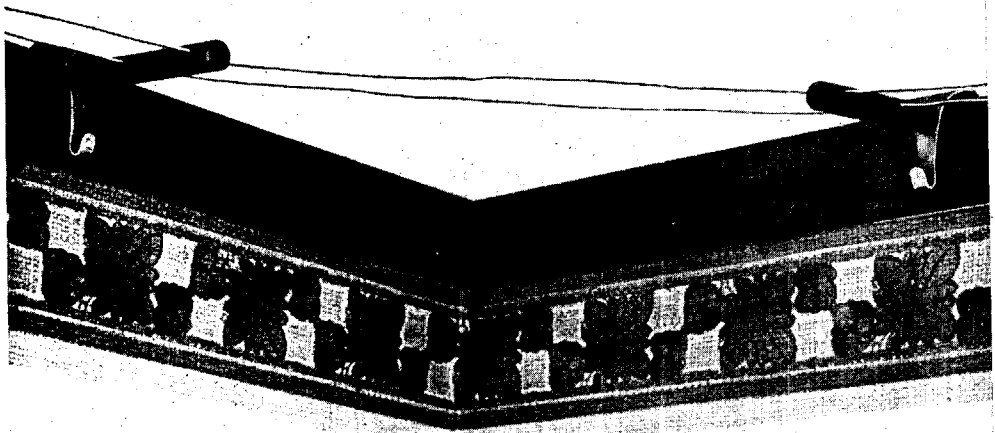

PICTURE HOOK AERIAL SUPPORTS

Fig 49. The aerial shown is of single copper-wire and threaded through insulators attached to picture hooks. The insulators consist of ordinary ebonite tubes

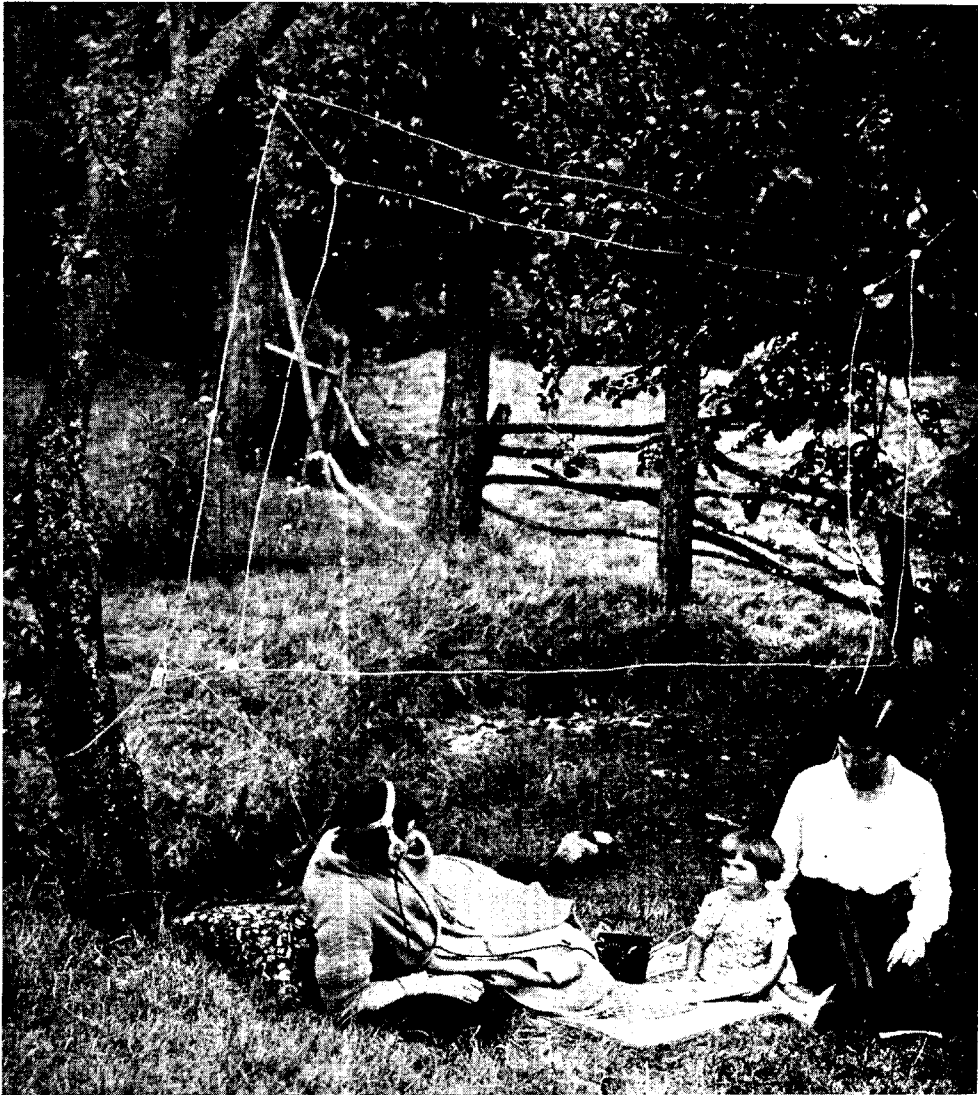

DIRECTIONAL AERIAL FOR TEMPORARY OUTDOOR USE

Fig. 50. An aerial is shown suspended between trees, and pointing in the direction of the nearest broadcasting station. The lead-in wires are fixed to insulators and tied to small stakes in the ground. Both ends of the aerial wire are brought down to the instrument.

Another method is to run a light-cord across the ceiling a few inches from it, supporting the ends by means of screw eyes or hooks and stretching the cord tightly. A number of insulators are threaded on to the cord before it is put up, and then the aerial wire is threaded through the insulators in such a way that it hangs in the form of a large diameter coil spring with the coils spaced about 12 in. apart. One end is made fast to the end insulator, which should be tied firmly

to the cord, and the other end is turned down and led direct to the receiving set. Often this can be so placed that the aerial will not touch the wall and need not be insulated. The same arrangement can be fitted if the cord slopes up, except that each of the insulators must be tied to it.

Fig. 48 shows a simple arrangement of indoor aerial, which consists of insulators attached to screw eyes by means of cords supporting a three-wire aerial over the staircase.—*E. W. Hobbs, A.I.N.A.*

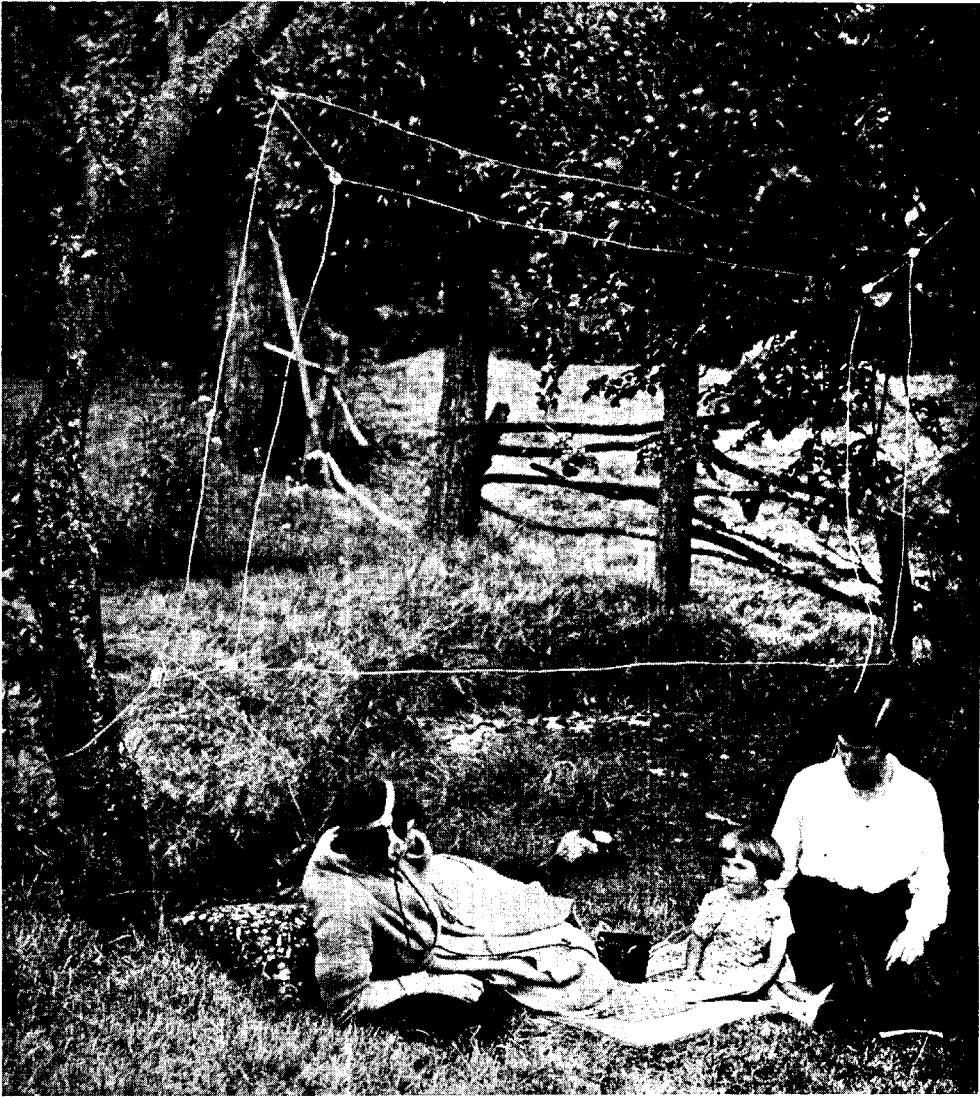

DIRECTIONAL AERIAL FOR TEMPORARY OUTDOOR USE

Fig. 50. An aerial is shown suspended between trees, and pointing in the direction of the nearest broadcasting station. The lead-in wires are fixed to insulators and tied to small stakes in the ground. Both ends of the aerial wire are brought down to the instrument.

Another method is to run a light cord across the ceiling a few inches from it, supporting the ends by means of screw eyes or hooks and stretching the cord tightly. A number of insulators are threaded on to the cord before it is put up, and then the aerial wire is threaded through the insulators in such a way that it hangs in the form of a large diameter coil spring with the coils spaced about 12 in. apart. One end is made fast to the end insulator, which should be tied firmly

to the cord, and the other end is turned down and led direct to the receiving set. Often this can be so placed that the aerial will not touch the wall and need not be insulated. The same arrangement can be fitted if the cord slopes up, except that each of the insulators must be tied to it.

Fig. 48 shows a simple arrangement of indoor aerial, which consists of insulators attached to screw eyes by means of cords supporting a three-wire aerial over the staircase. - *E. W. Hobbs, A.I.N.A.*

AERIAL CURRENT. The current in an aerial system measured at an antinode of current. See Antinode; Root Mean Square; Wave; Transmission.

AERIAL EFFECT. A non-directional disturbing effect occurring in a directional receiver, due to lack of symmetry in the disposition of stray capacity in the receiving apparatus.

AERIAL RESISTANCE. The total effective resistance offered by an aerial system at a particular wave-length. The figure expressing this resistance, multiplied by the square of the aerial current, is a measure of the total power dissipated by the aerial, the radiated power being included. See Resistance; Transmission.

AERIAL SWITCH. Any form of a switch included in the aerial circuit for the purpose of diverting the path of the incoming waves. There are numerous constructive differences in such switches.

In one, a simple piece of metal is free to turn about a pivot mounted at one end of an insulated base, and making contact with another piece at the other end of it. It should be mounted on an ebonite or porcelain base, with neat but

substantial contact pieces made of stout copper. A common application of such switches in the ordinary receiving aerial circuit is to divert the path of the ether waves, so that they can at will be sent to the receiving set or to earth. This type of switch is often known as an earth switch, as it earths the aerial when the contact arm is turned in one direction.

A neat and efficient aerial switch is the Elwell, shown in Fig. 1, and incorporates an air gap or lightning arrester. When the switch arm is in the position shown, the receiving set is disconnected and the ether waves are conducted to earth, as the aerial lead-in

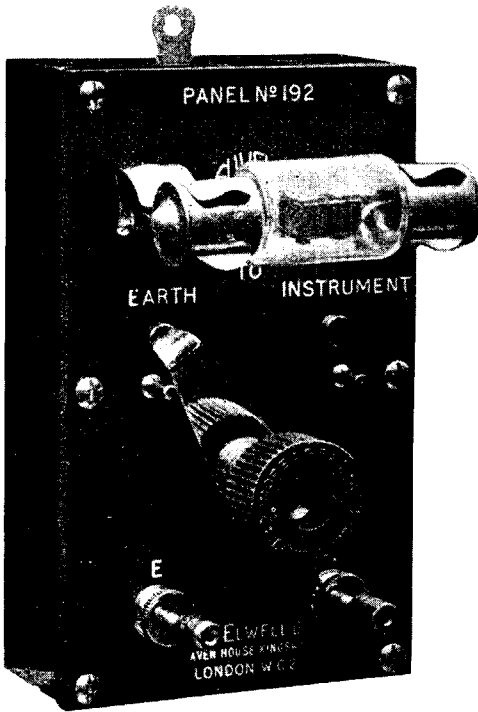

AERIAL-EARTH SWITCH
 Fig. 1. The lightning arrester is not permanently fixed in the Elwell earth switch, but is held by clips which are also conductors

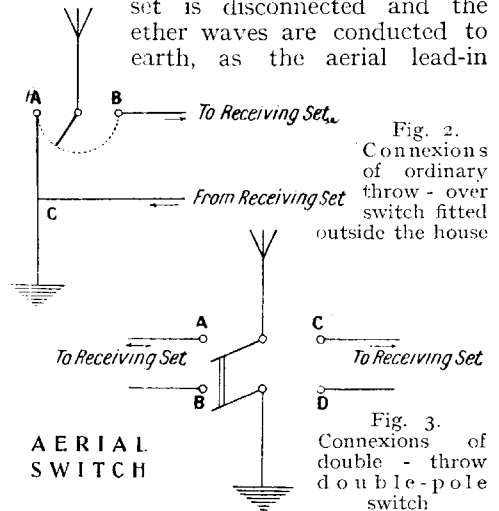

Fig. 2.
 Connexions of ordinary throw-over switch fitted outside the house

Fig. 3.
 Connexions of double-throw double-pole switch

wire is attached to the contact arm through the agency of a contact piece. The earth wire C is attached to the left-hand contact stud as at A in Fig. 2, the wire to the receiving set to the right-hand stud B. The lightning arrester is always in circuit. Hence, to protect the set, or to disconnect it when not in use, only necessitates throwing the switch arm from contact B to the other contact, A.

Aerial switches are also used to connect one or more circuits to the receiver, enabling one or the other to be used as desired. Such a switching arrangement is illustrated in Fig. 3, and shows how a double-throw double-pole switch is connected. When the contact arms are on the studs A B, the left-hand set is receiving. When the arms are on the studs C D, the other set is in operation. And when contact is not made with either, the aerial circuit is interrupted. With this arrangement, a separate lightning arrester is generally added to the aerial circuit.

AERIAL SYSTEM.

The combination of an aerial with its earth arrangements and tuning arrangements. The diagram shows the theoretical circuit, which is one of the simplest forms of an aerial system, consisting merely of a simple inductance with slider and a variable condenser for fine tuning. See Aerial.

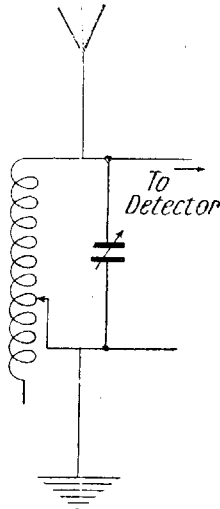

The simplest aerial system

AERIAL TUNING

CONDENSER. This expression, generally abbreviated in diagrams and elsewhere as A.T.C., is used to define all types of condenser employed in the aerial circuit for the purpose of tuning it. A typical example is the variable plate type of condenser with an air space between the plates. In some cases a fixed value condenser is used in conjunction with a variable condenser; the function of the former being to increase or decrease the natural wave-length of the aerial, the latter to complete the tuning.

See Air Condenser; Condenser.

AERIAL TUNING INDUCTANCE.

The name given to all forms of inductance used in the aerial circuit to effect tuning. It is frequently referred to in the abbreviated form A.T.I. A common example comprises a coil of insulated wire wound around a former or insulated tube. One end of the winding is connected to the aerial lead-in wire. Tuning is effected by means of a movable contact sliding over a bared path on the top of the coils, thus providing a contact with every turn of the wire step by step. Other types include a tapped inductance coil (*q.v.*); independent coils of a known capacity suited to specific wave-length ranges; and coils variably coupled by moving them nearer to each other or moving them farther apart.

See Basket Coil; Inductance Coil; Loose Coupler.

AETHER. This is an alternative spelling of ether (*q.v.*).

A.F. Abbreviation in wireless for Audio-Frequency (*q.v.*).

A.G. Abbreviation for American wire gauge. See Gauge.

Ag. Chemical symbol for silver, derived from its Latin name argentum. See Silver.

AGATE. A variegated quartz with distinctive markings. The bulk of commercial varieties are artificially coloured, the bandings or markings being very absorptive. In wireless work, agate is employed in certain forms of loud speakers. See Loud Speaker.

AGGLOMERATE LECLANCHÉ.

A modification of the Leclanché cell in which the porous pot is dispensed with and a mixture of manganese used in the form of blocks or slabs. These are manufactured under pressure and assembled around the sides of the carbon block or element, to which they are secured with rubber bands or other method. A zinc rod is used as in the ordinary Leclanché cell, and the whole is placed in a glass jar filled with the

electrolyte. This is the usual solution of sal-ammoniac.

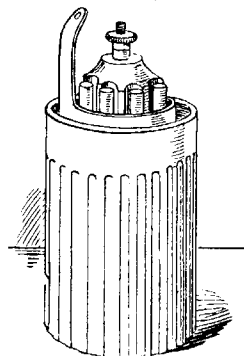

Agglomerate Leclanché cell

In the six-block agglomerate Leclanché cell the blocks are six in number and circular in section. They are assembled around a central carbon element with six grooves around it.

The agglomerate blocks rest in these grooves, and are retained by a canvas wrapping and rubber bands. The zinc is in the form of a plate bent around to encircle the central elements. A connecting terminal is fitted to the carbon block and to the zinc plate. The elements are placed in an open-topped jar containing the usual electrolyte. It is claimed that by this construction the internal resistance is lowered, thus giving a more uniform current. A typical example of the agglomerate Leclanché cell is illustrated. See Leclanché Cell.

AGOMETER. An instrument used either to measure electrical resistance or to vary the resistance of a circuit by means of a column of mercury, the length being adjusted as required. See Wheatstone Bridge.

AGONIC LINES. Lines on the surface of the earth connecting points at which the magnetic needle points to the geographical north and south. They are also called lines of no variation or declination. There are two such lines. One, starting from the north magnetic pole, runs across Canada, the United States, and South America, fairly straight to the south geographical pole; the other, from the south magnetic pole, passes through Australia, Arabia, and Russia to the north geographical pole. See *Isoclinal*; *Isogonal*; *Isomagnetic*.

AIR CHOKE or AIR CORE CHOKE. Coils of wire, the function of which is to prevent the high-frequency condenser discharge current from surging back into

the low-frequency circuit, without interfering with the low-frequency condenser charging current. In a standard Marconi $1\frac{1}{2}$ kilowatt spark set, used for transmission on ships, each coil is wound with fine wire in a single layer on an insulated stand contained in a teak box. Each has a resistance of about 15 ohms.

In another type of air choke for a similar transmitting set, the coils are of enamelled wire wound on a porcelain former to minimise the risk of fire through overheating of the wire. This form of choke is pile wound in sections. A similar air core choke is used on small $\frac{1}{2}$ kw. sets fitted on small passenger liners and cargo boats.

See *Choke Coil*.

AIR CONDENSERS FOR RECEIVING SETS

How the Amateur can Make his Own Variable Condenser

Construction and assembly of components of air condensers are described in this article, as well as the functions, faults, and methods of adjustment. Testing and the capacity of plates are also dealt with. See also *Aluminium*, *Capacity*, *Condenser*, &c.

An air condenser is a condenser in which air constitutes the dielectric. Air condensers are very commonly employed in many types of wireless apparatus for tuning purposes; here will be dealt with a few forms generally used in amateur receiving sets.

The example illustrated in Fig. 1 has a maximum capacity of .001 mfd., and is applicable to most broadcast receiving sets. Various other patterns are available for panel mounting, in which case they usually

terminate with studs or bolts, intended for fixing the condensers to the inside of the panel. Such a condenser is shown in Fig. 2.

The condenser shown in Fig. 1 consists essentially of two discs of ebonite, one for the base of the instrument and one for the top. These can be purchased ready for use together with other parts in the form of a complete set of components, as illustrated in Fig. 3. For those with limited constructional facilities this is the cheapest and best form in which to buy materials in order to

undertake the construction of the apparatus, otherwise the plates should be cut to shape from sheet aluminium, flattened, planished, and turned to shape. The other small parts should be turned and screwed from aluminium, brass, or other material as specified. The making of aluminium plates is dealt with in the article on *Aluminium (q.v.)*. There are two varieties of plates used in these condensers. The first are known as the fixed plates and are larger than the others, the moving plates. Both kinds

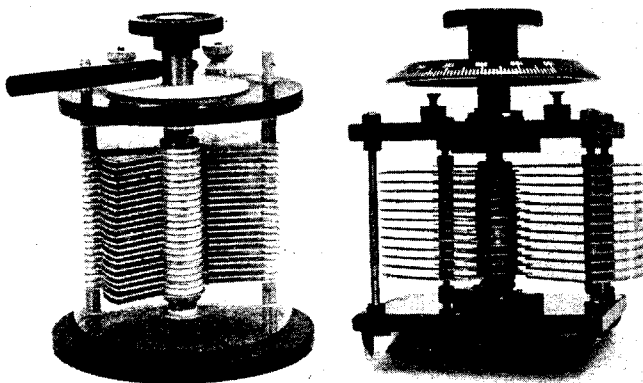

VARIABLE CONDENSERS

Fig. 1. A .001 microfarad air condenser as frequently used for broadcast reception. Fig. 2. Another example of condenser with calibrated dial adapted for fine tuning when panel mounted

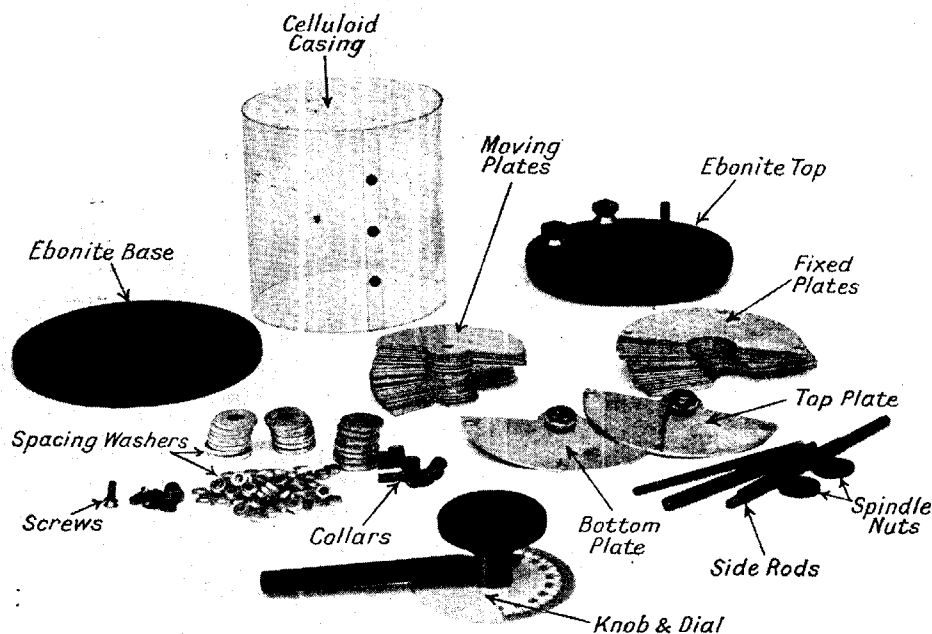

PARTS REQUIRED FOR MAKING A VARIABLE CONDENSER

Fig. 3. Before assembling the components are counted out and placed ready to hand. Building up from instructions given in the accompanying article is simplified by reference to this photograph. The parts may be purchased separately or for a complete condenser

are substantially semicircular in shape. The fixed plates are held together by three brass rods, which terminate with nuts and are screwed so that the ebonite ends can be attached to them. It is most important that these rods be perfectly true and of the same length.

To assemble the plates, the bottom nuts, or collars, are first placed on the three rods, then the bottom plate with the brass bushing for the spindle, then the collars and one of the fixed aluminum plates, which simply slides on to the three rods, passing through holes drilled in the plates. The next step is to put a spacing washer over each of the rods and then another fixed plate upon them, following this with another set of washers and another plate, and so on until all of them are in place.

The moving plates are fitted in a somewhat similar manner, and the nuts at the top and bottom assembled in a similar way, the nut at the bottom being screwed into position, followed by a spacing washer and plate alternately, as for the fixed

plates. There will be one less moving plate than fixed plates, as it is necessary for the moving plates to turn through the spaces between the fixed plates. The appearance when assembled is shown on the left in Fig. 4. The spindle with the moving plates fixed upon it is then inserted into the bearing in the bottom of the fixed plates, and the top fixed plate slipped into position, when the spindle should turn smoothly in the bushing.

The top plate rests on collars or a deep spacing washer and is secured by tightening the top nuts, as shown in Fig. 6.

The condenser is best erected by fixing the upright rods to the ebonite base as soon as the fixed plates are in position, as it will then stand up without difficulty. As the clearance between the plates is very small, it is absolutely essential that all should be perfectly flat and smooth and all the spacing washers of exactly the same thickness. The slightest trace of any burr on any of them must be carefully removed with a fine file or

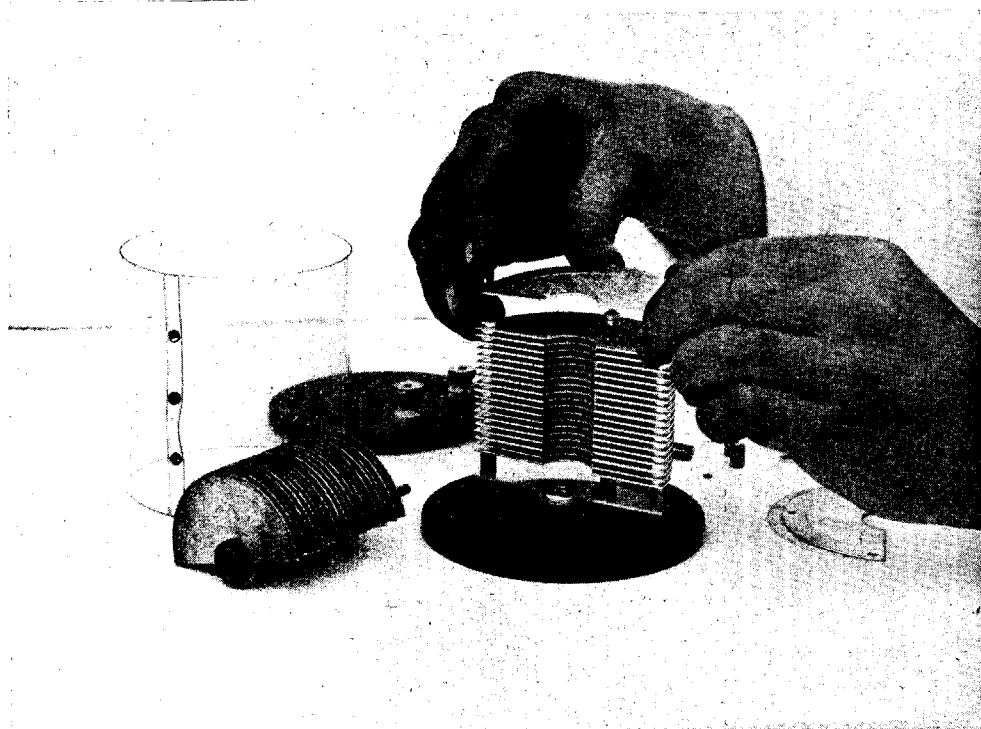

ASSEMBLING THE FIXED PLATES OF A CONDENSER

Fig. 4. Aluminium vanes or plates are fairly durable, but the operation of putting them together should be carried out with care lest they bend. Force should not be employed when placing in position or pressing past the threaded tops of the upright rods

emery paper, so that when the whole is assembled, the moving plates, when rotated by turning the spindle upon which they are mounted, turn perfectly freely between the fixed plates. On no account must they touch each other, otherwise the condenser will be discharged.

Adjustment of Condenser. A variable condenser of this type will call for adjustment in two or more directions. Firstly, the plates themselves must be evenly spaced by means of the spacing washers; secondly, the fixed plates must be parallel with the moving plates, and consequently the spindle upon which the moving plates are mounted must be at right angles in the plane of the plates. If it is not, the plates will clear perfectly for about a quarter of a turn and then touch at the top or bottom for the rest of the turn. This will indicate the direction in which the adjustment is to be effected.

Another point to observe is to see that the three rods which hold the fixed plates together are parallel to the moving

spindle, as if these are the least bit out of truth, the plates will jam. This is corrected by grasping the top and bottom in the right and left hand respectively, and twisting very slightly. The final adjustment is best carried out when both the ebonite ends have been screwed in their places. The screws should not be drawn up tightly, but only sufficiently so to hold the whole thing together.

To keep the plates clean, a tube of celluloid is fitted into the grooved portion of the ebonite ends, and this must be assembled with the end pieces. Adjustments are generally provided in the form of a screwed bush at the top and bottom of the moving spindle which fix into the end plates. These are just the same as the other aluminium fixed plates, but are placed slightly wider apart.

When the spindle can be turned easily and smoothly between the finger and thumb, an ebonite knob and dial may be fixed to it, taking care that this turns without binding on the top of the ebonite end. The terminals and connexions have

then to be made. Two terminals are required on the top plate, one being connected to the moving spindle by connecting it to the bush in which it turns, and the other to one of the nuts on the end of one of the rods holding the fixed plates.

The connexions are made by short lengths of insulated wire. The end of one is fixed to the bush on the top plate. The other end is turned around one of the terminals, and is secured to it by a nut, which should be tightened by a thin spanner, as shown in Fig. 5. The other wire is fixed to the opposite terminal and bent round so that when the top plate is placed in position the wire will be held by the screw which secures the ebonite top to the side rods. Care must be taken to place the ebonite ends in the proper place, as shown in Fig. 7, and to see that those connexions are made.



WIRING AN AIR CONDENSER

Fig. 5. Connecting up an air condenser through the ebonite top is accomplished by means of the nuts attached to terminal screws

The holding screws are then tightened. The connexions are best left to the last, and made when the plates have been adjusted perfectly, removing the ebonite end for the wiring. The knob and dial is

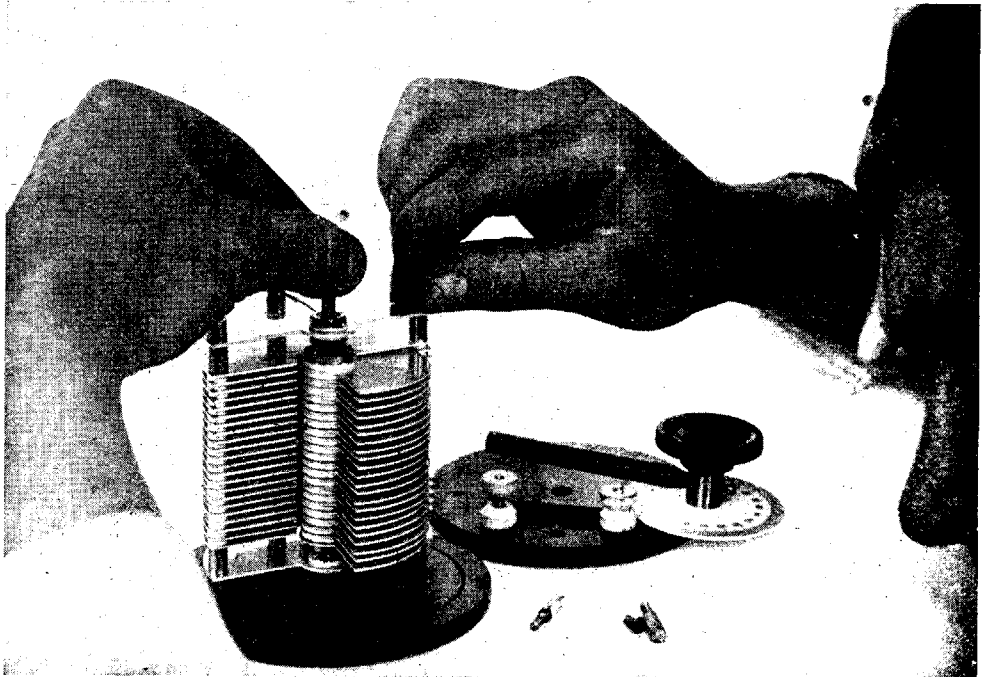

FITTING THE TOP PLATE TO A VARIABLE AIR CONDENSER

Fig. 6. Top and bottom plates are different from the other fixed and movable plates. The spacing of the top plate from the rest should be noted. The same method is adopted with the bottom plate, with the exception of the connecting wire

fixed to the spindle by a set screw, and when it can be turned through 180° without any of the plates apparently touching.

Condenser Testing. A simple test can be made by connecting one of the terminals to the plus terminal of an ordinary $1\frac{1}{2}$ -volt dry battery and connecting the negative terminal from the cell to an electric bell or buzzer, and from the terminal of the buzzer to the second terminal of the condenser. If any of the plates touch anywhere, the circuit will be completed and the bell or buzzer sound, assuming that the dry cell is able to actuate the bell or buzzer. This may be tested by connecting it directly to the dry cell. If one cell will not actuate the buzzer or bell, additional cells must be added until it functions properly. If the bell or buzzer sounds, further adjustments should be made to the plates.

The instrument when completed should be handled with care, as should it be strained it is more than likely that some of the plates will be bent and its usefulness destroyed.

The theoretical considerations and the design of condensers are dealt with under the heading Condenser. The capacity of an air condenser varies somewhat according to the quality or thickness of material, but as a rough guide the following will serve for the average commercial air condenser with aluminium plates.

No. of plates.	Max. capacity.
57001mfd
290005
190003
130002
70001
3	Vernier.

Since the capacity of an air condenser depends upon the area of the metal plates and the distance separating them, the above capacities can only be approximate. In actual practice the size of the plates and the distances between differ little in different types of condensers as usually sold for wireless telephony. It is, however, a comparatively simple matter to calculate the capacity of a condenser for any position of the plates and the formula is given under the heading Capacity. See Condenser.

AIR SPACE COIL. This is a type of inductance or tuning coil with many applications to home-made and other apparatus. By varying the size of the coil used any wave-length may be received. The windings are entirely enclosed in a moulded ebonite former and so arranged that there is an air space between each turn.

The ends of the wiring terminate in plugs to facilitate plugging into a suitable stand (such a coil is illustrated). One of the ways in which matters can be arranged so that two or three coils can be employed and the inductance varied is by rotating the coils about a vertical spindle, which acts as a pivot. With this arrangement short lengths of wire connect the terminals on the coils to others on the stand. This permits their use for reaction or for anode tuning. See Inductance Coil.

AIR WIRES. General term denoting the wires used in the Aerial (*q.v.*).

Al. Chemical symbol for the metal aluminium (*q.v.*).

ALEXANDERSON, Ernst Fredrick Werner (1878). Wireless engineer and inventor. Born at Upsala, Sweden, January 25th, 1878, he was educated at the High School and University of Lund,

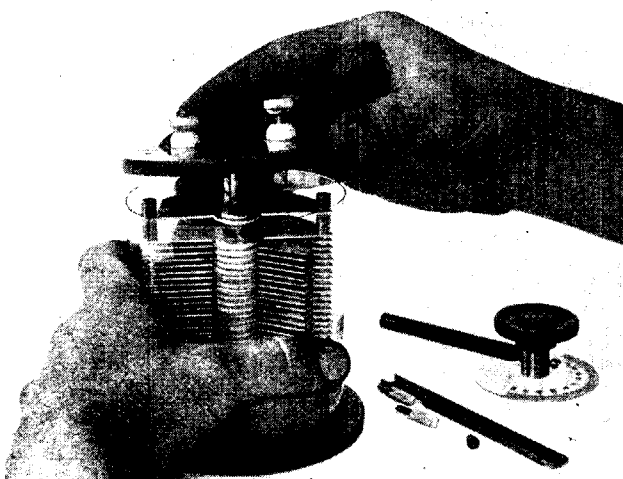

AIR CONDENSER

Fig. 7. The ebonite top fits firmly upon the celluloid wall and tops of the upright rods

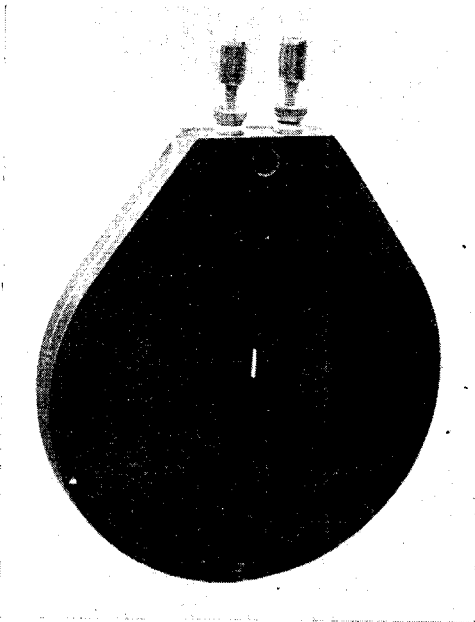

AIR SPACE COIL

The Elwell type of tuning and inductance coil showing the use of push-on connexions

Sweden, at the Royal Institute of Technology Stockholm and at Berlin. In 1902 he joined the General Electric Company, and has been for some years their consulting engineer. He holds the post of chief engineer to the Radio Corporation of America, and is a member of the American Institute of Radio Engineers. Alexanderson has read many papers on electrical subjects before the chief technical societies of America.

Alexanderson is famous for his work on high-frequency alternators used in wireless telegraphy. The Alexanderson alternator is connected directly or inductively to the aerial and earth, and constitutes the simplest possible connexion for producing continuous or undamped waves. It is a machine of great speed and many field poles, and frequencies as high as 200,000 cycles are obtained. For long distance work, employing very long wave-lengths, this high-frequency alternator is largely used. Alexanderson is also responsible for the magnetic amplifier, patented in 1913, and has carried out successful experiments on duplex wireless telephony. In the Alexanderson microphone transmitter the modulation is mainly effected by variations in the tuning of the aerial circuit. See Alternator.

ALINEMENT CHART. Method of expressing formulae by means of straight lines and curves. When engineers have frequent occasion to calculate some relation between two quantities, such as their product or ratio or other function, they usually take the trouble to tabulate them, so as to have a chart or table handy for future reference, thereby saving themselves much unnecessary arithmetic when a result is quickly wanted.

In wireless, a frequent calculation, for example, is to reckon the relation between the three quantities, wave-length, capacity, and inductance, so as to find any one of them if the other two are given. The most obvious way to tabulate them is to plot inductances horizontally and capacities vertically, or vice versa, and to fill in the squares so formed with the wave-lengths corresponding to the capacity-number on the left hand and the inductance-number above. The formula to reckon them by is

$$\lambda_m = 1885 \sqrt{LC}$$

But if this table is made it is more natural to proceed from step to step, both for L and C, not by constant differences, but by constant ratios; otherwise the table would be of absurd dimensions. The numbers might proceed: .001, .01, .1, 1, 10, 100, etc., both in the horizontal row and in the vertical column. The numbers in the body of the table representing wave-lengths would, of course, have the values that the arithmetic gives them.

But a more ingenious plan has been devised, which is called an alinement chart. The numbers for L are set up on the right-hand side, vertically; the numbers for C are set up on the left-hand side, also vertically, separated by a space, in the middle of which is another vertical line to contain the numbers representing wave-lengths. And when the table is complete, all that has to be done is to lay a straight-edge from the desired value of L to the corresponding value of C, and read off the number (representing wave-length) on the middle line. Or, more generally, the straight edge thus put on the diagram, wherever it is put, exhibits the right relation between the three quantities, if the table is properly constructed.

But it may be asked, how comes it that this can give the right result, when this geometrical or metrical method of procedure is obviously such as would give the

arithmetic-mean between the numbers on the left and on the right, not the geometric-mean? It may be well to explain that by the arithmetic-mean of two numbers, a and b , is meant $\frac{1}{2}(a + b)$; while by the geometric-mean is meant \sqrt{ab} . But from the fact that the numbers in the right and left columns are spaced out on a logarithmic basis, with

C in accordance with their logarithms; and thus the simple straight-edged method, read off on the middle line, gives the figure of the wave-length which is required. —*Oliver Lodge, F.R.S.*

ALLOY. An alloy is a mechanical compound of two or more metals. Generally the alloy is a more usable material than the separate constituents for a given purpose.

In electrical and mechanical work alloys are of paramount importance. Suitable alloys are of great value to the designer and user of wireless apparatus, as by proper proportioning it is feasible to vary the physical properties of the basic metals when they are employed in the form of an alloy, and thereby gain some advantage. Copper, for example, has a specific resistance of 1.561, but when copper is alloyed to form phosphor bronze, the specific resistance of the alloy is 8.5, both taken in legal microhms at 0° C. per centimetre cube. The mechanical properties are also modified, the alloy being less ductile than the copper, harder and more elastic.

One other peculiar feature of a suitable alloy is that by using the proper proportions of the appropriate metals, the melting-point of such an alloy can be considerably varied from that of any of the components. When the alloy melts at a very low temperature, often below that of the basic metal of which it is composed, it is generally known as a fusible alloy, and has a wide application in wireless work. For example, a fusible wire is used to protect apparatus in circuit against the effect of a sudden excess of current, the

alloy being made up in such a way that as the temperature rises it causes the alloy to melt, or the fuse to "blow," as it is usually termed. The circuit is interrupted, and the current ceases to pass. Another application is the use of an alloy with a melting point well below the boiling point of water (212° F.). Such alloys serve many purposes, as the fixing of a crystal to its holder. At the other end of the scale are resistance alloys used in the form of wire.

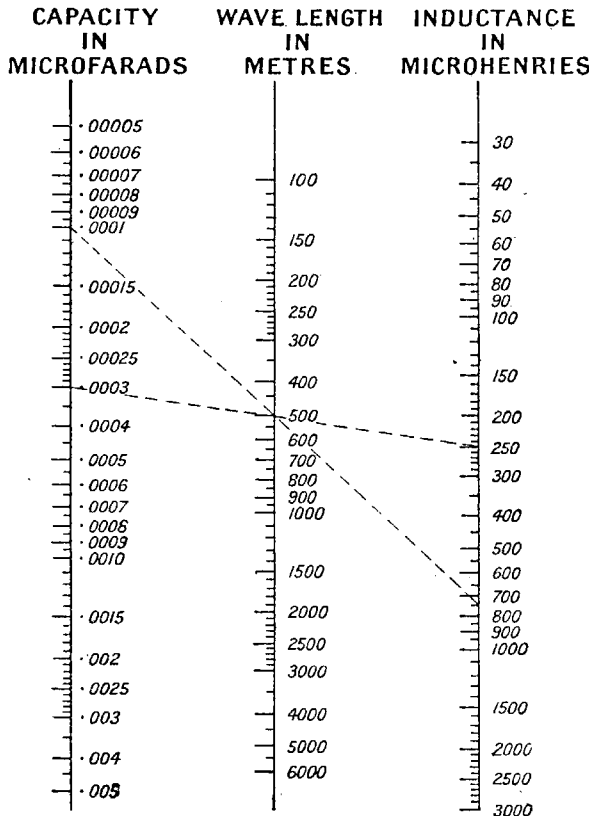

ALIGNMENT CHART FOR WAVE-LENGTHS

This chart enables any one of the quantities capacity, wave-length, and inductance to be calculated supposing the other two known. Suppose the capacity 0.003 mf. is known, and the inductance 250 mh. Join these points with a ruler, and where the line cuts the wave-length line read off the wave-length, in this case just over 500 metres

equal steps and yet represent increasing ratios, instead of differences, it is really the geometric-mean that will be given by the construction.

Another mode of expressing the fact is to say that the logarithm of \sqrt{ab} is equal to $\frac{1}{2} \log a + \frac{1}{2} \log b$; that is to say, the logarithm of the geometric-mean is equal to the arithmetic-mean of the logs. Hence one may say that in making the table you space out the numbers representing L and

These have several important electrical properties, including the ability to offer a considerable resistance to the passage of a current, and also the more important quality that the rise in the temperature of the wire, due to the passage of the current, is not accompanied by any change in the value of the electrical resistance of the wire. See Conductor; Fuse; Resistance Wire; Wood's Metal.

ALTERNATING CURRENT. A current may be steady or intermittent or alternating. A steady current, always flowing in one direction, is also called a direct current and denoted by D.C. An intermittent or jerky current we need not deal with here. But an alternating current, denoted by A.C., is the kind of current dealt with in wireless, the only steady currents used being those provided by batteries.

An alternating current oscillates to and fro, like a pendulum. It has a positive phase and a negative phase passing momentarily through zero from one to the other, just like a sine or cosine. Diagrammatically the simplest alternating current can be represented as in Fig. 1, where the oscillations from A to B and back again are represented as spread out in line in accordance with the simple equation:

$$y = a \sin pt$$

OA or a is called the amplitude, and upon it depends the intensity or strength of the current. The average strength is $\sqrt{\frac{1}{2}a^2}$. The number p is called the frequency-constant. Whenever pt equals 2π the oscillation repeats itself. Hence $\frac{p}{2\pi}$ is called the frequency, that is to say the number of complete oscillations

per second, and its reciprocal $\frac{2\pi}{p}$ is called the time period and denoted by T.

In Fig. 1, the time period, shown by T, is long, or the frequency constant. In Fig. 2 it is short and the frequency is high. Of course, time cannot really be represented by a length, but for diagrammatical purposes it is the only way to represent it. When an alternating current is really spread out in this way, it constitutes wave motion (*q.v.*), and much more might be said about it; but no actual wave is intended by the diagram, though certainly it is a wavy line.

Engineering frequencies for ordinary light and power currents, etc., lie usually

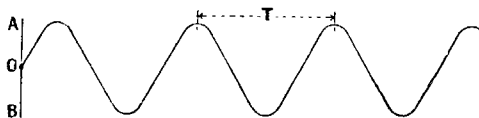

Fig. 1

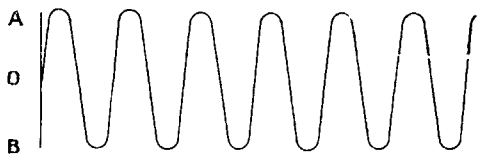

Fig. 2

SIMPLE ALTERNATING CURRENTS

Fig. 1 (above) represents the simplest type of current, the time period, or frequency constant, being shown at T. In Fig. 2 (below) the time period is short and the frequency high

between 25 and 100 per second. Audio-frequencies from, say, 200 to 2,000 are commonly used for telephone work. Radio-frequencies are too rapid for the ear, and may be anything from twenty thousand to two or three million per second.

One great advantage of alternating currents is that their voltage can be readily changed by transformers (*q.v.*). They cannot be used without modification for charging accumulators, or electroplating, but they can always be rectified (*q.v.*) by certain devices. In order to make themselves accessible to our senses, the alternating currents collected by the receiving aerial must be rectified, and all the devices of coherers, crystal detectors, valves, etc., are for the purpose of rectifying them, so that they can deflect a galvanometer or affect a telephone.



Fig. 3



Fig. 4

RECTIFIED ALTERNATING CURRENTS

In Fig. 3 the negative phases are reversed and in Fig. 4 cut off, as by a valve



ALTERNATING CURRENT CURVE

Fig. 5. The current need not be perfectly sinusoidal as in Figs. 1 and 2, but its frequency must be regular

A rectified current might be represented diagrammatically as in Fig. 3, where the negative phases are reversed and all made positive, or as in Fig. 4, where the

negative phases are cut off, sent elsewhere, or stopped from passing on, as by a valve.

An alternating curve need not be a perfectly sinuous curve as shown in Figs. 1 and 2; it may be irregular as in Fig. 5, but it must repeat itself in the time period with a regular frequency. It can be analysed by a Duddell oscillograph (*q.v.*). See Alternator; Oscillation; Transformer; Rectifier.—*Oliver Lodge, F.R.S.*

ALTERNATOR. Machines (symbol ) that generate alternating or pulsating currents are known as alternators. The frequency of the alternating waves of current per second depends upon the class of work the machine is intended for.

In producing the extremely high frequencies of 10,000 or more cycles per second required in radio work a very large number of poles in the alternator have to be provided, and the machine must be run at a very high speed.

Rotary generators may be classified in four broad divisions. In the first fall the machines which resemble the ordinary types of alternator; in the second, machines in which the rotation of the rotor periodically varies the inductance or capacity in a circuit; in the third, machines which make use of the harmonics in the flux and E.M.F. wave; and, lastly, those which make use of the cascade principle.

The first class of machine is not of much use save for the generation of very long wave-lengths. Such alternators may be used to generate currents of 10,000 to 15,000 cycles, and may be employed to feed quenched spark gap transmitters operating at rates above audio frequency. With the aid of a frequency raiser (*q.v.*) the frequency may be increased sufficiently for direct transmission.

20,000 Revolutions per Minute

In the second class or inductor type of alternator fall the Alexanderson type of machines. These may have a single or double rotor. The rotor, a nickel-steel disk, may be driven at 20,000 revolutions per minute. A large number of slots are cut near the edge and filled with phosphor bronze or other non-magnetic metal plugs. The armature windings are simple zig-zag windings in slots. The air gap between the rotor and stator is small, to reduce magnetic leakage to the lowest possible limits, and a usual gap is 0.015 in.

It is clear, with such a small air gap and with such high speeds of revolution of the rotor, that the greatest care has to be taken in the construction of machines of this type.

To the third class belong frequency raisers. In an ordinary single phase alternator the field magnet windings are excited by direct current. If alternating current is used, it may be shown that the E.M.F. induced in the rotor windings will have a frequency greater than that of the original current, and this principle is made use of in a number of frequency raising or adding machines.

The Alexanderson and Tesla Alternators

In the Alexanderson high-frequency alternator, for instance, the stator pole pieces are finely laminated, and the rotor is a solid chrome nickel steel disk, with gaps in the periphery filled in with non-magnetic material to avoid losses from air resistance.

Two methods are employed for the armature windings in the simpler forms of the Alexanderson machines. In the first form there is a simple to and fro winding, one turn per slot in the disk. In this form there are 600 slots for a 100,000 cycle machine. In the second form there are two windings in parallel, in each of which a 300-slot rotor field produces 100,000 cycle current in the same phase in each of the armature windings. By using a winding of this type in an 800-slot armature, a 200,000 cycle current may be produced by direct generation, the highest frequency produced directly by an alternator.

A large number of machines have been built on the Alexanderson principle, and here a brief description is given of a 50-kilowatt, 50,000 cycle alternator. The machine is normally operated at 125 amperes and 400 volts. A transformer is used between the machine and its output circuit. The transformer is closely coupled, with an efficiency of about 95 per cent, between the frequencies of 25,000 and 50,000 cycles.

The direct generation of radio frequencies by a machine working on the principle of a simple alternator is possible only by the use of a very low voltage winding.

Other designs of high-frequency alternators have been developed by Tesla, who adopted a rotating armature with disk windings running between 480 stationary

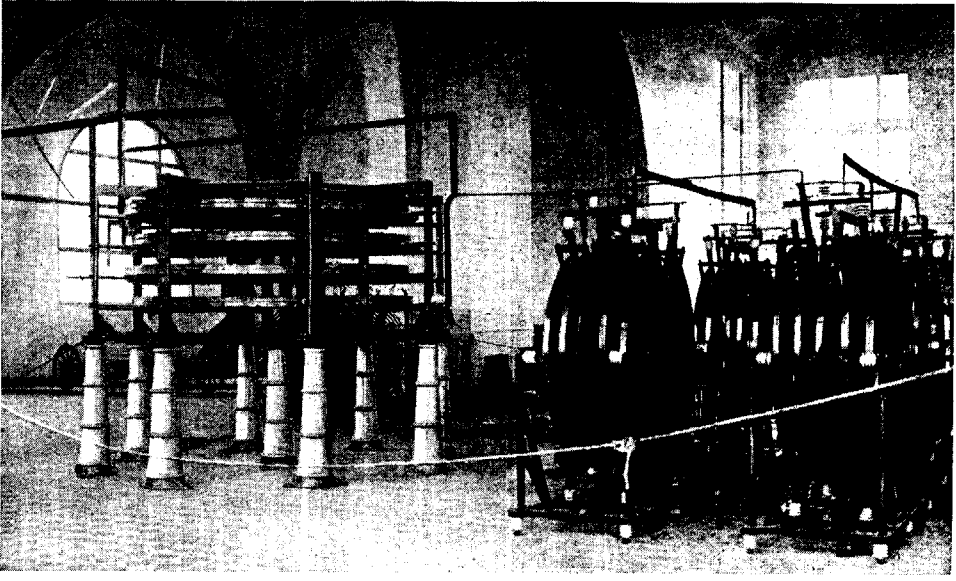

Tesla alternators at the St. Assise trans-continental station near Paris. In these machines the armatures rotate between a large number of stationary field poles

Photo, Rel

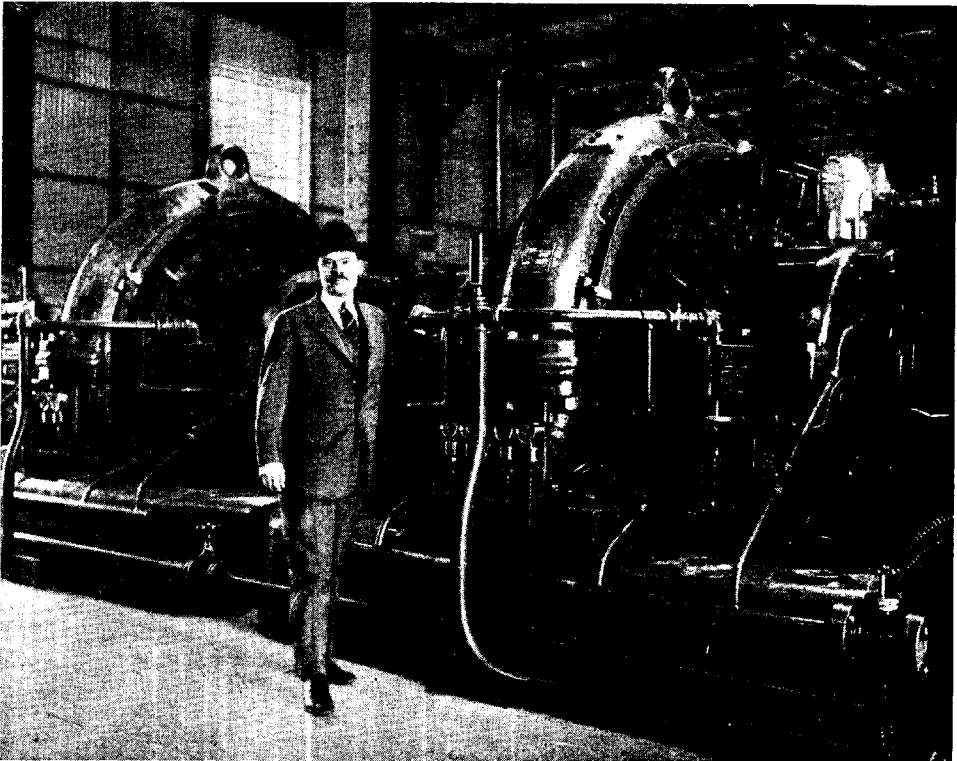

Dr. E. F. Alexanderson, chief engineer of the Radio Corporation of America, standing by one of the Alexanderson alternators with which frequencies as high as 200,000 cycles are obtained

Photo, Radio Corporation of America

ALTERNATOR : HIGH-FREQUENCY GENERATORS IN GREAT TRANSMITTING STATIONS

field poles at 2,500 revolutions per minute, giving a frequency of 15,000 cycles.

The alternator of Sir David Salomons has the field and armature rotating in opposite directions, with 174 pairs of poles, which, at 1,500 revolutions per minute, gave a frequency of 8,700 cycles.

Thomson, Steinmetz, Lodge, Ewing, Thury, Latour, and Duddell have also evolved distinctive types, mainly of the inductor pattern, while Goldschmidt has applied an ingenious principle which consists in stepping up the frequency in one or more stages. See Generator.

ALUMINIUM: ITS USES AND METHODS OF WORKING

A Metal with Many Applications in Wireless Apparatus

Throughout our Encyclopedia appear articles on the various metals used in wireless work. Here is described the importance of aluminium in the construction of wireless apparatus and a full account given of working in the metal. The reader should also consult the articles on Brass; Copper; Iron; and also such cognate subjects as Conductor; Wire, etc.

Aluminium is a very light and ductile metal which has many industrial applications. It is pleasing in appearance, has a bright silvery colour, takes a good polish, and retains its lustre with no other attention than an occasional rub with a dry cloth. Aluminium has several properties that commend it for wireless work. It is light in weight, the specific gravity varying from 2.5 to 2.7, the cast metal being slightly lighter than the rolled or drawn bars. Sheet aluminium has a specific gravity of 2.68 in the purest commercial state, but it is more often in the neighbourhood of 2.8 owing to the presence of impurities.

The metal is often alloyed with other metals to alter the properties of the latter to some extent, as, for example, aluminium bronze, and the various proprietary alloys, such as Duralumin.

The melting point of aluminium is 1,218 F. (659° C.), the co-efficient of linear expansion by heat is .0000125 per degree Fahrenheit. It is a splendid conductor of heat, surpassed in this respect only by gold, copper, and silver. Aluminium is a good conductor of electricity, having a conductivity equal to 60% of that of copper of equal volume, or nearly double that of copper when compared by weight. The metal is not magnetic, nor is it affected by air or water alone, but is liable to a peculiar form of corrosion when attacked by both at once. It is readily dissolved by strong solutions of caustic alkali, is liable to attack by ammonia, and is most readily dissolved by hydrochloric acid.

When aluminium is heated to a temperature of about 1,000° F. it passes through a thermal change and assumes a granular form, and is very brittle. It can then be pulverised with a hammer.

For this reason it should never be forged or worked at such a temperature. The amateur worker will find it difficult to bend to a sharp angle, and so far as possible it is best used in the form of sheets or bars united by rivets or bolting. Intricate shapes are best made from castings, which can be obtained from home-made or other patterns. These can be made in wood, metal, or, for a single casting, from plaster of paris. All should be well finished, and varnished with shellac varnish to get the smoothest possible surface. When made they should be sent to the foundry with explicit instructions for the number and type of casting required. The metal shrinks rather more than brass in cooling, and therefore a greater allowance has to be made on the patterns, a commonly used figure being 17-64th of an inch per foot of length.

Having obtained the castings, the machining presents some problems. So far as the ordinary processes of turning and drilling are concerned, the chief and great difficulty is to dispose of the chips. They seem to have an affinity for the teeth of a milling cutter and the points of drills and turning tools. The best way to overcome the difficulty is to use an efficient lubricant or cutting compound. The best lubricants are paraffin oil and turpentine, but a mixture of soap and water gives good results. This must be applied from a regular pipe system if any quantity of work is to be undertaken, but when only a few jobs have to be turned out the lubricant can be poured on from an oil can, applying it so that it falls on the point of the tool just at the spot where the cutting is taking place. This is shown in Fig. 1, which illustrates a typical turning job—shaping the groove in a sheave for an aerial pulley.



Fig. 1. The correct arrangement for lubricating the tool when turning aluminium provides for the lubricant to be directed to the point of the tool

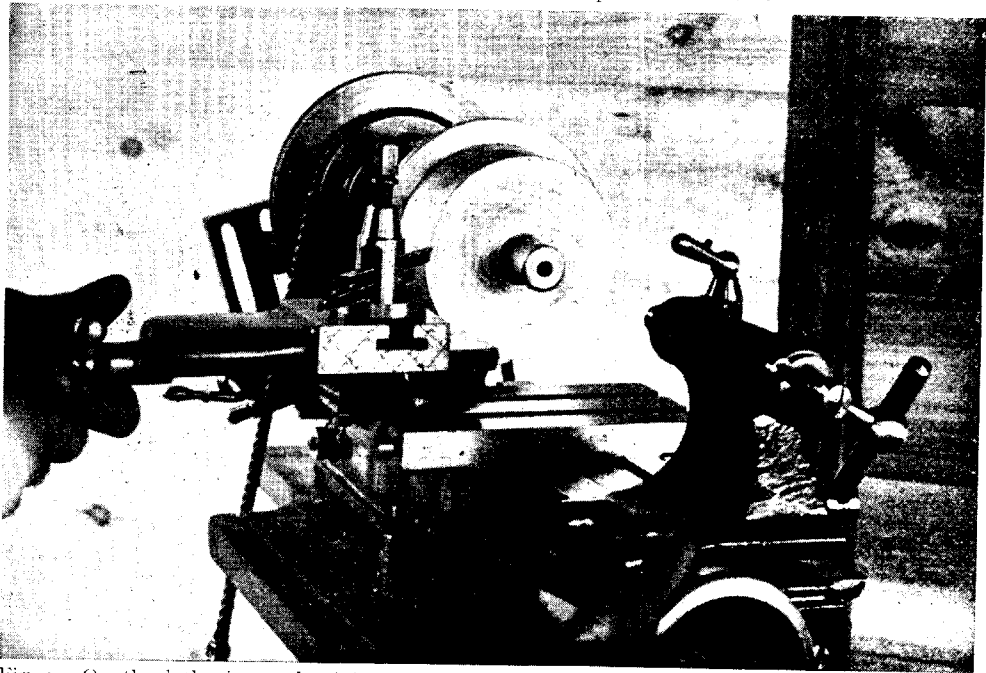
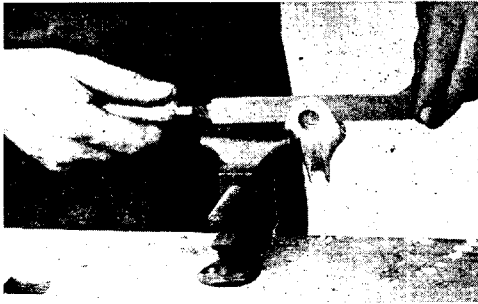

Fig. 2. On the lathe is an aluminium base for a loud speaker in the course of turning. The exterior of the casting is being worked

ALUMINIUM TURNING : TOOLS AND METHODS OF WORKING THE METAL



FILING ALUMINIUM

Fig. 3. A sharp file being used in the process of making a pulley. Chalk makes a good lubricant for aluminium

Turning Aluminium. Aluminium may be turned with the ordinary type of hand tool as used for brass work, but the cutting edge must be very keen and sharp, and should be finished on an oil stone. As a rule, aluminium may be turned more quickly than brass, although the particular alloys which this contains and the nature of any individual job will be modifying factors. For example, Fig. 2 shows the operation of machining the exterior of an aluminium casting for the base of a loud speaker. This and similar jobs can be turned with slide rest tools having a small top rake of about 5° and a clearance angle

of 15° to 20° . The tool should be lubricated with paraffin oil or turpentine from a drip can as illustrated in Fig. 1, or by brushing the lubricant on to the work with a stiff, hard brush. This latter plan is quite practical for a few jobs, or on comparatively small work.

A boring operation on a small casting is illustrated in Fig. 4. In this case the lubricant can be introduced from time to time into the interior of the work by brushing it on. Centrifugal force will keep it in position and efficiently lubricate the point of the tool. Milling cutters for aluminium must be very keen and sharp and should also be perfectly sharp on the corners. The teeth should not be too fine, as the larger they are the greater freedom for the clearance of the chips.

Aluminium castings can be filed in very much the same manner as ordinary brass castings, and Fig. 3 shows a typical example of a sheaved pulley block for use on an aerial mast. The operation shown is that of filing out the jaws to allow the sheave to turn freely between them. A good, sharp, new file should be used, and should be lubricated with chalk.

The amateur wireless enthusiast will find that sheet aluminium is very handy for making up many pieces of apparatus, as,

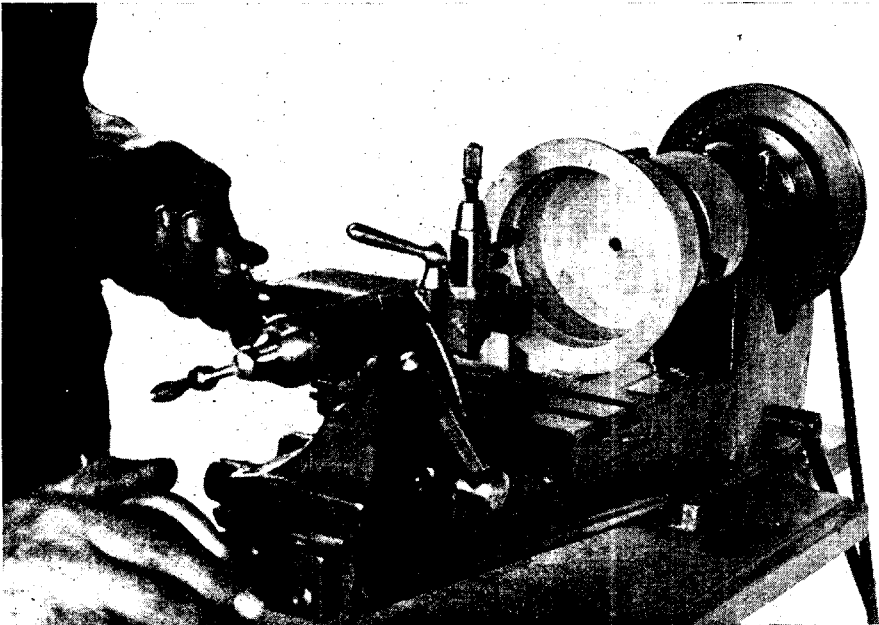

BORING AN ALUMINIUM CASTING

Fig. 4. In order to lubricate the cutting tool operating upon the interior of the base of the loud speaker on the lathe, the lubricant, paraffin oil or turpentine, is brushed on to the inside wall with a hard brush. The cutting edge of the tool must be kept keen

Look Out For

Part 2 of

HARMSWORTH'S WIRELESS ENCYCLOPEDIA !

Among its Wonderfully Varied Contents—Practical, Theoretical and Constructional—will be important articles on

Amplifiers : Their Pur- poses and Construction

Describing and illustrating in detail a large number of different types of high-frequency and low-frequency amplifiers. The amateur constructor is given full details for making no fewer than five different amplifiers. Each of these sets has been actually made for the purpose of testing the construction and preparing the photographs. Fifty-one illustrations, including a three-folder plate in photogravure.

The Anode Circuit : Its Principles and Functions

Giving a full description, with specimen photographs and diagrams, of this important part of the valve receiving circuit. The use of reaction in this circuit is dealt with fully.

Anti-Capacity Switches : Construction and Uses

The disadvantages in wireless work of ordinary types of switches constructed on wrong principles are vividly demonstrated in diagram and word. The best types of switches with very low self-capacity are illustrated and described in directions given showing how to make a simple anti-capacity four-way switch.

Armstrong Circuits and Receivers

The great importance and extraordinary interest of the Armstrong circuits, which are among the most important developments in wireless telephony, are well brought out in this article, with its 27 new photographs and diagrams. The evolution of Armstrong's discoveries, and the theories underlying them, are clearly and simply explained. The construction of two super-regenerative receivers is given in great detail.

Part 2 will contain 168 NEW photographs and diagrams, all of which are specially prepared for HARMSWORTH'S WIRELESS ENCYCLOPEDIA to be of practical use to the amateur and experimenter in wireless work

Part 2
ON SALE EVERYWHERE
Tuesday, November 20th.



The Brightest and Best Wireless Weekly

Week by week "Popular Wireless" caters for every possible class of wireless amateur, from the veriest tyro to the most advanced amateur. "Super" circuits are described for those who desire to experiment in that direction, simple crystal and valve receivers are explicitly detailed, while articles of general interest that will appeal to all readers are included in every number.

The first popular weekly journal to supply a long felt want when broadcasting was started in this country, "Popular Wireless" still leads both in public opinion and circulation figures. It appeals alike to the "listener-in" and the more serious minded experimenter.

Buy a copy NOW

Ask for

POPULAR ^{3d} WIRELESS Weekly

Scientific Adviser :

Sir Oliver Lodge, F.R.S., D.Sc., M.I.E.E.

Printed and Published every alternate week by the Proprietors, The Amalgamated Press (1922), Ltd., The Fleetway House, Farringdon Street, London, E.C.4. Sole Agents for South Africa: Central News Agency, Ltd.; for Australasia: Messrs. Gordon & Gotch, Ltd.; and for Canada: The Imperial News Co., Ltd. (Canada).
Subscription Rates: Inland and Abroad, 1s. 5½d. per copy. November 6th, 1923.