

65  
2/6

# WIRELESS ENGINEER

*The Journal of Radio Research & Progress*

Vol. XXIII.

MARCH 1946

No. 270



## CONTENTS

EDITORIAL. Aerial Resistance and Cable Impedance .. . . .	65
CARRIER-FREQUENCY AMPLIFIERS By C. C. Eaglesfield .. . . .	67
NOISE FACTOR OF VALVE AMPLIFIERS By N. R. Campbell, Sc.D., F.Inst.P., V. J. Francis, B.Sc., F.Inst.P., A.M.I.E.E., and E. G. James, Ph.D., B.Sc. . . . .	74
TRANSIENT RESPONSE OF FILTERS By D. G. Tucker, Ph.D., A.M.I.E.E.	84
CORRESPONDENCE .. . . .	91
WIRELESS PATENTS .. . . .	94
ABSTRACTS AND REFERENCES Nos. 521—814 .. . . .	A41-A62

Published on the sixth of each month  
SUBSCRIPTIONS (Home and Abroad)  
One Year 32/-                      6 months 16/-  
Telephone:                              Telegrams:  
WA Terloo 3333 (35 lines)              Wirenger Sedist London

# Your designs

LET US BRING THEM TO

# LIFE!

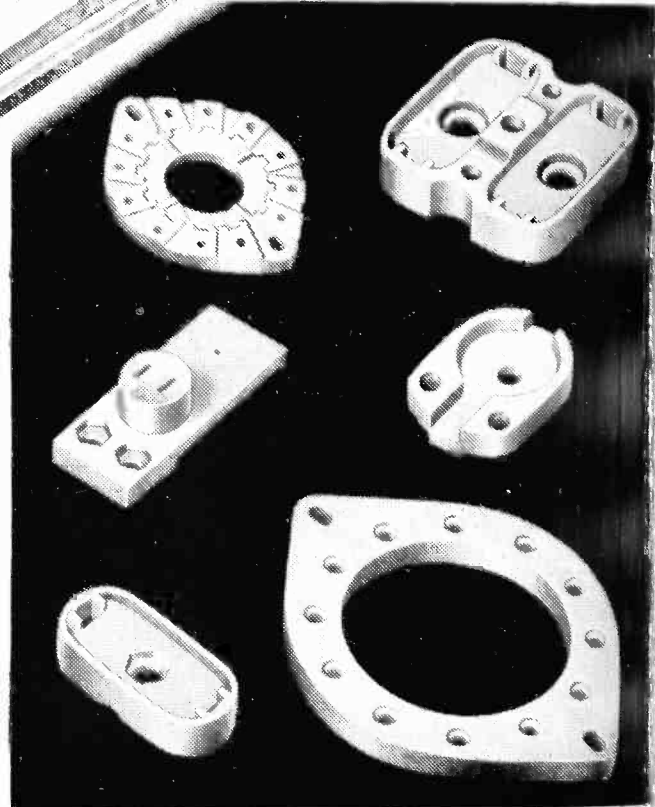

*the most difficult problems solved by...*

**Made in Three  
Principal Materials**

**FREQUELEX**

An insulating material of Low Dielectric Loss, for Coil Formers, Aerial Insulators, Valve Holders, etc.

**PERMALEX**

A High Permittivity Material. For the construction of Condensers of the smallest possible dimensions.

**TEMPLEX**

A Condenser material of medium permittivity. For the construction of Condensers having a constant capacity at all temperatures.

# Bullers



**BULLERS LOW LOSS CERAMICS**

BULLERS LTD., 6, LAURENCE POUNTNEY HILL, LONDON, E.C. 4  
Telephone: Mansion House 9971 (3 lines)    Telegrams: "Bullers, Cannon, London"    Manchester Office: 196, Deansgate, Manchester

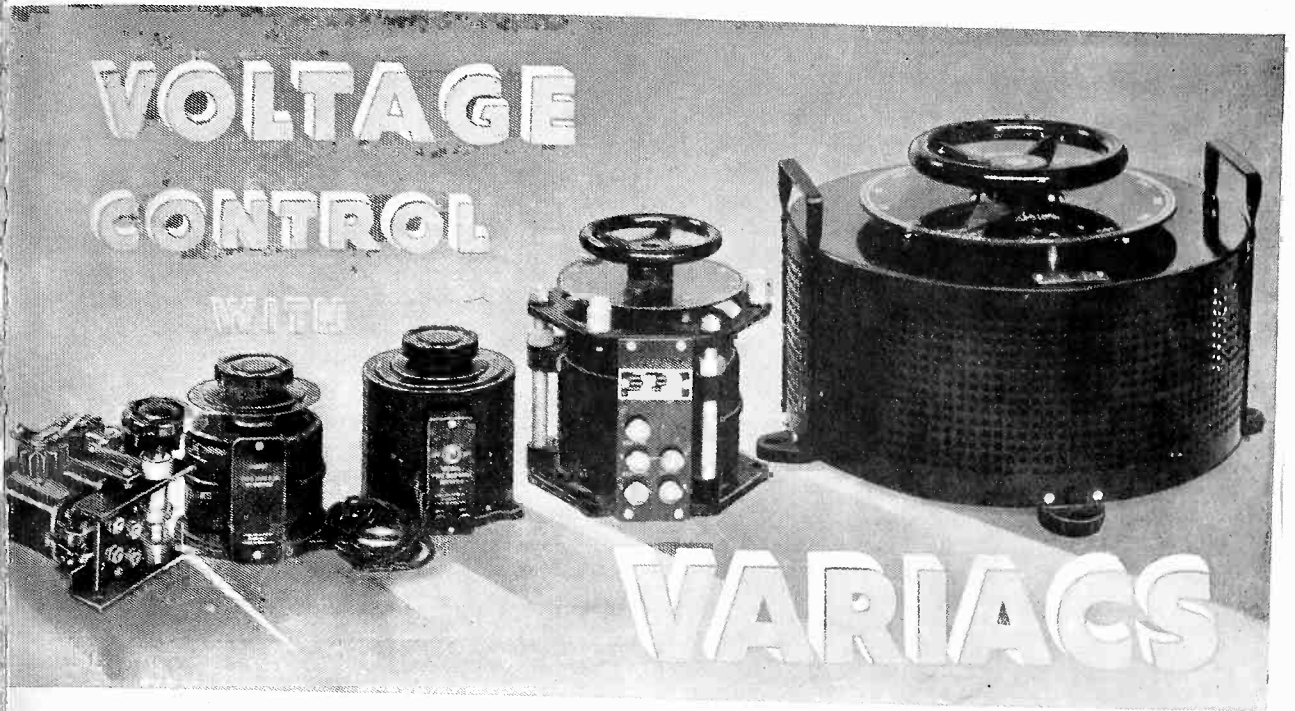

**With the VARIAC . . . the *right* voltage every time**

Thousands of enthusiastic users testify to the general usefulness of the VARIAC\* continuously adjustable auto-transformer for use in hundreds of different applications where the voltage on any a.c. operated device must be set exactly right.

The VARIAC is the original continuously-adjustable, manually-operated voltage control with the following exclusive features, which are found in no *resistive* control.

- **EXCELLENT REGULATION**—Output voltages are independent of load, up to the full load rating of the VARIAC.
- **HIGH OUTPUT VOLTAGES**—VARIACS supply output voltages 15% higher than the line voltage.
- **SMOOTH CONTROL**—The VARIAC may be set to supply any predetermined output voltage, with absolutely smooth and stepless variation.
- **HIGH EFFICIENCY**—Exceptionally low losses at both no load and at full power.
- **SMALL SIZE**—VARIACS are much smaller than any other voltage control of equal power rating.
- **LINEAR OUTPUT VOLTAGE**—Output voltages are continuously adjustable from zero by means of a 320 degree rotation of the control knob.
- **CALIBRATED DIALS**—Giving accurate indication of output voltage.
- **SMALL TEMPERATURE RISE**—Less than 50 degrees C. for continuous duty.
- **ADVANCED MECHANICAL DESIGN**—Rugged construction—no delicate parts or wires.

VARIACS are stocked in fifteen models with power ratings from 165 watts to 7 kw; prices range between 70/- and £34 : 0 : 0. Excellent deliveries can be arranged. Most types are in stock.

\* Trade name VARIAC is registered No. 580,454 at The Patent Office. VARIACS are patented under British Patent 439,567 issued to General Radio Company.

Write for Bulletin 424-E & 146-E for Complete Data.

**Claude Lyons Ltd.**

**ELECTRICAL AND RADIO LABORATORY APPARATUS ETC.**  
180, Tottenham Court Road, London, W.1 and 76, OLDHALL ST. LIVERPOOL, 3, LANCs.

# SKYTOWER

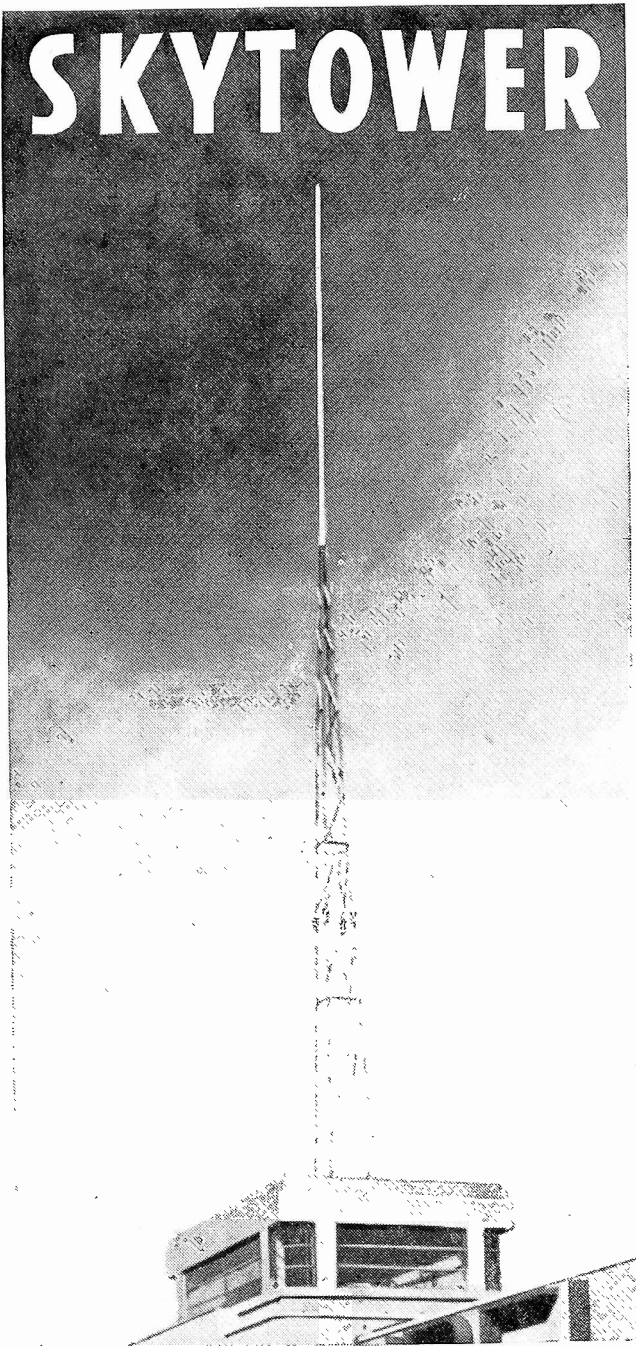

A 52ft. VERTICAL AERIAL developed for the Army and now offered as ideal for laboratories, factories, relay receiving stations, etc., where serious reception is required. Heavy porcelain insulators 15ft. from base, leaving 37ft. vertical collector generally terminating in "Eliminoise" matching transformers and transmission line.

List No. 574, Price £90, erection extra depending on site.

**BELLING & LEE LTD**  
CAMBRIDGE ARTERIAL ROAD, ENFIELD, MIDDX

**FLOATING ROTOR**

**DOUBLE CONTACT**

*Only in the famous*

**OAK SWITCH**



Manufactured by  
**BRITISH N.S.F. CO. LTD.,**  
KEIGHLEY, YORKS.

Phone : Keighley 4221/4.  
Grams : Enesef, Keighley.

Available in a wide range of circuit combinations for radio, television and other applications.

Sole Licensees : **OAK MANUFACTURING CO.,** Chicago, GA

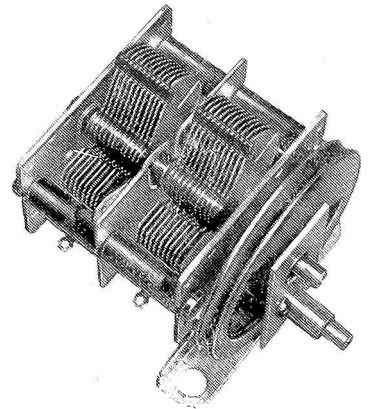

### M.G.R.N. 1, 2 or 3 GANG CONDENSER

This is made in various capacities up to 540mmf. of Rigid construction, with smooth slow motion drive and with tropical finish. The Spindle is tapped 6 BA for attachment of pointer. An indicator can be driven by cord from the drum disc. Built in trimmers can be supplied if required.



**JACKSON**

**BROS (LONDON) LIMITED**  
KINGSWAY · WADDON · SURREY  
TELEPHONE: CROYDON 2754-5 TELEGRAMS: WALFILCO. PHONE, LONDON

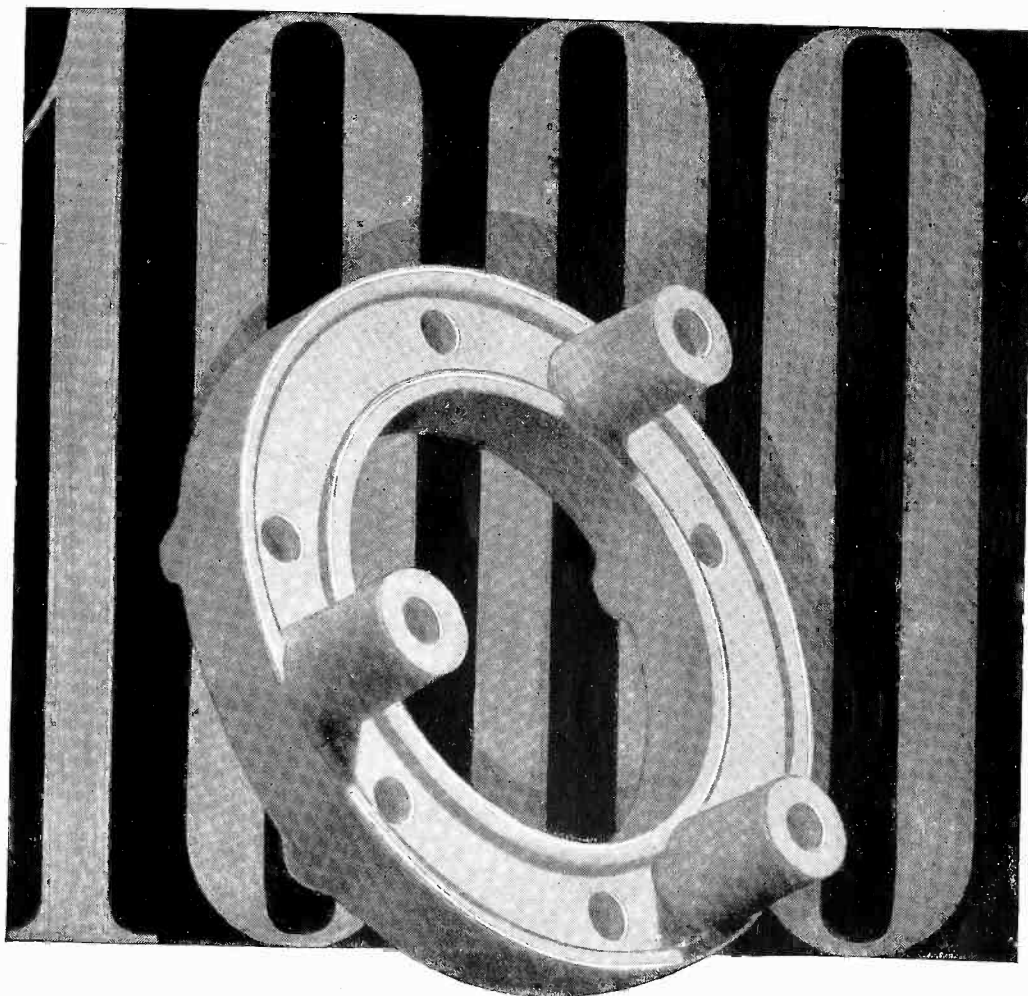

## specify **FREQUENTITE**

The range of Frequentite components covers more than a thousand pieces of every shape and size. Before finalising the design of new components consult



**STEATITE & PORCELAIN PRODUCTS LTD**

Head Office : Stourport-on-Severn, Worcs.

Telephone : Stourport 111

Telegrams : Steatint, Stourport

S.P.17a

# From the pages of our POST-VICTORY CATALOGUE

MANY and varied are the Speakers which we have been called upon to design and produce for War's insatiable needs. Some of these Speakers, because of their specific duties and characteristics find no place in the to-morrow. Here, in the T2/12 however, is an instrument—tested and proven under conditions far more exacting than any which Peace can provide—which is destined to set a new and higher standard of performance and reliability in Speakers for Public Address work, the smaller Cinema, and for high-power Radiograms.

★ Obtainable in limited quantities through the usual channels.

## GOODMANS Loudspeakers

GOODMANS INDUSTRIES LTD · LANCELOT RD · WEMBLEY · MIDDX ·

### The T2/12\*

Overall dia. 12½ in.: Voice Coil Impedance, 15 ohms at 400 C.P.S.: Power Handling Capacity, 12 w. Peak A.C. on flat 4 ft. baffle (15 w. horn loaded). Flux Density, 13,000 gauss.

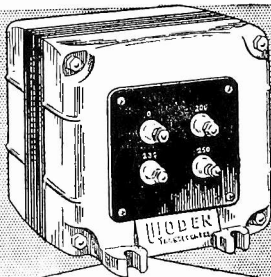
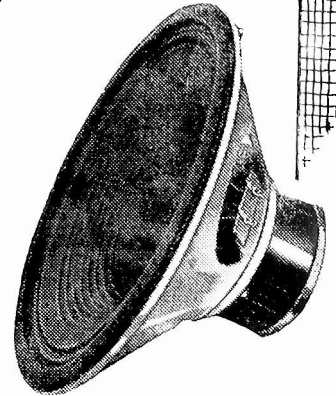

HERE IS THE NEW

### TRANSFORMER *that has Everything*

● SUPERB TECHNICAL DESIGN ● FINEST QUALITY MATERIALS ● HIGH OPERATIONAL EFFICIENCY ● GUARANTEED RELIABILITY ● BEAUTIFUL APPEARANCE

#### BRIEF DETAILS OF THE RANGE

Mains Transformers, 5—5,000 Watts.; Input and Output Transformers; Filter Chokes.

AND OF THEIR CONSTRUCTION  
High Quality Silicon iron laminations; wire to B.S.S. Standards; finest grade insulation; Die Cast Streamline Shrouds; Black bakelite Terminal panels; High Vacuum Impregnated coils layer wound with condenser tissue interleaving; Porcelain terminals insulated and/or silver plated soldering tags.

**WODEN** *de Luxe* TRANSFORMERS  
WODEN TRANSFORMER COMPANY LTD.  
Moxley Rd., Bilston, Staffs. Tel: BILSTON 41959



Crash Helmets  
for Dispatch Riders  
reaching from  
LONDON TO  
EDINBURGH

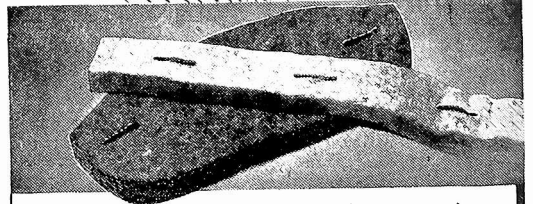

During 6 war years we have made  
**FELT SHOCK ABSORBING PADS** for  
**1,000,000 CRASH HELMETS**

If your peace-time productions need **FELT** Let STERLING quote you

Any *SHAPE*—any *SIZE*—any *QUANTITY*

**STERLING TEXTILE INDUSTRIES LTD**

STERLING WORKS, ALEXANDRA ROAD, PONDERS END  
MIDDLESEX

Phone HOWARD 2214-5, 1755

STEREX, ENFIELD

PROBLEMS WE HAVE SOLVED—No. 6

# THE DINGHY BLOWER

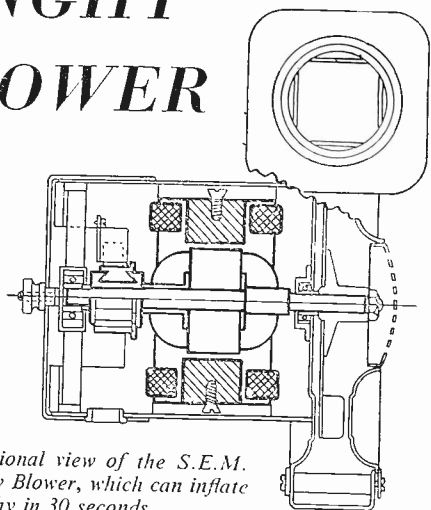

*A sectional view of the S.E.M. Dinghy Blower, which can inflate a dinghy in 30 seconds*

BEFORE the introduction of dinghies inflated by means of a compressed-air bottle, rubber dinghies for life-saving in British aircraft were inflated by means of an ingenious electrically operated blower designed and constructed by S.E.M. research engineers.

A high speed electric blower was developed suitable for operation from a 12-volt battery. The characteristics of the fan and motor were so adjusted that the dinghy was completely inflated in 30 seconds. Incorporated in the outlet of the blower was a special valve which, while offering minimum resistance to the blowing up of the dinghy, provided perfect sealing when it was fully inflated.

One of the chief difficulties in all previous equipments had been the weight problem. S.E.M. engineers, however, managed to reduce the weight of the blower to only 3 lb., making a total of only 12 lb. together with the dinghy.

This is only one of the many technical problems that we have been called upon to solve. We specialize in supplying non-standard electrical devices for particular purposes. The resources of our research laboratories are available now to manufacturers who have a special problem.

## SMALL ELECTRIC MOTORS LTD.

A SUBSIDIARY OF BRODCAST RELAY SERVICE LTD.  
BECKENHAM · KENT

# PLOTTING THE COURSE

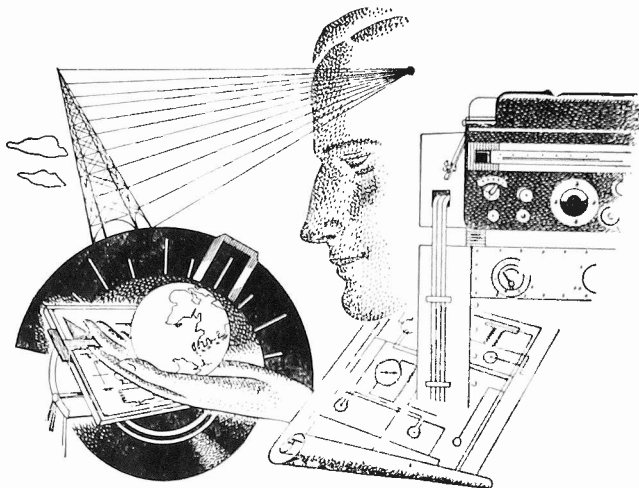

# IN TOMORROW'S WORLD

In the world of to-morrow, as in the world of yesterday and to-day, Marconi's will carry forward the tradition of meticulous workmanship in communications apparatus.

New problems have been met as they have arisen by a team of experts with all the experience of a pioneer organisation behind them. Still newer problems are on the horizon of the post-war world. These too will be handled with the same resourceful skill. Whatever the demands of a new age—you know where you are with Marconi.

# MARCONI

*the greatest name in wireless*

MARCONI'S WIRELESS TELEGRAPH COMPANY LTD  
THE MARCONI INTERNATIONAL MARINE  
COMMUNICATION COMPANY LTD  
ELECTRA HOUSE, VICTORIA EMBANKMENT, LONDON, WC2

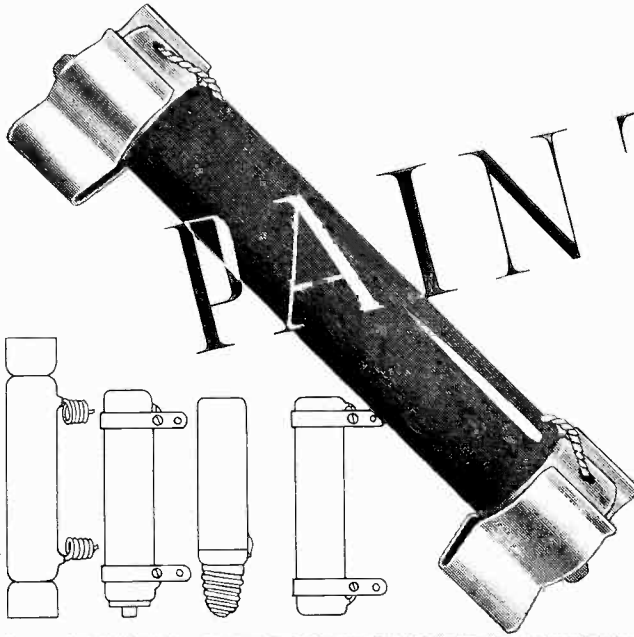

# PAINTON VITREOUS RESISTORS

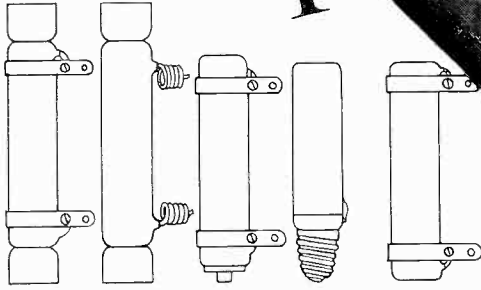

Painton Vitreous Resistors are available in values from 1 ohm to 100,000 ohms; from 10 watts to 150 watts rating, and are made in a wide variety of fittings.

The Resistors consist of a fully vitrified porcelain tube, which carries a winding of high-grade resistance alloy wire. The ends are electrically welded to the copper terminal leads. This winding is held firmly in position by a coating of extremely durable vitreous enamel, rendering the unit absolutely impervious to the effects of moisture, and ensuring absolute stability of value under all conditions of service.

Type approval of these Resistors has been given for use under the most severe tropical conditions.

**PAINTON & CO. LTD**  
KINGSTHORPE NORTHAMPTON

# CELESTION

**LOUDSPEAKERS  
VALVEHOLDERS**

Celestion Limited  
Kingston-on-Thames  
Telephone : KINeston 5656-7-8

# MINIATURE or MIDGET

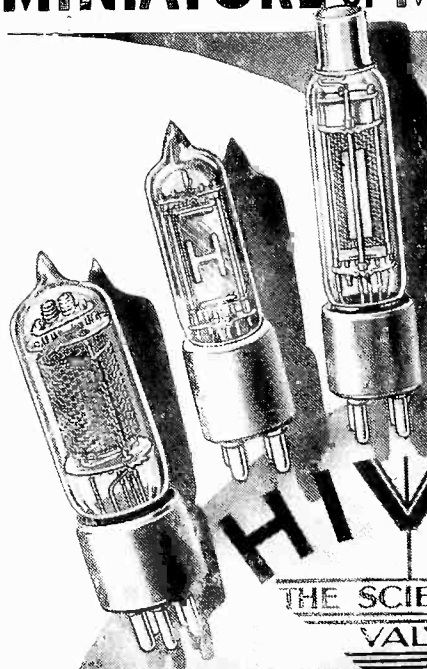

We specialise  
in their  
manufacture

**HIVAC**  
THE SCIENTIFIC  
VALVE

BRITISH MADE

*Originators,  
designers & manufacturers of Midget Valves*

HIVAC LIMITED. Greenhill Crescent, Harrow on the Hill, Middx. Phone: 08 HAR 08



# SOUND JUDGMENT...

We offer you understanding and co-operation and when planning your future enterprises, we invite you to submit your problems to us.

At B.S.R. we have a team of Research Engineers co-operatively engaged with many new problems which demand the highest degree of accuracy, in both thought and design.

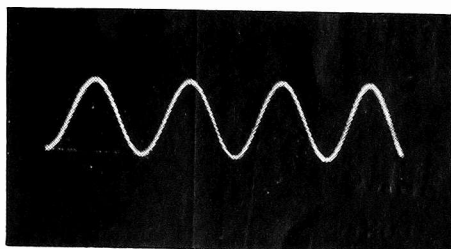

OSCILLATORS  
AMPLIFIERS  
ELECTRONIC DEVICES  
TRANSFORMERS AND CHOKES

**BIRMINGHAM  
SOUND  
REPRODUCERS LTD.**



CLAREMONT WORKS, OLD HILL, STAFFS.

Phone: Cradley Heath 621213 Grams: Electronic, Old Hill

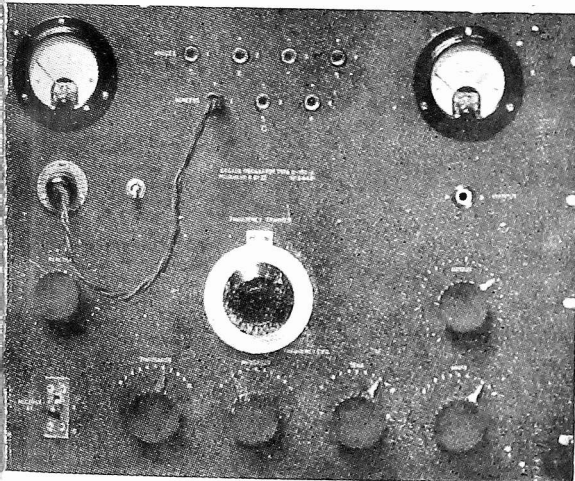
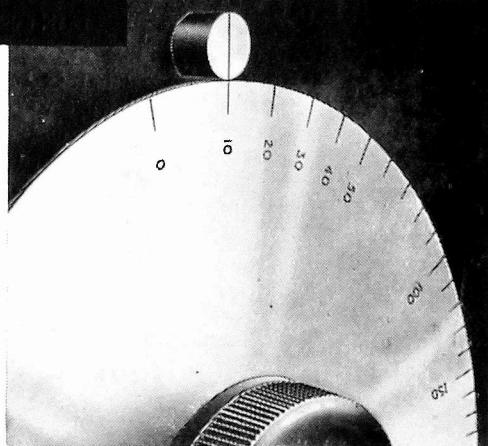

## DECADE OSCILLATOR

Type D-105-A "... as easy to use as a Resistance Box"

The MUIRHEAD - WIGAN DECADE OSCILLATOR. Type D-105-A, illustrated, is an instrument of outstanding performance embodying something entirely new in oscillator design.

FREQUENCY IS DIRECT READING TO PRECISION ACCURACY ON FOUR DECADES. There are no troublesome calibration charts to refer to or engraved scales to adjust.

Write for Bulletin, B-528-B.

# MUIRHEAD

MUIRHEAD & CO. LTD., ELMERS END,  
BECKENHAM, KENT

Telephone: Beckenham 0041-0042

**FREQUENCY:** 1 c.p.s. to 111.1 Kc/s on two ranges:

1 c.p.s. to 11.11 Kc/s by 1 c.p.s. steps.

10 c.p.s. to 111.1 Kc/s by 10 c.p.s. steps.

**ACCURACY:** + 0.2% or 2 c.p.s. over the entire frequency range. **OUTPUT:** 2 watts maximum.

**HARMONIC CONTENT:** 2½% at 2 watts:

1.25% or less below 1 watt.

**POWER SUPPLY:** 200 to 250 v. 50 c.p.s.

FOR OVER 60 YEARS DESIGNERS AND MAKERS OF PRECISION INSTRUMENTS

**TELCON METALS**  
for the **SCIENTIFIC INSTRUMENT**  
and **RADIO INDUSTRIES**

★ **MUMETAL**  
REGD.  
**MAGNETIC SCREENS**

MUMETAL is a renowned TELCON alloy unsurpassed for the shielding of delicate equipment from uni-directional or alternating magnetic fluxes. During wartime MUMETAL has been extensively employed for screens in Radar and other important equipment. The experience gained from these activities is now available for the solution of your peacetime problems and enquiries are invited.

**THE TELEGRAPH CONSTRUCTION & MAINTENANCE CO. LTD.**  
Founded 1864  
Head Office: 22 OLD BROAD ST., LONDON, E.C.2. Tel: LONDON Wall 3141  
Enquiries to TELCON WORKS, GREENWICH, S.E.10. Tel: Greenwich 1040

**FOR RESISTORS WRITE-**

**Welwyn**

Welwyn Electrical  
Laboratories Ltd  
Welwyn Garden  
City Herts

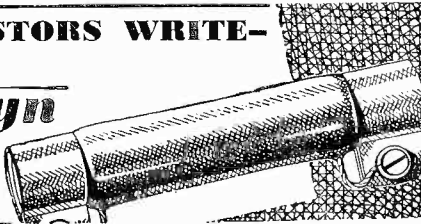

**NEW DUAL TESTSCOPE**



Ideal for High and Low Voltage Testing: 1/30, 100/850 A.C. and D.C.

Allowance made on old models. Send for interesting leaflet G24 on Electrical and Radio Testing, from all Dealers or direct.

**RUNBAKEN MANCHESTER**

**LONDEX for RELAYS**

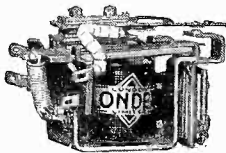

Midget Relay ML for A.C. or D.C.

The wide range of Londex Relays covers especially the Wireless and Electronic fields. The illustrations show only a few out of a multitude of reliable relays.

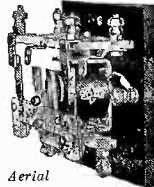

Aerial Change-over Relay, A.E.C.O.A. for Radio Frequency

Ask for leaflet 205/112/WE.

**LONDEX LTD**

MANUFACTURERS OF RELAYS  
207 ANERLEY ROAD, LONDON S.E.20  
ENGLAND

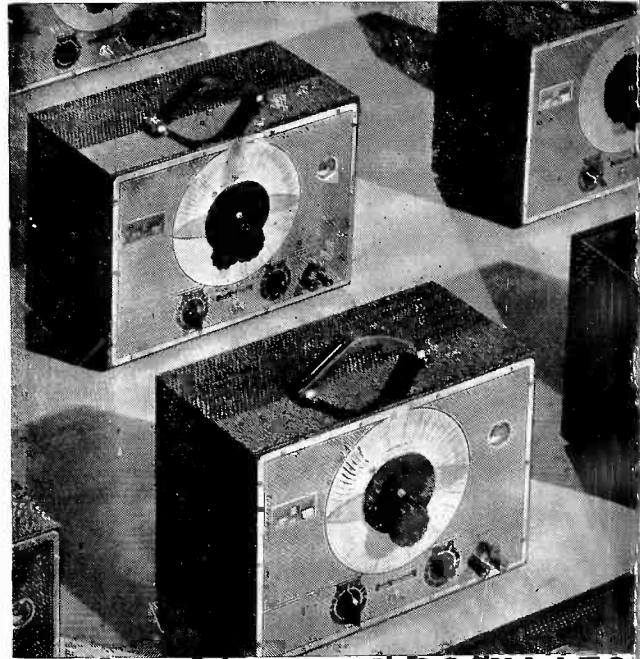

**BEAT FREQUENCY OSCILLATOR**

**LELAND INSTRUMENTS LTD**

—for priority requirements at present. Write for particular stating frequency range required.  
21, JOHN STREET, BEDFORD ROW, LONDON  
TELEPHONE: CHANCERY

LARGE DEPT. FOR WIRELESS BOOKS.

**FOYLES**

FINEST STOCK IN THE WORLD OF NEW AND SECONDHAND BOOKS ON EVERY SUBJECT.

Quick Postal Service. Books Bought.  
119-125, CHARING CROSS ROAD, LONDON, W.C.2.  
Tel.: GERrard 5660 (16 lines). Open 9 a.m.—6 p.m., including Saturday.

**VENT-AXIA**

**VENTILATING UNITS**

—readily adaptable for Valve Cooling

VENT-AXIA LTD., 9 Victoria Street, London, S.W.1  
Also at: Glasgow, Manchester, Birmingham and Leeds

*Improved Battery Charging*  
**CLIPS**

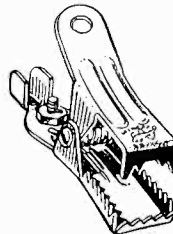

Well made of steel, double ridged for strength. Teeth on three sides of lower jaw and special design of upper jaw ensure firm grip and good contact.

**Wingard**  
(MA) LTD.

CHURCH ROAD · HENDON · LONDON · N.W.1

**DISCIPLINE YOUR POWER LINE**

*Advance Constant Voltage TRANSFORMERS*

Line Voltage Variations of  $\pm 15\%$  reduced to  $\pm 1\%$

**TYPICAL SPECIFICATION**  
 INPUT VOLTAGE 190-260 v. 50 cps.  
 OUTPUT VOLTAGE 230 v.  $\pm 1\%$   
 MAX. LOAD. 150 watts.  
 Input power factor over 90%

Prices on application Write for details.

**ADVANCE COMPONENTS LTD.**

BACK ROAD, SHERNHALL STREET, WALTHAMSTOW, LONDON, E.17 Phone: LARKSWOOD 4366 & 4367

**'AVO'** PRECISION TESTING INSTRUMENTS

*Regd. Trade Mark*



Models available for very operation and for Mains operation.

**All-Wave AVO-OSCILLATOR**

continuous fundamental frequency band from 95 Kc. to by means of six separate coils. Calibrated harmonic extends range to 80 Mc. Each band calibrated in Kc.; to within 1 per cent. Max. output 1-v., delivered into ohms non-inductive output load. Internally modulated, fully modulated or pure R.F. signal at will. Separate valve provides L.F. modulation of good wave form at 400 c/s to a depth of 30 per cent. Fully screened lead; dummy aerials for long, medium and short waves. screened case.

Representatives and Manufacturers

AUTOMATIC COIL WINDER & ELECTRICAL EQUIPMENT CO. LTD., Winder House, Douglas Street, London, S.W.1.

**THE 'AVO' TEST BRIDGE**

A self-contained 50-cycles measuring bridge of exceptional accuracy and utility. Provides for the direct measurement of all normal sizes of condensers and resistances. Accuracy, except at the extreme ends of the range, is better than 5%. Facilities are also provided for condenser power factor measurements and leakage tests. Inductances from 0.1 Henry upwards can be checked against external standards. It may also be employed as a highly efficient valve voltmeter indicator for the measurement of both audio and radio frequency voltages.

**CAPACITY:**

- Range C.1—0.00005  $\mu$ F to 0.005  $\mu$ F.
- Range C.2—0.0005  $\mu$ F to 0.05  $\mu$ F.
- Range C.3—0.05  $\mu$ F to 50  $\mu$ F.

**RESISTANCES:**

- Range R.1— 5 ohms to 5,000 ohms.
- Range R.2— 500 ohms to 500,000 ohms.
- Range R.3—50,000 ohms to 50 megohms.

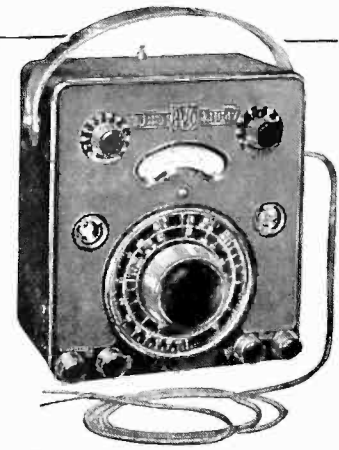

Fully descriptive leaflets will be sent on application

Phone: Victoria 3404-8

# LEAK

## "POINT ONE" RANGE OF ALMOST DISTORTIONLESS AMPLIFIERS

Here are performance figures, inclusive of output transformer, for the type 15:—

**TOTAL DISTORTION**, including hum and noise, for 15 watts output:—

1,000 c.p.s. - 0.1% (one-tenth of one per cent)  
60 c.p.s. - 0.2% (one-fifth of one per cent)

**FREQUENCY RESPONSE**: level within 0.25db. 20-20,000 c.p.s.

**LOAD DAMPING FACTOR**: 20 (10 times better than for average Class A triode).

**GAIN**: The basic amplifier requires 0.5v RMS at grid impedance. An additional two stages can be supplied built into the chassis, thus reducing the input to 0.005v R.M.S.

Full information on leaflet G.15

**SPECIAL NOTE**· The above figures establish such radically new standards that they may occasion some surprise. We therefore wish to stress that no error appears in this announcement. The circuits are original, and result from war-time research in our laboratory.

H. J. LEAK & COMPANY LIMITED  
470 UXBRIDGE ROAD · LONDON · W.12  
TELEPHONE : SHEPHERDS BUSH 5626



### Piezo QUARTZ CRYSTALS for all applications.

Full details on request.

QUARTZ CRYSTAL CO., LTD.,

(Phone : MALden 0334.) 63-71, Kingston Rd., New Malden, SURREY.

### WANTED

## "WIRELESS ENGINEER"

1940 to 1945 complete.

Offers to:

WM. DAWSON & SONS, LTD.,

102, Wigmore Street, W.1. WELbeck 8433.

WALTER SWITCHES  
ARE MADE FOR



WALTER  
INSTRUMENTS LTD.

Earl's Court Exhibition Buildings, Earl's Court, London, S.W.5.  
FULHAM 6192. 'GRAMS: WALINST, FULROAD, LONDON

C. R. Casson 7



# 5 mmf/ft

NEW LOW LEVELS in capacity and attenuation of CO-AX Cables mean new possibilities in electronic equipment design both for the war effort and for the post-war electronic age.

**BASICALLY BETTER  
AIR-SPACED**

## CO-AX LOW LOSS CABLES

TRANSRADIO LTD. 16 THE HIGHWAY · BEACONSFIELD · 7 BUCKINGHAMSHIRE

LAMINATIONS & SCREENS  
RADIOMETAL · PERMALLOY  
SILICON ALLOYS

ELECTRICAL SOUND & TELEVISION PATENTS LTD  
12, PEMBROKE STREET, LONDON, N.1

### APPOINTMENT VACANT.

ELECTRICAL ENGINEER or PHYSICIST with knowledge of editorial and press work required as Assistant Editor of the Journal of The Institution. Mathematics and foreign languages an advantage. Application, by letter only, to the Secretary, The Institution of Electrical Engineers, Savoy Place, W.C.2.

**The Dainite Moulded Rubber Service**  
Invite enquiries for Moulded Rubber Parts. 5 years experience of mouldings and compounds.

**HARBORO' RUBBER CO. LTD., MARKET HARBOROUGH**

# Electrical Standards for Research and Industry

Testing and Measuring Apparatus  
for Communication Engineering

WAVEMETERS

— OSCILLATORS

CONDENSERS

INDUCTANCES

RESISTANCES

BRIDGES — Capacitance  
Inductance  
Resistance

## H. W. SULLIVAN — LIMITED —

London, S. E. 15

ALL TYPES—ALL FREQUENCIES—ALL ACCURACIES

Tel. New Cross 3225 (Private Branch Exchange)

## For Peak Performance

*with High Voltages*

U.I.C. Fixed Ceramic Pot and Plate Capacitors have been primarily developed for use in transmitter circuits. Made only from the highest grade raw materials and subjected to the most rigorous mechanical and electrical inspection, their performance especially with H.F. loads and high voltages is unsurpassed. TYPE APPROVED. Full details on request.



# CERAMIC *High-Voltage* CAPACITORS

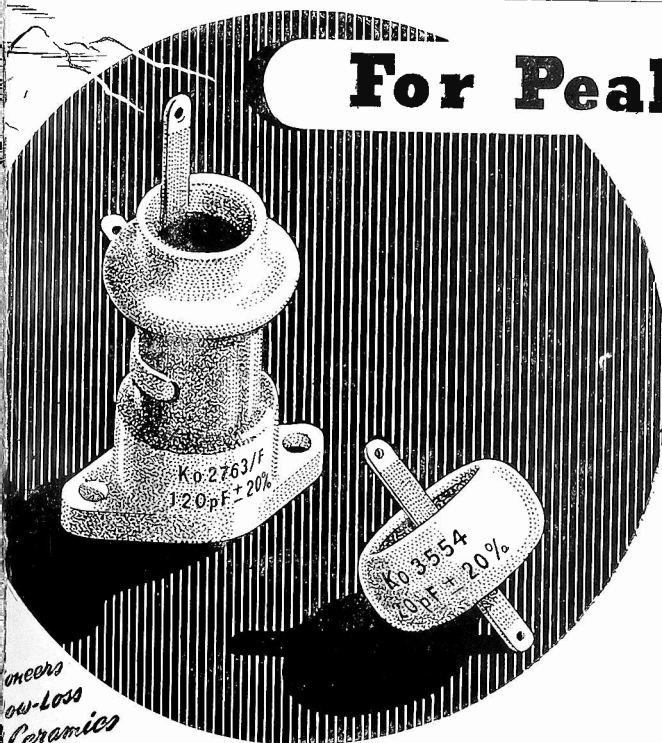

*oneers  
ow-loss  
Ceramics*

LIMITED INSULATOR CO. LTD. 12-22 LAYSTALL ST. LONDON, E.C.1

TERminus 7383 (5 lines)

Grams: Calanel, Smith, London

# MULLARD

## VALVES



FOR DOMESTIC RECEIVERS



**Recommended Types for A.C./D.C.  
Mains Operated Receiver.**

- |        |                                   |
|--------|-----------------------------------|
| CCH 35 | Frequency changer.                |
| EF 39  | Intermediate Frequency Amplifier. |
| EBC 33 | Detector L.F. Amplifier.          |
| CL 33  | Output Pentode.                   |
| CY 31  | Rectifier.                        |

*Other recommended types are available for A.C., battery and portable receivers.*

**MULLARD** THE DOMINANT NAME IN ELECTRONICS

# ACOUSTICAL RESEARCH

THE TANNOY LABORATORY can provide a skilled and specialised service in the investigation of all problems connected with vibration and sound. This covers most aspects of acoustical research and is available to industry and Government Departments engaged on priority projects.

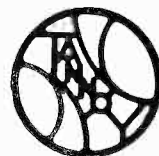

"TANNOY" is the registered trade mark of equipment manufactured by GUY R. FOUNTAIN LTD. the largest organisation in Great Britain specialising SOLELY in Sound Equipment.

# TANNOY

RESEARCH LABORATORY  
CANTERBURY GROVE, S.E.27  
PHONE: GIPSY HILL 1131

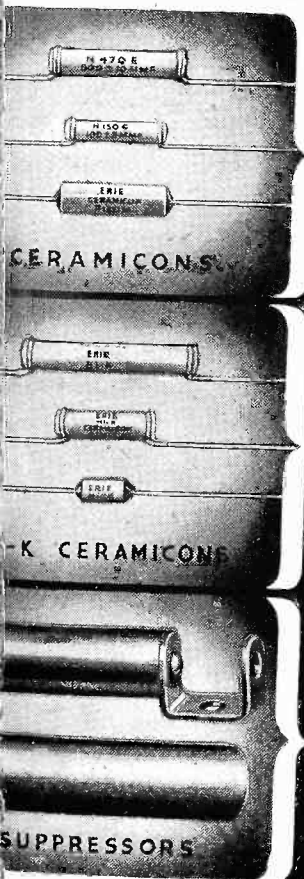

CERAMICONS

K CERAMICONS

SUPPRESSORS

1093

## ERIE

# *Electronic Components*

The engineering resources which produced hundreds of millions of Erie components for war-time needs are now at your service. May we advise you, quote you, or send you samples?

**ERIE RESISTOR LTD.**  
CARLISLE ROAD, THE HYDE,  
LONDON, N.W.9.

Telephone : Colindale 8011

FACTORIES : London, England  
Toronto, Canada • Erie, Pa., U.S.A.

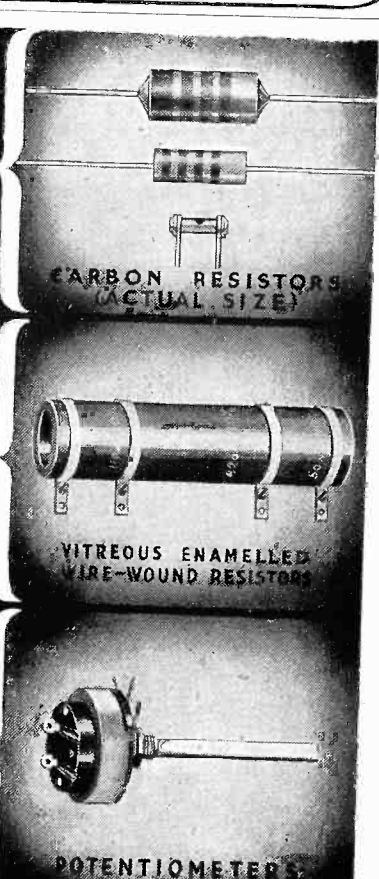

CARBON RESISTORS (ACTUAL SIZE)

VITREOUS ENAMELLED WIRE-WOUND RESISTORS

POTENTIOMETERS



# THE LONDON SYMPHONY ORCHESTRA SWELLS IN . . . AGAIN

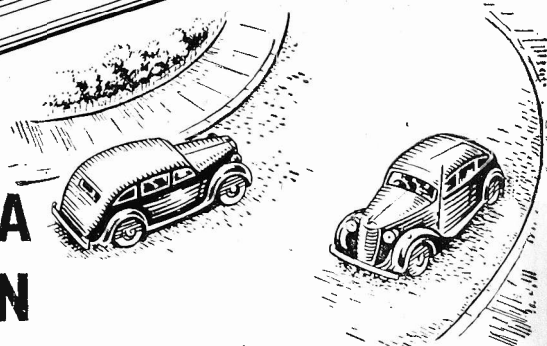

SOON the highway and the byways will come to life with cars. Soon the people of this land will want to enjoy the fruits of peace. Soon, thousands of cars, radio equipped, will be tuned in to the London Symphony Orchestra — or Geraldo — or the News . . .

voltages and temperatures, with an ability to withstand reasonable ripple current conditions.

To you who make miniature sets or radio sets for cars, Hunts supply the dual Miniature Electrolytic Capacitor Type L31A. This is a dual type capacitor of minimum size but possessing the latest technical design improvements, and capable of giving long life and performance under appropriate

This is just one more example of the Hunt ability to supply capacitors for any and every type of radio, based on a sound manufacturing policy of "capacitors only."



A. H. HUNT LTD · LONDON · S.W.18 · ESTABLISHED 1901

Printed in England for the Publishers, LIPPE & SONS LTD., Dorset House, Stamford Street, London, S.E.1, by The Cornwall Press Ltd., Paris Garden, Stamford Street, London, S.E.1.



# WIRELESS ENGINEER

MARCH 1946

VOL. 23 No. 270

—Editor

W. T. COCKING, M.I.E.E.

Managing Editor

HUGH S. POCOCK, M.I.E.E.

Technical Editor

Prof. G. W. O. HOWE, D.Sc., M.I.E.E.

*Editorial Advisory Board.*—F. M. COLEBROOK, B.Sc., A.C.G.I. (National Physical Laboratory), I. W. HAYES, O.B.E., M.I.E.E. (British Broadcasting Corporation), Professor E. B. MOULLIN, Sc.D., M.I.E.E., A. H. MUMFORD, O.B.E., B.Sc. (Eng.), M.I.E.E. (G.P.O. Engineering Department), R. L. SMITH-ROSE, D.Sc., Ph.D., M.I.E.E. (National Physical Laboratory).

## EDITORIAL

### Aerial Resistance and Cable Impedance

A READER has propounded the following problem for our consideration. "It is known that, for a coaxial transmission line in which the losses are wholly concentrated in the conductors, there exists an optimum ratio of outer to inner conductor diameter at which the attenuation loss of the line is a minimum. It so happens that this ratio provides at high frequencies a characteristic impedance of 72 ohms. It is also known that the radiation resistance of a half-wave dipole in free space is 72 ohms. Is this interesting relation a mere coincidence or is it likely that there exists a real physical identity which is demonstrable?"

The first question to decide is whether the facts are as stated. Let us consider the coaxial line and determine the characteristic impedance when made with the optimum ratio of radii.

#### The Coaxial Line

In a coaxial line the inductance and capacitance per unit length are given by the formulac.\*

$$L = 2 \log r_2/r_1 \times 10^{-9} \text{ henry}$$

$$C = \frac{1}{2 \log r_2/r_1} \times \frac{10^{-11}}{9} \text{ farad}$$

At high frequencies the currents will be confined to a thin surface layer the depth of which will depend only on the material and frequency. The resistance per unit length will therefore be inversely proportional to the periphery and we may write  $R = \rho/r_1$

+  $\rho/r_2$  where  $\rho$  is not the specific resistance but a constant for a given material and frequency.

For the propagation constant we can write  $P = \alpha + j\beta$  where, since we assume negligible leakage and a small value of  $R/\omega L$ , we can put

$$\begin{aligned} \alpha &= \frac{R}{2} \sqrt{\frac{1}{L}} = \frac{\rho}{2} \cdot \frac{r_1 + r_2}{r_1 r_2} \cdot \frac{1}{2 \log r_2/r_1} \cdot \frac{1}{30} \\ &= \frac{\rho}{120} \left( \frac{1}{r_1} + \frac{1}{r_2} \right) \frac{1}{\log r_2/r_1} \end{aligned}$$

If now we regard the radius  $r_2$  of the outer conductor as fixed and wish to determine the value of  $r_1$  to give a minimum value of the attenuation constant  $\alpha$  we must differentiate this expression with respect to  $r_1$  and equate to zero.

$$\begin{aligned} &\frac{d}{dr_1} \left\{ \frac{r_1 + r_2}{r_1 r_2} \cdot \frac{1}{\log r_2/r_1} \right\} \\ &= \frac{1}{r_1^2 \log r_2/r_1} \left( \frac{r_1 + r_2}{r_2} \cdot \frac{1}{\log r_2/r_1} - 1 \right) \end{aligned}$$

For this to be zero

$$\log r_2/r_1 = 1 + r_1/r_2$$

and by plotting a few values of  $\log r_2/r_1$  it is easily seen that this condition holds when  $r_2/r_1 = 3.597$  and  $\log r_2/r_1 = 1.278$ .

If  $r_2/r_1$  be given this optimum value the characteristic impedance  $Z_0$  will be given by the formula

$$\begin{aligned} Z_0 &= \sqrt{L/C} = 60 \log r_2/r_1 \\ &= 60 \times 1.278 = 76.7 \text{ ohms.} \end{aligned}$$

in which we have neglected the effect of the resistance; if this were taken into account

\* All the logarithms in this article are to the base  $e$ .

it would slightly increase  $Z_0$ . It is interesting to note that this characteristic impedance is independent of the size of the line so long as it has the correct ratio of outer and inner radii, but the above expression for the attenuation constant  $\alpha$  shows that it decreases as the size is increased. Our correspondent gave no indication of the source from which he obtained the value of 72 ohms for the impedance.

### The Half-wave Dipole.

The radiation resistance of a half-wave dipole is a much more difficult matter. In the Editorial of April, 1945, we showed how it could be calculated from fundamental principles on making certain simplifying assumptions, *viz.*, that the length of the dipole is exactly half a wave-length and that the current distribution is sinusoidal. On these assumptions we showed that the radiation resistance was 73.2 ohms. This immediately suggests that perhaps, if other assumptions were made, approximating more closely to the actual facts, the value might approach more closely to the 76.7 ohms found for the coaxial line. This is not so, however. In *Hochfrequenztechnik und Elektroakustik* of 1934, p. 166, Siegel and Labus calculate the value 73.3 ohms for the radiation resistance when  $\lambda = 2l$ , but show that to obtain resonance  $l/\lambda$  must be decreased below 0.5 by an amount depending on the size of the conductor, and that this causes a rapid decrease in the radiation resistance, thus removing it still further from the impedance of the coaxial line.

If there were any physical relationship between the radiation resistance of a dipole and the characteristic impedance of a transmission line, one would surely expect to find it in the case of two parallel wires rather than in a coaxial line.

### A Line of Two Parallel Wires

In a line consisting of two parallel wires of radius  $r$  at a distance  $D$  between centres, the inductance, capacitance and resistance per cm of length at high frequencies are given by the formulae:—

$$L = 4 \log \left( \frac{D}{2r} + \sqrt{\left(\frac{D}{2r}\right)^2 - 1} \right) \times 10^{-9} \text{ henry}$$

$$C = \frac{1}{4 \log \left( \frac{D}{2r} + \sqrt{\left(\frac{D}{2r}\right)^2 - 1} \right)} \times \frac{10^{-11}}{9} \text{ farad}$$

$$R = 0.825 \sqrt{f} \frac{(D/2r) \times (1/r)}{\sqrt{\left(\frac{D}{2r}\right)^2 - 1}} 10^{-9} \text{ ohm}$$

This last formula assumes the wires to be of copper. The complexity of the formulae is due to the so-called proximity effect, that is, to the non-uniform distribution of charge and current on the surface of the wires. As before, we have for the attenuation constant  $\alpha = \frac{1}{2} R \sqrt{C/L}$  which now becomes

$$\alpha = \frac{0.34 \sqrt{f}}{10^{11}} \frac{D/2r}{r \sqrt{\{(D/2r)^2 - 1\}}}$$

$$\frac{1}{\log [D/2r + \sqrt{\{(D/2r)^2 - 1\}}]}$$

We now assume that the frequency and the distance between the wires are fixed, and determine the value of the radius  $r$  that makes  $\alpha$  a minimum by equating  $d\alpha/dr$  to zero.

This leads to the condition that

$$\frac{D}{2r} \cdot \frac{1}{\sqrt{\left(\frac{D}{2r}\right)^2 - 1}} \cdot \frac{1}{\log \left( \frac{D}{2r} + \sqrt{\left(\frac{D}{2r}\right)^2 - 1} \right)} + \frac{\left(\frac{D}{2r}\right)^2}{\left(\frac{D}{2r}\right)^2 - 1} = 2$$

If  $\frac{D}{2r}$  be put successively equal to 2.2, 2.3, and 2.4 the left-hand side is found to equal 2.05, 1.985 and 1.9335, and on plotting these we find that to give exactly 2.0,  $D/2r$  must be 2.28. This then is the optimum relation between  $D$  and  $2r$ . With this value of  $D/2r$

$$\log \left( \frac{D}{2r} + \sqrt{\left(\frac{D}{2r}\right)^2 - 1} \right) = \log (2.28 + 2.05)$$

$$= \log 4.33 = 1.461$$

For the characteristic impedance we have (neglecting the effect of resistance)

$$Z_0 = \sqrt{\frac{L}{C}} = 120 \log \left( \frac{D}{2r} + \sqrt{\left(\frac{D}{2r}\right)^2 - 1} \right)$$

$$= 120 \times 1.461 = 175.5 \text{ ohms.}$$

This is 2.4 times the radiation resistance of the half-wave dipole. We are forced to the conclusion that the interesting relationship is non-existent.

G. W. O. H.

# CARRIER-FREQUENCY AMPLIFIERS\*

## Transient Response with De-tuned Carrier

By C. C. Eaglesfield

(Mullard Radio Valve Company)

**SUMMARY.**—A treatment is given of the problem of the transient response of amplifiers when the carrier frequency may differ from the central frequency of the amplifier. The importance of the depth of modulation of the input waveform is investigated: it is shown that there are good reasons for taking the modulation depth small. Several curves are given, showing typical responses.

### CONTENTS

1. Introduction
- List of Main Symbols
2. Step Response (Full Modulation)
3. Steady State Characteristic
4. Step Response (Small Modulation)
5. Numerical Examples

### 1. Introduction

IN a previous article<sup>1</sup> the writer has given the solution of the envelope response of a multistage carrier-frequency amplifier, with certain limitations on the analysis. These limitations were that successive valves in the chain should be coupled by staggered single circuits, that is circuits tuned to adjacent frequencies, or by double circuits; and that the carrier frequency should be the same as the central frequency of the amplitude-frequency characteristic of the amplifier.

This second condition is now removed, and the solution is given for the case where the carrier frequency differs from the central frequency of the amplifier.

The test input waveform used before was the carrier frequency modulated by a unit step, as shown in Fig. 1 (a). It soon became apparent, with the unrestricted input frequency, that this was a bad choice. The test input waveform now used is as shown by Fig. 1 (c), where the modulation is still a unit step, but the depth of modulation is small instead of, as formerly, 100 per cent. By restricting the depth of modulation a great simplification is made in the analysis, and it is shown that there exists a "modulation impedance" connecting the output current envelope with the input modulation voltage, this impedance being linear when the depth of modulation is small. In this way the relation between the current envelope and the modulation voltage is made exactly

analogous to the more simple case of the current in an impedance subjected to a voltage.

It is worth remarking that if a receiver is tested experimentally, for instance, by using a signal generator modulated by square waves, the depth of modulation should be small. If a large modulation depth is used, the output waveform will not be symmetrical about the time axis.

It so happens that for the case considered previously, the envelope response is the same whether the input is according to Fig. 1 (a) or 1 (c); so that no modification need be made in the results already given.

Since a further parameter is now introduced—the relation between the carrier frequency and the amplifier central frequency—it is hardly practicable to give comprehensive numerical results; another difficulty is that the response curves are now more complicated, and cannot be summarized by the two descriptive figures, speed and overshoot, previously used by the writer.

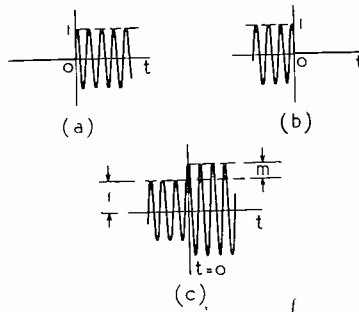

Fig. 1. The three input waveforms used in the analysis. "a" and "b" full modulation, "c" small modulation.

Since the general form of the expressions for double circuits is the same as for an equal number of staggered pairs, only the latter case has been considered, as the analysis is rather simpler.

As before, the analysis is simplified by making the carrier frequency, together with

\* MS. accepted by the Editor, July 1945.

the central frequency of the amplifier, tend to infinity; the difference-frequency being kept constant.

The treatment given follows the sequence of the writer's own approach; thus in Section 2 the envelope is calculated for  $N$  staggered-pairs driven by the waveform of Fig. 1 (a), and an explicit but cumbersome result is obtained; from this the steady-state equations are obtained in Section 3. In Section 4 the difficulties due to using 100 per cent. modulation are discussed, and general small-modulation equations are developed, which lead to a simpler result. Some numerical results are given in Section 5, which show the modulation response for four staggered-pairs with different degrees of adjustment of stagger and carrier frequency.

**List of Main Symbols**

- $n$  The number of valves in the chain.
- $N$  Equal to  $n/2$ ; an integer.
- $p$  The differential operator  $d/dt$  (with reservations).
- $\omega_0$  The angular frequency of the carrier.
- $(\omega_0 + \omega_1)$  The angular frequency of resonance of one set of circuits of the chain.
- $(\omega_0 + \omega_2)$  The angular frequency of resonance of the other set of circuits of the chain.
- $g$  The mutual conductance of each valve.
- $C$  The total capacitance per valve stage.
- $R$  The parallel resistance across each circuit.
- $a$  The ratio  $1/2CR$ .
- $k$  The "stagger coefficient"; equal to  $\frac{\omega_1 - \omega_2}{2a}$
- $h$  The "detune coefficient"; equal to  $\frac{\omega_1 + \omega_2}{2a}$
- $\theta$  The steady-state phase change.
- $z$  Equal to  $kat$ .
- $x$  Equal to  $at$ .
- $J_\nu(z)$  The Bessel function of the first kind of order  $\nu$  and argument  $z$ .
- 1** The Heaviside unit step function.

**2. Step Response (Full Modulation)**

Consider an amplifier chain consisting of  $n$  stages, of which Fig. 2 is a typical stage. For each stage  $C$  and  $R$  are the same, but in alternate stages  $L$  has one of two values, so that one set of circuits is resonant at one frequency and the other set, equal in number, at a second frequency.  $n$  is an even integer.

A voltage is injected into the grid of the

first valve: the form of this voltage is a third frequency modulated by a unit step, as shown in Fig. 1 (a). The voltage at the end of the amplifier will be calculated, and then its envelope.

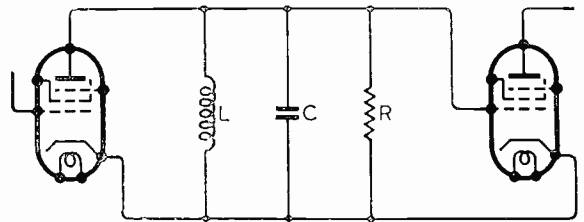

Fig. 2. A typical amplifier stage.

As a means of simplifying the various expressions that will occur, the carrier frequency is made to tend to infinity, while the difference frequencies between the carrier frequency and the resonant frequencies of the circuits are kept constant.

The stage gain is  $gZ$ , where  $g$  is the mutual conductance of each valve, and  $Z$  is the impedance of the circuit. This assumes that the anode A.C. resistance of each valve is very much larger than the circuit impedance.

The admittance of one of the circuits is:—

$$\frac{1}{Z} = \frac{1}{R} + pC + \frac{1}{pL}$$

or  $Z = \frac{1}{C} \frac{p}{(p+a)^2 + \omega^2}$

where  $a = \frac{1}{2RC}$  and  $\omega^2 = \frac{1}{LC} - a^2$

We can thus write for the impedances of two successive circuits:—

$$Z = \frac{1}{C} \frac{p}{(p+a)^2 + (\omega_0 + \omega_1)^2}$$

and

$$Z' = \frac{1}{C} \frac{p}{(p+a)^2 + (\omega_0 + \omega_2)^2}$$

where  $\omega_0$  will be taken as the carrier angular frequency, and  $\omega_1, \omega_2$  as the difference angular frequencies.

The gain for two stages is  $g^2ZZ'$ .

With the Heaviside notation the input voltage is  $\cos \omega_0 t \mathbf{1}$ ; that is, the real part of  $e^{j\omega_0 t} \mathbf{1}$ .

Thus the voltage at the anode of the second valve is

$$\left(\frac{g}{C}\right)^2 \frac{p^2}{[(p+a)^2 + (\omega_0 + \omega_1)^2][(p+a)^2 + (\omega_0 + \omega_2)^2]} e^{j\omega_0 t} \mathbf{1}$$

the real part to be taken.

By Heaviside's Shifting Theorem, the exponential term  $e^{j\omega_0 t}$  can be shifted outside the operator by writing  $(p + j\omega_0)$  in the place of  $p$  :—

$$e^{j\omega_0 t} \left(\frac{g}{C}\right)^2 \frac{(p + j\omega_0)^2}{[(p + a + j\omega_0)^2 + (\omega_0 + \omega_1)^2][(p + a + j\omega_0)^2 + (\omega_0 + \omega_2)^2]} \mathbf{1}$$

Now factorise the denominator :—

$$e^{j\omega_0 t} \left(\frac{g}{C}\right)^2 \frac{(p + j\omega_0)^2}{[p + a + j(2\omega_0 + \omega_1)][p + a - j\omega_1][p + a + j(2\omega_0 + \omega_2)][p + a - j\omega_2]} \mathbf{1}$$

Now let  $\omega_0 \rightarrow \infty$

then  $\frac{(p + j\omega_0)^2}{[p + a + j(2\omega_0 + \omega_1)][p + a + j(2\omega_0 + \omega_2)]} \rightarrow \frac{1}{4}$

and our expression becomes :—

$$e^{j\omega_0 t} \left(\frac{g}{2C}\right)^2 \frac{\mathbf{1}}{(p + a - j\omega_1)(p + a - j\omega_2)} \mathbf{1}$$

Having simplified the operator by the removal of  $\omega_0$ , it is now advisable to start moulding it into a standard form.

Note that

$$\begin{aligned} (p + a - j\omega_1)(p + a - j\omega_2) &= \left(p + a - j\frac{\omega_1 + \omega_2}{2}\right)^2 + \left(\frac{\omega_1 - \omega_2}{2}\right)^2 \\ &= (p + a - jb)^2 + \omega^2 \end{aligned}$$

The operator  $\frac{p}{(p^2 + \omega^2)^{n/2}} \cdot \mathbf{1}$  is a standard form.

See for example, McLachlan<sup>2</sup> Appendix II, equation 35, from which is obtained

$$\frac{p}{(p^2 + \omega^2)^{n/2}} \mathbf{1} = \frac{\sqrt{\pi}}{(n/2 - 1)!} \left(\frac{t}{2\omega}\right)^{\frac{n-1}{2}} J_{\frac{n-1}{2}}(\omega t) \dots \dots (3)$$

Thus, substituting from equation (3) in equation (2) :—

$$e^{j\omega_0 t} \left(\frac{g}{2C}\right)^n \frac{\sqrt{\pi}}{(n/2 - 1)!} \left(\frac{\mathbf{1}}{2\omega}\right)^{\frac{n-1}{2}} \left[ \int_0^t e^{-at} (\cos bt) t^{\frac{n-1}{2}} J_{\frac{n-1}{2}}(\omega t) dt + j \int_0^t e^{-at} (\sin bt) t^{\frac{n-1}{2}} J_{\frac{n-1}{2}}(\omega t) dt \right] \dots \dots (4)$$

where  $b = \frac{\omega_1 + \omega_2}{2}$  and  $\omega = \frac{\omega_1 - \omega_2}{2}$

The expression for the voltage is now :—

$$e^{j\omega_0 t} \left(\frac{g}{2C}\right)^2 \frac{\mathbf{1}}{(p + a - jb)^2 + \omega^2} \mathbf{1} \dots \dots (1)$$

This can now be simplified by the removal of an exponential term :—

$$e^{j\omega_0 t} \left(\frac{g}{2C}\right)^2 \int_0^t e^{-(a-jb)t} \frac{p}{p^2 + \omega^2} \mathbf{1} dt$$

This is the voltage after two valves ; after  $n$  valves the expression is :—

$$e^{j\omega_0 t} \left(\frac{g}{2C}\right)^n \int_0^t e^{-(a-jb)t} \frac{p}{(p^2 + \omega^2)^{n/2}} \mathbf{1} dt \dots \dots (2)$$

Before finding the envelope of equation (4), rewrite it after making several new substitutions :—

$$\left. \begin{aligned} \text{Put } \omega t &= z \\ n/2 &= N \\ b/a &= h \\ \omega/a &= k \\ \frac{\sqrt{2\pi N} N^N e^{-N}}{N!} &= H(N) \end{aligned} \right\} \dots \dots (4a)$$

Equation (4) then becomes :—

$$e^{j\omega_0 t} \left(\frac{g}{2Ca}\right)^n \frac{\mathbf{1}}{2^N k^N} H(N) [I_1(z) + jI_2(z)] \dots \dots (5)$$

where

$$\begin{aligned} I_1(z) &= \int_0^z e^{N-z/k} \cos\left(\frac{h}{k}z\right) \left(\frac{z}{N}\right)^{N-\frac{1}{2}} J_{N-\frac{1}{2}}(z) dz \\ I_2(z) &= \int_0^z e^{N-z/k} \sin\left(\frac{h}{k}z\right) \left(\frac{z}{N}\right)^{N-\frac{1}{2}} J_{N-\frac{1}{2}}(z) dz \end{aligned} \dots \dots (6)$$

The real part of equation (5) is the voltage from the *n*th valve. The envelope is given by the modulus, since  $\omega_0$  is tending to infinity. The envelope after *n* valves is thus

$$V_n = \left(\frac{g}{2Ca}\right)^n \frac{1}{2^N} \frac{1}{k^n} H(N) [I_1^2(z) + I_2^2(z)]^{\frac{1}{2}} \dots \dots (7)$$

At this stage it is reasonable to pause for a moment. We now have, in equation (7), an expression for the envelope which is explicit, but not very pleasant. It contains two parameters, *h* and *k*. The parameter *k* is a measure of the separation between the resonant frequencies of the circuits; and *h* is a measure of the separation between the carrier frequency and the circuit frequencies. *k* might be called the "stagger" coefficient and *h* the "detune" coefficient. The function *H(N)* tends to unity for large *N*. The Bessel function is of half integral order (since *n* is an even integer); it is tabulated to some extent, and can be expressed in terms of a finite number of elementary functions.

For numerical values of the parameters, the envelope can be calculated numerically.

**3. Steady State Characteristic**

Now consider the case when the input voltage is in the form of an unmodulated frequency, merely  $\cos \omega_0 t$ . This corresponds to the case of Section 2 when *t* is very large, and the output voltage is obtained in the usual way by putting *p* = 0.

Equation (1) gives the voltage after two stages; after *n* stages it is:—

$$e^{j\omega_0 t} \left(\frac{g}{2C}\right)^n \frac{1}{[(p+a-jb)^2 + \omega^2]^{n/2}} \dots \dots (8)$$

Put *p* = 0, and remove the step sign:—

$$\begin{aligned} & e^{j\omega_0 t} \left(\frac{g}{2C}\right)^n \frac{1}{[(a-jb)^2 + \omega^2]^{n/2}} \\ &= e^{j\omega_0 t} \left(\frac{g}{2Ca}\right)^n \frac{1}{[(1-jh)^2 + k^2]^{n/2}} \\ &= e^{j\omega_0 t} \left(\frac{g}{2Ca}\right)^n \frac{1}{[(1+k^2-h^2)^2 + 4h^2]^{n/4}} e^{j\frac{n\theta}{2}} \dots \dots (9) \end{aligned}$$

where  $\tan \theta = \frac{2h}{1+k^2-h^2} \dots \dots (10)$

The amplitude of expression (9) is:—

$$\left(\frac{g}{2Ca}\right)^n \frac{1}{[(1+k^2-h^2)^2 + 4h^2]^{n/4}} \dots \dots (11)$$

The amplitude-frequency characteristic in the steady state condition is given by equation (11): *h* being regarded as a measure of the "detune" of the carrier frequency. When *h* is zero the carrier frequency is symmetrically in the centre of the amplitude--frequency characteristic.

Several things of interest can be got from equation (11). The first is the "detune ratio," defined as the amplitude for a certain value of *h* divided by the amplitude at the centre of the characteristic (*h* = 0). This can be written down from equation (11):—

$$\text{"Detune ratio"} = \left[ \frac{(1+k^2)^2}{(1+k^2-h^2)^2 + 4h^2} \right]^{n/4} \dots \dots (12)$$

The next thing of interest is the peak to centre ratio of the characteristic. This is obtained by differentiation of equation (11) with respect to *h* to find the maximum value of the characteristic, and then division by the value at the centre of the characteristic. The details, which are straightforward, are omitted. The result is

$$\text{"Peak to centre ratio"} = \left[ \frac{1+k^2}{2k} \right]^{n/2} (13)$$

provided *k* ≥ 1. For *k* < 1 the characteristic has only a single peak. *k* = 1 is a critical case for the characteristic, at which it changes from single to double peaks.

The next thing is to observe how to arrange matters so that the amplitude (*i.e.*, the gain of the amplifier chain) is constant for any values of *h* and *k*. This requires that

$$\left(\frac{g}{2Ca}\right)^n \frac{1}{[(1+k^2-h^2)^2 + 4h^2]^{n/4}}$$

be independent of *h* and *k*. This can be done by making *a* depend on *h* and *k*. Suppose *a* = *a*<sub>0</sub> for *h* = *k* = 0.

$$\text{Then } a = \frac{a_0}{[(1+k^2-h^2)^2 + 4h^2]^{1/4}} \dots \dots (14)$$

*a*<sub>0</sub> corresponds to the case of the circuits all resonant to the same frequency and driven at that frequency. Equation (14) expresses the adjustment of *R* (Fig. 2) required to keep the gain constant for different amounts of stagger and detune.

**4. Step Response (Small Modulation)**

We have obtained in Section 2 equation (7) an expression for the step response with full modulation, that is the input has the shape of Fig. 1 (a). Now consider the case where

the carrier, instead of being suddenly applied, is suddenly removed. That is, the input has the shape of Fig. 1 (b). It might be expected that the new response would be the mirror image of the first response, since that happens when a plain step is applied to or removed from an ordinary linear network.

The waveform of Fig. 1 (b) is expressed operationally by

$$\cos \omega_0 t (\mathbf{1} - \mathbf{1})$$

and by combination of the equations in Sections 2 and 3 the envelope response can be obtained.

Fig. 3 shows the envelope for a particular case ( $n = 8, h = 1, k = 1$ ), both for the application and removal of a step. It can be seen that the one is by no means the mirror image of the other, in fact, the shapes are quite different.

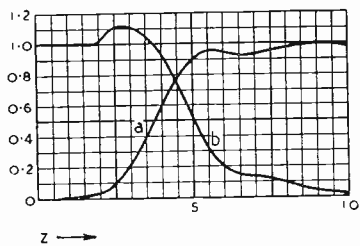

Fig. 3. The envelope response for a numerical case,  $n = 8, h = 1, k = 1$ . "a" is the response to an input of the shape of Fig. 1 (a); "b" is the response to Fig. 1 (b).

Since there is no obvious reason to favour either Fig. 1 (a) or 1 (b) in preference to the other, it seems that neither is a convenient test waveform.

A more convenient test waveform is shown in Fig. 1 (c), where the amplitude changes suddenly from 1 to  $(1 + m)$  at  $t = 0$ .  $m$  is effectively the modulation depth, and the cases considered so far have been equivalent to 100 per cent. modulation.

It will be shown that if  $m$  is kept small, the shape of the response is independent of  $m$ .

Before dealing with the particular problem, consider the general case of an admittance subjected to a voltage of the form of Fig. 1 (c).

The voltage is represented by

$$e^{j\omega_0 t} (\mathbf{1} + m\mathbf{1}).$$

Write  $A(p)$  for the admittance. Then the resulting current is

$$A(p) e^{j\omega_0 t} (\mathbf{1} + m\mathbf{1})$$

Shift the exponential term outside the operator:—

$$e^{j\omega_0 t} A(p + j\omega_0) (\mathbf{1} + m\mathbf{1})$$

This is made up of two terms, of which one is a steady state term

$$A(p + j\omega_0)\mathbf{1} = A(j\omega_0)$$

We can thus rewrite it

$$e^{j\omega_0 t} [A(j\omega_0) + mA(p + j\omega_0)\mathbf{1}] = e^{j\omega_0 t} A(j\omega_0) \left[ \mathbf{1} + m \frac{A(p + j\omega_0)}{A(j\omega_0)} \mathbf{1} \right]$$

To obtain the envelope we take the modulus.

Write  $M_0$  for the modulus of  $A(j\omega_0)$  and  $B(p)$  for the real part of  $\frac{A(p + j\omega_0)}{A(j\omega_0)}$

For  $m$  very small the modulus is

$$M_0[\mathbf{1} + mB(p)\mathbf{1}].$$

Remove from this the steady state term  $M_0$ .

There is left  $M_0 m B(p)\mathbf{1}$ .

This is the current resulting from an applied modulation voltage  $m\mathbf{1}$ .

The expression  $M_0 B(p)\mathbf{1}$  may be regarded as the "modulation admittance." It has been derived on the assumption that  $m$  is vanishingly small, and with that condition it is a linear admittance.

If  $m$  is finite the modulation admittance is not linear.

It is convenient to omit the factor  $M_0$ , which is merely the steady state gain, and take  $B(p)\mathbf{1}$  as the "modulation response." Since  $B(0) = 1$ , this response will become unity for large values of  $t$ . If  $B(p)\mathbf{1} = f(t)$ , then  $f(t)$  uniquely determines the modulation admittance. The response when any (small) modulation voltage is substituted for the step is obtained from  $f(t)$  in the usual way, by Borel's Theorem.

Now apply these results to the particular problem.  $A(p + j\omega_0)$  is given by equation (8):—

$$\left(\frac{g}{2C}\right)^n \frac{\mathbf{1}}{[(p + a - jb)^2 + \omega^2]^{n/2}}$$

Thus

$$\frac{A(p + j\omega_0)}{A(j\omega_0)} \mathbf{1} = \left[ \frac{(a - jb)^2 + \omega^2}{(p + a - jb)^2 + \omega^2} \right]^{n/2} \mathbf{1}$$

and of this the real part is the modulation response.

The denominator is rationalized by the

removal of an exponential term  $e^{-(a-jb)t}$  as before, and the numerator in the same way as led to equation (9). Omitting the details of the work, the modulation response is given by

$$A \int_0^z e^{N-z/k} \left\{ \cos \left( \frac{h}{k} z - N\theta \right) \right\} \left( \frac{z}{N} \right)^{N-\frac{1}{2}} J_{N-\frac{1}{2}}(z) dz \quad (15)$$

where  $A = \left[ \frac{(1 + k^2 - h^2)^2 + 4h^2}{4k^4} \right]^{n/4} H(N)$  .. .. (16)

$H(N)$  is given by equation 4(a).

$\theta$  is given by equation (10).

$z = kat, N = n/2.$

The expression (15) tends to unity for large  $z$ . It will be observed that (15) is much simpler than (7), so that the use of very small modulation has led to a simpler result in addition to its other advantages. Three degenerations of equation (15) are worthy of remark.

First,  $h = 0.$

Then  $\theta = 0,$  and the expression becomes

$$A \int_0^z e^{N-z/k} \left( \frac{z}{N} \right)^{N-\frac{1}{2}} J_{N-\frac{1}{2}}(z) dz \quad (17)$$

Second,  $k = 0.$

This makes  $z = 0;$  define a new variable  $x = at.$

After some manipulation, equation (15) becomes :—

$$\frac{(1 + h^2)^{n/2}}{(n-1)!} \int_0^x e^{-x} x^{n-1} \cos(hx - N\theta) dx \quad (18)$$

Third,  $h = 0$  and  $k = 0.$

Equation (18) reduces to :—

$$\frac{1}{(n-1)!} \int_0^x e^{-x} x^{n-1} dx \quad (19)$$

The expression (19) will be recognised as the incomplete gamma function, which is well tabulated<sup>3</sup>.

Inspecting the expressions (16) to (19), it is seen that "stagger" is characterised by a Bessel function in the integrand and "detune" by a sinusoidal function.

**5. Numerical Examples**

A few examples have been calculated. It is difficult to produce enough evidence on which to base firm conclusions, not because

the calculation for any particular case is very laborious, but because of the number of parameters —  $n, h, k.$  Accordingly only a single value of  $n$  has been taken,  $n = 8,$  which is high enough to be interesting, but not so high as to be irrelevant; and a few values of  $h$  and  $k.$

The general expression is given by (15), and the first thing to be observed is that it contains a Bessel function of half-integral order. These functions are tabulated<sup>4</sup>, but only apparently for integral values of the argument. This is rather wide and the integration needs care.

The numerical integration of a function is likely to daunt the amateur computer, but it is not in fact difficult. Many formulae are generally known for evaluating a single definite integral; the writer is indebted to Mr. D. P. Dalzell for drawing his attention to the following method of performing a functional integration. The derivation given should not be taken too seriously.

Suppose a function  $y$  of  $x$  is known at a number of values of  $x,$  separated by uniform increments of  $x.$  E.g. :—

$x$	0	1	2	—
$y$	$y_0$	$y_1$	$y_2$	—

Required  $\int_0^1 y dx, \int_0^2 y dx,$  etc.

By Taylor's Theorem in finite differences

$$y = (1 + \Delta)^x y_0$$

Thus  $\int y dx = \frac{(1 + \Delta)^x}{\log(1 + \Delta)} y_0$

and

$$\begin{aligned} \int_0^1 y dx &= \left[ \frac{1 + \Delta}{\log(1 + \Delta)} - \frac{1}{\log(1 + \Delta)} \right] y_0 \\ &= \frac{\Delta}{\log(1 + \Delta)} y_0 \\ &= \left[ 1 + \frac{1}{2} \Delta - \frac{1}{12} \Delta^2 + \frac{1}{24} \Delta^3 \right. \\ &\quad \left. - \frac{19}{720} \Delta^4 \dots \right] y_0 \dots (20) \end{aligned}$$

The rule is therefore to construct a set of  $Y$ 's such that

$$Y_n = y_n + \frac{1}{2} \Delta y_n - \frac{1}{12} \Delta^2 y_n + \frac{1}{24} \Delta^3 y_n \dots (21)$$

and the successive values of the integral are

$$0, Y_0, Y_0 + Y_1, Y_0 + Y_1 + Y_2, \text{ etc.}$$

for  $x = 0, 1, 2, 3, \text{ etc.}$

Equation (21) is convenient only if a machine for forming differences is available.



If only a normal calculating machine is available, it is better to rewrite (21) in terms of  $y_n, y_{n+1}, \dots$ . The formula will depend on the order of difference retained. If differences above the third are neglected, then since

$$\begin{aligned} \Delta y_n &= y_{n+1} - y_n \\ \Delta^2 y_n &= y_{n+2} - 2y_{n+1} + y_n \\ \Delta^3 y_n &= y_{n+3} - 3y_{n+2} + 3y_{n+1} - y_n \end{aligned}$$

equation (21) becomes

$$Y_n = \frac{9}{24} y_n + \frac{19}{24} y_{n+1} - \frac{5}{24} y_{n+2} + \frac{1}{24} y_{n+3} \quad \dots \quad (22)$$

In practice the process is surprisingly quick and simple.

Modulation response curves for several adjustments of  $h$  and  $k$  are given in Fig. 4. These have been normalized for equal gain by equation (14), and the time variable is  $a_0 t$  where  $a_0$  corresponds to the adjustment of Fig. 4 (a).  $n = 8$  in all cases. Each curve is accompanied by a diagram of the amplitude-frequency characteristic, not, of course, to scale, the arrow showing the position of the carrier frequency relative to the characteristic. The inclusion of the amplitude characteristic is not to be taken

as suggesting more than a cousinly relationship between it and the modulation response; it is put in chiefly for convenience in assessing the parameters.

The maximum slope and stationary values are inserted on the curves.

While it is dangerous to generalize from such restricted information, a few remarks may be permitted. "Stagger", alone and "detune" alone are characterized mainly by

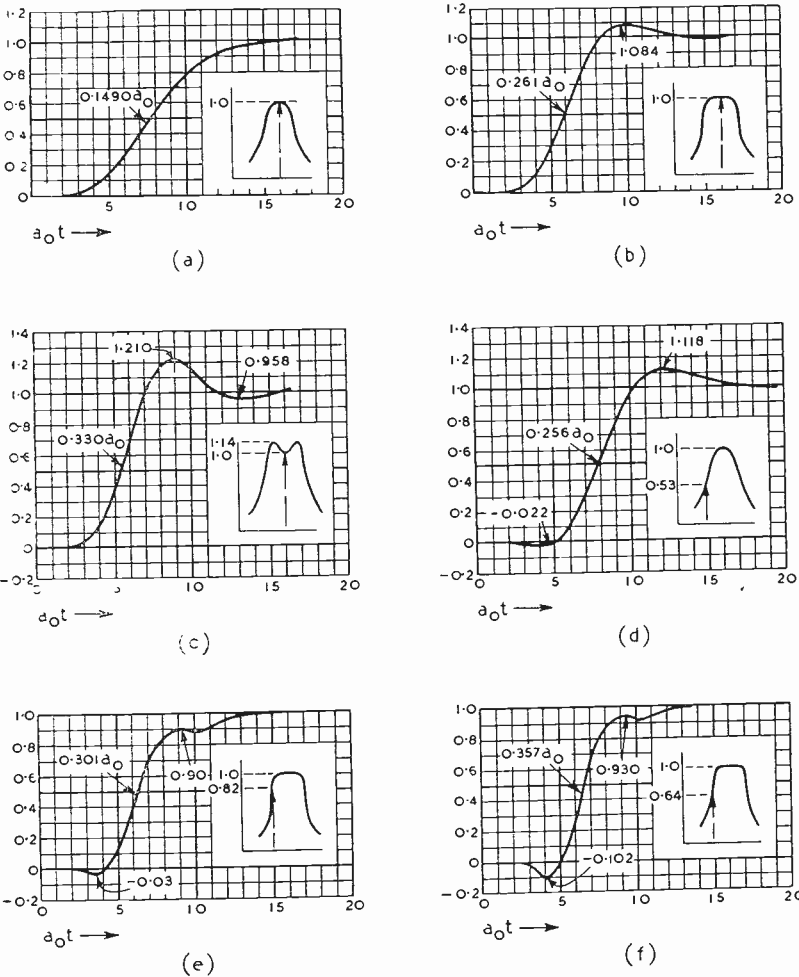

Fig. 4. Transient response for various values of  $h$  and  $k$ .

- (a)  $h = 0, k = 0$ ;
- (b)  $h = 0, k = 1$ ;
- (c)  $h = 0, k^2 = 5/3$ ;
- (d)  $h = \sqrt{2} - 1, k = 0$ ;
- (e)  $h = 0.8, k = 1$ ;
- (f)  $h = 1, k = 1$ .

The process therefore consists in multiplying the set of  $y$ 's first by  $9/24$ , then by  $19/24$ , etc.; and adding appropriately. It is worth while to write the  $y$ 's on a separate slip of paper, which can be moved relative to the paper on which the products are recorded: the four products making up the  $Y$ 's can then be kept in a straight line across the paper.

an overshoot. Detune alone gives a lower slope and more overshoot than stagger alone; it may well be generally true that for the same amount of overshoot, stagger gives a greater slope than detune. Detune alone gives a preliminary swing in the reverse direction, but of small magnitude compared to the overshoot. A combination of stagger

and detune makes this reverse swing much more important, the combination being marked by reverse swing and a pause at less than the final value.

Both stagger and detune increase the slope, and both together increase the slope still further. It is difficult to compare the response with stagger and detune with the response for stagger alone, since the shape in the first case is more complicated. It is not easy to summarize the distortion of the response by a single figure, so that while the

slopes can be compared the distortions cannot.

Thus, while it seems permissible to increase the slope of the response by stagger alone or detune alone, preferably stagger, it is not clear whether it is advisable to use both at once.

#### REFERENCES

- <sup>1</sup> Eaglesfield. *Wireless Engineer*, November 1945.
- <sup>2</sup> McLachlan. *Complex Variable and Operational Calculus*.
- <sup>3</sup> Karl Pearson. *Tables of the Incomplete  $\Gamma$ -Function*.
- <sup>4</sup> Jahnke and Emde. *Tables of Functions*.

## NOISE FACTOR OF VALVE AMPLIFIERS\*

By N. R. Campbell, Sc.D., F.Inst.P., †

V. J. Francis, B.Sc., F.Inst.P., A.M.I.E.E., and E. G. James, Ph.D., B.Sc.

(Communication from the Research Staff of The M.O. Valve Company at the G.E.C. Research Laboratories, Wembley, England)

#### CONTENTS.

1. Introduction.
  2. General Formulae for Noise.
  3. General Formulae for the Gain.
  4. Formulae for the common-grid triode.
  5. Formulae for the Common-Cathode Pentode.
  6. Important relations for an impedor.
  7. General Properties of a Transformer.
  8. Further Development of the Noise Formulae.
  9. Stages in Cascade.
  10. Definition of and Formulae for Noise Factor.
  11. Application of Noise Factor Formulae.
  12. Noise Factor of a Common-Cathode Pentode.
  13. The Effect on the Noise Factor of a Pre-fixed Stage.
  14. Conclusion.
- Acknowledgments.  
References.

#### 1. Introduction

**I**N this and in later papers, we shall apply the conclusions of two earlier papers<sup>1, 2</sup> to the problems that arise in the design of valve amplifiers. Little has to be added by way of principle to what has already been established; but, since the algebraical development necessary to apply the principles in their most convenient form is unavoidably long and complicated, it will be well to indicate at the start the problems to which the discussion is immediately directed and the nature of the results that are attained.

We suppose, then, that an amplifier has been designed with a pass-band from  $f_1$  to  $f_2$  and a defined cut-off at each end. We want to know whether the noise factor can be improved, subject to some condition limiting the permissible distortion of the pass-band, by prefixing to the amplifier another stage with known properties, *e.g.*, a common-cathode pentode, a common-cathode triode, or a common-grid triode. § We shall show that, so long as the amplifier and the pre-fixed stage belong to the class of valve circuits to which *B* refers, this problem can be solved formally without any approximations or simplifying assumptions, and without neglecting any circuit elements. In practice, however, assumptions may be necessary in all but the simplest cases because some of the factors that enter into the problem are not readily ascertained; further in complex problems the retention of all the circuit elements leads to algebra, and even to

\* MS. accepted by the Editor, November 1945.

† Late Member of the Staff of the G.E.C. Research Laboratories.

‡ These papers are referred to throughout as A and B, respectively.

§ The use of the word "common" in this connection denotes that electrode which is common to input and output circuits.

arithmetic, of almost prohibitive complexity. On the other hand, it is perfectly feasible to discuss the effect of some factors that are ignored completely in the conventional treatment of the problem (e.g., the inductances in the earth leads).

In stating the problem the term "noise factor" has been mentioned. None of the previous definitions of this term that we know has the generality required for our purpose; one of our results will be a better definition. But it should be insisted here that our definition rests on the same basis as all others, namely, the comparison of an "ideal" with a "practical" receiver, when both are fed by the same signal generator. The ideal receiver is supposed to have the same gain at any frequency as the practical receiver, but it generates no noise; when the ideal receiver is used, all the noise arises in the signal generator. If  $S/N$  denotes signal/noise ratio, and the suffix  $O$  refers to the ideal receiver and no suffix to the practical receiver, then the noise factor  $N$  is defined as  $(S/N)_O/(S/N)$ .

## 2. General Formulae for Noise

We shall start by re-stating those results of the two previous papers that will be used in this paper.

Noise is due to the happening of events random in time with a mean frequency  $\lambda$ . If these events act on a linear system, each of them, if it acted alone, would produce an effect

$$y = s(t) \quad \dots \quad (2.1)$$

at the place where the noise is measured, and the effects of different events would be simply additive. We suppose that the events are effectively instantaneous, that is to say, that the duration of each is very small compared with any period characteristic of the system that it affects. This assumption implies that the "transit time" of the electrons in the valve is effectively zero. Many of the propositions about to be stated are actually true even if there is transit time; but since not all are true, the assumption is made generally. The system is dissipative, so that the effect of each event ultimately dies away, and  $s(\infty) = 0$ .

In these circumstances the noise, measured by the mean square deviation of  $y$  from its mean, is given by

$$\overline{(y - \bar{y})^2} = \lambda \int_0^\infty |s(t)|^2 dt = 2\lambda \int_0^\infty |S(j\omega)|^2 d\omega \quad \dots \quad (2.2)$$

where  $S(j\omega)$  is the Fourier transform of  $s(t)$ . Since  $\lambda$  depends only on the nature of the events, the problem of finding the effect of the amplifier on the observed noise reduces to that of finding  $s(t)$  or  $S(j\omega)$ .

This problem is attacked in B. Consideration is there limited to a particular class of single-stage amplifiers (called here class X), which includes many—but perhaps not all—R.F. single-stage amplifiers.\* This class is that in which the relation between currents and voltages is linear; that all the connections between the terminals of the valve(s) are, or are equivalent to, a set of impedors each connecting one pair of terminals and independent of the input impedances of the valve(s) themselves—and that any signal E.M.F. is introduced in series, actually or effectively, with one of these impedors. The use of the expression "equivalent" here allows some, but not all, circuits involving mutual inductance to be included. The terminals of a valve consist of its electrodes together, possibly, with an "earth" terminal which is in general the common terminal of the signal input and output circuits, but is not identical with (*i.e.*, connected by an element of zero impedance to) any of the electrodes.

In amplifiers of class X the events that constitute noise can be simulated by instantaneous changes in the E.M.F. of impedanceless generators, one in series with each of the impedors. Then the transform  $S(j\omega)$  is closely related to the "gain" between each simulating generator and the terminals at which the noise is measured; by the "gain"  $A_{klpq}$  between the generator in series with the impedor connecting terminals  $(p, q)$  and the output terminals  $(k, l)$ , we mean the generally complex and frequency-dependent ratio  $V_{kl}/E_{pq}$ , where  $V_{kl}$  is the voltage appearing between the terminals  $(k, l)$  in virtue of the application of a sinusoidal E.M.F.  $E_{pq}$  of frequency  $\omega/2\pi$  in series with the impedor.

If the noise is thermal noise, arising from a resistor that forms part, or the whole of, the impedor between the terminals  $(p, q)$ , then

\* In paper B, it was stated that circuits in which an admittance is common to two branches each connecting a pair of electrodes were excluded from the theory there given. This, in fact, is incorrect and consideration shows that such circuits can be dealt with in the obvious way suggested by the theory. The only circuits therefore excluded from the theory are the special cases of mutual inductance mentioned in paper B.

(2.2) becomes Johnson's formula

$$\overline{(v - \bar{v})^2} = \frac{2k'I}{\pi} \int_0^\infty R_{pq} |A_{kl,pq}(j\omega)|^2 d\omega \quad (2.3)$$

where  $v$  is the noise voltage at the terminals ( $k, l$ ),  $R_{pq}$  the real and generally frequency-dependent part of the impedance of the impedor,  $T$  its absolute temperature, and  $k'$  Boltzmann's constant. (The dash is attached to the usual symbol for this constant in order to distinguish it from the symbol denoting a terminal.)

If the noise is shot noise, arising from a stream of electrons that leave the electrode  $p$  and either return to the cathode in virtue of space charge or reach a single electrode  $q$ , then

$$\overline{(v - \bar{v})^2} = \frac{I_0 \epsilon I^2}{\pi} \int_0^\infty \frac{I}{\omega^2 C_{pq}^2} |A_{kl,pq}(j\omega)|^2 d\omega \quad (2.4)$$

where  $I_0$  is the current conveyed by the electrons arriving at  $q$ ,  $\epsilon$  is the electronic charge,  $C_{pq}$  is the capacitance between the terminals ( $p, q$ ) including the mutual capacitance of the electrodes ( $p, q$ ), and  $I^2$  is the space-charge-reduction factor so denoted by North.<sup>3</sup> If, on the other hand, the electron stream permanently leaving the electrode  $p$  is divided between two electrodes  $q, r$  in such a ratio that the current  $\alpha_q I_0$  reaches the former and the current  $\alpha_r I_0$  reaches the latter, with  $\alpha_q + \alpha_r = 1$ , then (2.4) is to be replaced by

$$\begin{aligned} \overline{(v - \bar{v})^2} &= \frac{I_0 \epsilon \alpha_q}{\pi} (\alpha_q I^2 + \alpha_r) \int_0^\infty \frac{I}{\omega^2 C_{pq}^2} |A_{kl,pq}(j\omega)|^2 d\omega \\ &+ \frac{I_0 \epsilon \alpha_r (\alpha_r I^2 + \alpha_q)}{\pi} \int_0^\infty \frac{I}{\omega^2 C_{pr}^2} |A_{kl,pr}(j\omega)|^2 d\omega \quad \dots \dots \dots (2.5) \\ &- \frac{2I_0 \epsilon \alpha_q \alpha_r (I - I^2)}{\pi} \int_0^\infty \text{real part of} \left\{ \frac{I}{j\omega C_{pq}} A_{kl,pq}(j\omega) \right\} \left\{ \frac{I}{j\omega C_{pr}} A_{kl,pr}(j\omega) \right\}^* d\omega \end{aligned}$$

where the asterisk denotes the complex conjugate of the expression in  $\{ \}$  to which it is attached.

If the random events in two different sources of noise are uncorrelated, i.e., if the chance of an event's happening in one source is independent of the occurrence of events in the other source, then, but only then, the value of  $\overline{(v - \bar{v})^2}$  for the combination of the

two sources is the sum of its values for the individual sources; the sources may then be termed independent. The final confirmation that any two sources are in fact independent must often be decided ultimately by experimental comparison of the noise of the combination with the noises of the components; but the condition for independence just given suggests certain general rules that are found to be valid. Thus the random events in resistors occur in the material of which they are composed; those of a stream of electrons in the cathode from which they proceed. Accordingly we suspect—and find—that thermal noise is always independent of shot noise; that two resistors are independent when the material composing one includes no part of the material composing the other; and that streams of electrons are independent when they proceed from different cathodes, or from distinct parts of the same cathode. The anode and screen currents of a pentode are not independent, because they proceed from the same part of the same cathode.

### 3. General Formulae for the Gain

The application of formulae (2.3, 4, 5) requires a knowledge of the gains  $A_{kl,pq}$ . It is proved in *B* that, if the amplifier is of class *X*, these gains can be expressed in terms of a determinant  $\Delta$ , whose elements involve the admittances of the impedors, the co-factors of  $\Delta$ , the admittances themselves,

and (if they exist) the mutual inductances between the impedors. Some of the formulae established will now be given and illustrated by the examples of the common-cathode pentode and the common-grid triode, in order that their significance may be clear.

If there is an earth terminal, not identical with any of the electrodes and forming a common terminal of input and output

circuits ("input" here means signal input), then  $\Delta$  has  $n^2$  elements, where  $n$  is the number of the electrodes, which are distinguished by the numerals 1 to  $n$ ; the earth terminal is denoted by 0.  $\Delta$  will be written

$$\Delta = \begin{vmatrix} (11) & (21) & \dots & (n1) \\ (12) & (22) & \dots & (n2) \\ \vdots & \vdots & \ddots & \vdots \\ \vdots & \vdots & \vdots & \vdots \\ (1n) & (2n) & \dots & (nn) \end{vmatrix} \dots \quad (3.1)$$

An element  $(xx)$  is given by

$$(xx) = \alpha_x g_x + \sum_y Y_{xy} \dots \quad (3.2)$$

An element  $(xy)$  by

$$(xy) = \alpha_y g_x - Y_{xy} \dots \quad (3.3)$$

Note that

$$(yx) = \alpha_x g_y - Y_{xy} \neq (xy) \dots \quad (3.4)$$

Here  $Y_{xy}$  is the admittance of the impedor connecting terminals  $(x, y)$ , and  $\alpha_x$  is the proportion of the total current  $I_0$ , permanently leaving the cathode, that arrives at the electrode  $x$ . If  $x$  is the cathode,  $\alpha_x$  is to be taken as  $-1$ , so that

$$\sum_x \alpha_x = 0 \dots \quad (3.5)$$

The  $g$ 's are valve conductances defined by\*

$$I_0 = g_2 V_{21} + g_3 V_{31} + \dots + g_n V_{n1} \dots \quad (3.6)$$

where the cathode is identified with terminal 1, so that  $V_{x1}$  is the potential of terminal  $x$  relative to the cathode.  $g_1$  is to be taken as  $-$  (sum of the remaining  $g$ 's), so that

$$\sum_x g_x = 0 \dots \quad (3.7)$$

The summation in (3.2, 5, 7) is to be taken over all the terminals including earth; but, since  $\alpha_0 = g_0 = 0$ , the inclusion of earth does not affect (3.5) or (3.7).  $Y_{0x}$  does not occur in (3.3, 4), since neither  $x$  nor  $y$  in  $(xy)$  is 0; but  $Y_{0x}$  occurs in (3.2) as part of  $(xx)$ . It is to be observed that

$$\sum_y (xy) = Y_{0x}; \quad \sum_x (xy) = Y_{0y} \dots \quad (3.8)$$

These relations are useful in checking the values assigned to the elements.

If there is no separate earth, but one of

the electrodes (say  $m$ ) is the common terminal of input and output circuits, then  $\Delta$  reduces to the minor of  $(mm)$ ; all elements that include  $m$  disappear; admittances  $Y_{p0}$  and  $Y_{pm}$ , being now in parallel, are merged. Otherwise nothing is changed. It may be observed that this rule can be obtained by putting  $Y_{0m} = \infty$  in the full determinant (3.1).

The general formula for the gains is now

$$A_{kl, pq} = Y_{pq} \cdot \rho_{kl, pq} \dots \quad (3.9)$$

where  $\rho_{kl, pq}$  involves  $\Delta$  and its cofactors, and depends on  $Y_{pq}$ , though it does not contain  $Y_{pq}$  as a factor. If the mutual inductances between the impedors are 0 (in which case the amplifier will be said to belong to the class  $X_1$ ),

$$\rho_{kl, pq} = \frac{\Delta_{kp} - \Delta_{kq} - \Delta_{lp} + \Delta_{lq}}{\Delta} \quad (3.10)$$

where  $\Delta_{kl}$  is the cofactor of  $(kl)$  in  $\Delta$ .

(3.10) will sometimes be written for brevity

$$\rho_{kl, pq} = \delta_{kl, pq} / \Delta \dots \quad (3.11)$$

If the mutual inductances are not zero, and the amplifier belongs to class  $X$  but not to class  $X_1$ , the formula for  $\rho_{kl, pq}$  is more complicated; the formula when only one pair of impedors have mutual inductances is given in *B*. But it is to be observed that  $\rho_{kl, pq}$  has always the dimensions of an impedance. If one of  $k, l, p, q$  is 0, two of the  $\Delta$ 's have a suffix 0; since 0 does not appear in any element of  $\Delta$ , such  $\Delta_{0k}$  are to be put equal to zero. If one of  $(k, l)$  and one of  $(p, q)$  is zero (which means that the input and output terminals for this gain have both an earthed terminal),  $\delta_{kl, pq}$  reduces to one term. If there is no separate earth, but the electrode  $m$  is common to input and output, then any  $\Delta$  which has  $m$  as a suffix is to be put equal to zero.

It may be well to insist here that, when a common terminal of input and output is mentioned, *signal* input is always meant. The exceptional position accorded to such a common terminal in formulae which apply to the gain between *any* one pair of terminals and *any* other may appear anomalous. But it is due to a convention adopted in *B* which is convenient, but not in any way necessary; the formulae could be given in a form that gives no exceptional position to any terminal, but they would be less useful in the problem we are about to discuss and, indeed, in any problem concerning valve

\* (3.6) is in effect a definition of what is meant by a linear "single-stage" amplifier.

amplifiers where signal input and output circuits have actually a common terminal.

It has been assumed hitherto that the E.M.F.  $E_{pq}$  (which is impedanceless), involved in the definition of the gain in Section 2, is in series with the impedor whose admittance is  $Y_{pq}$ , and that there is no other admittance between the terminals ( $p$ ,  $q$ ). But in the signal input circuit, this assumption is not usually true; the signal generator is in series with its internal impedance, but the interelectrode capacitance  $C_{pq}$  is across the combination. However this

in that branch. This is an extremely important proposition which will often be used in what follows, sometimes without explicit mention of (3.12).

On the other hand, if, as in Fig. 2, there is an impedor  $Y_3$  in series with both  $Y_1$  and  $Y_2$ , in the equivalent Fig. 1(b).

$$Y = \frac{Y_3(Y_1 + Y_2)}{Y_1 + Y_2 + Y_3} \quad \dots \quad (3.14)$$

$$E' = \frac{Y_2}{Y_1 + Y_2} \cdot E \quad \dots \quad (3.15)$$

Accordingly in this case, we may *not* substitute  $EY_2$  for  $E'Y$  in the factor of  $\rho_{kl,pq}$ , but may substitute  $EY_2 \cdot \frac{Y_3}{Y_1 + Y_2 + Y_3}$

Another useful formula is that for  $Y_{kli}$ , which is the admittance looking into the terminals ( $k$ ,  $l$ ). We have, according to B,

$$Y_{kli} = \frac{I}{\rho_{kl,kl}} \quad \dots \quad (3.16)$$

If the amplifier is of class  $X_1$ , this becomes

$$Y_{kli} = \frac{\Delta}{\delta_{kl,kl}} \quad \dots \quad (3.17)$$

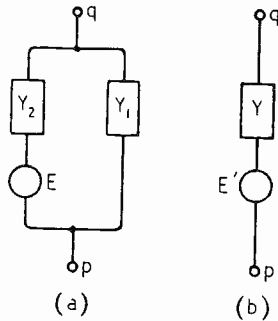

Fig. 1. By the application of Thévenin's theorem, two admittances (a) can be combined as in (b) if the generator E.M.F. is altered to  $E'$ .

arrangement is equivalent to one of which the assumption is true. For, according to Thévenin's theorem, the arrangement of Fig. 1(a) is equivalent to that of Fig. 1(b) in respect of any circuit connected to the terminals ( $p$ ,  $q$ ) if  $Y = Y_1 + Y_2$ , and if  $E' = EY_2/Y$ . Accordingly in such an input circuit, we may replace the parallel impedors by a single impedor whose admittance is the sum of their admittances, if at the same time we replace the E.M.F.  $E$  in series with one only of the parallel impedors by an E.M.F.  $E'$  in series with the single impedor, where

$$E'Y = EY_2 \quad \dots \quad (3.12)$$

We have then

$$\left. \begin{aligned} V_{kl} &= E'_{pq} A_{kl,pq} \\ &= E' \cdot Y \cdot \rho_{kl,pq} \\ &= E \cdot Y_2 \cdot \rho_{kl,pq} \end{aligned} \right\} \quad \dots \quad (3.13)$$

Now  $A_{kl,pq}$  is used only to calculate  $V_{kl}$ ; accordingly (3.13) means that, in calculating  $A_{kl,pq}$ , we must use for  $Y_{pq}$  the sum of the admittances of all parallel branches of the impedor when we are calculating  $\rho_{kl,pq}$ , but for the factor multiplying  $\rho_{kl,pq}$  we may use the admittance of that branch which contains the E.M.F., ignoring the other branches, and for  $E_{pq}$  the actual E.M.F.

#### 4. Formulae for the Common-Grid Triode

We shall now apply the results of Section 3 to the common-grid triode, taking into account the possible presence of unavoidable inductance  $L$  in the leads connecting the electrodes to earth. If we identify electrodes

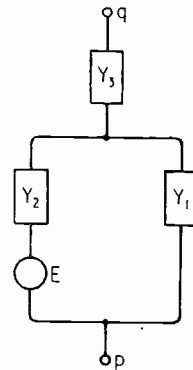

Fig. 2. Some modification of the formulae is necessary when the admittance  $Y_3$  is included as explained in the text.

1, 2, 3 respectively with cathode, control grid and anode, the circuit is represented by Fig. 3. The inductance in the grid lead is shown explicitly; but, in order to avoid complications unnecessary at this stage, the inductances in the cathode and anode leads are merged in  $Y_u$ ,  $Y_v$ ; they must be taken into account in assigning values to these quantities.  $E_u$  is the signal generator (or its

Thévenin equivalent), the admittance of its internal impedance being  $Y_u$ .  $Y_v$  is the admittance of the load across which the output is taken off. Then we have

$$\left. \begin{aligned} Y_{01} &= Y_u + j\omega C_{01}; & Y_{12} &= j\omega C_{12} \\ Y_{02} &= \frac{I}{j\omega L} + j\omega C_{02}; & Y_{13} &= j\omega C_{13} \\ Y_{03} &= Y_v + j\omega C_{03}; & Y_{23} &= j\omega C_{23} \end{aligned} \right\} (4.1)$$

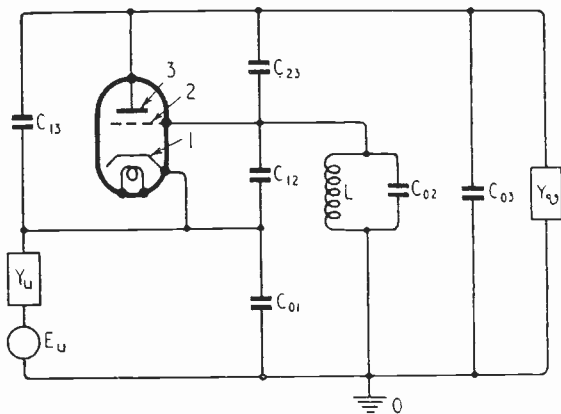

Fig. 3. The diagram of a common-grid triode amplifier is shown here.

If the grid is negative and receives no current,

$$x_2 = 0; \quad x_3 = I; \quad x_1 = -I \quad \dots (4.2)$$

$g_2$  is the mutual conductance,  $g_3$  the anode conductance,  $g_1 = -(g_2 + g_3)$ .

Hence

$$\Delta = \begin{vmatrix} (11) & (21) & (31) \\ (12) & (22) & (32) \\ (13) & (23) & (33) \end{vmatrix}$$

where

$$\left. \begin{aligned} (11) &= g_2 + g_3 + Y_u + j\omega(C_{01} + C_{12} + C_{13}) \\ (21) &= -g_2 - j\omega C_{12} \\ (31) &= -g_3 - j\omega C_{13} \\ (12) &= -j\omega C_{12} \\ (22) &= I/j\omega L + j\omega(C_{02} + C_{12} + C_{23}) \\ (32) &= -j\omega C_{23} \\ (13) &= -(g_2 + g_3) - j\omega C_{13} \\ (23) &= g_2 - j\omega C_{23} \\ (33) &= g_3 + Y_v + j\omega(C_{03} + C_{13} + C_{23}) \end{aligned} \right\} \dots (4.3)$$

The output terminals are (0, 3). If we are concerned only with gains to these terminals,  $A_{kl, pq}$  is  $A_{03, pq}$ , and  $\delta_{kl, pq}$  involves only the

cofactors  $\Delta_{31}, \Delta_{32}, \Delta_{33}$ , which therefore alone need be calculated. Now

$$\left. \begin{aligned} \Delta_{31} &= (12)(23) - (13)(22) \\ \Delta_{32} &= (21)(13) - (23)(11) \\ \Delta_{33} &= (11)(22) - (12)(21) \\ \Delta &= (31)\Delta_{31} + (32)\Delta_{32} + (33)\Delta_{33} \end{aligned} \right\} (4.4)$$

It is not worth while at the present stage to insert values of the elements from (4.4) and multiply out; for, when numerical values are inserted, many of the numerous terms prove to be negligible.

If  $L = 0$  and the grid is really earthed,  $\Delta$  reduces to the minor of (22); i.e.

$$\Delta = \begin{vmatrix} (11) & (31) \\ (13) & (33) \end{vmatrix} \dots \dots (4.5)$$

(2, 3) are the output terminals, and  $\delta_{kl, pq}$  involves only

$$\left. \begin{aligned} \Delta_{31} &= -(13) \\ \Delta_{33} &= (11) \end{aligned} \right\} \dots \dots (4.6)$$

where the elements are still given by (4.3).

### 5. Formulae for the Common-Cathode Pentode

The common-cathode pentode circuit with unavoidable inductance in the earth leads is represented in Fig. 4, the cathode, control grid and anode being again denoted by 1, 2, 3, the screen by 4, and the suppressor by 5. In the same way and for the same reason as before, the inductances in the grid and anode leads are merged in  $Y_u, Y_v$ .

Then we have

$$\left. \begin{aligned} Y_{01} &= \frac{I}{j\omega L_1} + j\omega C_{01} \\ Y_{02} &= Y_u + j\omega C_{02} \\ Y_{03} &= Y_v + j\omega C_{03} \\ Y_{04} &= \frac{I}{j\omega L_4} + j\omega C_{04} \\ Y_{05} &= \frac{I}{j\omega L_5} + j\omega C_{05} \end{aligned} \right\} \dots (5.1)$$

otherwise

$$Y_{pq} = j\omega C_{pq}$$

$x_3, x_4$  are the proportions of the current received by anode and screen

$$\left. \begin{aligned} x_3 + x_4 &= I; \quad x_2 = x_5 = 0; \quad x_1 = -I \\ g_1 &= -g_2 - g_3 - g_4 - g_5 \end{aligned} \right\} \dots \dots (5.2)$$

Then

$$\Delta = \begin{vmatrix} (11) & (21) & (31) & (41) & (51) \\ (12) & (22) & (32) & (42) & (52) \\ (13) & (23) & (33) & (43) & (53) \\ (14) & (24) & (34) & (44) & (54) \\ (15) & (25) & (35) & (45) & (55) \end{vmatrix} \dots \dots (5.3)$$

$$(11) = -g_1 + \frac{I}{j\omega L_1} + j\omega(C_{01} + C_{12} + C_{13} + C_{14} + C_{15})$$

$$(21) = -g_2 - j\omega C_{12}$$

$$(31) = -g_3 - j\omega C_{13}$$

$$(41) = -g_4 - j\omega C_{14}$$

$$(51) = -g_5 - j\omega C_{15}$$

$$(12) = -j\omega C_{12}$$

$$(22) = Y_u + j\omega(C_{02} + C_{12} + C_{23} + C_{24} + C_{25})$$

$$(32) = -j\omega C_{23}$$

$$(42) = -j\omega C_{24}$$

$$(52) = -j\omega C_{25}$$

$$(13) = \alpha_3 g_1 - j\omega C_{13}$$

$$(23) = \alpha_3 g_2 - j\omega C_{23}$$

$$(33) = \alpha_3 g_3 + Y_v + j\omega(C_{03} + C_{13} + C_{23} + C_{34} + C_{35})$$

$$(43) = \alpha_3 g_4 - j\omega C_{34}$$

$$(53) = \alpha_3 g_5 - j\omega C_{35}$$

$$(14) = \alpha_4 g_1 - j\omega C_{14}$$

$$(24) = \alpha_4 g_2 - j\omega C_{24}$$

$$(34) = \alpha_4 g_3 - j\omega C_{34}$$

$$(44) = \alpha_4 g_4 + \frac{I}{j\omega L_4} + j\omega(C_{04} + C_{14} + C_{24} + C_{34} + C_{45})$$

$$(54) = \alpha_4 g_5 - j\omega C_{45}$$

$$(15) = -j\omega C_{15}$$

$$(25) = -j\omega C_{25}$$

$$(35) = -j\omega C_{35}$$

$$(45) = -j\omega C_{45}$$

$$(55) = \frac{I}{j\omega L_5} + j\omega(C_{05} + C_{15} + C_{25} + C_{35} + C_{45}) \dots \dots (5.4)$$

If the inductances  $L_1, L_4, L_5$  are all zero, only those elements that are common to the minors of (11), (44), (55) survive. We then have

$$\Delta = \begin{vmatrix} (22) & (32) & \dots & \dots \\ (23) & (33) & \dots & \dots \end{vmatrix} \dots \dots (5.5)$$

Any  $\Delta$ , one of whose suffixes is 1, 4 or 5, is to be put equal to 0. Accordingly  $\alpha_4$  does not appear. This is the expression of the fact that the current flowing to the screen has no effect.

The output terminals are (1, 3) and  $\delta_{kl, pq}$  involves only

$$\left. \begin{aligned} \Delta_{32} &= -(23) \\ \Delta_{33} &= (22) \end{aligned} \right\} \dots \dots (5.6)$$

These results are used in section 12.

### 6. Important Relations for an Impedor

We also need some subsidiary propositions. One set concerns well-known properties of impedors. Let  $Z, Y, R, X, G, B$  be respectively the impedance, admittance, resistance, reactance, conductance and susceptance of an impedor; this notation will

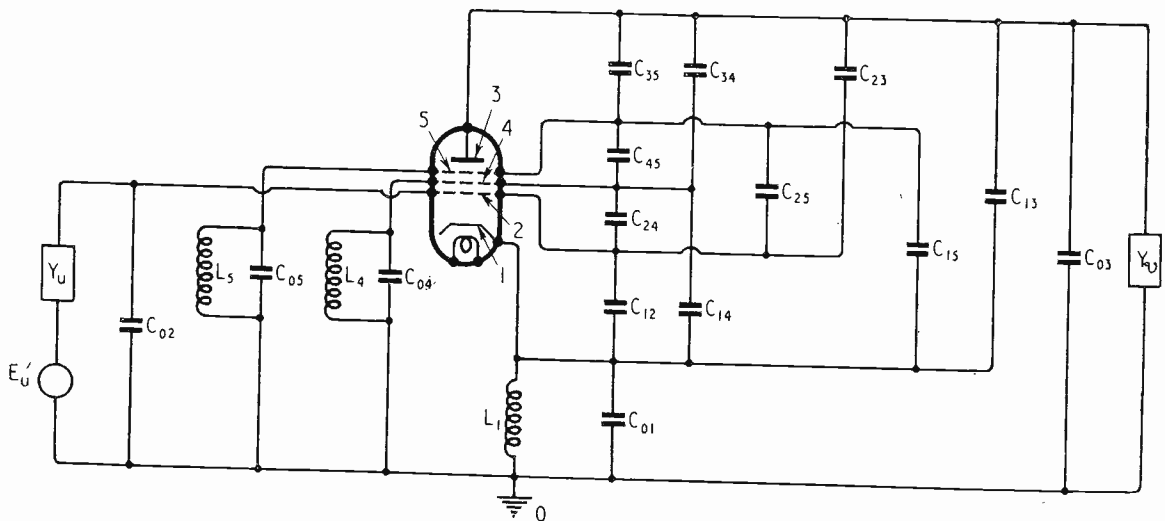

Fig. 4. The common-cathode pentode circuit, when account is taken of the lead inductances and inter-electrode capacitances.



be employed hereafter without notice, e.g.  $R_x$  will always mean the real part of  $Z_x$ .

Then

$$\left. \begin{aligned} Y = G + jB = \frac{I}{Z} = \frac{I}{R + jX} \quad (a) \\ R|Y|^2 = G \quad (b); \quad X|Y|^2 = -B \quad (d) \\ G|Z|^2 = R \quad (c); \quad B|Z|^2 = -X \quad (e) \end{aligned} \right\} (6.1)$$

Frequent use will be made of 6.1(b); the reader should bear it in mind.

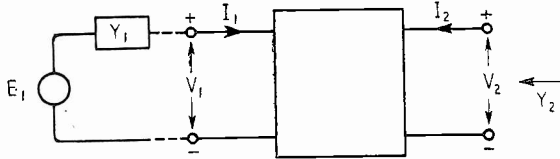

Fig. 5. Defining voltages and currents used in equations for perfect transformer in equation 7.1 of text.

### 7. General Properties of a Transformer

The other set concerns the properties of 4-terminal passive networks which we shall term transformers. When the elements of the network are all pure reactors and there is no dissipation, the network will be called a *perfect transformer (PT)*.

If  $I_1, I_2, V_1, V_2$  are the currents into and voltages across the terminals of a *PT* (see Fig. 5),

$$\left. \begin{aligned} I_1 = jy_{11}V_1 + jy_{12}V_2 \\ I_2 = jy_{12}V_1 + jy_{22}V_2 \end{aligned} \right\} \dots \dots (7.1)$$

where the  $y$ 's are all real. If an E.M.F.  $E_1$ , in series with an impedor of admittance  $Y_1$ , is connected across the input terminals, and if the output terminals are open, a voltage  $E_2$  will appear across the output terminals and the admittance looking into them will have some value  $Y_2$ ; by Thévenin's theorem that arrangement is then equivalent, in respect of anything connected to the terminals 2, to an E.M.F.  $E_2$  in series with an impedor of admittance  $Y_2$ . We require a relation between  $E_1, E_2, Y_1, Y_2$ . (It should be noted that, though  $Y_2$  is the admittance looking into terminals 2,  $Y_1$  is *not* the admittance looking into terminals 1; for the admittance of the network is in parallel with  $Y_1$ . This asymmetry is natural to the particular problem that concerns us.)

$$\left. \begin{aligned} E_2 \text{ can be found by combining (7.1) with} \\ V_1 = E_1 - I_1/Y_1; \quad I_2 = 0; \quad V_2 = E_2 \\ \dots \dots (7.2) \end{aligned} \right\}$$

This leads to

$$\frac{E_2}{E_1} = \frac{-y_{12}Y_1}{y_{22}Y_1 - j(y_{12}^2 - y_{11}y_{22})} \dots (7.3)$$

The admittance  $Y_2$  can be obtained by making  $E_1 = 0$  and introducing an E.M.F. between the terminals 2. The equations to be combined with (7.1) are then

$$I_1 = -V_1Y_1; \quad I_2 = V_2Y_2 \dots (7.4)$$

This leads to

$$Y_2 = \frac{y_{12}^2 - y_{11}y_{22} + jy_{22}Y_1}{Y_1 + jy_{11}} \dots (7.5)$$

Writing  $Y_1 = G_1 + jB_1, Y_2 = G_2 + jB_2$ , we find

$$G_2 = G_1 \frac{y_{12}^2}{G_1^2 + (B_1 + y_{11})^2} \dots (7.6)$$

and

$$\left| \frac{E_2}{E_1} \right|^2 = \frac{y_{12}^2 |Y_1|^2}{|Y_2|^2 G_1^2 + (B_1 + y_{11})^2} = \left| \frac{Y_1}{Y_2} \right|^2 \cdot \frac{G_2}{G_1} \dots \dots (7.7)$$

$$[\text{by 6.1 (b)}] = \frac{R_2}{R_1} \dots \dots (7.8)$$

If the transformer always operates at the same frequency, the three  $y$ 's in (7.1) are in principle completely at our disposal. If, given  $Y_1, G_2$  and  $B_2$  are to have assigned values, (7.5) gives two equations between them; the third is still free. Accordingly in principle we can give  $Y_2$  any assigned value (subject to the limitation that, if  $G_1$  is positive, so must be  $G_2$ ), and still have a characteristic of the *PT* at our disposal. In practice our freedom of choice is not so great. If the transformer is a uniform line closed at one end with tappings for the input and output, two of the characteristics are the distances of these tappings from the closed end, which can easily be made adjustable. But the third is then the characteristic impedance of the line, which is not so easily adjustable.

No actual transformer is perfect; it always has some dissipation. The  $y$ 's in (7.1) are then complex and, since the network is passive, the real part of each  $jy$  will be positive. Then, even if the three  $y$ 's are completely at our disposal, subject to this limitation, it is not possible to give  $Y_2$  any desired value; in particular  $G_2$ , the real part of  $Y_2$ , will be non-zero and positive. We shall assume that, in considering the adjustment of an imperfect transformer at an

assigned frequency, we may regard it as the equivalent of a *PT* with a conductor of conductance  $\gamma$  across its output terminals. We must not assume that  $\gamma$  is independent of the adjustment of the *PT* or that, when the *PT* has been adjusted to fulfil some condition,  $\gamma$  is independent of frequency, but only that, when the *PT* has been adjusted and operates at an assigned frequency,  $\gamma$  has some ascertainable value. We do not pretend that this assumption can be proved rigidly to be true generally; but it appears to be highly plausible in the limited conditions in which we shall actually use it.

## 8. Further Development of the Noise Formulae

We now start to combine the very general propositions that have been enunciated to give formulae applicable to our problem.  $v^2$  with suffixes will always denote a component (or possibly the whole) of the noise  $(v - \bar{v})^2$ ; a suffix  $\theta$  will denote that the component is thermal noise, a suffix  $\sigma$  that it is shot noise.

Combining (2.3) and (3.10), we have for the component of the noise at the output terminals ( $k, l$ ) of a stage, arising from the impedor between the terminals ( $p, q$ ),

$$\begin{aligned} v_{\theta pq}^2 &= \frac{2k'T}{\pi} \int_0^\infty R_{pq} |Y_{pq}|^2 |\rho_{kl, pq}|^2 d\omega \\ &= 4k'T \int_0^\infty G_{pq} |\rho_{kl, pq}|^2 df \end{aligned} \quad \dots \quad (8.1)$$

If an impedor contains several resistors, it is often important, *e.g.* when one of the resistors is the signal generator, to distinguish the contributions of the different resistors. If the resistors lie in different independent parallel branches, and  $G_{pq1}, G_{pq2}, \dots$  are the conductances of these branches, then the appropriate formula is

$$v_{\theta pq}^2 = 4k'T \int_0^\infty (G_{pq1} + G_{pq2} + \dots) |\rho_{kl, pq}|^2 df \quad \dots \quad (8.2)$$

Of course, in calculating  $\rho_{kl, pq}$  all the branches are taken into account.

(8.2) is a consequence of the general proposition that a conductor consisting of several branches is *in all respects* equivalent to a single conductor whose conductance is the sum of those of its branches. In order

to deduce it more particularly, we have to go behind (2.3) and consider the E.M.F.'s that simulate the noise events. Then (8.2) appears as a consequence of (3.13).

The capacitor, across which electrons pass through the vacuum between a pair of terminals, cannot have anything in series with it, though the impedor connecting those terminals may include elements in parallel with the capacitor. Accordingly the admittance of that branch of the impedor which is in series with the E.M.F. simulating the shot noise is simply that of the capacitor, *i.e.*  $j\omega C_{pq}$ . Combining (2.4) and (3.10), we have therefore for the component of the noise at the output terminals ( $k, l$ ) due to the space current between the terminals ( $p, q$ ), when there is no partition and all the electrons leaving  $p$  arrive at  $q$ ,

$$\begin{aligned} v_{\sigma pq}^2 &= \frac{I_0 \epsilon I^2}{\pi} \int_0^\infty \frac{I}{|Y_{pq}|^2} \cdot |Y_{pq}|^2 |\rho_{kl, pq}|^2 d\omega \\ &= 2I_0 \epsilon I^2 \int_0^\infty |\rho_{kl, pq}|^2 df \end{aligned} \quad \dots \quad (8.3)$$

If we write

$$2\epsilon/4k'T = a \quad \dots \quad (8.4)$$

this becomes

$$v_{\sigma pq}^2 = 4k'T \int_0^\infty a I_0 I^2 |\rho_{kl, pq}|^2 df \quad \dots \quad (8.5)$$

$a$  has the dimensions of (voltage) $^{-1}$ , and at room temperature (292 deg. K) is 20 volt $^{-1}$ .  $I_0 I^2 a$  has the dimensions of a conductance. If we denote it by  $G_{pq\sigma}$ , the combined thermal and shot noise arising between the terminals ( $p, q$ ) takes the symmetrical form

$$v_{pq}^2 = 4k'T \int_0^\infty (G_{pq} + G_{pq\sigma}) |\rho_{kl, pq}|^2 df \quad \dots \quad (8.6)$$

The whole noise at the output terminals is then

$$v^2 = 4k'T \int_0^\infty \sum_{pq} (G_{pq} + G_{pq\sigma}) |\rho_{kl, pq}|^2 df \quad \dots \quad (8.7)$$

the summation being taken over all pairs of terminals ( $p, q$ ).

If the electron stream leaving terminal  $p$  is divided between terminals  $q, r$ , we have from (2.5) and (3.10), that the noise output, which we denote by  $v_{\sigma pqr}^2$  is given by

$$v_{\sigma_{pq}}^2 = 2I_0 \int_0^\infty [\alpha_q(\alpha_q \Gamma^2 + \alpha_r) |\rho_{kl,pq}|^2 + \alpha_r(\alpha_r \Gamma^2 + \alpha_q) |\rho_{kl,pr}|^2 - 2\alpha_q \alpha_r (1 - \Gamma^2) \{\text{real part of } \rho_{kl,pq} \rho_{kl,pr}^*\}] df \quad (8.8)$$

If we write

$$\rho_{kl,pq} = \eta_1 + j\xi_1; \quad \rho_{kl,pr} = \eta_2 + j\xi_2 \quad (8.9)$$

this becomes

$$v_{\sigma_{pq}}^2 = 4k'T \int_0^\infty aI_0 [\Gamma^2 (\alpha_q \eta_1 + \alpha_r \eta_2)^2 + (\alpha_q \xi_1 + \alpha_r \xi_2)^2 + \alpha_q \alpha_r (\eta_1 - \eta_2)^2 + (\xi_1 - \xi_2)^2] df \quad (8.10)$$

$$= 4k'T \int_0^\infty aI_0 [\Gamma^2 |\alpha_q \rho_{kl,pq} + \alpha_r \rho_{kl,pr}|^2 + \alpha_q \alpha_r |\rho_{kl,pq} - \rho_{kl,pr}|^2] df \quad (8.11)$$

If  $\rho_{kl,pq} = \rho_{kl,pr}$ , the second term of the integrand vanishes and, since  $\alpha_q + \alpha_r = 1$ , (8.11) reduces to (8.5), as it should.

### 9. Stages in Cascade

Equations (8.2, 3, 4, 5, 8, 11) are true of all class X amplifiers, whether they are or are not of class X<sub>1</sub>. In each of them the integrand has the dimensions of an impedance. Accordingly in class X amplifiers any component of the noise at the output terminals, or the whole noise, which is the sum of these components, can be written in the familiar form,

$$v^2 = 4k'T \int_0^\infty Z df \quad (9.1)$$

We now write the noise due to the rth stage at the output terminals of the rth stage as

$$v_r^2 = 4k'T \int_0^\infty Z_r df \quad (9.2)$$

where in general  $Z_r$  is equal to the integrand of (8.11) summed over all pairs of terminals  $p_q$  plus the sum of the thermal noise terms corresponding to the  $\sum_{pq} G_{pq} |\rho_{kl,pq}|^2$  of (8.7).

If there is no partition noise  $Z_r$  reduces to the integrand of (8.7).

The noise at the output terminals of the

amplifier due to that arising in the rth stage is

$$4k'T \int_0^\infty Z_r |A_{r+1}|^2 |A_{r+2}|^2 \dots df \quad (9.3)$$

In (9.3)  $A_{r+1}$  is the gain of the (r + 1)th stage defined as follows (see Fig. 6): so

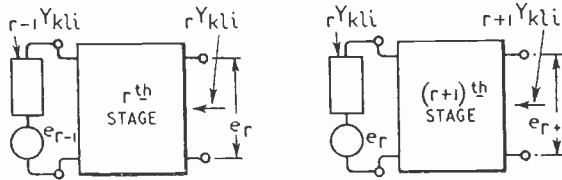

Fig. 6. This diagram defines the parameters of the rth and (r + 1)th stages.

far as the effect of the rth stage on the (r + 1)th and succeeding stages is concerned the rth stage can be represented by an impedanceless voltage generator of frequency  $f$ , in series with an admittance equal to the output admittance of the rth stage which we shall denote by  ${}_r Y_{kli}$ . (This notation is general. When a suffix  $r$  denoting a stage is attached to a symbol with other suffixes,  $r$  will be placed before the symbol.) Then if the generator of voltage  $e_r(f)$  produces a voltage at the open circuit output terminals of  $e_{r-1}(f)$  we define  $A_{r-1}$  as

$$A_{r-1} = \frac{e_{r+1}}{e_r} \quad (9.4)$$

In the case of the first stage the gain  $A_1$  will be the open circuit voltage of the first stage divided by the E.M.F. of the signal generator.

It should be noted here that the network connecting two stages can be divided into two parts at any point; one part of the network is regarded as part of the first stage, the output terminals of which then become those at which the network is cut. The other part is considered as part of the succeeding stage. This is considered in more detail in Section II.

(To be concluded.)

### REFERENCES

- 1 N. R. Campbell and V. J. Francis. "A Theory of Valve and Circuit Noise."
- 2 N. R. Campbell, V. J. Francis and E. G. James. "Linear Single-Stage Valve Circuits," *Wireless Engineer*, July 1945, Vol. xxii, p. 333.
- 3 D. O. North. *R. C. A. Review*, April 1940, Vol. iv, p. 441.

# TRANSIENT RESPONSE OF FILTERS

By *D. G. Tucker, Ph.D., A.M.I.E.E.*

(Post Office Research Station)

(Concluded from page 42 of the February issue)

### 3. Single-Section Filters with Resistance-Terminations. Analysis Based on the Actual Circuit

FOR some purposes it is necessary to assess the performance of single-section filters, and for such cases the two methods described above are not very suitable. The ideal filter method gives considerable errors, whilst the Carson and Zobel method is too complicated for ordinary use, as well as being based essentially on image terminations. A single-section filter is normally used between resistance terminations equal to its design resistance  $R$ . The following work shows some of the properties of such circuits, worked out where necessary by the use of the Heaviside Expansion Theorem.

The only type of section considered is the series-derived  $T$  arrangement, of "symmetrical" 4 or 6-element band-pass type. As far as transient response is concerned, this is probably sufficiently representative of all symmetrical types. The steady-state responses, and particularly the effects of dissipation, are considerably different in the various cases, however; this is discussed fairly fully in a previous paper<sup>11</sup>.

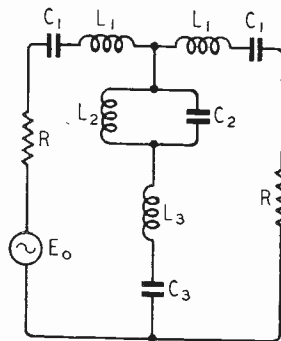

Fig. 3. 6-element symmetrical filter.

#### 3.1 Analysis of "6-element Symmetrical" Filter Section

The circuit diagram of this filter is shown in Fig. 3. The arrangement is the series-derived  $T$ -section.

If  $m$  is the "derivation" parameter,

$$n = \text{fractional bandwidth} \\ = \frac{\text{actual bandwidth}}{\text{mid-band frequency}}$$

$R$  = design impedance

Then

$$L_1 = \frac{m}{n} \cdot \frac{R}{\omega_0} \quad C_1 = \frac{n}{m} \cdot \frac{1}{R\omega_0}$$

$$L_2 = \frac{n}{2m} \cdot \frac{R}{\omega_0} \quad C_2 = \frac{2m}{n} \cdot \frac{1}{R\omega_0}$$

$$L_3 = \frac{1-m^2}{2mn} \cdot \frac{R}{\omega_0} \quad C_3 = \frac{2mn}{1-m^2} \cdot \frac{1}{R\omega_0}$$

Now if the filter is replaced by the simple network of Fig. 4, we have

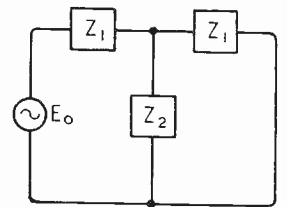

Fig. 4. Simplified network representing Fig. 3.

$$\frac{\text{Output current}}{E_0} = \frac{Z_2}{Z_1(Z_1 + 2Z_2)} \quad (14)$$

In the actual circuit,

$$Z_1 = R \left( 1 + \frac{mp}{n\omega_0} + \frac{m\omega_0}{np} \right),$$

and

$$Z_2 = R \left[ \frac{pn}{2m\omega_0} + \frac{p(1-m^2)}{2mn\omega_0} + \frac{(1-m^2)\omega_0}{2mn p} \right]$$

where  $p = \frac{d}{dt}$  = differential operator;

$$\frac{1}{p} = \int_0^t \dots dt$$

Putting  $\frac{m}{n} \left( \frac{p}{\omega_0} + \frac{\omega_0}{p} \right) = M$

$$Z_1 = R(1 + M)$$

and  $Z_2 = \frac{R}{2} \left( \frac{1}{M} + \frac{1-m^2}{m^2} M \right)$

$$\therefore \text{from (14), } \frac{\text{Output volts}}{\frac{1}{2} E_0} \\ = \frac{1 + \frac{1-m^2}{m^2} M^2}{1 + 2M + \frac{1+m^2}{m^2} M^2 + \frac{M^3}{m^2}} \quad (15)$$

3.11 *Build-up and Decay Curves for Applied Frequency = Mid-band Frequency*

The correct way to determine these would be by the use of the Heaviside Expansion Theorem<sup>12, 13</sup>. Equation (15) would be written

$$\frac{\text{Output volts}}{\frac{1}{2} E_0} = \frac{Y_{(p)}}{Z_{(p)}} \mathbf{1} \quad \dots \quad (16)$$

where  $Y_{(p)}$  and  $Z_{(p)}$  are expressed as functions of  $p$  and  $\mathbf{1}$  is the Heaviside Unit Function.

Then the roots would be found of

$$Z_{(p)} = 0 \quad \dots \quad (17)$$

and if these are  $p_1, p_2, p_3$  etc., then the solution of (16) is

$$\frac{Y_{(0)}}{Z_{(0)}} + \sum_{p=p_1}^{p=p_n} \frac{Y_{(p)} \epsilon^{pt}}{p \frac{dZ_{(p)}}{dp}} \quad \dots \quad (18)$$

Since the applied E.M.F. is alternating (i.e.  $E_0 \sin \omega t$ ),

$\frac{Y_{(p)}}{Z_{(p)}} = \frac{p\omega}{p^2 + \omega^2} \times$  the original right-hand side of equation (15)

Since  $p^2 + \omega^2$  is now a factor of  $Z_{(p)}$ , one solution of  $Z_{(p)} = 0$  is  $p = \pm j\omega$ . This gives the steady-state term in (18), for the exponentials concerned are

$$\epsilon^{+j\omega t} + \epsilon^{-j\omega t} \text{ (with the same modulus)}$$

which combine to give  $2 \cos \omega t$ .

The other solutions of  $Z_{(p)} = 0$  give the transient terms, and if these are oscillatory, the roots of  $Z_{(p)}$  occur in conjugate pairs; the real part gives the decay exponential index and the imaginary part gives the frequency.

This working may only be applied to the amplitude terms if no roots of  $Z_{(p)}$  are equal or zero.

Now this method does not work out satisfactorily for complicated circuits such as filters, for in such cases  $Z_{(p)}$  is a polynomial of high order, and it is practically impossible to find its roots. In some cases,  $Z_{(p)}$  can be expressed in some simple functional form, and the solutions for such cases have been worked out and tabulated by Campbell and Foster<sup>14</sup>. But in the present instance the denominator of (15) is a sixth-power polynomial in  $p$ , and no such solution is available.

A method of dealing with these complicated circuits has been described by Laurent<sup>15, 16</sup>, under the general title of

"Frequency Transformations." The process is to replace the complex network by a simple one which is identical when multiplied throughout by a frequency transformation function. The equation  $Z_{(p)} = 0$  then refers only to the simple network, and the final transient expression has additional amplitude and exponential factors. It will generally be fairly straightforward to solve  $Z_{(p)} = 0$ . The method has been tried for the 6-element filter, but the result obtained by the author for the amplitude terms is not correct.

In view of the difficulties described above, no analysis of the transient amplitude response is given here. But the build-up characteristics can be dealt with on a largely analytical basis.

The *natural frequencies of the system* must first be found. These can be determined fairly closely by putting the terminating resistances equal to zero; the equations are then sufficiently simplified to enable a solution to be obtained. So we have

$$Z_1 = RM$$

$$Z_2 = \frac{R}{2} \left( \frac{1}{M} + \frac{1 - m^2}{m^2} M \right)$$

And from (14)

$$\frac{\text{Output volts}}{\frac{1}{2} E_0} = \frac{\frac{1}{M} + \frac{1 - m^2}{m^2} M}{M \left( \frac{1}{M} + \frac{M}{m^2} \right)}$$

For the transient terms we must find the roots of

$$M \left( \frac{1}{M} + \frac{M}{m^2} \right) = 0$$

i.e.  $M^2 + m^2 = 0$

i.e.  $\left( \frac{p}{\omega_0} + \frac{\omega_0}{p} \right)^2 = -n^2$

$$\therefore p = \pm j\omega_0 \sqrt{1 + \frac{n^2}{2}} \mp n \sqrt{1 + \frac{n^2}{4}}$$

Also  $M = 0$

$$\therefore p = \pm j\omega_0$$

Thus, if the bandwidth,  $n$ , is small, we may say

Transient frequencies

$$= \omega_0, \omega_0 \left( 1 + \frac{n}{2} \right) \text{ and } \omega_0 \left( 1 - \frac{n}{2} \right)$$

There are, of course, no decay (i.e. real)

indices, as the terminating resistances are zero. We can assume that the transient frequencies are unaffected by the terminating resistances if the bandwidth is small, for then  $R \ll \omega_0 L$ , etc.

To obtain the decay index we must solve a more complicated equation, i.e. the denominator of (15),

$$\text{i.e. } 1 + 2M + \frac{1 + m^2}{m^2} M^2 + \frac{M^3}{m^2} = 0$$

$$\begin{aligned} \text{i.e. } y^6 + \frac{n}{m} (1 + m^2) y^5 + (2n^2 + 3) y^4 \\ + \left[ \frac{n^3}{m} + \frac{2n}{m} (1 + m^2) \right] y^3 + (2n^2 + 3) y^2 \\ + \frac{n}{m} (1 + m^2) y + 1 = 0 \end{aligned}$$

where  $y = p/\omega_0$ .

If we neglect terms in  $n^2$  and  $n^3$  in comparison with unity

$$\begin{aligned} y^6 + \frac{n}{m} (1 + m^2) y^5 + 3y^4 + \frac{2n}{m} (1 + m^2) y^3 \\ + 3y^2 + \frac{n}{m} (1 + m^2) y + 1 = 0 \quad (19) \end{aligned}$$

This is very nearly

$$\left[ y^2 + \frac{n}{3m} (1 + m^2) y + 1 \right]^3 = 0$$

which gives, very nearly (neglecting  $n^2$  terms)

$$y = - \frac{n(1 + m^2)}{6m} \pm j$$

$$\text{i.e. Decay index} = \frac{-n(1 + m^2)\omega_0 t}{6m}$$

(with a frequency  $\doteq \omega_0$ —but this is too inaccurate, hence the preceding work with zero terminating resistances).

Now we have a transient consisting of three frequencies,  $\omega_0$  and  $\omega_0(1 \pm \frac{n}{2})$ . If the phases are suitable, these represent an amplitude modulated wave, which can be expressed as

$$\sin \omega_0 t \left( 1 + G \sin \frac{n\omega_0 t}{2} \right)$$

where  $G$  is a constant. Moreover, for an applied frequency equal to the mid-band frequency, the transient and steady-state components must be equal and opposite at  $t = 0$ , and we may therefore not unreasonably express the build-up envelope characteristic as

$$1 - \epsilon \frac{-n(1 + m^2)\omega_0 t}{6m} \cdot \left( 1 + G \sin \frac{n\omega_0 t}{2} \right) \quad (20)$$

and the decay as the same function without the  $(1 -)$  term.

If fewer approximations are made, the result may be obtained in a somewhat different form.

Equation (19) may be written

$$\begin{aligned} \left[ y^2 + \frac{n}{m} y + 1 \right] \left[ y^4 + mn y^3 \right. \\ \left. + (2 + n^2) y^2 + mn y + 1 \right] = 0 \end{aligned}$$

$$\text{i.e. (a) } y^2 + \frac{n}{m} y + 1 = 0$$

$$\text{i.e. } y = - \frac{n}{2m} \pm j$$

$$\text{(b) } y^4 + mn y^3 + (2 + n^2) y^2 + mn y + 1 = 0$$

An expression, obtained by the use of the Laurent Frequency Transformations, which can be seen to fit very closely to this equation, is

$$y = - \frac{mn}{4} \pm j \left( 1 \pm \frac{n}{2} \sqrt{1 - \frac{m^2}{4}} \right)$$

Here, then, we have from (a), the frequency  $\omega_0$  with an index  $-\frac{n\omega_0 t}{2m}$ ; and from (b) the

frequencies  $\omega_0 \left( 1 \pm \frac{n}{2} \sqrt{1 - \frac{m^2}{4}} \right)$  with an index  $\frac{-mn\omega_0 t^*}{4}$ . This leads to a build-up curve thus:—

$$\begin{aligned} 1 - \epsilon^{-\frac{n\omega_0 t}{2m}} \left[ 1 + G \epsilon^{\left( -\frac{mn}{4} + \frac{n}{2m} \right) \omega_0 t} \right. \\ \left. \cdot \sin \frac{n\omega_0}{2} \sqrt{1 - \frac{m^2}{4}} \cdot t \right] \quad (21) \end{aligned}$$

The build-up curve of (20) is rather simpler to compute, but is not such a good match to the measured values as (21), as will be seen from the examples which follow. The constant  $G$  can theoretically be determined from the Expansion Theorem, but this has not been found feasible by direct processes. The analogous T-section of low-pass filter, with a D.C. pulse applied, can, however, be

\* It is worth noting that in the case of the low pass filter analogous to the band-pass being considered, the natural frequencies can readily be shown to be exactly 0 and  $\omega_c \sqrt{1 - \frac{m^2}{4}}$ , which correspond correctly to those given in equation (21) according to the rules given in the introduction.

solved fairly readily, and gives values of  $G$  as follows :—\*

$m = 1.0,$	$G = 1.15$
$m = 0.9,$	$G = 1.0$
$m = 0.8,$	$G = 0.85$

The value of  $G$  for  $m = 1.0$  appears to apply fairly closely to the band-pass case, but experiments (described below) indicate that, with dissipative narrow-band filters at

Fig. 5 shows, in Curve 1, the characteristic measured on the actual filter by means of a Cambridge Oscillograph. The curve shown is actually taken from the build-up, but the measured decay curves are very nearly the same, of course. It will be seen that the envelope becomes zero at one place, and actually is oscillatory, with high damping.

Fig. 5. Decay curves for  $n = 0.037, m = 0.884, \omega_0 = 16.65 \times 10^3$ .  
Curve 1, measured;  
curve 2, calculated from  $e^{-0.349t} (1 + 0.6 e^{0.212t} \sin 0.276t)$ ;  
curve 3, calculated from  $e^{-0.207t} (1 + 0.4 \sin 0.308t)$ ;  
curve 4, calculated from  $e^{-0.207t} (1 + 0.5 \sin 0.308t)$ .

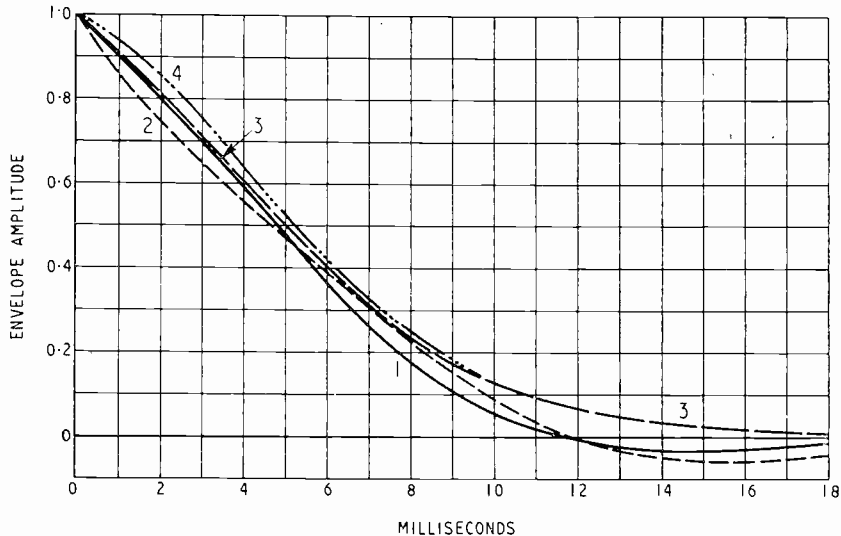

least, the values of  $G$  for  $m = 0.9$  and  $0.8$  should be somewhat lower.

It must be appreciated that equations (20) and (21) are empirical, since it has been assumed that the phases of the components are suitable; but the ideal filter theory gives an amplitude modulated wave (see equations 5 and 6) so it is not unreasonable to expect the same in this case.

An example and a check against measured results will now be discussed. The filter concerned had  $m = 0.884, n = 0.037$  and  $\omega_0 = 16.65 \times 10^3$  and the  $Q$  value of the inductors was 100. The unit of time was taken as 1 ms, so that the equations of decay (which is easier to consider than build-up) are

(a) corresponding to eqn. (20) :—

$$e^{-0.207t} \cdot (1 + G \sin 0.308t)$$

(b) corresponding to eqn. (21) :—

$$e^{-0.349t} (1 + G e^{0.212t} \cdot \sin 0.276t)$$

\* For the  $\pi$ -section of low-pass filter with  $m = 1$ , Kallmann, Spencer and Singer (19) obtain the following build-up expression (see their equation 11) :—

$$1 - e^{-\omega_0 t} - 1.15 e^{-\omega_0 t/2} \cdot \sin 0.86 \omega_0 t$$

It will be seen that this is identical with the results obtained in the present paper for the  $T$ -section, with  $G$  equal to 1.15. This confirms an earlier suggestion that the transient responses of the various types of section are more or less the same.

This is generally found on the decay, but the corresponding effect of overshoot is not always observable on the build-up. Curve 3 is the simpler equation (20), with  $G = 0.4$ , and gives a fair match, but does not show the oscillatory or overshoot effect. The same equation with  $G = 0.5$  is shown in Curve 4, so that the effect of a change in  $G$  can be observed. Curve 2 shows the more complex equation (21), with  $G = 0.6$ . This shows the overshoot, and on the whole gives the best match of all. It should be noted, though, that the build-up time measured at the half-amplitude point (according to the definition) is given more accurately by the simpler equation (20); the slope of (21) at half-amplitude is considerably different from the measured value.

It is seen that the  $G$  values given earlier are not necessarily the best, and that rather lower values of  $G$  are more suitable in practice. This may be the effect of dissipation in the filter, which cannot easily be allowed for.

The above work enables the build-up and decay curves to be calculated with enough accuracy for ordinary purposes. It has the disadvantage that it does not lead to a simple expression of the rate of build-up at half amplitude. But it will be observed that

the rate deduced for the idealised filter—see equation (4b) applies quite closely in practice to the single-section filter. The filter discussed in the above example had a bandwidth of 100 c/s, and a measured build-up at the half-amplitude rate of about 9.5 ms, as compared with 10 ms deduced by equation (4b).

### 3.12 Transient Interference Response

The question of the peak amplitude of the transient signal at the output of the filter, when a pulse of frequency outside the band is applied to the filter input, is a rather difficult one. The ideal filter theory discussed in section 1.1 gives a very simple relationship (equation 6) which is useful in practice for filters of  $1\frac{1}{2}$  or 2 sections or more. For the single-section filter, the transient peak amplitude is larger than in the ideal filter, but it has already been explained that the analysis is difficult and is not dealt with here. Consequently only some measured results will be given and discussed.

Fig. 6 shows the waveform of the signals at various frequencies. All were photographed from a Cathode-ray Oscillograph, and the relative amplitudes are chosen only for convenience, having no other significance. The filter concerned was the 6-element whole-section previously discussed. It had a 100 c/s bandwidth with a mid-band frequency of 2,650 c/s. No. 1 shows the mid-band build-up and decay curves, which have been discussed in the previous section. No. 2 shows how the waveform appears when the applied frequency is one of the cut-off frequencies. The transient already exceeds the steady-state component. This is almost always true of filters. Very rarely can the steady-state amplitude at any frequency exceed the transient. No. 3 shows the waveform when the applied frequency is at the frequency of the attenuation (steady-state) peak. Here the steady-state component is almost negligible. No. 4 shows the waveform at a frequency where the steady-state attenuation is near its minimum value, and the transient and steady-state components are nearly equal. Owing to the phasing in and out of the two components during the "make" build-up period, the maximum amplitude of the signal is nearly twice that of the transient component.

As regards the amplitudes of the transient peaks, Fig. 1 shows these compared with those of an ideal filter (calculated from equation 6) and also with those measured on a half-section filter and on the combination of whole plus half-sections. It will be noted that the transient peak amplitudes of a  $1\frac{1}{2}$ -section filter are near enough to those of the ideal filter, and it has been found that this is generally true for narrow-band filters of more than one section of 6-element or constant- $k$  type. The transient peaks of the

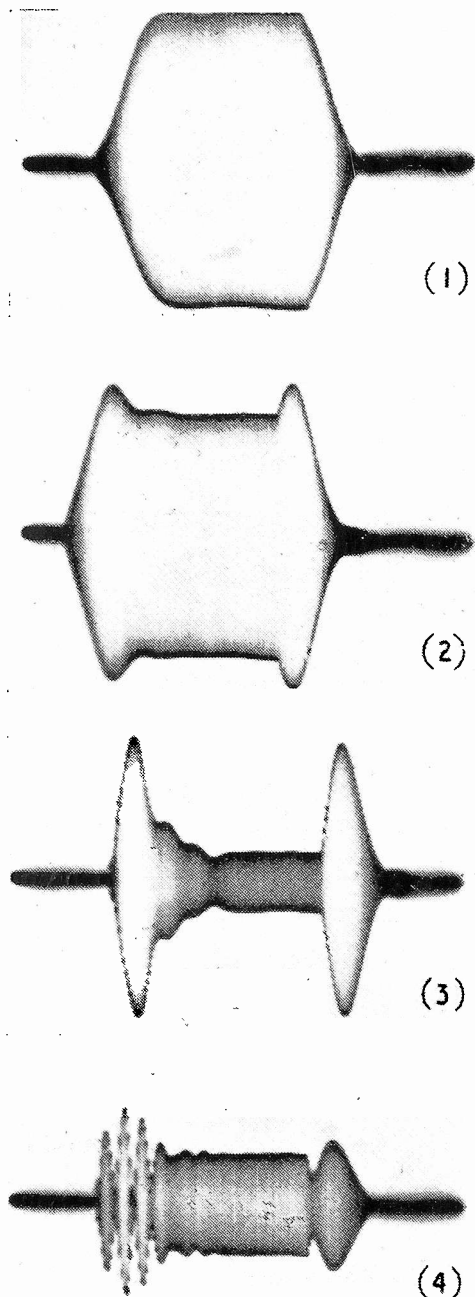

Fig. 6. Pulse waveforms in 6-element filter section (bandwidth = 100 c/s); applied frequencies, (1) 2,650 c/s = mid-band, (2) 2,600 c/s, (3) 2,550 c/s, (4) 2,400 c/s.



single section are, however, 5 db larger than in the ideal filter. For design purposes it should be satisfactory to state that the transient peak amplitudes of a single-section

and according to the more complex theory (see equation 21) by

$$1 - \epsilon^{-\frac{n\omega_0 t}{2}} \left( 1 + G \epsilon^{\frac{n\omega_0 t}{4}} \cdot \sin \frac{n\omega_0}{2} \sqrt{\frac{3}{4}} \cdot t \right) \dots (23)$$

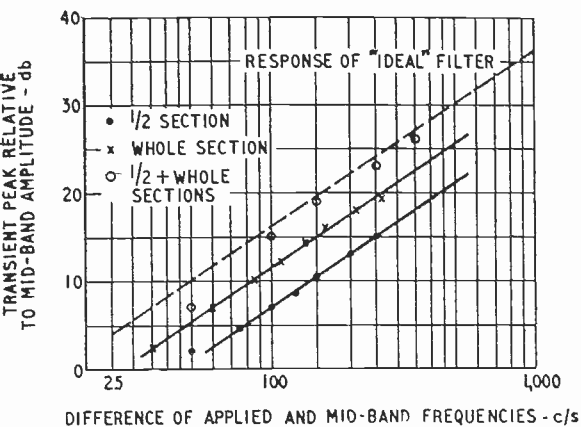

This diagram is a repetition of Fig. 1, showing the transient response of 6-element filters; bandwidth = 100 c/s, mid-band = 2,650 c/s.

6-element filter are twice those of the ideal filter of the same design bandwidth. In addition, some allowance must be made for the effect of the steady-state component adding to the transient at certain points in the frequency range.

### 3.2 Analysis of Constant-k Filter Section

The constant-k filter is merely a special case of the 6-element filter when  $m = 1$ . Consequently the equations of the previous section apply, and become as follows:—

A single-section constant-k filter was made and tested. It had  $\omega_0 = 16.03 \times 10^3$  (i.e. 2,550 c/s mid-band),  $n = 0.038$  (i.e. 100 c/s bandwidth) and the  $Q$  of the inductors was about 100.

The measured build-up and decay curves were found to be slightly different, in that the build-up showed no "overshoot." Consequently both are shown on the diagram, Fig. 7, though the build-up has been represented as a decay for convenience. It will be seen that the curves are very different from those of the 6-element filter with  $m = 0.884$  (see Fig. 5); there is a very slow commencement of the change, over 1 ms elapsing before any measurable change takes place at all. This is allowed for by making  $G$  larger. The best value for the simpler equation (22) is 0.75 and for the more complex equation (23) it is 1.0. The build-up time at the rate at the half-amplitude point is about 8.5 ms, which is somewhat less than that for the "ideal" filter. The calculated curves agree with the measured curves fairly well on this point.

It should be noted that for values of  $m$  which are not very different from 1.0 (say, for  $m > 0.7$ ), the equations (22) and (23) are

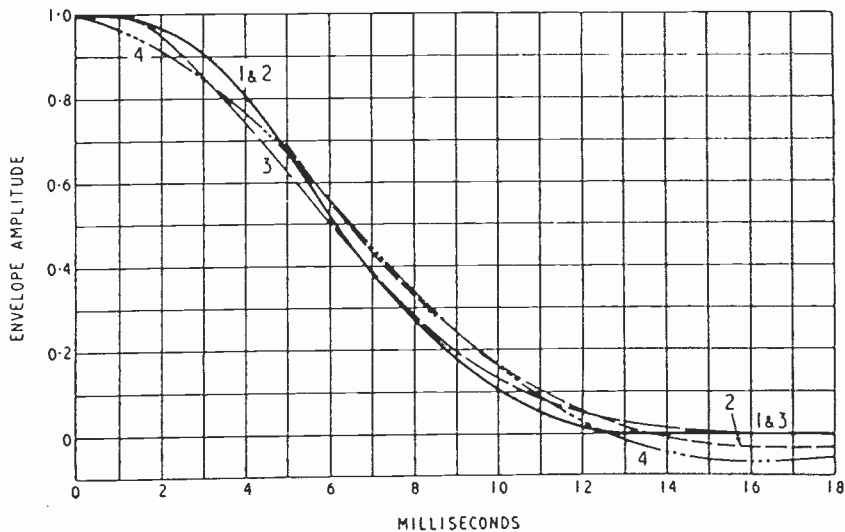

Fig. 7. Decay curves for  $n = 0.037$ ,  $m = 1$ ,  $\omega_0 = 16.03 \times 10^3$ .  
Curve 1, measured "make";  
curve 2, measured "break";  
curve 3, calculated from  $\epsilon^{-0.203t} (1 + 0.75 \sin 0.305t)$ ;  
curve 4, calculated from  $\epsilon^{-0.305t} (1 + \epsilon^{0.153t} \sin 0.264t)$ .

Build-up envelope according to the simpler theory (see equation 20)

$$1 - \epsilon^{-\frac{n\omega_0 t}{3}} \left( 1 + G \sin \frac{n\omega_0 t}{2} \right) \dots (22)$$

almost indistinguishable from the more complicated equations (20) and (21) given for derived sections. Since in very narrow-band filters,  $m$  values less than 0.7 are rare,

the constant- $k$  formulae can safely be used as general forms for very narrow bands. This conclusion also supports the use of the formulae for other circuit configurations. The value of  $G$  is, of course, dependent on the  $m$  value, and is the main factor distinguishing the responses of the various filter types.

#### 4. Conclusions

A summary has been given of two methods of approach to the determination of the transient response of band-pass filters, and it has been shown that the method which considers the filter in the abstract, as an idealised transmission characteristic, gives results which are very useful for multi-section filters. For single-section filters, however, the results are not sufficiently applicable, and a special method of determination of the build-up and decay envelopes at mid-band frequency is given; the

transient component of the envelope is of the form

$$\epsilon^{-A_1 t} [I + G \epsilon^{A_2 t} \cdot \sin A_3 t]$$

where  $A_1$ ,  $A_2$  and  $A_3$  are functions of the bandwidth, and  $m$ , the derivation parameter; and  $G$  is a function of  $m$ .

#### BIBLIOGRAPHY

- <sup>12</sup> L. Cohen, "Heaviside's Electrical Circuit Theory," 1928, (McGraw-Hill).
- <sup>13</sup> E. J. Berg, "Heaviside's Operational Calculus," 1936 (McGraw-Hill).
- <sup>14</sup> G. A. Campbell and R. M. Foster, "Fourier Integrals for Practical Applications," Bell Monograph B 584, Sept. 1931.
- <sup>15</sup> T. Laurent, "The Calculation of Passive Linear Impedance Networks by means of Frequency Transformations," *E.N.T.*, Nov. 1936, Vol. 13, p. 365.
- <sup>16</sup> T. Laurent, "Frequency Transformations Applied on the Heaviside Expansion Theorem," *Ericsson Review*, 1937, p. 40.
- <sup>17</sup> E. C. Cherry, "The Transmission Characteristics of Asymmetric-Sideband Communication Networks," *J.I.E.E.*, Part 3, 1942, Vol. 89, p. 19.
- <sup>18</sup> D. G. Tucker, "The Transient Response of Tuned Circuits," *Electronic Engineering*, to be published shortly.
- <sup>19</sup> H. E. Kallmann, R. E. Spencer and C. P. Singer, "Transient Response," *Proc. I.R.E.*, March 1945, Vol. 33, p. 169.

### Physical Society's Exhibition

TWO errors, unfortunately, occurred in the review of this exhibition in the February issue. The butterfly-oscillator referred to on p. 59 and illustrated on p. 60 was attributed to the General Electric Co., whereas in fact it was exhibited by the British Thomson-Houston Co.

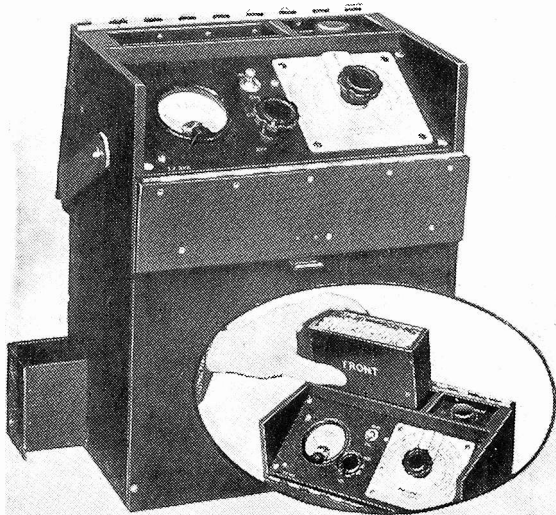

Marconi Instruments moisture-in-grain meter.

The second error occurred on p. 61; the caption to the illustration of a moisture-in-grain meter attributes it to Marconi Instruments, whereas it is

actually a Mullard product. The model shown by Marconi Instruments is of quite different appearance as the accompanying illustration of their battery-driven equipment shows.

### Book Review

#### Currents in Aerials and High Frequency Networks

By F. B. PIDDUCK. Pp. 97 with 29 Figs. Oxford University Press, Amen House, Warwick Square, London, E.C.4. 8s. 6d.

This small book is an account of investigations based on a paper published by H. C. Pocklington in 1897 and on fundamental formulae published in 1931 by F. H. Murray, an American mathematician. It is stated that the theory of transmission lines is established rigorously as that of a system of two aerials, avoiding errors [this presumably is the author's name for approximations] prevalent in elementary presentations, and considering the effect of radiation. The book is of an ultra-mathematical character, many pages being full of most forbidding looking formulae, some of which occupy a dozen lines or more. These are doubtless essential to the rigorous accuracy aimed at. The opening pages are devoted to the fundamental formulae involved, including on p. 3 the interesting subject of the ratio of the volumes occupied by electrons and atoms, but this I must confess I could not follow. The mathematical rigour does not extend to the text, for on p. 2 we are told that "it is convenient to suppose that since every electron  $E$  came originally from an atom, it from some atom near to it." The last twelve pages are occupied by tables of values of special functions that occur in the text.

This book will doubtless appeal to those who dislike approximations in such problems and prefer rigorous mathematical accuracy at all costs.

G. W. O. H.

# CORRESPONDENCE

Letters of technical interest are always welcome. In publishing such communications the Editors do not necessarily endorse any technical or general statements which they may contain.

## Valve Equivalent Circuit

To the Editor, "Wireless Engineer."

SIR,—Your publication in *Wireless Engineer* of September, 1945, "Valve Equivalent Circuit Conventions and Negative Feedback" has induced me to explain my viewpoint of the problem of valve equivalent circuit conventions. The discussion on this subject arises only from inconsistency and insecurity in defining, and in the proper choice of, the signs in the circuits.

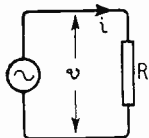

Fig. 1.

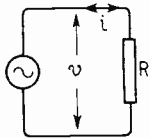

Fig. 2.

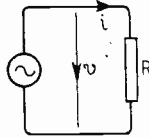

Fig. 3.

The following axioms and definitions seem to me to be basic:—

(1) The physical discussion of equations for electrical circuits is possible and correct only when the significance of the signs is defined.

(2) Alternating current and voltage change their direction periodically. If we want to write mathematical relations, we must define which direction is called positive.

(a) The arrow for a current is such that a positive value for this current means a current flowing in the direction of the arrow (the electrons flow in the opposite direction).

(b) A voltage is positive in the direction of the electric field from the positive to the negative electrode. For a positive voltage, the arrow indicates the direction of the electric field.

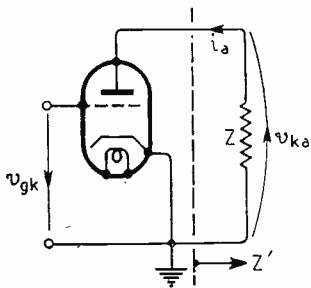

Fig. 4.

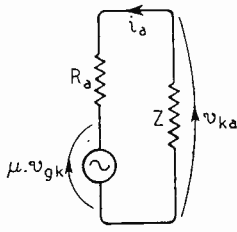

Fig. 5.

NOTE.—It is not reasonable to denote in a circuit a current with a simple arrow, and a voltage with a double one (Fig. 1). Since both quantities change their direction periodically, it would be logical to give to the current a double arrow similar to that of the voltage (Fig. 2). A clear discussion of the equations of the circuit is only possible when the indications are as in Fig. 3.

(3) The arrows for current and voltage are generally referred to each other in such a way that Ohm's law for an impedance (motor, not a generator)

can be written in the positive form:

$$+v = +i \cdot R$$

Now when the directions of positive instantaneous values for current and voltage are thus defined, the question of a positive or negative sign for the amplification factor, for the sign of the E.M.F. of the equivalent circuit, or for the direction of valve vectors, does not arise. In the case of a valve, the choice of signs is fixed and in such a way that the physical action can be seen immediately.

Let  $v_{gk}$ ,  $i_a$ ,  $v_{ka}$  be the instantaneous values of the alternating quantities of the valve, double suffixes giving at the same time the positive direction of the voltages. In Fig. 4, the circuit for a simple triode valve is shown, in which the direct currents and voltages are omitted for simplicity's sake. When  $v_{gk}$  is positive,  $i_a$  flows in the direction of the arrow, hence is positive.  $i_a$  produces a voltage  $v_{ka}$  across  $Z$  also in the direction of the arrow, hence  $v_{ka}$  is positive. As a physical reality,

$$i_a = \frac{\mu \cdot v_{gk}}{R_a + Z} \quad \dots \quad (1)$$

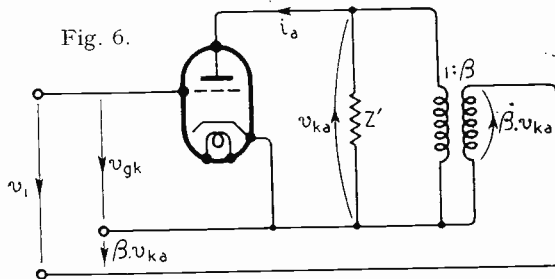

Fig. 6.

Voltage, current and their signs in the equivalent circuit have to fulfil the same equation (1). If we do not change part "Z" in Fig. 4, we must obtain Fig. 5 with the direction indicated for the equivalent E.M.F.  $\mu \cdot v_{gk}$  of the generator. For the voltage,  $v_{ka}$  and the amplification  $M = v_{ka}/v_{gk}$  we obtain:

$$v_{ka} = Z' \cdot i_a = \frac{\mu \cdot Z' \cdot v_{gk}}{R_a + Z'}; \quad M = \frac{v_{ka}}{v_{gk}} = \frac{\mu \cdot Z'}{R_a + Z'}$$

If all voltages are referred to the common cathode point, we have negative signs:

$$v_{ak} = -v_{ka} = -\frac{\mu \cdot Z' \cdot v_{gk}}{R_a + Z'};$$

$$M' = \frac{v_{ak}}{v_{gk}} = -\frac{\mu \cdot Z'}{R_a + Z'} = -M$$

These equations show that the valve acts as a phase inverter with a phase-angle of  $180^\circ$ .

From the above formulae the directions of the different valve vectors can be derived:

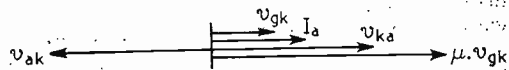

To illustrate and to employ these conventions and rules, let us consider the negative feedback stage shown in Fig. 6.

The application of equation (1) gives :

$$v_{ka} = \frac{\mu \cdot Z' \cdot v_{gk}}{R_a + Z'} \dots \dots \dots (2)$$

From Fig. 6 :

$$v_1 = v_{gk} + \beta \cdot v_{ka} \therefore v_{gk} = v_1 - \beta v_{ka} \dots (3)$$

(3) in (2) :

$$v_{ka} = \frac{\mu \cdot Z'}{R_a + Z'} (v_1 - \beta \cdot v_{ka}) \dots \dots (4)$$

From (4) :

$$v_{ka} \left( 1 + \frac{\beta \mu \cdot Z'}{R_a + Z'} \right) = \frac{\mu \cdot Z'}{R_a + Z'} v_1 \dots (5)$$

Amplification :

$$M_1 = \frac{v_{ka}}{v_1} = \frac{\frac{\mu \cdot Z'}{R_a + Z'}}{1 + \frac{\beta \mu Z'}{R_a + Z'}} = \frac{\mu Z'}{R_a + Z' (1 + \beta \mu)}$$

$$= \frac{\frac{\mu Z'}{1 + \beta \mu}}{\frac{R_a}{1 + \beta \mu} + Z'} \dots \dots \dots (6)$$

Current :

$$i_a = \frac{v_{ka}}{Z'} = \frac{\frac{\mu \cdot v_1}{1 + \beta \mu}}{\frac{R_a}{1 + \beta \mu} + Z'} \dots \dots (7)$$

Equation (7) gives the following values for the equivalent circuit :

Fig. 7.

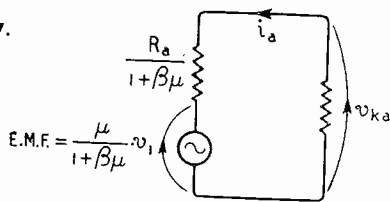

Baden, Switzerland.

HANS BIEFER.

**An Interesting Electrodynamical Problem**

To the Editor, "Wireless Engineer."

SIR,—I have found it very interesting to compare the evaluation of the force acting on the lower limb BC of a rectangular circuit, given in your Editorial, October issue, with a similar treatment of the problem given in 1938 by O'Rahilly in his book "Electro Magnetics," Chap. IV. If I understand O'Rahilly correctly, the forces given for the action of the remaining sides of the rectangle on BC are the same, whether we choose Biot-Savart's Law or Ampère's formula ; the distinction appears when the force exerted by BC on the remaining sides is computed. Biot-Savart's Law does not give the force acting on BC equal and opposite to the force exerted by BC. If this is true it surely constitutes a very grave defect in the Biot-Savart Law.

S. RODDA.

New Barnet, Herts.

[Our correspondent is quite correct when he says that the forces given for the action of the remaining sides of the rectangle on BC are the same, whether

we choose the Biot or the Ampère formula ; they both agree with the measured force. He is not so correct, however, when he says that the Biot law does not give the force acting on BC equal and opposite to the force exerted by BC. They are exactly equal and opposite and this result is given by both formulae, if properly applied. It is impossible to make any measurement which is not equally in agreement with the results calculated by either formula. The Ampère formula assumes action at a distance between any two current elements producing a force in the line joining the elements, but the only force on the element that can be measured is the resultant force, and that is always found to be at right-angles to the element as the Ampère formula gives when integrated around the whole circuit. The Biot formula is based on an entirely different point of view. Biot first found that the magnetic field near a long wire was inversely proportional to the distance from the wire. After Laplace had pointed out that this was explicable by assuming the field due to each element of conductor to be inversely proportional to the square of the distance and some function of the angle, Biot made further experiments and found that the required function was the sine of the angle between the element and the line joining it to the point considered. Biot measured the field strength by timing the oscillations of a magnetic needle and his formula is primarily for the determination of the field strength at any point due to any system of conductors. One can then use it to calculate the force on a current element at the point. We find the force on BC by finding the field strength at various points along it due to the whole circuit BADC. We cannot expect to obtain an equal and opposite force on any part or on the whole of the circuit by considering the magnetic field due only to BC. Just as the force on BC depends on the field in which it is situated, so the equal and opposite force on the rest of the circuit depends on the field in which it is situated and not merely on that portion of the field produced by the current in BC. When the field at all points of BADC has been found by the Biot formula, the forces on the three sides can be calculated and, since the forces on AB and CD are equal and opposite, the resultant force on the three sides is the upward force on AD. If the short side BC is fixed and the system BADC free to move, this is the force with which it will be moved upwards and this force can only be exerted by BC. It is, of course, equal and opposite to the force acting on BC.

G. W. O. H.]

**Resistance Networks**

To the Editor, "Wireless Engineer."

SIR,—In reading the article "Resistance Networks," by Messrs. Colchester and Gough, in *Wireless Engineer* for May, 1940, which I have only recently received, I was reminded of the fact that I do not recollect having seen in print the following simple memory-rule for the minimum insertion loss in parallel mixers with impedance matching in all directions (Fig. 10 on p. 212 of the above-mentioned article).

The rule states that with *n* mixers the maximum output current is one *n*th of the input current.

This must be so, because the output current from any particular mixer must divide equally between

the  $n-1$  other mixers and the output circuit, all of which present the same impedance, viewed from their common junction point.

JAMES STEFFENSEN,  
Technical Department,  
State Broadcasting Service.

Copenhagen, Denmark.

**Pulse Modulation**

*To the Editor, "Wireless Engineer."*

SIR,—We agree with Mr. Cooke on the desirability of the early stabilization of nomenclature in the realm of pulse modulation. Without claiming originality for the following terms, many of which have gained circulation among those "skilled in the art," we would suggest these definitions and abbreviations as appearing reasonably explicit and convenient:

Term	Abbreviation	Description
Pulse Amplitude Modulation.	PAM	Amplitude only is varied by the modulation.
Pulse Length Modulation.	PLM	Total duration varied by modulation.
(a) Symmetrical	PLMs	Times of start and stop varied equally in opposite senses about the mean time.
(b) Asymmetrical.	PLM <sub>1</sub>	Time of start, only, varied.
	PLM <sub>2</sub>	Time of stop, only, varied.
Pulse Phase Modulation.	PPM	Mean time of pulse varied.
Pulse Frequency Modulation.	PFM	Pulse chain (train) frequency varied according to the modulation.
Time Allocation Multiplex.	TAM	Multichannel system in which each channel occupies the whole of the available frequency band for small consecutive intervals in rotation.
Frequency Allocation Multiplex.	FAM	Multichannel system in which each channel continuously occupies a separate fixed part of the available frequency band.

It is tacitly assumed in these descriptions that the leading and trailing edges of the pulses are substantially instantaneous and that the pulses are rectangular in form. We feel, however, that no difficulty will arise in any given case, even for such pulse shapes as the probability-function type, in deciding the appropriate description of the modulation.

We had in mind the suppression or insertion of pulses in the train when we mentioned Pulse Number Modulation, and we agree with Mr. Cooke's remarks regarding the limitations of this system.

F. F. ROBERTS.  
J. C. SIMMONDS.

London, N.W.2.

**Rationalization of Publications**

*To the Editor, "Wireless Engineer."*

SIR,—I wish to thank Mr. R. E. Burgess for drawing my attention to the fact that a result which I included in a paper published in October 1941 had already been published by Mr. F. M. Colebrook in 1930; but I also wish to use this as an example of the whole problem of rationalizing scientific publications.

In an ideal world, each piece of information would be published once in an "original paper," in such a way as to be accessible to everyone interested, and thereafter would be incorporated either completely or by reference in textbooks and handbooks. But not every paper published at the present time is literally original. In a limited and detailed piece of work, I say quite frankly that if it appears novel to both author and editor, it will probably be new to a high proportion of readers: in the present example, this seems to be borne out by the fact that only after the lapse of over four years has the duplication of publication been noticed. Nevertheless, duplicate publication represents a waste of the author's time and the publisher's paper; in order to minimize waste, we need two and possibly three types of publication: (1) The full-length book on a limited branch of science or engineering—e.g. the "International Series in Physics," published by McGraw-Hill Book Co. (2) The encyclopaedia, which gives a brief outline of each topic of an extensive field, with references to more detailed work—e.g. the "Radio Handbooks" of American origin. (3) Possibly also the interim summary, to bridge the gap between original papers and the two types of book just mentioned which take a fair time to compile—e.g. the Physical Society's "Reports on Progress in Physics."

Am I being unduly pessimistic in suggesting that in the field of radio and electronics, none of these types of publication is available as a British book by a British author? Alternatively, since the better type of book is international in scope (a glance through the index of a book published in U.S.A. in 1933 showed references to Appleton, Moullin and Watson-Watt) should we welcome the extension of rationalization of publication by a further stage, and conclude that so long as the Americans do these things adequately there is no need for British engineers to give up their time to writing books? A definite policy is urgently needed now, because there is an accumulation of the greater part of six years' work which is presumably now being released for general publication.

D. A. BELL.

London, N.21.

**Books Received**

**Inside the Vacuum Tube**

By John F. Rider. Pp. 407 + xiii. John F. Rider Publisher Inc., 404, Fourth Avenue, New York, 16, N.Y. Price \$4.50.

**The Cathode-Ray Tube Handbook**

By S. K. Lewer, B.Sc. Pp. 100 + xviii. Sir Isaac Pitman & Sons Ltd., Pitman House, Parker St., Kingsway, London, W.C.2. Price 6s.

# WIRELESS PATENTS

## A Summary of Recently Accepted Specifications

The following abstracts are prepared, with the permission of the Controller of H.M. Stationery Office, from Specifications obtainable at the Patent Office, 25, Southampton Buildings, London, W.C.2, price 1/- each.

### ACOUSTICS AND AUDIO-FREQUENCY CIRCUITS AND APPARATUS

572 481.—Filter circuit, fed by rectifiers at two different points, to serve as a noise-reduction unit in sound-recording equipment.

*Radio Corporation of America. Convention date (U.S.A.) 31st December, 1942.*

572 500.—Magneto-strictive oscillator for generating sound or supersonic pressure-waves, e.g., for under-water echo-sounding.

*Marconi's W. T. Co., Ltd. and H. J. Round. Application dates 24th November, 1938, and 16th May, 1939.*

572 576.—Construction of acoustic conduits or chambers for dissipating or absorbing noises of high intensity.

*V. Jacobsen. Application date 29th March, 1943.*

572 688.—Automatic cut-out switch for the motor of a gramophone or radiogram.

*E. W. Mortimer and The Garrard Engineering and Manufacturing Co., Ltd. Application date 5th November, 1943.*

### DIRECTIONAL WIRELESS

572 470.—Capacitance-balancing arrangement for a loop-and-vertical aerial, to ensure a clear-cut cardioid response on ultra-short waves.

*Marconi's W. T. Co., Ltd. and F. M. Wright. Application date 7th July, 1941.*

572 508.—Training equipment for simulating the conditions under which D. F. observations are taken on a mobile craft from a fixed transmitter.

*Rediffusion Ltd. and P. Adorjan. Application date, 21st February, 1940.*

572 570.—Training equipment for simulating the conditions under which D. F. observations are taken on a number of fixed beacon-stations.

*Rediffusion Ltd., P. Adorjan and R. P. Gabriel. Application date, 11th July, 1940.*

572 912.—Indicator circuit for sharply distinguishing the "dot" from the "dash" signals, say in a blind-landing beam system.

*Standard Telephones and Cables Ltd., C. M. le G. Eyre and D. Hamilton. Application date, 11th February, 1944.*

### RECEIVING CIRCUITS AND APPARATUS

572 426.—Means for ensuring an accurately-graded sliding movement of the powdered-iron cores of ganged tuning inductances.

*Zenith Radio Corp. Convention date (U.S.A.), 14th September, 1942.*

572 511.—Mounting and encasing the two elements of a crystal detector, particularly for use as a mixer when receiving very short waves.

*The General Electric Co., Ltd., F. H. Brittain and*

*C. F. Ransley. Application date, 5th November, 1941.*

572 955.—Portable valve-receiver in which the listener's body is coupled, as an aerial, to the tuned input circuit through the headphones, and the dry batteries serve as a counterpoise.

*H. Jackson. Application date, 27th April, 1942.*

### TRANSMITTING CIRCUITS AND APPARATUS

572 781.—Construction of a R. F. tuning chamber provided with fixed and movable sheets or septums to vary its resonant frequency.

*E. B. Moullin and Metropolitan-Vickers Electrical Co. Ltd. Application date, 30th April, 1943.*

572 783.—Loud-speaker installation coupled to the circuit of a ship's radio-transmitter.

*International Marine Radio Ltd. and C. G. G. Withey. Application date, 21st February, 1944.*

### SUBSIDIARY APPARATUS AND MATERIALS

572 163.—Remote-control device comprising a fixed ring-magnet and a rotary bar-magnet for indicating the setting of a distant condenser or potentiometer.

*Standard Telephones and Cables, Ltd. and S. H. Towner. Application date 5th November, 1943.*

572 208.—Remote control and indicating equipment for exploring and recording the condition of a series of electrical track or like circuits.

*Standard Telephones and Cables, Ltd. (communicated by International Standard Electric Corporation). Application date 22nd October, 1943.*

572 292.—Process for "spot-welding" or bonding together sheets of dielectric materials by high-frequency current.

*Radio Corporation of America. Convention date (U.S.A.) 31st July, 1942.*

572 324.—Hand-tool for connecting wires together, or to circuit components, by electric welding or fusion.

*Standard Telephones and Cables, Ltd. and G. Gilliver. Application date 20th March, 1944.*

572 329.—Diphenyl composition, particularly for use as the impregnating dielectric for "interleaved" condensers.

*The British Thomson-Houston Co., Ltd. Convention date (U.S.A.) 25th February, 1942.*

572 398.—Hand-tool of the pincers type for stripping electric cables.

*Dorman and Smith, Ltd., and T. Atherton. Application date 30th March, 1944.*

572 443.—Hand-tool for "spot-welding" sheets of dielectric materials by radio-frequency currents.

*Radio Corporation of America. Convention date (U.S.A.) 31st July, 1942.*

# ABSTRACTS AND REFERENCES

Compiled by the Radio Research Board and published by arrangement with the Department of Scientific and Industrial Research

In order to enhance the usefulness of the abstracts, certain changes have been made in their presentation. The subject sections have been increased in number and made more in accordance with the modern trend of development, and they are now arranged in alphabetical order. Universal Decimal Classification numbers have been added to each abstract, and heavy-face type has been adopted for the serial number and title in order to increase their legibility.

Acoustics and Audio Frequencies	...	...	41
Aerials and Transmission Lines	...	...	43
Circuits	...	...	43
General Physics	...	...	46
Geophysical and Extraterrestrial Phenomena	...	...	46
Location and Aids to Navigation	...	...	47
Materials and Subsidiary Techniques	...	...	50
Mathematics	...	...	52
Measurements and Test Gear	...	...	52
Other Applications of Radio and Electronics	...	...	54
Propagation of Waves	...	...	56
Reception	...	...	56
Stations and Communication Systems	...	...	57
Subsidiary Apparatus	...	...	58
Television and Phototelegraphy	...	...	60
Transmission	...	...	60
Valves and Thermionics	...	...	61
Miscellaneous	...	...	61

The elaborate precautions to ensure the exclusion of external noise and to minimize sound reflection from the walls, ceiling and floor of the room are given in detail.

534.851 524  
**The Error in the Light-Bandwidth Measurement on Gramophone Records.**—R. Bierl. (*Akust. Z.*, May 1940, Vol. 5, No. 3, pp. 145-147.) An exact calculation of the theory of light-bands on records gives an expression for the error in the approximate formula given by Buchmann and Meyer (1930 Abstracts, p. 458.) as a two-part correcting term. The first part represents the fact that the extreme reflection point is not at the point of greatest slope, which gives an error not greater than 1%. The second represents an error at small radii, amounting to about 3% for a radius of 4 cm on a 78 turn/min record, and 6% for a 6 cm radius on a 33½ turn/min record.

534.851.6 525  
**Results of Phono Needle Tests.**—Consumers Union of U.S. (*Radio Craft*, Nov. 1945, Vol. 17, No. 2, pp. 99, 143.) Data from *Consumer Reports* on tests for fidelity and record wear of "permanent" gramophone needles. Needles were used for several thousand playings and the increased noise level measured electrically.

## ACOUSTICS AND AUDIO FREQUENCIES

534.321.9 : 621.396.9 521  
**Acoustic Control in the Flight of Bats.**—D. W. Ewer; H. Hartridge; M. Wilkinson. (*Nature, Lond.*, 8th Dec. 1945, Vol. 156, No. 3971, pp. 692-693.) Correspondence following 258 of February (Hartridge).

534.61 522  
**A Method for Obtaining Small Mechanical Vibrations of Known Amplitude.**—D. H. Smith. (*Proc. phys. Soc.*, 1st Nov. 1945, Vol. 57, No. 324, pp. 534-542.) The amplitude of a vibrating diaphragm is measured by observing interference fringes between the surface of a thin glass plate attached to the diaphragm and a fixed lens. Theory shows that the fringes disappear for certain critical amplitudes which differ by approximately  $\lambda/4$ . The amplitude is deduced from the number of times the fringes disappear as the amplitude is raised from zero. The instrument is suitable for a standard source of sound. In favourable circumstances the amplitude can be set to any assigned value by adjusting the current, with an error not greater than 1 in 500.

534.862.3 526  
**A Multisection Rerecording Equalizer.**—W. L. Thayer. (*J. Soc. Mot. Pict. Engrs*, Nov. 1945, Vol. 45, No. 5, pp. 333-338.) "This paper describes an assembly of 5 equalizers [for film recording] arranged so that they can be controlled by one hand, thereby leaving the other hand free for dialogue level adjustments. The equalizers are capable of lowering or raising the response in 5 different frequency bands without creating changes in reproduced level."

534.62 523  
**N.Y. Navy Yard's Quiet Room.**—W. M. Rees. (*Communications*, Oct. 1945, Vol. 25, No. 10, p. 68.) A description of a room in which ship microphones, telephones, loudspeakers, etc., can be calibrated.

621.395.61/.62] : 621.317.39 527  
**Curve-Tracer for Acoustic Devices.**—R. K. Hellmann. (*Electronics*, Dec. 1945, Vol. 18, No. 12, pp. 130-133.) The frequency of a beat-frequency oscillator is varied by a motor drive which also actuates a potentiometer controlling the horizontal position of the spot on a long-persistence screen of a cathode ray tube. The beat-frequency oscillator is connected to the acoustic device under test, the sound output being received by an artificial ear and passed through an amplifier to give a vertical deflection to the cathode ray beam. The response curves obtained in this way have been used for the quality control of full scale production of handset receivers over a period of five years.

- 621.395.623.7 + 621.396.623 + 534.43 **528**  
**"High Fidelity".**—A. C. Matthews. (*Radio*, N. Y., Nov. 1945, Vol. 29, No. 11, pp. 33-74.) Data on a wide range of subjective tests are given. The objective requirements in respect of frequency and volume ranges and of noise levels in relation to f.m. transmissions and gramophone reproduction are discussed. Room acoustics and speaker directivity as well as listening habits receive attention. The approach to perfection is finally a matter of economics.
- 621.395.623.7 : 621.392.53 **529**  
**Woofers-Tweeter Crossover Network.**—P. W. Klipsch. (*Electronics*, Nov. 1945, Vol. 18, No. 11, pp. 144-145.) Details of design of two simple filters operated in parallel as the load for the push-pull triodes of an a.f. amplifier. They are constructed of inexpensive materials and enable a low-frequency horn and a high-frequency horn to be operated together to give a response flat within 2 db in the range 30-10 000 c/s.
- 621.395.623.8 **530**  
**An Improved [two-way] Loudspeaker System for Theaters.**—J. B. Lansing & J. K. Hilliard. (*J. Soc. Mot. Pict. Engrs*, Nov. 1945, Vol. 45, No. 5, pp. 339-349.) "New permanent magnet low-frequency and high-frequency units having replaceable diaphragms are described. These units are combined in a horn system having the following advantages: a higher efficiency, extended frequency range, permanent magnet units providing higher air gap flux densities, elimination of back-stage radiation from the diaphragms, better transient response, and an improved over-all presence."
- 621.395.623.8 **531**  
**Sound Distributor.**—(*Radio*, N. Y., Nov. 1945, Vol. 29, No. 11, pp. 25-28.) A non-directional resonator and sound distributor built up from five separate loud speakers arranged round the faces of a 24 inch cubical "reproducing chamber" is claimed to provide musical "depth" by virtue of optimum blending of the separate tonal responses. The acoustical quality is such that this single outlet can replace the usual 25-50 loudspeakers in a large auditorium. Summary of a paper by C. A. Volf (reference not given).
- 621.395.623.8 **532**  
**A 9-Speaker Battle Announcing System.**—H. W. Duffield. (*Communications*, Oct. 1945, Vol. 25, No. 10, pp. 48-50.) "The system's frequency response rises from about 250 to 500 cycles and then is reasonably flat at 6 000 cycles at which point it decreases. It is capable of creating a sound level of about 116 db above the reference level of 0.000 204 dyne per square cm, at a distance of 30ft from the loud speakers. The major part of the energy is radiated through a cone of 50°." Diagrams of the amplifier (output 250 W) are given, and the loudspeakers are described.
- 621.395.623.8 **533**  
**Modulated-Air Super Speaker.**—(*Electronics*, Nov. 1945, Vol. 18, No. 11, pp. 426-430.) Air at 20 to 25 pounds/sq inch pressure is pumped through an electro-mechanical modulator to the horn. The modulator comprises thirty-four 0.006 inch slits, the apertures of which are controlled by the currents in the speech coil. Acoustic power output 15 to 20 W.
- 621.395.625.2 + 534.43 **534**  
**Improving Recordings.**—N. C. Pickering. (*Electronic Industr.*, Oct. 1945, Vol. 4, No. 10, pp. 82-214.) "How to get the most out of phonograph recordings." Eccentricity of the centre hole of a record of as little as .008 inch may cause objectionable variations in pitch, and non-uniform speed produces distortion ("wow"). High-frequency response which does not accentuate some harmonics and attenuate others is desirable, and harmonic distortion should be avoided. Methods of volume expansion are described.
- 621.395.625.2 + 534.43 **535**  
**Crystal [gramophone] Pickup Compensation Circuits.**—B. Bauer. (*Electronics*, Nov. 1945, Vol. 18, No. 11, pp. 128-132.) "From consideration of recording practice, record properties, pickup frequency characteristics, and listener acceptance, the appropriate corrective network for connecting crystal pickup to amplifier input to give desired overall frequency response is determined."
- 621.395.625.2/3 **536**  
**Some Aspects of Sound Recording.**—V. M. Brooker. (*Proc. Instn Radio Engrs, Aust.*, Sept. 1945, Vol. 6, No. 3, pp. 3-7. Discussion, pp. 7-9.) Magnetic recordings are made on tungsten steel tape 0.08 mm thick and 3 mm wide moving at 5 ft/s; alternatively carbon steel (0.5 or 0.8% C) wire of about 0.003 inch diameter is used. A wiping head magnetizes the wire to saturation and the recording head applies local variations in the magnetization which follow the a.f. signal. Background noise is dependent on the quality and uniformity of the tape, and can be improved by superposing an h.f. component of about 30 kc/s on the a.f. current to the recording head. Disks of ethyl cellulose, operated at a constant groove speed, are used in embossing systems of recording; the weight of the recording head is critical. Scratch and rumble noises, the ionization treatment of wax masters, and sapphire cutting tools are discussed.
- 621.395.625.2 **537**  
**Recorder on Tape has Voice Control.**—J. M. Lee. (*Radio Craft*, Dec. 1945, Vol. 17, No. 3, pp. 167-189.) The Hartron, formerly the Recordgraph, records at 60 ft/min on embossed grooves on a 50-foot film belt; there are 115 parallel grooves. The starting and stopping is voice-controlled. Immediate playback to a p.a. system or to the modulator of a radio transmitter is possible. The equipment is easily portable and was used for battle recording.
- 621.395.625.3 **538**  
**Magnetophon Tape Recording Equipment.**—(*Electronic Industr.*, Nov. 1945, Vol. 4, No. 11, pp. 234-238.) Account of an observer's report on a German device. Tissue-thin tape made of plastic impregnated with iron oxide is used for magnetic recording. The recordings have a frequency range of 50-8 000 c/s with some response at 12 000 c/s. The tape can be cut and spliced with ease.
- 621.395.625.3 **539**  
**Postwar Recorders Show New Ideas.**—I. Queen. (*Radio Craft*, Dec. 1945, Vol. 17, No. 3, pp. 176, 185.) Recorders for home and office use will soon



appear on the market. A typical instrument is  $7\frac{1}{4} \times 4 \times 1\frac{1}{2}$  inches in size, weighs 3 lb, and carries sufficient 0.003 inch diameter steel wire to give  $2\frac{1}{2}$  hours recording time.

62I.395.64I

540

**Discussion on "Modern Submarine Cable Telephony and the Use of Submerged Repeaters".**—R. J. Halsey. (*J. Instn elect. Engrs*, Part III, Dec. 1945, Vol. 92, No. 20, pp. 279-280.) Discussion on 1100 of 1945.

62I.395.667

541

**A True Tone Control.**—G. Bertsche. (*Radio Craft*, Nov. 1945, Vol. 17, No. 2, pp. 97-123.) A simple condenser-resistance network which can be calculated to give any required bass or treble boost and attenuation. The attenuation equation is given.

62I.396.62

542

**[Receiver] Power Output Stages.**—King. (See 722.)

### AERIALS AND TRANSMISSION LINES

62I.315.2(091)

543

**From the Single-Strand Overhead Telephone Line to the Modern High-Frequency Cable.**—D. (*Bull. Schweiz. elektrotech. Ver.*, 14th Nov. 1945, Vol. 36, No. 23, pp. 789-791. In German.) An historical survey of cable technology.

62I.315.213.12 : 62I.317.3.029.58/62

544

**Apparatus for Measurements on Balanced-Pair High-Frequency Cables in the Range 10-200 Mc/s.**—Simmonds. (See 667.)

62I.315.229

545

**Jacketing Materials for H-F Transmission Lines.**—Warner. (See 631.)

62I.392

546

**Waves and Wave Guides.**—G. G. (*QST*, Dec. 1945, Vol. 29, No. 12, pp. 53-102.) Continuation of 284 of February.

62I.392

547

**The Capacity of Twin Cable.**—Craggs & Tranter. (See 660.)

62I.392.012.2

548

**New Transmission-Line Diagrams.**—A. C. Schwager & P. Y. Wang. (*Trans. Amer. Inst. elect. Engrs*, Sept. 1945, Vol. 64, No. 9, pp. 610-615.) Three new charts are developed from those of Evans and Sels (*Elect. J.* 1922, p. 550). (a) Circle diagram for calculation of the power at one end of a transmission line when the power at the other end is known. This chart is deduced essentially by a conformal transformation between the transmitting plane and the receiving plane. (b) Circle diagram for calculation of the impedance at one end when that at the other is known. This is obtained in a similar way. (c) Universal transmission line chart for determining the essential data pertaining to the line when either the power and voltage at the same end, or the power at one end and the voltage at the other are given.

62I.392.21

549

**Solving Transmission Line Problems.**—R. C. Paine. (*Communications*, Oct. 1945, Vol. 25, No. 10, pp. 66-89.) Charts of  $\tanh$  and  $\coth$  ( $\alpha + j\beta$ ) are given, with two numerical examples of their application to line problems.

62I.392.21

550

**The Application of Heaviside's Transposition Rule to the Study of the Rise of Current and Voltage in a Line.**—S. Colombo & M. Parodi. (*Rev. gén. Elect.*, Oct. 1945, Vol. 54, No. 10, pp. 309-312.) The application of operational methods, in particular the use of the unit function and the transposed or delayed unit function to the study of the transient regime in uniform lines.

62I.392.21

551

**The Capacitance and Thermal Conductance of Screened Multi-Pair Systems in High-Frequency Cables.**—H. R. F. Carsten. (*J. Instn elect. Engrs*, Part I, Nov. 1945, Vol. 92, No. 59, pp. 423-425.) Long abstract of 3323 of 1945.

62I.396.67

552

**Note on Broadcasting Antenna at Trivandrum.**—M. K. N. Abraham. (*Electrotechnics*, Sept. 1945, Nos. 17/18, pp. 122-124.) The aerial is a vertical radiator grounded at the base, and power is supplied at a tapping approximately half-way along it. Wavelength 453.9 m, aerial length 0.169 $\lambda$ . See 368I of 1937 (Morrison & Smith) for basic work.

62I.396.67

553

**Artificial Antenna.**—S. Wald. (*Electronics*, Nov. 1945, Vol. 18, No. 11, pp. 150-154.) "Design of a two-terminal lumped-constant network that simulates, within a specified frequency band, the impedance variations of a single-wire antenna." The design is effected in terms of the following parameters:—reactance and resistance at the low frequency limit; resonant and antiresonant frequencies; resistance at the resonant frequency; resistance at some frequency between the upper frequency limit and the resonant frequency; resistance at the upper frequency limit.

62I.396.674

554

**Receiver Loop Antenna Design Factors.**—E. M. Kendell. (*Communications*, Nov. 1945, Vol. 25, No. 11, pp. 62, 64.) A high  $Q$  is necessary, and this must be obtained with the loop in its normal position in the receiver. Test results on solenoid, basket weave, and embossed (Airloop—see 289 of February) types of loops are given.

62I.392 + 62I.396.67

555

**Transmission Lines, Antennas and Wave Guides** [Book Review].—R. W. P. King, H. R. Mimno, & A. H. Wing. McGraw-Hill, New York, 1945, 347 pp., \$3.50. (*Electronics*, Nov. 1945, Vol. 18, No. 11, p. 516.) See 3803 of 1945.

### CIRCUITS

62I.3.012

556

**Graphical Analyses of Nonlinear Circuits.**—A. Preisman. (*Quart. appl. Math.*, Oct. 1945, Vol. 3, No. 3, pp. 185-197.) The currents in the circuit are determined from the points of intersection of lines representing the linear elements of the circuits with the current/voltage characteristic curve of the non-linear element. In the case of a non-linear resistance in series with an inductance, a finite operator curve involving  $L/\Delta t$  (corresponding to Heaviside's  $L_p$ ) is introduced. Similar methods are available for other reactive circuits, and when applied to a negative resistance in series with an inductance show that this circuit can produce relaxation oscillations.

- 621.395.623.7 + 621.396.623 + 534.43 **528**  
**"High Fidelity"**.—A. C. Matthews. (*Radio*, N. Y., Nov. 1945, Vol. 29, No. 11, pp. 33-74.) Data on a wide range of subjective tests are given. The objective requirements in respect of frequency and volume ranges and of noise levels in relation to f.m. transmissions and gramophone reproduction are discussed. Room acoustics and speaker directivity as well as listening habits receive attention. The approach to perfection is finally a matter of economics.
- 621.395.623.7: 621.392.53 **529**  
**Woofer-Tweeter Crossover Network**.—P. W. Klipsch. (*Electronics*, Nov. 1945, Vol. 18, No. 11, pp. 144-145.) Details of design of two simple filters operated in parallel as the load for the push-pull triodes of an a.f. amplifier. They are constructed of inexpensive materials and enable a low-frequency horn and a high-frequency horn to be operated together to give a response flat within 2 db in the range 30-10 000 c/s.
- 621.395.623.8 **530**  
**An Improved [two-way] Loudspeaker System for Theaters**.—J. B. Lansing & J. K. Hilliard. (*J. Soc. Mot. Pict. Engrs*, Nov. 1945, Vol. 45, No. 5, pp. 339-349.) "New permanent magnet low-frequency and high-frequency units having replaceable diaphragms are described. These units are combined in a horn system having the following advantages: a higher efficiency, extended frequency range, permanent magnet units providing higher air gap flux densities, elimination of back-stage radiation from the diaphragms, better transient response, and an improved over-all presence."
- 621.395.623.8 **531**  
**Sound Distributor**.—(*Radio*, N. Y., Nov. 1945, Vol. 29, No. 11, pp. 25-28.) A non-directional resonator and sound distributor built up from five separate loud speakers arranged round the faces of a 24 inch cubical "reproducing chamber" is claimed to provide musical "depth" by virtue of optimum blending of the separate tonal responses. The acoustical quality is such that this single outlet can replace the usual 25-50 loudspeakers in a large auditorium. Summary of a paper by C. A. Volf (reference not given).
- 621.395.623.8 **532**  
**A 9-Speaker Battle Announcing System**.—H. W. Duffield. (*Communications*, Oct. 1945, Vol. 25, No. 10, pp. 48-50.) "The system's frequency response rises from about 250 to 500 cycles and then is reasonably flat at 6 000 cycles at which point it decreases. It is capable of creating a sound level of about 116 db above the reference level of 0.000 204 dyne per square cm, at a distance of 30ft from the loud speakers. The major part of the energy is radiated through a cone of 50°." Diagrams of the amplifier (output 250 W) are given, and the loudspeakers are described.
- 621.395.623.8 **533**  
**Modulated-Air Super Speaker**.—(*Electronics*, Nov. 1945, Vol. 18, No. 11, pp. 426-430.) Air at 20 to 25 pounds/sq inch pressure is pumped through an electro-mechanical modulator to the horn. The modulator comprises thirty-four 0.006 inch slits, the apertures of which are controlled by the currents in the speech coil. Acoustic power output 15 to 20 W.
- 621.395.625.2 + 534.43 **534**  
**Improving Recordings**.—N. C. Pickering. (*Electronic Industr.*, Oct. 1945, Vol. 4, No. 10, pp. 82-214.) "How to get the most out of phonograph recordings." Eccentricity of the centre hole of a record of as little as .008 inch may cause objectionable variations in pitch, and non-uniform speed produces distortion ("wow"). High-frequency response which does not accentuate some harmonics and attenuate others is desirable, and harmonic distortion should be avoided. Methods of volume expansion are described.
- 621.395.625.2 + 534.43 **535**  
**Crystal [gramophone] Pickup Compensation Circuits**.—B. Bauer. (*Electronics*, Nov. 1945, Vol. 18, No. 11, pp. 128-132.) "From consideration of recording practice, record properties, pickup frequency characteristics, and listener acceptance, the appropriate corrective network for connecting crystal pickup to amplifier input to give desired overall frequency response is determined."
- 621.395.625.2/3 **536**  
**Some Aspects of Sound Recording**.—V. M. Brooker. (*Proc. Instn Radio Engrs, Aust.*, Sept. 1945, Vol. 6, No. 3, pp. 3-7. Discussion, pp. 7-9.) Magnetic recordings are made on tungsten steel tape 0.08 mm thick and 3 mm wide moving at 5 ft/s; alternatively carbon steel (0.5 or 0.8% C) wire of about 0.003 inch diameter is used. A wiping head magnetizes the wire to saturation and the recording head applies local variations in the magnetization which follow the a.f. signal. Background noise is dependent on the quality and uniformity of the tape, and can be improved by superposing an h.f. component of about 30 kc/s on the a.f. current to the recording head. Disks of ethyl cellulose, operated at a constant groove speed, are used in embossing systems of recording; the weight of the recording head is critical. Scratch and rumble noises, the ionization treatment of wax masters, and sapphire cutting tools are discussed.
- 621.395.625.2 **537**  
**Recorder on Tape has Voice Control**.—J. M. Lee. (*Radio Craft*, Dec. 1945, Vol. 17, No. 3, pp. 167-189.) The Hartron, formerly the Recordgraph, records at 60 ft/min on embossed grooves on a 50-foot film belt: there are 115 parallel grooves. The starting and stopping is voice-controlled. Immediate playback to a p.a. system or to the modulator of a radio transmitter is possible. The equipment is easily portable and was used for battle recording.
- 621.395.625.3 **538**  
**Magnetophon Tape Recording Equipment**.—(*Electronic Industr.*, Nov. 1945, Vol. 4, No. 11, pp. 234-238.) Account of an observer's report on a German device. Tissue-thin tape made of plastic impregnated with iron oxide is used for magnetic recording. The recordings have a frequency range of 50-8 000 c/s with some response at 12 000 c/s. The tape can be cut and spliced with ease.
- 621.395.625.3 **539**  
**Postwar Recorders Show New Ideas**.—I. Queen. (*Radio Craft*, Dec. 1945, Vol. 17, No. 3, pp. 176, 185.) Recorders for home and office use will soon

appear on the market. A typical instrument is  $7\frac{1}{2} \times 4 \times 1\frac{1}{2}$  inches in size, weighs 3 lb, and carries sufficient 0.003 inch diameter steel wire to give  $2\frac{1}{2}$  hours recording time.

621.395.641 540  
Discussion on "Modern Submarine Cable Telephony and the Use of Submerged Repeaters".—R. J. Halsey. (*J. Instn elect. Engrs*, Part III, Dec. 1945, Vol. 92, No. 20, pp. 279-280.) Discussion on 1100 of 1945.

621.395.667 541  
A True Tone Control.—G. Bertsche. (*Radio Craft*, Nov. 1945, Vol. 17, No. 2, pp. 97-123.) A simple condenser-resistance network which can be calculated to give any required bass or treble boost and attenuation. The attenuation equation is given.

621.396.62 542  
[Receiver] Power Output Stages.—King. (See 722.)

### AERIALS AND TRANSMISSION LINES

621.315.2(091) 543  
From the Single-Strand Overhead Telephone Line to the Modern High-Frequency Cable.—D. (*Bull. Schweiz. elektrotech. Ver.*, 14th Nov. 1945, Vol. 36, No. 23, pp. 789-791. In German.) An historical survey of cable technology.

621.315.213.12 : 621.317.3.029.58/.62 544  
Apparatus for Measurements on Balanced-Pair High-Frequency Cables in the Range 10-200 Mc/s.—Simmonds. (See 667.)

621.315.229 545  
Jacketing Materials for H-F Transmission Lines.—Warner. (See 631.)

621.392 546  
Waves and Wave Guides.—G. G. (*QST*, Dec. 1945, Vol. 29, No. 12, pp. 53-102.) Continuation of 284 of February.

621.392 547  
The Capacity of Twin Cable.—Craggs & Tranter. (See 660.)

621.392.012.2 548  
New Transmission-Line Diagrams.—A. C. Schwager & P. Y. Wang. (*Trans. Amer. Inst. elect. Engrs*, Sept. 1945, Vol. 64, No. 9, pp. 610-615.) Three new charts are developed from those of Evans and Sels (*Elect. J.* 1922, p. 550). (a) Circle diagram for calculation of the power at one end of a transmission line when the power at the other end is known. This chart is deduced essentially by a conformal transformation between the transmitting plane and the receiving plane. (b) Circle diagram for calculation of the impedance at one end when that at the other is known. This is obtained in a similar way. (c) Universal transmission line chart for determining the essential data pertaining to the line when either the power and voltage at the same end, or the power at one end and the voltage at the other are given.

621.392.21 549  
Solving Transmission Line Problems.—R. C. Paine. (*Communications*, Oct. 1945, Vol. 25, No. 10, pp. 66-89.) Charts of  $\tanh$  and  $\coth$  ( $\alpha + j\beta$ ) are given, with two numerical examples of their application to line problems.

621.392.21 550  
The Application of Heaviside's Transposition Rule to the Study of the Rise of Current and Voltage in a Line.—S. Colombo & M. Parodi. (*Rev. gén. Elect.*, Oct. 1945, Vol. 54, No. 10, pp. 309-312.) The application of operational methods, in particular the use of the unit function and the transposed or delayed unit function to the study of the transient regime in uniform lines.

621.392.21 551  
The Capacitance and Thermal Conductance of Screened Multi-Pair Systems in High-Frequency Cables.—H. R. F. Carsten. (*J. Instn elect. Engrs*, Part I, Nov. 1945, Vol. 92, No. 59, pp. 423-425.) Long abstract of 3323 of 1945.

621.396.67 552  
Note on Broadcasting Antenna at Trivandrum.—M. K. N. Abraham. (*Electrotechnics*, Sept. 1945, Nos. 17/18, pp. 122-124.) The aerial is a vertical radiator grounded at the base, and power is supplied at a tapping approximately half-way along it. Wavelength 453.9 m, aerial length 0.169λ. See 3681 of 1937 (Morrison & Smith) for basic work.

621.396.67 553  
Artificial Antenna.—S. Wald. (*Electronics*, Nov. 1945, Vol. 18, No. 11, pp. 150-154.) "Design of a two-terminal lumped-constant network that simulates, within a specified frequency band, the impedance variations of a single-wire antenna." The design is effected in terms of the following parameters:—reactance and resistance at the low frequency limit; resonant and antiresonant frequencies; resistance at the resonant frequency; resistance at some frequency between the upper frequency limit and the resonant frequency; resistance at the upper frequency limit.

621.396.674 554  
Receiver Loop Antenna Design Factors.—E. M. Kendall. (*Communications*, Nov. 1945, Vol. 25, No. 11, pp. 62, 64.) A high  $Q$  is necessary, and this must be obtained with the loop in its normal position in the receiver. Test results on solenoid, basket weave, and embossed (Airloop—see 289 of February) types of loops are given.

621.392 + 621.396.67 555  
Transmission Lines, Antennas and Wave Guides [Book Review].—R. W. P. King, H. R. Mimno, & A. H. Wing. McGraw-Hill, New York, 1945, 347 pp., \$3.50. (*Electronics*, Nov. 1945, Vol. 18, No. 11, p. 516.) See 3803 of 1945.

### CIRCUITS

621.3.012 556  
Graphical Analyses of Nonlinear Circuits.—A. Preisman. (*Quart. appl. Math.*, Oct. 1945, Vol. 3, No. 3, pp. 185-197.) The currents in the circuit are determined from the points of intersection of lines representing the linear elements of the circuits with the current/voltage characteristic curve of the non-linear element. In the case of a non-linear resistance in series with an inductance, a finite operator curve involving  $L/\Delta t$  (corresponding to Heaviside's  $L_p$ ) is introduced. Similar methods are available for other reactive circuits, and when applied to a negative resistance in series with an inductance show that this circuit can produce relaxation oscillations.

Application of the method to an ideal balanced amplifier shows that the output and mid-branch currents can only contain odd and even harmonics respectively.

621.314.12

557

**Crystal-Driven Modulator for D-C Amplifiers.**—J. A. Williams. (*Electronics*, Dec. 1945, Vol. 18, No. 12, pp. 128-129.) The d.c. input is passed through a carbon microphone button mechanically joined to a rochelle-salt crystal. The crystal unit is excited by a constant-output 1 kc/s oscillator. The vibrations of the button convert the d.c. input to an a.c. signal which is amplified in a three-stage band-pass amplifier. A continuously variable calibration voltage is provided, and a gain control and step-attenuator in the amplifier allow for a wide range of input levels.

621.314.2 + 621.317.72] : 621.362

558

**A.C. Amplifier and Voltmeter.**—L. C. Roess. (*Electronic Industr.*, Oct. 1945, Vol. 4, No. 10, p. 113.) Abstract, with circuit diagram, of a paper (*Rev. sci. Instrum.*, July 1945) on an instrument for measuring thermocouple outputs down to a limit of  $5.10^{-10}$ V. The radiation to the couple is interrupted at 1-5 c/s, and the amplifier sharply tuned to the interruption frequency.

621.316.722.078.3 : 621.385.18

559

**Utilizing the VR-Series Tubes** [for voltage stabilizers].—Anderson. (See 801.)

621.318.32 : 621.318.42

560

**Ferroiductance as a Variable Electric-Circuit Element.**—Ryder. (See 643.)

621.318.72]/.73].012.3

561

**Resistance-Capacitance Filter Chart.**—E. Frank. (*Electronics*, Nov. 1945, Vol. 18, No. 11, pp. 164-165.) Gives values of  $R$  and  $C$  for low-pass and high-pass filters in terms of the rejection desired at any frequency from  $10^{-3}$  to  $10^9$  c/s, and gives also the reactance of a capacitor at any such frequency.

621.392.5 : 621.3.015.33

562

**Pulse Response: A New Approach to A.C. Electric-Network Theory and Measurement.**—E. C. Cherry. (*J. Instn elect. Engrs*, Part I, Dec. 1945, Vol. 92, No. 60, pp. 462-464.) Long summary of 3841 of 1945.

621.392.52

563

**A New Kind of Filter Circuit.**—T. S. Skillman. (*Communication Rev.*, 1945, Vol. 1, No. 1, pp. 39-41.) Consideration of filter circuits followed or preceded by a highly back-coupled amplifier, for use in a carrier telephone system. By the use, for example, of one simple resonant circuit, a response to frequencies "flat to within 0.2 db has been achieved over a working range where previously only something like 2 or 3 db could be achieved".

621.392.53 : 621.395.623.7

564

**Woofers-Tweeter Crossover Network.**—Klipsch. (See 529.)

621.394/.397].64

565

**Analysis of Cathode Follower.**—C. N. Jeffery. (*Electronics*, Nov. 1945, Vol. 18, No. 11, pp. 434-450.) Long summary of 2922 of 1945.

621.394/.397].645

566

**Cathode Biased Amplifiers.**—P. H. Hunter. (*Electronic Industr.*, Nov. 1945, Vol. 4, No. 11, p. 92.) "Analytical methods for determining the operating point when circuit constants and supply voltages are known."

621.394/.397].645.34

567

**A New Method of Investigating Stability.**—A. Leonhard. (*Arch. Elektrotech.*, Jan./Feb. 1944, Vol. 38, Nos. 1/2, pp. 17-28.) A theoretical and mathematical paper on the stability of electrical systems in which there is a back-coupling of energy from the output to the input terminals. It postulates that the ratio of the feed-back voltage to the input voltage can be stated in the form of a polynomial fraction function of  $p$  (the disturbance being assumed proportional to  $e^{pt}$ ). Equating this ratio to unity gives a polynomial function of  $p$ . The new method consists of the substitution of  $j\omega$  for  $p$  in this polynomial and the plotting of the resultant curve  $H(j\omega) = 0$  in the complex plane as a function of  $\omega$ . The stability of the system, and even, in many cases, approximation to the frequency and damping of the damped oscillatory modes, can be deduced from the form of this curve by certain rules which are stated and proved. It is claimed that the process is simpler to apply and wider in scope than those of Hurwitz and Nyquist, to which detailed reference is made. The process is illustrated, and compared with the former methods, by a number of examples. See also 1932 Abstracts p. 279 (Nyquist).

621.396.611.21

568

**Crystal Oscillator Theory.**—(*Radio*, N. Y., Nov. 1945, Vol. 29, No. 11, pp. 16-25.) Summary and discussion of 3324 of 1945 (Fair).

621.396.615

569

**Notes on the Stability of LC Oscillators.**—N. Lea. (*J. Instn elect. Engrs*, Part III, Dec. 1945, Vol. 92, No. 20, pp. 261-274. Discussion, pp. 275-279.) The stability of 2-terminal and 4-terminal oscillators is considered generally. The frequency instability (due to phase instability) and the temperature coefficient of frequency are minimized by reducing the phase error. The effects of harmonics, inter-electrode capacitances, cathode-heater coupling, photo-electric effect, microphony, and changes during warming up are briefly considered. The use of bridge stabilization and of buffer stages is discussed.

The stability of the L and C elements of the resonator depend on temperature, humidity, and mechanical effects. The performance of the variable-gap capacitance compensator is analysed.

The thermal performance of the Franklin oscillator is analysed approximately, and the results are found to be in fair agreement with measured values of the frequency deviations during warming up.

Three experimental oscillators are described and their measured stabilities given to illustrate features of design and performance discussed earlier.

It is stressed that humidity can have a serious effect, though it usually receives little attention.

621.396.615

570

**On the Frequency Maintained by a Valve Oscillator.**—J. Queffelec. (*C.R. Acad. Sci., Paris*, 5th Feb. 1945, Vol. 220, No. 6, pp. 194-196.) The tuned-anode back-coupled oscillator is treated

as a class C amplifier, and the formula  $\omega^2/\omega_0^2 = 1 - 1/Q^2(1 + \mu M/L)$  derived for the ratio of the oscillator frequency to the natural frequency of the tuned anode circuit in terms of the amplification factor ( $\mu$ ), the  $Q$ -factor and self-inductance of the tuned circuit ( $Q$  and  $L$ ), and the mutual inductance ( $M$ ) between the anode and grid circuits.

621.396.615.17 : 621.317.755

571

**A Single Sweep Time Base—Part I.**—D. McMullan. (*Electronic Engng.*, Jan. 1946, Vol. 18, No. 215, pp. 21–23.) A modified Eccles-Jordan trigger circuit operated by negative pulses. It gives single sweeps with automatic or manual resetting. The time delay is a fraction of one microsecond. A circuit is given for the expansion of any given portion of a recurrent waveform, using an auxiliary time base.

621.396.615.17.029.62.

572

**Frequency Multiplication for the V.H.F. Bands.**—Gardner. (See 793.)

621.396.621.54.029.6 : 621.396.611.21

573

**Crystal-Controlled Receivers for A-M, F-M and Television.**—S. X. Shore. (*Communications*, Oct. 1945, Vol. 25, No. 10, pp. 70–110.) A discussion of design features for crystal oscillators suitable for use in f.m. receivers and for the sound channel of television receivers. In the case of television receivers required to cover several channels, a bridge circuit with a number of crystals in parallel is proposed. For previous parts see 3826 of 1945 and 170 of January.

621.396.622 : 621.396.619.018.41

574

**F-M Ratio Detectors.**—R. G. Peters; S. W. Seeley. (*Communications*, Nov. 1945, Vol. 25, No. 11, pp. 42–84.) Analysis of a detector system described by Seeley in an I.R.E. paper (reference not given), by which it is possible to build an f.m. receiver without a limiter. For another account see *Electronic Industr.*, Nov. 1945, Vol. 4, No. 11, pp. 82–164.

621.396.622.6 : 546.28

575

**Silicon Crystals for UHF Detection Circuits.**—Cornelius. (See 771.)

621.396/[397].645.31

576

**Some Considerations in the Design of Wide-Band Radio-Frequency Amplifiers.**—J. E. Cope. (*J. Instn elect. Engrs*, Part III, Dec. 1945, Vol. 92, No. 20, pp. 237–246.) Theoretical and practical consideration of sensitivity, bandwidth, amplitude linearity, gain control, electrical stability, and paralysis. Particular reference is made to television amplifiers for 45 Mc/s with a bandwidth of 4 Mc/s. The design of the input circuit for maximum sensitivity gives a noise factor of 6 db. Inter-stage coupling is arranged to give adequate stage gain consistent with bandwidth and phase linearity requirements.

Diode and anode-bend detectors are compared; the push-pull diode is best. Methods of gain control and their effect on the input capacitance are considered, but no fully satisfactory method exists.

Regeneration is influenced by valve effects, filtering, chassis materials, earthing points, coil screening and decoupling condensers, and means of reducing it are suggested.

Paralysis by impulsive interference can be countered by making the l.f. impedance of the decoupling circuits as small as possible.

621.396.645.31

577

**Role of the Neutralizing Capacitor in Tuned Power Amplifiers.**—W. Pritchett. (*Communications*, Oct. 1945, Vol. 25, No. 10, pp. 52–84.) An analysis giving consideration to the problem of wide-band neutralization, and to factors influencing the design of neutralizing capacitors.

621.396.662.2.076.2

578

**Permeability Tuning.**—W. J. Polydoroff. (*Electronics*, Nov. 1945, Vol. 18, No. 11, pp. 155–157.) A survey of the technique and advantages in typical receiver applications. "Using the same geometrical dimensions of core and coil we may expect an inductance variation in broadcast receivers of the order of 10 to 1, in short-wave receivers of the order of 4 to 1, and less than 2 to 1 in the v.h.f. bands." The problem of moulding a core so as to provide uniform properties along its length, and the use of dust cores in transmitter circuits are briefly considered.

621.396.662.34 : 621.396.611.21

579

**Specially-Wide-Band Filters Using Cultivated Crystals.**—W. Bantle, B. Matthias & P. Scherrer. (*Schweiz. Arch. angew. Wiss. Tech.*, June 1945, Vol. 11, No. 6, pp. 161–164.) By the use of piezoelectric crystals of mono-potassium or mono-ammonium phosphate it is possible to construct band-pass filters having a bandwidth of up to 33% of the mid-frequency, as compared with 13% for similar constructions using quartz. Also, the auxiliary inductances required are smaller than for quartz. This is due to the more favourable ratio of the effective series capacitance to the effective shunt capacitance in the equivalent electric circuit of such crystals. The use of various combinations of the two kinds of cultivated crystal also has possibilities outside the range covered by quartz alone.

621.396.665

580

**Volume Expander Design.**—R. W. Ehrlich. (*Electronics*, Dec. 1945, Vol. 18, No. 12, pp. 124–127.) An electronic expander in which the gain of a push-pull amplifier is controlled by a separate amplifier and rectifier. Full expansion is obtained in about ten milliseconds with a return to normal gain in one second. Control of the amount of expansion and of the time constant makes the unit applicable to practically all classes of programme material.

621.3.015.3

581

**Simple Calculation of Electrical Transients** [Book Review].—G. W. Carter. University Press, Cambridge, 120 pp., 8s. 6d. Macmillan, New York, \$1.75. (*Elect. Engng.*, N.Y., Nov. 1945, Vol. 64, No. 11, p. 422.) "... an elementary treatment of transient problems by Heaviside's operational method in linear electrical circuits with lumped constants." See also 742 and 2830 of 1945.

621.392 : 621.3.015.33

582

**Pulsed Linear Networks** [Book Review].—E. Frank. McGraw-Hill, New York, 267 pp., \$3.00. (*Radio*, N.Y., Nov. 1945, Vol. 29, No. 11, pp. 30, 68. Also *Electronic Industr.*, Nov. 1945, Vol. 4, No. 11, pp. 222, 224.) "... for a first course in transient phenomena for college students." "... covers its field extremely well."

621.394./397].645.34 **583**  
**Network Analysis and Feedback Amplifier Design** [Book Review].—H. W. Bode. D. Van Nostrand, New York, 1945, 551 pp., \$7.50. (*Electronics*, Nov. 1945, Vol. 18, No. 11, pp. 508-510.) "Basic circuit theory and mathematical analysis of feedback amplifiers is presented in generalized form for the design engineer. . . . The discussion is interspersed with practical circuit considerations and conclusions."

621.396.662.3 **584**  
**Einführung in die Theorie der Rundfunk-Siebschaltungen** [Book Review].—R. Feldtkeller. S. Hirzel, Leipzig, 1940, 168 pp., RM 12. (*Akust. Z.*, July 1940, Vol. 5, No. 4, pp. 231-232.) ". . . an excellent text" for university students.

### GENERAL PHYSICS

537.226 : 621.315.616 **585**  
**Synthetic Rubbers and Plastics—X. Electrical Properties : Theoretical Considerations in Relation to the Dipole Theory.**—E. D. Humphries & A. W. Stannett. (*Distrib. Elect.*, Jan. 1946, Vol. 18, No. 161, pp. 71-75.) The variation of dielectric constant and loss factor with frequency and temperature is explained qualitatively in terms of the Debye theory of dispersion, and is illustrated by experimental results on polyvinyl chloride.

537.56 **586**  
**On the Formation of Small Ions, Large Ions and Neutral Centres.**—G. Reboul. (*C.R. Acad. Sci., Paris*, 26th Feb. 1945, Vol. 220, No. 9, pp. 267-268.) A description of a mechanism to account for the observations noted in 3786 of 1945.

538.32 **587**  
**An Analysis of Electromagnetic Forces.**—W. A. Tripp. (*Elect. Engng, N. Y.*, Oct. 1945, Vol. 64, No. 10, pp. 351-356.) The lack of evidence for the attraction between electrons in a cathode-ray beam suggests that the attraction between parallel conductors carrying current in the same direction is not due to attraction between the currents themselves, but to attraction between stationary "unneutralized" protons in one conductor and the moving electrons in the other. This leads to the general propositions that like charges in *relative* parallel motion repel each other, and that unlike charges in *relative* parallel motion attract each other. It is shown that the development of this point of view not only accounts satisfactorily for forces between neighbouring current-carrying conductors, but also for phenomena, such as the "pinch effect" in current-carrying molten metal, that are not explained satisfactorily in terms of the attraction between filaments of current. (But see 1413 of 1945.)

538.56 : 517.512.2 **588**  
**Fourier Transforms of Retarded and Advanced Potentials.**—S. T. Ma. (*Phys. Rev.*, 1st/15th Oct. 1945, Vol. 68, Nos. 7/8, pp. 166-172.) "The Fourier transforms of the retarded and advanced potentials of the electromagnetic field and of the wave fields of elementary particles are obtained with the help of the invariant functions of Jordan, Pauli, and Dirac, together with their generalizations. It is shown that the Fourier transforms of these potentials are closely related to those of the outward and inward moving waves given by Dirac for the

scattering problems in quantum mechanics, and their connection is discussed. It is also shown that there exists a type of potentials which represents waves with frequencies of opposite signs propagating in opposite directions."

538.561.029.6 **589**  
**The Production of Extremely Short Electromagnetic Waves.**—J. P. Cooley & J. H. Rohrbaugh. (*Phys. Rev.*, 1st/15th May 1945, Vol. 67, Nos. 9/10, pp. 296-297.) "By using as electric dipole radiators many small, aluminum particles in a rapid, continuously flowing stream of oil, radiation measured to be between approximately 2.2 mm and 0.2 mm was produced. The necessary electric field was supplied by a shock excitation circuit generating 1 000 surges per second, which were applied to a 1 cm gap containing the oil-stream." Spectra produced by wire diffraction gratings were examined with thermopiles. The apparatus is briefly described.

535.22 **590**  
**The Velocity of Light** [Book Review].—N. E. Dorsey. Trans. Amer. Phil. Soc., New Series, Vol. 34, Part 1, 1944, 110 pp., \$2.50. (*Science*, 2nd Nov. 1945, Vol. 102, No. 2653, pp. 458-459.) A critical review of the experimental data. The author "has set a standard of rigorous and objective criticism. . . ."

621.396.61 **591**  
**Théorie des Oscillateurs** [Book Review].—Y. Rocard. Editions de la Revue Scientifique, Paris, 1941, 220 pp. (*Proc. phys. Soc.*, 1st Nov. 1945, Vol. 57, No. 324, pp. 587-588.) "On the whole a book which the physicist with a taste for elementary mathematics would do well to buy."

### GEOPHYSICAL AND EXTRATERRESTRIAL PHENOMENA

061.6 : 550.38 **592**  
**Summary of the Year's Work, to June 30, 1945, Department of Terrestrial Magnetism, Carnegie Institution of Washington.**—J. A. Fleming. (*Terr. Magn. atmos. Elect.*, Dec. 1945, Vol. 50, No. 4, pp. 279-286.)

523.165 **593**  
**The Geophysical Aspect of Cosmic Rays** [Twenty-ninth Guthrie Lecture].—A. Duperier. (*Proc. phys. Soc.*, 1st Nov. 1945, Vol. 57, No. 324, pp. 464-477.) The results of a number of workers investigating the correlation of cosmic ray intensity and temperature of the earth or atmosphere, are discussed. Measurements of the diurnal variation of cosmic radiation can be accounted for by assuming a magnetic field at the surface of the sun sufficient to prevent particles of less than  $2.10^6$ eV from reaching the earth. A marked 24 hour and a 12 hour periodicity has been observed. The most notable feature of the effect of magnetic storms is a decrease in cosmic ray intensity of world-wide nature.

523.746 + 550.38 **594**  
**Solar and Magnetic Data, July to September, 1945, Mount Wilson Observatory.**—(*Terr. Magn. atmos. Elect.*, Dec. 1945, Vol. 50, No. 4, p. 313.)

523.746 **595**  
**Provisional Sunspot-Numbers for July to September, 1945.**—W. Brunner. (*Terr. Magn. atmos. Elect.*, Dec. 1945, Vol. 50, No. 4, p. 319.)

550.38

**A Preliminary Study of the Relation Between Geomagnetism and the Circulatory Motions of the Air in the Atmosphere.**—O. R. Wulf. (*Terr. Magn. atmos. Elect.*, Dec. 1945, Vol. 50, No. 4, pp. 259-278.)

551.51.053.5

**Scattering of Radio Waves from Great Virtual Distances.**—L. Harang. (*Terr. Magn. atmos. Elect.*, Dec. 1945, Vol. 50, No. 4, pp. 287-296.) "Using a pulse-transmitter of high power, scattered reflections corresponding to virtual reflection-distances of 500 to 2 500 km have been obtained.

"The test-frequencies used (10-11 Mc/sec) were usually greater than the critical penetration-frequencies of the  $F_2$ -layer. Records on a fixed frequency over a number of days have been taken in order to study the diurnal variation and dependence on geomagnetic activity and aurora. Four different phases in the diurnal variation have been recorded. During the two day-phases it has been shown that the scattered reflections cannot come in vertically as they are not cut off by the  $F$ -layer.

"During the two night-phases the echoes are reflected from scattering areas lying in or near the zenith at heights of 500 to 800 km. Small geomagnetic disturbances increased the scattering at these heights. Stronger perturbations were accompanied by scattering from heights down to 100 to 200 km."

551.51.053.5

**Note on Diffusion in the Ionosphere.**—J. C. Jaeger. (*Proc. Phys. Soc.*, 1st Nov. 1945, Vol. 57, No. 324, pp. 519-523.) The general equations of diffusion, recombination and ion production set up by Hulburt (*Phys. Rev.*, 1928, Vol. 31, p. 1018.) are quite insoluble. An exact solution is given for the special case of an atmosphere in which the particle density varies exponentially with height, and in which the effects of recombination and the earth's magnetic field are neglected. Numerical results are given for three special initial distributions of ion density.

551.51.053.5 : 523.78

**Radio-Echo Observations at Tromsø During the Solar Eclipse on July 9, 1945.**—L. Harang. (*Terr. Magn. atmos. Elect.*, Dec. 1945, Vol. 50, No. 4, pp. 307-310.) "The critical frequencies of the ionized layers were determined during the partial eclipse at Tromsø. The maximum obscuration was 92 per cent. For the  $F_1$ - and  $E_1$ -layers a symmetrical decrease and increase of the critical frequencies and the corresponding maximum electron-densities were observed during the eclipse. For the  $F_1$ -layer the maximum electron-concentration decreased from  $3.47$  to  $1.48 \times 10^5$  electrons/cm<sup>3</sup>, that is, by 57 per cent. For the  $E$ -layer the maximum electron-concentration decreased from  $2.04$  to  $1.04 \times 10^5$  electrons/cm<sup>3</sup>, that is, by 49 per cent. For the  $F_2$ -layer the commencement of the eclipse was followed by a sudden decrease in the ionization-curve, the latter having a minimum at about the time of maximum obscuration. But after the eclipse the previous conditions of the  $F_2$ -layer seem not to have been restored. From the observations it seems to be evident that the eclipse has an effect on the  $F_2$ -layer but that this effect is masked by vertical movements and the slower recombination-processes."

596

621.316.93

**Lightning Investigations on 33-Kv Wood-Pole Lines.**—Andrews & McCann. (See 760.)

621.396.91 : 551.509

[E layer] "Controls" the Weather. — (*Sci. News Lett.*, Wash., 17th Nov. 1945, Vol. 48, No. 20, p. 310.) Solar radiation appears to be connected both with the weather and with the thickness of the  $E$  layer of the ionosphere.  $E$ -layer measurements may therefore assist forecasting of temperature peaks and troughs a week ahead. Article duplicated in *Science*, 16th Nov. 1945, Vol. 102, No. 2655, Supplement p. 12.

601

## LOCATION AND AIDS TO NAVIGATION

621.3(41) "1939/1945"

**British Electrical Engineers and the Second World War.**—Dunsheath. (See 729.)

602

621.38 : 538.74 : 629.13

**Flux Valve Aero Compass.**—R. Lewis. (*Radio Craft*, Nov. 1945, Vol. 17, No. 2, pp. 93-126.) To overcome frequent manual resetting of the azimuth scale of an airborne gyro-compass, resetting is continuously performed by the amplified signals from a flux valve through a selsyn motor. The three horizontal "star" coils of the flux valve superimpose the pick-up from the earth's magnetic field on a 400 c/s exciting field.

603

621.396 : 629.13

**Aviation Communication Systems.**—D. W. Rentzel. (*Elect. Engng*, N. Y., Nov. 1945, Vol. 64, No. 11, pp. 387-391.) An account of the progress that has been made in two-way communication, basic methods of navigation, and blind landing systems. The present and future frequency allocations over both long and short distances for these requirements are given. The problems of collision warning indicators, radio altimeters, air traffic control, and written communication to aircraft, which remain to be solved before air travel is safe and reliable, are closely analysed. The basic problems of voltage supply and weight and size of airborne equipment are discussed.

604

621.396.9

**The Loran System - Part I.**—D.G.F. (*Electronics*, Nov. 1945, Vol. 18, No. 11, pp. 94-99.) Description of the principles of "hyperbolic" navigation systems with particular reference to Loran. The system comprises two pairs of synchronized pulse transmitters operating on the same radio frequency within the band 1.7 to 2.0 Mc/s, each pair of transmitters having its own characteristic and accurately controlled pulse repetition frequency. At the receiving station (on board the craft which desires to fix its position) arrangements are made to measure the difference in the times of arrival of pulse-trains from the respective transmitters in each pair. By utilizing signals reflected from the  $E$  layer as well as ground-wave signals, and by suitably disposing the transmitters, useful ranges of up to 750 miles by day and 1 500 miles by night are obtained. Mention is made of the SS Loran system in which synchronization of the pulse repetition frequencies at the slave transmitters remote from the "double master station" is achieved by using the signals received at the "slaves" from the "master" via the  $E$  layer. For Part II see 606 below. See also 3916 of 1945 for an account of a similar system (Gee).

605

621.396.9

**Loran Receiver-Indicator.**—D.G.F. (*Electronics*, Dec. 1945, Vol. 18, No. 12, pp. 110-115.) Exact coincidence, to an accuracy of  $1 \mu\text{s}$ , of the  $40 \mu\text{s}$  pulses from the master and slave stations is accomplished by two expansions of the portion of the horizontal sweep upon which the pulses appear. By substituting a time scale for the pulses on each trace, the time difference is measured in units, tens, hundreds, and thousands of microseconds. Circuit diagrams and photographs of the presentation are given. The complete process can be carried out in less than one minute, and can be repeated for a second pair of stations working on the same r.f., but with a slightly different pulse repetition rate. For part I see 605 above.

621.396.9

**New Aid to Navigation.**—(*Electrician*, 30th Nov. 1945, Vol. 135, No. 3522, pp. 592-593.) A brief account of the Decca navigator system. See also 331 of February.

621.396.9

**The SCR-584 Radar - Part I.**—D.G.F. (*Electronics*, Nov. 1945, Vol. 18, No. 11, pp. 104-109.) Detailed description of an equipment used to control anti-aircraft fire, capable of tracking aircraft automatically at a range of 18 nautical miles and of detecting them at a range of 40 nautical miles. The wavelength used is between 10 and 11 cm, and a pulse length of  $0.8 \mu\text{s}$  enables the target range to be indicated to an accuracy of  $\pm 25$  yds, repeatable to  $\pm 2$  yds. Helical scanning at 6 rpm is used for searching, and conical scanning at 1400 rpm for tracking, the angular accuracy of follow then being  $0.06^\circ$ . The equipment is normally trailer-mounted, and the 6ft-diameter paraboloid reflector used with the aerial can be retracted for transportation. For part II of this article see 609 below.

621.396.9

**The SCR-584 Radar - Part II.**—D.G.F. (*Electronics*, Dec. 1945, Vol. 18, No. 12, pp. 104-109.) The antenna feed system consists of coaxial transmission lines, the inner conductor supported by quarter-wave stubs. The rotating joints have quarter-wave overlaps between inner and outer conductors with a small gap forming a capacitance path for the r.f. energy while allowing free rotation of the joint about the line axis. To enable the same antenna to be used for the transmitter and for the receiver, a low pressure gas discharge tube (TR cell) is inserted in the feed to the receiver. This tube has two conical electrodes forming part of a resonant cavity which can be tuned to the transmitter frequency. When the cavity is excited by the strong transmitted pulse a high potential appears across the electrodes, sufficient to break down the gap and short-circuit and de-tune the cavity. The transmitter pulse is thus made harmless to the receiver. After the end of the transmitted pulse the gap de-ionizes in about  $1 \mu\text{s}$  and the weaker echo signals are coupled through the TR cavity to a silicon crystal mixer, with a reflex klystron as the local oscillator. The 30 Mc/s i.f. signal passes to two preamplifier stages mounted adjacent to the crystal, then to the i.f. stages in the receiver proper where, after the fifth stage, the i.f. channel divides into two. The servo

606

channel, operating through a narrow gate, feeds the auto-tracking circuits, and the range channel feeds the indicators. For Part I see 608 above.

621.396.9

**Fire-Control Radar MPG-1.**—H. A. Straus, L. J. Rueger, C. A. Wert, S. J. Reisman, M. Taylor, R. J. Davis & J. H. Taylor. (*Electronics*, Dec. 1945, Vol. 18, No. 12, pp. 92-97.) A 3 cm wavelength radar unit, housed in a water-tight trailer van, to give tracking of small fast targets with sufficient resolution and accuracy for use in directing the fire of heavy calibre coastal defence batteries, and capable of being operated within a few hours of the selection of a site. A 35 kW pulse,  $1 \mu\text{s}$  wide for the PPI (searching), and  $1/4 \mu\text{s}$  for the tracking B-scope, is obtained from a magnetron oscillator. The r.f. energy is fed to the antenna system through four waveguide arms in the rotating feed assembly. For PPI, one of the feed arms is fixed in the centre of the antenna throat and energy is radiated along the antenna axis. For the B-scope, the feed assembly rotates at 4 revolutions per second across the antenna throat, causing the beam to sweep 16 times per second across a  $10^\circ$  sector centred on the antenna axis, which is itself adjustable between  $0^\circ$ - $360^\circ$  with either presentation. The receiver system contains a duplexer with TR and anti-TR switch valves, to enable the same antenna to be used for transmitter and receiver, a klystron local oscillator with automatic frequency control to compensate for drift of transmitter frequency, a 30 Mc/s i.f. amplifier with 10 Mc/s bandwidth, and a video output amplifier feeding the oscilloscopes. A 163.88 kc/s crystal oscillator is used for the synchronization system and to derive the range markers. Maximum accuracy when tracking, 20 yds and  $0.5^\circ$  azimuth, at a maximum range of 28 000 yds. Searching range 80 000 yds with reduced accuracy.

621.396.9

**Radar in A.A. Defence.**—H. G. Foster. (*Electronic Engng*, Jan. 1946, Vol. 18, No. 215, pp. 2-8.) A description of a G.L. Mk. II radar set giving slant range, elevation and azimuth. Operating frequency between 55 and 85 Mc/s. The receiver uses separate aerials and cathode-ray tubes for range, elevation, and bearing; aerials and display are switched by a synchronous motor to a single receiver channel. Outputs from two bearing aerials are opposed, and the resultant alternately added to and subtracted from the range-aerial output, giving two equal pips on the screen when on target. Elevation is determined by comparing the outputs, with a goniometer, from two dipoles  $\lambda$  and  $3\lambda/2$  above the ground. Range 2 000-14 000 yds, accuracy  $\pm 25$  yds, bearing and elevation accuracy  $\pm 1^\circ$ .

A Command Post is described, and tactics used in engaging aircraft are described in relation to the limitations of Mk. II equipment.

A brief description is given of G.L. Mk. III, using centrimetric aerial systems in paraboloid reflectors. Range 36 000 yds, accuracy  $\pm 25$  yds, bearing and elevation accuracy  $\pm 10'$ .

621.396.9

**Radar Specifications.**—D. G. F. (*Electronics*, Nov. 1945, Vol. 18, No. 11, pp. 116-119.) Specifications of radar equipment require details of the type of pulse, of the radiator, and of the scanning mechanism. Maximum range of detection is

607

608

609

610

611

612



determined from pulse and radiator specifications as indicated by the radar equation, which is given (see also 2879 of 1945). Angular accuracy is determined by the radiator specification, and range accuracy by the pulse specification.

The considerations which determine the type and rate of scanning are discussed, and the different types of presentation are listed. A table is given of the specifications of U.S. Signal Corps radar sets working on frequencies from 110 to 10 000 Mc/s, numbered SCR-268, 270, 516, 545, 547, 582/682, 584/784 and AN/TPS-3, AN/TPL-1, AN/MPG-1.

621.396.9 **613**  
**Shipborne Radar.**—G. E. M. Bertram. (*Communications*, Nov. 1945, Vol. 25, No. 11, pp. 52-56.) A general description, with illustrations, of an SO (Raytheon) radar. Pulse input 250 kW, 1  $\mu$ s pulses at 400 c/s repetition; receiver uses PPI display. Expected maximum range of commercial model 15-20 miles on ship targets, 4-6 miles for e.g. bell-buoys. For another account see *Electronic Industr.*, Nov. 1945, Vol. 4, No. 11, pp. 98-130.

621.396.9 **614**  
**U.S. Carrier Radar.**—E. A. Witten. (*Radio Craft*, Dec. 1945, Vol. 17, No. 3, pp. 162, 196.) A general description of the radio communications and radar equipment on U.S.S. Lake Champlain.

621.396.9 **615**  
**The Evolution of Radar.**—(*Engineering, Lond.*, 4th Aug.-12th Oct. 1945, Vol. 160, Nos. 4154-4161, pp. 154-285.) An eight-part historical account of the main war-time applications.

621.396.9 **616**  
**Radar Indicators.**—E. E. Skinner. (*Radio Craft*, Nov. 1945, Vol. 17, No. 2, pp. 95-133.) Descriptions of c.r. tube displays used in radar, including the plan position indicator and sector scanning in detail.

621.396.9 : 534.321.9 **617**  
**Acoustic Control in the Flight of Bats.**—D. W. Wer: H. Hartridge; M. Wilkinson. (*Nature, Lond.*, 8th Dec. 1945, Vol. 156, No. 3971, pp. 692-93.) Correspondence following 258 of February Hartridge).

621.396.9 : 551.515.43 **618**  
**Records of Storms with Radar Equipment.**—*Science*, 26th Oct. 1945, Vol. 102, No. 2652, Supplement p.14.) A brief report of the use of microwave radar for the location of storms. The waves are reflected by the rain associated with the storms.

621.396.9 : 623.26 **619**  
**Mine Detector.**—H. Chireix. (*Electronic Industr.*, Oct. 1945, Vol. 4, No. 10, pp. 128-194.) The change in self-inductance of a search-coil caused by the proximity of metal alters the phase relation between two voltages applied to a special bridge circuit. This change actuates a relay which in turn operates visual and aural indicators. Summary of S. patent 2 376 659.

621.396.932/.933].25 **620**  
**Radio Marker Buoy.**—(*Electrician*, 11th Jan. 1946, Vol. 136, No. 3528, p. 108.) Brief details of the "ally fish" radio responder buoy.

621.396.932/.933].25 **621**  
**"Racon" May Guide Ships Safely Through Dense Fog.**—(*Sci. News Lett., Wash.*, 24th Nov. 1945, Vol. 48, No. 21, p. 327.) A radar transmitter on the ship interrogates an electronic beacon on shore, which responds automatically. The coded response identifies the beacon; the range and direction given by the radar determine the relative position. Brief note only. See also 620.

621.396.933.23 **622**  
**Ground-Controlled Approach for Aircraft.**—C. W. Watson. (*Electronics*, Nov. 1945, Vol. 18, No. 11, pp. 112-115.) Two ground-based radars are used to assist aircraft in landing in conditions of poor visibility. The search radar with a plan-position indicator guides the aircraft from a range of 30 miles into a position ready for a landing glide. This radar, working at a super-high frequency uses a stacked dipole array with a parabolic reflector giving a beam 6° wide in azimuth. The landing-glide is controlled by the use of a higher-frequency higher-precision radar with a range of 10 miles. This has two beams given by separate aerial systems. The azimuth beam is 1.5° high and 0.6° wide and sweeps a volume 1.5° high and 20° wide; the elevation beam is 3° wide and 0.4° high and sweeps a volume 3° wide and 7° high. The position of the aircraft relative to a correct approach is relayed to the aircraft.

623.454.25 : 621.396.9 **623**  
**Proximity Fuze.**—F. R. (*Electronics*, Nov. 1945, Vol. 18, No. 11, pp. 110-111.) An oscillator feeds an aerial, which may be the missile itself or a small dipole. Energy reradiated from the target is picked up on the aerial and changes its impedance, this change being used to detonate the projectile. Power supply is obtained from a battery, supplied with acid through the acceleration produced during projection, or from a small wind-driven generator in the nose of the projectile. For an equivalent explanation of the mechanism in terms of Doppler effect see 89 of January and 625 below.

623.454.25 : 621.396.9 **624**  
**Generator-Powered Proximity Fuze.**—R. D. Hutton & B. J. Miller. (*Electronics*, Dec. 1945, Vol. 18, No. 12, pp. 98-103.) A detailed description of mechanism and design features. Developed for use with rocket projectiles, the fuze contains a c.w. oscillator tightly coupled to the antenna, which is the rocket itself. Reflections received from the target in varying phase relative to the oscillator effectively cause a cyclic fluctuation of aerial input impedance, so causing the oscillator to beat. This is equivalent to beats between the oscillator and the received signal assuming Doppler effect (c.f. 89 of January and 625 below). The beat falls in frequency and rises in amplitude as the rocket approaches its minimum distance from the target. The detonation occurs when the frequency and amplitude of the beat are within prescribed limits. The beat-frequency signal is selected and passed to an amplifier with regenerative feedback at the triggering frequency, high degenerative feedback at higher frequencies, and no feedback at lower frequencies. The amplifier characteristic and aerial directivity give a sharply defined detonation region. When the amplifier output reaches a critical value it fires a thyratron which triggers the explosion. A

wind vane in the nose of the rocket drives a generator which, with a voltage regulator and selenium bridge rectifier, provides the h.t. and bias supplies. Raw a.c. is used for the filaments.

623.454.25 : 621.396.9 **625**  
**The Radio Proximity Fuze.**—R. G. Peters. (*Communications*, Oct. 1945, Vol. 25, No. 10, pp. 45..94.) Description of the operation of the fuses in terms of the Doppler principle and also in terms of the principle of changing aerial impedance.

623.454.25 : 621.396.9 **626**  
**The Proximity Fuze.**—(*Radio News*, Dec. 1945, Vol. 34, No. 6, pp. 51..157.) **Radio Fuze Fires Shells.**—(*Radio Craft*, Dec. 1945, Vol. 17, No. 3, pp. 160..201.) **Navy Proximity Fuze.**—(*Electronic Industr.*, Nov. 1945, Vol. 4, No. 11, pp. 104..136.) General descriptions.

629.13 : 621.396.9 **627**  
**VHF for Safe Landing.**—(*Sci. News Lett.*, Wash., 1st Sept. 1945, Vol. 48, No. 9, pp. 131-132.) Description of some of the work of the Civil Aeronautics Administration in U.S.A. on the development of aids to air navigation with particular reference to use of v.h.f. radio apparatus for blind approach and landing. No technical details are given.

629.13 : 621.396.9 **628**  
**Funknavigation in der Luftfahrt** [Book Review].—P. von Handel & K. Krüger. Friedr. Vieweg & Sohn, Brunswick, 1944, 108 pp., RM 4.50. (*Z. Ver. dtsh. Ing.*, 5th Aug. 1944, Vol. 88, Nos. 31/32, pp. 431-432.) "A comprehensive and exhaustive account of the principles and practice . . ."

### MATERIALS AND SUBSIDIARY TECHNIQUES

531.788.7 **629**  
**Manometer Circuit.**—C. J. Calbick. (*Electronic Industr.*, Oct. 1945, Vol 4, No. 10, p. 198.) Alternating voltages are used to prevent errors due to leakage between anode and grid of ionization gauges. The leakage current, being a.c., is not recorded on the d.c. meters. Summary of U.S. patent 2 375 280.

533.56 **630**  
**High-Vacuum Pumping.**—(*Electronic Industr.*, Nov. 1945, Vol. 4, No. 11, pp. 77..142.) Eimac HV-1 oil diffusion pump gives an ultimate vacuum of  $4 \cdot 10^{-7}$  mm of mercury, if every possible source of contamination is removed from the high vacuum system and a special oil of low vapour pressure is used. Maximum speed 33 or 72 L/sec at  $10^{-5}$  mm according to whether a baffle is or is not used. Neoprene is recommended in place of rubber for gasket material.

621.315.229 **631**  
**Jacketing Materials for H-F Transmission Lines.**—A. J. Warner. (*Communications*, Nov. 1945, Vol. 25, No. 11, pp. 38-40, 87.) Suitable materials must (1) flex at  $-40^{\circ}\text{C}$ , (2) withstand  $80^{\circ}\text{C}$  for long periods and  $120^{\circ}\text{C}$  for short periods without deformation, (3) prevent cable deterioration on immersion in fresh or salt water, (4) withstand petrol, hot lubricating oils and hydraulic brake fluids, (5) have toughness and abrasion resistance,

(6) not corrode copper, (7) have no adverse effect on the primary dielectric. Long life and good flame resistance are desirable properties.

Most materials used are deficient in some of these properties. Polyvinyl chloride and polyvinyl chloracetate are now most used. Improved plasticizers which do not contaminate the primary dielectric are described.

621.315.612 + 621.315.616 **632**  
**Radio Insulating Materials: Part 3.**—A. H. Postle. (*Radio*, N. Y., Nov. 1945, Vol. 29, No. 11, pp. 42..70.) The principal electrical and mechanical differences between plastics and ceramics are explained by simple structure theory. Ceramics are classified by their thermal behaviour and chemical nature.

621.315.612.4 **633**  
**High Permittivity Crystalline Aggregates.**—W. Jackson & W. Reddish. (*Nature*, Lond., 15th Dec. 1945, Vol. 156, No. 3972, p. 717.) Wul's results (347 of February) are characteristic of a range of materials. A graph shows the temperature of peak permittivity for  $\text{BaTiO}_3\text{-SrTiO}_3$  solid solutions of various compositions. Peak permittivities of the order of 10 000 have been observed.

621.315.613.1 : [621.317.372 + 621.317.333] **634**  
**Judging Mica Quality Electrically.**—K. G. Coutlee. (*Trans. Amer. Inst. elect. Engrs*, Vol. 64, No. 11, pp. 735-740.) To overcome the uncertainties of the visual quality-classification of natural ruby mica, methods have been devised to test the two electrical properties required for capacitors, namely dielectric loss and dielectric strength. For the former a  $Q$ -meter is used, comprising a circuit resonant at 1 Mc/s which incorporates test electrodes between which the sample is inserted. The change in capacitance on insertion is corrected by a vernier capacitor which gives a direct classification, on a suitably calibrated meter, according to the  $Q$  of the specimen. A high-voltage spark test set is used to locate semi-conducting areas, pinholes and cracks. An account is included of tests on finished capacitors made with mica so classified. The tests are found to be satisfactory for testing block mica in accordance with ASTM specification D-748-45T.

621.315.613.1 : 621.319.4 **635**  
**Manufacture of Silvered Mica Capacitors.**—Chapman. (*See* 755.)

621.315.615 : 621.319.4 : 621.365.5 **636**  
**Capacitors for High-Frequency Induction-Heating Circuits.**—F. M. Clark & M. E. Scoville. (*Trans. Amer. Inst. elect. Engrs*, Vol. 64, No. 11, pp. 791-796.) A description of the development of a new type of organic liquid "Lectronol" dielectric for use in water-cooled, hermetically sealed capacitors, suitable for tank circuits of electronic induction heaters. A comparison of the properties of this dielectric with other commercial dielectric liquids shows superiority in capacity per unit volume and instability under severe conditions.

621.315.616 : 537.226 **637**  
**Synthetic Rubbers and Plastics - X. Electrical Properties: Theoretical Considerations in Relation to the Dipole Theory.**—Humphries & Stannett. (*See* 585.)

- 621.315.616.9 **638**  
**Discussion on "The Development of Polythene as a High-Frequency Dielectric."**—W. Jackson & J. S. A. Forsyth. (*J. Instn elect. Engrs*, Part III, Dec. 1945, Vol. 92, No. 20, pp. 295-297.) Discussion on 2768 of 1945.
- 621.315.616.9 **639**  
**Structure and Orientation in Thin Films of Polythene.**—A. Charlesby. (*Proc. phys. Soc.*, 1st Nov. 1945, Vol. 57, No. 324, pp. 496-509.)
- 621.315.616.9 **640**  
**Effect of Temperature on the Structure of Highly Polymerized Hydrocarbons.**—A. Charlesby. (*Proc. phys. Soc.*, 1st Nov. 1945, Vol. 57, No. 324, pp. 510-518.) The structure of polyethylene over a range of temperature from that of liquid oxygen to above the melting point, has been examined in the electron diffraction camera. As the temperature is raised there is a tendency to form a pseudo-hexagonal structure, but a change from crystalline to an amorphous form sets in at a temperature lower than the accepted melting point.
- 621.315.617.3 **641**  
**Insulation Materials.**—(*Electrician*, 14th Dec. 1945, Vol. 135, No. 3524, p. 672.) Report of I.E.E. Radio Section discussion on "Film-Forming Materials used in Insulation" led by C. R. Pye. For another account see 352 of February.
- 621.318.22 + 621.318.322 **642**  
**Magnetic Materials.**—L. Bragg. (*J. Instn elect. Engrs*, Part I, Dec. 1945, Vol. 92, No. 60, pp. 444-451.) An account of the development of magnetic theory is given, leading up to the modern conception of electrons as elementary magnets, in which ferromagnetism arises from unbalanced electron shells. Magnetization proceeds in three stages:—(1) domain boundary displacement (reversible); (2) sudden change-over of domains into the "easy" direction of magnetization nearest that of the applied field; (3) slow change from easy direction to that of the field.  
 Fundamental atomic properties which cannot be changed are saturation, remanence, and Curie point; initial permeability, coercivity, and hysteresis loss can be improved considerably by use of modern alloys and appropriate heat treatment. For transformer sheet steel, suitable rolling and annealing assists correct crystal alignment for small hysteresis loss.
- 621.318.32 : 621.318.42 **643**  
**Ferroinductance as a Variable Electric-Circuit Element.**—J. D. Ryder. (*Trans. Amer. Inst. elect. Engrs*, Oct. 1945, Vol. 64, No. 10, pp. 671-678.) An expression involving the gudermannian is claimed to be superior to previous mathematical expressions for the  $B$ - $H$  curve for a ferro-magnetic.  
 The expression  $B = B_n g d \frac{aNi}{l} + \frac{cNi}{l}$ , where  $B_n$ ,  $g$ , and  $c$  are constants, when adjusted to fit the  $B$ - $H$  curve of a ferromagnetic at three points, gives reasonable agreement with experiment at all values. The expression is used to compute the inductance, effective resistance, reactance, and resonance of ferroinductances, and the results are compared with experiment. The expression indicates maximum permeability when  $B = 0$ , and is consequently in error at low values of  $B$ .
- 621.318.322.029.5 **644**  
**Radio Frequency Cores of High Permeability.**—H. Beller & G. O. Altmann. (*Electronic Industr.*, Nov. 1945, Vol. 4, No. 11, pp. 86-154.) The cores are designed for coils required to have a high magnetic flux as well as a reasonably low loss. A special grade of carbonyl iron powder is used and cores with permeabilities of 40 to 70 can be produced. The permeability increases with packing factor of the particles and depends also on the manner of packing. The properties of three toroidal coils made from the new material are investigated.
- 621.318.322.029.54/.64 **645**  
**The Permeability of Ferromagnetic Materials at Frequencies between  $10^5$  and  $10^{10}$  c/s.**—J. T. Allanson. (*J. Instn elect. Engrs*, Part III, Dec. 1945, Vol. 92, No. 20, pp. 247-255.) A survey of theories and of methods of measurement and results. Indirect measurements by the following methods are described: (1) transmission line, (2) resonant circuit, (3) impedance bridge, (4) thermojunction, (5) wire grating. Factors bearing on the results, such as the strength of h.f. and d.c. fields, chemical composition, size and temperature of the specimen are discussed. Explanatory theories for the decrease of permeability with increase of frequency are described, and that of Becker (1719 of 1939), depending on eddy-current braking of domain changes is considered a satisfactory explanation of observed results.
- 621.318.323.2 : 621.306.662.2 **646**  
**Effective Permeability of High Frequency Iron Cores.**—W. J. Polydoroff & A. J. Klapperich. (*Radio*, N.Y., Nov. 1945, Vol. 29, No. 11, pp. 38-71.) The effective permeability of the cores and the  $Q$  of the inductors made with them depend on basic magnetic properties and physical dimensions. True permeability was measured at 1 kc/s by the toroidal ring method, and the effective permeability of cylindrical slugs was measured by observing the difference in inductance of coils with and without the slugs in place. Curves are given showing effective permeability with core-length = coil-length versus true permeability for length/diameter ratios from 0.2 to 8.0. An empirical formula connects these effective values with effective values for different coil lengths.
- 621.357 : 621.38 **647**  
**Electro-Chemical Processes in the Manufacture of Electronic Devices.**—A. Korbela. (*Beama J.*, Dec. 1945, Vol. 52, No. 102, pp. 424-428.) Abridgement of a paper presented to the Electro-Chemical Society, New York. The deposition of 17 different metals, the electrostatic deposition of various non-metals, electrolytic cleaning, and electro-polishing are discussed.
- 621.357.9 **648**  
**Improvement in the Electrolytic Polishing of Aluminium and its Alloys.**—P.-A. Jacquet. (*Génie civ.*, 1st June 1944, Vol. 121, No. 11, p. 92.) Short abstract of a paper in *Métaux, Corrosion, Usure*, Nov. 1943. The process can be applied to surfaces up to about 100 cm<sup>2</sup> in area with voltages of 25-50V, and is applicable to very pure aluminium, and to the most important alloys with copper and magnesium. The compositions of the electrolytes and conditions of working are given in the original paper.

- 621.385.832 649  
**"Characteristics of Luminescent Materials for Cathode-Ray Tubes."**—(J. *Instn elect. Engrs*, Part III, Dec. 1945, Vol. 92, No. 20, pp. 299-300.) I.E.E. Radio Section discussion led by C. G. A. Hill, dealing with the emission spectra, phosphorescence, efficiency, secondary emission, mechanical properties and stability of materials as determined by their physical and chemical properties and by the conditions of operation.
- 621.396.69 650  
**One Facet of Naval Electrical Research.**—E. F. Seaman. (*Elect. Engng*, N. Y., Oct. 1945, Vol. 64, No. 10, pp. 358-362.) "That concerned with the adaptation of shipboard equipment to wartime conditions." Items include fungus, jewel vibration, mica, magnet wire, and various tests.
- 621.791.352 : 621.385 651  
**Brazing Operations in Transmitter Tube Assembly.**—(*Electronics*, Nov. 1945, Vol. 18, No. 11, pp. 340-364.) Contains, *inter alia*, a description of a ceramic-lined burner so arranged that the electrode assembly is untouched by the flame during processing.
- 679.5 + 621.315.616.9 652  
**Notes on Plastics.**—J. Taylor. (*Electrician*, 30th Nov. 1945, Vol. 135, No. 3522, pp. 595-596.) Properties and uses of methyl methacrylate and polythene.
- 679.5 653  
**Plastic Materials.**—J. Taylor. (*Electrician*, 14th Dec. 1945, Vol. 135, No. 3524, pp. 675-676.) Properties and uses of polactron (a polymer of vinyl carbazole), polyvinyl alcohol, polyamide moulding materials, and nylon.
- 533.5 + 531.788 654  
**High Vacuum Technique** [Book Review].—J. Yarwood. Chapman & Hall, London, 2nd edn. 1945, 140 pp., 12s. 6d. (*Electrician*, 30th Nov. 1945, Vol. 135, No. 3522, p. 617.) "The author... has included many new sections, but generally preserves the previous condensed treatment." See also 3996 of 1945.
- 518.61 658  
**Calculation of the Magnetic Field in Dynamo-Electric Machines by Southwell's Relaxation Method.**—H. Motz & W. D. Worthy. (*J. Instn elect. Engrs*, Part II, Dec. 1945, Vol. 92, No. 30, pp. 522-528.) An explanation and example of the numerical solution of Laplace's equation with assigned boundary conditions, using the relaxation method.
- 519.283 659  
**Statistical Methods in Quality Control I-VI.**—A.I.E.E. Sub-committee on Educational Activities. (See 805).
- 621.392 660  
**The Capacity of Twin Cable.**—J. W. Craggs & C. J. Tranter. (*Quart. appl. Math.*, Oct. 1945, Vol. 3, No. 3, pp. 268-272.) A solution of Laplace's equation for the case of two long parallel cylindrical conductors, each surrounded by a coaxial sheath of dielectric, the boundaries of the two dielectric cylinders touching.
- 621.396.11 : 551.51.053.5 661  
**On the Propagation of Radio Waves.**—Rydbeck. (See 709.)—Tables of useful cylinder functions of order  $\pm 1/3$  and  $\pm 2/3$  are given with interval 0.02 from  $x = 0$  to 1, and interval 0.2 from  $x = 0$  to 8.
- 51 : 5 + 51 : 6 662  
**Die Mathematik des Naturforschers und Ingenieurs — Vols. 3 & 4** [Book Review].—B. Baule. S. Hirzel, Leipzig, Vol. 3, 80 pp., RM 4.40, Vol. 4, 112 pp., RM 5. (*Z. Ver. dtsh. Ing.*, 8th July 1944, Vol. 88, Nos. 27/28, p. 380.) Analytical geometry, and ordinary differential equations. Part I noted in 4091 of 1945.
- 518.3 663  
**Alignment Charts : Construction and Use** [Book Review].—M. Kraitchik. D. Van Nostrand, New York, 94 pp., \$2.50. (*Radio Craft*, Dec. 1945, Vol. 17, No. 3, p. 199.) "... the basic theory of nomograms is built round determinants."

## MATHEMATICS

- 512.942 655  
**Vector Analysis.**—H. G. Shea. (*Electronic Industr.*, Nov. 1945, Vol. 4, No. 11, pp. 94-97.) "Review of vector mathematics including divergence and curl for engineers dealing with wave guides and radiation."
- 517.512.2 : 518.5 : 621.383 656  
**A Photo-Electric Fourier Transformer.**—M. Born, R. Fürth & R. W. Pringle. (*Nature, Lond.*, 22nd Dec. 1945, Vol. 156, No. 3973, pp. 756-757.) Note on an instrument for producing a graph of  $g'(y) = \int_a^b f(x)\cos(yx + \delta)dx$  on the screen of a c.r. tube from a mask cut out of black paper in the shape of the graph of  $f(x)$  or from a photographic record of the function in density variation.

- 517.512.2 : 538.56 657  
**Fourier Transforms of Retarded and Advanced Potentials.**—Ma. (See 588.)

## MEASUREMENTS AND TEST GEAR

- 531.765 : 621.317.755 664  
**The Exact Measurement of Short Time Intervals on a Cathode-Ray Tube.**—W. Amrein & A. von Wattenwyl. (*Schweiz. Arch. angew. Wiss. Tech.*, Sept. 1945, Vol. 11, No. 9, pp. 257-262. In German.) A circular time-base of accurately known frequency is generated from crystal or tuning-fork-controlled circuits. The impulses, between which the time interval is to be measured, are applied to give brightness modulation of the trace, and the angular interval between the starting points of the bright streaks on the screen, measured on a photograph, give a measure of the time. To prevent the trace of the second impulse from overlapping that of the first on a later sweep of the time-base, the first impulse is made to trigger a saw-tooth discharge circuit, coupled to the post-accelerator of the tube so as to change slightly the diameter of the time-base circle for the second impulse. In an example quoted, an interval of 2 ms between impulses was measured to  $2\mu s$ . The time-base

frequency was 10 kc/s, so that 20 sweeps were made between the starting points of the two traces, and a displacement of  $7^\circ$  corresponded to  $2\mu\text{s}$  interval.

There are errors due to ellipticity and phase irregularities of the time-base. It is relatively easy to keep the first sufficiently small. An error of  $2-3^\circ$  in location of the deflector plates is common in most c.r. tubes, and there can also be phase errors due to stray capacitances, etc., in the phase-shift circuit for producing the time-base, and due to harmonics of the deflecting voltages. Errors due to the last two causes can be minimized by the choice of circuit values, by the use of high- $Q$  circuits, and by taking care not to overload the amplifiers. The accuracy of the time-base can be checked by measuring the angular displacement between the bright traces caused by brightness modulation at a frequency which is an exact multiple of the time-base frequency. A total residual error of the order of  $3-4^\circ$  can be expected in the position of the trace, its relative importance depends on the number of sweeps of the time-base during the interval to be measured.

534.62 **665**  
**A Method for Obtaining Small Mechanical Vibrations of Known Amplitude.**—Smith. (See 522.)

621.315.212 : 621.317.341.029.58/62 **666**  
**The S-Function Method of Measuring Attenuation of Coaxial Radio-Frequency Cable.**—C. Stewart, Jr. (*Trans. Amer. Inst. elect. Engrs*, Sept. 1945, Vol. 64, No. 9, pp. 616-619.) The  $Q$ -factor and input reactance of a short-circuited length of cable are measured on a commercial  $Q$ -meter. The  $S$ -factor, which is a function of the characteristic impedance (assumed to be known) and the measured input reactance of the short-circuited sample, is taken from a graph. The attenuation constant of the cable is  $S/Qd$  db/100 ft, where  $d$  is the length of the sample in feet. The accuracy of the result is not critically dependent on the accuracy of the value assumed for the characteristic impedance. The usefulness of the method is limited to the range 1-100 Mc/s.

621.315.213.12 : 621.317.3.029.58/62 **667**  
**Apparatus for Measurements on Balanced-Pair High-Frequency Cables in the Range 10-200 Mc/s.**—J. C. Simmonds. (*J. Instn elect. Engrs*, Part III, Dec. 1945, Vol. 92, No. 20, pp. 282-286.) The apparatus described earlier (3322 of 1945) for use up to 10 Mc/s is extended to 200 Mc/s by replacing the variable capacitor by a short-circuited transmission line of variable length, and the diode resistor by a thermistor. The transmission line reactance is taken as  $Z_0 \tan(\omega l/v)$  with  $v = 3.10^{10}$  cm/sec. Measurements at 200 Mc/s showed that for a thermistor whose d.c. resistance is less than 10 000  $\Omega$  the difference between the h.f. and d.c. values is not greater than  $\pm 3\%$ .

The measurement of reactance, resistance, or impedance is made by substitution; characteristic impedance, attenuation, and phase velocity are also readily determined, and typical measurements on a balanced cable are given. Measurements on  $\frac{1}{2}$  W solid-carbon-type resistors are shown graphically, and are in close agreement with Howe's theory.

The accuracy of the apparatus is estimated at  $\pm 3\%$  for reactance and  $\pm 2\%$  for resistance if the thermistor resistance is not too high. The error in phase velocity measurement should not exceed  $\pm 1\%$ .

621.315.613.1 : [621.317.372 + 621.317.333] **668**  
**Judging Mica Quality Electrically.**—Coutlee. (See 634.)

621.317.331 : 621.3.015.33 **669**  
**Resistance Measurement at High Impulse Voltages.**—S. L. Shive. (*Electronics*, Nov. 1945, Vol. 18, No. 11, pp. 158-159.) A condenser is discharged through the primary of a suitable step-up transformer, and the damped train so produced is applied across a Wheatstone bridge composed of resistors with zero voltage coefficient. Two cathode-ray tubes are used as null-point indicator and voltmeter respectively. It is found that composition-type resistors have a negative voltage coefficient of resistance: the importance of this property in the design of suppressor circuits for ignition systems is considered.

621.317.335 **670**  
**Capacitance Measurement in Multi-Electrode Systems.**—W. Pritchett. (*Communications*, Nov. 1945, Vol. 25, No. 11, pp. 66-68.) A parallel substitution method developed for measuring neutralizing and other small value capacitors, which is most useful in the range 1-100  $\mu\mu\text{F}$ .

621.317.372 : 621.317.755 **671**  
**Cathode-Ray Q Meter.**—R. Feldt. (*Electronics*, Nov. 1945, Vol. 18, No. 11, pp. 462-470.) The component under test is excited by means of short pulses synchronized with the sweep frequency. The resulting damped oscillations are taken to the vertical deflection plates, or associated amplifier. The  $Q$ , or the decrement of the circuit, may be measured directly by means of a suitably engraved transparent scale fitted to the screen. Reprinted from *DuMont Oscillographer*, Mar./Apr. 1945.

621.317.715.025 **672**  
**A-C Galvanometer.**—A. L. Quirk & H. D. Hall. (*Electronics*, Dec. 1945, Vol. 18, No. 12, pp. 147-149.) An amplifier used in conjunction with a variable self-biased 6E5 electron-ray valve provides a null-point indicator for a.c. bridges that is electrically and mechanically strong, free from vibration troubles, and insensitive to stray fields. The minimum signal that can be detected is 20  $\mu\text{V}$ .

621.317.72 + 621.314.2 : 621.362 **673**  
**A.C. Amplifier and Voltmeter.**—L. C. Roess. (See 558.)

621.317.72 : 621.385 : 541.132.3 **674**  
**pH Meter.**—C. Dorsman. (*Electronic Industry*, Oct. 1945, Vol. 4, No. 10, pp. 194-198.) A circuit for the measurement of a small d.c. voltage across a source of high internal impedance. The difference between this voltage and a known adjustable voltage is converted into a.c. and, on amplification, is applied to a cathode-ray indicator. Summary of U.S. patent 2 372 062.

621.317.72.084 **675**  
**Notes on Zero-Suppressed A.C. Voltmeters.**—L. Medina. (*Proc. Instn Radio Engrs, Aust.*, Sept. 1945, Vol. 6, No. 3, pp. 11-16.) Limited demand causes mechanical means of zero suppression, which involve special tooling, to be uneconomic in Australia. Of a number of electrical zero-suppressing circuits investigated and described the best, used for an a.c. voltmeter, has a parallel resonant circuit in series with the instrument. A 20  $\Omega$  100 mA moving-iron instrument is connected

in series with a resistance of  $480 \Omega$  and with a capacitor of  $1 \mu\text{F}$ . The capacitor is in parallel with an iron-cored reactor so that the combination is in resonance when 220 V are applied to the whole circuit. Increase of voltage causes a disproportionately great increase of current through the instrument due to change of inductance with current. The scale is nearly linear over the range 220 to 260 V, which occupies more than half the full length of the scale. The circuit is only suitable for a fixed frequency, and is subject to wave-form error.

621.317.73.029.54/.58

676

**A Radio-Frequency Capacitance and Conductance Bridge.**—R. F. Proctor & E. G. James. (*J. Instn elect. Engrs*, Part III, Dec. 1945, Vol. 92, No. 20, pp. 287–290.) A bridged-T network suitable for measurement of partial capacitances and conductances, which operates at 1 Mc/s but can be used up to 50 Mc/s if the usual precautions for residuals are taken. The design, construction, and theory of the bridge are given, and the method of calibrating for conductance is described. Capacitances of  $0.28 \mu\mu\text{F}$  and conductances of  $0.11 \mu\text{mho}$  can be measured with balancing accuracies of  $0.02 \mu\mu\text{F}$  and  $0.05 \mu\text{mho}$  respectively. A correction to the capacitance reading, which is a function of the measured conductance, is required.

621.317.73.029.62

677

**Bridge Method of Measurement at Ultra High Frequencies.**—S. Datta. (*Electrotechnics*, Sept. 1945, Nos. 17/18, pp. 85–95.) A modified form of Schering bridge is used at frequencies up to 45 Mc/s for the measurement of capacitance and power factor. The corrections to be applied for residual inductance of the resistors are considerable.

621.317.735

678

**Industrial [insulation] Testing with High Voltage.**—(*Electronic Industr.*, Nov. 1945, Vol. 4, No. 11, pp. 106–108.) Equipment for testing insulation in aircraft. Portable model operates off 110 V 60 c/s, and tests  $10\text{--}10\,000 \text{ M}\Omega$  at any voltage between 2 000–15 000 V d.c. Other models test at voltages up to 200 000 V d.c.

621.317.761.029.62/.64

679

**The Measurement of Frequencies in the Range 100 Mc/s to 10 000 Mc/s.**—L. Essen & A. C. Gordon-Smith. (*J. Instn elect. Engrs*, Part III, Dec. 1945, Vol. 92, No. 20, pp. 291–295.) Description of a small portable apparatus for frequency measurement by the interpolation method. A quartz oscillator provides a standard frequency of 1 Mc/s and controls multivibrators at 100 kc/s and 10 kc/s. Two oscillating detectors with respective ranges of 300–600 Mc/s and 15–20 Mc/s enable the unknown frequency to be suitably divided by the observation of audible beats and compared with the standard frequency. The accuracy is estimated at  $\pm 1$  part in  $10^6$  if the measurement is made rapidly to reduce the effect of drift of the detector oscillators.

621.317.784 : 621.385

680

**Electronic Wattmeter.**—L. R. Malling. (*Electronics*, Nov. 1945, Vol. 18, No. 11, pp. 133–135.) In early designs of electronic wattmeters, voltages corresponding to the voltage and current supplied to the load were fed to the wattmeter through transformers. In later models the frequency range has been increased by the substitution of cathode followers for the transformers. The circuit includes

push-pull pentode rectifiers that should be well balanced against each other and have accurately parabolic characteristics. Input power is indicated on a d.c. meter with a linear scale.

621.395.61/.62 : 621.317.39

681

**Curve-Tracer for Acoustic Devices.**—Hellmann. (See 527.)

621.396.611.21

682

**Crystal Oscillator Theory.**—(*Radio*, N. Y., Nov. 1945, Vol. 29, No. 11, pp. 16..25.) Summary and discussion of 3324 of 1945 (Fair).

621.396.611.21

683

**Practical Problems of [piezoelectric] Crystal Dimensioning.**—C. W. Franklin. (*Electronic Industr.*, Oct. 1945, Vol. 4, No. 10, pp. 96..158.) A finished crystal has one dimension which is thought of as governing its frequency. Changes in other dimensions may however alter the frequency. The frequency and amplitude of vibration are affected by wetness, unequal pressure, or if the air-gap resonates and damps the vibration. Graphs show variations of frequency with different conditions.

621.396.611.21

684

**Shear Modes in Piezo-Electric Crystals.**—S. Bhagavantam & D. Suryanarayana. (*Electronic Industr.*, Oct. 1945, Vol. 4, No. 10, p. 202.) Reprint of 1875 of 1945.

621.396.611.21 : 549.514.1

685

**Aging of Quartz Crystals.**—S. X. Shore. (*Communications*, Nov. 1945, Vol. 25, No. 11, pp. 70..77.) The surface of a crystal prepared by abrasion is stressed and slowly breaks down; consequently the frequency of the crystal increases with age. This process can be hastened by artificial ageing by a series of heat cycles. Ageing can be avoided by using etching instead of abrasion for the final process of manufacture. For an 8 Mc/s crystal, preparation by abrasion was stopped when the frequency was 10 kc/s below the required value, and final adjustment was made by etching in ammonium bifluoride solution. Part 4 of a series, for previous parts see 3826 of 1945, 170 of January, and 573 above.

621.396.615

686

**Notes on the Stability of LC Oscillators.**—Lea. (See 569.)

621.396.67

687

**Artificial Antenna.**—Wald. (See 553.)

621.396.933.083.7 : 629.13

688

**Plane-to-Ground Radio Telemetering.**—Moore. (See 701.)

621.317.715 + 621.317.75

689

**Galvanómetros y Oscilógrafos** [Book Review].—S. Gerszonowicz. G. E. Stechert (distributor), New York, 1943, 392 pp., \$6.00. (*Beama J.*, Dec. 1945, Vol. 52, No. 102, p. 419.) "... a very real contribution to the technical literature on galvanometers."

#### OTHER APPLICATIONS OF RADIO AND ELECTRONICS

518.5 : 621.383

690

**A Photo-Electric Fourier Transformer.**—Born, Fürth & Pringle. (See 656.)

- 54I.132.3 : 62I.317.72 : 62I.385  
pH Meter.—C. Dorsman. (See 674.) 691 623.26 : 62I.396.9 700  
Non-Metallic Mine Detector.—T. E. Stewart.  
(*Electronics*, Nov. 1945, Vol. 18, No. 11, pp. 100-103.)  
A description of equipment type AN/PRS-1, and  
its method of adjustment and use in the detection  
of both metallic and non-metallic mines located a  
few inches below the surface of the ground. It  
comprises a 300 Mc/s oscillator carried at the end  
of a suitable exploring handle: a horizontal dipole  
is coupled to the oscillator and a reflecting dipole  
is mounted above the first. Alterations in the  
oscillator grid current are arranged to vary the  
amplitude of an a.f. note heard in the operator's  
headphones. The batteries and a.f. apparatus are  
carried on the operator's back. In operation it is  
arranged that the resonant frequency of the dipole  
is lower than that of the oscillator. The ground is  
explored with the antenna a few inches above the  
surface. Non-metallic mines increase the resonant  
frequency of the antenna, thus decreasing grid  
current and increasing the intensity of the audible  
note, while metallic mines produce an increase of  
grid current and a decrease in the audible indication.
- 55I.509 : 62I.396.91 692  
[E layer] "Controls" the Weather.—(See 601.)
- 55I.515.43 : 62I.396.9 693  
Records of Storms with Radar Equipment.—  
(See 618.)
- 62I.317.39 : 539.37 : 62I.395.645.33 694  
Strain Analyzing and Recording Instruments.—  
C. M. Hathaway. (*Electronic Industr.*, Oct. 1945,  
Vol. 4, No. 10, pp. 74-190.) The operation of  
inductance-type and resistance-type strain gauges  
is described, as well as bridge circuits, amplifiers,  
and recording oscillographs used with them.  
Inductance-type gauges can be used without  
amplifiers. For resistance-type gauges, amplifiers  
are required to cover from 0 to about 1 500 c/s.
- 62I.365.5 695  
Crucible Failure in the Induction Melting Process.  
—A. Gemant & J. Sticher. (*J. appl. Phys.*, Nov.  
1945, Vol. 16, No. 11, pp. 661-667.) Zirconia  
crucibles occasionally melt locally owing to over-  
heating although the melting point is far in excess  
of that of most alloys commonly used. A theory is  
developed which shows that the overheating is more  
probable the steeper the electrical resistivity/  
temperature characteristic of the zirconia. The  
fault may be due to impurities.
- 62I.365.5 : 62I.315.615 : 62I.319.4 696  
Capacitors for High-Frequency Induction-Heating  
Circuits.—Clark & Scoville. (See 636.)
- 62I.365.5 : 62I.785.6 : 669.14 697  
Superficial Hardening [of steel] by Medium-  
Frequency Induction Heating.—Seulen & Voss.  
(*Génie civ.*, 15th June 1944, Vol. 121, No. 12, p. 100.)  
Short abstract of a paper in *Stahl und Eisen*,  
23rd & 30th Dec. 1943. Frequencies of 600 c/s  
to 2 Mc/s are used according to the thickness  
required for the hardened layer.
- 62I.365.92 698  
[Dielectric] Heating by High-Frequency Currents.  
—G. Génin. (*Rev. gén. Élect.*, Oct. 1945, Vol. 54,  
No. 10, pp. 291-297.) Particular reference to the  
application to rubber vulcanization processes, and  
to the economics of the method in general (cost of  
generator, and of the energy used). A simple analysis  
of the limiting factors leads to the conclusion that  
the process is applicable to materials of which the  
"loss factors" (product of power factor and per-  
mittivity) range between 0.005 and 0.01. The  
article is essentially a survey, with a bibliography  
of 19 references.
- 62I.369.2 699  
The Drying of Varnished or Humid Surfaces by  
Radiation : Descriptions of Infra-Red Installations.  
—B. Haznadaroff. (*Rev. gén. Élect.*, Oct. 1945,  
Vol. 54, No. 10, pp. 298-302.) In addition to de-  
tailed descriptions of equipment and applications,  
the paper contains a qualitative theoretical dis-  
cussion leading to the conclusion, verified by a  
simple experiment, that an irradiated varnished  
metal surface may reach a higher temperature than  
a similar unvarnished surface.
- 62I.396.933.083.7 : 629.13 701  
Plane-to-Ground Radio Telemetering.—D. W.  
Moore, Jr. (*Electronics*, Nov. 1945, Vol. 18, No. 11,  
pp. 125-127.) In flight testing of aircraft or in the  
control of aircraft flight by radio means it is neces-  
sary to reproduce on the ground the readings of the  
various aircraft instruments. This has been done  
by attaching to the pointer of each instrument a  
small permanent magnet that controls the phase  
of a 500 c/s note. The note is transmitted to ground  
over a radio link, together with a 250 c/s note which  
serves as a reference for phase. The two signals  
received on the ground are used to actuate an in-  
strument similar to the primary instrument in the  
aircraft.
- 622.19 : 62I.395.645.33 702  
Geophysical Prospecting Equipment.—D. Sheffet.  
(*Electronics*, Dec. 1945, Vol. 18, No. 12, pp. 119-123.)  
A field seismograph may consist of groups of twenty-  
four or more seismometers connected by multi-  
conductor cables to a control and test panel in the  
recording van. The outputs of the groups are fed  
to a number of identical amplifiers connected to a  
multiple recording oscillograph. The input signals  
to the amplifiers may vary by 10 000 to 1; to reduce  
this to an average of 2 to 1 at the oscillograph either  
automatic volume control or pre-adjusted time-  
rate expansion, to vary the gain with time, is  
employed. Filters are used to restrict the fre-  
quency range of the amplifiers, which must be  
identical in amplitude and phase response. Accu-  
rate control of the timing circuits is accomplished by  
the use of a 100 c/s temperature-compensated  
tuning fork.
- 623.454.25 : 62I.396.9 703  
The Proximity Fuse.—(See 623/626.)
- 629.13 : 62I.389 704  
Electronic Timer for Aircraft De-Icing.—D. W.  
Blaser & G. R. Holt. (*Electronics*, Dec. 1945,  
Vol. 18, No. 12, pp. 152-155.) A thyatron timing  
circuit is used to control the rate of operation of the  
de-icing boots. Any one of four rates can be  
selected to counter the different icing conditions  
that may occur.

629.13 : 621.396

705  
**Aviation Communication Systems.**—Rentzel.  
(See 604.)

621.317.39

706  
**Electrical Measurements of Mechanical Quantities** [Elektrische Messung mechanischer Grössen : Book Review].—P. M. Pflieger. Springer, Berlin, 2nd edition 1943, reprinted (in German) by J. W. Edwards, Ann Arbor, Mich., U.S.A., 259 pp., \$6.50. (*Electronic Industr.*, Nov. 1945, Vol. 4, No. 11, pp. 220.. 222.) "The book will prove an excellent reference . . ." See also 1705 of 1945.

621.38

707  
**Electronic Equipment and Accessories** [Book Review].—R. C. Walker. George Newnes, London, 1945, 428 pp., 25s., and Chemical Pub. Co., Brooklyn, N.Y., \$6.00 (*Proc. Instn Radio Engrs, Aust.*, Oct. 1945, Vol. 6, No. 4, p. 15. Also *Electronic Industr.*, Nov. 1945, Vol. 4, No. 11, p. 225.) See also 3751 of 1945.

621.386 : 6

708  
**Die Photozelle in der Technik** [Book Review].—H. Geffcken & H. Richter. J. Schneider, Berlin-Tempelhof, 3rd edn., RM 2. (*Akust. Z.*, Sept. 1940, Vol. 5, No. 5, p. 364.)

## PROPAGATION OF WAVES

551.51.053.5 : 621.396.11

709  
**On the Propagation of Radio Waves.**—O. E. H. Rydbeck. (*Chalmers tekn. Högsk. Handl.*, 1944, No. 34, 168 pp. In English.) Full paper of which the author's summary was noticed in 1382 of 1945. Tables of useful cylinder functions of order  $\pm 1/3$  and  $\pm 2/3$  are given with interval 0.02 from  $x = 0$  to 1, and interval 0.2 from  $x = 0$  to 8.

551.51.053.5 : 621.396.11

710  
**On the Question of Short-Wave Propagation.**—O. Burkard. (*Funktech. Mh.*, May 1945, No. 5, pp. 65-66.) A satisfactory theoretical explanation of short-wave long-distance communication has not yet been given. The theory of multiple reflection between the ionosphere and earth is inadequate (e.g. there are not multiple annular skip-zones around the transmitter). The theory of gradual bending in the ionosphere is unacceptable because, e.g., very small changes in the intensity of ionization in the refracting layer would produce very large changes in range of the signal, so that, contrary to observation, long-distance communications would be confined to very brief intervals when the refracting conditions give exactly the correct range. The existence of "gliding" waves that follow the lower boundary of the ionosphere is proposed. They are somewhat analogous to Sommerfeld's ground waves. The "conducted" waves proposed by Uller (*Jb. drahtl. Telegr.*, 1917, Vol. 15, p. 123, *Z. ges. Naturwissenschaft*, 1939, Vols. 9/10, p. 353.) are not the same, for the conditions necessary for the existence of "conducted" waves are usually not possible in the upper atmosphere.

Following the work of Joos (2642 of 1939), the part of the "gliding" wave that is in the ionosphere has its wave fronts perpendicular to the base of the ionized layer, the part that is in the unionized air below has its wave fronts trailing behind, and energy is radiated obliquely downwards. Taking account of the earth's curvature, this oblique radiation will

reach the earth if the angle between its direction of propagation and the vertical is less than a critical value, which is about  $75^\circ$  for a layer height of 230 km. For 30 Mc/s waves this critical angle is calculated to be given by a density of ionization corresponding to a critical frequency of 7.76 Mc/s, which agrees almost exactly with the value for the critical frequency (7.8 Mc/s) observed for limiting long-distance propagation. Other evidence giving qualitative confirmation of the existence of "gliding" waves is mentioned.

621.3.011.2 + 621.3.011.5].029.62 : 631.437

711  
**The Electrical Properties of Soil at Wavelengths of 5 Metres and 2 Metres.**—J. S. McPetrie & J. A. Saxton. (*J. Instn elect. Engrs*, Part III, Dec. 1945, Vol. 92, No. 20, pp. 247-255.) "The paper gives the results of a year's observations on the electrical constants of a grass-covered sandy loam site at the National Physical Laboratory. Measurements of the reflection coefficient of the ground for radiation of wavelength 5 m indicated that the dielectric constant varied between 5 and 25, and that the conductivity varied from  $0.7 \times 10^8$  to  $4 \times 10^8$  e.s.u. Measurements of the attenuation in soil were also made at wavelengths of 5 m and 2 m, and the results indicated similar values for the electrical constants."

621.396.11 : 631.437

712  
**A Note on the Variation of the Ground Absorption Factor with Distance in India at Medium Wave Broadcasting Frequencies.**—S. Ramaswamy. (*Electrotechnics*, Sept. 1945, Nos. 17/18, pp. 104-107.) "Methods for calculating this factor have been given and the actual results for Lahore medium-wave broadcasting station have been worked out."

538.56 + 532.59 + 534] "1687-1943" : 016

713  
**Waves and Wave Action** [Book Review].—C. C. Lee, Vicksburg, Miss., U.S.A., revised 1944, 91 pp., \$5.00. (*Elect. Engng*, Oct. 1945, Vol. 64, No. 10, p. 382.) Annotated bibliography of about 800 books, periodicals, and society publications appearing from 1687 to Dec. 1943.

## RECEPTION

621.396/.397].62

714  
**"Design of Broadcast and Television Receivers for the Post-War Market."**—(*J. Instn elect. Engrs*, Part III, Dec. 1945, Vol. 92, No. 20, pp. 298-299.) I.E.E. Radio Section discussion, led by L. H. Bedford, of the relation between elaboration of design and the economic and manufacturing problems of radio industry after the war. Reference is made to projection *vs.* direct-viewing, and to the limited contribution of radar technique to television receiver design.

621.396.62 : 519.283

715  
**Sensitivity Limits in Radio Manufacturing.**—A. S. Blatterman. (*Electronics*, Nov. 1945, Vol. 18, No. 11, pp. 141-143.) A discussion of the statistical considerations underlying the fixing of acceptance limits for the sensitivity of radio receivers coming off a production line. A selected set of average valves is used to determine whether a rejection is due to valve or circuit deficiency.



621.396.621 **716**  
**Bicycle Radio with 4 Tubes.**—R. B. Essex. (*Radio Craft*, Dec. 1945, Vol. 17, No. 3, pp. 172-189.) A superheterodyne receiver using battery supplies and miniature valves, mounted on the handlebars.

621.396.621 **717**  
**Miniature Pocket Receiver Design.**—W. J. Brown. (*Communications*, Nov. 1945, Vol. 25, No. 11, pp. 33-37, 54.) Hearing aid technique is used to obtain a radio receiver  $6 \times 2\frac{1}{2} \times 1\frac{3}{16}$  inches in size, including batteries. The earphone leads are also the aerial. The circuit includes an r.f. pentode, a tetrode detector, either anode-bend or grid-leak, an a.f. tetrode and an output tetrode. Daylight outdoor range on a 50 kW broadcasting station is from 20 to 100 miles.

621.396.621.029.62 **718**  
**Build Your Own V.H.F. FM-AM Receiver.**—A. Rattray. (*Radio News*, Dec. 1945, Vol. 34, No. 6, pp. 29-159.) Circuit diagrams and constructional details of a receiver to cover the frequency range 88-108 or 115-140 Mc/s. Acorn valves are used for the r.f. amplifier, oscillator and mixer. Two high-gain i.f. stages at 4.3 Mc/s are followed by a stage operating as a low-gain i.f. amplifier for a.m. reception, and as a limiter for f.m. signals.

621.396.621.52.029.56/62 **719**  
**Explorer All-Wave Radio.**—B. White. (*Radio Craft*, Nov. 1945, Vol. 17, No. 2, pp. 96-135.) Design and construction of a regenerative receiver for 4.5 to 665 metres using plug-in coils.

621.396.622 : 621.396.619.018.41 **720**  
**F-M Ratio Detectors.**—Peters. (See 574.)

621.396.622 : 621.396.619.018.41 **721**  
**F.M. Detector.**—W. R. Ferris. (*Electronic Industr.*, Oct. 1945, Vol. 4, No. 10, p.194.) The incoming wave is incident on a plane or concave diffraction grating with line spacing about one wavelength. A plurality of probes, or dipoles, are placed in the frequency-sensitive zones of maximum field strength of the resultant diffraction pattern. Summary of U.S. patent 2 367 764.

621.396.623 **722**  
**[Receiver] Power Output Stages.**—J. King. (*Radio Craft*, Dec. 1945, Vol. 17, No. 3, pp. 173-207.) Points considered include impedance matching, bias resistance, cathode bypass condenser, output transformer ratio, effect of speaker coil inductance, and use of push-pull.

621.396.662 **723**  
**Practical Radio Course : Part 39** [Push-button station selectors].—Ghirardi. (See 772.)

621.396.665 **724**  
**Radio Design Worksheet : No. 42—Some Notes on Automatic Volume Control : Parallel Resonance.**—(*Radio*, N. Y., Nov. 1945, Vol. 29, No. 11, pp. 51-52.) Application of simple time constant theory to the design of orthodox a.v.c. circuits.

621.396.682 : 621.396.621 **725**  
**Electrification for the Old Set.**—G. A. Chase. (*Radio Craft*, Dec. 1945, Vol. 17, No. 3, pp. 177-178.) A detailed description of the conversion of a

battery operated receiver to a.c. mains operation at 110-120 V.

621.396.828 **726**  
**Reduction of Heterodyne Interference.**—H. W. Belles. (*Electronics*, Dec. 1945, Vol. 18, No. 12, pp. 150-151.) The amplitude and phase modulations of the desired carrier signal that are produced by adjacent channel signals, are separately rectified in balanced rectifier circuits. The rectified outputs are combined in opposition, leaving only the desired signal. Attenuation of strong interfering signals to below audibility has been accomplished without effect on the wanted signal.

621.396.932 **727**  
**Boat Radio Installations.**—H. B. O. Davis. (*Radio Craft*, Nov. 1945, Vol. 17, No. 2, pp. 94-138.) The factors governing the selection and installation of transmitters and receivers for small craft.

621.396/397/621 **728**  
**Radio Receiver Design - Part II** [Book Review].—K. R. Sturley. Chapman & Hall, London, 1945, 479 pp., 28s. (*Electronic Engng*, Jan. 1946, Vol. 18, No. 215, p. 30.) See also 414 of February.

**STATIONS AND COMMUNICATION SYSTEMS**

621.3(41) " 1939/1945 " **729**  
**British Electrical Engineers and the Second World War.**—P. Dunsheath. (*Engineering, Lond.*, 26th Oct., 2nd Nov. & 9th Nov. 1945, Vol. 160, Nos. 4163, 4164 & 4165, pp. 335, 360-361 & 383-384. *Beama J.*, Oct. & Nov. 1945, Vol. 52, Nos. 10 & 11, pp. 332-337 & 374-380.) Further summaries of the I.E.E. presidential address. See 415 of February.

621.396 **730**  
**Communication Development.**—A. H. Mumford. (*Electrician*, 26th Oct. 1945, Vol. 135, No. 3517, pp. 437-438.) Summary of inaugural address of Chairman I.E.E. Radio Section. See also 4046 of 1945.

621.396 : 629.13 **731**  
**Aviation Communication Systems.**—Rentzel. (See 604.)

621.396.44 (091) **732**  
**New Systems of Carrier Current Transmission.**—A. Marzin. (*Génie civ.*, 1st July 1944, Vol. 121, No. 13, p. 107.) Short abstract of an historical paper read before the Soc. franç. des Électriciens.

621.396.619.018.41 **733**  
**New FM Bands.**—A. Jay. (*Radio Craft*, Dec. 1945, Vol. 17, No. 3, pp. 163-216.) Trouble due to skywave transmission was possible on the old 40-50 Mc/s band. Propagation characteristics of the new 88-106 Mc/s band are discussed. Replies to a questionnaire on the new f.m. frequency allocations are given.

621.396.619.018.41 **734**  
**Frequency Modulation.**—K. R. Sturley. (*J. Instn elect. Engrs*, Part I, Dec. 1945, Vol. 92, No. 60, pp. 455-456.) Long summary of 4047 of 1945.

621.396.619.018.41 : 621.396.61.029.62 **735**  
**Simplified F.M.**—Geist. (See 788.)

- 629.13 : 621.396 **705**  
**Aviation Communication Systems.**—Renzel.  
 (See 604.)
- 621.317.39 **706**  
**Electrical Measurements of Mechanical Quantities**  
 [Elektrische Messung mechanischer Grössen : Book  
 Review].—P. M. Pflier. Springer, Berlin, 2nd  
 edition 1943, reprinted (in German) by J. W.  
 Edwards, Ann Arbor, Mich., U.S.A., 259 pp., \$6.50.  
 (*Electronic Industr.*, Nov. 1945, Vol. 4, No. 11,  
 pp. 220..222.) "The book will prove an excellent  
 reference . . ." See also 1705 of 1945.

- 621.38 **707**  
**Electronic Equipment and Accessories** [Book  
 Review].—R. C. Walker. George Newnes, London,  
 1945, 428 pp., 25s., and Chemical Pub. Co., Brook-  
 lyn, N.Y., \$6.00 (*Proc. Instn Radio Engrs, Aust.*,  
 Oct. 1945, Vol. 6, No. 4, p. 15. Also *Electronic*  
*Industr.*, Nov. 1945, Vol. 4, No. 11, p. 225.) See  
 also 3751 of 1945.

- 621.386 : 6 **708**  
**Die Photozelle in der Technik** [Book Review].—  
 H. Geffcken & H. Richter. J. Schneider, Berlin-  
 Tempelhof, 3rd edn., RM 2. (*Akust. Z.*, Sept. 1940,  
 Vol. 5, No. 5, p. 364.)

### PROPAGATION OF WAVES

- 551.51.053.5 : 621.396.11 **709**  
**On the Propagation of Radio Waves.**—O. E. H.  
 Rydbeck. (*Chalmers tekn. Högsk. Handl.*, 1944,  
 No. 34, 168 pp. In English.) Full paper of which  
 the author's summary was noticed in 1382 of 1945.  
 Tables of useful cylinder functions of order  $\pm 1/3$  and  
 $\pm 2/3$  are given with interval 0.02 from  $x = 0$  to 1,  
 and interval 0.2 from  $x = 0$  to 8.

- 551.51.053.5 : 621.396.11 **710**  
**On the Question of Short-Wave Propagation.**—  
 O. Burkard. (*Funktech. Mh.*, May 1945, No. 5,  
 pp. 65-66.) A satisfactory theoretical explanation  
 of short-wave long-distance communication has not  
 yet been given. The theory of multiple reflection  
 between the ionosphere and earth is inadequate  
 (e.g. there are not multiple annular skip-zones  
 around the transmitter). The theory of gradual  
 bending in the ionosphere is unacceptable because,  
 e.g., very small changes in the intensity of ionization  
 in the refracting layer would produce very large  
 changes in range of the signal, so that, contrary to  
 observation, long-distance communications would  
 be confined to very brief intervals when the re-  
 fracting conditions give exactly the correct range.  
 The existence of "gliding" waves that follow the  
 lower boundary of the ionosphere is proposed. They  
 are somewhat analogous to Sommerfeld's ground  
 waves. The "conducted" waves proposed by  
 Uller (*Jb. drahtl. Telegr.*, 1917, Vol. 15, p. 123,  
*Z. ges. Naturwissenschaft*, 1939, Vols. 9/10, p. 353.)  
 are not the same, for the conditions necessary for  
 the existence of "conducted" waves are usually  
 not possible in the upper atmosphere.

Following the work of Joos (2642 of 1939), the  
 part of the "gliding" wave that is in the ionosphere  
 has its wave fronts perpendicular to the base of the  
 ionized layer, the part that is in the unionized air  
 below has its wave fronts trailing behind, and energy  
 is radiated obliquely downwards. Taking account  
 of the earth's curvature, this oblique radiation will

reach the earth if the angle between its direction of  
 propagation and the vertical is less than a critical  
 value, which is about  $75^\circ$  for a layer height of  
 230 km. For 30 Mc/s waves this critical angle is  
 calculated to be given by a density of ionization  
 corresponding to a critical frequency of 7.76 Mc/s,  
 which agrees almost exactly with the value for the  
 critical frequency (7.8 Mc/s) observed for limiting  
 long-distance propagation. Other evidence giving  
 qualitative confirmation of the existence of "glid-  
 ing" waves is mentioned.

- 621.3.011.2 + 621.3.011.5].029.62 : 631.437 **711**  
**The Electrical Properties of Soil at Wavelengths**  
**of 5 Metres and 2 Metres.**—J. S. McPetrie & J. A.  
 Saxton. (*J. Instn elect. Engrs*, Part III, Dec.  
 1945, Vol. 92, No. 20, pp. 247-255.) "The paper  
 gives the results of a year's observations on the  
 electrical constants of a grass-covered sandy loam  
 site at the National Physical Laboratory. Measure-  
 ments of the reflection coefficient of the ground for  
 radiation of wavelength 5 m indicated that the  
 dielectric constant varied between 5 and 25, and  
 that the conductivity varied from  $0.7 \times 10^8$  to  
 $4 \times 10^8$  e.s.u. Measurements of the attenuation in  
 soil were also made at wavelengths of 5 m and 2 m,  
 and the results indicated similar values for the  
 electrical constants."

- 621.396.11 : 631.437 **712**  
**A Note on the Variation of the Ground Absorption**  
**Factor with Distance in India at Medium Wave**  
**Broadcasting Frequencies.**—S. Ramaswamy. (*Elec-*  
*trotechnics*, Sept. 1945, Nos. 17/18, pp. 104-107.)  
 "Methods for calculating this factor have been  
 given and the actual results for Lahore medium-  
 wave broadcasting station have been worked out."

- 538.56 + 532.59 + 534] "1687-1943" : 016 **713**  
**Waves and Wave Action** [Book Review].—C. C.  
 Lee, Vicksburg, Miss., U.S.A., revised 1944, 91 pp.,  
 \$5.00. (*Elect. Engng*, Oct. 1945, Vol. 64, No. 10,  
 p. 382.) Annotated bibliography of about 800 books,  
 periodicals, and society publications appearing from  
 1687 to Dec. 1943.

### RECEPTION

- 621.396/.397].62 **714**  
**"Design of Broadcast and Television Receivers**  
**for the Post-War Market."**—(*J. Instn elect.*  
*Engrs*, Part III, Dec. 1945, Vol. 92, No. 20,  
 pp. 298-299.) I.E.E. Radio Section discussion, led  
 by L. H. Bedford, of the relation between elabora-  
 tion of design and the economic and manufacturing  
 problems of radio industry after the war. Reference  
 is made to projection vs. direct-viewing, and to the  
 limited contribution of radar technique to television  
 receiver design.

- 621.396.62 : 519.283 **715**  
**Sensitivity Limits in Radio Manufacturing.**—  
 A. S. Blatterman. (*Electronics*, Nov. 1945, Vol. 18,  
 No. 11, pp. 141-143.) A discussion of the statistical  
 considerations underlying the fixing of acceptance  
 limits for the sensitivity of radio receivers coming  
 off a production line. A selected set of average  
 valves is used to determine whether a rejection is  
 due to valve or circuit deficiency.

- 621.396.621 **716**  
**Bicycle Radio with 4 Tubes.**—R. B. Essex. (*Radio Craft*, Dec. 1945, Vol. 17, No. 3, pp. 172-189.) A superheterodyne receiver using battery supplies and miniature valves, mounted on the handlebars.
- 621.396.621 **717**  
**Miniature Pocket Receiver Design.**—W. J. Brown. (*Communications*, Nov. 1945, Vol. 25, No. 11, pp. 33-37, 54.) Hearing aid technique is used to obtain a radio receiver  $6 \times 2\frac{1}{2} \times 1\frac{3}{16}$  inches in size, including batteries. The earphone leads are also the aerial. The circuit includes an r.f. pentode, a tetrode detector, either anode-bend or grid-leak, an a.f. tetrode and an output tetrode. Daylight outdoor range on a 50 kW broadcasting station is from 20 to 100 miles.
- 621.396.621.029.62 **718**  
**Build Your Own V.H.F. FM-AM Receiver.**—A. Rattray. (*Radio News*, Dec. 1945, Vol. 34, No. 6, pp. 29-159.) Circuit diagrams and constructional details of a receiver to cover the frequency range 88-108 or 115-140 Mc/s. Acorn valves are used for the r.f. amplifier, oscillator and mixer. Two high-gain i.f. stages at 4.3 Mc/s are followed by a stage operating as a low-gain i.f. amplifier for a.m. reception, and as a limiter for f.m. signals.
- 621.396.621.52.029.56/.62 **719**  
**Explorer All-Wave Radio.**—B. White. (*Radio Craft*, Nov. 1945, Vol. 17, No. 2, pp. 96-135.) Design and construction of a regenerative receiver for 4.5 to 665 metres using plug-in coils.
- 621.396.622 : 621.396.619.018.41 **720**  
**F-M Ratio Detectors.**—Peters. (See 574.)
- 621.396.622 : 621.396.619.018.41 **721**  
**F.M. Detector.**—W. R. Ferris. (*Electronic Industr.*, Oct. 1945, Vol. 4, No. 10, p.194.) The incoming wave is incident on a plane or concave diffraction grating with line spacing about one wavelength. A plurality of probes, or dipoles, are placed in the frequency-sensitive zones of maximum field strength of the resultant diffraction pattern. Summary of U.S. patent 2 367 764.
- 621.396.623 **722**  
[Receiver] **Power Output Stages.**—J. King. (*Radio Craft*, Dec. 1945, Vol. 17, No. 3, pp. 173-207.) Points considered include impedance matching, bias resistance, cathode bypass condenser, output transformer ratio, effect of speaker coil inductance, and use of push-pull.
- 621.396.662 **723**  
**Practical Radio Course : Part 39** [Push-button station selectors].—Ghirardi. (See 772.)
- 621.396.665 **724**  
**Radio Design Worksheet : No. 42—Some Notes on Automatic Volume Control : Parallel Resonance.**—(*Radio, N. Y.*, Nov. 1945, Vol. 29, No. 11, pp. 51-52.) Application of simple time constant theory to the design of orthodox a.v.c. circuits.
- 621.396.682 : 621.396.621 **725**  
**Electrification for the Old Set.**—G. A. Chase. (*Radio Craft*, Dec. 1945, Vol. 17, No. 3, pp. 177-178.) A detailed description of the conversion of a battery operated receiver to a.c. mains operation at 110-120 V.
- 621.396.828 **726**  
**Reduction of Heterodyne Interference.**—H. W. Belles. (*Electronics*, Dec. 1945, Vol. 18, No. 12, pp. 150-151.) The amplitude and phase modulations of the desired carrier signal that are produced by adjacent channel signals, are separately rectified in balanced rectifier circuits. The rectified outputs are combined in opposition, leaving only the desired signal. Attenuation of strong interfering signals to below audibility has been accomplished without effect on the wanted signal.
- 621.396.932 **727**  
**Boat Radio Installations.**—H. B. O. Davis. (*Radio Craft*, Nov. 1945, Vol. 17, No. 2, pp. 94-138.) The factors governing the selection and installation of transmitters and receivers for small craft.
- 621.396/.397/.621 **728**  
**Radio Receiver Design - Part II** [Book Review].—K. R. Sturley. Chapman & Hall, London, 1945, 479 pp., 28s. (*Electronic Engng*, Jan. 1946, Vol. 18, No. 215, p. 30.) See also 414 of February.

## STATIONS AND COMMUNICATION SYSTEMS

621.3(41) "1939/1945" **729**

**British Electrical Engineers and the Second World War.**—P. Dunsheath. (*Engineering, Lond.*, 26th Oct., 2nd Nov. & 9th Nov. 1945, Vol. 160, Nos. 4163, 4164 & 4165, pp. 335, 360-361 & 383-384. *Beama J.*, Oct. & Nov. 1945, Vol. 52, Nos. 10 & 11, pp. 332-337 & 374-380.) Further summaries of the I.E.E. presidential address. See 415 of February.

621.396 **730**

**Communication Development.**—A. H. Mumford. (*Electrician*, 26th Oct. 1945, Vol. 135, No. 3517, pp. 437-438.) Summary of inaugural address of Chairman I.E.E. Radio Section. See also 4046 of 1945.

621.396 : 629.13 **731**  
**Aviation Communication Systems.**—Rentzel. (See 604.)621.396.44 (091) **732**

**New Systems of Carrier Current Transmission.**—A. Marzin. (*Génie civ.*, 1st July 1944, Vol. 121, No. 13, p. 107.) Short abstract of an historical paper read before the Soc. franç. des Électriciens.

621.396.619.018.41 **733**

**New FM Bands.**—A. Jay. (*Radio Craft*, Dec. 1945, Vol. 17, No. 3, pp. 163-216.) Trouble due to skywave transmission was possible on the old 40-50 Mc/s band. Propagation characteristics of the new 88-106 Mc/s band are discussed. Replies to a questionnaire on the new f.m. frequency allocations are given.

621.396.619.018.41 **734**

**Frequency Modulation.**—K. R. Sturley. (*J. Instn elect. Engrs*, Part I, Dec. 1945, Vol. 92, No. 60, pp. 455-456.) Long summary of 4047 of 1945.

621.396.619.018.41 : 621.396.61.029.62 **735**

**Simplified F.M.**—Geist. (See 788.)

- 621.396.619.018.41 : 621.396.81 **736**  
**Range Prediction Chart for F-M Stations.**—F. C. Everett. (*Communications*, Nov. 1945, Vol. 25, No. 11, p. 57.) Gives the range from transmitter power, aerial height, distance, and desired field strength at the receiver, for "average" ground constants, based on 98 Mc/s, horizontal polarization.
- 621.396.619.018.41 : 621.396.81 **737**  
**Ground Wave Range Calculator for FM.**—(*Electronic Industr.*, Nov. 1945, Vol. 4, No. 11, p. 109.) A chart linking field strength, transmitter height and distance, based on a frequency of 98 Mc/s and 30 ft receiving antenna. Similar data to that presented in 736 above, but in a different form.
- 621.396.619.018.41 + 621.397.24].052 **738**  
**Transmission Networks for Frequency Modulation and Television.**—H. S. Osborne. (*Elect. Engng*, N. Y., Nov. 1945, Vol. 64, No. 11, pp. 392-397.) Present and possible future f.m. requirements in the U.S. using ordinary telephone wires for local circuits and carrier telephone networks for inter-city connexions can be met with existing plant. For short-distance television transmission ordinary telephone pairs with special equipment have been used, and the use of existing or improved coaxial cables for longer distances has been advocated. Experiments at 2, 4 and 12 Mc/s have been started on microwave relay systems, and the possible use of waveguides is considered. The programme of the Bell System Companies to meet these broad-band developments is included.
- 621.396.619.16 **739**  
**Pulse Modulation.**—C. W. Hansell. (*Electronic Industr.*, Oct. 1945, Vol. 4, No. 10, p. 128.) Odd pulses are delayed and even pulses are advanced relative to the unmodulated pulse-train during the positive half cycle of the modulation, and *vice versa* during the negative half cycle. This allows higher peak power, use of higher frequencies, improved signal-to-noise ratio and a degree of secrecy. Diagrams are given. Summary of U.S. patents 2 379 899 and 2 379 900.
- 621.396.619.16 **740**  
**Pulse-Time Modulation.**—D. Philips. (*Communications*, Nov. 1945, Vol. 25, No. 11, pp. 46. 86.) A transmitter of about 4 500 Mc/s is modulated with a 4  $\mu$ s marker pulse and eight 1  $\mu$ s carrier pulses, forming a frame with a repetition rate of 8 000 c/s. Each carrier pulse provides a channel which conveys intelligence by the movement of the pulse in time relative to the marker pulse. The magnitude of this movement is proportional to the amplitude of the modulation. The receiver contains gating circuits, which are synchronized with the transmitter by the marker pulse, and which separate the carrier pulses into the eight output circuits.  
 Demonstrations of a Federal Telephone & Radio Corp. 24-channel 40-mile inter-city system, Bell Telephone Lab. military set AN/TRC-6, and RCA military set AN/TRC-5 are described.
- 621.396.619.16 **741**  
**PT Modulation for Multiple Transmission.**—(*Electronic Industr.*, Vol. 4, No. 11, pp. 90-91.) Account of the Federal Telephone and Radio Corp. system. See also 740 above.
- 621.396.619.16 **742**  
**Pulse-Time Modulation.**—(*Radio Craft*, Dec. 1945, Vol. 17, No. 3, pp. 161..197.)
- 621.396.63 : 621.396.619.018.41 **743**  
**FM Radio Relay.**—J. M. Lee. (*Radio News*, Dec. 1945, Vol. 34, No. 6, pp. 54..154.) U.S. Army equipment for linking to a telephone system. Frequency 70-100 Mc/s with a transmitter power of 50 W, or 250 W with an additional amplifier. Phase-shift modulation is used, with deviation up to  $\pm 30$  kc/s.
- 621.396.712 **744**  
**The CBC H-F Global Transmitting System.**—R. D. Cahoon. (*Communications*, Oct. 1945, Vol. 25, No. 10, pp. 60..87.) An account of the station described in 193 of January.
- 621.396.97(091) **745**  
**25th Anniversary of Radiobroadcasting.**—(*Elect. Engng*, N. Y., Oct. 1945, Vol. 64, No. 10, pp. 365-366.) "History and events that led to the first scheduled broadcast of November 2nd, 1920, from the first established station, KDKA, Pittsburgh."
- 621.396.97.029.62 **746**  
**On the Possibility of an Ultra-Short-Wave First Grade Broadcasting Service in India.**—S. P. Chakravarti. (*Electrotechnics*, Sept. 1945, Nos. 17/18, pp. 96-103.) Tropical countries, and India in particular, present special problems, *e.g.* high level of atmospheric and man-made static, large seasonal variation of ground conductivity, comparatively low and dense ionosphere, inadequate funds. It is probable that the highest efficiency would be obtained from about 60 low-power stations operating on a wavelength of 5 metres.
- 621.39 **747**  
**Jahrbuch des elektrischen Fernmeldewesens** [Book Review].—F. Gladenbeck. Georg Heidecker, Berlin, 1940, 379 pp., RM 22. (*Akust. Z.*, July 1940, Vol. 5, No. 4, p. 233.) An account of the research by the German post office during the year.
- 621.39(05) **748**  
**Communication Review.**—A quarterly house journal newly published by Communication Engineering Pty. Ltd., Sydney, Australia. The contents of the first number are mainly concerned with carrier-cable telephony and associated equipment.

## SUBSIDIARY APPARATUS

- 531.788.7 **749**  
**Manometer Circuit.**—Calbick. (*See* 629.)
- 533.56 **750**  
**High-Vacuum Pumping.**—(*See* 630.)
- 535.312 **751**  
**Directive Optical Systems.**—(*Electronic Engng*, Jan. 1946, Vol. 18, No. 215, pp. 27-28.) The transmission of light beams by internal reflections along Perspex rods, for photo-cell and other applications. The amount of light transmitted is shown for typical cases.
- 621.3.042.5 **752**  
**Multiple Magnetic Circuits.**—J. F. Manildi. (*Electronics*, Nov. 1945, Vol. 18, No. 11, pp. 160-163.) It is shown how the field in the gap of, say, a measuring instrument may be increased for the same gap configuration and amount of magnetic

material by using a number of parallel elements in the magnetic circuit to replace a single series element.

62I.314.2 **753**  
**Design Construction and Testing of Radio Power Transformers.**—P. Prabhakar & V. V. L. Rao. (*Electrotechnics*, Sept. 1945, Nos. 17/18, pp. 108-121.) After a brief description of various parts, empirical formulae for determining the core size, wire size, and number of turns, are given. Useful constructional hints and an illustrative example are included.

62I.314.5 **754**  
**The Design of Non-Synchronous Vibrators for Radio Sets and Equipment.**—R. N. Dewan. (*Electrotechnics*, Sept. 1945, Nos. 17/18, pp. 125-133.) Their underlying principles are discussed and details are given of a type made by the author because of their scarcity on the market.

62I.315.613.1 : 62I.319.4 **755**  
**Manufacture of Silvered Mica Capacitors.**—A. T. Chapman. (*Electronics*, Nov. 1945, Vol. 18, No. 11, pp. 146-149.) "Discussion of mica quality factors, and details of new manufacturing techniques developed [at Western Electric Co.] to conserve existing stocks of mica and . . . improve tolerances and quality standards of finished units." Stresses the importance of proper assembly, processing, and moulding, to ensure that even the best quality mica does not yield capacitors having poor stability and high temperature-coefficient.

62I.316.722.078.3 : 62I.396.682 **756**  
**Voltage-Regulated Power Supplies.**—G. E. Hamilton & T. Maiman. (*Communications*, Nov. 1945, Vol. 25, No. 11, pp. 44-81.) Electronic means of voltage stabilization which are described include cold cathode gas filled (neon) tubes,  $\mu$ -bridge stabilizers, transconductance bridge stabilizers, and degenerative amplifiers. The first of two papers.

62I.316.74 **757**  
**Tapered-Thickness Bimetal.**—W. B. Elmer. (*Trans. Amer. Inst. elect. Engrs*, Sept. 1945, Vol. 64, No. 9, pp. 661-665.) Bimetal strips for use in thermostats are most economical in the tapered-thickness form. Charts giving corrections to standard formulae for uniform strips are included. Formulae for determining the fundamental frequency of vibration of single- and dual-tapered strips are also given.

62I.316.74 : 62I.396.611.2 **758**  
**Design of Thermostatic Ovens.**—T. S. Skillman. (*Communication Rev.*, 1945, Vol. 1, No. 1, pp. 41-45.) An oven is described, capable of accommodating the tuning circuits of 16 oscillators and of maintaining a temperature constant to within  $\pm 0.15^\circ\text{C}$ .

62I.316.74 : 62I.396.611.21 **759**  
[Quartz] **Crystal Oven Anticipates Temperature Changes.**—(*Electronics*, Nov. 1945, Vol. 18, No. 11, pp. 406-414.) "... it consists of an inner Bakelite chamber to hold the crystals, an insulating air chamber surrounding the Bakelite one and containing heating coils and a limiting [bimetal] thermostat, and an outside Bakelite cover." It is a small unit with standard 11-pin base, to operate with ambient temperatures  $-40^\circ\text{C}$  to  $+70^\circ\text{C}$  and control the internal temperature to  $1^\circ\text{C}$ .

62I.316.93 **760**  
**Lightning Investigations on 33-Kv Wood-Pole Lines.**—F. E. Andrews & G. D. McCann. (*Trans. Amer. Inst. elect. Engrs*, Vol. 64, No. 11, pp. 768-777.) A study of the lightning performances of various types of line design and lightning protection. The investigation made use of photographic surge-current recorders and surge-crest-ammeter links installed on lines. Detailed data were obtained for wood-pole lines continuously protected by overhead ground wires and by deion protector tubes.

62I.317.755.087.5 **761**  
**A Continuous Film-Recording Camera for Use with Standard Cathode-Ray Oscilloscopes.**—A. H. Simons. (*Electronic Engng*, Jan. 1946, Vol. 18, No. 215, pp. 10-12.) A friction-drive camera taking 85 mm film or paper, perforated or unperforated. Film speed continuously variable 12.5-50 in/s, f/4.5 lens, no shutter, 100 ft spools. Two discharge lamps are fitted for making timing marks on each edge of the film.

62I.318.323.2 : 62I.396.662.2 **762**  
**Effective Permeability of High Frequency Iron Cores.**—Polydoroff & Klapperich. (See 646.)

62I.318.42 **763**  
**Optimum Air Gap for Various Magnetic Materials in Cores of Coils Subject to Superposed Direct Current.**—V. E. Legg. (*Trans. Amer. Inst. elect. Engrs*, Oct. 1945, Vol. 64, No. 10, pp. 709-712.) The method developed is used to calculate curves from which the design dimensions can be obtained to meet specified requirements of inductance, resistance, and d.c. burden. Special cases, in which other quantities are specified, are considered.

62I.318.42.017.31 **764**  
**Eddy-Current Resistance of Multilayer Coils.**—T. H. Long. (*Trans. Amer. Inst. elect. Engrs*, Oct. 1945, Vol. 64, No. 10, pp. 712-718.) Formulae suitable for strip-wound coils with partial magnetic circuits (e.g., in the slots of machines) are extended to apply to coils wound from round wire having no external magnetic circuit, by assuming a fictitious permeability and wire of an equivalent square section, which "seems to give results of usable accuracy".

62I.318.423 **765**  
**The Self-Inductance of a Toroidal Coil Without Iron.**—H. B. Dwight. (*Trans. Amer. Inst. elect. Engrs*, Nov. 1945, Vol. 64, No. 11, pp. 805-806.) A method for computing the inductance of a coil with rectangular section and a comparatively thick winding, based on the product of magnetic flux lines and the number of turns linked.

62I.319.4.011.4 **766**  
**Resistance and Capacitance Relations Between Short Cylindrical Conductors.**—F. L. ReQua. (*Trans. Amer. Inst. elect. Engrs*, Oct. 1945, Vol. 64, No. 10, pp. 724-730.) Formulae are given for a number of side-by-side dispositions of the conductors, taking account of end effects. These give results in better agreement with experiment than the conventional formulae which assume the length of the conductors great compared with their distance of separation.

- 621.384.6 767  
**100,000,000-Volt Betatron.**—(*Sci. News Lett., Wash.*, 3rd Nov. 1945, Vol. 48, No. 18, pp. 278-279.) Popular account of the device described in 438 of February.
- 621.385.832 768  
**Application Techniques for Cathode-Ray Tubes.**—Christaldi & Lempert. (See 775.)
- 621.386 769  
**Industrial X-Ray Tubes.**—Z. J. Atlee. (*Electronics*, Nov. 1945, Vol. 18, No. 11, pp. 136-140.) A survey of properties of X-ray tubes for micro-radiography and diffraction, at voltages from 50 kV to 2 MV peak. Difficulty has been encountered in providing targets with a wide range of atomic number. The atomic number of the target should be lower than that of the material under examination by diffraction.
- 621.386 (091) 770  
**Roentgen-Ray Tubes.**—W. D. Coolidge & E. E. Charlton. (*Gen. elect. Rev.*, Nov. 1945, Vol. 48, No. 11, pp. 36-41, 44-51.) An authoritative review of developments in the past 50 years.
- 621.396.622.6 : 546.28 771  
**Silicon Crystals for UHF Detection Circuits.**—E. C. Cornelius. (*Electronic Industr.*, Nov. 1945, Vol. 4, No. 11, pp. 74-140.) At frequencies of the order of 1 000 Mc/s and upwards the diode detector is no longer serviceable and has been replaced by a silicon crystal and tungsten "cat's whisker". The combination is assembled in a ceramic cartridge and embedded in wax. The performance is much improved by the inclusion in the silicon of controlled small amounts of other substances. The operating conditions are discussed with the aid of an equivalent circuit diagram.
- 621.396.662 772  
**Practical Radio Course : Part 39** [Push-button station selectors].—A. A. Ghirardi. (*Radio News*, Dec. 1945, Vol. 34, No. 6, pp. 56-136.) Reviews various selector systems and the special oscillator preselector tracking problems that arise. Considers very fully systems using preset trimmers or tuned circuits with capacitance or inductance tuning.
- 621.396.662.2 773  
**Winding Universal Coils.**—A. W. Simon. (*Electronics*, Nov. 1945, Vol. 18, No. 11, p. 170.) Simple rules for modifying a coil of known self-inductance so as to obtain a desired inductance value. Similar rules are given for locating the tap on a coil and for adjusting the mutual inductance or coupling coefficient between two coils to a required value.
- 621.396.682 : 621.396.621 774  
**Electrification for the Old Set.**—Chase. (See 725.)
- 621.396.619.018.41 + 621.397.24].052 776  
**Transmission Networks for Frequency Modulation and Television.**—Osborne. (See 738.)
- 621.396[.397].62 777  
**"Design of Broadcast and Television Receivers for the Post-War Market"**.—(See 714.)
- 621.397 778  
**Television Developments.**—(*Wireless World*, Dec. 1945, Vol. 51, No. 12, pp. 371-372.) A description of the system referred to in 230 of January.
- 621.397.26(73) "1927-1944" 779  
**Television Broadcasting Practice in America - 1927 to 1944.**—D. G. Fink. (*J. Instn elect. Engrs*, Part I, Dec. 1945, Vol. 92, No. 60, pp. 457-458.) Long summary of 3955 of 1945.
- 621.397.3 780  
**"Colour Television"**.—(*J. Instn elect. Engrs*, Part III, Dec. 1945, Vol. 92, No. 20, pp. 258-259.) Report of I.E.E. discussion led by L. C. Jesty embracing point, line, and frame scanning using the minimum requirement of three primary colours, and definition, bandwidth, and colour fringing on moving objects.
- 621.397.5 781  
**Studio Technique in Television.**—D. C. Birkinshaw & D. R. Campbell. (*J. Instn elect. Engrs*, Part I, Dec. 1945, Vol. 92, No. 60, p. 459.) Long summary of 3961 of 1945.
- 621.397.62 782  
**Functions of Video Circuit.**—E. M. Noll. (*Radio News*, Dec. 1945, Vol. 34, No. 6, pp. 48-151.) Explains the need for d.c. restoration on the picture tube to maintain correct average brightness, and describes the necessary video circuits.
- 621.397.82 783  
**Multipath Interference in Television Transmission.**—D. I. Lawson. (*J. Instn elect. Engrs*, Part I, Dec. 1945, Vol. 92, No. 60, pp. 460-461.) Long summary of 3958 of 1945.
- 621.386 : 6 784  
**Die Photozelle in der Technik** [Book Review].—H. Geffcken & H. Richter. J. Schneider, Berlin-Tempelhof, 3rd edn., RM 2. (*Akust. Z.*, Sept. 1940, Vol. 5, No. 5, p. 364.)
- 621.397.5 785  
**Television Programming and Production** [Book Review].—R. Hubbell. Murray Hill Books, New York, 1945, 207 pp., \$3.00. (*Elect. Engng*, Oct. 1945, Vol. 64, No. 10, p. 382.) "Provides a foundation for the techniques. . ."

## TELEVISION AND PHOTOTELEGRAPHY

- 621.385.832 775  
**Application Techniques for Cathode-Ray Tubes.**—P. S. Christaldi & I. E. Lempert. (*Proc. Radio Cl. Amer.*, Nov. 1945, Vol. 22, No. 1.) Comprehensive recommendations for the selection of cathode-ray tubes, and for the design of appropriate power supplies, with special reference to the use of makers' specifications.

## TRANSMISSION

- 621.396.61.029.56/.58 786  
**A Four-Band 125-Watt Transmitter.**—B. Goodman. (*QST*, Dec. 1945, Vol. 29, No. 12, pp. 22-24.) Oscillator and doubler include 7C5 tetrodes, amplifier 4D32 tetrode; operation is on 3.5, 7, 14, or 28 Mc/s.

- 621.396.61.029.58 **787**  
**Engineering Details of OWI 200 Kw Units.**—H. Romander. (*Electronic Industry*, Oct. 1945, Vol. 4, No. 10, pp. 100-162.) This fully modulated inverted amplifier operating in the range 6-22 Mc/s occupies a space  $22\frac{1}{2}$  ft  $\times$  6 ft  $\times$   $6\frac{1}{2}$  ft and is driven by a 50 kW transmitter. It includes two F-135-A tubes. A motor-driven shorting bar is used to tune a pair of copper pipes which, together with a second pair coupled to the antenna, form the anode circuit. Push-pull circuits are used in the a.f. equipment; satisfactory harmonic suppression and good stability are obtained with three negative feedback loops. The main rectifier has twelve F-857A rectifiers arranged in a three-phase full-wave rectifier circuit with a transformer bank connected in delta-delta.
- 621.396.61.029.62 : 621.396.619.018.41 **788**  
**Simplified F.M.**—J. C. Geist. (*QST*, Dec. 1945, Vol. 29, No. 12, pp. 29-90.) A  $2\frac{1}{2}$  metre a.m. or f.m. transmitter. For a.m. the modulator is connected to the final amplifier. "With the switch in the f.m. position the oscillator is [anode] amplitude modulated at a low percentage. Amplitude modulation of the self-excited oscillator also causes frequency modulation. . . . Since the depth of modulation is kept low, the amplitude modulation is wiped out by the succeeding Class-C stages. The frequency modulation remains. . . . The resulting output from the transmitter is a virtually constant-amplitude frequency-modulated carrier."
- 621.396.61.029.62 : 621.396.645.31.029.62 **789**  
**300 Watts on 50 and 144 [Mc/s].**—E. P. Tilton. (*QST*, Dec. 1945, Vol. 29, No. 12, pp. 25-28.) A frequency-tripler and amplifier for use with the 4 Mc/s a.m.-f.m. transmitter described in 468 of February.
- 621.396.615 **790**  
**Notes on the Stability of LC Oscillators.**—Lea. (See 569.)
- 621.396.615 **791**  
**On the Frequency Maintained by a Valve Oscillator.**—Queffelec. (See 570.)
- 621.396.615.14 **792**  
**Some Measurements on Micro-Radio Waves of Wavelengths from 15 to 19 Centimetres.**—Das & hakravarti. (See 803.)
- 621.396.615.17.029.62 **793**  
**Frequency Multiplication for the V.H.F. Bands.**—A. Gardner. (*QST*, Dec. 1945, Vol. 29, No. 12, pp. 45-102.) Points considered are the choice of valves, the use of push-pull circuits, frequency checking, and decoupling. Circuits are given for 50 Mc/s transmitter controlled by a 3.5 Mc/s crystal and a 144 Mc/s transmitter using either a 6 or a 7.2 Mc/s crystal.
- 621.396.645.31 **794**  
**Role of the Neutralizing Capacitor in Tuned Power Amplifiers.**—Pritchett. (See 577.)
- 621.396.932 **795**  
**Boat Radio Installations.**—H. B. O. Davis. (*Radio Craft*, Nov. 1945, Vol. 17, No. 2, pp. 94-8.) The factors governing the selection and installation of transmitters and receivers for small craft.
- 537.58 **796**  
**Saturation Currents of Thermionic Emission in Vacuum.**—C. Macherey. (*Génie civ.*, 1st/15th Nov. 1944, Vol. 121, Nos. 21/22, pp. 170-172.) Calculation of the effect of space charge on the current between plane electrodes, and an account of the range of application of Richardson's and Child's formulae.
- 621.385 **797**  
**Measuring Emission Characteristics with Pulse Technic.**—R. L. Sproull. (*Electronic Industry*, Nov. 1945, Vol. 4, No. 11, pp. 112-113.) Long summary, with diagrams, of 2642 of 1945.
- 621.385 **798**  
**Tube Replacements.**—I. Queen. (*Radio Craft*, Nov. 1945, Vol. 17, No. 2, pp. 100-101.) U.S. valves with identical characteristics but different bases or filament voltages are listed.
- 621.385 : 621.791.352 **799**  
**Brazing Operations in Transmitter Tube Assembly.**—(See 651.)
- 621.385.16 **800**  
**Centimeter-Wave Magnetrons.**—H. F. Argento. (*QST*, Dec. 1945, Vol. 29, No. 12, pp. 17-21.) The anode of a cavity magnetron consists of a thick-walled copper cylinder with a number of identical key-hole shaped slots opening into the inner face. Precision machining of a solid block has been replaced by building up from punched sheets and brazing, thus expanding production rates ten times. The oxide-coated cathode may give up to 100 A emission current. Peak outputs of up to a  $10^6$  W on microsecond pulses are obtained at centimetre wavelengths with about 50% efficiency, 30 000 V input, and magnetic fields of 2 000 gauss. Tunable magnetrons and velocity-modulated tubes are briefly described.
- 621.385.18 : 621.316.722.078.3 **801**  
**Utilizing the VR-Series Tubes.**—W. H. Anderson. (*QST*, Dec. 1945, Vol. 29, No. 12, pp. 36-37.) Basic design data and nomographs are given for voltage regulators using a simple circuit with gas-filled stabilizing tubes.
- 621.385.8 **802**  
**Sensitive Gas Relay Tube.**—J. Reiss. (*Electronics*, Nov. 1945, Vol. 18, No. 11, pp. 450-458.) Summary of 3302 of 1945.
- 621.396.615.14 **803**  
**Some Measurements on Micro-Radio Waves of Wavelengths from 15 to 19 Centimetres.**—P. N. Das & S. P. Chakravarti. (*Electrotechnics*, Sept. 1945, Nos. 17/18, pp. 78-84.) A 4036A triode is used to generate Barkhausen oscillations in the range 1 580-2 000 Mc/s and some estimates of the power output are made.

## MISCELLANEOUS

- 519.283 **804**  
**Statistical Methods in the Development of Apparatus Life Quality.**—E. N. Ferrell. (*Elect. Engng.*, Oct. 1945, Vol. 64, No. 10, p. 367.) Abstract of a paper before the Amer. Inst. Elect. Engrs.

519.283

805

**Statistical Methods in Quality Control I-VI.**—A.I.E.E. Sub-committee on Educational Activities. (*Elect. Engng, N. Y.*, May/Nov. 1945, Vol. 64, Nos. 5/11, pp. 181..402.) The first six parts of a series dealing, respectively, with I. Variability of quality/frequency distributions; II. Measurement by variables and by attributes; III. Frequency distribution for set-up check of process; IV. Sub-grouping of data, finding causes of trouble; V. Variations to be expected in sampling; VI. Charts for go-and-no-go inspection.

620.193

806

**Some Practical Instances of the Corrosion of Non-Ferrous Metals in Telecommunications Plant.**—W. G. Radley. (*J. sci. Instrum.*, Dec. 1945, Vol. 22, No. 12, pp. 237-238.) Corrosion of cable sheaths and of bunches of wires behind switchboards is mainly due to moisture and leakage currents. Chemical inhibitors have been used with some success.

620.193

807

**Controlling Factors in Atmospheric and Immersed Corrosion.**—W. H. J. Vernon. (*J. sci. Instrum.*, Dec. 1945, Vol. 22, No. 12, pp. 226-230.) The controlling factor in immersed corrosion is usually either cathodic potential, the production of protective films, or the rate of supply of the promoting factor. In atmospheric corrosion it may be the humidity and impurity of the atmosphere, or the physical properties of the initial film. The influence of these factors is reviewed.

620.193.7

808

**Electrochemical Measurements for Corrosion Studies.**—P. T. Gilbert. (*J. sci. Instrum.*, Dec. 1945, Vol. 22, No. 12, pp. 235-237.) The potentials and corrosion currents of four couples were measured and it was found that (a) if the corrosion is largely electrochemical the corrosion current is directly related to the amount of corrosion; (b) when two metals are corroding in contact an unknown factor is usually introduced; (c) local cathodes on the anode and *vice versa* cause an increase in corrosion; (d) with a single metal these local elements cause most of the corrosion, but for an electro-positive and an electro-negative couple, they may be of only secondary importance.

621.394/.396].6(213)

809

**Report on the Deterioration of Telecommunications Equipment in Tropical Areas.**—R. J. Collins, C. S. Gittoes & D. W. Rowed. (*Proc. Instn Radio Engrs, Aust.*, Oct. 1945, Vol. 6, No. 4, pp. 3-8.) Report on observations made by the Radio Mission of the Instn Radio Engrs, Aust., with the First Australian Army, July-August 1945. Most faults were due to effects of moisture. Normal air day temperature is 90° F, with 90% relative humidity at night and same moisture content by day. Power-driven equipment is usually sheltered in huts or vehicles and heaters can be fitted to lower the relative humidity. Portable equipment may be exposed to weather and even immersed in water. Moisture lowers the insulation resistance, alters dielectrics, increases the value of some resistors, and may lead to fungus growth. Fungus itself apparently did not affect performance. Faults due to electrolytic action of dissimilar metals were not apparent. Waxes and varnishes increase com-

ponent life but do not stop moisture absorption. Components should be waterproofed, and it is recommended that variable controls, such as rheostats, should have leads sealed, and glands of silicone around the control shaft. Silicone glands and rubber gaskets can be used for sealing equipment cases. Greater use of thermoplastic insulators is advised as the ambient temperature rarely exceeds 90° F. New ceramics are non-porous and do not need surface treatment. Tough rubber or polyvinyl chloride insulated wires are satisfactory. Dry batteries in sealed cans are weather-proof, and failure, except due to age, is rare. Packing cases should be strong, allow ventilation when stacked, and have metal or plastic inner linings which can be resealed.

Portable equipment should fit inconspicuously on operator. For jungle use r.t. sets with an output of 2W and receiver sensitivity of 1μV are suggested. Batteries need only have a life of a few hours. Erection of large aerials is often impossible, and remote erection would be useful.

621.396.69

810

**One Facet of Naval Electrical Research** [Adaptation of equipment to war conditions].—Seaman. (See 650.)

621.798 : 621.396.69

811

**Hermetic Sealing.**—G. Herbert. (*Radio, N. Y.*, Nov. 1945, Vol. 29, No. 11, pp. 44-47, 89.) A satisfactory seal must provide a perfect environment for the functional unit and maintain that condition through all external changes. A practical specification includes 5 cycles of temperature change from +85° C to -55° C followed by at least 5 cycles in salt water between +85° C and 0° C, without insulation resistance falling below the minimum limit. The main protective case can follow the lines of canned-food containers, which prevent the troubles associated with moisture, fungus, dirt, and lowered atmospheric pressure. The insertion of insulated terminals presents many difficulties. Gasket technique has many applications but will not hold gas pressures. Ceramics may be metallized and "blended" into metal cases, but glass to metal seals, as in valve technique, offer many attractions.

519.283

812

**Sampling Statistics and Applications** [Book Review].—J. G. Smith & A. J. Duncan. McGraw-Hill, New York and London, 1945, 498 pp., \$4.00. (*Elect. Engng, N. Y.*, Nov. 1945, Vol. 64, No. 11, p. 422.) Fundamentals of the theory of statistics.

621.3.029.5/.6

813

**Fortschritte der Hochfrequenztechnik - Vol. 2** [Book Review].—F. Vilbig & J. Zenneck (Eds.). Akad. Verlagsges. Becker & Erler Komm.-Ges., Leipzig, 1943, 856 pp., RM 56. (*Z. Ver. dtsh. Ing.*, 5th Aug. 1944, Vol. 88, Nos. 31/32, p. 431.) "The book is important and valuable for the high-frequency physicist and technician." Vol. 1 was noted in 577 of 1942.

621.396

814

**Modern Radio** [Book Review].—K. S. Tyler. Harcourt, Brace & Co., New York, 230 pp., \$2.50. (*J. Televis. Soc.*, Dec. 1944, Vol. 4, No. 4, p. 88.) "... an excellent example of a semi-technical book..."