

2/6

WIRELESS ENGINEER

The Journal of Radio Research & Progress

Vol. XXII.

OCTOBER 1945

No. 265

CONTENTS

EDITORIAL. An Interesting Electro-dynamical Problem	469
CASCADE H.T. GENERATOR By R. G. Mitchell, B.Sc.	474
PREFERRED NUMBERS AND FILTER DESIGN By H. Jefferson, B.A., A.Inst.P., A.M.I.E.E.	484
OSCILLOGRAPH FOR THE DIRECT MEASUREMENT OF FREQUENCY EMPLOYING A SIGNAL CONVERTER (Concluded) By P. Nagy, Dipl. Eng., and M. J. Goddard, M.Sc.	489
CORRESPONDENCE	497
WIRELESS PATENTS	500
ABSTRACTS AND REFERENCES Nos. 3250—3457	504-520

Published on the sixth of each month
SUBSCRIPTIONS (Home and Abroad)
One Year 32/- 6 months 16/-
Telephone: Telegrams:
WA Terloo 3333 (35 lines) Experiwyr Sedist London

11

GECCALLOY RADIO CORES

An All-British product — the result of continuous research and development during the last 16 years. Made by the largest manufacturers in the industry of magnetic powders and dust cores.

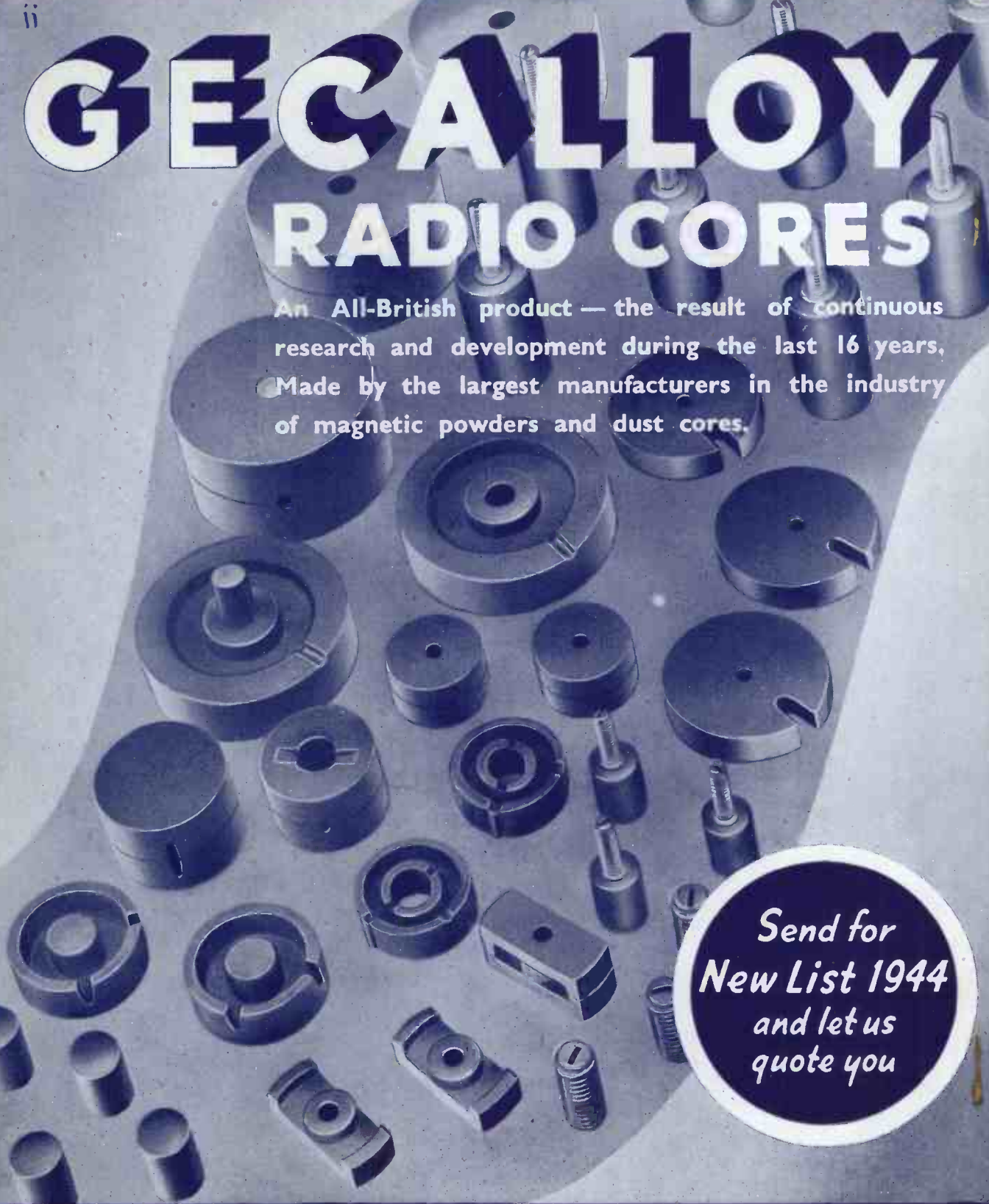

*Send for
New List 1944
and let us
quote you*

SALFORD ELECTRICAL INSTRUMENTS LTD.
PEEL WORKS, SALFORD, 3. Telephones : BLAckfriars 6688 (6 lines). Telegrams and Cables : " Sparkless, Manchester "
PROPRIETORS : THE GENERAL ELECTRIC Co. Ltd., OF ENGLAND



AUTOMATIC VOLTAGE REGULATORS



Varying Input Voltage :
185-270 Volts.

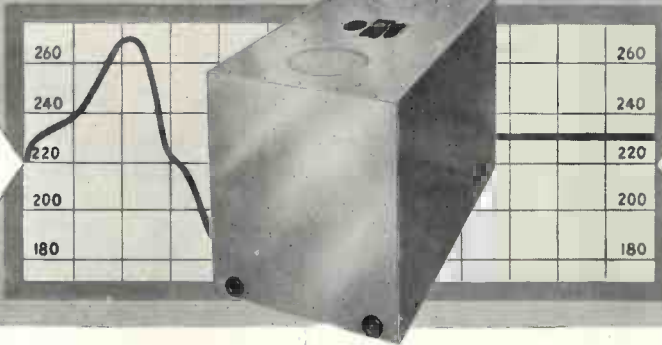

Constant Output Voltage :
230 Volts \pm 1 %

General Characteristics

Constant A.C. Output

Example : 230 volts \pm 1%—50-cycles/sec.—single phase. Any output voltage may be ordered (see below)

Wide A.C. Input Voltage Limits

Example : 185-270 volts, 50-cycles, 1-phase. Other single-phase voltages or frequencies can be dealt with, on special orders.

Entirely Automatic—Quick Action

There are no moving parts. No adjustments need ever be made and no maintenance is required. The regulating action is virtually instantaneous, the time required for adjustment to a new voltage, or load condition being so short that it is quite imperceptible by ordinary means.

Load Rating

Eight standard, nominal ratings are carried in stock as listed below. Others can be built, including models giving (example) 115 v. \pm 1% on 185-270 v. input : or multiple outputs, all regulated. The regulators also stabilize well under all load conditions, from no-load to 100% load.

General Advantages and Uses, etc.

Constant A.C. Input voltage is essential for the effective operation of many electrical devices, both industrial and laboratory patterns. Examples : X-ray apparatus, Incandescent-lamp light sources (photometers, photo-printing, colour comparators, photo-electric cell applications, spectrography, etc.), laboratory test-gear (VTVM's, signal generators, amplifiers, oscillators, signal generators, standards of frequency, etc.) : the larger patterns for stabilizing a complete laboratory room or test-bench : the smaller units as integral components of equipment.

1a Priority Orders Only

Conditions are such that we can only consider orders and enquiries where essential-work is indicated. On IA Priorities delivery is either early or ex stock.

Complete Data

Please request Bulletin VR 10744.

EIGHT STOCK MODELS ARE OFFERED

Type	Watts	A.C. Input Voltage	Output Voltage	Net Wt.	Price
VR-10	10	185-270	230 v. \pm 1 per cent.	3 lbs.	£5 - 15
VR-20	20			7 lbs.	£8 - 0
VR-60	60			17 lbs.	£10 - 10
VR-150	150	50~ 1-phase	Or, as ordered (see text above)	42 lbs.	£13 - 10
VR-300	300			62 lbs.	£22 - 10
VR-500	500			68 lbs.	£29 - 10
VR-1000	1000			120 lbs.	£47 - 10
VR-2500	2500			450 lbs.	£175 - 0

Claude Lyons Ltd.

ELECTRICAL AND RADIO LABORATORY APPARATUS ETC.

180, Tottenham Court Road, London, W.1 and 76, OLDHALL ST. LIVERPOOL, 3, LANCs.

RULE OF THUMB...

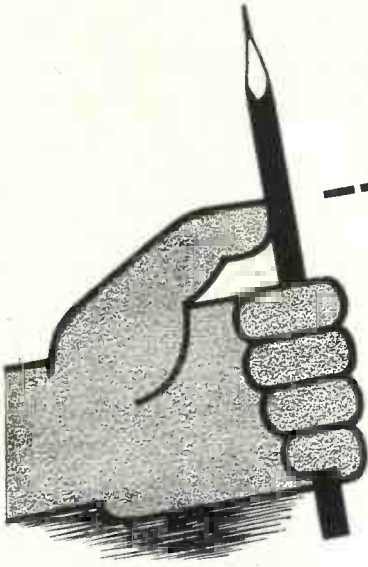

In communications, wherever measurement for testing purposes is involved, empiricism can be ruled out. Of no avail without scientific instruments is anything the eye can see, the hand feel or the most observant remember.

The radio engineer, therefore, must have test gear on which he can rely and, thanks to the foresight of Marconi Instruments Ltd., has a wide selection from which to choose. And he finds exemplified in these Marconi products the qualities so characteristic of British engineering craftsmanship—rational design, precise workmanship and technical efficiency.

MARCONI INSTRUMENTS LTD.

ST. ALBANS, HERTFORDSHIRE.

Telephone: St. Albans 4323-6



THE TANNOY

RESEARCH LABORATORY

With its specialised equipment and resources is able to undertake experimental researches and the mathematical investigations of problems connected with vibration and sound, for projects of the highest priority. Your preliminary enquiry will bring details of the day to day availability of this service.

TANNOY is the registered trade mark of products manufactured by Guy R. Fountain, Ltd., the largest organisation in Great Britain specialising solely in sound equipment. Canterbury Grove, London, S.E.27; and branches. Phone: Gipsy Hill 1131.



NO.2 IDENTIFICATION...



A great advantage of "Viskrings" Cable Markers is that they are available in all colours, indelibly printed in black with any wording. Here is double identification—colour and wording. A positive boon in complicated circuits.

- NO TOOLS REQUIRED
- NO RUBBER USED
- IMPERISHABLE, IMPERVIOUS TO OILS AND PETROLEUM
- INDELIBLY PRINTED
- SELF FIXING BY SHRINKAGE
- DO NOT INCREASE DIAMETER OF CABLE

VISKRINGS CABLE MARKERS

VISCOSE DEVELOPMENT CO. LTD.
Woldham Road, Bromley, Kent. Phone: Ravensbourne 2641



A. H. Brolly . . . Chief Engineer of Television Station WBKB, Chicago, adjusts the grid circuit of the Eimac 304-TL's in the Class B linear stage of the video transmitter.



Mr. Brolly calls attention to the Eimac 1000-T's in the final stage of the Audio FM Transmitter which operates at 65.75 megacycles. It is a very stable amplifier of good efficiency.

**IT'S EIMAC AGAIN!
FIRST CHOICE FOR
THE KEY SOCKETS
AT TELEVISION
STATION WBKB**

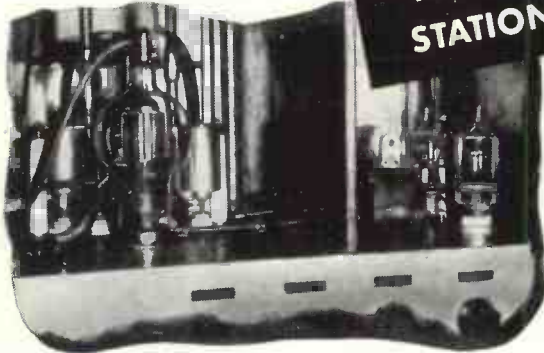

The video transmitter operates at 61.25 megacycles; peak power output is 4 KW which provides a television service throughout metropolitan Chicago and reaches suburbs out to 35 miles or more.

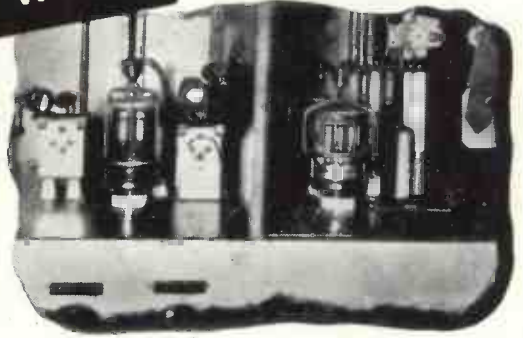

Eimac 152-T's are used in the modulated stage and 304-T's in the first Class B linear amplifier of the video transmitter.



E. F. Cawthon and W. R. Brock are operating the station which has been broadcasting television programs with the present equipment since 1942 and began operation on a commercial schedule in October, 1943.

Grid modulation is employed at WBKB and a broad band of frequencies must be passed in all stages following the modulated amplifier. Multiple-tuned resistance loaded coupling circuits are used between stages.

Performance, stability, dependability are good reasons why Eimac valves are to be found in the key sockets of the outstanding new developments in Electronics. Balaban & Katz, owners of television station WBKB of Chicago, offer potent confirmation of the fact that Eimac valves are first choice of leading Electronic Engineers the world over.

FOLLOW THE LEADERS TO



ELECTRONIC TELESIS—fully illustrated. Send for a copy now. The Science of Electronics written in simple language. You'll find it of valuable assistance in explaining electronics to the layman. No obligation.

EITEL-McCULLOUGH, INC., 1032 San Mateo Ave., San Bruno, Calif.
Plants located at: San Bruno, California and Salt Lake City, Utah
Export Agents: Frazar & Hansen
301 Clay Street, San Francisco 11, California, U.S.A.

Authorised Distributors: **EERRY'S (SHORT-WAVE) LTD.**, 25 HIGH HOLBORN, LONDON, W.C.1.

HULLO,
-I'M AN
ERG!

I am the c.g.s.
unit of energy—
you'll find me
in every radio
circuit.

ERG

ERG is the
trade mark that
will identify our
products of quality—small parts for big jobs.

ERG

ERG RESISTORS LTD

1021a, FINCHLEY ROAD,
LONDON, N.W.11

Phone: Speedwell 6967 

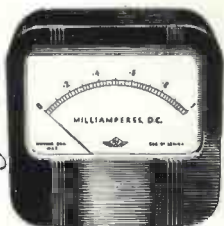

Precision Instruments of Maintained Accuracy

Switchboard and Portable
Pattern Microammeters,
Milliammeters, Ammeters,
Voltmeters, Wattmeters
and Testing Sets.



MEASURING INSTRUMENTS (PULLIN) LTD

ELECTRIN WORKS, WINCHESTER ST., LONDON, W.3

Cyldon

VARIABLE CAPACITORS

Present circumstances demand increased production by standardization. We are, nevertheless, looking to the future and would welcome an opportunity to discuss with you your requirements for production, development and new designs.

SYDNEY S. BIRD & SONS LTD.

CAMBRIDGE ARTERIAL ROAD, ENFIELD.

MINIATURE or MIDGET



HIVAC

THE SCIENTIFIC
VALVE

BRITISH

MADE

*Originators,
designers & manufacturers of Midget Valves*

HIVAC LIMITED, Greenhill Crescent, Harrow on the Hill, Middx. Phone: HARROW 0895



Standard Sine Wave Sources

FREQUENCY RANGES (3 Models)

- 0-15,000 c.p.s.
- 0-25,000 c.p.s.
- 0-50,000 c.p.s.

Three range Output Voltmeter incorporated—0-250, 0-50, and 0-10.

Four output impedances, 5,000, 1,000, 600 and 15 ohms.

OUTPUT UP TO 5 WATTS.

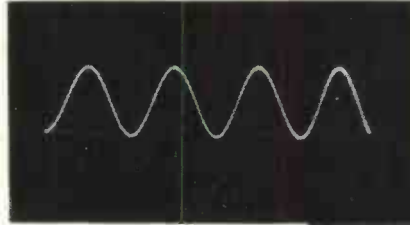

10 CYCLES PER SECOND

TYPE LO.800A

This model is chosen as a Standard by most Departments.

Stable, reliable and indispensable to all serious workers.

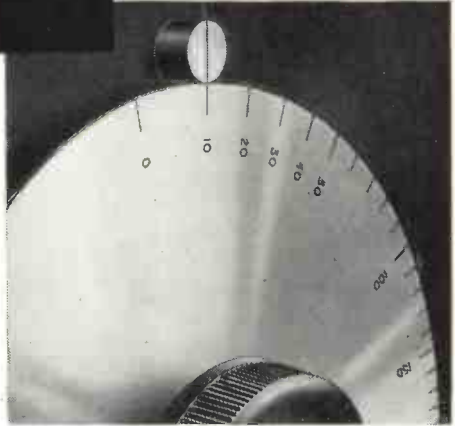

TYPE LO.800A OSCILLATOR, a scale of which is illustrated together with an actual oscillogram of output voltage, gives good waveform even below 10 c.p.s. This necessitates a minimum "pull-in" between the two H.F. oscillators. Superlative design results in an almost perfect waveform from lowest to highest frequencies. Output voltage is constant to within a few per cent. over the frequency range.

**BIRMINGHAM SOUND REPRODUCERS LTD.,
CLAREMONT WORKS, OLD HILL, STAFFS.**

'Phone : Cradley Heath 6212/3.

'Grams : Electronic, Old Hill.

DISCIPLINE YOUR POWER LINE

**Advance
Constant Voltage
TRANSFORMERS**

Line Voltage Variations of
± 15% reduced to ± 1%

TYPICAL SPECIFICATION
 INPUT VOLTAGE 190-260 v. 50 c.p.s.
 OUTPUT VOLTAGE 230 v. ± 1%
 MAX. LOAD. 150 watts.
 Input power factor over 90%
 Prices on application Write for details.

ADVANCE COMPONENTS LTD.

DEVELOPMENTS IN MEASUREMENT AND CONTROL

We offer manufacturers and process users a service on problems of measurement and control . . . a service based on scientific method, technical ingenuity and modern production, covering the field of Idea, Prototype and Manufacture.

BALDWIN

INSTRUMENT COMPANY LIMITED
CUMNOR, OXFORD

originators and makers of scientific instruments for
measurement and control

B1

NO —
WE DON'T
MAKE THIS
CHAIN ...



WE make the smallest chain that can be fashioned from fine drawn wire. Our output has, in the main, been devoted to war priority precision instruments, but the change-over to peace time production will be made as rapidly as possible, and we hope it will not be long before our skill and experience are again at your service.

**BRITISH
MACHINE
CHAIN LTD.**
ELM ROAD, NEW
MALDEN, SURREY.

'Phone - Malden 1749.
Telegrams and Cables—
Britchain, New Malden.

**SIZES FOR EVERY PURPOSE BETWEEN
36 LINKS AND 3 LINKS TO THE INCH.**

Best between



and

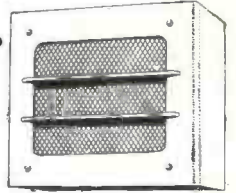

Woden Amplifiers are designed and built to give adequate volume and perfect reproduction when used with suitable microphones and speakers. Two models are available—the 15-watt “Junior” and the 50-watt “Classic.” We will gladly

WODEN send you fullest details
and data on request.

WODEN TRANSFORMER CO. LTD
MOXLEY RD · BILSTON · STAFFS TEL BILSTON 41959
1075

for **HIGH · HIGHER and
HIGHEST FREQUENCIES!**

TENAPLAX Co-axial Cable

SOME TENAPLAX CABLES HAVE

60% AIR INSULATION

Patented method of construction
reduces losses to a minimum.

- Plastic Cover
- Electrical Screening
- Alkathene Sleeve
- Braided Alkathene Filaments
- Conductor

Write for details to :

TENAPLAS LTD., 7 PARK LANE, LONDON, W.1

WAVEMETERS

OSCILLATORS

CONDENSERS

INDUCTANCES

RESISTANCES

BRIDGES — Capacitance
Inductance
Resistance

H. W. SULLIVAN
— LIMITED —

London, S. E. 15

Tel. New Cross 3225 (Private Branch Exchange)

ALL TYPES—ALL FREQUENCIES—ALL ACCURACIES

From the pages of our

POST-VICTORY CATALOGUE

MANY and varied are the Speakers which we have been called upon to design and produce for War's insatiable needs. Some of these Speakers, because of their specific duties and characteristics find no place in the to-morrow. Here, in the T2/12 however, is an instrument—tested and proven under conditions far more exacting than any which Peace can provide—which is destined to set a new and higher standard of performance and reliability in Speakers for Public Address work, the smaller Cinema, and for high-power Radiograms.

★ Obtainable in limited quantities through the usual channels.

GOODMANS
Loudspeakers

GOODMANS INDUSTRIES LTD · LANCELOT RD · WEMBLEY · MIDDX ·

The T2/12*

Overall dia. 12½ in. : Voice
Coil Impedance, 15 ohms
at 400 C.P.S. : Power
Handling Capacity, 12 w.
Peak A.C. on flat 4 ft.
baffle (15 w. horn loaded).
Flux Density, 13,000
gauss.



★ SUPREME FOR RADIO COMMUNICATIONS

TELCON CABLESwith
TELCOThENE
REGD.
INSULATION

This new material produced by TELCON is the latest development in low loss thermoplastic insulants. A complete range of "TELCOThENE" insulated cables is now available for use in the Audio, Radio and Ultra High Frequency fields.

Send for H.F. brochure.

TELCON Designed H.F.
Cables are the Basis of
World Standards.

THE TELEGRAPH CONSTRUCTION & MAINTENANCE CO. LTD.

Founded 1864

Head Office: 22 OLD BROAD ST., LONDON, E.C.2. Tel: London Wall 3141
Enquiries to TELCON WORKS, GREENWICH, S.E.10. Tel: Greenwich 1040**Remember-
Walter**

J.C.H. LTD

RADIO STAMPINGS • RÁDIO CHASSIS • RADIO PRESSINGS

FARM LANE, FULHAM, S.W.6. TELEPHONE: FULHAM 5234

C. R. C. 4.

MOULDED RUBBER PARTSTHE
Dainite
SERVICE

With fifty years' experience of compounds and mouldings and an up-to-date plant, will quote for your particular requirements in MOULDED RUBBER PARTS.

THE HARBOR'D RUBBER CO. Ltd., MARKET HARBOROUGH



The Old Grammar School, Market Harborough, Leicestershire, 1914

TRANSFORMERS

Best for all Purposes

RADIO INSTRUMENTS LTD
PURLEY WAY, CROYDON.
Telephone: THOrnton Heath 3211

TURNING AND MACHINING OF PLASTIC MATERIALS
SCREWS in bakelite fabric, COIL FORMERS,
BOBBINS, etc., built to specification.**KESSLERS (LONDON) LTD.,**
201-203, STOKE NEWINGTON CHURCH STREET, LONDON, N.16**Piezo QUARTZ CRYSTALS**
for all applications.

Full details on request.

QUARTZ CRYSTAL CO., LTD.,

(Phone: MALden 0334.) 63-71, Kingston Rd., New Malden, SURREY.

KING**ELECTRIC
CHAIN
PULLEY
BLOCK**

Write for booklet on lifting and shifting or separate catalogue of conveyors, cranes, and other mechanical handling equipment.

● **GEO. W. KING LTD.,**
HARTFORD WORKS · HITCHIN · HERTS
MANCHESTER CENTRAL 3947 NEWCASTLE 34196

HITCHIN 960

GLASGOW

DOUGLAS 27980

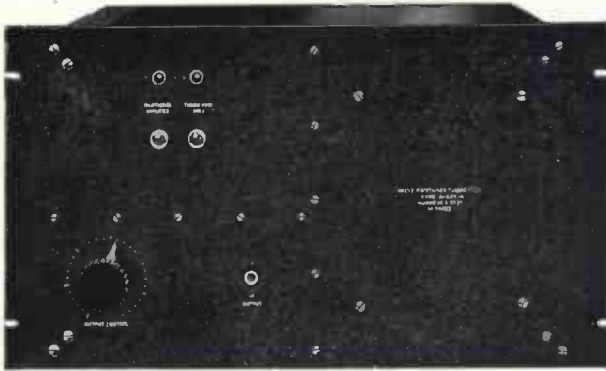

VALVE MAINTAINED TUNING FORK, TYPE A-339

(Incorporating our MINIATURE TUNING FORK)

An audio-frequency standard of precision accuracy, small dimensions and reasonable price.

SPECIFICATION

GENERAL. Elinvar Tuning Fork, hermetically sealed and temperature controlled. Special negative feedback drive circuit.

FREQUENCY. Normally 1000 c.p.s. — may be supplied for any frequency between 500 c.p.s. and 4000 c.p.s.

SUPPLIES. Type A-339-A A.C. Mains.
Type A-339-B ... Batteries.

POWER OUTPUT. Type A-339-A 1 watt into 600 ohms for 2% distortion.

Type A-339-B. ½ watt into 600 ohms for 2% distortion.

DIMENSIONS. Both types.
1 9/16" x 1 1/2" x 1 1/2" deep.

Bulletin No. B-522-A, giving full particulars of these instruments will be supplied on request.

MUIRHEAD

MUIRHEAD AND COMPANY LIMITED
ELMERS END, BECKENHAM KENT
Telephone: Beckenham 0041-0042

FOR OVER 60 YEARS DESIGNERS & MAKERS OF PRECISION INSTRUMENTS

C.R.C.34



Regd. Trade Mark

PRECISION TESTING INSTRUMENTS

HIGH accuracy, simplicity, exceptional versatility and proven reliability have won for "AVO" Instruments a world-wide reputation for supremacy wherever rapid precision test work is demanded. There is an "AVO" Instrument for every essential electrical test.



The MODEL 7 50-Range Universal AVOMETER Electrical Measuring Instrument

A self-contained, precision moving-coil instrument, conforming to B.S. 1st Grade accuracy requirements. Has 50 ranges, providing for measuring A.C. & D.C. volts, A.C. & D.C. amperes, resistance, capacity, audio-frequency power output and decibels. Direct readings. No external shunts or series resistances. Provided with automatic compensation for errors arising from variations in temperature, and is protected by an automatic cut-out against damage through overload.

Sole Proprietors and Manufacturer

THE AUTOMATIC COIL WINDER & ELECTRICAL EQUIPMENT CO., LTD., Winder House, Douglas Street, London, S.W.1.

'Phone: VICTORIA 3404-8



BEAT FREQUENCY OSCILLATORS

**LELAND
INSTRUMENTS LTD.**

—for priority requirements only
at present. Write for particulars
stating frequency range required.

21, JOHN STREET, BEDFORD ROW, LONDON WC1
TELEPHONE: CHANCERY 8765

Aladdin **RADIO CORES**
REGD TRADE MARK
for all purposes

GREENFORD, MIDDLESEX • WAXLOW 2300

RADIO BATTERY TESTER

Use "Quixo" method of battery
testing. Reliable results guaran-
teed. Send for interesting
leaflet G215, on bat-
tery testing.



RUNBAKEN • MANCHESTER 1

SPECIALIST ATTENTION

The solution of individual problems has for many
years formed a part of our normal day's work. If
transformers are employed in the equipment you
manufacture, we shall be glad to give you the advan-
tage of our experience and to offer the same efficient
service that has

Telephone:

Abbey 2244

**PARTRIDGE
TRANSFORMERS LTD**

76-8, PETTY FRANCE, LONDON, S.W.1

won the confi-
dence of the
Government
Experimental
Establishments
and of the Lead-
ing Industrial
Organisations.



5 mmf/ft
NEW LOW LEVELS in capacity
and attenuation of CO-AX Cables
mean new possibilities in electronic
equipment design both for the
war effort and for the post-war
electronic age.

**BASICALLY BETTER
AIR-SPACED**

CO-AX LOW LOSS CABLES

TRANSRADIO LTD. 16 THE HIGHWAY, BEACONSFIELD 7 BUCKS.

LARGE DEPT. FOR WIRELESS BOOKS.

F O Y L E S

FINEST STOCK IN THE WORLD OF NEW AND
SECONDHAND BOOKS ON EVERY SUBJECT.

Quick Postal Service.

Books Bought.

119-125, CHARING CROSS ROAD, LONDON, W.C.2.

Tel.: GERrard 5660 (16 lines). Open 9 a.m.—6 p.m., including Saturday.

VENT-AXIA

FOR BETTER AIR CONDITIONS

VENT-AXIA LTD. 9 VICTORIA STREET, LONDON, S.W.1 AND AT GLASGOW & MANCHESTER

LEWIS'S SCIENTIFIC LENDING LIBRARY

**ELECTRICAL & RADIO ENGINEERING
TEXTBOOKS & WORKS OF REFERENCE**

*New Works and New Editions can be had from the
Library immediately on publication.*

ANNUAL SUBSCRIPTION from ONE GUINEA

Prospectus on Application

H. K. LEWIS & Co. Ltd.
136 Gower Street, London, W.C.1

Telephone: EUSton 4282 (5 lines)

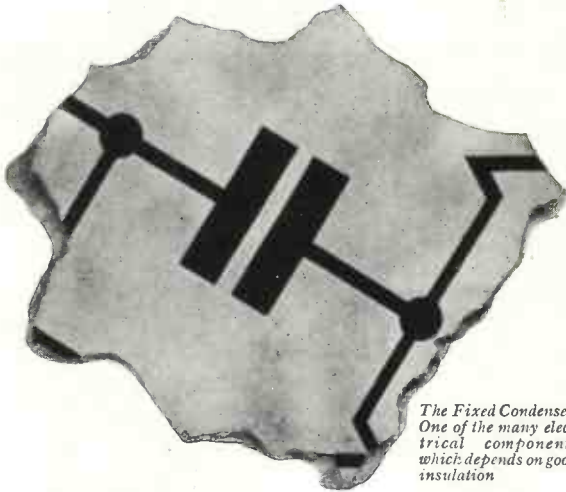

*The Fixed Condenser.
One of the many electrical components which depends on good insulation*

IF YOU WANT THE BEST PLASTIC INSULATORS RADIO HEATING IS ESSENTIAL

IT'S all very well saying that a good insulator must neither hold nor absorb water; that it must have the highest possible electric strength and wet and dry surface resistivity; and that in low-loss grade materials the lower the loss factor the better.

But how are you going to achieve what every manufacturer of plastic insulators has been trying to do for years?

Well, in case you haven't heard about it already, the answer is to pre-heat your plastic preform or powder by the radio-frequency method.

This method ensures that the *whole* finished article is perfectly cured—usually in under 50% of the time taken by any other method—and that all the required improvements in its insulating properties are constant in the thick and thin portions of the finished article. You can't get a better insulation any other way, and Redifon radio heating sets have been specially developed to do this very job.

The Redifon sets have all the necessary safety devices; they are fully enclosed and simple to operate. Manufacturers who wish for further particulars of the use of radio heating should get in touch with Rediffusion research engineers now.

REDIFFUSION Ltd.

Designers and Manufacturers of Radio Communication and Industrial Electronic Equipment

A SUBSIDIARY OF BROADCAST RELAY SERVICE LTD.

CARLTON HOUSE, REGENT ST., LONDON, S.W.1



SILVERED MICA CAPACITORS

*for Carrier Current Telephony
and for Instruments*

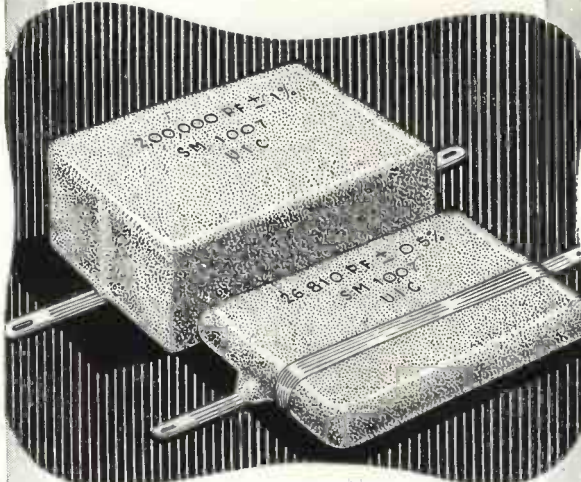

High stability filter capacitors 0.001 to 0.2 mfd. tolerance ± 0.5% or wider. Full details on request.

UNITED INSULATOR CO. LTD.
12-22, Laystall St., E.C.1

Telephone : Telegrams :
TERminus 7383 (5 lines) Calanel, Smith, London

THE PIONEERS OF LOW LOSS CERAMICS

WHY ERSIN MULTICORE



the Solder wire with 3 cores of non-corrosive ERSIN FLUX is preferred by the majority of firms manufacturing the best radio and electrical equipment under Government Contracts.



WHY THEY USE CORED SOLDER

Cored solder is in the form of a wire or tube containing one or more cores of flux. Its principal advantages over stick solder and a separate flux are:

- (a) it obviates need for separate fluxing (b) if the correct proportion of flux is contained in cored solder wire the correct amount is automatically applied to the joint when the solder wire is melted. This is important in wartime when unskilled labour is employed.

applied to the joint when the solder wire is melted. This is important in wartime when unskilled labour is employed.

WHY THEY PREFER MULTICORE SOLDER. 3 Cores—Easier Melting Multicore Solder wire contains 3 cores of flux to ensure flux continuity. In Multicore there is always sufficient proportion of flux to solder. If only two cores were filled with flux, satisfactory joints are obtained. In practice, the care with which Multicore Solder is made means that there are always 3 cores of flux evenly distributed over the cross section of the solder,



so making thinner solder walls than single cored solder, thus giving more rapid melting and speeding up soldering.

ERSIN FLUX

For soldering radio and electrical equipment non-corrosive flux should be employed. For this reason either pure resin is specified by Government Departments as the flux to be used, or the flux residue must be pure resin. Resin is a comparatively non-active flux and gives poor results on oxidised, dirty or "difficult" surfaces such as nickel. The flux in the cores of Multicore is "Ersin"—a pure, high-grade resin subjected to chemical process to increase its fluxing action without impairing its non-corrosive and protective properties. The activating agent added by this process is dissipated during the soldering operation and the flux residue is pure resin. Ersin Multicore Solder is approved by A.I.D., G.P.O., and other Ministries where resin cored solder is specified.

PRACTICAL SOLDERING TEST OF FLUXES

The illustration shows the result of a practical test made using nickel-plated spade tags and bare copper braid. The parts were heated in air to 250° C. and to identical specimens were applied ½" lengths of 14 S.W.G. 40/60 solder. To

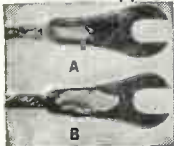

sample A, single cored solder with resin flux was applied. The solder fused only at point of contact without spreading. A dry joint resulted, having poor mechanical strength and high electrical resistance. To sample B, Ersin Multicore Solder was applied, and the solder spread evenly over both nickel and copper surfaces, giving a sound mechanical and electrical joint.

ECONOMY OF USING ERSIN MULTICORE SOLDER

The initial cost of Ersin Multicore Solder per lb. or per cwt. when compared with stick solder is greater. Ordinary solder involves only melting and casting, whereas high chemical skill is required for the manufacture of the Ersin flux and engineering skill for the Multicore Solder incorporating the 3 cores of Ersin Flux. However, for the majority of soldering processes in electrical and radio equipment Multicore Solder will

ERSIN MULTICORE SOLDER WIRE is now restricted to firms on Government Contracts and other essential Home Civil requirements. Firms not yet using Multicore Solder are invited to write for fuller technical information and samples.

show a considerable saving in cost, both in material and labour time, as compared either with stick solder or single cored solder. Cored solder ensures that the solder and flux are put just where they are required, and by choice of suitable gauge, economy in use of material is obtained. The quick wetting of the Ersin flux as compared with resin flux in single core resin solder ensures that with the correct temperature and reasonably clean surface, immediate alloying will be obtained, and no portions of solder will drop off the job and be wasted. Even an unskilled worker, provided with irons of correct temperature, is able to use every inch of Multicore Solder without waste.

ALLOYS

Soft solders are made in various alloys of tin and lead, the tin content usually being specified first, i.e. 40/60 alloy means an alloy containing 40% tin and 60% lead. The need for conserving tin has led the Government to restrict the proportion of tin in solders of all kinds. Thus, the highest tin content permitted for Government contracts without a special licence is 45/55 alloy. The radio and electrical industry previously used large quantities of 60/40 alloy, and lowering of tin content has meant that the melting point of the solder has risen. The chart below gives approximate melting points and recommended bit temperatures.

ALLOY Tin Lead	Equivalent B.S. Grade	Solidus C.°	Liquidus C.°	Recommended bit Temperature C.°
45/55	M	183°	227°	267°
40/60	C	183°	238°	278°
30/70	D	183°	257°	297°
18.5/81.5	N	187°	277°	317°

VIRGIN METALS—ANTIMONY FREE

The wider use of zinc plated components in radio and electrical equipment has made it advantageous to use solder which is antimony free, and thus Multicore Solder is now made from virgin metals to B.S. Specification 219/1942 but without the antimony content.

IMPORTANCE OF CORRECT GAUGE

Ersin Multicore Solder Wire is made in gauges from 10 S.W.G. (.128"—3.251 m/ms) to 22 S.W.G. (.028"—.711 m/ms). The choice of a suitable gauge for the majority of the soldering undertaken by a manufacturer results in considerable saving. Many firms previously using 14 S.W.G. have found they can save approximately 33 1/3%, or even more by using 16 S.W.G. The table gives the approximate lengths per lb. in feet of Ersin Multicore Solder in a representative alloy, 40/60.

S.W.G.	10	13	14	16	18	22
Feet per lb.	23	44.5	58.9	92.1	163.5	481

CORRECT SOLDERING TECHNIQUE

Ersin Multicore Solder Wire should be applied simultaneously with the iron, to the component. By this means maximum efficiency will be obtained from the Ersin flux contained in the 3 cores of the Ersin Multicore Solder Wire. It should only be applied direct to the iron to tin it. The iron should not be used as a means of carrying the solder to the joints. When possible, the solder wire should be applied to the component and the bit placed on top, the solder should not be "pushed in" to the side of the bit.



WIRELESS ENGINEER

Editor HUGH S. POCKOCK, M.I.E.E.

Technical Editor Prof. G. W. O. HOWE, D.Sc., M.I.E.E.

VOL. XXII

OCTOBER, 1945

No. 265

EDITORIAL

An Interesting Electrodynamical Problem

IN the *Philosophical Magazine* for January, 1945, there is an interesting Paper by I. A. Robertson entitled "A historical note on a paradox in electrodynamics." We propose to show that there is really nothing paradoxical about the phenomena involved, if viewed correctly. To quote the Paper: "According to the Biot-Savart law, a current element or slowly moving electron gives rise at a position r to a magnetic field H . This field is given by

$$H = \frac{i(ds \times r)}{r^3} = \frac{e(v \times r)}{r^3}$$

Where an electron of charge e moving with velocity v corresponds to a current element ids , and where $(v \times r)$ represents the vector product of v and r ." Now, in the first place, we shall separate fact from fancy by distinguishing between the moving electron, which is a realisable fact, and the current element, which cannot even be imagined apart from the remainder of the circuit. In the Editorial of March, 1944, we dealt with "the problem of two electrons and Newton's third law," and we shall therefore confine our attention now to the forces between current elements. Fig. 1(a) shows two current elements ids and $i'ds'$ in the plane of the paper separated by a distance r and making angles θ, θ' with the line joining them. By Biot-Savart's law the element ids produces at the other element a magnetic field of strength $ids \sin \theta / r^2$ normal to the paper and the element $i'ds'$ experiences a force equal to $ii' ds ds' \sin \theta / r^2$ in the direction shown. Similarly the element $i'ds'$ produces a field

$i'ds' \sin \theta' / r^2$ at the other element, which therefore experiences a force $ii' ds ds' \sin \theta' / r^2$ in the direction shown. Hence the forces are neither equal nor in the same direction, which leads the author to say that "Biot's law leads to a violation of Newton's laws for isolated elements," but, seeing that isolated elements are contrary to Nature, they cannot be expected to conform to natural laws.

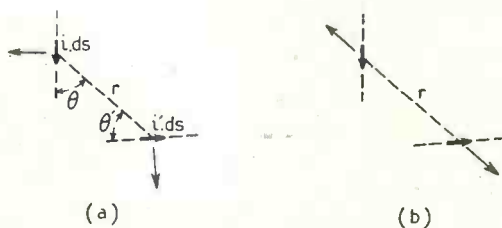

Fig. 1.

The real test can only be applied to the integration of Biot's law around the whole circuit, and it is then found that the result agrees with experiment and with Newton's laws. An important point, however, which the author discusses is that Biot's is not the only law which, when integrated around the circuit, gives the correct result. In 1823 Ampère published his *Mémoire* on the subject, criticising Biot's law and giving an alternative which is more complicated, but which gives equal and opposite forces on the two current elements. Ampère's formula for the force is $ii' ds ds' (2 \sin \theta \sin \theta' \cos \omega - \cos \theta \cos \theta') / r^2$ in which ω is the angle between the plane containing ds and r and that containing ds' and r . In our example $\cos \omega = 1$.

According to Ampère's assumption these forces are as shown in Fig. 1(b). It is, of course, impossible to measure these forces because on integrating round the circuit all the components except those normal to the elements cancel out and leave resultant forces in the directions shown in Fig. 1(a). The author draws attention to the fact that Ampère's formula gives a force between two current elements when they are in the same straight line, but, since these cancel out when the whole circuit is considered, Ampère's experiment to prove the existence of such a force is fallacious.

Ampère's formula can also be expressed in the form

$$ii' ds ds' (2 \cos \epsilon - 3 \cos \theta \cos \theta')/r^2$$

where ϵ is the angle between the two current elements. In "Electricity and Magnetism," by Mascart and Joubert (translated by Atkinson) a whole chapter is devoted to explaining the method by which Ampère arrived at his formula.* They point out that it is not "determinate," but is based on the assumption that the force acts along the line joining the elements. Although one must admire his ingenuity, there is no doubt that he sacrificed simplicity to the idea that the force between the elements should conform to Newton's third law.

The author devotes considerable attention to an experiment described by W. F. Dunton in *Nature* of August 1937 and discussed by Mathur in the *Phil. Mag.* of August 1941. A rectangular circuit was made up as shown in Fig. 2 (a) with mercury cups at *M* and *N* so that the lower part *MBCN* was free to move and the force on it could be measured.

found that in this case the force in dynes on the side *BC* was equal to $8.7i^2$ where i is the current in absolute units. This force can be calculated by both formulæ. By Ampère's formula it is a laborious procedure, but Robertson has carried it out and gives as his result $8.24i^2$; details of the method are given in the *Phil. Mag.* Mathur employs the Biot-Savart formula and obtains as his result $6.9i^2$, but, as we shall see, this is a wrong result, the correct result being in close agreement with the experimental result. The following quotation from p. 36 of the *Phil. Mag.* of January last is an amusing example of the readiness of some people to throw laws overboard; "Nevertheless Dunton's experiment has been used by S. B. L. Mathur as experimental evidence that Biot's law is correct, and that Newton's third law is wrong. However, on careful examination of Mathur's paper, excellent reasons can be deduced for discarding Biot's law."

The simplest way of calculating the force on the side *BC* is as follows. The magnetic field *H* at a point *P* distant x from an infinitely long wire is $2i/x$, and if the wire is not infinitely long but is represented by

OJ in Fig. 2 (b), $H = \frac{i}{x} \times \frac{y_1}{x} = iy_1/x^2$. For

the whole wire $JKH = i(y_1 + y_2)/x^2$. We take 7 points on *BC* at various distances from *B*, and by drawing circles with these points as centres to touch the side *AB* at the point *B*, it is a simple matter to measure y in each case and thus determine iy/x^2 . This gives the following result in which i and r have been taken as unity; otherwise every figure in the last four columns must be multiplied by i/r .

Distance from <i>B</i> = x	y	iy/x^2	<i>H</i> due to <i>AB</i> and <i>CD</i>	<i>H</i> due to <i>AB</i> + <i>CD</i> + <i>DA</i>	= $H_1 + H_2$
r	r	1	1.0161	1.0179	= 1.000 + 0.0179
10 <i>r</i>	10 <i>r</i>	0.1	0.1192	0.1210	= 0.100 + 0.0210
20 <i>r</i>	19.8 <i>r</i>	0.0495	0.07375	0.0755	= 0.05 + 0.0255
30 <i>r</i>	29.4 <i>r</i>	0.0327	0.0654	0.0672	= 0.033 + 0.0339
40 <i>r</i>	38.8 <i>r</i>	0.02425			
50 <i>r</i>	48 <i>r</i>	0.0192			
59 <i>r</i>	56 <i>r</i>	0.0161			

If r is the radius of the wire, *AB* was made equal to 180 r and *BC* to 60 r and Dunton

* Ampère set this out fully in a paper read before the Royal Academy of Sciences 10th June, 1822, and published in *Annales de Chimie et de Physique* Vol. 20, 1822, p. 398. We may add that although we refer to the other law as that of Biot and Savart, it is very doubtful whether it originated with them.

The value of *H* at each point due to the opposite side *AD* is small, but can be found in the same simple way; the values vary from 0.00176 i/r at *B* or *C* to 0.00183 i/r at the mid point *E*. These are added to 4th column to obtain the 5th column, which is then split up into the purely hyper-

bolic part H_1 and the small remainder H_2 . The field is, of course, symmetrical about the mid point E . To find the mean value of H between $x = r$ and $x = 59r$, we have for the mean value of H_1

$$\frac{I}{29r} \int_r^{30r} H_1 dx = \frac{I}{29} \times 3.4 \times \frac{i}{r} = 0.1172 i/r.$$

By plotting H_2 its mean value is easily seen to be about $0.0245i/r$; hence the mean value

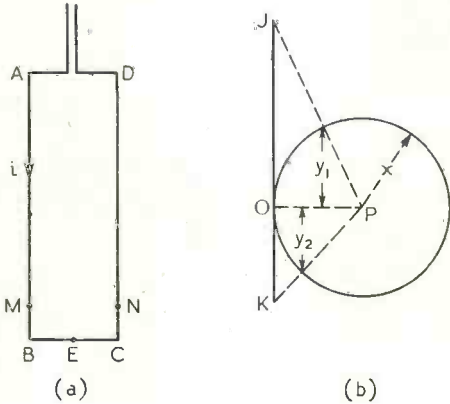

Fig. 2.

of $H = 0.1417 i/r$ and the force on the conductor $BC = B \times l \times i = 0.1417 \frac{i}{r} \times 58r \times i = 8.22 i^2$ dynes. This compares with 8.24 obtained by Robertson by Ampère's formula and 8.7 measured by Dunton.

The Corner Effect

There is some uncertainty as to what assumption one should make at the corners, and it is very important to be clear on this point because it is just at the corners that the force is a maximum, as can be seen from the table. The above calculations are really based on the assumptions that the vertical wires are faced at the end with a disc of infinitely conducting material, so as to ensure uniform current density, and that the horizontal wire is very fine and makes contact with the edge of the infinitely conducting disc as shown in Fig. 2 (a). In the unavoidable absence of discs of zero resistance, the current will not be uniformly distributed but will crowd towards the contact point, thus increasing the force above the calculated value as Dunton found.

Perhaps a closer approximation to the actual conditions is obtained by assuming that the fine horizontal wire, which is really

the axis of the actual conductor, goes to the centre of the cross section before making contact, as shown in Fig. 3 (b). This will increase the force on it; the extra length of wire is $2r$ and the mean value of H is $0.5 i/r$; hence the additional force is simply equal to i^2 . Instead of $8.22 i^2$ dynes we therefore have $9.22 i^2$ for the total force on BC . It is interesting to note that the mean of these two values is $8.72 i^2$, which is exactly the value measured by Dunton.

The force is unaltered if the breaks are not at B and C but at any points such as M and N in the sides AB and CD , because the wires experience no force in the direction of their length. The force on AD is, of course, exactly equal and opposite to that on BC . Experiments on the forces in such circuits were described by F. F. Cleveland in the *Phil. Mag.* for Feb., 1936, and concerning these Mr. Robertson makes the following strange remark: "These experiments prove conclusively that action and reaction are equal and opposite for the mechanically separable parts of a rectangular circuit, thus showing again that the Biot-Savart law is wrong in this instance." On the contrary the result is strictly in accordance with the Biot-Savart law, and also, of course, with the Ampère law. There is confusion of thought here between mechanically separable parts of a circuit and isolated current elements.

A Celebrated Experiment

In the *Trans. of the American Institute of Electrical Engineers* for February, 1923, Carl Hering described an ingenious experiment

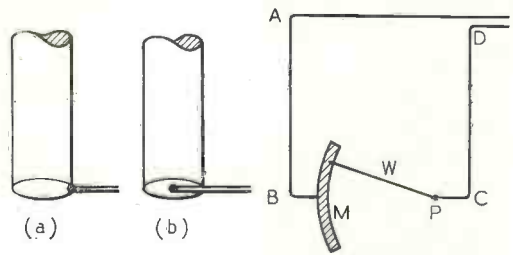

Fig. 3.

Fig. 4.

that upset many preconceived views and led various people to invent strange explanations of the phenomenon. Hering arranged a circuit as shown in Fig. 4 in which the wire W is pivoted at P at one end and moves in a curved mercury trough M at the other. If placed as shown and then allowed to move, the question is whether the wire W will move

inwards or outwards. Every physicist that Hering consulted said that it would move outwards so as to include the maximum amount of flux, but as a matter of fact it moves inwards, and for the same reason. Before seriously considering the problem we will quote some of the explanations that have been put forward. "Imagine billions of electrons rushing along from the negative terminal of the battery, along the connecting wire and plunging into the liquid of the trough. Then remember that each of these electrons is about $1/1845$ of the mass of the hydrogen atom. Remember that for the currents used there would be about a thousand billion billion of these electrons taking that plunge each second. Now I simply raise the question: Is it inconceivable that, as they do plunge, they would kick back on the slider? I do not believe it is inconceivable, and I cannot see—and here is where I differ and am unpopular—I cannot see that flux and other Maxwellian concepts enter into the problem at all." This was not written by Walt Disney but by John Mills, of the Bell Telephone Laboratories. Although not so picturesque the explanation given by Mr. Robertson is on the same lines. He says that, according to Ampère's theory, "there is a longitudinal repulsion between the elements of the current (i.e., the electrons) in a metallic wire; these forces practically cancel each other, but in a liquid like mercury this longitudinal repulsion is able to push the free end of the wire W inwards. The wire W will eventually be in equilibrium under the repulsive force inwards from the forces in the mercury, and the outward force due to the rest of the circuit $CDAB$." It is, of course, much simpler to draw these pretty pictures than to calculate the force on the moving wire, but in a serious scientific journal one might expect some attempt made to carry out the necessary calculation and see if there is any need or room for these fancy pictures. Although Ampère's formula gives component forces acting along the length of the current element when two isolated current elements are imagined, they cancel out on integrating around the circuit, so that, whether one uses the Biot-Savart method or the Ampère method of calculation, the resultant force on any current element, whether made of copper or mercury, is at right angles to its length. This disposes of the longitudinal repulsion.

Fig. 5 shows a circuit resembling that employed by Carl Hering; the trough of

mercury has been replaced by a straight solid conductor EG of radius r . The conductor FG is hinged at the point F and makes contact with EG as shown. Here again we assume the current in EG to be uniformly distributed over the cross section right up to the end, which, as we have already pointed out, would only be possible if we could cover the end with a disc of infinitely conducting material. Having thus robbed the electronic imps of the pleasure of plunging into the mercury and kicking back at the movable arm, we can apply the Biot-Savart (or the Ampère) formula and calculate the force on the rod FG and the turning moment about F , and thus determine whether the rod tends to move outwards or inwards. We have made $BC = 60r$, $EF = 50r$, $EG = 30r$ and $FG = 40r$; the angle at G is thus a right-angle. A and D are assumed to be so remote that the effect of the side AD can be neglected. The actual length of the movable rod is $39r$, because it stops at the periphery of the rod EG . The distances of the four points 1, 2, 3 and 4 from the centre line of EG are 1, 10, 20 and 30 respectively (taking r as the unit), and their distances from F therefore 39, 30, 20 and 10.

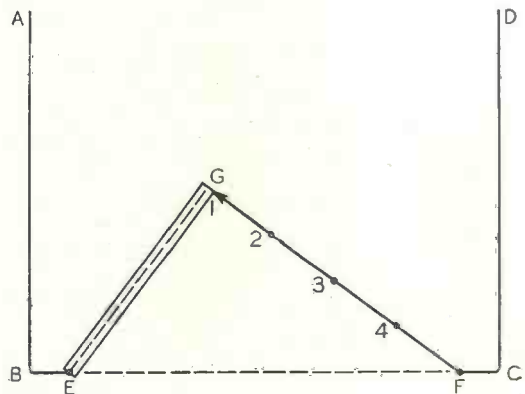

Fig. 5.

At each of these points we calculate the magnetic field due to AB , BE , FC , and CD and add the four components; we then calculate the field due to EG which is obviously in the opposite direction. The difference gives the resultant field at the point considered, which may be in either direction. If the four component fields are stronger than that due to EG the force at that point of FG will act outwards, but if that due to EG is the stronger it will act inwards. The values are easily determined by the graphical method described

above; as before, the current is assumed to be the absolute unit and the radius r is taken as unity, so that we only have to determine y/x^2 for each case. In this way the following values were obtained:

On plotting these and finding the mean it is found that the resultant negative or outward moment is about $96.4i^2r$. Hence the inward moment exceeds the outward moment by $108.5 - 96.4 = 12.1i^2r$ and the

Point	Due to AB	Due to CD	Due to BE	Due to FC	Due to EG	Sum of AB, CD, BE, FC
1	0.0714	0.0426	0.0037	0.0016	1.0000	0.1193
2	0.0485	0.0527	0.0023	0.0028	0.0950	0.1063
3	0.0325	0.0715	0.0010	0.0052	0.0419	0.1102
4	0.0242	0.1094	—	0.0167	0.0236	0.1503

A comparison of the last two columns shows that the force will be outwards over a large part of the rod but that there will be a strong inward force near the end 1 where the arm about which the force acts is a maximum.

To obtain an accurate integration of the moments the forces can be expressed as follows, where the first column is made hyperbolic:

Point	Forces	Arm
1	$1.0000 - 0.1193 = 1.0000 - 0.1193$	39
2	$0.1000 - 0.0050 - 0.1063 = 0.1000 - 0.1213$	30
3	$0.0500 - 0.0081 - 0.1102 = 0.0500 - 0.1183$	20
4	$0.0333 - 0.0097 - 0.1503 = 0.0333 - 0.1600$	10

The summation of the moments due to the hyperbolic component $1/x$ acting at a radius of $(40 - x)$ is equal to

$$\int_1^{40} \frac{40-x}{x} dx = \int_1^{40} \frac{40}{x} dx - \int_1^{40} dx = 40 \log_e 40 - 39 = 147.5 - 39 = 108.5$$

For the negative moments we have

- At point 1 $0.1193 \times 39 = 4.65$
- „ 2 $0.1213 \times 30 = 3.64$
- „ 3 $0.1183 \times 20 = 2.37$
- „ 4 $0.1600 \times 10 = 1.60$

rod, if free to move, will move inwards as Hering observed. As a matter of fact the inward moment will be somewhat greater than that calculated because of the crowding of the current at G to the point of contact, but the result of the above calculation is obviously very dependent on the radius assumed for the conductor EG which replaces the mercury trough. In the actual case of the bent rod dipping into mercury the distribution of current and magnetic field around the area of contact will be very complex but the above calculation shows conclusively that the inward force on FG can be explained without going outside the ordinary laws of electromagnetism. If the moving rod, instead of making contact at the periphery at G , be continued to the centre of the disc before making contact, it will experience a greatly increased inward force, the moment being increased from 12.1 to $27.1i^2r$. If the radius of the conductor EG is increased, but the other dimensions left unchanged, the inward moment is decreased; calculation shows that doubling the radius would cause the inward and outward moments to be approximately equal and thus cause the rod FG to be in equilibrium in the position shown.

We thus see that, if properly applied, the ordinary laws of electrodynamics explain all the phenomena here considered without any trace of paradox.

G. W. O. H.

CASCADE H.T. GENERATOR*

By R. G. Mitchell, B.Sc.

(Physicist, Radiotherapy Dept., Northampton General Hospital)

SUMMARY.—The operation of the cascade H.T. generator is described and the circuit analysed. Curves and formulae are derived by means of which the performance of the circuit can be assessed in terms of the various known constants.

1. Introduction

IN a previous publication¹ the author gave an analysis of the commoner types of H.T. generators employing vacuum rectifiers, and curves were derived which enabled the performance of these circuits to be pre-determined from the various known constants.

In this article the theory is applied to the cascade H.T. generator, and readers wishing to follow the analysis in detail should refer to the previous publication. Those who desire solely to make use of the curves and formulae can do so without studying the theory. While the cascade circuit was primarily developed for the purpose of obtaining very high voltages, its usefulness is not confined to that field, and suggestions are given at the end of the article as to possible applications in radio work.

2. List of Symbols

- E_2 = Transformer secondary voltage (A.C.).
 E = Transformer secondary voltage peak.
 $V_{D.C.}$ = Mean D.C. output voltage.
 V_c = Mean D.C. condenser voltage.
 η = Voltage conversion ratio
(Mean D.C. Output)
(Peak A.C. Input)
- δV = Amplitude of ripple voltage.
 K = $\frac{\text{Peak ripple voltage.}}{V_c}$
 I_L = Mean D.C. load current.
 I_{st} = Mean stage load current.
 i = Instantaneous charging current.
 \dot{i} = Peak charging current.
 R_L = Actual load resistance.
 R_e = Effective load resistance.
 r_c = Charge resistance, including transformer A.C. resistance, common to all stages.
 r_a = Impedance of rectifiers.
 r_e = Effective charge resistance.
 ϕ_1 = Angle between point of commencement of charge current and peak input voltage.
 ϕ_2 = Angle between peak input voltage and current cut off.

- ϕ = $\left(= \frac{\phi_1 + \phi_2}{2} \right)$ Half angle of current flow per cycle.
 f = Frequency of supply.
 T = $(= 1/f)$ Time of one complete oscillation.
 t_c = Charge period of condensers, per cycle.
 t_d = Discharge period of condensers, per cycle.
 C = Capacitance of condensers.
 X = Reactance of condensers at supply frequency.
 X_e = Effective reactance (as applied to the charging of the individual condensers).
 N = Number of stages in unit.
 M = Number of any particular stage counted from the output end of the generator.

3. Description of the Circuit

The basic circuit diagram for a 3-stage unit is shown in Fig. 1(a). While there is no theoretical limit to the permissible number of stages, three is the most common and is convenient for the purpose of description. Moreover the required condenser capacitances increase rapidly with increase of the number of stages. When this exceeds three the arrangement shown in Fig. 6 and described in Section 8 is recommended. The formulae developed are general ones applicable to any number of stages.

It should be noted that each stage comprises two rectifiers and two condensers. Condensers C_1 , C_3 and C_5 in Fig. 1 will be referred to as "feed" condensers, and C_2 , C_4 and C_6 as "load" condensers.

In order to describe the operation it is convenient to split the circuit as in Figs. 1(b) and 1(c). In these the rectifiers which are non-conductive over the positive and negative half cycles of input respectively are omitted, so that on the positive half cycle (i.e., b positive to a) we consider Fig. 1(b), and on the negative half cycle Fig. 1(c).

Consider all the condensers charged, so that, as the circuit is loaded by R_L , condensers C_2 , C_4 and C_6 in series, discharge steadily through it. Over some portion of the positive half cycle of input, therefore,

* MS. accepted by the Editor, May 1945.

the potential of points *d*, *f* and *h*, will fall below that of points *c*, *e* and *g* respectively, so that the rectifiers T_2 , T_4 and T_6 will become conductive, the lost charges thus being replenished.

It must be remembered that, as all the individual charges must come from the source of E.M.F., i.e., the transformer, the current passing through C_1 is three times, and that through C_3 twice, that through C_5 , though the currents flowing through the rectifiers are equal. This means that the charges lost on these condensers are in the same proportion, as also are the charges gained by C_2 , C_4 and C_6 respectively.

On the negative half cycle, when *a* is positive to *b* (Fig. 1c) the potential of points *a*, *d* and *f* will, over some portion of the half cycle, become positive to points *c*, *e* and *g*, so that the rectifiers T_1 , T_3 , and T_5

condenser on successive half cycles are thus equal. Equilibrium is thus maintained.

Fig. 2 shows the current waveforms in each stage. As T_1 , T_3 and T_5 and T_2 , T_4 and T_6 are respectively conductive over approximately the same periods, the various pulses are additive in the condensers to which they are common. When the ripple is appreciable however this no longer holds, and there is a progressive phase change throughout the circuit.

It should be noted that all the feed condensers discharge entirely by short period pulses, whereas all the load condensers, except the final one, are subject to a steady discharge due to the load current combined with a short period discharge pulse during the charging of the feed condensers. The discharge of the final load condenser is steady throughout.

Fig. 3 shows the voltage waveforms. It is seen from Fig. 1 that C_1 in conjunction with the transformer and T_1 , T_3 and T_5 in parallel effectively form a single-phase half-wave circuit, so that C_1 charges up to

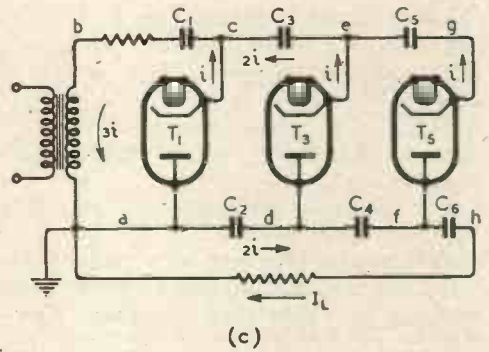
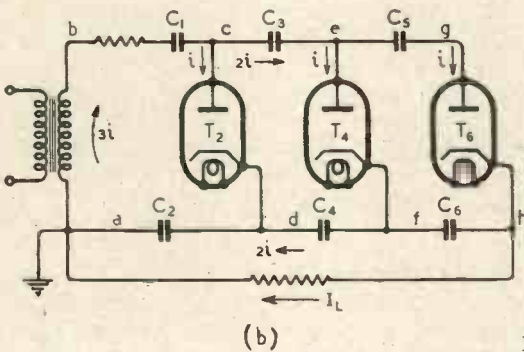
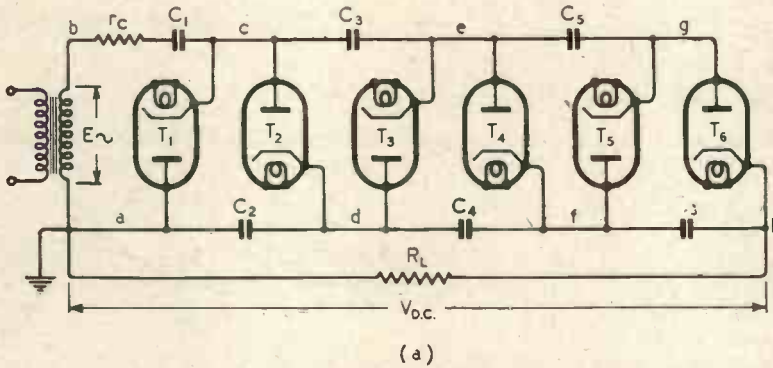

Fig. 1.

will become conductive, and the charges lost on C_1 , C_3 and C_5 during the previous half cycle will be replenished. Thus in addition to supplying the steady load current I_L , C_4 supplies an equivalent charge to C_5 and C_2 supplies twice that amount to C_3 . The charges lost and gained on any

some voltage less than E , depending on the circuit constants.

The charging voltage on C_2 is the sum of the sinusoidal A.C. input voltage E and the voltage across C_1 , i.e. the shaded area in Fig. 3(a). This is redrawn on a linear base in Fig. 3(b). The waveform will deviate

from sinusoidal according to the degree of ripple on C_2 . The peak positive value of the charging voltage is $E + V_{c1}$; C_2 is thus charged up to a voltage of some value lower than this.

The charging voltage on C_3 is the difference between the voltage across C_2 and the voltage charging it, i.e., the voltage between

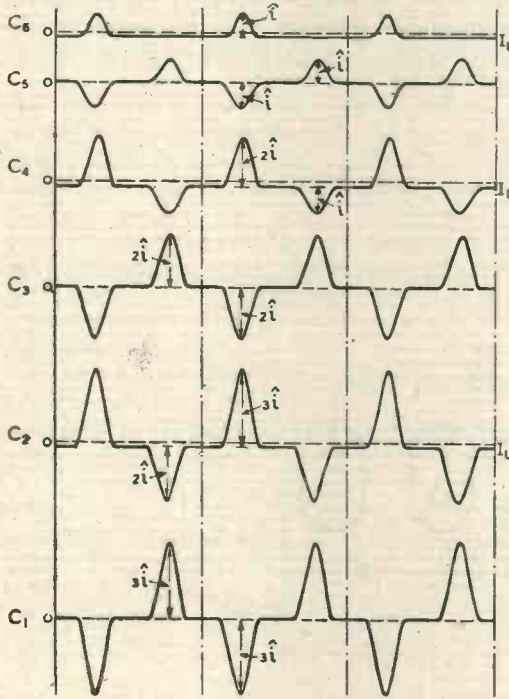

Fig. 2. Current waveforms.

points d and c in Fig. 1. This is the voltage delineated by the shaded area of Fig. 3(b) and is redrawn on a linear base in Fig. 3(c). The peak value of this charging voltage is $E + V_{c2} - V_{c1}$ which is approximately the same as for C_2 , as V_{c2} is approximately twice V_{c1} .

The charging voltages for subsequent condensers are obtained in the same way, each being the difference between the voltage across the previous condenser and the voltage charging it. Thus each condenser after C_1 charges to approximately the same value, somewhat less than $2E$.

The discharge waveforms are clear when Figs. 2 and 3 are considered in conjunction, the charge period of any condenser corresponding to the "rapid" discharge period of the condenser immediately preceding it, as shown by the vertical dotted lines in Fig. 3.

4. Analysis

Consider first the normal arrangement of uniform condenser capacitance (C) throughout.

Condenser C_1 will charge to some value less than E according to the load and feed conditions, as in the single-phase half-wave circuit, say $\eta_1 E$.

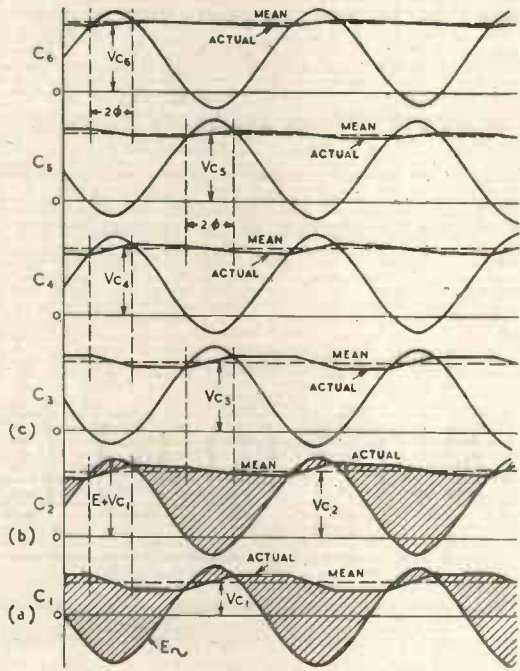

Fig. 3. Voltage waveforms.

Now in the case of condenser C_2 we can consider the charging voltage to consist of a steady D.C. voltage equal to V_{c1} , with the sinusoidal charging voltage E_- superimposed. V_{c2} is thus equal to V_{c1} plus a voltage $\eta_2 E$, developed as in the normal rectifier circuit, where η_2 depends on the circuit constants.

$$\text{Thus } V_{c1} = \eta_1 E$$

$$\text{and } V_{c2} = \eta_1 E + \eta_2 E$$

$$\text{The charging voltage on } C_3$$

$$= E_- + V_{c2} - V_{c1} = E_- + \eta_2 E$$

This can again be considered as a steady voltage $\eta_2 E$ with the sinusoidal voltage E_- superimposed. Then if η_3 is the conversion ratio for C_3 ,

$$V_{c3} = E(\eta_2 + \eta_3)$$

The charging voltage on C_4 is

$$E_- + V_{c1} + V_{c3} - V_{c2} = E_- + \eta_3 E,$$

$$\therefore V_{c4} = E(\eta_3 + \eta_4)$$

Similarly it can be shown that

$$V_{c5} = E(\eta_4 + \eta_5)$$

and $V_{c6} = E(\eta_5 + \eta_6)$

$\therefore V_{D.c.} = E(\eta_1 + \eta_2 + \eta_3 + \eta_4 + \eta_5 + \eta_6)$
for the 3-stage generator, and $= E\Sigma\eta$
for any generator.

We now have to find some means of assessing the values of the desired factors. This can be accomplished for each condenser by the same method as was evolved for the single-phase half-wave circuit, but there are complications due to the interdependence of each stage on the others. For example, during the charging of condenser C_6 , the resistance r_c is not only handling the pulse flowing into C_6 , but also similar pulses flowing through T_2 and T_4 to C_2 and C_4 , respectively. Thus the voltage drop through r_c is three times what it would be were C_6 charging alone. Also the charging of any condenser is affected by ripple on condensers in previous stages. This point is clearly seen by considering the charging of C_2 . It will readily be appreciated that it is effectively charged through C_1 and C_2 in series, in that the points of start and finish of charge depend on the ripple on both. This means that the effective capacitance on which angles ϕ_1 and ϕ_2 , and hence also the performance of the circuit, depend, is $C/2$ and not C . In later stages the effect is even more complicated on account of the different stage currents. We have, therefore, to assess "effective" values r_e , X_e , and R_e for feed resistance, condenser reactance and load resistance, respectively, in each case.

Now r_e for any stage is that resistance which acting alone would be required in order to give the same charging rate were the stage concerned the only one being charged.

Then at any point in the charging period of a generator in stage M of a unit of N stages,

$$Mi r_e = Ni r_c + i r_a$$

$$\therefore r_e = \frac{Nr_c + r_a}{M}$$

as the current in the stage concerned is Mi , that through r_c is Ni , and that through the rectifier is i .

Similarly X_e is that reactance which, acting alone, would have the same effect on the charge conditions as all the various reactances comprising it, i.e., cause the same rate of increase of the voltage over the

charging cycle, which opposes, and finally stops, further charge.

Then in a set of N stages we have, in the case of the feed condensers,

$$MiX_e = NiX + 2(N-1)iX + 2(N-2)iX \dots (N-M+1) \text{ terms}$$

$$= Xi[(N-M+1)(N+M) - N]$$

$$\therefore X_e = X/M[(N^2 - M^2) + M]$$

For the load condensers,

$$MiX_e = 2Xi[N + (N-1) + (N-2) \dots (N-M+1) \text{ terms}]$$

$$\therefore X_e = X/M[(N-M+1)(N+M)]$$

The effective load resistance R_e on any stage is V_c/I_{st}

i.e. $R_e = \frac{V_{D.c.}}{NMI_L} = \frac{R_L}{NM}$

assuming $V_c = \frac{V_{D.c.}}{N}$, which will be shown to be true when X_e/r_e is low. When this is not the case the resultant errors tend to cancel out in the final assessment of the output voltage.

Having established these values, we now wish to determine how the performance of the circuit depends on them. Consider first the charge analysis. The formula derived for the single-phase half-wave circuit,¹ giving the mean charge current in terms of the various constants, still holds good, provided r is taken as r_e and I as I_{st} . Thus

$$I_{st} = \frac{E}{2\pi r_e} F(\phi, \phi_1, \phi_2)$$

i.e., $V_c/R_e = \frac{E}{2\pi r_e} F(\phi, \phi_1, \phi_2)$

Taking $V_c = 2\eta E$, i.e., assuming η constant in any one stage

$$\frac{2\eta E}{R_e} = \frac{E}{2\pi r_e} F(\phi, \phi_1, \phi_2)$$

Also $\eta = \frac{\cos \phi_1 + \cos \phi_2}{2}$

$$\therefore R_e/r_e = \frac{2\pi(\cos \phi_1 + \cos \phi_2)}{F(\phi, \phi_1, \phi_2)}$$

$$= \frac{2\pi}{\tan \phi - \phi}$$

As in the previous analysis, ϕ depends on η and the peak ripple voltage, but in this case the latter will be the sum of all the ripple voltages on the condensers comprising the

effective capacitance, i.e.,

$$\begin{aligned} \cos \phi_1 &= \frac{\eta E - \Sigma \delta V}{E} \\ &= \eta - \frac{2\eta}{V_c} \Sigma \delta V \\ &= \eta(1 - 2K) \text{ where } K = \frac{\Sigma \delta V}{V_c} \end{aligned}$$

and hence also

$$\cos \phi_2 = \eta(1 + 2K).$$

Choosing arbitrary values of η and K we can calculate ϕ and so obtain curves of η against R_e/r_e with K as parameter.

Now from the discharge conditions we see that for the load condensers

$$\begin{aligned} 2C\Sigma\delta V &= I_L T [2N + 2(N-1) + 2(N-2) \dots (N-M+1) \text{ terms}] \\ &\quad - I_L t_c (N-M+1) \\ &= I_L T [(N-M+1)(N+M-\phi/\pi)] \\ \therefore K &= \frac{\Sigma \delta V}{V_c} \\ &= \frac{I_L T [(N-M+1)(N+M-\phi/\pi)]}{2CV_c} \\ &= \frac{[(N-M+1)(N+M-\phi/\pi)]}{MR_e} \cdot \pi X \end{aligned}$$

$$\therefore X/R_e = \frac{MK}{\pi[(N-M+1)(N+M-\phi/\pi)]}$$

As ϕ/π will always be small compared with $(N+M)$, it may for the present purpose be neglected, so that

$$\begin{aligned} X/r_e &= \frac{MK}{\pi(N-M+1)(N+M)} = \frac{K}{\pi} \cdot \frac{X}{R_e} \\ \therefore X_e/R_e &= K/\pi \\ \therefore X_e/r_e &= K/\pi \cdot R_e/r_e. \end{aligned}$$

The same result is obtained in the case of the feed condensers.

Then choosing the same values of K and η as before, we know R_e/r_e and can thus calculate X_e/r_e , and plot curves of η against X_e/r_e with K as parameter.

Correlating the two sets of curves enables us to obtain curves of η against R_e/r_e with X_e/r_e as parameter (Fig. 4). The desired values of η can then be assessed. Note that

$$R_e/r_e = \frac{R_L}{N(Nr_c + r_a)}$$

i.e., constant for each stage, so that η will be constant provided the capacitances are sufficiently high as to render X_e/r_e small. This justifies the assumption made above, namely $V_c = V_{D.C.}/N$.

The overall ripple on the output voltage is obtained as follows:—

$$\begin{aligned} 2C\Sigma\delta V &= [NI_L T - I_L t_c] + [(N-1)I_L T - I_L t_c] \dots N \text{ terms} \\ &= I_L T [N + (N-1) + (N-2) \dots N \text{ terms}] - NI_L t_c \\ &= I_L T [N/2(N+1) - N\phi/\pi] \\ &\quad \pi N \left[\frac{N+1}{2} - \phi/\pi \right] X \end{aligned}$$

$$\therefore \Sigma \delta V / V_{D.C.} = \frac{R_L}{R_L}$$

Percentage R.M.S. ripple

$$\begin{aligned} &= \frac{\pi N(N+1-2\phi/\pi) X}{2\sqrt{2} R_L} \times 100 \\ &= 111 N(N+1-2\phi/\pi) X/R_L \\ &\doteq 111 N(N+1) X/R_L \end{aligned}$$

Note that in this case X is the reactance of the individual condensers.

In view of the nondescript waveform of the ripple voltage, which varies from triangular in the output stage to something approaching trapezoidal in the input stage, this assessment can only be approximate. In any case this factor is not desired to any high degree of accuracy.

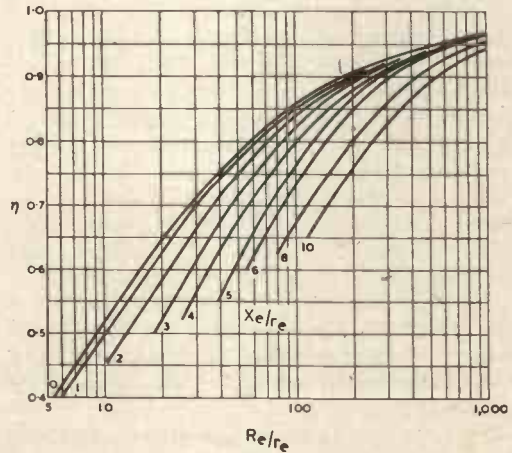

Fig. 4.

The assessment of the factors i/I_L , anode dissipation and transformer secondary current follow from the theory in the previous publication, the formulae being as follows:—

(a) Peak current in rectifiers.

$$i/I_L = 1.57 \pi/\phi.$$

(b) Anode dissipation in rectifiers.

$$D = 1.24 I_L^2 \cdot r_a \cdot \pi/\phi$$

(c) Transformer secondary current (R.M.S.).

$$I_{R.M.S.} = NI_L \sqrt{2.47 \pi/\phi},$$

where π/ϕ is the value for stage N .

(d) Dissipation in feed resistance.

$$D = I_{R.M.S.}^2 \cdot r_c$$

(e) Condenser circulating currents. It is only necessary to assess this factor for the first condenser C_1 , in which it is a maximum, and it is obvious that the value is the same as the transformer secondary current.

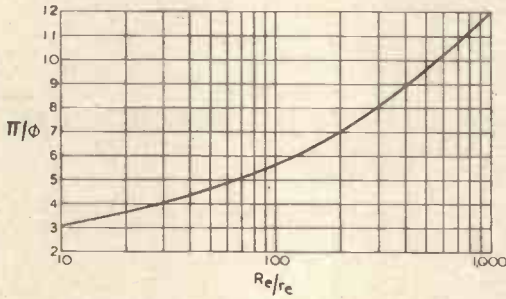

Fig. 5.

[The values of π/ϕ are plotted against R_e/r_c in Fig. 5.]

(f) Peak reverse voltage on rectifiers.

$$V_{P.R.} = E(1 + \eta) \text{ in all cases.}$$

5. Effect of Phase Changes

In deducing these formulae we assumed that the pulses through the various rectifiers were in phase. This is only true, however, when the ripple is low. To ensure that this is so requires the use of high values of capacitance, in view of the resulting values of X_c which in the later stages are many times the reactance of the individual condensers.

The effect of ripple is best appreciated by considering the point where T_1 is just about to start conducting, i.e., points a and c are equipotential (Fig. 1c). On account of the ripple voltages on C_2 and C_3 , however, the potential of point d is higher than that of point e by an amount equal to $\delta V_{e2} + \delta V_{e3}$, so that T_3 is already conducting. Similar reasoning shows that T_5 begins to conduct before T_3 . This affects the circuit in several ways. Firstly C_1 will start to charge earlier than if there were no ripple on the subsequent condensers, while the completion of charge is not affected. The total period of charge is thus lengthened. Also over this first part of the charging cycle r_c is $r_c + r_a$, and not $r_c + r_a/N$, so that R_e/r_c is reduced slightly. The result is a reduction in the value of η . As the effect depends on the number of stages following, it decreases towards the

output end. It is not possible to allow for this effect theoretically, but the resultant errors are not appreciable within the range of the curves given. If any particular case is not covered by the curves it means that certain of the various assumptions outlined in the previous article are no longer valid. It is advisable to choose values of capacitance high enough to avoid operation in this region.

Other factors involving the term π/ϕ will be reduced below the theoretical, on account of the increase of ϕ .

6. Analysis of Circuit for Multiple Loading

Supplies at N different voltages may be obtained by loading between any stage and earth (i.e., between points h, f, d , and a in Fig. 1). Consider first the case in which each stage is supplying separately the same output current I_L to its own load. Then

$$\text{Mean current in final stage } (M = 1) = I_L$$

$$\text{Mean current in 2nd last stage } (M = 2) = 2I_L + I_L = 3I_L$$

$$\text{Mean current in 3rd last stage } (M = 3) = 3I_L + 2I_L + I_L = 6I_L$$

and so on.

$$\text{Thus for any stage } M, I_{st}$$

$$= I_L(1 + 2 + 3 \dots M)$$

$$= I_L \frac{M(M + 1)}{2}$$

$$\text{Thus the effective load resistance } R_e = V_c/I_{st}$$

$$= \frac{2R_L}{NM(M + 1)}$$

To determine the effective feed resistance we require to know the current in the common resistance r_c , and also that in the rectifier concerned, during the charging pulse.

The mean current in r_c is the current in stage M when $M = N$, i.e.,

$$= I_L \frac{N(N + 1)}{2}$$

while the rectifier current is MI_L . The instantaneous currents during the charging periods will be in the same proportion, so that at any point in the charging cycle when the current through the final rectifier is i , we have

$$r_c i \frac{M(M + 1)}{2} = i r_c \frac{N(N + 1)}{2} + M i r_a$$

$$\therefore r_c = \frac{N(N + 1)r_c + 2Mr_a}{M(M + 1)}$$

$$\text{and } R_e/r_c = \frac{2R_L}{N[N(N + 1)r_c + 2Mr_a]}$$

In this case R_L is the load resistance on the final stage. The load resistances on the other stages will be approximately $R_L \cdot \frac{N - M + 1}{N}$.

R_e/r_e now varies from stage to stage as M has not been eliminated. It would appear on this account that the assumption on which R_e is based, namely, $V_e = V_{D0}/N$ is not valid. However, X_e/r_e also varies appreciably throughout the circuit, and in such a way as to tend to compensate for changes in η caused by the change in R_e/r_e . Tests on this operation showed a slight increase in voltage across the various load condensers towards the output end of the unit.

To obtain X_e we have at any point in the charging cycle of a load condenser,

$$\begin{aligned} iX_e \frac{M(M+1)}{2} &= 2iX \frac{N(N+1)}{2} + 2iX \frac{(N-1)N}{2} + 2iX \frac{(N-2)(N-1)}{2} \dots (N-M+1) \text{ terms} \\ &= iX[N(N+1) + (N-1)N + (N-2)(N-1) \dots (N-M+1) \text{ terms}] \\ &= iX(N-M+1) \left[N^2 - (N-M-1) \left(\frac{2N+M}{3} \right) \right] \\ \therefore X_e &= \frac{2X(N-M+1)}{M(M+1)} \left[N^2 - (N-M-1) \left(\frac{2N+M}{3} \right) \right] \end{aligned}$$

In the case of the feed condensers,

$$X_e = \frac{2X}{M(M+1)} \left[(N-M+1) \left(N^2 - (N-M-1) \left(\frac{2N+M}{3} \right) \right) - \frac{N(N+1)}{2} \right]$$

The values of η can then be obtained from Fig. 4, as the formulae obtained from the charge and discharge analysis are unaltered. The output voltage for any stage = $E \times$ sum of values of η up to that stage.

In this operation we desire to know the overall ripple between each stage and point a , expressed in relation to the respective D.C. voltages. Then

$$\begin{aligned} 2C\Sigma\delta V &= I_L T \left[\frac{N(N+1)}{2} + \frac{(N-1)N}{2} + \frac{(N-1)(N-2)}{2} \dots (N-M+1) \text{ terms} \right. \\ &\quad \left. - \phi/\pi \left(N + (N-1) + (N-2) \dots (N-M+1) \right) \text{ terms} \right] \\ &= I_L T \left[\frac{(N-M+1)}{2} \left(N^2 - (N-M-1) \left(\frac{2N+M}{3} \right) - \phi/\pi(N+M) \right) \right] \end{aligned}$$

$$\therefore K = \frac{\Sigma\delta V}{V_{D.o.(M)}} = \frac{I_L T}{4CV_{D.o.(M)}} \left[(N-M+1) \left(N^2 - (N-M-1) \left(\frac{2N+M}{3} \right) - \phi/\pi(N+M) \right) \right]$$

where $V_{D.o.(M)} = \frac{V_{D.o.}(N-M+1)}{N}$

$$\begin{aligned} \text{i.e., } K &= \frac{\pi X}{2R_L \frac{(N-M+1)}{N}} \left[(N-M+1) \left(N^2 - (N-M-1) \left(\frac{2N+M}{3} \right) - \phi/\pi(N+M) \right) \right] \\ &= \frac{\pi N X}{2R_L} \left[N^2 - (N-M-1) \left(\frac{2N+M}{3} \right) - (N+M)\phi/\pi \right] \end{aligned}$$

Therefore percentage R.M.S. ripple

$$= 111 X/R_L N \left[N^2 - (N-M-1) \left(\frac{2N+M}{3} \right) - (N+M)\phi/\pi \right]$$

To obtain the other factors the formulae in Section 4 must be modified as follows:—

(a) and (b) Substitute MI_L for I_L . (c) Substitute $\frac{N(N+1)}{2}$ for N .

In view of the high ratios in the case of the rectifier and stage currents between the first and last stages, obtained with the above arrangement, it is more satisfactory to have the intermediate stages more lightly loaded than the output stage. One convenient scheme is to have a uniform load impedance throughout, so that the load currents increase in the ratio 1, 2, 3 . . . N, from input to output stages.

The rectifier current in any stage *M* is then

$$I_L \left(1 + \frac{N-1}{N} + \frac{N-2}{N} + \dots M \text{ terms} \right)$$

i.e. $= MI_L \left(\frac{2N-M+1}{2N} \right)$

The stage current is

$$I_L / N (MN + (M-1)(N-1) + (M-2)(N-2) + \dots M \text{ terms})$$

This reduces to

$$I_L \frac{M(M+1)}{6N} (3N-M+1)$$

When *M* = *N* (input stage)

$$I_{st} = \frac{(N+1)(2N+1)}{6} I_L$$

The effective load resistance is

$$R_e = \frac{V_{D.O.}}{NI_{st}} = \frac{6R_L}{M(M+1)(3N-M+1)}$$

The effective charge resistance is obtained by the same reasoning as before, and gives

$$r_e = \frac{N(N+1)(2N+1)r_c + 3M(2N-M+1)r_a}{M(M+1)(3N-M+1)}$$

$$\therefore R_e/r_e = \frac{6R_L}{N(N+1)(2N+1)r_c + 3M(2N-M+1)r_a}$$

Except under the special conditions mentioned in Section 7, the formula for *X_e* is, however, impracticably involved, so the values of *C* must be found empirically. The above formula enables the maximum values of η to be determined.

By using the formula for *X_e* derived for uniform loading an approximate estimate may be obtained for the required values of capacitance, as the above operation lies somewhere between uniform loading and single loading, as far as the performance of the circuit is concerned.

Another scheme which lends itself to analysis is to take from the intermediate stages a uniform load current which is a definite fraction of the load on the final stage. If this fraction be *P*, then by reason-

ing on the same lines as before we obtain the following formulae:—

$$\text{Rectifier current} = I_L(1 + (M-1)P)$$

$$\begin{aligned} \text{Stage current} &= (MI_L + (M-1)PI_L \\ &\quad + (M-2)PI_L \dots M \text{ terms}) \\ &= I_L(M/2)(PM - P + 2) \end{aligned}$$

$$R_e = \frac{V_{D.O.}}{NI_L M/2 (PM - P + 2)} = \frac{2R_L}{NM(PM - P + 2)}$$

$$r_e = \frac{N(PN - P + 2)r_c + 2(1 + (M-1)P)r_a}{M(PM - P + 2)}$$

$$R_e/r_e = \frac{2R_L}{N[N(PN - P + 2)r_c + 2(1 + (M-1)P)r_a]}$$

As in the previous case the formula for *X_e* is too involved, and the same procedure should be followed.

In both the above operations the other desired factors are obtained from the formulae in Section 4, provided the following correct ones are made.

In (a) and (b) substitute the appropriate rectifier current for *I_L*.

In formula (c) substitute the current in stage *N* for *NI_L*.

7. Circuits with unequal Capacitances

It is possible by choosing values of capacitance for each stage which are proportional to the corresponding stage currents, to have approximately equal ripple voltages across all the condensers in the unit. This reduces the overall ripple, increases the values of η , and also greatly simplifies the formulae for *X_e* in the various cases of multiple load operation. We now have for the load condensers in all cases,

$$iX_e \cdot I_{st}/I_L = 2(i \cdot I_N/I_L)(X \cdot I_L/I_N) + 2(i \cdot I_{N-1}/I_L)(X \cdot I_L/I_{N-1}) \dots (N-M+1) \text{ terms.}$$

$$\therefore X_e \cdot I_{st}/I_L = 2(N-M+1)X$$

$$\therefore X_e = 2(N-M+1)X \cdot \frac{I_L}{I_{st}}$$

For the feed condensers we get,

$$X_e = (2N - 2M + 1)X \cdot \frac{I_L}{I_{st}}$$

The resulting formulae in the individual operations are as follows:—

(a) Single loading

$$X_e = \frac{2(N-M+1)X}{M} \text{ load condensers}$$

and
$$= \frac{(2N - 2M + 1)X}{M}$$
 feed condensers

(b) Uniform loading on each stage

$$X_e = \frac{4(N - M + 1)X}{M(M + 1)}$$
 load condensers

and
$$= \frac{2(2N - 2M + 1)X}{M(M + 1)}$$
 feed condensers

(c) Uniform load impedance throughout

$$X_e = \frac{12N(N - M + 1)X}{M(M + 1)(3N - M + 1)}$$
 load condensers

and
$$= \frac{6N(2N - 2M + 1)X}{M(M + 1)(3N - M + 1)}$$
 feed condensers

(d) Constant load = PI_L on all but output stage

$$X_e = \frac{4(N - M + 1)X}{M(PM - P + 2)}$$
 load condensers

and
$$= \frac{2(2N - 2M + 1)X}{M(PM - P + 2)}$$
 feed condensers

N.B.—In cases *c* and *d* we now have practicable formulae for X_e .

under the above conditions, and to any stage in the case of multiple loading.

8. The Centrally Fed Generator

A generator comprising an even number of stages may have the transformer in the middle, as shown in Fig. 6. This arrangement has the following advantages:—

(1) The required condenser capacitances are much lower than if the system were fed from one end as in the normal arrangement.

(2) The overall ripple is enormously reduced, as during the charging of the load condensers on one side those on the other are at the point in their cycle when they are discharging rapidly into the feed condensers. The net effect is that only the steady discharge due to the load causes any resultant ripple, the other components cancelling out.

The disadvantage is that, unless it is permissible to earth the centre of the system, the transformer must be insulated to withstand half the D.C. output volts.

The values of η can be assessed by treating each half of the unit separately and adding the resultant output voltages. The correct

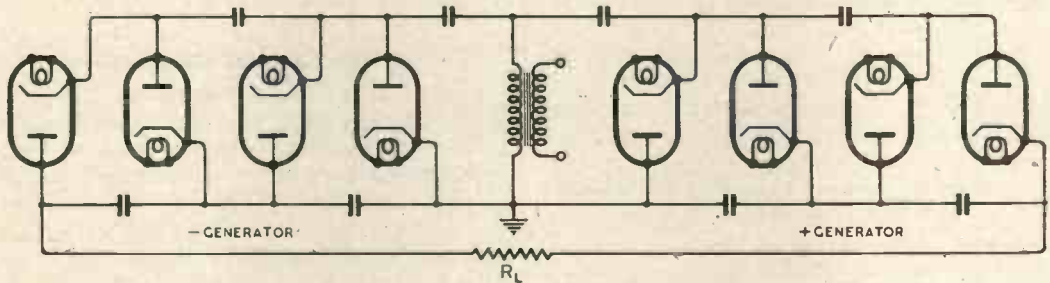

Fig. 6.

In all cases the ripple voltage peak, δV , on any condenser is approximately

$I_{st} \cdot T/2C_M$ so that, as $C_M = C \cdot I_{st}/I_L$, $\delta V = I_L T/2C$, and is constant throughout the circuit. The overall ripple is thus N times the ripple on any one condenser, i.e.

$$\delta V = \frac{N I_L T}{2C}$$

$$\therefore K = \frac{N I_L T}{2C V_{D.C.}} = \pi N X / R_L$$

where X is the reactance of C , the condenser in the final stage.

Hence percentage R.M.S. ripple

$$\doteq 222 N X / R_L$$

and is applicable to any mode of operation

value of load resistance will be $R_L/2$, and the number of stages $N/2$, in each case.

For the overall ripple voltage we have,

$$2C\Sigma\delta V = N/2 I_L t_d - N/2 I_L t_c$$

whence
$$\Sigma\delta V / V_{D.C.} = \frac{N I_L (t_d - t_c)}{4C V_{D.C.}}$$

i.e.,
$$K = \frac{N(T - 2t_c)}{2R_L} \cdot \pi f X = \frac{N(1 - 2\phi/\pi)}{2R_L} \cdot \pi X$$

Therefore percentage R.M.S. ripple

$$= \frac{\pi}{2\sqrt{2}} N(1 - 2\phi/\pi) X / R_L \times 100$$

$$= 111 N(1 - 2\phi/\pi) X / R_L$$

N.B.—As the ripple frequency is doubled in this operation, subsequent smoothing is more easily accomplished.

9. Practical Tests

Tests were made on all the various operations described. The values of output voltage obtained agreed with the theoretical values to within 2 or 3 per cent. in most cases. As was expected, the ripple voltage errors tended to be larger, the maximum being of the order of 12 per cent., but that is sufficiently accurate for this particular factor.

When the ratios X_e/γ_e were high all factors involving the term π/ϕ tended to be lower than the theoretical on account of increase of ϕ due to phase change through the circuit.

Tests on a centrally fed unit showed an overall ripple of 0.7 per cent., whereas the ripple on each half was 1.8 per cent. The overall ripple under identical conditions in the case of the normal end-feed arrangement was as much as 4.5 per cent.

10. Conclusions

The circuit has the very great advantage that no single component has to withstand the full output voltage, so that a high output voltage can be obtained with relatively low voltage components. While this would not justify the necessarily larger number of components required if the unit were being designed from scratch, except in the case of very high voltage sets, it does enable a high voltage unit to be constructed when only low voltage components are available.

Another useful application of the circuit is to obtain a number of supplies at different

voltages, depending on the number of stages, all with good regulation. This is not possible when the lower voltage supplies are obtained by means of a resistance network as in conventional units. Moreover the power wastage inseparable from the latter method is avoided.

The difficulty of the filament transformers insulation can be avoided by employing metal rectifiers. Philips² have evolved a scheme whereby the filaments are heated by an H.F. current circulating round the whole filament system, but this is only economic for large installations.

Practical tests showed good agreement with the predicted values, the highest accuracy being obtained where it was most important, namely, in the case of the output voltages.

REFERENCES

¹ *Wireless Engineer*, September 1943, Vol. XX, No. 240.

² A. Bouwers and A. Kuntke, *Zeitschr. f. tech. Phys.* 1937.

International Bibliography

THE opening meeting of the Session of the British Society for International Bibliography will be held on October 16th at which Dr. S. C. Bradford will give his inaugural address as President. His subject will be "Fifty Years of International Documentation." This will be followed by a discussion on "The Technique of Making Abstracts of Scientific and Technical Papers," which will be opened by Eng. Comdr. D. Hastie Smith, R.N. (ret.). The meeting will be held at the I.E.E., Savoy Place, London, W.C.2, at 2.30.

PREFERRED NUMBERS AND FILTER DESIGN*

By *H. Jefferson, B.A., A.Inst.P., A.M.I.E.E.*

DURING the last few years there has been an accelerating trend towards limiting the production of small resistors and capacitors to values which are members of a "rationalised" scale. Even when close tolerances are available, restrictions have been imposed to discourage the use of non-standard values. The introduction of such a scheme of standardisation has depended on the fundamental fact that the actual size of most circuit elements is not critical, even when it is necessary that the size chosen should be repeated accurately. Most amplifier components, for example, are selected arbitrarily rather than computed rigorously, though in production close tolerances may be imposed to ensure identity of performance among amplifiers. Filter designers often feel, however, that the formality of their design technique demands close adherence to the computed values, even though the initial conditions may have been chosen rather arbitrarily. It often happens, in practice, that the designer of a simple filter computes the element values and then examines them and attempts to bend the design to fit the available components. Several attempts may have to be made before a design is reached which uses standard components and meets the original or modified requirements. It is the purpose of this paper to show that this procedure is unnecessary. The simpler kinds of electric wave filter can be designed directly to use standard components, and the method described here is such that the designer knows what performance changes are involved before completing the design. The problem under consideration is the engineering problem of the simple filter, not the textbook problem. As the whole point of the method is that ordinary production values and tolerances are to be used, complex filters with close impedance and attenuation specifications cannot be designed in this way. Such filters will always present special problems: here we are concerned only with filters such as

those used in the intermediate-frequency amplifiers of broadcast receivers, or those used in scratch-filter circuits in audio-frequency systems. The channel filters of a carrier telephone system are completely outside our scope.

The first half of the paper discusses the "preferred number" system, the second half makes use of the logarithmic nature of preferred numbers in filter design.

Preferred Numbers

It is not generally appreciated that the preferred number scheme used for radio components has a thoroughly logical basis. In fact, the system used, although only one of a multitude of possible systems, is based upon very sound foundations. The principle is, that there shall only be a restricted number of nominal values, and that any particular real value shall be considered to be an approximation to one of the nearest values. Formally, we may define a scale of preferred numbers as a set of numbers N_n such that for any number M (which need not be an integer) a preferred number can be taken, and, if the preferred number corresponding to M is N_m , then

$$(a) \text{ if } M > N_m, \quad M \leq N_m/p.$$

$$(b) \text{ if } M < N_m, \quad M \geq N_m/q.$$

In these two expressions, p and q are defining constants of the particular preferred number system. It is necessary that $N_r/p = N_{r+1}/q$, where N_r and N_{r+1} are the r th and $(r+1)$ th members of the set. This condition is imposed to ensure that p and q together define a unique and complete set of preferred numbers. It is necessary also that one member of such a set should be defined. If $N_r/p \neq N_{r+1}/q$, there are two possibilities:

$$(a) \frac{N_r}{p} < \frac{N_{r+1}}{q}. \text{ In this event there is}$$

a gap in the coverage, for no preferred number exists corresponding to $\frac{1}{2} \left(\frac{N_r}{p} + \frac{N_{r+1}}{q} \right)$.

* MS. accepted by the Editor, May 1945.

(b) $\frac{N_r}{p} > \frac{N_{r+1}}{q}$. In this event there is an overlap, and both N_r and N_{r+1} satisfy the definition of the preferred number corresponding to $\frac{1}{2} \left(\frac{N_r}{p} + \frac{N_{r+1}}{q} \right)$. It will be seen

that if one basic number and two coefficients are chosen, the infinity of real numbers in any range is replaced by a finite set of numbers. For engineering purposes some arrangement of this sort is clearly desirable.

In radio component standardisation the basic number is chosen as unity and the two coefficients are chosen to provide the tolerances which were already in common use before standardisation was introduced. The effect of this is to enable bins to be marked $N_r \pm s$ per cent., where s may be 20, 10 or 5. Rounding out in such a way that alternate members of the 5 per cent. series constitute the 10 per cent. series, and alternate members of the 10 per cent. series constitute the 20 per cent. series. For convenience a further rounding technique is adopted which makes all powers of ten members of the series.

If we consider the defining relationship $\frac{N_r}{p} = \frac{N_{r+1}}{q}$ we see that we must have

$$\frac{1}{p} = 1 + \frac{s}{100} \text{ and } \frac{1}{q} = 1 - \frac{s}{100}, \text{ so that}$$

$$N_r = \frac{1 + s/100}{1 - s/100} \cdot N_{r+1} = k N_{r+1}$$

We have said that powers of ten should be members of the series, and it follows that $10 = k^a$ where a is an integer. The initial choice of $s=20$ gives $k=1.5$ and $a=6$; it is therefore necessary that $a=6$ giving $k=1.47$ ($\sqrt[6]{10}$). For the series in which $s=10$ or 5, the actual integer used for a becomes 12 or 24, and the approximate rounded values of k become 1.2 and 1.1. The series for $s=20$ is formed by listing the values of $(1.47)^r$, where r is an integer, and rounding them to two significant figures. The complete series for $s=5$ can be produced by making $r=(r'/4)$ where r' must now be an integer. The result is tabulated for the decade 1 to 10 in Table I.

As we have seen, $N_r = (1.47)^r$, or $r = \log_{1.47} N_r$, so that this table is actually an anti-log table, with base 1.47, of the preferred numbers. Interpolation is not permitted, and the table can be used as a table

of logarithms without rearrangement. Thus $\log_{1.47} 6.2 = 4\frac{3}{4}$. In the discussion which follows we shall, for convenience in printing, write $\log_{1.47} = \text{logp}$, so that $\text{logp } 6.2 = 4\frac{3}{4}$. For numbers greater than 10 it would be pedantically attractive to use the scale of six for the logarithms, and write, for example, $\text{logp } 62 = 14\frac{3}{4}$, $\text{logp } 620 = 24\frac{3}{4}$. It is thought that most readers will find it more convenient to note that if a preferred number $N = P \times 10^n$, where P lies between 1 and 10, $\text{logp } N = \text{logp } P + 6n$, so that $\text{logp } 62 = 10\frac{3}{4}$, and $\text{logp } 620 = 16\frac{3}{4}$, both in the scale of ten. With this notation, we shall have $\text{anti-logp } 38\frac{3}{4} = \text{anti-logp } (36 + 2\frac{3}{4}) = 3.10^6$.

The logarithmic nature of the preferred numbers leads to an important property of designs involving them. In multiplying and dividing preferred numbers we add and subtract their logarithms. If, confining ourselves to the 20 per cent. series, these logarithms are all integers, the logarithm of any product of integral powers of preferred numbers must also be an integer, so that the product must be a preferred number. If we have, for example, some quantity $Q = ab^2c/de$, where a, b, \dots, e are all preferred, then Q also must be a preferred number. It is sufficient in this example that, say, c/d should be preferred, but there may also be another quantity Q' with which we are concerned containing only c or d , so that it is desirable to avoid computations involving non-preferred numbers. Further, not only is the result of any series of multiplications and divisions of preferred numbers a preferred number, but the square root of any member of the 20 per cent. series is a member of the 10 per cent. series, and the square root of any member of the 10 per cent. series is a member of the 5 per cent. series. Thus $\sqrt{3.3} = 1.8$ and $\sqrt{1.8} = 1.3$. The above argument about the preferred nature of the product of preferred numbers is, of course, not restricted to the 20 per cent. series, but applies to any system evolved on the basis we have considered.

TABLE I

r	0	$\frac{1}{4}$	$\frac{1}{2}$	$\frac{3}{4}$
0	1.0	1.1	1.2	1.3
1	1.5	1.6	1.8	2.0
2	2.2	2.4	2.7	3.0
3	3.3	3.6	3.9	4.3
4	4.7	5.1	5.6	6.2
5	6.8	7.5	8.2	9.1
6	10			

Before going on to consider the uses of these properties of preferred numbers, the "preferring" of any number must be considered. In Table II the numbers are listed in a way more convenient for this purpose.

TABLE II

5 per cent. series	10 per cent. series	20 per cent. series
10	10	10
11		
12	12	
13		
15	15	15
16		
18	18	
20		
22	22	22
24		
27	27	
30		
33	33	33
36		
39	39	
43		
47	47	47
51		
56	56	
62		
68	68	68
75		
82	82	
91		
100	100	100

Examination of this table shows that the preferred number corresponding to any chosen number can quickly be identified. Thus in any calculations, 38 would be replaced by 39, a number preferred in two of the three series with which we are concerned.

The value of π . In any design work involving frequency, a preferred number for π will be needed. If the non-preferred value of π is defined as $22/7$, the preferred value will be $22/6.8$. Referring to Table I, it will be seen that $\log_p \pi = 8 - 5 = 3$, so that $\pi = 3.3$. In the same way $2\pi = 6.2$ and $4\pi = 12$. It is desirable to maintain consistency throughout, rather than to perform some multiplications before going to preferred numbers, which would, in the particular example above, give $4\pi = 13$. As 3.9 and 3.3, the preferred numbers for 4 and π , are both members of the 10 per cent. series, 4π must also be kept in the 10 per cent. series to prevent our final answer falling in the 5 per cent. series.

Application to Filter Design

The application of the properties of preferred numbers to filter networks necessarily involves some compromises. As we have seen above, the value available for π involves an error of about 5 per cent. The overall errors, however, do not exceed those which any introduction of preferred numbers inevitably involves, and generally are much smaller than the tolerance permitted.

The low-pass filter of Fig. 1 will be considered first. If the design impedance is R ohms and the cut-off frequency is f_c c/s, the component values will be

$$L = R/\pi f_c \quad \text{henries}$$

$$C = 1/2\pi f_c R \quad \text{farads.}$$

For most applications the termination resistance of this filter will be provided by a normal composition resistor. It is desirable, therefore, that R should be a preferred number. We have already seen that π and 2π can be replaced by preferred numbers. If C is to have a preferred value, therefore, we must choose f_c to be preferred. It is interesting to note that in choosing $\pi = 3.3$ and $2\pi = 6.2$ we introduce an error of only $2\frac{1}{2}$ per cent. into the characteristic impedance of the filter. As such a filter would normally be designed with about 25 per cent. mismatch to give cut-off sharpening, the mismatch due to preferred numbers is trivial.

Fig. 1. Prototype π -section; low-pass filter.

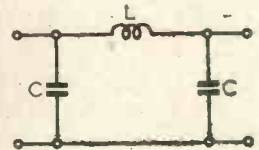

The error in cut-off frequency is also small, about 2 per cent., and thus is completely unimportant compared with the effects of component tolerances. The procedure for the design of a low-pass filter is therefore along the following lines. The impedance and cut-off frequency are chosen and are then replaced by the appropriate preferred numbers. In making this change any impedance mismatch required must be included. Thus if a π -section is required to work at a nominal impedance level of 650 ohms, a value of $R = 470$ ohms would probably be chosen if the best cut-off was required, although $R = 620$ ohms would give better matching in the parts of the band remote from cut-off. With the preferred values

chosen, the two formulæ-become :

$$\log p L = \log p R - \log p - 3$$

$$\log p C = -4\frac{3}{4} - \log p R - \log p f_c \text{ if } C \text{ is in farads.}$$

$$\text{or } \log p C = 67\frac{1}{4} - \log p R - \log p f_c \text{ if } C \text{ is in picofarads.}$$

The values of $\log p R$ and $\log p f_c$ are derived from Table I and are, of course, of the form $r/4$, where r is an integer.

If improved performance is required, it is usual to add m -derived sections or half-sections. If half-sections are to be used for providing good matching, we can take $m=0.62$, and in series-derived sections the capacitance will have a preferred value. In shunt-derived sections, however, a multiplier $(1 - m^2)/4m$ appears in one of the capacitance terms, and this will not be a preferred number when m is preferred. The most satisfactory procedure here is to retain m as a preferred number, and to determine the nearest preferred number to $(1 - m^2)/4m$. These values are then used for calculating the element capacitances. The inductance used with the $(1 - m^2)/4m$ capacitance is not calculated in the direct way, but the anti-resonant frequency f_∞ of the series arm is calculated from the true value of $a = 1/(1 - m^2)^{1/2}$. This actual anti-resonant frequency is used to determine the non-preferred inductance, which constitutes the other element of the anti-resonant circuit. There is usually little difficulty in adjusting inductance in filter circuits of such frequency and impedance that the capacitors are given in preferred values.

In the discussion of the low-pass filter given above the reader will see the logic of this method of treatment. Preferred values of capacitance and resistance impose limits on the designer: if this procedure is adopted the limitations are made perfectly clear at the outset and it should never be necessary to indulge in faking techniques to complete a filter design. The same treatment is directly applicable to high-pass filters but will not be discussed here.

New problems arise when band-pass filters are considered. We shall discuss only the constant- k and three element types, of which Figs. 2 and 3 are examples. In general, filter designs requiring more complex structures are so inflexible in their specification that the use of non-standard components is justified. Certainly there is no question of the use of 10 per cent. or 20 per cent. toler-

ances in such filters, and the method of computation described here is not applicable.

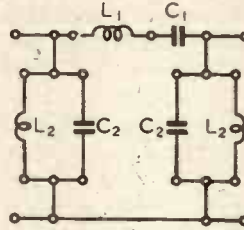

Fig. 2. Constant- k π -section; band-pass filter.

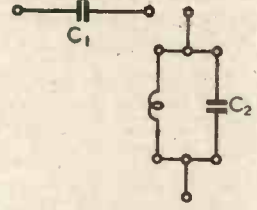

Fig. 3. Elements of 3-element band-pass filter.

The constant- k π -section of Fig. 2 has values :

$$C_1 = (f_2 - f_1)/4\pi f_1 f_2 R$$

$$C_2 = 1/2\pi(f_2 - f_1) R$$

where f_1 and f_2 are the cut-off frequencies, and R is the impedance. If we write :

$$f_2 - f_1 = f_b, \text{ the band-width, and}$$

$(f_1 f_2)^{1/2} = f_m$, the geometric mid-band frequency, these expressions reduce to

$$C_1 = f_b/4\pi f_m^2 R$$

$$C_2 = 1/2\pi f_b R$$

In this form it is clear that it will be necessary for our purposes to have f_b and f_m^2 preferred numbers. This gives a very wide choice for f_m , for if we are allowing C to be a 5 per cent. preferred number, f_m can be any member of a $2\frac{1}{2}$ per cent. series; $\log p f_m$ must be of the form $r/8$ if $\log p f_m^2$ is to be of the form $r/4$. To illustrate the possibilities, a broadcast I.F. filter could be designed to have a mid-band frequency of 430 kc/s, 450 kc/s, 470 kc/s or 490 kc/s and a band-width such that the equivalent audio cut-off frequency would be 4,100 c/s, 4,550 c/s, 5,000 c/s or 5,500 c/s. It seems very unlikely that a case could be made for deliberate choice of any intermediate values.

In the constant- k sections there is, as we have seen, no difficulty, for the expressions all involve products only. When we turn to the 3-element sections, of which Fig. 3 is a typical example, we find that sums and differences are involved. Thus

$$C_1 = (f_1 + f_2)/4\pi f_1 f_2 R$$

$$C_2 = f_1/\pi f_2(f_2 - f_1) R$$

where again f_1 and f_2 are the cut-off frequencies and R is the impedance. Here, not only must f_1 and f_2 be preferred, but $(f_1 + f_2)$ and $(f_2 - f_1)$ should also be preferred. In general, this condition cannot be met, and

the designer must use considerable care in rounding off the non-preferred terms, and must always keep in mind the original specification. If, for example, in the specification f_2 was a preferred number and f_1 was not, f_1 should be rounded to the nearest preferred value, but (f_1+f_2) and (f_2-f_1) should be rounded in the same direction. If f_1 was preferred and f_2 was not, (f_1+f_2) should be rounded in the same direction as f_2 , and (f_2-f_1) should be rounded in the opposite direction. This procedure reduces the errors introduced by rounding. As the extent of rounding is clearly shown at the outset, this method is much to be preferred to the usual "compute and then round" procedure, for the designer knows what approximations in frequency he has introduced for the sake of preferred values of components. He can thus assess the merits of the various designs which are produced by changes of tolerance.

The same principle is applicable to the other forms of three-element sections, and the difficulties which arise should be handled in the same way.

We shall not discuss band-stop or high-pass filters, for no new features appear in their design. We shall conclude with an arbitrary filter design to illustrate the actual workings of the method.

Example. A filter is required to pass frequencies between about 18.5 Mc/s and 25 Mc/s, and to be inserted in tandem with a 75-ohm line. A prototype π -section will be used.

To give some mismatch sharpening of cut-off, a design impedance of 82 ohms is chosen. The specification gives

$$f_b = 6.5 \times 10^6 \text{ c/s}$$

$$f_m^2 = 4.625 \times 10^{14}$$

The preferred numbers which are appropriate are

$$f'_b = 6.8 \times 10^6$$

$$f'_m{}^2 = 4.7 \times 10^{14}$$

$$R = 82.$$

For this filter, which is shown in Fig. 2, we have

$$C_1 = f_b / 4\pi f_m^2 R$$

and so $\log_p C_1 = 72 + (36 + 5) - (6\frac{1}{2} + 84 + 4 + 6 + 5\frac{1}{2})$
 $= 7$, when C_1 is in picofarads.

Hence $C_1 = 15 \text{ pF}$

The other values are

$$L_1 = 390 \mu\text{H}, L_2 = 20 \mu\text{H}, C_2 = 300 \text{ pF}$$

If now we examine the behaviour of this filter, we find that while the specification value of the mid-band frequency was 21.4 Mc/s, and of the preferred value design 21.7 Mc/s, the two values given by the expressions $1/2\pi (L_1 C_1)^{\frac{1}{2}}$ and $1/2\pi (L_2 C_2)^{\frac{1}{2}}$ are 21.9 Mc/s and 22.1 Mc/s. As it is implicit in our design that we shall allow 5 per cent. tolerances, these results are probably good enough. In building the filter, however, improved performance can be obtained by using capacitors having the calculated nominal values, and adjusting the inductances to give anti-resonance frequencies, with their own capacitance and wiring, of the original value, 21.4 Mc/s. The overall perturbation of design is then quite trivial.

It is hoped at a later date to publish tables for filter design based upon the system of preferred number computations described here.

MEETINGS

Institution of Electrical Engineers

Radio Section.—Inaugural address by A. H. Mumford, B.Sc.(Eng.), Chairman, October 10th.

"Radio Measurements in the Decimetre and Centimetre Wavebands," by R. J. Clayton, M.A., J. E. Houldin, Ph.D., B.Eng., H. R. L. Lamont, M.A., Ph.D., and W. E. Willshaw, M.Sc.Tech., November 7th.

The above meetings will be held at 5.30 at the I.E.E., Savoy Place, London, W.C.2.

Cambridge Group.—"Notes on Measurements at Very-High Frequencies."—Inaugural address by L. B. Turner, M.A., Chairman of the Group, October 9th.

"Frequency Modulation," by K. R. Sturley, Ph.D., B.Sc., October 29th.

The above meetings will be held at 6.0 at the Technical College, Collier Road, Cambridge.

British Institution of Radio Engineers

London Section.—"Symposium on Mathematical Methods for Radio Engineers," by L. Jofeh and M. Levy, October 17th, at 6.0, at the Institution of Structural Engineers, 11, Upper Belgrave Street, London, S.W.1.

North-Eastern Section.—"Engineering Methods in the Design of the Cathode-Ray Tube," by Hilary Moss, Ph.D., October 10th, at 6.0, at Neville Hall, Westgate Road, Newcastle-on-Tyne.

OSCILLOGRAPH FOR THE DIRECT MEASUREMENT OF FREQUENCY EMPLOYING A SIGNAL CONVERTER

By P. Nagy, Dipl.Eng., and M. J. Goddard, M.Sc.

(International Television Corporation)

(Concluded from page 441 of September issue)

PART II

THE SIGNAL CONVERTER AS A TIME-BASE GENERATOR

TABLE OF CONTENTS

1. Method and conditions of oscillation.
2. The correct choice of the converter supply potentials, and the effect of the generator circuit on the converter characteristics.
3. Choice of circuit constants.
4. Practical example, calculation of circuit constants.
5. Oscillograms.
6. The signal converter applied to various types of time bases.

1. Method and Conditions of Oscillation

A CONCISE description of the construction and operation of the converter was given in Section 2 of Part I.

Based on Figs. 1, 2, 12 and 13 the complete cycle of oscillations will now be described.

In Fig. 2 the deflection potential of P_2 (or P_1 in Fig. 13) determines the actual position of the image at the output electrode. Thus, if a certain position of the image is assumed, the potential on P_2 is defined.*

Assume that the beam is placed on the negative part X of the output electrode. (This assumption is made for the sake of clarity of the description; before the start of the oscillations the image may in fact fall anywhere on the output electrode.) Thus the output electrode acquires the "negative

equilibrium potential" * close to the potential $V_{\theta 1}$ of the suppressor screen. (See Fig. 12, $i_x = f_2(V_0)$).

Let the image now be biased into the sloping part $x-y$ of the output-deflection characteristic (image falls at tip of Y). Secondary electrons are now collected by G_1 from Y, this current $i_{\theta 2}$ develops a potential drop across R_1 , and the negative transient thus produced is fed via C_2 on to the deflection plate P_2 .† If $R_1 di_{\theta 2}/dV_{P_2} > 1$ the image is instantaneously deflected wholly on to the positive part of the output electrode. By the correct choice of R_1 the image may be deflected on to any part of Y. The output load C is now charged positively by the "positive" output electrode current

$i_y = i_x(S/P - 1)$ where $S/P = f_1(V_0)$. (See Fig. 12.)

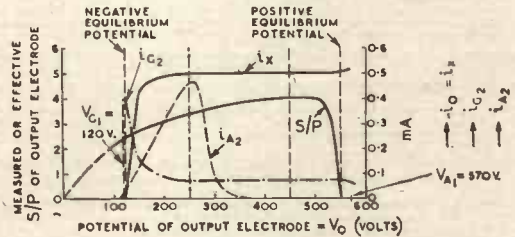

Fig. 12. Variation of secondary electron emission, negative output electrode current, collector screen current, and second anode current for $V_{A2} = 300$ volts, with the potential of the output electrode. $V_{A1} = V_{\theta 2} = 570$ volts; $V_{A2} = 300$ volts; $V_{\theta 1} = V_P \text{ mean} = 120$ volts; $S/P = f_1(V_0)$ when $V_{P1} = +15$ volts; $i_x = f_2(V_0)$ and $i_{\theta 2} = f_3(V_0)$ when $V_{P1} = -15$ volts; $i_{A2} = f_4(V_0)$ when $V_{P1} = +5$ volts.

This charging continues until the "positive equilibrium potential" * is reached close to

* The output-electrode-current deflection-plate characteristic of a signal converter corresponds to the anode-current (i_a) grid-voltage (V_g) characteristic of a conventional valve. The $x-y$ slope of Fig. 2 would be the "useful" part of the conventional valve characteristic. The similarity is quite apparent when the grid-bias of the conventional valve is expanded far into the negative and positive regions: the negative region where $i_a = 0$ corresponds to i_x and the positive region where i_a is constant ($di_a/dV_g = 0$) corresponds to i_y .

* *Wireless Engineer*, June 1943, p. 283.

† The capacitance of C_2 is negligible compared with the resistance of R_2 at the frequency of time-base oscillations.

V_{a2} , when the collector screen current drops from

$$i_{a2} = i_x S/P + (i_b - i_x) = i_x(S/P - 1) + i_b$$

to $i_{a2} = i_b$.*

During this "fly-back" period the negative feedback potential $R_1 i_x S/P$ on the deflection plate is leaking away exponentially

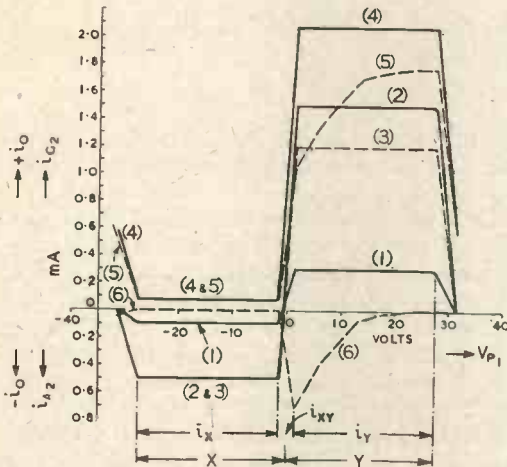

Fig. 13. Improved output-deflection characteristic [$i_0 = f(V_{P1})$; second anode is at an intermediate potential, between $V_{P\text{mean}}$ and V_{a2}]. Also collector screen and second anode current characteristics [$i_{a2} = f(V_{P1})$; $i_{a2} = f(V_{P1})$] for $V_0 > V_{A2}$ and $V_0 < V_{A2}$. Type SC1; $V_{A1} = V_{a2} = 570$ volts; $V_{A2} = 300$ volts; $V_{P1\text{mean}} = V_{P2\text{mean}} = V_{a1} = 120$ volts; $S/P = f(V_{P1}) = \text{constant}$.

- Curve 1 (i_0), $i_x = 0.1\text{mA}$; $i_b = 0.115\text{mA}$; $V_0 = 450$ volts; $S/P = 4$.
- Curve 2 (i_0), $i_x = 0.5\text{mA}$; $i_b = 0.575\text{mA}$; $V_0 = 450$ volts; $S/P = 4$.
- Curve 3 (i_0), $i_x = 0.5\text{mA}$; $i_b = 0.575\text{mA}$; $V_0 = 250$ volts; $S/P = 3.4$.
- Curve 4 (i_{a2}), for i_0 of Curve 2; $i_{a2} = 0 = f(V_{P1})$.
- Curve 5 (i_{a2}), for i_0 of Curve 3.
- Curve 6 (i_{a2}), for i_0 of Curve 3.

via R_2 , at a rate determined by the time constant $C_2 R_2$, ($R_1 \ll R_2$). At the same time the change in i_{a2} due to the variation

* A small fraction of i_b , $i_b - i_x$, is always collected by G_2 independently from the image position. This current corresponds to that part of the image which falls on the wires of G_2 .

In the Type S.C.1, this is approximately 15 per cent. of i_b . Secondary emission produced at the wires of G_2 may be disregarded; all secondary electrons return to G_2 , because the potentials of all the electrodes surrounding G_2 are less positive.

See also Fig. 12, $i_{a2} = f_3(V_0)$ and Fig. 13. The beam current i_b is the current which passes through the first anode; it is substantially equal to the total current leaving the cathode.

of $S/P = f_1(V_0)$ produces a corresponding effect on V_{P2} . The actual potential of P_2 , i.e., the image position on Y , is the resultant of this and the aforesaid leakage.

The sudden decrease of the collector screen current when the positive equilibrium potential is reached produces a reversed transient at P_2 , which deflects the image on to the negative part X of the output electrode;* then $i_{a2} = i_b - i_x$. The useful linear scan now commences; the constant output electrode current i_x , independent of V_0 , V_{P1} and V_{P2} (see Figs. 2, 12 and 13), charges the load C negatively.

During this scan period the positive charge on P_2 leaks away via R_2 , and the image returns exponentially towards the sloping region $x-y$. If it reaches this before the output electrode attains the negative equilibrium potential, the negative transient is produced, as was described at the outset. If the negative equilibrium potential is approached before the image reaches the sloping part, the collector screen begins to collect current (see Fig. 12, $i_{a2} = f_3(V_0)$); this produces a negative transient deflecting the image into the sloping region $x-y$.† In either case the image is deflected instantaneously on to the positive part Y thereby completing the time-base cycle, and the signal converter continues oscillating.

To produce self-generation.

(1) The transient feedback potential must be greater than the deflection potential of the sloping portion; this expressed in a differential form is:

$$\frac{di_{a2}}{dV_{P2}} R_1 > I;$$

(2) To start oscillations the image must be biased within the slope of the deflection characteristic.

The first is the well known condition of oscillation, namely, that the feedback signal

* The reaching of the positive equilibrium potential is not an essential condition of oscillation. If the image reaches the sloping part of the characteristic due to the leakage via R_2 before the positive equilibrium potential is reached, the positive transient is initiated. When $S/P > 2$ this will not occur.

† At the negative equilibrium potential the secondary electron current leaving X is equal to the primary current i_x , the greater part of the secondary current being collected by G_2 and the remainder by G_1 : $i_{a2} + i_{a2} = (i_b - i_x) + i_x = i_b$. It is possible to exploit the whole of the useful negative return transient ($i_x R_1$) by connecting the suppressor screen to the deflection plate P_2 .

must be greater than the input signal responsible for the feedback signal.

The second condition follows from the first. When the image is biased in the regions x or y the self-generation cannot start, as in these constant current regions an infinitesimal displacement of the image does not alter the collector screen current:

$$\frac{di_{o_2} R_1}{dV_{P_2}} = 0$$

Calculations based on the above theoretical considerations and Figs. 2, 12 and 13, give the variations of the output time-base potential, the feedback potential on the deflection plate P_2 , and the collector screen current and voltage as functions of time, shown in Fig. 14. The significance of Fig. 14 and how it is affected by the choice of the circuit constants will be referred to later.

2. Choice of the Converter Supply Potentials, and the Effect of the Generator Circuit on the Converter Characteristics

The guiding principles for a good time-base output are: (a) In order to preserve the constancy of the "negative" charging of the output condenser C , i.e., the linearity of the scan, the image of the signal converter must not be deflected beyond the constant x part of the output-deflection characteristic during the useful scan period.

(b) The time-base oscillations must be stable and easy to synchronise.

These conditions are best served when the constant current part x of the output-deflection characteristic is as wide as possible relative to the slope $x-y$, i.e., if the useful length of the negative part of the output electrode is considerably greater than the image-width.

It is also desirable that the image-width remains constant for all useful beam current values, from 0.05 to 1.00 mA, i.e., the ratio of x to $x-y$ should remain constant.

When the circuit of Fig. 1 is employed, where the mean potential of the deflection plates is equal to the potential of the second anode, the imperfection of the electron-lens formed by the first anode and the lower part of the second anode causes an increase of the image-width when the beam current is increased (see Fig. 2); also the aberration of the "field-lens," formed by the upper part of the second anode and the collector screen, decreases the effective length of X ,

because when deflected, the "field-lens" bends the image.*

It was found that both effects can be considerably improved by placing the members of the second anode A_2 at an intermediate potential between first anode and deflection plates, (e.g., $V_{A_1} = V_{G_2} = 570$ volts, $V_{P_{\text{mean}}} = 120$ volts, $V_{A_2} = 300$ volts).

The "strong" lenses A_1-A_2 , A_2-G_2 are thus each replaced by two "weak" lenses (A_1-A_2 , $A_2-P_1P_2$ and $P_1P_2-A_2$, A_2-G_2); it is a well known principle in optics that the aberrations of a strong lens (short focal length) are improved when replaced by two weak lenses of equal total power.

The improved x to $x-y$ ratio and the independence of the length of X from i_x can be seen in Fig. 13 (curves 1 and 2).

Fig. 13 also shows that if the second anode is placed at a potential more positive than the negative equilibrium potential it collects current when the image falls wholly or partly on Y and when $V_0 < V_{A_2}$; the dependence of the second anode current i_{A_2} on V_0 is shown in Fig. 12. The useful current i_{o_2} is reduced by i_{A_2} (see Fig. 13, curve 5), which in turn results in a deflection of the image during the flyback towards the sloping part $x-y$ of the characteristic. This undesirable effect can be reduced to negligible proportions by connecting A_2 through a suitable resistance to the source of potential, thus decreasing V_{A_2} approximately to the level of V_0 when the conditions producing i_{A_2} prevail, and so reducing i_{A_2} to a small value. During the scan (image on X) i_{A_2} is zero (see Fig. 13, curve 6), so that the reduction of V_{A_2} occurs only during the flyback, when a well focused image is not necessary.

3. Choice of Circuit Constants

$$(3.1) R_1 \ll R_2.$$

When R_1 is a small fraction of R_2 the load of the collector screen is substantially equal to R_1 , a pure ohmic load. Thus the potential changes at G_2 are proportional to the collector screen current i_{o_2} . As can be seen from Fig. 13, curves 4 and 5, and as shown in Fig. 14c, during the scan period i_{o_2} , and so V_{G_2} , is constant, so that the potential variations at the collector screen—when fed via a condenser on to the grid of the C.R. tube—are ideally suited for the blacking out of the flyback of the time base; the grid

* *Wireless Engineer*, June 1943, p. 292.

voltage of the C.R. tube is constant and least negative during the scan, keeping the intensity of the trace on the fluorescent screen uniform. The magnitude of the negative feed-back pulse (maximum 50 volts) is ample for the effective blacking-out of the fly-back trace for commercially available C.R. tubes.

Further reasons why R_1 should be a fraction of R_2 are the following: the time constant C_2R_2 has an optimum fixed value as will be described later; by making R_2 large (500,000 ohms to 3 megohms) the condenser C_2 can be kept small. The economic advantages ensuing are obvious; the dissipation in R_2 is less than 1/100 of a watt,

(3.2) Determination of C

As was mentioned in Part I the output load C is:

$$C = \frac{i_x T}{V}$$

where V is the required datum time-base output potential,

i_x is the converter current charging C , and

T the time of the scan of amplitude V .

(3.3) The Choice of the Time Constant C_2R_2

The time constant C_2R_2 determines the rate at which the deflected image returns exponentially towards the sloping part

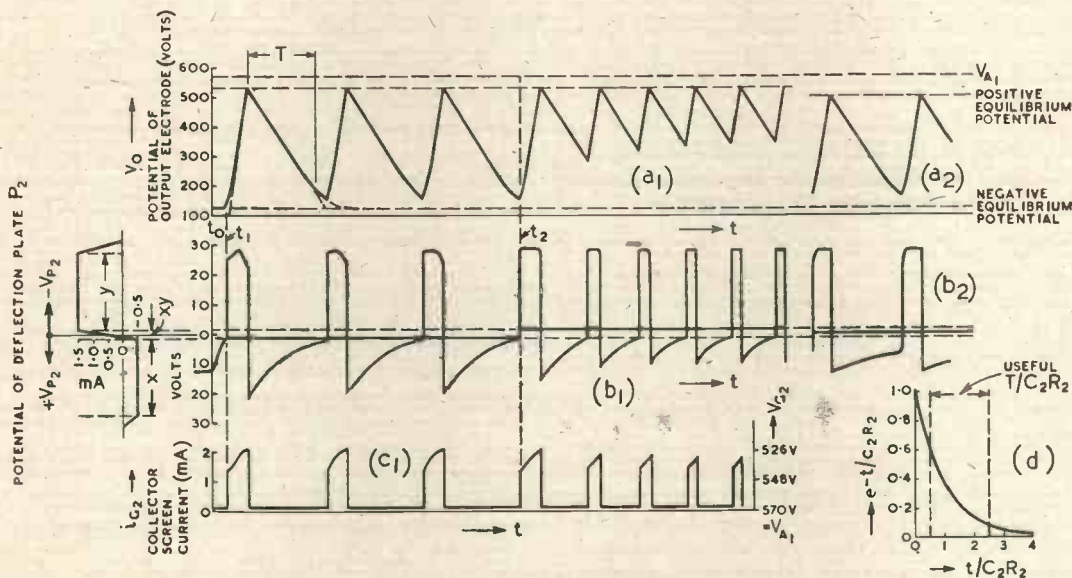

Fig. 14. The output time-base potential, the feedback deflection plate potential and the collector screen current and potential, as functions of time, for different values of C_2R_2 and different bias positions. $i_x = 0.5 \text{ mA}$; $C = 0.05 \text{ } \mu\text{F}$; $V = 350 \text{ volts}$; $T = CV/i_x = 0.035 \text{ sec}$; $R_2 = 520000 \text{ ohms}$; $S/P = f_1(V_0)$ (See Fig. 12). For (a1), (b1), (c1); $R_1 = 22000 \text{ ohms}$; $C_2 = 0.03 \text{ } \mu\text{F}$; $T/C_2R_2 = 2.25$. For (a2), (b2); $R_1 = 24000 \text{ ohms}$; $C_2 = 0.096 \text{ } \mu\text{F}$; $T/C_2R_2 = 0.7$.

because the maximum possible R.M.S. voltage across it is approximately 20 volts, while the size of C_2 is determined by the potential $V_{\sigma_2} - V_{P_{\text{mean}}} \cong 450 \text{ volts}$. Like the control grids of conventional valves the deflection plates of the signal converter are sensitive to hum; the use of mica condensers (C_2) and "deflection plate leaks" (R_2) of small dimensions is desirable. The general considerations regarding a clean circuit are analogous to those of an R.C. coupled amplifying stage.

x - y . Fig. 14d shows the relation between e^{-t/C_2R_2} and t/C_2R_2 ; from considerations based on this curve a suitable T/C_2R_2 ratio can be selected, and hence C_2R_2 can be calculated for any given value of the scan period T . Reasonable values of T/C_2R_2 are from 0.5 to 2.5. When $T/C_2R_2 = 0.5$, V_{P_2} drops only 40 per cent. during the scan period, and a drop of at least this order is necessary for the clean operation of the circuit. When $T/C_2R_2 = 2.5$, the drop is already more than 90 per cent. The value of T/C_2R_2 influences

the stability of synchronisation. It can be shown that the greatest stability of synchronisation is obtained when $T/C_2R_2 = 1$; this is discussed fully in Appendix III.

In Fig. 14 the output and the feedback deflection plate potential are drawn from calculations based on $T/C_2R_2 = 2.25$ (a_1, b_1) and $T/C_2R_2 = 0.7$ (a_2, b_2). In a_1, b_1 at $t = t_0$ the image falls on X ($V_{P_2} = +13$ volts), V_{P_2} is then biased towards the slope $x-y$ and the oscillations start at t_1 ($V_{P_2} = +1.5$ volts); after 3 cycles the steady state is virtually reached. Note that the "negative" transient deflecting the image on to Y is actuated by the approach of the potential of the output electrode to the negative equilibrium potential and the time base attains its maximum amplitude.

At t_2 the image is biased towards Y ($V_{P_2} = -1.5$ volts). The amplitude of the time base is considerably reduced, the "negative" transient being actuated by the image reaching the slope.

In a_2, b_2 the oscillations are shown in their steady state; the image is biased in the centre of the slope, but this is of small consequence since for substantially all bias positions the negative transient is actuated by the approach of the output electrode potential to its negative equilibrium value and so the time-base output is virtually independent of the biasing of the image position.

For most applications a fast return (large T/C_2R_2) is preferable, because the time-base amplitude can be sensitively controlled by the bias potential of the deflection plates, and small signals (e.g., 0.2 volt) will synchronise the output in all bias positions.

When the return is slow (small T/C_2R_2) the image, unless biased far on to the positive side, is still several "volts" (6 volts in Fig. 14b₂) from the slope $x-y$ at the "negative" transient, requiring an input signal of several volts for synchronisation, and thus the output amplitude is not sensitive to hum. This condition can, however, be reproduced in the case of a fast return, provided that S/P is large, by biasing the image further on to the negative side. The procedure to obtain tight locking is thus to increase the synchronising signal and to bias the image towards the negative side.

(3.4) Determination of R_1

Since $R_1 \ll R_2$ the transients at the deflection plates are substantially equal to $i_x S/P R_1$.

The image should be deflected as far as possible on to the "constant current" negative part, but not beyond it.*

The following calculation shows that the part of the "positive" transient falling on x (K_1 and K_2 in Fig. 15) is independent of the secondary emission coefficient of the output electrode, and lies between $2i_x R_1$ and $i_x R_1$ for small and large C_2R_2 values, respectively.

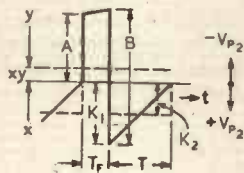

Fig. 15. The simplified feedback deflection-plate potential as function of time.

In Fig. 15 the exponential return on x and y and $S/P = f(V_0)$ are assumed linear for the approximation. For small C_2R_2 the negative half-cycle is then a triangle and for large C_2R_2 a rectangle.

Since the feedback signal on P_2 in the steady state of oscillations is a pure a.c. signal the time integrals of the positive and negative half-cycles are equal; therefore, for small C_2R_2 :

$$\frac{1}{2} K_1 T = \frac{A + B - K_1 T}{2} T_f \dots \dots (1)$$

Let $s_n = S/P$ at start of flyback,
 $s_p = S/P$ at end of flyback.

Then $T = \left(\frac{s_n + s_p}{2} - 1 \right) T_f \dots \dots (2)$

Substituting T/T_f from (2) into (1)

$$A + B - K_1 = \frac{K_1 T}{T_f} = K_1 \frac{s_n + s_p}{2} - K_1$$

$$K_1 \frac{s_n + s_p}{2} = A + B$$

but $A = s_n i_x R_1$

and $B = s_p i_x R_1$

$$\therefore K_1 = \frac{2}{s_n + s_p} (s_n + s_p) i_x R_1 = 2 i_x R_1 \quad (3)$$

Similarly for large C_2R_2 :

$$K_2 T = \frac{A + B - K_1 T}{2} T_f \dots \dots (4)$$

* No such limitation is present for the positive part y , since, if the "negative" transient deflects the image into the decreasing region of the y part, the decrease in the screen current automatically limits the amplitude of the negative half of the feedback cycle (see Fig. 14b); it is not necessary to have constant charging current for the flyback.

From equations (1), (4) and (3)

$$\frac{1}{2}K_1T = K_2T$$

$$K_2 = \frac{1}{2}K_1 = i_x R_1$$

These results are optimistic. In Appendix IV the exact solution is given.

A safe value for R_1 can be calculated from equation (3) by putting $K_1 = 0.75 x$; then

$$R_1 = \frac{0.375x}{i_x} \dots \dots \dots (5)$$

The image is then not deflected beyond x for any bias position and for any practicable value of $C_2 R_2$, while most of the negative constant current part of the output-deflection characteristic is used.

4. Practical Example, Calculation of the Circuit Constants

Based on the above considerations the circuit constants C, C_2, R_1, R_2 may now be calculated.

- Assume: $i_x = 0.5 \text{ mA.}$
- $V = 350 \text{ volts.}$
- $T = 0.035 \text{ sec.}$

Hence the output load

$$C = \frac{Ti_x}{V} = \frac{0.035 \times 0.0005}{350} = 0.05 \text{ microfarad.}$$

From Fig. 13

$$x = 26 \text{ volts}$$

Thus $R_1 = \frac{0.375x}{i_x} \approx 20,000 \text{ ohms.}$

Take $R_2 \approx 25R_1 = 500,000 \text{ ohms.}$

and $T/C_2R_2 = 2.25$

Then $C_2 = \frac{0.035}{2.25 \times 500,000} \approx 0.03 \text{ microfarad.}$

Considerable latitude is possible in the above constants, except C .

5. Oscillograms

The oscillograms shown in Fig. 16 were all taken with the oscillograph described in Part I of this paper. In (a), (b) and (c) the same sine-wave input signal is shown when the signal converter beam current is changed from low to medium and high values. Note the linearity of the scan for all beam current values.

The time-base output potential is shown in (d), illustrating the "straight" scan and also curvature of the flyback due to changing S/P (see also Fig. 14a).

In (e), (f) and (g) are shown the time-base output potential, and the corresponding potentials on the deflection plate P_2 and the collector screen (the two latter being in opposite phase to the calculated curves in Fig. 14, b and c) for three bias positions of the image; the output potentials are respectively, 360 volts, 310 volts, and 220

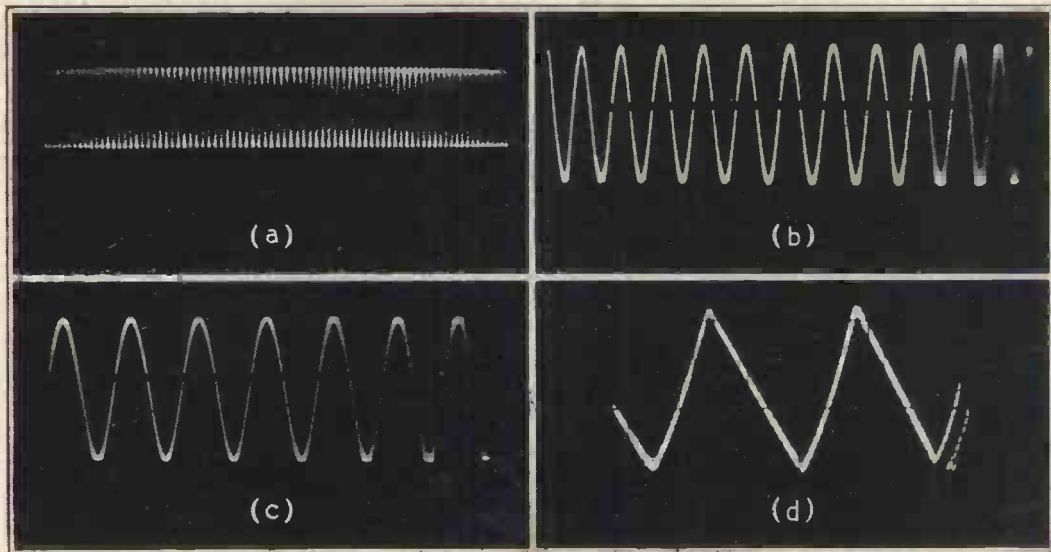

Fig. 16. (a), (b), (c) and (d)

volts, while $T/C_2R_2 = 2.25$ when $V = 350$ volts as in Fig. 14, a_1, b_1, c_1 ; note the constancy of the collector screen potential during the scan period, and—in (e)—the

base is produced which is synchronised at the start of the *flyback*.

(b) If the secondary emission coefficient is not greater than 2, or if the electron image

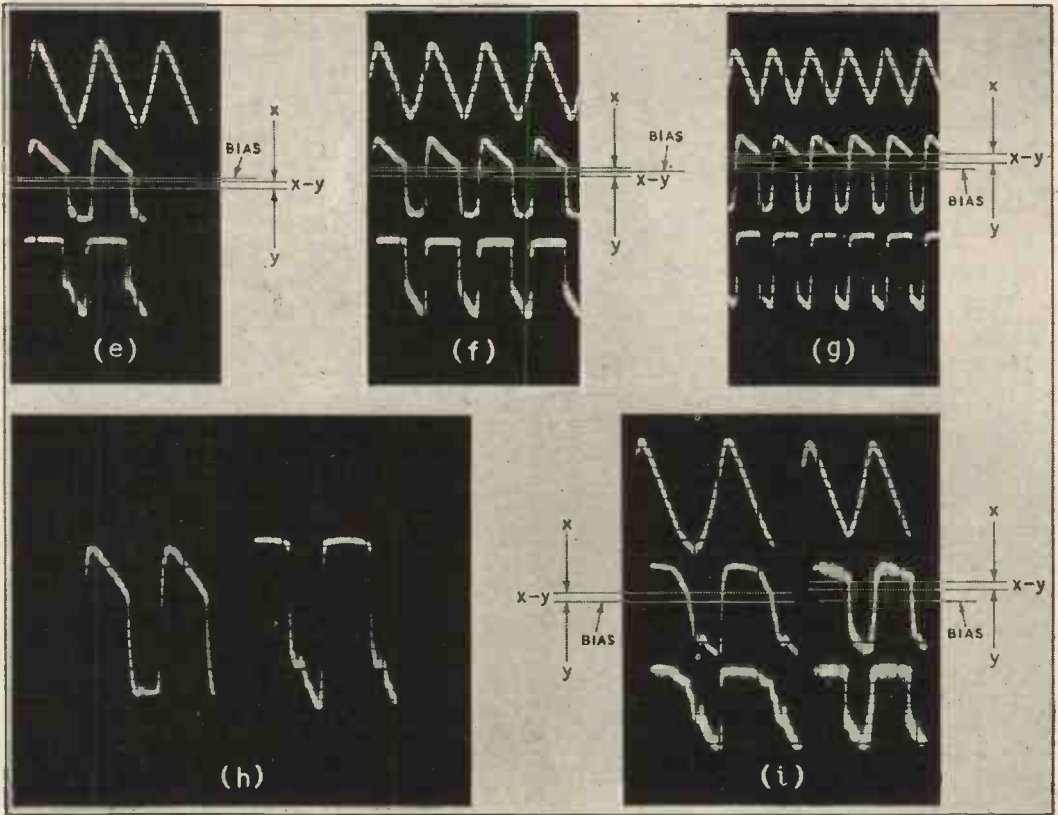

Fig. 16. (e), (f), (g), (h) and (i).

effect on the collector current, during the flyback, of the current collected by the second anode. The extremely rapid transients at the transition points from scan to flyback and vice versa are particularly apparent on the larger oscillograms (h), showing the deflection plate and collector screen potentials for conditions as in (e).

In (i) are shown the time-base output, deflection plate and collector screen potentials for $T/C_2R_2 = 0.7$ when $V = 350$ volts (conditions as in Fig. 14, a_2, b_2), for two extreme bias positions. Note the small effect of biasing on the output amplitude.

6. The Signal Converter Applied to Various Types of Time-Bases

(a) In the circuit described with reference to Fig. 1, a self-generating continuous time

base is produced which is synchronised at the start of the *scan* can be produced.

(c) A single sweep time base can be produced if the electron image is biased on to either the positive or the negative side, and a starting signal of appropriate phase and amplitude is applied.

(d) Signals recurring at irregular intervals can be examined in their entirety by "Pure Signal Conversion." Several different signals of this type can be investigated simultaneously.

(e) A time base equal in frequency to a standard signal and with scan period equal to a definite fraction of the period of the standard signal can be produced by "Pure Signal Conversion" of the standard signal.

In all these cases the synchronising signal may be of "positive" or "negative" sign,

because a deflection plate is available on either side of the electrode system (P_1 and P_2).

It will thus be seen that almost any type of time base requirement can be satisfied by employing a signal converter.

APPENDIX III

For good synchronisation, the signal converter should be able to discriminate well between successive pulses applied to the deflection plate at the instant of synchronisation. This power of discrimination is greatest if the motion of the electron beam across the output electrode is as fast as possible at the time of synchronisation. The time constant C_2R_2 should be selected with this end in view.

Let V_P be the deflection plate potential at time after the commencement of the scan, and let V_{P0} be the value of V_P at the commencement of the scan, i.e., at $t = 0$.

Then: $V_P = V_{P0} e^{-t/C_2R_2}$

The rate at which the electron beam moves

$$i_z Z \ll \frac{x}{1 + \frac{e^Q - 1}{e^Q - e^{-Q/(s-1)}} \left\{ s_p - s_n e^{-Q/(s-1)} + \frac{H_1}{Q} \left[e^{-Q/(s-1)} - \left(\frac{s_p - s_m}{s_m - s_n} \right)^2 \right] \right\}}{(s-1)H_2 - 1}$$

across the output electrode at any time t is given by:

$$\frac{dV_P}{dt} = - \frac{V_{P0}}{C_2R_2} e^{-t/C_2R_2}$$

The rate of movement of the beam at the time of synchronisation, i.e., when $t = T$, is:

$$\left[\frac{dV_P}{dt} \right]_T = - \frac{V_{P0}}{C_2R_2} e^{-T/C_2R_2}$$

In order to determine the value of C_2R_2 which makes this rate of motion greatest, we differentiate this expression with respect to C_2R_2 and equate to zero:

$$0 = \frac{\partial}{\partial(C_2R_2)} \left[\frac{dV_P}{dt} \right]_T = \frac{V_{P0}}{(C_2R_2)^2} e^{-T/C_2R_2} - \frac{V_{P0}}{C_2R_2} e^{-T/C_2R_2} \cdot \frac{T}{(C_2R_2)^2} = \frac{V_{P0}}{(C_2R_2)^2} e^{-T/C_2R_2} \left[1 - \frac{T}{C_2R_2} \right]$$

This gives $T/C_2R_2 = 1$

It can readily be shown that this represents the greatest and not the least rate of motion.

APPENDIX IV

In Section 3.4 of Part II, a simplified method for calculating R_1 was given in order to make clear the physical effect of changes in S/P and in the time constant C_2R_2 .

Since the deflection of the image depends on the secondary emission law, which is not known as a mathematical function, a completely exact calculation of R_1 is not possible; but a close approximation to the actual conditions prevailing is given by assuming that, when the valve is oscillating over the maximum possible potential range, the secondary emission coefficient rises exponentially with time during the flyback period, from its value s_n at the commencement of the flyback to a value s_p at the end of the flyback. Here s_p represents the effective value of the secondary emission coefficient at the end of the flyback taking into account any reduction in this effective value due to the electron beam being deflected beyond the straight portion of the positive part y of the characteristic. If s is the mean value of the secondary emission coefficient during the flyback, s_m is the secondary emission coefficient at the end of half the flyback time, and Q is the ratio of the maximum possible output potential to the normal operating output potential, then it can be shown that the electron beam is never deflected beyond the end of the straight portion x of the characteristic if R_1 is chosen from the equation:

where $Z = \frac{R_1R_2}{R_1 + R_2}$
 $H_1 = \frac{(s_m - s_n)^2}{2s_m - s_p - s_n}$
 $H_2 = 2 \log_e \frac{s_m - s_n}{s_p - s_m}$

On the basis of Fig. 12, $S/P = f_1(V_0)$, we have $s_n = 2.70$ at $V_0 = 150$ volts and $s_p = 4.00$ at $V_0 = 520$ volts. An approximate integration of the flyback potential against time using this curve gives $s = 3.57$ and $s_m = 3.65$. Assuming that, if the secondary emission coefficient deviates from its value as given by Fig. 12, $S/P = f_1(V_0)$, then it does so in the same ratio at all potentials, and assuming a normal operating output potential of 200 volts, we find:

- $s_p = 2 \quad i_z Z \ll 0.409 x$
- $s_p = 3 \quad i_z Z \ll 0.381 x$
- $s_p = 4 \quad i_z Z \ll 0.370 x$
- $s_p = 5 \quad i_z Z \ll 0.366 x$

If $R_1 \ll R_2$, then $Z \cong R_1$. In the converter Type S.C.1, s_p is of the order of 3, and so

$$i_z R_1 = 0.375 x = \frac{3}{8} x$$

is a safe value for all conditions of oscillation.

CORRESPONDENCE

Letters of technical interest are always welcome. In publishing such communications the Editors do not necessarily endorse any technical or general statements which they may contain.

"Time-base Converter and Frequency Divider"

To the Editor, "Wireless Engineer"

SIR,—In your August issue Dr. Moss describes a "Time-Base Converter and Frequency Divider." By employing conventional valves a similar result is obtainable to that achieved by the "Signal Converter," described by us in your June 1943 issue. He states: "... that the introduction of a new and specialised type of valve is a retrograde step to achieve any object unless it is clearly impossible to reach the same ends by other methods."

We feel that this is an unprogressive attitude. Surely the replacement of a number of conventional valves and their associated circuits by a single deflection-modulated hard valve (the signal converter) is justified, especially so as the results obtained are better at the higher time-base frequencies, the linearity of the time base is ideal, the ratio of d.c. supply potential to time-base output approaches unity, synchronisation is superior at high frequencies, and the power required is

while preserving the high-frequency response of the input stage of the circuit.

V_2 converts the arbitrary signal into square pulses, in order to ensure rapid transition through the slope of the anode-current/grid-voltage characteristic of the valve V_3 , and to keep within reasonable limits the input amplitude applied to the grid of V_3 .

V_3 discharges the time-base condenser, thus producing the fly back.

V_4 is the constant current device to achieve linearity.

Thus to reproduce satisfactorily "pure signal conversion" of an arbitrary signal four conventional valves are needed.

The limitation of such a circuit at higher frequencies arises from the fact that the resistances employed in the circuit are in practice shunted by capacitances. When the frequency is such that the capacitances are of the order of the resistances, synchronisation is unreliable and the linearity of the scan is destroyed. In the signal converter the

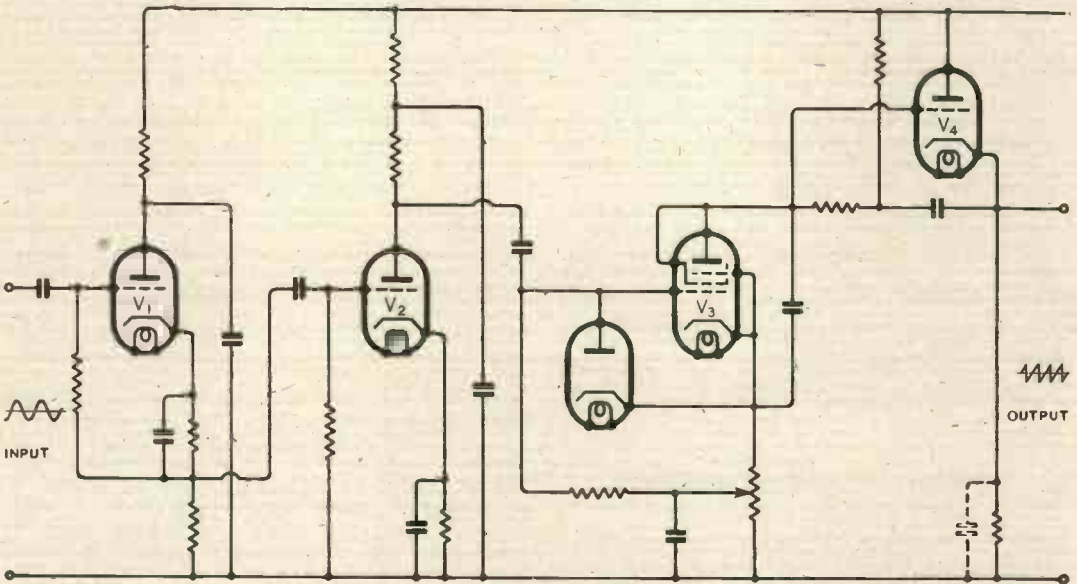

Circuit of a single-cycle time-base converter.

a fraction of that of the conventional-valve circuit.

The diagram shown represents a detailed circuit of a "Single-Cycle Time-Base Converter" corresponding to the schematic circuit of Fig. 1 in the article by Dr. Moss. Circuits of this type were known to us in the early stages of the signal converter development.

Valve V_1 is a cathode-follower input stage. This stage is desirable to avoid loading by the "cut off" and so distorting the signal under investigation,

linearity of the scan is ensured by having a "floating" output electrode, and thus a pure capacitive load; while the synchronisation is superior on account of the far simpler input network.

Basically, the signal converter is superior to conventional valves because two parameters are available—the intensity of the beam current and the position of the beam. The versatility also is enhanced, because any number of "ideal grids" is available in the form of deflection plates.

We do not regard the signal converter as a

complex and expensive "specialised type of valve." As was pointed out in the *Journal of the Television Society* (Vol. 4, No. 2, 1944), the dimensions of the Type S.C.1 converter can be considerably reduced and the electrode system simplified; the manufacturing cost of such a valve is of the order of that of a conventional valve.

It may well be that, in the near future, conventional valves will for many applications be regarded as obsolescent, and will be replaced by deflection-modulated cathode-ray valves.

P. NAGY.
M. J. GODDARD.

London, W.1.

"Schwingtöpfe"

To the Editor, "Wireless Engineer"

SIR,—This German word should be translated as "cavity resonators." Your reviewer, in the August *Wireless Engineer* and also in *Wireless World*, uses "Klystrons." The Klystron is a valve, with a velocity-modulated electron stream, working on the "buncher-catcher" principle.

H. MORGAN.

London, S.E.

[The following definitions from the "British Standard Glossary of Terms used in Telecommunication" show that Mr. Morgan's criticism is well founded. They also indicate how the confusion has arisen.

No. 1743, *Klystron*.—A velocity-modulated valve in which the electrodes of the output circuit (and also possibly of the input circuit) are combined in the circuit to form a Rhumbatron (see 4526.)

No. 4526, *Rhumbatron*.—A resonant circuit characterised by an electromagnetic field bounded by a substantially closed conducting surface, energy being transferred to or from the electromagnetic field by inductive loops or capacitive elements in the field or by radiation through an opening in the conducting surface or by a beam of electrons projected through the field.

Hence, although the Rhumbatron (or Schwingtopf) forms an essential part of the Klystron, we were certainly not justified in referring to it as a Klystron. The book under review was not concerned with the velocity-modulated valve but solely with the Rhumbatron or cavity resonator.—G.W.O.H.]

"Stabilisation of Feedback Oscillators"

To the Editor "Wireless Engineer"

SIR,—The elegance of Mr. Jefferson's manipulation of oscillator networks in the August issue must not blind us to the fact that the premises on which his discussion is based severely limit the practical importance of the results.

So long as one considers only linear circuits with fixed reactances, the valve can influence the frequency of oscillations solely through the effective grid resistance, R_g , the effective anode resistance, R_a and the amplification factor μ ; and it is fortunate that in practice all three of these are largely independent of the electrode potentials and cathode emission in a triode valve.

With normal values of grid-leak and condenser, this part of the circuit functions as a linear diode rectifier, the effective resistance of which is well

known to be half that of the grid-leak (or one-third if the effect of a shunt grid-leak is included) provided that the internal resistance of the diode is reasonably small compared with the leak resistance; and the grid-cathode resistance of an oscillator valve usually satisfies this condition.

The amplification factor, μ , of a normal triode is very closely defined by geometry and electrostatics, and an experimental plot of V_a against V_g for constant I_a is a straight line over the whole of the working range of the valve, indicating that μ is constant. The limitation of the amplitude of oscillation must, therefore, be effected by the variation of the average value of the differential anode resistance of the valve, i.e., of R_a , in accordance with the variation of the range of the real non-linear valve characteristic which is traversed by the cycle of oscillation; and since R_a must always have that value which, in conjunction with the fixed network parameters, will maintain a steady state of oscillation, it is in effect a constant fixed by the circuit and not an independent variable controlled by the valve characteristics. The variation with amplitude of the effective resistance R_a can be calculated, by a Fourier analysis of the current resulting from the application of a sinusoidal voltage, as the ratio of the sinusoidal voltage to the component of current of the same form; or alternatively it can be measured experimentally.¹ Expressed in general terms, the equations of a linear oscillator will contain reactive elements and resistive elements so that there are two conditions to satisfy to ensure a steady state of oscillation; and there are two disposable variables, frequency and amplitude, so that there can be no other independent variables.

The first use of stabilising reactances seems to have been reported by Mallett² in a Meissner type of circuit, and the merit of "reactance stabilised" oscillators arises from the fact that they cause the tuned circuit to operate exactly at resonance, where the phase/frequency characteristic is steepest, and the frequency change resulting from a casual phase change at some point in the system is therefore minimised. As an example of the type of phase change which may occur, it has been shown³ that in most circuits the effect of harmonics generated by non-linearity of the valve characteristic is to cause a phase-shift in the fundamental component of anode current; and changes in the static valve characteristics can change the relative magnitudes of the various harmonics compared with the fundamental for a given value of average resistance R_a . It may then be advantageous to use a circuit with stabilising reactances of the kind deduced from linear theory, but with magnitudes adjusted empirically, so as to neutralise the pseudo-reactance due to non-linearity as well as phase shifts in the linear circuit.

The position may be summarised as follows:—
(1) "Stabilisation" according to linear circuit theory is relatively unimportant, because according to linear theory there can be no change in valve characteristic without destroying the state of steady oscillation.

(2) "Redundant" reactances may additionally

¹ D. A. Bell: "Investigation of Valve Performance by an Electro-dynamometer Method," *J.I.E.E.*, Vol. 76, p. 415, 1935.

² E. Mallett: "Frequency Stabilisation of Valve Oscillators," *J.I.E.E.*, Vol. 68, p. 578, 1930.

³ F. B. Llewellyn, Appendix to "Constant Frequency Oscillators," *Proc. I.R.E.*, Vol. 19, p. 2063, 1931.

be useful as a means of reducing frequency variations in a non-linear oscillator.

(3) Probably the best means of securing high stability of oscillator frequency is through automatic control of amplitude, as first suggested by Arguimbau⁴ and Groszkowski⁵.

London, N.21.

D. A. BELL.

⁴ L. Arguimbau: "An Oscillator Having a Linear Operating Characteristic," *Proc. I.R.E.*, Vol. 21, p. 14, 1933.

⁵ J. Groszkowski: "Oscillations with Automatic Control of the Threshold of Regeneration," *Proc. I.R.E.*, Vol. 22, p. 145, 1934.

Book Review

Formulaire pour le Calcul Symbolique

By N. W. McLACHLAN and PIERRE HUMBERT. Pp. 65. Gauthier-Villars, Paris. 50 francs.

This book is dated 1941, but has apparently only now arrived in this country. It is published in a series known as *Mémoires des Sciences Mathématiques* under the patronage of the Académie des Sciences de Paris. It is a collection of mathematical formulae made by Dr. McLachlan, who, being unable to find a publisher in this country, collaborated with Pierre Humbert, who has adapted the formulae to the symbols used in France. The formulae are designed to assist in the application of Heaviside's operational calculus to practically every known type of function from simple circular functions to those of Hankel, Struve and Weber. It is in no sense a text-book, but rather a book of reference for those who are skilled in the use of operational calculus and wish to know the operational forms for the various functions. To such the book should prove very valuable. It concludes with a useful bibliography of 34 references.

G. W. O. H.

Institute of Physics

We are informed that the address of the Institute of Physics and of its *Journal of Scientific Instruments* is now 19, Albemarle Street, London, W.1. (Telephone: Regent 3541.)

INSTITUTION OF ELECTRICAL ENGINEERS

Admission of Non-Members to Meetings

IN 1943 the Council of the Institution of Electrical Engineers instituted a scheme for making the technical meetings of the Institution accessible to those who may be interested in the proceedings but who may consider their technical experience and educational attainments do not suffice to admit them to any form of membership.

The working of the scheme during the past two Sessions has been reviewed and it has been decided that it should be continued for the coming Session. Any person, therefore, in the category outlined above who is interested in the proceedings at Ordinary Meetings, Section Meetings, Local Centre Meetings and Informal Meetings will, on application to the Secretary, receive an application form; on the completion of which and on payment of a fee of 10/- to cover administrative costs, he will receive notices of meetings and an invitation card which will serve as a title of admission to the technical meetings of the Institution.

It is stressed by the Council that the possession of the invitation card will not confer upon the holder any status within the framework of the Institution, nor will he have the right to join in the discussions without special permission from the Chair.

New Officers

With the commencement of the 1945-46 Session of the Institution on October 1st the following officers, who were elected earlier in the year, assume their duties on the Council:—President, P. Dunsheath, O.B.E., M.A., D.Sc.(Eng.); Vice-Presidents, V. Z. de Ferranti, M.C.; A. J. Gill, B.Sc.(Eng.); P. Good, C.B.E.; Hon. Treasurer, E. S. Byng; Ordinary Members, L. H. A. Carr, M.Sc.Tech.; J. G. Craven; J. Eccles, B.Sc.; H. Faulkner, B.Sc.(Eng.); Prof. Willis Jackson, D.Sc., D.Phil.; J. M. Meek, D.Eng.; A. F. Plummer, M.C.

The newly elected members of the Radio Section Committee are:—Chairman, A. H. Mumford, B.Sc.(Eng.); Vice-Chairman, F. Smith, O.B.E.; Ordinary Members, G. E. Condliffe, B.Sc.; D. C. Espley, D.Eng.; C. E. Strong, B.A.I.

WIRELESS PATENTS

A Summary of Recently Accepted Specifications

The following abstracts are prepared, with the permission of the Controller of H.M. Stationery Office, from Specifications obtainable at the Patent Office, 25, Southampton Buildings, London, W.C.2, price 1/- each.

ACOUSTICS AND AUDIO-FREQUENCY CIRCUITS AND APPARATUS

567 955.—Moving-coil loudspeaker movement in which the gap is made dust and damp proof without involving acoustic distortion.

The Mullard Radio Valve Co. Ltd. and C. L. Richards. Application date 15th September, 1943.

568 027.—Binaural hearing-aid device comprising two independent and separately-adjustable amplifiers arranged to give a stereophonic effect.

Murphy Radio Ltd.; G. B. Baker; and J. H. Balean. Application date 24th August, 1943.

568 235.—Microphone of the ribbon type in which vee-shaped silk screens are provided to protect the sensitive element against so-called "wind" effects, and to prevent blast.

Radio Corporation of America. Convention date (U.S.A.) 4th May, 1942.

568 468.—Method of cutting and mounting a flexural-vibration piezo-electric crystal, particularly suitable for audible frequencies.

B. Tenenbaum. Application date 31st August, 1943.

568 473.—Transformer or reactance coil of the split-core type in which a spring device is utilised to prevent displacement of the "spacer" forming the split or gap.

Marconi's W.T. Co. Ltd. (assignees of E. G. McAllister). Convention date (U.S.A.) 2nd October, 1942.

568 577.—Magneto strictive device for transmitting or receiving frequency-modulated supersonic pressure waves, particularly in submarine navigational systems.

H. F. Rost and P. H. E. Claesson. Convention date (Sweden) 3rd May, 1941.

568 682.—Moving-coil speaker or microphone in which layers of iron dust are associated with windings laid on a non-magnetic former.

The Mullard Radio Valve Co., Ltd., and J. E. Keddie. Application date 11th October, 1943.

568 788.—Remote control system using low-frequency pulses having a constancy which is regulated by a grid-controlled rectifier.

Landis and Gyr Soc. Anon. Convention date (Switzerland) 29th October, 1941.

569 031.—Amplifier for a public-address installation arranged to consume minimum current during stand-by periods.

H. J. Houlgate; G. C. Wheeler; and G. R. Fountain, Ltd., Application date 12th November, 1943.

DIRECTIONAL WIRELESS

567 876.—Aerial system for radiating a blind-landing beam, the equi-signal course being in-

dependent of variations in the reflecting characteristic of the ground.

Philips Lamps Ltd. (Communicated by N. V. Philips' Gloeilampfabrieken). Application date 24th December, 1941.

567 967.—Mechanical modulating system for radiating the identification signal from a radio beacon station on single or double side-bands without the carrier.

Standard Telephones and Cables Ltd. and C. W. Earp. Application date 23rd February, 1940.

568 119.—D.F. system in which the signals received on two spaced aerials are periodically balanced by applying the time-base voltage from a C.R. indicator to control the gain of one of the amplifiers.

Marconi's W.T. Co. Ltd.; F. T. Farmer; and L. W. Whitaker. Application date 12th January, 1940.

568 120.—D.F. system in which the bearings of a beacon station are constantly shown on the indicator of a mobile receiver, and in which all the transmitted signals are derived from a single carrier frequency. (Addition to 525 182).

Standard Telephones and Cables Ltd. and C. W. Earp. Application date 23rd February, 1940.

568 236.—Radio compass installation for automatically steering an aircraft along a predetermined course with provision for the correction of drifting and yawing.

L. A. Warner. Application date 5th May, 1943.

568 785.—Capacitance type of radio-goniometer, or phase-transformer, arranged to produce a predetermined variation of coupling with angular movement of the rotor vanes.

C. O. Browne. Application date 29th January, 1940.

RECEIVING CIRCUITS AND APPARATUS

(See also under Television)

567 813.—F.M. receiver in which a limiter valve feeds two tuned circuits for developing signal currents in quadrature to be added vectorially in a single rectifier.

The Mullard Radio Valve Co. Ltd. and C. L. Richards. Application date 30th July, 1943.

567 834.—Means for disengaging the manual tuning control of a receiver when the push-button or other automatic control is operated.

The General Electric Co. Ltd. and W. H. Peters. Application date 18th July, 1939.

567 963.—Pot-shaped powdered-iron core for R.F. windings, with provision for varying the inductance for tuning.

Neosid Ltd. and M. Grenly. Application date 18th October, 1943.

568 053.—Automatic tuning-control system, applicable to the reception of frequency-modulated signals,

or to the synchronisation of saw-toothed oscillation-generators.

"Patelhold" Patentverwertungs-und Elektro-holding A.G. Convention date (Switzerland) 10th July, 1942.

568 107.—Variable-attenuation device, say for measuring the "Q" of a resonator, comprising a line of fixed and telescopic tubes feeding oscillations to a wide-band amplifier.

The Mullard Radio Valve Co. Ltd. and K. E. Latimer. Application date 26th August, 1943.

568 116.—Valve generator adjustably coupled to a grid-leak detector and arranged to give absolute or relative measurements of the "Q" values of a tuned circuit or of its components.

Marconi's W.T. Co. Ltd. (assignees of W. van B. Roberts). Convention date (U.S.A.) 30th September, 1942.

568 200.—Vibratory converter for supplying two or more H.T. voltage levels to a wireless set, say from a 12-volt battery.

The Plessey Co. Ltd. (communicated by P. R. Mallory & Co. Inc.). Application date 18th September, 1943.

568 436.—Variable tuning device in which a coil is threaded by a relatively-long core, which is "tapered" either in cross-section, or in magnetic permeability, in order to extend the scale of the indicator dial.

Marconi's W.T. Co. Ltd. (assignees of W. L. Carlson). Convention date (U.S.A.) 30th September, 1942.

568 684.—Frequency changer for a superhet in which electronic noise is minimised by abruptly switching the discharge current from one output electrode to the other in the mixing valve.

A. C. Cossor, Ltd. and D. A. Bell. Application date 11th October, 1943.

568 697.—Suppressing interstation noise, particularly when receiving frequency-modulated signals, by applying the noise voltage to disable the signal channel.

The British Thomson Houston Co., Ltd. Convention date (U.S.A.) 23rd May, 1942.

568 821.—Visual tuning device of the magic-eye type adapted to give an unambiguous indication when used with frequency-modulated signals.

Marconi's W.T. Co., Ltd. (assignees of G. F. Elston). Convention date (U.S.A.) 29th August, 1942.

568 915.—Portable receiver provided with two or more frame aerials, and a collapsible rod aerial, all capable of being stored inside the casing of the set for use under different conditions of reception.

Zenith Radio Corp'n. Convention date (U.S.A.) 16th January, 1942.

568 944.—Switching arrangement for automatically selecting one or other of several alternative aerials, provided for use in a portable receiving set to meet different conditions of reception. (Divided from 568 915).

Zenith Radio Corp'n. Convention date (U.S.A.) 16th January, 1942.

569 091.—Variable-permeability tuning-coil in which the windings form a closed polygon and the moving cores are contained in the various sides.

Marconi's W.T. Co., Ltd. (assignees of C. Wentworth). Convention date (U.S.A.) 31st October, 1942.

TELEVISION CIRCUITS AND APPARATUS

FOR TRANSMISSION AND RECEPTION

568 326.—Colour television system in which the amplification of the signals corresponding to each primary colour is separately controlled by electron multipliers so as to ensure a correctly-balanced picture.

W. W. Triggs (communicated by Farnsworth Television and Radio Corporation). Application date 26th May, 1943.

568 747.—Balanced diode detector circuit adapted to receive either frequency- or amplitude-modulated waves, for instance the combination of sound and television signals.

The British Thomson-Houston Co., Ltd. Convention date (U.S.A.) 6th August, 1942.

568 982.—Viewing device for imparting natural colour to a sequence of normally black-and-white television images.

Marconi's W.T. Co., Ltd. (assignees of E. J. Quinby). Convention date (U.S.A.) 9th July, 1942.

TRANSMITTING CIRCUITS AND APPARATUS

(See also under Television)

567 517.—Modulating the amplitude of a carrier wave by applying the signal to vary the reactance of a transmission-line coupling between the oscillation generator and the aerial.

The British Thomson-Houston Co. Ltd. Convention date (U.S.A.) 3rd November, 1942.

567 541.—Fuse arrangement for safeguarding a contact-rectifying circuit against the breakdown of one of its parallel paths.

Standard Telephones and Cables Ltd. (assignees of C. A. Kotterman). Convention date (U.S.A.) 5th November, 1942.

567 585.—Single-valve variable-reactance oscillator suitable for frequency modulation or for the remote control of a tuned circuit.

Marconi's W.T. Co. Ltd. (assignees of H. C. Lawrence). Convention date (U.S.A.) 19th June, 1942.

567 637.—Movable piston-and-clamp device for making adjustable low-impedance connections to the conductors of a coaxial transmission line.

H. E. Holman and E. C. Cork. Application date 17th December, 1940.

568 008.—Metal-vapour rectifier with a single overload cut-out which is responsive to each of the phases of a polyphase supply.

The General Electric Co. Ltd., and W. Schiff. Application date 7th November, 1941.

568 185.—Timing circuit in which definite stopping and starting impulses are applied to the grid-controlled gas-discharge tubes of a full-wave rectifier.

Philips Lamps Ltd. and A. Nemet. Application date 18th May, 1943.

568 205.—Means for minimising voltage surges in a multiple-anode gas-filled discharge tube, with separate grids, for polyphase working.

Akt Brown, Boverie & Cie. Convention date (Switzerland) 26th January, 1942.

568 378.—Parallel-strip type of transmission line, and its application to a valve generating ultra-short waves.

Ferranti Ltd.; R. G. B. Gwyer; and J. G. Heaps. Application date 3rd May, 1940.

568 379.—Transmission-line circuit in which oscillations are switched to one side or other of a "tee" coupling by varying the impedance of two or more quarter-wave stubs.

The General Electric Co. Ltd. and D. C. Espley. Application date 18th November, 1941.

568 544.—Removable oscillator unit for use with a portable transmitter for generating short waves of high stability, comprising a valve with pre-set tuning elements and plug-in terminals.

Communications Patents, Ltd. and G. B. Ringham. Application date 8th June, 1943.

568 564.—Short-wave oscillation-generator in which the cathode leads are isolated by impedances which are readily varied for different wavelengths.

Ferranti, Ltd.; R. G. B. Gwyer; and J. G. Heaps. Application date 30th April, 1941.

568 825.—Frequency-modulation system in which the mean carrier wave is automatically stabilised against temperature variations by a process of heterodyning.

Marconi's W.T. Co., Ltd. (assignees of S. W. Seeley). Convention date (U.S.A.) 29th September, 1942.

568 831.—Quarter-wave screened terminal device for coupling a two-wire transmission line to another line, without allowing the transfer of unbalanced currents or voltages.

Standard Telephones and Cables, Ltd. (assignees of C. B. Watts). Convention date (U.S.A.) 15th August, 1942.

569 044.—Valve circuit for controlling a motor-driven condenser in a frequency-modulation system, or for remote control purposes.

Marconi's W.T. Co., Ltd. (assignees of M. G. Crosby). Convention date (U.S.A.) 14th May, 1941.

SIGNALLING SYSTEMS OF DISTINCTIVE TYPE

568 123.—Differentiating circuit for clarifying the response of a receiver to signals transmitted as a sequence of spaced pulses, each pulse having a duration of say 70 microseconds.

Marconi's W.T. Co. Ltd.; C. S. Cockerell; and M. H. Cufflin. Application date 15th December, 1941.

568 240.—Time-delay circuit for improving the signal-to-noise ratio in a receiver for signals consisting of trains of short non-sinusoidal pulses.

Marconi's W.T. Co. Ltd. (assignees of T. T. Eaton and D. G. C. Luck). Convention date (U.S.A.), 11th September, 1942.

CONSTRUCTION OF ELECTRONIC-DISCHARGE DEVICES

567 683.—Construction of electron-discharge-tube with a mercury-pool cathode.

Westinghouse Electric International Co. Convention date (U.S.A.) 17th June, 1942.

567 718.—The provision in a cathode-ray or like discharge tube of an auxiliary pellet of barium for the purpose of replenishing the barium content of the cathode.

The General Electric Co. Ltd. and L. Jacob. Application date 21st May, 1943

567 860.—Symmetrical spacing and arrangement

of the magnetic pole pieces surrounding an electron-multiplier tube.

The Mullard Radio Valve Co. Ltd. and R. W. Kersey. Application date 30th August, 1943.

567 889.—Electrode arrangement designed to produce a beam effect in order to improve the mutual conductance of a mixing valve.

Philips Lamps Ltd. (communicated by N. V. Philips' Gloeilampfabrieken). Application date 29th April, 1943.

567 971.—Graphite or like layer interposed between a valve and an electrostatic screen in order to minimise undesirable heating.

G. Liebmann and Cathodeon Ltd. Application date 29th October, 1942.

568 121.—Spacing and arrangement of the electrode system of a cathode-ray tube, including the alignment of the deflecting plates.

J. R. Hunt. Application date 12th July, 1940.

568 122.—Process for making certain insulator components in the manufacture of thermionic valves, wherein a temporary core is subsequently required to be completely destroyed by heat.

The M-O Valve Co. Ltd. and J. H. Partridge. Application date 27th December, 1940.

568 208.—Coating of titanium dioxide for moderating the normal operating temperature of the anode of a power valve.

The M-O Valve Co. Ltd. and L. R. E. Windsor. Application date 18th June, 1943.

568 259.—Electron microscope with means to facilitate the insertion and withdrawal of objects under examination without undue disturbance of the overall evacuation of the tube.

The British Thomson-Houston Co. Ltd. Convention date (U.S.A.) 19th September, 1941.

568 411.—Assembling and spacing the electrodes of a valve by the use of clamping devices which form a permanent part of the valve structure.

B. Erbner. Application date 29th March, 1943.

568 437.—Arrangement of clamps for holding the various electrodes of a valve in accurate alignment.

(Divided from 568 411). B. Erbner. Application date 29th March, 1943.

568 452.—Construction and arrangement of the sealing stem and lead-in conductors of an electron discharge tube, particularly of the cathode-ray type.

Standard Telephones and Cables Ltd. and W. R. Moscrip. Application date 24th September, 1943.

568 494.—Fluorescent device for giving a visual indication of the fact that the normal discharge current is flowing through a thermionic valve.

T. Williams. Application date 22nd November, 1943.

568 572.—Electron-lens system for a cathode-ray tube in which three tubular electrodes are arranged to produce a saddle-shaped field, free from undesired space-charges.

O. E. H. Klemperer (commonly known as O. Klemperer). Application date 2nd January, 1942.

568 698.—Process for cementing the cap to a thermionic valve by induction heating so as to avoid blistering.

The M-O Valve Co., Ltd. and H. S. Smith. Application date 26th May, 1943.

568 962.—High-emission cathode in which a mixture of thorium-oxide and powdered tungsten is sintered on to a core of tantalum.

Marconi's W. T. Co., Ltd. (assignees of L. P. Garner). Convention date (U.S.A.) 6th October, 1942.

568 968.—Producing a high vacuum by a process in which ionisation by X-ray or gamma-ray bombardment is combined with ionic migration due to an applied electric field.

J. W. Tills; J. B. Lovatt; and F. C. Potts. Application date 12th November, 1943.

569 048.—Making and processing spiral cathodes so as to prevent subsequent deformations of the windings, particularly in short-wave valves.

Standard Telephones and Cables, Ltd. (assignees of L. C. Goodale). Convention date (U.S.A.) 11th March, 1942.

569 150.—Two-stage process of making a metal-to-glass seal, particularly for large-sized vacuum tubes.

Standard Telephones and Cables, Ltd. and T. W. Wingent. Application date 2nd November, 1943.

569 197.—Offsetting space-charge effects and maintaining a constant focus throughout the operating range of an X-ray tube.

The British Thomson-Houston Co., Ltd. (communicated by the General Electric Co.). Application date 16th July, 1943.

SUBSIDIARY APPARATUS AND MATERIALS

567 485.—Construction of condenser and terminals suitable for use in a short-wave filter network.

Tobe Deutschmann Corp. Convention date (U.S.A.) 18th May, 1943.

567 491.—Photo-electric system utilising polarised light for the generation of musical or other sound waves having a predetermined content of harmonic frequencies.

International Polaroid Corpn. Convention date (U.S.A.) 16th September, 1940.

567 571.—Frequency meter which indicates the value of the D.C. current produced by applying the opposite phases of an A.C. input to two alternately-conducting valves.

The General Electric Co. Ltd. and F. C. F. Phillips. Application date 26th December, 1941.

567 572.—Frequency meter in which the consecutive digits of the numerical value of the frequency under test are separately ascertained by a process of heterodyning against a series of standard frequencies.

The General Electric Co. Ltd. and F. C. F. Phillips. Application date 29th December, 1941.

567 588.—Terminal connections for the closed ends of a rolled-paper type of condenser.

P. A. Sporing and The Telegraph Condenser Co. Ltd. Application date 9th August, 1943.

567 597.—Variable condenser in which movable electrodes co-operate with a solid dielectric containing a mixture of conducting particles.

The Mullard Radio Valve Co. Ltd. and C. L. Richards. Application date 25th June, 1943.

567 601.—Rotary-commutator type of contact breaker for generating a steady high voltage by

transformer action from a low-voltage source.

Stackpole Carbon Co. Convention date (U.S.A.) 8th May, 1942.

567 602.—Arrangement of a slit rubber disc to serve as an automatic vent for the gases generated in an electrolytic condenser.

P. A. Sporing; C. P. Johnson; and The Telegraph Condenser Co. Ltd. Application date, 9th August, 1943.

567 633.—High-speed relay for counting electric impulses under the control of a resistance-capacitance circuit of given time-constant. (Addition to 471 987).

Siemens Bros. & Co. Ltd. and D. P. Long. Application date 10th December, 1943.

567 639.—Cross-shaped arrangement of four cylindrical conductors, three of which serve as adjustable transmission-line elements, for use in making high-frequency measurements. (Divided from 567 637).

H. E. Holman and E. C. Cork. Application date 17th December, 1940.

567 863.—Impulse-counting apparatus comprising a closed chain of gas-filled discharge-tubes which are flashed and blocked in definite sequence.

Standard Telephones and Cables Ltd; F. H. Bray; and L. R. Brown. Application date 31st August, 1943.

567 993.—Spade or plug type of terminal in which the wire is gripped between a non-threaded shaft and sleeve.

A. Baily and The Castle Fuse and Engineering Co. Ltd. Application date 16th June, 1943.

568 400.—Telemeter circuit in which the movement of one pointer is repeated by a second through a follow-up device which regulates the grid potential of a control valve.

Standard Telephones and Cables Ltd. and C. H. Chambers. Application date 28th September, 1943.

568 418.—Composition and processing of permanent-magnet alloys of the Cu-Ni-Co type plus a small content of lead.

The British Thomson-Houston Co. Ltd. Convention date (U.S.A.) 24th July, 1942.

568 446.—Valve stabilising circuit for deriving a constant voltage, which is independent of the load, from a fluctuating supply.

The Mullard Radio Valve Co. Ltd. and A. J. H. van der Ven. Application date 22nd July, 1943.

568 554.—Impedance-measuring bridge with a self-balancing arrangement of two motors, one being controlled by the in-phase, and the other by the quadrature component of the output voltage.

J. H. Reyner; Furzehill Laboratories, Ltd.; and S. Smith & Sons (Motor Accessories), Ltd. Application date 11th October, 1943.

568 556.—Frequency-dividing circuit of the multi-vibrator type for generating a stable frequency greater than ten times that of the input.

Westinghouse Electric International Co. Convention date (U.S.A.) 22nd October, 1942.

568 622.—Signalling system giving continuous visual indications of the controlled progress of incoming and outgoing traffic at an aerodrome.

Automatic Telephone and Electric Co., Ltd. and L. M. Simpson. Application date 9th October, 1943.

ABSTRACTS AND REFERENCES

Compiled by the Radio Research Board and published by arrangement
with the Department of Scientific and Industrial Research

Comparative Length of the Abstracts.—It is explained to new readers that the length of an abstract is no sign, by itself, of the importance of the work concerned. An important paper in English may be dealt with by a short abstract, or even, if it is in a journal readily obtainable, by a square-bracketed addition to the title; while a paper of similar importance in a language other than English may be given a long abstract. In addition to these questions of language and accessibility, the nature of the work has, of course, a great effect on the useful length of its abstract.

	PAGE
Propagation of Waves	504
Atmospherics and Atmospheric Electricity ...	505
Properties of Circuits	505
Transmission	507
Reception	507
Aerials and Aerial Systems	508
Valves and Thermionics	509
Acoustics and Audio-Frequencies	510
Phototelegraphy and Television	510
Measurements and Standards	511
Subsidiary Apparatus and Materials	513
Stations, Design and Operation	515
General Physical Articles	516
Miscellaneous	516

PROPAGATION OF WAVES

3250. ELECTROMAGNETIC FIELD INSIDE A CYLINDER WITH A GAP.—C. C. Wang. (*Journ. Applied Phys.*, June, 1945, Vol. 16, No. 6, pp. 351-366.)

The paper gives the development of the complete equations for the fields inside a hollow metallic cylinder, excited through a gap, in terms of an assumed field at the gap, for frequencies below the lowest cut-off frequency for the transverse magnetic type. The equations are illustrated by curves, which can be used to estimate the field-strength at points inside the cylinder. The equivalent capacitance corresponding to the actual energy-storage in the cylinder can be calculated and used for estimating the resonant frequency of the cavity. "The equations can be degenerated to an electrostatic form and used for electron-optical calculations."

3251. STANDARDS ON RADIO WAVE PROPAGATION [Definitions of Terms Relating to Guided Waves].—I.R.E. Publication, 1945.

3252. MICROWAVE RADIATION FROM THE SUN.—G. C. Southworth. (*Journ. Franklin Inst.*, April 1945, Vol. 239, No. 4, pp. 285-297.)

Theoretical and experimental work on black-body radiation is first briefly described, with special

reference to the sun, and the possibility of the existence of radiation at radio wavelengths. Johnson thermal-agitation noise in resistances is then considered, and its application to the radiation resistance of aerials. Solar noise can be regarded as either a form of resistance noise in the aerial or black-body radiation from the sun.

Experiments on three wavelengths in the range 1 cm to 10 cm are described. Using a highly directive aerial connected to a conventional receiver it was found that the noise was least with the aerial directed towards the open sky. When directed towards the sun the noise increased; at the longest wavelength the measured value was 3 per cent below that calculated by the Rayleigh-Jeans formula. At the other wavelengths agreement between theory and experiment was less close. The possible reasons for this are discussed, and the need for further work using more refined apparatus is suggested.

3253. SOLAR ECLIPSE OBSERVATIONS: EFFECTS ON THE IONISATION OF THE E AND F LAYERS.—(*Wireless World*, August 1945, Vol. 51, No. 8, p. 240.)

Observations taken at Datchet for the Radio Research Board during the solar eclipse of 9th July, 1945.

3254. ECLIPSES OF THE SUN.—R. K. Marshall. (*Journ. Franklin Inst.*, April 1945, Vol. 239, No. 4, pp. 299-324.)

A comprehensive account of solar eclipses: the frequency of eclipses and their predictions, from 747 B.C. to the present day: types of eclipse, corona, and solar prominences: sun-spots and their effects: brief mention of the possibility of observing some phenomena during normal conditions which could hitherto only be detected during an eclipse.

3255. A PHYSICAL THEORY OF THE SOLAR CORONA.—M. Saha. (*Proc. Phys. Soc.*, 1st July 1945, Vol. 57, Part 4, No. 322, pp. 271-286.)

The line $\lambda 686$ of ionised helium which occurs as a low-level chromospheric line in the solar spectrum is inexplicable by the thermal ionisation theory. It is suggested that α -particles produced by some nuclear process at the sun's surface are projected into the solar atmosphere and after cap-

turing an electron become He^+ which can radiate $\lambda 686$.

The coronal lines which are mostly due to highly ionised atoms of Fe, Ni and Ca, are very broad at the base and cannot be explained by the meteoric flash theory. It is suggested that the ions responsible are produced by a fission process similar to that of ^{235}U by neutrons, which yields two lighter atoms which are highly ionised and fly off with high energy (~ 200 MeV total). Bohr and Wheeler have shown that only heavy nuclei are capable of fission, but the presence of these in the sun is not impossible.

Dirac has suggested that the β -rays emitted by the unstable fission products may be the high-energy electrons (5 to 10 MeV) responsible for auroral phenomena.

"It is the view of the present author that . . . prominences, spots, flares giving rise to radio fade-outs may find their explanation in nuclear reactions taking place vigorously on limited parts of the surface."

3256. THE GEOGRAPHIC INCIDENCE OF AURORA AND MAGNETIC DISTURBANCE, SOUTHERN HEMISPHERE.—E. H. Vestine & E. J. Snyder. (*Terr. Mag. & Atmos. Elec.*, June 1945, Vol. 50, No. 2, pp. 105-124.)

3257. "THE VELOCITY OF LIGHT" [Book Review].—N. E. Dorsey. (*Proc. Phys. Soc.*, 1st July 1945, Vol. 57, Part 4, No. 322, pp. 369-370.)
"The best value for the velocity of light is given as 29977_3 km/sec in a vacuum, with a dubiety of ± 10 km/sec."

ATMOSPHERICS AND ATMOSPHERIC ELECTRICITY

3258. LIGHTNING PROTECTION OF BURIED TOLL CABLE.—E. D. Sunde. (*Bell S. Tech. Journ.*, April 1945, Vol. 24, No. 2, pp. 253-300.)

Author's summary:—"A theoretical study of lightning voltages in buried telephone cable, of the liability of such cable to damage by lightning and of remedial measures, together with the results of simulative surge tests, oscillographic observations of lightning voltages and lightning trouble experience."

PROPERTIES OF CIRCUITS

3259. CAVITY RESONATORS.—W. Daellenbach. (*Electronic Industries*, April 1945, Vol. 4, No. 4, pp. 104-105, 162.) Abstracted from *Hochf. tech. u. Elek. Akus.*, May 1943, Vol. 61, No. 5. See 29 of 1944.

3260. WIDE-RANGE TUNED CIRCUITS AND OSCILLATORS FOR HIGH FREQUENCIES [Butterfly Circuits].—E. Karplus. (*Proc. I.R.E.*, July 1945, Vol. 33, No. 7, pp. 426-441.)

Author's summary:—"Tuned circuits for frequencies from 100 to 1000 Mc/s. are described, which combine the mechanical simplicity and compactness of low-frequency coil-capacitor circuits with electrical performance suitable for very-high-frequency and ultra-high-frequency applications. Tuning ranges of 4 to 1 are readily obtained, both with and without sliding contacts. Application of the circuits in negative-grid-triode oscillators is discussed."

3261. STABILISATION OF FEEDBACK OSCILLATORS.—H. Jefferson. (*Wireless Engineer*, August 1945, Vol. 22, No. 263, pp. 384-389.)

"The test for stability of a feedback oscillator is performed by considering the feedback circuit alone. The equations relating input and output voltages and currents for this network are written down in standard form, having been derived by any convenient method . . . the resulting equations give the frequency of oscillation and the conditions for stability."

3262. PIEZOELECTRIC CRYSTALS IN OSCILLATOR CIRCUITS.—Fair. (See 3324.)

3263. THE MEASUREMENT OF THE PERFORMANCE INDEX OF QUARTZ PLATES.—Harrison. (See 3325.)

3264. TUNED-CIRCUIT, PARALLEL-RESISTANCE SUBSTITUTION APPARATUS FOR MEASUREMENTS ON BALANCED-PAIR CABLES AT FREQUENCIES UP TO 10 MC/s.—Simmonds. (See 3322.)

3265. DUAL-TRIODE TRIGGER CIRCUITS.—B. E. Phelps. (*Electronics*, July 1945, Vol. 18, No. 7, pp. 110-113.)

"Non-mathematical step-by-step description of the operation of the Eccles-Jordan trigger circuit, with practical suggestions for making the circuit distinguish between positive and negative pulses, and other helpful design data."

3266. TIME-BASE CONVERTER AND FREQUENCY DIVIDER.—H. Moss. (*Wireless Engineer*, August 1945, Vol. 22, No. 263, pp. 368-372.)

Author's summary:—"A circuit is described which converts any arbitrary repetitive wave form into its own time base. The time base is essentially of the driven type and employs no metastable oscillators or trigger devices. This feature ensures a stability of a very high order. The circuit is fundamentally a frequency divider and may find its greatest use as such rather than as a time base."

3267. THE PERFORMANCE AND MEASUREMENT OF MIXERS IN TERMS OF LINEAR-NETWORK THEORY.—L. C. Peterson & F. B. Llewellyn. (*Proc. I.R.E.*, July 1945, Vol. 33, No. 7, pp. 458-476.)

Authors' summary:—"This paper discusses the properties of mixers in terms of linear-network theory. In Part I the network equations are derived from the fundamental properties of nonlinear resistive elements. Part II contains a résumé of the appropriate formulas of linear-network theory. In Part III the network theory is applied, first to the case of simple nonlinear resistances, and next to the more general case where the nonlinear resistance is embedded in a network of parasitic resistive and reactive passive-impedance elements. In Part IV application of the previous results is made to the measurement of performance properties. The 'impedance' and the 'incremental' methods of measuring loss are contrasted, and it is shown that the actual loss is given by the incremental method when certain special precautions are taken, while the impedance method is in itself incomplete."

3268. STABILISED NEGATIVE IMPEDANCES: PART I.—E. L. Ginzton. (*Electronics*, July 1945, Vol. 18, No. 7, pp. 140-144, 146, 148, 150.)

Negative impedance is produced from a positive impedance of the desired type by positive feedback through an amplifier stabilised with negative feedback. In this way negative resistance, capacitance and inductance can be produced as circuit elements. Part I deals with basic ideas and fundamental equations. Parts II and III to be published will deal with effects on negative feedback of variations in amplifier frequency parameters, and with illustrative applications. Good bibliography appended.

3269. SIGNAL/NOISE RATIO [Letter on Callendar's letter (1751 of June) concerning Burgess's Paper "Triode Input Circuits" (1038 of April)].—R. E. Burgess: Callendar. (*Wireless Engineer*, August 1945, Vol. 22, No. 263, p. 389.)

Points out that Callendar's comments relate primarily to frequencies higher than those considered by Burgess. A complete theory of noise in the space-charge limited triode will need to take into account the effects of transit time and of internal valve leads.

3270. ARTIFICIAL DELAY-LINE DESIGN.—J. B. Trevor, Jr. (*Electronics*, June 1945, Vol. 18, No. 6, pp. 135-137.)

Author's summary:—"Design of artificial line for signal delay is facilitated by a chart. Permissible delay per section is determined from equations on the basis of tolerable distortion of the signal by the line. This information is used with the chart to determine line components."

3271. OPTIMUM VALVE LOAD: UNIFIED TREATMENT FOR DIFFERENT OPERATING CONDITIONS.—E. Hughes. (*Wireless World*, August 1945, Vol. 51, No. 8, pp. 246-247.)

3272. VALVE VECTORS [Author's Reply to Critics of His Paper "Valve Vectors" (2179 of July): Misconceptions due to Mistake in Drawing; Conventional Alternative Treatment given by R. G. Wood].—K. R. Sturley. (*Wireless Engineer*, August 1945, Vol. 22, No. 263, pp. 390-391.)

3273. BASIC THEORY AND DESIGN OF ELECTRONICALLY REGULATED POWER SUPPLIES.—A. Abate. (*Proc. I.R.E.*, July 1945, Vol. 33, No. 7, pp. 478-482.)

Author's summary:—"Various types of electronic regulator circuits are discussed and an analysis is made of the degenerative or cathode-follower type, since it offers the most in flexibility and regulation. Equations are derived showing the theoretical output voltage, regulation characteristics, and output impedance for the basic circuit. Practical design considerations evolved from these equations show the desirability of high-transconductance series-control tubes and high gain in the amplifier section.

"A complete circuit is presented for a multiple-output regulator which, by combining regulated sections in opposition, covers the range of 0 to 500 volts. The design is such that a single rectifier and filter are supplying constant current throughout the selected range of output current. This

effectively eliminates from consideration the usual regulation introduced by the latter components.

"Curves are included showing actual regulation characteristics for several combinations of output voltage and current."

3274. ANALYSES OF THE VOLTAGE-TRIPLING AND QUADRUPLING RECTIFIER CIRCUITS.—D. L. Waidelich & H. A. K. Taskin. (*Proc. I.R.E.*, July 1945, Vol. 33, No. 7, pp. 449-457.)

Authors' summary:—"The analyses presented for both the voltage-tripling and quadrupling rectifier circuits have been made, the chief assumption being that of zero potential across the tubes when conducting. The characteristics obtained from the analyses and checked experimentally include those of the output direct voltage and the per cent ripple. These characteristics are useful in the design of the circuits and in predetermining their performance."

3275. COMPUTING MUTUAL INDUCTANCE.—M. J. di Toro. (*Electronics*, June 1945, Vol. 18, No. 6, pp. 144, 146, 148.)

Author's summary:—"Chart gives a factor from which the mutual inductance of two coaxial circular coils can be readily determined by a simple multiplication."

3276. MUTUAL INDUCTANCE: SIMPLIFIED CALCULATIONS FOR CONCENTRIC SOLENOIDS.—A. J. Maddock. (*Wireless Engineer*, August 1945, Vol. 22, No. 263, pp. 373-383.)

"This paper is concerned with the case of two concentric solenoids symmetrically disposed about their common centre-line and by means of curves it is possible to reduce the calculations to a simplicity comparable with that of determining self-inductance. . . . Some notes are appended on the design of coupling coils covering the cases of obtaining (i) maximum mutual inductance, (ii) maximum coefficient of coupling (k), (iii) maximum step-up ratio of current, (iv) maximum variation of inductance, as in variometers.

"To obtain maximum mutual inductance, maximum k , greatest step-up ratio, or greatest variation of inductance keep the ratio of coil diameters as near unity as possible and the lengths of inner and outer coils the same. For highest value of k , greatest step-up ratio or greatest variation of inductance keep the length-to-diameter ratio not less than 0.7."

3277. ELECTROMECHANICAL ANALOGIES AND THEIR USE FOR THE ANALYSIS OF MECHANICAL AND ELECTROMECHANICAL SYSTEMS.—A. Bloch. (*Journ. I.E.E.*, Part I, April 1945, Vol. 92, No. 52, pp. 157-169.)

Author's summary:—"After some introductory remarks which outline the problem and special features of its treatment, Section 3 explains how complex notation and the impedance concept can be applied directly to the analysis of mechanical systems. This leads naturally to the first or 'direct' method of constructing an electrical 'model' of a mechanical system, where a mechanical force is represented by a voltage and a mechanical velocity by a current; a mechanical impedance, i.e. the ratio of a force to a velocity is then represented by a proportional electrical impedance. In this analogy a mass is represented by an inductance. It is shown that this representation,

when established for one particular frequency, is valid for all other frequencies.

"Section 4 shows that there exists a perfectly consistent, alternative method of constructing such an electrical model in which all these correspondences are replaced by their dual counterparts and which is therefore called the 'indirect' or 'inverse' analogy. A mechanical force is here represented by an electric current and a mechanical velocity by a voltage. Accordingly, a mechanical impedance is then represented by an electrical admittance of proportional magnitude; in particular a mass is represented by a capacitance. This analogy has the advantage that it enables a circuit diagram of the electrical model to be copied from the diagram of the mechanical system, if this is drawn in accordance with certain conventions. The circuit diagram found by this method is the dual of the circuit found by the first method, and as it is a routine procedure to draw the dual of a given network the second analogy may also be useful when utilising the first type of analogy.

"The paper supplements the development of this method by showing how levers fall into the general scheme of this geometrical correspondence, if they are interpreted as auto-transformers. It also shows how the circuits of both these analogies may be found with advantage by an alternative method, by a 'method of successive generalisation' of simplified systems—again without the need of establishing the equations of performance of the system. When the circuit of the inverse analogy cannot be drawn in a plane without crossing between its branches certain difficulties arise, the solution of which is dealt with in a separate paper.

"In Section 5, combined electrical and mechanical systems are discussed. If the mechanical system is represented by an electrical model, then the electromechanical convertor which links it to the electrical system can usually be replaced by a passive electrical four-terminal network—provided the right type of analogy is chosen for constructing the model; we arrive thus at a purely electrical system. The type of analogy to be chosen is the direct one if the electromechanical convertor utilises the action of electrostatic forces, and the inverse analogy if the convertor utilises electromagnetic forces.

"Two appendices give examples of the application of these methods to the treatment of purely mechanical and of electromechanical systems."

TRANSMISSION

3278. REFLEX OSCILLATORS [Discussion].—Pierce. (See 3299.)
3279. A CRYSTAL-CONTROLLED 112 Mc/s MOBILE TRANSMITTER.—R. A. Waters. (*QST*, July 1945, Vol. 29, No. 7, pp. 41–44.)
3280. HIGH-FREQUENCY TRANSMISSION.—D. H. Ray. (*Journ. I.E.E.*, Part I, March 1945, Vol. 92, No. 51, pp. 133–134.)

The behaviour of transmission lines at power, telephone, and radio frequencies is briefly discussed. At power frequencies the voltage and current are governed mainly by the resistance and inductance, and there is a phase change along the line dependent on the frequency and velocity of propagation. At telephone frequencies the shunting effect of leakage and capacitance are important, and variation of

reactance with frequency complicates the problem. At radio frequencies the phase change is usually the predominating factor and standing waves are produced. It becomes essential, if efficient transmission of power is required, to match the termination to the characteristic impedance of the line.

3281. TECHNICAL DEVELOPMENTS IN LONG-DISTANCE TELECOMMUNICATIONS: [Multiplex Transmission: Problems for the Rio de Janeiro Conference: Short Account of Paper Read to the Société des Radioélectriciens].—G. Rabuteau. (*Génie Civil*, 15th April 1945, Vol. 122, No. 8, p. 63.)
3282. "RADIO RECEIVERS AND TRANSMITTERS" [Book Review].—S. W. Amos and F. W. Kellaway. (*Nature*, 23rd June 1945, Vol. 155, No. 3947, p. 743.)
3283. "RADIO TECHNIQUE" [Book Review].—A. G. Mills. (*Nature*, 23rd June 1945, Vol. 155, No. 3947, p. 743.)

RECEPTION

3284. F. M. CONVERTERS [Permit Reception in the Proposed New Band 84–102 Mc/s on Pre-War F. M. Receivers Built for the Old Band 42–50 Mc/s].—Hallicrafters Company. (*Scient. American*, August 1945, Vol. 173, No. 2, p. 113.)
3285. THE ALIGNMENT OF F. M. RECEIVERS [Apparatus Required and Methods of Use].—M. Besson. (*Toute la Radio*, June 1945, No. 2, pp. 7–9.)
3286. ARMY SET—TYPE RIO7: COMMUNICATIONS RECEIVER COVERING 1.2–17.5 Mc/s.—(*Wireless World*, August 1945, Vol. 51, No. 8, pp. 235–238.)
3287. SINGLE-VALVE REFLEX RECEIVER.—G. F. (*Funk*, 1st/15th March 1943, pp. 81–83; Abstract in *Revista de Formacion y Documentacion Profesional* [Spanish], 1945, Year IV, No. 10, p. 51.)

An economical arrangement in most cases equal in tone-quality, but not in output, to a multi-valve receiver. Any type of five-electrode valve is suitable and variations of this arrangement are given.

3288. THERMAL STABILITY IN RECEIVER OSCILLATORS.—R. R. Batcher. (*Electronic Industries*, April 1945, Vol. 4, No. 4, pp. 96–97, 180, 182, 184.)

Part I of a survey of the common causes of frequency drift in receivers. The effects of temperature changes on the spacing and area of the plates of the oscillator tuning condenser are discussed. The choice of material for the plates and for the spacers to minimise temperature effects is considered. To be continued.

3289. "RADIO RECEIVERS AND TRANSMITTERS" [Book Review].—S. W. Amos and F. W. Kellaway. (*Nature*, 23rd June 1945, Vol. 155, No. 3947, p. 743.)
3290. "RADIO TECHNIQUE" [Book Review].—A. G. Mills. (*Nature*, 23rd June 1945, Vol. 155, No. 3947, p. 743.)

AERIALS AND AERIAL SYSTEMS

3291. THEORY AND PERFORMANCE OF CORNER REFLECTORS FOR AERIALS.—E. B. Moullin. (*Journ. I.E.E.*, Part III, June 1945; Vol. 92, No. 18, pp. 58-67; Discussion pp. 80-85.)

Author's summary:—"The paper opens by arguing that the problem of constructing a highly directive aerial system is dominated by the difficulty of providing the necessary feeding cables. Continuous reflecting sheets are used as a device for reducing the number of such cables. A construction which readily suggests itself is a pair of sheets inclined to one another to form a V, with a single aerial on the bisector, more especially because the field would be known everywhere if the sheets extended to infinity. For the field of an aerial in a V can be calculated by image treatment, and an algebraic formula for the diffraction pattern can be found when the angle of the V is a proper fraction of 180°. It is shown that such algebraic expression can be expanded in a Fourier series which has the same form for all angles of the V and has coefficients which are the Bessel functions J_N , J_{3N} , J_{5N} , etc. It follows at once from this expansion that the ideal pattern must be indistinguishable from a simple sine curve unless the circumferential width across the V at the aerial exceeds $\frac{1}{2}\lambda$, and will not differ appreciably from a sine curve unless this width is verging on $3\lambda/2$. Recognition of this general condition is very valuable in practice and saves much wasted effort in laborious computation. A numerical example illustrates the convenience of the Fourier series for evaluating the pattern when the aerial is sufficiently distant from the apex to make the main beam much sharper than a sinusoid, and concurrently to produce side lobes.

"The second part of the paper describes an experimental investigation, at a wavelength of about 1.25 m. of the equatorial pattern produced by a half-wave aerial on the bisector of a V formed by two sheets, $3\lambda/2$ high and about 2λ wide, inclined at 90°, 60° or 45°. The purpose of the experiments was to compare the observed pattern with the "ideal pattern" appropriate to infinite sheets: they are restricted to the range in which the ideal pattern differs insensibly from a simple sinusoid. Sheets 2λ wide produce a beam narrower than the ideal when inclined at 90°, and wider than the ideal when inclined at 60°. If the sheets are 2λ wide then the best angle between them is about 60°.

"Experiment shows the pattern is not modified appreciably if the apex of the V is amputated and the resulting hole closed by a flat sheet. Such an amputation affords a saving of space and also shows that the pattern is insensitive to the shape of the back of the reflector: therefore it is not necessary to construct V reflectors to close tolerances of manufacture. Moreover, the optical concept of the advantage of a concave mirror does not apply when the source is distant only some $\frac{1}{2}\lambda$ from it.

"Experiment shows that the pattern is affected insensibly by replacing continuous sheets by wire netting whose mesh has a side of about $\lambda/40$.

"Experiment also shows that the continuous sheets can be replaced by a comb of open rods, about $\frac{1}{2}\lambda$ long, without appreciable detriment to the pattern. A blunt resonance effect occurs when the frequency is such as to make the rods precisely $\frac{1}{2}\lambda$ long, but such as it is this resonance is undesirable. The distribution of current in a flat

reflecting sheet is solved analytically in Appendix II.1."

3292. THE MEASURED PERFORMANCE OF HORIZONTAL DIPOLE TRANSMITTING ARRAYS.—H. Page. (*Journ. I.E.E.*, Part III, June 1945, Vol. 92, No. 18, pp. 68-79; Discussion pp. 80-85.)

Author's summary:—"Measurements of the performance of the horizontal dipole arrays are described, and are compared with the theoretical performance under ideal conditions. The measurements include polar diagrams, the effect of ground slope and radiation through other arrays, and the performance over a frequency band of ± 2 per cent relative to the design frequency, which is typical of the width of existing short-wave broadcasting bands.

"One method of measurement consisted in elevating a calibrated frame receiving aerial using a captive balloon; by varying the height and position of the balloon, the field strengths in different directions from the array were measured. In the second method a frame aerial at ground level was used; this gave only relative values of field strength and was used mainly to determine the frequency characteristic:

"It was found that for an array radiating over a flat site free from obstacles there was good agreement between the theoretical and measured performance; the maximum field strength was of the order of 0.8-0.9 of the theoretical value. A sloping site or radiation through other near-by arrays, however, may cause appreciable departures from the theoretical characteristics.

"An array having no reflector curtain covers the frequency band of ± 2 per cent without appreciable loss in radiation efficiency. This is also true for an array with a parasitic reflector curtain which is tuned to the working frequency. If, however, the reflector is tuned always to the mid-band frequency, the radiation efficiency at other frequencies is reduced. The band-width can be increased by reducing the characteristic impedance of the dipoles, and measurements have been made on two types, one consisting of single wires and the other of two parallel wires spaced 6 inches apart. For an array of four rows of single-wire dipoles, the band-width is ± 1 per cent for a 10 per cent drop in field strength relative to the mid-band frequency; for a similar array of two-wire dipoles the corresponding band-width is ± 2 per cent. The band-width of arrays containing less than four rows is approximately the same."

3293. A PRETUNED TURNSTILE ANTENNA.—G. H. Brown & J. Epstein. (*Electronics*, June 1945, Vol. 18, No. 6, pp. 102-107.)

The antenna is designed to give a circular horizontal pattern and low angle vertical radiation. The method of adjusting for symmetry of radiation and for an impedance match to the feeders is described. The system used enables the radiator structure to be connected metalically to the mast and thus earthed against lightning, and heaters are provided to prevent icing.

3294. AERIALS FOR USE ON AIRCRAFT: A COMPARISON BETWEEN FIXED AND TRAILING TYPES ON THE 900-METRE WAVEBAND.—C. B. Bovill. (*Journ. I.E.E.*, Part III,

June 1945, Vol. 92, No. 18, pp. 105-115: Discussion pp. 115-119.)

Author's summary:—"Although trailing aeriels have been used satisfactorily on aircraft for many years, the increasing speeds of modern aircraft have made it necessary to discard them in favour of fixed aeriels. The paper reviews briefly the past development of aircraft aeriels, and describes an investigation into the characteristics of the two types which was designed to provide data on which the design of equipment for medium-frequency operation on fixed aeriels could be based. Measurements on typical examples of both types are described, and the values of effective height, radiation resistance, loss resistance and capacitance are discussed and compared. The increase in transmitter power which would be necessary in order to obtain the same performance with a fixed aerial as that formerly obtained with a trailing aerial is calculated. Some particulars are given of equipment which goes some way towards meeting this requirement, and an estimate is made of its probable performance. Possible future developments in aircraft aeriels for medium frequencies are discussed."

3295. THE RADIATION RESISTANCE OF A MISTUNED DIPOLE AERIAL.—G. W. O. H. (*Wireless Engineer*, August 1945, Vol. 22, No. 263, pp. 365-367.)

An approximate analysis for the cases when the wavelength is 4 times, $1\frac{1}{2}$ times, and equal to, the length of aerial. See 1802 of June for a similar analysis of a tuned aerial.

3296. RADIO ANTENNA SUSPENDED FROM 1000 FT. TOWERS. [Discussion on Wind Pressure, Station Layout, Design of Antenna, Guys and Towers].—J. Feld. (*Journ. Franklin Inst.*, May 1945, Vol. 239, No. 5, pp. 363-389.)

3297. CALCULATIONS FOR ANTENNA ORIENTATION [Mathematical Formulas for Azimuth and Distance Calculations].—W. E. Marquart. (*QST*, July 1945, Vol. 29, No. 7, pp. 46-47.)

VALVES AND THERMIONICS

3298. "ELEKTRISCHE SCHWINGTÖPFE UND IHRE ANWENDUNG IN DER ULTRAKURZWELLEN VERSTÄRKERTECHNIK" [Klystrons and Their Use in Ultra-Short-Wave Amplification: Book Review].—A. de Quervain. (*Wireless World*, August 1945, Vol. 51, No. 8, p. 242.) "The thesis is well prepared and should appeal to anyone interested in klystrons."

3299. REFLEX OSCILLATORS [Discussion].—J. R. Pierce. (*Proc. I.R.E.*, July 1945, Vol. 33, No. 7, pp. 483-485.)

A discussion on the paper by Pierce. (See 1435 of May.) The contributors to the discussion take exception to the author's suggestion that the modern reflex oscillator, or reflex klystron, is a modified form of Barkhausen oscillator. The author in his reply defends his contention: "... in negative plate Barkhausen tubes ... the electron stream does become velocity modulated and bunched and does deliver energy to the circuit." His remarks should not be taken to imply, however, that one particular device arose merely as a development of another.

3300. GRID EMISSION IN VACUUM TUBES.—H. E. Sorg & G. A. Becker. (*Electronics*, July 1945, Vol. 18, No. 7, pp. 104-109.)

"Causes and effects of primary and secondary emission are discussed. Emission photographs of various materials, taken with an electron microscope, are presented. Tests which resulted in the development of a special grid are described."

3301. THE ALIGNMENT OF GRIDS IN THERMIONIC VALVES.—C. S. Bull. (*Journ. I.E.E.*, Part III, June 1945, Vol. 92, No. 18, pp. 86-92.)

Author's summary:—"The system formed by the cathode, control grid and screen grid of a tetrode valve is considered from an electron-optical point of view. It is shown that the ratio of the screen current to the anode current, and its variation with grid bias, can be accounted for over the whole of the characteristic. The formulae developed yield the data required to obtain optimum performance under any given conditions."

"Attention is also given to the application of electron-optical considerations to the problem of noise in the so-called silent screen-grid valves, and also to an interesting filamentary-beam tetrode in which the screen current is kept low by the application of electron-optical principles different from those used in other aligned valves."

3302. THE "TELEION" [A Versatile Gas Discharge Relay Valve].—J. Reiss. (*Wireless World*, Aug. 1945, Vol. 51, No. 8, pp. 226-228.)

See 2816 of August for application of this valve to High-Speed Radio-Telegraphy.

3303. A FIGURE OF MERIT FOR ELECTRON-CONCENTRATING SYSTEMS.—J. R. Pierce. (*Proc. I.R.E.*, July 1945, Vol. 33, No. 7, pp. 476-478.)

Author's summary:—"Electron-concentrating systems are subject to certain limitations because of the thermal velocities of electrons leaving the cathode. A figure of merit is proposed for measuring the goodness of a device in this respect. This figure of merit is the ratio of the area of the aperture which, in an ideal system with the same important parameters as the actual system, would pass a given fraction of the cathode current to the area of the aperture which in the actual system does pass this fraction of the cathode current. Expressions are given for evaluating this figure of merit."

3304. SPACE CHARGE AND ELECTRON DEFLECTIONS IN BEAM TETRODE THEORY [Parts I and II: Formation of a Virtual Cathode: Deflection at the Control Grid: Deflection at the Screen].—S. Rodda. (*Electronic Eng'g*, June 1945, Vol. 17, No. 208, pp. 541-545; July, No. 209, pp. 589-592.)

3305. CONTRIBUTION TO THE TECHNIQUE OF MANUFACTURING TRANSMITTING VALVES [Recent Valve Improvements—Low-Inductance Grid Leads, Convexity of Bulb Facilitating Dissipation of Heat: H.F. Welding of Metals to Glass: Demountable Valves: Short Account of Paper Read to the Société des Radioélectriciens].—M. Matricon. (*Génie Civil*, 1st April 1945, Vol. 122, No. 7, p. 55.)

3306. VALVES IN THE SERVICES: TYPE DESIGNATIONS AND THEIR COMMERCIAL EQUIVALENTS.—(*Wireless World*, August 1945, Vol. 51, No. 8, pp. 232-234.)

ACOUSTICS AND AUDIO-FREQUENCIES

3307. CONDENSER MICROPHONE WITH GILDED CELLULOSE DIAPHRAGM [0.009 mm Thick: Requires Perfect Insulation, Uniform Tension and Adequate Suspension].—E. D. M. König. (*Funk*, 1st/15th March 1943, pp. 75-79: abstract in *Revista de Formacion y Documentacion Profesional* [Spanish], 1945, Year IV, No. 10, p. 52.)

3308. MOVING-COIL PICKUP DESIGN.—T. Lindenberg, Jr. (*Electronics*, June 1945, Vol. 18, No. 6, pp. 108-110.)

A moving coil pickup is described which has a high-frequency resonance at about 12 000 to 15 000 c/s, and the low-frequency resonance at about 18 c/s. The design provides reasonable mechanical strength and normal sensitivity while a needle pressure much lighter than usual is possible. A duralumin stylus, tipped with a diamond pin, actuates the coil which is wound on a split sleeve of silicon steel, and is supported by two plastic strips.

3309. MULTI-CHANNEL SOUND RECORDING ON FILM.—(*Electronic Industries*, April 1945, Vol. 4, No. 4, pp. 92-93, 158, 160.)

Description of the Recordograph system. The recording needle embosses parallel grooves on a continuous 50 ft belt of 35 mm film, giving a recording capacity of 5750 ft on each side. For voice recording at 40 ft/min about 5 hours continuous recording is obtained. Any of the 115 tracks can be selected and played back.

3310. THE ABC OF PHOTOGRAPHIC SOUND RECORDING [Variable Density and Variable Area Methods: Push-Pull Tracks: Noise Reduction: Film Characteristics and Processing: Copying: Miscellaneous Points of Technique: Comprehensive Bibliography].—E. W. Kellogg. (*Journ. Soc. Mot. Pict. Eng.*, March 1945, Vol. 44, No. 3, pp. 151-194.)

3311. SUPERSONIC BIAS FOR MAGNETIC RECORDING.—L. C. Holmes & D. L. Clark. (*Electronics*, July 1945, Vol. 18, No. 7, pp. 126-136.)

"Reasonable fidelity is possible at the present time. In order to get a system with low distortion, careful control of the bias field is necessary. The signal to noise ratio . . . is superior to that which is obtained from ordinary shellac disc recordings. It is not as good as can be obtained from the newest vertically-cut vinylite transcriptions . . . It seems feasible at the present time to produce recordings at 2.5 ft per second on 0.004 inch diameter wire which are reasonably flat from 70 to 6500 c/s."

3312. IMPROVED BASS FOR SMALL RADIOS.—Revelation Patents Holding Co. (*Electronics*, July 1945, Vol. 18, No. 7, pp. 224, 228, 232, 236, 240.)

Poor low-frequency response is an inherent characteristic of small receivers because it is not economically feasible to use speakers that have flat response at low frequencies. It is a physiological fact that combinations of odd harmonics of a low

frequency give the impression to the ear of the presence of that frequency even though the fundamental is absent. To take advantage of this behaviour, non-linearity is introduced only at low-frequencies into the output stage of the receiver, so producing chiefly third harmonic to which the speaker will readily respond.

3313. BASS BOOST [Compensation for Bass Cut in Recording].—G. Grammer. (*QST*, July 1945, Vol. 29, No. 7, pp. 35-38.)

3314. CHEAPER HEARING AIDS: SHOULD THEY BE SOLD BY WIRELESS DEALERS?—C. M. R. Balbi. (*Wireless World*, August 1945, Vol. 51, No. 8, pp. 241-242.)

3315. AUDIO MIXER DESIGN. [High- and Low-Impedance Circuits for Mixing Multiple Inputs to an Audio System].—R. C. Crane. (*Electronics*, June 1945, Vol. 18, No. 6, pp. 120-121.)

3316. SOUND WAVES IN ROOMS.—P. M. Morse & R. H. Bolt. (*Reviews of Modern Phys.* April 1944, Vol. 16, No. 2, pp. 69-150.)

Eight chapters, including geometrical room acoustics, general aspects of wave acoustics, acoustic impedance, steady-state sound in rectangular rooms, transient sound in rectangular rooms, perturbation calculations for rooms of various shapes, and free-wave calculations for rooms having random wave motion.

PHOTOTELEGRAPHY AND TELEVISION

3317. RECENT DEVELOPMENTS IN TELEVISION IN THE U.S.A. AND FRANCE [R.C.A. Orthiconoscope and its French Equivalent the Barthélemy Isoscope: Use of Decimetric Carrier Waves].—M. Adam. (*Génie Civil*, 1st March 1945, Vol. 122, No. 5, pp. 33-35.)

1000-line definition has already been reached in the laboratories of the Compagnie des Compteurs under R. Barthélemy, who considers that no insuperable obstacle to its operation in public service remains, though several years may be needed for experimental work in transmitter and receiver design, cables, relays, etc.

3318. D.C. PICTURE TRANSFER.—H. N. Kozanowski. (*Electronic Industries*, April 1945, Vol. 4, No. 4, pp. 106-107, 140, 142, 144.)

The use of direct current setting in television transmission to give the correct range of illumination in the picture is explained and methods for obtaining it are described. Improved receiver performance and better utilisation of transmitter power result from its use.

3319. DEFINITION IN THE CINEMA: ASSESSMENT OF OPTICAL STANDARDS FOR TELEVISION.—H. W. Lee. (*Wireless World*, August 1945, Vol. 51, No. 8, pp. 238-239.)

"A definition represented by 600 lines is probably the highest the eye could appreciate under the most exacting conditions and this is probably within the range of resolution of the finest grain film that is used."

3320. BASIC PHOTOCHEMISTRY [Principles, Laws, Types of Photochemical Reaction].—A. Boutaric. (*Génie Civil*, 1st April 1945, Vol. 122, No. 7, pp. 51-53.)

MEASUREMENTS AND STANDARDS

3321. U.H.F. IMPEDANCE MEASUREMENTS. — N. Marchand & R. Chapman. (*Electronics*, June 1945, Vol. 18, No. 6, pp. 97-101.)

Equipment consists of a standing-wave transmission-line system with a high-impedance probe loosely coupled to a sensitive receiver, and can be used between 150 and 1000 Mc/s. Average accuracy of measurement is 10 per cent. A $50\ \Omega$ coaxial line or $95\ \Omega$ balanced line can be used. The null shift and the standing wave ratio when the unknown impedance is connected enable the latter to be determined.

3322. TUNED-CIRCUIT, PARALLEL-RESISTANCE SUBSTITUTION APPARATUS FOR MEASUREMENTS ON BALANCED-PAIR CABLES AT FREQUENCIES UP TO 10 Mc/s.—J. C. Simmonds. (*Journ. I.E.E.*, Part III, June 1945, Vol. 92, No. 18, pp. 120-124.)

Author's summary:—"Apparatus has been developed which enables the characteristics of balanced-pair cables and feeders to be determined at frequencies at least as high as 10 Mc/s. It operates on the tuned-circuit parallel-resistance substitution principle, the necessary variable resistance being provided by means of diodes with variable cathode resistance loads, and it may be used for measurements on any balanced impedance."

3323. THE CAPACITANCE AND THERMAL CONDUCTANCE OF SCREENED MULTI-PAIR SYSTEMS IN HIGH-FREQUENCY CABLES.—H. R. F. Carsten. (*Journ. I.E.E.*, Part III, June 1945, Vol. 92, No. 18, pp. 93-104.)

Author's summary:—"The design of cables for high-frequency power transmission used in telecommunication, as well as for heating purposes, is based on the capacitance and thermal conductance of the conductor system employed. Capacitance and thermal conductance are equivalent problems of potential theory, and the author, after establishing the principle of equivalence, gives an account of the method of images for obtaining the potential on the surface of circular conductors. This method is first applied to a screened pair as used in high-frequency cables, and then generally to an even-numbered conductor system within a coaxial screen. General expressions for the potential functions are derived in the form of asymptotic expansions. A graph is given of the potential functions of the symmetrical and unsymmetrical systems of a screened pair, from which the capacitance, inductance and impedance can be found for a given design, and *vice versa*. Finally, the temperature rise of dielectrically-heated cables is treated, and it is shown that for this also the result can be expressed in terms of capacitances which may be obtained either from measurements or by computation."

3324. PIEZOELECTRIC CRYSTALS IN OSCILLATOR CIRCUITS.—I. E. Fair. (*Bell. S. Tech. Journ.*, April 1945, Vol. 24, No. 2, pp. 161-216.)

"It is proposed, therefore, in this paper to cover briefly a number of the studies on crystal oscillators so as to point out the different modes of attack and the different behaviour points in the oscillators which the various investigators have studied. After covering these points, there will be discussed the frequency control properties of the crystal and the frequency stability of crystal oscillators. The performance of the crystal in the oscillator with

respect to activity is then treated. There will be introduced two new yard-sticks for measuring or indicating crystal quality, one called 'figure of merit' and the other called 'performance index'. These are related to the crystal constants and paralleling capacitances which are usually involved. They will be defined and their method of use and application in oscillators will be pointed out." See 2713 of August and 1526 of May for other articles by this author.

3325. THE MEASUREMENT OF THE PERFORMANCE INDEX OF QUARTZ PLATES.—C. W. Harrison. (*Bell. S. Tech. Journ.*, April 1945, Vol. 24, No. 2, pp. 217-252.)

"The need for a system of measurement using units that are fundamental and not empirical has led to the proposal of 'Performance Index'. An instrument to make such measurements is to be described in this paper.

"Specifically, the Performance Index is $PI = \omega L / \omega C_i R$ where C_i is the paralleling capacitance that is found in the oscillator circuit to which the crystal is attached, and L and R represent the effective inductance and resistance of the crystal as measured at the operating frequency indicated in Fig. 15.1c, which is its equivalent at that frequency. If the loss in the holder is so low that the resistance, R_L , may be neglected, then PI may be expressed in other relations that are more useful, such as,

$$PI = M / \omega C_0 (1 + C_i / C_0)^2 \quad \text{or} \quad PI = P^2 R_1$$

where the symbols R_1 and C_0 are as shown in Figs. 15.1A and 15.2 and P is expressed as

$$P = M / (1 + C_i / C_0)$$

"With the effective capacitance, C_i , of the remainder of the oscillator added to the paralleling capacitance, C_0 , in Fig. 15.2, the operating frequency will be that frequency at which the combination will exhibit a pure resistance at the terminals AB (excluding the generator 'X' which is involved in the measuring technique). This leads to the definition:

"The Performance Index is the anti-resonant resistance of the crystal and holder having in parallel with it the capacitance introduced by the remainder of the oscillator."

"The Performance Index is therefore a term to express performance not in terms of the grid current of some particular oscillator, but in fundamental circuit units—impedance. The Performance Index is a term that may be used to compare performance of crystals at different frequencies. Its value is independent of plate voltage, grid leak resistance, or of plate impedance. It provides a measuring stick that should replace the 'activity' figures of grid current in so far as the crystal is concerned. It paves the way for the oscillator circuit designers to come forth with standards of measurement for the oscillator circuit without the crystal in the hope that the two may be quantitatively associated and lend themselves to theoretical calculation of full oscillator performance."

3326. PREDIMENSIONING QUARTZ CRYSTAL PLATES.—B. P. Haines, C. D. O'Neal & S. A. Robinson. (*Electronics*, June 1945, Vol. 18, No. 6, pp. 112-119.)

3327. STANDARDS ON PIEZOELECTRIC CRYSTALS [Recommended Terminology].—I.R.E. Publication 1945.

3328. MEASURING R.F. POWER WITH THREE AMMETERS.—J. L. Hollis. (*Electronics*, June 1945, Vol. 18, No. 6, pp. 142-143.)

Author's summary:—"With a known capacitor across the load, currents at full power are measured with r.f. ammeters and their ratios applied to the accompanying chart and formulas to determine the r.f. resistance of the load. A computation of I^2R then gives power. Uses include checking directional antenna systems."

3329. STEADY-STATE SENSITIVITY OF A VACUUM BOLOMETER.—I. Amdur & C. F. Glick. (*Review Scient. Instr.*, May 1945, Vol. 16, No. 5, pp. 117-124.)

Authors' summary:—"The theory of the steady-state sensitivity of a vacuum bolometer as a function of operating temperature has been developed from exact heat flow equations which take into account losses by wire conduction as well as by radiation, and increase of bolometer resistance with temperature. Sensitivities predicted by the present theory differ by more than 50 per cent from those computed from an earlier theory in which the effects of wire conduction and of increase of bolometer resistance with temperature were considered negligible. Experimental sensitivities determined with a test bolometer show good agreement with values calculated from the present theory, particularly in the region of optimum sensitivity where deviations are of the same order as experimental errors. The method of extending the theory to predict steady-state sensitivities of bolometers which are not operated in vacuum has been illustrated for the pressure region in which free molecule conduction predominates."

3330. DIRECT-READING FREQUENCY METER.—W. R. Strauss. (*Journ. Soc. Mot. Pict. Eng.*, April 1945, Vol. 44, No. 4, pp. 257-262.)

Author's summary:—"An instrument capable of indicating audio frequencies of 10 to 50 000 c/s to accuracies limited only by the panel meter or pen-and-ink chart recording meters, regardless of audio-voltage variations, is described herein."

3331. THE USE OF THE FRANKLIN MASTER OSCILLATOR CIRCUIT FOR THE MEASUREMENT OF CAPACITANCE AND INDUCTANCE.—F. H. Gage. (*Journ. of Scient. Instr.*, July 1945, Vol. 22, No. 7, pp. 125-127.)

The Franklin circuit is a stable oscillator maintained by two resistance-coupled valves with "feed-back" from the second. The output from this is combined with that from a quartz-controlled oscillator to give a Lissajou figure on a cathode-ray tube. Measurements are made, by substitution in the Franklin circuit, in terms of a standard variable capacitor.

3332. IMPROVED VACUUM-TUBE VOLTMETERS.—J. T. McCarthy. (*Electronics*, July 1945, Vol. 18, No. 7, pp. 137-139.)

Circuits are described in which a cathode-coupled triode is connected in the input. This provides high input resistance, high sensitivity and larger output currents so that more robust indicating meters can be used. Circuits for measuring direct and alternating voltages are given.

3333. TAMING THE VACUUM-TUBE VOLTMETER, PART I [New Methods for Increasing Utility and Dependability].—McMurdo

Silver. (*QST*, July 1945, Vol. 29, No. 7, pp. 17-23.)

The problems arising in the design of an instrument with an input resistance of 50 megohms are discussed, and the conclusions are translated into a practical circuit employing a balanced cathode follower stage. Constructional details will be given in Part II.

3334. A PORTABLE ELECTROMETER FOR THE MEASUREMENT OF ELECTROSTATIC CHARGES.—D. Bulgin. (*Journ. of Scient. Instr.*, August 1945, Vol. 22, No. 8, pp. 149-151.)

The instrument measures voltage by the induction, by capacity coupling on to the grid of an electrometer valve, of a small voltage proportional to that of the source under examination. The sign, voltage and quantity of charge can be ascertained on stationary or moving objects (e.g. spinning fibres) by direct reading of a pointer. Also leakage resistances to earth from 10^7 to $10^{12}\Omega$ can be measured.

3335. ELECTRONIC OHMMETER [Insulation Tests and Resistivity of Fluids].—(*Elec. Review*, 3rd Aug. 1945, Vol. 137, No. 3532, p. 163.)

Current is passed through the unknown resistance and standard resistances in series, and the voltage across the standard is measured by a valve voltmeter. The instrument is operated on the mains supply or from a small battery and vibrator.

3336. THE GULF ABSOLUTE MAGNETOMETER.—V. Vacquier. (*Terr. Mag. & Atmos. Elec.* June 1945, Vol. 50, No. 2, pp. 91-104.)

Author's summary:—"In response to the need for a more accurate method of measuring the vertical magnetic intensity in the field... the Gulf Research and Development Company built an absolute magnetometer of new design for the determination of declination (D), vertical intensity (Z) and horizontal intensity (H). (D) is measured in the customary manner by means of a fibre-suspended magnet. The intensity measurements are made by comparing the field of a Helmholtz coil with the component of the Earth's field to be measured. H is obtained by the sine-galvanometer method. The zero-field detecting device for Z is a special vertical field-balance in which the polarity of the magnet can be reversed."

3337. THE COMPARISON OF HORIZONTAL-INTENSITY MAGNETOMETERS.—A. Ogg. (*Terr. Mag. & Atmos. Elec.*, June 1945, Vol. 50, No. 2, pp. 125-130.)

3338. AN IMPROVED MAGNETOMETER [Time of Oscillation Decreased by Use of New Magnetic Materials].—W. Sucksmith. (*Journ. of Scient. Instr.*, July 1945, Vol. 22, No. 7, p. 129.)

3339. THE TIME/DEFLECTION CHARACTERISTICS OF MOVING-COIL INSTRUMENTS.—G. F. Tagg. (*Journ. I.E.E.*, Part II, June 1945, Vol. 92, No. 27, pp. 214-225.)

Author's summary:—"The design of moving-coil instruments includes a consideration of such factors as damping and speed of response, in addition to torque, resistance, etc. Some information has been published on this subject, but it is rather scattered; this paper is an attempt to present the information necessary to understand the per-

formance of a moving-coil instrument under various conditions in as complete a form as possible, and in such a form that it can readily be used.

"In the ordinary forms of instruments such as ammeters and voltmeters, the time/deflection characteristics are of importance in determining the damping and the time of response, but have no effect on the steady reading of the instrument. In special types of instrument, such as the ballistic galvanometer and the flux meter, the time/deflection characteristics are of importance in determining the reading given by the instrument."

3340. THE PREDETERMINATION OF CURRENT TRANSFORMER ERRORS.—G. F. Freeman. (*Journ. I.E.E.*, Part II, June 1945, Vol. 92, No. 27, pp. 190-193.)

Author's summary:—"The flux density in a current transformer depends upon core proportions, frequency, ampere-turns and total burden. The errors are usually estimated by reference to data curves for the core material in which specific loss and magnetising voltamperes appear as functions of flux density.

"While step-by-step calculation is simple and straightforward in individual cases, there is some advantage on general grounds, in view of the number of factors involved, in grouping these factors in a systematic manner which allows the whole position to be reviewed. An attempt to do this is made in the paper, and the resulting formulae are alternatively expressed in chart form for quick reference."

3341. ELECTRICAL CONDUCTIVITY OF CONDUCTORS.—L. F. Roehmann. (*ASTM Bulletin*, May 1945, No. 134, pp. 58-61.)

The electrical conductivity of a conductor can be expressed in terms of volume resistivity or weight resistivity, or their reciprocals, thus leading to multiplicity of terms. The author favours the standardisation of per cent volume conductivity, and the use of a standardised form of coil, which is described, for its measurement.

3342. REMOTE MEASUREMENT AND CONTROL WITH VIBRATING WIRE INSTRUMENT.—Rieber Research Laboratory. (*Electronics*, June 1945, Vol. 18, No. 6, pp. 160, 164, 168, 172, 176, 180.)

The measuring unit (Vibratron) consists of a stretched wire in a magnetic field driven at its resonant frequency, and the measured quantity is permitted to change the length or tension of the wire. The frequency of vibration is then interpreted at the receiving end by a similar system which is adjusted to give the same frequency. The method has been applied to the measurement of atmospheric pressure by the radiosonde.

3343. THE FIXING OF CONFIDENCE LIMITS TO MEASUREMENTS.—H. J. Josephs. (*Journ. I.E.E.*, Part II, June 1945, Vol. 92, No. 27, pp. 194-206; Discussion pp. 205-213.)

Author's summary:—"The idea of significance testing underlies most practical applications of probability theory to electrical measurements. This paper discusses the problems involved in the application of simple tests of significance to small sets of measurements. It opens with an account of the *w*-test, which is designed to apply to normally

distributed variables. This is followed by a description of the *t*-test, which is of particular use in dealing with a small number of observations. A method of rapidly applying this test is given, and it is shown that if the true mean value of a physical quantity is unknown the confidence limits to be attached to an estimated value obtained from the measurements may be easily determined. The paper describes a rapid method of estimating the standard deviation of a set of measurements; it is shown that for very small samples the extreme-mean or median forms a good alternative to the arithmetic mean and is often easier to calculate. Pearson's χ^2 -test of goodness-of-fit is explained and illustrated. Emphasis is placed on the flexible nature of this test and its relationship to the *w*-test."

3344. STANDARDISATION [Mainly of Electrical Apparatus; Abstract of Chairman's Address to the I.E.E. North-Eastern Centre].—J. A. Harle. (*Journ. I.E.E.*, Part I, Feb. 1945, Vol. 92, No. 50, pp. 73-77.)

SUBSIDIARY APPARATUS AND MATERIALS

3345. NEW DEVELOPMENTS IN ELECTRON MICROSCOPY.—R. G. Picard. (*Journ. Franklin Inst.*, June 1945, Vol. 239, No. 6, pp. 421-436.)

The paper describes recent developments in the R.C.A. instrument, including:—

50 000 V direct-current from a radio-frequency source; simple and faster vacuum pumping systems; "microtome" for cutting sections less than 1μ in thickness; staining technique based upon atomic weight rather than colour; polystyrene-silica replicas, stereoscopic photographs, etc.

3346. THE BETATRON.—T. J. Wang. (*Electronics*, June 1945, Vol. 18, No. 6, pp. 128-134.)

The Betatron is an induction electron accelerator providing beams of energies of hundreds of MeV. The equations of the system are given and the design of the pole-face for focussing the beam and giving stable orbits is described. The β -rays can be used for transmutation of nuclei, generation of X-rays and the investigation of cosmic-ray effects.

3347. UNIT FOR DEGREE OF VACUUM [Letters in Reply to F. H. Townsend's letter, 2756 of August, giving some Advantages of the Proposed Unit].—R. Feinberg, G. A. P. Wyllie; F. H. Townsend. (*Nature*, 21st July 1945, Vol. 156, No. 3951, p. 85.)

3348. ELECTRONIC WELDING OF GLASS.—E. M. Guyer. (*Electronics*, June 1945, Vol. 18, No. 6, pp. 92-96.)

Author's summary:—"Localized heating of restricted areas that must be softened and flowed without destructive surface-boiling is accomplished by conduction. Novel high-frequency guns utilise auxiliary pin-point flames to lower glass resistance, provide a sharply defined gaseous conduction path from gun to glass and facilitate close control of heating."

3349. THE APPLICATION OF V.H.F. HEATING TO THE FUSION AND TECHNICAL TREATMENT OF GLASS [Involves Frequencies of the Order of 300 Mc/s: Brief Report of Lecture Delivered to Société française des Elec-

- triciens].—Descarsin. (*Génie Civil*, 15th March 1945, Vol. 122, No. 6, p. 46.)
3350. BASIC THEORY AND DESIGN OF ELECTRONICALLY REGULATED POWER SUPPLIES.—Abate. (See 3273.)
3351. DIMENSIONAL STABILITY OF PLASTICS.—R. Burns. (*ASTM Bulletin*, May 1945, No. 134, pp. 27-30.)
3352. SYNTHETIC RUBBER FOR WIRE INSULATION.—V. T. Wallder. (*Bell Lab. Record*, June 1945, Vol. 23, No. 6, pp. 209-214.)
3353. SYNTHETIC RUBBERS AND PLASTICS: IX—MECHANICAL PROPERTIES IN RELATION TO MOLECULAR STRUCTURE (CONTINUED).—W. F. O. Pollett. (*Distribution of Elec.*, July 1945, Vol. 18, No. 159, pp. 19-23.) See 2333 of July.
3354. AUTOMOTIVE RUBBER [Synthetic Rubber replacing Natural Rubber as an Engineering Material].—(*Scient. American*, August 1945, Vol. 173, No. 2, pp. 96-98.)
3355. PERMEATION AND SORPTION OF WATER VAPOUR IN VARNISH FILMS [Based on a B.E.A. Report].—A. M. Thomas & W. L. Gent. (*Proc. Phys. Soc.*, 1st July 1945, Vol. 57, Part 4, No. 322, pp. 324-349.)
3356. HIGH FREQUENCY INSULATION [Superiority of Zircon Porcelain to Steatite].—Westinghouse Electric and Manufacturing Company. (*Review Scient. Instr.*, May 1945, Vol. 16, No. 5, p. 134.)
- "The high-frequency loss-factor of zircon porcelain is superior to all grades of steatite except those grades known as ultra-steatite. Aside from better electrical characteristics, zircon porcelain is characterised by improved mechanical properties."
3357. SILICONES—A NEW CLASS OF HIGH POLYMERS OF INTEREST TO THE RADIO INDUSTRY [Dielectrics of Organo-Silicon-Oxide Polymers having High Heat-Stability: Physical and Electrical Properties of Liquid Silicones, Silicone Greases, Varnishes and Resins].—S. L. Bass & T. A. Kauppi. (*Proc. I.R.E.*, July 1945, Vol. 33, No. 7, pp. 441-447.)
3358. SURFACE FINISHES FOR ALUMINIUM.—W. L. Maucher and C. B. Gleason. (*Gen. Elec. Review*, June 1945, Vol. 48, No. 6, pp. 26-30.)
- Anodic coatings 0.0005 inch thick made in sulphuric acid may have breakdown voltages as high as 600 V, but weak spots may occur which would withstand only 200 V. Chromic acid anodized coatings have much lower breakdown voltages, averaging only 25-30 V, the probable reason being that they are much thinner.
3359. TROPIC-PROOF RADIO APPARATUS, PARTS I, II & III.—W. J. Tucker. (*Electronic Eng.*, May 1945, Vol. 17, No. 207, pp. 498-499; June, No. 208, pp. 538-540; July, No. 209, pp. 598-600.)
- In tropical regions high relative humidity, a large range of temperature, and fungus growth, are the main causes of breakdown. Consideration is given to the choice of insulators and protective finishes for metals as well as to the layout of components. The design of transformers, chokes, meters and switches, resistors, capacitors, earphones, etc., is also discussed.
- A successful export industry will depend on our ability to produce reliable apparatus suitable for world-wide use.
3360. CABLE TERMINATIONS.—D. B. Irving. (*Journ. I.E.E.*, Part II, April 1945, Vol. 92, No. 26, pp. 73-84; Discussion pp. 84-89.)
- Author's summary:—"The performance, over the period of twelve years ended 1943, of the cable terminations in service on the British Grid system at voltages between 3.3kV and 132kV is reviewed, and the causes of breakdown are examined. Features of construction which have contributed to failure, and the measures adopted to secure improvement in service performance, are indicated. Consideration is given to the fundamental characteristics required of a termination, and to the test and other requirements embodied in the specifications of the Central Electricity Board. Recent types of termination are described, including 132kV outdoor sealing ends for use with the latest types of mass-impregnated pressure cable. Directions in which design developments may be expected are indicated."
3361. INTERVAL SELECTOR FOR RANDOM PULSES.—F. J. Davis & L. F. Curtiss. (*Journ. of Res. of Nat. Bur. Stds.*, Dec. 1942, Vol. 29, No. 6, pp. 405-415.)
- Authors' summary:—"An interval selector is described which has been developed to study the distribution of pulses from Geiger-Müller counters. The circuit is designed to count pulses with a separation less than τ where τ may be varied between 3×10^{-5} sec and 0.2 sec. Tests are described which show that the circuit accomplishes these measurements with considerable precision. . . ."
3362. FREQUENCY METER FOR USE WITH GEIGER-MÜLLER COUNTER.—L. F. Curtiss & B. W. Brown. (*Journ. of Res. of Nat. Bur. Stds.*, January 1945, Vol. 34, No. 1, pp. 53-58.)
- Authors' summary:—"An improved circuit is described for reading the rate of pulses from a Geiger-Müller counter. Based on the usual procedure of levelling and rectifying the pulses to charge a condenser, the improvements concern a bridge-type vacuum-tube voltmeter to read the voltage on the condenser and an arrangement to compensate parasitic potentials developed in the rectifier for the pulses. An adequate source of potentials from one small transformer is described, which renders the circuit useful in portable instruments. Particular care has been taken to design a circuit that is independent of the voltage of the alternating-current mains from which the circuit is operated. A modification of the circuit for rapidly decaying sources is also described."
3363. A RESISTANCE-COUPLED THYRATRON RECORDING CIRCUIT.—J. B. Wilkie. (*Review Scient. Instr.*, April 1945, Vol. 16, No. 4, p. 97.)
- A simplification of the circuit originally described by Pompeo and Penther (3179 of 1942).
3364. MAGNETOSTRICTION COMPASS.—R. G. Rowe. (*Electronics*, July 1945, Vol. 18, No. 7, pp. 123-125.)
- "Rods of magnetostrictive material are subjected to an alternating magnetic field, and rotation in

the earth's field changes the amplitude of vibration sufficiently to actuate a crystal pickup, feeding an electronic amplifier and zero-centre direction-indicating meter."

3365. SUPERSONIC BIAS FOR MAGNETIC RECORDING.—Holmes & Clark. (See 3311.)

3366. MILITARY TELEPHONE INSTRUMENTS [Special Difficulties Overcome:—Extraneous Noise of Battle; Use with Gas Mask; Submersion; Tropical Conditions].—J. R. Erickson. (*Bell Lab. Record*, June 1945, Vol. 23, No. 6, pp. 193-199.)

3367. VOICE-OPERATED ELECTRONIC RELAY.—C. J. Quirk. (*Electronics*, June 1945, Vol. 18, No. 6, pp. 236-248.)

Voice-operated switch for mains-driven apparatus is described. It comprises a microphone, two triode amplifiers and a thyatron which energises the relay. A "decaying bias" circuit is used to give stabilised operation.

3368. "LIGHT-SENSITIVE RECORDING MATERIAL" [B.S. Specification No. 1193, 1945, on Film and Paper for Recording Instruments; Review].—B. S. I. (*Engineering*, 8th June 1945, Vol. 159, No. 4143, p. 448.)

3369. THE ABC OF PHOTOGRAPHIC SOUND RECORDING [Variable Density and Variable Area Methods: Push-Pull Tracks: Noise Reduction: Film Characteristics and Processing: Copying: Miscellaneous Points of Technique: Comprehensive Bibliography].—E. W. Kellogg. (*Journ. Soc. Mot. Pict. Eng.*, March 1945, Vol. 44, No. 3, pp. 151-194.)

3370. THE VALUATION AND CAPITALIZATION OF TRANSFORMER LOSSES [Economic Aspects of Transformer Design].—W. Szwander. (*Journ. I.E.E.*, Part II, April 1945, Vol. 92, No. 26, pp. 125-134: Discussion pp. 134-139.)

3371. THE ECONOMIC UTILIZATION OF MODERN PERMANENT MAGNETS.—D. J. Desmond. (*Journ. I.E.E.*, Part II, June 1945, Vol. 92, No. 27, pp. 229-244: Discussion pp. 244-252.)

Author's summary:—"The paper first establishes the equation to the demagnetization curve and then proceeds to discuss the uses of permanent magnets in typical pieces of apparatus. The working of the magnet under these various conditions is considered and the useful part of the magnetic energy is calculated. This introduces a new method by making use of the unit permeance of a circuit, or the permeance as seen from each centimetre cube of the magnet.

"Certain approximations are made in this calculation and the limitations of the simple theory are then discussed. A method is given of designing a magnet in terms of the constants of the iron circuit.

"Figures are given for two modern alloys in common use, and curves are plotted for the complete solution to all design problems. The interchangeability of these two alloys is discussed, and it is pointed out that not all the additional energy of the anisotropic alloy can be usefully employed. This is due to the larger curve factor, which reduces

the recovery when a demagnetizing force is removed. It is shown that the $(BH)_{max}$ value is not the criterion as to the usefulness of a magnet, except in the simplest case, and that it is not necessary for the magnet to work at the $(BH)_{max}$ point."

3372. SYNTHETIC SAPPHIRES.—The Linde Air Products Company. (*Review Scient. Instr.*, May 1945, Vol. 16, No. 5, pp. 134-135.)

The hardness of sapphire leads to its use chiefly as a bearing material, but it has also important applications for gauges. It has been produced in a long crystal form known as rod corundum. These crystals have diameters ranging from 0.060 to 0.125 inch, and have been made in lengths up to 30 inches.

3373. A SIMPLE ANTI-VIBRATION GALVANOMETER SUPPORT.—G. E. Coates & J. F. Coates. (*Journ. of Scient. Instr.*, August 1945, Vol. 22, No. 8, pp. 153-154.)

Suppressing the horizontal rather than the vertical components of vibration is necessary and this may be achieved by a fairly freely vibrating support whose natural period is long relative to the periods of the interfering disturbances. The method is more effective than the use of sponge rubber or other damping material.

3374. ELECTRIC MOTOR MAINTENANCE [A Variety of Faults and their Remedies].—"Rotor." (*Elec. Rev.*, 20th July 1945, Vol. 137, No. 3530, pp. 82-84.)

3375. RESISTANCE OF COMPRESSED POWDERS TO H.F. ALTERNATING CURRENTS [Short Account of Paper Read before the Académie des Sciences].—G. Granier & J. Granier. (*Génie Civil*, 15th January 1945, Vol. 122, No. 2, p. 15.)

The results of measurements on different salts (SnS_2 , $CuSO_4$, SnO_2 , $HgSO_4$) show that the apparent resistance decreases considerably with increase of frequency; the apparent permittivity decreases to an even greater extent; phase displacement increases and, for very high frequencies, the salt pellet behaves more like a dielectric than a conductor.

3376. THE CONTROL OF ELECTRIC DISCHARGE LAMPS.—H. Cotton. (*BEAMA Journ.*, June 1945, Vol. 52, No. 96, pp. 192-197.) To be continued.

3377. "RADIO SERVICE TEST GEAR" [Book Review].—W. H. Cazaly. (*Wireless World*, August 1945, Vol. 51, No. 8, p. 242.)

STATIONS, DESIGN AND OPERATION

3378. MICROWAVE RELAY STATIONS [Proposal to Set up Seven Microwave Relay Stations between New York and Boston using Eight Channels each 20 Mc/s wide in each of Three Parts of the Spectrum, namely, 2000, 4000 and 12000 Mc/s].—(*QST*, June 1945, Vol. 29, No. 6, pp. 22 and 92.)

3379. A CRYSTAL-CONTROLLED 112 Mc/s MOBILE TRANSMITTER.—R. A. Waters. (*QST*, July 1945, Vol. 29, No. 7, pp. 41-44.)

3380. DETAILS OF THE SCR-300 F.M. WALKIE-TALKIE.—D. E. Noble. (*Electronics*, June 1945, Vol. 18, No. 6, pp. 204, 209, 212, 216.)

The SCR-300 is a portable f.m. transmitter and receiver covering the band 40-48 Mc/s. Nominal range is 3 miles. Weight of basic transmitter-receiver unit is 9 lbs., and of complete station is 38 lbs.

3381. FINAL F.C.C. 25-30 000 Mc/s [Frequency] ALLOCATIONS [Complete List given].—F. C. C. (*Electronics*, July 1945, Vol. 18, No. 7, pp. 92-93.)

"44-108 Mc/s unassigned at present, will ultimately be used for Television and F.M."

3382. F.C.C.'s FINAL [Frequency] ALLOCATIONS ABOVE 25 Mc/s.—(*QST*, July 1945, Vol. 29, No. 7, pp. 11-14, and 98.)

3383. F.C.C.'s PROPOSED [Frequency] ALLOCATIONS BELOW 25 Mc/s.—(*QST*, July 1945, Vol. 29, No. 7, pp. 15-16.)

3384. BROADCAST BAND SATELLITE TRANSMITTERS.—R. H. Beville. (*Electronics*, July 1945, Vol. 18, No. 7, pp. 94-99.)

"Use of boosters to fill in dead spots or extend coverage when a directional antenna system is not feasible. The unattended booster transmitter may be fed by r.f. line as with WWDC or by space radiation as with WINX, using standard telephone lines for remote control."

GENERAL PHYSICAL ARTICLES

3385. KINEMATIC RELATIVITY: A REPLY TO PROF. W. WILSON.—E. A. Milne. (*Phil. Mag.*, Feb., 1945, Vol. 36, No. 253, pp. 134-143.) See 3011 of 1944 for Wilson's paper.

3386. KINEMATIC RELATIVITY.—R. A. Newing. (*Phil. Mag.*, Feb. 1945, Vol. 36, No. 253, pp. 113-115.)

3387. SPIN IN THE UNIVERSE [Presidential Address to the Royal Society of Edinburgh].—E. Whittaker. (*Phil. Mag.*, Feb. 1945, Vol. 36, No. 253, pp. 101-113.)

3388. "MAGNETISM OF THE EARTH" [U.S. Coast and Geodetic Survey; Book Review].—A. K. Ludy & H. H. Howe. (*Terr. Mag. & Atmos. Elec.*, June 1945, Vol. 50, No. 2, p. 138.)

3389. "SEISMOLOGY" [Book Review].—P. Byerly. (*Nature*, 28th July 1945, Vol. 156, No. 3952, pp. 95-96.)

3390. "TIME, NUMBER AND THE ATOM" [Book Review].—R. Fortescue Pickard. (*Journ. of Scient. Instr.*, July 1945, Vol. 22, No. 7, p. 138.)

3391. THE PRODUCTION OF PHOTONS RELATIVE TO IONISATION BY COLLISION IN A TOWNSEND GAP.—R. Geballe. (*Phys. Review*, 1st/15th Dec. 1944, Vol. 66, No. 11/12, pp. 316-320.)

3392. THE VISCOSITY OF GASES AT HIGH PRESSURES.—E. W. Comings, B. J. Mayland & R. S. Egly. (*University of Illinois Bulletin*, 28th November 1944, Vol. 42, No. 15, 66 pp.)

MISCELLANEOUS

3393. EXTENSION OF MAXWELL'S EQUATIONS.—P. Foulkes. (*Journ. & Proc. Roy. Soc. New South Wales*, Parts I & II, 1944, Vol. 78, pp. 14-16.)

The paper contains a modification in Maxwell's equations to take into account magnetic currents, evidence for the existence of which was recently claimed by Ehrenhaft (Cf. 3408 of 1942.)

3394. "VORLESUNGEN ÜBER ALLGEMEINE FUNKTIONENTHEORIE UND ELLIPTISCHE FUNKTIONEN" [Functions of a Complex Variable; Book Review].—A. Hurwitz. (*Nature*, 21st July 1945, Vol. 156, No. 3951, p. 67.)

3395. "THE THEORY OF FUNCTIONS" [Book Review].—J. E. Littlewood. (*Science*, 1st June 1945, Vol. 101, No. 2631, pp. 561-562.)

3396. "A TREATISE ON THE THEORY OF BESSEL FUNCTIONS" [Book Review].—G. N. Watson. (*Phil. Mag.*, Feb. 1945, Vol. 36, No. 253, pp. 146-147.)

3397. NOTES ON THE EVALUATION OF ZEROS AND TURNING VALUES OF BESSEL FUNCTIONS [Part I—Introductory; Part II—The McMahon Series: Facilitating Additional Computation pending Further Publication of Tables].—W. G. Bickley & J. C. P. Miller. (*Phil. Mag.*, Feb. 1945, Vol. 36, No. 253, pp. 121-131.)

3398. NOTES ON THE EVALUATION OF ZEROS AND TURNING VALUES OF BESSEL FUNCTIONS [Part III—Interpolation by Taylor Series: Method Applicable to a Wide Interval].—W. G. Bickley. (*Phil. Mag.*, Feb. 1945, Vol. 36, No. 253, pp. 131-133.)

3399. "TABLES OF ELEMENTARY FUNCTIONS" [Book Review].—F. Emde. (*Proc. Phys. Soc.*, 1st July 1945, Vol. 57, Part 4, No. 322, pp. 368-369.)

"Four-figure accuracy is standard, and the tabular intervals are generally so chosen that it is attainable by linear interpolation (for which a slide-rule is advocated). Divided differences are given, and in some ranges where linear interpolation is not adequate they are printed in italics. Text and legends are in both German and English."

3400. "AN INTRODUCTION TO DIFFERENTIAL EQUATIONS" [Book Review].—S. L. Green. (*Phil. Mag.*, Feb. 1945, Vol. 36, No. 253, pp. 150-151.)

3401. "THE THEORY OF POTENTIAL AND SPHERICAL HARMONICS" [Book Review].—W. V. Sternberg & T. L. Smith. (*Nature*, 7th July 1945, Vol. 156, No. 3949, pp. 5-6.)

3402. "MATHEMATICAL TABLES AND OTHER AIDS TO COMPUTATION" [Book Review].—R. A. Archibald & D. H. Lehmer. (*Phil. Mag.*, Feb. 1945, Vol. 36, No. 253, p. 147.)

3403. "FIVE-FIGURE LOGARITHM TABLES" [Book Review].—Ministry of Supply. (*Phil. Mag.*, Feb. 1945, Vol. 36, No. 253, p. 145.)

3404. "WAVEFORM ANALYSIS: A GUIDE TO THE INTERPRETATION OF PERIODIC WAVES INCLUDING VIBRATION RECORDS" [Book Review].—R. G. Manley. (*Journ. of Scient. Instr.*, August 1945, Vol. 22, No. 8, p. 158.)
3405. DIRECTIONAL LOCI IN A MAGNETIC FIELD, AND THE LOCATING OF NEUTRAL POINTS.—D. Owen. (*Proc. Phys. Soc.*, 1st July 1945, Vol. 57, Part 4, No. 322, pp. 294-301.)
Author's summary:—"A method of exploration of a magnetic field by means of directional loci is described. The points of intersection of any two loci are neutral points. The method is exemplified in the simpler cases of the combination of the earth's field with the field of a bar magnet and with the field of a circular current."
3406. WHAT IS QUALITY CONTROL? BACKGROUND FOR WIRELESS TECHNICIANS.—T. Roddam. (*Wireless World*, August 1945, Vol. 51, No. 8, pp. 243-245.)
3407. NATIONAL PHYSICAL LABORATORY FOR INDIA [Proposals of Council of Scientific and Industrial Research, India].—(*Nature*, 7th July 1945, Vol. 156, No. 3949, p. 15.)
3408. FRENCH RADIO RESEARCH DURING THE GERMAN OCCUPATION [Brief Report of Paper Read before the Société des Radio-électriciens].—P. Brenot. (*Génie Civil*, 15th Feb. 1945, Vol. 122, No. 4, pp. 31-32.)
Description of French radio research done at Lyons and Algiers during the occupation, including television, propagation on centimetre waves, design and construction of magnetron and klystron valves of high power.
3409. RUSSIAN PHYSICS JOURNALS.—W. H. George. (*Nature*, 23rd June 1945, Vol. 155, No. 3947, pp. 763-765.)
Details of physics journals available in Russian, German, French and English, with list of libraries carrying the most complete sets. A note on transliteration is added.
3410. "SCIENCE AND THE PLANNED STATE" [Book Review].—J. R. Baker. (*Journ. of Scient. Instr.*, July 1945, Vol. 22, No. 7, p. 138.)
3411. "LIFE AND WORK OF JOHN TYNDALL" [Book Review].—A. S. Eve & C. H. Creasey. (*Journ. of Scient. Instr.*, July 1945, Vol. 22, No. 7, p. 138.)
3412. RESEARCH AND TRAINING IN THE ENGINEERING INDUSTRY [Abstract of Chairman's Address to the I.E.E. East Midland Sub-Centre].—A. Brookes. (*Journ. I.E.E.*, Part I, March 1945, Vol. 92, No. 51, pp. 116-118.)
3413. THE POST-WAR TRAINING OF ENGINEERS [Abstract of Chairman's Address to the West Wales Sub-Centre I.E.E.].—R. O. Kapp. (*Journ. I.E.E.*, Part I, March 1945, Vol. 92, No. 51, pp. 124-126.)
3414. SOME THOUGHTS ON EDUCATION [Abstract of Chairman's Address to I.E.E. Mersey and North Wales Centre].—J. Cormack. (*Journ. I.E.E.*, Part I, Feb. 1945, Vol. 92, No. 50, pp. 69-72.)
3415. THE TRAINING OF PERSONNEL FOR THE ELECTRICAL ENGINEERING INDUSTRY [Abstract of Chairman's Address to the I.E.E. Sheffield Sub-Centre].—R. A. H. Sutcliffe. (*Journ. I.E.E.*, Part I, March 1945, Vol. 92, No. 51, pp. 127-129.)
3416. "THE UNIVERSITY AND THE MODERN WORLD" [Book Review].—A. S. Nash. (*Nature*, 23rd June 1945, Vol. 155, No. 3947, pp. 740-741.)
3417. THE INDUSTRIAL DESIGN CONSULTANT.—F. A. Mercer. (*Journ. Roy. Soc. Arts.*, 8th June 1945, Vol. 93, No. 4693, pp. 342-352.)
"To sum up, the industrial design consultant must be a man of executive calibre. Not only must he himself be a man of imagination and good taste, with an appreciation of the value of good, clean-cut, simple lines, and have a technical background enabling him to understand the nature of materials and the methods used in their conversion into products. He must also be able to express his own ideas in graphic form; be able to gather round him, train and inspire, a team of design specialists, working in harmony to a single purpose. Even this is not enough. He must also be tactful, able to get along with executives and technicians in his clients' businesses, and be able to understand their problems and assist their solution."
3418. THE PHYSICIST'S MIND AND THE JUDGMENT OF ART.—M. Johnson. (*Journ. of Scient. Instr.*, July 1945, Vol. 22, No. 7, pp. 121-125.)
The author suggests that a subtle but important mutual relevance is developing between the physicist's professional mind and the other portion of his mind which appreciates music or poetry or art. The physicist and the artist are no longer limited to representations of perceived objects.
3419. RADIO PROSPECTS: SUGGESTIONS FOR REORGANISATION.—H. A. Hartley. (*Wireless World*, August 1945, Vol. 51, No. 8, pp. 229-231.) Concluding instalment of 2875 of August.
3420. MICROFILM AND OTHER MEANS OF DOCUMENTARY REPRODUCTION.—(*Nature*, 7th July 1945, Vol. 156, No. 3949, pp. 24-26.)
Report of a conference held in London to discuss the suitability of several methods for reducing photographically and subsequently reproducing documentary material. A "Micro Card" system is described whereby a hundred pages of text can be carried on a typical 5 x 3 inch library index card.
3421. REPRODUCTIONS [Large Scale Reproduction of Drawings; Blueprints; Vandyke; Photostat].—D. R. McCormack. (*Bell Lab. Record*, June 1945, Vol. 23, No. 6, pp. 202-208.)
3422. STUDIES IN THE SENSITIVITY OF PHOTOGRAPHIC MATERIALS.—A. P. H. Trivelli. (*Journ. Franklin Inst.*, April 1945, Vol. 239, No. 4, pp. 269-284.)
3423. THE QUANTITATIVE EVALUATION OF PHOTOGRAPHIC LINE PATTERNS.—J. C. M. Brentano. (*Journ. Opt. Soc. Am.*, June 1945, Vol. 35, No. 6, pp. 382-389.)
Author's summary:—"A discussion is given of some difficulties encountered in the quantitative

evaluation of photographic line patterns, particularly in such cases where integrated intensities are required. As a result of this discussion two methods applicable to absorption densitometry are proposed intended to facilitate such measurements and to reduce the errors involved . . ."

3424. BRITISH SCIENTIFIC INSTRUMENTS IN WAR AND PEACE [Scientific Instrument Manufacturers' Association Luncheon].—(*BEAMA Journ.*, June 1945, Vol. 52, No. 96, pp. 198-200.)

3425. FIFTY YEARS OF SCIENTIFIC INSTRUMENT MANUFACTURE.—(*Engineering*, 11th May 1945, Vol. 159, No. 4139, pp. 361-363; No. 4141, pp. 401-403; No. 4144, pp. 461-462; No. 4146, pp. 501-502.)

Fiftieth anniversary of the Cambridge Scientific Instrument Company. Development of temperature-measuring instruments including mercury thermometers, resistance thermometers, Whipple indicator, thermocouples, pyrometers, etc. Electrical apparatus includes galvanometers, electrocardiographs, ray-track expansion chambers, etc.

3426. TRANSMISSION-LINE PROTECTION.—D. H. Towns & H. McDonald. (*Elec. Rev.*, 20th July 1945, Vol. 137, No. 3530, pp. 95-100.)

The system uses a carrier signal at a frequency between 50 and 200 kc/s which is initiated by the fault-finding relays of the network. A receiver is permanently connected to the line.

3427. ELECTRONICS ON THE ROAD [Two Way Vehicle Radio; Walkie Talkie; Electronic Ignition].—J. Markus. (*Scient. American*, August 1945, Vol. 173, No. 2, pp. 90-92.)

3428. "RADIO SERVICE TEST GEAR" [Book Review].—W. H. Cazaly. (*Elec. Review*, 3rd August 1945, Vol. 137, No. 3532, p. 164.)

3429. A GEOPHYSICAL PROSPECTING INSTRUMENT USING ALTERNATING CURRENTS OF AUDIO-FREQUENCY.—R. Guelke. (*Journ. of Scient. Instr.*, August 1945, Vol. 22, No. 8, pp. 141-145.)

An alternating current of audio-frequency (500 c/s) is passed through a long straight wire stretched on the surface across the region to be investigated. The lines of force are circles around the wire and any conducting body situated in this field will have eddy currents induced in it. These eddy currents will interfere with the magnetic field on the surface above the conducting body in both magnitude and phase. If therefore two identical coils are placed horizontally on the surface one above a conducting body and the other over a clear region, the voltages induced in these coils will differ in magnitude and phase. Measurements of intensity and phase thus enable contours of conductivity variations to be made.

3430. SUMMARISED PROCEEDINGS OF CONFERENCE ON X-RAY ANALYSIS—LONDON 1945.—A. M. B. Parker, A. R. Stokes & A. J. C. Wilson. (*Journ. of Scient. Instr.*, July 1945, Vol. 22, No. 7, pp. 131-138.)

The fourth conference on X-Ray Analysis organised by the Institute of Physics was held in London in April 1945. The article gives an account of short papers on new and improved methods, and of discussions on laboratory equipment and the use

of optical principles in X-Ray analysis. Accounts of the business session and Prof. J. D. Bernal's lecture have appeared in *Nature*. (See 3230 of September.)

3431. 'A SURVEY OF X-RAYS IN ENGINEERING AND INDUSTRY.—V. E. Pullin. (*Journ. I.E.E.*, Part I, June 1945, Vol. 92, No. 54, pp. 226-233; Discussion pp. 233-238.)

Author's summary:—"The paper contains nothing original. It does, however, attempt to show the development of X-radiography in industry and engineering from the time of Röntgen's discovery in 1895.

"The paper is divided into three sections. In the first, developments up to the beginning of the present war have been recorded in broad outline, with regard both to uses and to equipment. In the second, the war-time development of engineering and industrial radiography, particularly with regard to Service requirements and inspection, has been dealt with. Both the applicability and the limitations of radiography in the engineering sphere have been remarked upon. The third section is devoted to an attempt to forecast radiographic developments in future with regard to modifications in engineering inspection and development. The author has also attempted to foreshadow the trend of development in X-ray apparatus and equipment.

"No attempt has been made in the paper to describe the applications of X-ray crystal analysis in industry, and no cognizance has been taken of the enormous progress made by radiology in the medical and surgical fields."

3432. INDUSTRIAL RADIOGRAPHY.—W. T. Sproull. (*Electronics*, June 1945, Vol. 18, No. 6, pp. 122-127.)

Author's summary:—"How X-rays and radium can be used most effectively in the factory for inspection of welds, castings, and finished products. Practical information for industrial readers with explanations of how X-rays behave under various conditions."

3433. IMPERFECTIONS OF CRYSTAL LATTICES AS INVESTIGATED BY THE STUDY OF X-RAY DIFFUSE SCATTERING.—A. J. Guinier. (*Proc. Phys. Soc.*, 1st July 1945, Vol. 57, Part 4, No. 322, pp. 310-324.)

Author's summary:—"A perfect crystal diffracts X-rays only in discrete directions, given by the Bragg-Laue Laws. All scattering observed in directions other than these, except Compton scattering, is due to imperfections of the crystal. The experimental method of obtaining useful scattering patterns and the principles of the calculation of actual structure from the distribution of anomalous scattering are described. Examples of application of this method to the study of thermal atomic movements, lattice deformations under mechanical stresses; defects of periodicity in diamond and in fibrous crystals, space-arrangement of atoms in solid solutions (order-disorder transformation, age-hardening) and scattering by small particles are briefly outlined."

3434. GEIGER-COUNTER X-RAY SPECTROMETER.—North American Phillips Co. Inc. (*Journ. of Scient. Instr.*, August 1945, Vol. 22, No. 8, p. 155.)

The Norelco X-ray spectrometer can measure diffraction angles to within $\pm 0.03^\circ$.

3435. GENERAL PROPERTIES OF INDUSTRIAL RADIOGRAPHIC FILMS.—H. E. Seemann. (*ASTM Bulletin*, May 1945, No. 134, pp. 17-27.)
3436. H.F. HEATING AND SPECIAL WOODS.—H. Seymour. (*Electrician*, 20th July 1945, Vol. 135, No. 3503, pp. 62-63.)
3437. RADIO-FREQUENCY DEHYDRATION [Pharmaceuticals which are Unstable at High Temperatures can be Dehydrated by Radio-Frequency Fields].—G. H. Brown. (*Electronics*, March 1945, Vol. 18, No. 3, pp. 308, 310, 312.)
Report of I.R.E. 1945 Winter Technical Meeting.
3438. ELECTRONIC COOKING AND STERILISATION OF FOODS [Non-Uniform Heating traced to Geometry of the Part: Cost of Cooking: Cocoa Beans are shelled by Explosive Action, and Continued Heating yields Oils of Possible Commercial Value: Sterilisation, and Its Cost: Selection of Frequency: etc.].—V. W. Sherman. (*Electronics*, July 1944, Vol. 17, No. 7, pp. 150-160.)
Long summary.
3439. ELECTROSTATIC PAINTING [Cottrell Principle of Electrostatic Precipitation].—H. J. Ransburg Co. (*Elec. Rev.*, 27th July 1945, Vol. 138, No. 3531, p. 130.)
3440. ELECTROSTATIC PRECIPITATION OF DUST FROM BOILER-PLANT FLUE GASES.—J. Bruce. (*Journ. I.E.E.*, Part II, April 1945, Vol. 92, No. 26, pp. 58-68: Discussion pp. 68-72.)
Author's summary:—"The paper deals particularly with the electrostatic precipitation of dust entrained by flue gases produced from the combustion of anthracite in pulverised form. It describes field experiments and results on a pilot-scale electrostatic precipitator operating on such flue gases, as well as the salient features of a large-scale commercial installation, and discusses some of the operating results obtained therefrom."
3441. THICKNESS MEASUREMENT.—(*Scient. American*, Feb. 1945, Vol. 172, No. 2, p. 94.)
A supersonic contact instrument, for the measurement of the thickness of aircraft parts of which one side is inaccessible, has been developed in the research laboratories of General Motors. It has been described in a paper to the Society of Automotive Engineers by W. S. Erwin. The Sonigage, as it is called, measures the frequency of oscillation at which the metal is set into resonant vibration.
3442. FLUORESCENT LIGHTING.—S. E. Pugh. (*P.O. Elec. Eng. Journ.*, Oct. 1944, Vol. 37, Part 3, pp. 65-70.)
Describes some of the constructional and operating features of the fluorescent tube and its associated control gear, and gives some suggestions for the installation and maintenance of fluorescent lighting fittings. A 0.05 μ F condenser is connected across each tube to suppress any radio interference which might be caused by the discharge of the tube or by the breaking of the starting switch.
3443. HOW ILLUMINANTS ARE BORN [Infra Red Radiators, Mercury Lamps, Fluorescent Illuminants, Ultraviolet Lamps].—S. G. Hibben. (*Journ. Franklin Inst.*, May 1945, Vol. 239, No. 5, pp. 391-401.)
3444. ON TRACING RAYS THROUGH AN OPTICAL SYSTEM.—T. Smith. (*Proc. Phys. Soc.*, 1st July 1945, Vol. 57, Part 4, No. 322, pp. 286-293.)
Author's summary:—"An iterative method of tracing rays through an optical system which is suitable for operation by a fully automatic recording machine is described. The rays may be axial or skew, and the surfaces of any rotationally symmetrical form suitable for optical working. The relation of this method to earlier schemes and the advantages to be gained by successive approximations are considered."
3445. DIRECT CURRENT PLANT FOR CRACK DETECTION.—Equipment and Engineering Co. Ltd. (*Electrician*, 27th July 1945, Vol. 135, No. 3504, p. 97.)
The disadvantages of alternating current impulse methods of crack detection are discussed and a direct current impulse magnetising equipment is described using selenium metal rectifiers generating 1000 Amperes at low voltage. The impulse is of 1 second duration with repetition rate of one every thirty seconds.
3446. "AN OUTLINE OF INDUSTRIAL METALLURGY" [Book Review].—D. G. P. Paterson & J. Bearn. (*Engineering*, 8th June 1945, Vol. 159, No. 4143, p. 443.)
3447. UNIFICATION OF SCREW THREADS, PART I.—(*Engineer*, 29th June 1945, Vol. 179, No. 4668, pp. 503-504.) Report on I.M.E. conference.
3448. "ELECTRO-PLATING: A SURVEY OF MODERN PRACTICE" (Fifth Edition) [Book Review].—S. Field & A. Dudley Weill. (*Electrician*, May 25th, 1945, Vol. 134, No. 3495, p. 472.)
3449. AN ALTERNATING CURRENT DIAPHRAGM PUMP [made from a Radio Headset Telephone Receiver].—C. Wertenbaker. (*Review Scient. Instr.*, Feb. 1945, Vol. 16, No. 2, p. 35.)
3450. \$1000 EDITORIAL AWARD: THREE AWARDS TO BE MADE BY *Electronic Industries* FOR ENGINEERING ARTICLES OF OUTSTANDING VALUE IN ADVANCING ELECTRONIC PRINCIPLES.—(*Electronic Industries*, March 1945, Vol. 4, No. 3, p. 95.)
3451. THE NAVY ELECTRONICS PROGRAM AND SOME OF ITS PAST, PRESENT, AND FUTURE PROBLEMS.—J. B. Dow. (*Proc. I.R.E.*, May 1945, Vol. 33, No. 5, pp. 291-299.)
"The decisive factor in determining the outcome of the present world conflict may well be the wide and intelligent use of the latest products in the field of electronics."
3452. LEAD COVERED CABLE ATTACKED BY WOOD WASP [Low-Insulation Fault caused by Larva of the Wood Wasp Boring Holes in Lead Sheath of Buried 14/20 Lead Cable].—(*P.O. Elec. Eng. Journ.*, April 1945, Vol. 38, Part 1, p. 27.)
3453. RECORDING ELECTRIC DISCHARGE PATHS IN AIR-GAPS.—E. W. H. Banner. (*Engineering*,

- 18th May 1945, Vol. 159, No. 4140, pp. 383-385, and 390.)
- The discharge is made to occur along the surface of a photographic film, on which an image of the discharge is produced by the light associated with the discharge.
3454. ANTI-VIBRATION MOUNTINGS FOR AIRCRAFT RADIO EQUIPMENT.—W. W. Honnor. (*A.W.A. Tech. Review*, March 1945, Vol. 6, No. 6, pp. 291-310.)
- Refers to the difference between the static and the dynamic characteristics of the "Lord" type of mounting and describes a vibration-table method of determining the dynamic values of the attenuation factors and moduli of elasticity.
3455. GRAPHICS OF WORLD AVIATION [Description of Various Map Projections for Aviation; Geared Hemispheres; Great Circle Charts].—A. J. Dilloway. (*Journ. Roy. Aeronautical Soc.*, March 1945, Vol. 49, No. 411, pp. 112-140.)
3456. RADAR FIRE HAZARD [Danger of Explosion when Pouring Petrol due to Induced Currents in Containers and Resultant Sparks].—(*Electronics*, April 1945, Vol. 18, No. 4, p. 212.)
3457. EXPORT WARNINGS [Letter on Need for Tropicalisation and for Efficient Servicing Organisation].—J. Banner. (*Wireless World*, June 1945, Vol. 51, No. 6, p. 180.)

REORGANISATION OF THE RADIO RESEARCH BOARD'S "ABSTRACTS AND REFERENCES"

Retirement of H. Dobell, M.A., Sen. Mem. I.R.E.

FOR more than sixteen years, the Radio Research Board's "Abstracts and References" have been in the sole charge of Mr. H. Dobell, of the Department of Scientific and Industrial Research. Mr. Dobell, who was due to retire in 1942 but agreed to continue until the end of the war in Europe, retired in July of this year.

There is evidence that this service has been very widely appreciated, not only in this country, but over the whole radio world. In a letter to Mr. Dobell, the Radio Research Board, which is representative of radio interests in the civil and military services and the universities, described it as "an outstanding service to radio science". It is therefore fitting to record that, although Mr. Dobell had at his back the resources and facilities of the D.S.I.R., the production of this feature has been almost entirely his own personal work, supplemented during the war years by the valuable voluntary assistance of his wife as secretary. If the magnitude of the result seems more appropriate to a team, it is because a rare combination of special abilities made him in effect a team in himself. Moreover, he was able to bring to this work the experience of many years of active and adventurous participation in the development of "wireless". As a member of the Marconi Company, he served for two years on Marconi's personal experimental staff of three, working at Poldhu. Later he took part

in pioneer work up the Amazon and in Spain. His service in the first World War was largely concerned with radio, but was brought to an untimely end in 1915 by the forced landing behind enemy lines of an aeroplane in which he had volunteered to act as machine gunner, in a search for Zeppelins reported to be setting out on their first raid on London. After three years as a prisoner of war, he rejoined the Marconi Company, where he later became Deputy-Chief of the Designs Department. He joined the D.S.I.R. in 1928, and shortly after took over and reorganised the R.R.B. abstract service, for which he has ever since been personally responsible.

Since his retirement, his work has been taken over by the Radio Division of the National Physical Laboratory, and, for the present, it will be continued in its existing form without any essential modification. The end of this year, however, will be a convenient time to make any changes that may seem necessary or desirable to bring the service closely into line with current developments and requirements, and it is here that those for whom the feature is produced can help themselves and those who will be carrying out this work, by constructive comment and criticism. Any such suggestions or criticisms, addressed to "The Superintendent, Radio Division, National Physical Laboratory, Teddington", will be much appreciated and very carefully considered.

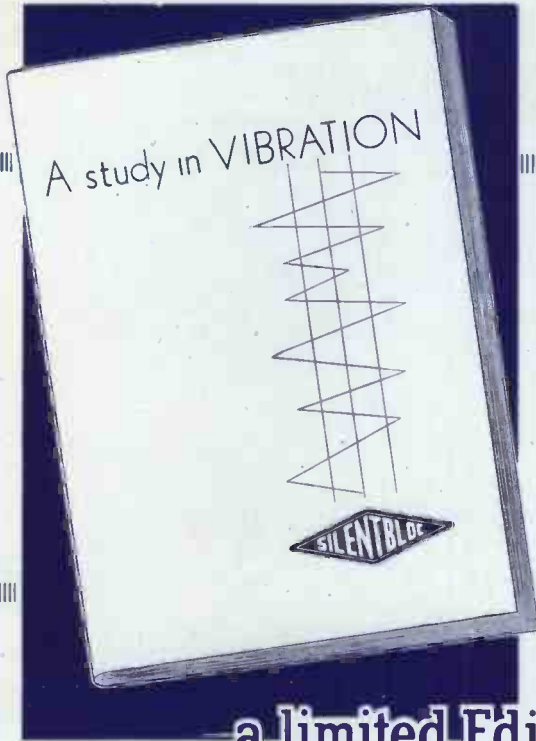

Vibration problems have confronted engineers to such an increasing extent in recent years that we felt some information in a concise form dealing with fundamentals would be of especial interest.

Accordingly, we present "A study in VIBRATION," a publication available to all interested Engineers on application to the Company.

SILENTBLOC LTD
Victoria Gardens, Ladbroke Road
LONDON, W.11

Announcing

Glass Seal Terminals

(Process Patent applied for)

AFTER rather more difficulties than we expected, we have developed a method of production in our factory at Enfield, where we are able to turn out many thousands per week.

Terminals at present available are illustrated about actual size; other sizes will follow.

They withstand instantaneous and repeated thermal shocks of at least 250°C and will support at least 40 lbs. per square inch air pressure without leakage. These terminals are supplied tin-plated to permit soldering with modern resin cored solders or solder pastes.

Supplied packed in cartons containing 100.

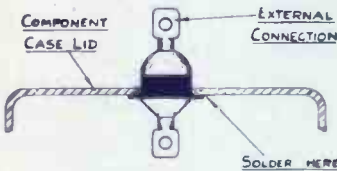

LIST No. 576.

750 V. DC. Working at 40,000 feet.
1,500 V. DC. Working at sea level.

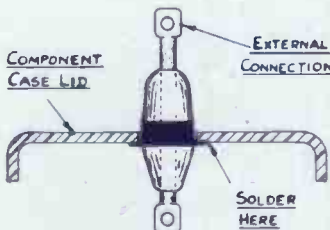

LIST No. 577

1,500 V. DC. Working at 40,000 feet.
3,000 V. DC. Working at sea level.

BELLING & LEE LTD
CAMBRIDGE ARTERIAL ROAD, ENFIELD, MIDDX

HIGH PERFORMANCE

Long years of patient training and practice are behind every Dubilier volume control and variable resistor. There is no substitute for these years of experience which ensure that uniformly high performance for which all Dubilier products are world famous.



Illustration shows Volume Controls

DUBILIER

CONDENSER CO. (1925) LTD.



C. R. C. 4