

2/6

WIRELESS ENGINEER

The Journal of Radio Research & Progress

Vol. XX

MAY 1943

No. 236

CONTENTS

EDITORIAL. Reflections from Unmatched Feeder Terminals ..	215
SHORT-WAVE DIPOLE AERIALS. By N. Wells, M.Sc.	219
F.M. COMMUNICATION SYSTEMS. By D. A. Bell, M.A., B.S. ..	233
WIRELESS PATENTS	243
ABSTRACTS AND REFERENCES	245-266

Published on the first of each month
SUBSCRIPTIONS (Home and Abroad)
One Year 32/- 6 months 16/-
Telephone: Telegrams:
Waterloo 3333 (35 lines) Experiwyr Sedist London

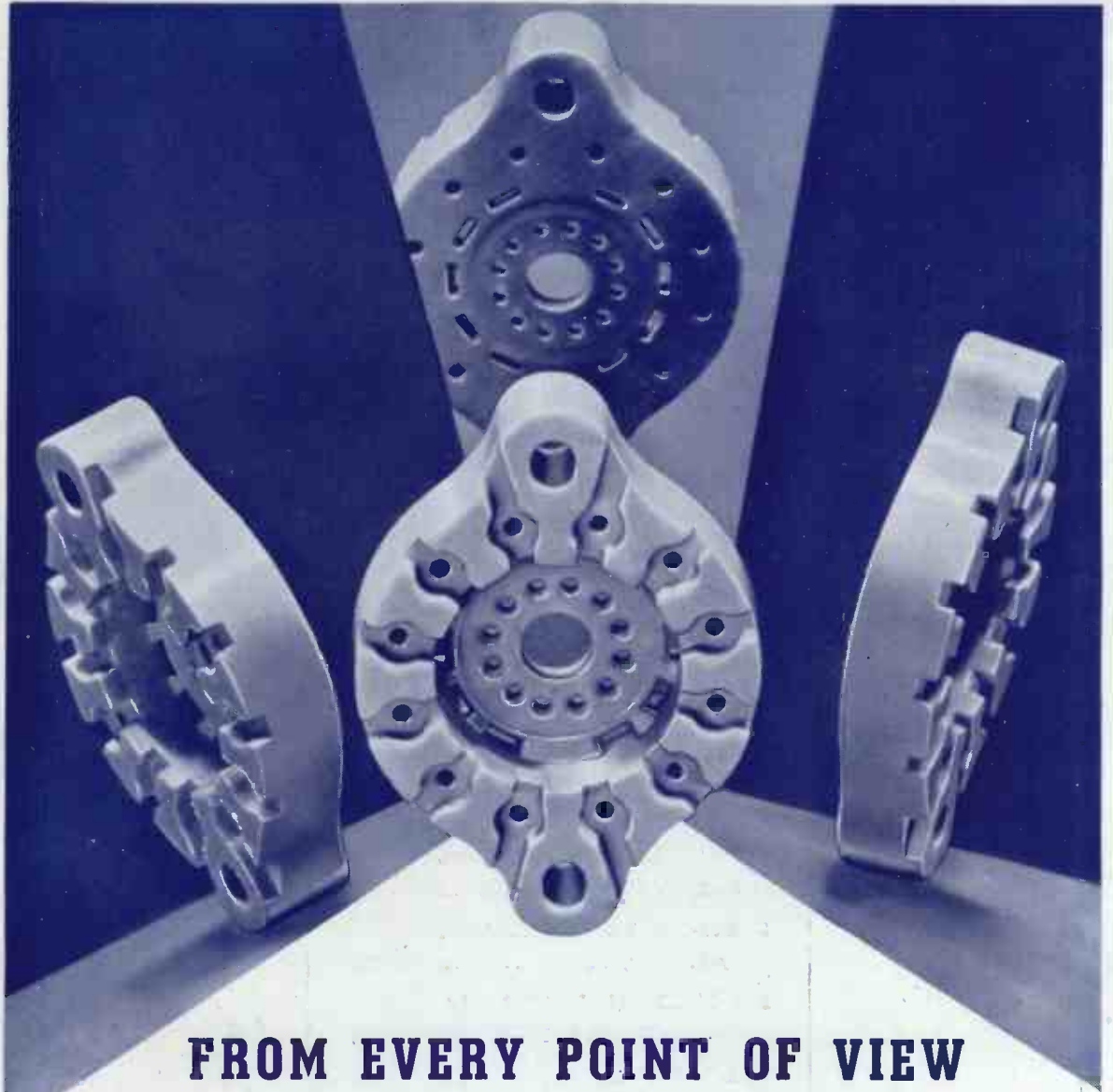

FROM EVERY POINT OF VIEW

“Frequentite” is the most suitable insulating material for all high frequency applications. Ten years ago we introduced the first British-made low loss ceramic, and consultation with us before finalising the design of new components is a wise precaution.



STEATITE & PORCELAIN PRODUCTS LTD.

Head Office: Stourport-on-Severn, Worcester.

Telephone: Stourport 111.

Telegrams: Steatins, Stourport.

SP19

BUILT TO ENDURE!

These four colossal heads, occupying an area of 1½ acres of solid granite rock-face and proportionate in size to full figures of men 465 ft. tall, will weather the storms and fury of ages to come.

ALSO BUILT TO ENDURE!

The ubiquitous "VARIAC" A-C Voltage Control—a device with 1,001 uses, covering innumerable applications in the electrical, radio and "communications" fields. In 15 models, with power ratings from 170 watts to 7 k.w.



(Complete data on request.)

FROM 6300 FT.
OF DEMO
NATIONAL MI
TURAL WORK
THE ARTIST
ADVISED THE
TIONS AND FE
WATE TO MEN
LEAD TO TIP OF
THE BUSTS ARE
ROOSEVELT
BY CALVIN CO
FOR BY J. S. CO
ROOSEVELT 1934
BUILT BY GOV BU
CARRIES WORK

CLAUDE LYONS LTD. LIVERPOOL 3 AND LONDON. W. I.

CL20

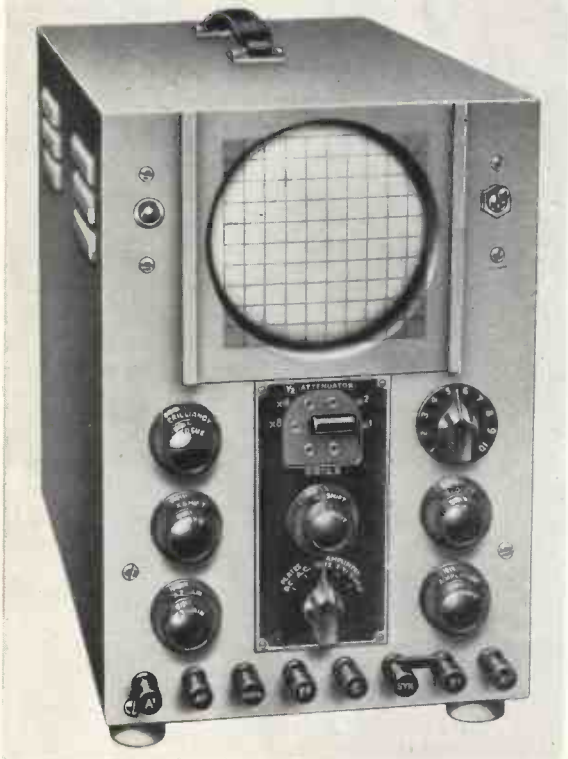

G.P.9015

COSSOR

Double Beam

CATHODE RAY OSCILLOGRAPH

Produced by the pioneers of Cathode Ray Tube development and application, Cossor Model 339 Oscillograph is the most comprehensive instrument of its type. In addition to remarkable performance, it is unique in enabling the simultaneous examination of two variables such as voltage and current.

Further details may be had on application to :

A. C. Cossor Ltd.

Instrument Dept., Cossor House,
Highbury Grove, London, N.5.

BOONTON

MODEL 170-A Q-METER

The latest and improved type, designed to extend range of measurement to 200 Mc.

BOONTON

SIGNAL GENERATOR for FREQUENCY MODULATION

Standard frequency ranges 1 to 10 and 41 to 50 Megacycles. (Special ranges to order.)

Also products of :

BALLANTINE LABORATORIES INC.
MEASUREMENTS CORPORATION
TRIUMPH MANUFACTURING CO.

SOLE AUTHORIZED BRITISH AGENTS

A&H Radio Ltd

Buchanan Buildings, 24, Holborn, London, E.C1

Phone: Holborn 7394 Grams, Tungol, Smith, London

A 'POINT' TO CONSIDER

"VISKRINGS"

**TUBULAR CABLE MARKERS
ARE SELF-FIXING BY SHRINKAGE
NO TOOLS REQUIRED**



No rubber used · Supplied ready for use in all sizes and colours, indelibly printed in black · Imperishable · Impervious to oils and petroleum · Do not increase diameter of cable.

VISKRINGS

CABLE MARKERS

VISCOSE DEVELOPMENT CO. LTD., Woldham Rd., Bromley, Kent

Telephone: Ravensbourne 2641

WIRELESS TELEGRAPHY BOARD

SPECIFICATION K.110 (Revised Nov., 1942)

Electrical Telecommunication Apparatus

for use in
Damp, Tropical Climates

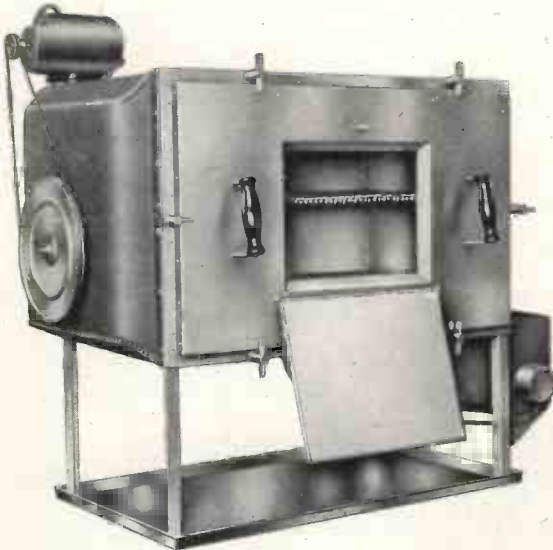
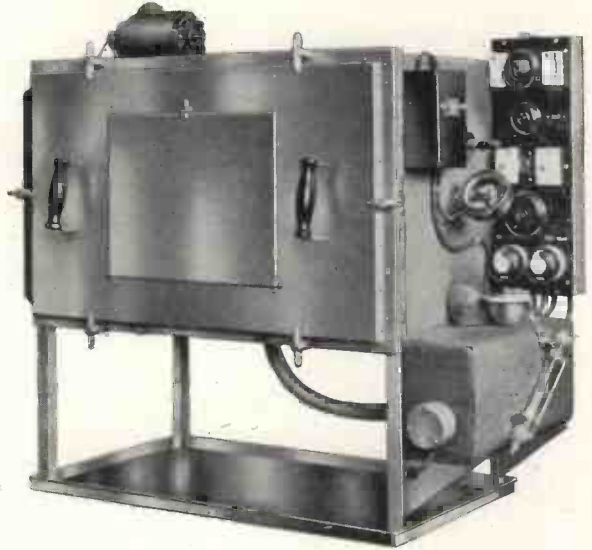

By testing your products in a chamber of this design you are assured of recording results identical to those that will be obtained by the testing authorities of all the services. Each equipment is supplied with its individual performance curve superimposed on that of the prototype now in use at R.A.E.

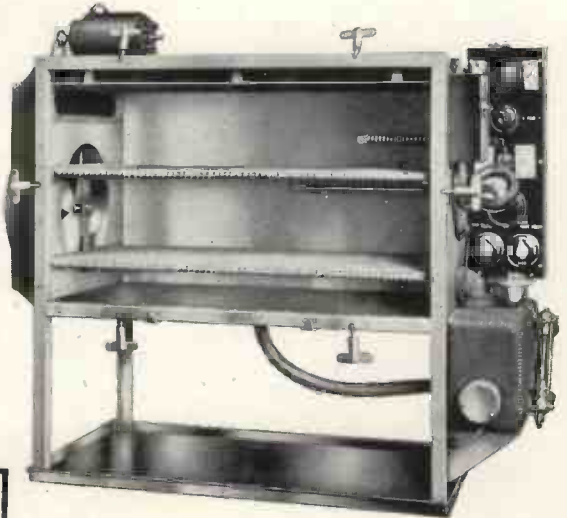

We are actually in production with Humidity Chambers to this specification, identical to those supplied by us to the parent research establishments of the services. Deliveries are steady though slow—materials are difficult—considerable orders are already in hand, please help us to help you by advising us in good time as to your requirements.

BELLING & LEE LTD
CAMBRIDGE ARTERIAL ROAD, ENFIELD, MIDDX



On every battlefield

Condensers are at work

Perfect communication by radio is essential in all modern war operations, from grand strategy down to the smallest tactical manoeuvre. Nothing but the very best of apparatus is good enough.

TRADE **HUNTS** MARK

The
Home of Condensers

ADVT. of A. H. HUNT, LTD., LONDON, S.W.18. EST. 1901

**TRANSFORMERS FOR THE
TROPICS**



WODEN TRANSFORMER CO.
Thornley Street, Wolverhampton

Tel.: Wolverhampton 22829

MAKERS OF TRANSFORMERS, POWER PACKS, & SPECIAL RECEIVING & TRANSMITTING APPARATUS

F.M. Equipment
ARMSTRONG SYSTEM



TWO-WAY MOBILE INSTALLATION
VICTORY SERIES 565Y.

F.M. insures minimum interference—compact single-unit design
100% crystal controlled. 25/30 watts.
NOW IN QUANTITY PRODUCTION BY
RADIO ENGINEERING LABORATORIES INC.
America's Pioneer F.M. Manufacturers.

Available on Priority Orders only.

Electronic Engineering Services, Ltd.

SOLE BRITISH DISTRIBUTORS



24, STANLEY ROAD, HEATON MOOR, STOCKPORT.
TELEPHONE: HEATON MOOR 3107



HETERODYNE OSCILLATOR

with exclusive B.S.R. features

Never has a commercial Oscillator been produced with such a performance irrespective of price. Built to retain its superlative performance indefinitely.

8 Watts with under 1% total Harmonic distortion.

2-5½" dia. Nickel Dials with slow motion.

4 Output Impedances selected by switch.

Multi-range Rectifier Output meter.

All stages checked by milliammeter.

Hum Content less than 0.16%.

Alternative R.C. Output down to 5 c.p.s.

Output within ± 0.5 db. 20 to 15,000 c.p.s.

110/200/250 volts, 50 cycles.



£67-10-0.

Model LO800.

BIRMINGHAM SOUND REPRODUCERS LTD.,

CLAREMONT WORKS, OLD HILL, STAFFS.

'Phone: Cradley Heath 6212/3.

'Grams: Electronic, Old Hill.

ADVANCE



Constant Voltage

TRANSFORMERS

Line Voltage Variations of
 $\pm 15\%$ reduced to $\pm 1\%$

Typical Specification:

Input Voltage	...	190-260 v. 50 c.
Output Voltage	...	230 v. $\pm 1\%$.
Max. load	...	150 watts.

Input power factor over 90%.

Prices on application.

Write for details.

ADVANCE

COMPONENTS LTD

BACK ROAD, SHERNHALL STREET, WALTHAMSTOW, LONDON, E.17.

Phone: LARKSwood 4366 & 4367



Regd. Trade Mark

PRECISION
TESTING INSTRUMENTS

HIGH accuracy, simplicity, exceptional versatility and proven reliability have won for "AVO" Instruments a world-wide reputation for supremacy wherever rapid precision test work is demanded. There is an "AVO" Instrument for every essential electrical test.

Some delay in delivery of Trade Orders is inevitable, but we shall continue to do our best to fulfil your requirements as promptly as possible.

Sole Proprietors and Manufacturers:

THE AUTOMATIC COIL WINDER & ELECTRICAL EQUIPMENT CO. LTD., Winder House, Douglas Street, London, S.W.1.

'Phone: VICTORIA 3404-7



The MODEL 7 46-Range Universal
AVOMETER
Electrical Measuring Instrument

A self-contained, precision moving-coil instrument, conforming to B.S. 1st Grade accuracy requirements. Has 46 ranges, providing for measuring A.C. & D.C. volts, A.C. & D.C. amperes, resistance, capacity, audio-frequency power output and decibels. Direct readings. No external shunts or series resistances. Provided with automatic compensation for errors arising from variations in temperature, and is protected by an automatic cut-out against damage through overload.

B O O N T O N



A Signal Generator developed specifically for use in the design of F.M. equipment.

Full specification will be sent on request.

F.M. Model 150-A
F.M. SIGNAL
GENERATOR

- ★ Frequency Ranges: 41-50 mc and 1-10 mc. (Other ranges to order.)
- ★ Output: 1 Microvolt to 1 Volt.
- ★ Deviation: From zero to 2000 KC. Amplitude Modulation also available separately or simultaneously.

**LELAND
INSTRUMENTS LTD**

21, JOHN STREET, BEDFORD ROW, LONDON W.1
TELEPHONE: CHANCERY 8765

CLOUGH-BRENGLE • BOONTON • FERRIS • BALLANTINE • HEWLETT-PACKARD

Dainite

MOULDED RUBBER PARTS

As soon as the war is won we hope to offer our usual "DAINITE" Service for Moulded Rubber Parts. In the meantime, enquiries for permitted essential lines will receive every attention.

THE HARBORO' RUBBER CO. LTD.
MARKET HARBOROUGH.

TECHNICAL BOOKS

supplied from stock or obtained to order.

Particulars of books on Radio and Electrical Engineering post free on application.

Foreign books obtained under licence.

LEWIS'S POSTAL SERVICE

Please state interests when writing.

H. K. LEWIS & Co. Ltd.
136 Gower Street, London, W.C.1

Telephone: EUSton 4282 (5 lines)



**SILVERED CERAMIC
FIXED CONDENSERS**

PEARL TYPE
0.5 pF to 5 pF.

Max. Dimensions 7 x 9mm
Test Voltage 1500V D.C.
Loss Factor 20 x 10⁻⁴

Mechanical and electrical
stability whatever the
climatic conditions.
Type approved.

MULTUM IN PARVO



UNITED INSULATOR CO LTD
12-20 LAYSTALL STREET, LONDON, E.C.1.
Phone: TERminus 7383

*The Pioneers
of Low-Loss
Ceramics*

Grams: Calancl, Smilh, London.

Have you such a problem?

$$X = \frac{60 \times 10^8 (V - IR)}{p/c \text{ } \& \text{ } Z}$$

But for the war our research and design laboratory staffed by experienced technicians could supply you with the answer and our manufacturing department with the goods.

We are not primarily interested in the simple mass-produced job, it's the difficult ones we like to manufacture. To these we can bring an advisory and production service able to cope resourcefully with problems of every kind

involving Small Electric Motors, Alternators, Generators and Electro-Mechanical apparatus.

In due course we shall be pleased to give all our attention and experience to any question you may submit to us.

Write for particulars of any special type of apparatus that interests you; we will forward details and literature when available.



SMALL ELECTRIC MOTORS LTD.,
BECKENHAM, KENT.

A subsidiary of
**BROADCAST RELAY
SERVICE LIMITED**

The glory of the future..



when the harsh roar of battle gives place to the merry music of "fiddle, 'cello and big bass drum," Goodmans Loudspeakers will be available again to reproduce music's most transient note with a faithfulness rarely achieved in the commercial sphere.



GOODMANS

Makers of

HIGH GRADE LOUDSPEAKERS

Priority Orders only can be accepted

GOODMANS INDUSTRIES LTD., LANCELOT ROAD, WEMBLEY, MIDDLESEX

BASICALLY BETTER...



Air Insulation...

is the basic principle of

CO-AX LOW LOSS CABLES

Unequalled H.F. Properties

There is a CO-AX Cable for every H.F. Purpose

TRANSRADIO LTD. Inc. TELEQUIPMENT CO. 16 HIGHWAY BEACONSFIELD

WHEN YOU REQUIRE

machine-engraved, chemically-etched or die-pressed calibrated dials and rack arms, instrument panels, labels etc., in metal or plastic (in English, Russian or other languages) consult

THE STAR PROCESS ENGRAVING CO. LTD

Lower Mosley Street, Manchester 2

A.I.D FULLY APPROVED

LARGE DEPT. FOR WIRELESS BOOKS.

FOYLES

FINEST STOCK IN THE WORLD OF NEW AND SECONDHAND BOOKS ON EVERY SUBJECT.

Quick Postal Service.

Books Bought.

119-125, CHARING CROSS ROAD, LONDON, W.C.2.

Tel.: GERrard 5660 (16 lines). Open 9 a.m.—6 p.m., including Saturday.

KESSLERS (London) LTD.

Machining and Turning of Plastic Material.
Signal Lamp Caps, Screw-cutting in Bakelised Fabric
ALBION HOUSE, 201-3, CHURCH STREET,
LONDON, N. 16.

Tel. Otisold 8247

Your enquiries are invited.



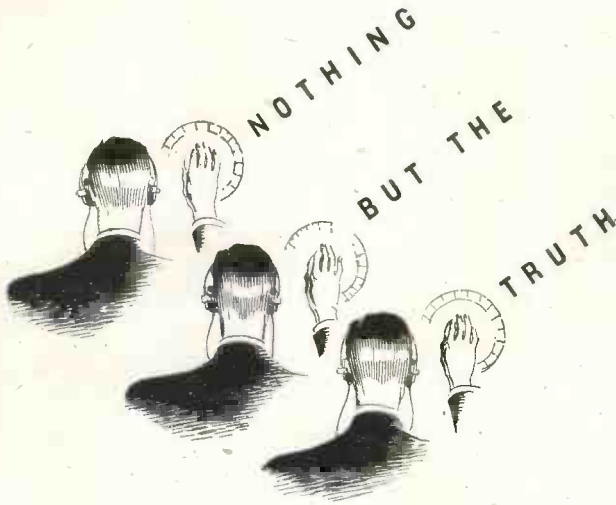

An electrical instrument may embody every assembled component necessary for an accurate measuring device. But it will remain ineffective for its purpose until its own individual performance has been checked and proved and calibrated. It is on the test bench that it finds itself: the inquisitor will be content with nothing less than the truth.

The testing of every measurement device produced by Marconi Instruments—and there are 60 of them in production—is as uncompromising as is every phase in its design and production. For these are instruments made for the measurement of very fine limits of performance. They apply the experience of a lifetime to the demands of a new technical age. In every requirement of to-day they live up to the traditions of accuracy and resource that have belonged for *nearly* half a century to the name Marconi.

MARCONI Instruments Ltd
ST. ALBANS HERTS TELEPHONE 4323

INDUSTRIAL ELECTRONICS

The applications of radio frequency engineering and the general technique of electronic communication to many fields of industry is writing a new chapter in the history of industrial developments.

The development of Rediffusion within its own field provides knowledge and experience which will be fully at the service of industries of the future and will contribute in great measure to an increasing efficiency of operation.

REDIFFUSION LIMITED

A subsidiary of BROADCAST RELAY SERVICE LIMITED

DESIGNERS & MANUFACTURERS of RADIO COMMUNICATION and INDUSTRIAL ELECTRONIC EQUIPMENT
Victoria Station House, Victoria Street, London, S.W.1 (Phone Victoria 8831)

Switches?

From small Q.M.B. to heavy duty pattern switches—millions have been supplied and have given complete satisfaction. State the specification—give your priority Ct. Nos.—and your order will receive immediate attention



CONTACT

Claude Lyons LTD

ELECTRICAL AND RADIO LABORATORY APPARATUS ETC.

180 TOTTENHAM COURT RD., LONDON, W.1
and 76 Oldhall Street, Liverpool, 3, Lancs.

HIVAC

THE SCIENTIFIC
VALVE

BRITISH MADE



Specialists in
MIDGET VALVES

HIVAC LIMITED
Greenhill Crescent,
Harrow on the Hill, Middx.

Telephone: Harrow 0895.

LONDEX for RELAYS

For A.C. and D.C.
TWO STEP RELAY LF/FS
(Heavy Silver Contacts).



First Impulse "ON."
Second Impulse "OFF."
Also Aerial Change-over Relays.
Ask for Leaflet 88A/WE.

LONDEX LTD.

Manufacturers of Relays.

Anerley Works, 207, Anerley Rd., London, S.E.20.
Telephone: SYDENHAM 6258 & 6259.

KING

ELECTRIC CHAIN PULLEY BLOCK



Write for booklet on lifting and shifting or separate catalogue of conveyors, cranes, and other mechanical handling equipment.

● **GEO. W. KING LTD.,**
HARTFORD WORKS · HITCHIN HERTS.

TESTOSCOPE



Makes 30 important tests, 100 to 750 volts, A.C. or D.C. Used everywhere by Electricians, Wiremen, etc. From Wholesalers or direct. Send for leaflet "G24"

RUNBAKEN -- MANCHESTER -- I

Appointment Vacant

Director of research and development, to take complete charge of these departments, required by a London firm of Electrical Engineers manufacturing radio frequency, acoustic and electrical instruments. First class qualifications in Physics or Electrical Engineering essential, coupled with wide industrial experience. Write, stating full particulars, to "Wireless Engineer" **Box 829.**



Piezo QUARTZ CRYSTALS

for all applications.
Full details on request.

QUARTZ CRYSTAL CO., LTD.,
(Phone: MALden 0334.) 63-71, Kingston Rd., New Malden, SURREY.

TANNOY

Specialists in Sound Amplifying Equipment, Microphones, Power Amplifiers, Loudspeakers, etc.
Also makers of Scientific Instruments.

TANNOY PRODUCTS (Guy R. Fountain Ltd.) W. NORWOOD, S.E.27

POWER LEVEL INDICATORS

Power Level Indicators

TYPES D-152-A and D-152-B

- ★ Embodying a simple resistance bridge, self-balancing at a predetermined power level—Robust—Accurate—Inexpensive.
- ★ Type D-152-A indicates a fixed power level; D-152-B is variable over a limited range.
- ★ Equally accurate on D.C. or A.C. Accuracy is independent of wave form and frequency up to 53 K/c/s.
- ★ With A.C., telephones will indicate balance to better than 0.1 db; a reasonably sensitive galvanometer (e.g. 100-0-100 uA.) gives equivalent discrimination with D.C.
- ★ Cannot be damaged by overloads up to 1000%.
- ★ Indispensable to Transmission Engineers, Meter Manufacturers, and others requiring a standard power level.

Full particulars are given in Bulletin B-540-A a c. py of which will gladly be sent on request.

STANDARD TYPES

TYPE NO.	POWER INDICATION REF. 1 mW	INPUT RESISTANCES	DIMENSIONS	WEIGHT
D-152-A	+ 20 db ± 0.1 db	630Ω ± 1%	6" × 5" × 5½"	3 lbs.
D-152-B	+ 10 to ± 22 db ± 0.2 db	600Ω ± 5%	8" × 5" × 5½"	4 lbs.

MUIRHEAD & COMPANY, LTD.
ELMERS-END, BECKENHAM,
KENT; Beckenham 0041-0042
FOR OVER 60 YEARS DESIGNERS
AND MAKERS
OF PRECISION INSTRUMENTS



C.R.C.40



Type D-152-A

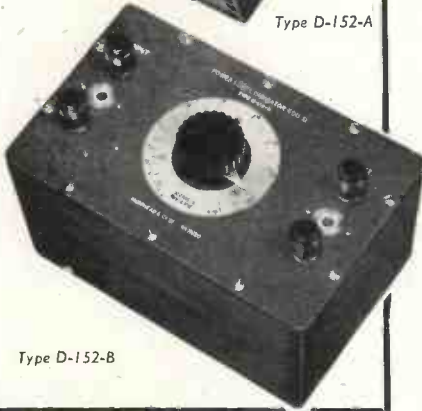

Type D-152-B

**Electrical Standards for
Research and Industry**
Testing and Measuring Apparatus
for Communication Engineering

BRIDGES — Capacitance
Inductance
Resistance
RESISTANCES
INDUCTANCES

CONDENSERS

OSCILLATORS

WAVEMETERS

H. W. SULLIVAN
— LIMITED —

London, S.E.15

ALL TYPES—ALL FREQUENCIES—ALL ACCURACIES

Tel. New Cross 3225 (Private Branch Exchange)

T I M I N G T I M E

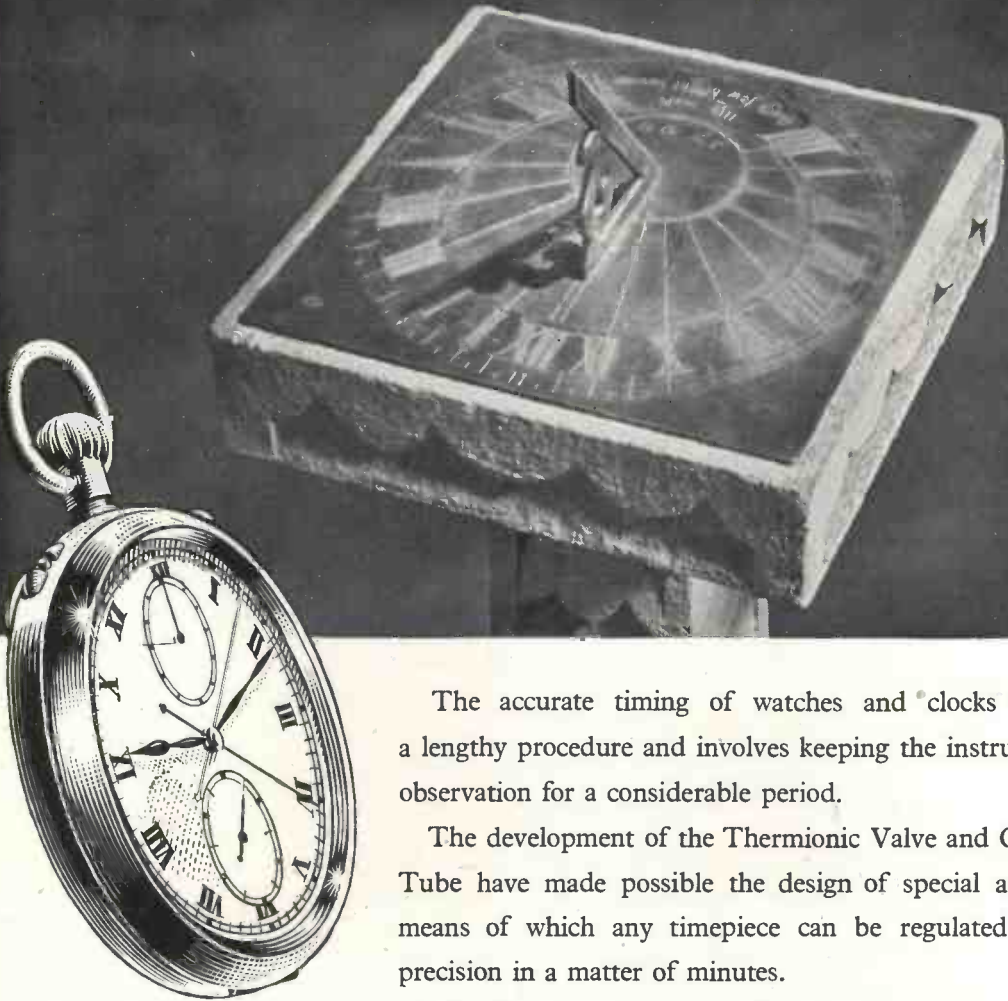

The accurate timing of watches and clocks is normally a lengthy procedure and involves keeping the instrument under observation for a considerable period.

The development of the Thermionic Valve and Cathode Ray Tube have made possible the design of special apparatus by means of which any timepiece can be regulated with great precision in a matter of minutes.

This is yet another example of the important part which the valve plays in solving specialised problems of control which arise in almost every industry.

COMMERCIAL
INDUSTRIAL
SCIENTIFIC
MEDICAL
EXPERIMENTAL
DOMESTIC

MULLARD

THE MASTER VALVE

A Valve for Every Purpose

WIRELESS ENGINEER

Editor HUGH S. POCOCK, M.I.E.E.

Technical Editor Prof. G. W. O. HOWE, D.Sc., M.I.E.E.

VOL. XX

MAY, 1943

No. 236

Editorial

Reflections from Unmatched Feeder Terminals

ALTHOUGH this subject is far from new and has been dealt with in a number of articles and text-books, it has lately become of increasing interest to a great number of people, and we therefore propose to explain a simple graphical method of representing the conditions that exist under various circumstances and of solving the design problems that arise.

If a pair of Lecher wires or the feeder to a short-wave aerial has a terminal load of impedance Z_l the resultant voltage wave is the sum of the incident or forward wave and the reflected or backward wave. If the former is represented at the load end of the line by the vector V_f , it will be represented at any point along the line by $V_f e^{j\beta x}$ where $\beta = 2\pi/\lambda$ and x is the distance from the end. If the reflected or backward wave is represented at the end by V_b , it will be represented at a distance x by $V_b e^{-j\beta x}$ or by $(\rho V_f e^{j\beta y}) e^{-j\beta x}$ where βy is the phase displacement suffered by the wave on reflection and ρ the magnitude of the reflection coefficient V_b/V_f . If the line be assumed to have negligible losses, its characteristic impedance Z_0 will be a resistance R_0 equal to $\sqrt{L/C}$, and the currents of the two waves will be in phase with the voltages and, of course, proportional to them. For the resultant voltage and current at any point, we have

$$V = V_f e^{j\beta x} + \rho V_f e^{-j\beta(x-y)}$$

$$I = I_f e^{j\beta x} - \rho I_f e^{-j\beta(x-y)}$$

the negative sign in the current equation

being due to the fact that the two waves transmit power in opposite directions. At the load end, $x = 0$,

$$V_l = V_f + \rho V_f e^{j\beta y} \quad \dots \quad (a)$$

and

$$I_l = I_f - \rho I_f e^{j\beta y} \quad \dots \quad (b)$$

$$\therefore \frac{V_l}{Z_l} = \frac{V_f}{R_0} - \rho \frac{V_f}{R_0} e^{j\beta y}$$

$$\text{or } V_l \frac{R_0}{Z_l} = V_f - \rho V_f e^{j\beta y} \quad \dots \quad (c)$$

From (a) and (c)

$$V_l \left(1 + \frac{R_0}{Z_l} \right) = 2V_f \quad \dots \quad (d)$$

and

$$V_l \left(1 - \frac{R_0}{Z_l} \right) = 2\rho V_f e^{j\beta y} \quad \dots \quad (e)$$

These equations are shown graphically in Fig. 1 for a specific case. The whole diagram rotates, of course, at an angular velocity $\omega = 2\pi f$, but it is drawn for the moment when the voltage across the load is passing through zero. As one proceeds back along the line V_f rotates anti-clockwise and V_b clockwise as indicated by the arrows, until at a distance $x_1 = y/2$ they come into phase and give an antinode with a maximum resultant voltage V_1 equal to their sum $V_f + V_b$. Proceeding further along the line we reach a minimum V_2 equal to $V_f - V_b$ at a distance $x_2 = \frac{y}{2} + \frac{\lambda}{4}$, since the two vectors will then have turned through 90°

but in opposite directions from the maximum position. After another distance of $\lambda/4$ they will come into phase again and so on.

If

$$\frac{\text{maximum}}{\text{minimum}} = \frac{V_1}{V_2} = \frac{V_f + V_b}{V_f - V_b} = k$$

then
$$\frac{V_f}{V_b} = \frac{k + 1}{k - 1}$$

in which the symbols refer merely to the magnitudes of the vectors.

An Example

As an illustration, we assume that a line for which $\sqrt{L/C} = R_0 = 600$ ohms is fed

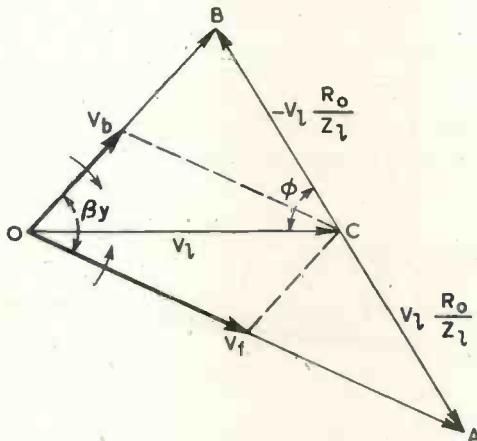

Fig. 1.

by an oscillator at a frequency of 100 Mc/s and terminated by an impedance Z_l , the nature of which we wish to determine. It is found that a maximum occurs at a distance x_1 of 30 cm and that the voltage V_1 at this point is 3.7 times the voltage V_2 at the following minimum.

$$\rho = \frac{V_b}{V_f} = \frac{k - 1}{k + 1} = \frac{3.7 - 1}{3.7 + 1} = \frac{2.7}{4.7} = 0.575$$

and, since $\lambda = 300$ cm,

$$\beta y = 2x_1\beta = 2 \times 30 \times \frac{2\pi}{300} = 0.4\pi = 72^\circ$$

A line of any suitable length is drawn in Fig. 1 to represent V_f , and V_b is drawn at an angle βy of 72° and equal to $0.575V_f$. Equations (d) and (e) show that by simply doubling the lengths of these lines we get $V_1(1 + R_0/Z_l)$ and $V_1(1 - R_0/Z_l)$. On completing the triangle and joining the origin O to the

mid-point C of the base AB we have V_1 , the resultant of V_f and V_b , and to the same scale $CA = V_1R_0/Z_l$. Hence $Z_l = R_0 \frac{OC}{CA}$, which we find from the figure to be 790 ohms. This is then the magnitude of Z_l ; its phase angle ϕ is 58.5° . It will be seen that $1/Z_l$, operating on OC , turns it through a negative angle to CA , but since $\frac{1}{Z} / \phi = \frac{1}{Z/\phi}$ the load impedance is $Z_l / 58.5^\circ = 790 / 58.5^\circ = 412 + j673$ ohms.

If the problem had been reversed, that is, if we had been given the terminating impedance Z_l/ϕ and the line characteristic R_0 , and were required to find the positions and relative magnitudes of the maxima and minima along the line, the line $OC = V_1$ would be drawn to any suitable scale and ACB set out at the correct angle ϕ and length $2V_1R_0/Z_l$. On completing the triangle V_f, V_b and the angle βy can be read off; then

$$k = \frac{\text{maximum}}{\text{minimum}} = \frac{V_f + V_b}{V_f - V_b} = \frac{1 + \rho}{1 - \rho}$$

and $x_1 = y/2 = \lambda \cdot \frac{\beta y}{4\pi}$.

It is interesting and instructive to consider what happens to the diagram as the nature

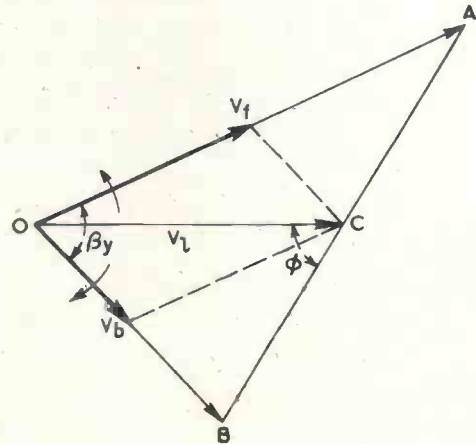

Fig. 2.

of the terminating load is varied. If the magnitude of Z_l is maintained constant but its phase angle ϕ gradually reduced, the line BCA will swing round left-handedly until,

when the load is purely resistive, *OB* will lie on a straight line, *V_f* will reach its maximum and *V_b* its minimum value, and the antinode will occur at the end of the line. If the purely resistive load is made equal to *R₀*, *BC* and *CA* become equal to *OC*; the point *B* thus falls on *O* and *V_b* vanishes. The line is then correctly matched.

If the load is now made capacitive, that is, if ϕ is made negative, *BCA* will swing further round, until, when ϕ has the same

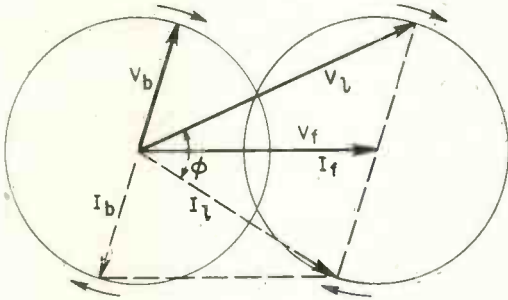

Fig. 3.

value as in Fig. 1 but of opposite sign, we get Fig. 2, which we can also get by looking through the paper at Fig. 1 upside down. *V_f* is still bigger than *V_b* but it will be noticed that as one proceeds along the feeder, they get further out of phase, and a minimum will occur before the first maximum is reached. If one still denotes the acute angle *AOB* by βy then the above formula for x_1 will give the distance beyond the end of the line to a fictitious maximum, but if βy denotes the large external angle then the formula will give the distance x_1 to the real maximum, and the first minimum will occur at a distance $x_2 = x_1 - \lambda/4$.

If the load is purely inductive or purely capacitive, the triangle *AOB* becomes isosceles, $V_f = V_b$, the maxima = $2V_f$ and the minima = 0.

If the line is open, that is, if Z_l is infinite *A* and *B* coalesce at *C* and $V_f = V_b = V_l/2$. If Z_l is made progressively smaller but V_l decreased proportionately so that I_l remains constant, the line *ACB* will remain of constant length but *C* will approach *O* until when $Z_l = 0$, that is, when the line is short-circuited, *C* and *O* coalesce, and $V_f = -V_b = I_l R_0/2$.

Current Waves

Up to this point we have confined our attention almost entirely to the voltage waves, but we saw that in finding the resultant current wave, the sign of the backward or reflected current wave must be reversed. This is illustrated in Fig. 3 in which the scales of voltage and current are such that the same vector serves for both; this is possible since both V_f/I_f and V_b/I_b are equal to R_0 . I_f is drawn in the same direction as V_f , but I_b is drawn in the opposite direction to V_b . V_l is the resultant voltage and I_l the resultant current at the end of the line. Taking V_f as our standard of reference, i.e., keeping V_f horizontal, as we proceed along the line away from the load, the line $V_b I_b$ rotates as shown through an angle $2\beta x = 720^\circ \times x/\lambda$ where x is the distance.

It will be noted that a complete revolution corresponds to only half a wave-length. A circle of radius V_b is drawn about each end of V_f and it is seen that the ends of the vectors V and I (they cease to be V_l and I_l as soon as one leaves the end of the line) move around the right-hand circle, always being at the opposite ends of a diameter. When $x = 30$ cm, $2\beta x = 72^\circ$ and V and I will be horizontal, V a maximum and I a minimum. For the next 180° , i.e. $\lambda/4$, the current will lead, and they will then come into phase again with V a minimum and I a maximum.

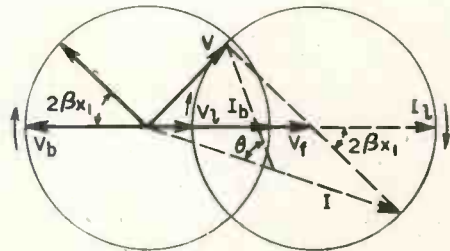

Fig. 4.

Stub Matching

Figs. 4 and 5 illustrate another example of a different type. Here the 600-ohm feeder is assumed to be terminated by a non-inductive resistance R_l of 100 ohms. Since $R_0/R_l = 6$, it will be seen from (d) and (e) that $V_f = 3.5V_l$ and $V_b = -2.5V_l$. In Fig. 4 V_l , V_f and V_b are drawn horizontally to any suitable scale. Using as before the

same vectors to represent either currents or voltages, I_l will be represented by the sum of V_f and V_b reversed. As one proceeds back along the line, V_b rotates as shown, and the ends of the vectors V and I move around the right-hand circle. When the distance x_1 from the end is 18.3 cm, the angle $2\beta x_1 = 44^\circ$ and V is exactly tangential to the circle. Fig. 4 is drawn for this point. V is at right-angles to the diameter and I and V form the hypotenuse and base of a right-angled triangle. The current I may be regarded as the resultant of two components in parallel, one in phase with V and represented by the same vector, and the other in quadrature with V and represented by the diameter of the circle. The in-phase component being represented by the vector V must be equal in magnitude to V/R_0 , i.e. to $V/600$, and if the quadrature component of the current could be eliminated the feeder would appear to be perfectly matched. The elimination of the quadrature component is achieved by connecting at this point a short-circuited stub or length of line, which we assume to be of the same character as the feeder, viz. with $R_0 = 600$ ohms as shown in Fig. 5. If this is made of the correct length it will take a wattless leading current equal to the lagging quadrature component in the feeder and thus cancel it, leaving only the in-phase component V/R_0 .

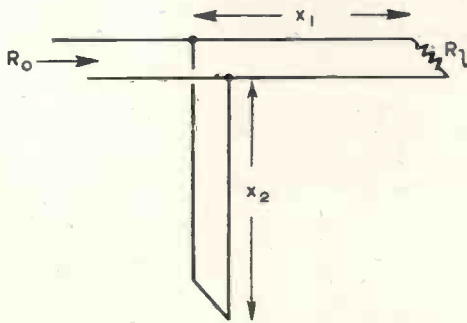

Fig. 5.

Fig. 6 shows the conditions in the short-circuited stub. In this case we have already seen that $V_f = -V_b = I_l R_0/2$; I_l is therefore made twice as long as V_f ; V_l is, of course, zero. When V_b begins to rotate the current is lagging, but after 180° the current passes through zero and becomes a leading current. When the angle $2\beta x_2$ is equal to 309° , i.e. when $x_2 = 129$ cm the conditions are as

shown in Fig. 6 in which the right-angled triangle IV is similar to that in Fig. 4, but with the phase-angle reversed, so that the capacitive reactance of one balances the inductive reactance of the other. The stub in Fig. 5 must therefore have a length x_2 of 129 cm.

In practice it is not necessary to draw Fig. 6 since the length x_2 can be obtained directly from Fig. 4. Since the two right-

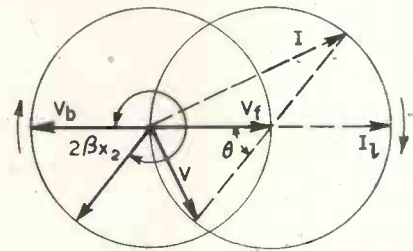

Fig. 6.

angled triangles must be similar the line joining the right-angle to the mid-point of the hypotenuse must make the same angle with the hypotenuse. In Fig. 6 this angle θ is $2\pi - 2\beta x_2$. Hence if in Fig. 4 a line be drawn from the right angle to the mid-point of the I vector, the angle θ will be equal to $2\pi - 2\beta x_2$ from which x_2 can be calculated. Hence Fig. 4 gives us straight away both the distances x_1 and x_2 with nothing more than a protractor and a pair of compasses.

If the stub is not short-circuited but open, the initial positions of the I and V vectors in Fig. 6 will be interchanged, but the same result is then obtained by increasing or decreasing the angle $2\beta x_2$ by 180 degrees, i.e., by making the open stub longer or shorter than the short-circuited one by $\lambda/4$.

Attention should be drawn to the fact that in this example we have assumed the load to be purely resistive and the stub to have the same characteristic resistance as the feeder. Any departure from these two assumptions necessitates some modification of Fig. 4.

It need hardly be emphasised that this simple treatment of the problem is based on the assumption that the transmission losses are negligible over the short lengths of line involved, so that we have to deal with circles and simple trigonometrical functions instead of spirals and hyperbolic functions.

G. W. O. H.

Notes on

Short-wave Dipole Aerials*

By N. Wells, M.Sc.

Introduction

THE horizontal half-wavelength aerial, usually known as a dipole, is the most ubiquitous and popular type of aerial unit employed in the entire range of short-wave radio communication; this may be because of its symmetrical and technically satisfying appearance, coupled with ease of erection, but whatever the reason a discussion of the various factors affecting its performance, and the performance of allied S.W. aerials, may be of interest. Actually in the course of the discussion it will soon become apparent that the half-wavelength is only important in the case of single dipoles, where exactitude of dimension, i.e. of tuning, permits the Y form feeder coupling to be standardised and applied with ease and certainty: when it is a case of twin aerials, either employed alone as in Fig. 4, or grouped in the form of beam arrays, there are standing waves along the feeder whether the twin aerials are dipoles, or differ appreciably from the half-wavelength; in fact,

appeared to be the most useful form in which to present them.

Dimensions and Coupling for Single Dipole

To some extent the effective length of a dipole is dependent on the added capacitance of its end insulators, though for most cases it is sufficiently accurate to make the physical length 95 per cent. of half the working wavelength. As to diameter, for low powers this is simply a matter of tensile strength to withstand the stress in the triatic, and generally No. 10 S.W.G. or 7/0.044in. strand is sufficiently strong; for the higher powers larger diameters are essential, not from the point of view of strength but in order to neutralise the risk of brushing and "torch" discharge, of which more will be said when discussing feeder dimensions.

Some notes on coupling between aerial and feeder are given at the end, under the heading "Line Termination"; in the meantime it may be said that in the case of single dipoles the usual coupling is in the form of a symmetrical Y tapping on either side of the centre, the length included between the tapping points being adjusted to throw back on to the feeder a load equivalent to some 600 ohms for transmitters, and some 500 ohms for receivers. The correct tapping length varies slightly with the height of dipole above earth, but for transmission a reasonable compromise is to take 24 per cent. of the overall length, while for reception the figure is 20 per cent. Appropriate dimensions are indicated on Figs. 1 and 2.

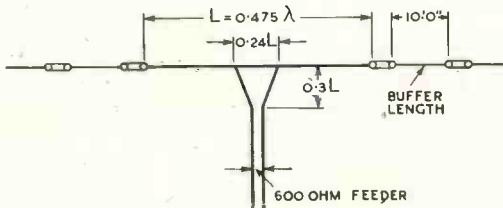

Fig. 1.—Transmitting dipole.

the precise half-wavelength dimension has no longer any particular virtue. As suggested above, the discussion centres mainly around the horizontal form of S.W. aerial but, because of its importance, the vertical dipole has been given a certain amount of attention. The notes are descriptive rather than analytical, being based partly on theory and partly on experiment, as this

Directivity of Horizontal Dipoles

The ordinary single dipole has appreciable directivity, as shown by the half polar diagram *A* of Fig. 5. When greater directivity is required a simple and effective plan is to employ twin dipoles in line, as shown in Fig. 3(a), for which the corresponding half polar diagram is curve *B* of Fig. 5: in this arrangement there is no attempt to match the

* MS. accepted by the Editor, August, 1942.

feeder, the latter being simply connected to the inner ends of the twin dipoles. Still greater directivity can be realised by increasing the twin dipoles until they are twin aerials each with a physical length of 0.625λ ;

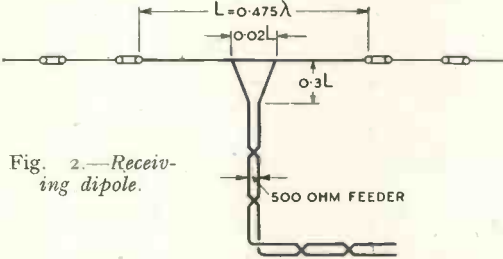
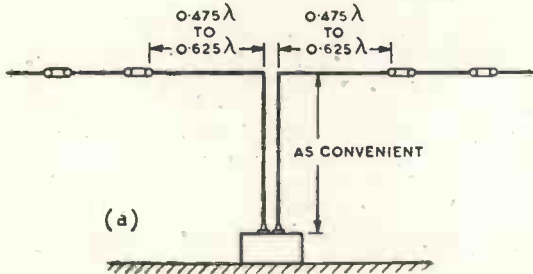

Fig. 2.—Receiving dipole.

in this case the half polar diagram is given by curve C of Fig. 5, and it will be noticed that two side lobes have appeared. Roughly speaking, the field strength due to twin dipoles is 20 per cent. greater than that for a single dipole, while that due to twin $\frac{5}{8}$ wavelength aerials is 45 per cent greater, figures which correspond to gains of 1.6 db. and of 3.3 db. respectively. The three diagrams are intended to indicate relative field strength on one side of and in the plane of the aerial when this plane is inclined to coincide with the major axis of emission, as discussed a little farther on.

The Multi-wave Aerial and Horizontal Omni-aerial

The dipole of Figs. 1 and 2 is a continuous conductor, and constitutes a fairly selective circuit, hence when working over a wide



(a)

Fig. 4, we have at once an aerial that is less selective and, because of balance, suitable for multi-wave working. For this type of aerial the upper frequency limit is critical, being governed by the $\frac{5}{8}\lambda$ relation given in the previous section, and is thus such that :—

$$\text{Overall Length} = 1.25 (\lambda \text{ min.})$$

If the wavelength is shorter than given by the above relation the side lobes, as seen on curve C of Fig. 5, increase at the expense of the major lobes until the latter disappear—see curves C and D of Fig. 6. The maximum wavelength is determined by considerations of radiation efficiency, and is not at all critical ; very roughly it can be taken as being from twice the overall length, giving

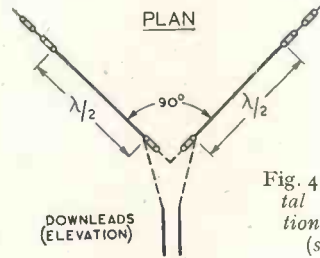
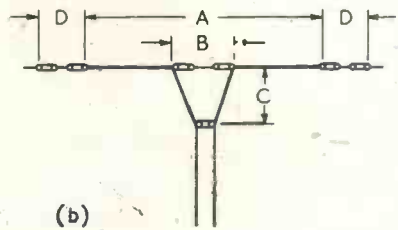

Fig. 4.—Horizontal omni-directional aerial (spot wave).

thus a waverange of $2.5/1.0$, to as much as 4.0 times the overall length, when the wave-range becomes $5.0/1.0$: a further note on this matter will be found in the Appendix. Actually the form of aerial shown in Fig. 3 (b) is sometimes preferable for multi-wave working to that in Fig. 3 (a), as it is less directive at the upper frequencies because of a slight degree of vertical polarisation. It is impor-



(b)

Fig. 3.—(a) Directive twin aerial. (b) Multi-wave aerial. A, $1.25 (\lambda_{min})$; B, $0.15 (\lambda_{min})$; C, $0.10 (\lambda_{min})$; D, Buffer lengths about 10ft.

band it is necessary to employ an aerial of different and less selective form : by the simple expedient of splitting the conductor into two halves, somewhat on the lines of

tant to appreciate that the multi-wave aerial has marked directivity on the upper frequencies. The distance between aerial and transmitter, or receiver, should be kept as

low as possible because of standing waves on the feeder.

For omni-directional working there are various types of horizontal aerial, but undoubtedly the simplest and most easily erected is the right angle V pattern, in which the length of arms is made equal to one-half of the working wavelength, see Fig. 4: provided the arm length is as indicated the radiation pattern of this form of twin aerial is a compromise between a square and a circle, an excellent pattern for omni-directional transmission or reception.

Vertical Radiation Diagrams

It will be appreciated that short-wave communication over long distance is due to inclined rays which are "reflected" between the ionosphere and the earth, and therefore short-wave radio transmission should be directed at an inclination to the horizontal. It is known that for any given service there is an optimum inclination,* which largely depends on the distance to be covered and on seasonal conditions; it follows that in order to radiate efficiently, the aerial employed should have its direction of maximum emission coincident with the optimum inclination for the service in question. For the purpose of these notes we may take this inclination as varying, very roughly, between a minimum of from 7 deg. to 10 deg., suitable for the longest distances and the shorter short waves, and a maximum of 45 deg., suitable for local services, when the longer short waves are employed.

In practice the zenithal direction of maximum radiation of a horizontal aerial is determined by its height above earth: this is clearly shown in the nine polar diagrams of Fig. 6, which indicate the zenithal distribution of field strength, i.e. the field strength in the vertical plane, for nine different heights of aerial. For each height there are two conditions of earth, the full line curve being drawn for ideal perfectly conducting earth, the dotted line curve being calculated for rather poor, rocky earth. Upon examination of the diagrams it becomes apparent that the modifying influence of the ground, while appreciable, is not so marked at lower inclinations; at first sight

this would seem to give the horizontal dipole an advantage over the vertical dipole, where these conditions are reversed, but the matter will be discussed a little farther on. Let us now consider the merits of the nine diagrams. At a height of $\frac{1}{4}\lambda$ or $\frac{1}{3}\lambda$ radiation is somewhat flat, with a maximum in a vertical direction in the case of $\frac{1}{4}\lambda$, and around 45 deg. inclination in the case of $\frac{1}{3}\lambda$: such diagrams, but more particularly

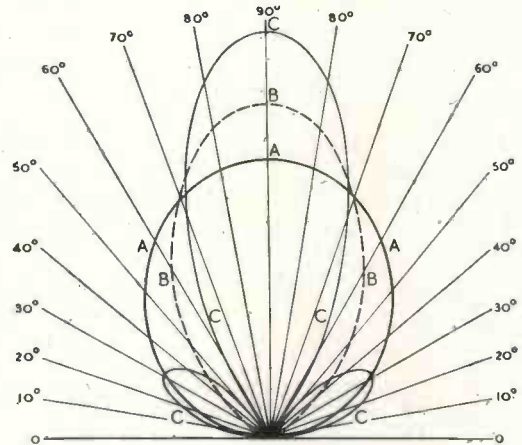

Fig. 5.—Horizontal polar diagrams.

the latter, are suitable for local communications, that is, for distances up to 300 kilometres, when the lower frequencies would be employed. On rising to the height of $\frac{1}{3}\lambda$ there is a well-defined maximum at 30 deg., suitable for medium-distance communications when the intermediate short-wave frequencies would be employed: this is obviously an excellent general height. At 0.60λ the maximum angle drops to 25 deg., which is somewhat more suitable for the longer mid-distances, though the improvement is offset by the appearance of a lobe pointing upwards and dissipating an appreciable proportion of the total radiated energy. At heights of 0.75λ and 0.90λ most of the energy is dissipated by unwanted high angle radiation, and it is clear that heights intermediate to 0.60λ and 1.0λ are to be avoided. At 1.0λ there are two pairs of well-defined lobes, the lower with axes at 15 deg. inclination, which should be excellent for long-distance communications. The last two diagrams for heights of 1.5λ and 2.0λ are given more as a matter of interest,

* In reality this is an average angle, the inclination varying appreciably at times on most services.

though cases may arise, such as abnormal conditions, or a difficult circuit passing close to the magnetic pole, when their

coming rays, i.e. due to rapidly fluctuating ionospheric conditions.

It may be mentioned here that the dotted

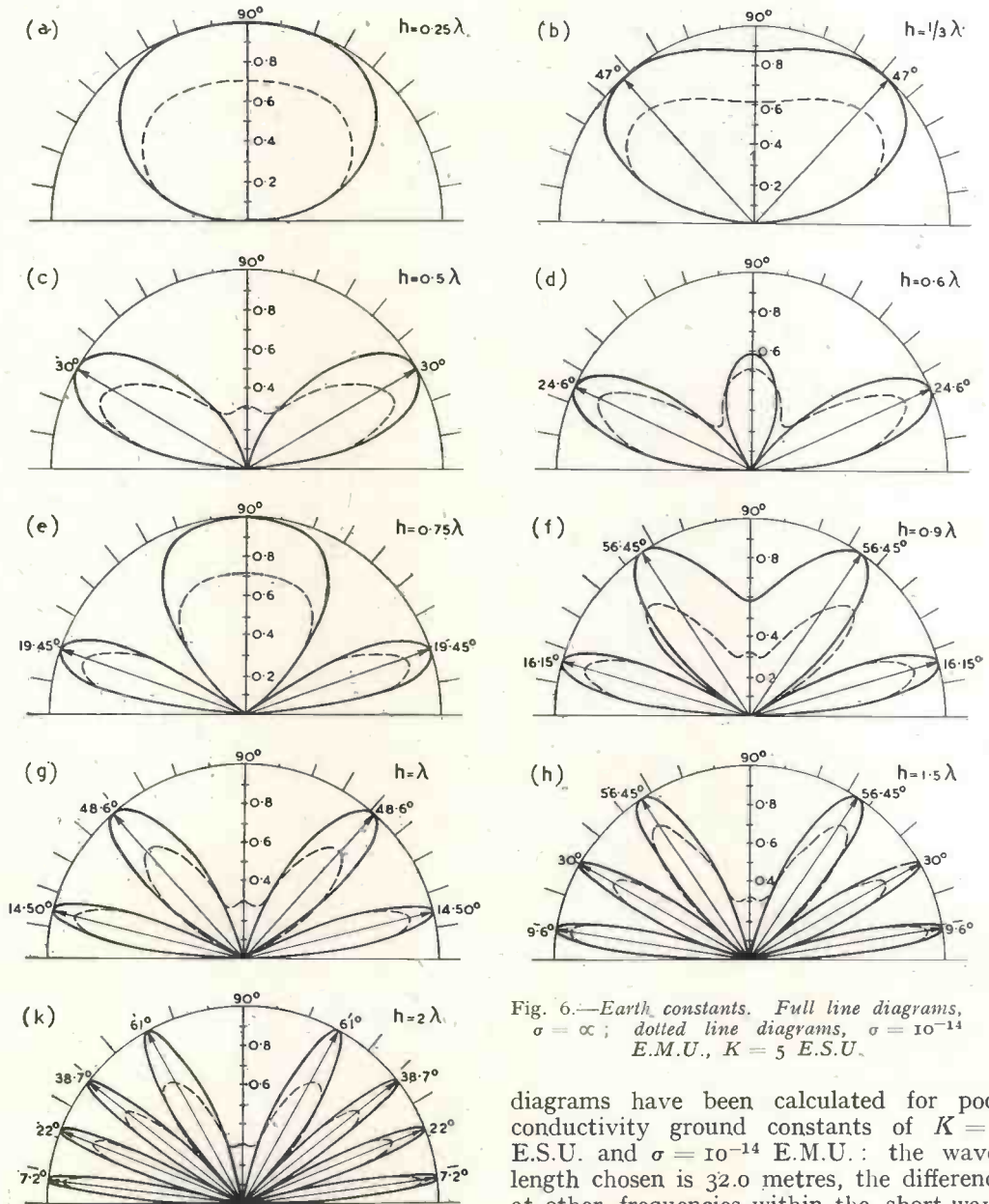

Fig. 6.—Earth constants. Full line diagrams, $\sigma = \infty$; dotted line diagrams, $\sigma = 10^{-14}$ E.M.U., $K = 5$ E.S.U.

multiple lobes might give a useful diversity effect against the type of fading that is due to a rapidly varying inclination of down-

diagrams have been calculated for poor conductivity ground constants of $K = 5$ E.S.U. and $\sigma = 10^{-14}$ E.M.U.: the wavelength chosen is 32.0 metres, the difference at other frequencies within the short-wave band being insignificant. A second series of diagrams for good conductivity ground, with constants of $K = 25$, and $\sigma = 10^{-13}$, has been calculated, but it was found that

they came just about half-way between perfect earth and poor earth, and so, for the sake of clarity, have been omitted.

Generally speaking when heights of one wavelength and upwards are available, it is customary to employ stacked dipoles, because by this means we have more control over the shape of the vertical polar diagram, and can concentrate the greater portion of the energy into a single pair of major lobes; but we are now getting beyond the scope of these notes, except perhaps, that it may be both useful and pertinent to describe the simple two-tier stack.

The Two-tier Stack

Broadly speaking there are three variants of the two-tier stack, corresponding to overall heights of 0.75λ , 1.0λ and 1.25λ , the general arrangement being indicated in Fig. 8, while the corresponding three vertical polar diagrams are shown in Figs. 8 (a), (b), and (c): these are useful diagrams, the inclinations being lower, and the energy distribution generally preferable, than for similar overall heights of single dipoles. Clearly where a more elaborate aerial system is justified, and poles of sufficient height are available, the stacked dipoles should be installed. An overall height of 0.75λ , see Fig. 8 (a), is more suitable for the longer waves and shorter distances, or for when overall height is limited; arrangement (b), with an overall height of 1.0λ is suitable for the medium short waves and medium distances, being the most frequently adopted, though arrangement (c) with an overall height of 1.25λ is most suitable for the shorter wavelengths and longer distances. Reverting to the sketches, it will be seen that there is a constant distance of 0.50λ between the two tiers, the variations being in the distance of the lower tier above ground. Note that in order to maintain the tiers in phase with each other there is a cross-over in the vertical feeder that links them together. As before, the length of each branch aerial may be from 0.25λ to 0.625λ .

Horizontal versus Vertical Polarisation. Vertical Dipoles

Although an analysis of the effect of reflection at the earth's surface upon the space component of vertically polarised waves and the space component of hori-

zontally polarised waves is favourable to the latter, it should be admitted that any such analysis is based upon an imperfect knowledge of all the subsequent conditions. This statement is due to a fairly close acquaintance with the results over many years on long-distance communication services, results which indicate that there is nothing to choose between the two systems, provided each is properly installed; when conditions are good both systems are completely satisfactory, but when conditions are poor each system causes anxiety to the controlling engineer, an anxiety that finds

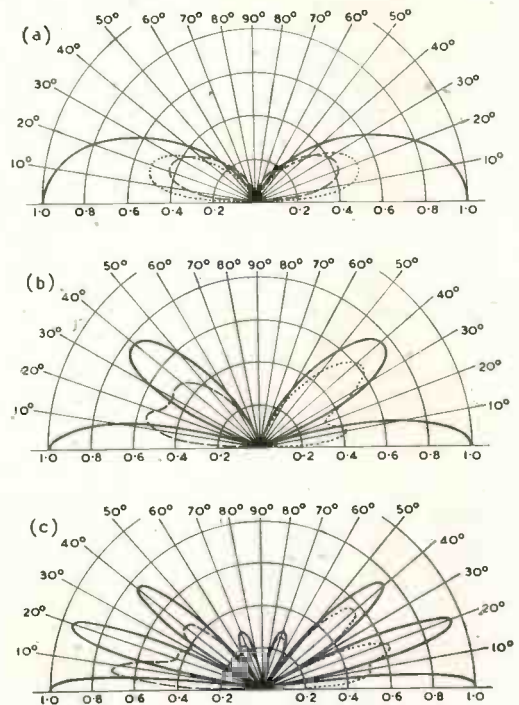

Fig. 7.—(a) Vertical dipole close to earth. (b) Vertical dipole 0.5λ clear of earth. (c) Vertical dipole 1.25λ clear of earth. Earth constants. Ideal (full line), $\sigma = \infty$; good land (dotted line), $\sigma = 10^{-13}$ E.M.U., $K = 25$ E.S.U.; poor land (broken line), $\sigma = 10^{-14}$ E.M.U., $K = 5$ E.S.U.

no substantial lessening in changing over from vertical to horizontal aerials, or vice-versa. The question has become largely one of predilection, or prejudice, with economic factors slowly tilting the scale in favour of the horizontal systems. Un-

doubtedly from an economic point of view there is much to be said in favour of horizontal suspension for smaller installations and for low in-line arrays, because in the first place they do not require radial earth systems, while in the second place the effective height of a horizontal aerial is practically the height of the supporting masts. On the other hand, for local short-wave broadcasting services the vertical aerial is generally the better proposition, because the surface-wave attenuation of vertical S.W. polarisation is appreciably

this may not be an inappropriate place to say something about vertical dipoles. As indicated previously, the attenuation of the space wave is greater than with horizontal polarisation, an effect that is most marked when the aerial is close to the earth's surface; with increasing height, however, the difference in attenuation between vertical and horizontal is less marked, and generally speaking a safe rule is to erect a vertical dipole as high as is economically possible, whatever the nature of the service in view. Broadly speaking, an overall height of one wavelength, giving one-half wavelength ground clearance, is a good working height for a vertical dipole. To go a little more into detail, in the case of vertical polarisation the outline of the vertical radiation changes with changing earth conditions, and for this reason diagrams for both poor conductivity and good conductivity earth have been included in Figs. 7 (a), (b), and (c), which indicate the effect of the earth upon a vertical dipole; Fig. 7 (a) when close to earth, 7 (b) when the centre of the dipole is raised 0.75λ above earth, and 7 (c) when it is raised to $1\frac{1}{2}$ wavelengths above earth. The full line curves represent perfectly conducting earth, the dash line curves represent the effect of poor conductivity earth, while the dotted line curves represent the effect of good conductivity earth; in the diagrams for the two higher dipoles the dash line and dotted line curves have been separated to avoid confusion. Apart altogether from the usual effect of height on the basic ideal curves, it will be observed that as regards the effect of physical earth the gain due to height is considerable, particularly in the case of poor conductivity earth.

Coming to purely practical considerations, when a vertical dipole is fed at its base, or is otherwise close to earth, it is of major consequence to install a good earth system. This may consist of half-wavelength radial wires every 3 deg., centred immediately below the aerial and comprising 120 radials altogether; the wires should be laid just below the surface, if possible not more than three inches deep, and pegged at their far ends to keep them in place. The gauge of wire is preferably No. 16 or No. 14 S.W.G. To the uninitiated 120 radials may seem an unnecessary number, but, unless the service

Fig. 8.—Two-tier stack. Vertical polar diagrams of the overall heights of 0.75λ , 1λ and 1.25λ are given in (a), (b) and (c) respectively.

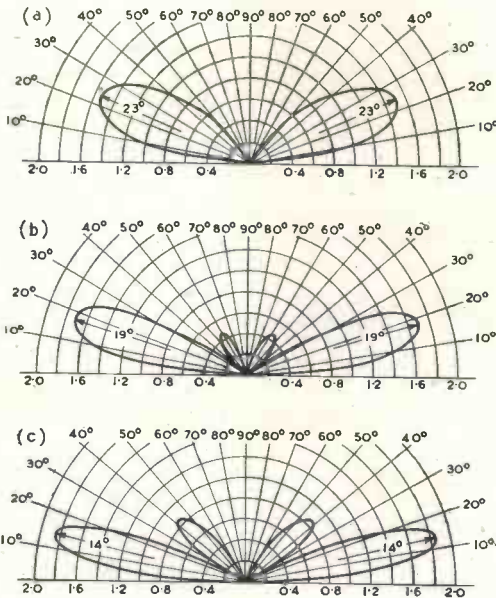
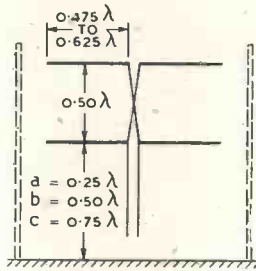

less than that of horizontal polarisation; while a more obvious but less important reason is the perfect omni-directional pattern of a vertical aerial.

A discussion of the difference between horizontal and vertical polarisation will be found in Appendix 2; in the meantime

is of minor importance, consistency of results justifies the labour and expense. For minor services, where variation in results is of little consequence, 36 radials or less will always work. For small powers a vertical dipole can be conveniently suspended from a single wooden pole, with a gallows arm, or arms, supporting the aerial wire about three feet clear of the pole.

Base fed vertical aërials may vary in overall height between $\frac{1}{4}\lambda$ and $\frac{5}{8}\lambda$; perhaps because the quarter-wave is the simplest and most readily comprehended aerial it is popular even for short waves, but this form of S.W. aerial is most inefficient, since ground losses rise with frequency, and with the comparatively heavy earth current of the quarter-wave aerial the ground losses are very heavy; on the other hand, the $\frac{5}{8}\lambda$ high aerial, though seldom employed, is efficient, because the vertical radiation pattern is excellent, the earth current is reasonably low, and also the terminal potential is much lower than, say, for the more popular half-wave high aerial.

Directivity of Twin Vertical Dipoles

Where horizontal directivity is desirable twin (parallel) vertical dipoles form a simple but very useful combination; when fed in phase with equal currents the equation for the shape of the resulting horizontal radiation pattern can be expressed in the simple form:—

$$F_{\theta} = \sqrt{2} I \cos\left(\pi \frac{d}{\lambda} \cos \theta\right)$$

where F_{θ} is the force at a distant station, θ is the direction of the station measured from the centre line connecting the twin dipoles, d is their distance apart, and I is the current in each. From an inspection of the equation it is clear that the maximum value of F is $\sqrt{2} I$; but there is mutual coupling between the dipoles and, therefore, I varies with d , a point not disclosed by the apparently simple equation, hence the problem of determining maximum F becomes one of determining the spacing which gives maximum I . It is a complex problem, and is best tackled by determining the value of d for minimum radiation resistance, when, of course, I will be maximum. The curve of Fig. 13 (a) gives the variation of R_r against d , and indicates that R_r reaches a minimum

when d is $\frac{2}{3}\lambda$; at this spacing the gain over a single dipole is about 4.8 db. when θ is 90 deg.: the appropriate radiation diagram is shown on the right of Fig. 13 (b). When d is $\frac{1}{2}\lambda$ we get the "figure of 8" diagram seen to the left of Fig. 13 (b): for dual working on one site this is an admirable pattern, because, when both transmitter and receiver are equipped with twin aërials, each pair being spaced $\frac{1}{2}$ of the transmitted wave, and the two pairs erected in line, there is remarkably little pick-up in the receiver aerial during transmission. The gain of the "figure of 8" is 3.5 db.

Reverting to Fig. 13 (b), it may be of interest to note that the curve is derived from the argument in the latter part of an article by L. Lewin on the radiation resistance of dipoles, in the *Marconi Review*, No. 39 of 1939. By drawing a dotted horizontal line at a height corresponding to the R_r of a single dipole in free space it can be seen how the mutual coupling between the twin dipoles adds to and subtracts from this value; further, the spacing where the R_r value of the single dipole is coincident with the R_r of each of the twins (at about 0.45λ , etc.) is indicated, and this is obviously the spacing where the effect of mutual coupling upon the loading component (resistance) is neutral, and therefore where the individual currents may be varied without mutual effect: this may be a digression, but it is of some interest when special radiation patterns are required.

Arrangement and Dimensions of Balanced Feeder Lines

Where possible it is obviously better to suspend the feeder directly between aerial and lead-in insulators, but when some distance intervenes it is usual to come down to within about 3.0 metres of the ground, and thence to carry on with a horizontal feeder line. In the case of twin aërials there is an unavoidable mis-match between feeder and aerial, with consequent standing waves along the feeder; for short lengths this is immaterial, but on long runs the horizontal feeder should be matched as close to where the downleads join it as possible. A short section on the subject of matching has been added at the end of these notes.

The choice of feeder dimensions is governed by both practical and technical considera-

tions. As to practical, it is clear that in a power transmission line the twin wires, when stretched between supports, must be far enough apart to avoid the risk of swinging together in high winds; about 6in. separation is the safe minimum on 60 feet spans for the smaller conductors, while 10in. or 12in. is the normal limit for the larger conductors.

The main technical consideration is the avoidance of the phenomenon known as torch discharge, peculiar to the higher frequencies, and the avoidance of the more common corona effects and flash-overs; these unwanted phenomena are, of course, due to high voltage, therefore the problem only arises on high power. The direct approach is to reduce the voltage by reducing the line impedance, and for very high powers we do this by increasing the number of conductors from two to four, thereby roughly doubling the capacitance and halving the impedance; but the practical lower limit of impedance is still around 300 ohms, and this precaution alone is not really enough for the surges that may occur on long lines. The indirect and most effective approach to the problem is to increase the diameter of the conductors; of course this reduces the impedance, but a far more valuable effect is that it reduces the voltage gradient at the surface of the conductor, where it is steepest, and, therefore, most critical. There is a certain amount of literature on this subject, but briefly it may be accepted that for a safe working telephone load of 50.0 kW. a twin line should be constructed of not less than No. 6 S.W.G. (4.9 mm. dia.) conductors separated 30.0 cm.; provided the line has been properly terminated this gives a reasonable margin for safety. At the other end of the scale No. 14 gauge (2.0 mm. dia.) is about the smallest wire that is mechanically robust enough for transmission lines; when separated 15 to 20 cm. such a gauge is good up to 5.0 kW. telephone load. It might be thought that the distance between feeders is also a matter for technical consideration, but while this is true to some extent, both theory and experiment make it clear that when the initial ratio between spacing and diameter is not less than, say, 30, the effect of doubling the spacing only reduces the break-down voltages slightly, whereas doubling the diameter increases the break-

down voltages in almost the same proportion.

The torch discharge mentioned earlier should not be confused with corona or flash-over; it takes a flame-like form upwards into space, and is started by some point, such as a speck of dust, or surface roughness; it is dangerous because it burns away the wire.

Feeder lines employed for reception alone are in a different category, because here the conductors are brought as close together as possible, in order to reduce extraneous pick-up; normally 4.0 cm. is a satisfactory separation, but as this is small it becomes necessary to keep the conductors apart by introducing separators at regular intervals, say every two metres, more or less according to circumstances. In order to further neutralise unwanted pick-up it is usual to transpose a receiving feeder by means of special transposition insulators, which, of course, also act as separators. Care and patience should be exercised to maintain receiving feeders at even length; this is more important than appears to be appreciated, because a discrepancy of only one centimetre on a long run may permit quite an appreciable pick-up. The gauge of receiving feeders is preferably No. 18, as this lends itself readily to the bending at transposition insulators; No. 16 can be used where lines are not transposed.

Load Circuit Tuning

In the case of transmitters, provided the feeder is correctly terminated at the aerial end the load it offers approximates to 600 ohms of resistance, a value that will couple up well across a shunt circuit. When the feeder is not terminated the load at the transmitter end will perhaps vary between 200 and 2,000 ohms of more or less reactive impedance; its value can be calculated, or measured, but in most cases the form of transmitter coupling circuit best adapted to the load is most conveniently determined by experiment.

For reception the conditions are reversed, as discussed under "Line Termination," the feeder being terminated in the receiver; this implies that the input circuit of the receiver should offer some 500 ohms to the incoming feeder. Such a value is, perhaps,

best dealt with by a series circuit, unless, as is usually the case, the receiver is fitted with a transformer specially wound to offer the appropriate termination.

Reflectors and Directors

On one-way services, or substantially unidirectional services, reflectors may be employed with marked advantage, as giving a gain in forward signal strength whilst, what is sometimes more important, reducing back radiation. There seems to be a certain amount of misunderstanding about reflector spacing, due, perhaps, to overlooking the mutual coupling between driver and driven; on the whole for single dipoles a spacing of 0.15λ between aerial and reflector is best, the reflector element being exactly 0.50λ long physically; this combination of spacing and dimension gives an increase in forward signal strength of 60 per cent. to 70 per cent., say 4.0 to 5.0 db., whilst there is a reduction of 60 per cent. to 70 per cent., say minus 8.0 to minus 9.0 db., in back signals. A spacing of 0.20λ with a reflector 0.475λ in physical length gives somewhat better results, but both spacing and length are

then more critical, and for this reason it is not generally recommended. For twin dipoles and parallel vertical dipoles, also for stacked dipoles, the spacing is 0.20λ : in the case of stacked dipoles the gains are not so marked, but are still important. For twin aerials 0.625λ long the spacing is 0.25λ , the reflectors and aerials being in line at their outer ends.

Directors have the same effect as reflectors, except, as the title would indicate, the action is in reverse. A combination of director in front and reflector behind a single dipole can be made to give a forward gain in signal strength of 100 per cent. For this combination the reflector should be 0.50λ long physically, and spaced 0.20λ behind the dipole, whilst the director should be $0.50(\lambda - 10 \text{ per cent.})$ long and spaced 0.20λ in front of the dipole. There is a weakness in these combinations in that they are, quite naturally, sensitive to frequency, and once erected it must be appreciated that they are definitely spot wave aerials.

Line Termination

The sequel to a mis-matched feeder line termination is the presence of standing waves; in the case of transmission this condition leads to dissipation of otherwise useful energy, and also to abnormal voltages, while from the point of view of reception the bad effects are loss of signal strength and the pick-up of unwanted signals. In either case it is desirable to have a properly terminated feeder, a statement which does not imply perfection but rather such a match, between the surge impedance of the feeder line and the load impedance of the aerial termination, as will reduce the ratio between the standing wave minimum and maximum currents to a residual figure of about 0.85.

Notes on the process of terminating twin feeders are given below, but it may be advisable to write a few preliminary words on the different aspects of transmission and reception. In the case of transmission, when the coupling between aerial and feeder offers to the latter a load equal to its surge impedance, all the energy conveyed by the feeder is absorbed, hence there is no reflected energy travelling backwards, and hence there are no standing waves. But in the

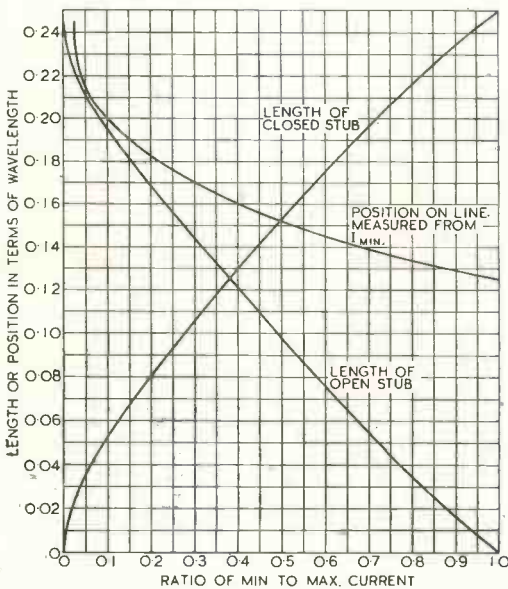

Fig. 9.—Line stub curves. For closed stubs position is towards transmitter from I_{min} , for open stubs position is towards aerial from I_{min} . The length curve applies when stub and feeder have similar impedances.

converse case of reception the aerial is the source of energy, and correct coupling between aerial and feeder simply implies that all the available energy is being fed into the feeder, while the absorption of energy is now at the receiver end, i.e., in one case the feeder feeds, or is terminated at, the aerial, in the other case it feeds, or is terminated at, the receiver. Fortunately conditions for optimum coupling are identical with conditions for correct termination, so that the same form of adjustment at the aerial-feeder transformer applies in either case.

In order to bring about a satisfactory termination it is necessary to measure the ratio between minimum and maximum current on the feeder line, also to determine the location of the point of minimum current nearest to the aerial end: with this information it is possible to locate the whereabouts of a point on the feeder where the resistance component equals in magnitude the surge impedance of the feeder; let us call this point P . There will also be a reactance component at P , but—and this is the crux of the matter—if the reactance is neutralised it follows that the resistance component becomes isolated, as it were, and will act as the correct termination for the feeder line. The principles by which the point is located and its reactance determined are well known—for instance, see an article by Sterba and Feldman in the *Proceedings of the I.R.E.* for July, 1932—and will not be considered here; the technique consists of employing an indicating ammeter that can be slid along one or other of the twin feeder lines in order to give an indication of relative minimum and maximum current values, as distinct from actual current values. Having obtained the ratio between minimum and maximum in the vicinity of the end of the feeder, and having also located the position of current minimum nearest the end, we are in a position to consult the curves of Fig. 9, and from them to read off the distance of P from current minimum, and also to compute the length of neutralising reactance to be applied at P . This latter subject requires further explanation and so will be dealt with next.

A length of feeder less than one-quarter wavelength will behave either as an inductive or as a capacitive reactance, according to

whether it is either closed or open at its far end; this form of reactance is known as a stub, and it is obviously a particularly suitable form for neutralising unwanted reactance at any point along a feeder line. Usually the stub has the same dimensions,

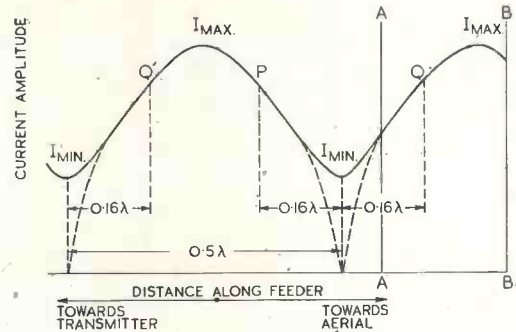

Fig. 10.

that is, the same surge impedance as the main feeder line, in which case the required length can be read directly off the appropriate curve of Fig. 9. To determine whether a stub should be open or closed the rule is that, looking towards the load end of the line, where the aerial is attached, any point will have inductive reaction if current is rising, while reaction will be capacitive if current is falling; thus at a point where current is rising towards the load an open stub is indicated as neutralising reactance, whereas if current is falling a closed stub is indicated. It will be appreciated that on a long line there will be a number of possible points, spaced at regular intervals on either side of each current minimum, see Q , P and Q' on Fig. 10. Note that current minimum is chosen as the datum because it is definitely sharper and easier to locate than current maximum.

It will be easier to follow the foregoing remarks with the help of Fig. 10, which represents a feeder line along which there is a succession of "humps" of standing wave current, and to which the down-coming aerial feeder is connected either at AA or, alternatively, at BB . If the connection is at AA , and the point is located at P , the reaction at P is capacitive, and hence a closed stub is required; but were the connection to be at BB the corresponding nearest point would be Q , where the reaction is inductive and an open stub would be

necessary. Normally, however, the closed stub is preferable, so even in this latter case the point *P* would be chosen, unless it were particularly important to reduce the amount of unterminated feeder line. The closed stub is preferable for two reasons, first because its closed end can be made adjustable by means of a sliding clamp bar, and second, because the voltage drops along a closed stub, whereas it rises along an open stub. Note that in the case of the closed stub the voltage at the closed end is neutral, that is, at earth potential, and for this reason it is possible to anchor the end directly to earth, always provided it is close enough to ensure a short non-inductive connection.

It may be helpful to take a concrete example; suppose the relative values of minimum and maximum currents are found on the sliding meter to be 0.17 and 0.41 amps, giving a ratio of 0.415; upon consulting the curves of Fig. 9 we find that the desired point is at a distance of a shade less than 0.16λ from minimum current; if the feeder line ends at *AA*, as indicated on Fig. 10, the point will coincide with *P*, but if the line ends at *BB* the point will be at *Q*. On again consulting Fig. 9, we find that for *P* the length of closed stub is 0.132λ , while for *Q* the length of open stub is 0.118λ . A useful check is that the addition of 0.132λ and 0.118λ totals one-quarter wavelength, which is as it should be.

Having ascertained the current ratio and located the current minimum which is nearest to the end of the feeder, both the location of, and length of, the stub should be pretty accurately determined; none the less slight variations in positions, with slight adjustments in stub length for each trial position, are often necessary before the residual standing wave current is reduced to the stipulated ratio of 0.85, or better still, towards the ratio of 0.90. With the object of leaving a margin for adjustment, the lengths of the stubs should be cut longer than the figure as computed from the curve.

The following additional notes are given as being of practical interest to those engaged on terminating feeder lines.

(a) In the case of the closed stub there will be idle tails behind the sliding bar; it is undesirable to leave these longer than about one-half of a metre.

(b) The stubs may be carried in two or

three different ways, as indicated on Fig. 11.

(c) On a long feeder line the cumulative effect of the capacitance of the supporting insulators may easily cause a recurrence of standing waves farther down the line, towards the transmitter, and this despite the fact that there is a good termination at the aerial end. The presence of such waves is easily ascertained by running the ammeter farther back along the line; should it be

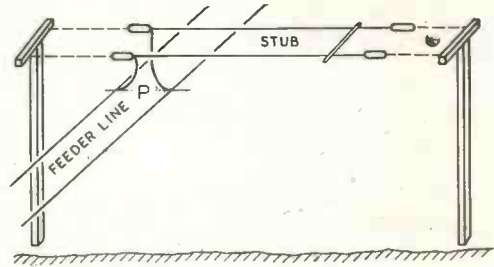

(a)

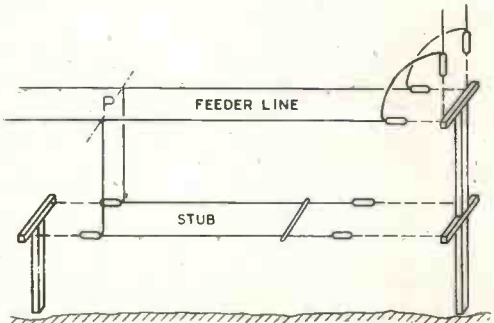

(b)

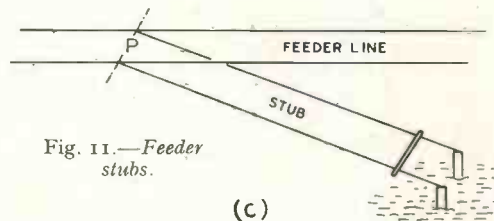

(c)

Fig. 11.—Feeder stubs.

found that standing waves have grown to any appreciable extent, the remedy lies in locating another terminating point *P* in some preceding section, and neutralising its reactance as described above by means of a stub.

(d) The sliding ammeter may have a scale of about one-half ampere, depending on the power available. It is fitted with two hooks made of stout wire and firmly clamped

to prevent lateral movement : obviously the length of feeder line between the hooks will vary the sensitivity. The meter may be attached to a wooden handle for convenience. It should be observed that the potential difference between the two hooks is very small, and, in consequence, the contacts are very sensitive to pressure ; for this reason it is of the utmost importance to clean the line under test, and to reclean it at short intervals of time. To overcome the difficulties inherent with a simple sliding meter, difficulties which often become serious on the higher frequencies, the Marconi Company have developed a new form of uncoupled Line Ratio Meter.

APPENDIX I

The Limits of Multi-wave Aerials

If the upper sketch in Fig. 12 is taken to represent a horizontal twin aerial, l being the length of either limb measured in wavelengths, then it can be shown that the shape of the horizontal polar diagram is given by the expression :

$$F_{\theta} \propto [\cos 2 \pi l - \cos (2 \pi l \cos \theta)]$$

where F_{θ} is the horizontal field strength at any constant radial distance subtending an angle θ with the line of the aerial.

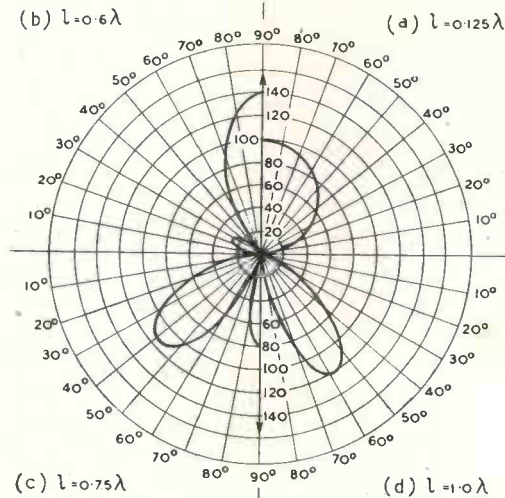
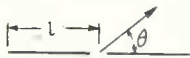

Fig. 12.—Vertical polar diagram for multi-wave aerial.

This formula is common to numerous papers, e.g. see Appendix I of the author's paper "Aerial Characteristics," *Journal I.E.E.*, 1942, 89 part 3,

p. 76. Moreover it can be shown that the field strength normal to the aerial, when θ is 90 deg., reaches a maximum when l becomes $\frac{5}{8} \lambda$ in length, see Fig. 2 and text of the same paper ; it follows that when l exceeds this length the polar diagram becomes unsuitable for either ordinary reception or ordinary transmission. For instance, applying the above formula to the four respective values of $l = 0.125 \lambda$, $l = 0.6 \lambda$, $l = 0.75 \lambda$, and $l = 1.0 \lambda$, as has been done in the lower part of Fig. 12, we see in quadrant (a) a quarter of the diagram for $l = 0.125 \lambda$; in quadrant (b) for $l = 0.6 \lambda$; in quadrant (c) for $l = 0.75 \lambda$, and in quadrant (d) for $l = 1.0 \lambda$: these curves are confirmed by experiment, and represent very closely the shape of the radiation pattern actually given when the aerial is in proximity to earth, hence we can deduce from them that when the limbs exceed $\frac{5}{8} \lambda$, as in quadrants (c) and (d), the shape of the radiation pattern is quite unsuitable for general purposes. It is this consideration that determines the overall length in terms of the shortest wavelength, thus overall length = $2 \times \frac{5}{8} \lambda = 1.25 \lambda$, where λ is the shortest wavelength.

As regards the longest wavelength, the distinction is not so clear cut, being simply one of radiation efficiency ; for example, if each of the twin limbs were one-half wavelength long, and the aerial were one wavelength above ground, the radiation resistance would be of the order of 170 ohms ; if, however, the wavelength were doubled each limb becomes one-quarter wavelength long, the height above ground is reduced to one-half wavelength and the resistance drops to some 80 ohms ; * hence for a given power the current would rise in the proportion $\sqrt{\frac{170}{80}}$ or roughly 1.4. If we again double the wavelength the resistance drops to something that we may guess to be of the order of 10 ohms, allowing for an equivalent height of one-eighth wavelength above ground, and current rises in the proportion of $\sqrt{\frac{170}{10}}$ or roughly four times its original value, when it is pretty certain that the un-matched feeder losses and other losses will be mounting to appreciable proportions. It is this form of reasoning that causes us to fix the limiting value of long wave as being from 2.0 to 4.0 times the overall length of the aerial.

Although we are here only concerned with the shape of the radiation patterns, it may be mentioned in passing that the relative values of field strength are shown pretty accurately in Fig. 12. It will be recalled that half polar diagrams for $l = 0.25 \lambda$, $l = 0.5 \lambda$ and $l = 0.625 \lambda$ ($\frac{5}{8} \lambda$) have already been given in Fig. 5.

APPENDIX II

The Effect of Ground upon Horizontal and upon Vertical Polarisation

The difference between horizontal and vertical polarisation is perhaps best discussed in connection with the image. Just as the eye demonstrates

* L. Lewin, "Radiation Resistance of a Horizontal Dipole above Earth," *Marconi Review*, 1939, No. 73, p. 13.

the existence of a virtual image "behind" the surface of a mirror, so do measurements of the shape of the vertical radiation pattern of an aerial confirm that it is of the nature of an interference pattern as between the aerial and its virtual image "below" the surface of the ground. But since the composition of the ground departs from the ideal of perfect conductivity the image is blurred, and it is precisely the difference in the effect of ground upon the

slightly onwards as the vertical radiation diagram is traced from 0 deg. to 90 deg., and this is accompanied by an almost uniform drop in virtual current amplitude: both of these effects are easily comprehended, and are indicated by dotted line curves on Fig. 14. In this figure, which indicates the variation of image phase, and also of image virtual current, as the inclination of the vertical radiation diagram is traced from 0 deg. to 90 deg., it will be seen that there are two sets of curves, the dotted line set covering horizontal polarisation, and the full line set covering vertical polarisation. The two sets of curves correspond, respectively, to poor ground conductivity and to good ground conductivity.

In the case of vertical polarisation over a perfectly conducting earth the image is in phase with the aerial, and its current amplitude is in unity ratio; but when we come to the physical earth, an earth with resistivity, this simple picture no longer holds, and a little discursive explanation is necessary. In order to analyse the effect of a physical earth it is necessary to split the wave into two components, a surface component and a space component; this is also true with horizontal polarisation, but here the surface component (though real) is so insignificant as to be ignored, whereas in the case of vertical polarisation the

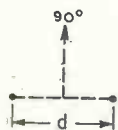
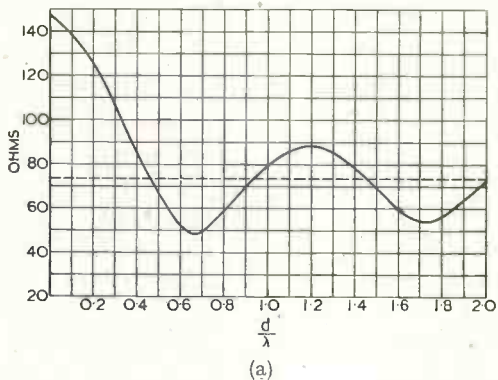

Fig. 13.—(a) Radiation resistance of one of a pair of in-phase dipoles in free space, when the distance between them, d , is varied. Note: 73.2 ohms is taken as the R_r of a single dipole in free space, (b) Horizontal polar diagrams for twin vertical dipoles.

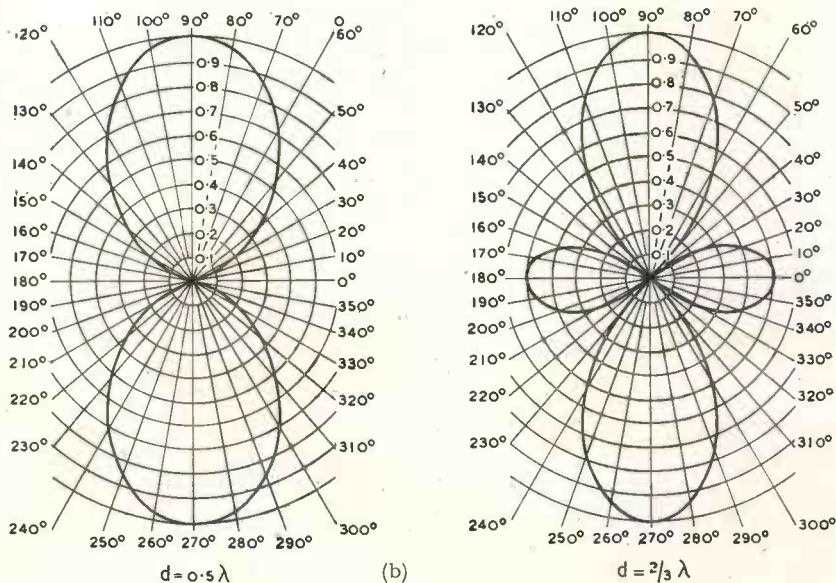

image that marks the difference between horizontal and vertical polarisation.

Consider the images of vertically polarised and of horizontally polarised aerials in relation to their respective vertical radiation diagrams, when traced from 0 deg. to 90 deg. In the case of horizontal polarisation over perfect earth it will be apparent that the virtual current amplitude of the image is unity in relation to that of the aerial, while the phase difference is constant at 180 deg.; for physical earth the phase difference of the image shifts

surface component is significant and can predominate for some distance along the surface, and up to a very limited (but real) height above it: for local S.W. broadcasting, say of waves beyond 30 metres, the property is very useful, but in this note we are mainly concerned with long-distance effects, that is, with the space component. In order to treat this component mathematically it is necessary to conceive an abrupt change to 180 deg. in the phase of the image, corresponding to zero inclination of radiation; it is, perhaps, correct to say that

the abruptness is only part of the picture, and that since surface and space components merge, the complete picture is of a modulus phase shift that is rapid, but not abrupt. All this by way of explaining the full line curves of Fig. 14, which indicate the effect of two grades of physical earth upon the image of a vertical aerial: the effect is obviously complex, and it is interesting to note the dip in virtual current amplitude at the Brewster angle, where the phase difference has advanced through a quadrant, and is at 270° .

For further information the articles cited at the end of this appendix should be consulted, though the reader is cautioned beforehand that the sign of the phase angle as indicated in Fig. 14 departs from that adopted by Feldman, and that this in turn affects one sign in the equations for the vertical

aspect is that, while the working difference between the space components of the two polarisations can best be discussed in terms of the ground effect upon their respective images, the actual vertical radiation patterns are a result of the combination of aerial and image, and that, in addition to the phase and amplitude to be ascribed to the image as a result of ground characteristics, there is the phase difference which varies with the distance separating aerial

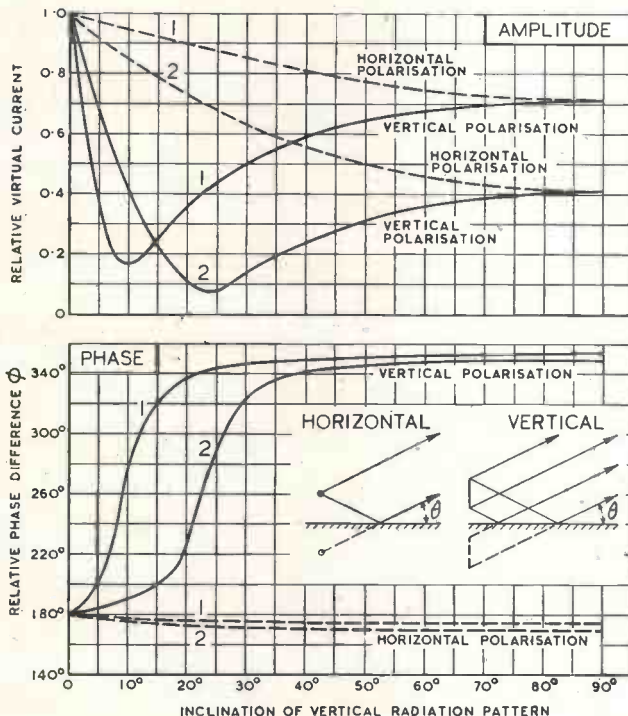

Fig. 14.—Virtual current amplitude and phase of aerial image. Curves 1, good conductivity, $\epsilon = 25$ E.S.U., $\sigma = 10^{-13}$ E.M.U.; curves 2, poor conductivity, $\epsilon = 5$ E.S.U., $\sigma = 10^{-14}$ E.M.U. $\lambda = 32$ metres.

radiation diagrams. The equations employed here, for Figs. 6 and 7, are:

$$I(\text{vertical}) = \cos \theta \sqrt{I + 2A \cos(2h \sin \theta + \phi) + A^2}$$

$$I(\text{horizontal}) = \sqrt{I + 2A \cos(2h \sin \theta + \phi) + A^2}$$

where I is the current (or voltage) value of the vertical radiation diagram at any inclination θ , while h is the angular height of the centre of the aerial above earth, A the current amplitude of the image, and ϕ its phase, both relative to the aerial: these latter two values are shown on Fig. 14 for earth of good conductivity and for earth of poor conductivity. Actually the formulae apply to doublets of no magnitude, and therefore the resultant diagram for vertical polarisation is not an accurate trace of the diagram of a vertical half-wave dipole, but it is quite close enough for practical purposes.

Two aspects of this discussion may require a little emphasis; the first is that it is only concerned with the image effect on the space component, i.e. with the rays reflected from the earth. The second

and image, i.e. the effect of height, while there is also the fundamental difference between the two patterns in free space, that for horizontal polarisation being a circle, while that for, say, a vertical half-wave dipole is the figure of 8, one-half of which is shown in Fig. 5, curve A.

Finally, it must not be overlooked that there is appreciable ground absorption below a horizontal dipole: writing from memory of test data (U.S.A.) the absorption varies only slightly for heights between $\frac{1}{4}\lambda$ and, perhaps, 2.0λ , and is of the order of 25 per cent. of the total.

- (1) K. A. Norton, "Physical Reality of Space and Surface Waves." *Proc. Inst. Rad. Eng.*, 1937, Vol. 25, p. 1192.
- (2) R. M. Wilmette, "The Radiation Distribution of Antenna Systems." *Journ. I.E.E.*, 1930, Vol. 68, p. 1174.
- (3) J. S. McPetrie, "The Magnitude and Phase of the Electric Field in the Neighbourhood of an Antenna." *Journ. I.E.E.*, 1931, Vol. 69, p. 290.
- (4) J. S. McPetrie, "A Method for Determining the Effect of the Earth on the Radiation from Aerial Systems." *Proceedings Wireless Section I.E.E.*, 1932, Vol. 7, p. 54.
- (5) C. B. Feldman, "The Optical Behaviour of Ground." *Proc. Inst. Rad. Eng.*, 1933, Vol. 21, p. 764.

F.M. Communication Systems*

Interference and Propagation Characteristics

By D. A. Bell, M.A., B.Sc.

(A. C. Cossor, Ltd.)

1. Introduction

THIS paper is not intended to be either a theoretical analysis of frequency modulation, or a comprehensive survey of the subject, but rather a summary of the known data on a subject which has received less attention in this country than in the U.S.A. In this spirit, the bibliography has been restricted to a short list of critically selected references; they were chosen as the most useful papers for the reader who has not specialised in frequency modulation, but requires a more detailed treatment of some of the points mentioned here. The omission of very many papers does not imply any judgment on their intrinsic merit or priority.

2. Definition of Frequency Modulation and Phase Modulation

The method of telephonic modulation of a radio-frequency signal which was first invented was amplitude modulation, probably by analogy with simple land-line telephony where the carrier (if any) was D.C. and therefore capable only of amplitude modulation and not of phase or frequency modulation. But if a mathematician were to approach the problem of carrier-wave signalling without previous practical experience, he would see at once that there are three ways of modulating a sinusoidal oscillation of the form

$$V = E \sin (\omega t + \phi_0) \quad \dots \quad (1)$$

One could operate on E , giving amplitude modulation, on ϕ , giving phase modulation, or on ω , giving frequency modulation. Amplitude modulation is too well known to need further discussion, and since there is no objection to negative values of ϕ , phase modulation can at once be written down in the form

$$V = E \sin (\omega t + \phi \sin pt) \quad \dots \quad (2)$$

where $p/2\pi$ is the modulation frequency. In frequency modulation the frequency cannot be allowed to become negative, but will normally vary by only a small fraction about its mean value; by analogy with the expression for amplitude modulation, namely

$$V = E (1 + m \sin pt) \sin (\omega t + \phi) \quad (3)$$

one is tempted to write for frequency modulation

$$V = E \sin [(\omega + \delta\omega \sin pt)t + \phi_0] \quad (4)$$

But this can be re-arranged as

$$V = E \sin [\omega t + t \delta\omega \sin pt + \phi_0] \quad (5)$$

when it becomes clear that the factor which oscillates at modulation frequency now increases in magnitude with time, and is in fact a modulation of ωt , not of ω . To avoid this one writes

$$V = E \sin [\omega t + \delta\omega \sin pt + \phi_0] \dots (5a)$$

or more simply

$$V = E \sin (\omega t + \phi \sin pt) \quad \dots \quad (6)$$

since there is no point in retaining the fixed phase angle ϕ_0 of equation (5a), and $\delta\omega \sin pt$ being in effect a variable phase might as well be written as $\phi \sin pt$. Thus the frontal attack on frequency modulation has led us back to phase modulation.

In order to understand the expression for frequency modulation, we must have a clearer idea of what is meant by "frequency," especially when it is not constant, and for this case a convention can be derived with the aid of the rotating vector representation of alternating quantities.

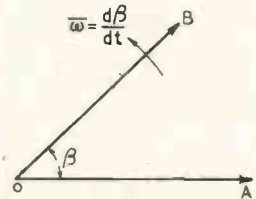

Fig. 1.

In Fig. 1, OA defines a fixed direction of reference, and OB the direction at a given instant of the rotating vector under consideration. The angle AOB , denoted by β , is called the *phase*

* MS. accepted by the Editor, December, 1942.

of the vector, and the angular velocity $\bar{\omega}$ of OB at any instant is 2π times the *instantaneous frequency*; there is then a pair of reciprocal relations between $\bar{\omega}$ and β :

$$\bar{\omega} = \frac{d\beta}{dt} \quad \dots \quad (7a)$$

$$\beta = \int \bar{\omega} dt + \phi_0 \quad \dots \quad (7b)$$

From equations (7a) and (7b) it is clear that any phase modulation must produce some associated frequency modulation, and vice versa.

Returning to equation (2) for phase modulation, V is represented by a vector whose amplitude is E and whose phase (β in the notation of Fig. 1) is $\omega t + \phi \sin pt$; from equation (7a) it follows that its instantaneous frequency is

$$\bar{\omega} = \frac{d}{dt} (\omega t + \phi \sin pt) = \omega + p\phi \cos pt \quad \dots \quad (8)$$

This represents a frequency modulation, but by an amount varying with the value of p , the modulation frequency. The equation for an oscillation which is frequency modulated by an amount independent of the modulation frequency can be deduced by inspection from (8), or obtained by putting $\bar{\omega} = \omega - k \sin pt$ in (7b):

$$\beta = \int (\omega - k \sin pt) dt = \omega t + \frac{k}{p} \cos pt + \phi_0.$$

Omitting the arbitrary initial phase ϕ_0 , the expression for a frequency-modulated oscillation is

$$V = E \sin \beta = E \sin \left(\omega t + \frac{k}{p} \cos pt \right) \quad \dots \quad (9)$$

The frequency-modulated oscillation (9) is not sinusoidal, but, as shown in Appendix I, is equivalent to a carrier and an infinite series of sidebands whose amplitudes are Bessel functions with argument k/p :

$$\begin{aligned} \sin \left(\omega t + \frac{k}{p} \cos pt \right) &= J_0 \left(\frac{k}{p} \right) \sin \omega t \\ &+ \sum_{n=0}^{\infty} (-1)^n J_{2n+1} \left(\frac{k}{p} \right) \{ \cos [\omega + (2n+1)p]t + \cos [\omega - (2n+1)p]t \} \\ &+ \sum_{n=1}^{\infty} (-1)^n J_{2n} \left(\frac{k}{p} \right) \{ \sin (\omega + 2np)t + \sin (\omega - 2np)t \} \quad \dots \quad (10) \end{aligned}$$

The distribution of amplitudes among the sidebands is thus a function of k/p , a quantity which is called the *modulation index*; the quantity k , which represents the maximum positive and negative departure of instantaneous frequency from the carrier frequency, is called the *frequency swing*.

If a carrier is frequency modulated by more than one sinusoidal signal simultaneously (i.e. by a complex wave form) the spectrum analysis of the complex modulated wave includes sidebands corresponding to combinations of the modulating frequencies as well as those corresponding to the sinusoidal modulating frequencies taken separately. (See references 1 and 2.) The amplitudes of these sidebands, however, are given by the products of two or more Bessel functions, and since Bessel functions are less than unity, these sidebands of composite frequency tend to have smaller amplitudes than those corresponding directly to the sinusoidal components and having amplitudes which are given by single Bessel functions. The general effect is that as the modulation wave-form becomes more complex, the energy distribution tends to become more uniform over the frequency range covered by the frequency swing.

3. Signal/Interference Characteristics

3.1. *Basis of F.M. Superiority.*—Of the three possible modes of modulation, amplitude modulation (abbreviation A.M.) was at first universally adopted. Frequency modulation (abbreviation F.M.) was later considered, in the hope that it would result in a narrower bandwidth than that required for A.M. if it used only a very narrow frequency swing, but mathematical analysis soon showed that this hope was unjustified, and F.M. was shelved for some years. It was then thought that since various forms of "noise," e.g. atmospheric and interference from electrical machinery, represent sudden changes of amplitude of current in

the receiver, a communication system relying only on change of carrier frequency, instead of change of amplitude, would be immune from these disturbances. Experiment showed that a substantial improvement was obtained by the use of F.M., though the reasoning just outlined was faulty.

A typical "noise" E.M.F. is of completely random and arbitrary wave form, and so is just as likely to be modulated in phase or frequency as in amplitude. The advantage of communication by means of F.M. rather than A.M. depends largely on the fact that if two oscillations are combined, the relation of the frequency modulation of the resultant to the frequencies and amplitudes of the components is different from the relation of the resultant amplitude modulation to the component amplitudes. The actual laws concerned are as follows: if we take two components of the form $A \sin \omega_1 t$ and $B \sin \omega_2 t$, and express the resultant in the form $R \sin \bar{\omega} t$ we find

$$R = [A^2 + B^2 + 2AB \cos (\omega_2 - \omega_1)t]^{\frac{1}{2}} \quad \text{(11)}$$

$$\bar{\omega} = \frac{A^2 \omega_1 + B^2 \omega_2 + AB (\omega_1 + \omega_2) \cos (\omega_2 - \omega_1)t}{A^2 + B^2 + 2AB \cos (\omega_2 - \omega_1)t} \quad \text{(12)}$$

In view of the close relationship between frequency and phase modulation shown in equations (7a) and (7b), they have identical characteristics as regards signal/interference ratio; but the contrast between (11) and (12) shows that F.M. and A.M. differ markedly in this respect.

The two important factors in the signal/interference performance of F.M. systems are as follows.

(I). When the combined signal and interference have been passed through a limiter, the detector will respond only to the phase or frequency of the resultant, and the resultant of two signals $A \sin \omega_1 t$ and $B \sin \omega_2 t$ such that the difference frequency $(\omega_2 - \omega_1)$ is supersonic, has effective frequency

$$\omega_0 = \omega_1 + (\omega_2 - \omega_1) \frac{B^2}{(A^2 + B^2)} \quad \text{(13)}$$

so that if B becomes small compared with A , the frequency shift which it causes decreases as the square of the ratio of the two amplitudes. (Equation (13) is derived from (12)

by omitting the terms in $\cos (\omega_2 - \omega_1)t$, which being supersonic will have no ultimate effect in the receiver.)

(II). The band width of the receiver can be limited to the frequency swing which has been chosen to represent 100 per cent. modulation; then even if $B > A$, so that it causes the resultant frequency ω_0 to swing over from ω_1 to ω_2 , it can never produce more than 100 per cent. modulation, and if $\omega_2 - \omega_1$ is less than corresponds to 100 per cent. modulation, i.e. ω_2 is not at the edge of the received band, the maximum depth of modulation due to the interference is reduced. Further, the post-detector response of the receiver may be limited to the desired audio-frequency bandwidth, usually less than the radio-frequency half bandwidth, so that an interfering E.M.F. of such frequency as to produce deep modulation also produces a beat note of so high a frequency as to be rejected by the A.F. amplifier.

But equation (13) shows that of two signals the stronger predominates, and it is therefore necessary that the signal should be at least equal to the noise before factor (I) becomes effective.* Increasing the bandwidth of the R.F. portion of the receiver increases the amplitude of noise at the limiter,† and therefore increases the threshold signal level at which factor (I) becomes effective. Once this threshold has been passed, however, the extended bandwidth does not add to the A.F. noise, because the additional components are at supersonic frequency. The signal/noise improvement of a F.M. receiver is usually expressed in terms of the difference between the output (A.F.) signal/noise ratio of the F.M. receiver and that of an A.M. receiver having the same A.F. bandwidth.

3.2. *Fluctuation Noise.*—In F.M. work it is necessary to distinguish between "fluctuation noise" and "impulsive noise." The former is defined as noise made up of numerous components of similar amplitude occurring at random intervals, but occurring sufficiently frequently to ensure that a large

* Factor (II) is effective even for signal below noise level; see below, under "Impulsive Interference."

† In examining F.M. characteristics, the effective input signal/noise ratio is that at the limiter, because this is (or should be) the first non-linear stage of the receiver, the point at which linear superposition of two signals is no longer valid.

number of the components occur within a period equal to the time-constant of the receiver; the response of the receiver is then to the resultant of many components in random phase. Using the symbol $[S/N]$ for signal/noise ratio expressed in db., the performance of a F.M. receiver on fluctuation noise is given by

$$[S/N]_{F.M.} = [S/N]_{A.M.} + 20 \log_{10} D + 4.75 + P \quad (14)$$

provided the input $[S/N]$ is above the threshold of improvement. D is the "deviation ratio," i.e. the ratio of the R.F. half bandwidth to the A.F. bandwidth, and the term $20 \log_{10} D$ is the expression of the fact that the noise components so situated as to produce the highest audible output frequency produce less than 100 per cent. modulation (whatever their amplitude) by a factor of D ; the addition of 4.75 db. represents the effect of the "triangular noise spectrum,"^{3,4} i.e. the fact that even within the narrower R.F. band corresponding to twice the A.F. band, the effectiveness of the noise components decreases linearly from a maximum at the edges of the band to zero at the carrier frequency. Since the strongest components of noise in the A.F. output are those of highest frequency, a top cut in the A.F. circuits is even more effective with F.M. than with A.M.; it is therefore customary to apply a top boost or "pre-emphasis" in the A.F. circuits of the transmitter, so that a corresponding cut, or "de-emphasis," may be applied in the receiver. The resulting gain in $[S/N]$ is represented by the symbol P in equation (14). The standard degree of pre-emphasis used in American F.M. broadcasting (with an A.F. band extending up to 15 kc/s and deviation ratio of 5) is that corresponding to a circuit having a time-constant (CR or L/R) of 100 μ s, which has a negligible effect on frequencies below 1 kc/s, but gives a gain of about 20 db at 15 kc/s; if the programme fed to the transmitter could be distorted in this way without increasing the total depth of modulation, we should have $P = 7.35$ db. for these standards, but in practice the pre-emphasis necessitates a slight reduction in the average programme level at the transmitter to avoid over-modulation³, and $P = 4$ db. for American broadcasting conditions.

To find the threshold value of signal/noise

ratio, note that equation (13) is derived in terms of instantaneous values of amplitude, and when signal and interference have different wave forms, the peak values should be used, not R.M.S. Now ideally the peak value of fluctuation noise is indeterminate; but a peak value can be defined in terms of the probability of its being exceeded⁵, and a reasonable value is 4:1 for the ratio peak:R.M.S. But the peak:R.M.S. of a sinusoidal signal is only $\sqrt{2}:1$, so that for equal peak values the R.M.S. value of a sinusoidal signal must be greater than that of a fluctuation noise in the ratio 4: $\sqrt{2}$, or about 9 db. The R.M.S. fluctuation noise voltage increases in proportion to the square root of the bandwidth, so that by comparison with the minimum bandwidth which would suffice for A.M. reception, the noise in the R.F. side of the F.M. receiver is greater by $10 \log_{10} D$ db., and whereas $9 + 10 \log_{10} D$ gives equality of peak values, some superiority of signal over noise is necessary before the output is acceptable. The acceptability of the output signal/noise ratio is an arbitrary judgment, and depends upon the purpose for which the signal is required; but the published data suggest two values of the threshold, $[S/N]_0$, in terms of the R.M.S. signal/noise ratio measured in the A.M. bandwidth:—

(a) For high-fidelity entertainment,

$$[S/N]_0 = 22 + 10 \log_{10} D \quad (15)$$

(b) For speech of high intelligibility,

$$[S/N]_0 = 15 + 10 \log_{10} D \quad (16)$$

If the signal is initially below noise level, it is practically eliminated in the F.M. receiver. Theoretically, therefore, the A.M. receiver is superior to the F.M. receiver over a range of $[S/N]$ up to $9 + 10 \log_{10} D$ db., if the interference consists solely of fluctuation noise; but in fact this represents a range over which the signal is not usable.

3.3. *Impulsive Noise.*—This is defined as noise made up of discrete impulses, each of short duration compared with the time-constant of the receiver, and having a separation long compared with the time-constant of the receiver. The typical impulsive interference is that due to motor-car ignition, and may have a peak amplitude many times that of the signal, though the R.M.S. energy is small.

If the impulse is analysed into a series of sinusoidal components, they will be found to constitute a uniform continuous spectrum throughout the bandwidth accepted by the receiver; the spectrum therefore has the same frequency distribution as that of fluctuation noise, but there is the important condition that for each single impulse all components are in the *same phase*, as compared with the random phase for fluctuation noise. It follows that the peak noise voltage is proportional to the bandwidth, as compared with fluctuation noise which is proportional to the square root of the bandwidth. The special phase condition also increases the gain due to the "triangular noise spectrum" and to pre-emphasis⁴. For strong signals the gain on impulsive noise is then

$$[S/N]_{F.M.} = [S/N]_{A.M.} + 20 \log_{10} D + 6 + P' \quad \dots \quad (17)$$

The "triangular noise spectrum" gain is increased to 6 db. for impulsive noise, and the pre-emphasis gain P' for 15 kc/s A.F. band and 100 μ s correction circuit is 9.5 db. if no adjustment to the programme level at the transmitter is necessary, or about 6 db. in the practical case of high-fidelity broadcasting.

Since the sinusoidal components representing an impulse are uniformly distributed throughout the received frequency band, and are in a fixed phase relationship, the resultant instantaneous frequency is the mid-frequency to which the receiver is tuned. (Another way of looking at the practical result is that the receiver contains a number of tuned circuits, and the effect of an impulse will be to cause these circuits to "ring" at the frequency to which they are tuned.) The effect of a very strong impulse is then to shift the instantaneous frequency momentarily to the centre of the band, which should coincide with the unmodulated frequency of the received carrier; in other words, the impulse can momentarily wipe out the modulation of the received signal, but cannot generate any modulation of its own. This is a very important feature of frequency modulation, since an impulse, even of much greater amplitude than the signal, cannot produce an A.F. output greater than that due to the signal at the instant at which it occurs. We have, how-

ever, assumed that the receiver is accurately tuned to the desired signal, and that the selectivity characteristic of the receiver is symmetrical about the mid-frequency. If the receiver is detuned, say by an amount x kc/s out of a total bandwidth of $\pm X$ kc/s, the impulse may shift the resultant frequency by this amount plus the depth of modulation; so that the noise level can be related to the signal level by the following decibel equation:

$$\left[\begin{array}{c} \text{Level of} \\ \text{impulsive noise} \end{array} \right]_{F.M.} = \left[\begin{array}{c} \text{Level of 100 per cent,} \\ \text{modulated signal} \end{array} \right]_{F.M.} + 20 \log_{10} \left[\frac{M}{100} + \frac{x}{X} \right] \quad \dots \quad (18)$$

where M is the percentage modulation: Thus with reasonable accuracy of tuning, the impulsive noise level is below the signal level in the audio-frequency output, regardless of the input signal/noise ratio, so that there is no threshold and F.M. gives a substantial elimination of impulsive noise even on very weak signals.*

3.4. *C.W. Interference.*—If the difference between the carrier frequency of the desired signal and the frequency of the interfering signal, say B kc/s, is audible, there would be a heterodyne note in A.M. reception. F.M. can then be said to give an improvement defined by the following equation, which is valid for $[S/N] \gg 0$ db.:

$$[S/N]_{F.M.} = [S/N]_{A.M.} + 20 \log_{10} (X/B) + P' \quad \dots \quad (19)$$

The term P' , representing the effect of pre-emphasis, depends on both the value of B and the pre-emphasis characteristic, but can be large. For example, with 100 μ s pre-emphasis and $B = 15$ kc/s, P' is about 20 db., and with a deviation of ± 75 kc/s $X/B = 5$, so that the total improvement is 34 db.; if B is only 1 kc/s, P' is negligible but X/B is 75, giving an improvement of 37.5 db.

If B is a supersonic frequency there is no question of an improvement due to F.M., because it could cause no interference in an A.M. receiver. In fact the modulation of the

* Normally, $M < 100$ and $x \ll X$, so that $\log_{10} \left[\frac{M}{100} + \frac{x}{X} \right]$ is usually negative, and the right-hand side of (18) is therefore less than "Level of 100 per cent. modulated signal."

desired signal is reduced according to the equation

$$\left[\begin{array}{l} \text{Level of} \\ \text{signal + C.W.} \end{array} \right] = \left[\begin{array}{l} \text{Level of} \\ \text{signal} \end{array} \right] - 20 \log_{10} \left[\frac{V_n^2}{V_s^2 + V_n^2} \right] \quad \dots \quad (20)$$

where V_n and V_s are the amplitudes of the interfering and desired carriers. If the signal is weaker than the interfering carrier, then the predominant effect is that shown by equation (20), both for B audible and super-sonic, and the signal is rapidly lost as the interference level rises. The presence of an interfering carrier also shifts the mean or carrier frequency of the resultant of the signal and interference, and so is equivalent to detuning the receiver by an amount

$$x^1 = BV_n^2 / (V_s^2 + V_n^2) \quad \dots \quad (21)$$

This will increase impulsive noise (if the receiver is left tuned to the original frequency of the signal) as indicated by adding x^1 to x in equation (18).

3.5. *Modulated Interference.*—The response to modulated interference can be a complex problem if the selectivity of the receiver is such as to cut some of the sidebands of the interfering signal.⁶ But if all sidebands of the interfering signal are received approximately equally, the undesired frequency modulation imposed on the desired carrier by the modulated interference can be deduced from equation (13); taking $A \cos \omega_1 t$ as the desired signal and $B \cos \omega_2 t$ as the interfering signal, one represents the effect of amplitude modulated interference by writing

$$\omega_0 = \omega_1 + (\omega_2 - \omega_1) \left\{ \frac{B^2(1 + k \sin nt)^2}{A^2 + B^2(1 + k \sin nt)^2} \right\} \quad \dots \quad (22)$$

and frequency-modulated interference by

$$\omega_0 = \omega_1 + [(\omega_2 + \delta\omega \sin nt) - \omega_1] \frac{B^2}{A^2 + B^2} \quad \dots \quad (23)$$

It can then be shown that for amplitude modulated interference with $B \ll A$, the A.F. signal/noise ratio is related to the R.F. signal/interference level by the equation

$$\left[\frac{S}{N} \right]_{A.F.} \doteq 2 \left[\frac{S}{N} \right]_{R.F.} + 20 \log_{10} \left[\frac{X}{(\omega_2 - \omega_1)} \right] \quad \dots \quad (24)$$

where $\pm X$ is the frequency change corresponding to 100 per cent. modulation of the desired signal. (It is assumed that $[S/N]_{R.F.}$ includes a factor for the percentage modulation of the two signals, as well as the carrier ratio.) For comparison it should be noted that in an A.M. receiver having rectifier discrimination (i.e. using linear detection which causes "apparent demodulation of a weak signal by a strong one") we should have

$$\left[\frac{S}{N} \right]_{A.F.} = 2 \left[\frac{S}{N} \right]_{R.F.} + 6 \quad \dots \quad (25)$$

When the interfering signal is amplitude modulated, therefore, the chief advantage of using F.M. communication is in the reduction

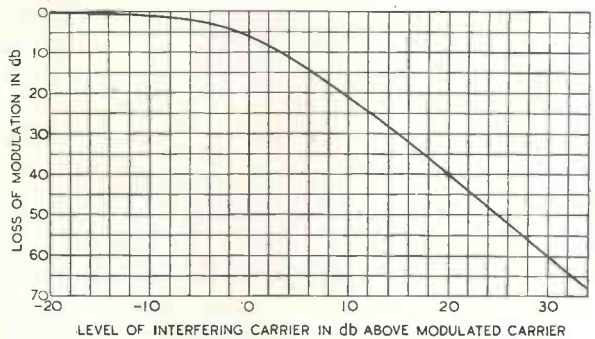

Fig. 2.

of heterodyne interference, in accordance with equation (19), rather than of interfering modulation. From equation (23) it can be seen that the variation in the received frequency ω_0 due to the frequency modulation $\delta\omega \sin nt$ of the interfering signal is

$$\Delta(\omega_0) = \frac{B^2 \delta\omega \sin nt}{A^2 + B^2} \quad \dots \quad (26)$$

If the wanted and interfering signals both work on the same amplitude of frequency swing, and $[S/N]_{R.F.}$ includes a factor equal to the depth of modulation of the interfering signal, then for $B \ll A$,

$$\left[\frac{S}{N} \right]_{A.F.} \doteq 2 \left[\frac{S}{N} \right]_{R.F.} \quad \dots \quad (27)$$

The threshold of improvement occurs at $[S/N]_{carrier} = 0$ db., and below this level the interference suppresses the signal. It is commonly stated that a difference in level of 6 db. is sufficient to give freedom from interference, but it is doubtful whether this could be called a "high-fidelity" standard of interference, and 10 db. seems more reasonable; the relation between $[S/N]_{R.F.}$

and $[S/N]_{A.F.}$, from equation (26), is plotted in Fig. 2.

3.6. *Cross Modulation*.—If a frequency modulated wave is represented by a carrier and series of sidebands, and is then considered to be applied simultaneously with another carrier frequency to a non-linear device, it will be found that the output contains terms whose frequencies correspond to sidebands of the originally unmodulated carrier, spaced about it in the same way as the sidebands of the original F.M. signal, i.e. cross modulation has occurred. But if now the carrier which was originally supposed to be unmodulated, is frequency modulated, we shall have the equivalent of two frequency modulated signals on a common carrier, and it has been shown above that a difference of 10 db. is sufficient to eliminate the weaker. It is therefore only in exceptional circumstances that cross modulation can be observed in a F.M. receiver, since the cross modulation is usually considerably below the level of the direct signal.

3.7. *Transmitter gain*.—Any gain in field strength from the transmitter will result in a better signal/noise ratio at a given receiving site, and a transmitter with a given size of output valve or power consumption can give a better field strength with F.M. than with A.M. In an amplitude modulated transmitter the peak power output at 100 per cent. modulation rises to four times the carrier power, so that if the limitation is one of peak power, the change over to constant amplitude F.M. instead of A.M. will allow the carrier power to be raised four times or 12 db., but if the limitation is of R.M.S. power, the permissible increase of power is only 1.5 times, or 3.6 db. This is physically represented by the fact that in an A.M. transmission (single-tone modulation) the carrier amplitude is twice the sideband amplitude at 100 per cent. modulation, whereas with F.M. the carrier amplitude is almost always less than the sum of the sideband amplitudes, and vanishes for certain ratios of deviation to frequency of modulation. There is thus less waste of energy in the carrier with F.M. than with A.M.

4. Propagation Characteristics and Applications.

There are certain limitations on the carrier frequencies that can be used for wideband

F.M., and this naturally influences the type of service to which it can be readily applied. If long-distance communication is attempted, it will usually be found that the signal travels by two or more alternative paths, having variable differences in transmission time, which results in "selective fading," i.e. some of the sidebands decrease or vanish at the same time that others increase; and F.M. is more severely distorted than A.M. by selective fading^{8,9}. This effect may be imagined qualitatively in terms of the large number of sidebands required in F.M. to represent a single-tone modulation; there is more chance of some of these numerous sidebands being displaced than if there were only two sidebands. This suggests, as is verified by mathematical analysis and experiment, that the distortion is more severe for modulation frequencies which are small compared with the frequency sweep, and therefore have their energy spread over many sidebands.

The first reaction to this difficulty was to work at carrier frequencies above 40 Mc/s, where propagation is (usually) by direct ray only. This is quite convenient for broadcasting, and in U.S.A. a substantial number of commercial F.M. broadcasting stations had been put into operation in the band from 43 to 50 Mc/s by the end of 1941; further development of broadcasting was then stopped by the war, but it had been decided to make F.M. standard for the sound accompaniment of television in U.S.A. The frequency swing is ± 75 kc/s, and the range of modulation frequencies transmitted extends to 15 kc/s, since it is a "high-fidelity" service (see Appendix II). The nominal service areas of these transmitters are about 7,000 square miles (say 45 miles radius), but some of the transmitters are situated on mountains, giving an effective aerial elevation of the order of 1,200 feet, and good reception at a distance of 200 miles is frequently reported.

F.M. communication on slightly higher carrier frequencies is being used in U.S.A. for mobile communications, e.g. with police cars and repair parties patrolling long electric power lines. One of the advantages of F.M. for these applications is the reduction of impulse interference from the ignition system of the vehicle in which the receiver is installed, and (in cars used in urban areas)

from the ignition systems of other traffic. It seems that in urban areas the interference, both from ignition and from electrical machinery, is predominantly impulsive; for F.M. has been reported to be superior to A.M. for mobile work even at signal/noise ratios so low that it would be definitely inferior if the noise were random noise. It is usual to employ a 5 : 1 deviation ratio but to restrict the A.F. band to 3 kc/s for these communication services, so that the channel occupied is only ± 15 kc/s.

Proceeding to still higher frequencies, wide-band F.M. is used with highly directional aerial systems for point-to-point communication. One example is the link between broadcasting studio and transmitter; it is claimed that the F.M. radio link on a carrier frequency of the order of 300 Mc/s is cheaper, quieter, and has a greater A.F. bandwidth than a telephone line. In this case the advantage of using F.M. rather than A.M. is probably the reduction of receiver noise (shot and thermal), since external noise is small at such frequencies but receiver noise is liable to be high owing to the comparative inefficiency of amplifying valves used at these carrier frequencies.

Wideband F.M. is impracticable on carrier frequencies much below 40 Mc/s for two reasons: the distortion with multi-path transmission and the lack of sufficient space in the frequency band to allow 200 kc/s per channel. But a number of experiments have been carried out with F.M. using only a relatively narrow frequency sweep; the logical minimum value of sweep is that equal to the highest audio frequency, so that it occupies approximately the same band width as an A.M. transmission. Although a fair proportion of the noise-reducing properties are sacrificed by using a narrow frequency sweep, there are still certain advantages:

(i) The noise reduction due to the "triangular noise spectrum" remains, and together with a suitable degree of pre-emphasis this can contribute a gain of about 10 db. in the ratio of signal to fluctuation noise.

(ii) The gain on impulsive noise is somewhat greater, and in addition there is the automatic limiting action which prevents any noise impulse from giving an output exceed-

ing the peak value obtained from a 100 per cent. modulated signal.

(iii) There is a reduction of heterodyne and shared-channel interference compared with A.M. working.

The disadvantage to set against these features is the difficulty with selective fading. Experimental data have been published by Crosby⁸ for communication over a distance of 1,150 miles with a carrier frequency of 26.3 Mc/s and unity deviation ratio. Three different propagation conditions were observed:

(i) On about half the days on which signals were received, communication was satisfactory and free from the effects of selective fading.

(ii) On one-fourth of the total days, conditions were such as to superimpose noise on the signal.

(iii) On the remaining fourth of the total days, there was selective fading sufficient to give severe distortion of the F.M. signal.

Satisfactory limiting of interference impulses due to static (atmospherics) was noted during these experiments.

The technique of transmission and reception in narrow-band systems tends to differ from that of wideband frequency modulation. Owing to the narrowness of the phase or frequency swing, the obvious method of generation appears to be to vary the phase of a constant frequency oscillator, and this makes it possible to take advantage of the stable carrier generators available, such as crystal oscillators. In the receiver, the problem is no longer linearity of the discriminator characteristic, but rather the securing of sufficient steepness of the amplitude/frequency characteristic; crystal filter circuits may be used.

Acknowledgments

The author wishes to express his thanks to Mr. L. H. Bedford and to Mr. K. I. Jones of the Cossor Research Laboratories for their interest and encouragement which made possible this work; and to the management of A. C. Cossor Ltd. for permission to publish it.

REFERENCES

¹ "Carrier and Side-Frequency Relations with Multi-tone Frequency or Phase Modulation." *R.C.A. Review*, Vol. 3, p. 103. 1938.

² "Non-Linear Distortion, with particular reference to the Theory of Frequency-Modulated Waves." Part I. *Phil. Mag.*, Vol. 32, p. 265. 1941.

³ "N.B.C. Frequency Modulation Field Test." *R.C.A. Review*, Vol. 5, p. 190. 1940.
⁴ "Frequency Modulation Noise Characteristics." *Proc. I.R.E.*, Vol. 25, p. 472. 1937.
⁵ "The Distribution of Amplitude with Time in Fluctuation Noise." *Proc. I.R.E.*, Vol. 29, p. 50. 1941.
⁶ "Interference in Relation to Amplitude, Phase and Frequency Modulated Systems." *Wireless Engineer*, Vol. 18, pp. 6 and 56. 1941.

⁷ "A Method of Reducing Disturbances in Radio Signalling by a System of Frequency Modulation." *Proc. I.R.E.*, Vol. 24, p. 689. 1936.
⁸ "Observations of F.M. Propagation on 26 Mc/s." *Proc. I.R.E.*, Vol. 29, p. 398. 1941.
⁹ "Frequency Modulation and Distortion." *Wireless Engineer*, Vol. 7, p. 482.
¹⁰ "Amplitude, Frequency and Phase-Angle Modulation." *Wireless Engineer*, Vol. 17, p. 339. 1940.

APPENDIX I

The Sideband Representation of F.M. Waves

In reading various papers, one may find different combinations of sine and cosine terms for carrier and sidebands, some of which at first glance do not seem consistent with each other in their sideband

phase relationships; the four fundamental cases are therefore set out here, and the vector diagrams for the sidebands shown in the table given at the foot of the page.

Case A.—Carrier = $\sin \omega t$, phase modulation = $x \sin pt$.

The expression for this case is

$$E = \sin(\omega t + x \sin pt) = \sin \omega t \cos(x \sin pt) + \cos \omega t \sin(x \sin pt)$$

This can be expanded in terms of series of Bessel functions:

$$E = \sin \omega t \{ J_0(x) + 2 J_2(x) \cos 2 pt + 2 J_4(x) \cos 4 pt + \dots \} + \cos \omega t \{ 2 J_1(x) \sin pt + 2 J_3(x) \sin 3 pt + \dots \}$$

$$\therefore E = J_0(x) \sin \omega t + \sum_{n=0}^{\infty} J_{2n+1}(x) [\sin(\omega + 2n + 1)p)t - \sin(\omega - 2n + 1)p)t] + \sum_{n=1}^{\infty} J_{2n}(x) [\sin(\omega + 2np)t + \sin(\omega - 2np)t]$$

CARRIER PHASE	PHASE-MODULATION PHASE	CARRIER TO SIDEBAND PHASE RELATIONSHIPS AT $t=0$	
<p>CASE A</p>		<p>ODD SIDEBANDS</p>	<p>EVEN SIDEBANDS</p>
<p>CASE B</p>		<p>(4n-1)th SIDEBANDS</p> <p>(4n+1)th SIDEBANDS</p>	<p>4nth SIDEBANDS</p> <p>(4n-2)th SIDEBANDS</p>
<p>CASE C</p>		<p>ODD SIDEBANDS</p>	<p>EVEN SIDEBANDS</p>
<p>CASE D</p>		<p>(4n-1)th SIDEBANDS</p> <p>(4n-1)th SIDEBANDS</p>	<p>4nth SIDEBANDS</p> <p>(4n-2)th SIDEBANDS</p>

The three lines of the final expression for E represent carrier, odd sidebands and even sidebands respectively.

Case B.—Carrier = $\sin \omega t$, phase modulation = $x \cos pt$.

$E = \sin (\omega t + \cos pt)$ can be developed by the same method to yield $E = J_0(x) \sin \omega t$

$$+ \sum_{n=0}^{\infty} (-1)^n J_{2n+1}(x) [\cos (\omega + 2n + 1p)t + \cos (\omega - 2n + 1p)t]$$

$$+ \sum_{n=1}^{\infty} (-1)^n J_{2n}(x) [\sin (\omega + 2np)t + \sin (\omega - 2np)t]$$

Case C.—Carrier = $\cos \omega t$, phase modulation = $x \sin pt$.

$E = \cos (\omega t + x \sin pt)$ is equivalent to

$E = J_0(x) \cos \omega t$

$$+ \sum_{n=0}^{\infty} J_{2n+1}(x) [\cos (\omega + 2n + 1p)t - \cos (\omega - 2n + 1p)t]$$

$$+ \sum_{n=1}^{\infty} J_{2n}(x) [\cos (\omega + 2np)t + \cos (\omega - 2np)t]$$

Case D.—Carrier = $\cos \omega t$, phase modulation = $x \cos pt$.

$E = \cos (\omega t + x \cos pt)$ is equivalent to

$E = J_0(x) \cos \omega t$

$$+ \sum_{n=0}^{\infty} (-1)^n J_{(2n+1)}(x) [\sin (\omega + 2n + 1p)t + \sin (\omega - 2n + 1p)t]$$

$$+ \sum_{n=1}^{\infty} (-1)^n J_{2n}(x) [\cos (\omega + 2np)t + \cos (\omega - 2np)t]$$

APPENDIX II

Standards of F.M. Broadcasting in the U.S.A.

In licensing commercial F.M. broadcasting stations in the U.S.A. the Federal Communications Commission has made a number of rules covering both those standards which must be known before receivers can be constructed, and quantitative standards to ensure that a satisfactory signal can be received by a properly designed receiver. The following is the substance of the performance specification with which stations must comply.

(1) Audio-frequency characteristics.

(i) Pre-emphasis: the transmitter shall have a rising frequency characteristic, as produced by a circuit having a time constant of 100 microseconds.

(ii) Frequency range: the frequency response shall be correct within ± 2 db. from 50 to 15,000 c/s.

(iii) Harmonic distortion: not to exceed 2 per cent. R.M.S. at ± 75 kc/s swing of carrier frequency.

(iv) Noise: spurious frequency modulation must be at least 60 db. below 100 per cent. frequency modulation; amplitude modulation must be at least 60 db. below carrier.

(2) Radio-frequency characteristics.

(i) Frequency stability: in the band of frequencies from 42 to 50 Mc/s, the carrier must remain on its allotted frequency to within ± 2 kc/s.

(ii) Polarisation: F.C.C. allows either horizontally or vertically polarised radiation. (In practice horizontal polarisation seems to be universal.)

(iii) Field strength: field strength is defined in terms of the E.M.F. set up in a receiving aerial having an effective clearance from ground of 30 feet.

In the service area the E.M.F. in the receiving aerial must be 1,000 μ V in urban areas or 50 μ V in rural areas.

I.E.E. Wireless Section

THE next meeting of the Section will be on May 5th when H. J. Finden will deliver a paper on "The Frequency Synthesiser." The last meeting of the present session will be on May 11th when an informal discussion on "Factors Determining the Choice of Carrier Frequencies for an Improved Television System" will be opened by B. J. Edwards.

"Shot-Effect in Space-Charge-Limited Diodes"

THE author of the above article, which appeared in the March issue, has asked for the following correction to be inserted.

Equation 17 should read

$$\overline{\Delta I^2} = \overline{\Delta J^2} \cdot \frac{I^2}{J^2} \cdot \left\{ 1 + \frac{\epsilon V_1^{\frac{1}{2}} \cdot V_2^{\frac{3}{2}}}{\alpha k T} \right\}^2$$

Paper Goes to War

FIVE times as much paper is needed for the manufacture of various types of ammunition as is required for any of the other purposes for which paper must be found. Waste paper is a weapon of war.

Wireless Patents

A Summary of Recently Accepted Specifications

The following abstracts are prepared, with the permission of the Controller of H.M. Stationery Office, from Specifications obtainable at the Patent Office, 25, Southampton Buildings, London, W.C.2, price 1/- each

ACOUSTICS AND AUDIO-FREQUENCY CIRCUITS AND APPARATUS

549 518.—Microphone attachment, say for an oxygen mask, compensated to prevent distortion due to reflected sound-waves.

Standard Telephones and Cables and J. S. P. Robertson. Application date, 2nd May, 1941.

549 701.—Magnetic diaphragm arranged as a balanced armature for telephone transmission and reception without the use of batteries.

Standard Telephones and Cables and J. S. P. Robertson. Application date, 27th November, 1940.

549 926.—Device for continuously varying the linear characteristic of an attenuation-equalising network from a positive to a negative slope.

Standard Telephones and Cables (assignees of W. R. Lundry). Convention date (U.S.A.), 24th October, 1940.

AERIALS AND AERIAL SYSTEMS

549 564.—Impedance-matching device for a frame aerial coupled to a wireless receiver.

Philips Lamps (communicated by N. V. Philips' Gloeilampenfabrieken). Application date, 3rd October, 1941.

549 753.—Electromagnetic-wave horn for radiating waves with different planes of polarisation without mutual interference in duplex signalling systems.

Marconi's W. T. Co. (assignees of M. Katzin). Convention date (U.S.A.), 29th October, 1940.

549 958.—Aerial screening arrangement for varying the sharpness with which a navigational course is marked out by a pair of overlapping beams.

Aga-Baltic Radio Akt. Convention date (Sweden) 10th April, 1940.

RECEIVING CIRCUITS AND APPARATUS

549 367.—Mounting and controlling the movable iron cores of high-frequency tuning coils.

Johnson Laboratories, Inc. (assignees of W. H. James). Convention date (U.S.A.), 5th June, 1940.

549 459.—Construction of permeability-tuned coils, particularly for producing a constant "difference" frequency in superheterodyne sets.

Marconi's W. T. Co. (assignees of W. F. Sands and P. F. G. Holst). Convention date (U.S.A.), 17th May, 1940.

549 465.—Receiving circuit of the homodyne type in which a local carrier frequency is utilised to give increased selectivity.

Hazeltine Corporation (assignees of N. P. Casé). Convention date (U.S.A.), 10th July, 1940.

549 480.—Device, responsive to a calling-up signal,

for preparing the wireless receiver, say in a police car, to respond to headquarters messages.

The General Electric Co.; N. R. Bligh; D. M. Heller; and L. C. Stenning. Application date, 6th October, 1941.

549 484.—Automatic grid-biasing circuit, utilising a copper-oxide detector, particularly for modulator valves.

Telefon Akt. L. M. Ericsson. Convention date, (Sweden), 26th October, 1938.

549 489.—Super-regenerative circuit including a velocity-modulated oscillator for receiving ultra-short waves.

Akt. Brown, Boverie et Cie. Convention date (Switzerland), 27th February, 1940.

549 537.—Means for maintaining a constant output over a wide frequency range from a heterodyne "mixing" circuit.

Standard Telephones and Cables (assignees of T. Slonczewski). Convention date (U.S.A.), 3rd July, 1940.

549 769.—Receiver with a tuning system which scans over a frequency range in which several short-wave transmitters are operating and automatically maintains contact with a selected one.

S. Young. Convention date (U.S.A.), 29th February, 1940.

549 770.—Method of using a superposed tone frequency to facilitate the tuning of a television or like receiver to one or other of a number of different transmitters operating within a given frequency band.

S. Young. Convention date (U.S.A.), 29th February, 1940.

549 834.—Amplifier circuit in which a filter type of feed-back circuit is combined with regenerative and degenerative reaction to reduce noise.

Marconi's W. T. Co. (assignees of N. J. Oman). Convention date (U.S.A.), 29th July, 1940.

TRANSMITTING CIRCUITS AND APPARATUS

549 644.—Inductive coupling between a tuned oscillator and an inductive load wherein the power transferred is maintained constant over a range of operating frequencies.

Standard Telephones and Cables and E. C. Wiloughby. Application date, 27th May, 1941.

549 721.—High-frequency transmission line formed in two tandem parts which have different characteristic impedances so that one part may be the more conveniently matched to a very high-frequency load.

The General Electric Co.; M. R. Cavin; and V. A. Heathcote. Application date, 6th October, 1941.

549 979.—Apparatus for maintaining a constant relation between the carrier frequency and the speed of keying in a telegraph transmitter.

Marconi's W. T. Co. and H. J. Wassell. Application date, 13th June, 1941.

CONSTRUCTION OF ELECTRONIC-DISCHARGE DEVICES

549 301.—Construction of base or holder for valves of the "acorn" type, to avoid straining the glass seals during insertion or withdrawal of the valve.

Standard Telephones and Cables; M. M. Levy; and A. S. Merritt. Application date, 12th May, 1941.

549 476.—Arrangement for preventing undesired secondary-emission effects in the focusing system of a cathode-ray tube.

Philips Lamps (communicated by N. V. Philips' Gloeilampenfabrieken). Application date, 19th September, 1941.

549 485.—Process for preparing or coating valve electrodes made of steel in order to reduce secondary emission and to increase their heat-radiating efficiency.

Hygrade Sylvania Corporation. Convention date (U.S.A.), 8th December, 1939.

549 676.—Electron multiplier in which secondary emission is utilised for generating oscillations of the order of 1,000 to 5,000 kilocycles.

Standard Telephones and Cables and R. M. Barnard. Application date, 30th April, 1941.

549 778.—Low-emission alloy suitable for making grids for thermionic valves.

Marconi's W. T. Co. (assignees of E. G. Widell). Convention date (U.S.A.), 31st May, 1940.

549 795.—Construction and assembly of resonant electrodes as used for "bunching" or velocity-modulating an electron stream.

Standard Telephones and Cables (assignees of C. V. Littón). Convention date (U.S.A.), 27th August, 1940.

549 976.—A frequency-selective amplifier valve in which the space charge developed by the input oscillations applied to one grid induces phase-displaced oscillations on a second grid which, in turn, modifies the output taken from the valve.

Sir L. Sterling. Convention date (U.S.A.), 8th August, 1940.

SUBSIDIARY APPARATUS AND MATERIALS

549 449.—Process for making the powdered magnetic material used for the cores of variable-permeability tuning coils.

Johnson Laboratories, Inc. (assignees of G. Berge). Convention date (U.S.A.), 21st June, 1940.

549 453.—Triggering circuits for the gas-filled valves used in impulse signalling.

Standard Telephones and Cables; F. H. Bray; and L. R. Byrown. Application date, 19th May, 1941.

549 499.—Stabilising arrangement for a valve oscillator, particularly when used for generating a

number of different frequencies for multiplex working.

The General Electric Co.; L. I. Farren; and R. S. Rivlin. Application date, 13th August, 1941.

549 594.—Cutting and mounting piezo-electric crystals to ensure constant frequency and immunity from temperature variations.

Standard Telephones and Cables (assignees of W. P. Mason). Convention date (U.S.A.), 20th September, 1940.

549 623.—Means for coupling a carrier-wave signalling circuit to a high-power transmission line.

Standard Telephones and Cables (assignees of K. S. Johnson and L. K. Swart). Convention date (U.S.A.), 5th October, 1940.

549 674.—Inductive "leader gear" system for automatically steering a road vehicle or other mobile body over a predetermined course, particularly under black-out conditions.

C. L. Paulus and R. K. Stout. Convention dates (U.S.A.), 12th April and 19th April, 1940.

549 835.—Safety device for minimising the effect of accidental contact with a source of high voltage, such as the supply-leads to a cathode-ray tube.

E. G. Gage. Application date, 2nd July, 1941.

549 881.—Capacitance device for measuring electrically the mechanical displacements due to hydrostatic or like pressure.

Philips Lamps (communicated by N. V. Philips' Gloeilampenfabrieken). Application date, 6th June, 1941.

549 948.—Means for minimising the effect of phase drift in a power-line signalling system utilising a single carrier wave.

Standard Telephones and Cables (assignees of H. R. Moore). Convention date (U.S.A.), 22nd October, 1940.

549 952.—Composition of electrolyte suitable for use in the dry type of electrolytic condenser.

Standard Telephones and Cables (assignees of K. G. Compton). Convention date (U.S.A.), 25th March, 1941.

The Industry

IN a recent publication (No. C102-A) Muirhead and Co., Ltd., Elmers End, Beckenham, Kent, have collected together technical information and data on all the types of resistances and resistance networks which they can manufacture. These include the "Munit" series of decade resistances, a number of precision low resistance slide wire units, and screened attenuators for A.F. and R.F., the latter for figures up to 20 Mc/s.

The use of latex sleeves for identifying cable ends have many advantages which are set out in a descriptive leaflet issued by E. Siegrist, Ltd., 39 Berners Street, London, W.1.

The Minister of Supply has appointed R. L. Prain, to be Controller of Quartz Crystals, to whom all communications relating to the supply of quartz crystals should be addressed, at Portland House, Tothill Street, London, S.W.1. Telephone: Abbey 7788.

Abstracts and References

Compiled by the Radio Research Board and reproduced by arrangement with the Department of Scientific and Industrial Research

For the information of new readers it is pointed out that the length of an abstract is not necessarily an indication of the importance attached to the work concerned. An important paper in English, in a journal likely to be readily accessible, may be dealt with by a square-bracketed addition to the title, while a paper of similar importance in German or Russian may be given a long abstract. In addition to these factors of difficulty of language and accessibility, the nature of the work has, of course, a great influence on the useful length of its abstract.

	PAGE		PAGE
Propagation of Waves	245	Directional Wireless	253
Atmospherics and Atmospheric Electricity	248	Acoustics and Audio-Frequencies...	254
Properties of Circuits	249	Phototelegraphy and Television ...	256
Transmission	251	Measurements and Standards ...	257
Reception	252	Subsidiary Apparatus and Materials	259
Aerials and Aerial Systems	252	Stations, Design and Operation ...	262
Valves and Thermionics	252	General Physical Articles	262
		Miscellaneous	262

PROPAGATION OF WAVES

1361. THE RADIATION FIELD OF A VERTICAL TRANSMITTING DIPOLE OVER STRATIFIED GROUND.—J. Grosskopf. (*Hochf.tech. u. Elek.ikus.*, Nov. 1942, Vol. 60, No. 5, pp. 136-141.)

"In a series of previous papers (1833 of 1941 and 376 & 964 of 1942) it was shown experimentally and theoretically that in the propagation of electromagnetic waves it is practically never possible to reckon on homogeneous ground, and that on the contrary the ground stratification has a decisive influence. It was shown that the measurement of the Zenneck rotating-field ellipse described by the electric vector, by means of the dipole measuring method, enables σ and ϵ to be determined for homogeneous ground, but that this method applied to stratified ground yields values for σ and ϵ which have no direct physical significance and which are therefore termed the 'effective' conductivity σ_{eff} and the 'effective' dielectric constant ϵ_{eff} . They bear, obviously, a relation to the ground constants of the individual layers and the thicknesses of those layers. It was further shown that from the measurement of the frequency characteristics of σ_{eff} and ϵ_{eff} it was possible to obtain knowledge of the ground constants and thicknesses of the strata.

"The question now arises as to the manner in which the ground stratification influences the propagation attenuation of the field radiated from a transmitter. It is known from the researches of Sommerfeld, Weyl, and van der Pol & Niessen that over homogeneous ground the propagation is determined by the Sommerfeld function $F(w)$, whose argument [eqn.1] ... is termed the 'numerical distance'. The same attenuation is

obtained for equal numerical distances, whatever the individual values of r , z , ϵ , and σ may be. Is there, then, a similar general function applicable to stratified ground, and how is the numerical distance calculated in this case? It will be shown that for stratified ground also the propagation is governed by the Sommerfeld function $F(w)$ and that the corresponding numerical distance w^* stands in the closest relation to σ_{eff} and ϵ_{eff} , and therefore to the rotating field present over stratified ground. Thus the measurement of the rotating-field ellipse by the dipole method attains an immediate importance also for the measurement of the attenuation".

Dealing first with propagation over unstratified ground, and using Weyl's (1919) method, the writer arrives at eqn.19 for F , the propagation law of the Hertzian vector already obtained by Sommerfeld and others by various ways and applicable in that form only at the ground and for small angles of elevation. He then obtains the modified eqn. 23 for F' , applicable to an arbitrary angle of elevation (van der Pol & Niessen): the new numerical distance w' differs from that for small angles of elevation only by the replacement of the distance r measured at the ground by the distance of the measuring point through space, $R = \sqrt{r^2 + z^2}$. For practical applications eqn. 25 for F' , involving the Fresnel reflection coefficient for plane waves, is preferable. Passing then to propagation over stratified ground, the writer obtains as a first approximation eqn.52 for F'^* , which differs from eqn.23 only by the fact that in the expression for the numerical distance w'^* the complex refraction coefficient of the top layer, n_1 , is replaced by the effective refraction coefficient $n_1^* = n_1/\tan(\delta_1 - j\phi)$ of the stratified ground: for the significance of $\tan(\delta_1 - j\phi)$ see

eqns. 33/35: the German characters represent the hyperbolic tangent.

A full discussion of this effective refraction coefficient n_1^* and of its determination from the tangent relief diagram has already been given in a previous paper on the propagation of plane ground waves over stratified ground (no special reference is quoted but for previous papers involving propagation over stratified ground see 3001 of 1942 and the beginning of the present abstract). It was there found that the Zenneck rotating-field ellipse over stratified ground could be derived from that over homogeneous ground by multiplying the complex refraction exponent $n = \sqrt{\epsilon + j \cdot 2\sigma/f}$ by the correction factor $1/\tan(\delta_1 - j\phi)$. This calculation, derived there for the case of plane waves, is seen from the above considerations to be applicable not merely to plane wave fronts (i.e. for large distances from the transmitter) but quite generally. The dependence of the above correction factor on the layer thicknesses, the frequency, and the ground constants of the individual layers, is discussed in the paper in question with the help of the tangent relief diagram. Whereas on that occasion the course and knowledge of the function $\tan(\delta_1 - j\phi)$ was decisive for the shape of the rotating-field ellipse, and gave the possibility of working backwards to obtain information as to the structure of the stratified ground by measuring the frequency characteristic of the rotating-field parameters, in the present case the function is of importance for the numerical distance and thus for the attenuation of propagation. The simultaneous appearance of the function in the rotating field of the electric vector and in the numerical distance makes possible the direct application of the effective ground constants, determined by the dipole method from the rotating-field parameters, to the calculation of the numerical distance and the attenuation: thus the dipole procedure for measuring ground constants is given a further field of application and importance.

The tangent relief diagram yields some very interesting deductions regarding the influence of stratification on the numerical distance and thus on the range of the ground wave. Fig. 3, taken from the paper in question, shows the tangent relief diagram with some inserted frequency curves of the argument $\delta_1 - j\phi$. According to whether the upper or the lower layer is the better conducting, and to the values of frequency and layer thickness, the absolute value of $\tan(\delta_1 - j\phi)$ is greater or less than unity, and the numerical distance greater or less than that over unstratified ground. It may happen that a poorly-conducting layer lying under a well-conducting layer will be favourable to propagation, and that propagation over a badly conducting ground may be made still worse by the presence of a well-conducting under-layer. The physical basis for this remarkable behaviour is to be found in the formation of reflections at the layer boundaries which, like the reflections at the ionosphere, produce additional contributions to the radiation: this interference effect is also evident in the periodic characteristic of the factor $\tan(\delta_1 - j\phi)$ with respect to frequency and layer thickness.

In the determination of field-strength values for high angles of elevation the Hertzian potential takes, as has been seen above, the form of eqn. 25 ($F' = [(1 + \mathfrak{R}_0) + (1 - \mathfrak{R}_0) F]$), directly involving the reflection coefficient for plane waves. But as eqn. 36 shows, in the first approximation here used the reflection coefficient for stratified ground is also obtained from that for homogeneous ground by multiplying the complex refractive index of the upper layer by the correction factor $1/\tan(\delta_1 - j\phi)$, as must be the case also from general considerations. K. A. Norton has built up a very comprehensive and useful collection of the expressions for all the field components of an arbitrarily polarised radiator over ground of finite conductivity, from potentials of the form of eqn. 25 (14 of 1937 and 32/33 of 1938). "Since his derivations are valid only for homogeneous unstratified ground, it is fortunate that the simple correction of the refractive index just described allows the direct application of the Norton formulae to stratified grounds, which are what must be reckoned with in most practical cases of propagation."

1362. CORRECTION TO THE PAPER "THE QUESTION OF PARTIAL REFLECTION AND THE CALCULATION OF THE APPARENT HEIGHT OF IONOSPHERIC LAYERS [3035 of 1939].—K. Rawer. (*Hochf.tech. u. Elek.akus.*, Nov. 1942, Vol. 60, No. 5, p. 141.) Shortened version of the correction dealt with in 987 of April.

1363. A SIMPLE METHOD OF DEMONSTRATING THE CIRCULAR POLARIZATION OF IONOSPHERICALLY REFLECTED RADIO WAVES [by Production of Beat Envelopes, taking Advantage of Early Morning or Evening Doppler Effect to use Ground Wave as Heterodyne].—E. V. Appleton. (*Nature*, 27th Feb. 1943, Vol. 151, No. 3826, p. 250.)

1364. FURTHER NOTES ON THE ELECTRON DENSITY DISTRIBUTION OF THE UPPER ATMOSPHERE.—O. E. H. Rydbeck. (*Phil. Mag.*, Feb. 1943, Vol. 34, No. 229, pp. 130-139.) Calculation of true electron density in the F layer from virtual height data. For previous work see 23 of 1941.

1365. ON THE SIGNAL MAXIMUM DURING THE SUNSET PERIOD.—S. K. Khastgir & S. N. Mazumdar. (*Sci. & Culture* [Calcutta], Nov. 1942, Vol. 8, No. 5, pp. 235-236.)

If the explanation of the sunrise and sunset maxima in number and field strength of distant atmospherics proposed in another letter in the same number of this journal (see 1379, below) is correct, similar effects in the signal-strength observations of a distant transmitter at the time of ground sunrise and sunset at the receiving site would be expected. Accordingly the Calcutta short-wave station (4840 kc/s, $\lambda = 61.98$ m) was chosen and continuous observations of the signal current in the anode circuit of the detector valve of a three-valve receiver were taken for some days during the evening hours, well covering the sunset period. Typical curves for three different days show galvanometer deflections due to the signal at short-time intervals during the sunset period.

A distinct maximum is evident in each of the three curves. The computed time is in good agreement with the observed time of occurrence of the signal maximum after the ground sunset.

1366. ON THE ATMOSPHERIC ABSORPTION IN THE ULTRA-VIOLET [in Connection with the Determination of the Optical Thickness of the Atmospheric Ozone in Various Parts of the Spectrum].—A. Vassy. (*Ann. de Physique*, July/Sept. 1941, Vol. 16, p. 145 onwards.)

For recent *Comptes Rendus* Notes see 633 & 640 of 1942. In the present very long report the writer investigates the course of the relative absorption-coefficients by spectrographic-photometric methods, taking as her basis the values of absorption in the Huggins bands (3000–3300 AU) given by Ny Tsi Zé. The ozone absorption-coefficients between 4380 and 7585 and between 2020 and 2170 AU are determined, and the values of absorption in the ground layers of the air measured between 1898 and 4260 AU. Regions of transparency and absorption bands of ozone and oxygen are obtained: the transparency values are higher than those given by Götz and Maier-Leibnitz. The paper ends with a calculation of the atmospheric transparency for extra-terrestrial sources, and of the penetration depth of sunlight of wavelengths below 3000 AU.

1367. ATMOSPHERIC ABSORPTION AND THE λ^{-4} LAW [Rejection of Duclaux' Conclusion, from Müller & Kron's Tenerife Measurements, that Rayleigh's Dispersion Law is replaced by a λ^{-3} Law: λ^{-4} Law confirmed by These Same Measurements and by Smithsonian Institution Results].—J. Dufay. (*Journ. de Phys. et le Radium*, Series 8, No. 7, Vol. 1, 1940, p. 251 onwards.)

1368. PRELIMINARY RESULTS OF OBSERVATIONS MADE DURING THE TOTAL ECLIPSE OF THE SUN ON SEPTEMBER 21st, 1941.—B. G. Fessenkov. (*Journ. of Phys.* [of USSR], No. 1/2, Vol. 6, 1942, pp. 1–5: in English.)

"Contrary to expectations it was found, however, that the aurora circles . . . were very weak. This weak development . . . is a characteristic peculiarity of the 1941 eclipse and needs interpreting." Photographs make it clear "that the chromosphere in the equatorial regions of the sun extends to great heights and is much brighter than at the poles". The 1941 corona shows a "lack of symmetry between the two sides of the equator, and in this it differs sharply from the typical look of the corona when the sunspots are at a minimum". On 16th September an "unusual group of spots passed through the centre of the sun's disc. On 18th September at 6.30, when night had already long fallen at Alma-Ata, bright aurora polaris suddenly broke across the sky . . . At 6.40 the phenomenon had almost disappeared. At about 9 there was a renewal of the phenomenon but less intense. We noticed a third flare-up at about 11. The next day the usual morning radio broadcast on the short wave was completely upset. It is interesting to notice that this strong disturbance,

obviously connected with the above-mentioned group of sunspots, influenced the luminosity of the night sky for several days", increasing it from the normal value between 1 and 1.5 millistilbs to 2.3 millistilbs immediately after the ionospheric disturbance and then during the following nights letting it drop slowly to its normal value by about 25th September. It is difficult to say definitely whether this sunspot group also influenced the corona, but "it is of interest that the chaotic disturbances in the equatorial regions of the corona were on the same side of the equator as this group of spots, which at the moment of the eclipse almost reached the edge of the disc . . .". Very good corona photographs were taken, and the Abas-Tuman expedition obtained excellent material for determining the degree of polarisation in different spectral rays: radiometric measurements showed (in agreement with Nikonov) that "in the infra-red rays in the region about 1–2 there is a noticeable excess of radiation".

1369. THE SYSTEMATIC MOVEMENT OF SUNSPOTS IN HELIOGRAPHIC LATITUDES [Statistical Investigation of Greenwich Photographic Results, Recurring Groups only].—J. Tuominen. (*Physik. Berichte*, 1st Sept. 1942, Vol. 23, No. 17, p. 1676: summary of Finnish paper.)

Leading to the "law" that sunspots have a general flow, those between the parallels $\pm 16^\circ$ moving towards the equator, while those outside this region move towards the poles. The speed of these last seems to be the greater, the further they are from the equator.

1370. ON THE NATURE OF THE FACULAE ON THE SOLAR DISC: II—PHOTOMETRY OF THE REGIONS OF FACULAE.—P. ten Bruggencate. (*Physik. Berichte*, 1st Aug. 1942, Vol. 23, No. 15, p. 1531: summary from *Zeitschr. f. Astrophys.*, No. 3, Vol. 21, 1942, p. 162 onwards.) For previous work see 998 of April.

1371. TENTATIVE THEORY OF SOLAR PROMINENCES.—H. Alfvén. (*Arkiv för Mat., Astron., och Fysik* [Stockholm], No. 20, Vol. 27A, 1941.)

For other recent work by the same writer see 3501 & 3504 of 1942 and 13 of January. In the present paper he explains the solar prominences on the hypothesis that the sun is to be regarded as a good electrical conductor up to a definite limiting layer, beyond which it must be looked upon as a vacuum where only free electrons or ions with long free paths can transport energy. In that case, electrical potential differences can be produced only through movements in a magnetic field. In the outer region an electric current, in the presence of magnetic fields, can flow practically only along the magnetic lines of force. For an eddy motion about a magnetic pole (*i.e.* a sunspot) such a mechanism, on plausible assumptions of values, would yield on the sun's surface potential differences of the order of 10^7 volts, which would draw after themselves, in the outer space, discharges along the magnetic lines of force. The calculated field lines show a similarity to the path curves of the prominences.

1372. RELATION OF THE COSMIC RADIATION TO GEOMAGNETIC AND HELIOPHYSICAL ACTIVITIES.—J. W. Broxon. (*Phys. Review*, 1st/15th Dec. 1942, Vol. 62, No. 11/12, pp. 508-522.)
1373. ON THE THEORY OF COSMIC-RAY SHOWERS [Further Contributions to the Fluctuation Problem].—W. T. Scott & G. E. Uhlenbeck. (*Phys. Review*, 1st/15th Dec. 1942, Vol. 62, No. 11/12, pp. 497-508.)
1374. AN EXCEPTIONAL INCREASE OF COSMIC RAYS? [in mid-August, 1942].—A. Duperier. (*Nature*, 13th March 1943, Vol. 151, pp. 308 and 309.) For previous work see 2279 of 1942.
1375. PROPAGATION METHODS OF RADIO PROSPECTING: B—ABOVE-GROUND METHODS [including Those of Grosskopf & Vogt and of Burstyn].—V. Fritsch. (*Arch. f. Tech. Messen*, June 1941, Part 120, V65-21, Sheets T80-8i.)
1376. ATMOSPHERIC VERTICAL MOVEMENTS.—M. Robitzsch. (*Meteorol. Zeitschr.*, No. 2, Vol. 59, 1942, p. 52 onwards.) For a long summary see: *Physik. Berichte*, 15th Aug. 1942, Vol. 23, No. 16, pp. 1604-1605.
1377. DETERMINATION OF THE NUMBER OF DROPS PER UNIT VOLUME AND THE RELATIVE HUMIDITY IN CLOUDS [95% in Stable Clouds, sometimes sinking to 75% in Unstable Clouds, but reaching Saturation in Clouds with Big Drops of Radius greater than 8μ].—J. Bricard. (*Comptes Rendus* [Paris], No. 9, Vol. 214, 1942, p. 439 onwards.) For a summary see *Physik. Berichte*, 15th Aug. 1942, Vol. 23, No. 16, p. 1608.
1378. "EINFÜHRUNG IN DIE GROSSWETTERFORSCHUNG" [Second & Improved Edition: Book Review].—F. Baur. (*Zeitschr. f. tech. Phys.*, No. 9, Vol. 23, 1942, p. 243.) For reference to Baur's methods see 1897 of 1942.
- ATMOSPHERICS AND ATMOSPHERIC ELECTRICITY**
1379. ON THE OBSERVED MAXIMA IN NUMBER AND FIELD STRENGTH OF DISTANT ATMOSPHERICS DURING SUNRISE AND SUNSET PERIODS.—S. R. Khastgir. (*Sci. & Culture* [Calcutta], Nov. 1942, Vol. 8, No. 5, pp. 233-235.)
- A general explanation is given of the observed maxima in number and field strength of the distant atmospherics before the ground sunrise and after the ground sunset in terms of the changes in the ionospheric conditions during the transition time from day to night or *vice versa*. "It is now well known that the E-layer ionisation gradually falls during the night and attains a minimum value in the small hours of the morning. The ionisation then begins to increase and the increase is rather rapid during the sunrise period. Before the ionisation minimum is attained, it is evident there is a gradual decrease in attenuation due to gradually diminishing collision frequency in the layer, causing thereby a gradual increase in the intensity of the down-coming waves, until there is a peak when the E-layer ionisation is minimum. After the ionisation minimum, the ionisation rapidly increases during the sunrise period. This would cause a large fall in the intensity of the down-coming waves due to two causes, *viz.*, (1) higher attenuation due to larger collision frequency in the layer, and (2) larger deviation of the rays due to higher electron density. A maximum is therefore expected during the sunrise period. Before the sunset time, too, it is known that there is a gradual decrease in the E-layer ionisation. Thus there would be a gradual rise in the intensity of the down-coming waves due to a continuous fall in ionospheric absorption or attenuation. At the sunset time when the ionising solar rays are suddenly withdrawn, there would be a sudden and a perceptible decrease in electron density of the layer, so that the down-coming waves originally coming from the distant source of atmospherics would be much less deviated and would necessarily fail to reach the receiving point. At this point of the withdrawal of the ionising solar rays, the intensity would therefore fall in spite of small attenuation. Subsequently, however, the gradually decreasing attenuation would assert itself and the intensity would increase. This explains the sunset maximum." See also 1365, above.
1380. THE ACTION OF LIGHTNING CURRENTS OF LONG DURATION ON LIGHTNING PROTECTORS OF THE VARIABLE-RESISTANCE TYPE [Theoretical Treatment leading to Approximate Formulae: Importance of Thermal Capacity: etc.].—S. Szpor. (*Bull. Assoc. suisse des Elec.*, 13th Jan. 1943, Vol. 34, No. 1, pp. 15-21: in French.)
1381. "MECHANISM OF THE ELECTRIC SPARK" [Book Review].—L. B. Loeb & T. M. Meek. (*Nature*, 13th Feb. 1943, Vol. 151, No. 3824, p. 178.) Referred to in 968 of 1942.
1382. WAITING FOR LIGHTNING [Measurements of Crest Value of Lightning Current entering Buried Telephone Cables: Steepness of Wave Front: Quantity of Electricity in Lightning Surge and Crest Voltage across Insulation of Buried Cable Conductors].—T. J. Mahoney. (*Bell Lab. Record*, Dec. 1942, Vol. 21, No. 4, pp. 86-90.)
1383. LOCATION OF THUNDERSTORMS BY RADIO METHODS [Atmospherics associated with Lightning Strokes to Ground: Lightning Strokes as Cause of Breakdown of Overhead Power Lines: Warning obtained of Approaching Thunderstorms].—J. S. Forrest. (*Nature*, 6th March 1943, Vol. 151, pp. 285-286: summary only.)
1384. METEOROLOGICAL PHENOMENA ON THE OCEAN, AND THE EARTH'S ELECTRIC FIELD [Estimate of Influence of "Waterfall" Electricity at Surface of Sea (due to Winds and especially Cyclones) on the Atmospheric-Electric Field: contributes to Space Charge of Air Layers next to Surface, &

to Ionisation: Possible Importance in Maintenance of Earth's Negative Charge].—G. Aliverti & G. Lovera. (*Physik. Berichte*, 15th Aug. 1942, Vol. 23, No. 16, p. 1599.)

PROPERTIES OF CIRCUITS

1385. AMPLIFIER PROBLEMS [Investigation of Noise Level due to Thermal Motion of Electrons: Amplification of Wide Frequency Bands with Resistance-Coupled & Carrier-Frequency Amplifiers].—E. Baldinger. (*Bull. Assoc. suisse des Elec.*, 3rd June 1942, Vol. 33, No. 11, p. 310 onwards: in German.)
1386. "RADIO RECEIVER DESIGN: PART I—RADIO-FREQUENCY AMPLIFICATION AND DETECTION" [Book Review].—Sturley. (*See* 1409.)
1387. AMPLIFICATION OF DIRECT VOLTAGES WITH A HIGH-FREQUENCY PUSH-PULL CIRCUIT [for the Measurement of Small Voltages].—F. Kerkhof. (*Zeitschr. f. tech. Phys.*, No. 10, Vol. 23, 1942, pp. 267–269.)

In a previous paper (2982 of 1942) the writer described a method of avoiding the various disadvantages of resistance-coupled amplifiers for d.c. voltages, by conversion of the latter into audio-frequency voltages with the help of a push-pull mixing stage. The present note describes how a similar arrangement can be used with the addition of a special compensating method, for a h.f. carrier (actually 1000 kc/s) in place of the 310 c/s carrier previously employed. This a.f. carrier had the advantage that the output indicating instrument could take the form of a loudspeaker or simple a.c. meter, without any need for rectification. It had also, however, the objection that any unwanted harmonic components were very difficult to compensate. Filtering by h.f. resonant circuits is much easier, and above all the use of higher frequencies makes the harmonics fundamentally more easy to suppress (as a simple consideration of the logarithmic decrement will show) provided that the ratio of inductance to ohmic resistance in the coil is maintained constant.

Circuits were developed for valves of the A series and of the E series: the one here illustrated and discussed uses two AK2 octodes and an AF7 pentode. By using octodes or multiple valves in the push-pull stage the need for a separate oscillator is avoided: the oscillator is obtained by joining the grids G_1 and G_2 of the two pentodes: its frequency is about 1000 kc/s, with an amplitude of 8 v_{eff}. The d.c. voltage to be measured is applied between the two control grids G_4 at E_1 and E_2 . The resistances between these points can be of such a value that (as an alternative) an input stage can be formed from an electrometer valve T113 with grid resistance up to 10^{10} ohms: in this case the anode of the T113 is connected to E_1 , the space-charge grid to E_2 , and the necessary working voltage is provided for the electrometer valve by introducing a larger cathode resistance in the push-pull stage. The anodes of the octodes are linked by a push-pull resonance transformer with the same number of turns in the two primaries and the

secondary, all the windings being wound to have as little capacitance as possible. The secondary is connected to an AF7 amplifying stage to which a cathode-ray oscillograph or a rectifying stage can be connected through a simple resonance transformer. All supplies can be derived from a stabilised mains unit. The d.c. voltages for the grids G_2 , G_{3+5} of the two push-pull valves are provided by an ordinary voltage-dividing circuit with bridging condensers: for the amplifying AF7 a "sliding" screen-grid voltage U_{G_2} is supplied, but the well-known circuits for this purpose are omitted from the diagram for simplicity's sake.

However carefully the circuit was designed, it was found that with the desired compensation to (at the least) 5×10^{-5} v certain balancing difficulties presented themselves in the mixing stage, due principally to capacitive retroaction of the h.f.-carrying anode leads onto the control grids G_1 of the oscillator system. A convenient compensation was finally obtained by taking off a small h.f. voltage from the push-pull transformer by means of an additional winding of 3 turns only, and applying it to G_1 , its fine adjustment being carried out by a voltage-dividing circuit with a trimmer condenser T and a rotating condenser C , in series with the three turns. By this means the high-frequency bridge shown can be balanced much more easily than the previous a.f. type, down to a residual voltage corresponding to an input voltage-difference of about 5×10^{-5} v. The amplification of the two stages shown in Fig. 1 is then about 2×10^4 , given by the ratio of the effective h.f. voltage appearing at A (terminal of the secondary of the output transformer of the amplifier AF7) to the d.c. voltage change between E_1 and E_2 . To prevent the appearance of h.f. voltages which would upset the balance and which readily occur from unavoidable capacitive couplings between circuit components (carrying large h.f. voltages) and sensitive grids, care must be taken to build the apparatus very rigidly so that, for instance, capacities between leads are very constant. On this depends the constancy of the zero point in the presence of vibration, and the difficulty is one disadvantage of the apparatus in comparison with the a.f. bridge previously described.

1388. COMPARISON OF VOLTAGE- AND CURRENT-FEEDBACK AMPLIFIERS.—E. H. Schulz. (*Proc. I.R.E.*, Jan. 1943, Vol. 31, No. 1, pp. 25–28.)

Author's summary:—"This paper points out the differences between an amplifier with voltage feedback and one with current feedback. The effect of variations of amplifier constants on output voltage and current is decreased by either type of negative feedback. Voltage feedback decreases the effect of load impedance on output voltage, and current feedback decreases the effect of load impedance on load current. Voltage feedback increases the damping of a loudspeaker and improves its response. A table is also given to assist in the choice of type and amount of feedback to be used in a given application."

1389. RESEARCH ON A DOUBLE-VALVE-RECTIFICATION SYSTEM: THE OPERATING CURRENT AS A FUNCTION OF THE TIME, MEAN VALUES OF CURRENT, AND THE WAVINESS [Analysis of

Circuit for Supply of Direct Current from A.C. Mains, for Relays, etc.].—C. Weisglass. (*Physik. Berichte*, 15th Aug. 1942, Vol. 23, No. 16, pp. 1568-1569: summary of an Istanbul University paper.)

1390. IMPEDANCE OF SOME SIMPLE ELECTRICAL CIRCUITS [with Reference Sheets to aid in Analysis of More Complicated Circuits].—B. Dudley. (*Electronics*, Dec. 1942, Vol. 15, No. 12, pp. 75-77.)

1391. THE MUTUAL INDUCTANCE OF COAXIAL CIRCULAR RINGS IN THE PRESENCE OF A PERMEABLE CORE.—H. Buchholz. (*Zeitschr. f. tech. Phys.*, No. 9, Vol. 23, 1942, pp. 221-234.)

The mutual inductance of parallel and coaxial rings has hitherto been calculated always on the assumption that the rings were in a homogeneous medium incapable of magnetic polarisation: the coefficient of mutual inductance is then dependent only on the radii of the rings and their spacing. But if a coaxial permeable core is present, the magnetic coupling of the rings is also a function of the core diameter and of the magnetic properties of the core material, and the question arises to what extent the mutual inductance in such a case varies linearly with the core permeability, and how the various dimensions of the arrangement influence the deviations from the linear law. The analytical treatment of this problem is very difficult, at any rate as regards the numerical working out, and it is advisable not to tackle it directly for the case of a single pair of rings, but to approach it by way of the much more convenient solution for a number of current rings equally spaced along an infinitely long permeable core of circular cross-section. Further, the mathematical treatment of the permeability of magnetisable materials is complicated as a rule by the variation of the permeability with field strength, according to a law which is too complicated to adapt itself to calculation. These complications are avoided in the present work by the assumption that the core is of some modern compressed-powder or other material for which the dependence of permeability on field strength is greatly reduced.

Author's summary:—"The question investigated is the magnetic coupling of coaxial current rings in the presence of a common permeable core of circular cross section. The basic problem consists in the calculation of the magnetic field of a single ring in the presence of such a core. This fundamental solution is then extended step by step. It is first adapted to the case where the exciting current ring is a ribbon-shaped conductor, and the final case considered is that where a large number of equidistant current rings of quasi-linear or ribbon construction excite the field. In the limiting case of an infinite number of such rings, the field becomes a strictly periodic structure and at the same time lends itself most readily to calculation. For the magnetic coupling between such an infinite system of current rings and a single external current ring a formula is obtained [eqn. 4.6, p. 232] which is suitable for numerical calculation. Among other things it shows under what

external conditions a large deviation from the linear law of increase of coupling with permeability can occur."

1392. REMARK ON THE INVESTIGATION BY H. STEYSKAL, BERLIN, ON "A SPECIAL TYPE OF CONCENTRIC LINE AS ULTRA-SHORT-WAVE RESONATOR," and A SUPPLEMENT TO THE ABOVE REMARK.—F. Borgnis: H. Steyskal. (*Zeitschr. f. tech. Phys.*, No. 9, Vol. 23, 1942, pp. 240-241: p. 241.)

Steyskal's paper (2969 of 1942) deals with a finite length of concentric-tube conductor open at both ends and provided with a radial conducting joining-wall. The oscillation mode considered is one which shows no electric field in the axial direction (magnetic type) and whose field components are independent of the z -coordinate. "The present note gives some remarks on the oscillation modes possible in such a resonator, which should be of interest as an extension of Steyskal's work." The case in point is similar to that of the static magnetic field of a cylindrical coil: for an infinitely long coil the inside field may be considered as uniform and can be calculated easily, but for a finite length of coil the H lines are closed in open space, and the distortion of the internal field is more and more marked the shorter the coil. Similarly, in the case considered the H lines will be closed in the external space: this involves a definite participation by the latter in the oscillation régime. Apart from the radiative damping, this will bring with it an alteration to the resonance wavelength. Steyskal's equations 20 & 22 show that in certain cases the resonator can be regarded as a Lecher system, short-circuited at both ends and bent into a circle, with a mean length $(r_1 + r_2)\pi = m \cdot \lambda/2$: in this case the equation for the resonance wavelength is directly interpretable on physical lines. In other cases however (small values of l/λ and large values of $p = r_2/r_1$) large deviations from the theoretical resonance wavelength must be expected. Investigation to find a mode of oscillation possible for the short resonator under consideration, such that no serious participation by the external space can occur, leads to the conclusion that only an electric type of wave can fulfil the conditions: the natural wavelength of the fundamental is found to be

$$\lambda = 2\sqrt{\{1/(p-1)r_1\}^2 + (l/\lambda)^2},$$

or, when l is large, $\lambda/2 \approx (r_2 - r_1)$. This oscillation régime is the only one for the system in question in which the oscillation is practically concentrated in the interior of the resonator: small edge distortions are naturally to be expected, of the same order of magnitude as in a concentric open $n \cdot \lambda/2$ Lecher system."

Steyskal supplements this note by some practical data regarding the magnitude of the effects due to the participation by the external space pointed out by Borgnis. For four different experimental models, with air filling for both the internal and external spaces, the departure $\Delta\lambda$ of the observed resonance wavelength from the values given by formulae 19 or 20 of Steyskal's paper was less than 1% for $l/\lambda = 0.36$ and 0.32 , and about 2% for $l/\lambda = 0.074$ and 0.064 (p being 1.5 in all cases). Hence if the ratio l/λ is not too small the effect of

the external space may be neglected without appreciable loss of accuracy.

1393. THE NATURAL ELECTROMAGNETIC OSCILLATIONS OF CAVITIES.—M. Jouguet. (*Rev. Gén. de l'Elec.*, June 1942, Vol. 51, No. 6, p. 318 onwards.)

1394. RADIO DATA CHARTS: 5 ["Q" of Quarter-Wavelength Resonant Line].—J. McG. Sowerby. (*Wireless World*, March 1943, Vol. 49, No. 3, pp. 72-74.)

1395. THE CAPACITY EFFECTS IN SOLENOIDS [and the Calculation of the Self-Capacitance by a New Formula].—A. C. Lopez. (*Formacion y Documentacion profesional* [Madrid], July/Aug. 1942, Vol. 1, No. 4, pp. 404-408.)

Breit's simple formula $C_0 = 0.44R$ is not satisfactory in practice, and Palermo attributes this fact to the neglect of two fundamental quantities, the wire diameter d and the spacing between turns, S . He obtains for the capacitance between two turns the expression $C_0 = \pi D / 3.6 \cosh^{-1} S/d$ pF, and argues that as the coil contains N turns, the coil capacitance must be N times larger, but that as the potential between turns is $1/N$ of the total, the coil capacitance is equal to that of one complete turn. Sacco (2119 of 1941) starts from the same hypothesis that the only effect to be considered is that of the capacitance between adjacent turns, but differs from Palermo by concluding that the capacitance C_s of the whole solenoid is $(n-1)/n^2$ times the capacitance C_0 of one turn.

The present writer's treatment, to decide whether the factor by which Palermo's single-turn expression must be multiplied to give the capacitance for the whole coil is the unity of Palermo, the $(n-1)/n^2$ of Sacco, or some other value, leads to the result that for $S/d = 2$, for instance, the following values apply to this factor for coils of 2, 3, 5, and 7 turns respectively (Sacco's corresponding values are given in brackets):—0.25 (0.25), 0.30 (0.22), 0.33 (0.16), and 0.34 (0.12). Thus for a seven-turn coil the self-capacitance (for $S/d = 2$, as before) would be $0.34 \times D / 3.6 \cosh^{-1} S/d = 0.44R$, thus agreeing with Breit's simple formula in this particular case. Among the various references listed at the end of his paper is the Hamburger-Miller article dealt with in 820 of 1941, where the failure of the Palermo formula as applied to thick-wire coils for ultra-high frequencies is mentioned.

1396. THE INFLUENCE OF LOSSES ON THE PROPERTIES OF ELECTRICAL NETWORKS [Treatment, by Two Methods, of Low-Pass Filters of Basic & Transformed Types and Band-Pass Filter of Basic Type].—J. H. Schouten & J. W. Klüte. (*Philips Tech. Rundschau*, May 1942, Vol. 7, No. 5, p. 138 onwards.)

1397. PERFORMANCE CURVES FOR m -DERIVED FILTERS.—W. J. Cunningham. (*Journ. Applied Phys.*, Dec. 1942, Vol. 13, No. 12, pp. 768-772.)

Author's summary:—"For a composite filter made up of several m -derived sections, the greatest discrimination will be obtained if the values of the design parameter m for the various parts of the filter are chosen so that successive minima of inser-

tion loss in the attenuation band are all the same. Many different low-pass structures were set up and adjusted experimentally to show this type of performance. The necessary values of m and the resulting discrimination for each network have been plotted on curves, which give information about the sharpness of cut-off. These curves are useful for the most economical design of low-pass, or high-pass, composite filters to meet definite requirements."

1398. A BRIDGING FILTER FOR OPEN-WIRE LINES.—E. A. Schramm. (*Bell Lab. Record*, Dec. 1942, Vol. 21, No. 4, pp. 93-96.)

1399. FILTERS FOR CARRIER-FREQUENCY TELEPHONE SYSTEMS [and the Spectral Distribution of Speech Intensities, Microphone Sensitivity, Distribution of Attenuation between the Various Filters, Practical Filter Design, etc.].—T. J. Weijers. (*Philips Tech. Rundschau*, April 1942, Vol. 7, No. 4, p. 104 onwards.)

1400. TRANSITRON OSCILLATORS [Wide Range and High-Frequency Stability with Untapped Coils].—A. G. Chambers. (*Wireless World*, March 1943, Vol. 49, No. 3, pp. 86-87.) For other papers on the "transitron" oscillator see, for example, 3557/8 of 1942.

1401. SOME USEFUL CIRCUITS EMPLOYING THYRATONS AND IGNITRONS.—A. J. Maddock. (*Journ. of Scient. Instr.*, March 1943, Vol. 20, No. 3, pp. 37-46.)

Circuits are described for several typical examples of applications. These are:—(1) relays for amplification of power as in temperature control, counting of physical phenomena, etc.; (2) instantaneous switches for control of power as in pulse generators, cathode-ray tube time bases, etc.; (3) current and voltage regulators; (4) commutating devices.

TRANSMISSION

1402. THE "TRAFFIC COP" TRANSMITTER [Compact and Economical 200-Watt Transmitter].—P. J. Palmer. (*QST*, Jan. 1943, Vol. 27, No. 1, pp. 38-41 and 90, 92.)

1403. A FREQUENCY-MODULATED RESISTANCE-CAPACITANCE OSCILLATOR [Alternative Method to Armstrong & Reactance-Tube Methods, giving Wide Frequency Deviation directly].—C. K. Chang. (*Proc. I.R.E.*, Jan. 1943, Vol. 31, No. 1, pp. 22-25.) A resistance element in an R - C -tuned oscillator is replaced by the output resistance of a variable- μ valve.

1404. COUPLED RESONANT CIRCUITS FOR TRANSMITTERS [Design of Interstage Coupling Units].—N. I. Korman. (*Proc. I.R.E.*, Jan. 1943, Vol. 31, No. 1, pp. 28-35.)

1405. AMPLITUDE MODULATION UP TO DATE [Improving the Efficiency of Low-Powered R.T. Transmitters].—O. J. Russell. (*Wireless World*, March 1943, Vol. 49, No. 3, pp. 64-67.)

1406. FREQUENCY MODULATION: III [Interference Suppression, the Limiter, and the Capture Effect].—C. Tibbs. (*Wireless World*, March 1943, Vol. 49, No. 3, pp. 82-85.)
1407. BACK-HEATING OF MAGNETRON FILAMENT BY IONS OR OUT-OF-PHASE ELECTRONS COUNTERED BY CURRENT LIMITER, SUCH AS DISCHARGE TUBE WITH TUNGSTEN CATHODE OR SPACE-CHARGE GRID, IN ANODE D.C. SUPPLY CIRCUIT.—F. Hülster. (*Hochf.tech. u. Elek.akus.*, Nov. 1942, Vol. 60, No. 5, pp. 144-145.) Telefunken patent, D.R.P. 720 620.
1408. FACTORS DETERMINING THE INTENSITY OF OSCILLATIONS IN THE PLASMA OF GASEOUS DISCHARGE.—A. A. Sluzkin & A. P. Maydanov. (*Journ. of Phys.* [of USSR], 1942, Vol. 6, No. 1/2, pp. 7-14: in English.)
Authors' summary:—(1) The effect of the shape of electrodes upon the intensity of oscillations occurring in the plasma of a gaseous discharge has been studied. It is shown that the maximum intensity is obtained with a cylindrical anode and a cathode in the form of a straight-line filament placed along the axis of the anode. (2) The effect of the anode current, anode voltage, and pressure upon the intensity of the oscillations was studied. The existence of optimum waves giving maximum intensity of oscillations is shown. (3) The dependence of the optimum wavelength is shown to be proportional to the anode diameter. (4) Certain considerations concerning the possible mechanism of self-excitation of oscillations in the plasma are suggested.

RECEPTION

1409. "RADIO RECEIVER DESIGN: PART I—RADIO-FREQUENCY AMPLIFICATION AND DETECTION" [Book Review].—K. R. Sturley. (*Electrician*, 26th Feb. 1943, Vol. 130, No. 3378, p. 220.) A detailed study of the theoretical and practical bases.
1410. A SIMPLE BAND-SPREAD METHOD FOR SHORT-WAVE RECEPTION [Use of Usual Tuning Condenser with Added Series & Parallel Fixed Condensers: Simple Mechanical Construction, No. Additional Knob, Specially Low Noise Level, & Absence of Acoustic Retroaction].—C. J. van Loon. (*Philips Tech. Rundschau*, No. 9, Vol. 6, 1941, p. 269 onwards.)
1411. METHOD FOR THE DEMODULATION OF FREQUENCY-MODULATED OSCILLATIONS [Circuit embodying Push-Pull Connection of Two Gas- or Vapour-Filled Valves controlled by a "Commutating" Condenser which Extinguishes One Valve when the Other Ignites].—G. R. Clark. (*Hochf.tech. u. Elek.akus.*, Nov. 1942, Vol. 60, No. 5, p. 146.) A.E.G. patent, D.R.P. 720 781.
1412. FREQUENCY MODULATION: III [Interference Suppression, the Limiter, and the Capture Effect].—C. Tibbs. (*Wireless World*, March 1943, Vol. 49, No. 3, pp. 82-85.)
1413. CORRECTIONS TO "DIODE AS A FREQUENCY CHANGER" [1080 of April].—Colebrook & Aston. (*Wireless Engineer*, March 1943, Vol. 20, No. 234, p. 126.)

AERIALS AND AERIAL SYSTEMS

1414. THE RADIATION FIELD OF A VERTICAL TRANSMITTING DIPOLE OVER STRATIFIED GROUND.—Grosskopf. (See 1361.)
1415. "RHOMBIC ANTENNA DESIGN" [Book Review].—A. E. Harper. (*Proc. I.R.E.*, Jan. 1943, Vol. 31, No. 1, p. 43.)
1416. CORRECTIONS TO "THEORY OF ANTENNAS OF ARBITRARY SIZE AND SHAPE."—S. A. Schelkunoff. (*Proc. I.R.E.*, Jan. 1943, Vol. 31, No. 1, p. 38.) See 1049 of 1942.
1417. AIRCRAFT ANTENNA CHARACTERISTICS [with Charts for Reactance & Radiation-Resistance Estimation (e.g. for Design of Dummy Aerial)].—P. J. Holmes. (*Electronics*, Dec. 1942, Vol. 15, No. 12, pp. 46-48.)

VALVES AND THERMIONICS

1418. RADIO VALVES [Notice of the Issue of a "War Emergency British Standard Code of Practice relating to the Use of Radio Valves in Equipment"].—(*Electrician*, 26th Feb. 1943, Vol. 130, No. 3378, p. 230.)
1419. [ULTRA-] "HIGH-FREQUENCY THERMIONIC TUBES" [Book Review].—A. F. Harvey. (*Electrician*, 26th Feb. 1943, Vol. 130, No. 3378, p. 220.)
1420. THE STANDARDISATION OF BROADCAST RECEIVING VALVES [American & European Classifications].—M. Adam. (*Formacion y Documentacion profesional* [Madrid], May/June 1942, Vol. 1, No. 3, pp. 308-309: summary, from *Génie Civil*, 12th/19th April 1941.)
1421. NEW TUBE TYPES [Characteristics of a Cathode-Ray Tube, a Pentode, a Twin Triode, and a Full-Wave Rectifier].—(*Radio* [New York], Dec. 1942, No. 275, pp. 20-21.)
1422. ULTRA-SHORT-WAVE TRANSMITTING VALVE WITH CENTRE-FED FILAMENT, GRID, AND ANODE EACH BUILT AS AN OPEN DIPOLE.—H. E. Hollmann. (*Hochf.tech. u. Elek.akus.*, Nov. 1942, Vol. 60, No. 5, p. 144.) D.R.P. 720 303.
1423. ELECTRON-TUBE TERMINOLOGY [First Published Record of Word "Electron" (Stoney, 1891): Its Use as an Adjective, and Occasions where "Electronic" should be employed: "Electronics" & Its Use: Early Tube Names: Suggestions for Proper Naming, including the Westinghouse-General Electric Agreement].—W. C. White. (*Electronics*, Dec. 1942, Vol. 15, No. 12, pp. 42-45 and 154.)

1424. ULTRA-HIGH-FREQUENCY MAGNETRON OSCILLATORS [Brief Account of Types of Magnetrons].—E. M. Noll. (*Radio* [New York], Dec. 1942, No. 275, pp. 12-13.)
1425. PHYSICAL ASPECT OF THE PRINCIPAL LIMITS TO THE FUNCTIONING OF CONVENTIONAL VALVES AT ULTRA-HIGH FREQUENCIES [13-Page Survey].—R. Warnecke. (*Rev. Gén. de l'Élec.*, April 1941, p. 231 onwards.)
1426. THORIUM DETECTOR [which automatically Sorts Filament Wire to determine whether It is made of Pure Tungsten or contains Thorium: Arc & Spectroscope Combination].—Westinghouse Company. (*Electronics*, Dec. 1942, Vol. 15, No. 12, p. 82.) Cf. 786 of March.
1427. SHOT EFFECT IN SPACE-CHARGE-LIMITED DIODES [Discussion of Space-Charge Reduction of Shot Effect in Planar Diodes].—M. Surdin. (*Wireless Engineer*, March 1943, Vol. 20, No. 234, pp. 127-130.) For a letter on the effect in temperature-limited diodes see 2420 of 1941.
1428. GRAPHICAL DETERMINATION OF POWER-AMPLIFIER PERFORMANCE [Complete Performance of Class B & C Power-Amplifiers obtained Quickly from Static Characteristics by use of Plastic Calculating Device].—R. I. Sarbacher. (*Electronics*, Dec. 1942, Vol. 15, No. 12, pp. 52-56 and 158.)
1429. SECONDARY ELECTRON EMISSION FROM METALS WITH A LOW WORK FUNCTION [Experiments to clear up Contradictory Views on the Small Output].—H. Bruining. (*Physica*, No. 10, Vol. 8, 1941, p. 1161 onwards.)

Measurements were made on compact aluminium and beryllium plates whose oxide skins were removed by sputtering. The removal diminished the s.e. output considerably. In the case of aluminium the output curve of the oxide-free film was identical with that of a film deposited by vaporisation. With beryllium the oxide skin could not be removed completely, and the emission was therefore rather higher than that of a vaporised layer.

1430. VELOCITY-MODULATION CURRENTS [in Mathematical Treatment of Bunching in Klystron].—D. L. Webster. (*Journ. Applied Phys.*, Dec. 1942, Vol. 13, No. 112, pp. 786-787; letter expanding part of paper dealt with in 3950 of 1939.)

DIRECTIONAL WIRELESS

1431. ELIMINATION OF QUADRANTAL ERROR IN LOOP-AERIAL DIRECTION FINDERS MOUNTED IN SWAYING VEHICLES.—F. Stein & E. Marre. (*Hochf.tech. u. Elek.akus.*, Nov. 1942, Vol. 60, No. 5, p. 146.)

Telefunken patent, D.R.P. 720 746. To compensate for re-radiation effects, the axis of rotation of a frame aerial may be so inclined to the polarisation direction of the incoming waves that the

resulting decrease in sensitivity just counteracts the field-strength increase due to the re-radiation. To make this plan still serve in the case of swaying vehicles, it is proposed to fit (at the back of the vehicle) two frames R_1 and R_2 rotated by a common drive, connected in series or parallel to the receiver, and inclined in opposite sense to the direction of polarisation at an angle $\gamma = 2 \arctan \sqrt{\sin f_{\max}}$, where f_{\max} is the maximum value of the quadrantal error.

1432. METHOD FOR THE RECEPTION OF PERIODIC IMPULSES [in Pulse Direction Finding].—G. Ulbricht. (*Hochf.tech. u. Elek.akus.*, Nov. 1942, Vol. 60, No. 5, p. 148.)

Telefunken patent, D.R.P. 720 842. In order to separate the ground and space waves, the transmitter sends out oscillations which when briefly interrupted renew themselves in correct phase: they are, in fact, coherent. The receiver picks out the coherent oscillations carried by the ground wave, in preference to the incoherent space-wave oscillations, because the beat frequency produced by heterodyning gives only for the coherent ground-wave impulse a difference between beat and impulse frequencies which can be separated out by filtering. See also 720 of 1942.

1433. ARRANGEMENT FOR THE DETECTION OF AN OBJECT MOVING IN AN ELECTROMAGNETIC RADIATION FIELD.—E. Gerhard. (*Hochf.tech. u. Elek.akus.*, Nov. 1942, Vol. 60, No. 5, p. 147.)

Telefunken patent, D.R.P. 720 352. Part of the energy from the unmodulated transmitter "1" (Fig. 15) arrives at the receiver "3" after reflection at the object "2," by the path 5-6: another part arrives directly by the path 8-9, which includes the re-radiator "10" modulated by a modulator "7," and produces interference at the receiver. By this method of modulation with an easily amplified frequency, small frequency fluctuations at the transmitter are rendered harmless and the full energy of the main beam 5 can be utilised.

1434. DIRECTION-FINDING SYSTEM USING A CAPACITIVE GONIOMETER AND A CATHODE-RAY OSCILLOGRAPH.—W. Hasselbeck. (*Hochf.tech. u. Elek.akus.*, Nov. 1942, Vol. 60, No. 5, p. 148.) Telefunken patent, D.R.P. 729 855.

1435. AERIAL AND FEEDER SYSTEMS FOR THE PRODUCTION OF LANDING BEAMS [C. Lorenz Patents].—J. Goldmann: R. von Ottenthal. (*Hochf.tech. u. Elek.akus.*, Nov. 1942, Vol. 60, No. 5, p. 147; p. 147.) D.R.P. 720 837 & 720 745.

1436. BLIND LANDING SYSTEM GIVING CONTINUAL INFORMATION AS TO DISTANCE FROM LANDING POINT.—Y. Rocard. (*Hochf.tech. u. Elek.akus.*, Nov. 1942, Vol. 60, No. 5, p. 147.) D.R.P. 720 748.

1437. MULTI-BEAM ULTRA-SHORT-WAVE LANDING SYSTEM GIVING HEIGHT INDICATIONS.—F. Nebel. (*Hochf.tech. u. Elek.akus.*, Nov. 1942, Vol. 60, No. 5, p. 148.) Telefunken patent, D.R.P. 720 785.

1438. COMMERCIAL AIRCRAFT AIDS [C.A.A. Innovations, including Radio-Range Monitor giving Automatic Warning of 3° Drift].—(Electronics, Dec. 1942, Vol. 15, No. 12, pp. 86 and 88.)

ACOUSTICS AND AUDIO-FREQUENCIES

1439. CONTEMPORARY PROBLEMS IN TELEVISION SOUND.—Townsend. (See 1462.)
1440. ON THE MUTUAL SUPERPOSITION OF PLANE UNDAMPED PRESSURE WAVES OF LARGE AMPLITUDE IN GASES.—H. Priem. (Akust. Zeitschr., March 1942, Vol. 7, No. 2, pp. 56-65.)
1441. THE PERCEPTION OF NOTE PITCH.—J. F. Schouten. (Akust. Zeitschr., Jan. 1942, Vol. 7, No. 1, pp. 33-35.) A long summary of the Philips paper, an Italian abstract of which was dealt with in 1425 of 1942.
1442. SUBJECTIVE MEASUREMENT OF THE QUALITY OF TELEPHONIC LINKS: II—OBSERVATIONS OF REPETITIONS: TECHNICAL PROCEDURE.—Panzerbieter & Rechten. (Bull. Assoc. suisse des Elec., 13th Jan. 1943, Vol. 34, No. 1, pp. 22-24.) French version of the German paper referred to in 1141 of April. For Part I of the German paper see 3023 of 1942.
1443. REMARKS ON THE "OELSNER" BUILDING CONSTRUCTION [Review of W. Oelsner's "The Carrying Out of Modern House Construction as a Mechanically Non-Rigid System"].—G. Hofbauer: Oelsner. (Akust. Zeitschr., May 1942, Vol. 7, No. 3, pp. 111-115.) See also 1448, below.
1444. SELECTED PROBLEMS IN ARCHITECTURAL ACOUSTICS [Undesirable Acoustic Effects and Remedial Measures].—M. Rettinger. (Proc. I.R.E., Jan. 1943, Vol. 31, No. 1, pp. 18-22.)
1445. ABSORPTION OF SOUND BY POROUS MATERIALS: I & II.—J. van den Eijk & C. Zwikker. (Akust. Zeitschr., Jan. 1942, Vol. 7, No. 1, pp. 40-42.) Long summary of a paper in Physica, Nos. 2 & 5, Vol. 8, 1941, pp. 149 & 469 onwards.
1446. THEORY OF SOUND EXCLUSION BY THIN WALLS FOR OBLIQUE INCIDENCE.—L. Cremer. (Akust. Zeitschr., May 1942, Vol. 7, No. 3, pp. 81-104.)
1447. THE IMPROVEMENT OF AUDIBILITY BY SOUND REFLECTORS [Experiments on Improvement of Acoustically Bad Lecture Theatre of Trondheim Technical College].—R. Berg & J. Holtmark. (Akust. Zeitschr., May 1942, Vol. 7, No. 3, pp. 119-120: summary only.)
1448. RECENT IMPROVEMENTS IN THE TECHNIQUE OF THE ACOUSTICS OF ROOMS [particularly the Oelsner Technique, including the Use of Plate Resonators with Electronic Control of Tension].—M. Nuovo: Oelsner. (Formacion y Documentacion profesional [Madrid], March/April 1942, Vol. 1, No. 2, p. 201: summary, from L'Electrotecnica, May 1941.)
1449. THE SOUND-EXCLUDING ACTION OF WALLS ON SPEECH AND MUSIC [and the Failure of the Usual Method of Specifying Its Value to give Direct Practical Conclusions as to the Noise-Level Reduction in Given Conditions: New Method enabling Noise-Reducing Action for a Given Noise Spectrum to be expressed in Phons].—J. Capek. (Akust. Zeitschr., July 1942, Vol. 7, No. 4, pp. 152-156.)
1450. THE PROPAGATION OF SUPERSONIC WAVES IN WIRES.—E. Czerlinsky. (Akust. Zeitschr., Jan. 1942, Vol. 7, No. 1, pp. 12-17.)
"Up to the present, no information has been available as to the frequency-dependence of the propagation velocity of supersonic waves in long wires: only concerning the very large ranges of supersonic signals along wires are measurements known (Sokolov, 2258 of 1936 ["theoretical range 10 000 km for one watt"]: Kuntze, 3472 of 1936). Author's summary:—"The working out of the frequency equation derived from the oscillation equation for infinitely long cylinders yields a representation of the dispersion curves for supersonic waves along wires. In the frequency region where the wavelength is of the order of the wire diameter, the propagation velocity falls steadily with increasing frequency; for higher frequencies the velocity is practically independent of frequency. Dead zones do not occur. The simple calculation of two points characterising the shape of the dispersion curve is given. Comparison with measurements on fifteen cylinders of different materials and diameter shows the agreement of these investigations with the above calculations."
1451. A SUPERSONIC-WAVE TRANSMITTER DRIVEN BY AN ARC GENERATOR.—H. H. Zschirnt. (Hochf. tech. u. Elek. akus., Nov. 1942, Vol. 60, No. 5, pp. 126-135.)
The two chief methods of generating supersonic waves are the particularly simple magnetostriction oscillator, for frequencies from 20 to about 50 kc/s, and the piezo-quartz oscillator for higher frequencies. Unlike the latter device (which has low mechanical and electrical losses and converts nearly the whole of the energy supplied to it into oscillating energy) the magnetostriction oscillator has serious losses due to internal friction, eddy currents, and hysteresis. Since such an oscillator is usually required to deliver considerable supersonic power, its excitation needs a fairly large input, and valve generators of some kilowatts are neither cheap nor simple. These facts led to the idea that a Poulsen arc generator might be used as exciter: on the face of it, it provides the simplest device for producing large h.f. outputs with a good efficiency, though with the defects of rather poor constancy of frequency and amplitude.
Experiments were therefore made with a Poulsen arc in a coal-gas atmosphere, with a water-cooled copper anode and a rotating carbon, a transverse magnetic field, and a 700 v d.c. generator as supply. The magnetostriction oscillator in the first series of tests was a commercial type (for submarine

signalling) built up of nickel stampings with two rectangular slots through which the thick rubber-covered exciting turns were wound (Fig. 2): its natural frequency was 20.8 kc/s, varying slightly with temperature or with change of biasing current. It was water-cooled, the top only of the core being in contact with the atmosphere. Its position in the complete arc circuit is shown at "Sch" in Fig. 1.

In developing methods for measuring the supersonic amplitudes and frequencies, it was decided that the applications of such a magnetostriction oscillator did not require very great frequency or amplitude constancy, and that very brief fluctuations of amplitude, or indeed short complete breaks in the oscillations, would not be serious provided they lasted no longer than about 1/100th of a second. It was therefore necessary to look for an amplitude-recording device with sufficient sensitivity and a response time of less than 1/100th of a second. Tests with thermophones showed that these had too great inertia even when very thin wires were used. Finally, a torsional sound-pressure recorder was developed (similar to the Rayleigh disc but with the plate comparable in size with the wavelength and suspended asymmetrically) on the lines of Fig. 3, where a $20 \times 20 \times 0.1$ mm mica plate is cemented at one edge to a stretched wire and damped by a drop of castor oil above and below it, close to its suspension. The plate is silvered on one side so as to act as a reflector in the optical system of Fig. 3b, in which the illumination of a photocell is varied, as the mica disc is raised by the sound pressure coming from below it, by the action of the wedge-shaped aperture in the stop *B*. The photocurrent is amplified in a d.c. amplifier and recorded on a loop oscillograph. An adjustable reflector *R* above the disc can be used to increase the deflection, a maximum being obtained when *R* is a whole multiple of a half-wavelength away from the oscillator and the mica plate lies in a pressure antinode of the standing waves. Fig. 6 shows the circuit developed for recording the frequency and amplitude fluctuations of the Poulsen arc oscillations, and the oscillograms of Fig. 9 show how the arc, when the magnetostriction generator is put out of action, behaves as regards current (trace 1) and frequency (trace 2): the former is practically a straight line, while the latter shows completely irregular fluctuations between 20.85 and 20.44 kc/s. Very different is the frequency oscillogram of Fig. 10: the interaction between the oscillator and the Poulsen arc circuit brings about an emphasis on the natural frequency of the former (20.99 kc/s) and such fluctuations as there are show a drawn-out saw-tooth course about this frequency. The lower trace is that of the supersonic intensity as measured with the mica-disc device: it shows a practically steady value with small dips corresponding to the steep sides of the frequency saw-tooth trace. Both traces can be considerably improved (Fig. 11) by measures described in section IV which make the fullest use of the stabilising effect of the magnetostriction oscillator and ensure the optimum conditions (reduced magnetic field, at the cost of some efficiency, thinner carbon, etc.). Preliminary results, interrupted by the war, showed that a much greater constancy of frequency and amplitude could be attained

for smaller supersonic powers by the use of a "Poulsen test lamp" arc generator (without a magnetic field) combined with an air-cooled nickel-tube oscillator: no fluctuations could be detected with the instruments used, apart from the slight modulation due to the brushes of the d.c. generator.

Finally, it was found that by replacing the magnetostriction oscillator by an equivalent electrical circuit (Fig. 13) the same stabilising interaction with the arc circuit was obtained: Fig. 14 shows the frequency trace for the greatest output (thick carbon, strong magnetic field) and Fig. 15 that for the greatest constancy (thin carbon, weak field).

1452. SUPERSONIC WAVES: THEIR EFFECTS AND EMPLOYMENT IN VARIOUS FIELDS OF MODERN TECHNIQUE [including Purification of Water, Stroboscopy, Television, etc.].—G. Oggioni. (*L'Elettrotecnica*, 25th Aug. 1941, p. 410 onwards: summary in *Formacion y Documentacion profesional*, Sept./Oct. 1942, Vol. 1, No. 5, p. 543.)

1453. A NEW SONIC AND SUPERSONIC TRANSMITTER FOR THE PRODUCTION OF STRONG INTENSITIES IN GASES.—L. Ehret & H. Hahnemann. (*Zeitschr. f. tech. Phys.*, No. 10, Vol. 23, 1942, pp. 245-266.)

The development of supersonic applications in industry such as the preparation of the finest colloids, the coagulation of aerosols, the supersonic testing of materials, and so on, as well as the medical application of the biological effects of supersonic waves, is continually impeded by the present lack of a high-intensity sound generator of reasonable design, reliable working, and satisfactory efficiency. Piezoelectric and magnetostrictive radiators deliver their high intensities (up to 10 w/cm^2) only to liquid media (Bergmann's book is cited here): gaseous media take up only a 2.5×10^4 th part of the intensity radiated in the liquid. Hartmann's air-jet generator (see, for example, 4304 of 1940 and back reference [and, for later work, 1118 of 1941]) is particularly suitable for gases, but has the great disadvantage that the generated sound field lies actually in the gas current which produces it, which in many applications is out of the question or at least troublesome.

The writers, therefore, working at the Motor Research Institute of the Hermann Göring Aircraft Research Establishment, Brunswick, have modified the air-jet generator so as to separate the sound field from the flow of air. Two possible ways of doing this are illustrated in Fig. 3. A cylindrical ring *cc* could be fixed just in front of the entrance to the Hartmann resonator *b* (for the relation of *b* to the compressed-air nozzle *D* see Fig. 1): it would be designed so that its radial natural frequency was equal to the Hartmann frequency, and would be excited by the Riemann shock-waves formed a few millimetres from the resonator by the main and resonator beams. This plan has certain disadvantages, including the fact that the sound field obtained is not plane but approximately cylindrical. The second method was therefore adopted, in which the base of the resonator is replaced by a diaphragm *aa*, with a transverse natural frequency equal to the Hartmann frequency, close to the open back of the resonator *b*. With this "aerodynamic plate

oscillator" intensities of the order of 1 w/cm^2 , free from the stream of air, were obtained. Various possible ways of improving the efficiency are discussed at considerable length, and it is concluded that the perfected apparatus would be useful also for the excitation of liquids, as a substitute for the piezoelectric generator: preliminary tests with the unimproved model have confirmed this. A long section (pp. 253-261) describes measuring methods of various kinds developed in the course of the investigations: they assist in the rapid and accurate adjustment of the apparatus to give the maximum radiation.

1454. "PHYSIK UND TECHNIK DES TONFILMS" [Book Review].—H. Lichte & A. Narath. (*Journ. Applied Phys.*, Dec. 1942, Vol. 13, No. 12, p. 746.) A German review was referred to in 725 of 1942.

1455. MEASUREMENTS IN CONNECTION WITH THE THEORIES OF THE NATURAL VIBRATIONS OF HOLLOW CIRCULAR RINGS OF ARBITRARY WALL THICKNESS [Magnetically Excited Steel Rings, at Frequencies up to 100 kc/s].—W. Kuhl. (*Akust. Zeitschr.*, July 1942, Vol. 7, No. 4, pp. 125-152.) Cf. Federhofer, 1184 of April.

1456. METERS FOR D.I.N. SOUND LEVELS: COMMITTEE'S RECOMMENDATIONS.—(*Akust. Zeitschr.*, July 1942, Vol. 7, No. 4, pp. 156-159.) For an instrument on these lines see Kalden, 1153 of April.

1457. THE RECORDING OF RAPIDLY VARYING PROCESSES WITH THE NEUMANN ATTENUATION RECORDER [on the Magnetic Rotating-Disc-&-Fork Principle: Application to Reverberation-Time & Noise-Level Recording: etc.].—M. Gosewinkel. (*Akust. Zeitschr.*, May 1942, Vol. 7, No. 3, pp. 104-111.) Cf. 799 of March.

1458. SIMPLE HARMONIC WAVE ANALYSER [Amplifier-Filter-Rectifier Instrument for Direct Reading of Amount of Second- & Third-Harmonic Distortion, for Rapid Testing & Inspection of A.F. Devices].—R. F. Thomson. (*Electronics*, Dec. 1942, Vol. 15, No. 12, pp. 61-62 and 155.)

1459. SOME DETAILS IN DIRECTIONAL DISCRIMINATION IN HEARING [Researches with "Artificial Head": Discrimination between Fore & Aft Sounds (and also between Sources above & below Horizontal Plane) attributed to Small Involuntary Movements of Head, Not to Asymmetry of Head due to Shell of Ear].—K. de Boer & A. Th. van Urk. (*Philips Tech. Rundschau*, No. 12, Vol. 6, 1941, p. 363 onwards.) For previous work see 2741 of 1941.

1460. ELECTRONIC MUSICAL INSTRUMENTS AND THE PROGRESS OF THE PIPELESS ORGAN.—L. Vellard. (*Rev. Gén. de d'Élec.*, April 1941, p. 214 onwards.) A fourteen-page survey.

1461. RECEIVER FOR SOUND SIGNALS TO GIVE WARNING TO MOTOR VEHICLE BEING OVERTAKEN BY ANOTHER [Maximum Sensitivity selected so as to allow for Doppler Effect, assuming Speed Difference of 20-40 km per Hour].—W. M. Hahnemann. (*Akust. Zeitschr.*, July 1942, Vol. 7, No. 4, p. 159.) Lorenz patent, D.R.P. 694 508.

PHOTOTELEGRAPHY AND TELEVISION

1462. CONTEMPORARY PROBLEMS IN TELEVISION SOUND.—C. L. Townsend. (*Proc. I.R.E.*, Jan. 1943, Vol. 31, No. 1, pp. 3-7.)

Author's summary:—"The present rapid development of television is introducing new problems in sound pickup and operation. As the art progresses, engineering tools and methods must not only keep pace with, but generally anticipate, the needs of the program-producing staff in the production of more and more intimate material. The nature of the acoustic problems so raised, and their solutions, are treated in this paper. New tools necessary to proper operation and the methods of their employment are discussed. For a better understanding of television requirements the methods normally employed in motion pictures and standard radio broadcasting are compared with those in use in the present television studio. Some indications as to what may be required in the near future are discussed and possible developments suitable for such use are described."

1463. AUTOMATIC FREQUENCY AND PHASE CONTROL OF SYNCHRONISATION IN TELEVISION RECEIVERS.—K. R. Wendt & G. L. Fredendall. (*Proc. I.R.E.*, Jan. 1943, Vol. 31, No. 1, pp. 7-15.)

A summary was dealt with in 829 of March. From the authors' summary:—"One of the problems in the reception of television images is to provide satisfactory synchronisation in the presence of noise. . . . This paper describes a synchronising means at the receiver that employs a new principle in the field of synchronisation. The principle is automatic frequency and phase control of the saw-tooth scanning voltages. . . . Consideration of this new development indicates that its use would result in several improvements in television service: (1) when severe noise conditions occur, an improved picture is obtainable at points within the present service area; (2) under such noise conditions, the useful service area is extended; (3) the maximum resolution permitted by a television channel is realisable at locations having low field strengths. It is expected that these improved results will be attained without increase in the cost of the television receiver."

1464. AN EXPERIMENTAL TELEVISION SYSTEM [for 114 Mc/s Band: Semi-Portable: Experience with Type 1847 Two-Inch Iconoscope (including Effect of Excessive Capacitance to Ground, and the Desirability of a Shading-Voltage Generator): etc.].—R. Mautner & F. Somers. (*Electronics*, Dec. 1942, Vol. 15, No. 12, pp. 68-71 and 170-173.)

1465. A 9-KILOWATT TELEVISION TRANSMITTER FOR EXPERIMENTAL PURPOSES [with Particular Attention to the Output Stage & Modulator].—M. van der Beek. (*Philips Tech. Rundschau*, May 1942, Vol. 7, No. 5, p. 129 onwards.)
1466. THE OBTAINING OF HIGH VOLTAGE FROM THE LINE-SWEEP UNIT: II [Variation of the Derived Voltage with Load: Relation between High Voltage & Angle of "Kipp": Analysis, including Form of Deflecting Coils, Inductance of Deflecting System, Resultant Inductance of "Kipp" Transformer loaded by Deflecting Coils, and Dependence of Coil Length on Deflection Angle & Ray Length].—H. Bähring. (*Fernseh-A.G. Hausmitteilungen*, No. 3, Vol. 2, 1941, p. 84 onwards.) For part I see 446 of 1941.

MEASUREMENTS AND STANDARDS

1467. STANDARDS AND STANDARDISATION [Attempt to Define "Accuracy" as applied to Standards of Self-Inductance, Capacitance, and Resistance].—W. H. F. Griffiths. (*Wireless Engineer*, March 1943, Vol. 20, No. 234, pp. 109-126.)
1468. A PUSH-PULL ELECTROMETER-VALVE POTENTIOMETER [for Use with a Glass Electrode in pH Measurement].—C. T. Abichandani & S. K. K. Jatkar. (*Quarterly Journ. Indian Inst. Science*, Oct./Dec. 1940, Vol. 3, No. 4, pp. 91-97.)
A d.c. amplifier having extremely low input-grid current, comprising two electrometer triodes in push-pull, followed by a pair of high-mutual-conductance triodes. Overall sensitivity $0.8 \mu\text{A}/\text{mV}$, which could be increased to $100 \mu\text{A}/\text{mV}$ with adequate screening. Zero drift $0.2 \mu\text{A}$ per hour at the lower sensitivity.
1469. RECTIFIER MILLIAMMETERS [Satisfactory Instrument for indicating Small Out-of-Balance Currents].—T. A. Ledward. (*Electrician*, 5th March 1943, Vol. 130, No. 3379, p. 239.)
1470. AN ELECTROSTATIC VOLTMETER WITH LIGHT-SPOT INDICATION ["Universal Electrometer," for D.C. & A.C. up to 6 Mc/s: in Plastic Case about $8" \times 9" \times 5"$: Quadrant-Electrometer Movement with Stretched-Ribbon Suspension: Wide Range].—Siemens & Halske A.G. (*Arch. f. Tech. Messen*, May 1941, Part 119, J762-3, Sheet F3.)
1471. ON THE DEVELOPMENT OF A NEW CURRENT AND VOLTAGE MEASURING INSTRUMENT FOR ULTRA-HIGH FREQUENCIES [Readings Independent of Frequency from Zero up to about 100 Mc/s] BASED ON THE OPTICAL STRIÆ OR "SCHLIEREN" METHOD.—W. Frings. (*Hochf. tech. u. Elek. akus.*, Nov. 1942, Vol. 60, No. 5, pp. 117-125.)
Covering the same ground as the paper by Malsch & Frings dealt with in 2430 of 1942, but in a fuller way. Thus the d.c. amplifier developed for the differential photocell is described fully and its working discussed. Currents down to about 10 mA can be measured with an accuracy within 5%. The agreement between results obtained with this instrument and those given by Braune's instrument (see abstract cited above) and by a "home-made" thermojunction, and the disagreement with those given by a Hartmann & Braun thermojunction meter, led to the conclusion that at 3 m the latter instrument was incorrect. Enquiries on this point to the makers led to a reply from J. Fischer saying that a series of their thermo-converters had just been tested at the P.T.R. with the result that the 50 mA and 100 mA converters were found to have a 4.5% error at 3 m, while the 10 mA model showed about a 5% error at 6 m: "at metric wavelengths, conditions in the converters below the 50 mA size are rather difficult from the h.f. viewpoint, in so far as the hot wire is not stretched straight but is coiled." The particular H. & B. instrument in question had a full-scale reading for 20 mA. The writer points out the special suitability of the "Schlieren" instrument for testing the u.h.f. errors of commercial meters.
1472. MAGNETIC ZERO-CURRENT AMPLIFIERS [for Measuring & Control Purposes].—W. Geyger. (*Arch. f. Tech. Messen*, June 1941, Part 120, Z634-2, Sheet T91.) For other papers see 1134 of 1942 and back references.
1473. AMPLIFICATION OF DIRECT VOLTAGES WITH A HIGH-FREQUENCY PUSH-PULL CIRCUIT.—Kerkhof. (See 1387.)
1474. MEASUREMENTS IN CONNECTION WITH THE THEORIES OF THE NATURAL VIBRATIONS OF HOLLOW CIRCULAR RINGS OF ARBITRARY WALL THICKNESS.—Kuhl. (See 1455.)
1475. ON THE MEASUREMENT OF THE LOSS ANGLE OF INSULATING MATERIALS [with Description of Equipment & Technique at the Radio Laboratory of the Italian Ministry of Aeronautics].—F. Bocci. (*Formacion y Documentacion profesional* [Madrid], May/June 1942, Vol. 1, No. 3, p. 290: summary, from *L'Electrotecnica*, 10th & 25th July 1941.)
1476. NOTES ON BRIDGE BALANCING [Brief Account of Types of Bridges for measuring Impedances].—C. F. Nordica. (*Radio* [New York], Dec. 1942, No. 275, pp. 9-11 and 46, 47.)
1477. THE MUTUAL INDUCTANCE OF COAXIAL CIRCULAR RINGS IN THE PRESENCE OF A PERMEABLE CORE.—Buchholz. (See 1391.)
1478. THE CAPACITY EFFECT IN SOLENOIDS [and a New Method of calculating the Self-Capacitance of a Multi-Turn Coil].—Lopez. (See 1395.)
1479. AUTOMATIC CIRCUIT TESTING.—Bissmire & Davies. (See 1537.)
1480. COUNTER TUBES AND THEIR USE IN MEASURING TECHNIQUE.—H. Neuert. (*Arch. f. Tech. Messen*, June 1941, Part 120, J076-1, Sheets T85-86.) For later papers see 2918 of 1942.

1481. PRECISION TIME CONTROL [Amplified Tuning-Fork-Output Power-Supply avoids Synchronous-Clock Variations caused by War-time Overloading of A.C. Mains: Accurate to One-Third Second per Day].—Nat. Broadcasting Company. (*Electronics*, Dec. 1942, Vol. 15, No. 12, pp. 49 and 156, 157.)
1482. A FREQUENCY-MODULATED RESISTANCE-CAPACITANCE OSCILLATOR.—Chang. (See 1403.)
1483. A NEW FREQUENCY-DIVIDER FOR OBTAINING REFERENCE FREQUENCIES.—F. R. Stansel. (*Bell Lab. Record*, Dec. 1942, Vol. 21, No. 4, pp. 97-99.)
1484. A METHOD FOR THE EXACT REGULATION OF FIXED ROTATIONAL SPEEDS OF AN AXLE.—F. Kirschstein. (*Zeitschr. f. tech. Phys.*, No. 9, Vol. 23, 1942, pp. 234-240.)

In measuring technique it is often necessary to drive some rotating apparatus at various exact speeds: at each speed the r.p.m. must be adjusted to the predetermined value with a definite absolute accuracy and must be held constant over a certain time of test. If the speeds involved differ greatly among themselves the only type of driving motor which can be considered is a d.c. motor with its field excited by a fixed current and its armature supplied from a special d.c. generator with adjustable excitation (Leonhard connection). The speed of the driving motor is then proportional to the voltage delivered by the d.c. generator, and thus can be regulated over a wide range through the excitation of the latter. Such an arrangement, however, adjusted to a definite number of r.p.m. and then left to itself, will show after only a short time a departure from the prescribed speed as a result of variable frictional resistances, mains fluctuations, warming-up effects in field and armature windings, and so on: and sooner or later it will be necessary to restore the wanted speed by a readjustment. This readjustment must be made with the help of some form of tachometer and is liable to be not very precise because of the limited accuracy of these instruments. The paper describes a regulating method suitable for those cases which demand an exact setting and maintenance of rotational speed.

The arrangement is shown schematically in Fig. 1, where "2" is the driving motor with its axle prolonged in one direction to form the driving shaft "1" and in the other to terminate in the magnetic-brake disc "10." The shaft "1" carries a toothed tone-wheel "5" which generates in the telephone pick-up coil "6" a voltage of frequency proportional to the r.p.m. of the shaft: this voltage is taken to a phase-circuit "7" where it is combined with a voltage of frequency f_0/n given by the action of a frequency-dividing circuit "4" on the fundamental frequency f_0 of a precision generator "3" which may be of the tuning-fork hummer type. Fig. 2a shows how the circuit "7" adds together the control voltage U_{st} of frequency f_0/n and the tone-wheel voltage U_T , and with the help of a rectifier G and resistance R_0 converts the resultant voltage U_0 into a d.c. regulating voltage and (through an amplifier valve V) causes a corresponding regulating d.c. to flow through the winding of the magnet "8," which flows

with the copper or aluminium disc "10" an eddy-current brake on the driving motor. On the assumption of synchronism, so that the two alternating voltages U_{st} and U_T are of precisely the same frequency, Fig. 2b gives the vector diagram for these voltages and the resultant, U_0 : from this it is seen how a rise in axle speed would cause the vector U_T to rotate in the direction reducing the angle ϕ (about 90°) of its lag behind U_{st} , with a resulting increase in U_0 and in the current through the magnet winding, and a consequent braking of the driving motor. The reverse action is produced by fall in the axle speed, so that speed constancy is obtained: it is not necessary to adjust the speed accurately so that the two frequencies are precisely equal, only so that suitably slow beats occur between U_{st} and U_T , after which the synchronisation occurs automatically.

The above arrangement is satisfactory for balancing out small fluctuations of the driving moment: such, for instance, as might occur if the motor were left to itself for a few minutes. If it is desired to compensate for larger fluctuations, occurring gradually, the additional device included in Fig. 3 may be used. Here the amplifier valve V of the original arrangement has added to it in parallel a second, similar valve V' , to whose grid the regulating d.c. is taken through an RC section, and whose anode circuit contains two relays, R_1 and R_2 . The anode circuit of the valve V is shunted by two resistances in series, of which R_0 is set by hand and R_a is adjusted by a series motor M with two oppositely-wound field coils F_1 and F_2 , so that the motor runs forwards or backwards according to whether the armature is supplied through F_1 or F_2 . The relay R_1 closes the contact r_1 putting F_1 in circuit, while the relay R_2 opens the contact r_2 which normally keeps F_2 in circuit: shunt resistances are adjusted so that R_1 closes and opens for larger currents than R_2 , so that (in fact) R_1 opens in the presence of a current larger than that required to close R_2 . The mode of action of this arrangement (depending on the fact that the current through V , and consequently through V' , depends on the value of the driving moment obtaining at any particular instant) is described on p. 237. The result is that the equipment can be run for hours on end at the required speed without any readjustment, provided only that no sudden large fluctuations occur: for the two controls, being as it were "in series," have a fairly large time constant. Testing technique is described in section IV: in the actual case of a turntable revolving at 100 r.p.m., the estimated fluctuations were 10^{-3} of the mean r.p.m., with a period of a few seconds, and 5×10^{-4} of the mean r.p.m., with a period of one rotation of the turntable.

In a discussion of the choice of a frequency-dividing device, an arrangement due to Well-schmid (to be published in the near future) is mentioned as very satisfactory: this consists of two "kipp" circuits in series, of which the first is synchronised by the control frequency f_0 , and the second by the frequency given by the first. With an input frequency of 10 kc/s the arrangement gives 23 available frequencies between 100 and 500 c/s by the rotation of a single selector switch.

SUBSIDIARY APPARATUS AND MATERIALS

1485. A METHOD FOR THE EXACT REGULATION OF FIXED ROTATIONAL SPEEDS OF AN AXLE.—Kirschstein. (See 1484.)
1486. RADIO BIBLIOGRAPHY: REMOTE CONTROL [and List of Previous Subjects].—Rettenmeyer. (*Radio* [New York], Dec. 1942, No. 275, pp. 26 and 29..34.) For a previous set see 455 of February.
1487. SOME USEFUL CIRCUITS EMPLOYING THYRATONS AND IGNITRONS.—Maddock. (See 1401.)
1488. LOCALISATION OF THE DISCHARGE IN GEIGER-MÜLLER COUNTERS.—Wilkening & Kaune. (*Phys. Review*, 1st/15th Dec. 1942, Vol. 62, No. 11/12, pp. 534-537.)
1489. ELECTRONIC VOLTAGE REGULATOR FOR PRECISE DENSITOMETRIC MEASUREMENTS.—Dieter & Hasler. (*Journ. Opt. Soc. Am.*, Jan. 1943, Vol. 33, No. 1, pp. 45-49.)
1490. THE STATISTICAL AVERAGE IN THE MEASUREMENT AND USE OF DRY-PLATE RECTIFIER PLATES: I & II.—Maier. (*Arch. f. Tech. Messen*, May & June 1941, Parts 119 & 120, Z52-3 & 4, Sheets T76-77 & 89-90.)
1491. FACTORS DETERMINING THE INTENSITY OF OSCILLATIONS IN THE PLASMA OF GASEOUS DISCHARGE.—Sluzkin & Maydanov. (See 1408.)
1492. THE RECORDING OF RAPIDLY VARYING PROCESSES WITH THE NEUMANN ATTENUATION RECORDER.—Goswinkel. (See 1457.)
1493. THE METHOD OF CHROMATOGRAPHIC ABSORPTION IN PHOSPHORESCENCE CHEMISTRY [for Purification of the Basic Material in the Preparation of Sulphide Phosphors], and ON THE FINE STRUCTURE OF ALKALINE-EARTH SULPHIDE PHOSPHORS.—Tiede & Schikore: Tiede. (*Physik. Berichte*, 15th Sept. 1942, Vol. 23, No. 18, pp. 1720-1721: p. 1721: summaries only.)
1494. TWO NEW HOT-FILAMENT RESISTANCES.—Minter. (*Journ. Applied Phys.*, Jan 1943, Vol. 14, No. 1, pp. 49-50.)

Author's summary:—"This report gives the results of attempts to produce a gaseous atmosphere in which the thermal conductivity increases with increasing ambient temperature much more rapidly than the normal, thereby causing a hot filament mounted in such an atmosphere to behave as if it had a negative temperature coefficient of resistance. There is also described a means of producing a gaseous atmosphere the thermal conductivity of which decreases very rapidly as the ambient temperature is increased, so that a hot filament mounted in such an atmosphere behaves as though it had a positive

temperature coefficient of resistance three to four times as great as normal." The two resistances described should be useful in many laboratory circuits, provided there is enough current flowing to heat the filament to a sufficiently high temperature above surroundings.

1495. STANDARDISATION OF FIXED RESISTORS [Agreement on Preferred Values and Tolerances].—(*Wireless World*, March 1943, Vol. 49, No. 3, p. 71.) The result of consultation between the Interservice (Communications) Components Committee and others.
1496. REMARKS ON THE USE OF "SIMMER" RINGS AS VACUUM-TIGHT GLANDS.—Raether. (*Zeitschr. f. tech. Phys.*, No. 10, Vol. 23, 1942, pp. 266-267.)

"In many laboratories use is now being made of 'Simmer rings' (made by Carl Freudenberg, Simmerwerk, Weinheim/Bergstr.) where some kind of movement inside a vacuum apparatus is required, such as the rotation or longitudinal adjustment of a spindle. Such a 'Simmer' ring is shown schematically in Fig. 1. In the type most generally used the ring is composed of a cylindrical outer sheath continuing inwards to form a sleeve or cuff which makes the air-tight sliding joint: both parts are made of 'Simrit', a rubber-like material. The outer sheath is stiffened by a metal ring [helping to press it outwards against the fixed tube or housing, to make a stationary vacuum-tight joint]. The vacuum-tightness of the cuff is brought about with the help of its 'vacuum lip', whose diameter is rather smaller than that of the spindle: it also is made of 'Simrit', and thanks to its flexibility it clings to the spindle and prevents the entrance of air. With the help of a spiral-spring ring or a rubber ring (shown in Fig. 1 as 'pressing') the lip is given an additional pressure against the spindle, the contact surface being about 0.5 mm long. The 'Simmer ring' is pressed into the housing and sits firmly in it, since the outer sheath is a 'press fit' to the housing diameter specified in the catalogue. Since the vacuum-tightness thus obtained is questionable, we insert a ring of Apiezon wax in the seating before introducing the ring.

"The simplification of the vacuum gland for rotatable and displaceable spindles compared with previous arrangements is obvious. To find out the limits of usefulness of these glands we have carried out the following orienting measurements", with a polished steel (or glass) spindle of 8 mm diameter, freed from grease (as was also the "lip" of the ring) with benzine. The conditions of vacuum were such that within four hours the pressure rose by about 3×10^{-4} mm Hg whether the ring was in place or was replaced by a glass plate, so that this leakage had nothing to do with the ring. A single slow rotation of the de-greased spindle caused a barely measurable rise in pressure, ten whole turns made it rise by about 4×10^{-4} mm Hg. A careful and slow displacement of the spindle through 5 cm raised the pressure by 5×10^{-4} mm. Converted to atmospheric pressure, an increase of 1×10^{-4} mm represented about half a cubic centimetre of air.

With a good pump, such a leakage is of little

importance as a rule, particularly since in many cases the spindle would be moved only for a moment and would be stationary during an actual test. But in certain circumstances, as in a vaporising apparatus with hot metallic foils, it is desirable to reduce the entrance of air as much as possible. The writer therefore repeated the measurements after moistening the spindle with Apiezon oil B (high-vacuum pump oil): the pressure rises were smaller by at least one order of magnitude, ten rotations causing no change that could be read on the McLeod gauge, and displacements of a few centimetres a barely measurable rise of a few 10^{-5} mm Hg. The use of the oil is not only harmless but also lasting: Simrit is unaffected by oil. In some cases the writer filled the part above the lip with oil, in others a moistening with oil was all that was required. Since these rings are supplied in diameters up to 285 mm they can be employed for expansion chambers in addition to their many other uses. Altogether, the writer believes that they will soon become indispensable.

1497. AN ELECTRICAL CONTACT TESTING MACHINE.—Suggs. (*A.S.T.M. Bulletin*, Dec. 1942, No. 119, pp. 25-30.)

Consists principally of three units of mechanism for opening and closing electrical contacts, with equipment for measuring their operating characteristics. Three pairs of contacts can be fitted and can be tested simultaneously.

1498. PROTECTIVE RELAYS [Notes on New British Standard Specification].—Casson. (*Elec. Review*, 12th March 1943, Vol. 132, No. 3407, pp. 346-348.)

1499. "BOUNCELESS BALL" [Steel Ball Half-Filled with Metallic Powder] POINTS WAY TO PROGRESS IN ELECTRICAL RELAYS.—(*Scient. American*, Nov. 1942, Vol. 167, No. 5, p. 207.)

1500. INVESTIGATION OF CAR CONDENSERS [Russian & Foreign: Dependence of Capacitance-Variation, with Temperature, on Nature of Paper-Impregnating Dielectric (Castor Oil or Halowan): of Loss-Angle Variation, with Temperature, on Nature of Contacts to Aluminium Foil: Exclusion of Moisture: etc.].—Renne & Schljachter. (*Physik. Berichte*, 1st Sept. 1942, Vol. 23, No. 17, pp. 1637-1638: summary of Russian paper.)

1501. THE MUTUAL INDUCTANCE OF COAXIAL CIRCULAR RINGS IN THE PRESENCE OF A PERMEABLE CORE.—Buchholz. (*See* 1391.)

1502. NEW STACKPOLE IRON CORES [Note on New Product].—(*Radio* [New York], Dec. 1942, No. 275, pp. 49-50.)

1503. THE PERMEABILITY OF IRON AT RADIO FREQUENCIES.—Smith & Dickey. (*Phys. Review*, 1st/15th Dec. 1942, Vol. 62, No. 11/12, p. 561: summary only.)

1504. A PERMALLOY MAGNETOMETER.—Johnson. (*Phys. Review*, 1st/15th Dec. 1942, Vol. 62, No. 11/12, p. 561: summary only.)

1505. HAMMERED SOLDERING-IRON TIPS LAST LONGER [Technique evolved for Hotter Irons now necessary with Tin-Economising Solders].—(*Electronics*, Dec. 1942, Vol. 15, No. 12, p. 84.)

1506. CONTRIBUTION TO THE INDIRECT BRAZING OF ALUMINIUM [Use of Autogal-C Paste & Silumin Filings].—Maier. (*Physik. Berichte*, 15th Aug. 1942, Vol. 23, No. 16, pp. 1588-1589.)

1507. RESEARCH ON A DOUBLE-VALVE-RECTIFICATION SYSTEM [for Supply of Direct Current to Relays, etc.].—Weisglass. (*See* 1389.)

1508. EXPERIMENT ON THE ELECTROSTATIC REPELLSION BETWEEN PARALLEL ELECTRON RAYS.—Stehberger. (*Ann. der Physik*, No. 5, Vol. 41, 1942, p. 325 onwards.)

Of the two ways in which a mutual repulsion of the electrons in an electron beam can manifest itself—a longitudinal effect (space-charge action in a valve) and a transverse effect (in the long rays of electron optics)—the latter has had hardly any quantitative investigation. The writer has therefore carried out measurements with two "spiral" electron beams, such as he used in previous experiments (*see* 1154 of 1938), running parallel and close to each other. The maximum deflection was always less than 1 mm. The measured values corresponded quite well with theory: a discrepancy which appeared to increase with increasing longitudinal magnetic field was attributed to a small retroactive component of the spiral beam.

1509. THE ELECTROSTATIC FOCUSING OF HIGH-SPEED ION AND ELECTRON BEAMS.—Craggs. (*Journ. Applied Phys.*, Dec. 1942, Vol. 13, No. 12, pp. 772-780.)

An account is given of experiments carried out in preparation for the development of an apparatus for artificial atomic disintegrations (*see* also 2797 and 3356 of 1942). The problems involved are (1) the focusing of a beam of 10-30 kv hydrogen ions from a canal-ray ion source, and (2) the behaviour of a cascade acceleration tube of the Coolidge type. The general properties of electrostatic focusing systems are treated briefly and references are given to other investigations in this field.

1510. CATHODE-RAY TUBE FOR VERY HIGH FREQUENCIES, WITH DEFLECTING ELECTRODES FORMED OF STRETCHED CONDUCTORS ON EITHER SIDE OF RAY, WITH TERMINATING RESISTANCE AT FAR END TO ELIMINATE REFLECTION.—Graffunder. (*Hochf. tech. u. Elek. Anst.*, Nov. 1942, Vol. 60, No. 5, pp. 145-146.) Telefunken patent, D.R.P. 720 754.

1511. ELECTROSTATIC ELECTRON MICROSCOPY: I.—Bachman & Ramo. (*Journ. Applied Phys.*, Jan. 1943, Vol. 14, No. 1, pp. 8-18.)

Investigations to develop a simplified, practical microscope yielding magnified images of transparent specimens. The first part deals with the general problem of design, including the electron gun and imaging lenses.

1512. MICROSCOPES IMPROVED [New Portable Models make Electron Microscope available for Wider Usefulness in Small Laboratories and War Industries].—(*Sci. News Letter*, 12th Dec. 1942, Vol. 42, No. 24, pp. 374-375.)

1513. SURFACE-LEAKAGE PHENOMENA IN PHENOLIC RESIN PLASTICS.—Esch. (*Physik. Berichte*, 1st Aug. 1942, Vol. 23, No. 15, p. 1517: summary, from *Kunststoffe*, No. 3, Vol. 32, 1942, p. 81.)

Beginning with an extract from the reports of Stäger and his colleagues (see 3144 [and 3521] of 1941) dealing with investigations of structure and surface leakage, the writer shows that results with phenolic, cresolic, and aniline resins (by the usual dropping method with electrolytes containing a Nekal addition, in the presence of an electric field) indicate that the chemical influence of the electrolyte plays a dominating rôle. Thus salts of the alkaline elements are particularly effective in introducing surface leakage, the chlorides being more active than the sulphates. Sodium sulphate is distinguished by a particularly small temperature dependence in the formation of leakage paths.

1514. SURFACE-LEAKAGE CURRENTS ON SYNTHETIC MATERIALS.—Vieweg & Klingelhöffer. (*Physik. Berichte*, 1st Aug. 1942, Vol. 23, No. 15, p. 1517: summary, from *Kunststoffe*, No. 3, Vol. 32, 1942, pp. 77 onwards.)

A new method is described of measuring the surface conductivity of materials, which is so important in the development of synthetic insulators: previous methods using two knife-edges only measure currents which are the sum of the surface-leakage and penetrating currents and are not, therefore, satisfactory in the knowledge they provide. In the new method, a circular disc of the material is covered on both sides with a metallic coating, that on one side being divided into a number of rings by concentric spaces. The conductivity is measured for various sizes of electrode, by connecting all the rings together for the first measurement and then disconnecting ring after ring, starting at the centre. The conductivity is plotted as a function of the surface, and extrapolation to zero surface gives the pure surface conductivity at the periphery of the sample. As a precaution, all specimen discs are made with the same length of periphery.

Results are given for "Type S" material at various degrees of humidity and various temperatures, and also under the action of ammonia. The influence of water-vapour pressure on the surface conductivity is explained by the hypothesis of conduction paths due to absorption by the salts existing in the surface: these paths unite, at high humidities, and form closed circuits. For previous work by these writers see 2815 of 1942.

1515. DUCTILITY OF FOILS OF SYNTHETIC MATERIALS [Important in the Insulation of Wires, particularly of Those of Fine Diameter].—Fischer & Witte. (*Physik. Berichte*, 1st Aug. 1942, Vol. 23, No. 15, pp. 1517-1518: summary, from *Kunststoffe*, No. 4, Vol. 32, 1942, p. 110 onwards.)

Even polystyrol is found to be suitable for the

insulation of wires, in spite of its small breaking elongation: apparently the application to the wire causes a marked increase in ductility. The present work investigates this point by experiments on styroflex foils gummed to carrier foils, after it had been shown that the mere treatment of the styroflex with the gum had no influence on the ductility. Measurements on foils of styroflex (polystyrol), luvitherm (polyvinyl chloride), triafol N (cellulose acetate), and lyafol (polyamide) gave in all cases ductilities for the combined foils which were higher than that for polystyrol alone: in the case of triafol and styroflex, higher than that of the carrier foil. The writers conclude that the breaking stretch of the foils is very greatly reduced by the effects of inhomogeneities, variations in thickness, and non-uniform loading: when these are reduced (as happens when the foils are stuck onto a carrier foil) the ductility is considerably improved.

1516. HIGH-FREQUENCY ENERGY LOSSES IN SOLUTIONS CONTAINING MACROMOLECULES [Measurements by Malsch Thermometric Method at Frequencies up to 60 Mc/s].—Conner. (*Physik. Berichte*, 1st Sept. 1942, Vol. 23, No. 17, p. 1640.)

1517. ELASTIC AFTER-EFFECTS AND DIELECTRIC ABSORPTION IN GLASS [and Similar Highly Viscous Fluids such as Ebonite: Investigation of the Mechanism].—Taylor. (*Physik. Berichte*, 1st Sept. 1942, Vol. 23, No. 17, p. 1640: summary, from *Journ. Applied Phys.*, No. 10, Vol. 12, 1941, p. 753 onwards.)

1518. DIELECTRIC MEASUREMENTS ON PLASTICISED POLYVINYL CHLORIDE WITH EXTERNAL AND INTERNAL PLASTICISER.—Wüstlin. (*Physik. Berichte*, 1st Sept. 1942, Vol. 23, No. 17, p. 1639.)

1519. DIELECTRIC MEASUREMENTS ON BITUMEN AND ITS DERIVATIVES: II.—Walther. (*Physik. Berichte*, 1st Sept. 1942, Vol. 23, No. 17, p. 1638: summary, from *Kolloid-Zeitschr.*, No. 2, Vol. 99, 1942, p. 129 onwards.)

1520. ALTERNATIVE MATERIALS: DEVELOPMENTS OF ELECTRICAL INTEREST FOR PANELS AND SCREENING.—(*Electrician*, 12th March 1943, Vol. 130, No. 3380, p. 270.)

Metrelite boards are made by a process in which finely divided metals, zinc or aluminium, are sprayed on to synthetic resin bonded boards or similar materials. The electromagnetic screening properties of a standard sheet are equal to those of tinfoil of 0.2 mm thickness.

1521. ENAMELLED WIRE [Exceptionally Good Properties of "Thermex" and "Formex" Enamel].—(*Elec. Review*, 26th Feb. 1943, Vol. 132, No. 3405, p. 290.)

1522. BRITISH PLASTICS [Report of Speech at British Plastics Federation Luncheon].—Mohr. (*Electrician*, 26th Feb. 1943, Vol. 130, No. 3378, p. 211.)

1523. FIBRE GLASS AND ITS APPLICATIONS IN ELECTRICAL TECHNIQUE [Comparative Data of "Vetrotex," Cotton, & Silk: Use of Fibre Glass as Substitute for Mica, etc.].—Esmé. (*Physik. Berichte*, 15th Aug. 1942, Vol. 23, No. 16, p. 1584: summary of French paper.)
1524. ON THE MECHANISM OF FILM-FORMATION FROM EMULSIONS OF SOME HIGH-POLYMER COMPOUNDS [particularly Polychlorvinyl].—Wojtuzki & Dsjadel. (*Physik. Berichte*, 1st Aug. 1942, Vol. 23, No. 15, p. 1518: summary of Russian paper.)
1525. MEASUREMENT OF THE FILM THICKNESS OF ANODIC COATINGS ON ALUMINIUM AND ALUMINIUM ALLOYS [Method depending on Special Solvent which Dissolves the Oxide Skin without Damage to the Metal].—Wiederholt & others. (*Physik. Berichte*, 15th Aug. 1942, Vol. 23, No. 16, p. 1586.)
1533. THE EXTREME PROPERTIES OF MATTER [49th James Forrest Lecture to Institution of Civil Engineers: Subjects discussed include Elasticity, Plastics, Fluids, Gases, Weight, Electrical Properties, and Magnetism].—Darwin. (*Engineering*, 12th March 1943, Vol. 155, pp. 136-137: 19th March, pp. 144-145.)
1534. ON THE THEORY OF COSMIC-RAY SHOWERS [Further Contributions to the Fluctuation Problem].—Scott & Uhlenbeck. (*Phys. Review*, 1st/15th Dec. 1942, Vol. 62, No. 11/12, pp. 497-508.)
1535. RELATION OF THE COSMIC RADIATION TO GEOMAGNETIC AND HELIOPHYSICAL ACTIVITIES.—Broxon. (*Phys. Review*, 1st/15th Dec. 1942, Vol. 62, No. 11/12, pp. 508-522.)

MISCELLANEOUS

STATIONS, DESIGN AND OPERATION

1526. SUBJECTIVE MEASUREMENT OF THE QUALITY OF TELEPHONIC LINKS: II—OBSERVATIONS OF REPETITIONS: TECHNICAL PROCEDURE.—Panzerbieter & Rechten. (See 1442.)
1527. A 112-Mc/s TRANSMITTER—RECEIVER.—Lynch. (*QST*, Jan. 1943, Vol. 27, No. 1, pp. 30-33.)
1536. AMPLIFICATION OF DIRECT VOLTAGES WITH A HIGH-FREQUENCY PUSH-PULL CIRCUIT.—Kerkhof. (See 1387.)
1537. AUTOMATIC CIRCUIT CHECKING [Design of Apparatus for Increasing Speed and Reliability].—Bissmire & Davies. (*Wireless World*, March 1943, Vol. 49, No. 3, pp. 68-71.)
1538. RADIO BIBLIOGRAPHY: REMOTE CONTROL [and List of Previous Subjects].—Rettenmeyer. (*Radio* [New York], Dec. 1942, No. 275, pp. 26 and 29..34.) For a previous set see 455 of February.

GENERAL PHYSICAL ARTICLES

1528. A PROBLEM IN ELECTROSTATICS.—Thomas. (*Phys. Review*, 1st/15th Dec. 1942, Vol. 62, No. 11/12, p. 561: summary only.)
1529. RATIONAL ELECTRODYNAMICS: I—THE LIMITATIONS OF CLASSICAL ELECTROMAGNETISM: II—THE IDEAS OF KINEMATICAL RELATIVITY.—Milne. (*Phil. Mag.*, Feb. 1943, Vol. 34, No. 229, pp. 73-82, 82-101.)
The ideas developed "constitute the extension to the domain of electromagnetism of the methods which I have been developing since 1932 in the realms of kinematics, dynamics, and gravitation."
1530. FUNDAMENTAL ELECTROMAGNETIC CONCEPTS AND THEIR DIMENSIONS [Editorial].—G.W.O.H. (*Wireless Engineer*, March 1943, Vol. 20, No. 234, pp. 105-109.)
1531. THE MOTION OF THE MESON IN A HOMOGENEOUS MAGNETIC FIELD [Theoretical Treatment leading to Expressions for Energy of Meson showing Its Possession of a Magnetic Moment of Magnitude which (unlike That of an Electron) is Independent of the Velocity].—Galanin. (*Journ. of Phys.* [of USSR], No. 1/2, Vol. 6, 1942, pp. 27-34: in German.) For a further paper, on electron and meson spin, see pp. 35-47.
1532. THEORETICAL PHYSICS IN THE U.S.S.R. DURING THE PAST TWENTY-FIVE YEARS.—Ivanenko. (*Nature*, 13th March 1943, Vol. 151, pp. 293-294.) Cf. 1309 of April.
1539. AMPLIFIERS AND MAINS UNITS FOR THE SUPPLY OF COUNTER TUBES [including the Various Components of the Over-All Resolving Power of the Equipment, Rossi-Type Coincidence Amplifiers, Principles of Hexode Mixing, etc.].—Rehbein. (*Physik. Berichte*, 15th Aug. 1942, Vol. 23, No. 16, p. 1547: summary only.)
1540. SUPER-FREQUENCY DEVICES IN VIBRATION MEASUREMENT [Short Survey of Pick-Ups with Natural Frequencies Higher than That of Vibration to be Measured: including the A.E.G. Rochelle-Salt Pick-Up, Meister's Capacitive Type, etc.: with Literature References].—Meister. (*Arch. f. Tech. Messen*, June 1941, Part 120, VI72-1, Sheet T78.)
1541. MAGNETIC ZERO-CURRENT AMPLIFIERS [for Measuring & Control Purposes].—Geyger. (*Arch. f. Tech. Messen*, June 1941, Part 120, Z634-2, Sheet T91.) For other papers see 1134 of 1942 and back reference.
1542. FILTERS FOR CARRIER-FREQUENCY TELEPHONE SYSTEMS.—Weijers. (See 1399.)
1543. OPPORTUNITIES FOR ELECTRONICS IN INDUSTRIAL TEMPERATURE INSTRUMENTATION.—Béhar. (*Electronics*, Dec. 1942, Vol. 15, No. 12, pp. 72-74 and 163..166.) See also p. 41.

1544. "ARZTLICHE ELEKTROKARDIOGRAPHIE" [Book Review].—Holzer & Polzer. (*Elektrot. u. Maschbau*, 5th June 1942, Vol. 60, No. 23/24, p. 260.)
1545. ELECTRONIC COUNTER FOR RAPID IMPULSES [primarily Action-Potential "Spikes"].—Wellman & Raeder. (*Electronics*, Oct. 1942, Vol. 15, No. 10, pp. 74 and 140. 142.)
1546. THE USE OF THE PHILIPS PRESSURE INDICATOR IN GEOPHYSICAL PROSPECTING BY THE RADIO METHOD.—Fritsch & Forejt. (*Zeitschr. f. Geophys.*, No. 5/6, Vol. 17, 1942, p. 217 onwards.) The method was dealt with in a paper in another journal (3167 of 1942); the present paper is concerned with the geophysical application and the carrying out of the tests.
1547. THE DYNAMIC MEASUREMENT OF THE MODULUS OF ELASTICITY OF SYNTHETIC MATERIALS [using Mechanico-Pneumatic Note Generator & Electro-Magnetic Vibration Detector to find Resonance Point].—Frölich. (*Physik. Berichte*, 15th July 1942, Vol. 23, No. 14, p. 1447: summary of a *Kunststoffe* paper.)
1548. VIBRATION TABLE FOR DYNAMIC TESTS IN THE NOTCH-FREQUENCY RANGE [for Investigations on the Frequency Characteristics of Vibrometers: Sinusoidal Vibrations up to 10 kc/s].—Meister. (*Akust. Zeitschr.*, No. 2, Vol. 7, 1942, pp. 51-56.)
1549. ELECTRICAL-RESISTANCE PROPERTIES OF DILUTE BINARY ALLOYS OF COPPER, SILVER, AND GOLD [including a Silver-Manganese Alloy very suitable for the Measurement of Pressure].—Linde. (*Zeitschr. f. Instr. Kunde*, Oct. 1941, Vol. 61, No. 10, pp. 353-355: summary only.)
1550. AN INSTRUMENT FOR MEASURING SURFACE ROUGHNESS [using Rochelle-Salt Pick-Up].—Gravley. (*Electronics*, Nov. 1942, Vol. 15, No. 11, pp. 70-73.)
1551. MEASURING INSTRUMENTS FOR STATIC EXPANSION MEASUREMENTS: III—INSTRUMENTS WITH ELECTRICAL INDICATION [Types using Barrier-Layer Photocell, Inductance-Change, Capacitance-Change (Too Sensitive to Disturbances) & Steel-Wire (Maihak) Principles].—Lehr. (*Arch. f. Tech. Messen*, Oct. 1942, Part 136, V91122-7, Sheets T102-103.)
1552. ENERGY-STORAGE WELDING CONTROLS: PART 5 [Magnetic & Electrostatic Storage Systems to reduce Peak Power Demand on Mains, for Resistance Welding of Non-Ferrous Metals].—Rogers. (*Electronics*, Dec. 1942, Vol. 15, No. 12, pp. 63-67 and 174, 175.)
1553. RADIO-FREQUENCY HEATING AIDS TIN-CAN MAKERS [in Their Electroplating Method of Economising in Tin].—(*Electronics*, Dec. 1942, Vol. 15, No. 12, p. 86.)
1554. AVOIDING PATENT PITFALLS [particularly the Necessity of keeping Records of Invention & All Work relating Thereto].—Wild. (*Electronics*, Dec. 1942, Vol. 15, No. 12, pp. 78 and 159. 162.)
1555. FROM THE PHYSICS AND TECHNIQUE OF THE SHORTEST RADIO WAVES [Circuit Components, Valves, Velocity-Modulation Devices].—Tank. (*Bull. Assoc. suisse des Elec.*, 3rd June 1942, Vol. 33, No. 11, p. 315 onwards.) A ten-page survey.
1556. PRECISION TIME CONTROL [for Synchronous Clocks].—Nat. Broadcasting Company. (See 1481.)
1557. PAPER ON THE EMPLOYMENT OF SUPERSONIC WAVES IN MODERN TECHNIQUE.—Oggioni. (See 1452.)
1558. RESULTS WITH GEOELECTRICAL POLARISATION MEASUREMENTS [Method of Prospecting based on the Forces of Polarisation set up by A.C. or Periodic D.C., and altering the Electrical Properties: Special Advantages].—Müller. (*Physik. Berichte*, 15th Aug. 1942, Vol. 23, No. 16, p. 1612: summary, from *Zeitschr. f. Geophys.*, No. 7/8, Vol. 16.)
1559. PROPAGATION METHODS OF RADIO PROSPECTING: B—ABOVE-GROUND METHODS [including Those of Grosskopf & Vogt and of Burstyn].—Fritsch. (*Arch. f. Tech. Messen*, June 1941, Part 120, V65-21, Sheets T80-81.)
1560. NEW DEVELOPMENTS IN THE ANALYSIS OF MACHINE VIBRATIONS [Short Survey of Various Methods (including Piezoelectric) leading to Inertialess System of Light Beam, Rigidly Attached Mirror, & Photocell/Amplifier/Cathode-Ray-Oscillograph Combination].—De Gregorio. (*Formacion y Documentacion profesional* [Madrid], Jan./Feb. 1942, Vol. 1, No. 1, pp. 46-47: summary, from *L'Energia Elettrica*.)
1561. "QUARZDRUCKMESSGERÄTE HOHER EIGENFREQUENZ" [Pressure-Measuring Devices (for Motor Research) of High Natural Frequency: Vibration Properties, and Prevention of Troubles due to Inertia: Book Review].—Gohlke. (*Akust. Zeitschr.*, July 1942, Vol. 7, No. 4, pp. 168-170.)
1562. A METHOD FOR THE EXACT REGULATION OF FIXED ROTATIONAL SPEEDS OF AN AXLE.—Kirschstein. (See 1484.)
1563. THE ARABIC TELEGRAPH ALPHABET.—Worrell. (*QST*, Jan. 1943, Vol. 27, No. 1, p. 34.)
1564. NEW ENEMY-SPONSORED EUROPEAN POSTS AND TELECOMMUNICATIONS UNION.—(*Elec. Review*, 12th March 1943, Vol. 132, No. 3407, p. 362.)

1565. GENERATORS FOR SHORT-WAVE THERAPY [Choice of Frequency & Power: Generator Circuits: Matching to the Patient Circuit: Details of Actual Equipment: etc.].—J. Fransen & J. M. Ledebøer. (*Philips Tech. Rundschau*, May 1942, Vol. 7, No. 5, p. 147 onwards.)
1566. THE STATISTICAL AVERAGE IN THE MEASUREMENT AND USE OF DRY-PLATE-RECTIFIER PLATES.—Maier. (*Arch. f. Tech. Messen*, May & June 1941, Parts 119 & 120, Z52-3 & 4, Sheets T76-77 & 89-90.)
1567. THE USE OF SECONDARY ELECTRON EMISSION TO OBTAIN TRIGGER OR RELAY ACTION.—Skellett. (*Journ. Applied Phys.*, Aug. 1942, Vol. 13, No. 8, pp. 519-523.) A summary was dealt with in 676 of February.
1568. ELECTRICAL REMOTE CONTROL [Typical Applications, Circuit Initiating Methods and End-Actions].—Doit & Galton. (*Electronics*, Nov. 1942, Vol. 15, No. 11, pp. 60-64 and 173, 174.) Continued in Dec. issue, pp. 57-60 and 167-169.
1569. TEMPERATURE MEASUREMENT AND CONTROL BY ELECTRONICS [General Account with a Description of Several Electronic Instruments].—Walsh. (*Electronics*, Oct. 1942, Vol. 15, No. 10, pp. 56-61 and 94-98.)
1570. A NEW METHOD OF MEASURING THE VELOCITY OF A GASEOUS JET WITH STEADY FLOW [Electric Circuit with Two Grids across the Flow, and a Condenser whose Potential is Measured by Sensitive Instrument].—Yadoff. (*Physik. Berichte*, 1st July 1942, Vol. 23, No. 13, p. 1296: summary, from *Comptes Rendus* [Paris], No. 3, Vol. 214, 1942, p. 102 onwards.)
1571. ON THE PRODUCTION, PREVENTION, AND DANGEROUSNESS OF ELECTROSTATIC CHARGES [in Industrial Processes: including Data on Minimum Spark Energies for Ignition of Various Vapour-Air Mixtures].—Nitka. (*Physik. Berichte*, 15th June 1942, Vol. 23, No. 12, pp. 1234-1235.)
1572. ELECTRIFICATION BY BUBBLING: IV—EFFECT OF VISCOSITY AND OF TEMPERATURE [Further Development of Researches on Electrification by passing Gases through Liquids].—Lovera & Pochettino. (*Physik. Berichte*, 15th July 1942, Vol. 23, No. 14, pp. 1423-1424: summary of Italian paper.)
1573. APPLICATIONS OF CATHODE-RAY TUBES [in Ultra-High-Frequency Technique: Survey].—Dudley. (*Electronics*, Oct. 1942, Vol. 15, No. 10, pp. 49-52 and 154, 155.)
1574. THE CATHODE-RAY OSCILLOGRAPH IN POLAROGRAPHY [Application of Electronic Methods to Chemical Analysis].—Jones. (*Electronic Eng'g*, Feb. 1943, Vol. 15, No. 180, pp. 367-371.)
1575. MEASUREMENT OF THE MOISTURE CONTENT OF SALTS WITH HIGH ELECTRICAL CONDUCTIVITY, BY AN ULTRA-HIGH-FREQUENCY METHOD, SUITABLE FOR RAPID ANALYSIS, BASED ON THE DEPENDENCE OF DIELECTRIC CONSTANT ON MOISTURE CONTENT.—Worasko & others. (*Physik. Berichte*, 1st July 1942, Vol. 23, No. 13, pp. 1302-1303: summary of a Russian paper.)
1576. RADIO-FREQUENCY HEATING SPEEDS PLYWOOD BONDING [by Extending the Use of Hot Press Methods to Thick Plywood].—(*Electronics*, Nov. 1942, Vol. 15, No. 11, p. 79.) Cf. 975 of March.
1577. THE USE OF WOOD, DRIED IN A HIGH-FREQUENCY (PARTICULARLY AN ULTRA-HIGH-FREQUENCY) FIELD, FOR ELECTRICAL INSULATION.—Siemens-Schuckert. (*Zeitschr. f. Fernmeldetech.*, 16th Feb. 1942, Vol. 23, No. 2, p. 28.) D.R.P. 704 667.
1578. ON THE INFLUENCE OF SOME ELECTRICAL PARAMETERS ON THE CHEMICAL REACTION OF ETHYLENE IN A HIGH-FREQUENCY CORONA DISCHARGE [converting into Acetylene: Absence of Dependence on Wavelength, between 190 & 500 m: Dependence on Current Strength (with Empirical Formula)].—Eiduss & Netschajewa. (*Physik. Berichte*, 15th June 1942, Vol. 23, No. 12, p. 1241.)
1579. A SUMMARY OF X-RAY SATELLITES.—Hirsh. (*Reviews of Modern Phys.*, Jan. 1942, Vol. 14, No. 1, pp. 45-54.)
1580. X-RAY-TUBE CATHODES [Effect of Design Details on Performance of Tube].—Long. (*Electronic Eng'g*, Feb. 1943, Vol. 15, No. 180, pp. 364-366.)
1581. THE BETATRON [Possible Use of New Powerful X-Ray for Medical Purposes].—(*Science*, 4th Dec. 1942, Vol. 96, No. 2501, p. 10.) For the Betatron see 153 of January.
1582. A NEW SONIC AND SUPERSONIC TRANSMITTER FOR THE PRODUCTION OF HIGH INTENSITIES IN GASES [and Liquids].—Ehret & Hahnemann. (See 1453.)
1583. LOCALISATION OF THE DISCHARGE IN GEIGER-MÜLLER COUNTERS.—Wilkening & Kaune. (*Phys. Review*, 1st/15th Dec. 1942, Vol. 62, No. 11/12, pp. 534-537.)
1584. COUNTER TUBES AND THEIR USE IN MEASURING TECHNIQUE.—Neuert. (*Arch. f. Tech. Messen*, June 1941, Part 120, J076-1, Sheets T85-86.) For later papers see 2918 of 1942.
1585. RESEARCHES ON THE CHEMICAL REACTIONS OF ELECTRICAL DISCHARGES: XXVII—NOTE ON THE PRODUCTION OF HYDRAZINE BY MEANS OF THE ARC, OF HIGH OR LOW FREQUENCY, IN NITROGEN-HYDROGEN MIXTURES OR AMMONIA.—Briner & Hofer. (*Physik. Berichte*, 15th Aug. 1942, Vol. 23, No. 16, p. 1564: summary, from *Helvet. Chim. Acta*, 1942.)

1586. ON THE FUNCTIONING OF AN X-RAY TUBE SUBMITTED TO VOLTAGE PULSES [for Very Short Exposures: the Magnitude of the Pulse Currents: Equipment: the Practicability of making Stroboscopic Records of Periodic Processes].—Herreng. (*Comptes Rendus* [Paris], No. 9, Vol. 214, 1942, p. 421 onwards: summary in *Physik. Berichte*, 15th Aug. 1942, Vol. 23, No. 16, p. 1570.)
1587. RADIATION MEASUREMENT IN THE ULTRAVIOLET: I—GENERAL CONSIDERATIONS AND MEANS OF MEASUREMENT [Thermal, Photoelectric, Photochemical, Photographic, Fluorescence Methods: for Wavelengths 200–400 Nanometres ($1 \text{ nm} = 10^{-9} \text{ m}$): etc.]. Seitz & Meyer. (*Arch. f. Tech. Messen*, Oct. 1942, Part 136, J323-1, Sheets T108–109.)
1588. CONTRIBUTION TO OUR KNOWLEDGE OF THE VARIATION OF TRANSPARENCY OF COLLOIDAL IRON IN A MAGNETIC FIELD.—Frongia & Agus. (See 1173 of April.)
1589. ON AN OPTICAL EFFECT IN [Flowing] COLLOIDS, and ON THE TYNDALL LIGHT OF COLLOIDS IN A MAGNETIC FIELD [Experiments with Colloidal Silver, Bravais' Iron, etc.: Effects due to Imperfect Sphericity of Particles].—Peralia. (*Physik. Berichte*, 1st Aug. 1942, Vol. 23, No. 15, p. 1484: pp. 1484–1485: summaries of Italian papers.)
1590. ZEISS T-OBJECTIVE [with Reflection-Reducing Films: Design Calculations, & Advantages additional to Increased Transmission].—Leistner. (*Physik. Berichte*, 15th July 1942, Vol. 23, No. 14, p. 1427: summary, from *Photogr. u. Forsch.*)
1591. TELESCOPES FOR MEASURING INSTRUMENTS [Combination of Refracting & Reflecting Telescope Systems to give a "Lens-Reflector" Telescope of Very Short Length but Large Aperture].—Wild. (*Zeitschr. f. Instr. kunde*, Oct. 1941, Vol. 61, No. 10, pp. 355–356: summary only.)
1592. THE DETERMINATION OF AN UNKNOWN FREQUENCY FROM A PHOTOGRAPHIC RECORD.—Scott. (*Electronic Eng'g*, Nov. 1942, Vol. 15, No. 177, p. 243.)
1593. "SICHTBEOBACHTUNGEN VOM METEOROLOGISCHEN STANDPUNKT" [Book Review: Visual Ranges & the Effects of Moisture, Dust, Mist, etc.].—Löhle. (*Zeitschr. f. tech. Phys.*, No. 9, Vol. 23, 1942, p. 242.)
- Referring to the chapter on telephotography and infra-red photography, the reviewer (Gaertner) disagrees with the author's contention that the increased ranges obtained by infra-red photography are chiefly due to the "chlorophyll" effect—an increased contrast between the green of foliage and its surroundings: for his own personal observations have proved the better haze-penetrating power of the infra-red rays in the case of objects having no foliage near them.
1594. A PHOTOELECTRIC DENSITOMETER [primarily to ensure Uniformity of Gray-Scale Densities of Colour-Photography Negatives].—Smith. (*Electronics*, Dec. 1942, Vol. 15, No. 12, pp. 79 and 82.)
1595. MEASURING FAINT LIGHT [Application of Selenium Cells].—Baker. (*Elec. Review*, 12th March 1943, Vol. 132, No. 3407, pp. 343–345.)
1596. THE PRESENT PRACTICAL RANGES OF APPLICATION OF PHOTOELECTRIC DEVICES [Photoelectric Cells & Multipliers, Photoelectric Resistances, & Dry-Plate Photo-cells: Life, and Loading Limit: Minimum Illumination: Frequency Characteristics: Temperature Limits].—Kluge. (*Arch. f. Tech. Messen*, May 1941, Part 119, J390-1, Sheets T74–75.)
1597. ELECTRONIC CONTROL FOR ONE-WAY TUNNEL [Traffic Lights controlled by Photoelectric Counter, Ventilation by Carbon-Monoxide Electronic Equipment].—(*Electronics*, Dec. 1942, Vol. 15, No. 12, p. 82.)
1598. PHOTOELECTRIC CONTROL OF COAL LARRY [for Even Distribution of Fuel to Hopper feeding Chain-Grate Boiler].—(*Electronics*, Dec. 1942, Vol. 15, No. 12, pp. 84 and 86.)
1599. A PHOTOMETRIC METHOD OF MEASURING THE SURFACE QUALITY OF FINISHED PRODUCTS.—Heyes & Lueg. (*Physik. Berichte*, 1st Aug. 1942, Vol. 23, No. 15, p. 1521: summary, from *Werkstattstech.*, No. 5/6, Vol. 36, 1942, p. 98 onwards.)
1600. NEW MEASUREMENTS OF THE VISUAL CONTRAST THRESHOLD [for Field Densities between 10^{-1} & 10^{-7} Stilb: Comparison of Values for Monocular and Binocular Vision: etc.].—Siedentopf. (*Physik. Berichte*, 15th Aug. 1942, Vol. 23, No. 16, p. 1590.)
1601. THREE-DIMENSIONAL SEEING. ["Stereo-Stroboscope", primarily to assist in Choice of Ground for Forced landing: Combination of Two Telescopes alternately blocked & opened by Perforated Rotating Disc: Base Length of 3 m for Flying Speed of 360 km/hour].—Bartow Beacons, Inc. (*Physik. Berichte*, 1st Aug. 1942, Vol. 23, No. 15, pp. 1465–1466: summary, from *Flight*, 1942.)
1602. POST-WAR INDUSTRIAL RESEARCH [Editorial].—(*Engineering*, 19th Feb. 1943, Vol. 155, pp. 151–152.)
1603. THE PROFESSION OF ENGINEER: THE DIFFERENT INTELLECTUAL CAPACITIES AND MORAL QUALITIES WHICH FORM THE GOOD ENGINEER, and REMARKS AND CONTRIBUTIONS FROM PRACTICAL EXPERIENCE.—Silberer: Schiesser. (*Bull. Assoc. suisse des Elec.*, 13th Jan. 1943, Vol. 34, No. 1, pp. 1–7: in French: pp. 7–9: in German.)

1604. SCIENTIFIC RESEARCH AND DEVELOPMENT [Research in War-Time: Comparison of Organisation in United Kingdom, U.S.A., and U.S.S.R.].—(Nature, 20th Feb. 1943, Vol. 151, No. 3825, pp. 203-207.)
1605. THE FULLER UTILISATION OF SCIENTIFIC RESOURCES FOR TOTAL WAR.—Rosebury. (Science, 25th Dec. 1942, Vol. 96, No. 2504, pp. 571-575.)
1606. PROGRESS IN ELECTRICAL RESEARCH [Review of 22nd Annual Report of the British Electrical & Allied Industries Research Association].—(Engineering, 19th Feb. 1943, Vol. 155, pp. 156-157.)
1607. "ELECTRICAL TECHNOLOGY FOR TELECOMMUNICATIONS" [Book Review].—Date. (Elec. Review, 12th March 1943, Vol. 132, No. 3407, p. 348.)
1608. "THE RADIO AMATEUR'S HANDBOOK, SPECIAL DEFENSE EDITION" [Book Review].—American Radio Relay League. (Proc. I.R.E., Jan. 1943, Vol. 31, No. 1, p. 43.) For another review see 3444 of 1942.
1609. "RADIO ENGINEERING" [Book Review].—R. C. Norris. (Elec. Review, 5th March 1943, Vol. 132, No. 3406, p. 331.)
1610. "ELEMENTARY ELECTRICITY FOR RADIO STUDENTS" [Book Review].—Flood. (Wireless World, March 1943, Vol. 49, No. 3, p. 71.)
1611. "ELECTRICAL FUNDAMENTALS OF COMMUNICATION" [Book Review].—Albert. (QST, Jan. 1943, Vol. 27, No. 1, p. 64.)
1612. "ELECTRICITY AND MAGNETISM" [Book Review].—Gilbert. (Journ. Applied Phys., Dec. 1942, Vol. 13, No. 12, pp. 745 and 746.)
1613. "EXPERIMENTAL RADIO ENGINEERING" [2nd Edition: Book Review].—Rapson, assisted by Ackermann. (Electrician, 26th Feb. 1943, Vol. 130, No. 3378, p. 220.) Describes experiments suitable for college laboratories.
1614. ELECTRON-TUBE TERMINOLOGY.—White. (See 1423.)
1615. "MITTEILUNGEN AUS DER FORSCHUNGSANSTALT DER DEUTSCHEN REICHSPOST (RPF): BAND VII, 1942" [Book Review].—(Hochf. tech. u. Elek. akus., Nov. 1942, Vol. 60, No. 5, p. 148.)
For the twelve papers here listed see (1) 2963 of 1941; (2) 3091 of 1941; (3) 356 & 926 of 1942; (4) 376 of 1942; (5) 1926 of 1942; (6) 1953 of 1942; (7) 1927 & 3526 of 1942; (8) 3552 of 1942; (9) 964 of 1942; (10) "Technical Applications of a Ground-Conductivity Meter"; this is probably the short T.F.T. paper mentioned at the beginning of the long abstract 2955 (see also 2956) of 1942; (11) 3586 of 1942; and (12) 1065 of 1942.
1616. "A SHORT COURSE IN TENSOR ANALYSIS FOR ELECTRICAL ENGINEERS" [Book Review].—Kron. (Journ. Applied Phys., Jan. 1943, Vol. 14, No. 1, p. 36.)
1617. "MATHEMATICS FOR ELECTRICIANS AND RADIOMEN" [Book Review].—Cooke. (Proc. I.R.E., Jan. 1943, Vol. 31, No. 1, p. 41.)
1618. THE USE OF A MECHANICAL SYNTHESIZER TO SOLVE TRIGONOMETRIC AND CERTAIN TYPES OF TRANSCENDENTAL EQUATIONS AND FOR THE DOUBLE SUMMATIONS INVOLVED IN PATTERSON CONTOURS.—Leroy Brown & Wheeler. (Journ. Applied Phys., Jan. 1943, Vol. 14, No. 1, pp. 30-35.)
Authors' summary:—"A method is shown whereby equations in trigonometric form and types of transcendental equations, which can be expanded into rapidly converging series, may be solved by a mechanical and graphical process. A mechanical and graphical method is also shown which effects the double summation of Fourier series used in the Patterson method for the determination of interatomic distances in crystals. Graphs are given to illustrate each of the processes discussed.
1619. A NEW ANALYTICAL METHOD OF SOLVING VAN DER POL'S AND CERTAIN RELATED TYPES OF NON-LINEAR DIFFERENTIAL EQUATIONS, HOMOGENEOUS AND NON-HOMOGENEOUS.—Shohat. (Journ. Applied Phys., Jan. 1943, Vol. 14, No. 1, pp. 40-48.)
Author's summary:—"A simple analytical treatment is developed for the differential equation $(d^2u/dt^2) - \epsilon(1-u^2)(du/dt) + u = 0$ (van der Pol), in order to study the behaviour of its solution assumed bounded in $(0, \infty)$. It is shown, without any further assumption, that, if $\epsilon \ll 1$, $u(t)$ can be approximated closely, for $t \gg 0$, by a simple oscillation with amplitude 2. This is a more precise form of a statement due to van der Pol. It is further shown that $u^2(t) + u^2(t) \sim 4$, $t \gg 0$, $0 < \epsilon \ll 1$. The method and results are then extended to the more general equation $(d^2u/dt^2) - \epsilon F(u)(du/dt) + u = 0$, in particular, for $F(u) = 1 - u^2$, $1 - 2au - u^2$, $a = \text{constant}$, also to the non-homogeneous equation $(d^2u/dt^2) - \epsilon F(u)(du/dt) + u = a$ a given function of t . The analytical results obtained in this paper show a remarkable agreement with those obtained for the same equations by mechanical means (on the differential analyser)".
1620. APPLICATION OF VECTOR ALGEBRA [Elementary Article on Application of Vector Methods to Radio Problems].—Rensselaer. (Radio [New York], Dec. 1942, No. 275, pp. 14-16 and 44, 45.)

GOODS FOR EXPORT

The fact that goods made of raw materials in short supply owing to war conditions are advertised in this journal should not be taken as an indication that they are necessarily available for export.

Higher load

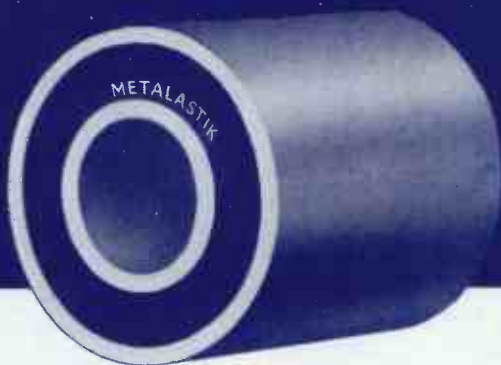

METALASTIK BUSHES are typical examples of the scientific application of Rubber-to-Metal Weld.

The rubber, being welded to the metal is used to the maximum efficiency, and the whole volume can be stressed in every conceivable combination of torsion, shear, compression or tension.

Thus it is that higher loads can be applied or smaller bushes employed.

The range of METALASTIK Rubber-to-Metal Weld Bushes is practically unlimited and covers such widely differing loads and frequencies as are called for in Automobiles, Ships, Railway Engines and Rolling Stock, Machine Tools, and in Agricultural, Textile and Domestic Machinery.

METALASTIK LTD.

METALASTIK
RUBBER-TO-METAL WELD

LEICESTER

CONSULT US ON ALL YOUR VIBRATION PROBLEMS



or smaller bush



Going one better
IN COMMUNICATIONS



To-day, wherever Bullers Low Loss Ceramics are used, reception is clearer and better than ever before.

Years of research in Bullers Laboratories have developed these materials to such a high level of efficiency that Dielectric Loss is virtually eliminated. Bullers Ceramics are now playing a vital part in maintaining communications under all conditions.

BULLERS LIMITED
THE HALL, OATLANDS DRIVE, WEYBRIDGE, SURREY
Telephone: Walton-on-Thames 2451
Manchester Office: 196 Deansgate, Manchester

Bullers

LOW LOSS CERAMICS

**Made
in Three
Principal
Materials:**

FREQUELEX. An Insulating Material of Low Dielectric Loss. For Coil Formers, Aerial Insulators, Valve Holders, etc.

PERMALEX. A High Permittivity Material. For the construction of Condensers of the smallest possible dimensions.

TEMPLEX. A Condenser material of medium permittivity. For the construction of Condensers having a constant capacity at all temperatures.

