

# THE WIRELESS ENGINEER

VOL. XVIII.

MARCH, 1941

No. 210

## The Oscillating High-Frequency Ammeter

IN 1937 H. M. Turner and P. C. Michel of Yale University described\* a novel type of ammeter suitable for frequencies above a megacycle per second. It depended on electrodynamic principles and was developed with the object of checking the readings of thermo-ammeters at extremely high frequencies. The principal novelty was that, instead of reading a steady deflection, one determined, by means of a stop-watch, the frequency of oscillation of a swinging coil. In its original form the oscillating coil was a single turn of No. 26 copper wire about  $\frac{3}{8}$  in. diameter suspended by means of a quartz fibre, the whole being enclosed in a glass tube to protect it from draughts. Near it was fixed another somewhat larger turn of wire carrying the high-frequency current to be measured. The two coils are adjusted to be approximately at right-angles as shown in Fig. 1. If they are exactly at right-angles the mutual inductance  $M$  between them is zero and the alternating current has no effect on the suspended coil. If the suspended coil is displaced from this position, current is induced in it and it experiences a force tending to bring it back, just as a pendulum does, and like the pendulum, its kinetic energy causes it to overshoot the zero position and to oscillate about it. In the present case as in the old Aron meter, the frequency of the oscillation is used to measure



Fig. 1.

the current producing the electrodynamic forces, but in a very different manner. If  $i_1$  and  $i_2$  are the currents at any instant in the fixed and moving coils, the e.m.f. induced in the moving coil will be  $e = M \frac{di_1}{dt}$ , and, if the resistance is negligible, this e.m.f. will set up a current  $i_2$  such that  $e = L di_2/dt$ .  $di_1$  and  $di_2$  will be magnetically opposed but always in the fixed ratio  $L/M$ ; hence  $i_1$  and  $i_2$  are  $180^\circ$  out of phase and  $i_1/i_2 = L/M$ . At the frequencies with which we are concerned  $M$  may be considered constant during a cycle of the alternating current. It can easily be shown that when two coils carrying currents  $i_1$  and  $i_2$  have a mutual inductance  $M$ , the torque is given by the formula  $T = i_1 i_2 dM/d\theta$ , where  $dM/d\theta$  is the change in  $M$  per radian of deflection. Putting  $i_2 = i_1 M/L$  we have  $T = i_1^2 \frac{M}{L} \frac{dM}{d\theta}$  for the torque due to the instantaneous current  $i_1$ ; the average torque during a cycle will thus be a measure of the mean square value of the current whatever its wave-form.

As the result of this restoring torque, the coil will oscillate slowly about its zero position. Let the frequency of this oscillation be  $F$  complete oscillations per second; then it can be shown that  $F = \frac{1}{2\pi} \sqrt{\frac{T/\theta}{J}}$  where  $T/\theta$  is the torque per radian of displacement and  $J$  is the moment of inertia of the moving system. Substituting the value of  $T$  found above we obtain the formula

$$F = \frac{1}{2\pi} \sqrt{\frac{I_1^2 \cdot M \cdot \frac{dM}{d\theta}}{L \cdot J}}$$

\* Proc. Inst. Rad. Eng., XXV., p. 1367.

For small values of  $\theta$ ,  $M$  may be assumed to vary linearly with  $\theta$  and  $dM/d\theta = M/\theta$ ; on this assumption\*.

$$I = \frac{2\pi F \sqrt{JL}}{dM/d\theta}$$

The instrument was calibrated both by calculation from the above formula and by comparison with a thermo-ammeter at frequencies between one and five megacycles per second, at which the thermo-ammeter could be assumed to give accurate readings. The agreement was excellent, but at higher frequencies the thermo-ammeter gave higher readings, the difference increasing from 4 per cent. at 10 Mc/s up to 80 per cent. at 80 Mc/s. Of this latter 50 per cent. was due to increased resistance of the heater due to skin-effect, leaving 30 per cent. to be accounted for in other ways.

When measuring small currents the frequency of oscillation becomes comparable with the natural frequency of oscillation of the suspended coil, and a correction must be then employed since the restoring force contains an appreciable component due to the quartz fibre. This correction factor is 0.98 when  $F$  is five times the natural frequency and 0.87 when it is only twice the natural frequency.

The next step in development was described by H. R. Meahl† who did away with the quartz fibre suspension and mounted the oscillating ring in jewelled bearings. The exciter loop about 1.5 in. diameter was made of No. 14 copper wire, and the oscillating ring of duraluminum and of about half the diameter was mounted at its centre. It was fitted with polished steel pivots and the bearings were polished sapphires. The whole instrument was placed under a glass cover, but as this glass cover was only about 3 in. × 3 in. × 3 in. it will be seen that the instrument has been reduced to a practical, portable, piece of apparatus occupying little, if any, more room than a thermo-ammeter, and capable of calibration by calculation in terms of length, mass and time. Comparisons were made with several thermo-

ammeters which had been calibrated at low frequency, or with direct current, and the correction due to skin-effect calculated for frequencies up to about 40 megacycles per second; the results were very satisfactory. Instead of observing the oscillations and checking them with a stop-watch, Meahl used a lamp and a photo-electric cell with an amplifier giving a record on a two-pen chronograph, the other pen being operated every second from a standard clock.

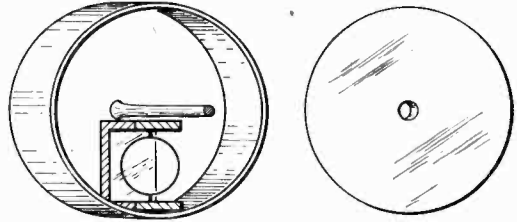

Fig. 2.

A later development was described quite recently by Michel and Meahl together with M. W. Scheldorf and T. M. Dickinson, who are all with the General Electric Co. of America\*. The primary loop is replaced by a single-turn toroid, as shown in Fig. 2. The current passes along the central conductor, then symmetrically radially outwards, returning along the outer cylinder and radially inwards in the cover which is shown removed in the diagram. The current system thus serves as a screen for the oscillating coil. In a thermo-ammeter the effect of frequency increases continuously with the frequency because the skin-effect causes a continuous increase of resistance. In the electrodynamic ammeter, on the other hand, the inductances upon which the indication depends tend, with increasing frequency, to constant limiting values independent of frequency. An example is given in which the indication of a conventional 5-ampere thermo-ammeter changed 1.6 per cent. between 0.5 and 5.0 Mc/s and over 40 per cent. between 5 and 50 Mc/s, whereas with an electrodynamic instrument the corresponding changes were 0.77 and 0.25 per cent. The instrument undoubtedly represents a valuable addition to the methods available for the measurement of currents of very high frequency. G.W.O.H.

\* There is a mistake in the formula in the original paper;  $F$  is shown as occurring twice on the right-hand side. There is also something wrong with Fig. 3;  $d$ , which is stated to be the diameter of the exciter coil, is probably the diameter of the wire of which the ring is made.

† *Proc. Inst. Rad. Eng.*, XXVI, 1938, p. 734.

\* *Electrical Engineering*, New York, Dec. 1940, p. 654.

# Measurements of Shot and Thermal Noise\*

## The Linear Rectifier as Indicator

By D. A. Bell, M.A.

### 1. Introduction

AS soon as the technique of amplification by thermionic valves had reached the stage where the possible gain is limited by the discontinuous nature of the electric current, the random fluctuations of which may be sufficient to drown a weak signal, the phenomena known as shot noise and thermal or Johnson noise acquired practical importance. Fortunately the progress which required these phenomena to be brought within the sphere of the designer of apparatus also provided the means of measurement, which can now be reduced to a routine nature. The classical work on "noise" established by direct measurements the fundamental laws on which substitution methods of measurement may be based, principles which may be summarised in two well-known formulae:—

(a) Nyquist's formula for the mean-square thermal noise voltage across a resistance,

$$\bar{V}^2 = 4RkTdf \dots \dots \dots (1)$$

(b) The formula for mean-square shot noise current through a temperature-limited diode,  $\bar{I}^2 = 2iedf \dots \dots (2)$

(The shot noise formula (2) is given in terms of a mean-square noise *current*, because a voltage expression would have to include the constants of the anode circuit external to the valve, and would therefore be less general.) In each case the mean-square noise is proportional to the width of frequency-band *df*, though independent of the mean frequency; by working at a high mean frequency it is possible to reduce the amplifier gain necessary for a measurable noise output, by the use of a wide frequency-band†.

Formulae (1) and (2) being known, measurements on such subjects as multi-electrode amplifying valves are best carried out by a substitution method, using either a resistance or a temperature-limited diode

as known noise source, rather than by measuring the gain and pass-band of the amplifier in terms of sinusoidal signals. At low frequencies the resistance is the more reliable noise source, since it is not subject to microphonic and "Flicker" effects; but at high frequencies the diode is preferable, since the anode current can be controlled by varying cathode temperature, thus varying the amount of noise generated without changing the reactance thrown across the external circuit, and at high frequencies spurious valve noises are not noticeable. A tungsten filament diode (actually a triode with grid and anode joined) was therefore used as a standard noise source for the experiments described in this paper.

Given a controllable noise source and a suitable amplifier (the latter such as might be developed for television work), it only remains to find a suitable output meter; and since formulae (1) and (2) are in terms of squared voltage and current respectively, it has been customary to use a square-law instrument. But a thermal meter is the only accurate square-law instrument for noise measurement, since devices such as an anode-bend valve voltmeter are liable to overload on the peak amplitude of an irregular signal before the mean energy is sufficient to give a good reading. Thermal meters, on the other hand, have the disadvantages of small overload capacity and slow action. As the amplifier which was available for certain noise measurements was already fitted with a linear rectifier (diode), some experiments were carried out to determine empirically the type of law relating the mean square of the applied noise voltage to the mean D.C. output of the linear rectifier (as indicated on a moving-coil galvanometer).

Strictly speaking, a substitution method makes it unnecessary to know the law of the indicating instrument; but a knowledge of the law makes interpolation possible

\* MS. accepted by the Editor, November 1940.

† cf. Percival and Horwood, *Wireless Engineer*, Vol. 15 (1938), p. 128.

where exact substitution is difficult (e.g. resistance substitution, using a series of fixed resistors) and can be used to increase the accuracy of measurement in the manner

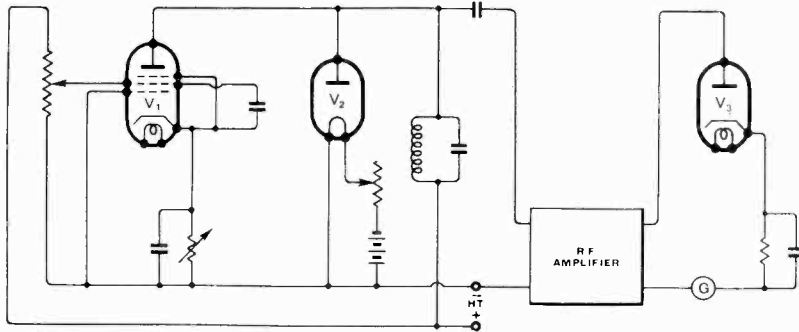

Fig. 1.

described below. The first experiment was therefore the determination of the rectifier law.

**2. Experimental Results**

As mentioned above, a diode with anode current controlled by cathode temperature was used as an adjustable noise source. (The diode anode potential was of course high enough to maintain saturation over the whole working range of anode currents.) The mean-square noise voltage reaching the diode rectifier from this source is then proportional to the mean anode current of the noise-generating diode. The arrangement of the apparatus is shown in Fig. 1, where  $V_1$  is the valve whose noise performance is to be examined,  $V_2$  the noise-generating diode, and  $V_3$  the rectifying diode. For determination of the rectifier law,  $V_1$  was removed and  $V_2$  alone used as noise source. The standing current in the rectifier load, with zero signal, was measured first, with the amplifier gain control set to minimum; this current will be denoted by  $I_0$ . With the amplifier working at normal gain, the values of rectified current  $I$  were noted for a series of values of anode current in the noise-generating diode, and the amount of the standing current in the rectifier subtracted from each, so as to give a net value of rectified current  $I' = I - I_0$ . A first plot of  $I'$  against anode current  $i_a$  of the noise diode gave a curve which suggested a square law relationship, and a subsequent

plot of  $(I')^2$  against  $i_a$  gave the straight line shown in Fig. 2. Later measurements confirmed this result, so the law of the diode rectifier as a noise indicator is that the square

of the mean rectified current is linearly related to the mean square noise voltage. The scatter of the points about the line in Fig. 2 is no greater than the probable experimental error, since the amplifier was mains driven without any stabilisation of supplies; the intercept on the Y

axis represents the amplifier noise. The apparatus was next applied to the measurement of noise generated by various amplifying valves connected to the input of

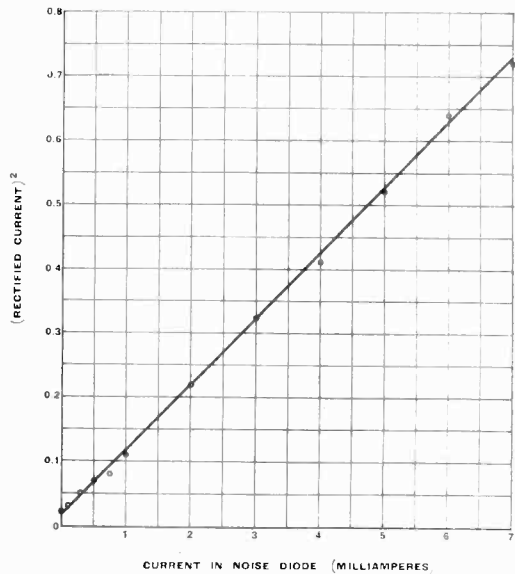

Fig. 2.—Rectifier calibration.

the amplifier. The simplest method would have been to adjust the current through the noise-generating diode until the mean square noise from diode plus valve under test was double that from the valve under test alone; the unknown valve noise would then be equal to the calculable diode noise. But to give a greater accuracy than that of a single

observation, and also to provide simultaneously a further check on the rectifier law, the rectified output current was actually observed both with the valve under examina-

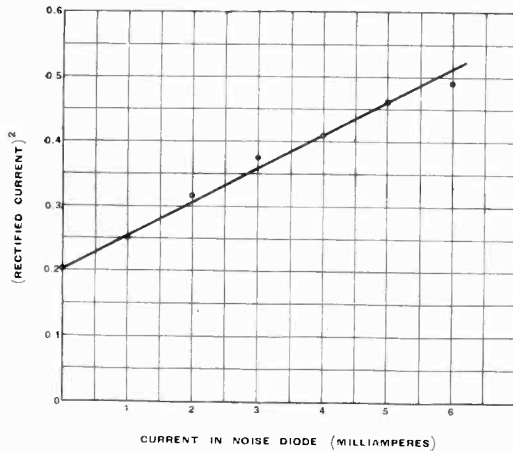

Fig. 3.—Cossor 4TSP.

tion as the sole source of noise and with a whole series of values of anode current through the noise-generating diode. By plotting the square of the rectified current  $I'$  against noise-diode current  $i_a$  a linear graph is obtained, and the best straight line through the points is then used to determine the value of noise-diode current which is sufficient to double the total noise. Fig. 3 shows the application of this method to a Cossor 4TSP valve, working at 15.5 mA. anode current and 3.5 mA. screen current. From the graph, the diode current which generates an equal amount of noise is 3.75 mA., so that the mean square noise ratio (or "smoothing factor") of the 4TSP is  $3.75/15.5 = 0.24$ . On the basis of Ziegler's theory of noise arising from sharing of current between screen and anode<sup>‡</sup>, the minimum possible noise ratio would be 0.197 and the observed value of 0.24 corresponds to a noise ratio of 0.05 for the valve if used as a triode. This latter value of 0.05 is quite a possible value, though perhaps a little low.

For most practical purposes the anode

current noise ratio is less useful than the equivalent grid resistance, i.e. the resistance whose thermal noise at room temperature is such that if connected to the grid of the valve it would produce in the anode circuit a noise voltage equal to that actually generated by the anode current. A useful approximate expression is

$$R_n = 15i/G^2$$

where  $R_n$  is the equivalent noise resistance,  $G$  the mutual conductance of the valve under consideration, and  $i$  its effective anode current, i.e. the actual anode current multiplied by the mean square noise ratio (or "smoothing factor"). On this basis, we find that the 4TSP has  $R_n = 1,330$  ohms.

Measurements on the Mullard EE 50 at 10 mA anode current are shown in Fig. 4; the linearity of this graph over a fairly extended range is useful confirmation of the assumed rectifier law. The equivalent noise current is 6.5 mA., against the actual anode current of 10 mA., giving a mean square noise ratio of 0.65; the mutual conductance of the specimen used was not checked, but on the basis of the nominal value of 14 mA/V., the equivalent grid noise resistance would be about 500 ohms.

### 3. Discussion of Results

There appears to be no theory covering the response of a linear rectifier to noise alone, comparable with the information

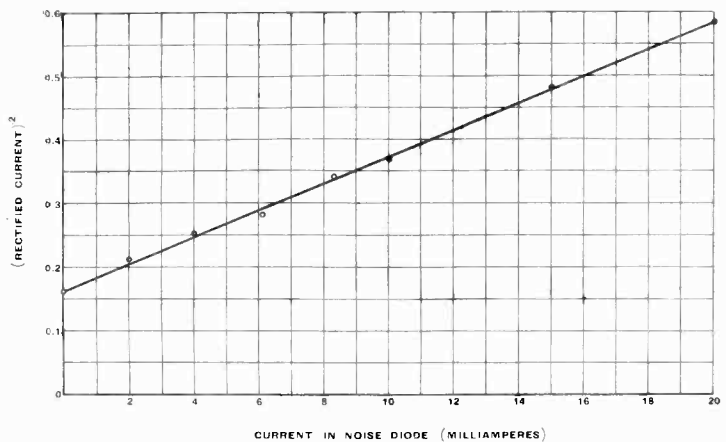

Fig. 4.—Mullard EE50.

available on the response of a linear rectifier to noise superimposed on a strong carrier<sup>§</sup>.

<sup>‡</sup>Reference (1).

<sup>§</sup>Reference (2).

Previous experimental work has been published by Landon<sup>||</sup> and by Jansky\*, but both of these authors studied the effect of variation of band-width, apparently without trying the effect of varying the intensity of the noise source. However, Jansky found the average voltage from a diode rectifier to be proportional to the square root of the band-width, which combined with the results shown above, that for a fixed band-width the average current from a diode rectifier is proportional to the R.M.S. noise voltage applied, suggests that for a given linear rectifier there is a constant relationship between R.M.S. input and average output. Both Landon and Jansky appear to have expected this relationship to be determined by a general constant, i.e. independent of the particular rectifier, and if there is a fixed relation between R.M.S. and average values, there should also be a relation between each of them and the peak value. But in theory the ratio of peak to mean voltage of a random noise should be indeterminate, tending to infinity as the time-constant of the peak-measuring device is reduced towards zero; and in fact the values of peak/mean ratio reported by Landon and Jansky from three different experiments are not the same, being 3.4, 4, and 4.47.

From the point of view of peak/mean ratio, and therefore equally from the point of view of R.M.S./mean ratio, there are two quite distinct types of combination of noise source, amplifier, and linear rectifier, according as the time-constant of the rectifier is much shorter or much longer than that of the preceding amplifier. Although theoretically infinite, the practical peak value is the maximum value of voltage which occurs sufficiently frequently to be detected. Since a maximum occurs through the addition of a number of the elementary events constituting the random phenomenon (e.g. simultaneous passage of a number of electrons through the valve in shot effect), the chance of any given amplitude being attained is a probability function of the rate at which the elementary events are occurring; but the R.M.S. voltage is simply proportional to the rate at which events are occurring, so there is presumably a probability function relating peak values (in the practical sense of

“peak”) and R.M.S. or average values. But it is unlikely that the ratio is independent of the frequency band covered by the amplifier; for going to the limit of an amplifier including a tuned circuit of zero decrement, the output voltage will tend to be sinusoidal, giving peak to R.M.S. ratio of 2, in contrast with values of 3.4 and 4.47 reported by Landon. It was an essential part of Jansky's experimental method that the linear rectifier should not follow the envelope of the applied voltage, and it is quite possible that the same limitation applied to Landon's work, since he used the same rectifier for wide and narrow band-widths of the amplifier; now such a rectifier must tend to exclude from the averaging process all values of voltage which are below the pseudo-average which it has at any instant established, so that it is really more a modified peak meter than an average meter.

If on the other hand the time-constant of the resistance-capacity combination in the rectifier were short, so that the averaging process depended upon the mechanical inertia or the inductance of the galvanometer, the smoothing system associated with the rectifier would be in effect of the choke input type; the mean voltage may then be expected to bear a different relation to the peak voltage. One would therefore expect the ratio of mean voltage from a linear rectifier to mean square voltage to depend upon the ratio of rectifier to amplifier frequency response.

#### 4. Conclusions

In any given combination of amplifier plus linear rectifier, the square of the average rectified current is proportional to the R.M.S. noise voltage applied to the rectifier; but the constant of proportionality will not necessarily be the same in different sets of apparatus. The linear rectifier is therefore applicable to noise measurement by substitution methods, but not by absolute methods.

#### 5. Acknowledgments

The author is indebted to Mr. L. H. Bedford for the interest he has taken in this work, and to A. C. Cossor Ltd. for permission to publish experimental results obtained in their Research Laboratories.

#### REFERENCES

- (1) M. Ziegler, *Philips Tech. Rev.*, 1937, Vol. 2, p. 32a.
- (2) F. C. Williams, *Journ. I.E.E.*, 1937, Vol. 80, p. 218.
- (3) V. D. Landon, *Proc. Inst. Rad. Eng.*, 1936, Vol. 24, p. 1514.
- (4) K. G. Jansky, *Proc. Inst. Rad. Eng.*, 1939, Vol. 27, p. 763.

<sup>||</sup> Reference (3).

\* Reference (4).

# The Measurement of Modulation Depth\*

By *H. D. McD. Ellis, M.A., A.M.I.E.E.*

IN order to broadcast speech and music a carrier wave of radio frequency is "modulated" at the transmitter by the programme from the studio. The process of modulation consists in varying some characteristic of the carrier in accordance with the waveform of the programme. For example, the frequency of the carrier may be made to vary about its mean value, a process called frequency modulation; but by far the most common, in fact almost universal, method is to vary the amplitude of the carrier about its mean value. It will be obvious that the amount of variation of carrier amplitude will depend on the amplitude of the programme and that the maximum variation which can be tolerated will be when the carrier amplitude is reduced to zero.

In order to keep a check on the modulation process and to ensure that the modulated carrier is actually being radiated, it is highly desirable to have an instrument at the transmitter continuously measuring the modulation depth. Further, it is also desirable to be able to measure the instantaneous modulation depth of the carrier when it arrives at a selected receiving point. Various instruments for measuring modulation depth have been described from time to time, and as a laboratory procedure the problem of measurement when the modulating source is pure tone is not difficult. The apparatus discussed in this article, however, has been developed for service use and enables the modulation depth to be watched under programme conditions.

Fundamentally the measurement of modulation depth involves two distinct measurements. First the average value of the carrier amplitude must be determined, and then the extent of its variation about this mean must be measured. The ratio of these two quantities gives the modulation depth. These two measurements are nearly always carried out by means of two rectifiers. The first rectifier is arranged to give an output

voltage equal to the peak value of the carrier wave. When the carrier is unmodulated the output from this rectifier will therefore be a steady potential, but when the modulation is applied this output voltage will vary in accordance with the waveform of the modulation. Fig. 1 shows diagrammatically the carrier modulated by a pure tone;  $x$  represents the amplitude of the carrier when unmodulated and  $y$  the carrier amplitude when modulated. It should be noted that  $x$  represents the mean amplitude of the carrier whether it is modulated or not, and when smoothed the steady D.C. passed by the rectifier circuit mentioned above will be proportional to  $x$ .

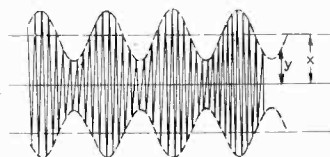

Fig. 1.

The output of this rectifier, therefore, may be separated out into two components by the smoothing circuit, one a steady potential proportional to the mean amplitude of the carrier and the other an alternating potential which follows the modulation envelope. By passing this component through a second rectifier circuit, a steady potential proportional to the amplitude of the modulation is obtained.

As mentioned above, the essential problem lies in measuring the amplitude of the modulation, and expressing this as a fraction of the mean carrier amplitude. Instruments already on the market do this by measuring and indicating the two quantities separately so that the accuracy of the measurement depends (a) upon the adjustment of the apparatus so that the indicator of mean carrier amplitude reaches a set value, and (b) upon the relative accuracy of the two distinct measuring chains. In any case,

\* MS. accepted by the Editor, November, 1940.

no reliable indication is possible if the mean carrier amplitude is constantly varying, or if the modulation is other than steady tone.

The circuit to be described largely overcomes these difficulties by comparing the amplitude of modulation with the mean carrier amplitude electrically, before applying the result to the indicating circuit. The two rectifier circuits mentioned above are used and the two steady potentials obtained when a modulated carrier wave is injected are arranged in series and in reverse sense, so that their difference may be read by the measuring instrument. A convenient, stable and accurate voltmeter for this purpose which draws no power from the circuit is obtained by using a valve as a "cathode follower" with a meter for reading the cathode current. Fig. 2 is a circuit diagram showing this arrangement in its simplest form.

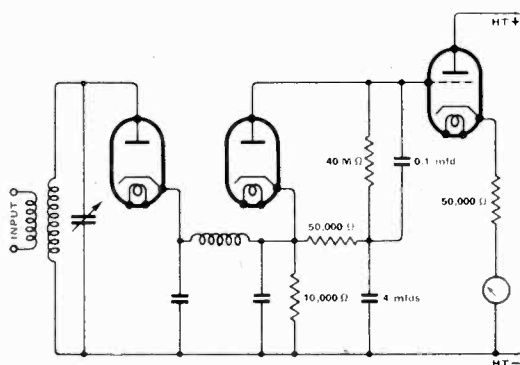

Fig. 2.

It will be seen that when the carrier is modulated 100 per cent. the peak amplitude of the modulation envelope is equal to the mean peak amplitude of the carrier, so that the nett difference potential as measured above will be zero. Thus the 100 per cent. modulation indication on the meter is fixed whatever the mean amplitude of the carrier and however it may vary. All other calibration marks on the meter, of course, depend on the correct setting of the carrier, but if the carrier level is maladjusted the indication of modulation depth gets more accurate as the modulation approaches 100 per cent., which is the region in which the greatest accuracy is usually required. Further, since the same measuring circuit is used for indicating the mean carrier amplitude and also

the modulation depth, it will be seen that relative accuracy is only required in that part of the circuit where it can hardly fail to be achieved. Thus the circuit as a whole approaches absolute accuracy for indication of 100 per cent. modulation.

The principal error arises from the contact potential of the second rectifier which results in about 1 volt appearing across its load with no input, or with an unmodulated carrier input. In practice this may be made negligible by employing a large carrier amplitude, and 100 volts is a convenient figure which reduces this error to about 1 per cent.

The accuracy of the measuring circuit is almost entirely dependent upon the accuracy of the meter itself and of the cathode resistance, provided the anode A.C. resistance of the valve is much smaller than this resistance.

The following table demonstrates the improvement in accuracy which results for readings above 50 per cent. modulation when this circuit is employed, compared with the normal circuit without compensation. Both circuits are assumed to be set up correctly for a normal carrier level, and the errors in reading introduced by a 10 per cent. variation in carrier level are tabulated.

Actual Mod.	Reading Error	
	Normal Circuit	Compensated Circuit
100%	10%	—
75%	10%	3.33%
50%	10%	10%
30%	10%	23%

For readings below 50 per cent. the compensated circuit gives a greater error than the normal circuit, but under working conditions indications on this part of the scale are, in general, quite uninteresting. It is the readings in the neighbourhood of 100 per cent. modulation which must be accurate.

The circuit actually adopted is shown in Fig. 3 and differs from Fig. 2 in two important particulars. It is sometimes desirable to measure both the positive and negative modulation peak amplitudes, that is to say, both the maximum and minimum excursion of the carrier amplitude. For example, with some transmitters the carrier may be modulated to more than double its mean



amplitude in the upward direction, but it cannot be reduced to less than zero in the other. Accordingly a 1/1 ratio transformer with two separate secondaries has been introduced, each secondary feeding a separate rectifier for picking out the opposite peaks of the modulation envelope. Such a transformer can be accurate to 0.1 per cent. over the whole audio range, and by adding a tertiary winding enables a high quality output to be obtained for audio monitoring purposes.

The second point to be noted in Fig. 3 is

supposed at first sight. In order to give instantaneous readings it is essential that the measuring apparatus shall respond in a very short time, but in order that these readings may be observed the indications must be preserved for a time long enough for the eye to follow. These conditions are met by the peak rectifier circuit in which the integrating condenser is charged through the relatively low impedance of the rectifier and source impedance and discharged through a high resistance when the rectifier is inoperative.

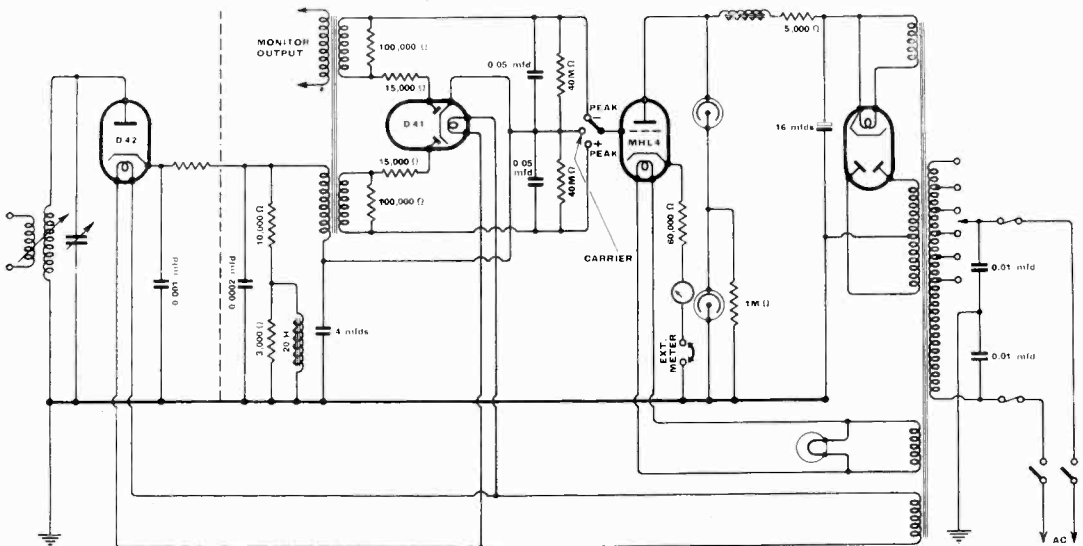

Fig. 3.

the resistance-shunted choke in the load of the first rectifier. It is well known that a rectifier will respond accurately to a 100 per cent. modulated carrier only if the impedance of its load circuit at modulation frequency is the same as for D.C. The impedance of the filtering circuit and input to the second rectifier appear as a shunt on the load resistance of the first rectifier at audio frequency. In order to remove the error so caused this resistance is padded out by the choke and resistance so that the impedance is constant for all audio frequencies and for D.C.

The problem of making the meter give a true measure of the instantaneous modulation depth is not so straightforward as might be

If the time constant of the circuit during the charging period is low enough, this arrangement will give an almost faithful indication of the instantaneous peaks of modulation. If this is followed by a valve circuit incorporating a very quick acting meter, the meter will keep rising suddenly to record the peak modulation depth and falling back slowly, so that the eye is able to observe the reading attained. By means of such an instrument it would be possible, provided the response was quick enough, to ensure that the maximum instantaneous modulation peaks never exceeded 100 per cent.

Considering the problem a little more closely, however, it will be realised that the

reason for limiting the modulation to 100 per cent. is to avoid the distortion introduced when the transmitter is overmodulated. It has been found, however, that if the peak of modulation is sufficiently short (for example, a drum beat) considerably more than 100 per cent. can be tolerated before the ear notices the distortion. In other words, the distortion must exist for a definite time before the ear knows it is there. In fact, the shorter the duration of the sound the greater the overmodulation which can be tolerated, and by this means the average modulation depth can be raised considerably without introducing noticeable distortion on the sudden peak passages, representing a considerable saving in transmitter power.

By making the response of the modulation indicator somewhat sluggish we can ensure that 100 per cent. is indicated only on modulation bursts lasting for an appreciable time, or conversely when those of short duration have considerably exceeded 100 per cent. After many laboratory tests and long periods of listening to actual programmes the time constant of the charging circuit was fixed so that the meter would read 80 per cent. of the true peak value in 5 milliseconds.

An instrument of this type, known as the Peak Programme Meter, has been employed by the B.B.C. at studio centres for some time for monitoring the programme before being sent to the transmitters, and it has proved very successful. The readings on the modulation meter may sometimes differ from those obtained on the peak programme meter. The reason for this is that whereas the amplifier to which the programme meter is connected is usually capable of passing the instantaneous peaks exceeding the normal peak level, in the case of the modulated carrier these peaks are definitely cut off if they are in the negative sense, i.e. reducing the instantaneous value of the carrier, and are most probably cut off if they are in the positive sense. It follows, therefore, that provided that instantaneous peaks do not exceed 100 per cent. modulation the modulation meter behaves similarly to the peak

programme meter, but when the instantaneous peaks exceed 100 per cent. the modulation meter will indicate a lower value than the peak programme meter. Fortunately, however, on most types of programme this effect is small.

The input circuit to the modulation monitor and the coupling to the transmitter have been kept as simple as possible. The requirements are (a) sufficient selectivity to filter out carrier harmonics to a negligible value while not introducing serious side-band cut, (b) easy adjustment of coupling to the transmitter capable of giving zero coupling for line-up purposes, and (c) low D.C. resistance to earth for the first rectifier circuit. All these conditions were adequately met with a single tuned circuit with adjustable mutual coupling to any normal type of feeder line, with a low impedance coupling to the transmitter at the far end. Since the power required for the monitor is of the order of 1 watt only, this coupling presents little difficulty.

When the monitor is used at a receiving point it must be preceded by a receiver having a good A.V.C. characteristic and capable of giving an output of about 1 watt R.F. 100 per cent. modulated without appreciable distortion. The high output power is required on account of the high voltage necessary, 100 volts peak, across the relatively low input impedance of the monitor. The input impedance measured across the tuned circuit is about 6,000 ohms and is determined by the load resistance of the first rectifier. This in turn must be low so that successive circuits in the monitor throw a negligible load on the preceding circuit. The A.V.C. characteristic of the receiver must be relatively good so that the variations of mean carrier level at the input to the monitor, due to fading, are small. As explained above, small variations of the order of 10-20 per cent. can be tolerated, but a good A.V.C. characteristic is required to bring the manifold variations due to fading within these limits.

The author is indebted to the British Broadcasting Corporation for permission to publish the above description.

# The Band-Pass Effect<sup>\*</sup>

## Its Nature in Electric Wave-filters Terminated in Negative Impedance

By *S. P. Chakravarti, M.Sc. (Eng.) (London), A.M.I.E.E., M.I.R.E.*

### CONTENTS

1. Introduction.
2. Discussion on author's earlier measurements.
3. Nature of negative impedance termination.
4. Band-pass effect in low-pass filter terminated in negative impedance.
5. Band-pass effect in high-pass filter terminated in negative impedance.
6. Adjustment of cut-off frequencies and sharpness of cut-off on two sides.
7. Conclusion.
8. Acknowledgment.

### 1. Introduction

IT was experimentally discovered by the author<sup>†</sup> some time ago that both low-pass and high-pass filter sections terminated in negative impedances of magnitude equal to their maximum characteristic impedance in the transmission band transform into "band-pass filters." It has also been observed<sup>‡</sup> that large gain is obtained at frequencies in the transmission band so that the transformed arrangement acts as a "band-pass ampli-filter."

The gain-frequency characteristic of the resulting arrangement has been found to be more uniform over the transmission band than that of the combination of a composite band-pass filter (for the same band) and an amplifier and hence the former can be said to be superior to the latter from a frequency distortion point of view. Phase and non-linear distortions in the former have also been observed to be comparatively inappreciable. The cost of the band-pass arrangement has worked out to be less than half of the combination of a composite band-pass filter and associated amplifier for the same gain over the same frequency band.

The "band-pass effect" has therefore application in the electrical communication

industry enabling a band-pass ampli-filter of performance superior to that of a normal composite band-pass filter and associated amplifier to be designed and manufactured from low-pass or high-pass filter sections of the simplest type and negative impedance of suitable value at less than half the cost.

The present paper discusses the mechanism of the "band-pass action" and the factors upon which the cut-off frequencies and the sharpness of cut-off of the band-pass arrangement depend.

### 2. Discussion on Author's Earlier Measurements

In earlier investigations, low-pass and high-pass filter sections designed for both low and high frequency ranges were used to obtain the effect. The negative impedance termination was adjusted to a value nearly equal to the maximum characteristic impedance of the filter in the transmission band. Frequency and non-linear distortions were measured and found to be inappreciable in all cases.

It was recognised that the total insertion gain introduced by the negative termination was due to the "reflection gain," and the band-pass effect was due to the variation of reflection gain with frequency. The calculated values of reflection gain at different frequencies obtained from a constant negative impedance termination and a characteristic impedance varying with frequency were found to differ from the experimental values. It was therefore considered desirable to study the variation of the negative impedance termination with frequency as well as to determine any other factor contributing to the effect.

The sharpness of cut-off was generally found to be greater on one side and the best value obtained was 7 db. in 0.1 kc/s. The factors upon which the values of cut-off frequencies and the sharpness of cut-off of

<sup>\*</sup>MS. accepted by the Editor, November, 1940.

<sup>†</sup>*Phil. Mag.*, Ser. 7, Vol. xxvi, pp. 173, 1938.

<sup>‡</sup>*Proc. Indian Academy of Sciences*, Vol. I, pp. 224-241, 1934.

*L'Onde Elec.*, Vol. xv, pp. 150-166, 1936.

the band-pass arrangement depended were not well known. Experiments only indicated that one of the cut-off frequencies lay near the cut-off frequency of the original filter section.

### 3. Nature of Negative Impedance Termination

Negative impedance obtained from thermionic vacuum tubes has been of three types, namely,

(1) *Dynatron type*§, in which the internal resistance of a triode or a tetrode (screen-grid tube) under secondary emission condition has been used to obtain negative impedance. The falling portion of the plate voltage—plate current characteristic has been used.

(2) *Transitron type*||, in which a five-electrode or double-grid tube employing negative trans-conductance has been used. The falling portion of the second grid voltage—second grid current characteristic has been used.

(3) *Feed-back or regenerative type*¶, in which the input and output terminals of a one-way amplifier are connected either in series or in parallel.

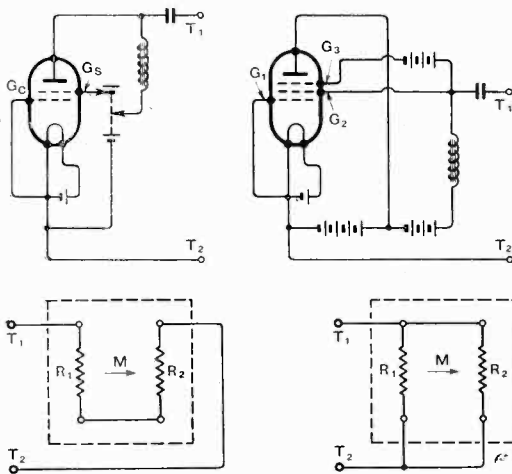

Fig. 1.

Fig. 1 shows the three types in suitable connection for use in an alternating current system.

Investigations on (a) the stability of the negative impedance element in an A.C. circuit, (b) the value and nature of the element impedance, (c) the linearity of the element and (d) the phase-shift caused by the element, for the frequency range 0.1 kc/s—1.0 Mc/s have

already been discussed by the author elsewhere\*\* and are therefore omitted here.

From a stability point of view alone, the transitron type has been found to be the best of the three. The dynatron type connected as termination to a filter network can be stable provided the variations in plate and screen-grid voltages and filament current are within limits discussed by the author elsewhere\*\*. From linearity point of view alone the dynatron type has appeared to be well-suited for use in A.C. circuits. Phase distortion has been found to be inappreciable for both dynatron and transitron types over the range 0.1 kc/s—0.5 Mc/s. From a majority of considerations the dynatron type formed from a screen-grid tube has been found to be most suitable.

#### Variation of negative impedance of the dynatron type with frequency.

Even neglecting the shunting effect of the choke inserted in the parallel battery path, the negative impedance element cannot be regarded as non-reactive except at low frequencies. The negative impedance at a certain frequency of the dynatron type represented by the equivalent circuit shown in Fig. 2 consists of (1) the negative A.C. resistance  $-R_a$  of the tube at that frequency, (2) anode-filament capacitance  $C'$  at that frequency and (3) inductance  $L'$  of the choke (inserted in the battery path) at that frequency; all three are connected in parallel. The self-capacitance of the choke has been neglected.

\*\**Phil. Mag.*, 1940: "The nature of negative resistance and negative resistance sections."

§*Proc. Inst. Rad. Eng.*, Vol. vi, 5, February, 1918.

||*Proc. Inst. Rad. Eng.*, pp. 1201-1223, October 1935.

¶*Bell. S. Tech. Journ.*, Vol. x, pp. 485-513, July 1931.

The impedance

$$Z_0' = \frac{R_a \omega L'}{-\omega L' + jR_a(\omega^2 L' C' - 1)} \dots (1)$$

As the frequency increases from low values to 1 Mc/s,  $|R_a|$  has been found to decrease in

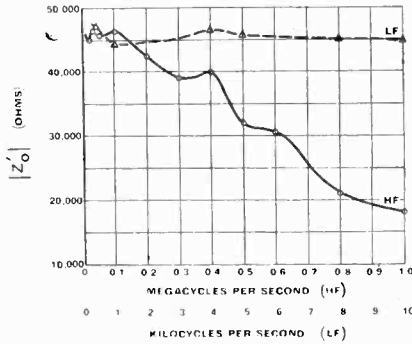

Fig. 3.

general from  $|R_a|$  the value obtained from the static characteristic. It must be noted that it does not decrease in a regular smooth curve, but increases here and there giving peakiness to the curve. Further,  $C$  has been found to decrease with increase of frequency up to 1 Mc/s similar to that discussed by Hartshorn.††  $|Z_0'|$  would therefore be expected to decrease in general with increase

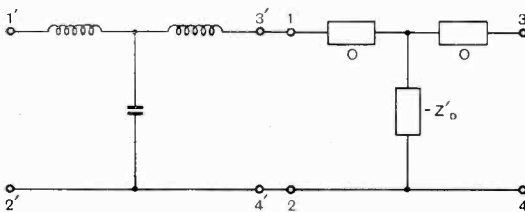

Fig. 4.

of frequency, though not in a regular smooth curve.

The values of  $|Z_0'|$  at various frequencies have been measured by observing the H.F. current into and the voltage drop across the impedance by thermo-milliammeter and valve voltmeter respectively. Fig. 3 shows the variation of the measured value of negative impedance with frequency for the ranges (1) 0.1-10 kc/s and (2) 10 kc/s-1 Mc/s.

The variation of negative impedance with frequency has been taken into account in

†† *Experimental Wireless (now Wireless Engineer)*, pp. 413-421, August 1931.

explaining the "band-pass action" in the following sections.

#### 4. Band-pass Effect in Low-pass Filters Terminated in Negative Impedance

The negative impedance termination  $-Z_0'$  (connected to the output of the filter) has been replaced for calculation purpose by a four-terminal symmetrical  $T$  section in which total series impedance is zero and total shunt impedance is  $-Z_0'$  as shown in Fig. 4. The total insertion gain or loss of the arrangement will be equal to the network gain or loss of the equivalent network formed from the combination of the original filter section and the four-terminal section mentioned above together with the reflection gain or loss between characteristic impedance of the original filter and termination impedance at the junction of the sections.

##### (a) Network Gain or Loss.

A symmetrical  $T$  type low-pass filter section of total series impedance  $R + j\omega L$  and total shunt impedance  $-j/\omega C$  connected in tandem to the four-terminal equivalent of the negative impedance  $-Z_0'$ , is equivalent to an unsymmetrical section (Fig. 4) in which  $Z_A$  and  $Z_B$  are series impedances

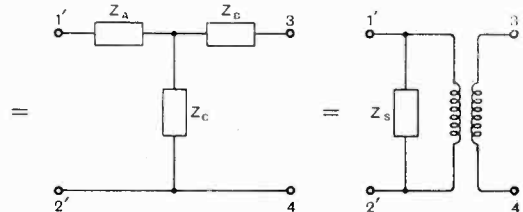

and  $Z_0'$  is shunt impedance given as follows:—

$$Z_A = \left( \frac{R}{2} + j\omega \frac{L}{2} \right) + \frac{-j/\omega C \left( \frac{R}{2} + j\omega \frac{L}{2} \right)}{-j/\omega C + \frac{R}{2} + j\omega \frac{L}{2} - Z_0'} \dots (2)$$

$$Z_B = \frac{-\left( \frac{R}{2} + j\omega \frac{L}{2} \right) Z_0'}{-j/\omega C + \frac{R}{2} + j\omega \frac{L}{2} - Z_0'} \dots (3)$$

$$Z_c = \frac{+ (j/\omega C \cdot Z_o')}{-j/\omega C + \frac{R}{2} + j\omega \frac{L}{2} - Z_o'} \dots (4)$$

For obtaining the transmission properties of the unsymmetrical network in various directions, it has further been made equivalent to an ideal transformer (Fig. 4) having in parallel with its primary winding a finite shunting impedance  $Z_s$ . If  $\phi$  = voltage transformation ratio and  $\phi^2$  = impedance transformation ratio in the same direction, then

$$Z_A = (1 - \phi)Z_s \dots (5)$$

$$Z_B = \phi(1 - \phi)Z_s \dots (6)$$

$$Z_c = \phi \cdot Z_s \dots (7)$$

It will be seen that  $\phi$  can be determined from any one of the ratios (I)  $\frac{Z_A}{Z_c}$ , (II)  $\frac{Z_B}{Z_c}$  and (III)  $\frac{Z_A}{Z_B}$ .

I. From (5) and (7).

$$\phi = \frac{1 + \frac{\omega^2 LCR}{2Z_o'} - \frac{R}{Z_o'} - \frac{\omega^2 LC}{2}}{D} + j \frac{\frac{\omega C}{Z_o'} \left( \frac{L}{C} + \frac{R^2}{4} - \frac{\omega^2 L^2}{4} - \frac{RZ_o'}{2} \right)}{D}$$

where  $D = \left[ 1 + \frac{\omega^2 LCR}{2Z_o'} - \frac{R}{Z_o'} - \frac{\omega^2 LC}{2} \right]^2 + \frac{\omega^2 C^2}{Z_o'^2} \left[ \frac{L}{C} + \frac{R^2}{4} - \frac{\omega^2 L^2}{4} - \frac{RZ_o'}{2} \right]^2$

The propagation constant  $P$  for the direction of transmission =  $\log_e \phi = A_1 + j\beta_1$ , where  $A_1$  = gain or attenuation constant in nepers and  $\beta_1$  = phase constant in radians given as follows :-

$$A_1 = \log_e \sqrt{\frac{1}{D}} \dots (9)$$

$$\beta_1 = \tan^{-1} \frac{\frac{\omega C}{Z_o'} \left( \frac{L}{C} + \frac{R^2}{4} - \frac{\omega^2 L^2}{4} - \frac{RZ_o'}{2} \right)}{1 + \frac{\omega^2 LCR}{2Z_o'} - \frac{R}{Z_o'} - \frac{\omega^2 LC}{2}} \dots (10)$$

II.—Similarly, from (6) and (7),

$$A_2 = \log_e \sqrt{\left( 1 - \frac{\omega^2 LC}{2} \right)^2 + \left( \frac{\omega CR}{2} \right)^2} \dots (11)$$

$$\beta_2 = \tan^{-1} \frac{\omega CR}{2 - \omega^2 LC} \dots (12)$$

III.—Similarly, from (5) and (6),

$$A_3 = \log_e \sqrt{\frac{1}{\left( \frac{R}{2Z_o'} - 1 \right)^2 + \frac{1}{Z_o'^2} \left( \frac{\omega L}{2} - \frac{2}{\omega C} \right)^2}} \dots (13)$$

$$\beta_3 = \tan^{-1} \frac{\omega^2 LC - 4}{\omega C (R - 2Z_o')} \dots (14)$$

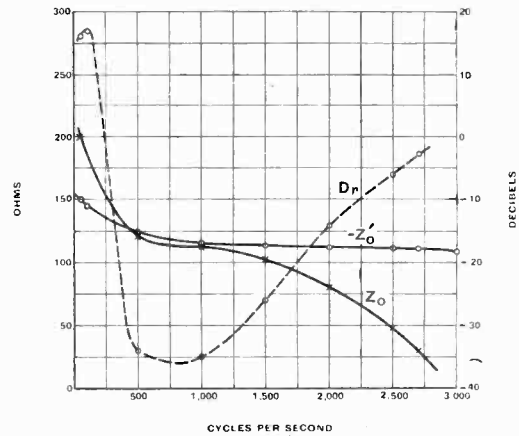

Fig. 5.

Three different sets of values for gain or attenuation constant and phase constant correspond to three possible ways in which input can be connected to the unsymmetrical  $T$  section. Table I (to be found at the foot of the next page) shows the values calculated for a low-pass filter in which  $L = 15$  mH,  $R = 12 \Omega$  and  $C = 1.0 \mu F$  and the theoretical characteristic impedance (at zero frequency) and the cut-off frequency are 125 ohms and 2,700 c/s respectively. The variation of  $-Z_o'$  with frequency has been taken into account in the calculations. (Minus and plus decibels indicate gain and loss respectively in the table).

It will be seen from equation (11) and Table I that (1)  $A_2$  does not involve  $|Z_o'|$ , (2)  $A_2$  and  $A_3$  do not give gain at frequencies in the transmitted band (up to 2,000 c/s) and (3)  $A_1$  gives gain over the range 50-2,700 c/s. The variation of  $A_1$  with frequency shows the "band-pass effect" only to a small degree.  $\beta_1$  will be seen to be roughly proportional to frequency at least up to 2,000 c/s.

(b) Reflection Gain or Loss.

If  $Z_0$  = characteristic impedance of the filter section at any frequency and  $-Z_0'$  = negative impedance of the termination at the same frequency, the reflection gain (or loss)  $D_r$  in decibels between two impedances at the same frequency is given by

$$D_r = 20 \log_{10} \frac{Z_0 - Z_0'}{j\sqrt{4Z_0Z_0'}} \\ = 20 \log_{10} \left[ -\frac{(Z_0 - Z_0')}{\sqrt{4Z_0Z_0'}} \right] + j \cdot 4.3\pi \dots \dots (15)$$

Since  $\log_e (jZ) = \log_e Z + j \cdot \frac{\pi}{2}$ .

Since both  $Z_0$  and  $-Z_0'$  vary with frequency, the reflection gain or loss will vary with frequency. As long as the magnitude of  $Z_0'$  is greater than that of  $Z_0$  but does not exceed  $5.6 Z_0$  reflection gain will be obtained. When it exceeds  $5.6 Z_0$  reflection gain will be changed to reflection loss. If, on the other hand, the magnitude of  $Z_0$  is greater than that of  $Z_0'$ , it must at least be greater than  $5.6 Z_0'$  to give reflection gain.

Fig. 5 shows (a) the measured values of the characteristic impedance of the filter section and of the negative impedance of the termination at different frequencies and (b) the variation of reflection gain or loss with frequency. It will be observed that the variation of the reflection gain or loss shows the "band-pass effect" to a remarkable degree.

(c) Total Insertion Gain or Loss.

Fig. 6 shows the variation of (1) the total insertion gain or loss with frequency and (2) the ratio of image impedance across 1'-2' terminal to that across 3-4 terminal with frequency. It will be observed that (a) the total insertion gain or loss curves are similar in form to the attenuation-frequency

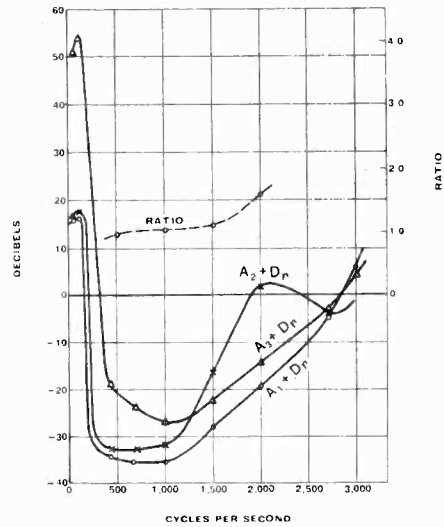

Fig. 6.

characteristic of a normal band-pass filter with the advantage of gain at frequencies in the transmitted band; and (2) the image impedances are more or less of the same

TABLE I

$f$ (c/s.)	$A_1$ (db.)	$\beta_1$ (degree)	$A_2$ (db.)	$\beta_2$ (degree)	$A_3$ (db.)	$\beta_3$ (degree)
50	-0.92	2°	+0.01	0° 6'	+34.00	89°
100	-0.91	4° 30'	+0.03	0° 12'	+38.00	88°
500	-0.86	22° 30'	+0.64	1° 12'	+14.50	80°
700	-0.87	31°	+1.32	2°	+11.74	76°
1000	-0.92	44°	+2.90	3°	+7.70	67°
1500	-1.63	59°	+8.80	9°	+3.65	51°
2000	-4.55	102°	+16.20	151°	+0.90	31°
2700	-1.04	11° 30'	-0.70	175°	-0.45	177°
3000	+4.16	28° 30'	-3.90	176°	+1.46	143°

magnitude over the frequency range involved except near the cut-off frequency of the original filter section. It can be said that the "band-pass effect" has been intensified due to the variation of the reflection gain or loss with frequency.

**5. Band-pass Effect in High-pass Filters Terminated in Negative Impedance**

(a) *Network Gain or Loss*

A *T* type symmetrical high-pass filter section in which total series impedance =  $-j/\omega C$  and total shunt impedance =  $R + j\omega L$ , connected in tandem to the four-terminal equivalent of the negative impedance  $-Z_o'$  is equivalent to an unsymmetrical section in which  $Z_A'$  and  $Z_B'$  are series impedances and  $Z_o'$  is the shunt impedance given as follows:—

$$Z_A' = -\frac{j}{2\omega C} + \frac{(R + j\omega L) \left(\frac{-j}{2\omega C}\right)}{R + j\omega L - j/2\omega C - Z_o'} \quad (16)$$

$$Z_B' = \frac{\left(\frac{j}{2\omega C} \cdot Z_o'\right)}{R + j\omega L - j/2\omega C - Z_o'} \quad (17)$$

$$Z_o' = \frac{-(R + j\omega L) Z_o'}{R + j\omega L - j/2\omega C - Z_o'} \quad (18)$$

Further, reducing as before the unsymmetrical network to an ideal transformer, we obtain three different sets of values for gain or attenuation constant and phase constant.

I. From  $Z_A'/Z_o'$  ratio,

$$A_1' = \log_e \frac{R^2 + \omega^2 L^2}{\sqrt{M^2 + N^2}} \quad (19)$$

$$\beta_1' = \tan^{-1} \frac{N}{M} \quad (20)$$

and  $N = \frac{R}{2\omega C} + \frac{Z_o'}{4\omega C} - \frac{R^2}{\omega C Z_o'} - \omega L Z_o'$

in which  $M = R^2 + \omega^2 L^2 - \frac{L}{2C} + \frac{R}{4\omega^2 C^2 Z_o'}$

II. From  $Z_B'/Z_o'$  ratio,

$$A_2' = \log_e \left( \frac{1}{R^2 + \omega^2 L^2} \right) \sqrt{\left( R^2 + \omega^2 L^2 - \frac{L}{2C} \right)^2 + \frac{R^2}{4\omega^2 C^2}} \quad (21)$$

$$\beta_2' = \tan^{-1} \frac{R/2\omega C}{R^2 + \omega^2 L^2 - \frac{L}{2C}} \quad (22)$$

III. From  $Z_A'/Z_B'$  ratio,

$$A_3' = \log_e \frac{1}{\sqrt{\left(\frac{2R}{Z_o'} - 1\right)^2 + \frac{1}{Z_o'^2} \left(2\omega L - \frac{1}{2\omega C}\right)^2}} \quad (23)$$

$$\beta_3' = \frac{4\omega^2 LC - 1}{2\omega C (2R - Z_o')} \quad (24)$$

Table II shows the values calculated for a high-class filter in which  $C = 0.5 \mu F$ ,  $L = 79 \text{ mH}$ , and  $R = 4 \Omega$  and the theoretical characteristic impedance (at infinite frequency) and the cut-off frequency are 400 ohms and 400 c/s respectively. The variation of  $-Z_o'$  with frequency has been taken into account in the calculations.

It will be seen from equation (21) and Table II that (a)  $A_2'$  does not involve  $-Z_o'$ , (2)  $A_2'$  and  $A_3'$  do not give gain at frequencies in the transmitted band, and (3)  $A_1'$  gives gain for the range 400–5,000 c/s (except near 4,000). Variation of  $A_1'$  shows the band-pass effect to a small degree.  $\beta_1'$  will be seen to increase rapidly in the beginning and slowly afterwards with frequency within the transmission band of the original filter above 400 c/s.

(b) *Reflection Gain or Loss.*

The relative magnitudes of  $Z_o$  and  $-Z_o'$  necessary for reflection gain in this case are exactly the same as those discussed in the previous section for low-pass filter.

Fig. 7 shows (a) the measured values of the characteristic impedance of the filter section and of the negative impedance of the termination at various frequencies and (b) the variation of reflection gain or loss with frequency. It will be observed that the variation of reflection gain or loss shows the "band-pass effect" to a remarkable degree.

(c) *Total Insertion Gain or Loss.*

Fig. 8 shows the variation of (1) the total insertion gain or loss with frequency and (2) the ratio of image impedance across 1'–2' terminal to that across 3-4 terminal with frequency. The results are similar to those discussed in the preceding section. It



can be said as in the case of low-pass filter that the band-pass effect has been intensified due to the variation of the reflection gain or loss with frequency.

**6. Adjustment of Cut-off Frequencies and sharpness of Cut-off on the Two Sides**

Earlier measurements were made only with negative termination of magnitude equal to the maximum characteristic impedance of the filter in the transmission

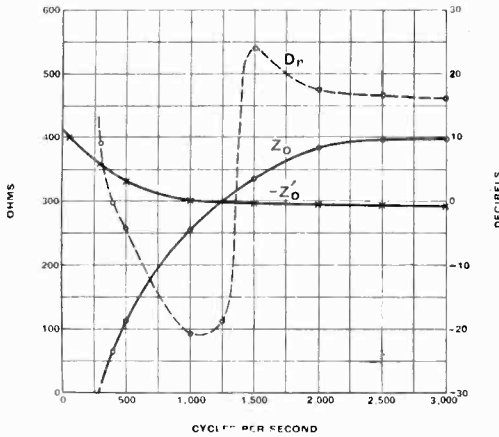

Fig. 7.

band, and therefore the dependence of the cut-off frequencies and the sharpness of cut-off of the resulting band-pass arrangement on the magnitude of the negative termination remained unknown. It was only observed that one of the cut-off frequencies

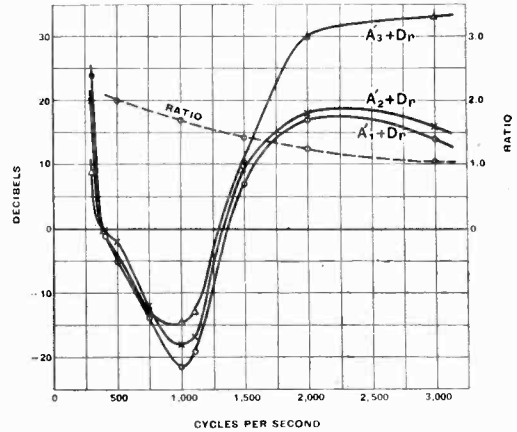

Fig. 8.

of the band-pass arrangement lay near the cut-off frequency of the original filter section.

Negative terminations of different magnitudes have been considered in the present treatment and their variation with frequency has been taken into account.

Fig. 9 shows the variation of reflection gain or loss with frequency in case of a low-pass filter section for three different terminations. The results obtained are as follows:—

(1) For negative termination nearly equal in magnitude to the maximum characteristic impedance of the filter, the band-width is greater, the cut-off frequencies are away from the cut-off frequency of the original filter but lie within its transmission band, and the sharpness of cut-off is widely different on

TABLE II

$f$ (c/s.)	$A'_1$ (db.)	$\beta'_1$ (degree)	$A'_2$ (db.)	$\beta'_2$ (degree)	$A'_3$ (db.)	$\beta'_3$ (degree)
100	+41.8	99° 30'	-29.75	175°	+12.35	76°
400	-0.40	178°	+0.035	178°	-0.18	6°
1000	-0.37	138°	+3.31	0° 13'	+6.78	116°
2000	-0.02	157°	+0.72	0° 1'	+13.22	102° 30'
3000	-2.00	165°	+0.31	Negligible	+16.96	98°
4000	+0.002 ?	168° 30'	+0.17	„	+19.48	96°
5000	-0.002	171°	+0.11	„	+21.40	95°
6000	+0.01	172° 30'	+0.09	„	+23.14	94°

the two sides (for example, 18 db. in 200 c/s on one side and 4 db. in 1,000 c/s on the other).

(2) For negative termination less in magnitude than the maximum characteristic impedance, the band-width becomes smaller, the cut-off frequencies get nearer to the cut-off frequency of the original filter and sharpness of cut-off improves and tends to become less different on the two sides (for instance, 49 db. in 200 c/s on one side and 15 db. in 200 c/s on the other).

Fig. 10 shows the variation of reflection gain or loss with frequency in the case of a high-pass filter section for three different terminations. The results obtained are exactly similar to those in the case of the low-pass filter and are therefore not discussed again.

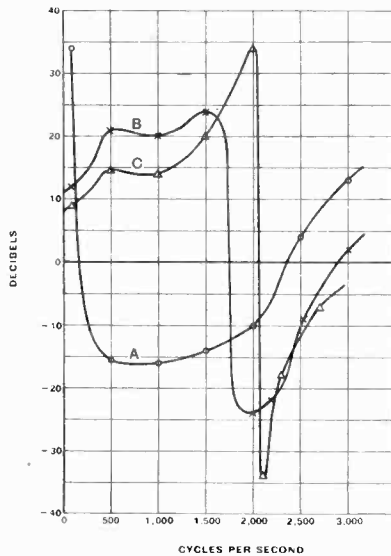

Fig. 9.

## 7. Conclusion

In this paper some investigations relating to the mechanism of band-pass action observed in low-pass and high-pass filters terminated in negative impedances are described. The following conclusions have been arrived at.

(1) The band-pass arrangement resulting from a symmetrical low-pass or high-pass filter section and a negative impedance termination is *unsymmetrical* from gain (or attenuation) and phase-shift points of view.

Unlike the unsymmetrical section, the magnitudes of the image impedances on the two sides do not differ very much from each other for the frequency range involved in the original filter section except at frequencies near the original cut-off frequency.

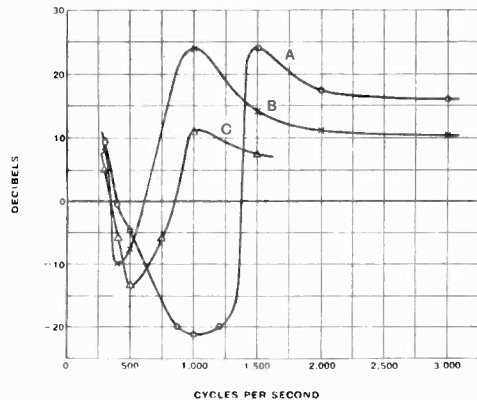

Fig. 10.

(2) The cause of the band-pass action has been sought in (a) the nature of variation of the network gain or loss of the equivalent network (formed from the original section and negative termination) with frequency and (b) the nature of variation of the reflection gain or loss between characteristic impedance of the original filter and negative impedance termination with frequency.

It has been found that the former variation contributes little to the band-pass action whereas the latter variation contributes mainly to it. Further, the nature of variation of reflection gain or loss with frequency which intensifies the "band-pass effect" is largely due to variation of the negative impedance with frequency.

(3) The cut-off frequencies and the sharpness of cut-off of the arrangement depend upon the magnitude of the negative impedance termination *relative* to that of the characteristic impedance of the filter. For negative impedance of about the maximum characteristic impedance of the filter, the cut-off frequencies differ from the cut-off frequency of the original filter but lie within the transmission band, and the sharpness of cut-off is very different on the two sides. For negative impedances of lesser value, the cut-off frequencies are nearer to the original cut-off frequency and the sharpness

of cut-off tends to be less different on the two sides.

### 8. Acknowledgment

The experimental portion of the work has been carried out at the Kanodia Electrical Communication Engineering Laboratories, University of Calcutta. The author desires to thank his assistant Mr. N. L. Dutt, M.Sc., for checking some of the numerical calculations and Professor P. N. Ghosh, Sc.D., Ph.D., F.Inst.P., for his great interest in the problem.

## Broadcasting in India

PRIOR to relinquishing his post as the first Controller of Broadcasting in India, Mr. Lionel Fielden issued the first report on the activities of All India Radio, the Government-controlled broadcasting organisation. In so doing he has taken the opportunity of including an historical survey of the development of broadcasting in India.

One chapter of the report deals with the engineering and technical aspects of the development scheme which was introduced following the visit of Mr. H. L. Kirke, of the B.B.C. Research Department, in 1936 in the capacity of adviser. It gives a very interesting summary of the difficulties en-

countered and the means employed to overcome them in establishing a short-wave broadcasting service, which, in sharp contradistinction to the general purpose of a short-wave service, is intended to serve the country in which it is located, and not overseas.

The report, which occupies 250 pages plus many graphs, circuit diagrams and photographs, is published by the Manager of Publications, Government of India, Delhi, at Rs. 3 (5s.).

## The Industry

ENQUIRIES regarding "Eddystone" components should now be addressed to Stratton & Co., Ltd., Lapworth Court, Old Warwick Road, Lapworth, Warwickshire.

The instruction manual issued with the Cossor Double Beam C.R. Oscillograph (Model 3339) is now available separately (price 2s. 6d.) from A. C. Cossor, Ltd., Highbury Grove, London, N.5. It contains much useful general information on cathode-ray technique in addition to data relating specifically to the instrument itself.

Manufacturers interested in tin-coated finishes will find a comprehensive survey of hot-dipping processes for all types of ferrous and non-ferrous articles in Publication No. 102, "Hot Tinning," issued by The Tin Research Institute, Fraser Road, Greenford, Middlesex.

# Wireless Patents

## A Summary of Recently Accepted Specifications

The following abstracts are prepared, with the permission of the Controller of H.M. Stationery Office, from Specifications obtainable at the Patent Office, 25, Southampton Buildings, London, W.C.2, price 1/- each

### ACOUSTICS AND AUDIO-FREQUENCY CIRCUITS AND APPARATUS

528 631.—Volume-control arrangement for a two-stage low-frequency amplifier in which a combination of positive and negative reaction is utilised.

*Marconi's W.T. Co. (assignees of M. C. Jones). Convention date (U.S.A.) 30th April, 1938.*

### AERIALS AND AERIAL SYSTEMS

528 817.—Short-wave aerial, particularly for television, consisting of a quarter-wave ellipsoidal radiator having a transverse thickness equal to a substantial fraction of the working wavelength.

*Marconi's W.T. Co. (assignees of N. E. Lindénblad). Convention date (U.S.A.) 18th May, 1938.*

528 998.—Television aerial with a coaxial feeder and associated counterpoise.

*Telefunken Co. Convention date (Germany) 20th May, 1938.*

529 152.—Wide frequency-band aerial of conical shape with resistance-capacity "loading" at the upper and larger end.

*Telefunken Co. Convention date (Germany) 24th May, 1938.*

### DIRECTIONAL WIRELESS

528 061.—Direction-finding system in which a pilot signal is used to ensure that the amplifiers work with equal or matched gain.

*P. W. Willans and The Plessey Co. Application date 21st April, 1939.*

528 514.—Coupling arrangement for developing a signal equivalent to the vectorial sum of the signals received on the four dipoles of a directive aerial system of the Adcock type.

*Standard Telephones and Cables and C. F. A. Wagstaffe. Application date 28th April, 1939.*

528 605.—Method of mounting and protecting the dipole aerials and coupling lines of a directive aerial system of the Adcock type.

*Telefunken Co. Convention date (Germany) 11th May, 1938.*

528 861.—Means for eliminating spurious course-lines from the field radiated by a radio navigational beacon or transmitter of the overlapping-beam type.

*Standard Telephones and Cables (assignees of F. A. Kolster). Convention date (U.S.A.) 11th June, 1938.*

528 874.—Radio navigational beacon which transmits three directional lobes or patterns, one on each side of the centre lobe or true course.

*Standard Telephones and Cables (assignees of F. A. Kolster). Convention date (U.S.A.) 25th May, 1938.*

529 288.—Directive aerial array for a radio navigational system of the overlapping-beam type and means for energising it in a desired phase-relation.

*Standard Telephones and Cables (assignees of Le Matériel Téléphonique Soc. Anon.). Convention dates (France) 14th June and 30th July, 1938.*

## RECEIVING CIRCUITS AND APPARATUS

(See also under Television)

528 152.—Receiver for frequency-modulated signals with means for eliminating interference, particularly that due to very sudden impulses.

*Standard Telephones and Cables (assignees of H. Nyquist). Convention date (U.S.A.) 21st May, 1938.*

528 252.—Broad-band filter circuit incorporating negative feed-back, particularly for the intermediate-frequency stages of a superhet receiver.

*Hazeltine Corporation (assignees of H. A. Wheeler). Convention date (U.S.A.) 9th May, 1938.*

528 484.—Wireless receiver in which interference is suppressed by blocking the amplifying channel for short periods which are determined partly by the mean amplitude of the carrier wave and partly by its modulation envelope.

*Magyar Wolfram Co. Convention date (Hungary) 6th May, 1938.*

528 632.—Superheterodyne set with means for preventing any intermittent or "fluttering" action of the local oscillator due to interaction with the low-frequency circuits.

*Marconi's W.T. Co. (assignees of M. C. Jones). Convention date (U.S.A.) 30th April, 1938.*

528 633.—Mains-driven wireless set fitted with electrolytic condensers for automatically balancing-out the effect of fortuitous fluctuations in the supply voltage.

*Electric Research Products Inc. and S. H. W. Browning. Application date 2nd May, 1939.*

528 736.—Wireless receiver provided with means for filtering-out an interference tone and then using it to control the selectivity of the set.

*L. L. de Kramolin. Application date 7th March, 1939.*

528 893.—Thermionic valve circuit, including a stage with variable mutual-conductance and negative feed-back, for use as an amplifier or frequency-changer in a wireless receiver.

*Philips Lamps. Convention date (Netherlands) 19th May, 1938.*

528 916.—Push-button tuning-control system, arranged as an independent unit for fitting to any standard wireless receiver.

*Telefunken Co. Convention date (Germany) 6th May, 1938.*

528 944.—Tuning control system particularly for a wireless set arranged to simulate a pedestal or table lamp.

*D. J. Crowley. Convention date (U.S.A.) 20th June, 1938.*

529 044.—Push-pull valve circuit with variable negative resistance for deriving a volume control which is dependent either upon frequency or amplitude.

*A. C. Cossor and L. Jofeh. Application date 9th May, 1939.*

529 163.—Filter network and coupling designed to ensure automatic selectivity-control in a wireless receiver.

*Marconi's W.T. Co. and E. F. Goodenough. Application date 11th March, 1939.*

529 168.—Coupling arrangement designed to stabilise the voltage developed across a tuned anode "load" in a wireless receiver.

*Marconi's W.T. Co. and J. D. Brailsford. Application date 13th April, 1939.*

## TELEVISION CIRCUITS AND APPARATUS

FOR TRANSMISSION AND RECEPTION

528 179.—Negative feed-back circuit, particularly for a television transmitter, in which a high signal-to-noise ratio is ensured.

*W. S. Percival. Application date 22nd March, 1939.*

528 198.—Construction of the cabinet of a television receiver, designed to facilitate inspection of the wiring and component parts for servicing purposes.

*D. Jackson. Application date 16th April, 1939.*

528 310.—Delay network in which an applied pulse and its reflection operate differentially, particularly for separating the frame and line synchronising signals in television.

*A. D. Blumlein. Application date 25th February, 1939.*

528 354.—Means for preventing the production of "ripple" bands in a television receiver caused by the use of A.C. lamps for illuminating the transmitting studio.

*Philips Lamps. Convention date (Holland) 7th May, 1938.*

528 424.—Means for preventing undesirable effects due to cracks in the surface of the photographic films used for transmitting television programmes.

*Radio-Akt. D. S. Loewe. Convention date (Germany) 6th May, 1938.*

528 444.—Television receiver with a projection screen made of gold or bronze coloured material, so as to offset the green colour of the light from the fluorescent screen.

*Kolster-Brandes and D. S. B. Shannon. Application date 6th January, 1939.*

528 685.—Cathode-ray television receiver in which the picture is deliberately projected on the image screen in a distorted form, which however lends itself to accurate magnification by cylindrical lenses.

*Scophony and F. Okolicsanyi. Application date 1st May, 1939.*

528 689.—Wide-band high-frequency amplifier in which the stage gain is deliberately limited in order to secure optimum results as regards attenuation and phase-shift at the edge of the band.

*Kölster-Brandes and C. N. Smyth. Application date 2nd May, 1939.*

528 894.—Television transmitter in which the picture signal-currents are supplied by an electron-multiplier, the output from which is substantially suppressed during the "fly-back" period between each scanning line.

*Philips Lamps. Convention date (Germany) 19th May, 1938.*

529 099.—Light-modulating device of the supersonic pressure-wave type, particularly for television.

*Scophony and A. H. Rosenthal. Application date 12th May, 1939.*

## TRANSMITTING CIRCUITS AND APPARATUS

(See also under Television)

528 151.—Amplifier circuit in which negative feedback including a non-linear resistance is used to prevent "singing" and the production of undesirable self-oscillation.

*Standard Telephones and Cables (assignees of H. S. Black). Convention date (U.S.A.) 27th May, 1938.*

528 344.—Piezo-electric control for a valve generator designed to give a stable output of good strength at a selected harmonic of the fundamental crystal frequency.

*Marconi's W.T. Co. and H. W. Pratley. Application date 4th May, 1939.*

528 473.—Push-pull system comprising a number of short-wave oscillators arranged symmetrically about a common cylinder, in order to increase the effective output.

*The General Electric Co. and M. R. Gavin. Application date 8th May, 1939.*

528 481.—Biasing circuit for a telephone or telegraph transmitter in which voltage regulation is effected by variable tappings along a "Thyrite" potentiometer.

*Marconi's W.T. Co. (assignees of C. W. Hansell). Convention date (U.S.A.) 7th May, 1938.*

528 513.—Negative feed-back arrangement for preventing harmonic distortion due to variations in the output load on the main amplifier of a broadcast relaying system.

*Standard Telephones and Cables; R. A. Meers; and P. R. Thomas. Application date 28th April, 1939.*

## CONSTRUCTION OF ELECTRONIC-DISCHARGE DEVICES

528 428.—Mounting and arrangement of the electrodes of a transmitting valve so as to prevent relative movement, such as would alter the working characteristic of the valve.

*Marconi's W.T. Co. (assignees of P. T. Smith). Convention date (U.S.A.) 29th April, 1938.*

528 801.—Arrangement and mounting of the magnetic deflecting coils of a cathode-ray tube to eliminate any field-component parallel to the axis of the tube.

*Standard Telephones and Cables and R. A. L. Cole. Application date 5th May, 1939.*

528 818.—Electron multiplier in which the photo-sensitive cathode is in a compartment almost completely separated or screened from the secondary-emitting or target electrodes.

*Marconi's W.T. Co. (assignees of V. K. Zworykin and J. A. Rajchman). Convention date (U.S.A.) 10th June, 1938.*

529 183.—Electrode arrangement designed to ensure the stable operation of an electron-multiplier tube.

*Standard Telephones and Cables (assignees of Le Matériel Téléphonique Soc. Anon.). Convention date (France) 29th June, 1938.*

## SUBSIDIARY APPARATUS AND MATERIALS

528 345.—Frequency-wobbling circuit, particularly designed for indicating the altitude of an aeroplane by comparing outgoing signals with their counterparts after reflection from the ground.

*Marconi's W.T. Co. and B. J. Witt. Application date 4th May, 1939.*

528 568.—Means for locating and determining the depth of a submarine cable or other submerged conducting body capable of distorting (or producing) a magnetic field.

*British Western Union. Convention date (U.S.A.) 26th February, 1938.*

528 806.—Multivibrator circuit, with negative feedback, particularly designed to handle frequencies of the order of megacycles.

*R. Calvert. Application date 5th May, 1939.*

528 860.—Thermionic valve circuit for generating a frequency which varies cyclically, for instance in saw-toothed fashion, as is required when measuring the altitude of an aeroplane by reflected radio-waves.

*The General Electric Co.; H. C. Turner; and G. M. Tomlin. Application date 8th May, 1939.*

529 131.—Arrangement and mounting of the crystal element in a piezo-electric filter circuit.

*Marconi's W.T. Co. and A. T. Starr. Application date 22nd May, 1939.*

529 132.—Phase-advancing circuit comprising a filter combination terminated by a negative resistance.

*Soc. Francaise Radio-Electrique. Convention date (Germany) 23rd May, 1938.*

# Abstracts and References

Compiled by the Radio Research Board and reproduced by arrangement with the Department of Scientific and Industrial Research

For the information of new readers it is pointed out that the length of an abstract is generally no indication of the importance of the work concerned. An important paper in English, in a journal likely to be readily accessible, may be dealt with by a square-bracketed addition to the title, while a paper of similar importance in German or Russian may be given a long abstract. In addition to these factors of difficulty of language and accessibility, the nature of the work has, of course, a great influence on the useful length of its abstract.

	PAGE		PAGE
Propagation of Waves ... ..	114	Directional Wireless ... ..	124
Atmospherics and Atmospheric Electricity ... ..	118	Acoustics and Audio-Frequencies	124
Properties of Circuits ... ..	119	Phototelegraphy and Television ...	125
Transmission ... ..	120	Measurements and Standards ...	126
Reception ... ..	121	Subsidiary Apparatus and Materials	128
Aerials and Aerial Systems ...	122	Stations, Design and Operation ...	130
Valves and Thermionics ... ..	123	General Physical Articles ... ..	131
		Miscellaneous ... ..	132

## PROPAGATION OF WAVES

669. HOLLOW PIPES OF RELATIVELY SMALL DIMENSIONS.—Bartow & Shaevitz. (See 757.)

670. INVESTIGATIONS ON STOPS [Apertured Screens] WITH CENTIMETRIC WAVES.—K. Erler. (*Hochf.tech. u. Elek. answ.*, Oct. 1940, Vol. 56, No. 4, pp. 104-111.)

Measurements were first carried out on 14.1 cm waves from the retarding-field generator described in detail by Brömel (105 of 1937), radiated from a vertical half-wave dipole at the focus of a parabolic reflector: additional gain to the extent of 35-40% was obtained by a reflector dipole in front of the radiating dipole, giving a total energy gain of about 40 compared with the latter by itself. Stops with square, slit-shaped, and circular apertures were used, fixed in the middle of a  $170 \times 170$  cm<sup>2</sup> screen which, like the stops themselves, was of 2 mm aluminium plate. This was mounted at a distance of some 40λ from the apex of the mirror, since in the immediate neighbourhood of the mirror interference phenomena occur which produce inhomogeneities of intensity (Bach, 2758 of 1939) and prevent a uniform irradiation of the stop. Reception was by a hot-wire-bolometer bridge-circuit with its wire at the mid-point of an exploring half-wave dipole. All tests were in the open air, to avoid reflections, and the transmitter and receiver were both raised 2 m above the ground.

Most of the tests were repeated on a 7 cm wave from a magnetron oscillator combined with the same radiating arrangements. The dimensions of the apertures were altered in proportion to the wavelengths, and the distance between stop and reflector was again made 40λ: the height of the apparatus above the ground was left unchanged. In both cases measurements were made with the exploring dipole close up to the stop and at increasing distances up to 30λ. No fundamental differences between the 14.1 cm and 7 cm results

were found: the presence of certain subsidiary maxima on the curves for the longer wave was due to the fact that the height above the ground, measured in wavelengths, was smaller for this wave than for the 7 cm wave, so that reflections were more in evidence.

Author's summary:—"The intensity distribution at and behind stops was investigated on 14.1 cm and 7 cm waves. In both cases marked interference phenomena occur, whose dimensions in space vary in the same proportion as the wavelengths. Behind the stops high intensity maxima occur, their position depending on the stop aperture. They are most strongly formed by circular apertures. At a maximum, for example, a five-fold increase of intensity compared with the 'free' field can be attained by the use of a suitable stop. Still greater increases are obtained by the use of a two-stop combination: thus with two square-aperture stops a 6.5-fold increase was found [section III 2d mentions a 'nearly doubled' intensity compared with the single stop]. The intensity at the maximum depends chiefly on the apertures of the combined stops, and less on their spacing. The position of the maximum is chiefly determined by the [aperture of the] stop nearer to the receiver.

"The intensity as a function of the receiver distance, and also as a function of the aperture size, is calculated by a formula from optics [Fresnel diffraction formula] and compared with the experimental results. The agreement can be regarded as satisfactory." [Figs. 11/13: the calculated curves show a series of very narrow maxima close behind the stop, whereas the measured curves have, in this region, a single maximum only: this discrepancy is due to the optical formula being strictly applicable only at greater distances. Otherwise the agreement is distinctly good, the position of the broad maximum further from the stop, and its gradual descent to the homogeneous, interference-free "distant" field, being well given by the formula].

671. EXPERIMENTS ON THE PROPAGATION OF ULTRA-SHORT RADIO WAVES [41.5 & 45 Mc/s, from Alexandra Palace Television Station to Cambridge (71.3 km), May/Aug. 1939].—A. H. Waynick. (*Proc. I.R.E.*, Oct. 1940, Vol. 28, No. 10, pp. 468-475.)  
Fast (half-minute) fading partly, at least, a refractive effect due to small regions; slow (five-minute) to large regions: correlation between signal strength and meteorological conditions: cold tropopause correlation with peak-signal days (water-vapour content and ground-level temperature not important): considerable variation in horizontal direction of arrival: apparent discrepancy between theoretical and observed height/gain relations: reflections on rare occasions only: etc.
672. VERTICAL *versus* HORIZONTAL POLARISATION [for Ultra-Short Waves: Theory and Experiment].—G. H. Brown. (*Electronics*, Oct. 1940, Vol. 13, No. 10, pp. 20-23.)  
“In spite of the preponderance of the vertically polarised field near the surface of the earth, horizontally polarised waves yield a more favourable signal/noise ratio for television and aural broadcast services (between 30 and 300 Mc/s) where the transmitting antenna is at least a few wavelengths above ground level. . . In the case of transmission between two mobile units with both transmitting and receiving antennas near the ground, a more favourable signal/noise ratio is obtained with vertically polarised waves.”
673. THE IONOSPHERE AND RADIO TRANSMISSION, SEPT. 1940, WITH PREDICTIONS FOR DEC. 1940 [and Recent Observations indicating (contrary to Statements in Literature) that Sudden Ionospheric Disturbances sometimes affect Sky-Wave Transmission in Broadcast Band, either Increasing or Decreasing the Daytime Field Strength].—Nat. Bur. of Stds. (*Proc. I.R.E.*, Oct. 1940, Vol. 28, No. 10, pp. 485-486.)  
“The different effects result from the fact that transmissions in this band take place *via* the E layer, or the D layer, or both at once. The effect is a decrease in intensity or complete failure of E-layer transmission, and either an increase in intensity or no change of D-layer transmission. This is a further indication that the fade-out region is below the E layer and in or above the D layer. It also provides a means of separating and identifying transmissions *via* the D and E layers. . .”
674. A RADIO TRANSMISSION ANOMALY [“North Atlantic Anomaly”]: COOPERATIVE OBSERVATIONS BETWEEN THE UNITED STATES AND ARGENTINA.—Dellinger & Cosentino. (*Proc. I.R.E.*, Oct. 1940, Vol. 28, No. 10, pp. 431-437.) The full paper, a summary of which was dealt with in 4198 of 1940.
675. STATIONARY ELECTRIC AND MAGNETIC FIELDS IN BEAMS OF LIGHT [Light Beam have Electric Stationary Components in Direction of Wave-Front Normal (with Consequent Stationary Electric Potential Differences between Different Points along the Beam, so that it should be possible to collect Electricity from the Beam): Similar Stationary Magnetic Field (giving Magnetising Effect): Conclusions from Experiments on Electro- & Magneto-Photophoresis].—F. Ehrenhaft. (*Nature*, 4th Jan. 1941, Vol. 147, p. 25.) For previous references to this work see 221 of January and back references (possible connection with polar light, magnetic storms, etc.): also Abstracts, 1931, p. 340; 1933, p. 287; and 327 of 1939.
676. MAGNETIC DISTURBANCE DURING SUDDEN FADE-OUTS OF RADIO TRANSMISSION [Measurements of Time Rate of Change of Magnetic Force: Presence of Bays: etc.].—H. Nagaoka. (*Sci. Abstracts*, Sec. A, 25th Nov. 1940, Vol. 43, No. 515, p. 746.) Using the induction magnetograph referred to in 21 of 1940: for previous work see 3300 of 1940.
677. IONOSPHERIC CHANGES ASSOCIATED WITH THE MAGNETIC STORM OF MARCH 24TH, 1940 [Huancayo—F<sub>2</sub> Layer was swept Upwards & disappeared in about 30 Minutes, E-Layer Ion Density rose 40%: Steady “New” F<sub>2</sub> Layer Growth proceeded for Next Hour (Estimation of Effective Recombination Coefficient & Rate of Ion Production at Max. Density Level) followed by Succession of Abnormal Increases & Decreases of Ion Density: Watheroo—Spatial Tilts of Iso-Ionic Surfaces followed by Rapid Rise of Height (lagging by nearly an Hour behind Huancayo) and Increased Scattering: Radio Fade-Out Comparisons].—L. V. Berkner & S. L. Seaton. (*Terr. Mag. & Atmos. Elec.*, Dec. 1940, Vol. 45, No. 4, pp. 393-418.)
678. SYSTEMATIC IONOSPHERIC CHANGES ASSOCIATED WITH GEOMAGNETIC ACTIVITY [U.R.S.I.-I.R.E. Joint Meeting Paper, April 1940].—L. V. Berkner & S. L. Seaton. (*Terr. Mag. & Atmos. Elec.*, Dec. 1940, Vol. 45, No. 4, pp. 419-423.)
679. GEOMAGNETIC TIDES IN HORIZONTAL INTENSITY AT HUANCAYO: PART II [including New Formula for  $I(M_2)$  supporting Dynamo Theory: Seat of Main Lunar Currents must be Low in Ionosphere, where Recombination is Rapid: certainly Not as High as F Region].—J. Bartels & H. F. Johnston. (*Terr. Mag. & Atmos. Elec.*, Dec. 1940, Vol. 45, No. 4, pp. 485-512.)
680. SPHERICAL HARMONIC ANALYSIS OF THE QUIET SOLAR DIURNAL VARIATIONS OF THE EARTH'S MAGNETIC FIELD, MAY/AUG. 1933.—N. P. Benkova. (*Terr. Mag. & Atmos. Elec.*, Dec. 1940, Vol. 45, No. 4, pp. 425-432.)
681. DISTRIBUTION OF SUNSPOTS OVER THE SUN'S DISC.—Archenhold. (*Nature*, 14th Dec. 1940, Vol. 146, p. 780: summary only.)
682. SUNSPOTS AND TELEPHONE SERVICE [particularly the Effects of the Magnetic Storm of 24th March 1940 on Bell System Services].—G. Ireland. (*Bell Tel. Quarterly*, July 1940, Vol. 19, No. 3, pp. 184-196.)

683. TIDAL FORCES IN THE SUN'S CORONA, DUE TO PLANETS, COMPARED WITH WOLF'S SUNSPOT CURVES.—Meldahl. (*Nature*, 11th Jan. 1941, Vol. 147, p. 61: summary only.)
684. F-REGION CRITICAL FREQUENCIES AT DEAL, NEW JERSEY, DURING PARTIAL (60% AREA) SOLAR ECLIPSE OF APRIL 7TH, 1940 [Effect on  $F_2$  Ionisation Not Pronounced: No Conclusions].—J. P. Schafer. (*Terr. Mag. & Atmos. Elec.*, Dec. 1940, Vol. 45, No. 4, p. 513.)
685. DECREASE IN IONISATION OF THE  $F_2$  REGION DURING SOLAR ECLIPSE.—Pierce, Higgs, & Halliday. (*Phys. Review*, Ser. 2, 15th Dec. 1940, Vol. 58, No. 12, p. 1119.) Already dealt with in 299 of February.
686. RADIATIVE DETACHMENT AND ATTACHMENT OF THE NEGATIVE OXYGEN ION [Quantum-Mechanical Treatment: if These Ions occur in Upper Atmosphere, They must be produced by Some Other Process (Dissociation of  $O_2$  Molecules or Collisions of Two O Atoms)].—T. Yamanouchi. (*Sci. Abstracts*, Sec. A, 25th Dec. 1940, Vol. 43, No. 516, p. 804.) For previous work see 3295 of 1940.
687. PAPERS ON COSMIC RAYS [including Connection with Echoes].—(See under "Atmospheric & Atmospheric Electricity.")
688. IONISATION AND DISSOCIATION OF WATER VAPOUR AND AMMONIA BY ELECTRON IMPACT [Mass-Spectrometric Study giving  $13.0 \pm 0.2$  V as Ionising Potential of  $H_2O$  Molecule: the Ions observed, and Their Formation].—Mann & others. (*Sci. Abstracts*, Sec. A, 25th Nov. 1940, Vol. 43, No. 515, p. 766.)
689. [Electron-] EXCHANGE EFFECTS IN THE THEORY OF THE CONTINUOUS ABSORPTION OF LIGHT: I [including Application of Results for Ca in connection with Interstellar Electron Densities].—D. R. Bates & H. S. W. Massey. (*Proc. Roy. Soc.*, Ser. A, 27th Nov. 1940, Vol. 176, No. 967, p. S 76.)
690. ON THE PROBLEM OF SPACE-WAVE PROPAGATION [Mathematical Investigation of the "Glide Wave" Hypothesis for Long-Distance & Round-the-Earth Short-Wave Transmissions].—O. Burkard. (*Hochf. tech. u. Elek. Akus.*, Oct. 1940, Vol. 56, No. 4, pp. 97-104.)

The "gradual bending" hypothesis of Fig. 1 is unsatisfactory as a mechanism for such long ranges (4000 km upwards) because, in the first place, it would require layer thicknesses of some hundreds of kilometres, which is quite contrary to the results of echo measurements; in the second place it would not explain multiple round-the-earth transits; and finally it cannot be reconciled with the experience of perfectly regular communication over distances of 12 000 km, hour after hour, in spite of the constantly present, if small, fluctuations in the ionisation conditions—Lassen's own curves (Fig. 2) showing the calculated relation between the ionisation (at 50 km and 200 km) and the range, on the "gradual bending" theory, indicate

that such stability could not reasonably be expected.

On the other hand the multiple-reflection, "zig-zag path" theory is just as unsatisfactory for the cases under consideration: not only is it in complete contradiction to observations on skip regions, but also it would involve too much energy loss; for if a flattened path with comparatively few reflections is assumed, a round-the-earth signal would have to traverse long stretches of the strongly absorbing lower ionospheric layers, while if a steeper course is assumed, the increased number of reflections would involve a similar considerable loss.

So far as the writer is aware the "glide wave" hypothesis was first put forward in 1917, by Uller. Hitherto, however, any attempts to work out the idea in connection with short-wave propagation have been thwarted by the mathematical difficulties. On the other hand, von Schmidt was able to show, in his experiments on explosion waves, the existence of elastic "glide waves" at the surface of separation of two media, and actually "pointed out the likelihood of similar phenomena in the propagation of electromagnetic waves" [he did more than this: see long abstracts 441 of 1937 and 1368 of 1939].

The writer first considers a wave source existing in the surface of separation between medium I (air:  $\mu_1 = \epsilon_1 = 1$ ) and medium II (ionosphere:  $\mu_2 = 1$ ,  $\epsilon_2 =$  arbitrary value) in contact along the plane  $z = 0$ : the magnetic lines of force of this source form concentric circles axially symmetrical to the  $z$  axis, its electric lines of force lie in planes through this axis. The glide wave along the surface of separation has its front perpendicular to the surface in medium II, but inclined at an angle  $i$  in medium I, where  $\tan i = \sqrt{\epsilon/\sqrt{1-\epsilon}}$ : it can be considered (Fig. 3) as a wave-pair with one component leading the way in the ionosphere, with a velocity  $c_1 = c_0/\sqrt{\epsilon}$ , and the second component drawn along behind it in the air (medium I). The Poynting vector in the latter case is normal to the wave front and directed earthwards; energy is therefore constantly being radiated to earth from the glide wave, but "owing to the varying ionisation conditions in the ionosphere" this down-radiated energy only reaches appreciable values "on certain quite definite assumptions": see below, sections IV and V (a paper by the writer in *Funktech. Monatshefte* for May 1940, No. 5, p. 65, is also mentioned in this connection).

Section III then deals with a source no longer in the surface of separation but on the ground, radiating a plane wave to fall with an angle of incidence  $\alpha$  (Fig. 4) on a boundary layer of the ionosphere. No particular layer is considered: medium I is still taken as having  $\mu_0 = \epsilon_0 = 1$  (the subscripts are now changed) while for medium II, the ionosphere,  $\mu_1 = 1$  and  $1 \leq \epsilon_1 \leq \sin^2 \alpha$  whenever  $z > 0$ . From the Fresnel equations the field components for the reflected wave ("return" wave: subscript  $r$ ) and the refracted wave (subscript  $d$ ) are obtained (equations 2 & 3,  $X$ ,  $Y$ ,  $Z$  representing the electric field strengths in the corresponding directions and  $U$ ,  $V$ ,  $W$  the magnetic, while  $E_p$  and  $E_s$  are respectively the field strengths parallel and perpendicular to the plane of incidence). Concentrating on the refracted wave only, the



writer considers the special case where  $\epsilon_1$  is nearly equal to  $\sin^2\alpha$ , for which the field components reduce, as an approximation, to the simple forms of eqns. 5 (the new terms here introduced for the sake of brevity are defined in eqns. 6). "The similarity with the earlier discussed glide wave propagating in medium II [section II, above] leaps to the eyes; it can readily be pictured that just in those cases where the refracted wave runs almost parallel to the surface of separation (as must happen if  $\epsilon_1$  is assumed about equal to  $\sin^2\alpha$ ), there must occur waves which never separate from the separation surface but form the new gliding type under consideration. . . ." The other component, lagging behind in medium I, is represented by eqns. 8.

Section IV considers the fact of the large variations, in the ionosphere, of  $\epsilon_1$  both in time and space: "these play an important part in the amount of energy radiated back to earth." On the assumption that  $\epsilon_1$  alters only with the  $x$ -coordinate, changing gradually from  $\epsilon_1$  to  $\epsilon_n$ , so that the ionosphere can be divided by planes  $x = \text{const.}$  into strips in which the local  $\epsilon_1$  may be considered as constant, the wave of eqns. 5 must undergo changes in amplitude and velocity in passing from one strip to the next. Taking these changes into consideration, eqns. 9 are obtained for the glide wave in medium II, and eqns. 10 (with II & 12) for the component in medium I, on which depends the energy radiated to earth.

Section V considers the application of these results to the explanation of long-distance communication. The difficulty is that the expressions show a complex dependence on a large number of quantities whose actual values are unknown. The whole derivation of the glide wave has been based on the assumption that  $\epsilon_1$  was approximately equal to  $\sin^2\alpha$ , but as can be seen from eqn. 11, for instance, the more closely this approximation is fulfilled the weaker becomes the intensity of the glide wave. "It can only be pointed out that among the various solutions there can be found one which is in astonishingly good agreement with observed facts: this is the case when  $\sqrt{\epsilon_1} = 1.002 \sin\alpha$  . . . eqn. 13." The intensity of the glide waves, so far as it depends on the data at the point of its origin, is thus determined: its dependence on the value of  $\epsilon_n$  can best be followed by means of the two functions  $z_1$  &  $z_2$  (eqn. 14) whose curves have the same form as those of the intensities given in eqns. 11 & 12: these curves are shown in Fig. 5. Both functions reach important values only when  $\epsilon_n$  is very small or very large: only then does the energy radiated to earth attain useful values, in all other cases it remains below the threshold of sensitivity of our receivers, and the skip-distance effect is encountered. Simultaneously with the energy, the downward-radiating angle  $\beta$  ( $\sin\beta = \sqrt{\epsilon_n}$ ; eqn. 12) varies continually: it may become so large that the waves no longer reach the earth: for the F layer, the glide waves just touch the earth tangentially when  $\beta$  is about  $74^\circ$ .

The particular case of a 20 m wave is then examined as to its intensity relations for various possible degrees of ionospheric ionisation. Figs. 8 & 9 show the influence of the degree of ionisation, and of the angle of incidence  $\alpha$  at the layer, on the

strength of the glide-wave components parallel and perpendicular to the plane of incidence, respectively. A value of  $65^\circ$  for  $\alpha$  gives a maximum strength, so that an aerial system producing this angle should give optimum results. It is concluded that according to the time of day and year, and to the wavelength, wireless communication as a whole depends predominantly on the glide wave or predominantly on the "return" wave. The former is characterised by the fact that its range has no direct connection with the degree of ionisation: three necessary conditions must however be satisfied—at the place where the wave first meets the ionosphere, the above-described approximate relations between angle of incidence and ionisation must exist; along the whole glide path the ionisation must not be too high (which would cause absorption) or too low (which would cause a loss of the "guiding" action); and finally, at the receiving end the ionisation must be right to produce a large enough intensity in the energy sent down. According to Figs. 8 & 9 this could occur for both high and low ionisation, but in practice the latter must be depended on, since strong ionisation would cause too much absorption loss both during the traversing of the lower layers and also, probably, in the glide path itself. "These considerations show that while the most varied ranges are possible for the glide waves, they are also the *only* waves which can carry long-distance short-wave communication": the "return" (reflected) waves are limited to ranges up to about 5000 km, their signals are louder and have a "stable" tone which is readily distinguished by the expert. The fact that the characteristic quality of long-distance signals has often been noticed from stations comparatively near at hand is a confirmation of the belief, expressed above, that glide waves appear on occasion at quite short ranges.

Finally, Figs. 11 & 12 give, in their top curves, for a January and a July day respectively, the critical frequencies of the  $F_2$  layer measured in our latitudes, while the lower curves show, for 4 different wavelengths, the intensities for glide wave and reflected wave calculated by eqns. 11 and 4, assuming for both waves an angle of incidence  $\alpha = 50^\circ$ . Taking the winter conditions, it is seen that the 10 m wave is too short for reflection-wave transmission, but that the glide wave is usable between 9.00 and 19.00—which agrees with observed results. The 20 m wave is seen to be suitable for glide-wave ranges at night (21.00 to 6.00), whereas during the mid-day hours short-distance reflected-wave transmission supervenes. Other cases where the writer's theory conforms with observed results are discussed.

691. THE IONOSPHERE AT WATHEROO, WESTERN AUSTRALIA: AT HUANCAYO, PERU: JANUARY/JUNE 1940.—Parkinson & Prior: Wells & Coile. (*Terr. Mag. & Atmos. Elec.*, Dec. 1940, Vol. 45, No. 4, pp. 471-476: pp. 477-483.) See also 677, above.
692. THE GENERATION OF SPURIOUS SIGNALS BY NON-LINEARITY OF THE TRANSMISSION PATH [Investigation of Severe External-Cross-Modulation Phenomena in Broadcast Reception in & about Seattle: occur when "Field Product" (computed from Field Strengths

- of the Associated Real Signals) exceeds Critical Value: Definition & Use of "Susceptibility Factor".—A. V. Eastman & L. C. F. Horle. (*Proc. I.R.E.*, Oct. 1940, Vol. 28, No. 10, pp. 438-443.)
693. SIMPLE PULSE-GENERATING CIRCUITS [using High-Vacuum Valves: Pulses of 100 Volts Amplitude & about 100 Microseconds Duration: Circuit giving Pulses of Controlled Width, from RC Series Network fed with Square Wave: Circuit using "V" Portion of Full-Wave Rectified Wave].—S. P. Sashoff & W. K. Roberts. (*Electronics*, Sept. 1940, Vol. 13, No. 9, pp. 40-41 and 88, 89.)
694. A FIVE-FIGURE TABLE OF THE BESSEL FUNCTION  $I_n(x)$  [for Travelling Waves on Line].—H. B. Dwight. (*Elec. Engineering*, Dec. 1940, Vol. 59, No. 12, p. 517: summary only.)
- ATMOSPHERICS AND ATMOSPHERIC ELECTRICITY**
695. THE DISTRIBUTION OF ELECTRICITY IN THUNDERCLOUDS: II.—G. D. Robinson & G. Simpson. (*Proc. Roy. Soc., Ser. A*, 27th Nov. 1940, Vol. 170, No. 967, p. S75.) Confirmation of Simpson & Scrase's conclusions (3605 of 1937).
696. THE ELECTRICITY OF CONTINUOUS [Non-Stormy] RAIN [and Comparison with Other Results: No Decision between Negative-Cloud and Bipolar-Cloud Theories].—J. A. Chalmers & E. W. R. Little. (*Terr. Mag. & Atmos. Elec.*, Dec. 1940, Vol. 45, No. 4, pp. 451-462.)
697. DEVELOPMENTS IN SURGE RECORDING BY MEANS OF THE KLYDONOGRAPH [E.R.A. Report Ref.S/T27].—J. L. Candler. (*Journ. I.E.E.*, Dec. 1940, Vol. 87, No. 528, pp. 597-609: Discussion pp. 609-614.)
698. SPARK GAPS WITH SHORT TIME LAG [Low Impulse Ratio: for Protective Devices, etc.].—Slepian & Berkey. (*Journ. Applied Phys.*, Dec. 1940, Vol. 11, No. 12, pp. 765-768.) A summary was dealt with in 4032 of 1940: cf. Race, 572 of February.
699. IMPULSE AND 60-CYCLE CHARACTERISTICS OF DRIVEN GROUNDS.—P. L. Bellaschi. (*Elec. Engineering*, Dec. 1940, Vol. 59, No. 12, p. 517: summary only.)
700. THE MOBILITY OF POSITIVE IONS IN THEIR OWN GAS [Measured Values considerably Smaller than Those Calculated from Alkali-Ion Values (owing to Electron Exchange occurring in Former but Not in Latter Case): Variation of Mobility with  $E$  &  $p$ ].—R. J. Munson & A. M. Tyndall. (*Proc. Roy. Soc., Ser. A*, 10th Jan. 1941, Vol. 177, No. 969, pp. 187-191.)
701. THE CHARACTERISTICS OF THERMAL DIFFUSION [Ratio  $k_T$  in Gas Mixtures may be Zero not only when Concentration Ratio  $c_1$  or  $c_2$  is Zero but also for at most One Intermediate Mixture-Ratio: etc.].—S. Chapman. (*Proc. Roy. Soc., Ser. A*, 31st Dec. 1940, Vol. 176, No. 968, pp. 38-62.)
702. ESTIMATION OF THE AIR-EARTH CURRENT.—P. J. Nolan. (*Terr. Mag. & Atmos. Elec.*, Dec. 1940, Vol. 45, No. 4, p. 483: summary only.)
703. "WEATHER PREDICTION," and "FORECASTING WEATHER" [Book Reviews].—R. M. Lester: Napier Shaw. (*Nature*, 28th Dec. 1940, Vol. 146, pp. 818-820.) Reviewed by Brunt.
704. "AMERICAN GEOPHYSICAL UNION, TRANSACTIONS OF 1940" [Book Review].—J. A. Fleming (Edited by). (*Terr. Mag. & Atmos. Elec.*, Dec. 1940, Vol. 45, No. 4, pp. 483-484.)
705. GEOMAGNETIC TIDES IN HORIZONTAL INTENSITY AT HUANCAYO: PART II.—Bartels & Johnston. (See 679.)
706. "GEOMAGNETISM" [Book Review].—S. Chapman & J. Bartels. (*Wireless Engineer*, Jan. 1941, Vol. 18, No. 208, p. 17.) A preview was referred to in 943 of 1940. See also article "A Valuable New Book on Geophysics," in *Terr. Mag. & Atmos. Elec.*, Dec. 1940, pp. 463-470.
707. RADIO ECHOES AND COSMIC-RAY SHOWERS [Cascade Showers exist of Sufficient Energy to produce Transient Ionic Clouds capable of Low-Level Sporadic Radio Reflections: Insufficient Published Evidence to decide whether Echoes already observed are due to Such Showers: Need for Data on Frequency-Size Distribution of Echoes from Horizontal or Vertical Beam].—P. M. S. Blackett & A. C. B. Lovell. (*Proc. Roy. Soc., Ser. A*, 10th Jan. 1941, Vol. 177, No. 969, pp. 183-186.) Cf., for example, Fendler, 6 of January.
708. COUNTER STUDIES ON COSMIC RAYS AT SEA LEVEL [including Effects of Passage of Cold & Warm Fronts and Barometric Depressions, and Effect of Magnetic Storms].—Altmann, Walker, & Hess. (*Phys. Review*, Ser. 2, 15th Dec. 1940, Vol. 58, No. 12, pp. 1011-1017.)
709. ENERGY DISTRIBUTION OF INCOMING COSMIC-RAY PARTICLES.—R. A. Millikan & H. V. Neher. (*Sci. Abstracts*, Sec. A, 25th Dec. 1940, Vol. 43, No. p. 790.)
710. COSMIC RAYS AND COMETS [and the Conjecture that Comets are "Contraterrene" Bodies (composed of Atoms of Negatively Charged Nuclei surrounded by Positrons): Some Consequences].—V. Rojansky. (*Phys. Review*, Ser. 2, 1st Dec. 1940, Vol. 58, No. 11, p. 1010.)
711. PENETRATING COSMIC-RAY SHOWERS [probably produced by Soft Component of Cosmic Rays: Estimation of Rate of Meson Production in Atmosphere by Process responsible for These Showers: etc.].—Jánossy. (*Nature*, 11th Jan. 1941, Vol. 147, pp. 56-57.)
712. A STUDY OF THE PRODUCTION AND ABSORPTION OF MESOTRONS IN THE SUBSTRATOSPHERE [Only 5% of Total Number are created by the Non-Ionising Radiation other than Photons suggested by Previous Experiments].—Schein & others. (*Phys. Review*, Ser. 2, 15th Dec. 1940, Vol. 58, No. 12, pp. 1027-1031.)

713. THE GENETIC RELATION BETWEEN THE ELECTRONIC AND MESOTRONIC COMPONENTS OF COSMIC RAYS NEAR AND ABOVE SEA LEVEL [Proper Lifetime of Mesotron at least 4 Microseconds : etc.].—Bernardini & others. (*Phys. Review*, Ser. 2, 15th Dec. 1940, Vol. 58, No. 12, pp. 1017-1026.)
714. ON THE VERTICAL SHIFT OF THE MESON-FORMATION LAYER.—H. Arakawa. (*Phys. Review*, Ser. 2, 15th Dec. 1940, Vol. 58, No. 12, pp. 1118-1119.)

### PROPERTIES OF CIRCUITS

715. CAPACITIVE CONDUCTIVITY [Reciprocal of "Condensance"].—M. Päsler. (*Arch. f. Elektrot.*, 15th Oct. 1940, Vol. 34, No. 10, pp. 598-602.)
- The quantitative expression for the reactance of a condenser is, as the theoretical treatment of the electrical oscillatory circuit shows, the well-known formula  $R_c = -j/\omega C$ . Its derivation, however, is accomplished on the special assumptions that the capacity is constant and that the potential applied is sinusoidal, so that the result cannot represent the general expression for the condensance. An effort has therefore been made to derive for this (and also for its reciprocal) such an expression as would retain nothing special but would be of quite a general character. This attempt appears to have been successful, for an expression was found which gives the above formula as a special case. The method was as follows: the current generated by the application of a voltage to a condenser was calculated, and on the basic assumption of the validity of Ohm's law the quotient voltage/current was found. This, by definition, represents the required resistance. . . . The full general expression found for the "capacitive conductivity"  $G_c$  (the reciprocal of  $R_c$ ) is  $G_c = C \cdot d \log_e U / dt + dC / dt$ .
- If the condenser is of constant capacity the last term of this expression is zero. The simplified formula remaining shows that a d.c. voltage is blocked and that for a sinusoidally varying a.c. voltage  $G_c = j\omega C$ , or  $R_c = -j/\omega C$ , the usual formula. For a damped sinusoidal voltage  $U = U_0 e^{-at} e^{j\omega t}$  the equation for the constant-capacity condenser gives  $|G_c| = C \sqrt{\alpha^2 + \omega^2}$ , so that, other things being equal, the "capacitive conductivity" of a condenser is larger for a damped than for an undamped sinusoidal a.c. voltage. This is explained, on p. 600, in two different ways.
- For a condenser whose capacity varies with time the complete expression for  $G_c$  given above is valid, and the conductivity is correspondingly larger: every change of capacity adds its contribution to the conductivity of the condenser. In the special case when the first term on the right-hand side of the equation is zero (that is, when a d.c. voltage is applied) the expression shows that a current will flow through the condenser: this, of course, conforms with practical experience. The rest of the paper deals with the converse problem, that is, the determination of the voltage necessary to cause a given condenser to show a required conductivity.
716. MATRIX CALCULUS AND ELECTRICAL NETWORKS.—W. Quade. (*Arch. f. Elektrot.*, 15th Oct. 1940, Vol. 34, No. 10, pp. 545-567.)
- Extension of Strecker's work (2540 of 1940): see also Pipes, 3572 of 1937; 868 & 2232 of 1938; 957, 1797, 2090, 2786, & 4226 of 1940; and 57 & 58 of January.
717. SOME NOTES ON COUPLED CIRCUITS [Analysis of Constant-Current-Fed Pair: No Approximations, Equations suitable for Further Manipulation and Subsequent Approximation: Condition for Matched Impedances, Expression for Resulting (Max. Possible) Gain: Curve showing Advantage of Proper Matching over Direct-Impedance or One-to-One Transformer Coupling].—W. R. Ferris. (*R.C.A. Review*, Oct. 1940, Vol. 5, No. 2, pp. 226-231.)
718. FILTER DESIGN CHARTS: II [for  $m$ -derived Sections for Low- & High-Pass and Band-Suppression Filters, when Corresponding Constant- $k$  Sections are known (from Part I)].—J. Borst. (*Electronics*, Oct. 1940, Vol. 13, No. 10, pp. 39 and 40). See 4222 of 1940.
719. THE DESIGN OF BAND-STOP FILTERS.—H. Stanesby. (*E. & Television & S-W. W.*, Nov. 1940, Vol. 13, No. 153, pp. 513-514 and 516, 517.) The full paper was dealt with in 3357 of 1940.
720. THE APPLICATION AND USE OF QUARTZ CRYSTALS IN TELECOMMUNICATIONS [with Modern Practice & Design].—C. F. Booth. (*Elec. Review*, 3rd Jan. 1941, Vol. 128, p. 201.) For a notice of this I.E.E. paper, here summarised, and the method of obtaining a copy, see *Wireless Engineer*, Nov. 1940, p. 488.
721. NEW DOUBLE-CRYSTAL BAND-PASS FILTERS, and IMPROVING CRYSTAL FILTER PERFORMANCE: A 455 KC/S FILTER WITH WIDE-RANGE SELECTIVITY VARIATION.—Flint: Bacon. (See 748/9.)
722. THE CATHODE FOLLOWER.—Lockhart. (See 816.)
723. FEEDBACK [and the Shift in Modulation Phase in Some Transmitters].—Bailey. (See 737.)
724. PHASE-INVERTER CIRCUITS [for Elimination of Push-Pull Input Transformer with Its Defects: Advantages & Disadvantages of Various Conventional Types, and Investigation of a New One-Valve Circuit: Complete Amplifier embodying This].—C. G. McProud & R. T. Wildermuth. (*Electronics*, Oct. 1940, Vol. 13, No. 10, pp. 52-58.)
725. PHASE ADJUSTER: A CONTINUOUSLY VARIABLE DEVICE WITH CONSTANT AMPLITUDE.—Kreiselheimer. (See 853.)
726. THE PERFORMANCE OF COMMUTATOR INVERTERS [Vibrator, Gaseous-Discharge, & Rotary-Commutator Types: Factors governing Performance: Distortion of Square-Wave Voltage: Calculation of Characteristics:

Equivalent Circuits: Calculation of Efficiency & Transformer Ratio: etc.].—L. C. Stenning. (*Wireless Engineer*, Dec. 1940, Vol. 17, No. 207, pp. 517-526.) From the General Electric laboratories.

### TRANSMISSION

727. VELOCITY MODULATION: RESULTS OF FURTHER CONSIDERATIONS [Calculation of Optimum Drift-Tube Length for Ideally Modulating Field (practicable if, e.g., Caesium Ions were used—1815 of 1940): for Sinusoidal Modulating Field (Derivation of "Time of Arrival" Function: Absolute Velocities of "Split Bunches": Relations between "Aperture," "Definition," & "Depth of Focus": etc.): Suggested Multi-Beam Micro-Wave Generator: Suggested Improved Image Dissector (with Line Storage, for Future More Advanced Television Technique)].—R. Kompfner. (*Wireless Engineer*, Nov. 1940, Vol. 17, No. 206, pp. 478-488.)
728. PHASE FOCUSING IN VELOCITY-MODULATED BEAMS [Simple Calculation, & Curves, showing Where and When the Bunching occurs: Analogy between Formula and Davisson Formula for Focal Length of Electron-Optical Cylindrical Lens (and Its Failure): Comparison with Results of Other Workers: etc.].—W. E. Benham. (*Wireless Engineer*, Dec. 1940, Vol. 17, No. 207, pp. 514-516.)
- The formula obtained applies only to low modulation depths. Mathematical details of the calculation for large depths are omitted for reasons connected with a patent application, but the results are shown by curves and their implications are discussed.
729. A DOUBLE BEAM-POWER ULTRA-HIGH-FREQUENCY TRANSMITTER: USING THE RCA 815 ON 28, 56, AND 112 Mc/s.—B. Goodman. (*QST*, Dec. 1940, Vol. 24, No. 12, pp. 40-43.)
730. EVOLUTION OF FREQUENCY MODULATION.—E. H. Armstrong. (*Elec. Engineering*, Dec. 1940, Vol. 59, No. 12, pp. 485-493.) Based on various A.I.E.E. lectures.
731. AMPLITUDE, FREQUENCY, AND PHASE-ANGLE MODULATION [Full Maintenance of Writer's 1922 Rejection of Frequency-Modulation Claims: Modern Results in Signal/Noise Improvement are Not Due to Frequency Modulation by Itself but to Combination with Amplitude Limitation: Suggestion of Term "Gonoidal" to include Frequency & Phase Modulation].—J. R. Carson. (*Wireless Engineer*, Nov. 1940, Vol. 17, No. 206, p. 477.)
- Prompted by the challenge in G.W.O.H.'s editorial, 3785 of 1940. Cf. Wald, 745, below. For comment on the present letter see Bell (*ibid.*, Dec. 1940, p. 526) who distinguishes between behaviour to "transient" interference and to such interference as fluctuation noise. See also 937, below.
732. MODULATION LIMITS IN FREQUENCY MODULATION [Derivation of Permissible Frequency Deviations, for Specified Degrees of

Adjacent-Channel Interference, at Various Audio Frequencies: etc.].—L. J. Black & H. J. Scott. (*Electronics*, Sept. 1940, Vol. 13, No. 9, pp. 30-31 and 65.)

733. TESTS ON SIMULTANEOUS FREQUENCY AND AMPLITUDE MODULATION FOR TWO PROGRAMMES, FOR STEREOPHONIC TRANSMISSION, AND FOR SINGLE PROGRAMME [e.g. for Transition Period or for Improved Quality].—Gee. (See 910.)
734. FREQUENCY versus AMPLITUDE MODULATION.—G. W. O. H.: Weir. (See 909.)
735. A NEW BROADCAST-TRANSMITTER CIRCUIT DESIGN FOR FREQUENCY MODULATION [prefaced by Discussion of the Broad Problem of F-M Transmitter Design].—J. F. Morrison. (*Proc. I.R.E.*, Oct. 1940, Vol. 28, No. 10, pp. 444-449.) The full paper, a summary of which was dealt with in 3372 of 1940.
736. INDIRECT MODULATION OF CENTIMETRIC WAVES [Extension of Glow-Discharge-Tube Method to Wavelengths down to 1.3 cm, including a Trial of Intermediate-Frequency Modulation].—H. Born. (*Hochf.tech. u. Elek.akus.*, Oct. 1940, Vol. 56, No. 4, pp. 112-118.)

From a 1938 Jena Dissertation. For a long abstract of Pietscher & Haass' paper on use of a glow-discharge tube for the modulation of decimetric waves, see 1934 Abstracts, pp. 436-437.

To adapt this principle to the modulation of centimetric waves, the present writer (working with the split-anode magnetron described by Richter—1819 of 1938—giving energies between  $10^{-5}$  and 0.1 watt according to the wavelength) combines the end portion of the Lecher system, carrying the dipole aerial, with the glow-discharge tube itself. Both Lecher wires are given an equal negative potential, and the anode is mounted in the same bulb opposite the dipole. This arrangement avoids the trouble encountered by Haass, in his work on similar lines with wavelengths down to 4.6 cm (468 of 1939), of cathode material being deposited by sputtering between the Lecher wires, forming an undesired leak for h.f. energy and also a shunt, incapable of being modulated, across the modulated glow-discharge.

Although the object of the investigation is given as the modulation of wavelengths down to 1 cm, and a "modulation tube" of the above type is illustrated as for 1.6 cm waves, in addition to a slightly larger tube for 4 cm waves, the shortest wavelength shown on the experimental curves is 3.05 cm (with the single exception of Fig. 7) and most of the work appears to have been done on wavelengths between 3.7 and 5.7 cm, presumably because of the extremely low output from the generator at the shortest wavelengths. Thus the static modulation characteristics of Fig. 5 are for 5.7 cm waves: an interesting point in these curves is that an increase of glow-discharge current beyond a certain point causes the radiated energy to increase again, although the ionisation (and hence the number of carriers available in the discharge) has increased. This result is examined more closely later on (see Fig. 9 and adjacent text) and is found to be due to the fact that whereas in calculating the characteristic impedance of a Lecher

pair in air the leakage between the wires can be neglected, in the present case the glow discharge constitutes a considerable leak of varying value: it forms, in fact, an intermediate circuit of variable characteristic impedance between the Lecher system and the load, and the matching of such an intermediate circuit has, it is known, a great influence on the efficiency of the energy transfer. The limitation of the depth of modulation noted above is therefore to be attributed to the change in matching conditions; if this is so, a further increase in the discharge current should make the radiated energy decrease again, and this has been found to occur.

Dynamic measurements of the modulation factor, by a loop-oscillograph method described in section IV, gives values over 60%: any accompanying frequency modulation is too small to be measured (section VII) and must therefore be less than 0.1%. The frequency-characteristic of the glow-discharge resistance, measured at modulation frequencies up to 20 kc/s, is better for a helium filling than for neon (Fig. 13), and the former gas also has the advantage of reducing the discharge current required for maximum modulation (Fig. 12), though the higher conductivity cannot actually increase the depth of modulation, owing to the above-discussed matching limitation. As regards the pressure of the tube filling, a lengthy examination is given in section II of the effect of pressure on the conductivity of an ionised gas at micro-wave frequencies: the theoretical formula, confirmed by Appleton & Bohariwalla's experiments (423 of 1936) for air and for wavelengths down to 16 cm, is here applied to the shorter wavelengths to obtain the pressures giving maximum conductivity in neon and helium. Modulation characteristics plotted at various pressures of neon from 5 to 17 mm (Fig. 6) show the increasing modulation with pressures decreasing towards the critical value, and confirm the belief that the modulation method depends on a damping action rather than a detuning action—contrary to the conclusions of Schirmacher (not yet published) whose conditions, however, were rather different.

In the final section VIII the writer, prompted by the advantages offered by the use of the intermediate-frequency modulation employed for propagation researches by Esau & Ahrens (decreased danger of over-modulation with consequent breaking-off of oscillation: possibility of auxiliary i.f. amplification), tries to adapt this principle to the glow-discharge method, but finds that a direct modulation of the glow-discharge tube cannot be obtained at a frequency above about  $10^5$  c/s, whereas the i.f. method calls for a frequency of the order of  $7.5 \times 10^5$  c/s. This failure is probably a space-charge effect, and space-charge relations in glow-discharge lamps could well be examined in this way. A final experiment, in which the d.c. anode voltage of the magnetron was replaced by the output voltage of an i.f. generator, and the centimetric-wave oscillation, now 100% modulated at the intermediate frequency, was then modulated at a.f. by the glow-discharge method, was more successful. It permitted the use of i.f. amplification at the receiver, and had an advantage over i.f. modulation of the anode voltage in that its own i.f., being unmodulated, could not be heard at all.

737. FEEDBACK [and the Shift in Modulation Phase in Some Transmitters, limiting Permissible Amount of Feedback: Usefulness of Zobel Filter Section with Negative Lag over a Range of Frequencies].—C. E. G. Bailey. (*Wireless Engineer*, Oct. 1940, Vol. 17, No. 205, p. 441.) Prompted by Sandeman's article, 3763 of 1940.
738. THE 6L6 AS A CRYSTAL OSCILLATOR [Combination Circuit for Best Results on Fundamental (Grid-Plate Circuit) and Second Harmonic (Tri-Tet Circuit)].—D. Mix. (*QST*, Dec. 1940, Vol. 24, No. 12, pp. 54-55 and 84.)
739. A FLEXIBLE BEAM-POWER TRANSMITTER [Medium-Power "Quick Shift" Telegraph Transmitter for Three Widely Separated Frequencies: Design simplified by Use of Beam-Power Valves].—E. F. Kiernan. (*Electronics*, Aug. 1940, Vol. 13, No. 8, pp. 40 and 42.)
740. PROBLEMS INVOLVED IN DESIGNING AND BUILDING RADIO TRANSMITTING EQUIPMENT FROM THE MECHANICAL ENGINEERING STAND-POINT.—E. A. Leach. (*Proc. I.R.E.*, Oct. 1940, Vol. 28, No. 10, p. 492: summary only.)

#### RECEPTION

741. A MICRO-WAVE SUPERHET: M.I.T. 700 Mc/s BLIND-LANDING RECEIVER [No R.F. Stage: Special Mixer Circuit with Western Electric D-157653 Diode (as used in Terrain Clearance Indicator): 10 Mc/s I.F.: Special A.F. A.V.C. Circuits: Reliable & Stable Operation].—F. D. Lewis. (*QST*, Dec. 1940, Vol. 24, No. 12, pp. 36-39 and 116.)

A footnote refers, for a more technical description, to a paper by Bowles & others, on the whole system, in *Elec. Engineering* of Dec. 1939; but from a reference on p. 502 of the Dec. 1940 issue of that journal it seems that the paper in question appears in *AIEE Transactions*, Vol. 59, 1940, pp. 859-865 (pages which are not printed in the journal itself but only in a December supplement and in the complete volume of *Transactions*). See also 414 of February.

742. THE NEW HALLICRAFTER ULTRA-HIGH-FREQUENCY RECEIVER S27U [27-140 Mc/s: for Amplitude and Frequency Modulation].—(*E. & Television & S.W.W.*, Dec. 1940, Vol. 13, No. 154, pp. 560-564.)
743. TUNED FILTER FOR FREQUENCY-MODULATION DETECTION.—M. G. Crosby. (*E. & Television & S.W.W.*, Nov. 1940, Vol. 13, No. 153, pp. 486-487.)
744. INTERFERENCE IN RELATION TO AMPLITUDE-, PHASE-, AND FREQUENCY-MODULATED SYSTEMS [Theoretical Investigation: Behaviour and Value of Intelligence Spectrum in the Three Cases: of Two or More Modulation Frequencies existing simultaneously: Comparison of Interference (for Ratio of Interfering/Wanted Amplitudes less than Unity): Use of Graphical Representation of Spectrum in reducing Computations of Equivalent

- Modulation: etc.].—O. E. Keall. (*Wireless Engineer*, Jan. & Feb., 1941, Vol. 18, Nos. 208 & 209, pp. 6-17 & 56-63.)
745. NOISE SUPPRESSION BY MEANS OF AMPLITUDE LIMITERS [Circuit which improves Signal/Noise Ratio even when Noise Oscillations are Smaller than Signal Amplitude: an U.S.W. Receiver embodying the Principle: Analogy to Armstrong F.M. Receiver, & Suggestion that Armstrong's Improved Signal/Noise Ratio may be due to This and Not to Frequency Modulation].—M. Wald. (*Wireless Engineer*, Oct. 1940, Vol. 17, No. 205, pp. 432-438.) Cf. Carson, 731, above.
746. INTERFERENCE BY EXTERNAL CROSS MODULATION: SEATTLE INVESTIGATION.—Eastman & Horle. (See 692.)
747. CORRECTING FREQUENCY DRIFT IN RADIO AND TELEVISION RECEIVERS [by Pair of Compensating Condensers, One affected by Ambient Temperature, the Other by Coil which heats It at Same Rate as Valves].—Gramophone Company. (*E. & Television & S-W.W.*, Sept. 1940, Vol. 13, No. 151, p. 407.)
748. NEW DOUBLE-CRYSTAL BAND-PASS FILTERS: A NEW SYSTEM EMPLOYING PAIRS OF MATCHED CRYSTALS.—W. A. Flint. (*E. & Television & S-W.W.*, Dec. 1940, Vol. 13, No. 154, pp. 552-554.) Marketed by Simmonds Accessories, Limited.
749. IMPROVING CRYSTAL FILTER PERFORMANCE: A 455 KC/S FILTER WITH WIDE-RANGE SELECTIVITY VARIATION [satisfactorily bridging Gap between Crystal "On" & "Off" Operation: particularly suitable for Communication Receivers].—D. Bacon. (*QST*, Dec. 1940, Vol. 24, No. 12, pp. 58-60 and 86.)
750. THE LOCKED-IN OSCILLATOR: ITS APPLICATION TO AUTOMATIC TUNING AND MEASUREMENT OF MODULATION [Experimental Investigation on the Locking-In Phenomenon as affected by Amplitude Modulation of the External Force: Successful Application to Above-Named Purposes].—S. Byard & W. H. Eccles. (*Wireless Engineer*, Jan. 1941, Vol. 18, No. 208, pp. 2-5.)
- Under such conditions, the oscillator "behaves as a very selective circuit, with the result that oscillatory energy taken from the oscillator is almost unmodulated. . . . Its behaviour is, indeed, analogous to that of a 'stenode' quartz plate of automatically variable thickness."
751. THE REPRODUCTION OF LOW NOTES AND HIGH NOTES IN RADIO RECEIVERS [Investigation of R.F. & A.F. Stages and Loudspeaker: Practical Methods of obtaining the Desired Frequency-Characteristic, particularly the Use of Variable Negative-Feedback Coupling].—V. C. Hendriquez. (*Philips Tech. Review*, April 1940, Vol. 5, No. 4, pp. 116-122.)
752. APPLYING NEGATIVE FEEDBACK TO A TONE-COMPENSATED VOLUME CONTROL.—(*E. & Television & S-W.W.*, Nov. 1940, Vol. 13, No. 153, pp. 501 and 527.)
753. VOLUME EXPANSION: A SIMPLIFIED ARRANGEMENT EMPLOYING A MODIFIED A.V.C. CIRCUIT [by Addition of Diode in Series with Adjustable Resistor].—R.C.A. Laboratories. (*E. & Television & S-W.W.*, Oct. 1940, Vol. 13, No. 152, p. 466.)
754. REDUCING HUM BY A BRIDGE-TYPE FEEDBACK CIRCUIT [in Receivers with P.M. Loudspeakers and therefore without Field Coils for Smoothing].—(*E. & Television & S-W.W.*, Oct. 1940, Vol. 13, No. 152, pp. 463-464.)
755. BROADCAST RECEIVERS: A REVIEW.—N. M. Rust, O. E. Keall, & others. (I.E.E. paper: Notice in *Wireless Engineer*, Nov. 1940, p. 488.) (For Summary see *Elec. Review*, 24th Jan. 1941, p. 281.)
756. RADIOTRON 1.4 V 5-VALVE RECEIVER [using Australian-made Valves: with A.V.C. (Aerial-Terminal Input may reach 0.4 V without Serious Distortion)].—(*Sci. Abstracts*, Sec. B, 25th Dec. 1940, Vol. 43, No. 516, p. 495.)

#### AERIALS AND AERIAL SYSTEMS

757. HOLLOW PIPES OF RELATIVELY SMALL DIMENSIONS [Description of Several Cross-Sectional Shapes providing Lower Operating Frequencies for Given External Dimensions than do Previous Simple Shapes: Theory of the "Separate Coaxial Cable": Cavity Resonators on these Principles].—W. L. Barrow & H. Shaevitz. (*Elec. Engineering*, Dec. 1940, Vol. 59, No. 12, p. 517: summary only.)
758. A FAN-TYPE AERIAL FOR ULTRA-SHORT WAVELENGTHS: A NEW AERIAL WITH LOW CENTRE IMPEDANCE ENABLING A COMPARATIVELY UNSELECTIVE MATCHING NETWORK TO BE EMPLOYED.—R.C.A. Laboratories. (*E. & Television & S-W.W.*, Dec. 1940, Vol. 13, No. 154, pp. 538 and 572.)
759. RADIATING CHARACTERISTICS OF SHORT-WAVE [20-120 Mc/s] LOOP AERIALS [Single-Turn: Behaviour can be classified into 3 Types, according to Ratio Perimeter/Wavelength: Current Distribution and Time Phase for the 3 Types: Special Investigation for  $P > 0.25\lambda$ , and the (Partial) Obtainment of Unidirectional Characteristic by Current-Distribution Control by Inductive Loading].—E. M. Williams. (*Proc. I.R.E.*, Oct. 1940, Vol. 28, No. 10, pp. 480-484.)
760. RAISING THE EFFICIENCY OF SHORT VERTICAL RADIATORS: RECENT DEVELOPMENTS IN THE TOP-LOADED ANTENNA [primarily for 2-4 Mc/s Mobile Transmitters of National Park Service].—W. C. Hilgedick & M. G. Morgan. (*QST*, Dec. 1940, Vol. 24, No. 12, pp. 30-33.) A net gain of 12 db over the fishing-rod aerial was obtained. Cf. 4272 of 1940.

761. THE ANALOGY BETWEEN TRANSMITTING AND RECEIVING AERIALS.—K. Fränz. (*Hochf.tech. u. Elek.akis.*, Oct. 1940, Vol. 56, No. 4, pp. 118-119.)  
 Author's summary:—"On the basis of transmission-line theory the view is expressed in the literature that the impedance of one and the same aerial is different in the transmitting and the receiving conditions, since it must depend on the nature of excitation of the aerial [the references given range from Colebrook and Wilmotte, both in 1927 (the former also in 1932) to Niessen & de Vries in 1939]. In the following pages a simple proof is given that every aerial, independently of its excitation, has at its terminals one single well-defined impedance. A simple law is also derived on the relation between the current distribution at transmission and the receiving distribution."  
 The reason why the usual form of the double-line theory yields an impedance which depends on the mode of excitation is given as follows:—"The ordinary procedure followed in dealing with the equation  $(R + j\omega L)i - e(x) = -\dot{e}v/\dot{c}x$  . . . (2) [the inhomogeneous form derived for the receiving aerial from the simple homogeneous equation for the transmitting aerial] is to solve it for the given excitation  $e(x)$  taking into account the boundary conditions resulting from the aerial termination, but neglecting  $R$  and  $G$ . From the current distribution thus obtained on the aerial, the radiation resistance is calculated, this being regarded as distributed over the conductor. At this point it would be necessary to calculate afresh, in successive approximation, the current distribution and line attenuation and insert them in eqn. 2. If this process converges, impedances must be obtained in the limit which would agree with those obtained in the transmitting case for the homogeneous equations 1 by the same method. Hitherto, however, the calculation has always stopped at the second stage of the approximation and a sign of convergence has been lacking. It is therefore not to be wondered at if the usual double-line theory gives results in contradiction to those obtained in other ways." A paper by the writer, in *Telefunken-Hausmitteilungen*, May 1940, deals with the reciprocity theory as it concerns the equivalence of the transmitting and receiving diagrams of an aerial.
762. A MULTIFREQUENCY TUNED ANTENNA SYSTEM [Single Balanced Doublet Aerial with Pairs of Tuned Circuits suspended (Waterproof Containers) at Suitable Points: at least 85% Efficiency on Four Frequencies].—H. K. Morgan. (*Electronics*, Aug. 1940, Vol. 13, No. 8, pp. 42-48.)
763. A PUSH-BUTTON OPERATED HIGH-POWER HIGH-EFFICIENCY, MULTI-BAND DIRECTIVE ANTENNA SYSTEM [at WLWO, for covering South America: Rhombic Antenna with Waste in Matching Resistor avoided by Reintroduction into Aerial Input].—W. S. Alberts. (*Proc. I.R.E.*, Oct. 1940, Vol. 28, No. 10, p. 489: summary only.)
764. "DIE BESTEN ANTENNEN" [Third Edition: Book Review].—Kappelmayer & Engel. (*Hochf.tech. u. Elek.akis.*, Sept. 1940, Vol. 56, No. 3, p. 95.)
765. IMPULSE AND 60-CYCLE CHARACTERISTICS OF DRIVEN GROUNDS, and PRACTICAL ASPECTS OF EARTHING [in connection with Electricity Supply Systems: including Section on Factors affecting Resistance of Electrodes (Size & Shape of Electrode, Soil Resistivity, Artificial Treatment, Seasonal Variation, etc.)].—Bellaschi: Fawssett & others. (*Elec. Engineering*, Dec. 1940, Vol. 59, No. 12, p. 517—summary only: *Journ. I.E.E.*, Oct. 1940, Vol. 87, No. 526, pp. 357-390: Discussion pp. 391-400.)
- ### VALVES AND THERMIONICS
766. ULTRA-HIGH-FREQUENCY TRANSMITTING TRIODES TYPES GL-8002 (Water-Cooled: 1800 W Output up to 150 Mc/s) AND GL-8002R (Forced-Air Cooling: 1800 W up to 120 Mc/s): Small Size].—General Electric. (*Electronics*, Sept. 1940, p. 66.)
767. A DOUBLE BEAM-POWER ULTRA-HIGH-FREQUENCY TRANSMITTER: USING THE RCA 815 ON 28, 56, AND 112 Mc/s.—B. Goodman. (*QST*, Dec. 1940, Vol. 24, No. 12, pp. 40-43.) See also *Communications*, Dec. 1940, pp. 31 and 32.
768. DISCUSSION ON "THE THEORY OF THE [Cylindrical] THERMIONIC DIODE" [particularly a Comparison with the Plane-Electrode Diode].—E. B. Moullin: Wheatcroft. (*Journ. I.E.E.*, Dec. 1940, Vol. 87, No. 528, pp. 691-693.) See 3028 of 1940. Two small printer's errors are corrected in the author's reply.
769. FLUCTUATIONS IN SPACE-CHARGE-LIMITED CURRENTS AT MODERATELY HIGH FREQUENCIES: PART III—MULTI-COLLECTORS [Theory & Experimental Confirmation].—D. O. North. (*R.C.A. Review*, Oct. 1940, Vol. 5, No. 2, pp. 244-260.)  
 "Combination of this theory with that of Part II [3420 & 3861 of 1940] yields a practical working formula for the apparent input shot effect of a conventional pentode amplifier with coated cathode and negative control grid . . ."
770. THE HUM PRODUCED BY THE MAGNETIC FIELD OF THE FILAMENTS IN TRANSMITTING VALVES [Theoretical Investigation on Certain Simplifying Assumptions: Experimental Confirmation: Possibility of Hum Reduction by Subdivision of Filament System and Suitable Phasing].—K. Posthumus. (*Philips Tech. Review*, April 1940, Vol. 5, No. 4, pp. 100-107.)
771. A DECADE OF PROGRESS IN THE USE OF ELECTRONIC TUBES.—Ingram: White. (See 968.)
772. "MODERNE MEHRGITTER-ELEKTRONENRÖHREN" [Second Edition: Book Review].—M. J. O. Strutt. (*Hochf.tech. u. Elek.akis.*, Sept. 1940, Vol. 56, No. 3, p. 95.)
773. OBTAINING LONG TUBE LIFE [Discussion of Factors governing Life of Transmitting Valves].—(*Electronics*, Aug. 1940, Vol. 13, No. 8, pp. 63-65.)

774. MINIATURE PENTODES FOR HEARING AIDS [Types CK-505 & -505X].—Raytheon. (*Electronics*, Sept. 1940, Vol. 13, No. 9, p. 66.) Cf. 2593 of 1940.
775. A NOVEL HOLDER FOR MINIATURE VALVES [where Banana Pins are replaced by Stout Lead-In Wires extended to form Contacts].—R.C.A. Laboratories. (*E. & Television & S-W.W.*, Sept. 1940, Vol. 13, No. 151, pp. 430-431.)
776. AMPHENOL VALVE HOLDERS [with Mounting Plate moulded into Holder : etc.].—Celestion. (*E. & Television & S-W.W.*, Dec. 1940, Vol. 13, No. 154, p. 571.)
777. A NEW METHOD OF MANUFACTURING ELECTRON-EMISSIVE CATHODES [for High-Voltage Gas or Vacuum Valves: Avoidance of Vaporisation of Chromium (and Condensation on Cold Parts): Chromium applied Electrolytically and Flashed in Ammonia Gas : etc.].—R.C.A. Laboratories. (*E. & Television & S-W.W.*, Oct. 1940, Vol. 13, No. 152, pp. 464-465.)
778. A NEW ALLOY FOR CATHODE CORES [Nickel Alloy with Carbon, Aluminium, Magnesium, & Silicon : Greatly Increased Strength].—R.C.A. Laboratories. (*E. & Television & S-W.W.*, Nov. 1940, Vol. 13, No. 153, pp. 520-522.)
779. ENSURING POSITIVE LOCATION OF CATHODES IN VALVES.—R.C.A. Laboratories. (*E. & Television & S-W.W.*, Sept. 1940, Vol. 13, No. 151, p. 428.)
780. SEALING GLASS TO METAL : A NEW METHOD [e.g. for Valve Support Wires : Impregnation of Wire Surface with Hydrocarbon Gas which later blows Bubbles in Glass, diminishing Strains : Alternative Method].—R.C.A. Laboratories. (*E. & Television & S-W.W.*, Nov. 1940, Vol. 13, No. 153, p. 503.)
781. ON THE EFFECT OF THORIA-CERIA, ALUMINA, AND MANGANESE OXIDE UPON A NICKEL CATALYST [Anti-Sintering Action of the First Two].—K. M. Chakravarty. (*Sci. & Culture*, Calcutta, Nov. 1940, Vol. 6, No. 5, pp. 308-309.)
- DIRECTIONAL WIRELESS**
782. INSTRUMENT LANDING OF AIRCRAFT [Indianapolis System : C.A.A.-M.I.T. Micro-Wave System : the Flightray Indicating Instrument].—(*Elec. Engineering*, Dec. 1940, Vol. 59, No. 12, pp. 495-502.)
783. FLIGHTRAY, A MULTIPLE INSTRUMENT INDICATOR [Cathode-Ray Type, for Instrument Landing, developed by Sperry Gyroscope Company].—Bassett & Lyman. (*Journ. Inst. Aeronaut. Sciences*, March 1940, Vol. 7, pp. 199-204.) Referred to in 782 above.
784. THE C.A.A.-M.I.T. MICRO-WAVE INSTRUMENT-LANDING SYSTEM.—Bowles, Barrow, & others. (See remark in 741, above.)
785. A MICRO-WAVE SUPERHET : M.I.T. 700 Mc/s BLIND-LANDING RECEIVER.—Lewis. (See 741.)
786. CIVIL AIR TRANSPORT COMMUNICATION [Ground Stations, Aircraft Equipment, etc.].—Hodgson. (See 918.)
- ACOUSTICS AND AUDIO-FREQUENCIES**
787. THE REPRODUCTION OF LOW NOTES AND HIGH NOTES IN RADIO RECEIVERS [Investigation of R.F. & A.F. Stages and Loudspeaker].—Hendriquez. (See 751.)
788. THE CRYSTAL STRUCTURE OF ROCHELLE SALT.—Beever & Hughes. (*Proc. Roy. Soc.*, Ser. A, 10th Jan. 1941, Vol. 177, No. 969, pp. 251-259.)  
A communication to *Nature* was referred to in 3446 of 1940. "A reversal of the continuous chain of carboxyl-water-water dipoles is a possible explanation of the peculiar dielectric properties of the salt."
789. VIBRATIONS OF FREE PLATES : ISOSCELES RIGHT-ANGLED TRIANGLES.—Mary D. Waller. (*Proc. Phys. Soc.*, 1st Jan. 1941, Vol. 53, Part 1, pp. 35-39.)
790. AEROPLANE "SPOTTING" BY ELECTROACOUSTICAL METHODS [Parabolic-Reflector Equipment to assist Roof Spotters].—(*E. & Television & S-W.W.*, Dec. 1940, Vol. 13, No. 154, pp. 535-537.)
791. RECENT IMPROVEMENTS IN [Instantaneous] RECORDING [for Broadcasting].—C. J. Lebel. (*Electronics*, Sept. 1940, Vol. 13, No. 9, pp. 33-35 and 79-81.)
792. A HIGH-FIDELITY RECORDING AMPLIFIER [with the Special Requirements for Instantaneous Recording (Negative Feedback making Allowance for Variations of Cutting-Head Load Impedance) but suitable also for Public Address, etc.].—I. J. Abend. (*Electronics*, Oct. 1940, Vol. 13, No. 10, pp. 44 and 46.)
793. VOLUME EXPANSION : A SIMPLIFIED ARRANGEMENT EMPLOYING A MODIFIED A.V.C. CIRCUIT.—R.C.A. Laboratories. (See 753.)
794. PARTIAL DEAFNESS AND HEARING-AID DESIGN [with Bibliography].—W. C. Beasley. (*Electronics*, Aug. 1940, Vol. 13, No. 8, p. 72 : summary only.)
795. ACOUSTICS IN CINEMAS [including the Special Care needed for Detail Design of Auditorium and Correct Siting of Loudspeakers : etc.].—C. A. Mason & J. Moir. (*Electrician*, 10th Jan. 1941, Vol. 126, p. 25.) Summary of an I.E.E. paper.
796. EQUIPMENT PRACTICE IN LARGE BROADCASTING STUDIOS OF THE AUSTRALIAN BROADCASTING COMMISSION.—W. H. Adam. (*Proc. Inst. Rad. Eng. Australia*, Oct. 1940, Vol. 4, No. 4, pp. 56-63.)
797. NEW STUDIOS FOR C.B.S. [in former Juilliard School of Music, New York].—(*Electronics*, Sept. 1940, Vol. 13, No. 9, pp. 23-25.)



798. "ACOUSTICS: A HANDBOOK FOR ARCHITECTS AND ENGINEERS" [Book Review].—P. L. Marks. (*Engineer*, 27th Dec. 1940, Vol. 170, p. 409.) "This is really a scrap book, and an interesting one at that."
799. THE LIMITATION OF TRANSFORMER NOISE.—Churcher & King. (*Journ. I.E.E.*, Nov. 1940, Vol. 87, No. 527, pp. 539-554: Discussion pp. 554-560.) See also 2639 of 1940.
800. AN OBJECTIVE NOISE-METER READING IN PHONS FOR SUSTAINED NOISES, WITH SPECIAL REFERENCE TO ENGINEERING PLANT.—King, Guelke, & others. (*Electrician*, 3rd Jan. 1941, Vol. 126, p. 6.) Summary of an I.E.E. paper.
801. DESIGN FOR AN AUDIO-FREQUENCY GENERATOR [10-23 000 c/s: based on Stabilising Methods of Anderson and Terman (Anode Feedback Resistance & Fixed Condenser)].—J. C. G. Gilbert. (*E. & Television & S-W.W.*, Dec. 1940, Vol. 13, No. 154, pp. 549 and 551, 558.)
- PHOTOTELEGRAPHY AND TELEVISION**
802. THE SUBJECTIVE SHARPNESS OF SIMULATED TELEVISION IMAGES [Tests on Small Group of Observers, using Controllably Out-of-Focus Small Motion Pictures (with Provision for making Horizontal Resolution different from Vertical) in Psychometric Method of Measurement: "Sharpness" increases More & More Slowly as Physical Resolution is Increased: Need for Equal Resolution in All Directions becomes Less & Less: etc.].—M. W. Baldwin, Jr. (*Proc. I.R.E.*, Oct. 1940, Vol. 28, No. 10, pp. 458-468.) Cf. 131 of January.
803. HOME TELEVISION IN COLOUR: SUCCESSFUL DEMONSTRATION IN LONDON—RESEARCH IN SPITE OF THE WAR.—Baird. (*Electrician*, 27th Dec. 1940, Vol. 125, p. 333.) See also *Elec. Review*, 3rd Jan. 1941, Vol. 128, p. 207.
804. COLOUR TELEVISION DEMONSTRATED BY C.B.S. ENGINEERS [Advantages and Limitations: the Possibility of Quadruple Interlacing to decrease Reduction in Detail: Problem of Direct Pick-Up, using Storage-Type Camera Tubes (Necessity for Avoidance of "Carry Over" of Stored Charge): etc.].—Goldmark. (*Electronics*, Oct. 1940, Vol. 13, No. 10, pp. 32-34 and 73, 74.) See also 453 of February.
805. A NEW DEVELOPMENT IN D.C. COMPONENT RESTORING CIRCUITS [avoiding Defect of Small Sawtooth Potential caused by Leak Resistance across Condenser in Usual Method], and A NOVEL SCHEME FOR RESTORING THE D.C. COMPONENT.—R.C.A. Laboratories. (*E. & Television & S-W.W.*, Oct. 1940, Vol. 13, No. 152, pp. 436 and 437: Nov. 1940, No. 153, p. 498.)
806. R.C.A. LARGE-SCREEN TELEVISION [High-Intensity Tube pointing away from Screen projects onto Concave Mirror (magnifying  $22\frac{1}{2}$  Times) and through Annular Lens surrounding Neck of Tube].—(*E. & Television & S-W.W.*, Oct. 1940, Vol. 13, No. 152, p. 455.)
807. TELEVISION CHANGE-OVER [Some of the Jobs involved in retuning W2XBS in accordance with F.C.C. Change of Television Channel from 44-50 to 50-56 Mc/s].—(*Electronics*, Oct. 1940, Vol. 13, No. 10, pp. 24-25.)
808. THE R.C.A. PORTABLE TELEVISION PICK-UP EQUIPMENT [including U-H-F Relay Transmitter & Receiver Units].—G. L. Beers, O. H. Schade, & R. E. Shelby. (*Proc. I.R.E.*, Oct. 1940, Vol. 28, No. 10, pp. 450-458.) The full paper, a summary of which was referred to in 3949 of 1940.
809. "WE PRESENT TELEVISION" [Book Review].—Porterfield & Kay Reynolds (Edited by). (*Electronics*, Aug. 1940, Vol. 13, No. 8, p. 38.)
810. CATHODO-LUMINESCENCE AS APPLIED TO TELEVISION [Survey, with New R.C.A. Data: Certain Foibles & Fallacies due to "Alchemical Birth & Upbringing" of Luminescent Art: Theoretical Mechanism (Difference between Pure-Crystal & Manganese-Activated Mechanisms, etc.): the Eight Important Qualities: Choice of Colour: 30 Frames & 60 Fields per Sec. as the Minimum Repetition Rate: Disadvantages of Long-Persistence Phosphors (and the Impracticability of obtaining Concave-Downward Characteristics): etc.].—H. W. Leverenz. (*R.C.A. Review*, Oct. 1940, Vol. 5, No. 2, pp. 131-175.)
811. AVOIDING DEFOCUSING WITH ELECTROSTATIC CATHODE-RAY TUBES: DETAILS OF A SCHEME FOR ENSURING A CONSTANT VOLTAGE RATIO ON THE FIRST AND SECOND ANODES.—R.C.A. Laboratories. (*E. & Television & S-W.W.*, Sept. 1940, Vol. 13, No. 151, pp. 400-401.)
812. SCREENED C-R-TUBE DEFLECTING YOKE [particularly for Pick-Up Tubes using Electromagnetic Deflection].—R.C.A. Laboratories. (*E. & Television & S-W.W.*, Dec. 1940, Vol. 13, No. 154, p. 568.)
813. SIMPLE PULSE-GENERATING CIRCUITS [using High-Vacuum Valves].—Sashoff & Roberts. (See 693.)
814. PREVENTING "DARK" CURRENT IN ELECTRON MULTIPLIERS [Special Preparation of Photocathode by Electron-Bombardment from a Third Filament after Sensitisation].—R.C.A. Laboratories. (*E. & Television & S-W.W.*, Dec. 1940, Vol. 13, No. 154, p. 565.)
815. SUGGESTED IMPROVED IMAGE DISSECTOR WITH LINE STORAGE [for Future More Advanced Television Technique].—Kompiner. (See 727.)
816. THE CATHODE FOLLOWER [and Its Advantages for Wide-Band Amplifiers: Discussion & Analysis of Circuit].—C. Lockhart. (*E. & Television & S-W.W.*, Nov. 1940, Vol. 13, No. 153, pp. 492-494.)
817. A WIDE-BAND AMPLIFIER WITH MAXIMUM GAIN.—R.C.A. Laboratories. (*E. & Television & S-W.W.*, Nov. 1940, Vol. 13, No. 153, pp. 491 and 522, 523.)

818. CORRECTING FREQUENCY DRIFT IN RADIO AND TELEVISION RECEIVERS.—Gramophone Company. (See 747.)

### MEASUREMENTS AND STANDARDS

819. MEASUREMENTS AT RADIO FREQUENCIES [Survey, including Ultra-High Frequencies].—H. R. Meahl & others. (*Elec. Engineering*, Dec. 1940, Vol. 59, No. 12, Transactions pp. 654-659.)

Problem of a practical standard of voltage at radio frequencies (use of phenomenon of resonance potential in gases?): the oscillating-ring electrodynamic ammeter: low-impedance thermocouple ammeter: clear fused quartz as power-factor standard in range 1 to 3000 Mc/s: etc. From the General Electric laboratories.

820. THE MEASUREMENT OF COIL REACTANCE IN THE 100-MEGACYCLE REGION [Desirability of Fairly Large-Diameter Tubes, and Axial Spacing Not Large compared with Diameter (taking Proximity Effect into Account), for Transmission Line: Interaction between Line & Generator avoided by Very Loose Coupling (Sensitive Resonance Indicator): Palermo Formula fails badly for Thick-Wire Coils: etc.].—F. Hamburger, Jr., & C. F. Miller. (*Proc. I.R.E.*, Oct. 1940, Vol. 28, No. 10, pp. 475-480.)

821. THE EFFECTIVE INDUCTANCE AND RESISTANCE OF SCREENED COILS [Theoretical Investigation and Empirical Formulae for Practical Estimation of Changes produced in Air-Cored Coils by Insertion into Screening Containers].—A. G. Bogle. (*Journ. I.E.E.*, Sept. 1940, Vol. 87, No. 525, pp. 299-316.) See also 822, below.

822. THE EFFECT OF SCREENING CANS ON THE EFFECTIVE INDUCTANCE AND RESISTANCE OF COILS.—G. W. O. H. Bogle. (*Wireless Engineer*, Dec. 1940, Vol. 17, No. 207, pp. 511-513.) Editorial based on Bogle's paper (821, above), the results of which are compared with those of Kaden, dealt with in earlier Editorials (see 1934 Abstracts, p. 571).

823. MEASURING THE CHARACTERISTIC IMPEDANCE OF TWISTED PAIRS [and Shielded Concentric Cables: Simple Method depending on Measurement of Relative Velocity of Propagation].—A. Alford. (*Electronics*, Aug. 1940, Vol. 13, No. 8, pp. 48-54.) By snipping off bits at free end and noting two minima in signals in receiver across whose input terminals the sample is shunted.

824. RADIO-FREQUENCY INDUCTANCE MEASUREMENTS USING BEAT-FREQUENCY TEST EQUIPMENT [True Inductance, with Elimination of Distributed Capacitance].—H. R. Heese. (*Electronics*, Aug. 1940, Vol. 13, No. 8, pp. 74 and 75: summary only.)

825. THE BEHAVIOUR OF RESISTORS AT HIGH FREQUENCIES [and the Strange Discrepancy between Calculated Capacitance (Howe's Theory, confirmed by Hartshorn's Measure-

ments) and the Bressi-Pontecorvo Results: Examination of Possible Causes: Inductive Effect of the Cut Spiral: etc.].—G. W. O. H. (*Wireless Engineer*, Nov. 1940, Vol. 17, No. 206, pp. 471-477.) Editorial prompted by the Italian work dealt with in 4276, 4277, & 4500 of 1938 and 4071 of 1939.

826. ON TORSIONAL VIBRATIONS OF QUARTZ BARS, AND THEIR USE FOR FREQUENCY STANDARDS.—E. Giebe & E. Blechschmidt. (*Hochf. tech. u. Elek. akus.*, Sept. 1940, Vol. 56, No. 3, pp. 65-87.)

Unlike those of other modes, these vibrations have scarcely ever been employed, though the possibility of exciting them was pointed out by Giebe & Scheibe long ago (1928 Abstracts, pp. 289 & 348) for bars cut perpendicular to the optical axis: Tsi-Ze & Ling-Chao also dealt with these vibrations, particularly for hollow cylinders, in more recent years (1934 Abstracts, pp. 332 & 569: 505, 1578, & 2027 of 1935: no reference is made to the later work dealt with in 2325 & 4171 of 1936, 1922 of 1937, and 2481 of 1938, or to Tawil's work on the production of what he calls "strophoelectricity," as distinct from piezoelectricity, by torsion: see, for example, 2376 of 1935). The formulae for the natural frequencies of torsional vibrations derived from Voigt's mathematical theory apply strictly only to elliptical and circular sections, and with sufficient approximation to the practically important rectangular section only if one side is much shorter than the other. Systematic measurements, yielding at least one empirical formula, were therefore necessary if the possibilities of this mode of vibration, for rectangular-section quartz rods of arbitrary ratio of sides of section, were to be explored.

Part I deals with this problem. Voigt's theory is found to be applicable unchanged only if the ratio smaller/greater side is small; the frequency formula agrees with the measurements for ratios not greater than 0.5, but only if certain theoretically derived constants are replaced by empirical ones. It is also found (section 8) that for cut II (axis parallel to electrical axis  $X$ ) the frequency is satisfactorily given for ratios between 0.25 and 1 (mostly quite outside the scope of the Voigt theory) by taking the formula for the propagation velocity of torsional waves in *isotropic* rectangular-section bars given by de Saint-Venant (eqn. 3), and assuming that this can be applied to quartz bars by replacing the torsional modulus by an "effective" modulus  $\sigma$  which is the same function of the sides-ratio  $\nu$  and of the two quartz moduli  $s_y$  and  $s_z$  as in the case of elliptical-section bars (eqns. 19 & 20) for torsional waves as given by Voigt: so that  $\sigma = (s_y y^2 + s_z z^2)/(y^2 + z^2)$ . On the other hand, complete agreement between calculated and observed results is obtained if this theoretical function is replaced by the purely empirical one given in eqn. 35, which has no plausible connection with theory. The writer concentrates on this orientation II for rectangular-section bars because the other orientations (I, axis parallel to  $Y$  axis, and III, axis parallel to  $Z$  axis) are unsuitable for torsional vibrations: see section 3.

Owing to the very severe requirements of to-day, such torsional-mode quartz bars can be satisfactory

as frequency standards only if they have a very low temperature-coefficient of frequency. Bechmann's results with quartz plates of various cuts (503 of 1935) make it probable that by the right dimensioning of a rectangular bar of suitable orientation it should be possible to obtain a zero coefficient. In the absence of a strictly derived mathematical formula for the frequency, however, the conditions for the obtainment of such a zero coefficient require a systematic measurement of the coefficients of various suitably chosen bars: this investigation is dealt with in Part II. The  $t$ -cs are measured over a temperature range  $0^{\circ}$ - $60^{\circ}$  C: the natural frequencies vary with the temperature not linearly but according to a quadratic equation. A bar with a ratio  $y/z = 0.953$  gives a  $t$ -c of zero at  $46.6^{\circ}$  C: the maximum of natural frequency is very flat, a temperature variation of  $\pm 6^{\circ}$  on both sides of  $46.6^{\circ}$  producing a frequency change of only  $-1 \times 10^{-6}$ . For any given temperature  $T_m$  between  $0^{\circ}$  and  $60^{\circ}$  the sides-ratio necessary to obtain a zero  $t$ -c can be calculated from the formula  $y/z = 0.9138 + 0.00085 T_m$ . For  $T_m = 20^{\circ}$  this gives  $y/z = 0.931$ . At this temperature, the  $t$ -c will be positive or negative according to whether  $y/z$  is greater or less than 0.931. A bar of ratio 1.25 shows, between  $0^{\circ}$  and  $60^{\circ}$ , a  $t$ -c of  $+19.8 \times 10^{-6}$  which is practically independent of temperature. Other results are summarised on p. 87.

All the above concerns the fundamental frequencies only. Part III considers the overtones. The elementary theory of torsional vibrations, according to which the frequencies of the overtones are multiples of the fundamental frequency, so that the overtones are harmonics, is based on the assumption that the transverse dimensions of the bar are small compared with its length and with the length of the standing elastic waves. In practice this condition is often only approximately fulfilled, especially for overtones of the high orders which can so easily be obtained piezoelectrically. The present series of measurements shows that the vibrations of a square-section bar conform with the harmonic law even at overtones whose elastic half-wavelengths are only about equal to the length of the sides of the cross-section. The observed small departures from the law, some positive and some negative in sign, are explained as due to inhomogeneities of the crystal. Bars of ratio  $z/y = 2$  fulfil the law very nearly, even for the highest observed overtone, the 28th, where the 1.8 mm half-wavelength is actually smaller than the longer 3 mm side. Other rectangular-section bars, and also cylindrical bars, show departures from the harmonic law; in nearly every case the frequencies of the overtones are higher than the multiples of the fundamental frequency. Other things being equal, the discrepancies are considerably greater for the  $o(\Pi, y)$  cut than for the  $o(\Pi, z)$  cut: the largest discrepancy measured was 25.5%, given by the 19th overtone of a bar with a ratio of 4. For each of these two cuts an empirical formula, containing only one empirical constant, is found for the departure from the harmonic law as a function of the order number and of the ratio of the cross-section sides to each other and to the elastic wavelength. No theoretical explanation of the departure has so far been found.

827. INTERPRETATION OF TORSIONAL FREQUENCIES OF CRYSTAL SPECIMENS.—W. F. BROWN, JR. (*Phys. Review*, Ser. 2, 1st Dec. 1940, Vol. 58, No. 11, pp. 998-1001.)
828. THE ELECTRIC FIELDS IN VIBRATING POLAR CRYSTALS.—Lyddane & others. (*Phys. Review*, Ser. 2, 1st Dec. 1940, Vol. 58, No. 11, pp. 1008-1009.)
829. THE APPLICATION AND USE OF QUARTZ CRYSTALS IN TELECOMMUNICATIONS.—Booth. (See 720.)
830. GRINDING AND SCRATCHING CRYSTALLINE SURFACES [and the Investigation of Quartz by Refraction Patterns and Their Density Analysis].—R. S. Rivlin. (*Nature*, 21st Dec. 1940, Vol. 146, pp. 806-807.)
831. THE CRYSTAL STRUCTURE OF ROCHELLE SALT.—Beevers & Hughes. (See 788.)
832. STANDARD-FREQUENCY TRANSMISSIONS FROM THE DEUTSCHLANDSENDER, JULY 1940.—Scheibe & Adelsberger. (*Hochf. tech. u. Elek. Akus.*, Sept. 1940, Vol. 56, No. 3, p. 87.)  
The reading for "31st April" (see 153 of January) is explained by a correcting statement that the table in question should have been headed "May." For some reason or other the first half of July shows a very large number of big deviations, up to  $-99$ . The August record (*ibid.*, Oct. 1940, p. 120) shows a return to normal behaviour.
833. REVISED STANDARD-FREQUENCY BROADCASTS [owing to Burning Down of WWV].—(*Tech. News Bull. Nat. Bur. of Stds.*, Dec. 1940, No. 284, p. 105.)
834. A METHOD OF MEASURING AND RECORDING THE FREQUENCY ERROR OF ALTERNATING-CURRENT POWER SUPPLIES.—F. O. Morrell & G. R. Oman. (*Journ. I.E.E.*, Nov. 1940, Vol. 87, No. 527, pp. 507-515: Discussion pp. 515-520.)
835. ON ALTERNATING-CURRENT BRIDGES WITH INCOMPLETE BALANCE [can often be used with Advantage: e.g. Campbell's  $M, C$  Frequency Bridge, where Balance to Minimum gives Frequency correctly without Knowledge of Condenser Loss or Impurity of Inductor].—A. Campbell. (*Proc. Phys. Soc.*, 1st Jan. 1941, Vol. 53, Part 1, pp. 47-50.)
836. DESIGN FOR A LINEAR DIODE-CONDENSER VALVE VOLTMETER [20 c/s to above 60 Mc/s: A.C. Mains-operated: with Acorn Diode Probe at End of Flexible Screened Cable].—J. C. G. Gilbert. (*E. & Television & S-W.W.*, Oct. 1940, Vol. 13, No. 152, pp. 456-460.)
837. THE FREQUENCY COMPENSATION OF MOVING-IRON VOLTMETERS [and the Fallacy of the Drysdale-Jolley Formula for Its Calculation: Correct Methods].—G. W. O. H. (*Wireless Engineer*, Oct. 1940, Vol. 17, No. 205, pp. 429-431.)
838. WIDE-RANGE CALIBRATION UNIT COVERING 10 VOLTS TO .0001 VOLT [using Transformer Potential-Divider].—J. C. G. Gilbert. (*E. & Television & S-W.W.*, Nov. 1940, Vol. 13, No. 153, pp. 504-506.)

839. A SCREENED SLIDE-WIRE BRIDGE FOR THE PRECISION MEASUREMENT OF THE LOSS ANGLES OF HIGH-QUALITY LIQUID INSULATING MATERIALS [at High Voltages, 50 c/s].—L. Mense. (*Arch. f. Elektrot.*, 15th Oct. 1940, Vol. 34, No. 10, pp. 568-581.)
840. A METHOD FOR DETECTING THE IONISATION POINT ON ELECTRICAL APPARATUS [Oscilloscope Method detecting H.F. Discharges at (often considerably below) the Minimum Voltage given by "Radio Noise Influence Voltage" Method].—G. E. Quinn. (*Elec. Engineering*, Dec. 1940, Vol. 59, No. 12, Transactions pp. 680-682.)
841. TESTING CERAMIC CAPACITORS [particularly the Accurate Determination of Small Temperature Coefficients of 10-1000  $\mu\mu\text{F}$  Condensers for the Elimination of Frequency Drift in Ultra-High-Frequency Work].—E. T. Sherwood. (*Electronics*, Sept. 1940, Vol. 13, No. 9, pp. 26-29 and 62-64.)
842. REFERENCE VALUES FOR TEMPERATURE, PRESSURE, AND HUMIDITY.—P. L. Bellaschi & P. H. McAuley. (*Elec. Engineering*, Dec. 1940, Vol. 59, No. 12, Transactions pp. 669-675.)
843. THE LOCKED-IN OSCILLATOR: ITS APPLICATION TO AUTOMATIC TUNING AND MEASUREMENT OF MODULATION.—Byard & Eccles. (See 750.)
844. A BRIDGE FOR THE MEASUREMENT OF THE WORKING LAG OF RELAYS.—(*L'Electrotecnica*, No. 20, Vol. 27, 1940, pp. 484-486.)
845. CATHODE-RAY OSCILLOGRAPH USED TO MEASURE SHORT TIME INTERVALS [Interval represented by Arc of Circle interrupting Straight-Line Trace].—H. D. Brailsford. (*Electronics*, Sept. 1940, Vol. 13, No. 9, p. 76.)
846. "PHOTOGRAPHISCHE MESSTECHNIK" [Measuring Technique using Photography: Book Review].—Fink. (See 947.)
- SUBSIDIARY APPARATUS AND MATERIALS**
847. THE USE OF THE ELECTROLYTIC TANK, WITH MODELS OF INSULATING MATERIAL, FOR THE INVESTIGATION OF H.F. MAGNETIC FIELDS.—Babat & Losinsky. (See 992.)
848. CATHODO-LUMINESCENCE AS APPLIED TO TELEVISION.—Leverenz. (See 810.)
849. ADJUSTABLE FOCUSING DEVICE FOR CATHODE-RAY TUBE [for centering Image by Separate Vertical & Horizontal Adjustments of Focusing Coil or Magnet].—(*E. & Television & S-W.W.*, Nov. 1940, Vol. 13, No. 153, p. 497.)
850. THE MEASUREMENT OF SCANNING SPEEDS OF CATHODE-RAY TUBES.—Blok. (*E. & Television & S-W.W.*, Oct. 1940, Vol. 13, No. 152, pp. 445-446.) From the paper dealt with in 4540 of 1938.
851. SIMPLE PULSE-GENERATING CIRCUITS [using High-Vacuum Valves].—Sashoff & Roberts. (See 693.)
852. EFFECT OF LIGHT ON NEON-TUBE STRIKING VOLTAGE [Change from 90 V to 123 V on Transition from Daylight to Darkness: Stabilised by Radium-Activated Paint].—(*E. & Television & S-W.W.*, Dec. 1940, Vol. 13, No. 154, p. 542.)
853. PHASE ADJUSTER: A CONTINUOUSLY VARIABLE DEVICE WITH CONSTANT AMPLITUDE [over 360°, by Use of One Control for Phase & Another for Quadrant Adjustment].—K. Kreielsheimer. (*Wireless Engineer*, Oct. 1940, Vol. 17, No. 205, pp. 439-441.) Cf. Pulley, 671 of 1937, for another phase-shifting device for a c-r-o time base.
854. A NOVEL LEAD-IN SEAL FOR CATHODE-RAY TUBES [in Side Wall of Tube, enabling Several Ring Electrodes to be led out Directly: Metallic Deposit, forming Ring, continued through Hole which is finally Sealed with Glass Bead].—R.C.A. (*E. & Television & S-W.W.*, Dec. 1940, Vol. 13, No. 154, pp. 564 and 569.)
855. SEALING GLASS TO METAL: A NEW METHOD.—R.C.A. (See 780.)
856. A NEW ELECTRON MICROSCOPE [Magnetic Type: Resolving Power between 50 & 100 A.U.].—Marton, Banca, & Bender. (*R.C.A. Review*, Oct. 1940, Vol. 5, No. 2, pp. 232-243.) See also 4002 of 1940 and back references. Henriot's simple derivation of the theoretical limits of resolving power, starting from the indetermination principle, is reproduced.
857. THEORY OF THE CYCLOTRON [Review of Previous Work and Further Calculations & Measurements: including Sections on Electric & Magnetic Focusing, Homogeneity of Beam Energy, "Shimming", and Path Wandering caused by Radial Decrease of Magnetic Field].—Wilson. (*Journ. Applied Phys.*, Dec. 1940, Vol. 11, No. 12, pp. 781-796.)
858. THE INDUCTION ELECTRON ACCELERATOR.—Kerst. (*Sci. News Letter*, 7th Dec. 1940, Vol. 38, No. 23, p. 355.)
859. THE VELOCITY DISTRIBUTION OF ELECTRONS IN A DISCHARGE PLASMA.—Pekar. (*Journ. of Exp. & Theoret. Phys.* [in Russian], No. 4, Vol. 10, 1940, p. 475.) A letter supplementing a previous paper in Vol. 9, 1939, p. 1015.
860. CONDENSATION OF MERCURY IN MERCURY-ARC TUBES.—Slepian & Brubaker. (*Electronics*, Aug. 1940, Vol. 13, No. 8, pp. 72 and 73: summary only.)
861. THE CONSTRUCTION AND PHYSICAL PROPERTIES OF GAS-FILLED TRIODES [and the Advantages of the Tetrode with Its Shielding Grid].—Windred. (*E. & Television & S-W.W.*, Oct. 1940, Vol. 13, No. 152, pp. 449-452.) One of a series of articles on gas-filled triodes and their practical use.
862. THE PERFORMANCE OF COMMUTATOR INVERTERS.—Stenning. (See 726.)

863. OPERATION OF A SELF-EXCITED INVERTER [giving Frequencies variable from 40 to 110 c/s from D.C. Source: Curves showing Efficiency, Wave-Form, Regulation, etc.].—Tompkins. (*Electronics*, Sept. 1940, Vol. 13, No. 9, pp. 36-39 and 81.) The poor regulation is one of the reasons why practical applications of the gas-filled inverter have not been more numerous.
864. A CONTRIBUTION TO THE CALCULATION OF THE D.C./A.C. MUTATOR WITH THE HELP OF THE LAPLACE TRANSFORMATION.—Müller-Strobel. (*Bull. Assoc. suisse des Elec.*, No. 22, Vol. 31, 1940, pp. 508-522: in German.)
865. MODERN CHARGING STATIONS FOR ELECTRIC VEHICLES [Automatic Selenium-Rectifier Installations].—Ruegg. (*Bull. Assoc. suisse des Elec.*, No. 21, Vol. 31, 1940, pp. 487-492: in German.)
866. THE BEHAVIOUR OF RESISTORS AT HIGH FREQUENCIES.—G. W. O. H. (See 825.)
867. THE HIGH-FREQUENCY RESISTANCE OF SUPERCONDUCTING TIN.—London. (*Proc. Roy. Soc.*, Ser. A, 27th Nov. 1940, Vol. 176, No. 967, pp. 522-533.) A summary was dealt with in 208 of January.
868. THE EFFECTIVE INDUCTANCE AND RESISTANCE OF SCREENED COILS.—Bogle: G. W. O. H. (See 821/2.)
869. A NEW METHOD OF PRESSING INSULATING MATERIAL ON COILS, ETC. [Elimination of Intricate Moulds by Pressure transmitted by Hot Steel Shot].—Warren. (*E. & Television & S.W.W.*, Oct. 1940, Vol. 13, No. 152, p. 465.)
870. AN IMPROVED METHOD OF MANUFACTURING FIXED CONDENSERS [Mica Plates metallised by Thermal Evaporation and subsequently Heat-Treated].—(*E. & Television & S.W.W.*, Oct. 1940, Vol. 13, No. 152, p. 444.)
871. CERAMIC MATERIALS: THEIR PHYSICAL AND ELECTRICAL PROPERTIES—SOME CONTINENTAL OBSERVATIONS [with Table of Data].—(*Electrician*, 13th Sept. 1940, Vol. 125, pp. 137-138.)
872. CERAMIC INSULATIONS FOR HIGH-FREQUENCY WORK [Steatite Group: Rutile Group (High Permittivity) & Rutile Group (Low Temperature-Coefficient of Permittivity): Manufacture: Electrical & Mechanical Properties: Applications].—Robinson. (*Journ. I.E.E.*, Nov. 1940, Vol. 87, No. 527, pp. 570-577.) From Bullers, Limited.
873. PAPER ON THE OCCURRENCE OF HIGH PERMITTIVITY IN SOLID INSULATING MATERIALS [depends on Electronic Polarisability of Constituent Ions and Atomic Polarisability of the Compound both being High: Dependence of Temperature-Coefficient of Permittivity on Relative Contributions of These Two Polarisations].—F. C. Frank. (Mentioned in Robinson's paper, 872, above.)
874. GLASS FIBRES AS INSULATION [Recent Developments: the Importance of Impregnants].—(*Electrician*, 10th Jan. 1941, Vol. 126, p. 17.)
875. THE DEVELOPMENT OF A PRE-STRESSED ("TOUGHENED") GLASS INSULATOR, and THE PERFORMANCE OF GLASS INSULATORS, AND COMPARISONS WITH PORCELAIN.—Hogg: E. R. A. (*Journ. I.E.E.*, Dec. 1940, Vol. 87, No. 528, pp. 615-624: pp. 625-656: Discussions pp. 656-664.)
876. INSULATION [Influence of Recent Researches & Applications on the Advance of the Art: "Tracking" Tendency (and Its Physical Aspect): Newer Synthetic Resins: Chlorinated Diphenyls: Glass (including Experiment showing Glass Rod heated to Incandescence by Current through It): Insulating Processes: etc.].—Warren. (*Journ. I.E.E.*, Dec. 1940, Vol. 87, No. 528, pp. 588-596.) Already referred to in 3585 of 1940.
877. THE THERMOPLASTIC BEHAVIOUR OF LINEAR AND THREE-DIMENSIONAL POLYMERS [and the Mechanism leading to the Large Physical Differences in High Polymers].—Kistler. (*Journ. Applied Phys.*, Dec. 1940, Vol. 11, No. 12, pp. 769-778.)
878. DISCUSSION ON "AN IMPROVED CELL FOR THE A.C. AND D.C. TESTING OF INSULATING OILS."—Bramley. (*Journ. I.E.E.*, Dec. 1940, Vol. 87, No. 528, pp. 689-691.)
879. A METHOD FOR DETECTING THE IONISATION POINT ON ELECTRICAL APPARATUS.—Quinn. (See 840.)
880. SPARK GAPS WITH SHORT TIME LAG [for Protective Devices, etc.].—Slepian & Berkey. (See 698.)
881. CALCULATION OF INITIAL BREAKDOWN VOLTAGES IN AIR [Spark-Over & Corona Starting Voltages predetermined by Modification of Townsend Theory], and D.C. BREAKDOWN STRENGTH OF AIR AND OF FREON [CCl<sub>2</sub>F<sub>2</sub>] IN A UNIFORM FIELD AT HIGH PRESSURES.—Planck: Trump & others. (*Elec. Engineering*, Dec. 1940, Vol. 59, No. 12, pp. 516-517: p. 517: summaries only.)
882. POWER CONSUMPTION AND TEMPERATURE OF HEATERS CONTAINING SILICON CARBIDE, AT CONSTANT VOLTAGE.—Beuken. (*Bull. Assoc. suisse des Elec.*, No. 21, Vol. 31, 1940, pp. 485-487: in German.) For the use of silicon carbide as "varistors" see 320 of February.
883. A FLUORESCENT-LAMP VOLTAGE STABILISER [giving Very Good Regulation for Photocell Amplifier: suitable for Devices requiring not more than 10-15 Watts].—Sweet. (*Electronics*, Aug. 1940, Vol. 13, No. 8, pp. 60 and 62.)
884. THE REGULATION OF THE SPEED OF D.C. MOTORS BY CURRENT PULSES [of Variable Duration].—Blaufuss. (*Arch. f. Elektrot.*, 15th Oct. 1940, Vol. 34, No. 10, pp. 581-590.)

885. AN INDICATING SYSTEM FOR HIGH-VOLTAGE POWER PACKS [e.g. 20 mA D.C. at 13 kV for "Precipitron" Air Cleaner: for Indication of Faulty Working].—Hildebrand. (*Electronics*, Oct. 1940, Vol. 13, No. 10, pp. 38 and 71, 72.)
886. ON THE FUNCTIONING OF THE LEAD ACCUMULATOR [Application of Reiffer's General Theory: Method of Neutralising the Injurious Secondary Chemo-Osmotic Reactions].—Bécot: Reiffer. (*Rev. Gén. de l'Élec.*, 16th/23rd March 1940, Vol. 47, No. 11/12, pp. 203-206.) See Reiffer, 2020 of 1940.
887. NOTE ON THE EFFECTS OF COBALT AND NICKEL IN STORAGE BATTERIES.—Vinal & others. (*Journ. of Res. of Nat. Bur. of Stds.*, Oct. 1940, Vol. 25, No. 4, pp. 417-420.)
888. STORAGE BATTERIES: A REVIEW OF THEIR APPLICATION.—McKinnon. (*Journ. I.E.E.*, Sept. 1940, Vol. 87, No. 525, pp. 225-242: Discussion pp. 243-250.)
889. AN ELECTRONIC RELAY TESTER [for Mechanical Life Testing of Modern A.C. Relays which wear out the Ordinary Motor-Driven Contactor].—Bagno. (*Electronics*, Sept. 1940, Vol. 13, No. 9, pp. 44 and 47.)
890. MATERIALS FOR ELECTRICAL CONTACTS [and the Causes of Failure].—Chaston. (*Electrician*, 17th Jan. 1941, Vol. 126, p. 40.) Summary of I.E.E. paper.
891. "ELECTRICAL CONTACTS" [Book Review].—Windred. (*Elec. Review*, 3rd Jan. 1941, Vol. 128, p. 204.)
892. COLLOIDAL GRAPHITE IN RADIO WORK.—(*E. & Television & S-W.W.*, Nov. 1940, Vol. 13, No. 153, pp. 502-503.)
893. NEW PROCESS FOR WELDING OF FERROUS AND NON-FERROUS METALS SUCH AS STEEL AND ALUMINIUM.—Batimat Ltd. (*Wireless Engineer*, Dec. 1940, Vol. 17, No. 207, p. 516: paragraph only.)
894. APPLICATION OF X-RAYS TO THE STUDY OF ALLOYS [Survey].—Lipson. (*Nature*, 21st Dec. 1940, Vol. 146, pp. 798-801.)
895. NEUTRON STUDIES OF ORDER IN Fe-Ni ALLOYS [and the Usefulness of Neutron Technique as a Tool].—Nix & others. (*Phys. Review*, Ser. 2, 15th Dec. 1940, Vol. 58, No. 12, pp. 1031-1034.)
896. THE ADIABATIC TEMPERATURE CHANGES ACCOMPANYING THE MAGNETISATION OF FERROMAGNETIC MATERIALS IN LOW AND MODERATE FIELDS [Results confirm Warburg's Law: Becker's Views essentially Correct: No Support for Preisach's Conception of Formation of Demagnetisation Nuclei in Extremely Soft Ferromagnetic Materials such as Permalloy].—Bates & Weston. (*Proc. Phys. Soc.*, 1st Jan. 1941, Vol. 53, Part I, pp. 5-34.)
897. FIELD DEPENDENCE OF THE INTRINSIC DOMAIN MAGNETISATION OF A FERROMAGNET.—Holstein & Primakoff. (*Phys. Review*, Ser. 2, 15th Dec. 1940, Vol. 58, No. 12, pp. 1098-1113.)
898. THEORY OF ANTI-FERROMAGNETISM [Substances showing Paramagnetism at High Temperatures, but at a Definite Temperature behaving as Ferromagnetic with Marked Increase of Susceptibility, at Lower Temperatures a Decrease].—Miyahara. (*Sci. Abstracts*, Sec. A, 25th Dec. 1940, Vol. 43, No. 516, p. 809.)
899. INFLUENCE OF HEAT TREATMENT ON THE MAGNETIC CHARACTERISTICS OF SEMI-HARD CARBON STEELS.—Bargone & Cocciolo. (*L'Elettrotecnica*, No. 20, Vol. 27, 1940, pp. 476-478.)
900. A DESIGN FOR AN ELECTRO-MAGNET AND PERFORMANCE OF A SMALL MODEL [Windings made of Copper Tubing of Special Cross Section for Water at High Pressure].—Freed. (*Review Scient. Instr.*, April 1940, Vol. 11, No. 4, pp. 117-119.)
901. DESIGN OF TRANSFORMER DIMENSIONS [Discussion of Previous Theories and Work on Optimum Transformer Design: Methods for Optimum Design with Given Conditions].—Faye-Hansen. (*Arch. f. Elektrot.*, 15th March 1940, Vol. 34, No. 3, pp. 121-142.) Cf. in particular Unger, 3341 of 1939 (see 2458 of 1940 for later work), whose conclusions are here contested.
902. THE INFLUENCE OF VARIOUS FACTORS UPON THE LEAKAGE REACTANCE OF TRANSFORMERS [using Roth's Potential-Vector Method of Analysis].—Morris. (*Journ. I.E.E.*, May 1940, Vol. 86, No. 521, pp. 485-495.)
903. COMPUTATION OF ACCURACY OF CURRENT TRANSFORMERS.—Sinks. (*Elec. Engineering*, Dec. 1940, Vol. 59, No. 12, Transactions pp. 663-668.)

#### STATIONS, DESIGN AND OPERATION

904. CHART OF FREQUENCY ASSIGNMENTS IN THE RADIO SPECTRUM FOR STATIONS IN THE UNITED STATES [compiled from Latest F.C.C. Lists].—(*Electronics*, Sept. 1940, Vol. 13, No. 9, Inset.)
905. COMMERCIAL APPLICATIONS OF ULTRA-SHORT WAVELENGTHS.—Harwood & Gardner. (*Sci. Abstracts*, Sec. B, 25th Dec. 1940, Vol. 43, No. 516, pp. 493-494.) From *Trans. S. African I.E.E.*
906. EVOLUTION OF FREQUENCY MODULATION.—Armstrong. (*Elec. Engineering*, Dec. 1940, Vol. 59, No. 12, pp. 485-493.) Based on various A.I.E.E. lectures.
907. AMPLITUDE, FREQUENCY, AND PHASE-ANGLE MODULATION [Full Maintenance of Writer's 1922 Rejection of Frequency-Modulation Claims].—Carson. (See 731.)
908. THE IMPROVED SIGNAL/NOISE RATIO OBTAINED WITH FREQUENCY-MODULATION SYSTEMS: DUE TO AMPLITUDE-LIMITING EFFECT OF RECEIVER?—Wald. (In paper dealt with in 745, above.)

909. FREQUENCY *versus* AMPLITUDE MODULATION [Editorial on "Better Coverage," 219 of January: Examination of the "Certain Conditions" under which the Striking Comparisons were obtained].—G. W. O. H. Weir. (*Wireless Engineer*, Jan. 1941, Vol. 18, No. 208, pp. 1-2.)
910. AMPLITUDE, FREQUENCY, AND PHASE MODULATION [Successful Reception of Two Programmes from Transmitter simultaneously Frequency- & Amplitude-Modulated: Simultaneous F.M. & A.M. on Single Programme gives Better Quality than A.M. only (cf. 973, 2224/5 of 1940)—suggested for Transition Period in Broadcasting: Test of Stereophonic Broadcasting by Use of the Two Channels (cf. 2068 of 1940)].—Ge. (*Wireless Engineer*, Oct. 1940, Vol. 17, No. 205, pp. 441-442.) Prompted by the Editorial dealt with in 2551 (see also 3786) of 1940.
911. INTERFERENCE IN RELATION TO AMPLITUDE-, PHASE-, AND FREQUENCY-MODULATED SYSTEMS.—Keall. (See 744.)
912. N.B.C. FREQUENCY-MODULATION FIELD TEST [April 1939/May 1940: F.M. Theory: Tests—Two Stations on Same Channel: on Adjacent Channels: Noise Threshold: Ignition Noise: Diathermal Interference: etc.].—Guy & Morris. (*R.C.A. Review*, Oct. 1940, Vol. 5, No. 2, pp. 190-225.) A summary was referred to in 3789 of 1940.
913. MODULATION LIMITS IN FREQUENCY MODULATION.—Black & Scott. (See 732.)
914. THE FIRST "SYNCHRONISED" FREQUENCY-MODULATION TRANSMITTER W2XOR WORKING 105 HOURS PER WEEK.—(*Electronics*, Sept. 1940, Vol. 13, No. 9, pp. 17-19 and 61, 62.) See also 3372 & 4246 of 1940.
915. FREQUENCY MODULATION FOR EMERGENCY COMMUNICATION [particularly Police Radio Systems].—DuVal. (*Electronics*, Oct. 1940, Vol. 13, No. 10, pp. 79 and 80, 81: summary only.)
916. HIGH-FREQUENCY WIRE BROADCASTING.—Buchmann. (*Bull. Assoc. suisse des Elec.*, No. 22, Vol. 31, 1940, pp. 523-525: in German.) From a 1937 *Siemens-Zeitschrift* paper.
917. WIRED RADIO [in Sweden].—Esping. (*Sci. Abstracts*, Sec. B, 25th Nov. 1940, Vol. 43, No. 515, p. 2008.)
918. CIVIL AIR TRANSPORT COMMUNICATION [Growth of Communication System: Technical Considerations & Requirements of Ground-Station Equipment: Aircraft Equipment & Installation: Atlantic & Empire Routes to East: Brief Outline of U.S.A. System: Future Developments].—Hodgson. (*Journ. I.E.E.*, Sept. 1940, Vol. 87, No. 525, pp. 317-343: Discussion pp. 344-350.)
919. RECENT TECHNICAL DEVELOPMENT IN WIRELESS AND BROADCASTING IN GREAT BRITAIN [based on Results of a Travelling Fellowship].—Rakshit. (*Sci. & Culture*, Calcutta, Nov. 1940, Vol. 6, No. 5, pp. 259-266.)
920. "REPORT ON THE PROGRESS OF BROADCASTING IN INDIA" [Book Review].—Kirke. (*Sci. & Culture*, Calcutta, Nov. 1940, Vol. 6, No. 5, pp. 251-254.) See also Editorial, pp. 249-250.
921. WEA.F, PORT WASHINGTON [New N.B.C. Station, transferred from Bellmore].—(*Electronics*, Sept. 1940, Vol. 13, No. 9, pp. 20-22.)
922. S.S. "AMERICA" RADIO INSTALLATION [Largest & Fastest Passenger Liner built in United States].—Byrnes. (*R.C.A. Review*, Oct. 1940, Vol. 5, No. 2, pp. 176-189.)
923. U.S. COAST GUARD EMERGENCY TRUCK [for Weather Reporting, Fire-Fighting, Ambulance Service, etc.: Two Transmitters & Receivers, for Simultaneous Working on Two Frequencies if desired].—(*Electronics*, Oct. 1940, Vol. 13, No. 10, p. 31.)

#### GENERAL PHYSICAL ARTICLES

924. STATIONARY ELECTRIC AND MAGNETIC FIELDS IN BEAMS OF LIGHT.—Ehrenhaft. (See 675.)
925. THE SCATTERING OF LIGHT BY THE ELECTROSTATIC FIELD OF A CHARGE ACCORDING TO HOFFMANN-INTELD NON-LINEAR ELECTRODYNAMICS.—Smirnov. (*Journ. of Exp. & Theoret. Phys.* [in Russian], No. 3, Vol. 10, 1940, pp. 257-262.)  
The scattering of light in the radial field of a charge is discussed from the standpoint of the Hoffmann-Inteld theory, and methods are indicated for calculating the angular distribution of the scattered radiation and the integral effective cross-section ( $\phi$ , eqn. 18, derived from eqn. 17, where  $\sigma_1$  and  $\sigma_2$  are numerical coefficients,  $d\Omega$  is an element of solid angle, and  $\delta$  the angle between incident and scattered rays).
926. THE STATISTICAL THEORY OF LIGHT DIFFUSION IN CONDENSED SYSTEMS.—Davydov. (*Journ. of Exp. & Theoret. Phys.* [in Russian], No. 3, Vol. 10, 1940, pp. 263-280.)  
Using the general method of Gibbs's statistical mechanics, formulae are derived for determining the intensity of the light diffused by liquids and gases under any conditions, including the critical point. The molecules and not the fluctuations of density are regarded in this investigation as the diffusing centres.
927. A LINEAR THEORY OF THE ELECTRON [Field Equations, Energy-Impulse Tensor: Point Charge & Motional Equations: Radiation Power: Development of the Hamiltonian Function].—Bopp. (*Ann. der Physik*, Ser. 5, No. 5, Vol. 38, 1940, pp. 345-384.)

928. METAL ELECTRONS [Conduction Electrons in the Electron Gas of a Metal] IN THE EARTH'S GRAVITATIONAL FIELD.—Wolf. (*Ann. der Physik*, Ser. 5, No. 5, Vol. 38, 1940, pp. 385-398.)
929. IONISATION, EXCITATION, AND CHEMICAL REACTION IN UNIFORM ELECTRIC FIELDS: IV & V [Reconsiderations of Electron Energy Balance (with Special Reference to Hydrogen) & of Kirkby's Investigation of Uniform Positive Column Reaction in Electrolytic Gas].—Lunt & others. (*Proc. Roy. Soc.*, Ser. A, 27th Nov. 1940, Vol. 176, No. 967, p. S 69 & 70.)
930. ON THE THEORY OF RECOMBINATION [of Ions in Gases: Development of General Formula for Coefficient of Recombination, covering All Ranges of Pressure & Temperature: Special Cases: Comparison with Experimental Data].—Jaffé. (*Phys. Review*, Ser. 2, 1st Dec. 1940, Vol. 58, No. 11, pp. 968-976.)
931. IONISATION AND DISSOCIATION OF WATER VAPOUR AND AMMONIA BY ELECTRON IMPACT.—Mann & others. (*See* 688.)
932. MOBILITIES [of Free Electrons & of Hydrogen Positive Ions] IN HYDROGEN AT HIGH CURRENT DENSITIES [Investigation of Silent Electric Discharge].—Bennett. (*Phys. Review*, Ser. 2, 1st Dec. 1940, Vol. 58, No. 11, pp. 992-997.)
933. THE MOBILITY OF POSITIVE IONS IN THEIR OWN GAS.—Munson & Tyndall. (*See* 700.)
934. THE CHARACTERISTICS OF THERMAL DIFFUSION.—Chapman. (*See* 701.)
935. "AN INTRODUCTION TO THE KINETIC THEORY OF GASES" [Book Review].—Jeans. (*Proc. Phys. Soc.*, 1st Jan. 1941, Vol. 53, Part 1, pp. 85-86.)
936. "ELECTRODYNAMICS" [Book Review].—Leigh Page & Adams. (*Electronics*, Sept. 1940, Vol. 13, No. 9, p. 42.)
- MISCELLANEOUS**
937. THE DEATH OF J. R. CARSON.—(*Proc. I.R.E.*, Oct. 1940, Vol. 28, No. 10, p. 488.)
938. MATRIX CALCULUS AND ELECTRICAL NETWORKS.—Quade. (*See* 716.)
939. VALUE OF A DETERMINANT WITH COMPLEX ELEMENTS [in Connection with Application of Matrix Algebra to Electrical Problems: Simple Methods of reducing Such a Determinant to Sum of Real-Element Determinants].—Tang. (*Elec. Engineering*, Dec. 1940, Vol. 59, No. 12, pp. 527-528.)
940. A FIVE-FIGURE TABLE OF THE BESSEL FUNCTION  $I_n(x)$ .—Dwight. (*See* 694.)
941. NOMOGRAPHY FOR THE ELECTRICAL ENGINEER [Procedure for Application of Basic Theory of Third-Order Determinants, which embraces Whole Theory of Nomography].—Ferrara. (*Elec. Engineering*, Dec. 1940, Vol. 59, No. 12, pp. 505-508.)
942. "MASSEINHEITEN UND KONSTANTEN" [Units and Constants in Mechanics, Acoustics, Heat, Light, Magnetism, & Electricity: Book Review].—Nentwig. (*Hochf.tech. u. Elek.akus.*, Sept. 1940, Vol. 56, No. 3, p. 95.)
943. "DIE MATHEMATIK DES FUNKTECHNIKERS" [The Wireless Engineer's Mathematics: Part 4—Symbolic Calculus: Book Review].—Schmid. (*Hochf.tech. u. Elek.akus.*, Sept. 1940, Vol. 56, No. 3, p. 94.)
944. AN ELECTRONIC METHOD FOR DETERMINING DISTRIBUTION CURVES [of Any Varying Quantity representable by Rotating Shaft].—Ware. (*Electronics*, Oct. 1940, Vol. 13, No. 10, pp. 36-37.) Primarily in connection with a hydraulic flow meter, but capable of many applications.
945. CATHODE-RAY OSCILLOGRAPH USED TO MEASURE SHORT TIME INTERVALS.—Brailsford. (*See* 845.)
946. APPLICATION OF THE [Geiger-Müller] COINCIDENCE METHOD FOR MEASUREMENTS OF SHORT LIFE PERIODS [Radioactive & Nuclear,  $10^{-7}$  to  $10^{-1}$  Second].—Rotblat. (*Proc. Roy. Soc.*, Ser. A, 10th Jan. 1941, Vol. 177, No. 969, pp. 260-271.)
947. "PHOTOGRAPHISCHE MESSTECHNIK" [Measuring Technique: Book Review].—Fink. (*Hochf.tech. u. Elek.akus.*, Sept. 1940, Vol. 56, No. 3, p. 96.)  
Including photographic recording of oscillograph traces, time and movement recording, length and position determination (aircraft, etc.), measurement of weak and short optical phenomena, and other applications.
948. AN ELECTRONIC TELESCOPE CONTROL [for tracking Aircraft: using Two Pairs of Photocells].—Rubenstein. (*Electronics*, Aug. 1940, Vol. 13, No. 8, pp. 54-60.) Successful development of the work referred to in 1934 Abstracts, p. 111.
949. ELECTRON-RAY TITRIMETER.—Serfass. (*Sci. Abstracts*, Sec. B, 25th Dec. 1940, Vol. 43, No. 516, p. 477.)
950. CORRECTION TO CIRCUIT DIAGRAM IN "A LIGHT REGULATOR."—Chance. (*Electronics*, Oct. 1940, Vol. 13, No. 10, p. 82.) *See* 3667 of 1940.
951. PHOTOCCELL REGISTER CONTROL ON ROTOGRAVURE COLOUR PRESS OF *Philadelphia Inquirer* [saves 15 000 Dollars a Year].—(*Electronics*, Oct. 1940, Vol. 13, No. 10, p. 60.)
952. BRISTOL-MYERS [Pharmaceutical-Products] FACTORY USE 25 PHOTOCCELLS IN 5 DIFFERENT APPLICATIONS [installed "without Hiring an Electronic Specialist"].—Walsh. (*Electronics*, Oct. 1940, Vol. 13, No. 10, pp. 16-19.)
953. LIGHT-OPERATED RELAY CIRCUITS [for Special Photocell Applications].—R.C.A. Laboratories. (*E. & Television & S.W.W.*, Dec. 1940, Vol. 13, No. 154, pp. 534 and 537.)



954. DETECTION OF CLAY MINERALS IN SOIL MORTARS BY PHOTOELECTRIC CELL.—Knight. (*Nature*, 4th Jan. 1941, Vol. 147, pp. 27-28.)
955. CRYOLITE FILMS ON GLASS SURFACES [Increased Transmission does Not require Exact Control of Thickness; etc.].—French. (*Nature*, 23rd Nov. 1940, Vol. 146, p. 687.)
956. THE LIGHT COUNTER [for Measurement of Very Low Intensities of Light].—Rodionov. (*Journ. of Exp. & Theoret. Phys.* [in Russian], No. 3, Vol. 10, 1940, pp. 294-303.)
- The writer remarks that existing types of counter have been developed empirically without due regard to theoretical considerations. He accordingly examines the processes taking place in a gas-filled discharge tube, and as a result of his investigations develops the special tube shown in Fig. 1, having a platinum cathode *A* with an aluminium layer deposited on it (other cathodes were tried, but this was the most satisfactory: Figs. 11 & 12) and a ring anode *B*, in an atmosphere of hydrogen at 1 to 4 mm Hg: good results were also obtained with nitrogen. A special circuit (Fig. 9) was developed for registering the discharges through the tube under the action of light falling on the cathode *A* through a quartz window: a feature of this circuit is the use of a photocell, in place of a resistance, as a load on the tube. By varying the illumination on this photocell the duration of the discharges can be adjusted: they are counted (after a single stage of amplification) by an electromagnetic meter. Table 1 shows a comparison with other methods of detection and measurement. The minimum intensity of light of wavelength 2500 Å falling on cathode *A*, required for detection and measurement, is 1000 quanta/sec. cm<sup>2</sup>.
957. A NEW TRANSMISSION PHOTOMETER [for Quantitative Spectrographic Analysis, Micro-Colorimetric Analysis, etc.].—Malpica & Fanter. (*Gen. Elec. Review*, Sept. 1940, Vol. 43, No. 9, pp. 384-385.)
958. STROBOSCOPE IN STRUCTURAL RESEARCH [Failure of Mine-Wall Structure studied in Model spun in Centrifuge and Stroboscopically Photographed].—Ireland. (*Electronics*, Aug. 1940, Vol. 13, No. 8, p. 76.)
959. UNINTERRUPTED LIGHT-TRANSMISSION MEASUREMENTS WITH A ROTATING SECTOR [with Help of a Contact-Stroboscope Circuit].—Harris & Kyger. (*Journ. Opt. Soc. Am.*, Oct. 1940, Vol. 30, No. 10, p. 505.)
960. PHOTOTUBE INSTALLATION PAYS FOR ITSELF IN SINGLE DAY [in safeguarding Dies in Six-Operation Press for Car Parts].—General Electric. (*Electronics*, July 1940, Vol. 13, No. 7, pp. 46, 48.)
961. PRESS-DEFLECTION INDICATOR [Photocell Equipment to give Warning against Excessive Cant of Ram of Steel-Works Hydraulic Press].—(*Journ. of Scient. Instr.*, Dec. 1940, Vol. 17, No. 12, pp. 279-281.)
962. ELECTROPHOTOGRAPHY OF CONDENSER PAPER [Effect of Applied D.C. Voltage on Blackness of Electrophotogram].—Akahira & Kamazawa. (*Jap. Journ. of Eng., Abstracts*, Vol. 19, 1940, p. 98.)
963. NEW KODATRON SPEEDLAMP [for High-Speed Photography: Condenser Discharge through Gas-Filled Tube].—Edgerton. (*Journ. of Applied Phys.*, Nov. 1940, Vol. 11, No. 11, p. vi.)
964. LIGHT CHANGE IN CLEAR SKY PERMITS PREDICTION OF CLOUDS [Several Hours before Their Formation, by Use of Polariscopes].—Neuberger. (*Sci. News Letter*, 7th Dec. 1940, Vol. 38, No. 23, p. 358.)
965. INDUSTRIAL DIAGNOSTIC LIGHTS ["Ang-Lites" (including Hooked Type for retrieving Wires) of Lucite bring 50-75 C.P. to Angles up to 180°].—Weiss. (*Electronics*, Oct. 1940, Vol. 13, No. 10, p. 92.) Cf. 378 of February.
966. BANK-Vault BURGLAR-Alarm RESEARCH [with Measurements of Sound Levels in Normal & "Attack" Conditions].—Brailsford. (*Electronics*, Oct. 1940, Vol. 13, No. 10, pp. 81 and 82.)
967. THE DETERMINATION OF HYDROGEN-ION CONCENTRATION [and the Cambridge Portable pH Meter].—(*Engineering*, 10th Jan. 1941, Vol. 151, pp. 21-23: to be contd.)
968. A DECADE OF PROGRESS IN THE USE OF ELECTRONIC TUBES: PART I—IN THE FIELD OF COMMUNICATION: PART II—IN OTHER THAN THE FIELD OF COMMUNICATION [particularly in Industry].—Ingram: White. (*Elec. Engineering*, Dec. 1940, Vol. 59, No. 12, Transactions pp. 643-649: pp. 650-654.) Each part has a long bibliography.
969. ELECTRIC TIMER FOR AEROPLANE CATAPULTS.—General Electric (America). (*Elec. Review*, 27th Dec. 1940, Vol. 128, p. 184.)
970. THE ELECTRICAL TRANSMISSION OF FLOW AND LEVEL RECORDS.—Linford. (*BEAMA Journ.*, Dec. 1940, Vol. 47, No. 42, pp. 97-101: to be contd.)
971. AIR-RAID WARNINGS OVER POWER-DISTRIBUTION NETWORKS BY THE TELEVOLT SYSTEM [Momentary Voltage Rise causes Neon Lamp to flash and activates Bell].—Blomberg. (*Sci. Abstracts*, Sec. B, 25th Nov. 1940, Vol. 43, No. 515, p. 447.)
972. DISCUSSION ON "FIRE-FIGHTING EQUIPMENT FOR ELECTRICAL INSTALLATIONS."—Hacking & McMahon: E.R.A. (*Journ. I.E.E.*, Sept. & Nov. 1940, Vol. 87, Nos. 525 & 527, pp. 251-281 & 535-538.)
973. DEFENCE TRAINING FOR ENGINEERS TO BE FINANCED BY GOVERNMENT [Nine Million Dollar Programme].—(*Elec. Engineering*, Dec. 1940, Vol. 59, No. 12, pp. 521-522 and 523.)
974. MICROFILM'S GIFT TO RESEARCH [Details of Service].—American Documentation Institute. (*Sci. News Letter*, 7th Dec. 1940, Vol. 38, No. 23, p. 366.)

975. CULTURAL SIGNIFICANCE OF SCIENTIFIC METHOD [Editorial Review of "Freedom and Culture"].—Dewey. (*Nature*, 28th Dec. 1940, Vol. 146, pp. 815-817.) "The fundamental thinking which is a prelude to a closer alliance between democracy and science, as a condition of a new and richer world order of freedom and plenitude, must be undertaken now . . ."
976. ENGINEERING PROGRESS AND THE SOCIAL ORDER.—Jewett & King. (*Nature*, 28th Dec. 1940, Vol. 146, pp. 824-828.)
977. A QUARTER OF A CENTURY WITH QST [and the Part played by American Amateurs in Wireless Development].—(QST, Dec. 1940, Vol. 24, No. 12, pp. 12-21.)
978. "EXPERIMENTAL RADIO ENGINEERING" [covering the Normal Radio Engineering Course: Book Review].—Rapson. (*Electrician*, 10th Jan. 1941, Vol. 126, p. 20.)
979. "EINFÜHRUNG IN DIE THEORIE DER SCHWACHSTROMTECHNIK" [Communication Engineering: Book Review].—Wallot. (*Hochf. tech. u. Elek. akus.*, Sept. 1940, Vol. 56, No. 3, p. 96.)
980. "MODERN SCIENCE" [Book Review].—Levy. (*Journ. Applied Phys.*, Sept. 1940, Vol. 11, No. 9, p. 571.)
981. "BRITISH SCIENTISTS OF THE 19TH CENTURY" [Book Review].—Crowther. (*Distribution of Electricity*, Oct. 1940, Vol. 13, No. 140, pp. 417-418.)
982. "BROADCASTING IN INDIA UP TO 31ST MARCH 1939" [Book Reviews].—(*Electrotechnics*, Bangalore, Sept. 1940, No. 13, pp. 90-92; *Nature*, 30th Nov. 1940, Vol. 146, pp. 709-711.)
983. "RADIO DESIGNER'S HANDBOOK" [Book Notice].—Langford Smith (Edited by). (*Wireless Engineer*, Dec. 1940, Vol. 17, No. 207, p. 526.)
984. "CHAMBERS TECHNICAL DICTIONARY" [Book Review].—(*E. & Television & S-W.W.*, Dec. 1940, Vol. 13, No. 154, p. 542.)
985. A FOLLOW-UP TELEMETERING SYSTEM.—Esterline - Angus Company. (*Electronics*, Sept. 1940, Vol. 13, No. 9, pp. 47-52.)
986. CARRIER-FREQUENCY CHARACTERISTICS OF POWER LINES [and Deductions regarding Important Points in Design of Channels].—Fujiki & others. (*Jap. Journ. of Eng., Abstracts*, Vol. 19, 1940, p. 98.)
987. EXPERIMENTS ON A 10 000 KM TELEPHONE CIRCUIT BY NON-LOADED CARRIER CABLE [Korea/Tokyo], and DESIGN OF 24-CHANNEL CARRIER TELEPHONE SYSTEM FOR NON-LOADED CABLE.—Shinohara, Saisyo, Matsumoto. (*Nippon Elec. Comm. Eng.*, July 1940, No. 21, pp. 22-26; pp. 52-60.)
988. THE C5 CARRIER TERMINAL.—Cowley. (*Bell Lab. Record*, Oct. 1940, Vol. 19, No. 2, pp. 52-56 & Plates.)
989. COORDINATION OF POWER AND COMMUNICATION CIRCUITS FOR LOW-FREQUENCY INDUCTION [Edison Electric and Bell System Committee's Work].—Coleman & Trueblood. (*Elec. Engineering*, July 1940, Vol. 59, No. 7, Transactions pp. 403-412.)
990. AUDIO-FREQUENCY RIPPLE FROM D.C. POWER SUPPLIES IN COMMUNICATION ENGINEERING.—Harbottle & others. (*Inst. P.O. Elec. Eng., Printed Paper* No. 173, 20 pp.)
991. ALTERNATING-CURRENT GROUNDS ON WATER PIPES [Investigation of Complaints of Damage & Pollution].—(*Tech. News Bull. Nat. Bur. of Stds.*, Dec. 1940, No. 284, p. 106.)
992. CONCENTRATOR OF EDDY CURRENTS FOR ZONAL HEATING OF STEEL PARTS [Wavelengths 300 m to 30 km: including Use of Electrolytic Tank Method (with Models of Insulating Material) for investigating Magnetic Fields].—Babat & Losinsky. (*Journ. Applied Phys.*, Dec. 1940, Vol. 11, No. 12, pp. 816-823.) For previous work see 2120 of 1940 and back references.
993. ELECTROLYTIC POLISHING: II [Confirmation of Diffusion Theory, and Some Practical Conclusions].—Elmore. (*Journ. Applied Phys.*, Dec. 1940, Vol. 11, No. 12, pp. 797-799.) For other work on this "bright etching" (Jacquet process) see *Sci. Abstracts*, Sec. B, 25th Nov. 1940, p. 440.
994. A NEW ELECTRON MICROSCOPE [Magnetic Type: Resolving Power between 50 & 100 A.U.].—Marton, Banca, & Bender. (See 856.)
995. THE PHOTOGRAPHIC IMAGE [Electron-Microscopic Investigation of Silver-Bromide Grains].—Kodak Laboratories. (*Science*, 6th Dec. 1940, Vol. 92, Supp. p. 10.)
996. RECENT EXPERIMENTS ON THE BIOLOGIC EFFECTS OF MAGNETIC FIELDS.—Lenzi. (*Sci. Abstracts*, Sec. A, 25th Dec. 1940, Vol. 43, No. 516, p. 810.) For previous work see 3709 of 1940.
997. FORMAL THEORY OF NERVE CONDUCTION [with General Solution: Previous "Non-Capacitive" Velocities are Too High].—Weinberg. (*Sci. Abstracts*, Sec. A, 25th Dec. 1940, Vol. 43, No. 516, p. 811.)
998. OUT-DETECTING THE LIE-DETECTOR ["Psychometer," measuring Changes in Sweat Glands, claimed to be More Accurate than Usual Methods depending on Blood-Pressure, etc.].—Rucknick. (*Electronics*, Sept. 1940, Vol. 13, No. 9, p. 70: photograph only.)
999. COLD EMISSION USED IN MICROSECOND RADIOGRAPHY.—Slack. (*Electronics*, Sept. 1940, Vol. 13, No. 9, pp. 56-60.) See also 4127 of 1940.
1000. DESIGN AND APPLICATION OF X-RAY TUBES.—Atlee. (*Electronics*, Oct. 1940, Vol. 13, No. 10, pp. 26-30 and 62, 64.)
1001. A NOTE ON THE ELECTRIFICATION OF POWDERED INSULATORS.—Ambrose Fleming. (*Proc. Phys. Soc.*, 1st Jan. 1941, Vol. 53, Part I, pp. 51-53.) For previous work see 4141 of 1940.