

No. 196
Jan. 1940

THE WIRELESS ENGINEER

VOL. XVII.

JANUARY, 1940

No. 196

Editorial

The Symbolic Representation of Impedance and Admittance

If Z is the joint impedance operator of a resistance and reactance (inductive or capacitive) in series, we write $\mathbf{V} = Z\mathbf{I} = (R + jX)\mathbf{I}$.* The plus sign in this equation is not strictly a sign of addition but indicates that the quantity in brackets is the resultant of two operators R and $+jX$. Assuming the phase of \mathbf{I} to be as shown in Fig. 1, the

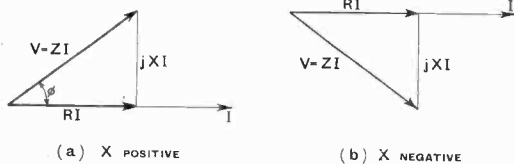

Fig. 1.

first term represents a vector drawn to the right or left depending on whether R is positive or negative, and the second term a vertical vector drawn upwards or downwards depending on whether X is positive or negative.

For a resistance and an inductance in series

$$\mathbf{V} = [R + j\omega L]\mathbf{I}; X = \omega L \text{ (Fig. 1a);}$$

for a resistance and a condenser in series

$$\mathbf{V} = \left[R + j\left(-\frac{1}{\omega C}\right) \right] \mathbf{I}; X = -\frac{1}{\omega C} \text{ (Fig. 1b);}$$

* Clarendon type is used to distinguish vector quantities.

for all three elements in series

$$\mathbf{V} = \left[R + j\left(\omega L - \frac{1}{\omega C}\right) \right] \mathbf{I}; X = \omega L - \frac{1}{\omega C}$$

and may be either positive or negative.

The impedance operator Z applied to the current vector \mathbf{I} in Fig. 1 gives the voltage vector \mathbf{V} in magnitude and phase, viz. $|\mathbf{V}| \angle \phi$ where $\tan \phi = X/R$, so that ϕ has the same sign as X . Reactance that moves the voltage vector forward is naturally regarded as positive and reactance that moves the vector in the negative direction as negative. We also write $Z = |Z| (\cos \phi + j \sin \phi) = |Z| e^{j\phi}$.

All of this is very familiar but we now turn to a less familiar field. If two pieces of apparatus are connected in parallel, one taking a current in phase and the other in quadrature with the applied P.D. we may

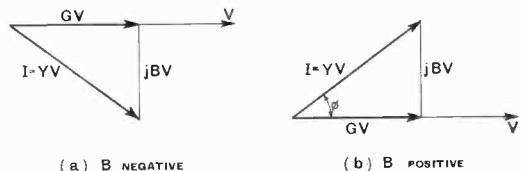

Fig. 2.

write $\mathbf{I} = Y\mathbf{V} = (G + jB)\mathbf{V}$. Here again the sign does not signify addition. Assuming the phase of \mathbf{V} to be as shown in Fig. 2, the first term represents a horizontal vector

drawn to the right or left depending on whether the conductance G is positive or negative, and the second term a vertical vector drawn upwards or downwards depending on whether the susceptance B is positive or negative.

For a resistance and an inductance in parallel

$$\mathbf{I} = [G + jB] \mathbf{V} = \left[\frac{\mathbf{I}}{R} + j \left(-\frac{\mathbf{I}}{\omega L} \right) \right] \mathbf{V};$$

$$B = -\frac{\mathbf{I}}{\omega L} \text{ (Fig. 2a);}$$

for a resistance and a condenser in parallel

$$\mathbf{I} = [G + jB] \mathbf{V} = \left[\frac{\mathbf{I}}{R} + j(\omega C) \right] \mathbf{V}; \quad B = \omega C$$

(Fig. 2 b);

for all three elements in parallel

$$\mathbf{I} = [G + jB] \mathbf{V} = \left[\frac{\mathbf{I}}{R} + j \left(\omega C - \frac{\mathbf{I}}{\omega L} \right) \right] \mathbf{V};$$

$$B = \omega C - \frac{\mathbf{I}}{\omega L} \text{ and may be either positive or negative.}$$

The admittance operator Y applied to the voltage vector \mathbf{V} in Fig. 2 gives the current vector \mathbf{I} in magnitude and phase, viz. $|I| \angle \phi$ where $\tan \phi = B/G$, so that ϕ has the same sign as B . Susceptance that moves the current vector forward is naturally regarded as positive and susceptance that moves the vector in the negative direction as negative. We also write

$$Y = |Y| (\cos \phi + j \sin \phi) = |Y| e^{j\phi}.$$

The equivalent conductance and susceptance in series may be found thus:—

$$\mathbf{I} = Y\mathbf{V} = \mathbf{V}/Z = \frac{\mathbf{V}}{R + jX}$$

$$= \left[\frac{R}{R^2 + X^2} + j \frac{-X}{R^2 + X^2} \right] \mathbf{V} = [G + jB] \mathbf{V}.$$

Hence $G = \frac{R}{R^2 + X^2}$ and $B = \frac{-X}{R^2 + X^2}$.

If the reactance is inductive, $X = \omega L$ and $B = \frac{-\omega L}{R^2 + \omega^2 L^2}$; if it is capacitive,

$$X = -\frac{\mathbf{I}}{\omega C} \text{ and } B = \frac{\mathbf{I}/\omega C}{R^2 + \mathbf{I}/\omega^2 C^2}.$$

Hence a resistance R and a reactance X in series are equivalent to a resistance

$\frac{\mathbf{I}}{G} = \frac{R^2 + X^2}{R}$ and a reactance $-\frac{\mathbf{I}}{B} = \frac{R^2 + X^2}{X}$ connected in parallel.

That X for an inductance should be positive whilst B for the same piece of apparatus should be negative is seen on consideration to be logical. The resistance and the reactance components of the impedance differ far more fundamentally than is expressed by a given number of ohms, and no statement of the reactance is complete without the j symbol. Hence although for a simple resistance, G can be regarded as the reciprocal of R , one cannot for a capacitance or an inductance regard B as the mere numerical reciprocal of X .

If a resistance, an inductance, and a condenser are in series, the total impedance is the resultant of three terms R , $j(\omega L)$ and $j\left(-\frac{\mathbf{I}}{\omega C}\right)$. If, however, they are in parallel, the joint admittance is the resultant of their reciprocals, $\frac{\mathbf{I}}{R}$, $\frac{\mathbf{I}}{j(\omega L)}$ and $\frac{\mathbf{I}}{j\left(-\frac{\mathbf{I}}{\omega C}\right)}$, that is, of

$\frac{\mathbf{I}}{R}$, $j\left(-\frac{\mathbf{I}}{\omega L}\right)$ and $j(\omega C)$. In the first case the magnitudes associated with j can be added together, and called X , so that $X = \omega L - \frac{\mathbf{I}}{\omega C}$; in the second case, they can be added together and called B , so that $B = \omega C - \frac{\mathbf{I}}{\omega L}$. In the first case $Z = R + jX$, in the second $Y = G + jB$.

Our reason for setting this out in such detail is that of three books published within the last few months, one, viz. Whitehead's *Electricity and Magnetism*, follows the above standard convention, whereas the other two, viz. Warren's *Mathematics Applied to Electrical Engineering*, and Dover's *Alternating Currents*, put $Y = G - jB$. With this latter convention it is necessary to change the signs of the components of B , i.e. to regard them as the mere numerical reciprocals of ωL and $-\frac{\mathbf{I}}{\omega C}$.

Warren obtains the minus sign by the following procedure.

$$Y = \frac{\mathbf{I}}{Z} = \frac{\mathbf{I}}{|Z| (\cos \phi + j \sin \phi)}$$

$$= |Y| (\cos \phi - j \sin \phi) = G - jB$$

but the final step may be regarded as premature, for one can put

$$|Y| (\cos \phi - j \sin \phi) = |Y| [\cos (-\phi) + j \sin (-\phi)] = G + jB.$$

This takes into account the fact that on transforming from the Z to the Y operator in any given case, Fig. 1 (a) is transformed into Fig. 2 (a) and Fig. 1 (b) into Fig. 2 (b), the angle ϕ being changed to $-\phi$ or vice versa.

In justification Warren and Dover could undoubtedly refer to several other text-books which adopt the minus sign convention. At one time similar differences of opinion existed in connection with impedance, and in Steinmetz's *Elements of Electrical Engineering* one finds $Z = R - jX$ and $Y = G + jB$

but we believe that the minus sign in the impedance formula is now quite obsolete. We have already referred to Whitehead's recent *Electricity and Magnetism*; in Kennelly's *Artificial Electric Lines* one also finds $Y = G + jB$, but more important than these references to text-books is the definition of "Susceptance" in the International Electrotechnical Vocabulary—published in 1938 by the International Electrotechnical Commission—as "the effective reactance (*with reversed sign*) divided by the square of the impedance." The reversed sign which we have italicised is only consistent with $Y = G + jB$. It is to be hoped that authors will in future adopt this standard practice. G. W. O. H.

Flexible Glass Insulation

FOR some time experiments have been going on, chiefly in America, with the production of flexible glass for replacing cotton, silk and similar substances as a means of insulating wire. A considerable degree of success has attended these experiments, and, according to a writer in the October, 1939, issue of *Electronics*, this new substance—usually known as fibrous glass—has already been employed to a considerable extent in power engineering work, and latterly it has been applied successfully to wireless work.

This insulating material is made up of glass fibres of almost incredible tenuity; their diameter is only 0.0002in. Yarn made from these fibres is quite flexible and can be

woven into tape or cloth suitable for replacing the customary silk or cotton covering of wire.

Coils wound with wire covered by this insulating material are able to withstand considerably higher temperatures, are less affected by corona, and resist moisture more effectively than the more conventional type.

In considering the possibilities of glass-insulated coils for radio work, it is noteworthy that with this type of insulation the American Institute of Electrical Engineers permits a much greater temperature rise than when cotton is used. The actual figures are 55 degrees Centigrade for cotton and 75 degrees for glass.

Glass-insulated anode chokes, capable of dissipating the same wattage over the same radio-frequency band as the replaced cotton-covered ones, have successfully been employed for transmitting work. The weight of the glass-insulated coils was only 25 per cent. of the older type, the figures for diameter and length being 67 per cent. and 43 per cent. respectively.

A useful comparison between cotton-insulated and glass-insulated anode chokes for use in a transmitter. The glass-insulated ones at the bottom have identical characteristics with their bulky counterparts above.

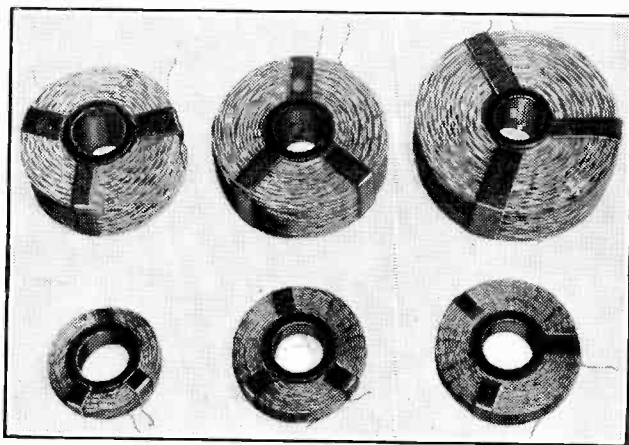

Courtesy "Electronics"

Non-Linear Circuits*

Graphical Determination of Performance

By J. Frommer and A. Rédl

(Tungsram Research Laboratory)

SUMMARY.—A graphical method has been developed for determining the performance of circuits containing a source of A.C. voltage and non-linear elements—such as rectifiers, vacuum valves, etc.

The method is based on the use of a family of curves denoted Equicurrent Lines. These curves form a helpful tool in determining the behaviour of such circuits under various load conditions.

The method is applied to the conventional rectifier circuits with different kinds of load such as : choke input filter, condenser input filter, resistance load without filter, resistance load through a transformer, and further to the investigation of a frequency-doubler circuit.

Introduction

IN an electric network containing one or more sources of alternating voltage and only linear elements (resistances, inductances, capacitances) the phenomena can be easily described by mathematical expressions. In such a network only alternating currents will flow ; their frequencies, amplitudes and relative phase-angles give full information. Each source of voltage can be treated independently from the others ; currents originating from the different sources simply superpose.

Conditions are much more complicated if the electric network contains also non-linear elements (vacuum or gas-discharge valves, etc.). In such cases a graphical treatment will be found more advantageous, especially if information on the non-linear elements is supplied in a graphical form as is customary with valves.

For a graphical treatment of this kind, a helpful tool can be introduced in the form of a family of curves corresponding to the flow of constant currents.

The complex network is first split into two or more sections, each having two terminals. Some of the sections will contain sources of power, others might contain only consumers.

It is obvious that for any two-terminal network containing alternating sources an alternating terminal voltage can be imagined such that it will oppose at each instant the internal sources with the result that no current at all will flow. (This is exactly

the voltage that would appear on the open-circuited terminals.) Further, a terminal voltage can also be found which varies from moment to moment in such a manner that a predetermined steady current will flow.

We shall call a curve representing such a terminal voltage plotted to a time base an *equicurrent line* of the two-terminal network. With the current as parameter a family of equicurrent lines can be constructed both for sources and consumers. For networks containing no A.C. sources the equicurrent lines degenerate into straight lines parallel to the time axis. The equicurrent lines can be constructed in all cases if we know the voltage-time functions of the sources and

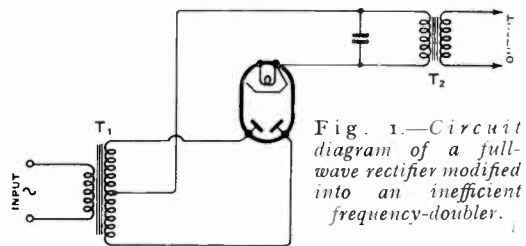

Fig. 1.—Circuit diagram of a full-wave rectifier modified into an inefficient frequency-doubler.

the voltage-current characteristics of the non-linear elements contained within the circuit to be investigated.

Frequency Doubling by Vacuum Valves

The first object of our investigations was the doubling of the mains' frequency by vacuum valves. (From 25 to 50 or from 50 to 100 cycles.) The most obvious circuit would be that of Fig. 1. This is a modifica-

*MS. accepted by the Editor, July, 1939.

tion of the customary full-wave rectifier. While in rectifier-operation the ripple is suppressed by a filter and the D.C. output is utilised, in this arrangement the terminals where the D.C. load is normally connected are short-circuited and a transformer T_2 put in place of the filter. The primary of T_2 is tuned to the double mains frequency; its secondary supplies the energy of double frequency to the consumer.

This arrangement is a very inefficient generator, however, for the following reason: The circuit will take the same current as a rectifier, the output-terminals of which are short-circuited. There will be a large D.C.

generalised for similar problems, and we therefore describe it in detail.

Analysis of the Full-Wave Rectifier

Let us, however, consider the circuit of Fig. 3 and find the current that will flow

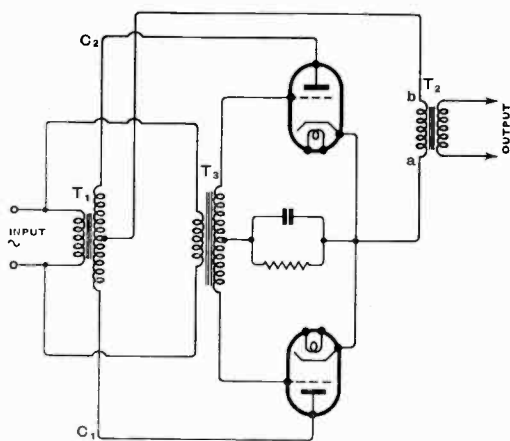

Fig. 2.—Circuit diagram of a frequency-doubler with grid-controlled valves.

current even if T_1 feeds low A.C. voltages into the circuit and the greater part of the energy will be dissipated on the anodes of the rectifier valves. On the other hand, if we introduce in series with the primary of T_2 an ohmic resistance shunted by a large condenser, the current-drain will be reduced, but this advantage is counteracted by the energy lost in the resistance. Therefore, rectifier valves cannot be used for this purpose and grid controlled vacuum valves were tried (see Fig. 2). The grid control is used to make the valves non-conductive for that part of the cycle in which the current through the load flows in the opposite direction to that of the emission current. This circuit has been tried experimentally and analysed by a graphical method outlined below. The method of analysis can be

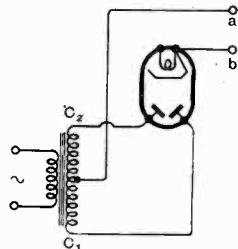

Fig. 3.—Circuit diagram of an open-circuited full-wave rectifier. The first investigations relate to this source of power with various loads (as represented in Fig. 4) across its terminals a and b.

between its terminals $a - b$, when different types of load (see Fig. 4) are connected to them. To this end we first plot a family of curves, which determine with uniqueness the behaviour of this two-terminal network under any circumstances of load. These curves represent the voltage which would have to be applied between the terminals $a - b$, as a function of time for a given steady D.C. current, the D.C. current values being the parameters, that is, they are the equicurrent lines. Knowing the voltage between each anode (C_1, C_2) and a as function of time—this function is a sine wave in ordinary cases of power conversion—the equicurrent curves are obtained by simply displacing the anode-voltage curve by the number of volts that can be read on the voltage-current diagram of the rectifier valve for the space current selected as parameter. This construction, however, is valid only for that part of the cycle, in which one system alone is conductive. For that part

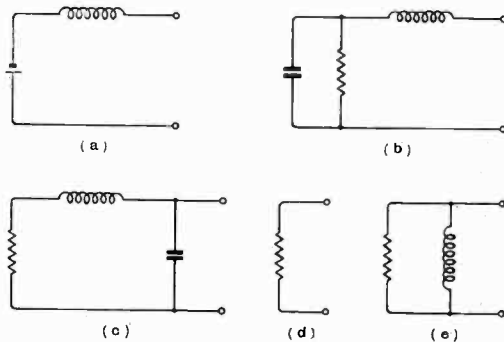

Fig. 4.—Different kinds of load investigated.

of the cycle where both systems conduct current, the equicurrent lines have to be constructed by connecting those points for which the sum of current drawn by the two systems together is constant, i.e. through the points where lines of one system intersect such lines of the other system that the sum of currents pertaining to these two lines is

Third range: neither of the valves conductive; all the area above the voltage line of both anodes represent the zero current condition. We shall call the boundary of this area the boundary equicurrent line. Any univalent line above the boundary line is an equicurrent line for zero current.

Fig. 5 shows the family of equicurrent

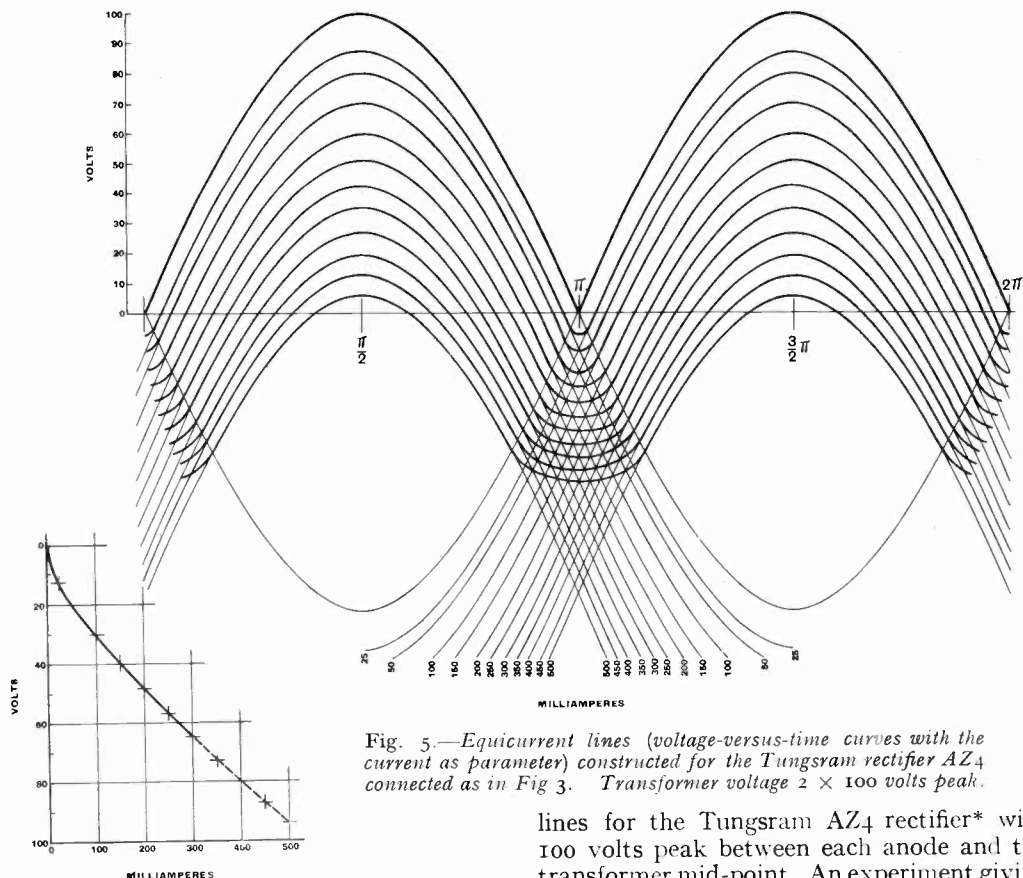

Fig. 5.—Equicurrent lines (voltage-versus-time curves with the current as parameter) constructed for the Tungfram rectifier AZ₄ connected as in Fig 3. Transformer voltage 2 × 100 volts peak.

the current for which the equicurrent line is being constructed. The nature of the equicurrent lines of a full-wave rectifier is different in three ranges of the plot:

First range: one of the two valves conducting current—area below the anode voltage line of one valve and above the anode voltage line of the other valve; equicurrent lines are sine-curves shifted downward.

Second range: both valves conducting current—area below the anode voltage line of both valves; equicurrent lines constructed by the process of intersection.

lines for the Tungfram AZ₄ rectifier* with 100 volts peak between each anode and the transformer mid-point. An experiment giving constant current, thus producing cathode potentials corresponding to one of the equicurrent lines would be a load consisting of a choke of infinite inductance in series with a D.C. battery connected across the terminals *a* and *b*; both choke and battery are supposed to have no D.C. resistance (Fig. 4a). By a suitable choice of voltage and polarity of this battery we can produce any of these equicurrent lines.

Having plotted the equicurrent lines we can proceed to the analysis of this system

* Known in England as Type RV-120/500.

with different kinds of load connected between its terminals *a* and *b*. For each kind of load, one must first obtain a curve, showing the voltage between terminals *a* — *b* as a function of time. We shall call this the *terminal voltage curve*. As examples of the method, we shall analyse first some well-known circuits, and thus arrive at already known facts.

Choke-input type filter circuit across the terminals a—b with D.C. load (Fig. 4b).

A choke of infinite inductance keeps the current rigorously constant and thus the terminal voltage curve will coincide with one of the equicurrent lines. The D.C. potential on the load end of the filter is the average height of the respective equicurrent line. For the no load condition we have to consider the equicurrent line for zero current, its mean value gives $2/\pi$ times the peak voltage, this is the D.C. voltage on the load-

current, we realise that the choke-input circuit can be replaced by a D.C. source giving $2/\pi$ times peak voltage, in series with one of the rectifier systems. This approximation keeps close to the actual circuit, as long as a small current is drawn. For larger currents, that portion of the cycle where simultaneously both valves conduct current, increases, so that the actual circuit will give more current than our simplification would give.

Condenser-input type filter circuit across the terminals a—b with a D.C. load (Fig. 4c).

The condenser is supposed to have infinite capacitance, so that the voltage across the terminals *a*—*b* will be constant, but will depend upon the load current. The terminal voltage curves will be straight lines, parallel to the time axis. We have to find for different average load-currents the constant values of the terminal voltage. To

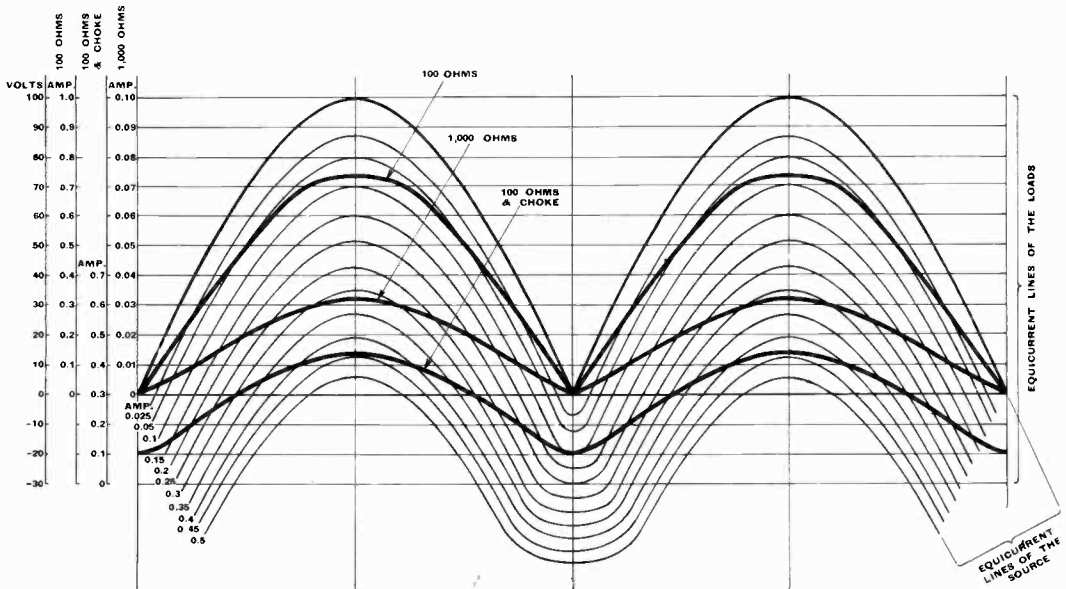

Fig. 6a.—Construction of the terminal voltage curves. Source, Fig. 3; loads, Fig. 4d with 100 ohms and 1,000 ohms and Fig. 4e with 100 ohms. These curves are constructed by connecting the intersecting points of the equicurrent lines of the source and of the load pertaining to the same currents.

end of the filter. Considering that, over the greater part, the subsequent equicurrent lines are plotted simply by shifting this first line by the voltage read off the voltage-current characteristic of one of the rectifier systems for the corresponding value of the

simplify construction we will assume a few constant values of terminal voltage and find the corresponding average load currents. In Fig. 6 this is done for the Tungram AZ4 rectifier. The lines for 80, 60, 40 and 20 volts cathode potential intersect the equi-

current lines, so that for each cathode voltage the current values can be plotted to the corresponding abscissae (Fig. 6b). The average value of the load current is

of simplification to a choke coil, having a self-inductance equal to the primary inductance of the transformer, the resistance load being parallel to this choke-coil. The

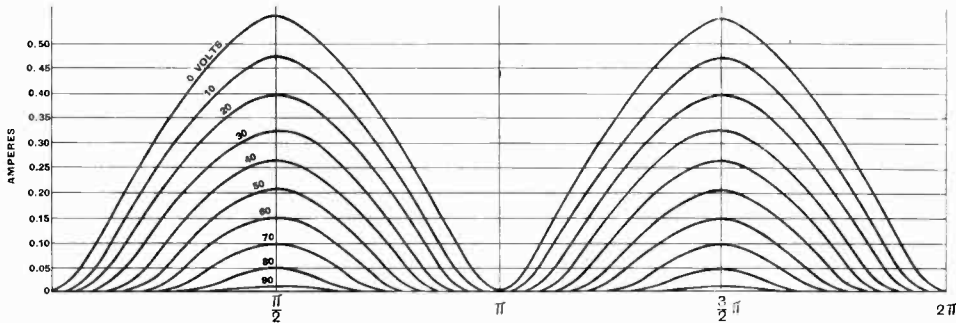

Fig. 6b.—Current-time curves for the source of Fig. 3 with the load of Fig. 4c. Load resistance varied from open circuit to short circuit. The current plotted is read on Fig. 6a as the current of the equicurrent line of the source, through which the terminal voltage horizontal of the load—taken as parameter—passes at the respective moment.

obtained as the area of the current curve averaged over a complete cycle. In the limiting case, when no current is drawn, the D.C. potential across the terminals *a—b* is equal to the peak voltage. In Fig. 6c we have plotted from the areas of the curves of Fig. 6b the voltage versus current relation for the Tungstram AZ₄ rectifier with 100 volts peak and infinite input capacitance.

equicurrent lines for the parallel combination of ideal choke and resistance are horizontal lines, corresponding to the sum of currents flowing through choke and resistance. As the current through an ideal choke cannot contain any A.C. component, the presence of the choke-coil merely causes a downward

Pure resistance load without filter across the terminals a—b (Fig. 4d).

First we draw the equicurrent lines for the load resistance; these are horizontal lines, plotted in volts equal to load current multiplied by load resistance. According to Kirchhoff's law the current in the rectifier is equal to the current in the load resistance. Therefore the terminal voltage line is determined by the points of intersection of the equicurrent lines of the rectifier and those of the load resistance, both for the same currents. In Fig. 6 we have constructed by the above method two terminal-voltage curves for 100 ohms and 1,000 ohms respectively. The current through the resistance being proportional to the voltage on its terminals, these curves will represent at the same time the current-lines of our system.

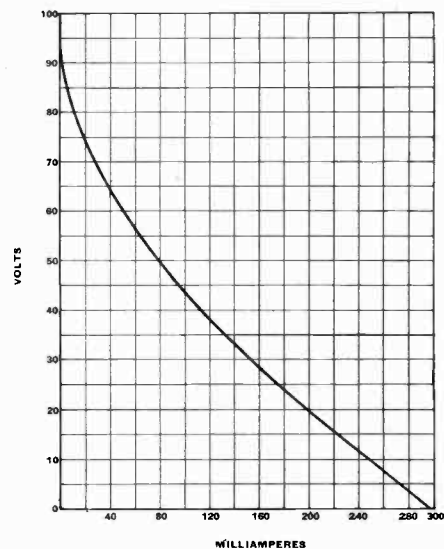

Fig. 6c.—D.C. voltage versus D.C. current diagram; source: Fig. 3, load: Fig. 4c. Areas enclosed by the current curves of Fig. 6b are plotted to the respective voltages.

Pure resistance load through an ideal transformer connected between terminals a—b. (Frequency doubler) Fig. 4e.

A transformer can be reduced for the sake

shift of the lines constructed for pure resistance load. The voltage between the

terminals of the choke can have no D.C. component, therefore the terminal voltage curve must have equal areas above and below the zero line. As there is no straightforward method of determining the current through the choke, we must assume some value for it, make the construction and, after this first assumption, repeat the construction with a corrected assumption of choke current. This process has to be repeated until the areas above and below the zero line become equal. We suppose first, that the current through the choke will be the same as if not shunted by the resistance; in that case we have to select that one of the equicurrent lines of the rectifier which dissects equal areas above and below the zero axis. Through

Fig. 7.—Circuit diagram of an open circuited half wave rectifier. Further investigations relate to this source of power with various loads (as represented in Fig. 4) across its terminals *a* and *b*.

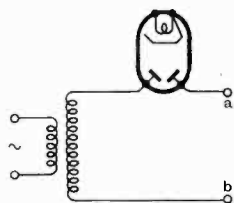

the points where the equicurrent lines of the rectifier intersect the equicurrent lines of the load representing the same current, we can draw the terminal voltage curve. We see that this curve based on our first assumption includes greater areas above the zero line than below it, therefore it needs a correction, i.e. the assumption of a somewhat greater current through the choke coil. Only this corrected construction is shown on Fig. 7 (lower heavy curve). It is apparent from this construction how small a quantity of useful A.C. power can be obtained from this circuit. The useful power cannot be increased by choosing a higher transformer voltage; this would cause an excessive current to flow in the rectifier valves.

Half-wave rectifier.

The equicurrent lines of a half-wave rectifier system (Fig. 7) are plotted by shifting the curve of voltage between anode and zero by the voltage necessary to draw the respective current through the rectifier valve.

(a) Condenser input filter. The construction will be identical with that of the double-wave rectifier with the difference that we

have current only in one half of the cycle. Thus for every value of D.C. voltage we get exactly half of the current of the full-wave rectifier.

(b) Choke input filter. The boundary equicurrent line being the A.C. voltage line of the rectifier anode it has the mean value of zero volts. All equicurrent lines below this boundary line give negative mean values so that no current will flow through such a circuit.

*Grid-controlled vacuum valves. Pure resistance load through an ideal transformer connected between terminals *a*—*b*.*

We choose on Fig. 2 the mid-tap of T_1 (point "b") as zero potential and all voltages will be referred to this level. Transformer T_1 impresses a sine voltage of known amplitude on the points C_1, C_2 ; transformer T_3 supplies to the grids a sine voltage which is arranged to be in phase with the voltage of T_1 . The grid currents flowing through the common grid resistor shunted by a condenser produce a negative grid bias.

The construction of the equicurrent lines can be best understood from an example (Fig. 8a). Let us assume the following conditions:

Valves, transmitting triodes 075/1,000; amplitude of A.C. anode voltage, 800 volts; amplitude of A.C. grid voltage, 570 volts; grid bias 400 volts. (Both grid and plate voltages pure sines.)

From these data the grid voltage is uniquely determined at every moment: it is the sum of the bias and the momentary potential impressed by the transformer T_3 . The momentary value of the valve voltage (between points $a - C_1$ or $a - C_2$) is the difference between the momentary voltage impressed by T_1 (between points $b - C_1$ or $b - C_2$) and the momentary voltage across the primary of T_2 ($a - b$). The equicurrent lines are obtained by subtracting from the momentary values of the input transformer voltage the momentary values of the valve voltage drop corresponding to the selected plate current and to the grid voltage of the respective instance.

In order to construct a family of equicurrent lines for 0, 0.2, 0.4, 0.6 . . . amperes we proceed in the following manner: First we plot the zero line, then the grid bias line, then a sine curve for the anode voltage with

800 volts amplitude and another sine curve with 570 volts amplitude shifted downwards with the bias value for the impressed A.C. grid voltage. Vertical lines are then drawn

for 0, 25, 50, 75 . . . grid volts. Now we plot on the respective vertical lines downwards from the sine curves that represent the voltages on C_1 and C_2 the valve voltage

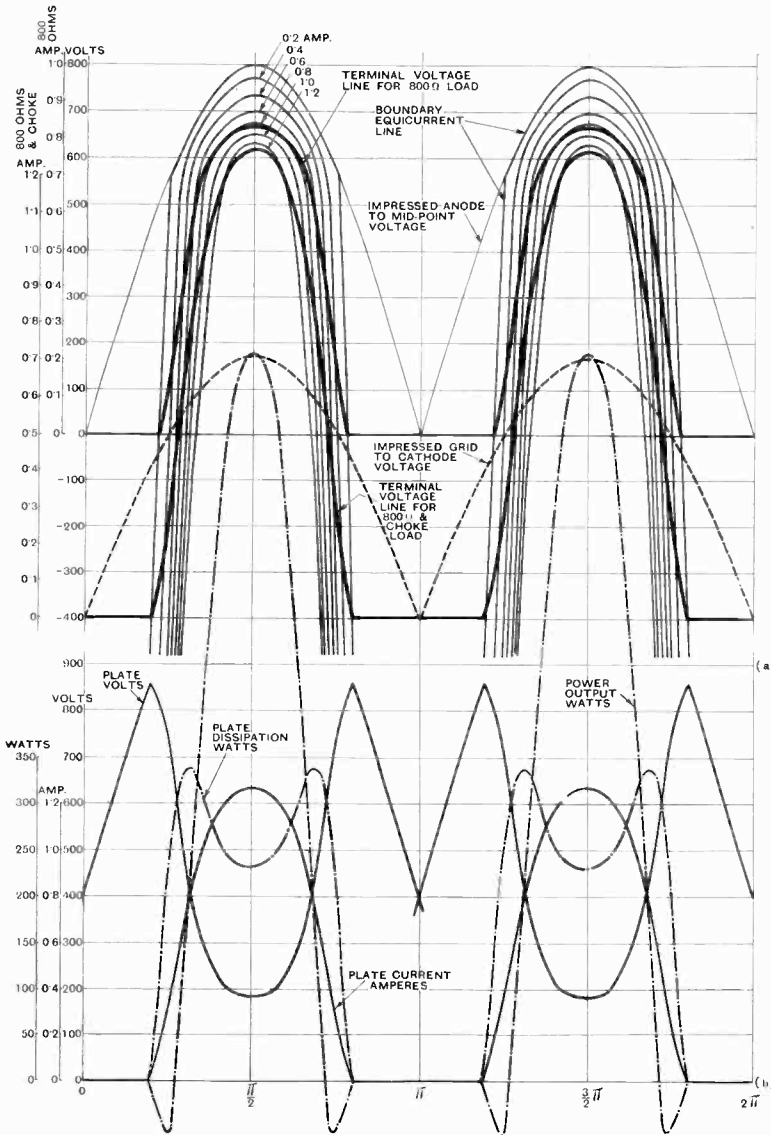

Fig. 8a.—Equicurrent lines and terminal voltage lines for grid controlled tubes. Circuit of Fig. 2. The terminal voltage line marked 800 ohms relates to pure resistance load between terminals a and b without choke or transformer. (Valves, Tungstram 075/1,000; 800 volts peak from each anode to transformer midpoint; grid bias, 400 volts; peak A.C. grid voltage, 570.) The equicurrent lines are based on Fig. 8c, subtracting the valve voltage drops from the anode to midpoint voltages. Terminal voltage curves constructed by intersection as in Fig. 6a. (N.B.—It is by mere chance that the terminal voltage curve for 800 ohms and choke has its bottom horizontal sections exactly at -400 volts, which happens to be the grid bias.)

Fig. 8b.—Valve voltage drop, plate current, plate dissipation, power output constructed from 8a. Negative power output means that the choke feeds back energy, which is dissipated on the anodes.

through those grid voltages for which we have anode-voltage—anode-current characteristics, viz., 0, 25, 50, 75 . . . volts (Fig. 8c). We read for 0, 0.2, 0.4, 0.6 amperes plate current the corresponding values of valve voltage drop on the curves

drop values thus found. By connecting these points we draw the equicurrent lines. As only one of the two valves is conducting current any time there is no combined area of equicurrent lines as with the rectifiers AZ4.

Comparing the equicurrent lines of Fig. 8a with those of Fig. 5, we see that a great part of the complete cycle is practically outside of the boundary equicurrent line. In other words, the plate current will flow only for a fraction of the cycle. As is known this small time of current-flow is the condition for suppressing the harmful D.C. component, which in the case of Fig. 1 was responsible for the poor efficiency of the circuit. This explains why the circuit of Fig. 2 gives more output with much better efficiency.

choke. We construct a family of equicurrent lines for 800 ohms load resistance assuming $276 \text{ volts}/800 \text{ ohms} = 0.345 \text{ A}$ current in the choke. Again with the process of intersection we obtain a terminal voltage curve. As this curve does not dissect equal areas above and below the zero axis we have to correct our assumption for the choke current. We assumed in subsequent steps other values for the choke current until we reached a terminal voltage curve that fulfils our requirement to dissect

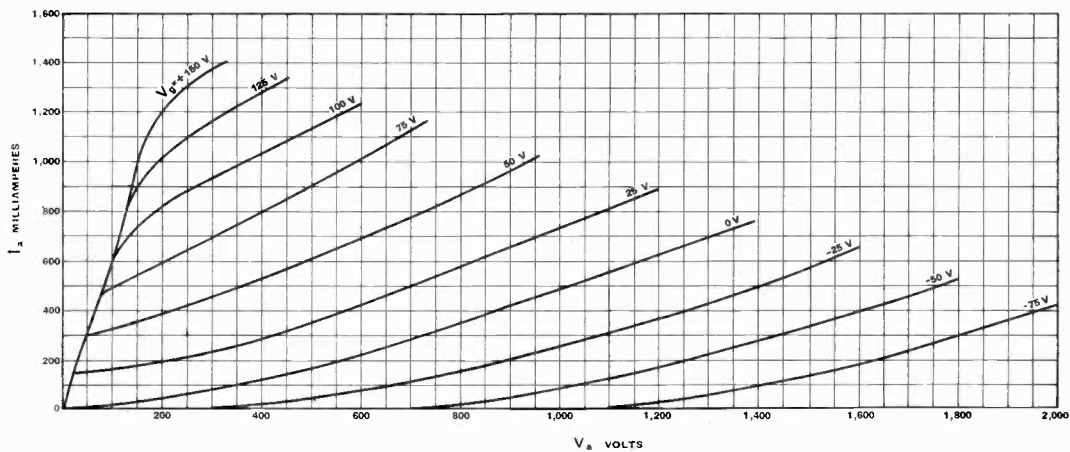

Fig. 8c.—Plate voltage versus plate current diagram of the Tungram 075/1,000 transmitting valve.

The terminal voltage curve for different loads can be constructed in the same way as hitherto by the use of the respective intersecting lines. In Fig. 8a we have drawn first a set of horizontal lines representing the equicurrent lines of the 800 ohms load with no current through the choke. The terminal-voltage line is drawn through the points of intersection of the respective curves; naturally this curve lies entirely above the zero axis with about 276 volts average value. For the case of a choke in parallel with the resistance (i.e. a loaded transformer) we must again make some preliminary assumptions regarding the current through the choke. In the case of diodes we assumed that the choke draws the same current as if not shunted by the resistance. In the present case this assumption would be quite wrong (see following paragraphs). We assume a choke current equal to the D.C. component of the current through the resistance as found above for the case without

equal areas above and below the zero axis. This was obtained at 500 mA choke current. Only this last terminal voltage line is shown in Fig. 8.

A striking property of the terminal voltage line is that it has horizontal bottom parts. This is so because during these parts of the cycle no current flows through the valves, the current through the choke and the current through the resistance must equal each other; the former being strictly constant, the latter must be constant too; the voltage across its terminals being proportional to the current is thus also constant. While the potential of point *a* is below zero the choke coil discharges through the resistance, while it is above zero, the choke stores energy. As the point *a* has zero potential when no current flows through the resistance the terminal voltage line will traverse the zero axis when the choke current is equal to the rectifier current, this is where the equicurrent line of the power source

corresponding to a current equal to the current through the choke (0.5 amp. in our example) passes through zero volts. Above this point the current through the resistance flows in the reverse direction.

For no load the terminal voltage curve is an equicurrent line, having equal areas above and below the zero line. As all equicurrent lines pertaining to currents different from zero have far greater areas below the zero line than above it, the only possible terminal voltage curve is one of the lines pertaining to zero current, i.e. one that remains over the boundary equicurrent line. There is an infinite number of equicurrent lines satisfying the condition of lying entirely above the boundary line and having equal areas above and below the zero axis. To find which of these lines is valid, we have to assume some leakage resistance and limit-curve for infinite leakage resistance.

We know that in those parts of the cycle in which any current flows through the valves, the terminal voltage curve lies under the boundary equicurrent line. The greater the load resistance, the closer the terminal voltage will approach the boundary equicurrent line. In those parts of the cycle, in which no current flows through the valves, the current through the resistance must equal the current through the choke. This latter being strictly constant, the leakage current and hence the voltage through the leakage resistance must be constant; consequently in that part of the cycle, the terminal voltage line is horizontal.

Thus for infinite leakage resistance the terminal voltage line has to be drawn so that in the upper part it lies on the boundary equicurrent line; it leaves this line and continues horizontally at such a height that the areas above and below the zero axis are equal.

Also the power loss and efficiency can be calculated from our graphical representation. For this calculation we need the voltage-time curve between the cathode and plate of the valve; this is obtained by replotting the voltages as read between the enveloping sine curve of the anode voltage and the line representing the terminal voltage. Further we need the current through the valve as a function of the time; this is constructed by

plotting to a time base those values of current which can be read on the equicurrent lines intersecting the terminal voltage curve at the respective abscissae. By plotting the product of momentary valve voltage and momentary valve current we obtain the curve of watts dissipated in the valve as a function of the time; the area of this latter curve averaged over the complete cycle gives the average valve loss in watts.

The total anode input energy can be calculated in a similar manner by multiplying the same momentary values of current as before by the total transformer voltage values. We obtain the terminal power by plotting a curve where the ordinates are products of valve current and terminal voltage. Fig. 8b shows the above four curves. There will be parts of the cycle where the terminal power is negative, that is, where some energy stored in the choke coil discharges partly through one of the valves—the corresponding energy being dissipated on the anodes. In those parts of the cycle where the watt curve of the load is zero, (because the current is zero) there is no exchange of energy between the source of power and the load, but the choke discharges through the resistance.

In actual frequency doubler circuits the transformer T_2 is tuned to the double frequency by a shunting condenser. The harmonics are thus suppressed and the terminal voltage line approximates to a sine wave.

The accurate construction of equicurrent lines for a complex circuit will often be found a long and tedious task and for the production of the voltage-versus-time and current-versus-time curves the oscillograph will be generally preferred. We think that in such a case the merit of this graphical method is that by an approximate construction the pattern to be expected on the oscillograph-screen can be foreseen, and qualitative considerations can be deduced before the actual circuit is built. In order to understand clearly the pattern viewed on the screen and to be able to trace from it irregularities in the functioning of the investigated circuit, it is desirable to form one's idea of the curves to be expected before observations are made.

Input Capacitance of a Triode Oscillator*

By J. van Slooten

(Natuurkundig Laboratorium der N. V. Philips' Gloeilampenfabrieken, Eindhoven, Holland)

Summary.—It is demonstrated in a general way that the input capacitance of a triode oscillator with grid condenser and leak decreases with increasing anode voltage. The numerical value of this capacitance variation is calculated and proves to be in agreement with experimental data.

FREQUENCY variations, resulting from supply voltage variations, are a serious inconvenience of the oscillator, used in superheterodyne receivers, especially in the short-wave band. In several receivers a neon tube stabiliser is built in for this purpose. Although the modern triode-hexode is a considerable improvement in this regard, the subject is still worthy of a careful examination.

Now the causes of frequency variation are numerous and there exists already a rather extensive literature on the subject. But on short wavelengths, namely on the 15-50-metre band, it appears that variations of the grid capacitance, due to space-charge effects, are the most important cause. When the wavelength is further reduced, electron transit-time effects become more and more important, but we will not consider these effects here.

Experiments showed that under very different circumstances and with many types of valves, the input capacitance always decreased with increasing anode voltage. We will first establish the general validity of this rule by a simple reasoning, at the same time defining the conditions for its validity. Afterwards we will calculate the variation of the input capacitance as a function of the anode voltage, using a result first obtained by van der Pol.¹

In order to simplify the reasoning and the following calculations, we make two assumptions, which are, however, for what follows not strictly necessary, viz. :

(1) The limiting of the oscillator amplitude by the grid condenser and leak-resistance is so rigorous, that the top of the oscillator voltage just reaches the point where grid current sets in.

(2) The retroaction is so far increased, that the valve is working as a "class-C" amplifier, which means, that the fraction of the period, during which anode current flows, is less than one half.

In Fig. 1 the oscillator grid voltage $E \cos \omega t$ is shown in connection with the anode-current characteristic. An arbitrary

Fig. 1.—The oscillator voltage $E \cos \omega t$ is shown in relation to the i_a-v_a characteristic of the valve. The definition of the working-angle ϕ will be clear from this diagram. The D.C. position of the grid voltage is O.A.

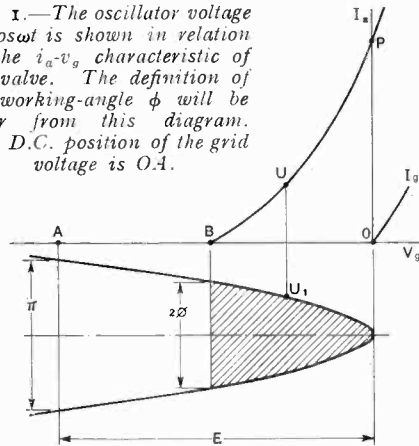

point U on the characteristic corresponds with the point U_1 on the sine-wave. We now suppose that there is a charge Q on the grid in the point U . This charge Q is determined by the potential distribution in the valve, or, which means the same, by the potentials on the electrodes and the space-charge distribution. Potential distribution and space charge are connected by Poisson's law: $\Delta V = -4\pi\rho$ (1)

Now let us suppose that the potentials of the anode v_a and the grid v_g and the intensity of the space charge in every point of the valve are multiplied by a factor p , then equation (1) still holds on account of its linearity, and it is obvious that the charge Q on the grid has also been multiplied by p . The capacitance of the grid in the new situation is the same as before, which can be found by considering the situations given by $v_a, v_g, + \Delta v_g, Q + \Delta Q$ and $p v_a, p v_g + p \Delta v_g, p Q + p \Delta Q$.

* MS. accepted by the Editor, September, 1939.
¹ Balth. van der Pol, *Physica*, 1923, Vol. 3, No. 253, and *Zeitschr. f. Hochf.tech.*, 1925, Vol. 25, No. 121.

A consequence is that when we consider an adjustment of the oscillator with anode voltage v_a and oscillator voltage E and a new adjustment, given by $p v_a$ and $p E$, the input capacitance is the same in both cases, corresponding points on the sine-waves having the same capacitance. Now this new adjustment $p E$ is in practice impossible as follows from considering the anode current in two corresponding points. The anode current is proportional to $\rho \sqrt{V}$ and therefore has been multiplied by $p \sqrt{p}$. Consequently the transconductance has not remained the same, but has been multiplied by \sqrt{p} and the equilibrium of the oscillator no longer exists. Hence if the anode voltage is multiplied by p , the oscillator voltage must increase by a larger factor and points with equal capacitance do not belong any longer to corresponding points on the sine-waves, in such a way that the part of the cycle, during which there is an increase of the capacitance resulting from space charge, has diminished. It will thus be sufficiently clear that we can draw the conclusion that the "effective" value of the input capacitance decreases with increasing anode voltage. This demonstration has a general character, the only restriction being that the anode current is not limited by saturation.

If such a saturation exists, it can be made acceptable that the result is still true, but we have not found a general demonstration for this case. As the saturation current of modern valves is large, the practical importance of this case can be considered as small. In the demonstration it was not necessary to make any supposition about the bearing of the grid capacitance as a function of v_a and v_g , except for the fact that this capacitance is larger in presence of anode current than in cut-off position. For the purpose of a numerical calculation we will make a more precise assumption about the capacitance in the next section. In passing it can be remarked that the capacitance increases as the cathode-temperature (filament voltage) is increased, as follows from a consideration of the behaviour of the potential minimum (Epstein minimum).² The frequency drift resulting from anode voltage variations is therefore in most cases

² Compare for instance: M. J. O. Strutt. *Moderne Mehrgitter-Elektronenröhren II*, page 64.

partly compensated by the variation of the filament voltage.

The calculation can be based on the assumption that the grid-cathode capacitance in absence of anode current is equal to the "cold" capacitance C_{gk} and, as soon as anode current flows, equal to:

$$C'_{gk} = \frac{4}{3} C_{gk} = C_{gk} + C' \quad \dots \quad (2)$$

This result has first been obtained by van der Pol (*l.c.*). In reality the behaviour of the input capacitance is more complicated, chiefly on account of the following facts:

(1) There is not a sudden jump in capacitance when anode current begins, as can be explained by considering the initial velocity of the electrons.

(2) The space charge between grid and anode is a factor which cannot be neglected.³

We will, however, not take these effects into consideration as we shall find that it is sufficient for our purpose to assume that there is a jump in capacitance as soon as anode current flows.

We consider the case in which the anode current is not limited by saturation and we define the i_a-v_g characteristic (Fig. 1) by:

$$i_a = A (v_a + g v_g)^{3/2} \quad \dots \quad (3)$$

Further we define the working angle ϕ by the part $\frac{2\phi}{2\pi}$ of a period, during which anode-current flows (see Fig. 1). It is obvious that we have the relation:

$$E(1 - \cos \phi) = \frac{v_a}{g} \quad \dots \quad (4)$$

The "effective" value \bar{S} of the transconductance being given by the first harmonic of the anode current, follows from:

$$E\bar{S} = \frac{2}{\pi} \int_0^\phi \cos \psi \cdot i_a \cdot d\psi \quad \dots \quad (5)$$

($0 < \psi < \phi$)

We can put:

$$v_g = -E(1 - \cos \psi) \quad \dots \quad (6)$$

When we substitute this in (3), making use of (4), we find:

$$i_a = A v_a^{3/2} \left(\frac{\cos \psi - \cos \phi}{1 - \cos \phi} \right)^{3/2} \quad \dots \quad (7)$$

³ Compare M. J. O. Strutt (*l.c.*) page 66.

We now replace $\cos \psi$ and $\cos \phi$ by $1 - \frac{1}{2}\psi^2$ and $1 - \frac{1}{2}\phi^2$ and find instead of (5):

$$E\bar{S} = \frac{2}{\pi} Av_a^{3/2} \int_0^\phi \left(1 - \frac{\psi^2}{2}\right) \left(1 - \frac{\psi^2}{\phi^2}\right)^{3/2} d\psi.$$

This integral can be found directly by means of two elementary integrals:

$$\int_0^1 (1 - y^2)^{3/2} dy = \int_0^{\pi/2} \cos^4 x dx = \frac{3}{16} \pi$$

$$\int_0^1 y^2 (1 - y^2)^{3/2} dy = \int_0^{\pi/2} \sin^2 x \cos^4 x dx = \frac{\pi}{32}.$$

When we further replace E by $\frac{v_a}{g} \cdot \frac{2}{\phi^2}$ (see eq. (4)), we find:

$$\bar{S} = \frac{A\sqrt{v_a}}{\pi} g\phi^3 \left(\frac{3}{16}\pi - \frac{\pi}{64}\phi^2\right) \dots (8)$$

As ϕ is of the order of one radian or less, we can make the approximation:

$$\bar{S} = \frac{3}{16} Av_a^{3/2} \frac{g}{v_a} \phi^3 \dots (9)$$

In this simple formula $Av_a^{3/2}$ has the meaning of the current OP in Fig. 1 and $\frac{v_a}{g}$ that of the voltage OB .

Now we know that the trans-conductance is on the other hand determined by the constants of the oscillator circuit (see Fig. 2):

$$M\bar{S} = Cr \dots (10)$$

As r is a constant, \bar{S} must be a constant and hence we can draw the conclusion from (9) that $\sqrt{v_a}\phi^3$ must be a constant. This means that the working angle decreases as v_a is increased and as a result the grid capacitance must decrease, the extra space charge capacitance being active during a shorter part of the total cycle 2π .

If we call C' this extra capacitance, due to space charge during the working angle, we have for the charging current i_e :

$$i_e = C' \frac{d}{dt} E \cos \omega t = -C' E \omega \sin \omega t.$$

$$(-\phi < \omega t < +\phi).$$

This current has the form of a sine wave between the limits $-\phi$ and $+\phi$ and is zero during the further part of the cycle 2π .

The first harmonic in this current determines the "effective" value of the extra input capacitance:

$$\Delta C = \frac{2}{\pi} C' \int_0^\phi \sin^2 \psi d\psi = \frac{C'}{\pi} (\phi - \frac{1}{2} \sin 2\phi) \approx \frac{2}{3} \frac{C'}{\pi} \phi^3 \dots (11)$$

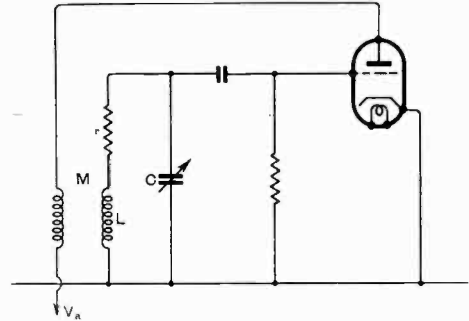

Fig. 2.—A conventional oscillator circuit. We see the variable capacitance C , the inductance coil L , the circuit resistance r and the mutual conductance M between reaction coil and circuit coil. The limitation of the oscillator amplitude is brought about by the grid condenser and the leak resistance.

We have seen that $\sqrt{v_a}\phi^3$ is a constant,

hence: $\frac{\partial \phi^3}{\partial v_a} = -\frac{1}{2} \frac{\phi^3}{v_a}$.

So we find as final result for the dependence of the input capacitance on the anode

voltage: $\frac{\partial \Delta C}{\partial v_a} = -\frac{1}{3\pi} C' \frac{\phi^3}{v_a} \dots (12)$

We will give a numerical example. On the high-frequency end of the short-wave band of a usual receiver we have the frequency $f = 2.10^7$ and the circuit capacitance is $C = 40\mu\mu F$. A practical value for C' is $0.5\mu\mu F$. When we have a change of 10 per cent. in the anode voltage and we suppose $\phi = 1$, we find $\delta \Delta C = 0.006\mu\mu F$.

The resulting frequency variation is 1500 periods/sec., a value in good accordance with measurements on modern small valves.

Although there are other sources of frequency variation with anode voltage, as we already remarked, and although the space-charge capacitance C' is not independent of v_a , nor of i_a , we believe that the main part of the frequency-variation mechanism on these wavelengths is given by the foregoing calculation.

Power Oscillators*

Circuit for Surface Hardening of Steel

By G. Babat and M. Losinsky

(Leningrad, Russia)

POWER electron valve oscillators have of late been used for inductive heating of steel for the purpose of surface hardening.† To produce a fine hardened layer, power values as high as several hundred watts per cm² of the treated surface area are required. When treating pieces with heated surface areas of several hundred sq. cms. oscillators with 100 to 500 kW output are needed. Heating for hardening does not require any stability of the frequency. At the same time it is desirable to have the circuit arrangement of the

coil types. A most simple and convenient circuit arrangement of an electron valve oscillator is the one with self-excitation without intermediate circuit. The heating of the piece lasts several seconds; then the oscillations are shut down while the heated piece is submitted to the cooling procedure.

In mass production sets for surface hardening the oscillator may be switched in and out hundreds of times in an hour.

In wireless technique a great many circuits for modulating electron valve oscillations are known. But all these circuits when applied

to power oscillators seem to be complicated and cumbersome. In this article a new circuit for the control of a power oscillator is described. In Fig. 1 (1) is the choke coil; (2) a blocking condenser; (4) and (5) the coil and condenser of the oscillatory circuit; (6) the grid-leak condenser; (7) the grid-leak resistor; (8) the grid-leak choke coil preventing the flowing of the high-frequency current

through the resistor (7); (9) is a transformer with 2-3 kV secondary for the anode supply of Thyratrons A and B [the grids of these Thyratrons are controlled by means of the phase-shifter (13) and the peak transformer (12)]; (10) are the resistors in the circuits of the Thyratron grids; (11) is the battery supplying negative biasing voltage to the Thyratron grids; (14) is a transformer with 1-2 kV secondary for the supply of two small "gasotrons" (15); (16) and (17) smoothing coils and (18) a condenser.

Fig. 2 shows schematically the voltage

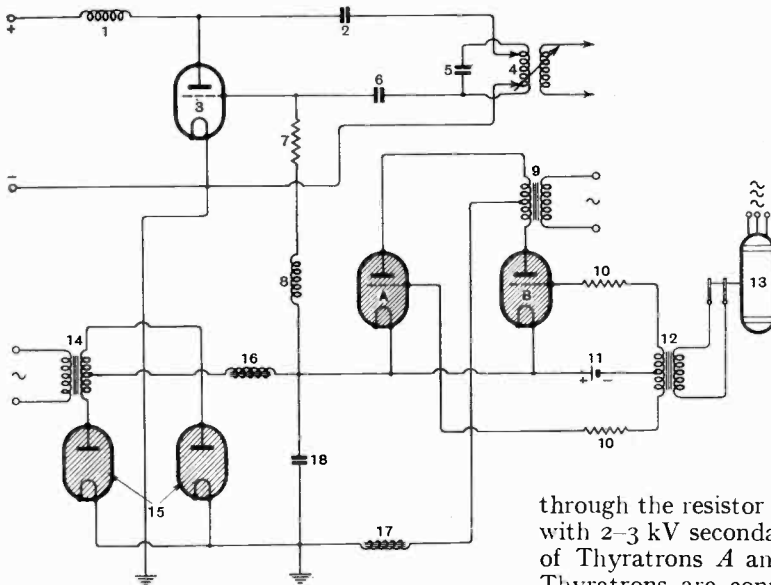

Fig. 1.

oscillator as simple as possible so that it requires little adjustment for different heater

* MS. accepted by the Editor, August, 1939.

† *Electronics*, June, 1938, "Surface Hardening," by G. Babat & M. Losinsky; *Rev. Gén. de l'Élec.*, 22nd October, 1938, "La trempe superficielle de l'acier à l'aide de courants à haute fréquence," by G. Babat and M. Losinsky.

between the cathodes of the Thyratrons *A* and *B* and the mid-point of the secondary of the transformer (9). Fig. 2 (a) illustrates the case when the starting angle α of the Thyratrons *A* and *B* is greater than 90° ;

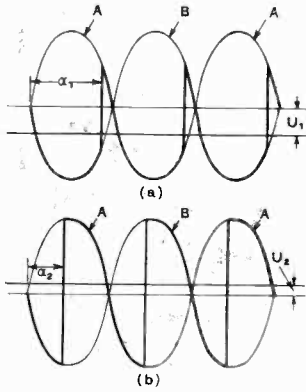

Fig. 2.

then the Thyratrons operate under inverter conditions. The D.C. component U_1 of the output voltage is negative. Curves Fig. 2 (b) are plotted for the case when α is less than 90° , then the Thyratrons operate in rectifier conditions and U_2 is positive.

Fig. 3 shows the D.C. component U_c of the voltage between the mid-point of transformer (9) and the cathodes of the Thyratrons, plotted against the current flowing through the Thyratrons for various starting angles. From the curves it may be seen that as long as the starting angle α is less than 90° the condenser (18) voltage at no load is equal to the amplitude E_m of the secondary voltage of the transformer (9). In Fig. 3 is also shown the line *ABCDEF* representing the falling voltage characteristic of the rectifier (15). It is desirable that this characteristic should have a sufficient slope—then the short-circuit current will be low. A steeply falling characteristic is easily obtained by making the transformer (14) with a high stray flux or by putting a coil in series with its primary.

If the grid current of the oscillator valve (3) is not taken into account, the condenser (18) voltage will be determined by the intersection point of the characteristic of the rectifier (15) with the characteristic of the inverter formed by the Thyratrons *A* and *B*. From the plot Fig. 3 it may be seen that as

long as α is less than 90° , the voltage on the condenser (18) will remain positive (points *E* and *F*). With Thyratrons operating at $\alpha > 90^\circ$, the voltage on the condenser (18) will be negative (points *B* and *C*). The value of the secondary voltage E_m of the transformer (9) may be adjusted so that the oscillations are shut down at the point *B*.

In this manner the possibility is given of smoothly varying the operating conditions of the oscillator, or of completely stopping the oscillations by adjusting the starting angle of the Thyratrons *A* and *B*. The grid current of the oscillator valve (3) will cause the voltage of the condenser (18) to be in fact more negative than is shown by Fig. 3, but the general character of the dependence of the grid voltage on the variation of the angle α will remain unaltered.

For an electron valve oscillator with self-excitation it is necessary for stable operation that the grid current should be not less than a tenth of the anode current. In a power oscillator of some hundred kilowatts the grid current may attain several amperes. The

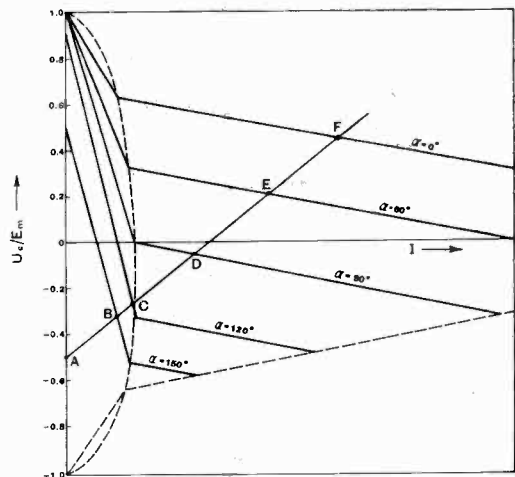

Fig. 3.

negative biasing grid voltage may be of the order of 1,000 volts. Thus the power to be handled in the grid circuit of the oscillator is several kilowatts.

A great advantage of the described circuit arrangement is that it operates with no power losses. When Thyratrons *A* and *B* operate

under inverter conditions, they transform the high frequency power fed to the grid of the oscillator valve (3) into 50-cycle power which is then given up to the line.

The chief advantage, however, is not so much the saving of power as the avoidance of rheostats which require care in dissipating the heat generated in them.

The circuit described was used in a 300-kW oscillator with four GDO-100 power valves. The combined grid current of all four valves was 10 amperes under given oscillation conditions and loaded. The Thyratrons used were of the type TG-162 and the "gasotrons"—of the 1-ampere type VG-129. A diode rectifier served for the supply of negative bias voltage to the grids of the Thyratrons A and B.

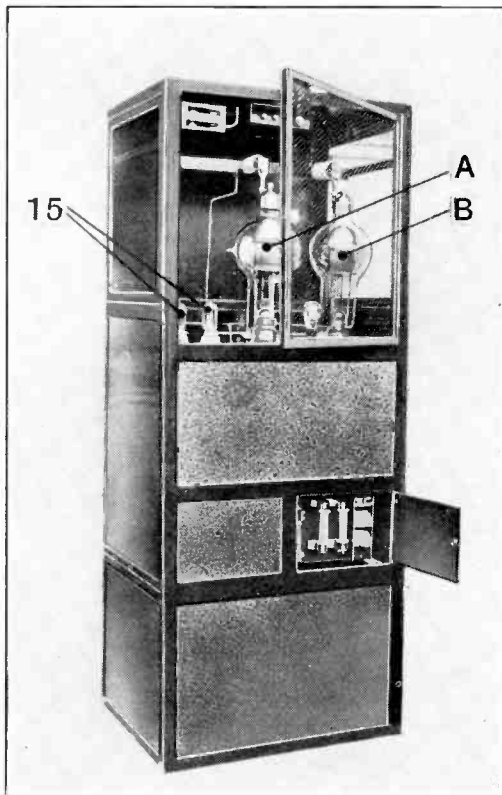

Fig. 4.

The circuit proved to be efficient and reliable. Fig. 4 shows a front view, and

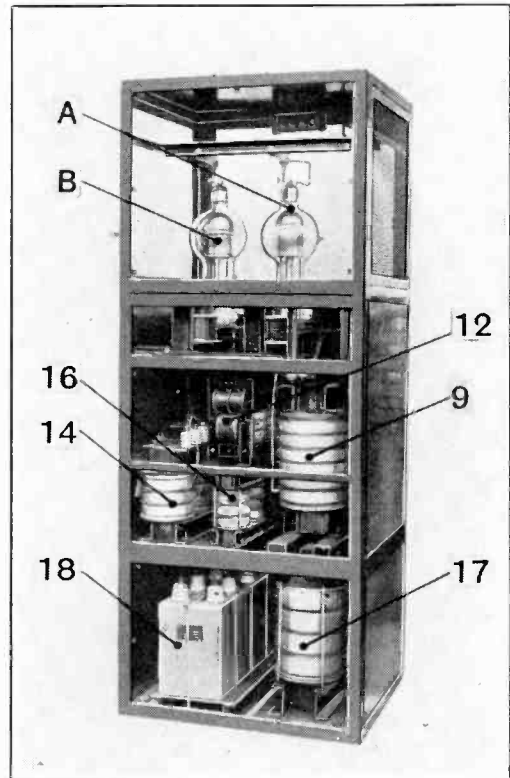

Fig. 5.

Fig. 5 a rear view with the cover removed of the arrangement described. The designations correspond to those of Fig. 1.

The History of the Post Office Engineering Department

Post Office Green Paper No. 46D. 46 Pp. H.M. Stationery Office, Adastral House, Kingsway, London, W.C.2.

"The history of the Post Office Engineering Department is in effect the history of electrical communications in the British Isles." Until 1870 the new method of sending messages was operated by a number of private companies, but in that year all the telegraphs were taken over by the Postmaster-General and the Engineering Department came into being. In 1878 the first telephone exchange was opened, and since 1912 all telephone systems have been under the control of the Post Office. The Post Office was closely identified with the development of wireless telegraphy from the beginning in 1896 when Marconi came to this country.

This history is an intensely interesting and well-illustrated account of the work of the department from its inception down to the present day.

G. W. O. H.

Correspondence

Letters of technical interest are always welcome. In publishing such communications the Editors do not necessarily endorse any technical or general statements which they may contain

Diode Operating Conditions

To the Editor, *The Wireless Engineer*.

SIR,—The paper by W. P. N. Court published in the November issue of *The Wireless Engineer* is a useful analysis of diode detection. Those sections which deal with the positively biased diode confirm the experimental results explained in pictorial form in my paper "The Diode Detector with Positive Bias" to *The Wireless World* (March 9th, 1939). The author assumes that the diode $I_a E_a$ characteristic curves are lines parallel to the I_a axis, i.e., the slope resistance of the diode is zero and the detection efficiency $\frac{E_a}{\hat{E}}$ is unity for an applied carrier voltage of $\hat{E} \sin \omega t$. At the

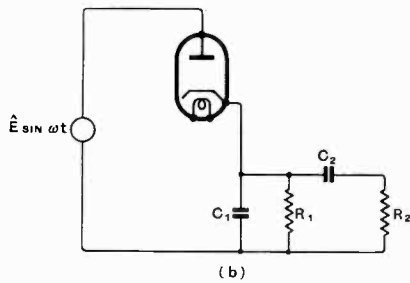
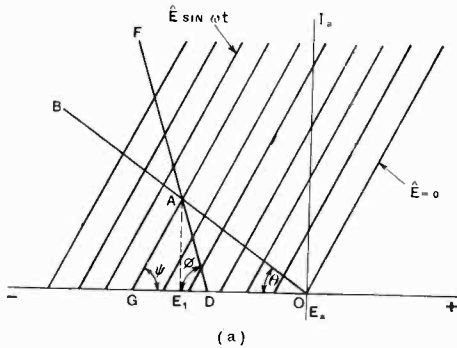

Fig. 1.

time my paper was written I calculated the formula for the critical modulation percentage for a ratio of A.C./D.C. diode load resistances less than unity and included the effect of the detection efficiency. The assumption was made that the diode $I_a E_a$ curves were straight lines at an angle to the E_a axis as shown in Fig. 1a and that conduction started at $E_a = 0$.

The D.C. load resistance line (R_1 in Fig. 1a) is represented by OB at an angle $\theta = \cot^{-1} R_1$ to the E_a axis, and the A.C. load line by FD at an angle $\phi = \cot^{-1} \frac{R_1 R_2}{R_1 + R_2}$.

The carrier voltage is $\hat{E}_1 \sin \omega t$ and the D.C. voltage developed across R_1 is E_1 . The critical modulation ratio is DG/OG

$$\text{but } DG = DE_1 + E_1 G = AE_1 \cot \phi + AE_1 \cot \psi \dots (1)$$

$$\text{and } OG = OE_1 + E_1 G = AE_1 \cot \theta + AE_1 \cot \psi \dots (2)$$

$$\text{Thus } \frac{DG}{OG} = \frac{\cot \phi + \cot \psi}{\cot \theta + \cot \psi} \dots (3)$$

$$\cot \psi = \frac{GE_1}{AE_1} = \frac{OG - OE_1}{AE_1} = \frac{1 - \frac{OE_1}{OG}}{\frac{AE_1}{OG}}$$

$$\frac{AE_1}{OG} = \frac{E_1 \tan \theta}{\hat{E}}$$

$$= \eta_D \tan \theta$$

$$\text{for } \frac{E_1}{\hat{E}} = \frac{\text{D.C. volts}}{\text{A.C. peak carrier volts}}$$

$$= \text{detection efficiency } \eta_D$$

$$\text{i.e. } \frac{OE_1}{OG} = \eta_D$$

$$\therefore \cot \psi = \frac{1 - \eta_D}{\eta_D \tan \theta}$$

Substituting this in (3) gives

$$\frac{DG}{OG} = \frac{\eta_D \cot \phi \tan \theta + 1 - \eta_D}{\eta_D + 1 - \eta_D} = \frac{1 - \eta_D (1 - \cot \phi \tan \theta)}{1} = 1 - \frac{\eta_D R_1}{R_1 + R_2} \dots (4)$$

Expression (4) for critical modulation ratio reduces to the well-known

$$M_C = \frac{R_2}{R_1 + R_2} \text{ when } \eta_D = 1.$$

An interesting point to observe is that a reduction of diode efficiency leads to a higher critical modulation ratio.

The critical modulation ratio for a diode with a positive bias of E_b can similarly be proved to be

$$\frac{(E_b + \hat{E})}{\hat{E}} \left[1 - \frac{\eta_D R_1}{R_1 + R_2} \right] \dots (5)$$

The above analysis assumes that the diode characteristics are straight lines and it is worth pointing out that the characteristics are always curved even for a diode having a straight conduction current—voltage line. The characteristics for the ideal linear diode are shown in Fig. 2, and each carrier characteristic curve joins the straight conduction curve at a positive value of $E_a = + \hat{E}$. The slope resistance of the characteristics is dependent on the D.C. load resistance and the original slope resistance of the conduction line. It is usually much greater than the latter and this

point is important in calculating the effect of the R.F. bypass capacitance C_1 across R_1 on the audio frequency response to the detected modulation.

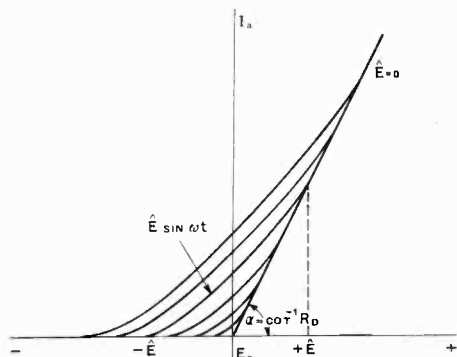

Fig. 2.

The value of the slope resistance R'_D is $\frac{\pi}{2 - \sin^{-1} \eta_D} R_D$, where R_D is the slope resistance of the conduction line. The D.C. load resistance controls R'_D since a reduction of R_1 decreases the detection efficiency η_D .
K. R. STURLEY.
Chelmsford, Essex.

High Frequency Alternating Currents

By K. McILWAIN and J. G. BRAINERD. Second edition, 1939. 509 pp. + index, 24 × 16 cm., with 226 Figs. Wiley & Sons, New York, and Chapman & Hall, Ltd., 11, Henrietta Street, London, W.C.2. Price, 30s.

The first edition of this book was published in 1931, and the preface to this, the second, edition begins with the words:—"Much to the authors' surprise the first edition of this mathematical analysis of the operation of electric circuits at high frequencies has been exhausted. . . ." The reader will scarcely share the authors' surprise; for the book fills a gap which is almost a void in American wireless literature, in that it does not merely quote results, but derives formulae from first principles, pointing out their limitations and the assumptions on which they are valid. Although two or three books published in this country fill certain parts of the gap, there is much in McIlwain and Brainerd's textbook which has hitherto only been available in original papers.

Here we may instance the attention given to distortion arising from causes frequently unexpected, or at least neglected, because we are accustomed to regard as "constants" many parameters which in fact are variables; and the demonstration in Chapter I that harmonics are of necessity present in the output of any microphone operating by change of impedance, even supposing that change to be a strictly linear function of the sound intensity—a point which until now has hardly received mention, let alone adequate discussion, in

other textbooks. Another conspicuous novelty is Appendix D, described as "a brief introduction" to the theory of non-linear oscillations, such as occur, for example, in the Multivibrator of Abraham & Bloch.

The book covers not only the ground usually regarded as specifically "Wireless," but also the field of Communication Engineering generally, including line telephony and an excellent chapter on Wave Filters based on the classical papers of Zobel.

The mathematical treatment throughout is just what seems to be needed by the engineer and research worker, as may be exemplified by the treatment of the tuned-anode oscillator. Equations are first derived for a very generalised case, making the minimum number of assumptions such as absence of grid-current or interelectrode capacities; before solving the equations, the usual simplifying assumptions are then made, but with careful explanation of exactly what each assumption involves and how far it is justified in practice. This avoids the necessity of printing unnecessarily complicated and uninteresting algebra, which would often obscure the main argument; and while giving rigorous proofs of the usual simplified equations such as are required for examination purposes, this procedure provides the research worker with the complete equations that he may occasionally require, so that he is able to modify them according to his needs and solve them for himself. Long mathematical proofs of such matters as the validity of an expansion are abbreviated or omitted (but always with a reference to sources of further information in text or footnote)—the engineer would probably "skip" such discussions anyway, while the pure mathematician has no cause for complaint of "lack of rigidity," since any weak points are not glossed over, but clearly indicated with a caution as to the mathematical limitations to which the particular process is in general subject.

A "General Bibliography of a few of the most important collateral books"—a well-chosen score or so—precedes the text; carefully selected brief bibliographies and references to original sources follow each chapter, bearing witness to the care and trouble taken in revision for the new edition, since the dates of more than half are subsequent to the date of issue of the first edition in 1931. The bibliography is not confined to American sources, the English work on the subject is well represented by books, and references to papers published in this journal, the *I.E.E. Journal*, and others. No attempt is made to be exhaustive, an attempt which often results in obscuring important work by burial in a mass of titles; the selection is unusually judicious, yet we could wish to find a few more references to Continental sources.

Diagrams of connections ("schematics") are very clear and free from inessentials, so as to be almost self-explanatory—which represents much more hard work and careful thinking by authors, with a corresponding reduction in mental effort on the part of the reader, than many writers realise—there is a competent index; and a very useful table headed "Notation," in which all symbols employed in the book are listed and defined, is printed on the back end-papers.
C. R. C.

Abstracts and References

Compiled by the Radio Research Board and reproduced by arrangement with the Department of Scientific and Industrial Research

For the information of new readers it is pointed out that the length of an abstract is generally no indication of the importance of the work concerned. An important paper in English, in a journal likely to be readily accessible, may be dealt with by a square-bracketed addition to the title, while a paper of similar importance in German or Russian may be given a long abstract. In addition to these factors of difficulty of language and accessibility, the nature of the work has, of course, a great influence on the useful length of its abstract.

	PAGE		PAGE
Propagation of Waves	21	Directional Wireless	33
Atmospherics and Atmospheric Electricity	24	Acoustics and Audio-Frequencies	33
Properties of Circuits	24	Phototelegraphy and Television ...	35
Transmission	26	Measurements and Standards ...	38
Reception	27	Subsidiary Apparatus and Materials	39
Aerials and Aerial Systems ...	29	Stations, Design and Operation ...	44
Valves and Thermionics	30	General Physical Articles	45
		Miscellaneous	45

PROPAGATION OF WAVES

1. ON DIFFRACTION AND RADIATION OF ELECTROMAGNETIC WAVES [Description of Several Theoretical Methods having Advantages over Methods based on Kirchoff Formula: Radiation from Horns].—S. A. Schelkunoff. (*Phys. Review*, 15th Aug. 1939, Series 2, Vol. 56, No. 4, pp. 308-316.) "The essential feature . . . is identification of certain portions of given electromagnetic fields as the fields of appropriate fictitious electric and magnetic current sheets." See also 1779 of 1936, and Stratton & Chu, 3875 of 1939.
2. ON DIFFRACTION AND RADIATION OF ELECTROMAGNETIC WAVES [Use of Kirchoff Formula leads to Grossly Inaccurate Results in Some Cases, Which cannot be Predicted: Advantage of "Equivalence Principle": the Alternative "Induction Theorem": etc.].—S. A. Schelkunoff. (*Proc. Inst. Rad. Eng.*, Sept. 1939, Vol. 27, No. 9, p. 615: summary only.) See also 1, above.
3. REMARK ON THE CLASSICAL DIFFRACTION THEORY [Physical Discussion of Exact Theory of Diffraction of Electromagnetic Waves round Dielectric Cylinder: Resonance Conditions for Forced Oscillations: Numerical Experimental Results].—T. Sxsl & P. Urban. (*Zeitsch. f. Physik*, No. 1/2, Vol. 114, 1939, pp. 92-97.)
4. DIFFRACTION OF ULTRA-SHORT RADIO WAVES [Length 2-3 m: Experiments showing that Radiation with Horizontally-Polarised Electric Vector gives Most Pronounced Attenuation of Received Field-Strength at Points within Shadow of Hills].—J. S. McPetrie & J. A. Saxton. (*Nature*, 7th Oct. 1939, Vol. 144, p. 631.)

5. THE PASSAGE OF ELECTRIC WAVES THROUGH WIRE GRIDS [Theory].—W. Wessel. (*Hochf.tech. u. Elek.aktus.*, Aug. 1939, Vol. 54, No. 2, pp. 62-69.)

This theory corresponds to the experiments of Esau, Ahrens, & Kebbel (2631 of 1939). The grid of wires is considered as plane and extending to infinity in all directions; plane waves are incident perpendicularly upon it. The mathematical method used depends on the formation of an integral equation, which is equivalent to the known method of superposition of Hertzian dipoles. The component of the electric vector perpendicular to the direction of the waves passes through the grid unaltered and only the electric vector in the direction of the grid wires is considered. The current induced in the wires is constant over their whole length but differs in phase from the incident oscillation. In § II the polarisation relations and transparency are worked out from the form and position of the oscillation ellipse; the secondary field is calculated in § III as a function of the current in the grid, which is calculated in § IV by the integral-equation method already mentioned. From this the radiation resistance and self-inductance per unit length are deduced (§ v). The radiation resistance is found to be constant so long as the wavelength is greater than the distance apart of the grid wires, while the self-inductance is constant for long wavelengths and similar to that of a Lecher-wire system. The transparency is found to be zero for very long wavelengths and to increase as the square of the frequency; plane waves of length equal to the distance apart of the grid wires pass undisturbed through the grid (in agreement with experiment). Numerical and graphical results are given in § vi.

6. PAPERS ON BEHAVIOUR OF LIQUIDS AT SHORT-WAVE AND MICRO-WAVE FREQUENCIES.—Schmale: Odenwald. (See 352 & 353.)

7. THE HEIGHTS OF THE REFLECTING REGIONS IN THE TROPOSPHERE [Summer, 1938, C Region at 1.8 km: Survey of Other Workers' Results: Meteorological Factors influencing Heights: Latest Results using Video-Frequency Superheterodyne Pulse Receiver: Comparison with Simultaneous Aeroplane Observations of Temperature, etc. (Correspondence between Reflections and Air-Mass Boundaries): etc.].—A. W. Friend & R. C. Colwell. (*Proc. Inst. Rad. Eng.*, Oct. 1939, Vol. 27, No. 10, pp. 626-634.) For previous work see 810 of 1938.
8. STRATOSPHERE TEMPERATURES BY NEW TYPE OF "METEOR SPEEDOMETER" [100° C at 38 Miles, 20° C at 70 Miles].—F. L. Whipple. (*Science*, 13th Oct. 1939, Vol. 90, Supp. p. 9.)
9. ATTENUATION OF HIGH FREQUENCIES OVER LAND AT SHORT RANGES [up to 10 Miles: Attenuation Increasing with Frequency up to about 4 Mc/s, Nearly Constant from 4 to 80 Mc/s (Signal varying Inversely as n th Power of Distance, where n is about 2.3): Variation of Attenuation predictable from Sommerfeld's Equations, but Measured Attenuation is Greater, particularly in Daytime (below 12.5 Mc/s)].—J. Hessel. (*Proc. Inst. Rad. Eng.*, Sept. 1939, Vol. 27, No. 9, p. 612: summary only.)
10. THE ABSORPTION OF RADIO WAVES IN WATER.—Hoag. (See 375.)
11. A GENERAL RADIATION FORMULA [for Power radiated in Non-Dissipative Media].—Schelkunoff. (See 108.)
12. DEVIATIONS OF SHORT RADIO WAVES FROM THE LONDON/NEW-YORK GREAT-CIRCLE PATH.—C. B. Feldman. (*Proc. Inst. Rad. Eng.*, Oct. 1939, Vol. 27, No. 10, pp. 635-645.) A summary was dealt with in 2181 (see also 3456) of 1938.
13. A SINGLE AND DOUBLE PULSE GENERATOR [Development of Getting's Circuit, entirely A.C.-Operated].—A. Roberts. (*Review of Scient. Instr.*, Oct. 1939, Vol. 10, No. 10, p. 316.) For Getting's generator see 415 of 1938.
14. COMPARISON OF SIMULTANEOUS IONOSPHERE OBSERVATIONS AT WASHINGTON, D.C., AND DEAL, NEW JERSEY [nearly 300 km N.E. of Washington: Small but Real Differences in F and F_2 Ionic Densities].—J. P. Schafer & W. M. Goodall. (*Terr. Mag. & Atmos. Elec.*, June 1939, Vol. 44, pp. 205-208: *Bell Tel. System Tech. Pub.*, Monograph B-1163.)
15. THE EFFECT OF THE LORENTZ POLARISATION TERM IN IONOSPHERIC CALCULATIONS.—J. A. Ratcliffe. (*Proc. Phys. Soc.*, 1st Sept. 1939, Vol. 51, Part 5, No. 287, pp. 747-756.)
Author's summary:—Some calculations are made concerning the propagation of waves through an ionospheric region having a parabolic distribution of electron density with height. The Lorentz term is included, but the effects of electron collisions and of the earth's magnetic field are neglected. Expressions are deduced for the group path at vertical incidence as a function of wave frequency, and for the horizontal range covered at oblique incidence as a function of angle of incidence and wave frequency. The results are presented graphically and are compared with calculations in which the Lorentz term is neglected. It is shown that experiments in which vertical-incidence and oblique-incidence propagation through region F are compared cannot be expected to be accurate enough to decide whether or not the Lorentz term should be included.
16. THE EXPERIMENTAL VERIFICATION OF THE DIFFRACTION ANALYSIS OF THE RELATION BETWEEN HEIGHT AND GAIN FOR RADIO WAVES OF MEDIUM LENGTHS.—T. L. Eckersley & G. Millington. (*Proc. Phys. Soc.*, 1st Sept. 1939, Vol. 51, Part 5, No. 287, pp. 805-809.)
The diffraction theory of propagation from a vertical aerial predicts an initial diminution of signal strength on going up from the ground. This is discussed theoretically and "a height/gain curve for a value 10^{-13} e.m.u. of σ is calculated from the diffraction theory [3835 of 1938] for comparison with the experimental curves of von Handel & Pfister [3429 of 1935] and very good agreement is obtained. The span of the initial drop and the slope of the eventually rising curve change rapidly as σ is altered, and it is suggested that aeroplane experiments on medium waves should form a useful method of determining the mean value of the conductivity σ of the earth over any given ground."
17. THE DISPERSION OF WIRELESS ECHOES FROM THE IONOSPHERE [Theoretical Discussion].—F. W. G. White. (*Proc. Phys. Soc.*, 1st Sept. 1939, Vol. 51, Part 5, No. 287, pp. 859-864.)
The methods of group analysis are here applied "in order to show under what ionospheric conditions true dispersion of the pulse signal will occur in an observable form." The effect of absorption in the wave path upon the amplitude of the pulse at the receiver is discussed; "it is shown that, for all ordinary conditions of observation, this dispersion does not give rise to any difficulties in the interpretation of experimental results, as regards either the time of travel or the amplitude of the wave train."
18. THE DIURNAL VARIATION OF ABSORPTION OF WIRELESS WAVES [from Measurements in New Zealand of Total Absorption of Waves reflected from F Region].—F. W. G. White & T. W. Straker. (*Proc. Phys. Soc.*, 1st Sept. 1939, Vol. 51, Part 5, No. 287, pp. 865-875.)
"The diurnal variation . . . has been investigated under conditions which exclude absorption at the top of the wave trajectory; the results refer to the absorption which is thought to occur in region E. The variation has been compared with that given by Appleton's theory of absorption in a simple Chapman region [395 of 1938]. The practical results are found to agree with the theory, as far as the diurnal variation is concerned, both in summer and in winter. The ratio of the summer absorption to the winter absorption is, however, smaller than it should be according to the theory. This discrepancy is discussed. It is shown also that

when the waves are returned from the intense E region, instead of region F, the absorption is of the same order of magnitude, a fact which indicates that the absorbing zone is beneath region E in conformity with Appleton's theory."

19. EXCHANGE OF ENERGY BETWEEN TRANSLATION AND ROTATION BY COLLISIONS [deduced from Spectra of Hollow-Cathode Discharge].—H. Haber. (*Physik. Zeitschr.*, 1st Sept. 1939, Vol. 40, No. 17, pp. 541-551.)
20. REPORT OF COMMISSION II, RADIO WAVE PROPAGATION, INTERNATIONAL SCIENTIFIC RADIO UNION.—J. H. Dellinger. (*Proc. Inst. Rad. Eng.*, Oct. 1939, Vol. 27, No. 10, pp. 645-649.) Already referred to in 4299 of 1939.
21. AN INDUCTION MAGNETOGRAPH [for recording Sudden Changes of Earth's Field: Applicable to Ionospheric Research].—H. Nagaoka & T. Ikebe. (*Electrician*, 20th Oct. 1939, Vol. 123, p. 364: summary only.)
22. MAGNETIC STORMS AND RADIO COMMUNICATION ON SHORT WAVES.—G. V. Balakov & M. P. Dolukhanov. (*Izvestiya Elektroprom. Slab. Toka*, No. 5, 1939, pp. 1-11.)
The effects of magnetic storms on radio communications can be countered by (a) equipment changes to increase the signal noise ratio at the receiving station (active methods), and (b) such measures as changing the wavelength, changing the route, etc., depending not on equipment changes, but rather on advance information on coming disturbances (passive methods). In the present paper the possibility of forecasting such disturbances is investigated, and to this end a comparative study is made of the receiving conditions prevailing at the Moscow Terminal Station of the Moscow/New York radio link, as recorded for the years 1935/1937, and of the variations of the earth's magnetic field during the same period. Numerous diagrams are shown and the main conclusion reached is that, provided further data are collected and studied, passive methods may acquire very great importance in improving the reliability of radio communication.
23. STATISTICAL STUDY OF THE ELEVEN-YEAR CYCLE IN THE DIURNAL COMPONENT OF THE MAGNETIC DECLINATION [on Calm Days: Parallelism with Solar Activity: Increase in Mean Value of Amplitudes and Their Eleven-Year Components with Increasing Geomagnetic Latitudes].—Labrouste & Labrouste. (*Comptes Rendus*, 9th Oct. 1939, Vol. 209, No. 15, pp. 565-568.)
24. SOLAR CYCLE AND THE F₂ REGION OF THE IONOSPHERE.—W. M. Goodall. (*Proc. Inst. Rad. Eng.*, Sept. 1939, Vol. 27, No. 9, p. 610: summary only.) For a letter to *Nature* on the same subject see 3437 of 1939.
25. CHARACTERISTICS OF THE IONOSPHERE AT WASHINGTON, D.C., JULY 1939 [and Notice of Change in Presentation of Critical-Frequency Data: No Support for 26-Hour Interval between Sudden Ionospheric Disturbances & Ionospheric Storms].—Gilliland, Kirby, & Smith. (*Proc. Inst. Rad. Eng.*, Sept. & Oct. 1939, Vol. 27, Nos. 9 & 10, pp. 603-604 & 677-679.)
(1) All critical frequencies are now being given in terms of the ordinary, instead of the extraordinary, wave, for reasons given. (2) The data indicate that both phenomena are produced by radiations from solar disturbances, but not from the same disturbance: it seems that a sudden ionospheric disturbance, but not a storm, is produced by a solar flare.
26. SUN AND IONOSPHERE [Summarising Account]: I—THE SUN AS THE CAUSE OF THE NORMAL IONISATION OF THE IONOSPHERE: II—THE SUN AS THE CAUSE OF IONOSPHERIC DISTURBANCES [from the Standpoint of the Solar Physicist].—W. Grotian. (*Naturwiss.*, 18th & 25th Aug. 1939, Vol. 27, Nos. 33 & 34, pp. 555-563: 569-577.)
27. RECENT SUNSPOT ACTIVITY [Data].—(*Nature*, 26th Aug. and 16th & 30th Sept. 1939, Vol. 144, pp. 362, 508, & 591.)
28. SOLAR VARIATION AND THE WEATHER [Variation of Barometer Height with Period 27.31 Days: Similar Tendency in Reported Aurora Occurrences in Great Britain: Possible Connexion with Abbot's Period of 274 Months in Meteorological Phenomena].—W. R. Priston. (*Nature*, 23rd Sept. 1939, Vol. 144, pp. 550-551.) See Abbot, 2654 of 1939.
29. RADIATION CLIMATE IN SCANDINAVIAN PENINSULA [Data and Analyses of Solar Luminous Radiation for Period 1933-1937].—T. E. Aurén. (*Arkiv f. Mat., Astr. och Fysik*, No. 5, Vol. 26A, 1939, Paper 20, pp. 1-50 & Plates.)
30. THE CORONAVISER, AN INSTRUMENT FOR OBSERVING THE SOLAR CORONA IN FULL SUNLIGHT [by Television Technique using Mechanical Spiral Scanning and C-R-Tube Reproduction].—A. M. Skellett. (*Science*, 3rd Nov. 1939, Vol. 90, pp. 409-410: summary only.)
31. THE SODIUM D LINES IN THE LIGHT OF THE NIGHT SKY [Discussion of Existing Measurements and Hypotheses: Description of Apparatus for determining Line Absorption with High Temporal Resolving Power].—G. Cario & U. Stille. (*Zeitschr. f. Physik*, No. 7/8, Vol. 113, 1939, pp. 442-448.)
32. MECHANISM OF NITROGEN EXCITATION IN THE NIGHT SKY [Relative Intensities of Bands in Spectrum of Nitrogen Molecule explained by Resonance Phenomena].—J. Cabannes & R. Aynard. (*Nature*, 2nd Sept. 1939, Vol. 144, p. 442.)

33. A NOTE ON THE SOLUTION OF SOME PARTIAL DIFFERENTIAL EQUATIONS IN THE FINITE DOMAIN [Wave Equation of Vertical Propagation in Atmosphere: Vibrations of Infinite Elastic Bar, etc.: Use of Laplace Transform combined with Boole's Operational Method].—W. T. Howell. (*Phil. Mag.*, Oct. 1939, Series 7, Vol. 28, No. 189, pp. 396-402.)
34. A NEW KIND OF EARTHQUAKE WAVE DISCOVERED [Fifth Fundamental Type, driving Particles diagonally to Path: Important Implications].—L. D. Leet. (*Science*, 13th Oct. 1939, Vol. 90, Supp. pp. 6 and 8.)
35. NEW TYPE OF [Seismic] WAVE OF LONGITUDINAL TYPE BETWEEN THE P AND S PHASES.—E. Rosini. (*La Ricerca Scient.*, Sept. 1939, Year 10, No. 9, pp. 798-808.)

ATMOSPHERICS AND ATMOSPHERIC ELECTRICITY

36. FURTHER STUDIES OF DIRECTIONS OF ATMOSPHERICS AT TOOWOMBA AND CANBERRA [including an Estimate of Thunderstorm Risks to Aircraft].—H. C. Webster, G. H. Munro, & A. J. Higgs. (*Australian Radio Research Board*, Report No. 14, 1939, pp. 7-21.) The report (which forms Bulletin No. 127 of the Council for Scientific & Industrial Research of Australia) also contains Webster's papers dealt with in 1774 & 1775 of 1938.
37. ATMOSPHERIC DISTURBANCES DUE TO THUNDERCLOUD DISCHARGES: PART I.—F. W. Chapman. (*Proc. Phys. Soc.*, 1st Sept. 1939, Vol. 51, Part 5, No. 287, pp. 876-894.)

Author's abstract:—The various ways of delineating photographically the random transient changes in the earth's electric field by means of a cathode-ray oscillograph are described together with a convenient method of recording the time history of all the disturbances that arise from a thundercloud discharge. An interpretation of these records and observations on the rate of change of field follow. It is found that a positive field change is almost invariably initiated by a volley of pulsations which is succeeded by a sequence of violent changes of similar characteristic structure and indicates the discharge of negative electricity from the cloud to ground by the familiar intermittent lightning flash. The results obtained give the magnitude and nature of the currents involved in the various stages of the flash. Negative field changes observed under the same conditions are recorded as a relatively slow variation of the field carrying minor pulsations and provide evidence relating to the different nature of discharges within the cloud. Following an analysis of the field change due to a component stroke of the intermittent flash, an explanation is given to account for the rate of dispersal of charge in the thundercloud towards the end of the lightning stroke, which requires a conductivity of the order of 10^2 e.s.u. The records obtained at great distances from the storm centre show that the strongly radiated pulse from each lightning stroke is accompanied by a

succession of echoes due to multiple reflections between the ionosphere and the ground.

38. PHOTOGRAPHS OF UNUSUAL DISCHARGES [near Ground Objects] OCCURRING DURING THUNDERSTORMS [Which might be Due to Horizontally-Moving Potential Wave].—R. E. Holzer & E. J. Workman. (*Journ. of Applied Phys.*, Sept. 1939, Vol. 10, No. 9, pp. 659-662.) For similar photographs see 1780 of 1938.
39. POLARISATION OF THE DIFFUSED LIGHT, RADIATION OF THE ATMOSPHERE, AND PROBABLE INDICATIONS OF METEOROLOGICAL TENDENCIES.—E. Medi. (*La Ricerca Scient.*, Sept. 1939, Year 10, No. 9, pp. 790-797.) For previous work see 4258 of 1938.
40. OBSERVATIONS OF THE ELECTRIC FIELD OF THE ATMOSPHERE IN THE ATLANTIC AND PACIFIC OCEANS [Diminution in Field near Equator].—J. Rouch. (*Comptes Rendus*, 9th Oct. 1939, Vol. 209, No. 15, pp. 564-565.)
41. A RIGOROUS THEORY OF THE RECOMBINATION OF BOTH SMALL AND LARGE IONS IN GASES AT HIGH PRESSURES.—W. R. Harper. (*Proc. Roy. Soc.*, Series A, 23rd Aug. 1939, Vol. 172, No. 950, p. S91: abstract only.)
42. DEMONSTRATION OF AEROLOGICAL RADIO SOUNDING EQUIPMENT.—Diamond & others. (*Proc. Inst. Rad. Eng.*, Sept. 1939, Vol. 27, No. 9, p. 609: summary only.)

PROPERTIES OF CIRCUITS

43. RESONANT IMPEDANCE OF TRANSMISSION LINES [as used as Circuit Elements in Ultra-High-Frequency Receivers, Transmitters, & Filters: Shorter Optimum Lengths indicated by Previous Theoretical Results are Incorrect (Neglect of Quadrature Component of Characteristic Impedance): Experimental Confirmation].—L. S. Nergaard & B. Salzberg. (*Proc. Inst. Rad. Eng.*, Sept. 1939, Vol. 27, No. 9, pp. 579-584.)
44. THE LOSS ANGLE OF THE VOLTAGE-REGULATED CAPACITANCE [between Anode and Cathode of a Valve: Useful for the Balancing of Bridges, Remote Tuning of Oscillatory Circuits in Transmitters and Receivers, Automatic Frequency Regulation (Below's) for Synchronising-Signal Generators, Telemetering, Wobble-Frequency Generators, Frequency Modulation: etc.].—E. Thon. (*T.F.T.*, Sept. 1939, Vol. 28, No. 9, pp. 344-354.)

Author's summary:—The loss angle of voltage-regulated capacitances is very dependent on the frequency, but it can be compensated for a definite frequency and a definite steepness of slope by a suitable choice of complex resistances in the grid circuit of the regulating valve.

After a general discussion of the conditions which the complex resistance in the grid circuit must fulfil in order that the decrease of loss angle may be effective over the widest possible ranges of frequency and slope, the paper shows the variations of the loss angle and of the anode impedance with

the frequency, the slope, and with the values of the circuit components in compensation circuits with two and three components; the calculated results are confirmed by measurements. The design calculations of such a circuit are discussed, and the limits of its applicability. As an example, a circuit is shown with which the frequency of a bridge-stabilised transmitter [Meacham, 263 of 1939] can be modulated over a range of $\pm 10\%$ with constant output voltage. For Below's arrangement, for which such a capacity-regulation is suitable, see 4023 of 1938.

45. DIODE OPERATING CONDITIONS.—Court. (See 154.)

46. SEPARATING FILTERS.—H. Piloty. (*T.F.T.*, Aug. & Sept. 1939, Vol. 28, Nos. 8 & 9, pp. 291-298 & 333-344.)

"Filters designed according to the hitherto usual methods (based on characteristic impedance and quadripole transmission equivalent) can form only either parallel or series separating filters and then only if the input impedance in the blocking region has no zero point and no 'pole' [point where the attenuation becomes logarithmically infinite]. For high- and low-pass working, this characteristic impedance must belong to the lowest possible class and show the performance represented in Fig. 1." The limitations of such an arrangement are pointed out, and the writer continues: "Now, however, separating filters are known whose performance is not subject to the data of Fig. 1" [references are here given to the same papers as are mentioned in 3510 of 1939, an abstract of a paper by Cauet with which the present writer was not acquainted when composing his paper, and which at many points agrees with his own results]. For the design and description of such filters, he maintains, the usual employment of the wave parameters (characteristic impedance and quadripole transmission equivalent) is complicated and detrimental, and the long section II is devoted to a filter theory eliminating these parameters and dealing only with directly measurable quantities, the current- and voltage-transmission equivalents (eqns. 3 & 4), depending on the complex input/output relations of current and voltage, respectively, when the output is closed by an ohmic resistance of unity. Sections III & IV deal with the application of this theory to the design of various types of separating filter, including partial-bridge circuits and the networks described by Norton (2900 of 1937).

47. THREE-CIRCUIT BAND-PASS FILTERS WITH SYMMETRICALLY BALANCED TRANSMISSION CURVES.—H. Wucherer. (*T.F.T.*, Aug. 1938, Vol. 28, No. 8, pp. 324-329.) Concluded from 3916 of 1939.

48. THE DESIGN CALCULATIONS OF WIDE-BAND TRANSFORMERS, TAKING INTO ACCOUNT THE CAPACITIVE EFFECTS [using Band-Filter Theory].—Th. Hegner. (*Funktech. Monatshefte*, Aug. 1939, No. 8, pp. 225-234.)

49. THE ANALYSIS OF THE OPERATION OF A DIFFERENTIAL TRANSFORMER.—V. F. Remnev. (*Izvestiya Elektroprom. Slab. Toka*, No. 5, 1939, pp. 21-24.)

The operation of a transformer having two

primary and one or several secondary windings (as used, for example, at the output of a push-pull amplifier) is discussed. Equations are derived for determining currents, voltages, and impedances for different parts of the transformer.

50. COUPLED CIRCUITS COUPLED BY AN INDUCTANCE DEPENDING ON THE CURRENT [Calculations giving Currents, Voltages, and Effect of Iron Core on Oscillations: Example of Condenser Choke shows Influence of Ohmic Resistance on Direction of Phase Angle].—W. Taeger. (*Arch. f. Elektrot.*, 15th Sept. 1939, Vol. 33, No. 9, pp. 573-584.) Continuation of work referred to in 4284 of 1938.

51. BEAT THEORY OF NON-LINEAR CIRCUITS [Complete Solution of Non-Linear Differential Equation: Check by Differential Analyser: Method of obtaining Linear Equivalent to Non-Linear Circuit: Explanation and Computation of Curious Wave Forms: Examples of Application to Transmission Line Circuits].—E. G. Keller. (*Journ. Franklin Inst.*, Sept. 1939, Vol. 228, No. 3, pp. 319-337.)

52. A CONSTANT-LOSS IMPEDANCE-TRANSFORMING NETWORK.—Daven Company. (See 256.)

53. CONSTANT IMPEDANCE EQUALISERS: SIMPLIFIED METHOD OF DESIGN AND STANDARDISATION.—F. Pyrah. (*P.O. Elec. Eng. Journ.*, Oct. 1939, Vol. 32, Part 3, pp. 204-211.)

54. THE TRANSMISSION EQUIVALENT [of a Line or a Telephone Apparatus] AND ITS CALCULATION FROM THE OVERALL TRANSMISSION LOSS CURVE (FREQUENCY CURVE) OF A TRANSMISSION SYSTEM.—K. Braun. (*T.F.T.*, Aug. 1939, Vol. 28, No. 8, pp. 311-318.)

55. INVESTIGATION OF THE PROPAGATION PHENOMENA IN AN UNSYMMETRICAL MULTIPOLE CONDUCTOR AS A DEVELOPMENT OF THE MULTIPOLE LINE THEORY [Analysis of Unsymmetrical Multipole Conductor into System of Unsymmetrical Quadripoles: Calculation of Voltages and Currents for Given Terminal Conditions at Sending or Receiving Side].—S. Koizumi. (*Arch. f. Elektrot.*, 15th Sept. 1939, Vol. 33, No. 9, pp. 609-622.) See 3092 of 1939.

56. CRITICAL INDUCTANCE AND CONTROL RECTIFIERS [Effect of Choke-Input Smoothing Filter for Controllable Rectifiers: Difficulties with Instability and Control Discontinuities due to Improper Value of Inductance: Derivation of Correct Value].—W. P. Overbeck. (*Proc. Inst. Rad. Eng.*, Oct. 1939, Vol. 27, No. 10, pp. 655-659.)

57. DISCUSSION ON "QUASI-STABLE FREQUENCY-DIVIDING CIRCUITS" [Simple Method of Calculating the Amplitude of Oscillation and Range of Operation: Author's Reply].—H. Mahmoud; R. L. Fortescue. (*Journ. I.E.E.*, Nov. 1939, Vol. 85, No. 515, pp. 640-647.) See 3099 of 1939.

58. THE EFFECT OF THE INPUT IMPEDANCE OF A VALVE ON THE FREQUENCY CHARACTERISTIC OF A TUNED AMPLIFIER.—N. I. Chistyakov. (*Izvestiya Elektroprom. Slab. Toka*, No. 5, 1939, pp. 12-16.)

A theoretical discussion is presented on the operation of a h.f. amplifier using one-section and two-section filters in the grid and anode circuits (Figs. 5 and 9). General formulae (I) and (II) are derived for determining respectively the input conductance of a valve circuit (Fig. 1) and of a two-section filter (Fig. 2). Further formulae are then derived for determining the active component G and the reactive component C_0 (input dynamic capacity) of the input conductance of a valve circuit, for the cases of an amplifier using (a) two-section filters (formulae 18 and 22) and (b) one-section filters (formulae 23 and 24). The effect of the variation of the active and reactive components of the input conductance on the frequency characteristic of an amplifier with one-section and two-section filters is then investigated, and the paper ends with a practical example illustrating the use of the principles evolved in the design of an amplifier.

59. THE THEORY AND DESIGN OF A TUNED AMPLIFIER WITH A DETUNED ANODE CIRCUIT.—V. I. Siforov. (*Izvestiya Elektroprom. Slab. Toka*, No. 7/8, 1939, pp. 3-18.)

The amplification factor of a tuned amplifier in which the anode circuit is inductively coupled to the load circuit depends on the operating frequency. For this reason the sensitivity of a radio receiver, particularly of one using a multi-stage amplifier, is not uniform over the wavelength range. One method for counteracting this effect consists in tuning the anode circuit to a frequency lower than the lowest frequency of the working range. In this paper a detailed theoretical discussion is presented of the operation of such an amplifier, and also of an amplifier in which the anode and load circuits are coupled capacitatively as well as inductively (Fig. 5). The paper is concluded by a numerical example showing that the amplification factor of a particular valve when used in an ordinary tuned circuit varies from 26 at 545 kc/s to 106 at 1500 kc/s, whereas with a detuned anode circuit the corresponding figures are 16 and 8.2, and when a mixed coupling is used the amplification factor remains practically constant (18 and 16).

60. CLASS B AUDIO-FREQUENCY AMPLIFICATION [Methods of Approximate Calculation for the Circuit Designer: Various Forms of Distortion & Their Avoidance (Grid Impulse Oscillations, etc.)].—M. Gordon. (*Wireless Engineer*, Sept. 1939, Vol. 16, No. 192, pp. 457-459.)

61. THE USE OF PHASE-INVERSION CIRCUITS IN THE L.F. AMPLIFIERS OF RADIO RECEIVERS.—Govyadinov. (See 97.)

62. THE USE OF FEED-BACK AT AUDIO FREQUENCIES.—Kotlov. (See 94.)

63. THE DAMPING REDUCTION OF SEPARATELY EXCITED AMPLIFIERS [e.g. Receiver excited by External Signal: Analysis: Vector-Diagram Representation of Positive & Negative Feedback].—S. Mansfield. (*Funktech. Monatshefte*, Aug. 1939, No. 8, pp. 246-249.)

64. SOME APPLICATIONS OF NEGATIVE FEEDBACK, WITH PARTICULAR REFERENCE TO LABORATORY EQUIPMENT [Direct-Reading A.F. Voltmeters with Permanent Calibration: Improved Laboratory Oscillators (Substitutes for Beat-Frequency Type): High-Selectivity Arrangements (by Stabilised Negative Resistance or Frequency-Selective Feedback): Amplifiers & Wave Analysers with Variable Selectivity but Constant Gain: etc.].—Terman, Buss, Hewlett, & Cahill. (*Proc. Inst. Rad. Eng.*, Oct. 1939, Vol. 27, No. 10, pp. 649-655.)

65. A NEGATIVE-FEEDBACK LINEAR-PULSE AMPLIFIER [providing Positive or Negative Output Pulses with Practically Exact Linearity and Little Back-Wave: primarily for Amplification of Bursts of Ionisation].—R. C. Waddell. (*Review of Scient. Instr.*, Oct. 1939, Vol. 10, No. 10, pp. 311-314.)

66. GRAPHICAL ANALYSIS OF TRANSIENT PHENOMENA IN ELECTRIC CIRCUITS [Method Comparable with Graphic Statics in Field of Statics of Rigid Structures].—K. J. Dejuhasz. (*Journ. Franklin Inst.*, Sept. 1939, Vol. 228, No. 3, pp. 339-373.)

67. TRANSIENTS IN SWITCHING INSTALLATIONS [Formulae for Voltage Variation at Points on Cables consisting of Any Number of Portions of Different Impedances].—W. Koch. (*Arch. f. Elektrot.*, 10th Aug. 1939, Vol. 33, No. 8, pp. 523-544.)

68. TRANSIENT RESPONSE IN TELEVISION.—Kallmann. (See 227.)

TRANSMISSION

69. ELECTRONIC-CURVE THEORY OF VELOCITY-MODULATED TUBES [Reformulation of Hahn's Theory, by Use of Retarded Electric & Magnetic Potentials, leading to Simplifications and New Conclusions: Computation of Optimum Drift-Tube Lengths & Transconductance: etc.].—S. Ramo. (*Proc. Inst. Rad. Eng.*, Sept. 1939, Vol. 27, No. 9, p. 615: summary only.) Cf. 4352 of 1939.

70. BEAM TUBES AS ULTRA-HIGH-FREQUENCY GENERATORS [Experimental Investigation: Wavelength Characteristics in Regenerative Circuit compared with Triode Characteristic: Wavelengths down to 150 cm: Efficiency: Means for preventing Oscillations in Amplifier Circuits using Beam Tubes].—R. King. (*Journ. of Applied Phys.*, Sept. 1939, Vol. 10, No. 9, pp. 638-647.) For beam tubes in power amplifiers see Salzberg & Haefl, 1428 of 1938, and Schade, 1890 of 1938.

71. RADIOELECTRIC OSCILLATIONS BY A TRIODE WITH INSULATED GRID ["Free" or "Floating" Grid: Possibility shown by Triode Characteristic: probably Relaxation Oscillations of Frequency about 250 Mc/s].—R. Fortrat & A. Caravel. (*Comptes Rendus*, 9th Oct. 1939, Vol. 209, No. 15, pp. 554-556.)

Resonance on a Lecher system was badly defined. "The phenomenon, on the other hand, constitutes

a convenient method for obtaining harmonic oscillations in circuits which would impose their own period on them."

72. TRIODE OSCILLATORS FOR ULTRA-SHORT WAVELENGTHS.—Ratsey: Gavin. (See 135.)
73. GENERATION AND RECEPTION OF CENTIMETRIC AND DECIMETRIC RADIO WAVES, 1934/1939.—(Sci. Library Bibliographical Series No. 492, 6 pp.)
74. RESONANT IMPEDANCE OF TRANSMISSION LINES.—Nergaard & Salzberg. (See 43.)
75. THE LOSS ANGLE OF THE VOLTAGE-REGULATED CAPACITANCE [for Frequency Modulation, Synchronising-Signal Regulation, etc.].—Thon. (See 44.)
76. A CATHODE-RAY FREQUENCY-MODULATION GENERATOR [Anode or Target of Such Configuration that Voltage Fluctuations applied to One or More Elements are translated into Frequency or Phase Modulation in Anode Circuit].—R. E. Shelby. (Proc. Inst. Rad. Eng., Sept. 1939, Vol. 27, No. 9, p. 615: short summary only.)
77. FREQUENCY OR PHASE MODULATION? [Essential Difference clearly brought out by Consideration of Rectangular Modulation].—G.W.O.H. (Wireless Engineer, Nov. 1939, Vol. 16, No. 194, p. 547.)
78. POINTERS ON DESIGN AND ADJUSTMENT OF HIGH-EFFICIENCY GRID-MODULATED AMPLIFIERS: EXPERIMENTAL TRANSMITTERS USING THE TERMAN-WOODYARD SYSTEM.—C. W. Winkler. (QST, Nov. 1939, Vol. 23, No. 11, pp. 34-37 and 108-112.) For this system see 4300 of 1938.
79. CATHODE MODULATION: COMBINING GRID AND PLATE MODULATION FOR ECONOMY AND EFFICIENCY.—F. C. Jones & F. W. Edmonds. (QST, Nov. 1939, Vol. 23, No. 11, pp. 23-25 and 102.)
80. THE OSCILLOSCOPE SHOWS—WHAT? ANALYSING SOME COMMON TROUBLES WITH OSCILLOSCOPE PATTERNS [of Transmitter Modulation].—T. M. Ferrill, Jr. (QST, Oct. 1939, Vol. 23, No. 10, pp. 30-34.)
81. THE THEORY OF PARASITIC OSCILLATIONS.—I. Kh. Nevyazhski. (Izvestiya Elektroprom. Slab. Toka, No. 7/8, 1939, pp. 18-37.)

A detailed theoretical investigation of parasitic oscillations in a neutralised push-pull circuit (Fig. 1). The relationships between the parameters of the circuit, the frequency of the oscillations, and the back-coupling factor are established, and conditions are determined necessary for the appearance of the oscillations. The oscillatory processes taking place in the circuit, under various conditions, are illustrated by a number of diagrams, and the distribution of the currents and voltages in the circuit is also shown. Numerical examples are given and the paper is concluded by a number of practical suggestions.

The paper is concerned with push-pull oscillations only, i.e. with oscillations determined by the anti-

phase potentials of similar electrodes of the two valves. Oscillations depending on the equipotentiality of the electrodes will be examined in a later paper.

82. "THEORY AND DESIGN OF VALVE OSCILLATORS" [Book Review].—H. A. Thomas. (Wireless Engineer, Sept. 1939, Vol. 16, No. 192, p. 460.)
83. NOVEL FEATURES IN THE WHAS (LOUISVILLE) BROADCASTING TRANSMITTER AND AERIAL SYSTEM.—Doherty & Towner. (See 378.)
84. SPECIFICATION AND TESTING OF BROADCAST TRANSMITTERS [based on Procedure in England, Holland, & U.S.A.].—V. V. L. Rao. (Electrotechnics, Bangalore, Aug. 1939, No. 12, pp. 77-84.)
85. A SAFETY KILOWATT TRANSMITTER: SOME IDEAS IN HIGH-POWER TRANSMITTER CONSTRUCTION.—W. T. Bishop. (QST, Nov. 1939, Vol. 23, No. 11, pp. 42-45 and 106, 108.)
86. A SINGLE-CONTROL WIDE-RANGE TANK CIRCUIT [4:1 Frequency Range by Ganged Combination of Split-Stator Condenser and Special Variometer].—T. M. Ferrill, Jr. (QST, Nov. 1939, Vol. 23, No. 11, pp. 38-39 and 61.)

RECEPTION

87. THE BEHAVIOUR OF CRYSTAL DETECTORS WITH VERY SHORT ELECTROMAGNETIC WAVES [Decrease of Sensitivity below 15 mm Wavelength: Rectifying Action practically Zero at 0.1-0.4 mm Wavelength: Thermal Apparatus only can be used in Region of Shortest Wavelengths].—H. Klumb & B. Koch. (Naturwiss., 11th Aug. 1939, Vol. 27, No. 32, pp. 547-548.)
88. GENERATION AND RECEPTION OF CENTIMETRIC AND DECIMETRIC RADIO WAVES, 1934/1939.—(Sci. Library Bibliographical Series No. 492, 6 pp.)
89. RECEIVER AMPLIFICATION OF WIDE FREQUENCY BANDS (AERIAL AMPLIFIERS) [Use of Valves in Parallel].—E. Alsleben. (Hochf. tech. u. Elek. akus., Aug. 1939, Vol. 54, No. 2, pp. 44-53.)

"In receiver amplifiers for wide frequency bands the amplification attainable with one valve can become so small that several valves connected in parallel give an amplification about the same as or higher than the ordinary series connection. If the parallel circuit is used, the frequency range of the amplifiers can be divided and each valve can work in part of the range. Thus reception disturbances, arising from non-linear distortion in the reception of strong stations, can be decreased." In §II the amplification obtainable by series and parallel connection of several valves is worked out theoretically, in §III the non-linear distortions when two stations are received. §IV discusses the decrease of these non-linear distortions by dividing up the frequency range. The use of band-filters for this division, with the valves matched to the aerial transmission lines and those leading to the distributing circuits, is worked out in §V (band-

filter circuit and its equivalent, Fig. 3), where formulae suitable for calculation are deduced. Figs. 5, 6 show the effect of detuning the parallel and the series resonant circuit respectively. The mutual action of band filters in parallel (Fig. 7) is shown in Figs. 8, 9; Fig. 10 gives resultant curves for four filters. A practical example is described in §VI and compared in §VII (Fig. 11) with a commercial amplifier with valves in series (frequency characteristics Fig. 11). The combination tones produced by two signals simultaneously received were measured with the arrangement shown in Fig. 12; the parallel-valve circuit was found to give less distorted reception than the series-valve circuit, in spite of its smaller valves (Figs. 13a, b).

90. INTERFERENCE REDUCTION WITH FREQUENCY MODULATION AS A FUNCTION OF AMPLITUDE LIMITATION.—H. Zuhrt. (*Hochf. tech. u. Elek. Akus.*, Aug. 1939. Vol. 54, No. 2, pp. 37-44.)

For the phenomenon in question see Armstrong, 2550 of 1936; Crosby, 2504 of 1937; Carson & Fry, 464 of 1938; and Plump, 491 of 1939. A physical explanation of this is here given, based on the curve form of the disturbed h.f. oscillation; the effect of incomplete amplitude limitation is to produce an additional disturbance voltage which decreases as the limitation becomes more complete (§1.2; Fig. 4). The magnitude of the disturbance is calculated in §II, for pure amplitude modulation (§II.1), for frequency modulation with ideal (§II.2) and with incomplete (§II.3) amplitude limitation. Fig. 9 shows the calculated "interference-improvement factor" [ratio of ratio interference-voltage/useful-voltage with frequency modulation to the same ratio for equivalent amplitude modulation] for various frequency bands and degrees of modulation as a function of the completeness of the amplitude limitation. The theory was found to be in good agreement with measurements made using the circuits of Figs. 10, 11.

91. FIRST FREQUENCY-MODULATION RADIO RECEIVERS FOR HIGH-FIDELITY RECEPTION [General Electric Models HM-80, 85, & 136].—(*Gen. Elec. Review*, Sept. 1939, Vol. 42, No. 9, p. 413.)

92. COMMUNICATIONS-TYPE SUPERHETERODYNE RECEIVER FOR THE 30-60 Mc/s RANGE [with New Coupling System giving Uniform Stage Gain of 15 over 2:1 Range].—National Company. (*Proc. Inst. Rad. Eng.*, Sept. 1939, Vol. 27, No. 9, pp. ii and vi.)

93. HIGH-FREQUENCY NEGATIVE FEEDBACK IN BAND-FILTER RECEIVERS [for flattening Characteristic without Reduction of Amplification: Two Resonant Circuits in Cathode Lead].—(*Funktech. Monatshefte*, Sept. 1939, No. 9, p. 272: summary only.)

94. THE USE OF FEED-BACK AT AUDIO FREQUENCIES.—S. Kotlov. (*Izvestiya Elektroprom. Slab. Toka*, No. 5, 1939, pp. 19-21.) The use of feed-back in the l.f. stages of a radio receiver employing pentodes and tetrodes is discussed and the resultant improvement in the quality of reception is pointed out.

95. THE EFFECT OF REACTION ON TUNING [Editorial: Retroaction in Receivers regaining Importance (for increasing Selectivity): Analysis of Effect on Tuning, leading to Design Hints and an "Unexpected Result" for Short-Wave Receivers].—W.T.C. (*Wireless Engineer*, Sept. 1939, Vol. 16, No. 192, pp. 433-434.) For Williams & Chester's paper see 2860 of 1939.

96. THE DEVELOPMENT OF THE SUPERHETERODYNE RECEIVER [from 1917 to Present Day].—G. Renatus. (*Funktech. Monatshefte*, Aug. & Sept. 1939, Nos. 8 & 9, pp. 235-240 & 257-261.)

97. THE USE OF PHASE-INVERSION CIRCUITS IN THE L.F. AMPLIFIERS OF RADIO RECEIVERS.—V. A. Govvadinov. (*Izvestiya Elektroprom. Slab. Toka*, No. 7/8, 1939, pp. 44-48.)

The advantages of using phase-inversion (paraphase) circuits at the l.f. amplification stages of a radio receiver, in place of push-pull input transformers, are enumerated, and different circuit types (Fig. 1-4) discussed (see Drabkina, 973 of 1939). It is shown that these circuits will operate satisfactorily in receivers designed for a band width of 6 kc/s, but a correcting circuit shown in Fig. 7 can be used in cases when a wider frequency band is required. A complete diagram of an inversion circuit, together with the push-pull output stage, is also shown, including the values of the circuit components. The paper is concluded by a short discussion of the advantages of tone control in steps over continuous control.

98. A.V.C. CHARACTERISTICS AND DISTORTION: GRAPHICAL ANALYSIS OF VALVE OPERATING CONDITIONS [with Examination of Some Practical Cases: Design of Gain Bias Characteristic to give Very Little Distortion over Whole Range: etc.].—E. G. James & A. J. Biggs. (*Wireless Engineer*, Sept. 1939, Vol. 16, No. 192, pp. 435-443.) From the Wembley laboratories. For a letter from Mandel calling attention to his own graphical method (3854 of 1935) see *ibid.*, Nov. 1939, No. 194, p. 557.

99. THE "INFINITE IMPEDANCE" DETECTOR [recently incorporated in Some New Receivers]: SOME USES OF CATHODE-COUPLED IN SUPERHETERODYNE RECEIVERS.—(*QST*, Oct. 1939, Vol. 23, No. 10, pp. 21 and 110, 112.)

100. A NEW IMPROVEMENT: "MIXED-RETROACTION" DETECTION, STRICTLY LINEAR IN AMPLITUDE AND FREQUENCY.—Glorie. (*Toute la Radio*, Sept./Oct. 1939, No. 67, pp. 285-289.)

101. ELECTRIC TUNING INDICATORS AND THEIR APPLICATIONS [Survey of Apparatus of Foreign Manufacture, and Their Circuits].—B. M. Tsarev. (*Izvestiya Elektroprom. Slab. Toka*, No. 6, 1939, pp. 41-49.)

102. THE SERIES-VALVE NOISE LIMITER: A NEW TYPE OF CIRCUIT FOR CHOPPING NOISE-PEAKS [Diode Circuit for reducing Ignition & Similar Interference].—D. H. Bacon. (*QST*, Oct. 1939, Vol. 23, No. 10, pp. 15-17.)

103. TESTING OF TRANSMISSION-LINE INSULATORS UNDER DEPOSIT CONDITIONS [with Comparison of Various Designs, Normal & "Anti-Deposit" (Protective Cylinder & Disc, etc.): including Behaviour as regards Interference].—W. J. John & C. H. W. Clark. (*Journ. I.E.E.*, Nov. 1939, Vol. 85, No. 515, pp. 590-609: Discussions pp. 609-624.)
104. PAPER ON THE TROLLEY BUS [including the Suppression of Radio Interference].—G. F. Sinclair. (*Electrician*, 10th Nov. 1939, Vol. 123, pp. 418 and 422: summary only.)
105. ADJUSTMENTS AND TESTS IN THE MASS PRODUCTION OF RADIO RECEIVERS.—F. N. Stepura. (*Izvestiya Elektroprom. Slab. Toka*, No. 7/8, 1939, pp. 68-70.)
A schedule of tests to which commercial-type radio receivers are subjected in a Russian factory. A list of apparatus required for each of the tests is given.
106. NEW MATERIALS USED IN THE MASS PRODUCTION OF RADIO APPARATUS.—I. M. Eftus. (*Izvestiya Elektroprom. Slab. Toka*, No. 7/8, 1939, pp. 76-80.) In a Russian factory using American methods. Conducting, insulating, magnetic, structural, and miscellaneous materials are dealt with in separate sections.
107. L.T. TO H.T. VIBRATORS WITH SYNCHRONOUS RECTIFICATION.—V. A. Semenov. (*Izvestiya Elektroprom. Slab. Toka*, No. 7/8, 1939, pp. 38-44.)
The design of vibrators for supplying high tension to a radio receiver and working from an l.t. battery is discussed. The method of operation is described and measures are considered for preventing sparking at the contacts. A system of equations (22) representing the operation is derived, and also two simplified equations for determining the current in the primary winding of the transformer (25) and the voltage across the load (26). That the accuracy of these equations is sufficient for practical purpose can be seen from a comparison between theoretical curves (Fig. 4) and experimental oscillograms (Fig. 5).
- AERIALS AND AERIAL SYSTEMS**
108. A GENERAL RADIATION FORMULA [for Power radiated in Non-Dissipative Media: Very Convenient for Ordinary Aerials, Arrays, & Electric Horns: based on Poynting-Vector Method and considering Distribution of Electric & Magnetic Currents].—S. A. Schelkunoff. (*Proc. Inst. Rad. Eng.*, Oct. 1939, Vol. 27, No. 10, pp. 660-666.) For application to rhombic aerials see Foster, 119 of 1938.
109. THE CORNER REFLECTOR [Beam System with Driven Element and a Reflector of Two Flat Sheets forming a "Corner": Single Flat Sheet Reflector as Special Case: Comparison with Parabolic Type: Design Factors for Solid-Sheet and Grid-Type Reflectors].—J. D. Kraus. (*Proc. Inst. Rad. Eng.*, Sept. 1939, Vol. 27, No. 9, pp. 613-614: summary only.)
110. COMPENSATION OF THE AERIAL REACTANCES OF TELEVISION TRANSMITTERS.—J. Labus. (*Hochf.tech. u. Elektrukus.*, Aug. 1939, Vol. 54, No. 2, pp. 60-62.)
The reactance of a television aerial, tuned to the carrier frequency, changes considerably when the frequency is modulated, owing to the wide modulation frequency bands of television signals; the change may be regarded as the formation of additional reactance depending on the frequency and the detuning of the matching of the aerial to the transmission line feeding it. The magnitude of this reactance is worked out for a double dipole (Fig. 1) and shown in Fig. 3 for two different diameters of the aerial wire. Partial compensation of the reactance change is found theoretically in a circuit connected between the transmission line and the aerial; this may take the form of a parallel wire circuit (Fig. 4) or an oscillating circuit (Fig. 6), for which suitable dimensions are found.
111. STACKING COAXIAL ANTENNAS: A NOVEL FOUR-ELEMENT COLLINEAR ARRAY FOR 56 Mc's WORK.—E. R. Sanders. (*QST*, Nov. 1939, Vol. 23, No. 11, pp. 17-19.) For Long's paper on the coaxial aerial, see 1450 (cf. 1449) of 1939.
112. MORE THOUGHTS ON EFFECTIVE ANTENNAS [for Transmission & Reception of 5-20 m Waves].—A. H. Lynch. (*QST*, Nov. 1939, Vol. 23, No. 11, pp. 11-16 and 116, 118.)
113. LINK COUPLING FOR THE ROTARY ANTENNA: A THREE-ELEMENT BEAM WITH CONTINUOUS ROTATION IN EITHER DIRECTION.—J. M. Burke, Jr. (*QST*, Nov. 1939, Vol. 23, No. 11, pp. 46-48.)
114. MODEL THREE-ELEMENT BEAM DEMONSTRATED AT PACIFIC-SOUTHWESTERN DIVISION CONVENTION.—C. Bane. (*QST*, Nov. 1939, Vol. 23, No. 11, pp. 59 and 120.)
115. ON INDUCED RADIATION RESISTANCES OVER LARGE DISTANCES.—A. Z. Fradin. (*Journ. of Tech. Phys.* [in Russian], No. 4, Vol. 9, 1939, pp. 329-338.)
In a book published by Tatarinov on short-wave directive aerials, tables are given showing the radiation resistance induced in a passive half-wave radiator when it is separated from the active radiator by a distance varying from 0 to 4λ . These data have been calculated from complicated formulae employing integral sines and cosines, and the use of these formulae becomes particularly difficult for distances exceeding 4λ . In the present paper simpler formulae (12) are derived which can be used for extending Tatarinov's tables. Methods are also indicated for determining the radiation resistance induced in a complex aerial by another complex aerial, and in the light of this discussion the operation of a receiving aerial is examined without the use of the theorem of reciprocity, i.e. without ascribing to a receiving aerial some of the properties of a transmitting aerial.

116. A SINGLE-SIDEBAND MUSA RECEIVING SYSTEM FOR COMMERCIAL OPERATION ON TRANS-ATLANTIC RADIOTELEPHONE CIRCUITS.—F. A. Polkinghorn. (*Proc. Inst. Rad. Eng.*, Sept. 1939, Vol. 27, No. 9, pp. 614-615: summary only.)
117. THE SCREENED LOOP AERIAL: A THEORETICAL AND EXPERIMENTAL INVESTIGATION [Theory giving Good First Approximation for Pick-Up Value: Increased Pick-Up by Capacitive Loading of Screen Gap, in preference to Turns Increase: Further Points for Investigation].—R. E. Burgess. (*Wireless Engineer*, Oct. 1939, Vol. 16, No. 193, pp. 492-499.)
118. THE AERIAL FED FROM ABOVE [for Broadcasting].—W. Wiechowski. (*Hochf. tech. u. Elek. akus.*, Aug. 1939, Vol. 54, No. 2, pp. 53-59.)
- The demands made on modern broadcasting transmitting aeriels and their satisfaction are discussed in § 1; Fig. 1 shows an aerial excited from above (see Metzler, 3376 of 1936) which should combine the advantages of a loaded aerial with those of feeding in the neighbourhood of the current antinode. The paper gives a theoretical investigation of the influence of its variable parameters (namely, relative height of aerial, inductance at the base, inductance of the coupling coil, and capacity at the top) on the radiation properties and the reactance and resistance at the feed point. The attenuation is considered in § III, the feeding (equivalent circuit Fig. 2) in § IV. The results are shown in the form of three-dimensional diagrams in orthogonal projection (Fig. 4, radiation resistance; Fig. 5, relative field-strength at the earth's surface; Fig. 6, relative useful radiation; Fig. 7, angular height of radiation minimum). The great advantage of this aerial is found to lie in the small influence of attenuation on the radiation diagram. Within certain limits, two of the characteristic quantities shown in Figs. 5-7 can be chosen to give required working conditions for the aerial, which will have a very small constructional height and yet better radiating properties than other designs. "The value of the real current component at the current node, which has an unfavourable influence on the field distribution, lies considerably below the corresponding value for aeriels excited at the foot, that is, near the current node; this must be regarded as an important characteristic of the aerial here investigated."
119. A CONSIDERATION OF THE RADIO-FREQUENCY VOLTAGES ENCOUNTERED BY THE INSULATING MATERIAL OF BROADCAST TOWER ANTENNAS.—G. H. Brown. (*Proc. Inst. Rad. Eng.*, Sept. 1939, Vol. 27, No. 9, pp. 566-578.) A summary was dealt with in 3590 of 1938.
120. NOVEL FEATURES IN THE WHAS (LOUISVILLE) BROADCASTING TRANSMITTER AND AERIAL SYSTEM.—Doherty & Townner. (See 378.)
121. GASEOUS IONISATION AND SURFACE-CORONA-DISCHARGE DETECTION AT LOW AND HIGH FREQUENCIES [including Possible Application to Insulator-Support Design: Corona in Coaxial Transmission Lines: etc.].—H. A. Brown. (*Proc. Inst. Rad. Eng.*, Sept. 1939, Vol. 27, No. 9, p. 608: summary only.)
122. RESONANT IMPEDANCE OF TRANSMISSION LINES.—Nergaard & Salzberg. (See 43.)
123. AN R.F. MATCHING NETWORK FOR GENERAL USE: SIMPLIFIED MATCHING OF LINES OF DIFFERENT IMPEDANCES.—W. M. Andrew. (*QST*, Oct. 1939, Vol. 23, No. 10, pp. 39-41.)

VALVES AND THERMIONICS

124. A NEW VALVE FOR GENERATING DECIMETRIC WAVES.—B. Tsvetkovski & N. Dzhibelli. (*Izvestiya Elektroprom. Slab. Toka*, No. 5, 1939, pp. 33-37.)

The authors have developed a new valve, type D.2, similar to the Western Electric type 316.A. A table is given comparing the operating constants of the two valves; the characteristic curves of the new valve are shown. A report follows on the use of the new valve in the following oscillating circuits: (a) Esau (Fig. 4), (b) Hollmann (Fig. 5), and (c) tuned-filament circuit (Fig. 7). The last circuit proved to be the most efficient, giving power outputs from 8.5 watts at 300 Mc/s to 1 watt at 700 Mc/s (Fig. 9). An experimental transmitter using this oscillator and a Heising modulator was built and gave a good performance. It is pointed out that the total weight of this transmitter was only 4 kg, while an equivalent transmitter employing a magnetron would weigh about 60 kg. The latter transmitter would also require 1200-1500 volts for the anode supply, while only 450 volts are necessary for the new valve.

125. CORRESPONDENCE ON PROF. ZEITLENOK'S PAPER "ON THE EFFECT OF THE SPACE CHARGE IN A VALVE ON THE VELOCITY OF ELECTRONS."—Bellustin, Kovalenkov. (*Izvestiya Elektroprom. Slab. Toka*, No. 6, 1939, pp. 59-62.)

Two letters criticising Zeitlenok's article (540 of 1939), mainly on the grounds that the author has not taken into account other publications on the subject and that the formulae proposed by him are not convenient for use in practice. In his reply Zeitlenok admits that the article in question represents an extract from a larger work written in 1932/3 and that papers have been published since, e.g. those by Fortescue and Moullin in the *Wireless Engineer* (2967 & 3375 of 1935), giving a more detailed treatment of the subject. At the same time he points out that his article was not so much a general survey as a study of the operation of an ultra-short-wave oscillator.

126. ON THE ELECTRONIC SPACE CHARGE BETWEEN PLANE ELECTRODES, TAKING INTO CONSIDERATION THE INITIAL VELOCITY AND VELOCITY DISTRIBUTION OF THE ELECTRONS.—M. J. O. Strutt & A. van der Ziel. (*Physica*, Oct. 1939, Vol. 6, No. 9, pp. 977-996: in German, with English summary.)

"The chief difference with previous treatments neglecting the velocity distribution of the incoming electrons resides in the fact that the double-valued regions of the characteristic curves are smaller in the present case and diminish with increasing width of the velocity distribution. Section v contains the application of the general equations to the familiar case of a diode. Langmuir's equation is obtained as a first approximation in this case."

127. SPACE-CHARGE EFFECTS IN ELECTRON BEAMS.—A. V. Haeff. (*Proc. Inst. Rad. Eng.*, Sept. 1939, Vol. 27, No. 9, pp. 586-602.)
Analysis and experimental confirmation, for long magnetically focused beams: multiple thin beams: modulation of beams, including current modulation in double beams: production of non-dissipative "electron-beam conductors" of appreciable length, and transfer of energy to external circuit: application of theory to electrostatically focused beams.
128. A WIDE-BAND INDUCTIVE-OUTPUT AMPLIFIER [RCA Valve giving 10 Watts Output at 500 Mc/s: Close Cathode-Grid Spacing & Large Grid-Screen Spacing (with Very High Screen Voltage): Low Output-Capacitance by Inductive-Output Arrangement: Magnetic Lenses].—A. V. Haeff & L. S. Nergaard. (*Proc. Inst. Rad. Eng.*, Sept. 1939, Vol. 27, No. 9, p. 610: summary only.)
129. DISCUSSION ON "A CONTRIBUTION TO TUBE AND AMPLIFIER THEORY" [and particularly Its Criticism of Pidduck's Paper on Magnetrans: the Neglect of Initial Velocities, etc.].—Benham: Pidduck. (*Proc. Inst. Rad. Eng.*, Oct. 1939, Vol. 27, No. 10, p. 679.)
For Benham's paper see 148 (and 1388) of 1939: Pidduck's paper was in the 1936 *Quart. Journ. of Math.*: see also 2952 of 1936.
130. ELECTRONIC-WAVE THEORY OF VELOCITY-MODULATED TUBES.—Ramo. (See 69.)
131. CURRENTS INDUCED BY ELECTRON MOTION [Simple & Direct Treatment by Repeated Use of Equation for Current due to Single Electron: only One Field Plot required].—S. Ramo. (*Proc. Inst. Rad. Eng.*, Sept. 1939, Vol. 27, No. 9, pp. 584-585.) The very simple equation derived for the purpose is $i = E_e v$.
132. BEAM TUBES AS ULTRA-HIGH-FREQUENCY GENERATORS.—King. (See 70.)
133. NEW TRANSMITTING TUBE [Type 828 Beam Power Valve].—(*QST*, Nov. 1939, Vol. 23, No. 11, p. 29.)
134. THE DIODE AS A FREQUENCY-CHANGER FOR MEASUREMENTS AT ULTRA-HIGH FREQUENCIES.—Gainsborough. (See 243.)
135. TRIODE OSCILLATORS FOR ULTRA-SHORT WAVELENGTHS [Transit-Time Delay and the Short-Wave Limit: Moullin's Results: Transit Time and the Reduction of Efficiency].—O. L. Ratsey: Gavin. (*Wireless Engineer*, Sept. 1939, Vol. 16, No. 192, pp. 459-460.) Prompted by Gavin's paper, 4358 of 1939. For Gavin's reply see *ibid.*, Nov. 1939, No. 194, pp. 556-557.
136. THE OPERATION OF VALVES ON SHORT [and Ultra-Short] WAVES [and a Method of Increasing Their Efficiency].—I. S. Gonorovski. (*Izvestiya Elektroprom. Slab. Toka*, No. 6, 1939, pp. 8-18.)
A theoretical investigation of the causes of the reduced efficiency of a valve on short waves. Various factors such as electron inertia, grid-drive voltage distortion, harmonics in the anode circuit, etc., are discussed separately, and the conclusion reached is that the reduction in efficiency is mainly due to the second of the above causes. The grid-drive voltage distortion is, in its turn, due to the non-linear properties of the grid filament circuit (which produces a certain rectifying effect) and the insufficient filtering of the anode-current harmonics. The interposition of series tuned harmonic-filter circuits between the grid and filament (Figs. 8 and 9) was therefore tested and with a push-pull stage operated on 15 m gave an increase in efficiency from 50% to 60%.
137. A PUSH-PULL PENTODE [for Ultra-Short Waves].—S. A. Zusmanovski. (*Izvestiya Elektroprom. Slab. Toka*, No. 7/8, 1939, pp. 49-55.)
The RCA type 832 valve was developed for operation on wavelengths below 10 m and consists of two separate pentodes mounted in a common glass envelope. In view of constructional difficulties this type of valve is not, however, suitable for high power outputs, and moreover the self-inductance of the interconnecting leads within the valve becomes pronounced at the higher frequencies. Accordingly a new type of valve has been developed by the author in which the self-inductance effect of these leads is eliminated by a special construction (Fig. 3, 4, & 5). The control grids and anodes of the two pentode sections are flat in form and are mounted on opposite sides of a common cathode. The screen and suppressor grids are common to both pentodes and surround the grid-cathode-grid assembly, the anodes being outside. A fixed balancing condenser is connected inside the bulb between the cathode and suppressor grid.
The operating constants of a valve of this type giving a power output of 100 w (with an anode voltage of 750 v) are discussed and the characteristic curves are shown. It is stated that valves of this type, not requiring special neutralising circuits, could be built for any power output up to several hundred kilowatts, in which case water-cooled anodes would have to be used.
138. DEVELOPMENT OF A 20-KILOWATT ULTRA-HIGH-FREQUENCY TETRODE FOR TELEVISION SERVICE [Two in Push-Bell deliver 40 kW Peak Power at 56 Mc/s into Circuit of 8 Mc/s Band Width: Electrical Design, Construction, Test Equipment & Results].—Haef, Nergaard, & others. (*Proc. Inst. Rad. Eng.*, Sept. 1939, Vol. 27, No. 9, pp. 610-611: summary only.)
139. SUPERHETERODYNE FIRST-DETECTOR CONSIDERATIONS IN TELEVISION RECEIVERS [Comparison of Signal/Noise Ratio, Gain, etc., of Three Valves (built around Identical Cathodes) designed for the Three Main Methods of Frequency Conversion: Conclusions for the Case (Commonest at Present) where No R.F. Stage precedes the First Detector].—E. W. Herold. (*Proc. Inst. Rad. Eng.*, Sept. 1939, Vol. 27, No. 9, p. 612: summary only.)

140. EXTREMELY BRIGHT SPOTS ON A COOLIDGE-TUBE TARGET [due to Electronic Bombardment of Minute Protrusions from Target Surface: Similar Appearances with Multi-Segment Magnetrons and Farnsworth Cold-Cathode Multiplier].—I. Koga & M. Tatabana: J. Forman. (*Nature*, 16th Sept. 1939, Vol. 144, p. 511.)
141. THE ELECTROSTATIC ELECTRON MULTIPLIER [with Electrodes Shaped & Positioned to give Accurate Focusing (without Magnet) and to minimise Space-Charge Limitations: Determination of Trajectories: Successful Preliminary Results (Linear Staggered, Partition, & Circular Types)].—Zworykin & Rajchman. (*Proc. Inst. Rad. Eng.*, Sept. 1939, Vol. 27, No. 9, pp. 558-566.) A summary was dealt with in 3689 of 1938.
142. THE RESIDUAL [Dark] CURRENT IN ELECTROSTATIC ELECTRON MULTIPLIERS.—J. Rajchman. (*Arch. des Sci. Phys. et Naturelles*, 5th Period, Vol. 20, Sept./Dec. 1938: mentioned in 141, above.)
143. SECONDARY ELECTRONS AND SECONDARY-ELECTRON MULTIPLIERS: PART II [Continuation of Survey, including the "Initial-Current-Controlled" Multiplier of Weiss & Peter].—O. Peter. (*Funktech. Monatshefte*, Sept. 1939, No. 9, Supp. pp. 65-68). Continued from 4455 of 1939. For the writer's multiplier see 1466 of 1939.
144. SECONDARY-ELECTRON EMISSION UNDER THE ACTION OF TWO ELECTRON BEAMS.—Kushnir & Milyutin. (See 210.)
145. THE SECONDARY-ELECTRON EMISSION FROM THIN DIELECTRIC LAYERS.—Vudynski. (See 211.)
146. EMISSION OF SECONDARY ELECTRONS AND CHARGING PHENOMENA AT INSULATORS [under Electron Impact: Negative Space-Charge Film below Surface: Surface Positive or Negative according to Velocity of Electrons: Secondary Electron Yield dependent on State of Charge of Insulator: Probable Connection of Charge Films with Secondary Electron Emission Phenomena].—H. Hintenberger. (*Zeitschr. f. Physik*, No. 1/2, Vol. 114, 1939, pp. 98-109.)
147. THEORY OF SECONDARY EMISSION [Quantum-Mechanical Treatment of Its Production by Interaction of Bombarding Electrons with Valence Electrons of a Metal Target: Consideration of Relative Rates of Absorption of Primary and Secondary Particles gives Results agreeing with Experiments].—D. E. Wooldridge. (*Phys. Review*, 15th Sept. 1939, Series 2, Vol. 56, No. 6, pp. 562-578.)
148. SECONDARY ELECTRON EMISSION: PART VI—THE INFLUENCE OF EXTERNALLY ADSORBED IONS AND ATOMS ON THE SECONDARY ELECTRON EMISSION OF METALS.—J. H. de Boer & H. Bruining. (*Physica*, Oct. 1939, Vol. 6, No. 9, pp. 941-950: in English.) For previous parts see 4456 of 1939.
149. ENERGY DISTRIBUTION OF LOW-TEMPERATURE SECONDARY ELECTRONS [Experimental Results for Ordinary Temperatures compared with Those at Temperature of Liquid Oxygen: Three Electron Groups: Their Probable Origins].—A. Bojinesco. (*Comptes Rendus*, 25th Sept. 1939, Vol. 209, No. 13, pp. 512-513.)
150. THE SECONDARY-ELECTRON EMISSION OF PURE METALS IN THE UNORDERED AND ORDERED STATE [of the Metal Atomic Lattice: Yield in Unordered greater than in Ordered State], and THE INFLUENCE OF ADSORBED OXYGEN ON THE SECONDARY-ELECTRON EMISSION OF PURE METALS AT 83° AND 293° ABS.—R. Suhrmann & W. Kundt. (*Naturwiss.*, 11th Aug. 1939, Vol. 27, No. 32, p. 548.)
151. "THEORY AND APPLICATIONS OF ELECTRON TUBES" [Reply to Book Review].—H. J. Reich. (*Wireless Engineer*, Nov. 1939, Vol. 16, No. 194, p. 556.)
152. SIGNAL-HANDLING CAPACITY OF H.F. VALVES: A METHOD OF MEASUREMENT ["Almost as Easy as Plotting a Static Characteristic": based on Relation between the Envelope Distortion due to Curvature of Characteristic and the Production of Carrier Third Harmonic].—R. W. Sloane. (*Wireless Engineer*, Nov. 1939, Vol. 16, No. 194, pp. 543-547.) From the M.O. Research Staff.
153. A DYNAMIC VALVE TEST SET [Accurate, Simple, & Safe Method for Medium & Large Amplifying, Modulating, & Transmitting Valves: the "Wheatcroft Effect" of some C-R-Oscillograph Tubes, and the Necessity of Avoiding It].—K. A. Macfadyen & B. L. Day. (*Journ. of Scient. Instr.*, Oct. 1939, Vol. 16, No. 10, pp. 324-331.)
154. DIODE OPERATING CONDITIONS [Analysis on Simplifying Assumption of Vertical Straight Characteristics (Load Resistance Very Large): Response Curve "Flutter" or "Not Flutter" than That of Tuned Circuit alone, according as Bias is Positive or Negative: Conditions for Distortionless Rectification for All Carrier Values: etc.].—W. P. N. Court. (*Wireless Engineer*, Nov. 1939, Vol. 16, No. 194, pp. 548-555.)
155. HOW TO FIGURE GRID-BIAS REQUIREMENTS [for Transmitting Valves, when Grid-Leak, Fixed & Grid-Leak, or Cathode Bias is employed].—H. Selvidge. (*QST*, Oct. 1939, Vol. 23, No. 10, pp. 24-26 and 41.)
156. THE EFFECT OF THE INPUT IMPEDANCE OF A VALVE ON THE FREQUENCY CHARACTERISTIC OF A TUNED AMPLIFIER.—Chistyakov. (See 58.)
157. NEW RCA VALVES [Types 6K8 and RCA-957, 958, & 959].—N. P. Brailo. (*Izvestiya Elektroprom. Slab. Toka*, No. 6, 1939, pp. 50-53.)

158. NEW METHOD OF RATING TRANSMITTING TUBES [New RCA Dual Ratings, "CCS" (Continuous Commercial Service) and "ICAS" (Intermittent Commercial & Amateur Service)].—(*QST*, Nov. 1939, Vol. 23, No. 11, pp. 48 and 92, 94.)

159. THE PRODUCTION OF BARIUM AND ITS USE IN VACUUM TECHNIQUE.—S. P. GvozdoV. (*Izvestiya Elektroprom. Slab. Toka*, No. 7/8, 1939, pp. 86-89.)

The use of barium as a getter is discussed and a report presented on a method developed in Russia for obtaining barium. The method is similar to that proposed by Güntz.

160. IMPROVED GLASS STRAIN ANALYSER [using Polaroid Sheets].—(*Gen. Elec. Review*, Oct. 1939, Vol. 42, No. 10, p. 452.)

DIRECTIONAL WIRELESS

161. BLIND LANDING FOR AIRPLANES [and the Problem facing the Nat. Acad. of Sci. Committee in Selecting a Standard American System].—(*Science*, 20th Oct. 1939, Vol. 90, Supp. p. 6.) The various systems from which the choice must be made include the Air Track, Army, Bendix, I.T.D., Lorenz, M.I.T.-Metcalf, and Navy (Dingle system, using very long waves).

162. CATHODE-RAY TUBES IN AIRCRAFT INSTRUMENTATION [including Multiple Indications on Single Screen: Blind-Landing and Radio-Range Systems: etc.].—C. W. Carnahan. (*Proc. Inst. Rad. Eng.*, Sept. 1939, Vol. 27, No. 9, p. 609: short summary only.)

163. AIRCRAFT RADIO COMPASSES—PRINCIPLES AND TESTING [U.S. Army Compasses and Technique].—R. J. Framme. (*Proc. Inst. Rad. Eng.*, Sept. 1939, Vol. 27, No. 9, p. 610: summary only.) For an earlier paper see 3712 of 1937.

164. ERRORS IN CLOSED-LOOP DIRECTION FINDERS CAUSED BY ABNORMAL POLARISATION [Not Directly Calculable from Theory: Empirical Formula].—R. I. Cole. (*Proc. Inst. Rad. Eng.*, Sept. 1939, Vol. 27, No. 9, p. 609: short summary only.)

165. THE CALCULATION OF THE SENSITIVITY OF A VISUAL RADIO DIRECTION FINDER.—G. P. Astaf'ev. (*Izvestiya Elektroprom. Slab. Toka*, No. 6, 1939, pp. 18-25.)

The principles underlying the operation of a visual radio direction finder are discussed in detail and formulae are derived for determining the meter deflection when the meter is (a) of the electrodynamic type (18), and (b) of the d.c. type (19). A conception is then introduced of the "sensitivity modulus" of a direction finder, equal to the ratio of the field intensity to the meter deflection corresponding to the rotation of the loop aerial through an angle of 1° from the zero position. Various stages of the design work of a direction finder are also set out.

166. A TRUE OMNIDIRECTIONAL RADIO BEACON [Signal on Any Azimuth distinguishable from Equal-Powered Signal on Any Other: Adaptor for Any Communication Receiver].—E. N. Dingley, Jr. (*Proc. Inst. Rad. Eng.*, Sept. 1939, Vol. 27, No. 9, pp. 609-610: summary only.)

ACOUSTICS AND AUDIO-FREQUENCIES

167. ON THE ACTION OF AUTOMATIC DEVICES FOR CONTROLLING SOUND INTENSITY.—B. S. Galperin. (*Journ. of Tech. Phys.* [in Russian], No. 4, Vol. 9, 1939, pp. 315-320.)

The operation of sound compressors is discussed, and certain advantages of the systems utilising the output voltage as the controlling factor (over the systems utilising the input voltage) are pointed out. A conception is introduced of "regulating functions" illustrating the process of regulation, and a graphical method is suggested for determining the compression coefficient (the ratio of primary and secondary dynamic ranges of sound) for any point of the amplitude characteristic of the amplifier.

168. A PHASE-SHIFTING DEVICE FOR THE RAPID DETERMINATION OF AUDIO-FREQUENCY AMPLIFIER CHARACTERISTICS [used with Beat-Frequency Oscillator & C-R Oscilloscope to determine Frequency Range over which the Gain is Constant within Some Allowed Variation].—K. Spangenberg & W. Palmer. (*Proc. Inst. Rad. Eng.*, Sept. 1939, Vol. 27, No. 9, pp. 555-558.)

169. ANALYSIS OF VARYING SOUND [Photographic Method of Frequency Analysis using Special Analysing Plate].—K. Imahori. (*Nature*, 21st Oct. 1939, Vol. 144, p. 708.)

170. CLASS B AUDIO-FREQUENCY AMPLIFICATION.—Gordon. (*See* 60.)

171. THE USE OF FEED-BACK AT AUDIO FREQUENCIES.—Kotlov. (*See* 94.)

172. WRINKLES IN RECORDING [on Acetate & Nitrocellulose Discs: Effects of Weather and Operator's "Personal Whims": etc.].—R. B. Jacques. (*Proc. Inst. Rad. Eng.*, Oct. 1939, Vol. 27, No. 10, p. 682: summary only.)

173. SPECIFIC HEAT OF A SUBSTANCE SHOWING SPONTANEOUS ELECTRIC POLARISATION, and HEAVY-WATER ROCHELLE SALT.—Mendelsohn: Holden & others. (*See* 252 & 253.)

174. VIBRATIONS OF FREE SQUARE PLATES: I—NORMAL VIBRATING MODES [Nodal Systems divided into Seven Classes: Natural Frequencies agree with Ritz's Calculations: Photographs of Experimental Vibrations].—M. D. Waller. (*Proc. Phys. Soc.*, 1st Sept. 1939, Vol. 51, Part 5, No. 287, pp. 831-844.)

175. THE STABILITY OF THE SOUND EMITTED BY A TUBE WITH A BEATING REED UNDER A CONSTANT PRESSURE [Experiments showing Jump from Tube Fundamental to Reed Frequency at Certain Pressure: Return Jump at Lower Pressure].—L. Auger. (*Comptes Rendus*, 25th Sept. 1939, Vol. 209, No. 13, pp. 508-509.)

176. CONSTANT IMPEDANCE EQUALISERS: SIMPLIFIED METHOD OF DESIGN AND STANDARDISATION.—F. Pyrah. (*P.O. Elec. Eng. Journ.*, Oct. 1939, Vol. 32, Part 3, pp. 204-211.)
177. A THYRATRON INFLECTION INDICATOR FOR TEACHING THE DEAF [giving Column of Light which Rises & Falls with Rising & Falling Pitch].—T. A. Sterne & H. J. Zimmermann. (*Journ. of Scient. Instr.*, Oct. 1939, Vol. 16, No. 10, pp. 334-336.)
178. NEW APPROACHES TO THE SCIENCE OF VOICE.—C. E. Seashore. (*Scient. Monthly*, Oct. 1939, Vol. 49, No. 4, pp. 340-350.)
179. THE UPPER FREQUENCY LIMIT FOR THE BINAURAL LOCALISATION OF A PURE TONE BY PHASE DIFFERENCE [lies between 1300 & 1500 c/s].—J. W. Hughes. (*Proc. Roy. Soc., Series A*, 23rd Aug. 1939, Vol. 172, No. 950, p. S90: abstract only.)
180. A NEW ELECTRICAL MUSICAL INSTRUMENT: THE "STORYTONE."—(*Scient. American*, Nov. 1939, Vol. 161, No. 5, pp. 294 and 295.) Developed by RCA engineers in collaboration with craftsmen of the Story & Clark Piano Company.
181. APPROXIMATE VALUES FOR THE CALCULATION OF TEMPERED NOTE FREQUENCIES, AND THEIR APPLICATION TO THE DRIVE OF FULLY-ELECTRIC [Rotating-Generator] ORGANS.—F. Trautwein. (*Akust. Zeitschr.*, July 1939, Vol. 4, No. 4, pp. 261-262.)
182. ELECTRONIC CHURCH CHIMES.—F. Dostal. (*Electronics*, Aug. 1939, Vol. 12, No. 8, pp. 18-19.)
183. ELECTRICAL MUSICAL INSTRUMENTS [Survey].—A. Ferrari-Toniolo. (*Boll. del Centro Volpi di Elett.*, English Edition, July/Sept. 1938, Year 1, No. 3, p. 95d.)
184. THEORY AND PRACTICE OF THE EXCITATION OF PIANO STRINGS: I.—N. Jakovlev. (*Journ. of Tech. Phys.* [in Russian], No. 4, Vol. 9, 1939, pp. 321-328.)
185. NOTES ON THE GENERAL THEORY OF IMPACT OF AN ELASTIC HAMMER ON A FINITE PIANOFORTE STRING.—Ghosh. (*Sci. & Culture*, Calcutta, Aug. 1939, Vol. 5, No. 2, pp. 132-133.)
186. THE THEORY OF ACOUSTIC RADIATION PRESSURE.—C. Schaefer. (*Ann. der Physik*, Series 5, No. 6, Vol. 35, 1939, pp. 473-491.)
The calculations here given, based on the fundamental hydrodynamical equations, lead to the conclusions that "(1) for sufficiently weak but yet finite acoustic oscillations the acoustic pressure is equal to the energy density, a result contrary to a much-quoted result of Rayleigh; (2) for very strong acoustic oscillations the theory of acoustic pressure must take into account the discontinuities which occur."
187. A NEW STANDARD VOLUME INDICATOR AND REFERENCE LEVEL.—Chinn, Gannett, & Morris. (*Proc. Inst. Rad. Eng.*, Sept. 1939, Vol. 27, No. 9, p. 609: short summary only.)
See also 1957 & 4529 of 1939.
188. ACOUSTIC TREATMENT AND MEASUREMENTS OF THE NEW BOMBAY STUDIOS OF ALL-INDIA RADIO.—N. L. Sahdev. (*Electrotechnics*, Bangalore, Aug. 1939, No. 12, pp. 64-76.)
189. AN ARRANGEMENT FOR REGULATING THE ACOUSTIC PROPERTIES OF ROOMS [Walls and Ceiling covered with Plates at a Distance from Them: Plates can vibrate with Adjustable Frequencies and Attenuation, to match Character of Music, etc.].—W. Oelsner. (*Hochf. tech. u. Elek. akus.*, Sept. 1939, Vol. 54, No. 3, p. 105: Industry Review: Brit. Pat. No. 496 384.)
190. THE FILTRATION OF SOUND IN NON-HOMOGENEOUS MEDIA [Analysis on Assumption of Gradual, instead of Abrupt, Transition of Acoustical Properties: No Selective Filtration].—R. B. Lindsay. (*Science*, 3rd Nov. 1939, Vol. 90, p. 409: summary only.)
191. "THE REDUCTION OF NOISE IN BUILDINGS" [Book Review].—Davis & Morreau. (*Engineering*, 27th Oct. 1939, Vol. 148, pp. 474-475.)
192. TRANSMISSION OF [Supersonic] SOUND THROUGH THIN PLATES [Experiments with Wavelengths of Order of 1 mm].—F. H. Sanders. (*Canadian Journ. of Res.*, Sept. 1939, Vol. 17, No. 9, Sec. A, pp. 179-193.)
193. DISPERSION AND SELECTIVE ABSORPTION IN THE PROPAGATION OF ULTRASOUND IN FLUIDS CONTAINED IN TUBES [and the Influence of Wall Rigidity].—G. S. Field. (*Canadian Journ. of Res.*, Oct. 1939, Vol. 17, No. 10, Sec. A, pp. 197-201.)
194. AN EFFICIENT PIEZOELECTRIC OSCILLATOR [More than 40% of Valve-Anode Input transformed into Ultrasonic (500 kc/s) Vibrations in Oil Bath surrounding Quartz Plate].—W. W. Salisbury & C. W. Porter. (*Review of Scient. Instr.*, Sept. 1939, Vol. 10, No. 9, pp. 269-270.)
195. THE INFLUENCE OF THE ANGLE OF INCIDENCE OF LIGHT ON THE DIFFRACTION OF LIGHT BY SUPERSONIC WAVES [Minimum in Curve of Intensity as Function of Angle of Incidence: Disappearance on Decrease of Certain Parameters: Experimental Curves].—E. A. Neumann. (*Proc. Phys. Soc.*, 1st Sept. 1939, Vol. 51, Part 5, No. 287, pp. 794-802.)
196. THE POSSIBILITY OF THE FORMATION OF ACOUSTIC IMAGES IN ANALOGY TO OPTICS: THE PROBLEM OF VISION THROUGH OPAQUE MEDIA ["Sound Optics," based on the Image-Forming Properties of Acoustic Waves: Examples: Experimental Test of Resolving Power using Images formed by Grid: Sound Image made Visible on Flat Cell containing Suspension of Aluminium Particles].—R. Pohlman. (*Zeitschr. f. Physik*, No. 11/12, Vol. 113, 1939, pp. 697-709.) For the principle of the suspension used to make sound waves visible see 1051 of 1938.

197. ABSORPTION OF SUPERSONIC WAVES IN WATER AND IN AQUEOUS SUSPENSIONS, AND THE DISPERSION OF SUPERSONIC WAVES IN CYLINDRICAL RODS OF POLYCRYSTALLINE SILVER, NICKEL, AND MAGNESIUM.—Hartmann & Focke: Shear & Focke. (*Phys. Review*, 15th July 1939, Series 2, Vol. 56, No. 2, p. 217; p. 217: abstracts only.)
198. ASYMPTOTIC PROPERTIES OF THE FUNDAMENTAL FUNCTIONS IN THE PROBLEM OF THE VIBRATIONS IN AN ELASTIC BODY.—A. Plejfel. (*Arkiv f. Mat., Astr. och Fysik*, No. 5, Vol. 26A, 1939, Paper 19, pp. 1-9.)
199. INTERCRYSTALLINE THERMAL CURRENTS AS A SOURCE OF INTERNAL FRICTION [Experiments with Brass of Varying Grain Size at Three Audio Frequencies: Internal Friction a Maximum at Anticipated Grain Size, confirming Zener's Theory].—R. H. Randall, F. C. Rose, & C. Zener. (*Phys. Review*, 15th Aug. 1939, Series 2, Vol. 56, No. 4, pp. 343-348.) See 1930 (and 3723) of 1938.
200. FORMULA FOR THE CHANGE OF VELOCITY OF SOUND WITH TEMPERATURE [Linear Velocity/Temperature Relation accurate to Three Significant Figures].—A. E. Bate. (*Nature*, 9th Sept. 1939, Vol. 144, p. 479.)
201. SOME NEW REMARKS ON THE SUPERSONIC ANALOGY OF THE ELECTROMAGNETIC FIELD [Auxiliary Role of Supersonic Velocity in Fundamental Equations].—D. Riabouchinsky. (*Comptes Rendus*, 16th Oct. 1939, Vol. 209, No. 16, pp. 587-589.) See 215 of 1939.
202. DETERMINATION OF THE VELOCITY OF SOUND IN A GAS: APPLICATION TO ANALYSIS OF MIXTURES OF HELIUM, OXYGEN, AND NITROGEN.—W. B. Dublin & others. (*Science*, 27th Oct. 1939, Vol. 90, pp. 399-400.)
203. ABSORPTION OF SUPERSONIC WAVES IN MERCURY [Measurements: Deviation from Classical Theoretical Values].—P. Rieckmann. (*Physik. Zeitschr.*, 15th Sept. 1939, Vol. 40, No. 18, pp. 582-590.)
204. DETERMINATION OF THE MOLECULAR RADII OF ORGANIC LIQUIDS FROM VELOCITY OF SOUND AND DENSITY [Theory].—W. Schaaffs. (*Zeitschr. f. Physik*, No. 1/2, Vol. 114, 1939, pp. 110-115.)

PHOTOTELEGRAPHY AND TELEVISION

205. TELEVISION PICK-UP TUBES USING LOW-VELOCITY ELECTRON-BEAM SCANNING [Photoelectric-Beam Scanning & Thermionic-Beam Scanning: Experimental Tubes give Negligible Spurious Signal and High Efficiency (e.g. 71%) & Output].—A. Rose & H. Iams. (*Proc. Inst. Rad. Eng.*, Sept. 1939, Vol. 27, No. 9, pp. 547-555.)

A low-velocity beam is defined as one in which the velocity is too low to produce a secondary emission ratio at the target greater than unity. Such a beam (10-volt beams are mentioned) has

certain disadvantages which have had to be overcome: thus a uniform axial magnetic field is used to form the electrons into tight spirals about the axis, guiding and focusing the beam near the target.

206. RECENT IMPROVEMENTS IN THE DESIGN AND CHARACTERISTICS OF THE ICONOSCOPE [Improvements in Envelope, Gun, & Mosaic: Extra Sensitivity & Improved Spectral Response by Processing the Mosaic: Improved Methods of Measuring the Signal Output, "Dark Spot," Emission, Resolution, etc.].—James & Hickok. (*Proc. Inst. Rad. Eng.*, Sept. 1939, Vol. 27, No. 9, pp. 535-540.) A summary was dealt with in 3690 of 1938.
207. THE IMAGE ICONOSCOPE [Electrostatic & Magnetic Types: Advantages besides Increased Sensitivity: Further Developments in Progress].—Iams, Morton, & Zworykin. (*Proc. Inst. Rad. Eng.*, Sept. 1939, Vol. 27, No. 9, pp. 541-547.) A summary was dealt with in 3690 of 1938.
208. FUNCTION OF ELECTRON BOMBARDMENT IN TELEVISION [in Pick-Up Tubes & Receiving Tubes: Discussion from Engineering Angle].—I. G. Maloff. (*Proc. Inst. Rad. Eng.*, Sept. 1939, Vol. 27, No. 9, p. 614: summary only.)
209. THE ELECTROSTATIC ELECTRON MULTIPLIER, AND THE RESIDUAL [Dark] CURRENT IN ELECTROSTATIC ELECTRON MULTIPLIERS.—Zworykin & Rajchman: Rajchman. (See 141 & 142.)
210. SECONDARY-ELECTRON EMISSION UNDER THE ACTION OF TWO ELECTRON BEAMS.—Yu. M. Kushnir & I. Milyutin. (*Journ. of Tech. Phys.* [in Russian], No. 4, Vol. 9, 1939, pp. 267-270.)

A report on experiments to determine the effect of two electron beams of different velocities, acting simultaneously, on the secondary emission from the following surfaces:—(a) Ag, (b) Ag₂O, and (c) Ag-Cs₂O-Cs. The apparatus used is described and experimental curves are shown. It appears that with the Ag surface the effects of two electron beams are additive, while with the Ag₂O and Ag-Cs₂O-Cs surfaces there is a decrease in the total secondary emission.

211. THE SECONDARY-ELECTRON EMISSION FROM THIN DIELECTRIC LAYERS.—M. M. Vudynski. (*Journ. of Tech. Phys.* [in Russian], No. 4, Vol. 9, 1939, pp. 271-274.)

For previous work see 4480 of 1938. Thin layers of NaCl and KCl were deposited on the surface of a metal cup, which could be heated from inside, and the secondary-electron emission was observed for various thicknesses and at different temperatures of these layers. Experimental curves are shown, and it appears that the secondary emission reaches a maximum when the thickness of the layer is increased up to 10⁻⁶ cm, but does not exceed that which is obtained with layers of normal thickness. The effect of raising the temperature of the layer (up to 200-250°C) is more complex, but the main conclusion reached is that this does not increase considerably the secondary emission. A theoretical discussion of the results obtained is given.

212. THE BINDING OF STOICHIOMETRICALLY SURPLUS SODIUM IN NaCl CRYSTALS WITH ADDED SrCl₂ [Measurements on Absorption Centres].—H. Pick. (*Zeitschr. f. Physik*, No. 1/2, Vol. 114, 1939, pp. 127-132.)
213. CRYSTALLISATION BY PULVERISATION [in connection with Selenium].—Dekeyser & Prins. (*Physica*, Oct. 1939, Vol. 6, No. 9, pp. 1009-1010; in French.) Prompted by the results of Das & Gupta, 2012 of 1939.
214. PHOTOVOLTAGE AT THE ELEMENT METAL/SEMICONDUCTOR/METAL: V—EXPERIMENTS ON POLYCRYSTALLINE SAMPLES OF CUPROUS OXIDE AT LOW TEMPERATURES.—G. Mönch. (*Ann. der Physik*, Series 5, No. 1, Vol. 36, 1939, pp. 1-8.) Details of the experimental arrangements and observational data of experiments referred to in 795 of 1936.
215. THE INFLUENCE OF THE ANGLE OF INCIDENCE OF LIGHT ON THE DIFFRACTION OF LIGHT BY SUPERSONIC WAVES.—Neumann. (See 195.)
216. THE INFLUENCE OF HINDERED ROTATION AND THE ANISOTROPY OF THE INTERNAL FIELD ON THE POLARISATION OF LIQUIDS: CONTRIBUTION TO THE MOLECULAR THEORY OF POLARISATION AND OF ARTIFICIAL DOUBLE REFRACTION IN LIQUIDS AND SOLUTIONS [with Reference to the Kerr Effect and Data for Nitrobenzol].—A. Peterlin & H. A. Stuart. (*Zeitschr. f. Physik*, No. 11/12, Vol. 113, 1939, pp. 663-696.)
217. A THEORY OF ELECTRIC POLARISATION, ELECTRO-OPTICAL KERR EFFECT, AND ELECTRIC SATURATION IN LIQUIDS AND SOLUTIONS.—A. Piekara. (*Proc. Roy. Soc.*, Series A, 23rd Aug. 1939, Vol. 172, No. 950, pp. 360-383.)
218. A NEW ELECTRO-OPTICAL EFFECT [shown by Bentonite Colloids: Dependence of Birefringence on Strength and Frequency of Acting Field: Possible Explanation by Superposition of Normal Positive Kerr Effect and New Effect causing Negative Birefringence].—H. Mueller & B. W. Sakmann. (*Phys. Review*, 15th Sept. 1939, Series 2, Vol. 56, No. 6, pp. 615-616.) Extension of results referred to in 2874 of 1939.
219. RASTER SHAPES WITH DOUBLE MAGNETIC DEFLECTION OF THE ELECTRON BEAM IN WIDE-ANGLE CATHODE-RAY TUBES.—J. Günther. (*Zeitschr. der Fernseh A.G.*, April 1939, Vol. 1, No. 3, pp. 88-94.)

Graphical treatment of the raster shape to be expected from two homogeneous magnetic fields at right angles to each other in the same space, and comparison with what would be obtained by the "usual" formula (eqn. 2) and by the "less known but more accurate formula" (eqn. 5, for flat screen) of Deserno (1523 of 1935): even the latter is inaccurate for the large deflecting angles in question. The writer derives an improved formula (eqn. 8; in full, eqn. 9) and then considers the case when the two fields are not in the same space but in successive equal spaces, without inter-penetration, obtaining

eqns. 12 & 13 for the total deflections in the two directions; these lead to a raster with "pin-cushion" distortion.

The rest of the paper deals with actual practice, where the distortion is smaller than that calculated, owing to the delimitation of the two fields being less perfect than the ideal. Air-cored coils are first considered, and the modifications in their design made necessary by the large deflection-angles now required, leading to the coil shape seen in Fig. 6: it is shown that the resulting increase of the edge field H_e compared with the main deflecting field H_R has a good effect in reducing the pin-cushion error by tending to produce a counteracting rounded ("life-buoy") raster shape and also by improving the proportionality of deflection to deflecting field. If, however, a second air-cored coil is used for the deflection in the second direction, this compensation of distortions is not so good (l-h column of p. 92). Finally the use of iron-cored coils is dealt with in considerable detail. Here the edge-field effect is so strong that the danger is over-compensation and production of "life-buoy" distortion.

By the use of air-cored coils for the horizontal deflection and an iron-cored coil for the vertical (Fig. 7, where the edge-field effect on the ray for two alternative positions of the iron-cored coil with respect to the air-cored coils is seen), distortion can be avoided for the vertical sides of the raster. The remaining problem, the correction of the horizontal error, is discussed in the r-h column of p. 93 onwards. The methods illustrated in Figs. 11/13 have the defect that by their distortion of the main field they upset the vertical compensation already attained. A successful method is shown in Fig. 14, where the stray field of a coil on the iron core is utilised to strengthen the field only between $CC'D'$. The "correcting" laminations seen here at the ends of the core limbs have the same effect. Such an arrangement is illustrated in Fig. 3 of Mulert & Bähring's paper (220, below). In his final paragraph the writer mentions the possibility of an "elegant solution" for raster-distortion elimination based on a modification of the arrangement shown in Fig. 11 which should tend to produce "life-buoy" distortion on all four raster sides, thus compensating the "pin-cushion" distortion. In all cases the importance is stressed of keeping the ray as fine as possible when passing through the deflecting fields, to avoid spot distortion at the edges (Deserno, *loc. cit.*, and Schwartz, 1580 of 1939).

220. TRANSFORMER "KIPP" DEVICES [as used in the Lorenz "Small Receiver" DE 7, etc.].—T. Mulert & H. Bähring. (*Zeitschr. der Fernseh A.G.*, April 1939, Vol. 1, No. 3 pp. 82-88.)

Authors' summary:—By a representation of the various currents and voltages, the mode of action of the inductively back-coupled relaxation-oscillation generator is described. The magnitude of the damping of the associated oscillatory circuit determines whether short pulses ("blocking oscillator") or saw-tooth currents are obtained. In the production of the latter the valve acts as a switch; grid and anode d.c. voltages are switched, through the appropriate internal resistances, to the deflecting inductance. The saw-tooth generator has the best efficiency if, as nearly as possible, only grid current

is flowing during the first half-period and as nearly as possible only anode current during the second half period. Finally the question of synchronisation is examined, and various circuits for this are given.

221. THE HISTORICAL DEVELOPMENT OF THE INTERLACED SCANNING METHOD: III—INTERLACED SCANNING OF SOUND FILMS.—F. Raeck. (*Funktech. Monatshefte*, Aug. 1939, No. 8, Supp. pp. 60-64.) Continued from 4576 of 1939.

222. THE PRODUCTION OF THE SYNCHRONISING PULSES FOR INTERLACED SCANNING ACCORDING TO THE "AUXILIARY SIGNAL" SYSTEM.—J. Schunack. (*Zeitschr. der Fernseh A.G.*, April 1939, Vol. 1, No. 3, pp. 98-102.)

The writer begins by describing the pulse "mixture" necessary for the transmission of the standard German synchronising signals. Mechanical methods of production are dismissed, for the time being, in one paragraph, and the writer then concentrates on the electrical method. In practice the following errors are liable to occur (and not merely to occur but to vary continuously) in a single-channel system:—the frame-change pulse may not coincide with the beginning and middle of the line (as alternate pulses should do); the line-synchronising pulse will not "get through" if the frame-change pulse arrives before its start—*i.e.*, the frame-change pulse, arriving too early, will produce a line change. If, on the other hand, the f.c. pulse arrives during a l.c. pulse, it will have different lengths for the two half-pictures, and the interval between its rear edge and the beginning of the following "satellite" pulse ("Trabant" signal, Fig. 2d) will be different for the two half-pictures; moreover, the "satellite" changes its length for a half-raster directly the frame change does not coincide with the beginning or middle of a line. Remedies based on separating the frame and line pulses at the receiver, by the "rear-edge" process, lead to "pairing" of the combined whole raster, with consequently increased flicker.

"The above defects can be not only diminished but fundamentally eliminated by the system with 'auxiliary signal' described below." In this new system (Figs. 7 & 8), as in the old (Fig. 3), the primary pulse frequency is double the line frequency, but the line-change frequency obtained by halving it (Fig. 7b) is now utilised only indirectly. Thus if, as drawn, it comes "late" out of the frequency divider, the effect of this lag is not felt, because this halved pulse-frequency is converted into a sine wave (Fig. 7c) on which the original frequency "a" is superposed, the only use of the halved frequency being to enable the alternate "a" pulses to be chopped off, yielding a pulse series "d" of half frequency and rigidly in phase with the original "a" series. A similar process provides the frame-change signals; application to the single-channel German standard system, with the necessary "main picture impulse" and its "satellite," is described in the r-h column of p. 101. Finally the writer returns to the mechanical methods and points out that the system described offers the possibility of improving these methods also. The theoretical conclusions have been confirmed by many tests on both the electrical and mechanical methods.

223. THE LOSS ANGLE OF THE VOLTAGE-REGULATED CAPACITANCE [for Frequency Modulation, Synchronising-Signal Regulation, etc.].—Thon. (See 44.)

224. SEPARATING FILTERS.—Piloty. (See 46.)

225. THE TRANSMISSION AND RECEPTION OF THE D.C. COMPONENT IN TELEVISION.—S. V. Novakovski. (*Izvestiya Elektroprom. Slab. Toka*, No. 6, 1939, pp. 26-40.)

The importance of the lowest frequencies (d.c. component) for improving the quality of televised images is discussed, and a comparison is made between the methods used for transmission and reception of these frequencies in the U.S.A. and Great Britain.

226. A THEORETICAL ANALYSIS OF SINGLE-SIDEBAND OPERATION OF TELEVISION TRANSMITTERS [Factors involved in Design of Power Valve for Television, and the Balance to be struck between Them: Effects, on Image, of Detuning to give Partial Suppression of One Sideband and Increase of Width of Other: Unfavourable Conclusions].—L. S. Nergaard. (*Proc. Inst. Rad. Eng.*, Oct. 1939, Vol. 27, No. 10, pp. 666-677.)

227. TRANSIENT RESPONSE IN TELEVISION [as Criterion for Quality of Amplifiers: Calculated Curves for Single & Cascaded Networks: Use of "Cathode-Follower" Stages or Staggered Circuits: Manipulation of Time-Delay Curve: Single-Sideband Systems and the Unpromising Possibilities of eliminating Distortion due to Sideband-Suppressing Filters: etc.].—H. E. Kallmann. (*Proc. Inst. Rad. Eng.*, Sept. 1939, Vol. 27, No. 9, p. 613: summary only.)

228. VESTIGIAL-SIDEBAND FILTER FOR USE WITH A TELEVISION TRANSMITTER [between Power Amplifier and Aerial, to suppress Lower Sidebands (beyond 0.75 Mc/s from Carrier) which are outside Prescribed Channel].—G. H. Brown. (*Proc. Inst. Rad. Eng.*, Sept. 1939, Vol. 27, No. 9, p. 608: summary only.)

229. DEVELOPMENT OF A 20-KILOWATT ULTRA-HIGH-FREQUENCY TETRODE FOR TELEVISION SERVICE.—Haefl, Nergaard, & others. (See 138.)

230. THE TELEVISION TRANSMITTING EQUIPMENT OF THE EIAR IN ROME [Film Scanner and Stage Camera with Storage-Type Pick-Up, and Associated Equipment, all by Fernseh A.G.].—J. Schunack. (*Zeitschr. der Fernseh A.G.*, April 1939, Vol. 1, No. 3, pp. 102-107.)

231. COMPENSATION OF THE AERIAL REACTANCES OF TELEVISION TRANSMITTERS.—Labus. (See 110.)

232. THE PRESENT STATE OF DEVELOPMENT OF TELEVISION [Summarising Account of the Various Problems, Their Physical Fundamentals and Present Technical Position].—F. Schröter. (*Naturwiss.*, 4th & 11th Aug. 1939, Vol. 27, Nos. 31 & 32, pp. 521-529 & 537-541.)

233. TELEVISION—FACTS AND PROBLEMS [Address at Convention of Cinema Exhibitors Association].—C. H. Bell. (*Journ. Television Soc.*, No. 2, Vol. 3, 1939, pp. 51-54.)
234. THE EFFECT OF NOISE AND INTERFERING SIGNALS ON TELEVISION TRANSMISSION [and Some Tests to determine the Minimum Satisfactory Signal/Noise Ratio].—R. F. J. Jarvis & E. C. H. Seaman. (*P.O. Elec. Eng. Journ.*, Oct. 1939, Vol. 32, Part 3, pp. 193-199.)
Results suggest that in the absence of all other noise random noise would be just visible at a ratio of about 40 db, while a ratio lower than about 28 db cannot be tolerated.
235. SUPERHETERODYNE FIRST-DETECTOR CONSIDERATIONS IN TELEVISION RECEIVERS.—Herold. (*See* 139.)
236. PRODUCTION ALIGNMENT APPARATUS FOR TELEVISION RECEIVERS.—L. J. Hartley. (*Proc. Inst. Rad. Eng.*, Sept. 1939, Vol. 27, No. 9, p. 612 : short summary only.) In the Bridgeport plant of the General Electric Company.
237. RECOMMENDATIONS FOR MARKING OF TELEVISION RECEIVER CONTROLS.—R.M.A. Subcommittee. (*Journ. Television Soc.*, No. 2, Vol. 3, 1939, p. 56.)
238. THE FOUNDATION OF A GERMAN POST OFFICE TELEVISION LIMITED LIABILITY COMPANY ["RFG"].—J. Tritz. (*T.F.T.*, Aug. 1939, Vol. 28, No. 8, pp. 329-330.)
239. THE WIRELESS EXHIBITION, 1939 : A TECHNICAL SURVEY.—(*Wireless Engineer*, Oct. 1939, Vol. 16, No. 193, pp. 500-510.)
240. THE RELEASE OF TELEVISION RECEPTION : CONCERNING THE 16TH GERMAN EXHIBITION, 1939 [including the "Unit" Receiver].—(*Funktech. Monatshefte*, Aug. 1939, No. 8, Supp. pp. 57-59.)
241. THE CORONAVISER, FOR OBSERVING THE SOLAR CORONA BY TELEVISION TECHNIQUE.—Skellert. (*See* 30.)
- MEASUREMENTS AND STANDARDS**
242. THE BEHAVIOUR OF CRYSTAL DETECTORS WITH VERY SHORT [15 mm-0.4 mm] WAVES.—Klumb & Koch. (*See* 87.)
243. THE DIODE AS A FREQUENCY-CHANGER FOR MEASUREMENTS AT ULTRA-HIGH FREQUENCIES [Demonstration of Linearity of Relationship between Amplitudes of High- and Intermediate-Frequency Oscillations : Alternating Potential Differences may be Compared after Frequency Conversion : Calibration of Variable H.F. Attenuator].—G. F. Gainsborough. (*Nature*, 23rd Sept. 1939, Vol. 144, pp. 548-549.)
244. SOME APPLICATIONS OF NEGATIVE FEEDBACK, WITH PARTICULAR REFERENCE TO LABORATORY EQUIPMENT.—Terman & others. (*See* 64.)
245. EQUIPMENT FOR TESTING ELECTRIC INSULATING MATERIALS FOR DIELECTRIC STRENGTH.—H. I. Morgan. (*Gen. Elec. Review*, Oct. 1939, Vol. 42, No. 10, pp. 436-440.)
246. A COIL FOR USE AT RADIO FREQUENCIES [for Laboratory Measurements : using a Ribbon Variant of Litz Wire, Self-Supporting when wound as Disc].—W. H. Ward & E. J. Pratt. (*Wireless Engineer*, Sept. 1939, Vol. 16, No. 192, pp. 453-456.)
247. COIL CHART FOR QUICK REFERENCE [Winding Dimensions for Frequencies from 100 kc/s to about 60 Mc/s].—L. C. Gallagher. (*QST*, Nov. 1939, Vol. 23, No. 11, pp. 28 and 29.)
248. TABLES AND NOMOGRAMS FOR THE CALCULATION OF COILS [Self & Mutual Inductances of Circular-Section Coils with Rectangular Winding Sections : Application to Multi-Section Coils such as H.F. Chokes : Agreement with Measured Values].—J. G. Lang. (*Funktech. Monatshefte*, Aug. 1939, No. 8, pp. 249-255.)
249. A DIRECT-READING WAVEMETER.—H. Straubel. (*Hochf. u. Elek. akus.*, Sept. 1939, Vol. 54, No. 3, pp. 94-96.)
"An automatically reading wavemeter is described, which consists of a constantly rotating condenser and an amplifier circuit [scheme Fig. 1, photographs Fig. 4]. When the condenser passes through resonance, an electrical impulse is emitted and passes via amplifier valves to a rotating-coil instrument. The grid of the last amplifier valve receives an additional alternating voltage which is synchronised with the condenser rotation. Thus the instrument indicates the phase difference between the resonance position of the rotating condenser and the alternating grid voltage, and thus, after previous calibration, gives the wavelength or frequency directly." The sources of error are shortly described (§ III).
250. A SIMPLE FREQUENCY-MONITOR [Frequency Drift due to Heat from Valve practically Eliminated by Use of the New "Dry-Cell" Valves].—H. S. Britt. (*QST*, Nov. 1939, Vol. 23, No. 11, pp. 20-21.)
251. THE BAND-EDGE LOCATOR : A 100 kc/s CRYSTAL-CONTROLLED OSCILLATOR WITH MULTI-VIBRATOR AND AMPLIFIERS.—D. R. Tibbetts.—(*QST*, Oct. 1939, Vol. 23, No. 10, pp. 27-29.)
252. SPECIFIC HEAT OF A SUBSTANCE [Potassium Dihydrogen Phosphate] SHOWING SPONTANEOUS ELECTRIC POLARISATION [like Rochelle Salt : No Anomaly at Lower Curie Point but Strong Anomaly at Higher Curie Point].—J. & K. Mendelssohn. (*Nature*, 30th Sept. 1939, Vol. 144, p. 595.)

253. HEAVY-WATER ROCHELLE SALT [has Different Critical Temperatures and Values of Dielectric Constant & Piezoelectric Constant which Exhibit the Critical Temperatures].—A. N. Holden & others. (*Phys. Review*, 15th Aug. 1939, Series 2, Vol. 56, No. 4, p. 378.)
254. MAGNETIC MEASUREMENTS ON LONG RODS OF CONSIDERABLE CROSS-SECTION MADE OF STEEL AND NEW ALLOYS [Theory: Method: Results: Disturbances of Precision Clocks due to Magnetic Influences].—H. Schmidt-Glenewinkel. (*Physik. Zeitschr.*, 15th Aug. 1939, Vol. 40, No. 16, pp. 519-533.)
255. A PARALLEL-T CIRCUIT FOR MEASURING IMPEDANCE AT RADIO FREQUENCIES [Normal Over-All Range from 500 kc/s to 30 Mc/s].—D. B. Sinclair. (*Proc. Inst. Rad. Eng.*, Sept. 1939, Vol. 27, No. 9, pp. 615-616: summary only.) For Tuttle's paper, here referred to, see 3736 of 1938.
256. A CONSTANT-LOSS IMPEDANCE-TRANSFORMING NETWORK [maintaining Constant Output Impedance & Insertion Loss: embodied in Direct-Reading Transmission-Measuring Set and Amplifier-Power Meter].—Daven Company. (*Proc. Inst. Rad. Eng.*, Oct. 1939, Vol. 27, No. 10, pp. ii and iv.)
257. METHODS AND APPARATUS FOR MEASURING PHASE DISTORTION [including the LMT Automatic Nyquist-Diagram Tracer].—M. Lévy. (*Proc. Inst. Rad. Eng.*, Oct. 1939, Vol. 27, No. 10, p. 682: summary only.)
258. A DYNAMIC VALVE TEST SET.—Macfadyen & Day. (See 153.)
259. SIMPLE METHOD OF MEASURING THE SIGNAL-HANDLING CAPACITY OF H.F. VALVES.—Sloane. (See 152.)
260. MEASURING RADIO-FREQUENCY POWER OUTPUT [Objections to Photometric Method: Use of Calorimetric Method].—R. L. Ebel. (*QST*, Nov. 1939, Vol. 23, No. 11, pp. 63-64 and 102.)
261. ADJUSTMENTS AND TESTS IN THE MASS PRODUCTION OF RADIO RECEIVERS.—Stepura. (See 105.)
262. THERMIONIC TEST SET [for D.C. and A.C. (up to 20 Mc/s) Voltages & Currents: No Calibration Change on Valve Replacement: Negative Feedback].—Salford Elec. Instruments. (*Journ. of Scient. Instr.*, Nov. 1939, Vol. 16, No. 11, p. 357.)
263. ON THE CONSTRUCTION AND OPERATION OF A SIMPLE FORM OF VACUUM ELECTROMETER [with Any Sensitivity up to Limit set by Brownian Motion or Mechanical Vibration].—I. Backhurst. (*Journ. of Scient. Instr.*, Nov. 1939, Vol. 16, No. 11, pp. 347-353.)
264. A NEW METHOD OF MEASURING A.C. VOLTAGES: APPLYING THE CATHODE-RAY OSCILLOSCOPE TO THE SLIDE-BACK VOLTMETER.—G. S. Wachtman. (*QST*, Nov. 1939, Vol. 23, No. 11, pp. 49-53.)
265. AN OSCILLOGRAPHIC TECHNIQUE FOR MEASUREMENTS IN A NETWORK ANALYSER [Two New Methods, based on Use of an "Intermediate Voltage"].—D. M. Myers & W. K. Clothier. (*Journ. I.E.E.*, Nov. 1939, Vol. 85, No. 515, pp. 639-645.) For Clothier's relay switch used in one (the "coincidence") method see 4655 of 1939. The "null" method requires only a small c-r tube and is very accurate.
266. THE COMPENSATION OF TEMPERATURE ERRORS IN MILLIVOLTMETERS; A STUDY OF THE SWINBURNE METHOD FOR MINIMUM ENERGY LOSS.—J. H. Miller & E. M. Underhill. (*Review of Scient. Instr.*, Oct. 1939, Vol. 10, No. 10, pp. 298-303.)
267. THE MOVING-IRON PRECISION MEASURING INSTRUMENT [Calculations of D.C. Errors of Moving-Iron Instruments: Description of New Instrument with Very Small Errors for Direct and Alternating Current Measurements].—H. Toeller. (*Arch. f. Elektrot.*, 15th Sept. 1939, Vol. 33, No. 9, pp. 593-608.)
268. MEASURING INSTRUMENTS: NOTEWORTHY DEVELOPMENTS OF THE PAST YEAR.—R. M. Archer. (*Electrician*, 27th Oct. 1939, Vol. 123, pp. 377-379.) See also *ibid.*, pp. 380-387.
269. A REVIEW OF THE DESIGN AND USE OF POTENTIOMETERS.—D. C. Gall. (*Journ. I.E.E.*, Oct. 1939, Vol. 85, No. 514, pp. 516-523: Discussion pp. 524-530.)
270. COMPARISON OF RESISTANCES OF FOUR TERMINAL RESISTORS [by Single Bridge Method].—A. Glynn. (*Nature*, 30th Sept. 1939, Vol. 144, p. 596.)
271. AN INDUCTION MAGNETOGRAPH [for recording Sudden Changes of Earth's Field: Applicable to Ionospheric Research].—H. Nagaoka & T. Ikebe. (*Electrician*, 20th Oct. 1939, Vol. 123, p. 364: summary only.)

SUBSIDIARY APPARATUS AND MATERIALS

272. SPACE-CHARGE EFFECTS IN ELECTRON BEAMS.—Haefl. (See 127.)
273. ELECTROSTATIC DEFLECTION IN CATHODE-RAY TUBES WITH NON-PARALLEL [Sloping of Bent] DEFLECTING PLATES.—Flechsig. (*Zeitschr. der Fernseh A.G.*, April 1939, Vol. 1, No. 3, pp. 94-97.) The full paper, a summary of which was dealt with in 4643 of 1939.
274. ELECTRON OPTICS [Kerr Memorial Lecture: including Electron Microscopes, Phase Focusing (and the Klystron), and Chronological Survey from 1859].—Myers. (*Journ. Television Soc.*, No. 2, Vol. 3, 1939, pp. 37-49.)
275. A SUPER-MICROSCOPE FOR RESEARCH INSTITUTES.—von Borries & Ruska. (*Naturwiss.*, 25th Aug. 1939, Vol. 27, No. 34, pp. 577-582.)

This instrument is a development of those referred to in 1934 Abstracts, p. 280, and 4078 (see

also 4077 & 4079) of 1938. It is designed in a more compact form and is simpler to handle, so that it does not need constant supervision by electron-optical specialists. A photograph is shown in Fig. 1; Fig. 2 gives a schematic comparison between its construction and that of the optical microscope. The parts of the instrument and its adjustment and use are described in detail. Electron-optical photographs of various inorganic and organic subjects are shown; the applications in colloid chemistry, biology, etc., are indicated.

276. EMISSION OF SECONDARY ELECTRONS AND CHARGING PHENOMENA AT INSULATORS.—Hintenberger. (See 146.)
277. EXTREMELY BRIGHT SPOTS ON A COOLIDGE-TUBE TARGET.—Koga & Tatibana: Forman. (See 140.)
278. FUNDAMENTAL CHARACTERISTICS OF IMAGE FORMATION BY ELECTRONS, AND APPLICATIONS (ELECTRON-MICROSCOPY) [Comprehensive Survey: Three-Dimensional Models of Lenses: Electron Microscopes (including "Raster" Type) and Some Microphotographs].—Hoffmann. (*Kolloid Zeitschr.*, Oct. 1939, Vol. 89, No. 1, pp. 59-76.)
279. CURVATURE OF THE IMAGE FIELD IN MAGNETIC LENSES.—Becker & Wallraff. (*Arch. f. Elektrot.*, 10th Aug. 1939, Vol. 33, No. 8, pp. 491-505.)
- The physical foundations of this curvature are first described (§ I); an apparatus for its experimental investigation (§ II) is shown in Fig. 2. The object point can move continuously along the axis and also in a plane perpendicular thereto. The luminescent image screen can also move along the axis. The results (§ III) are given in the form of tables and figures. Fig. 4 shows the sagittal, medial, and tangential image surfaces; magnetic lenses are astigmatically under-corrected. The field of view of which a satisfactory image can be obtained on a plane is about 6°. The radius of curvature of a spherical approximation to the image surfaces is found. The effects of focal length (§ III.2), distance of stop (§ III.3), lens thickness (§ III.4), and width of stop (§ III.5) are also investigated. Cross-sections of electron-optical astigmatic beams are shown in Fig. 8 and compared with ordinary optical beams (Fig. 9) which are found to be completely analogous, so that it appears quite justifiable to treat electron-optical problems by the methods of geometrical optics.
280. AN ELECTROSTATIC HIGH-VOLTAGE LENS OF SHORT FOCAL LENGTH [All Three Image-Producing Electrodes designed on Principles of High-Voltage Technique: Focal Length 2.5 mm: Constructional Diagrams].—von Ardenne. (*Naturwiss.*, 8th Sept. 1939, Vol. 27, No. 36, pp. 614-615.)
281. THEORY OF IMAGE ERRORS OF THE FIFTH ORDER IN ROTATIONALLY SYMMETRICAL [Optical] SYSTEMS.—Herzberger. (*Journ. Opt. Soc. Am.*, Sept. 1939, Vol. 29, pp. 395-406.)
282. THE TRANSFORMATION OF IMPULSE VOLTAGES [Investigation of the Possibilities of Transforming-Up Impulse Voltages in an Air-Cored Transformer, with the Object of Producing Rapid Electrons]: APPENDIX—CLOUD-CHAMBER OBSERVATIONS OF ELECTRON SCATTERING.—Heuse. (*Zeitschr. f. Physik*, No. 7/8, Vol. 113, 1939, pp. 514-525.)
283. COILS FOR THE PRODUCTION OF A UNIFORM MAGNETIC FIELD.—Lyddane & Ruark. (*Review of Scient. Instr.*, Sept. 1939, Vol. 10, No. 9, pp. 253-257.) Extension of Harris's work, 1182 of 1935.
284. TRANSFORMER "KIPP" DEVICES.—Mullett & Bähring. (See 220.)
285. THE DIELECTRIC LOSSES OF IRRADIATED ZINC-SULPHIDE PHOSPHORS.—Gisolf. (*Physica*, Oct. 1939, Vol. 6, No. 9, pp. 918-928: in English.)
286. ON THE PROPORTIONALITY OF THE LUMINESCENCE OF ZINC-SULPHIDE PHOSPHORS TO THE IRRADIATION AT LOW INTENSITIES [and the Changes in Colour with Change of Intensity: Influence of Temperature: etc.]. Gisolf & Kröger. (*Physica*, Oct. 1939, Vol. 6, No. 9, pp. 1101-1111: in English.) See also Riehl, 2934 of 1939.
287. LUMINESCENCE OF SULPHIDE AND SILICATE PHOSPHORS [Treatment using Mechanism based on Energy-Band Theory of Solid Insulator].—Johnson. (*Journ. Opt. Soc. Am.*, Sept. 1939, Vol. 29, No. 9, pp. 387-391.)
288. FLUORESCENCE AND PHOSPHORESCENCE RESPECTIVELY OF PHOTOGRAPHIC SILVER HALIDE/GELATINE FILMS AT LOW TEMPERATURES [Beginning of Fluorescence coincides with That of Decrease of Photographic Sensitivity].—Meidinger. (*Physik. Zeitschr.*, 15th Aug. 1939, Vol. 40, No. 16, pp. 517-518.)
289. THE OPTICAL PROPERTIES OF SEMI-TRANSPARENT SPUTTERED FILMS DETERMINED BY INTERFERENCE OF LIGHT.—Wathanson & Bartberger. (*Journ. Opt. Soc. Am.*, Oct. 1939, Vol. 29, No. 10, pp. 417-426.)
290. AN OPTICAL SET-UP FOR MEASUREMENT OF BUBBLE-WINDOW THICKNESS.—Green. (*Review of Scient. Instr.*, Sept. 1939, Vol. 10, No. 9, p. 272.)
291. DISTRIBUTION OF CHARGE AND POTENTIAL IN AN ELECTROLYTE BOUNDED BY TWO PLANE INFINITE PARALLEL PLATES [Calculations].—Corkill & Rosenhead. (*Proc. Roy. Soc.*, Series A, 23rd Aug. 1939, Vol. 172, No. 950, pp. 410-431.)
292. A MECHANICAL MODEL ILLUSTRATING THE PRINCIPLE OF THE CYCLOTRON [with Oscillating Horizontal Brass Plates and Steel Ball rolling in Grooves round Them].—Ward. (*Proc. Phys. Soc.*, 1st Sept. 1939, Vol. 51, Part 5, No. 287, pp. 810-816.)

293. FORMATION OF IONS IN THE CYCLOTRON [Measurements of Initial Ionisation: Theory of Electron Oscillation between the Dees].—Wilson. (*Phys. Review*, 1st Sept. 1939, Series 2, Vol. 56, No. 5, pp. 459-463.)
294. A MAGNET-CURRENT STABILISER [Precision Circuit adaptable to Wide Range of Current: Application to Cyclotron & Beta-Ray Spectrometer].—Lawson & Tyler. (*Review of Scient. Instr.*, Oct. 1939, Vol. 10, No. 10, pp. 304-307.)
295. A TWO-STAGE VOLTAGE STABILISER [with Output of 3000-7000 Volts Constant to 0.2-0.5 Volt].—Gill. (*Journ. of Scient. Instr.*, Nov. 1939, Vol. 16, No. 11, pp. 345-347.) Extension of Evans's circuit (I188 of 1935) to 2 stages.
296. "ELEKTRISCHE HÖCHSTSPANNUNG" [Book Review].—Bouwens. (*Journ. of Scient. Instr.*, Aug. 1939, Vol. 16, No. 8, p. 276.)
297. THE PRODUCTION OF BARIUM AND ITS USE IN VACUUM TECHNIQUE.—GvozdoV. (See 159.)
298. IMPROVED GLASS STRAIN ANALYSER [using Polaroid Sheets].—(*Gen. Elec. Review*, Oct. 1939, Vol. 42, No. 10, p. 452.)
299. SEALING PLATINUM TO PYREX GLASS.—Wichers & Saylor. (*Review of Scient. Instr.*, Sept. 1939, Vol. 10, No. 9, pp. 245-250.)
300. A RUBBER-LINED TAPERED VACUUM JOINT [Satisfactory for Diameters as Large as 10 Inches].—Kersten & Chace. (*Review of Scient. Instr.*, Sept. 1939, Vol. 10, No. 9, p. 271.)
301. GASKET FOR SEALS [e.g. for H.T. Insulator with Dielectric in Compression: Blotting Paper superior to Lead].—Williamson: Pockman. (*Review of Scient. Instr.*, Sept. 1939, Vol. 10, No. 9, p. 272.) Prompted by Pockman's design, 2505 of 1939.
302. TWO CONSTANT-PRESSURE DEVICES.—Clow & Shand. (*Journ. of Scient. Instr.*, Nov. 1939, Vol. 16, No. 11, pp. 354-355.)
303. THE INVENTION OF A THERMAL PUMP.—Bush & Rose. (*Science*, 20th Oct. 1939, Vol. 90, Supp. p. 8.)
304. GEISSLER TUBE PROTECTION FOR OIL VAPOUR PUMPS.—Bainbridge & Sherr. (*Review of Scient. Instr.*, Oct. 1939, Vol. 10, No. 10, p. 316.)
305. RAPID MEASUREMENT OF GLASS-CAPILLARY DIAMETERS [used in McLeod Gauges: Standard Twist-Drills satisfactory as Gauges].—Glockler & Horwitz. (*Review of Scient. Instr.*, Sept. 1939, Vol. 10, No. 9, p. 271.)
306. GASEOUS IONISATION AND SURFACE-CORONA-DISCHARGE DETECTION AT LOW AND HIGH FREQUENCIES.—Brown. (See 121.)
307. FOUNDATIONS OF A THEORY OF THE CIRCUITS USED WITH GASEOUS DISCHARGE LAMPS: I—THE WORKING PROPERTIES OF A GASEOUS DISCHARGE LAMP IN SERIES WITH AN OHMIC RESISTANCE ON THE A.C. MAINS NETWORK [Theory, confirmed by Measurements: Suppression of Current Overtones: Efficiency: Circuit suitable for Stroboscopic Effects]: II—THE CUSTOMARY A.C. CIRCUIT: III—THE USE OF VOLTAGE RESONANCE.—Strauch. (*Arch. f. Elektrot.*, 12th July 1939, Vol. 33, No. 7, pp. 465-478: 10th Aug. 1939, No. 8, pp. 505-522: 15th Sept. 1939, No. 9, pp. 561-572.)
308. THE TRANSITION FROM THE GLOW DISCHARGE TO THE ARC DISCHARGE, DUE TO SHORT CURRENT IMPULSES [Experimental Study].—Höfert. (*Ann. der Physik*, Series 5, No. 6, Vol. 35, 1939, pp. 547-576.)
309. THE SUBSIDIARY ELECTRONS PRODUCED BY THE PHOTOELECTRIC EFFECT IN A NON-SELF-SUPPORTING HYDROGEN DISCHARGE [Photoelectrically Active Radiation always present in Such a Hydrogen Discharge: Sudden Increase in Intensity of Discharge explicable by Subsidiary Electrons produced by This Radiation].—Costa. (*Zeitschr. f. Physik*, No. 9/10, Vol. 113, 1939, pp. 531-546.)
310. BREAKDOWN, GLOW DISCHARGE, AND PHOTOELECTRIC REACTION [Extension of Photoelectric Theory of Breakdown in Homogeneous Field to Inhomogeneous Field with Volume Ionisation, etc.].—Rogowski. (*Zeitschr. f. Physik*, No. 1/2, Vol. 114, pp. 1-52.) For this photoelectric theory and its experimental confirmation see 15 & 665 of 1939.
311. THEORY OF THE CATHODE DISCHARGE PORTIONS OF A LOW PRESSURE DISCHARGE: III [System of Six Equations for Negative Glow: First and Second Approximations: "Barometer" Formula and Its Validity Conditions].—Weizel, Rompe, & Schön. (*Zeitschr. f. Physik*, No. 11/12, Vol. 113, 1939, pp. 730-739.) For I & II see 4175 of 1939. See also Scherzer, 3306 of 1939.
312. INVESTIGATIONS ON HOLLOW CATHODES [Measurements of Voltage in Neon Discharge as Function of Pressure, Current Strength, and Geometrical Dimensions: Explanation of Hollow-Cathode Effect by Extension of Usual Cathode-Drop Theory].—Lompe, Seeliger, & Wolter. (*Ann. der Physik*, Series 5, No. 1, Vol. 36, 1939, pp. 9-37.) For the hollow-cathode effect see Güntherschulze, 1930 Abstracts, p. 347.
313. EXCHANGE OF ENERGY BETWEEN TRANSLATION AND ROTATION BY COLLISIONS [deduced from Spectra of Hollow-Cathode Discharge].—Haber. (*Physik. Zeitschr.*, 1st Sept. 1939, Vol. 40, No. 17, pp. 541-551.)
314. PULSES OF ELECTRICAL TENSION AND THE PROBABILITY OF SPARK-OVER.—de Seras. (*La Ricerca Scient.*, Sept. 1939, Year 10, No. 9, pp. 885-886.)

315. ENERGY MEASUREMENTS OF REIGNITING A.C. ARCS [Formation of Arc in Reigniting Cycles due to Field Emission of Electrons].—Eskin. (*Journ. of Applied Phys.*, Sept. 1939, Vol. 10, No. 9, pp. 631-638.)
316. THEORY OF MAGNETIC EFFECTS IN THE PLASMA OF AN ARC.—Tonks. (*Phys. Review*, 15th Aug. 1939, Series 2, Vol. 56, No. 4, pp. 360-373.)
317. REMARK ON THE ELECTRON PRESSURE IN THE THEORY OF PLASMA OSCILLATIONS [Introduction of Electron Pressure into Theory: Reason why It plays No Quantitative Rôle and Langmuir's Frequency Formula is Practically Correct].—Seeliger & Steenbeck. (*Zeitschr. f. Physik*, No. 7/8, Vol. 113, 1939, pp. 526-530.) See 1929 Abstracts, pp. 273 & 576.
318. SOME PROPERTIES OF THE HYDROGEN ARC [Oscillographic Measurements of Gradient, Total Voltage, and Current Density: Abrupt Changes lead to Identification of Three States of Hydrogen Discharge: Violent Arc Convection Movements].—Suits. (*Journ. of Applied Phys.*, Sept. 1939, Vol. 10, No. 9, pp. 648-650.)
319. HIGH-SPEED MULTIPLEX SYSTEM FOR LOADED SUBMARINE CABLES [particularly the Use of Thyratrons for Phase Correction, Signal Selection with Signal Interpolation, & Earth-Current Correction].—Haglund & Breyfogel. (*Proc. Inst. Rad. Eng.*, Sept. 1939, Vol. 27, No. 9, pp. 611-612: summary only.)
320. CRITICAL INDUCTANCE AND CONTROL RECTIFIERS.—Overbeck. (See 56.)
321. IMPULSE EXCITATION OF THE GRIDS OF A GAS-FILLED RECTIFIER.—Spitsyn & Voychinski. (*Izvestiya Elektroprom. Slab. Toka*, No. 7/8, 1939, pp. 60-67.)
The operation of a grid-controlled rectifier in which grid impulses are obtained from an auxiliary low-power rectifier is discussed, and various circuits are suggested. A brief report on an experimental investigation is also presented.
322. SECTIONAL H.T. MERCURY-VAPOUR RECTIFIERS.—Rakov & Fetisov. (*Izvestiya Elektroprom. Slab. Toka*, No. 7/8, 1939, pp. 56-59.)
A new type of mercury-vapour rectifier has been developed in Russia in which, to obtain a more uniform potential fall in the discharge gap, a number of intermediate electrodes connected to a capacitive voltage divider are mounted between the anode and the cathode. Rectifiers of capacities up to 200 kv, 1 A have been produced.
323. PHOTOVOLTAGE AT THE ELEMENT METAL/SEMICONDUCTOR/METAL: V—EXPERIMENTS ON POLYCRYSTALLINE SAMPLES OF CUPROUS OXIDE AT LOW TEMPERATURES.—Mönch. (See 214.)
324. MAGNESIUM/COPPER-SULPHIDE RECTIFIER BATTERY CHARGER [Selenium/Iron Rectifier also a Heavy-Duty Type].—Bartholomew: Kotterman. (*Elec. Engineering*, Sept. 1939, Vol. 58, No. 9, p. 396.) Prompted by Kotterman's paper, 3774 of 1939.
325. CRYSTALLISATION BY PULVERISATION [in connection with Selenium].—Dekeyser & Prins. (*Physica*, Oct. 1939, Vol. 6, No. 9, pp. 1009-1010: in French.) Prompted by the results of Das & Gupta, 2012 of 1939.
326. LARGE ANISOTROPY OF THE ELECTRICAL CONDUCTIVITY OF GRAPHITE [Conductivity in Basal Plane of Single Crystal 10 000 Times Larger than That along Normal to Plane].—Krishnann & Ganguli. (*Nature*, 14th Oct. 1939, Vol. 144, p. 667.)
327. L.T. TO H.T. VIBRATORS WITH SYNCHRONOUS RECTIFICATION [for Radio Receivers].—Semenov. (See 107.)
328. AN ACHIEVEMENT IN CONDENSER MANUFACTURE [Electrolytic Condenser of 1 Farad Capacity measuring only 185 × 135 × 140 mm].—Siemens & Halske. (*T.F.T.*, Aug. 1939, Vol. 28, No. 8, p. 330.)
329. A FROSTPROOF ELECTROLYTIC CONDENSER.—Gutin. (*Izvestiya Elektroprom. Slab. Toka*, No. 5, 1939, pp. 53-59.)
A report on an experimental investigation aiming at the development of electrolytic condensers capable of satisfactory operation at temperatures varying from +60°C to -60°C. It has been found that the most satisfactory results are obtained when ethylene glycol is used as the solvent in the working electrolyte, with an addition of some monohydric alcohol such as ethyl alcohol. The experiments are described in detail and the results shown in a number of curves and tables.
It is claimed that the condensers so developed are greatly superior to those of American manufacture, giving in some cases a decrease in capacity from 30.5 μF at 20°C to 21.5 μF at -60°C and a leakage current not exceeding 0.05 mA/μF at +60°C and 450 v. Condensers operating satisfactorily at -80°C were also prepared (Fig. 8).
330. AN INVESTIGATION ON THE FORMATION OF ALUMINIUM OXIDES IN CERTAIN ELECTROLYTES.—Morozov. (*Izvestiya Elektroprom. Slab. Toka*, No. 6, 1939, pp. 55-59.)
331. "THE CONDENSER IN COMMUNICATIONS TECHNIQUE" [Book Review].—Straimer. (*T.F.T.*, Aug. 1939, Vol. 28, No. 8, p. 332.) In the series "Physik und Technik der Gegenwart."
332. CONDENSERS OF NEGLIGIBLE LEAKAGE [Rhom-bic Sulphur Dielectric: Concentric-Tube Condensers, Strong, Easily Made, with Capacities up to 500 cm.].—Bradbury. (*Review of Scient. Instr.*, Oct. 1939, Vol. 10, No. 10, pp. 316-317.)
333. [Ultra-] H.F. INSULATION MATERIALS: RESULTS OF LABORATORY TESTS OF SYNTHETIC PLASTICS [on 6 m Wavelength: Good Behaviour of Loaded Ebonite, Special Cast Resin, & Unplasticised Polystyrol].—Mabb. (*Electrician*, 24th Nov. 1939, Vol. 123, pp. 453-454.)

334. SPECTRAL MEASUREMENTS AT WAVELENGTHS 0.2-0.5 mm ON SOME H.F. INSULATING MATERIALS AND OXIDES [Apparatus: Mercury Arc with Spectrometer and Radiometer: Transparency Measurements: Calculation of Absorption and Refraction Coefficients as Functions of Wavelength].—Maar. (*Zeitschr. f. Physik*, No. 7/8, Vol. 113, 1939, pp. 415-430.)
335. CERAMICS FOR RADIO-FREQUENCY USE [including Russian "Radio Porcelain"].—Bogoroditski & Fridberg. (*Izvestiya Elektroprom. Slab. Toka*, No. 5, 1939, pp. 43-52.)
The requirements imposed on ceramic materials for radio-frequency use are discussed, and tables are given showing the properties of various materials of Russian and foreign manufacture. This is followed by a description with details of a new material ("radio porcelain") developed in Russia, which is basically ordinary porcelain with an addition of oxides of heavy metals. The material is comparable with various American ceramics.
336. MOISTUREPROOF MYCALEX.—Bogoroditski & Fridberg. (*Izvestiya Elektroprom. Slab. Toka*, No. 7/8, 1939, pp. 80-85.)
The manufacturing processes employed in Russia for the production of mycalex are discussed. Leadless glass was used for this purpose and the quality of mycalex so obtained was comparable with that of the best British and American samples. It has, however, been observed that under conditions of high humidity the surface of parts manufactured from Russian as well as from foreign material shows signs of ageing and becomes covered by a film of white powder. A study was made and a new type of glass was developed, with the result that mycalex of very high resistivity to water was developed. It is stated for example that only 1.3% of fine powder was dissolved after boiling in water for 2½ hours. The electrical and mechanical properties of the new material are entirely satisfactory.
337. THE PRODUCTION OF MICANITE [Survey in U.S.A.].—Tyler. (*Engineering*, 15th Sept. 1939, Vol. 148, pp. 301-302.)
338. A SUBSTITUTE FOR MICA [Alsilfilm: also Possible Use of Ground Mica].—(*Engineer*, 17th Nov. 1939, Vol. 168, p. 495: paragraph only.) For alsilfilm & alsimag see 758 and 4700 of 1939.
339. THE DIELECTRIC CHARACTERISTICS OF A CHEMICALLY PURE SYNTHETIC RESIN [Glycol Phthalate: Effects of Known Amounts of Polar Impurities: No Modification of Debye's Theory will account for Observed Results unless with Hypothesis of Distribution of Relaxation Times: Successful Quantitative Expression for Loss Angle, on This Hypothesis: etc.].—Garton. (*Journ. I.E.E.*, Nov. 1939, Vol. 85, No. 515, pp. 625-638.)
340. SYNTHETIC MATERIALS AS WIRE INSULATION [particularly the Use of "Formex"].—Patnode & others. (*Elec. Engineering*, Sept. 1939, Vol. 58, No. 9, pp. 379-388.)
341. CELLULOSE AS AN INSULATING MATERIAL.—Kohman. (*Bell Tel. System Tech. Pub.*, Monograph B-1165, 26 pp.)
342. DIELECTRIC MEASUREMENTS IN THE STUDY OF CARBON-BLACK AND ZINC-OXIDE DISPERSION IN RUBBER.—Kemp & Herrmann. (*Bell Tel. System Tech. Pub.*, Monograph B-1154, 15 pp.)
343. BITUMINOUS MATERIALS AND THEIR USE IN THE ELECTRICAL INDUSTRY.—Heilmann. (*Rev. Gén. de l'Élec.*, 26th Aug. 1939, Vol. 46, No. 8, pp. 229-234.)
344. NEW MATERIALS USED IN THE MASS PRODUCTION OF RADIO APPARATUS.—Eltus. (See 106.)
345. EQUIPMENT FOR TESTING ELECTRIC INSULATING MATERIALS FOR DIELECTRIC STRENGTH.—Morgan. (*Gen. Elec. Review*, Oct. 1939, Vol. 42, No. 10, pp. 436-440.)
346. THEORY OF THE DIELECTRIC HYSTERESIS [in Condenser Discharge: Integro-Differential Equation for Voltage].—Castro. (*Zeitschr. f. Physik*, No. 1/2, Vol. 114, 1939, pp. 116-126.)
347. DIELECTRIC LOSS DUE TO POLAR MOLECULES IN SOLID PARAFFIN WAX [Experimental Examination of how Relaxation Time is affected by altering Chain Length of Wax in which Given Ester is dissolved].—Pelmore. (*Proc. Roy. Soc.*, Series A, 4th Sept. 1939, Vol. 172, No. 951, pp. 502-517.) Extension of work of Jackson and of Sillars (see 1233 of 1939).
348. THEORY OF THE ELECTRICAL BREAKDOWN OF CRYSTALLINE INSULATORS [Calculations on and Discussion of Ionisation and "Wave-Mechanical" Theories of Breakdown].—Franz. (*Zeitschr. f. Physik*, No. 9/10, Vol. 113, 1939, pp. 607-636.)
349. DIELECTRIC BREAKDOWN IN IONIC CRYSTALS, and REMARKS ON THE DIELECTRIC BREAKDOWN.—Fröhlich: Seeger & Teller. (*Phys. Review*, 15th Aug. 1939, Series 2, Vol. 56, No. 4, pp. 349-352: pp. 352-354.) Critical discussion of the theories proposed by Seeger & Teller (229 of 1939) and by Fröhlich (3503 of 1937).
350. THE ELECTROSTATIC FIELD PRODUCED BY A POINT CHARGE IN THE AXIS OF A CYLINDER [General Theoretical Solution: Approximation to Field Strength on Cylinder Surface].—Weber. (*Journ. of Applied Phys.*, Sept. 1939, Vol. 10, No. 9, pp. 663-666.)
351. THE RESEARCHES ON LIQUID DIELECTRICS, ACCORDING TO THE PAPERS OF THE AUTUMN CONGRESS OF THE AMERICAN CHEMICAL SOCIETY.—Gémin. (*Rev. Gén. de l'Élec.*, 29th July 1939, Vol. 46, No. 4, pp. 119-121.)
352. ABSORPTION IN THE RANGE OF SHORT ELECTRIC WAVES [10-20 m], MEASURED ON DIPOLE LIQUIDS AND ELECTROLYTES [and discussed in Connection with Debye's Theory].—Schmale. (*Ann. der Phys.*, Series 5, No. 8, Vol. 35, 1939, pp. 671-689.)

353. FRICTIONAL DISPERSION OF THE DIELECTRIC CONSTANTS OF ORGANIC LIQUIDS AT VERY HIGH FREQUENCIES (WAVELENGTH 15 cm) [Qualitative Agreement with Debye's Theory].—Odenwald. (*Ann. der Phys.*, Series 5, No. 8, Vol. 35, 1939, pp. 690-700.)
354. THE INDUCTOR WITH AIR-GAPPED MAGNETIC CIRCUIT [especially the Reaction of the Dynamic Rise of Mean Induction on the Design].—Glazier. (*Engineering*, 13th Oct. 1939, Vol. 148, pp. 406-408.)
355. APPROXIMATE CALCULATION OF CHOKES WITH SUPERPOSED D.C. MAGNETISATION.—Hartel. (*Arch. f. Elektrot.*, 15th Sept. 1939, Vol. 33, No. 9, pp. 585-592.)
356. COUPLED CIRCUITS COUPLED BY AN [Iron-Cored] INDUCTANCE DEPENDING ON THE CURRENT.—Taeger. (See 50.)
357. PERMEABILITY AT VERY HIGH FREQUENCIES [and the Loss of Special Magnetic Properties of Iron & Nickel at Frequencies between 10^9 and 10^{11} c/s].—G. W. O. H.: Möhring. (*Wireless Engineer*, Nov. 1939, Vol. 16, No. 194, pp. 541-542.) Editorial prompted by Möhring's work (4198 of 1939).
358. NEW MEASUREMENTS OF THE MAGNETIC PERMEABILITY OF IRON IN HIGH-FREQUENCY FIELDS.—Mash. (*Journ. of Tech. Phys.* [in Russian], No. 4, Vol. 9, 1939, pp. 339-342.)
For previous work see 2542 of 1939. Since the conclusions there reached were at variance with the results obtained by Schwarz and Kreilsheimer, additional experiments were carried out on a wavelength of 4.45 m, using somewhat different experimental methods. The results of this investigation fully bear out the original conclusions, that μ is independent of the radius of the iron ball and that the relationship between μ and the amplitude of the h.f. magnetic field is similar to that which is obtained when a static magnetic field is used.
359. ELECTRONIC CONDUCTION OF MAGNETITE (Fe_3O_4) AND ITS TRANSITION POINT AT LOW TEMPERATURES.—Verwey. (*Nature*, 19th Aug. 1939, Vol. 144, pp. 327-328.)
360. ERRATA IN "ON THE EXCHANGE INTERACTION IN MAGNETIC CRYSTALS."—Opechowski. (*Physica*, Oct. 1939, Vol. 6, No. 9, p. 1112: in English.) See 2386 of 1937.
361. AN APPARATUS FOR MAGNETIC TESTING AT MAGNETISING FORCES UP TO 5000 OERSTEDS [the High- H Permeameter for New Permanent-Magnet Alloys].—Sandford & Bennett. (*Journ. of Res. of Nat. Bur. of Stds.*, Sept. 1939, Vol. 23, No. 3, pp. 415-425.)
362. MAGNETIC FLUX: A CONVENIENT DIRECT-READING METER [using Bismuth Spirals].—Smith. (*Electrician*, 27th Oct. 1939, Vol. 123, pp. 375-376.)
363. THE FORMATION OF METALLIC BRIDGES BETWEEN SEPARATED CONTACTS [Electrostatic Force pulls Materials from the Electrodes: Experimental Data].—Pearson. (*Phys. Review*, 1st Sept. 1939, Series 2, Vol. 56, No. 5, pp. 471-474.) A summary was dealt with in 352 of 1938.
364. CONTACT MATERIALS: PROPERTIES REQUIRED: SINTERED SILVER-NICKEL.—Halls. (*Electrician*, 24th Nov. 1939, Vol. 123, pp. 454 and 455.)
365. ROSENBERG [Constant-Current] DYNAMO WITH FIXED POLARITY.—Rosenberg. (*Journ. I.E.E.*, Sept. 1939, Vol. 85, No. 513, pp. 423-430.)
366. ELECTRO-FRICTION [for Deposition of Metal Layer on Finished Article without Immersion in Electrolyte].—Ustraykh. (*Izvestiya Elektroprom. Slab. Toka*, No. 7/8, 1939, pp. 74-75.)
367. A SPEED-GOVERNED MIDGET ELECTRIC MOTOR [suitable for Radio-Meteorographs, etc.].—Jacobsen. (*Review of Scient. Instr.*, Oct. 1939, Vol. 10, No. 10, p. 315.)
368. ON METHODS FOR MEASURING AND FOR AUTOMATICALLY REGULATING THE SPEED OF THE ULTRACENTRIFUGE.—Björnståhl. (*Review of Scient. Instr.*, Sept. 1939, Vol. 10, No. 9, pp. 258-269.)
369. A SELF-SUPPORTING RIBBON VARIANT OF LITZ WIRE.—Ward & Pratt. (See 246.)
370. AN ELECTRIC-CIRCUIT TRANSIENT ANALYSER.—Peterson. (*Gen. Elec. Review*, Sept. 1939, Vol. 42, No. 9, pp. 394-400.)

STATIONS, DESIGN AND OPERATION

371. THE ULTRA-HIGH-FREQUENCY RELAY [from East Coast to Chicago, etc.: Results of Contest].—Handy. (*QST*, Nov. 1939, Vol. 23, No. 11, pp. 26-27 and 96, 98.)
372. CLEVELAND'S ULTRA-HIGH-FREQUENCY SCHOOL RADIO SYSTEM.—Woodward. (See 428.)
373. BROADCASTING OVER THE POWER MAINS [Note on Demonstrations of Possibility of Broadcasting Messages].—(*Nature*, 26th Aug. 1939, Vol. 144, p. 361: short note only.)
374. SEPARATING FILTERS.—Piloty. (See 46.)
375. THE ABSORPTION OF RADIO WAVES IN WATER [in connection with Communication with Submerged Submarines: Tests with Wavelengths 25.8-200 m: Good Agreement with Theory].—Hoag. (*Science*, 22nd Sept. 1939, Vol. 90, pp. 277-279.)
376. MEDIUM-POWER MARINE RADIOTELEPHONE EQUIPMENT [for Communication with Harbour & Coastal Services].—McDonald. (*Proc. Inst. Rad. Eng.*, Sept. 1939, Vol. 27, No. 9, p. 614: summary only.) For previous papers on these services see 2999/3002 of 1939.
377. THE SELECTION OF A RADIO-BROADCAST-TRANSMITTER LOCATION [Acceptable Field-Strengths for Various Areas: Unsuitability of Older & Poorer Sections of City (e.g. Cross Modulation from Old Wiring): Selection Technique illustrated by Examples of Re-Location of Boston and Los Angeles Stations].—Lodge. (*Proc. Inst. Rad. Eng.*, Oct. 1939, Vol. 27, No. 10, pp. 621-626.)

378. A 50-KILOWATT BROADCAST STATION UTILISING THE DOHERTY AMPLIFIER AND DESIGNED FOR EXPANSION TO 500 KILOWATTS [WHAS, Louisville: with Novel Features].—Doherty & Towner. (*Proc. Inst. Rad. Eng.*, Sept. 1939, Vol. 27, No. 9, pp. 531-534.)

Among the features mentioned are: no rotating equipment except fans and pumps; porcelain tubes replacing rubber hose in water-cooling system (which provides heat for the building); special four-conductor feed-line from nitrogen-filled transmission line to shunt-excited aerial, providing the distributed capacity necessary for matching.

379. THE NEW NATIONAL STATION OF FRENCH BROADCASTING AT ALLOUIS (CHER).—Adam. (*Génie Civil*, 11th Nov. 1939, Vol. 115, No. 20, pp. 349-353.)

GENERAL PHYSICAL ARTICLES

380. ON FLUCTUATIONS IN ELECTROMAGNETIC RADIATION (A CORRECTION).—Born & Fuchs. (*Proc. Roy. Soc.*, Series A, 4th Sept. 1939, Vol. 172, No. 951, pp. 465-466.) See 2591 of 1939. The mathematical objections against Heisenberg's critical paper are here withdrawn.

381. "INTRODUCTORY QUANTUM MECHANICS" [Book Review].—Rojansky. (*Science*, 3rd Nov. 1939, Vol. 90, pp. 420-422.)

382. "THE DECLINE OF MECHANISM (IN MODERN PHYSICS)" [Book Review].—d'Abro. (*Review of Scient. Instr.*, Oct. 1939, Vol. 10, No. 10, pp. 288-289.)

383. A THEORY OF ELECTRIC POLARISATION, ELECTRO-OPTICAL KERR EFFECT, AND ELECTRIC SATURATION IN LIQUIDS AND SOLUTIONS.—Piekar. (*Proc. Roy. Soc.*, Series A, 23rd Aug. 1939, Vol. 172, No. 950, pp. 360-383.)

384. THE ELECTRICAL DOUBLE LAYER AT THE INTERFACE OF TWO LIQUIDS [Theory: Potential Function].—Verwey & Niessen. (*Phil. Mag.*, Oct. 1939, Series 7, Vol. 28, No. 189, pp. 435-446.)

385. THE ELECTROSTATIC FIELD PRODUCED BY A POINT CHARGE IN THE AXIS OF A CYLINDER [General Theoretical Solution: Approximation to Field Strength on Cylinder Surface].—Weber. (*Journ. of Applied Phys.*, Sept. 1939, Vol. 10, No. 9, pp. 663-666.)

386. FURTHER NOTE ON THE COMPLETE ANALYTICAL EXPRESSION OF POTENTIAL.—Labocetta. (*La Ricerca Scient.*, Sept. 1939, Year 10, No. 9, pp. 880-883.)

387. A NEW DETERMINATION OF THE SPECIFIC CHARGE ON THE ELECTRON BY H. BUSCH'S METHOD [using Magnetic Electron Lens: Electron-Optical Increase of Intensity of Electron Beam by Intermediate Electrode: Good Agreement with Values for e/m_0 obtained by Other Methods].—Goedicke. (*Ann. der Physik*, Series 5, No. 1, Vol. 36, 1939, pp. 47-63.)

388. UNDOER CALCULUS AND CHARGE-CONJUGATION; also THE UNDOER EQUATION OF THE MESON FIELD; and ON THE SPIN ANGULAR MOMENTUM OF MESONS.—Belinfante. (*Physica*, Oct. 1939, Vol. 6, No. 9, pp. 849-898: in English.)

389. THEORY OF THE SENFLEBEN EFFECT [due to Influence of Magnetic Precession on Mean Free Path of Paramagnetic Gases].—Zernike & van Lier. (*Physica*, Oct. 1939, Vol. 6, No. 9, pp. 961-971: in English.)

MISCELLANEOUS

390. A NEW METHOD IN STATISTICAL MECHANICS [Treatment of Differential Equations of Motion of System of Similar Particles to obtain Equation of State].—Wiener & McMillan. (*Science*, 3rd Nov. 1939, Vol. 90, pp. 410-411: summary only.)

391. APPROXIMATION TO A FUNCTION OF ONE VARIABLE FROM A SET OF ITS MEAN VALUES.—Greenspan. (*Journ. of Res. of Nat. Bur. of Stds.*, Aug. 1939, Vol. 23, pp. 309-317.)

392. A MECHANICAL INTEGRATOR FOR EVALUATING THE INTEGRAL OF THE PRODUCT OF TWO FUNCTIONS, AND ITS APPLICATION TO THE COMPUTATION OF I.C.I. COLOUR SPECIFICATIONS FROM SPECTROPHOTOMETRIC CURVES.—Van den Akker. (*Journ. Opt. Soc. Am.*, Sept. 1939, Vol. 29, No. 9, pp. 364-369.) For erratum see *ibid.*, Nov. 1939, p. 501.

393. A NOTE ON THE SOLUTION OF SOME PARTIAL DIFFERENTIAL EQUATIONS IN THE FINITE DOMAIN.—Howell. (See 33.)

394. SOME FORMULAE FOR THE PRODUCT OF TWO WHITTAKER FUNCTIONS WITH DIFFERENT ARGUMENTS [deduced by Operational Methods].—Howell. (*Phil. Mag.*, Oct. 1939, Series 7, Vol. 28, No. 189, pp. 493-495.)

395. RELATIONS BETWEEN THE ELLIPTIC CYLINDER FUNCTIONS [deduced from the Homogeneous Integral Equations They Satisfy].—Ince. (*Proc. Roy. Soc. Edin.*, Part II, Vol. 59s 1938/39, pp. 176-183.)

396. FORMULAE FOR GENERALISED HYPERGEOMETRIC FUNCTIONS AS PARTICULAR CASES OF MORE GENERAL FORMULAE.—MacRobert. (*Phil. Mag.*, Oct. 1939, Series 7, Vol. 28, No. 189, pp. 488-492.)

397. THE ANALYSIS OF COMPOUND EXPONENTIAL CURVES [Simpler Method than Those of Walsh and Lupka].—Hancock. (*Engineer*, 17th Nov. 1939, Vol. 168, p. 492.)

398. "COMPLEX VARIABLE AND OPERATIONAL CALCULUS" [Book Review].—McLachlan. (*Wireless Engineer*, Nov. 1939, Vol. 16, No. 194, pp. 557-558.)

399. "HIGHER MATHEMATICS: WITH APPLICATIONS TO SCIENCE AND ENGINEERING" [Book Review].—Burington & Torrance. (*BEAMA Journal*, Oct. 1939, Vol. 45, No. 28, p. 90.)

400. "STATIC AND DYNAMIC ELECTRICITY" [Book Review].—Smythe. (*Review of Scient. Instr.*, Oct. 1939, Vol. 10, No. 10, p. 276.) Strongly recommended in view of the "increasing importance of field considerations in electron optics" and of the "unconventional types of resonant circuits" now involved in micro-wave technique.
401. "LEHRBUCH DER HOCHFREQUENZTECHNIK" [Second Edition: Book Review].—Vilbig. (*T.F.T.*, Aug. 1939, Vol. 28, No. 8, p. 332.)
402. "THE RADIO AND TELECOMMUNICATIONS ENGINEER'S DESIGN MANUAL" [Book Review].—Blakey. (*Wireless Engineer*, Aug. 1939, Vol. 16, No. 191, pp. 401-402.)
403. THE WIRELESS EXHIBITION, 1939: A TECHNICAL SURVEY.—(*Wireless Engineer*, Oct. 1939, Vol. 16, No. 193, pp. 500-510.)
404. RADIO EXHIBITION, OLYMPIA [Notes on New Receiver & Television Models, Technical Exhibits, etc.].—Smith-Rose. (*Nature*, 2nd Sept. 1939, Vol. 144, pp. 450-451.)
405. THE GREAT INTERNATIONAL RADIO EXHIBITIONS, BERLIN AND LONDON.—Adam. (*Génie Civil*, 16th Sept. 1939, Vol. 115, No. 12, pp. 240-242.)
406. THE GERMAN RADIO EXHIBITION: THREE STANDARDISED SETS FOR THE FUTURE: TELEVISION.—(*World-Radio*, 4th Aug. 1939, Vol. 29, p. 9.)
407. THE BERLIN SHOW.—(*Wireless World*, 17th Aug. 1939, Vol. 45, pp. 147-150.)
408. OLYMPIA 1939: FULL REPORT.—(*Wireless World*, 24th Aug. 1939, Vol. 45, pp. 171-182.)
409. SHOW REVIEW [Technical Trends at 1939 Olympia Exhibition].—(*Wireless World*, 31st Aug. 1939, Vol. 45, pp. 196-205.)
410. OLYMPIA CONVENTIONS: TECHNICAL MEETINGS AT THE SHOW.—(*Wireless World*, 7th Sept. 1939, Vol. 45, pp. 243-245.)
411. WHAT TO LOOK FOR AT RADIOLYMPIA.—Carter. (*World-Radio*, 25th Aug. 1939, Vol. 29, No. 735, pp. 12 and 15.)
412. RADIO AT THE [New York World's] FAIR.—Sperling. (*Communications*, May 1939, Vol. 19, No. 5, pp. 5-8 and 30.)
413. SOME CONTRIBUTIONS OF RADIO TO OTHER SCIENCES [Electrical Properties and Composition of Atmosphere: Meteorology: Terrestrial Magnetism: Solar Physics: Astronomy].—Dellinger. (*Journ. Franklin Inst.*, July 1939, Vol. 228, No. 1, pp. 11-42.)
414. THEN AND NOW: 1914-1939 [Survey of Progress in Various Branches of Electrical Engineering].—(*L'Elettrotecnica*, Supplement to No. 4 of 25th Feb. 1939, Vol. 26, pp. 129-228.)
415. AMERICAN PROGRESS—AND OURS: WHERE BRITAIN LEADS IN WIRELESS TECHNIQUE.—Scroggie. (*Wireless World*, 7th Sept. 1939, Vol. 45, pp. 238-240.) Based on a lecture. See also p. 243.
416. INVENTORS AND THE LEGISLATION ON ESPIONAGE [Serious Effect of French Law of 17th June 1938].—Fernand-Jacq. (*Rev. Gén. de l'Élec.*, 26th Aug. 1939, Vol. 46, No. 8, pp. 253-255.)
417. THE ASSIGNMENT OF THE RIGHT OF PRIORITY [in Patent Law].—Fernand-Jacq. (*Rev. Gén. de l'Élec.*, 15th July 1939, Vol. 46, No. 2, pp. 59-63.)
418. INVENTORS AND THE WAR: CHANGES IN PATENT LAW.—(*Wireless World*, 28th Sept. 1939, Vol. 45, p. 294.)
419. SCIENTISTS POOL RESOURCES IN 60 000 DOLLAR RESEARCH PLAN.—(*Sci. News Letter*, 19th Aug. 1939, Vol. 36, No. 8, p. 120.)
420. THE ORGANISATION OF THE NATIONAL CENTRE OF SCIENTIFIC RESEARCH (DECREES OF 19TH AND 22ND OCTOBER, 1939).—(*Génie Civil*, 4th Nov. 1939, Vol. 115, No. 19, pp. 344-345.)
421. INSTITUTION RECOLLECTIONS.—Atkinson. (*Journ. I.E.E.*, Oct. 1939, Vol. 85, No. 514, pp. 553-557.)
422. I.E.E. WIRING RULES: A GUIDE TO THE PRINCIPAL ALTERATIONS CONTAINED IN THE ELEVENTH EDITION.—(*Electrician*, 24th Nov. 1939, Vol. 123, pp. 468-469.)
423. COMPOUND WORDS [and Their Difficulties: Suggested Use of the "Disused" Colon as a Separator, with Hyphen as Connector: etc.].—Talmage & others. (*Science*, 18th Aug. 1939, Vol. 90, pp. 155-157.)
424. SOME TYPES OF "DISCUSSERS" [at Technical Meetings].—Karapetoff. (*Elec. Engineering*, July 1939, Vol. 58, No. 7.)
425. THE INTERNATIONAL CONFERENCE ON DOCUMENTATION.—(*Engineering*, 15th Sept. 1939, Vol. 148, pp. 300-301.)
426. COMPARISON OF ACCELERATED AGEING OF RECORD PAPERS WITH NORMAL AGEING FOR 8 YEARS.—Scribner. (*Journ. of Res. of Nat. Bur. of Stds.*, Sept. 1939, Vol. 23, No. 3, pp. 405-413.)
427. BASIC ECONOMIC TRENDS IN THE RADIO INDUSTRY [in U.S.A.: with Special Reference to Past and Probable Future Public Demand for Broadcast Receivers and Valves].—Weinberger. (*Proc. Inst. Rad. Eng.*, Nov. 1939, Vol. 27, No. 11, pp. 704-715.)
428. CLEVELAND'S ULTRA - HIGH - FREQUENCY SCHOOL RADIO SYSTEM [in 117 Elementary Schools, serving about 65 000 Listeners].—Woodward. (*Proc. Inst. Rad. Eng.*, Oct. 1939, Vol. 27, No. 10, p. 681: summary only.)
429. THE LIBRARIES AND INFORMATION BUREAUX OF THE BRITISH BROADCASTING CORPORATION.—Pocock. (*Journ. Roy. Soc. of Arts*, 1st Dec. 1939, Vol. 88, No. 4541, pp. 68-83.)

430. THE PRACTICAL APPLICATION OF RADIO PROSPECTING [Comprehensive Survey].—Fritsch. (*Funktech. Monatshefte*, Aug. & Sept. 1939, Nos. 8 & 9, pp. 241-245 & 261-268.) With a large number of literature references. For previous work by the same worker see 3017 of 1939.
431. THE EFFECT OF TEMPERATURE AND EXPOSURE TO X-RAYS UPON TRIBOLUMINESCENCE.—Wick. (*Journ. Opt. Soc. Am.*, Oct. 1939, Vol. 29, No. 10, pp. 407-412.)
432. MEASUREMENT OF SMALL OPTICAL ACTIVITIES WITH THE QUARTZ-CRYSTAL LIGHT MODULATOR.—McKinley. (*Canadian Journ. of Res.*, Oct. 1939, Vol. 17, No. 10, Sec. A, pp. 202-207.)
433. A SURVEY OF METHODS AND APPARATUS FOR MICRO-GAS ANALYSIS [including the Dielectric-Constant Method].—Hartridge. (*Journ. of Scient. Instr.*, Oct. 1939, Vol. 16, No. 10, pp. 317-324.)
434. A DIELECTRIC INVESTIGATION OF CARBON DIOXIDE/HAEMOGLOBIN SOLUTIONS CONTAINING IMPURITIES [using Wavelengths between 90 and 300 m: Dipole Moments smaller than Those of Pure Water Solutions].—Arrhenius. (*Physik. Zeitschr.*, 15th Aug. 1939, Vol. 40, No. 16, pp. 534-539.)
435. ON METHODS FOR MEASURING AND FOR AUTOMATICALLY REGULATING THE SPEED OF THE ULTRACENTRIFUGE.—Björnståhl. (*Review of Scient. Instr.*, Sept. 1939, Vol. 10, No. 9, pp. 258-269.)
436. DISCUSSION ON "THE QUADRATURE TACHOMETER."—Geyger; Brown. (*Journ. I.E.E.*, Nov. 1939, Vol. 85, No. 515, pp. 648-649.) See 3402 of 1939.
437. STROBOSCOPIC-LIGHT SOURCE [High Speed: Blocking-Oscillator Circuit produces Short Pulses of Several Amperes of Anode Current in High-Vacuum Tube with Anode coated with Fluorescent Material].—Kallmann. (*Proc. Inst. Rad. Eng.*, Nov. 1939, Vol. 27, No. 11, pp. 690-692.)
438. PHOTOCELLS AND THE MEASUREMENT OF QUANTITY OF LIGHT [Determination of the Constant *K* by the "Light-Flash" and "Dark-Flash" Methods].—Gogate & Kathavate. (*Current Science*, Bangalore, Sept. 1939, Vol. 8, No. 9, pp. 416-417.)
439. A NEW MERCURY-VAPOUR DETECTOR [Ultra-Violet-Lamp/Phototube/Triode Circuit, with Thyrite Stabiliser].—Woodson. (*Review of Scient. Instr.*, Oct. 1939, Vol. 10, No. 10, pp. 308-311.)
440. DETERMINING FILM THICKNESS WITH THE RECORDING SPECTROPHOTOMETER.—Adams & Ickis. (*Gen. Elec. Review*, Oct. 1939, Vol. 42, No. 10, pp. 450-451.) For other papers on the uses of this apparatus see 1330 of 1939.
441. A FOUR-FILTER PHOTOELECTRIC COLORIMETER.—Barnes. (*Journ. Opt. Soc. Am.*, Oct. 1939, Vol. 29, No. 10, pp. 448-452.)
442. AN APPARATUS FOR THE DETECTION OF MAGNETIC MATERIALS [working on Continuous D.C.: detects Presence of Hair-Pin carried by Passer-By].—Johnson & Field. (*Canadian Journ. of Res.*, Sept. 1939, Vol. 17, No. 9, Sec. A, pp. 194-195.)
443. THE MAGNETIC DETECTION OF FLAWS IN METAL ALLOYS.—Fluvot. (*Génie Civil*, 4th & 11th Nov. 1939, Vol. 115, Nos. 19 & 20, pp. 334-337 & 355-357.)
444. MAGNETIC ANALYSIS APPLIED TO THE INSPECTION OF BAR STOCK AND PIPE.—Zuschlag. (*ASTM Bulletin*, Aug. 1939, No. 99, pp. 35-40.)
445. ON A NEW MAGNETO-OPTICAL ACTION [Modifications of Colloidal Iron Solutions by Magnetic Field, producing Changes in Light-Absorbing Powers].—Majorana. (*La Ricerca Scient.*, Sept. 1939, Year 10, No. 9, pp. 783-789.)
446. INDUCTIVE COÖRDINATION WITH SERIES SODIUM HIGHWAY LIGHTING CIRCUITS [and the Noise in Exposed Telephone Lines].—Kent & Blye. (*Bell Tel. System Tech. Pub.*, Monograph B-1167, 17 pp.)
447. "THEORY AND APPLICATIONS OF ELECTRON TUBES" [Reply to Book Review].—Reich. (*Wireless Engineer*, Nov. 1939, Vol. 16, No. 194, p. 550.)
448. MEETING OF THE SOCIETY OF GERMAN ELECTROTECHNICIANS IN VIENNA [Notes on Technical Materials, Standardised Circuit Elements, Modulation Methods, Measuring Instruments, etc.].—V.D.E. (*E.N.T.*, July 1939, Vol. 16, No. 7, pp. 204-206.)
449. DESCRIPTION OF A PRESSURE CELL [Vibrating-Wire Method] FOR THE MEASUREMENT OF EARTH PRESSURE.—Morrison & Cornish. (*Canadian Journ. of Res.*, Nov. 1939, Vol. 17, No. 11, Sec. A, pp. 216-220.)
450. RADIUM EXPOSURE METER [Modified Portable Geiger-Müller Counter, including Alarm Arrangement].—Curtiss. (*Journ. of Res. of Nat. Bur. of Stds.*, Oct. 1939, Vol. 23, No. 4, pp. 479-484.)
451. DETERMINATION OF OPTIMUM VOLTAGE FOR AIRPLANE ELECTRIC SYSTEMS [including Equation for Change in Weight of Storage Batteries with Voltage for Given Watt-Hour Capacity].—Grant & Peters. (*Journ. of Res. of Nat. Bur. of Stds.*, Oct. 1939, Vol. 23, No. 4, pp. 485-496.)
452. WORK ON LIVE WIRES: EXPERIMENTS WITH EQUIPOTENTIAL RUBBER GLOVES.—Kervan. (*Electrician*, 1st Dec. 1939, Vol. 123, p. 483.)
453. SOCIAL RESPONSIBILITY OF THE ENGINEER.—Doherty. (*Elec. Engineering*, Sept. 1939, Vol. 58, No. 9, pp. 367-371.)
454. ENGINEERING ADMINISTRATION IN A SMALL MANUFACTURING COMPANY.—Burke. (*Proc. Inst. Rad. Eng.*, Sept. 1939, Vol. 27, No. 9, pp. 608-609: summary only.)

Wireless Patents

A Summary of Recently Accepted Specifications

The following abstracts are prepared, with the permission of the Controller of H.M. Stationery Office, from Specifications obtainable at the Patent Office, 25, Southampton Buildings, London, W.C.2, price 1/- each

ACOUSTICS AND AUDIO-FREQUENCY CIRCUITS AND APPARATUS

512 610.—Casing for a loud speaker with walls or sheets of insulating material for preventing undesired resonance.

W. West. Application date 3rd March, 1938.

513 010.—Adjustable centring-means for the moving coil of a loud speaker.

Kolstev-Brandes and R. Moore. Application date 29th March, 1938.

513 289.—Diaphragm suitable for a telephone or microphone, and made of solidified cellulose "foam."

H. Sell. Convention date (Germany) 18th December, 1937.

513 528.—Volume control systems for compressing or expanding the range of recorded or reproduced sounds to a desired or variable degree on the decibel scale.

K. H. F. Schlegel. Convention date (Denmark) 8th, 20th and 28th April, 1937.

AERIALS AND AERIAL SYSTEMS

512 705.—Directive aerial system, of the Adcock type, erected above a reservoir containing salt solution which provides a homogeneous earth.

C. Lorenz Akt. Convention date (Germany) 20th December, 1937.

DIRECTIONAL WIRELESS

512 304.—Automatic direction-finder in which the switching arrangement for determining the "course line" also gives an indication of "sense."

Telefunken Co. Convention date (Germany) 7th February, 1938.

RECEIVING CIRCUITS AND APPARATUS

(See also under Television)

511 533.—Automatic fine-tuning arrangement designed to come into operation when the tuning-knob of the set lies between two predetermined positions.

Telefunken Co. (addition to 505 896). Convention date (Germany) 20th February, 1937.

511 669.—Suppressing interference by rendering the receiving circuits inoperative, both to the signal and the disturbance, for very short periods.

Magyar Wolfram Lamp Co. Convention date (Hungary) 11th December, 1937.

511 852.—Tuning arrangements for wide-band amplifiers designed for short-wave signals.

Radio-Akt. D. S. Loewe. Convention date (Germany) 24th February, 1937.

511 912.—Volume control, combined with means for regulating the D.C. supply to the amplifier in accordance with the A.C. output.

N. V. Philips' Lamp Co. Convention date (Germany) 6th December, 1937.

512 141.—Wireless receiver designed to simulate a standard reading lamp, with the various tuning controls appropriately arranged.

D. J. Crowley. Convention date (U.S.A.) 4th December, 1936.

512 209.—Amplifier circuit designed to prevent distortion due to the impedance of components, such as smoothers, rectifiers, and grid-bias resistances, included in the H.T. supply.

Standard Telephones and Cables (assignees of Le Matériel Téléphonique Soc. Anon.). Convention date (France) 31st December 1937.

512 253.—Superhet receiver in which the incoming signal is "mixed" with a frequency which is derived by beating together two local-oscillators, only one of which is varied by the tuning control.

Marconi's W.T. Co. and A. L. Oliver. Application date 4th March, 1938.

512 284.—Remote tuning control for a superhet receiver in which the variable condenser is in the remote unit, whilst the associated tuning-inductance is in the stationary part of the set.

Soc. Anon. Fimi. Convention date (Italy) 15th July, 1937.

512 325.—Local-oscillator circuit designed to allow variations in the generated frequency whilst maintaining an output of constant amplitude.

Telefunken Co. Convention date (Germany) 2nd March, 1937.

512 348.—Push-button tuner in which the magnetic cores of two inductances are simultaneously operated at different rates, so as to maintain correct "tracking" over a wide frequency range.

E. K. Cole and H. A. Brooke. Application date 12th May, 1938.

512 730.—Means for measuring the precision of tuning in a press-button controlled receiver with motor-driven adjustment.

Murphy Radio; J. D. A. Boyd; and L. Fisher. Application date 16th March, 1938.

512 916.—Simplified means for adjusting a circuit for receiving at will either modulated or "interrupted" carrier-wave signals.

Marconi's W.T. Co. and R. B. Armstrong. Application date 21st March, 1938.

513 136.—Method of operating the various indicator needles on a wireless set so that they move in a straight line across a marked panel.

Kolstev-Brandes; K. G. Smith; and P. A. Tiller. Application date 1st April, 1938.

513 251.—Dial-operated tuning means for a wireless receiver in which the selection of a desired station automatically sets the wave-change switch to its appropriate position.

The General Electric Co. and W. H. Peters. Application date 30th December, 1937.

513 449.—Automatic tuning-control system for a wireless receiver in which the correcting frequency-shift is substantially constant for all wavelengths.

Marconi's W.T. Co. (assignees of D. E. Foster). Convention date (U.S.A.) 10th April, 1937.

513 476.—Thermionic oscillation-generator in which the space-change between two of the electrodes creates a negative-resistance effect (addition to 510 180).

Telefunken Co. Convention dates (Germany) 31st March and 1st April, 1937.

TELEVISION CIRCUITS AND APPARATUS

FOR TRANSMISSION AND RECEPTION

511 796.—Picture-forming screen, for use in television, made of crystals of potassium chloride sensitised with thallium chloride.

Scophony and A. H. Rosenthal. Application dates 25th February and 2nd December, 1938.

511 850.—Circuit for producing saw-toothed scanning-oscillations of high linearity.

Telefunken Co. Convention date (Germany) 20th February, 1937.

512 065.—Modulating circuit for producing single-sideband television signals having a substantially linear characteristic over the whole frequency range.

Marconi's W.T. Co. (assignees of N. E. Lindblad). Convention date (U.S.A.) 19th March, 1937.

512 109.—Switching circuit in which three diode valves are controlled by the synchronising-pulses in a television system.

A. D. Blumlein and E. L. C. White. Application dates 24th December, 1937, and 25th April, 1938.

512 173.—Valve circuit in which a secondary-emission effect is utilised to obtain a characteristic curve suitable for use as an amplitude filter in a television receiver.

The Mullard Radio Valve Co. and C. C. Eaglesfield. Application date 13th May, 1938.

512 421.—Film television system in which two separate optical paths, each comprising a "skew" prism, are used for interlaced scanning.

Baird Television (communicated by Fernseh Akt). Application date 1st March, 1938.

512 489.—Means for preventing the formation of undesired charges around the margins of a storage screen as used for developing television signals.

Fernseh Akt. Convention date (Germany) 6th March, 1937.

512 519.—Producing saw-toothed voltages by means of a magnetic deflecting-coil energised by two valves connected cathode to anode.

Baird Television and T. C. Nuttall. Application date 2nd March, 1938.

512 571.—Means for distributing the speech- and picture-frequency bands more evenly between the two carrier-waves used in television.

Marconi's W.T. Co. and L. E. Q. Walker. Application date 14th March, 1938.

512 716.—Method of mounting the cathode-ray tube in a television cabinet so as to afford convenient access to the leads and other circuit accessories.

Murphy Radio and H. F. Wedge. Application date 5th March, 1938.

512 795.—Synchronising circuit for an interlaced scanning system in which the line impulses are prevented from prematurely "trigging" the frame oscillator.

Baird Television and D. V. Ridgeway. Application date 15th March, 1938.

512 855.—Infra-red filter for maintaining the true colour-values when televising pictures in natural colours.

Baird Television and J. L. Baird. Application date 22nd March, 1938.

512 903.—Television transmitter in which an "image" screen of alkali-halide crystals is used to store the signal as a special form of photo-chemical energy.

Scophony and A. H. Rosenthal. Application date 18th March, 1938.

512 985.—Television light-modulating cell traversed by supersonic waves generated by a piezo-electric crystal and containing a volatile liquid such as heptane.

Scophony; J. Sieger; and R. E. Duggan. Application date 18th March 1938.

512 999.—Interlaced scanning system in which to ensure accurate synchronisation the "line" impulses are periodically suppressed.

Baird Television (communicated by Fernseh Akt). Application date 28th March, 1938.

513 019.—Arrangement of three pairs of deflecting-plates for a cathode-ray tube designed to prevent "keystone" distortion.

Marconi's W.T. Co. (assignees of J. B. Sherman). Convention date (U.S.A.) 30th March, 1937.

513 021.—Means for preventing the "black-spot" effect due to the action of the mosaic screen in a television transmitter of the Iconoscope type.

Marconi's W.T. Co. (assignees of A. W. Vance). Convention date (U.S.A.) 30th March, 1937.

513 093.—Applying voltages to the deflecting plates of a cathode-ray tube so that they are symmetrical with respect to the anode voltage.

Leibold und von Ardenne Akt. Convention date (Germany) 5th August, 1937.

513 099.—Cathode-ray television receiver of the type in which a wide homogeneous electron beam is modulated from point to point by passing it through a "storage" grid.

Baird Television; A. K. Denisoff; and V. A. Jones. Application date 1st April, 1938.

513 205.—Television synchronising system in which impulses of the same amplitude but unequal duration are converted into impulses of different amplitude.

C. L. Faudell; R. E. Spencer; and I. J. P. James. Application date 4th February, 1938.

513 332.—High-powered cathode-ray tube, for projecting large-sized television pictures, in which the fluorescent screen is backed by an artificially-cooled translucent plate.

The British Thomson-Houston Co.; J. T. Anderson; D. Gabor; H. W. H. Warren; and R. S. Wells. Application date 5th April, 1938.

513 486.—Television system in which the fluorescent screen of a cathode-ray tube is replaced by two "gratings" of wire, set at right-angles to each other, and connected to a picture screen placed outside the cathode-ray tube.

F. A. Lindemann. Application date 6th April, 1938.

513 518.—Fluorescent composition, including Beryllium, for use in a high-powered cathode-ray television receiver.

S. T. Henderson. Application date 10th February, 1938.

513 523.—Photo-sensitive material, based on a compound of antimony and palladium, for use in television transmitters of the cathode-ray type.

L. Klatzow. Application date 7th March, 1938.

TRANSMITTING CIRCUITS AND APPARATUS

(See also under Television)

512 121.—Condenser arrangement which automatically compensates for any alteration of the tuning involved in changing over from transmission to reception, or vice versa, in a combination set.

Soc. Anon. Fimi. Convention date (Italy) 28th January, 1938.

512 792.—Radio transmitter (or receiver) so designed that a considerable potential difference is permissible between the chassis and the power-supply lines.

Standard Telephones and Cables and C. W. Earp. Application date 15th March, 1938.

513 164.—Preventing distortion in a wireless transmitter due to the anti-resonance effects which occur at certain frequencies in the smoothing filter for the power supply.

Marconi's W.T. Co. and H. Cafferata. Application date 4th March, 1938.

513 229.—Carrier-wave signalling system in which a pilot current is used for compensating or indicating "line" conditions, or for frequency-synchronising.

Standard Telephones and Cables and K. G. Hodgson. Application date 1st April, 1938.

513 416.—Thermionic amplifier forming part of an equalising or attenuation-compensating network, for instance in a broadcast repeater system.

Standard Telephones and Cables; R. A. Meers; and F. G. Filby. Application date 8th March, 1938.

513 533.—Single-side-band signals sent over a transmission line simultaneously with Morse and other "impulse" signals.

Standard Telephones and Cables and V. J. Terry. Application date 8th April, 1938.

CONSTRUCTION OF ELECTRONIC-DISCHARGE DEVICES

512 245.—Method of mounting the filament of a valve so as to minimise "microphonic" noises and so-called "hissing."

Marconi's W.T. Co. (assignees of T. J. Henry). Convention date (U.S.A.) 27th February, 1937.

512 711.—Electron-multiplier fitted with a photo-sensitive cathode of spherico-concave shape, the first target electrode being located at radial distance from the cathode.

Radio-Akt. D. S. Loewe. Convention date (Germany) 16th February, 1937.

512 885.—Means for maintaining a high vacuum between the jacket and the walls of a gas-filled electric discharge tube.

K. Neimanis. Application date 18th February, 1938.

512 933.—Cathode-ray tube with an apertured diaphragm arranged beyond the first accelerating electrode and focusing means between that electrode and the fluorescent screen.

F. W. Cackett (communicated by the Telefunken Co.). Application date 19th February, 1938.

513 111.—Electron multiplier in which the discharge stream is controlled so as to secure a high signal-to-noise ratio.

Marconi's W.T. Co. (assignees of H. Nelson). Convention date (U.S.A.) 26th February, 1937.

513 157.—Arrangement of "lens" electrodes in a cathode-ray tube for focusing the electron stream (addition to 480 857).

O. Klemperer and W. D. Wright. Application date 17th February, 1938.

513 155.—Method of assembling the electrodes of a cathode-ray tube so as to ensure correct centering or alignment.

The General Electric Co. and R. H. Craig. Application date 2nd February, 1938.

SUBSIDIARY APPARATUS AND MATERIALS

511 415.—Method of flexibly connecting a conductor to the moving vanes of a variable condenser.

Philips' Lamp Co. Convention date (Germany) 21st March, 1938.

511 674.—Preventing the production of static interference when a make-and-break switch is operated.

F. R. W. Strafford and Belling and Lee. Application date 26th February, 1938.

511 795.—Form of resonant circuit, with a high ratio of reactance to resistance, for very short waves.

Telephone Manufacturing Co. and L. H. Paddle. Application date 24th February, 1938.

511 920.—Diaphragm and coil mounting and centring means for a moving-coil loud speaker.

N. V. Philips' Lamp Co. Convention date (Germany) 24th January, 1938.

512 327.—Amplifying valve coupled to a photo-sensitive cell through components which are substantially non-reactive.

Baird Television and P. E. A. R. Terry. Application date 4th March, 1938.

512 576.—Device for indicating to broadcast listeners the type of programme that is being given at each of a number of transmitting stations.

M. Lajta and K. Nekolny. Convention date (Hungary) 19th February, 1938.

512 570.—Connecting a branch "rejector" link to a high-frequency transmission line of the coaxial type.

Telefunken Co. Convention date (Germany) 13th March, 1937.

512 609.—Valve oscillator circuit fitted with electrodes for testing or measuring the sensitiveness to pain of a patient.

W. Rotherham. Application date 21st January, 1938.