

EXPERIMENTAL WIRELESS & The WIRELESS ENGINEER

VOL. VII.

AUGUST, 1930.

No. 83.

Editorial.

Side Bands and Selectivity.

ALTHOUGH much more is now known concerning the Stenode Radiostat than when we discussed it editorially in our January number, the published attempts which have been made to explain its principle of operation have so far been very unsatisfactory. In its simplest form it is merely a very sharply tuned receiver. Such a receiver, as is well known, produces great distortion due to the suppression of the higher acoustic frequencies, and this is so, we understand, in the case of the Stenode Radiostat, until a compensating device is inserted in the acoustic frequency output. This device restores the correct balance between the low and high notes, and thus gives an undistorted output without sacrificing the selectivity of the sharply tuned receiving circuit. This is the claim, and it appears to be substantiated by the evidence of several unbiased observers. Articles and letters which have appeared in *The Wireless World* have failed to throw much light on the subject; some of the writers have gone so far as to regard the success of the device as a proof of the non-existence, or, at least, of the non-essentialness, of the side-band

frequencies in the modulated wave. Personally, we should prefer to ascribe it simply to magic.

The following elementary considerations make no pretence of explaining the operation of the Stenode Radiostat, but are merely set out as a necessary foundation on which any satisfactory explanation must be based.

Effect of a Modulated Wave on a Very Selective Circuit.

If an alternating e.m.f. acts upon a simple oscillatory circuit consisting of a coil of inductance L and resistance R in series with a condenser of capacitance C , the current produced is given by the formula

$$I = \frac{E}{\sqrt{R^2 + \left(\omega L - \frac{1}{\omega C}\right)^2}}$$

If this circuit is tuned to the carrier frequency $\omega_0/2\pi$, then $\omega_0 L = \frac{1}{\omega_0 C}$ and at this frequency $I = \frac{E}{R}$. We shall call this resonant value of the current I_0 . At any other

frequency $\omega = \beta\omega_0$ we have

$$I^2 = \frac{E^2}{R^2 + \left(\beta\omega_0L - \frac{I}{\beta\omega_0C}\right)^2} = \frac{E^2}{R^2 + \omega_0^2L^2\left(\beta - \frac{I}{\beta}\right)^2}$$

$$= \frac{E^2}{R^2 \left[1 + \frac{\omega_0^2L^2}{R^2}\left(\beta - \frac{I}{\beta}\right)^2\right]}$$

Hence
$$\frac{I^2}{I_0^2} = \frac{1}{1 + \frac{\pi^2}{\delta^2}\left(\beta - \frac{I}{\beta}\right)^2} \quad \dots (A)$$

where $\delta = \frac{R}{2f_0L} = \frac{\pi R}{\omega_0L}$ is the logarithmic decrement of the circuit

$$\beta - \frac{I}{\beta} = \frac{\omega}{\omega_0} - \frac{\omega_0}{\omega} = \frac{\omega^2 - \omega_0^2}{\omega\omega_0} = \frac{(\omega - \omega_0)(\omega + \omega_0)}{\omega\omega_0}$$

If $\omega - \omega_0$ is small compared with ω_0 , this is approximately equal to $(\omega - \omega_0) \frac{2}{\omega_0}$.

Formula (A) enables us to calculate the variation of current as the frequency moves away from resonance; it enables us to calculate the relative magnitudes of the currents set up by the carrier and side-band frequencies from a given depth of modulation. It is seen to depend on two factors only, *viz.*, the ratio of the frequencies and the decrement of the circuit.

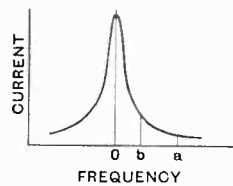

Fig. 1.

If I_a and I_b are the currents produced respectively by two frequencies, $\omega_a/2\pi$ and $\omega_b/2\pi$, the e.m.f. being assumed to have the same magnitude in every case, then from (A) we have approximately

$$\frac{I_a^2}{I_b^2} = \frac{1 + \frac{\pi^2}{\delta^2}(\omega_b - \omega_0)^2}{1 + \frac{\pi^2}{\delta^2}(\omega_a - \omega_0)^2} \quad \dots (B)$$

If, for any given conditions, this were equal to $\frac{1+2}{1+5} = \frac{3}{6}$, then if δ were decreased to half its value, the ratio would become $\frac{1+8}{1+20} = \frac{9}{21}$ or $\frac{3}{7}$, that is to say, a reduction of the damping causes a bigger relative difference between the two currents for two given frequencies, wherever these frequencies may be on the curve.

The Phase of the Current.

At the resonant frequency the current is exactly in phase with the e.m.f. producing it. At higher frequencies the current lags behind the e.m.f. by an angle ϕ , such that $\tan \phi = \frac{\omega L - I/\omega C}{R} = \frac{\pi}{\delta} \cdot \frac{\omega^2 - \omega_0^2}{\omega\omega_0}$. If the frequency is below the resonant value the current leads, the tangent becoming negative. If the circuit is very selective, *i.e.*, if δ is very small, ϕ is nearly 90° for small departures from resonance.

If several sinusoidal electromotive forces of different magnitudes and frequencies act simultaneously upon the circuit, they can be considered separately and the resultant current obtained by suitably compounding the constituent currents. A word of warning is necessary, however, with reference to the relative phases of these constituent currents, which will generally be different from the relative phases of the electromotive forces inducing them.

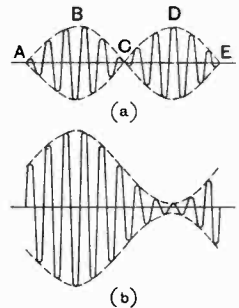

Fig. 2.

Let the inducing e.m.f. be a modulated wave given by the formula

$$e = \hat{e}(1 + m \cos pt) \cos \omega t \quad \dots (C)$$

where m represents the degree of modulation ($m = 1$ for 100 per cent. modulation); $\omega/2\pi$ and $p/2\pi$ are the carrier and acoustic frequencies respectively. This may also be represented as the resultant of three sine waves, *viz.*,

$$e = \hat{e} \cos \omega t + \frac{m}{2} \hat{e} \cos (\omega + p)t + \frac{m}{2} \hat{e} \cos (\omega - p)t \quad \dots (D)$$

It should be noted that there is no more or less mathematical abstraction about (D) than there is about (C). If a receiving circuit does not respond to the last two terms of (D) it will carry an unmodulated current, and nothing in the detector or low frequency amplifier can re-introduce the acoustic frequency.

As a warning against hasty conclusions when compounding several waves, it should be noticed that the sum of the two last terms gives Fig. 2 (a), which, when rectified—imagine the portion below the base line to be suppressed—would give an acoustic note of which the period is AC . The addition of the first term gives Fig. 2 (b), which shows the 100 per cent. modulated carrier; this, when rectified, would give an acoustic note of period AE , without any trace of the octave given by Fig. 2 (a). We are not concerned here with any distortion produced by the rectifier. It is important to notice that at A , C and E the two side-band waves neutralise each other and give zero resultant in Fig. 2 (a) and leave the carrier unaffected in Fig. 2 (b). At B the two side-band waves are in phase with each other and with the carrier, whereas at D the side-band waves are again in phase with each other, but exactly 180° out of phase with the carrier which is therefore wiped out. This shows that the phase of the carrier relatively to the side-bands is of great importance. If the carrier is suppressed, it can only be subsequently reintroduced if steps are taken to ensure that its phase has the correct relation to that of the side-bands. It must be exactly in phase or 180° out of phase with the side-bands at the moment when they are in phase with each other,

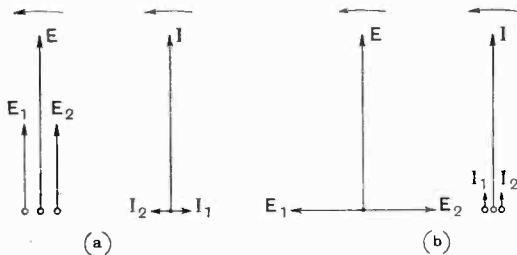

Fig. 3.

otherwise Fig. 2 (b) is not obtained. If the carrier were 90° out of phase with the side-bands at B and D , the resultant amplitude would be the same at these two points, and, on rectification, the octave would be obtained, as in Fig. 2 (a).

Circuit Tuned to Carrier of Modulated Wave.

If the modulated wave of e.m.f. shown in Fig. 2 (b) acts upon a very selective circuit tuned to the carrier wave, the carrier fre-

quency e.m.f. will produce a large current and the two side-band frequency electromotive forces will produce small currents which could be read off a curve such as Fig. 1; it must be remembered, however, that the side-band e.m.f.s are in general much smaller than the carrier e.m.f.

Since the differences in frequency are small, the voltages produced across the condenser in the oscillatory circuit will be very nearly proportional to the currents and in the same relative phase relation.

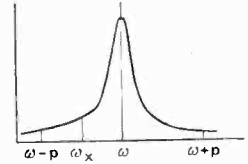

Fig. 4.

Fig. 3 (a) shows the three constituent electromotive forces of equations (C) or (D) at the moment when they are in exact conjunction, that is, when the modulated wave has its maximum amplitude. The carrier frequency e.m.f. E produces a current I in phase with it; the higher frequency e.m.f. E_1 produces a current I_1 lagging behind it; the lower frequency e.m.f. E_2 produces a current I_2 leading ahead of it. The angle of lag or lead will depend on the departure from resonance and on the selectivity of the circuit, as we have already seen, but we have shown it as 90° in the diagram. Fig. 3 (b) shows the conditions at a subsequent time when E_1 has pulled 90° ahead of E and E_2 fallen 90° behind it; the currents will then be as shown. Although all the vectors are rotating anti-clockwise at slightly different speeds, the amplitudes can best be studied by assuming E and I to stand still while E_1 and I_1 slowly rotate anti-clockwise, and E_2 and I_2 clockwise. It is then seen that the resultant amplitude of the current undergoes similar variations to those of the amplitude of the e.m.f. but of smaller magnitude and with a phase displacement. The resultant e.m.f. is a maximum in Fig. 3 (a), whereas the resultant current reaches its maximum amplitude in Fig. 3 (b).

The current vectors I, I_1 and I_2 in Figs. 3 (a) and 3 (b) represent to some scale the voltages across the condenser in the tuned receiving circuit.

Effect of Interfering Waves.

There are several assumptions which can

now be made; we may assume that an interfering unmodulated carrier is received having a frequency near that of our desired modulated carrier, or we may assume that an interfering modulated carrier is received when our desired carrier is unmodulated, or we may assume them both to be modulated, in which case we have to deal with two carriers and four side-bands. We shall confine our attention to the first case and assume the interfering carrier has a frequency midway between those of the desired carrier and its lower side-band. Those who do not like side-bands are at perfect liberty to express these assumptions in any other manner to suit their taste; referring to equation (C) the frequency of the interfering

carrier is $\frac{\mathbf{I}}{2\pi}(\omega - \frac{\dot{p}}{2})$. We assume that the two carriers have equal intensity and that the resonance curve of the circuit is as shown in Fig. 4. The currents produced by the two carriers will be proportional to the ordinates at ω and ω_2 , but the currents due to the side-bands will be much smaller than the ordinates at $\omega + \dot{p}$ and $\omega - \dot{p}$, because the electromotive forces of the side-bands are much smaller than those of the carriers. In Figs. 5 and 6 it is assumed that the inter-

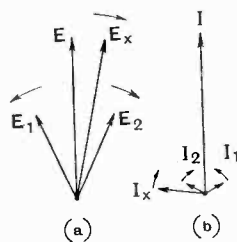

Fig. 5.

fering e.m.f. has its maximum value at the moment when the modulated e.m.f. is a maximum. The vector representing the desired carrier E is at rest in Fig. 5 (a), while the interfering vector E_x moves at half the angular velocity of E_2 . Fig. 5 (b) shows the corresponding currents, assumed for simplicity to lag or lead by exactly 90° on their respective e.m.f.s. The resultant of the four vectors will give the amplitude of the resultant current; this is shown in Fig. 6 for one and a half cycles of the side-band

currents and three-quarters of a cycle of the current due to the interfering carrier. It will be seen that, on the assumptions made, the interfering carrier causes a much larger variation of amplitude, *i.e.*, a much larger modulation of the voltage across the condenser than that produced by the modulation of the desired wave.

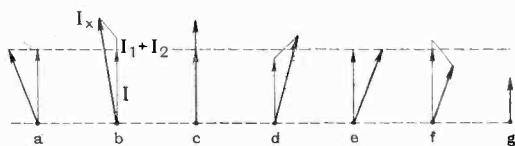

Fig. 6.

In my opinion, no device could be introduced capable of discriminating between these two modulations and detecting and amplifying one without the other, but it should be pointed out that the system which we have considered is not the same as that employed in the Stenode Radiostat. In the latter apparatus the heterodyne method is an essential factor, the various electromotive forces which we have considered, together with another produced by the local oscillator, acting on a circuit which is not ultra-selective to produce a resultant current which is rectified. It is this rectified current which is subjected to the filtering action of the ultra-selective circuit and we have already given a word of warning against jumping to hasty conclusions when the combination of several waves is associated with rectification. If the claims made for the Stenode Radiostat are substantiated we feel sure that the explanation will be found in this direction. The side-bands differ from any interfering wave, not in their non-existence, but in the fact that they are equal in amplitude, are equally spaced on either side of the carrier frequency and, as we have emphasised, have a definite phase relation to the carrier.

G. W. O. H.

Flat Piston Moving Coil Loud Speakers.*

By Robt. W. Paul, M.I.E.E., F.Inst.P., and B. S. Cohen, M.I.E.E.

EXPERIMENTS were started in the Autumn of 1927 with a view to ascertaining the possibility of constructing flat discs which, when vibrated at acoustic frequencies, would be substantially rigid yet light enough to operate effectively as pistons in loud speakers of the hornless type. The paper cones commonly used in such instruments offer no acoustic advantages and have, in fact, certain definite disadvantages, the conical form being necessitated in order to impart stiffness to a material inherently lacking in that quality. Preliminary trials of pistons of flat, cellular construction embodying paper tubes, vegetable stems, pith and mica in various combinations indicated that such devices were liable to shatter under vibration, besides possessing other disqualifications for our purpose.

Early in 1928 Dr. Ezer Griffiths suggested, as a suitable material for trial, Balsa Wood, cut from the tree *Ochroma Lagopus* which grows with great rapidity in the hot, moist climate of Ecuador and elsewhere. This wood, in common with other woods, has a strength along the grain about 12 times that across it; the specific gravity is from 0.09 to 0.12 only, while the Young's Modulus of Elasticity, measured along the grain, is of the order of 0.45×10^{11} . Hence the ratio of elasticity to density gives a velocity of sound, along the grain, of 60×10^4 centimetres per second; this is greater than that in any other material known to the authors and is nearly 20 times the velocity of sound in air.

With the aid of a suitable, non-hygroscopic adhesive balsa wood can be built up into any desired form of piston; the wood does not tend to shatter even under severe vibrations, nor has it any particular liability to warp. Although it can, in its natural state, take up its own weight of water on immersion, means were found to render it proof against absorption of atmospheric moisture, no appreciable increase in weight being involved.

As a result of these attributes the wood was adopted throughout the experiments here described.

Design and Construction of Balsa Pistons.

Early pistons had a thickness of 5 mm. and were lightened by cutting out slots elongated along the grain of the wood, the slots being sealed with a covering of thin muslin, doped with a cellulose varnish; the pistons were stiffened by ribs across the grain. The frequency-amplitude characteristics of these pistons were not satisfactory and all later experiments were made with discs 1 to 3 mm. thick, stiffened by ribs about 2 mm. wide and about 6 mm. deep. The coil was designed to add to the stiffness of the whole. Many such pistons were made and tested, their diameters varying from 12 to 30 cms., and many variations were made in the number and disposal of the ribs.

Tests of rigidity were made by various methods, *e.g.*, the piston being supported at its circumference, load was applied at the position of the coil; or, the support being at the position of the coil, loads were applied near the circumference; in both methods deflections were measured by the aid of a microscope. A typical piston having a radius of 10 cms., loaded with one kilogram at the coil position, deflected about 0.5 mm.

A third method enabled observations to be made under working, as well as static, conditions; a minute bead of mercury mounted at any desired point on the piston served to reflect a spot of light through a microscope on to a square-ruled screen; thus the motion of such point could be observed on a greatly enlarged scale.

Use was also made of Chladni figures, the piston, in a horizontal position, being lightly dusted with carborundum powder and set in vibration at known frequencies; series of such figures, many of which were photographed, assisted in indicating the nodes and anti-nodes.

Preliminary tests of the various pistons were made aurally, using a calibrated oscillator as source and a loud speaker of known characteristic as a sub-standard; precautions were taken, as far as possible, against the effect of standing waves. The gramophone sound-test records giving a "gliding-howl" tone, with a quick-acting

* MS. received by Editor, April, 1930.

change-over switch, also proved useful in rough comparisons of two loud speakers.

By such means, together with the frequency-amplitude characteristics subsequently taken, a certain amount of guidance in design was obtained. In order to test the reproducibility of the results, four similar pistons, mounted interchangeably in one magnet, were tested and were found to give precisely similar characteristics. Experiments of methods of ribbing the discs indicated that ribs placed symmetrically across the grain of the wood, or a system of radial ribs with chordal ribs, or plywood pistons, were incapable of yielding freedom from marked resonances at all parts of the audio range. Finally a form of piston was found in which the resonances were, in general, better distributed than those of paper cones; in this the ribs are asymmetrically disposed so as to divide the surface into areas which are roughly triangular in shape; the details are described later. Inspection of the characteristic curves for many pistons less than 10 inches in diameter indicated their deficiency in acoustic output in the neighbourhood of 500 p.p.s.; many attempts were made to rectify this peculiarity in the smaller pistons, but without success; and as it was desired to avoid the application of electrical corrections we decided to concentrate our attention on pistons having diameters of 10 inches or over.

The following are typical weights for pistons, including the centring device described later, and exclusive of the moving coil:—

Nominal diameter, inches	8	10	11½
Radius, centimetres	10	12.5	14.5
Weight, grams	12	18	24

Methods of Mounting the Piston.

Three methods of supporting and centring the pistons were tried: (a) With three radial threads attached to the circumference of the disc and three others attached to the inner end of the coil former and in a plane parallel to the first. In some models the threads were metallic and carried current to the coil. Several devices for centring the coil in the air-gap were made, but the method was abandoned in favour of (c), which gave easier and more positive centring. (b) A central plug, adapted to fit a hole in the centre of the

magnet, carried two volutes, spaced apart on the plug and attached at their outer edges to collars at the centre of the piston. These volutes restrained the motion of the piston to one along the axis and, being cut from thin celluloid sheet, exercised very little control. This method was usually combined with a surround attached to the edge of the piston and sealing the opening between it and its baffle. Although it was found advisable, in the light of experiments, to abandon the use of surrounds, of which many varieties were tried, it may be of interest to give the reason here. In one type the edge of the piston, with mounting (b), was lightly held between rings of soft Sorbo rubber carried in fixed metal rings; in another type a ring of flexible material (rubber, leather or fabrikoid sheeting) was cemented to the edge of the piston to form a free margin one or two cms. wide, the outer edge of the surround being held either in the Sorbo rings or in a manner which enabled the fabric to be tensioned equally all round and to any desired extent. The effect of the surround, as indicated by aural tests and actual measurements, was to complicate the characteristic by resonances additional to those of free-edge pistons; speech articulation proved to be truer with the latter.

(c) In the method finally adopted the surround, with its uncertain addition to the control or stiffness of the moving system, was eliminated, the piston working, with a small clearance, in a small baffle ring to which the actual baffle could be attached. The method of attachment to the magnet was similar to that of method (b), but the volutes were of metal of thickness such as to give a definite control or stiffness factor. The stiffness factor has been varied between 0.1 and 10 megadynes per cm. in the experiments; a control of about 0.5 megadyne per cm. was ultimately found suitable; this corresponds to a deflection of the piston of 0.1 inch for a pressure of 4 ounces.

Design of the Moving Coil and Magnet for Use with Flat Piston.

As well from electrical considerations as to distribute the force applied to the piston and to add to its rigidity, it was decided to make the diameter of the coil as large as convenient. In all the models the coil had an internal diameter of 2.970 inches (7.543

cms.) and was wound on a former consisting of tissue paper in the layers of which two copper strips were embedded to form the leads; the strips measured 1 mm. by 0.05 mm. Silk-covered wire was used, it having been found that enamelled fine wire was liable to breakdown of insulation under prolonged vibration. The space occupied by the coil was 7 mm. long, with a margin

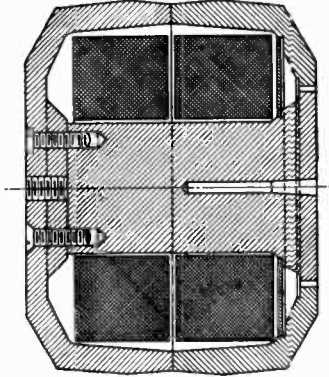

Fig. 1.

between it and the piston of 9 mm.; this portion of the coil former was overwound with fine silk thread and a presspahn flange was added in order to provide a flat, varnish-free surface for cementing the former to the piston. After attaching the flange and covering the winding with a layer of tissue paper the whole was bakelised and baked into a solid unit; the leads were brought through to the front of the piston as described later. The weight of the coil unit was 5.5 grams.

Coils of low resistance were generally used, in conjunction with a step-down transformer having a ratio of 10:1. Such a coil had, in two layers, 70 turns of No. 38 S.W.G. wire, with a length of 1,680 cms., and a d.c. resistance of 15 ohms. The self-inductance was 600 microhenrys, and the a.c. resistance about 30 ohms.

The electromagnets employed were of the ironclad or "pot" form, and in order to provide ample free space behind the piston the front of the magnet was bevelled off. Trial was made of a magnet having a hole two inches in diameter along its axis, but this gave no appreciable advantage over the solid core.

Accurate concentricity of the inner and outer poles was ensured by fitting between

them a brass centring washer as near as possible to the air-gap. A recent design of magnet, constructed solely of magnet iron, and with two joints only in the magnet circuit, is shown in section in Fig. 1; this design involves a minimum of machining work in its manufacture. Magnets of much larger dimensions, with power consumption up to 72 watts, were tried but gave no proportional increase in useful flux as compared with this form which has a maximum consumption of 22 watts, and a temperature rise, after 12 hours run, of about 45 degrees C. The radial length of the air-gap is .085 inch (2.16 mm.), with an axial length of .25 inch (6.2 mm.).

Typical windings for the form of magnet illustrated consist of two former-wound coils which can be joined in parallel or in series, for 100 or 200-volt circuits, by means of a terminal block; each coil has 11,500 turns of No 31 S.W.G. wire, with a resistance, cold, of 800 ohms. The air-gap has an area

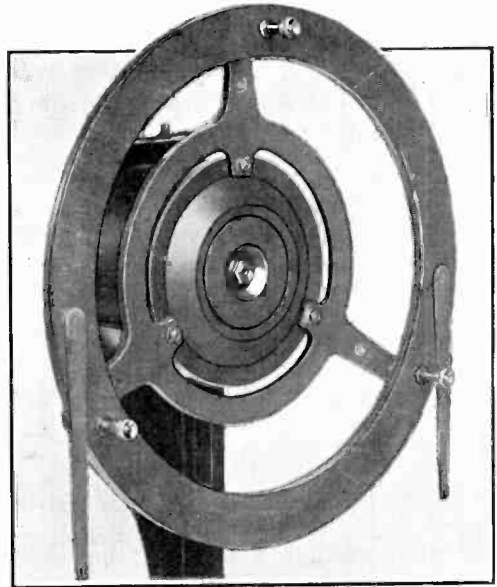

Fig. 2.—Magnet and frame.

of 15 sq. cms. and the flux in that area, as measured by a search coil of two turns used with a Grassot Fluxmeter, is 175,000 to 180,000 lines, or about 12,000 lines per sq. cm.; a further 80,000 to 90,000 lines are accounted for by leakage and fringing at the gap.

Permanent magnets, with or without polepieces were also tested; these gave, in an air-gap similar to that of the electro-magnet just described, a useful flux of

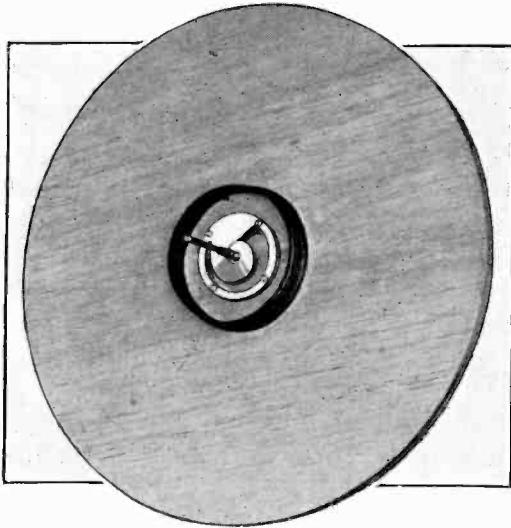

Fig. 3.—Rear view of piston.

60,000 lines when made without polepieces. Any piston could be used interchangeably in either type of magnet.

The Completed Loud Speaker.*

The loud speaker is adapted for inclusion in a cabinet, bolting to the rear of a fixed baffle or fixing to a stand with a baffle attached to the loud speaker, as illustrated in Fig. 5. The magnet is clamped between a spider at the front and a ring at the back, the latter carrying the terminal block already referred to; the spider supports the baffle ring; as seen in Fig. 2 the baffle ring carries two pivoted arms which can be turned to form connection with the moving coil and which have terminals, integral with them, at the back. On the axis of the magnet is a hole, the front end of which is coned to 5 degrees included angle.

In Fig. 3 is shown the rear view of the piston with the moving coil attached, the flexible strip connections passing through bushings to the front; the central plug is adapted to fit the conical hole in the magnet and has a plain extension which prevents

any possibility of the coil coming in contact with the poles on insertion. The plug passes through a clearance hole in the piston and has fixed to it two volutes, cut from thin duralumin sheet, spaced about 18 mm. apart. A distance collar of balsa wood, cemented on each side of the piston, forms the attachment for the outer rim of each of the volutes. The combined weight of these parts is only 2.2 grams, of which a certain proportion adds to the weight of the vibrating system; the volute exercises a definite control, or stiffness factor, usually 0.5 megadyne per cm.

The piston, ribbed asymmetrically in accordance with the method arrived at by experiment, is shown in place in Fig. 4. The assembly of the moving system to the magnet involves merely plugging it in, and then turning the two contact arms into the position shown; they click into definite positions on the contact block, carried on the plug, where the flexible strip connections to the moving coil are permanently attached. Thus it is a simple matter for an unskilled person, without the use of any tool, to remove

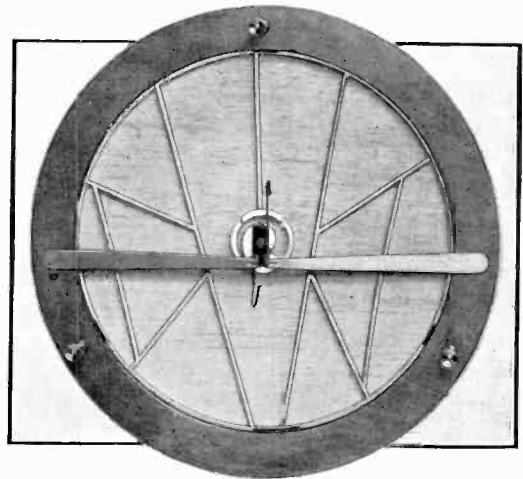

Fig. 4.—Front of Paul Loud Speaker.

the system, and replace it, in the event of it becoming necessary to clean out the air-gap. The absence of any surround, which is necessarily of a flexible and perishable nature, eliminates an element of instability and the need for readjustment after prolonged use.

* R. W. Paul's British Patent 315501.

The working parts may, as proved by measurements made, be protected by a thin silk cover without detriment to the acoustic effect; such a cover is shown in Fig. 5,

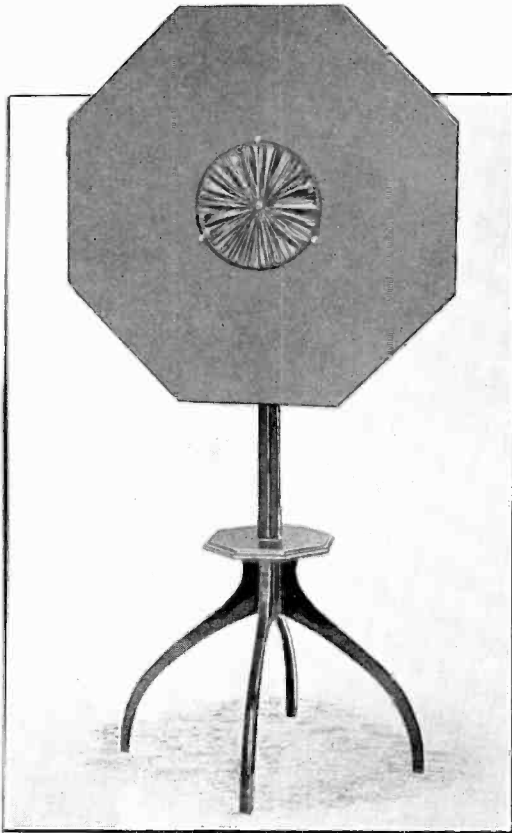

Fig. 5.—Loud Speaker, complete on stand.

which illustrates the instrument with its baffle on a stand suitable for indoor use.

Aural Tests.

Before proceeding to give the results of the scientific measurements of the acoustic output over the audio range it may be permitted to refer to the observations of trained listeners who have assisted the authors by their criticisms of the performance of the loud speaker described above. The bass response is entirely pure and free from the "booming" effect noticeable in instruments of the cone type. Speech articulation is extremely clear, the effect of a voice heard through the media of this loud speaker and

an electrostatic microphone being almost indistinguishable from that of the same voice heard directly; this results from the exceptional output at frequencies above 1,000 p.p.s. The notes of a piano played in a broadcasting studio were reproduced by the loud speaker without alteration of the concert pitch, while tests with a number of individual orchestral instruments showed, even in the case of percussion instruments, faithful and "brilliant" reproduction. The flat piston, as supported outside the magnetic field, has a natural frequency of 16 only, this being below the lower limit of audibility; although the measuring apparatus did not permit of tests above 7,000 p.p.s. the output at 10,000 p.p.s. proved quite noticeable.

Observations on permanency of adjustment and of quality have hitherto extended over about a year only, but indicate that no change need be expected over an indefinitely long period of use. The authors believe that, in view of these facts and of the measurements to be detailed in the following paragraphs a real advance has been made, in respect of uniformity of response and reliability, in moving coil loud speakers of the hornless type.

In the course of the development of the flat balsa wood disc loud speaker some electro-acoustic measurements under different conditions were carried out, and some calculations made, which may be of interest to readers.

Measurements.

One series of measurements was carried out in a chamber built of non-sound-reflecting material and contained

in a larger wooden building. Unfortunately, the inner chamber did not absorb all the sound, and a definite amount passed through and was reflected back by the outer room into the inner chamber and produced standing waves of small amplitude.

The loud speakers were fitted in baffles having a diameter of about 80 cms.; larger baffles could not conveniently be accommodated in the chamber available. The acoustic pressures were measured at a point

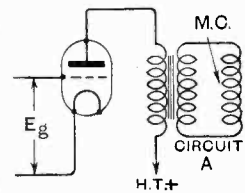

Fig. 6.

3ft. (91.4 cms.) along the axis of the loud speaker, by means of an electrostatic microphone which had been carefully calibrated for this purpose.

The moving-coil circuit was that shown in Fig. 6; the power valve (one LS5a) had an amplification factor of 2.5 and the output transformer a ratio of 10:1. The input to the power valve was supplied at a known voltage from a heterodyne oscillator giving a pure wave-form at all frequencies between 50 and 5,000. The moving coil of each loud speaker had 70 turns (length of wire 1,680 cms.), with a d.c. resistance of 15 ohms and a self-inductance of 600 microhenrys. The a.c. resistance of the circuit A

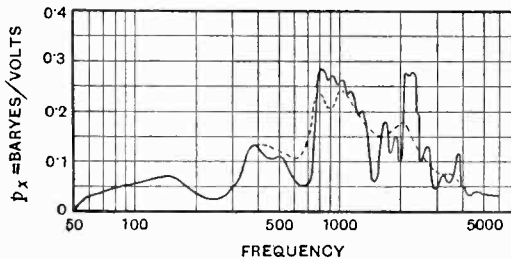

Fig. 7.

was 35 ohms and one volt at E_g gave 0.25 volt on the moving coil.

The acoustic pressures at 3ft. are recorded in baryes (*i.e.*, dynes per square cm.) per volt on the grid of the power valve.

In Fig. 7 the pressure characteristic of the Paul loud speaker with 11½ in. diam. free edge disc (Expt. 41) described above, is given for a point on its axis, and in Fig. 8 for the same distance from the microphone but with the piston at 45 degrees to the line joining the loud speaker and microphone. The irregularities due to standing waves and reflection from the baffle are noticeable, and especially so at the median and high frequencies. The dotted curve which has been added to Fig. 7 gives a mean of the two curves and may be accepted as a truer indication of the output than either of them taken separately.

To convert the pressure characteristics of Figs. 7 and 8 to response curves, the baryes

per volt of those curves are multiplied by 100 to correspond with a grid swing of 100 volts on the valve LS5a; the common logarithm is taken, in accordance with the

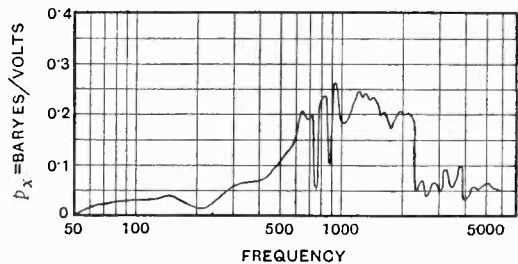

Fig. 8.

usual practice, to represent the aural response. Fig. 9 gives the resulting curve. Frequencies are not plotted logarithmically in this case.

It is of interest to compare the performance of a similar type of balsa wood disc but with the edge attached to a fabric surround, itself held between sorbo rubber rings, this edge control being in addition to the central helical control. Fig. 10 (Expt. 27) shows the pressure characteristic of a 10in. diam. disc loud speaker mounted in the above manner and tested under the identical conditions used for Expt. 41, Fig. 7.

Minor ripples, probably mostly due to standing waves, have been omitted in drawing the curve, thus accounting for the apparent smoothness of this characteristic.

The output round about 300 p.p.s. is considerably greater than in the case of Fig. 7 and this is probably due to mechanical resonance now occurring at this frequency

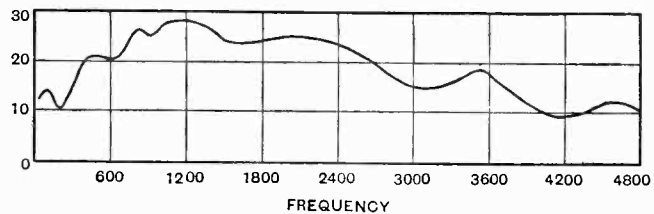

Fig. 9.

on account of the greater stiffness caused by the combination of edge and centre controls.

Owing to the uncertainty introduced by standing wave effects and to reflections from

the baffle, a further series of tests was carried out in another laboratory. In these tests, in addition to providing efficient sound-absorbing devices, the test frequencies were continuously oscillated through a few cycles on each side of test point and it was thought that the combination of these conditions eliminated standing wave effects to a greater extent than in the previous experiments. On the other hand, the calibration of the condenser microphone

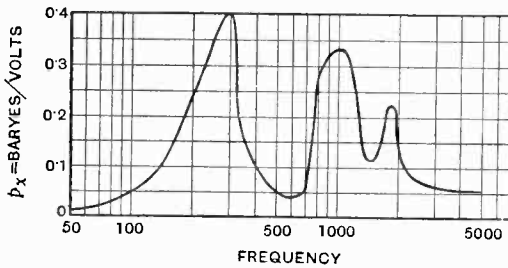

Fig. 10.

in the later experiments was not considered to be as accurate as in the first experiments.

Fig. 11 is the response curve measured at 2 metres along the axis under these conditions for an 11 1/2 in. diam. free edge disc (Expt. 41). The scale of ordinates is here equal to $20 \log_{10}(p_x \times 100)$.

In order to ascertain how far the results recorded on these various characteristic curves indicated departure from the performance of ideal infinitely rigid discs of same dimensions, masses and controls, operating in infinite baffles, some calculations have been made. For details of method of calculation reference should be made to the papers by Dr. N. W. McLachlan, *Phil. Mag.*, Vol. VII, No. 46, June, 1929, and C. R. Cosens, *E.W. & W.E.*, No. 70, July, 1929.

The electrical constants used in this calculation were derived from those of the moving coil circuit used in the earlier tests (see Fig. 6), as follows:—

- E_g = Volts on grid of power valve.
- μ = Amplification factor of power valve, 2.5.
- ρ = Step-down ratio of power transformer, 10.

- R = A.C. resistance of output and moving coil circuit A , 35 ohms.
- L = Inductance of do. at 800 ~, .0031 henry.
- γ = Length of wire in moving coil, 1,680 cms.
- B = Useful flux density in gap, 12,000 lines per cm.²
- I = R.M.S. current in output circuit.

(This depends on both the electrical and acoustical impedance of the moving coil circuit and the formula is given farther on.)

The mechanical and acoustical constants are as follows:—

- m_1 = Mass of moving systems, varied from about 20 grams for 10 cms. radius discs, up to 33 grams for 12.5 cms. radius discs.

(These weights refer to discs with surrounds, part of the weight of the latter being included. The pistons of later design with free edge weigh about 25 per cent. less.)

- m_2 = Added mass due to adherent air. This is calculated and plotted for frequencies of 50 to 5,000 p.p.s. (see Fig. 12). The formula used will be found in Cosens's paper, previously referred to.

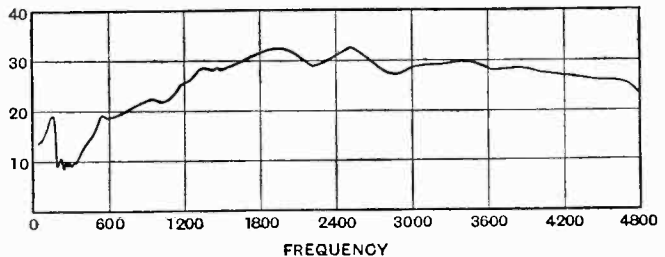

Fig. 11.

- h = Stiffness factor (control). This has been measured under various conditions (see first part of this article) and for purposes of calculation an average value of 1 megadyne per cm. has been taken.
- a = Velocity of sound in air, 33,000 cms. per second.
- σ = Density of air, .00128 gram per cm.

S_0 = Radiation resistance of free air = $a\sigma$
 = 42 approx.
 K = Radius of pistons. Calculations made
 for 10, 11.25 and 12.5 cms.
 f = Frequency; $\omega = 2\pi f$.

W_1 = Acoustic output
 = $r^2 S \times 10^{-7}$ ergs per second.

Lastly, p_x , the R.M.S. acoustic pressures
 at a distance x cms. along the axis of the
 instruments

$$= \sqrt{S_0 \frac{W_1}{2\pi x^2}}$$

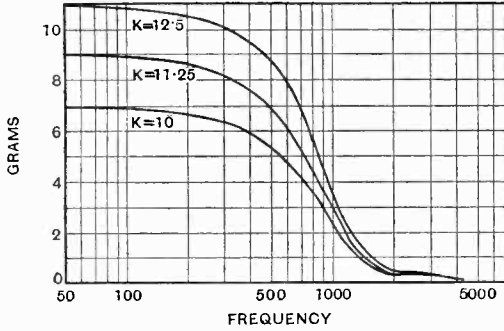

Fig. 12.

The following formulae will be found in
 Cosens's paper :-

$$z = \frac{4\pi}{a} Kf. \quad J_1(z) \text{ a Bessel function of } z.$$

β = Damping coefficient

$$= 2\pi K^2 S_0 \left[1 - 2 \frac{J_1(z)}{z} \right]$$

(Values of β for the three values of K are
 plotted in Fig. 13.)

$$\tau = \frac{1}{\beta} (m_1 + m_2 - \frac{h}{\omega^2})$$

S = Radiation resistance of piston

$$= \frac{\gamma^2 B^2}{\beta(1 + \omega^2 \tau^2)} 10^{-9} \text{ ohms}$$

$$I = \frac{\frac{\mu}{\rho} E_v}{\sqrt{(R + S)^2 + \omega^2(L - \tau S)^2}} \text{ amps.}$$

The value of I was first calculated for
 800 p.p.s. and then corrected to agree with
 actual measurements carried out at this
 frequency, and the value calculated at other
 frequencies were adjusted in a similar manner.

The discrepancies between the calculated
 and measured values of I were slight and,
 except for values at low frequencies near the
 mechanical resonance of the disc, the errors
 introduced by taking a constant value of I
 would be negligible.

It should be noted that the formula implies
 a uniform distribution of the acoustic output
 W_1 over the complete hemisphere bounded
 by the baffle.

Actually the distribution is not by any
 means uniform. An indication of the
 deviation from uniformity is given by the
 measured pressure values on the axis and
 at 45 degrees from the axis (Figs. 7 and 8).

The accompanying curves (Fig. 14) give
 the calculated acoustic pressures, at 3ft.
 along the axis of the system, in dynes per
 square centimetre per volt on the grid, for

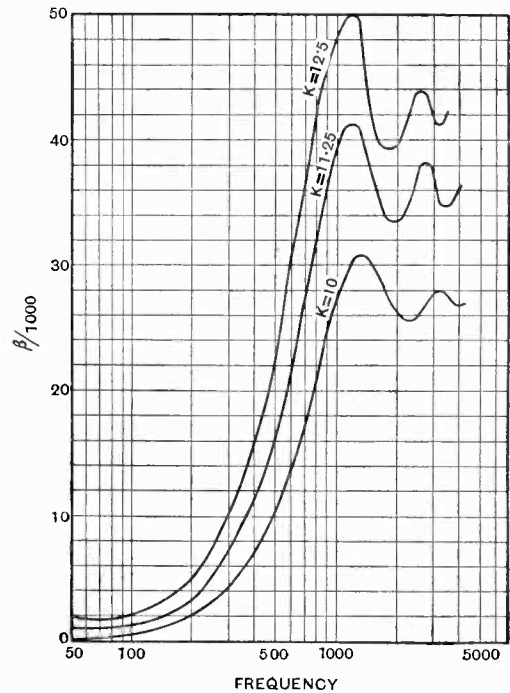

Fig. 13.

pistons having radii of 10 and 12.5 cms,
 and with frequencies from 50 to 5,000.

The following points will be noted in
 comparing these calculated results with the
 pressure characteristics actually measured.

The calculated pressure falls away more or less uniformly from the lower frequencies toward the higher ones. It is of interest to note that, with the assumed stiffness of 1 megadyne per cm., used in the calculation, the mechanical resonance $= \sqrt{h/m}/2\pi$ will occur at a low frequency probably outside the effective range of the amplifier used. On the other hand, as previously mentioned, there is an indication that with discs controlled both by edge and centre, the stiffness is considerably greater, resulting in shifting the mechanical resonances to about 300 \sim . In some cases there have been indications that a double mechanical resonance occurs, due to separate action of central and edge controls.

The measured pressures generally rise to a maximum value in the median frequency range and fall off at both low and high frequencies.

It is important to consider what assumptions are made in calculating and what factors are neglected. It is assumed that the piston is vibrating in a baffle of infinite dimensions, and that the piston is infinitely rigid. Losses due to air eddies at the edge and centre of the piston and around the moving coil are neglected; such losses are likely to be of some importance at low frequencies where amplitudes are considerable, consequently the output at low frequencies, as calculated, is not actually obtainable in practice. Lack of complete

rigidity introduces three factors: (a) gain of output at certain frequencies, due to resonance; (b) loss at certain frequencies due to interference between parts of the system; (c) losses due to internal friction in the system. These gains and losses occur in any vibrating system which "breaks up,"

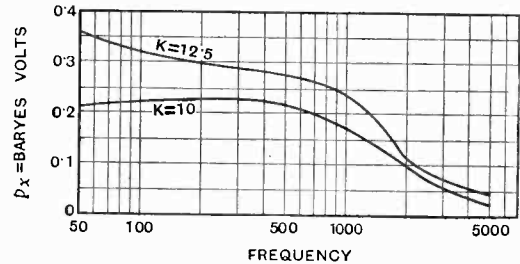

Fig. 14.

but owing to the high ratio of elasticity to density, which is a property of balsa wood, pistons of correct design, made from this material, do not break up to the same extent as occurs in the case of paper cones, hence the resonances are of simpler form and less pronounced.

It will be noted that the average calculated values of pressures, in dynes per cm.² per grid volt over the 50-5,000 p.p.s. frequency range, are only a few per cent. greater than the corresponding average of measured values.

Correspondence.

Letters of interest to experimenters are always welcome. In publishing such communications the Editors do not necessarily endorse any technical or general statements which they may contain.

Grid or Anode Rectification.

To the Editor, E.W. & W.E.

SIR,—Mr. Turner is right. Grid rectification properly applied, can give greater freedom from distortion than anode rectification. When my article was written the possibilities of grid rectification were, however, not generally realised. In practice, then, it left very much to be desired; anode rectification, for that matter, was far from perfect. My object was to show how, with anode rectification, a very reasonable standard of reproduction was possible. Some months later, I realised that grid rectification could, when properly applied, give better results. It is certain, however,

that Mr. Turner had discovered this earlier and put it into practice.

His criticism of my expression for the distortion is sound. It is only an approximation when the modulation is great. From the method of derivation, however, it is obvious that the expression can be made as exact as desired by including more terms of the series. If more than the second harmonic is required I prefer this extension of the series to Mr. Turner's method. That, however, is merely a personal failing (or virtue).

A. G. WARREN.

Heatherley, Bexley Heath.
July 7th, 1930.

On Banks of Paralleled Valves Feeding Reactive Loads without Distorting the Wave-form.*

By *W. Baggally.*

SUMMARY.

In a previous paper (*E.W. & W.E.*, June, 1928) the Author showed how to solve problems on power banks when the load is a pure resistance.

In the present article, the theory has been extended to the case of a general impedance.

It is shown that with inductive loud speakers it is not possible to work the bank under optimum power conditions with linear input owing to distortion setting in at the lower frequencies, and a method of obviating the distortion is given.

Some part of the previous paper is repeated so as to avoid the necessity of referring back.

THERE are four conditions which must be fulfilled by a bank supplying power without distorting the wave-form; they are:—

(1) The anode current must not rise above the top of the straight part of the characteristic curve.

(2) The anode current must not fall below the bottom end of the straight part of the characteristic curve.

(3) The grids must never receive a positive charge.

(4) The power dissipated at the anodes must not be greater than that for which the valves were designed.

The circuit to be considered is shown in Fig. 1.

The inductance and condenser are considered to have infinite and zero reactances respectively at all audio frequencies.

It is also convenient in the present analysis to neglect the D.C. resistance of the inductance, as by this we introduce but a small error and at the same time cause a cumbersome biquadratic equation which appears in the work to degenerate into a cubic with a simple solution; it also effects considerable simplifications in the rest of the work.

The symbols used are the same as in the previous paper but are repeated here for convenience:

a = anode current at bottom end of linear part of characteristic.

b = anode current at top end of linear part of characteristic.

D = allowable anode dissipation in each valve.

E = steady anode voltage.

E_g = steady grid voltage.

e = alternating grid voltage (peak value).

\bar{E}_a = total instantaneous anode voltage.

\bar{E}_g = total instantaneous grid voltage.

I = D.C. feed current to bank.

i = A.C. through load (peak value).

\bar{I} = total instantaneous current to bank.

\bar{I}_a = total instantaneous current to each valve.

k = power factor of load.

m = voltage factor of each valve.

N = number of valves in parallel.

p = A.C. power in load.

P_v = power dissipated in bank.

r = resistance of load.

R_a = slope resistance of each valve.

v = internal E.M.F. of valve (see appendix of previous paper).

x = reactance of load.

z = impedance of load.

Other symbols will be introduced as required.

The conditions for distortionless working can now be written as follows:

$$(1) \quad \bar{I} \leq Nb$$

$$(2) \quad \bar{I} \geq Na$$

$$(3) \quad E_g + e \leq 0$$

$$(4) \quad P_v \leq ND$$

It was shown in my previous paper that the valves are handling more power when silent than when dealing with speech current,

* MS. received by Editor, July, 1929.

so condition (4) demands that

$$EI \leq ND$$

Now for the linear part of the characteristic we have

$$\bar{I}_a = \frac{m\bar{E}_g + \bar{E}_a + v}{R_a} \quad \dots (1)$$

It is easily seen from the diagram that

$$E_a = E - i(r + jx) \sin \omega t \quad \dots (2)$$

we also have

$$\bar{E}_g = E_g + e \sin \omega t \quad \dots (3)$$

and

$$\bar{I}_a = \frac{I}{N} + \frac{i}{N} \sin \omega t \quad \dots (4)$$

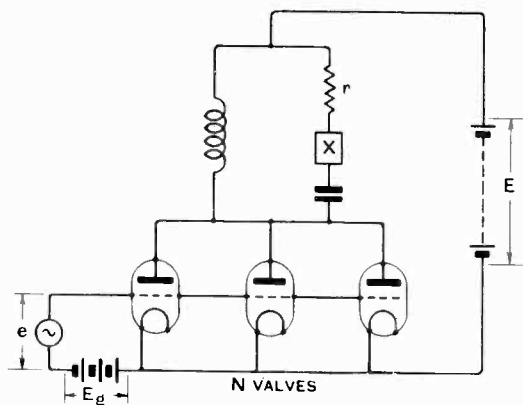

Fig. 1.

Equations (1), (2), (3), and (4) give

$$\frac{I}{N} + \frac{i}{N} \sin \omega t = \frac{m(E_g + e \sin \omega t) + (E - i(r + jx) \sin \omega t) + v}{R_a} \quad (5)$$

and on equating coefficients of unity and $\sin \omega t$

$$\frac{I}{N} = \frac{mE_g + E + v}{R_a} \quad \dots (6)$$

and

$$\frac{i}{N} = \frac{me - i(r + jx)}{R_a} \quad \dots (7)$$

which when transposed become

$$I = \frac{N(mE_g + E + v)}{R_a} \quad \dots (8)$$

and

$$i = \frac{me}{\sqrt{\left(\frac{R_a}{N} + r\right)^2 + x^2}} \quad \dots (9)$$

Using these results, we may again rewrite the four conditions, observing that

$$\bar{I}_{max.} = I + i \text{ and } \bar{I}_{min.} = I - i$$

thus :

$$(1) \frac{N(mE_g + E + v)}{R_a} + \frac{me}{\sqrt{\left(\frac{R_a}{N} + r\right)^2 + x^2}} \leq Nb \quad \dots (10)$$

$$(2) \frac{N(mE_g + E + v)}{R_a} - \frac{me}{\sqrt{\left(\frac{R_a}{N} + r\right)^2 + x^2}} \geq Na \quad \dots (11)$$

$$(3) E_g + e \leq 0 \quad \dots (12)$$

$$(4) \frac{EN(mE_g + E + v)}{R_a} \leq ND \quad \dots (13)$$

In any case $p = \frac{i^2 r}{2}$

$$p = \frac{m^2 e^2 r}{2 \left[\left(\frac{R_a}{N} + r\right)^2 + x^2 \right]} \quad \dots (14)$$

we shall have occasion to use this result later.

Now suppose that we start with such a large negative grid bias that the anode current is reduced to the value a , and that as the grid is made less negative, e is increased at the same rate so as always to cause the lower peaks of current to descend to the point a , then for a given value of E_g it will not be possible to increase e further without introducing distortion.

One of three things may occur to stop this increase of grid swing, either ;

(a) The upper peaks of anode current reach b , in which case equations (11) and (10) hold simultaneously.

(b) The steady anode current reaches such a value that the anodes are dissipating the maximum permissible power, and equations (11) and (13) hold.

(c) The upper peaks of grid potential reach zero, in which case (11) and (12) are both satisfied.

Combining the equations in this way and making use of (14) we get

Case a.

$$-E_g = \frac{I}{m} \left\{ E + v - \frac{R_a}{2} (b + a) \right\} \quad (15)$$

$$e = \frac{N(b-a)}{2m} \sqrt{\left(\frac{R_a}{N} + r\right)^2 + x^2} \quad (16)$$

$$p = \frac{N^2 r (b-a)^2}{8} = A \quad \dots \quad (17)$$

Case b.

$$-E_g = \frac{1}{m} \left\{ E + v - \frac{DR_a}{E} \right\} \dots \quad (18)$$

$$e = \frac{N \sqrt{\left(\frac{R_a}{N} + r\right)^2 + x^2}}{m} (D - a) \quad (19)$$

$$p = \frac{rN^2}{2} \left(\frac{D}{E} - a\right)^2 = B \quad \dots \quad (20)$$

Case c.

$$-E_g = e = \frac{1/m \sqrt{\left(\frac{R_a}{N} + r\right)^2 + x^2}}{\sqrt{\left(\frac{R_a}{N} + r\right)^2 + x^2 + R_a/N}} \left\{ E + v - aR_a \right\} \quad (21)$$

$$p = \frac{r \{ E + v - aR_a \}^2}{2 \left\{ \sqrt{\left(\frac{R_a}{N} + r\right)^2 + x^2} + \frac{R_a}{N} \right\}^2} = C \quad (22)$$

Of *A*, *B* and *C*, the one which happens to be the least will be the power obtainable under any given set of conditions.

The best value of load impedance will now be considered.

First it is to be noted that the power factor of the load depends only on frequency and the type of loud speaker or other apparatus constituting the load and is independent of the ratio of the coupling transformer, *i.e.*, *k* is constant and independent of *z*.

Putting *A*, *B* and *C* in terms of *z* we have

$$A = \frac{N^2 k z (b-a)^2}{8} \quad \dots \quad (23)$$

$$B = \frac{N^2 k z}{2} \left(\frac{D}{E} - a\right)^2 \quad \dots \quad (24)$$

$$C = \frac{k z \{ E + v - aR_a \}^2}{2 \left\{ \sqrt{\frac{R_a^2}{N^2} + 2kz \frac{R_a}{N} + z^2} + \frac{R_a}{N} \right\}^2} \quad (25)$$

Differentiating *C* to *z* and equating to zero for a maximum, we obtain on simplification,

$$z^3 - 3z \frac{R_a^2}{N^2} - 2k \frac{R_a^3}{N^3} = 0 \quad \dots \quad (26)$$

This is the cubic referred to at the beginning of the paper, its solution is

$$z = \frac{R_a}{N} \left[\{ k + \sqrt{k^2 - 1} \}^{\frac{1}{3}} + \{ k - \sqrt{k^2 - 1} \}^{\frac{1}{3}} \right] \quad \dots \quad (27)$$

Since *k* is always less than 1, this is best written

$$z = \frac{R_a}{N} \left[\{ k + j\sqrt{1 - k^2} \}^{\frac{1}{3}} + \{ k - j\sqrt{1 - k^2} \}^{\frac{1}{3}} \right] \quad \dots \quad (28)$$

Putting *k* = cos Θ where Θ is the phase angle of the load, an application of De Moivre's Theorem gives

$$z = 2 \frac{R_a}{N} \cos \frac{\Theta}{3} \quad \dots \quad (29)$$

the other two roots being negative in all cases.

Now for reasons similar to those given in my earlier paper, the best value of *z* will be given by equating *A* and *C*, or by equating *B* and *C*, or by equation (29), whichever value happens to be the greatest being the value of *z* giving maximum power.

Equating *A* and *C*, we have

$$z_1 = \frac{1}{N} \left[\sqrt{k^2 R_a^2 + \frac{2(E+v-aR_a)}{b-a}} \left(\frac{2(E+v-aR_a)}{b-a} - 2R_a \right) - kR_a \right] \quad \dots \quad (30)$$

Equating *B* and *C* gives

$$z_2 = \frac{1}{N} \left[\sqrt{k^2 R_a^2 + \frac{E(E+v-aR_a)}{D-aE}} \left(\frac{E(E+v-aR_a)}{D-aE} - 2R_a \right) - kR_a \right] \quad \dots \quad (31)$$

and from (29)

$$z_3 = 2 \frac{R_a}{N} \cos \frac{\Theta}{3} \quad \dots \quad (32)$$

Taking the greatest of these and substituting in (25) will give the power available, while the grid bias and grid swing will be given by

$$-E_g = e = \frac{\frac{1}{m} \sqrt{\frac{R_a^2}{N^2} + 2kz \frac{R_a}{N} + z^2}}{\sqrt{\frac{R_a^2}{N^2} + 2kz \frac{R_a}{N} + z^2} + \frac{R_a}{N}} \{ E + v - aR_a \} \quad \dots \quad (33)$$

which is equation (21) put in terms of *z*.

If, on the other hand, *z* has some arbitrary value other than the optimum, it will be

necessary to determine A , B and C and take the least as the power, afterwards determining the grid bias and swing from the appropriate formula corresponding to A , B or C .

In order to determine the number of valves required to supply a given power when the load is adjusted to the optimum value, we may proceed as follows:

Substituting (30) in (23) and rearranging gives

$$N_1 = 8\phi/k(b-a)^2 \left[\sqrt{k^2 R_a^2 + \frac{2(E+v-aR_a)}{b-a}} \left(\frac{2(E+v-aR_a)}{b-a} - 2R_a \right) - kR_a \right] \dots (34)$$

A similar operation with (31) and (24) leads to

$$N_2 = 2\phi/k \left(\frac{D}{E} - a \right)^2 \left[\sqrt{k^2 R_a^2 + \frac{E(E+v-aR_a)}{D-aE}} \left(\frac{E(E+v-aR_a)}{D-aE} - 2R_a \right) - kR_a \right] \dots (35)$$

Putting (32) in (25), and performing some trigonometrical transformations and rearranging, we obtain

$$N_3 = \frac{8\phi R_a (\cos \frac{2}{3}\theta + 1)}{(E+v-aR_a)^2 (2\cos \frac{2}{3}\theta - 1)} \dots (36)$$

the actual number of valves required will be N_1 , N_2 or N_3 according as Nz_1 , Nz_2 or Nz_3 is the greater respectively, these last quantities being calculated from equations (30), (31) and (32).*

Again, to find the number of valves required when the load is arbitrarily determined, transpose (23), (24) and (25) thus:—

* This brings to light a slip in Rule 4 of my previous paper, which I take this opportunity of correcting; the Rule should read as follows:

Determine Nr_1 , Nr_2 and Nr_3 from equations (42), (43) and (44), then find N from equations H_1 , H_2 and H_3 .

Take the value of N given by H_1 if Nr_1 is the largest.

Take the value of N given by H_2 if Nr_2 is the largest.

Take the value of N given by H_3 if Nr_3 is the largest.

The correct value of r is given by multiplying the largest of the Nr 's by N as found from the rule.

$$N' = \frac{2}{b-a} \sqrt{\frac{2\phi}{kz}} \dots \dots \dots (37)$$

$$N'' = \frac{E}{D-aE} \sqrt{\frac{2\phi}{kz}} \dots \dots \dots (38)$$

$$N''' = 2R_a \frac{\sqrt{2\phi kz} + E + v - aR_a}{(E+v-aR_a)^2 - \frac{2\phi z}{k}} \sqrt{\frac{2\phi}{kz}} \dots (39)$$

and the largest of these will be the required number.

If N'' or $N''' = \infty$ or is $-ve$, it means that it is impossible to obtain the required power with the given conditions, no matter how many valves we use.

There is an optimum value of high tension voltage which gives more power than any other value when the load is arbitrary and it may be found as follows.

It will be remembered that the power is given by the least of A , B and C (equations (23), (24) and (25)).

It will be noticed that A is independent of E , B decreases with increase of E while C increases with E .

A little consideration will show that the value of E giving greatest power will be given by equating B and C .

Doing this and rearranging, we get

$$E = \frac{1}{2} \{ \sqrt{4D(R+R_a) + (v+aR)^2} - (v+aR) \}, R = \sqrt{R_a^2 + 2kzNR_a + N^2z^2} \dots (40)$$

It is not quite so easy to find the optimum value of E when the load is also adjusted to its optimum value, but it may be accomplished in the following manner:—

Whatever the value of z , if E be adjusted to the value given by (40), $B = C$ and ϕ would be given by the least of A and C .

Substituting (40) in (25) gives

$$\phi = \frac{N^2 kz}{2(R+R_a)^2} \left\{ \sqrt{D(R+R_a) + \frac{1}{4}(v+aR)^2} - a \left(\frac{R}{2} + R_a \right) + \frac{v}{2} \right\}^2$$

$$\text{again } R = \sqrt{R_a^2 + 2kzNR_a + N^2z^2} \dots (41)$$

This will have some maximum value with respect to z ; P say, with a corresponding optimum for z ; call this value Z , and it is easy to see from graphical considerations that the best value for z will be given by Z or the point of intersection of the graphs of equations (23) and (41), whichever is greatest.

Substituting this value back in (40) gives the optimum value of E .

If we attempt to maximise (41) by differentiation and equation to zero, we are led to an equation of the eighth degree which does not appear to be soluble, so that the graphical method seems the most convenient in this case.

So far the analysis is applicable to a general impedance of any form whatever, the only limitation being that the resistance and reactance shall not vary with the current or P.D. applied.

We will now consider the special case of a loud-speaker winding which may be treated as a constant resistance in series with a constant inductance and condenser.

Turning to equations (16), (19) and (21) and putting $(\omega L - \frac{I}{\omega C})$ for X , it is seen that since the least of these expressions gives the grid swing the bank will accept without blasting, it will generally be necessary to reduce the grid swing well below the normal value so that the bank shall not blast where

$$\omega L = \frac{I}{\omega C}$$

This of course very much reduces the available power in the rest of the frequency spectrum.

The usual method for overcoming the difficulty is to so arrange matters that the slope resistance of the bank is at least equal to the impedance of the load, so that $(\frac{R_a}{N} + r)$

tends to swamp variations in $(\omega L - \frac{I}{\omega C})$ but of course the load impedance is then nowhere near its best value and we lose power again, although the response characteristic of the system is better than before.

If the grid swing could be so made to vary with frequency as to follow the graph of

$$e = h \sqrt{\left(\frac{R_a}{N} + r\right)^2 + \left(\omega^2 L^2 - \frac{I}{\omega C}\right)^2} \quad \dots (42)$$

(where

$$h = \frac{N(b-a)}{2m} \text{ or } = \frac{N}{m} \left(\frac{D}{E} - a\right) \quad \dots (43)$$

whichever is least) between two frequencies and outside these limits remain constant at the value given by (21) as the frequency increased or decreased still further, we should

have the two desirable conditions; that the valves would be accepting the maximum possible grid swing at all frequencies, and that the load would be the optimum at some middle frequency; satisfied simultaneously.

We should thus have a higher average power delivery from the bank at all frequencies than by other methods and at the same time the response curve would be horizontal between the selected frequencies, after which it would fall off slowly, as is already the case with the more usual methods of adjustment.

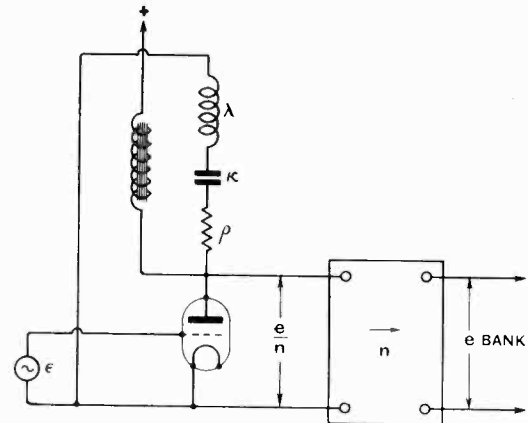

Fig. 2.

The grid swing may be made to follow the required characteristic approximately by introducing a suitable filter circuit into the amplifier which feeds the bank; this problem will now be considered.

Fig. 2 shows a valve whose voltage factor and slope resistance are μ and σ , connected to an amplifier whose gain is n -fold which feeds the grid of the bank; the anode circuit contains an inductance λ , a capacity κ and a resistance ρ in series.

Now we obviously have

$$e = n\mu\epsilon \sqrt{\frac{\rho^2 + (\omega\lambda - I/\omega\kappa)^2}{(\rho + \sigma)^2 + (\omega\lambda - I/\omega\kappa)^2}} \quad \dots (44)$$

Next it is to be noted that λ , κ , ρ and n are at our disposal so that this value of e may be made to coincide with the required characteristic at four points which we may decide upon.

Suppose we select some middle frequency ω at which the load is to have its optimum

value, then by a suitable adjustment of the ratio of the output transformer, the referred load in the anode circuit of the power bank may be made to have this optimum value at ω_1 .

Then in general there will be some other frequency ω_2 at which the load will have its optimum value and if ω_2 is less than ω_1 , the grid swing applied to the bank will have to be constant above ω_1 and below ω_2 and equal in value to $-E_g$.

This fixes n in equation (44) which becomes

$$e = -E_g \sqrt{\frac{\rho^2 + (\omega\lambda - I/\omega\kappa)^2}{(\rho + \sigma)^2 + (\omega\lambda - I/\omega\kappa)^2}} \dots (45)$$

because when we put $\omega = 0$ or $\omega = \infty$ in this equation it gives $e = -E_g$.

Now in order that the minimum points of (42) and (45) shall occur simultaneously, it is necessary that the two circuits shall come into resonance together, which gives

$$\lambda\kappa = LC \dots \dots (46)$$

Equating (42) and (45) at resonance,

$$h \left(\frac{R_a}{N} + r \right) = -E_g \frac{\rho}{\rho + \sigma}$$

giving

$$\rho = \frac{\sigma h(R_a/N + r)}{-E_g - h(R_a/N + r)} \dots (47)$$

Now it will not be possible to actually make $e = -E_g$ at ω_1 since it is asymptotic to this value at $\omega = \infty$.

However, putting $e = -E_g\delta$ at ω_1 where δ is a number slightly less than 1, we have by (45).

$$\delta = \sqrt{\frac{\rho^2 + (\omega_1\lambda - I/\omega_1\kappa)^2}{(\rho + \sigma)^2 + (\omega_1\lambda - I/\omega_1\kappa)^2}} \dots (48)$$

Which when transposed gives

$$\left. \begin{aligned} \omega_1^2\lambda\kappa - I &= \omega_1\kappa S \\ S^2 &= \frac{\delta^2(\rho + \sigma)^2 - \rho^2}{I - \delta^2} \end{aligned} \right\} \dots (49)$$

Solving this last equation together with (46) we have finally,

$$\kappa = \frac{\omega_1^2 LC - I}{\omega_1 S} \dots \dots (50)$$

$$\lambda = \frac{\omega_1 LCS}{\omega_1^2 LC - I} \dots \dots (51)$$

It sometimes happens that it is an advantage to use two or more of these filters in

cascade, and the analysis may be easily modified for this case as follows:

If there are q filters in cascade, equation (45) becomes

$$e = -E_g \left[\sqrt{\frac{\rho^2 + (\omega\lambda - I/\omega\kappa)^2}{(\rho + \sigma)^2 + (\omega\lambda - I/\omega\kappa)^2}} \right]^q \dots (45a)$$

leading to

$$\rho = \frac{\sigma \left[\frac{h}{-E_g} \left(\frac{R_a}{N} + r \right) \right]^{\frac{1}{q}}}{1 - \left[\frac{h}{-E_g} \left(\frac{R_a}{N} + r \right) \right]^{\frac{1}{q}}} \dots (47a)$$

and

$$\delta^{1/q} = \sqrt{\frac{\rho^2 + (\omega_1\lambda - I/\omega_1\kappa)^2}{(\rho + \sigma)^2 + (\omega_1\lambda - I/\omega_1\kappa)^2}} \dots (48a)$$

and

$$S^2 = \frac{\delta^{2/q}(\rho + \sigma)^2 - \rho^2}{I - \delta^{2/q}} \dots (49a)$$

all the other equations remaining unchanged.

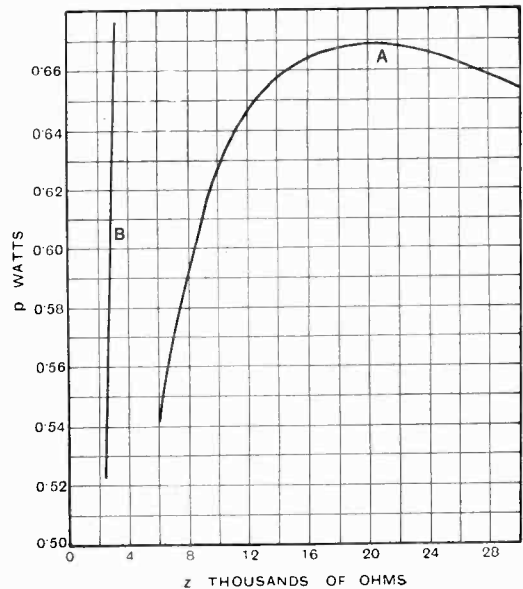

Fig. 3.

The following example shows how the foregoing analysis may be used in the practical design of public speech amplifying equipment and the like.

It was required to arrange a bank of L.S.5.a. valves to supply 250 small loud speakers in parallel, the resistance being 2,000 ohms and the inductance 1.8 henrys;

and motional capacity infinity, each speaker to receive 100 milliwatts.

It was required to determine the number of valves, the H.T. voltage, the grid bias, anode current and ratio of output trans-

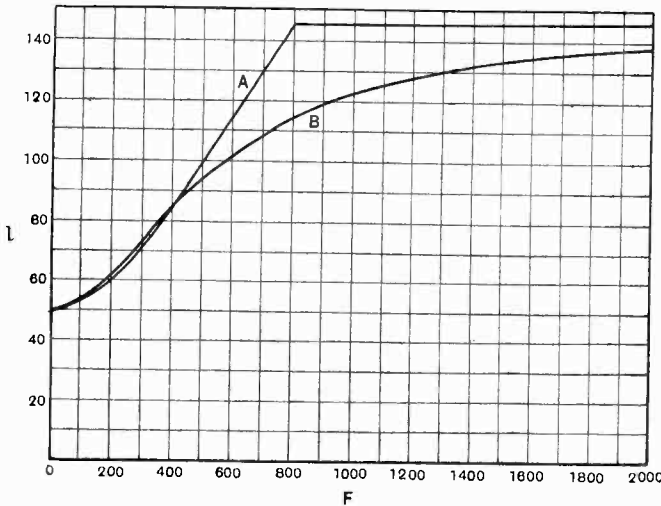

Fig. 4.

former; first, with the new variable grid swing as explained above, and secondly, with the more usual constant swing, so as to compare the two systems.

The first thing is to find the optimum anode voltage, which will obviously not depend on the number of valves in use provided the load is adjusted to its optimum value.

We may take the valve constants as $R_a = 2,750$ ohms, $m = 2.5$, $D = 12$ watts, $b = .1$ amp., $a = .01$ amp., $v = 0$.

Suppose we decide that the load shall have its optimum value at 800 cycles, then

$$\Omega = 5000 \text{ and } k = \frac{2000}{\sqrt{4 \times 10^6 + 8 \times 10^6}} = .22$$

Putting $N = 1$ and the appropriate values of k , D , a and R_a in equation (41), a graph is plotted of p against z (curve A, Fig. 3).

Also putting $N = 1$ in equation (23) and plotting, we get the line marked B.

In this particular case, the maximum for curve A occurs with a much larger value of z than does the intersection of curves A and B, so the best value of z is about 20,000 ohms.

Substituting this value in equation (40) gives $E = 438$ volts.

We see from Fig. 3 that we get .668 watt per valve, and since the speakers require 25 watts, it will be necessary to use 38 valves.

The optimum impedance for the load will thus be $\frac{20,000}{38} = 526$ ohms while the impedance of the speakers is $\frac{9200}{250} = 37$ ohms, thus we require a step down transformer whose ratio is $\sqrt{\frac{526}{37}} = 3.8 : 1$.

It is worthy of note that if the load impedance lies anywhere between 315 ohms and 810 ohms, the power will be within 3 per cent. of its maximum value, so that the transformer ratio is by no means critical.

To find the grid bias and swing we use equation (33) which may be written

$$-E_g = e = \frac{1}{m} \cdot \frac{R}{R + R_a} (E + v - aR_a) \quad (33a)$$

giving

$$-E_g = e = \frac{1}{2.5} \times \frac{20,780}{23,530} \times (438 - 27.5) = 145 \text{ volts.}$$

The anode current will be, from equation (8)

$$I = \frac{38(2.5 \times (-145) + 438)}{2750} = 1.04 \text{ amp.}$$

This completes the first part of the problem and the next thing to do is to design the filter circuit to give the required variable grid swing.

Of course, this is mixed up with the design of the voltage amplifier feeding the bank and we may proceed as follows.

Equation (43) gives $h = .264$.

Now suppose that the valve associated with the corrector circuit has a slope resistance of 20,000 ohms. then equation (47)

gives

$$\rho = \frac{20,000 \times .264 \times \left(\frac{2750}{38} + \frac{2000}{250} \times 3.8^2 \right)}{145 - .264 \times \left(\frac{2750}{38} + \frac{2000}{250} \times 3.8^2 \right)}$$

= 10,400 ohms.

since the transformer ratio is 3.8 : 1.

Substituting in (49) and assuming a value of δ of .78 we get

$$S = \sqrt{\frac{.78^2(10,400 + 20,000)^2 - 10,400^2}{1 - .78^2}}$$

= 33,400

$$\kappa = \infty, \lambda = \frac{33,400}{5000} = 6.7 \text{ henrys.}$$

It is instructive to see how nearly this corrector follows the theoretical grid-swing-frequency curve, and this is shown in Fig. 4 in which A is the ideal curve and B the actual frequency characteristic of the filter circuit (it is assumed that the amplifier is linear).

Turning now to the second part of the example, in which the usual practice of keeping the grid swing constant with frequency is to be followed, and compromising between efficiency and linearity of response by making the impedance of the load at 800 p.p.s. equal to the slope resistance of the valve bank, it is first to be noted that if it is not overloaded at the lowest frequencies it will certainly not be overloaded in the treble, so that it is a case of taking care of the bass and letting the treble take care of itself.

Accordingly, we first determine the optimum H.T. voltage by putting the value of z corresponding to zero frequency in equation (40), which gives

$$R = \sqrt{2750^2 + 2 \cdot I \cdot \frac{(.22 \times 2750) \times 2750}{+.22 \times 2750^2}} = 3355$$

$$\therefore E = \frac{1}{2} \left\{ \sqrt{48(3355 + 2750) + (.01 \times 3355)^2} - .01 \times 3355 \right\} = 253 \text{ volts}$$

and from equations (23), (24) and (25), we obtain the power per valve at zero frequency

thus :

$$A = \frac{.22 \times 2750 \times .09^2}{8} = .61 \text{ watt.}$$

$$B = \frac{.22 \times 2750}{2} \left(\frac{12}{253} - .01 \right)^2 = .42 \text{ watt.}$$

$$C = \frac{.22 \times 2750 \{253 - .01 \times 2750\}^2}{2 \times \left\{ \sqrt{2750^2 + 2 \times .22 \times 2750^2 + 2750^2 \times .22^2} + 2750 \right\}^2}$$

= .41 watt.

and since C is the least, we get .41 watt per valve.

The bias and grid swing will be given by (21), which may be written

$$-E_g = e = \frac{I}{mR + R_a} \{E + v - aR_a\} \quad (21a)$$

$$= \frac{I}{2.5} \times \frac{3355}{3355 + 2750} \{253 - .01 \times 2750\}$$

= 50 volts.

Now since this grid swing is to remain

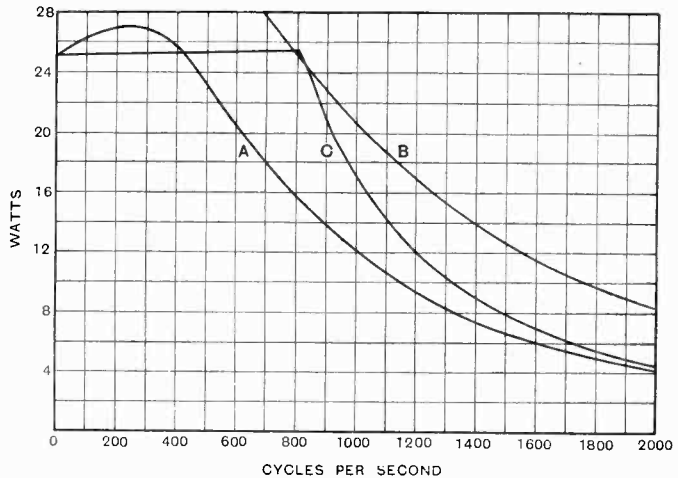

Fig. 5.

constant at all frequencies, the power at 800 cycles will be given by equation (14).

$$p = \frac{2.5^2 \times 50^2 \times .22 \times 2750}{2[(2750 + .22 \times 2750)^2 + (2750^2 - .22^2 \times 2750^2)]}$$

= .256 watt per valve

and since we require 25 watts at 800 cycles, it will be necessary to use 98 valves as against 38 when using variable grid swing with

optimum load, which is thus seen to be more than twice as efficient in this case.

Of course, things are not quite as bad as this in practice, for the amplifier will cut off at the lowest frequencies, thus introducing a certain amount of unintentional correction which will enable more grid swing to be applied without overloading, also the loud speakers will not be responding at these very low frequencies, but the example gives a very good idea of the kind of advantage to be gained by the use of a filter circuit if the load is highly inductive.

It is instructive to compare the power-frequency characteristics of the two systems, and this has been done in Fig. 5, where curve A is for the optimum load and cor-

rector and is plotted from equation (14) in conjunction with curve B of Fig. 4; while curve B is for the matched impedance condition and is also plotted from (14).

Curve C shows the result which would be obtained if the filter circuit were perfect and accurately followed curve A of Fig. 4.

Comparing curves A and C, it would appear that we should be better off with a better filter, but the design of more complicated filters hardly comes within the scope of the present paper and the reader is referred to a paper on filters by Turner, *E.W. & W.E.*, Vol. 2, No. 23, August, 1925.

The ratio of the output transformer, feed current, etc., may be determined in the same manner as in the previous case.

Exhibits of Wireless Interest at National Physical Laboratory.

ON the occasion of the annual invitation visit to the National Physical Laboratory on 27th June there was, as usual, a considerable number of items of experimental wireless interest.

In the Wireless Hut the exhibits were chiefly of a practical nature. A simple but neat experiment was a demonstration of the reception of a modulated wave. This consisted of a resonant circuit (with visual indication) energised from an oscillator which could be either C.W. or modulated. The C.W. gave the usual single-peaked resonance curve, the introduction of the modulation giving "side-band" bumps on either side of this. A valve rectifier milliammeter for radio-frequency currents used a resistance with a valve voltmeter across it, the readings thus being directly referable to current through the resistance. Apparatus was shown for receiving and recording signals from a rotating beacon transmitter, but, although result records were on view, the apparatus was not demonstrated in operation because the Air Ministry beacon transmitter at Orfordness was temporarily out of commission for overhaul. Various transmitting and receiving apparatus was on view for wavelengths of 1.5 to 10 metres, along with apparatus (shown first at the Physical Society Exhibition in January) using a resonance method for the measurement of resistance and reactance at the radio frequencies. A neat experiment was the measurement of very small changes of frequency on a special transmitter, which has to be set at a certain frequency, and small known changes of frequency made about this value. The method beats the transmitted frequency against that of a local oscillator to produce a note, set (by beats) to identify with a known audio-frequency oscillator. The trans-

mitter frequency is then swung through zero heterodyne beat to equal beat-note on the opposite side, producing a change of radio frequency equal to twice the frequency generated by the audio source.

The Electrical Standards Division contained the usual number of interesting exhibits of high refinement. The standard multivibrator apparatus is driven from an improved standard valve-maintained fork, constant to one part in a million and independent of battery voltage variation. This fork and other fork equipment for absolute frequency measurement and comparison are housed in the basement under conditions of very constant temperature. An improved Schering bridge for power factor, effective resistance and reactance from 50 to 1,000,000 cycles per second was shown in operation. Experiments on the use of screened valves with quartz crystals were demonstrated, while Dr. Dye's classical experiments on interferometer methods of examining the vibrations of quartz plates and rods were also shown in demonstration. Amongst audio-frequency apparatus were several exhibits of great interest. A bridge potentiometer equipment was shown for testing audio-frequency amplifier apparatus from 20 to 10,000 cycles per second. In another room in this division was a collection of equipment for general measurements of capacity, inductance and effective resistance at audio frequencies. A particularly interesting experiment was in connection with the performance of "rectifier-type" milliammeters. The experiments were devoted to determination and correction of the error at increasing frequencies up to 10 Kc/s, result curves being given for the correction applied to several commercial instruments.

Units Used in Telephone Transmission Engineering.

By *W. H. Grinstead, A.M.I.E.E., A.C.G.I.*

THE replacement some years ago of the "Mile of Standard Cable" by the "Transmission Unit" as the unit used for comparisons of the transmission efficiencies of different telephone circuits or apparatus has led to a somewhat chaotic state in the telephone world. A great many of the specifications referring to miles of standard cable are still in use, as well as a great deal of testing apparatus calibrated in this unit. Moreover, it will be remembered that the "Transmission Unit" was not acceptable to all administrations, and on the Continent of Europe another unit, the "neper," is in general use. Both these units are officially recognised by the C.C.I. (The International Consultative Committee for Long Distance Communications), which has decided to adopt the name "Decibel" for the Transmission Unit. The "decibel" is one-tenth of a "bel." A similar sub-multiple of the "neper" is in use known as the "decineper." Both the "bel" and the "neper" have the advantage that they can be defined fundamentally without reference to physical characteristics.

The C.C.I. definitions are:—

1. If two powers P_1 and P_2 are concerned, the number of units is:

Naperian (Nepers)	Decimal (Bels)
$\frac{1}{2} \log_e \frac{P_1}{P_2}$	$\log_{10} \frac{P_1}{P_2}$

2. If two voltages V_1 and V_2 or two currents I_1 and I_2 are concerned, the number of units is:

Naperian (Nepers)	Decimal (Bels)
$\log_e \frac{V_1}{V_2}$ or $\log_e \frac{I_1}{I_2}$	$2 \log_{10} \frac{V_1}{V_2}$ or $2 \log_{10} \frac{I_1}{I_2}$

It has been common practice in the past in measuring cross-talk to define the amount of cross-talk by the ratio of the current in the circuit on which cross-talk is being observed to the current in the inducing circuit, adjustments being made for any difference in the impedances of the circuits. This ratio has been expressed as so many "mil-

lionths." Of recent years, however, the practice of expressing amounts of cross-talk in the units used for measuring transmission efficiencies, namely, the "neper" and the "decibel," has grown.

In the present state of transition brought about by the introduction of these improved practices, some handy means of relating quantities expressed in one unit with corresponding values expressed in other units is badly needed. The relations can, of course, be shown as "curves" on a chart, but such a chart occupies considerable space and is somewhat cumbersome to use. The scale forms a much more compact and convenient means of making an approximate conversion from one unit to another. It has been issued in the form of a blotter by Messrs. Siemens Brothers & Co., Limited, London, to whom the writer is indebted for permission to publish this note.

A SCALE GIVING THE RELATIONSHIP BETWEEN THE UNITS GENERALLY USED IN TELEPHONE ENGINEERING.

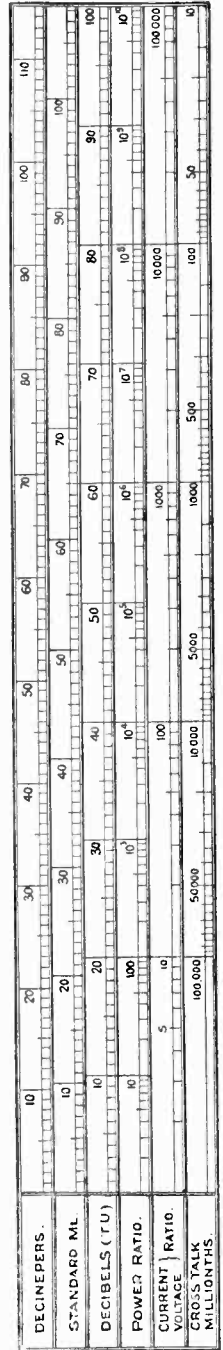

- 1 Neper = 8.686 Decibels, or 9.120 Standard Miles.
- 1 Decibel = 0.1151 Neper, or 1.084 Standard Miles.
- 1 Standard Mile = 0.0221 Decibels or 0.1062 Neper.

Electrical Wave Filters.

By *M. Reed, M.Sc., A.C.G.I., D.I.C.*

(Concluded from page 386 of July issue.)

Section F.

Composite Wave Filters.

Up to the present wave filters have been considered as made up of one or of a series of uniform sections. Now from the discussion on derived filters, it is seen that it is possible to alter the propagation characteristics of certain wave filter sections without changing their characteristic impedances. Therefore it should be possible to join up a number of these sections in series, thus giving an unsymmetrical network which introduces a number of different propagation constants. To ensure the absence of impedance irregularities and hence the minimum of transmission loss (see page 444) the adjacent sections are always so arranged that they are equivalent in characteristic impedance at their junction.

A composite wave filter may therefore be defined as a network of wave filter sections

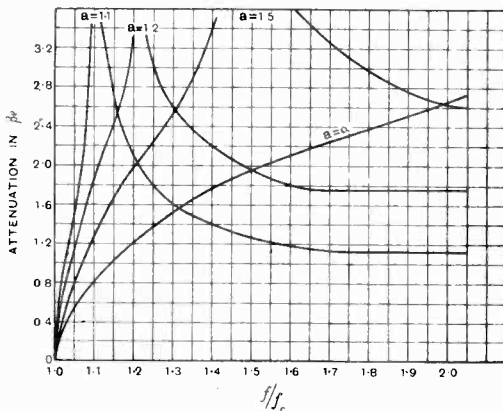

Fig. 51.—Attenuation characteristics for low pass derived filters.

connected in series; some or all of which are different in propagation constant, but adjacent sections of which are equivalent in characteristic impedance at their junction. From the section on unsymmetrical structures, it is seen that the composite filter is

specified by the sum of the propagation constants of the individual sections and the characteristic impedances of the end sections.

The advantage of composite over uniform wave filters is in their flexibility of design. By means of composite filters it is easier and more economical to meet the attenuation and impedance requirements in many wave filter networks. In the study of uniform wave filters it was found that the attenuation constant of any section varied quite considerably with frequency over the attenuating bands, the attenuation being much higher in some parts than in others. To utilise the frequency range as completely as possible, the attenuation of the network should in general rise rapidly upon entering the attenuating bands and remain high. In the case of the uniform filter, to obtain high attenuation at frequencies where the attenuation constant of a section is low, requires a relatively large number of sections; and this means that the attenuation will be much higher than is necessary at other frequencies. In the composite wave filter, however, it is possible to distribute the low and high attenuations of the individual sections over the frequency bands so that they combine to give the attenuation characteristic required.

As far as the impedance requirements are concerned, it is often desirable that the network should have an approximately constant resistance terminal impedance in the transmitting bands. Most uniform filters cannot satisfy this condition, whereas the composite wave filter will give the desirable impedance characteristic by using the requisite derived type of section as a termination.

Example of a Low Pass Composite Filter.

To illustrate the advantage of the composite filter, the design of a low pass filter will be considered. Suppose that it is desired to design a low pass filter which shall have a cut-off frequency of 5,000 cycles per second, and which shall operate between

terminal impedances of 600 ohms. Suppose further, that it is desired that the attenuation characteristic of this filter shall rise fairly rapidly after the cut-off frequency and that it shall remain fairly constant at a high value, say of $8 \beta l$.

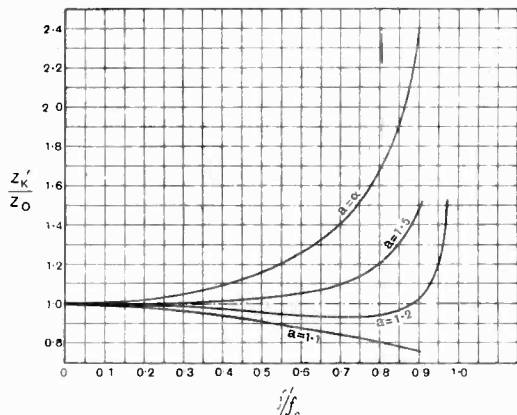

Fig. 52.—Mid-shunt characteristic impedance curves for low pass mid-series derived filters.

In order to design a filter of this nature, it is generally necessary to draw the attenuation characteristics for a number of the desired filters. Fig. 51 shows such a set of characteristics; these curves have been calculated from equation (26) for different values of "a" (i.e., f_∞/f_c). From these curves it is seen that in order to have an attenuation characteristic which rises fairly rapidly after the cut-off frequency, we must have a derived filter whose frequency of

should require about seven sections of this filter to give an attenuation of about $8 \beta l$ for frequencies above $1.5 \times f_c$.

To obtain the required attenuation characteristic, we must therefore combine a number of the derived filters whose attenuation characteristics are shown in Fig. 51. Since these filters have been derived from the same simple filter of Fig. 22, therefore we know that their series characteristic impedances will be the same, and hence they can be combined to form a composite filter. From the discussion on unsymmetrical structures, it follows that the resultant attenuation characteristic will be given by the sum of the individual attenuation characteristics of the constituent filters.

Now in addition to the requirements for the attenuation characteristic, there is also the question of the terminal impedances of the composite filter to be considered. Fig. 52 shows a set of curves for a number of derived filters, relating frequency with the ratio of the mid-shunt characteristic impedance of a mid-series derived filter to the nominal impedance, for frequencies during the transmitting band.* These curves have been obtained from equation (26a). From the curves of Fig. 52 it is seen that the derived filter given by $a = 1.2$ has an impedance which approximates very closely to that of the nominal impedance. This holds for all frequencies, except very near to the cut-off frequency, within the transmitting band. It is, therefore, desirable that a half-section of this type of filter (to

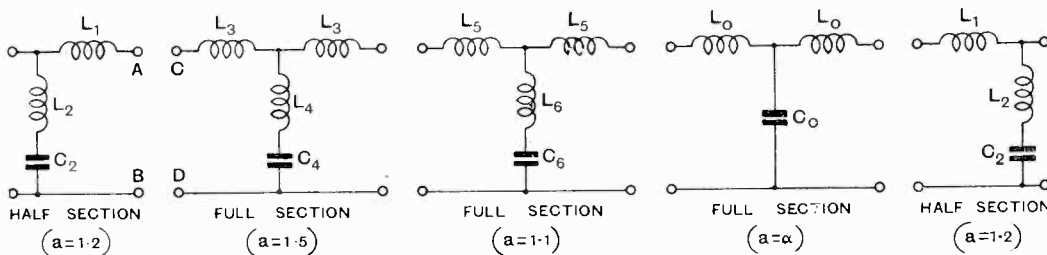

Fig. 53.

infinite attenuation must not be greater than $1.1 \times f_c$. Unfortunately, the attenuation of this filter decreases rather rapidly after the frequency of infinite attenuation and hence one section of this filter would not be sufficient. From Fig. 51 it is seen that we

give the necessary mid-shunt characteristic impedance) should terminate each end of the composite filter.

* For all the curves of Fig. 52, the value of Z'_K/Z_0 is infinite when $f/f_c = 1$.

Fig. 53 shows the constituents of a composite filter which will give the desired attenuation characteristic and which will also satisfy the terminal conditions.

The half-sections present no difficulty,

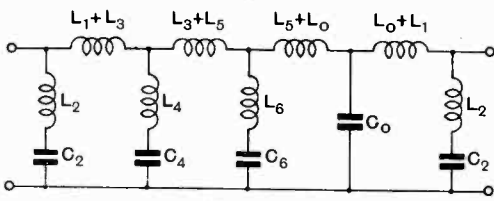

Fig. 54.

since it follows from what has already been said on the impedance and transfer constant of the half-section, that the impedance measured at *AB* (see Fig. 53) will be equal to the series characteristic impedance of the full section and hence to the impedance as measured between *CD*. The attenuation of the half-section at any frequency will be equal to one-half the attenuation of the full section at that frequency.

The elements of the structure of Fig. 53 can be combined to give the composite filter of Fig. 54.

The values of the elements of Fig. 54 can easily be calculated from formulæ (29) to (31) and for the filter under consideration they will be found to have the following values:—

- $L_1 = 10.55$ milli-henrys.
- $L_2 = 24.00$ milli-henrys.
- $L_3 = 14.2$ M.H.
- $L_4 = 5.70$ milli-henrys.
- $L_5 = 7.95$ milli-henrys.
- $L_6 = 19.0$ M.H.
- $C_2 = 0.02925$ M.F.
- $C_4 = 0.079$ M.F.
- $C_6 = 0.044$ M.F.
- $C_0 = 0.106$ M.F.

The attenuation characteristic of the composite filter of Fig. 54 is shown in Fig. 55. This curve is drawn for the non-dissipative filter, the characteristic for the dissipative filter can be obtained by taking into consideration the factors on page 260.

As a further application of the composite filter, consider the case of the band pass filter of page 256. It is possible to design

a band pass filter which shall have lower and upper cut-off frequencies of 20,000 and 30,000 cycles per second, respectively, by the combination of a low and a high pass filter. The low pass filter should have a cut-off frequency of 25,000 cycles per second, and the high pass filter should have a cut-off frequency of 20,000 cycles per second. The combined filter will therefore pass the frequency band given above. The advantage of this arrangement is that it is possible to obtain quite easily a frequency of infinite attenuation on each side of the band, whereas an ordinary band pass filter will only give more than one frequency of infinite attenuation if a fairly complicated structure, involving a large number of elements, is used (see Figs. 19 and 20). The combined filter will also give a better attenuation characteristic than the ordinary band pass filter. The procedure to be adopted in the design of the above filter is as follows:

(a) Design the low pass filter to have a cut-off frequency of 25,000 cycles per second, a convenient frequency of infinite attenuation, and to operate between terminal impedances of 600 ohms.

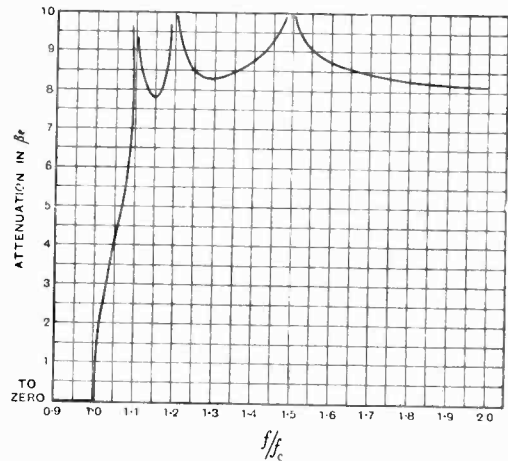

Fig. 55.—Attenuation curve for low pass composite filter. Cut-off 25,000 cycles/sec.

(b) Design a high pass filter to have a cut-off frequency of 20,000 cycles per second, a convenient frequency of attenuation, and to operate between 600 ohms.

The design of a high pass filter is very much the same as the design for a low pass filter. The main difference is that the

parameter "a" is now given by f_c/f_∞ instead of by f_∞/f_c .

(c) Combine the two filters in the manner indicated in this section. Since the two filters have been designed to operate between the same impedances, therefore there will be no loss at the junction (see next section).

Section G.

Transmission Losses in Wave Filters.

Up to the present we have only considered the losses due to dissipation. There are,

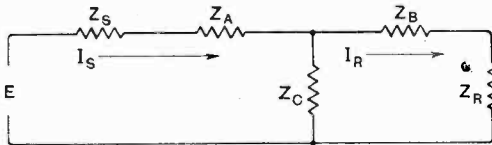

Fig. 56.

however, the losses due to incorrect terminations to be considered. These may be accounted for by means of the following analysis.

In the first place, if we solve equations (99), (100) and (108) for Z_a , Z_b , and Z_c , respectively, the following relations are obtained.

$$Z_a = Z_1' / \tanh \theta - \sqrt{Z_1' Z_2'} / \sinh \theta \quad (117)$$

$$Z_b = Z_2' / \tanh \theta - \sqrt{Z_1' Z_2'} / \sinh \theta \quad (118)$$

$$Z_c = \sqrt{Z_1' Z_2'} / \sinh \theta \quad (119)$$

Consider now the structure of Fig. 45(a), which is connected to terminal impedances Z_s and Z_r in the manner shown in Fig. 56.

Let the voltage and currents be as shown above.

From Kirchoff's Laws it can be shown that the received current I_r is given by:—

$$I_r = \frac{EZ_c}{(Z_s + Z_a)(Z_b + Z_c) + Z_r(Z_a + Z_c) + Z_b Z_c + Z_s Z_r}$$

Substituting the values for Z_a , Z_b and Z_c from (117), (118), and (119), we have:—

$$I_r = \frac{E\sqrt{Z_1' Z_2'}}{(Z_1' Z_2' + Z_s Z_r) \sinh \theta + (Z_1' Z_r + Z_2' Z_s) \cosh \theta}$$

Now since

$$\sinh \theta = \frac{1}{2}(e^\theta - e^{-\theta}) = \frac{1}{2}e^{-\theta}(e^{2\theta} - 1)$$

and

$$\cosh \theta = \frac{1}{2}e^{-\theta}[e^{2\theta} + 1]$$

$$\therefore I_r = \frac{E\sqrt{4Z_1' Z_2'} \times e^{-\theta}}{(Z_1' Z_2' + Z_s Z_r)(e^{2\theta} + 1) + (Z_1' Z_r + Z_2' Z_s)(e^{2\theta} + 1)}$$

which may be written in the form:—

$$I_r = \frac{E}{Z_s + Z_r} \times \frac{Z_s + Z_r}{\sqrt{4Z_s Z_r}} \times \frac{\sqrt{4Z_1' Z_s}}{Z_1' + Z_s} \times \frac{\sqrt{4Z_2' Z_r}}{Z_2' + Z_r} \times e^{-\theta} \times \frac{1}{1 - \frac{Z_2' - Z_r}{Z_2' + Z_r} \times \frac{Z_1' - Z_s}{Z_1' + Z_s} \times e^{-2\theta}} \quad (120)$$

From the above expression for I_r we can deduce the following:

$$\frac{E}{Z_s + Z_r}$$

gives the current which would have existed had there been no structure present.

The next three factors are of the same general type, although the first of the three is similar to the reciprocal of the other two. The two latter factors are called "reflection factors" and determine the "reflection loss" which is said to exist between the impedances involved. It is seen that the factor $\sqrt{4Z_1' Z_s} / (Z_1' + Z_s)$ becomes equal to unity if $Z_1' = Z_s$.

Similarly the second reflection factor is equal to unity if $Z_2' = Z_r$. Thus the reflection loss is brought about by the fact that the terminal impedances are not equal to the image impedances of the structure.

The fifth factor, which is $e^{-\theta}$, is the "transfer factor" and gives the reduction in current which is due to attenuation. θ has already been defined as the transfer constant.

The last factor of equation (120) is called the "interaction factor" and it is due to the repeated reflections at the terminals of the structure. This factor, like the reflection factors, is seen to have the value unity when either $Z_1' = Z_r$ or $Z_2' = Z_s$. Generally, the interaction factor is neglected. In a wave filter its effect is usually appreciable only in the transmitting band near the critical frequencies.

In the case of a wave filter Z_r and Z_s are generally of the same value, although they may be different from the image impedances. Therefore, neglecting the interaction factor,

equation (120) reduces to :—

$$I_R = \frac{E}{2Z} \times \frac{\sqrt{4ZZ_1'}}{Z + Z_1'} \times \frac{\sqrt{4ZZ_2'}}{Z + Z_2'} \times e^{-\delta}$$

where $Z = Z_R = Z_S$.

If the structure had not been inserted, the current I_R' would be given by $I_R' = E/2Z$

$$\therefore I_R/I_R' = \frac{\sqrt{4ZZ_1'}}{Z + Z_1'} \times \frac{\sqrt{4ZZ_2'}}{Z + Z_2'} \times e^{-\delta}$$

Therefore the total attenuation of the structure is given by

$$A = \log_e \left| \frac{I_R'}{I_R} \right| = \log_e \left| \frac{Z + Z_1}{\sqrt{4ZZ_1}} \right| + \log_e \left| \frac{Z + Z_2}{\sqrt{4ZZ_2}} \right| + |\theta| \quad \dots (121)$$

This follows from the analysis on page 125, where it is shown that the attenuation is given by the natural logarithm of the ratio of the absolute values of the currents.

In the case of a symmetrical structure $Z_1' = Z_2' = Z_K$, the characteristic impedance

$$\therefore A = 2 \log_e \left| \frac{Z + Z_K}{\sqrt{4ZZ_K}} \right| + |P| \quad (122)$$

Where $|P|$ denotes the real part of the propagation constant.

From the above it is seen that in any structure it is desirable, in order to reduce the transmission loss, that the terminal impedances should have a value which matches the image impedances to which they are connected. It follows from the above that any structure which contains any impedance irregularities (not necessarily at the terminals) will suffer a transmission loss at these irregularities. Hence in the case of a composite filter, it is desirable that the image impedances of adjacent sections should be equal.

Reflection Loss in Low Pass Filters.

As an illustration of the reflection loss, we shall consider the composite filter of section F. This filter as we have seen, has as its terminal impedances the mid-shunt characteristic impedance of a mid-series derived filter whose value for f_∞/f_c is 1.2. We have therefore to determine the reflection loss, at any desired frequency, between this impedance and the terminating impedance which has been assumed to be equal to the nominal impedance.

If Z_K' is the value of the mid-shunt characteristic impedance for this filter at any given frequency, then from equation (122) the reflection factor, for each terminus, at that frequency is given by :—

$$L_R = \frac{Z_0 + Z_K'}{\sqrt{4Z_0Z_K'}} = \frac{1 + Z_K'/Z_0}{\sqrt{4Z_K'/Z_0}} \quad (123)$$

Fig. 52 gives the value of Z_K'/Z_0 for all frequencies during the transmitting range, and hence the reflection factor can be easily calculated. The curve for $a = 1.2$ shows that when the value of f/f_c is as high as 0.95 the value of Z_K'/Z_0 is 1.515. Therefore, from equation (123) the reflection factor at this frequency is 1.026. The attenuation due to reflection at each terminus is therefore given by $A_T = \log_e L_R = .0276 \beta l$. The total loss due to reflection at this frequency is therefore only 0.0552 βl .

It is therefore seen that the terminating sections selected for the composite filter of section F are quite suitable. Very near to the cut-off frequency the value of Z_K'/Z_0 approaches infinity and the reflection loss is therefore very large, but it is seen from Fig. 52 that this condition holds only for a very small part of the transmitting range.

In some cases where it is desirable that the cut-off should be very sharp at the frequency for which the filter is designed, it will be found more convenient to use a terminating section whose value of "a" is about 1.05. For this type of section the value of Z_K'/Z_0 does not approach infinity until the value of f/f_c is greater than about 0.99.

Conclusions.

1.—The theory of the wave filter can be deduced by considering a symmetrical structure consisting of an infinite number of T or II sections.

2.—The design of wave filters is considerably simplified by utilising the "derived filter." These filters are of two kinds.

(a) The mid-series derived filter.

(b) The mid-shunt derived filter.

The former has the same mid-series characteristic impedance and cut-off frequencies and the latter the same mid-shunt characteristic impedance and cut-off frequencies as the simple filter from which they are derived, but their propagation

constant is different from that of the simple filter.

3.—Filters which contain mutual inductance of negative sign are in general identical with the filters of the same type which do not contain mutual inductance. On the other hand, filters which contain mutual inductance of positive sign have in general different attenuation and phase constant characteristics from the corresponding filters without mutual inductance.

4.—The unsymmetrical structure can be used as the basis for the theory of the composite filter.

5.—The composite filter can be built up

from sections which are derived from the same simple filter. These sections can be so selected as to give any required attenuation characteristic and terminal impedance.

6.—The loss due to reflection in the case of the wave filter depends on the relative values of the terminal impedance and the characteristic impedance at the terminals of the filter. This loss can be reduced to a minimum by making these two impedances as nearly identical as possible.

7.—In general, the attenuation and phase constant characteristics of any filter section can be obtained from the value of the ratio of the impedances of the series and shunt arms.

(Conclusion.)

Books Received.

TECHNIK UND AUFGABEN DES FERNSEHENS. By F. W. Winckel.

A short account of the methods and apparatus used in various systems of phototelegraphy and television. Pp. 74, with 65 illustrations and diagrams. Published by Rothgiesser und Diesing A.G., Berlin. Price RM.2.

MANUEL DE RECEPTION RADIO-ELECTRIQUE. By P. David.

A text-book for students and amateur constructors, comprising chapters on the Propagation of Waves, Aerials, Selectivity, Amplification, Reaction, Detection, Super-regeneration and various types of wireless receivers. Pp. 308 with 152 illustrations and diagrams. Published by Masson et Cie, Paris. Price Fr. 36.

A CRITICAL REVIEW OF LITERATURE ON AMPLIFIERS FOR RADIO RECEPTION, issued by the Radio Research Board, of the Department of Scientific and Industrial Research. Special Report No. 9.

A review and general bibliography of the more recent literature on the design of radio receivers divided into four main sections: I, Radio Frequency Amplifiers; II, Rectification; III, Audio Frequency Amplifiers; IV, Measurements. Each main section is subdivided and a critical essay based on the study of the literature of each subsection is followed by an abstract of the principal articles reviewed. Section I, III and IV compiled by Mr. H. A. Thomas, M.Sc., and Section II by Mr. F. M. Colebrook, B.Sc. Pp. 329+VIII. Published by H.M. Stationery Office. Price 5s. net.

ELECTRICAL WIRING AND CONTRACTING. Vols. VI and VII. Edited by H. Marryat, M.I.E.E., M.I.Mech.E.

Volume VI comprises Electric Lifts; Lamps and Illumination; House and Office Telephones. Volume VII comprises Radio Installation Work for hospitals, lecture halls and public buildings; Industrial installation work; Theatre and Cinema installation work. With numerous diagrams and illustrations. Published by Sir Isaac Pitman and Sons, Ltd., London. Price each volume 6s. net.

DER BAU VON ANODEN-UND HEIZSTROM-NETZAN-SCHLUSSGERÄTEN. By Manfred von Ardenne.

A short treatise on the principles and construction of H.T. Battery Eliminators. Pp. 78 with 95 illustrations and diagrams. Published by Rothgiesser and Diesing, A.G. Berlin. Price RM 1.70.

DEFINITIONS AND FORMULÆ FOR STUDENTS (Electrical Installation Work), by F. Peake Sexton, A.R.C.S., A.M.I.E.E., M.I.E.E.

A useful little pocket book giving the Definitions of Practical Electrical Units and Technical Terms, with the Symbols commonly employed; Tables of Cables and Wire; Current Capacity of Fuses; Specific Resistance of Various Metals; Heating Effects; Current Efficiency and Power Factor of Motors; Illumination Formulæ, and other useful data. Pp. 26, published by Sir Isaac Pitman and Sons, Ltd., London. Price 6d. net.

AUTOBIOGRAPHICAL AND OTHER WRITINGS. By the late A. A. Campbell-Swinton, F.R.S. Published by Longmans, Green & Co., Ltd., London. Price 10s. 6d. net.

Abstracts and References.

Compiled by the Radio Research Board and reproduced by arrangement with the Department of Scientific and Industrial Research.

PROPAGATION OF WAVES.

ON SOME MEASUREMENTS OF THE EQUIVALENT HEIGHT OF THE ATMOSPHERIC IONISED LAYER.—E. V. Appleton. (*Proc. Roy. Soc.*, March, 1930, Series A, Vol. 126, No. A803, pp. 542-569.)

Author's summary and conclusions:—The results of a series of early morning measurements [by the frequency-change method; cf. 1929 Abstracts, p. 145] of the equivalent height of the ionised layer for 400 metre waves are recorded and discussed. The normal type of nocturnal variation of equivalent height is a slow increase in height after sunset, reaching a maximum value (average 126 km.) at about 30 to 40 minutes before sunrise, after which a rapid reduction in height takes place. Such a variation is of the type we should expect if the upper atmospheric ionisation is produced by some type of solar radiation which travels in straight lines (e.g., ultra-violet light): On the cessation of the influence of this radiation after sunset recombination of ions would cause a slow increase in the height of the layer to take place, which would only cease on the advent of sunrise for this particular type of radiation at the height of the lower boundary of the ionised region. The renewed action of this radiation causes a rapid fall of the layer, as deduced from the measurements of equivalent height, and confirmed by observation on "phase-fading" which show that the optical path of the atmospheric waves is being steadily reduced. The reduction in the intensity of the atmospheric waves which takes place after the height of the layer has fallen to an approximately constant value appears to be due to the absorptive action of an ionised region (D region) formed below the normal deflecting region (E region). There is also a certain amount of evidence which suggests that on certain occasions, after sunrise, measurable reflection takes place from D region as well as from E region.

Although the type of nocturnal variation described above may be regarded as normal there have been experienced many occasions on which the changes in equivalent height are not so marked, and likewise many occasions on which much greater and more complicated variations are experienced. For example, it has been found that on certain nights the equivalent height remains approximately constant at about 100 to 110 km., so that the correlation with sunrise in the upper atmosphere is not apparent as in the normal case. It appears as if, on these occasions, either the recombination of ions is prevented or there is some ionising agent present which can influence the dark side of the earth.

On other occasions, during the 3 or 4 hours before dawn, abnormally great equivalent heights are recorded. So far these occasions have occurred during the winter months (October to

April) and have not been experienced during the remaining part of the year, but there is as yet insufficient evidence to generalise on this point. The detailed study of the interference "fringe" records, particularly in regard to the simultaneous reception of multiple down-coming waves, has shown that, on these particular nights, for a short time before the atmospheric waves of abnormally large equivalent path predominate, they are also recorded as subsidiary fringes on the main ones which are due to singly reflected waves from E region. After a short time the waves from E region are rapidly reduced in intensity, and the waves of abnormally long equivalent path remain as the predominating down-coming waves. Very often, however, they are accompanied by subsidiary waves, which are most probably multiple-reflected waves which have undergone two reflections. The disappearance of the primary rays from E region strongly suggests that we are dealing with a case of the penetration of the Kennelly-Heaviside layer and that the waves of abnormally long equivalent path are reflected at a still higher region (region F) which is richer in ionisation. This hypothesis of deviation by an abnormally high ionised region is supported by the fact that the equivalent height reached by waves during this period begins to fall, on the average, about 80 minutes before ground-level sunrise, a time considerably earlier than the time at which E region normally begins to fall. This fall continues until about 30 to 40 minutes before sunrise, when primary rays from E region are suddenly recorded again, the waves of abnormally long equivalent path being simultaneously received. As the sun's ionising influence gradually increases the electrical density of E region the waves reflected by it increase in intensity, while the intensity of those of abnormally long path is rapidly reduced. The normal fall of E region then proceeds.

Although, in explaining the phenomena of the reception of waves of abnormally long equivalent path, the hypothesis of a second deviating region above the Kennelly-Heaviside layer has been entertained, it is not necessary to assume that the two deviating regions are quite distinct, with an unionised region between. For example, we might attempt to explain the hypothetical change from reflection at E region to one of reflection at F region as a change from reflection to refraction in connection with a single (E) region. If in the normal case the atmospheric rays were, because of sufficiently rapid discontinuity in refractive index or conductivity, truly reflected by E region, the gradient might be expected to become less steep as a result of the recombination of ions, in which case there might be a change in the actual process of deviation from reflection to ionic refraction with a large increase in equivalent path. Also, we may note the fact that the abnormally

large equivalent paths correspond to a height of deviation which is sufficiently nearly twice that of E region to make it sometimes difficult to separate with certainty doubly reflected rays from E region from rays which have been deflected once by a still higher region. Such difficulties in connection with an unreserved acceptance of the hypothesis of two ionised regions led naturally to more elaborate experiments designed to test it further. For example, it was realised that by the use of simultaneous receiving stations at different distances from the transmitter it would be possible to distinguish between doubly reflected rays and rays from a second upper ionised region, particularly if one of the receiving stations were situated about half way between the transmitter and one of the other receiving stations. Further, as a matter of convenience, since the periods in which the phenomenon presented itself were usually short and not very frequent, it was felt that the extension of the observations to shorter wavelengths with greater penetrating power would increase the periods during which the upper ionised region, if it existed, would be observable. Two papers which will appear shortly deal respectively with these two extensions of the work described here.

RADIO ECHO SIGNAL RESEARCH.—U.S. Bureau of Standards Notes.—(*Journ. Franklin Inst.*, May, 1930, Vol. 209, No. 5, pp. 681-683; *Bur. of Stds. Tech. News Bull.*, April 1930, pp. 30-31.)

A preliminary notice of the results of research on radio "echoes" from the upper atmosphere. Pulse signals are sent at regular intervals from station NKF of the Naval Research Laboratory at Bellevue, D.C., and are received and oscillographed at the Bureau of Standards field station near Kensington, Md. Records obtained since the beginning of the year show that, on 4,045 kc/s, the sky wave arrives at the receiving station on the average 0.00143 sec. later than the ground wave, at 11.30 a.m. on normal days, while the retardation for the same frequency at 4 p.m. averages 0.00150 sec. These retardations correspond to 225 km. and 235 km. respectively, as the apparent heights of the ionised layer.

With the frequency of 8,650 kc/s, the average retardation is 0.00184 sec. at 11.30 a.m. and 0.00186 sec. at 4 p.m., corresponding to apparent heights of 287 km. and 290 km. respectively. The greater retardations for the higher frequencies may be attributed to dispersion. As with light waves, the index refraction is thus shown to increase with frequency.

The retardations are shown to increase after sunset to values as high as 0.003 sec. for 4,045 kc/s. At sunrise they return abruptly to normal daytime values. Records obtained at 4 p.m. on March 13, 1930, during a magnetic storm, show retardations of 0.00162 sec. for 4,045 kc/s, and 0.00285 sec. for 8,650 kc/s, as compared with the normal values of 0.00150 sec. and 0.00186 sec. respectively.

Extension of the work to other frequencies and study of seasonal variations is planned.

RASPROSTRANENIE ELEKTROMAGNITNOI VOLNI V MAGNITO-AKTIVNOI IONIZIROVANOI SREDE (The Propagation of Electro-magnetic Waves in an Ionised and Magnetically Active Medium).—L. Zhekulin. (*Westnik Elektrotechniki*, Leningrad, February, 1930, Part I, pp. 63-74.)

In Russian. A précis of the author's thesis giving a general revision of the modern theory of the propagation of electro-magnetic waves in a conducting medium under the influence of a magnetic field.

The case of a homogeneous conducting medium is first considered. The derivation is shown of the Lorenz formulæ for determining the average velocity of free electrons moving in such a medium when they are influenced by electro-magnetic waves.

The necessary conditions for the propagation of an electro-magnetic wave are derived from the fundamental Maxwell equations, and it is shown that in general two elliptically polarised waves appear in a magnetic field. Some cases, for different relative directions of the vectors of the wave and of the earth's magnetic field, are considered separately. It is concluded that the state of the ionised layer and the polarisation of waves are greatly affected by the earth's magnetic field, this effect being particularly pronounced on medium and long waves propagated along the lines of force of the field.

The following phenomena met with in practice are discussed in the light of modern theory:—

Critical Frequency.—The author is of the opinion that the well-known difficulty in establishing communication on wavelengths in the region of 200 m. is not due to the influence of the earth's magnetic field, particularly as it has been proved by Meissner that this phenomenon is not apparent on night transmission.

Solar Activity and Magnetic Storms.—It appears that even intense solar activity and magnetic storms do not appreciably affect the earth's magnetic field, and that therefore the variation in reception during periods when these occur is mainly due to the change in the state of the ionised layer.

Echo Effect.—The well-known echo effect is probably due to the complex refraction of the waves in the non-homogeneous ionised layer or to the multiple reflection of the waves from the undulating lower surface of the layer. This effect can also be caused by the earth's magnetic field (Breit and Tuve).

Fading.—In addition to other causes, the earth's magnetic field can also be responsible for this phenomenon. If two circularly polarised waves follow approximately the same path and are attenuated to the same degree, the resultant wave may be linearly polarised with a rotating plane of polarisation. With an ordinary receiving antenna the strength of reception will vary with the rotation of the plane of polarisation.

Polarisation.—The appearance of circularly and elliptically polarised waves and of waves with a rotating plane of polarisation are characteristic signs of the presence of a magnetic field.

Skip Distance.—The skip distance is not the same for the two waves propagated in a magnetic field, and this accounts for the appearance of so-called "flicker zone."

The case of a non-homogeneous conducting medium is next considered. Though the problem in general has not yet been solved, it appears that the laws of geometrical optics hold good for the entire path of a ray, except in the neighbourhood of the "critical" plane, where the apex of the curve is located, and where considerable deviations are possible. Methods are given for the construction of the path of a wave for the following two cases: (a) when the surfaces of equal ionic concentrations are horizontal planes, and (b) when these are concentric spheres. A method for determining the attenuation of a ray for these two cases is also shown. It is next pointed out that in a non-homogeneous conducting layer the magnetic field can produce most peculiar distortions of the path of a wave, such as, for instance, the double reversal of the direction. The greatest asymmetry is found with transmission in the plane of the magnetic meridian.

It is concluded that the question as to the extent to which the propagation of electro-magnetic waves is affected by the earth's magnetic field depends on which conception of the Heaviside layer is accepted.

If it is held (Appleton and Eckersley) that only those waves are received which do not penetrate far inside the Heaviside layer, then the effect of the magnetic field is almost confined to the variation of the polarisation of the reflected waves. If, on the other hand, as is held by Hulbert and Heising, the waves can penetrate far into the layer, the effect of the magnetic field will be more intense in all respects.

An index to the literature on the subject is appended.

KURZWELLEN-PHÄNOMENE UND IHR EINFLUSS AUF DIE DRAHTLOSE NACHRICHTENÜBERMITTLUNG (Short Wave Phenomena and Their Influence on Wireless Communication).—v. Arco. (*E.T.Z.*, 23rd Jan., 1930, Vol. 51, pp. 148-152.)

A general survey. Great superiority is claimed for the Telefunken "fir-tree" aerial system of horizontal dipoles (due to Böhm) over the Marconi vertical dipole and the Chireix saw-tooth systems. Runge's work on r.f. amplification (formerly considered hopeless for short waves) is claimed to have made possible enormous progress in compensating for fading by increasing the amplification at the receiving end and controlling the volume of signals thus obtained by automatic means. In the Nauen-Buenos Ayres facsimile service a speed of 2.7 min./square decimetre is attained, with 3 lines to the mm. The latest transmitter at Nauen (20 kw. in the aerial) can reduce its power to one hundredth without slowing down reception in America under normal conditions of reception; or by using its full power a receiving speed of 300 w.p.m. can be attained; better still, this word-capacity can be divided up into—say—6 channels, for telephone, telegraph and pictures; or the transmission of a picture may be divided among

the 6 channels, enabling slow transmission to be used.

The writer ends with a reference to ultra-short waves—between 8 m. and $1\ \mu$ —and their possibilities. "Naturally not for great distances, since for these waves propagation by way of the Heaviside layer does not come into account; but only for approximately straight-line propagation." But their greater possibilities of concentration, their short time-period and freedom from interference, render them very promising for navigation, television, etc.; and latest results suggest that ranges of the order of 100 km. are possible over sea water.

CARTES DE PROPAGATION D'ONDES COURTES (Short Wave Propagation Charts).—R. Bureau. (*L'Onde Elec.*, April, 1930, Vol. 9, pp. 166-177.)

Second and final part of the paper dealt with in July Abstracts, p. 387. F.—Variations from day to day. Influence of the meteorological situation. "The sense of these modifications may vary with the wave frequency and with the distance from the transmitter. . . . A zone of silence which expands, but in the middle of which an interior zone of audibility develops, improves propagation here but impedes it elsewhere." The results of Dobson and his collaborators in regard to the variations in thickness of the ozone layer with meteorological conditions: of Hergesell, Duckert and Keil in regard to the propagation of sound waves.

The final section is entitled "The Exploration of the Uppermost Atmosphere (Stratosphere-Ionosphere)." In it the writer urges the importance of further charts of this kind; he ends by developing further his interpretation (given in the *La Météorologie* paper referred to in the former abstract) of the varying forms of the zones of silence, as the result of the combined action of *two separate layers*. If the distribution of ionisation is asymmetrical in such a way that the ionisation varies more rapidly above the horizontal maximum plane than below it, the angle of incidence below which a ray will pass through the layer will be greater for an upward passage than for a downward passage.

A ray may therefore penetrate between the two layers and undergo a certain number of ricochets between the layers before it finds conditions permitting it to return to earth. The successive situation of rings of audibility and of silence would then depend only on the "altitude" [height at which a wave of a particular frequency becomes horizontal for the smallest possible angle of incidence] of the layers, and not at all on the curves of ionic densities; whereas the existence or absence of certain rings would depend on such a curve.

The existence of these two layers would explain various other phenomena, such as the apparently too small velocity of radio waves and the irreversibility of certain liaisons (A hears B when B cannot hear A.). "I think it unnecessary to point out that successive reflections at the ground cannot explain these phenomena." The paper is followed by a list of the stations and amateurs who took part in the tests.

INFLUENCE OF BEAM AERIAL HEIGHT ON SIGNAL INTENSITY.—T. L. Eckersley. (See under "Aerials and Aerial Systems.")

EFFECT OF A SCREEN ON ELECTRO-MAGNETIC WAVES: RELATION BETWEEN ELECTRIC AND MAGNETIC FIELDS.—D. Burnett, G. W. O. H., E. H. R. Green. (*E.W. & W.E.*, May and June, 1930, Vol. 7, pp. 265 and 239, 322-323.)

An argument arising out of the February editorial referred to in Englund's letter (June Abstracts, p. 330).

AN OPTICAL METHOD OF EXPLORING THE UPPER ATMOSPHERE.—Synge. (See abstract under "Miscellaneous.")

THE ELECTROMAGNETIC FIELD EXTERIOR TO A SYSTEM OF PERFECTLY REFLECTING SURFACES.—F. H. Murray. (*Proc. Nat. Ac. Sci.*, May, 1930, Vol. 16, pp. 353-357.)

"Weyl has investigated the problem of 'Hohlraumstrahlung' by making use of the properties of a certain vector solution of Laplace's equation, which is represented as a sum of potentials of a single and a double layer. The corresponding properties of a vector solution of the wave equation in three dimensions are employed here to determine the reflected field which results when a given electromagnetic field is modified by the presence of a system of perfectly reflecting surfaces. The problem is reduced to the solution of a system of integral equations of Fredholm type, in which the integration is extended over the reflecting surfaces. It is shown that a unique solution exists."

THEORY OF PHENOMENA OF PROPAGATION.—S. L. Straneo. (Abstract in *Science Abstracts*, Sec. B, May, 1930, Vol. 33, p. 341.)

An Accad. dei Lincei paper. "The evaluation is investigated of the functional operator $\sqrt{\frac{g+k\Delta}{r+l\Delta}}$, which is met with in the study of phenomena of propagation, where $\Delta = \partial/\partial t$ and g, k, l, r , are quantities independent of the time."

SUR L'INERTIE DE L'ÉNERGIE RADIANTE (On the Inertia of Radiant Energy).—R. Ferrier, Th. de Donder and others. (*Rev. Gén. de l'Élec.*, 12th and 19th April, 1930, Vol. 27, p. 125D and 133D.)

Summary of arguments about R. Ferrier's formula $P = \frac{W}{c^2} \cdot v$, where P is the total quantity of movement of the disturbance, W the total energy, v the velocity of its centre of energy, and c the velocity of light.

ATTENUAZIONE DISSIMMETRICA DI ENERGIA RAGGIANTE IN UN MEZZO ASSORBENTE (Asymmetric Attenuation of Radiant Energy in an Absorbing Medium).—Q. Majorana. (*Nuovo Cim.*, Dec., 1929, N.S. Vol. 6, No. 10, pp. 393-404.)

A paper based on certain results obtained dur-

ing the writer's tests on telephony with ultra-violet and infra-red rays (January and June Abstracts, pp. 56 and 354). A bundle of divergent rays arrived at the end of a fixed distance l with different intensities according to whether an absorbing material, such as nickel glass, was interposed at the beginning of the course l (where the rays were most concentrated), or at the end (where they were somewhat diffused owing to their divergence).

A STROBOSCOPIC RIPPLE TANK.—W. Baldwin, jun. (*Review of Scient. Instr.*, June, 1930, Vol. 1, pp. 309-324.)

The point source of waves is simply a succession of periodic air blasts directed downwards on to the surface of the water. Two or more such sources can be used simultaneously. For rectilinear waves a pulsating linear vibrator is employed. Specimen photographs include those showing interference patterns produced by two point sources, emission and focussing of plane waves by a parabolic mirror, interference of plane and circular waves (action of a receiving aerial), etc. Cf. Heck, February Abstracts, p. 93.

ATMOSPHERICS AND ATMOSPHERIC ELECTRICITY.

ÜBER DAS STRAHLUNGSFELD DES BLITZES (On the Field Radiated by a Lightning Flash).—F. Ollendorff. (*E.N.T.*, March, 1930, Vol. 7, No. 3, pp. 108-119.)

Author's summary:—The field radiated by a lightning flash is calculated under various simplifying assumptions. The flash is schematised as a doublet whose moment varies with time, so that its field can be derived from a Hertzian vector in a known manner. Certain general continuity conditions for the temporal variation of the doublet moment, which are valid for transient atmospheric phenomena, are deduced from the analytical expression for the radiated field; conversely, properties necessarily characteristic of the observable radiated field are found to follow from the conditions governing the doublet moment variation. It appears that the abrupt onset of a field change of exponential form due to atmospheric disturbances, such as is often made the basis of theoretical investigations, is not compatible with these conditions. The question is discussed as to how far the temporal course of the disturbance itself can be reconstructed: certain slowly varying transient phenomena in the atmosphere are found to be unobservable, but the disturbance may be reconstructed if such components are absent.

A scheme for the temporal course of the flash is developed on the basis of these general conditions of continuity; this scheme may be used for calculation when possible numerical values for the magnitudes involved are adopted. The "onset," i.e., the rapid descent of the flash to earth, must be distinguished from the gradual "decay" of the current in the path of the flash. Calculation of the two fields shows that only the "onset" radiates strong fields of considerable power; on the other hand, the amount of energy

thus transformed is only small, on account of the short duration of the "onset." The fields radiated by the "decay" period are of little importance compared with those due to the "onset," for their rate of change is small. The radiation resistance of a lightning flash can be calculated in a very simple way, if the velocity with which the lightning passes through the atmosphere is known.

Lastly, the effect of the disturbances on wireless telegraphy receivers is estimated by analysing the discharge into a continuous wave-spectrum. The effect of the transient phenomenon can be calculated by considering a sufficiently simple model of a receiver. It appears that the amplitude of the disturbance can be decreased by changing over to the use of short waves and very selective circuits; this should be particularly effective in the case of disturbances of near origin. It is shown numerically that the effect of the disturbances is in general unimportant in the case of telegraphy receivers, whereas the adverse effect upon wireless telephony receivers may be serious.

SIMULTANEOUS ATMOSPHERICS ON WIRELESS RECEIVER AND ON CABLE.—Wagner. (See abstract under "Miscellaneous.")

SURGES AND OVER-VOLTAGE PHENOMENA ON TRANSMISSION LINES, DUE TO LIGHTNING.—H. Norinder. (*Journ. I.E.E.*, May, 1930, Vol. 68, pp. 525-533.)

After a short reference to the Klydonograph ("very simple . . . it gives the amplitude and polarity of a surge, but it fails when an analysis is required in which it is necessary to determine the time within a few microseconds . . . a very reliable control instrument for recording surges on transmission-line systems, and should be more widely used"), the writer describes and illustrates his form of cathode ray oscillograph, the setting in and out of action of which is governed by the surge itself, without the intermediation of any relays. In repose, the cathode ray is blocked by a small target on the central axis of the tube: any stray radiation is prevented from blackening the film by the provision of a diaphragm with a small central aperture. Above the diaphragm there are two pairs of deflecting plates, one above and one below the target: these two pairs are cross-connected, with the result that a surge so deflects the ray that it is steered clear of the target and directed through the diaphragm aperture. Time-axis deflecting-plates are below this diaphragm.

The Westinghouse surge generator is described, and then the writer deals with:—Electrical conditions for lightning strokes; Experimental data in connection with the rate of cloud discharge; Some characteristic records of the discharge rate; Direct records of lightning surges on transmission lines; and General conclusions.

PERFORMANCE OF THYRITE ARRESTERS FOR ANY ASSUMED FORM OF TRAVELLING WAVE AND CIRCUIT ARRANGEMENT.—K. B. McEachron and H. G. Brinton. (*Gen. Elec. Review*, June, 1930, Vol. 33, pp. 350-357.)

The Thyrite (June Abstracts, p. 332) arrester

characteristics are particularly adapted to the calculation of arrester performance because the volt-ampère curve has no loop and therefore is fixed, having only one value of voltage for each value of current.

L'ÉLECTRICITÉ ATMOSPHÉRIQUE ET TELLURIQUE (Atmospheric and Telluric Electricity).—E. Leclerc. (*Bull. de l'Assoc. Ingén. élec. l'Inst. électrot. Montefiore*; summary in *Rev. Gén. de l'Élec.*, 26th April, 1930, Vol. 27, p. 141D.)

A study of the static field of the atmosphere, the free charges circulating in it, auroras, terrestrial magnetism and earth currents. The variations of potential gradient with temperature and pressure and the effects of solar activity and of the moon are discussed, and the maintenance of the earth's electric charge. The writer studies the mode of formation of storms and the influence of local conditions, and the various types of lightning. "It seems that the formation of a fulminant material composed of ozones more concentrated than O_3 is the cause of globular lightning and of lightning flashes in general."

THE ZODIACAL LIGHT AND THE GEGENSCHNITT AS PHENOMENA OF THE EARTH'S ATMOSPHERE.—E. O. Hulburt. (*Phys. Review*, 1st May, 1930, Series 2, Vol. 35, No. 9, pp. 1098-1118.)

ELECTRICAL ENERGY FROM THE ATMOSPHERE.—(*Engineer*, 23rd May, 1930, Vol. 149, p. 575.)

"A student of the University of Naples claims to have succeeded in constructing a machine by means of which he derives electrical energy from the air. Details of the apparatus are not available, but it is stated that it is quite simple and that by means of it he has produced sufficient current to light a lamp." For cynical comments, see *Electrician*, 13th June, p. 760.

PROPERTIES OF CIRCUITS.

THE RECIPROCAL ENERGY THEOREM.—J. R. Carson. (*Bell Tech. Journ.*, April, 1930, Vol. 9, No. 2, pp. 325-331.)

Author's summary:—This paper gives a simple theorem determining relative transmission efficiencies in a two-way transducer, and showing that the conditions for equal efficiencies of transmission in the two directions are simply those for maximum output and maximum reception of energy. The theorem is then applied to radio communication and a second theorem stated and proved by which the ratio of the transmitting efficiencies of any two antenna systems is expressed in terms of their receiving efficiencies. The paper closes with a mathematical note on a generalisation of Rayleigh's Reciprocal Theorem.

EINE UNTERSUCHUNG AN DER TIKKERSCHALTUNG (An Investigation into the Action of a Ticker).—M. v. Ardenne. (*Zeitschr. f. tech. Phys.*, May, 1930, Vol. 11, No. 5, pp. 165-166.)

It is known that the action of the Poulsen

ticker-circuit is of a complicated nature, but it seems never to have been thoroughly investigated. The writer has therefore carried out a series of preliminary tests with a ticker frequency of 4,000 p.p.s. and h.f. varying from 70 to 450 kilocycles p.s. He found that the effectiveness of the circuit (as indicated by a valve voltmeter with d.c. amplifier) *decreased* about hyperbolically with increase of frequency, while the fluctuations about a mean value simultaneously *increased*; also, that the effectiveness was increased, especially for the shorter waves, by increasing the ticker frequency. He gives an interpretation of these results.

QUADRIPOLES ET FILTRES (Quadripoles and Filters).—J. B. Pomey. (*Rev. Gén. de l'Élec.*, 15th February, 1930, Vol. 27, pp. 235-242.)

A theoretical study of passive quadripoles and filters.

ELECTRICAL WAVE FILTERS.—M. Reed. (*E.W. & W.E.*, May and June, 1930, Vol. 7, pp. 256-261 and 315-322.)

Continuation of the paper dealt with in May Abstracts, p. 271:—Band pass filter; derived band pass filter; frequency of infinite attenuation; values of the elements for a band pass filter; the effect of resistance in filter circuits. Wave filters using mutual inductance; low pass filter containing negative inductance; band pass filter containing mutual inductance; wave filters containing mutual inductance in general.

APPLICATIONS OF THE METHOD OF ALIGNMENT TO REACTANCE COMPUTATIONS AND SIMPLE FILTER THEORY.—W. A. Barclay. (*E.W. & W.E.*, May and June, 1930, Vol. 7, pp. 242-247 and 309-314.)

Third and fourth parts of the paper referred to in June Abstracts, p. 332.

"T" И "Π" ЭЛЕМЕНТЫ В ЭЛЕКТРИЧЕСКИХ ФИЛЬТРАХ ("T" and "Π" Elements in Electric Filters).—A. G. Lurie (*Westnik Elektrotechniki*, Leningrad, January, 1930, Part I, pp. 16-20.)

In Russian. A discussion on investigations by H. Backhaus (*Z. f. hochf. Tech.*, Vol. 24) and Prof. Iuriev (*Nauchno-Technicheskii Sbornik*, 1926) on the resonance curves of electric filters. The reduction of a filter to a number of separate "T" and "Π" elements for the purpose of determining its resonance curve is considered in detail. It appears that such a reduction is not always possible, but when a filter is reducible to a number of "T" elements its resonance curve can be deduced from the separate resonance curves of these elements. "Π" elements do not lend themselves to such calculations, and are therefore of smaller importance in the design of filters.

O DETEKTIROVANII BIENII (On the Detection of Beats).—A. A. Kharkevitch. (*Westnik Elektrotechniki*, Leningrad, January, 1930, Part I, pp. 20-24.)

In Russian. The method usually adopted for

the generation of audio-frequency beats lies in combining two high-frequency oscillations and rectifying the wave so produced in a linear detector. This method is discussed in detail, and it is pointed out that the resultant audio-frequency output is not entirely free from harmonics. When, however, a square law detector is used, an output free from harmonics can theoretically be obtained. A method is given for determining the portion of the characteristic curve of a detector which conforms to a square law. The necessary relation between the amplitudes of the beating oscillations and the operating constants of the valve is given.

A GENERAL TREATMENT OF THE AMPLIFICATION AND RECTIFICATION OF ELECTRON TUBES.—Vermes. (See under "Valves and Thermionics.")

DÉTECTION PAR LA PLAQUE OU PAR LA GRILLE (Anode-bend versus Leaky-grid Detection).—L. Chrétien. (*T.S.F. Moderne*; summary in *Rev. Gén. de l'Élec.*, 1st March, 1930, Vol. 27, p. 79D.)

ÜBER DIE ANPASSUNG EINER SYNCHRONMASCHINE AN EINE ELEKTRONENRÖHRE (The Balancing of a Synchronous Motor and a Thermionic Valve).—H. Bartels. (*Wiss. Veröff. Siemens-Konz.*, Vol. 8 [2], 1929, pp. 1-13; summary in *Physik. Berichte*, 15th March, 1930, Vol. 11, p. 545.)

A study of the relations between a synchronous motor and a valve, working on a.c. mains, which supplies it with power. The connection is investigated between the range of power-output of the machine within which the latter can run synchronously, and the anode load on the valve.

LES VARIATIONS DE FRÉQUENCE DES OSCILLATEURS À LAMPES (Frequency Variations of Valve Oscillators).—D. F. Martyn. (*Rev. Gén. de l'Élec.*, 15th March, 1930, Vol. 27, pp. 409-410.)

Summary of the *E.W. & W.E.* paper dealt with in March Abstracts, p. 155.

TEORIA MATEMATICA E CALCOLO DEI TRASFORMATORI TELEFONICI (Mathematical Theory and Calculation of Telephonic Transformers).—G. Madia. (*L'Eleotrotec.*, 15th April, 1930, Vol. 17, pp. 251-258.)

A communication from the Siemens-Halske Laboratory.

STUDIO DI UN PARTICOLARE CONDENSATORE ELETTROICO (Study of a Special Electrical Condenser).—E. Perucca, G. Fubini, and G. Vallauri. (*L'Eleotrotec.*, 25th April, 1930, Vol. 17, pp. 278-283.)

Three mathematical studies of a condenser composed of a straight wire of circular section and infinite length, placed at equal distance from two plane parallel conductors of infinite dimensions.

CAPACITY OF CONDENSERS IN SERIES.—H. S. Uhler. (*Science*, 9th May, 1930, Vol. 71, pp. 488-489.)

A note on the "unnecessarily inexact" nature of the usual expression for the capacity of condensers in series ($1/C = 1/C_1 + 1/C_2 + \dots$). The writer's argument deals with spherical condensers, but it can be extended to the case of parallel plate condensers. Two numerical examples (spherical condensers) display errors of -6.4 per cent. (for s.i.c. = 1) and -1.5 per cent. (for s.i.c. = 4.706).

THE DISTRIBUTION OF CURRENT AND POTENTIAL IN A TRANSMISSION LINE SUBJECT TO INDUCTION.—STEADY STATE.—Kovalenkov. (*See* under "Miscellaneous.")

APPLICATION DE LA THÉORIE DE L'INVERSION À LA CONSTRUCTION POINT PAR POINT, AU MOYEN DE LA RÈGLE ET DU COMPAS, DES COURBES DE RÉSONANCE DES CIRCUITS RÉSONNANTS ET DE LA COURBE D'IMPÉDANCE DES CIRCUITS ANTIRÉSONNANTS (Application of the Inversion Theorem to the Point by Point Construction, with Rule and Compasses, of the Resonance Curves of Resonant Circuits and of the Impedance Curve of Antiresonant Circuits).—F. Bedeau and J. De Mare. (*L'Onde Elec.*, April, 1930, Vol. 9, pp. 178-189.)

The writers first restate Kennelly's Inversion theorem and then show how it may be applied as stated in the title.

FREQUENCY TRANSFORMATION BY A.C.-MAGNETISED IRON-CORED INDUCTANCES.—Schmidt. (*See* under "Subsidiary Apparatus.")

TRANSMISSION.

ÜBER EIN VERFAHREN ZUM AUSGLEICH VON SCHWUNDERSCHEINUNGEN BEI KURZEN WELLEN (A Method of Short Wave Fading Elimination).—K. Krüger and H. Plendl. (*Zeitschr. f. hochf. Tech.*, May, 1930, Vol. 35, p. 191.)

Two horizontal dipoles are used, at right-angles to each other. They are excited alternately, in time with a modulating frequency, so that one dipole is radiating during positive half periods of the l.f. modulation and the other during the negative half periods. Two oscillating valves in a l.f. push-pull circuit are employed, both controlled as to their carrier-wave frequency by a common quartz-stabilised drive circuit.

Good results have been obtained on a radiated power of 50 w. over a distance of 500 km. With the above combination the minimum strength was 33 per cent. of the maximum, compared with 5 per cent. for one dipole radiating the same amount of energy. Further development is in progress, in particular a comparative test on a vertical-horizontal combination.

TRANSOCEANIC TELEPHONE SERVICE.—SHORT-WAVE TRANSMISSION.—R. Bown. (*Bell Tech. Journ.*, April, 1930, Vol. 9, No. 2, pp. 258-269.)

Author's summary:—The discussion relates to

the transmission problems involved in short-wave radiotelephony over long distances and the transmission bases for design of the systems used in commercial transatlantic service. Choice of operating frequencies, amounts of transmitter power, directive transmitting and receiving antennas, automatic gain controls in receivers, and voice-operated switching devices are all factors which may be invoked to aid in solving these problems. The way in which they have been applied in the transatlantic systems and the results which have been obtained are set forth briefly.

ULTRA-SHORT WAVE DEVELOPMENTS IN 1929.—Wagner. (*See* end of abstract under "Miscellaneous.")

RADIO TELEGRAPHY AND TELEPHONY ON [ULTRA-SHORT] HALF-METRE WAVES.—S. Uda. (*Tech. Rep. Tôhoku Univ. Sendai*, No. 2, Vol. 9, 1930, pp. 19-39.)

A complete version in English of the paper dealt with in July Abstracts, p. 392.

NOTIONS GÉNÉRALES DE TRANSMISSION APPLIQUÉES À LA RADIOTÉLÉPHONIE (General Principles of Transmission Applied to Wireless Telephony).—Ph. Le Corbeiller and G. Valensi. (*L'Onde Elec.*, April, 1930, Vol. 9, pp. 141-164.)

Authors' summary:—The writers first examine the chief circumstances in the transmission of a sinusoidal sound along a loaded [Pupinised or Krarupised] telephonic circuit, and give, as examples of the levels diagram, the diagrams of a land cable circuit and of the radio-telephonic circuit London—New York.

They then give the chief results of the analysis of speech sounds made in the U.S.A. during the last few years, and end by a description of the technique employed for the acoustic testing of telephonic apparatus (telephony).

THE PHYSICAL REALITY OF "SIDE-BANDS."—F. M. Colebrook. (*Nature*, 10th May, 1930, Vol. 125, pp. 726-727.)

A preliminary account of experiments on the rectification of a modulated continuous wave from a valve-maintained oscillator which give experimental evidence for the physical reality of side-bands in the sense defined in the paper.

PROHOJDENIE BOKOVH CHASTOT V RADIOTELEFONNIH PEREDATCHIKAH (The Attenuation of Side-band Frequencies in a Radio Transmitter).—G. A. Seitenok. (*Westnik Elektrotechniki*, Leningrad, January, 1930, Part I, pp. 8-10.)

In Russian. The effect of tuned circuits in a radio transmitter on the depth of modulation of the carrier wave is discussed. A formula is derived which indicates the increase in the decrement of a tuned circuit when a modulated carrier is transmitted. It is concluded that in order to reduce demodulation low impedance valves should

be used, operated as Class III amplifiers [i.e., amplifiers biased to the point of cut-off and driven hard on the grid so that grid current flows] with as high a plate potential as possible. It is also shown that the degree of demodulation depends on the depth of modulation in the case of amplitude modulation, but is independent of this in the case of frequency modulation.

ZAVISIMOST MEJDU KOLEBATELNOU MOSHNOSTIU I KOEFFICIENTOM POLEZNOGO DEISTVIA LAMPOVOGO GENERATORA (The Relation between the Power Output and the Efficiency of an Oscillating Valve).—P. N. Ramlau. (*Westnik Elektrotehniki*, Leningrad, January, 1930, Part 1, pp. 11-16.)

In Russian. A method is given for predicting the efficiency of an oscillating valve for various outputs. This consists in plotting two curves showing the relationship between the efficiency and the power output, the latter being limited in the first case solely by the maximum permissible plate dissipation and in the second case solely by the saturation current of the valve. Within the area above the efficiency axis and under both these curves, both these conditions are satisfied, and from the boundary line of this area the maximum efficiency for any power output can be read off. A numerical example is given showing how this method may be used to determine the most efficient operating conditions of a valve for any power output.

GLOW DISCHARGE TUBES FOR THE PROTECTION OF TRANSMITTING VALVES AGAINST LOSS OF NEGATIVE GRID POTENTIAL.—(German Pat. 490110, Philips, pub. 27th January, 1930.)

(For a summary, see *Zeitschr. f. hoch. Tech.*, May, 1930, Vol. 35, pp. 192-193.)

LORENZ H.F. GENERATORS: FREQUENCY MULTIPLICATION BY A.C.-MAGNETISED IRON-CORED INDUCTANCES.—Schmidt. (See abstract under "Subsidiary Apparatus.")

ULTRA-RAPID TELEGRAPHY.—(French Pat. 666782, Etab. Belin, pub. 5th October, 1929.)
A photoelectric facsimile method.

MODULATION OF TRANSMITTERS EXAMINED AND MEASURED BY MARCONI C.-R. EQUIPMENT.—Puckle. (See under "Subsidiary Apparatus.")

FREQUENCY STABILISATION OF VALVE OSCILLATORS.—Mallett. (See under "Measurements and Standards.")

A CONSTANT FREQUENCY OSCILLATOR.—Miller and Andrews. (See under "Measurements and Standards.")

HIGH FREQUENCY EQUIPMENT FOR BIOLOGICAL EXPERIMENTATION.—J. G. McKinley, jun., and G. M. McKinley. (*Science*, 16th May, 1930, Vol. 71, pp. 508-510.)

Description of a generating equipment for wavelengths 2 to 6 metres for laboratory use.

The output on the exposure circuit can be varied from 0 to about 4.5 A. It is found best to use a very loose inductive coupling between oscillatory and exposure circuits, and then provide a single wire feeder resembling the usual radio antenna feeder.

RECEPTION.

NOTE SUR LA STABILITÉ DE L'ACCROCHAGE (Note on the Stability of the Oscillation Threshold).—P. Godfrin. (*L'Onde Elec.*, April, 1930, Vol. 9, pp. 190-196.)

"A study of the oscillation threshold of reaction receivers with grid-characteristic detection. Working on a simple circuit, the writer shows that in certain cases no stable oscillation régime can exist. He thus explains the production of the parasitic l.f. noise commonly known as 'threshold howl'" (cf. Alder, June Abstracts, p. 335).

There are two conditions to be satisfied if this phenomenon is to take place. The first, $a < 0$ [see below for significance of a], is also the condition for smooth and reversible threshold adjustment; if $a > 0$, the adjustment is harsh and irreversible.

a here stands for $f'''(u_0) - \frac{g''(u_0)f''(u_0)}{1/r + g'(u_0)}$, where u_0 is the grid potential, and equations $j = f(u)$ and $i = g(u)$ represent the plate current characteristic as a function of u for a given plate voltage, and the static grid characteristic, respectively; r is the resistance of the shunted condenser.

The second condition is $f'''(u) > 0$. When these two conditions exist, there is (for a given plate-grid coupling) a position of equilibrium, but it is an unstable one, and it is here that the threshold howl occurs. The writer admits that a full treatment of the phenomenon would have to take into account the l.f. impedance of the plate circuit, which may well play an important part (cf. Alder, *loc. cit.*).

THRESHOLD HOWL.—M. G. Scroggie: J. A. Ratcliffe and L. G. Vedy: L. S. B. Alder. (*E.W. & W.E.*, May and June, 1930, Vol. 7, pp. 265 and 323.)

Correspondence on the last-named writer's paper (June Abstracts, p. 335). Ratcliffe and Vedy refer to the close bearing which his paper and Scroggie's letter have on the phenomenon of "interrupted triode oscillations" discussed by themselves in their *Camb. Phil. Soc.* paper (July Abstracts, p. 390).

UTILISATION OF REVERSE ROUND-THE-EARTH SIGNALS IN COMBINATION WITH DIRECT SIGNALS.—(German Pat. 489943, Telefunken, pub. 25th Jan., 1930.)

A second aerial and reflector system is used for the reverse signals, which are combined with the direct signals, the time lag being compensated for by a delaying circuit.

COUNTERACTING FADING EFFECTS.—(French Pat. 666767, Ateliers J. Carpentier, pub. 5th October, 1929; summary in *Rev. Gén. d. l'Élec.*, 28th December, 1929, p. 231D.)

A method depending on signal-inversion, the wave being emitted during the spaces and inter-

rupted for the dots and dashes. Fading is thus represented by additional signals. It is suggested that the message should be transmitted simultaneously on two wavelengths and received on two receivers actuating a common recorder.

ELIMINATION OF ATMOSPHERICS AND INTERFERENCE.—(French Pat. 674323, J. P. Lévy, pub. 27th Jan., 1930.)

A method of balancing two receivers using neon lamps as intermediaries. A signal on the receiver for the desired wavelength produces illumination of its own lamp, while a signal on the balancing receiver extinguishes the illumination of its own lamp. The actions of the two lamps are combined on a photoelectric cell and are thus transferred to a loud speaker.

SPACED AERIAL RECEPTION: EXPERIMENTS AT TERLING.—W. P. Wilson. (*Marconi Review*, April, 1930, pp. 1-6.)

A description of tests on the elimination of fading, carried out by the Marconi Company, with the co-operation of the B.B.C., in 1928-1930. The transatlantic 21.96 m. broadcast programmes from W.2XAD were used for the tests: three aerial systems, each consisting of four Franklin units (with reflectors) each of the equivalent height of three half-wavelengths, were staggered so as to be separated by approximately 1 mile intervals in the direction of N. York and by half-mile intervals in the direction at right angles to this—the site not allowing them to be arranged on the one great circle to N. York. Three double detection receivers were used: these are described briefly. "The spaced aerial method of short wave reception has proved of considerable utility for the purpose of providing rebroadcast programmes. The equipment at Terling is now in process of being transferred to the receiving station of the B.B.C. at Tatsfield."

RADIO TELEGRAPHY AND TELEPHONY ON [ULTRA-SHORT] HALF-METRE WAVES.—Uda. (*See under "Transmission."*)

RECEPTION CHARACTERISTICS OF THE BOMBAY BROADCASTING STATION.—M. N. Doraiswami. (*Electrotech.*, Bangalore, Feb., 1930, pp. 290-293.)

INTENSITY VARIATIONS OF THE MADRAS (FORT) RADIO TELEGRAPH STATION.—K. Ramaswami. (*Electrotech.*, Bangalore, Feb., 1930, pp. 315-317.)

EMERGENCY RECEIVERS FOR MINERS.—A. S. Eve. (*Science News-Letter*, 17th May, 1930, Vol. 17, p. 313.)

A simple, inexpensive headphone receiver will enable trapped miners to receive messages from those working to rescue them. Such a set has been found to receive Morse signals sent through 300 feet of sandstone and limestone over the Mammoth Cave in Kentucky.

THE MARCONI MARINE RECEIVER, TYPE 352.—Marconi Company. (*Marconi Review*, May, 1930, pp. 17-23.)

The complete equipment includes the two-valve receiver type 352 (15 m. to 20,000 m.), a separate heterodyne type 357 (200 to 22,000 m.), and a note filter type 358 (which may be tuned to accept any note between 800 and 1,200 p.p.s. approximately).

ENGINE-IGNITION SHIELDING FOR RADIO RECEPTION IN AIRCRAFT.—H. Diamond and F. G. Gardner. (*Proc. Inst. Rad. Eng.*, May, 1930, Vol. 18, pp. 840-861.)

See July Abstracts, p. 393.

PIEZOELECTRIC INTERFERENCE ELIMINATOR.—(U.S. Patent 1739494, Affel and A.T. & T.Co., 17th Dec., 1929.)

A method of suppressing an a.c. wave of definite frequency by means of a piezoelectric device of substantially different frequency, by beating with another wave so as to produce a third wave having the same frequency as the piezoelectric device, "whereupon the piezoelectric device becomes absorbent to the said third wave."

LE RÉGLAGE DES POSTES RÉCEPTEURS DE T.S.F. PAR L'EMPLOI DES DISPOSITIFS DE REPÉRAGE NOMINAL "VALUNDIA" (The Setting of Wireless Receivers by the "Valundia" System).—J. L. Routin. (*Rev. Gén. d. l'Élec.*, 4th January, 1930, Vol. 27, pp. 26-28.)

More on the system dealt with in 1929 Abstracts, p. 151, and referred to in the *Wireless World* of 4th June last (p. 578) as the "pianola of Wireless."

HYDRA - STORBEFREIUNGS - KONDENSATOREN (The "Hydra" Condensers for Preventing Interference).—(E.T.Z., 22nd May, 1930, Vol. 51, pp. 745-746.)

A German firm is producing condensers specially for this purpose: the metal case contains two condensers in series, extra terminals being provided for the mid-point tapping and for earthing the case.

AERIALS AND AERIAL SYSTEMS.

INFLUENCE OF BEAM AERIAL HEIGHT ON SIGNAL INTENSITY.—T. L. Eckersley. (*Marconi Review*, May, 1930, pp. 14-16.)

To obtain the whole (theoretical) benefit of the concentration produced by increasing the vertical height, the whole of the energy must be transmitted along the line perpendicular to the plane of the array, and the receiver must be on this line. "In any actual case we know, chiefly from various impulse and facsimile measurements, that the energy proceeds from the transmitter to receiver by a series of ricochets between the earth and Heaviside Layer." [Contrast Bureau, under "Prop. of Waves."] The writer quotes his 1927 I.E.E. paper, where experiments are described showing that for distances of 2,000 km. and more the rays which carry the main energy are confined to a sheaf

with a small angle of elevation, *i.e.*, not greater than 20° . "For this deviation from the horizontal (if the direction of propagation of the aerial is slightly elevated) the directive efficiency in the vertical plane is near its ideal value, so that the gain of a 2λ to 2.5λ height aerial over one of $h = \frac{1}{2}\lambda$ is approximately 2 to 2.5 to 1." He also mentions that American results confirm that the gain on raising the height of the aerial is close to its theoretical value.

In spite of this nearly horizontal transmission of the main energy, "high angle radiation may be present on the 24 to 29 metre [waves] from time to time"; but for high-speed working such rays are harmful owing to their delay, and are better cut out (even at the expense of some magnification) by using the vertical directivity of the high aerial.

ZUR THEORIE DER STRAHLUNGSKOPPLUNG VON KURZWELLEN-ANTENNENSYSTEMEN (Contribution to the Theory of Radiation Coupling of Short-Wave Antenna Systems).—R. Bechmann. (*Ann. der Phys.*, Series 5, 1930, Vol. 4, No. 7, pp. 829-862.)

Author's summary:—"A theoretical treatment of the radiation coupling of an antenna system consisting of any number of straight, parallel conductors. A system of differential equations, the same in number as the radiators and of the oscillation equation type, is obtained. Radiation damping is introduced by means of the 'Selbstkraft,' Planck's frictional force in the radiator itself. Concise forms for the electric field strengths induced between the several radiators are derived from the Hertzian vector.

"The coupling forces and the Fourier coefficients of their expansions in series of the eigenfunctions of the radiators are calculated and given explicitly for the fundamental oscillation of the radiators.

"The solution of the system of equations mentioned above gives a simple method of calculation of the radiation resistances. In particular, it is possible by this method to calculate the radiation resistances of complicated systems of antennæ and especially of such beam antennæ as are used nowadays in short wave work. An example is given of the case where the radiators are excited in the same phase. Further, the example of an emitting antenna with a wire reflector which is not separately excited is discussed. The most favourable distance between the emitting antenna and the reflector, in which a maximum amount of energy is radiated in the forward direction, is calculated."

A comprehensive list of references to relevant literature is given. Ohmic resistances in the antennæ are neglected. In the case of the emitting antenna and the wire reflector, the length of each is assumed to be one half the wave-length used. The case in which the reflector is not tuned to the emitter is not discussed.

TESTS OF AIRPLANE ANTENNAS.—Bureau of Standards. (*Bur. of Stds. Tech. News Bull.*, April, 1930, p. 31; *Journ. Franklin Inst.*, May, 1930, Vol. 209, pp. 683-684.)

There is still every indication that the vertical

pole aerial is the best for reception, but the accumulation of ice is a serious problem. A number of remedies are in view, but in the meantime other possible types of aerial have been investigated. The longitudinal inclined, transverse *T*, and wing-tipped *T* aeriels "give localising effects which may be quite as useful as that obtained with the vertical pole antenna; these types, however, introduce errors in course indication which are due to the inclination of the antenna with respect to the course when the orientation of the airplane is shifted, and may be very large when within 5 or 10 miles of the beacon station."

THE RECIPROCAL ENERGY THEOREM APPLIED TO AERIALS.—Carson. (*See abstract under "Properties of Circuits."*)

RICHTWIRKUNG VON STRAHLERN (The Directional Working of Radiators).—H. Stenzel. (*E.T.Z.*, 16th Jan., 1930, Vol. 51, p. 98.)

Summary of an *AEG-Mitteilung* paper which appears to cover the same ground as the *E.N.T.* paper dealt with in 1929 Abstracts, p. 450.

VALVES AND THERMIONICS.

H.F. HEATING OF TRANSMITTER VALVE FILAMENTS.—(German Pat. 485659, Lorenz, pub. 12th Feb., 1930.)

Since a defect may result in the heating filament receiving the high anode voltage, the transformer has to be insulated for high voltage. This involves great leakage, which may be compensated for by a condenser for obtaining resonance. But such a condenser, on the secondary side of the transformer, has to be very large and expensive. According to the invention the secondary winding has a third, multi-turn winding combined with it: this third winding is connected to a small tuning condenser.

CALCUL DES CARACTÉRISTIQUES ET LES DIMENSIONS DES TRIODES (Calculation of the Characteristics and Dimensions of Triode Valves).—Y. Kusunose. (*Rev. Gén. de l'Élec.*, 8th March, 1930, Vol. 27, pp. 367-368.)

A long summary of the I.R.E. paper referred to in January Abstracts, p. 47. Special prominence is here given to the electrolytic method of determining the amplification coefficient by means of a model including one turn only of the grid.

LES LAMPES À PLUSIEURS GRILLES (Multi-Grid Valves).—B. Decaux. (*Rev. Gén. de l'Élec.*, 5th April, 1930, Vol. 27, pp. 523-540.)

I. General considerations. II. Tetrodes:—A. Space-charge-grid valves: general properties: the use of small anode potentials: the use of steep slopes to obtain large amplification without exaggerated internal resistance. B. Screen-grid valves: general properties: use in tuned amplifiers: for short wave reception: in resistance amplifiers (in general, unsuitable); but for special purposes—for very weak signals—the negative resistance in the dip of the characteristic may be utilised for obtaining great—theoretically infinite—

magnification, somewhat delicate in adjustment. Of great service in d.c. amplification: Siemens and Halske thermionic voltmeter combining a space-charge-grid and a screen-grid valve. Screen-grid valves for transmission, as amplifiers and oscillators—particularly for short waves. The use of the screen grid in improving the efficiency of oscillators—the grid is here not so much a “screen grid” as a “retarding grid” for the secondary electrons liable to leave the plate when this falls in potential momentarily below the control-grid potential.

C. Multiple-function tetrodes:—“reflex” (r.f. and l.f.) reception: frequency-changing uses: balanced amplifier and oscillator arrangements (Barthélémy and Thébault “cryptadyne-isodyne”) especially useful for recording and measuring: negative resistance circuits—*e.g.*, for reducing the damping of several circuits in series, each with its own natural frequency: super-regeneration: reaction amplifier independent of frequency: relaxation oscillation generators. D. Pliodynatron, negatron.

III. Pentodes:—A. Space-charge-grid 3-grid valves. B. The English pentode—the use of an extra grid as “retarding grid” to avoid the secondary emission dip in the characteristic (see also above in II B). C. 3-grid multiple-function valves—innumerable applications, *e.g.*, in frequency changing, where the extra grid increases the slope while reducing the necessary anode voltage: the Barthélémy trisodyne. D. 2-grid 2-plate valves (Fotos), chiefly for frequency changing.

SECONDARY ELECTRONS FROM CONTAMINATED SURFACES.—P. L. Copeland. (*Phys. Review*, April 15th, 1930, Series 2, Vol. 35, No. 8, pp. 982-988.)

Some of the properties of metallic surfaces contaminated by small quantities of grease, or condensed vapours, or foreign metal have been investigated experimentally by means of electron reflection and secondary emission. The conclusions arrived at are as follows:—

(1) Strong fields are set up in the neighbourhood of a contaminated surface retarding the escape of reflected electrons. (2) In extreme cases of oil contamination the impurities form an insulating film which breaks down at some critical value of the applied field. (3) The breakdown potential of a given field varies with the energy of the incident electrons. (4) The conductivity observed in these films appears to be rather general and continuous.

INFLUENCE OF ACCELERATING FIELDS ON THE PHOTOELECTRIC AND THERMIONIC WORK FUNCTION OF COMPOSITE SURFACES.—W. B. NOTTINGHAM. (*Phys. Review*, May 1st, 1930, Series 2, Vol. 35, No. 9, p. 1128.)

See under “Phototelegraphy and Television.”

NOUVEAU PROCÉDÉ DE PRÉPARATION DES CATHODES À OXYDES (New Method of Preparation of Oxide-Coated Cathodes).—G. Déjardin. (*Bull. d. l. Soc. franç. de Phys.*, 21st Feb., 1930, p. 30 S; summary in *Rev. Gén. de l'Élec.*, 5th April, 1930, Vol. 27, p. 541.)

A description of the vaporisation method, using barium cyanide or a mixture of alkaline earth cyanides. Activation and de-activation pheno-

mena, resembling those found by Langmuir in the case of thoriated tungsten. The effect of the presence of a small quantity of oxygen in decreasing the emission.

RECHERCHES SUR L'ÉMISSION DE RAYONS X SE PRODUISANT À LA CATHODE DE CERTAINS TUBES À VIDE (Researches on the Emission of X-Rays occurring at the Cathodes of certain Vacuum Tubes).—A. Dauvillier. (*Rev. Gén. de l'Élec.*, 24th May, 1930, Vol. 27, pp. 809-815.)

The author investigates the origin and method of formation of the X-rays which have been known for some time to be emitted from certain vacuum tubes, notably the kenotrons. He concludes that the emission is due to the bombardment of the cathode, when momentarily positive, by electrons condensed on the glass of the tube: this can only occur in a very high vacuum. Ways of preventing this emission are suggested.

EINE ALLGEMEINE BEHANDLUNG DER VERSTÄRKUNG UND GLEICHRICHTUNG VON ELEKTRONENRÖHREN (A General Treatment of the Amplification and Rectification of Electron Tubes).—N. Vermes. (*Ann. der Phys.*, Series 5, 1930, Vol. 4, No. 7, pp. 943-969.)

The amplification and rectification factors of an electron tube are defined as follows: let de_a be the change in anode voltage due to an additional e.m.f. in the grid circuit of amount dE_g . For sufficiently small changes, de_a may be regarded as a quadratic function of dE_g :

$$de_a = c_1 - dE_g + c_2(dE_g)^2.$$

c_1 is called the “amplification factor” and c_2 the “rectification factor.”

Formule for c_1 and c_2 are derived which contain the constants of the electron tube and of the circuit; the derivation is illustrated geometrically and verified experimentally.

PROVE SU TRIODI RICEVENTI NORMALI USATI COME DIODI RADDRIZZATORI (Tests on Standard Receiving Triodes used as Diode Rectifiers).—G. Rutelli. (*L'Elettrotec.*, 15th March, 1930, Vol. 17, pp. 176-180.)

DIRECTIONAL WIRELESS.

DIRECT-READING D.F.—(German Pat. 488999, Lévy, pub. 6th Feb., 1930.)

Another arrangement in which a phase-meter (power factor meter) is used as the indicating instrument (*cf.* Berndorfer and Dieckmann, July Abstracts, p. 397). Here each of the two frame aerials (at right angles) is allotted a valve and an auxiliary generator: the currents of these generators are displaced in phase, one corresponding to the curve $\sin \omega t$ and the other to the curve $\cos \omega t$. Each generator supplies current to a fixed winding of the phase-meter, while the moving coil is supplied by the combined voltage—due to the two sets of signals and their superimposed auxiliary currents—given by $K.H. \sin \phi t \sin (\omega t - a)$, where a is the angle of incidence of the incoming signals, $H \sin \phi t$ is the a.c. field of the oscillations in the frames, and K is a constant.

AIRPLANE DIRECTION FINDERS.—U.S. Bureau of Standards Notes. (*Journ. Franklin Inst.*, May, 1930, Vol. 209, No. 5, pp. 684-685; *Bur. of Sids. Tech. News Bull.*, April, 1930, pp. 31-32.)

A preliminary notice of work on the development of a direction finder for use aboard aeroplanes. A direction finder of the rotating coil type is being developed, of maximum simplicity in use, usable either as a homing device or for bearing indications. It employs two small crossed loop antennae rotating as a unit. An antenna tuning system has been devised, permitting a uni-tuning control and proper combinations of the two antenna currents without mechanical switching in the radio-frequency circuits. It operates on the comparison of two signals rather than on zero signal. Course indications may be either aural (comparison of intensities, or the use of "interlocked" signals) or visual (zero-centre deflection instrument). Means are also being worked out whereby a vibrating-reed indicator gives the indications, thereby taking advantage of the freedom from interference inherent in this type of indication.

The research is expected to include flight tests of various types of direction finders.

DEVELOPMENT OF THE VISUAL-TYPE AIRWAY RADIOBEACON SYSTEM.—J. H. Dellinger, H. Diamond and F. W. Dunmore. (*Proc. Inst. Rad. Eng.*, May, 1930, Vol. 18, pp. 796-839.)

See July Abstracts, p. 398.

ACOUSTICS AND AUDIO-FREQUENCIES.

IMPROVEMENTS IN SYSTEMS OF TRANSMITTING AND AMPLIFYING CURRENTS AND VIBRATORY MOVEMENTS [RECORDING OF GRAMOPHONE RECORDS]. (French Pat. 677316, Toulon, pub. 6th March, 1930.)

A method of obtaining great fidelity of reproduction. The root idea is the comparison of the result attained with the result desired, in such a way that all disagreement automatically vanishes: instead of trying to make all the stages of amplification, etc., as perfect as possible, they are left to function "anyhow," but the apparatus automatically corrects itself directly any fault attempts to appear. Thus in the case of connecting a gramophone pick-up to a loud speaker, the electrical connections are such that the needle is rigidly (electrically) connected to the diaphragm, so that the movement of the one must result in a precisely equal movement of the other (this effect is obtained by an opposing auxiliary moving coil fixed to the working moving coil and connected through an amplifier to the pick-up coil). But although the movements are exactly equal, the power behind those movements may be very different. For a longer summary, see *Rev. Gén. de l'Élec.*, 26th April, 1930, Vol. 27, p. 152D.

ORIGIN AND DEVELOPMENT OF THE SOUND FILM SYSTEM OF THE AEG.—H. Tischner. (*AEG-Mitt.*, Jan., 1930, pp. 14-24.)

DIE ELEKTROMAGNETISCHE SCHALLAUFZEICHNUNG (Electromagnetic Recording of Sound).—C. Stille. (*E.T.Z.*, 27th March, 1930, Vol. 51, pp. 449-451.)

An article on the writer's steel tape or wire method of recording sound (see Jan. Abstracts, p. 55) based on Poulsen's "telegraphone" work. Points mentioned include:—the desirability of giving the band a preliminary magnetisation: the importance of using the best steel for the purpose—not only to avoid background noise, but to give long life, records on good steel giving unimpaired reproduction after 16 years: the writer has been able to decrease Poulsen's speed of 3 m./sec. for speech (which was all he dealt with) to 1 m./sec., while for music (sound films, etc.) speeds of 1.2 to 2 m./sec. are satisfactory.

One equipment illustrated (the "Dailygraph") is a dictating machine for office use. It employs a 0.2 mm.-thick steel wire, each roll giving one hour's recording. A special advantage claimed for this application is the possibility of erasing and correcting any errors; also, of course, the economy of using the same wire over and over again.

ACOUSTIC CONTROL OF RECORDING FOR TALKING MOTION PICTURES.—J. P. Manfield. (*Journ. Soc. Motion Picture Engineers*, Jan., 1930, Vol. 14, pp. 85-95.)

ELECTRICAL ENGINEERING OF SOUND PICTURE SYSTEMS.—K. F. Morgan and T. E. Shea. (*Bell Tel. Lab. Reprint B. 441.*)

A description of the technique and apparatus used in Western Electric Sound Picture Systems, with emphasis on the electrical engineering aspects.

DER EINFLUSS DER SPALTBREITE AUF DIE WIEDERGABE VON LICHTFILMEN (The Influence of Gap Breadth on the Reproduction of Sound Films).—H. Joachim. (*Zeitschr. f. tech. Phys.*, May, 1930, Vol. 11, No. 5, pp. 168-172.)

For both amplitude and density methods, the breadth of the gap has a great influence on volume and quality of reproduction: the writer investigates how far, for the sake of greater volume, the breadth can be increased without too much deterioration of quality. For a breadth of 4μ , a frequency of 25,000 p.p.s. is reproduced properly; for 12μ , the limit is 11,000; for 20μ it is 6,500; these values being based on the assumption that a 25 per cent. decrease of intensity may be neglected.

A THERMIONIC VALVE POTENTIOMETER FOR AUDIO FREQUENCIES.—W. S. Stuart. (*Journ. I.E.E.*, June, 1930, Vol. 68, pp. 769-772.)

In the Larsen method of measuring audio-frequency potential vectors, great care is essential to avoid the effects of stray capacities, particularly in connection with the detector (body capacity, etc.). Pagès evolved a practical potentiometer, using two triodes, which removed this difficulty: the present paper deals with a three-triode modification of this which is specially useful for tests on circuits such as artificial lines. A method of estimating the admittance existing between the input potential terminals is described.

A METHOD OF MEASURING MECHANICAL IMPEDANCE.—E. Mallett and R. C. G. Williams. (*Journ. I.E.E.*, May, 1930, Vol. 68, pp. 560-565.)

See April Abstracts, p. 218.

MEASUREMENT OF THE PERFORMANCE OF LOUD SPEAKERS.—E. J. Barnes. (*E.W. & W.E.*, June, 1930, Vol. 7, pp. 301-308.)

Conclusion of the paper dealt with in July Abstracts, p. 401. The recorder is described, and the final combination of the various component parts already dealt with. The rest of the paper illustrates and discusses a number of typical characteristics obtained.

THE MARCONI REFLECTION SOUNDING DEVICE.—J. A. Slee. (*Marconi Review*, May, 1930, pp. 1-10.)

A description of the equipment mentioned in April Abstracts, p. 232 (in connection with the Physical and Optical Societies' Exhibition).

UNTERSUCHUNGEN ÜBER ERSCHÜTTERUNGSSCHWINGUNGEN UND GERÄUSCHE (Investigations into Shock Vibrations and Noises).—H. Gerdien, H. Pauli and F. Trendelenburg; and

ZUR AUFNAHME UND ANALYSE VON SCHIFFSGERÄUSCHEN (The Recording and Analysis of Ship Noises).—E. Lübcke. (*Zeitschr. f. tech. Phys.*, October, 1929, Vol. 10, No. 9, pp. 374-378 and 378-382.)

CARRIER TELEPHONY THROUGH WATER BY SUPERSONIC WAVE.—M. Matudaira. (*World Engineering Congress Abstracts*, 1929, Paper 757.)

Speech was transmitted clearly through 1 km. of sea water by the writer's apparatus; the carrier wave (piezoelectrically generated) had a frequency of 250 kc. and the modulation was applied to the high frequency oscillator driving the quartz vibrator. Reception was by a piezoelectric resonator and an amplifier.

VIBRATING AIR COLUMN OF HIGH FREQUENCY.—S. K. Crews and F. C. Hymas. (*Nature*, 23rd Nov., 1929, Vol. 124, p. 793.)

A curious series of annular markings was observed in a glass tube through which air, carrying water-vapour and powdered charcoal, was passing at a pressure of 600 mm. mercury. If these were due to supersonic vibration (perhaps originating at the narrow inlet) this vibration was of 150,000 p.p.s. frequency—the writers believe the highest yet recorded.

EINE NEUE OPTISCHE MESSMETHODE FÜR GRAMMOPHONPLATTEN (A New Optical Method of Measurement of Gramophone Records).—G. Buchmann and E. Meyer. (*E.N.T.*, April, 1930, Vol. 7, No. 4, pp. 147-152.)

The microscopic method presents certain difficulties in view of the smallness of the amplitudes, especially at high frequencies. Moreover, the important factor to measure is not the amplitude but the "velocity-amplitude" (amplitude multi-

plied by frequency) which should be constant in the case of an ideal recorder and a constant a.c. voltage. The authors' new method is very simple and measures this quantity. A parallel beam of light falls on the record and on reflection produces a light band whose breadth is directly proportional to the velocity-amplitude.

PERFORMANCE OF SOUND TRANSMITTERS AND RECEIVERS DETERMINED BY A.C. POTENTIOMETER METHODS.—Drysdale. (See last part of abstract under "Measurements and Standards.")

ÜBER DIE EIGENFREQUENZEN EINSEITIG EINGESPANNTER PRISMATISCHER STÄBE MIT ZUSATZMASSEN AM FREIEN ENDE (The Natural Frequencies of Prismatic Rods Clamped at One End and Loaded at the Free End).—A. Esau and M. Hempel. (*Zeitschr. f. tech. Phys.*, May, 1930, Vol. 11, No. 5, pp. 150-153 and Plate.)

THE PRESSURES ON THE DIAPHRAGM OF A CONDENSER TRANSMITTER IN A SIMPLE SOUND FIELD.—W. West. (*Journ. I.E.E.*, April, 1930, Vol. 68, pp. 441-446.)

"It has been observed that the free air pressures of a sound wave may be increased at the diaphragm of a microphone in a ratio greater than 2:1 at certain frequencies, when there is concavity in the face of the microphone. A method of calculating the magnitude of this increase is applied to a condenser transmitter of the Wentz type, and close agreement is found with experimental results. The calculations involve certain simplifying assumptions the validity of which is discussed." See Oliver, June Abstracts, p. 340.

THE FREE AND FORCED SYMMETRICAL OSCILLATIONS OF THIN BARS, CIRCULAR DIAPHRAGMS, AND ANNULI [CONTRIBUTION TO THE MATHEMATICAL THEORY OF LOUD SPEAKER DESIGN].—A. G. Warren. (*Phil. Mag.*, May, 1930, Series 7, Vol. 9, pp. 381-901.)

SOME NOTES ON THE DESIGN OF A GRAMOPHONE PICK-UP.—G. W. Sutton. (*Journ. I.E.E.*, May, 1930, Vol. 68, pp. 566-577.)

See April Abstracts, p. 218.

LOUD SPEAKERS FOR USE IN THEATRES.—D. G. Blattner and L. G. Bostwick. (*Journ. Soc. Motion Picture Engineers*, Feb., 1930, Vol. 14, pp. 161-170.)

A general discussion of some of the inherent characteristics of the two types of loud speakers available for use in theatres, the horn type and the free radiator baffle type; the effects of these characteristics upon the requirements of theatre systems are illustrated.

DAS SCHALLFELD DER KREISFÖRMIGEN KOLBENMEMBRAN (The Acoustic Field of the Vibrating Circular Plate). [Application to Theory of Loud Speakers].—H. Backhaus. (*Ann. der Phys.*, 1st May, 1930, Series 5, Vol. 5, No. 1, pp. 1-35.)

Polar diagrams for the acoustic field for various

frequencies of a vibrating circular plate are obtained mathematically and compared with the results of experiments with plates of different radii.

LAUTSPRECHER GEALION ("Gealion" Loudspeaker).—A.E.G. Company. (*E.T.Z.*, 27th Feb., 1930, Vol. 51, pp. 336-337.)

The pivoting of the armature is designed to avoid non-linear distortion:—instead of the pivot being (as is usual) *above* the plane of the pole face, it is *below* it; as a result, the effective leverage decreases as the armature approaches the pole face. See also *AEG-Mitt.*, Sept., 1929, and April Abstracts, p. 233 (Kröncke).

IMPROVEMENTS IN CONE RECEIVERS AND REPRODUCERS OF SOUND. (French Pat. 673663, Goulier, pub. 17th Jan., 1930.)

The cone is held by being pulled (by way of the driving unit connected to its apex) against an outside annular support covered with an elastic material; or the ring may be inside, and the cone pressed against it.

THE APPROXIMATE NETWORKS OF ACOUSTIC FILTERS.—W. P. Mason. (*Bell Tech. Journ.*, April, 1930, Vol. 9, No. 2, pp. 332-340.)

Author's summary:—The approximate equivalent electrical networks of acoustic filters are developed in this paper, from the lumped-constant approximation networks for electric lines. In terms of this network, design formulæ have been developed for all single band pass filters. It is possible, from these formulæ, to determine the physical dimensions of an acoustic filter necessary to have a given attenuation and impedance characteristic.

GENERAL PRINCIPLES OF TRANSMISSION APPLIED TO WIRELESS TELEPHONY.—Le Corbeiller and Valensi. (See under "Transmission.")

ÜBER DIE GÜNSTIGSTE VERSTÄRKERFELDDAMPFUNG VON ZWEIDRAHTLEITUNGEN (On the Most Favourable Amplifier Field Attenuation in Two-Wire [Long-Distance Telephone] Circuits).—W. Weinitschke. (*E.N.T.*, April, 1930, Vol. 7, No. 4, pp. 141-146.)

ISOLIERUNG GEGEN SCHALL UND ERSCHÜTTERUNGEN (Insulating against Noise and Shock).—E. Zorn Company. (*E.T.Z.*, 6th March, 1930, Vol. 51, p. 371.)

A paragraph on various cork materials (Korfund, Korsil, Antivibrit, etc.) produced by this Company.

IMPROVING THE ACOUSTICS OF AN AUDITORIUM.—Wasson. (*Engineering News-Record*, 16th Jan., 1930.)

A short summary is given in *Génie Civil*, 24th May, 1930, Vol. 96, p. 519.

SOME INVESTIGATIONS INTO THE VELOCITY OF SOUND AT ULTRA-SONIC FREQUENCIES USING QUARTZ OSCILLATORS.—C. D. Reid. (*Phys. Review*, 1st April, 1930, Vol. 35, No. 7, pp. 814-831.)

ACTION CURRENTS IN THE AUDITORY NERVE IN RESPONSE TO ACOUSTICAL STIMULATION.—E. G. Wever and C. W. Bray. (*Proc. Nat. Ac. Sci.*, May, 1930, Vol. 16, pp. 344-350.)

A full account of the work referred to in May Abstracts, p. 283. "It may now be said that this present version of the Helmholtz theory can no longer be accepted; the theory must be subjected to further emendation or elaboration, or else be finally abandoned. . . the demonstration of a correspondence between stimulus-frequency and frequency of response, together with the discovery of a response-frequency in the nerve as high as 4,100 cycles per sec., makes more reasonable than ever before the outstanding rival of the Helmholtz hypothesis, the so-called telephone theory of audition." But it is possible for a high rate to be established by slowly acting fibres going off in volleys: further investigations are proceeding which may decide whether this occurs.

THE DEPRESSION AND ENHANCEMENT OF AUDITORY SENSITIVITY.—J. F. Allen. (*Phil. Mag.*, May, 1930, Ser. 7, Vol. 9, No. 59, Supplementary No., pp. 834-842.)

SOUND RELAYS AND MAGNIFIERS.—G. Laudet. (Summary in *Génie Civil*, 10th May, 1930, Vol. 96, pp. 460-461.)

Experiments with manometric flames led the writer to design acoustic energy relays depending on the combustion of gaseous mixtures, then to another design in which a 2 h.p. pump compressed air which escaped through a grid of 60 openings 6 mm. long and 0.15 mm. wide; this was covered by another (balanced) grid controlled by a phonograph needle, its movement being of the order of $\frac{1}{10}$ mm.

PHOTOTELEGRAPHY AND TELEVISION.

EIN VERFAHREN ZUR BILDUMKEHR BEI DER BILD-TELEGRAPHIE (A Method of Picture Reversal in Picture Telegraphy).—H. Lux. (*Zeitschr. f. tech. Phys.*, May, 1930, Vol. 11, No. 5, pp. 160-162.)

A method of obtaining a direct positive without the use of the second photoelectric cell which is needed for the usual "compensation" methods. It depends on the provision of an auxiliary ray of light at the transmitter, not controlled by the picture, of the same strength and same note-modulation as the scanning ray, but differing in phase by 180°. The easy application of the method to the ellipsoidal reflector scanning arrangement of Schröter (see past Abstracts), is shown.

1929 DEVELOPMENTS IN GERMANY.—Wagner. (See abstract under "Miscellaneous.")

LIGHT CONTROL BY INTERFERENCE BANDS REGULATED BY ELECTROSTRICTION.—(German Pat. 489659, Tonbild Synd., pub. 25th Jan., 1930.)

The position of the interference bands, produced by reflection at the front and back of a plane parallel transparent plate, depends on the angle of incidence and on the thickness of the plate. By

subjecting the plate to a varying electric field, this thickness can be varied by electrostriction; these variations, displacing the interference band, will control the amount of light passing through an aperture in a screen.

BRIDGE CIRCUIT FOR A PHOTOELECTRIC CELL SUPPLIED WITH A.C.—(German Patent 457902, Karolus, pub. 6th February, 1930.)

The modulated carrier wave is supplied by an a.c. generator, the photoelectric cell being in a bridge circuit containing a compensating capacity and two resistances.

LA CELLULE PHOTOÉLECTRIQUE ET SES APPLICATIONS (The Photoelectric Cell and its Applications).—L. Dunoyer. (*La Tech. Moderne*, 15th February, 1930, Vol. 22, pp. 137-144.)

ELECTRICAL AND OPTICAL BEHAVIOUR OF SEMI-CONDUCTORS.—Fleischmann. (See abstract under "Gen. Phys. Articles.")

ÜBER DEN LICHTELEKTRISCHEN EFFEKT BEI TROCKENGLEICHRICHTERN (On the Photoelectric Effect in Dry Rectifiers).—W. Graffunder. (*Physik. Zeitschr.*, 15th April, 1930, Vol. 31, No. 8, pp. 375-376.)

ÜBER EINEN NEUEN LICHTELEKTRISCHEN EFFEKT AN ALKALIZELLEN (On a New Photoelectric Effect with Alkali Cells).—E. Marx and A. E. H. Meyer. (*Physik. Zeitschr.*, 15th April, 1930, Vol. 31, No. 8, pp. 352-357.)

A more complete account of the effect described in January Abstracts, 1930, p. 51. See also below.

ON A NEW PHOTOELECTRIC EFFECT IN ALKALI CELLS.—E. Marx. (*Phys. Review*, May 1, 1930, Series 2, Vol. 35, No. 9, pp. 1059-1065.)

Author's abstract:—If two monochromatic beams fall simultaneously on an alkali electrode, a new photoelectric effect is shown as follows:—if the intensity of the high frequency light ν_1 is sufficient to establish the limiting potential corresponding to the Einstein law, the presence of any component of lower frequency ν_2 diminishes the potential according to the following equation

$$R = c(n_2/n_1) \cdot (\nu_1/\nu_2) (\nu_1 - \nu_2) h/e,$$

where R is the potential decrease and n_2/n_1 the ratio of the electronic emission of the two components, measured by the test cell itself. A tentative explanation of the phenomenon is advanced.

INFLUENCE OF ACCELERATING FIELDS ON THE PHOTOELECTRIC AND THERMIONIC WORK FUNCTION OF COMPOSITE SURFACES.—W. B. Nottingham. (*Phys. Review*, May 1st, 1930, Series 2, Vol. 35, No. 9, p. 1128.)

A preliminary account of experiments showing close relationships between the thermionic and photoelectric behaviour of thin films under the influence of accelerating potentials.

EIN EINFACHE UND EXAKTE METHODE ZUR MESSUNG DER GESCHWINDIGKEITSVERTEILUNG LICHT-ELEKTRISCHER ELEKTRONEN (A simple and Exact Method of Measuring the Velocity Distribution of Photo-Electrons).—R. Suhrmann and H. Theissing. (*Physik. Zeitschr.*, 15th April, 1930, Vol. 31, No. 8, p. 352.)

A proposal to use a compensation method with a string galvanometer for measuring current-voltage curves in the photoelectric effect.

APPARATUS FOR TESTING PHOTOELECTRIC CELLS IN SUNLIGHT.—J. Kunz and V. E. Shelford. (*Journ. Scient. Instr.*, June, 1930, Vol. 7, pp. 191-193.)

Consists essentially of a large light-tight box with the necessary adjustments, containing specially constructed rotating sector discs and a Macbeth illuminometer.

MEASUREMENTS AND STANDARDS.

RASCHET KOEFFICIENTOV VZAIMOINDUKCII (Calculations of Mutual Induction).—D. A. Vicker. (*Westnik Elektrotechniki*, Leningrad, January, 1930, Part 1, pp. 45-52.)

In Russian. It is shown that the calculation of the mutual inductance between two conductors of any geometrical form, and in any relative position, can be reduced to summing up the mutual inductances of pairs of "similar" configurations, i.e., of pairs of simple geometrical figures whose mutual inductance depends on the variation of one parameter only, such as the angle between two equal rectangles, the ratio of the diameters of two coaxial cylinders, etc. Curves showing the variation of mutual inductance for some of such configurations are given and the summation formulæ for the most common cases are derived.

RÈGLES À CALCUL ET ABAQUES POUR LA RÉOLUTION DE LA FORMULE DE M. LEVASSEUR (Slide Rules and Abacs for Applying the Levasseur [Resistance] Formula).—M. Mathieu. (*Rev. Gén. de l'Élec.*, 17th May, 1930, Vol. 27, pp. 763-766.)

Further development of the work referred to in July abstracts, p. 404.

FORMELN FÜR ZYLINDERKAPAZITÄTEN (Formulæ for the Capacity of Cylinders).—P. Mahlke. (*E.T.Z.*, 6th Feb., 1930, Vol. 51, p. 218.)

Summary only. New, simple formulæ are given for the calculation of the capacity of a cylinder to a plane and of two parallel cylinders.

SPANNUNGSMESSUNG BEI SCHNELLEN ELEKTROMAGNETISCHEN SCHWINGUNGEN MIT HILFE DES ELEKTRO-OPTISCHEN KERR EFFEKTES (Measurement of Voltage in Rapid Electromagnetic Oscillations by means of the Electro-optic Kerr Effect).—L. Pungs and H. Vogler. (*Physik. Zeitschr.*, 15th May, 1930, Vol. 31, No. 10, pp. 485-487.)

A short account of a method of voltage measurement for waves of length less than 100 m., based on the use of the electro-optic Kerr cell which was

chosen on account of its quickness of response to signals of the frequencies used. The basis of the measurements was the variation with mean field strength E_0 of the mean intensity L_m of the light passing through the analyser. The relation connecting L_m and E_0 is

$$L_m = \frac{L_0}{2} [1 - \cos \theta \cdot J_0(\theta)],$$

where L_0 is a constant depending among other things on the intensity of the light source used, $\theta = \pi B l \cdot E_0^2$ ($B =$ Kerr constant, $l =$ length of path) and J_0 is a Bessel function of zero order and real argument. To obtain unequivocal results it is therefore necessary to limit the readings to the region before the first maximum.

The (E_0, L_m) curve can be experimentally determined with frequencies low enough for instruments of known accuracy to be used. The light intensity is measured by a known subjective photometric method. This has certain disadvantages which are overcome by the use of a compensation arrangement.

Conditions for reliability of the method are (1) the Kerr effect must not depend on the frequency, (2) the two voltages to be compared must be approximately sinusoidal.

Condition (1) gives an upper limit to the frequencies which may be used. The method has been tested for voltages between 700 and 3,500 volts. See also v. Hámos, under "Miscellaneous."

ÜBER DIE MESSUNG KLEINER KAPAZITÄTSÄNDERUNGEN MITTELS UNGEDÄMPFTER ELEKTRISCHER SCHWINGUNGEN (On the Measurement of Small Alterations in Capacity by means of Undamped Electrical Oscillations).—K. Niemyer. (*Physik. Zeitschr.*, 1st May, 1930, Vol. 31, No. 9, pp. 451-456.)

The author has developed a valve oscillator in which the anode current is very sensitive to minute variations of capacity in the oscillating circuit.

MEASUREMENT OF VALVE PARAMETERS.—T. S. Rangachari. (*Electrotech.*, Bangalore, Feb., 1930, pp. 329-332.)

A modified form of the apparatus and procedure of the Miller a.c. bridge method for the direct measurement of amplification factor and plate-filament resistance. A greater degree of accuracy is obtained, since the modification makes a large number of determinations possible, for various values of the three bridge resistances. If there

are n sets of observations, $\frac{n(n-1)}{2}$ independent determinations are obtained for the same value of μ , and n for the same value of plate-filament resistance.

ON A NEW METHOD OF MEASUREMENT OF MINUTE ALTERNATING CURRENTS.—D. F. Martyn. (*Proc. Roy. Soc. Edin.*, 1930, Vol. 50, pt. 2, No. 12, pp. 166-174.)

Author's summary:—A highly sensitive method of measuring alternating currents of the order of microamperes and of any frequency is described. The current to be measured is passed through the filament of a diode valve. The main heating

current of this valve is supplied by an independent oscillator working at the frequency of the current under measurement. The change in the plate current of the valve is measured, thus indicating the amplitude of the alternating current being measured. Theoretical and practical details of the methods of working are given and particulars of the method by which the calibration was tested. It is suggested that the method is particularly applicable to the determination of electro-magnetic field strengths by measuring the currents induced in an aerial.

THE DEVELOPMENT OF A PRECISION AMMETER FOR VERY HIGH FREQUENCIES.—E. B. Moullin. (*Journ. I.E.E.*, May, 1930, Vol. 68, pp. 544-555.)

A description of the original ammeter, and the detailed analysis of the various correction factors, have already been given in a *Proc. Roy. Soc.* paper (1929 Abstracts, p. 49). Since then, considerable experience has been gained in the construction and use of the instrument, and the present paper deals chiefly with such recent developments, leading to the proposal of considerable changes.

The chief mechanical difficulty encountered was to provide supports for the moving cylinder which were heavy enough to carry the current and yet did not impose too great a control. The convenience of calibrating at, say, 500 p.p.s. has shown that a d.c. calibration is unnecessary and troublesome. The proposed new design therefore consists of one fixed cylinder eccentrically placed within a mobile screen tube; since all the current in the latter is induced in it by the field of the cylinder, no means are required for leading this current in and out. The advantages of the new design are many: e.g., a 20 A. instrument can now have an effective length of 10 cm. instead of 40 cm., and the correction for current distribution would then be only 1.7 per cent. at $\lambda = 2$ m.; moreover the inductance would be more than halved. The calibration would be independent of frequency between 100 cycles and 30,000 kilocycles per sec.

AN AMMETER FOR VERY HIGH FREQUENCIES.—C. L. Fortesque and L. A. Moxon. (*Journ. I.E.E.*, May, 1930, Vol. 68, pp. 556-559.)

Describing the theory and construction of a simple form of hot-wire ammeter for use at any frequency up to 100 megacycles per sec. See April Abstracts, p. 226.

THE MEASUREMENT OF THE MEAN VALUE OF A CURRENT.—G. W. Bowdler. (*Journ. Scient. Instr.*, May, 1930, Vol. 7, pp. 151-157.)

The determination of the mean value of an unsteady current has become very important, arising as it does in many measurements involving the use of thermionic valves and other types of a.c. rectifiers. The moving coil galvanometer designed by Campbell, in which the control is provided by a bifilar suspension, can give an accuracy of a few parts in 10,000; ordinary good galvanometers, one part in 1,000. When accuracy of the former order is desired, a null method is preferable. Two such methods are here described: a potentiometer method, and—for cases where

the current to be measured would be disturbed by the application of the potentiometer method—a differential galvanometer method. A comparison of measurements made simultaneously by the two methods is given; the current measured was the rectified current from a full-wave copper-oxide rectifier, for various frequencies from 0 to 4,000 p.p.s. The two sets of results agree to a few parts in 10^4 . A high-grade pointer type moving-coil milliammeter was also in the circuit: its behaviour led to the conclusion that "instruments of this type may be relied upon to integrate a current which is not steady, and which may contain components of audio-frequency, with an accuracy equal to that to which the deflection of the pointer may be read."

ALTERNATING-CURRENT POTENTIOMETERS AND THEIR APPLICATIONS.—C. V. DRYSDALE. (*Journ. I.E.E.*, March, 1930, Vol. 68, pp. 339-360: Discussion pp. 361-366.)

"An historical account of the evolution of the a.c. potentiometer is given, followed by descriptions of the Drysdale-Tinsley, Larsen, Gall, Pedersen, Campbell and other types of the instrument. The theory and accuracy of such instruments are discussed, and examples given of their application for various tests. . . . The a.c. potentiometer principle is also applicable for high-frequency measurements up to radio frequencies, and a valuable start in this direction has been made by Messrs. B. S. and F. D. Smith" [see 1929 Abstracts, pp. 160-161].

"A most valuable application . . . is the measurement of stray magnetic fields round the cables and busbars of switchboards, etc., and the author has employed it for investigating the magnetic field around submarine cables . . . in connection with the 'leader gear' . . ."

"Telephonic Measurements:— . . . By treating the receiver as an impedance and measuring that impedance with different frequencies up to and above its resonance frequency, we obtain its 'circle diagram' immediately, as the potentiometer gives the impedances directly as vectors; and the amount of electrical power put into the receiver and the proportion of it converted into mechanical power can be easily determined from this diagram. Repeating this test with the diaphragm prevented from vibrating by the use of wax, we find by difference the mechanical power imparted to the medium as sound. Conversely, the electrical output of a transmitter when excited by sound from a source fed from the a.c. supply can be measured. The whole performance of a receiver or transmitter over the audible range can be determined from the two sets of measurements obtained in this manner."

NOUVEAUX DISPOSITIFS DE MESURE DE COURANTS ALTERNATIFS AVEC APPAREILS A CADRE MOBILE ET AIMANT PERMANENT (New Arrangements for the Measurement of A.C. by Moving Coil Instruments with Permanent Magnets).—S. Held. (*Rev. Gén. de l'Élec.*, 22nd Feb. and 1st March, 1930, Vol. 27, pp. 277-284 and 317-324.)

A very full investigation of the new methods based on the dry plate rectifier.

A THERMIONIC VALVE POTENTIOMETER FOR AUDIO FREQUENCIES, SUITABLE FOR TESTS ON ARTIFICIAL LINES, ETC.—Stuart. (*See under "Acoustics."*)

A WIDE RANGE PORTABLE CAPACITY TEST SET.—W. H. F. Griffiths. (*Journ. Scient. Instr.*, June, 1930, Vol. 7, pp. 199-203.)

A range of 0.0003 $\mu\text{F.}$ to 1.0 $\mu\text{F.}$ is obtained on a single rotary scale without troublesome multiplying devices or range extensions. Scale reading accuracy is of the order of 2 per cent. from 0.0002 to 0.2 $\mu\text{F.}$, and below or above this may be 5 per cent., or perhaps 10 per cent. at the extreme ends of the scale.

TRANSVERSALSCHWINGENDE LEUCHTRESONATOREN ALS FREQUENZNORMALE IM BEREICH VON 1,000-20,000 HERTZ (Transversely Excited Glow Resonators as Frequency Standards for the Range 1,000-20,000 p.p.s.).—E. GIEBE and A. SCHEIBE. (*Zeitschr. f. hochf. Tech.*, May, 1930, Vol. 35, pp. 165-177.)

A full and authoritative account of the development of the quartz glow resonators described by Mögel (May Abstracts, p. 284). The method of fixing the rod at two nodal points is illustrated: the binding thread is twisted between the rod and the supporting metal bow so as to form a buffer preventing transference of the vibrations to the metal and thence to the glass supports and the container. The natural frequencies of the resonators were measured with an absolute accuracy of ± 5 millionths and remained constant within this limit during a year. The mean temperature coefficient between 0° and 20°C. varies from -7×10^{-6} for the lowest to -9×10^{-6} for the highest natural frequencies. The logarithmic decrement is of the order of 10^{-4} .

The resonators can also be excited longitudinally by changing the polarities of the four electrodes. But since the bindings are at the nodes for a transverse mode, and these are generally different from those for a longitudinal mode, the longitudinal vibrations (*i.e.*, extensions and contractions) are more or less impeded. Also the lengths and positions of the electrodes suitable for a transverse mode are not generally suitable for longitudinal modes. As a result, higher exciting potentials are needed for longitudinal excitation than in the case of resonators designed for this mode. Nevertheless, it is possible to use both modes: thus a transverse resonator for $f = 20,000$ p.p.s. ($k = 3$) will give a longitudinal harmonic ($k = 20$) of $f = 700,000$ p.p.s. The mean temperature coefficient of the longitudinal mode is only -1.5×10^{-6} between 0° and 20°C.

The temperature coefficient of the modulus of elasticity was found to be -10×10^{-6} . A section of the paper deals with the phenomenon of the intermittency of the glow, visible under certain conditions, and its cause.

PIEZO-CRYSTAL MOUNTINGS.—(French Pat. 667387, Florisson, pub. 16th October, 1929.)

A circular piezoelectric disc has its circumference bevelled so that the edge of the bevel lies in the nodal plane; the plate is held by three adjustable

holders with V-shaped grooves into which the bevelled edge fits. The surfaces of the disc are metallised, contact being made by light metallic springs or by two of the three holders.

PIEZO-CRYSTAL SUPPORTS MADE OF AMORPHOUS QUARTZ IN PLACE OF INVAR STEEL, ETC.—(German Pat. 490579, Siemens and Halske, pub. 30th Jan., 1930.)

Metal carriers of invar are not only expensive but are only serviceable for a limited temperature range. Here the quartz plates are cemented to a rectangular bar of amorphous quartz.

PAPERS ON THE NATURAL FREQUENCIES OF RODS CLAMPED AT ONE END.—Esau and Hempel (See under "Acoustics," and May Abstracts, p. 282.)

UN FREQUENZIOMETRO ETERODINA ED UN FREQUENZIOMETRO A LETTURA DIRETTA PER LA GAMMA DA 1 A 10,000 P/SEC. (A Heterodyne Frequency Meter and a Direct-reading Frequency Meter for the Range 1 to 10,000 p.p.s.)—F. Guarnaschelli and F. Uecchiacchi (*L'Elettrotec.*, 5th April, 1930, Vol. 17, pp. 224-229.)

COMPARISON OF RADIO-FREQUENCIES BY THE CATHODE-RAY OSCILLOGRAPH.—T. S. Rangachari. (*Elettrotec.*, Bangalore, Feb., 1930, pp. 274-279.)

A method is described which obtains the superposition of the two circular motions (Dye's "rotating ray" method of determining a radio-frequency in terms of a known low frequency) electrostatically instead of electromagnetically, without sacrificing independent adjustment of the two amplitudes. The looped patterns are analytically considered and a general law is derived which enables the quick determination of one frequency in terms of the other, whether their ratio be integral or fractional. The ground has already been covered in the writer's two papers in *E.W. & W.E.*, Vol. 5, p. 264 and Vol. 6, p. 184.

MISURE COMPARATIVE DI FREQUENZA (The Comparative Measurement of Frequency)—U. Ruelle. (*L'Elettrotec.*, 15th February, 1930, Vol. 17, pp. 110-112.)

A description of the international comparative tests (1929) of the frequency standards of the National Physical Laboratory, the Bureau of Standards, the Physikalisches-Technische Reichsanstalt, the Laboratoire National de Radioélectricité, and the University of Brussels.

EINIGE METHODEN ZUR FREQUENZMESSUNG VON KURZEN WELLEN (Some Methods of Short-Wave Frequency Measurement)—H. Mögel. (*E.N.T.*, April, 1930, Vol. 7, No. 4, pp. 133-140.)

A short description of the methods developed and the results obtained in short-wave frequency measurement at the Duplex-Reception lay-out of the Transradio A.-G. for wireless trans-oceanic communication in Gellow; the degree of accuracy

attained was 0.01 per cent. to 0.001 per cent. For abstract of a similar paper by the same writer, see May Abstracts, p. 284.

A CONSTANT TEMPERATURE DEVICE.—A. C. Eger-ton. (*Journ. Scient. Instr.*, May, 1930, Vol. 7, p. 172.)

A simple small constant-temperature bath (for thermocouple junctions, etc.) in which the outer vessel—after evacuation—is filled with mercury which acts as its own thermostatic liquid; the outer vessel is wound outside with a few turns of Nichrome wire, and lagged. The expansion of the mercury raises its level in an attached capillary tube and makes a platinum-point contact (enclosed in argon). The capillary tube is tapered so that the sensitiveness is adjustable.

NEW PIEZO OSCILLATIONS WITH QUARTZ CYLINDERS CUT ALONG THE OPTICAL AXIS.—A. Hund and R. B. Wright. (*Proc. Inst. Rad. Eng.*, May, 1930, Vol. 18, pp. 741-761.)
See July Abstracts, pp. 403-404.

THE PIEZO-ELECTRIC RESONATOR IN HIGH-FREQUENCY OSCILLATION CIRCUITS.—Y. Watanabe. (*Proc. Inst. Rad. Eng.*, May, 1930, Vol. 18, pp. 862-893.)

Parts II, III and IV of the paper referred to in July Abstracts, p. 404. Author's summary:—By 'piezo-electric coupler' is understood a piezo-electric resonator provided with two pairs of electrodes, by which, in the neighbourhood of a frequency of mechanical resonance, electrical energy may be transferred from one circuit to another. As the voltage transformation ratio between primary and secondary voltages is especially important in practice, this transformation ratio is investigated somewhat fully, and some experimental results are described. It is noted that this ratio must have a negative real component in order that the coupler may act as a regenerative linking device between anode and grid circuits of a tube oscillator.

"In the study of the effects of a crystal resonator on an electric circuit in which it is placed, the application of its motional admittance circle diagram has many advantages. Some theoretical applications are, for example, made in the present paper in considering the characteristics of a p.-e. oscillator and of a p.-e. frequency stabilizer. Representing the crystal resonator, which is an electro-mechanical vibrator, by an electrical circuit, we can obtain the conditions for the building-up of oscillations in a p.-e. oscillator. Three types of oscillators are treated here [regenerative coupling by (a) the p.-e. coupler, (b) the p.-e. resonator, and (c) anode-grid capacity].

"The effective frequency-stabilising action of a tube oscillator by means of a crystal resonator is considered from the point of view of the so-called 'Zieherscheinung' [pulling-into-tune effect] in the case of a tube oscillator containing coupled oscillation circuits."

FREQUENCY STABILISATION OF VALVE OSCILLATORS.—E. Mallett. (*Journ. I.E.E.*, May, 1930, Vol. 68, pp. 578-582.)

See April Abstracts, p. 222.

A CONSTANT FREQUENCY OSCILLATOR.—C. W. Miller and H. L. Andrews. (*Rev. of Scient. Instr.*, May, 1930, Vol. 1, pp. 267-276.)

In a tuned plate circuit operating with minimum coupling, the influence of the valve on frequency depends only on its plate resistance, and decreases as the plate resistance is increased. The steady drift in frequency usually observed is due mainly to the effect on the plate resistance of progressive changes in the filament. Owing to their rugged filaments, the UX852 and the screen-grid UX860 have been found particularly suitable for steady oscillators. The inner grid of the latter helps to steady the fluctuations in filament emission when connected to the filament through a battery and resistance:—increased emission increases the current through this circuit and reduces the grid potential; this diminishes the increase in plate current which would otherwise arise from the increased emission.

Another method found to be of great service in reducing the effects of filament changes was originally designed to compensate for changes in plate potential. This is the method (covered in U.S. Pat. 1438976, 1922, P. I. Wold) consisting in connecting a second valve in series, so that the same current i from the anode battery flows through both valves and a resistance R ; any increase in i increases the potential drop in R and makes the grid of the second valve more negative. This decreases the voltage across the first (oscillator) valve.

The apparatus used for the study of frequency changes is described: it includes an audio-frequency oscillator controlled by a stretched string, one end of which passes over a microphone button.

MEASUREMENT OF THE DIELECTRIC CONSTANT AND INDEX OF REFRACTION OF WATER AND AQUEOUS SOLUTIONS OF KCl AT HIGH FREQUENCIES.—F. H. Drake, G. W. Pierce and M. T. Dow. (*Phys. Review.*, 15th March, 1930, Vol. 35, No. 6, pp. 613-622.)

The method employed in these experiments consists in the measurement of standing electric waves between a pipe and a wire concentrically located within the pipe. The liquid is the dielectric between the wire and the pipe. The frequencies employed were accurately measured by a piezo crystal standardising a zero beat method, and corresponded to vacuum wave-lengths between 3.918 metres and 25.47 metres. The half wave-lengths within the dielectric were obtained by moving a piston in the liquid and observing reactions in the source.

A theoretical discussion of the method is given.

MEASUREMENTS OF THE DIELECTRIC CONSTANTS OF CONDUCTING MEDIA.—J. Wyman, Jr. (*Phys. Review.*, 15th March, 1930, Vol. 35, No. 6, pp. 623-634.)

Author's abstract:—It is possible to build small, rigid circuits which have natural periods determined by the medium in which they are immersed. If $T\gamma$, the product of the natural period of the circuit and the conductivity of the medium, is sufficiently small, this period is proportional to the square root of the dielectric constant of the latter. On the

basis of this fact, measurements have been made of the dielectric constant of water from 0° to 100°C. to an accuracy of 0.2 per cent. or better and covering a range of frequency from $T = 1.4 \times 10^{-8}$ to 81×10^{-8} . If $T\gamma$ is not sufficiently small, the period is affected by the conductivity of the medium in a complicated way and cannot be used to obtain the dielectric constant. With the smallest circuits used, measurements of the dielectric constants of liquids having conductivities as high as 100 times that of water can be made.

MEASUREMENT OF SMALL D.C. POTENTIALS AND CURRENTS IN HIGH RESISTANCE CIRCUITS BY USING VACUUM TUBES.—W. B. Nottingham. (*Journ. Franklin Inst.*, March, 1930, Vol. 209, No. 3, pp. 287-348.)

Author's abstract:—Part I. The grid current and plate current characteristics of three element vacuum tubes are described and the simple equations of the d.c. amplifier are developed with special attention given to the circuit for measuring photoelectric currents. The grid current characteristic is shown to play a very important part in the equations for sensitivity.

Part II. The second part deals with some common output circuits, namely, (1) the single tube circuit with an auxiliary battery to balance out the normal plate current; (2) the single tube bridge circuit; and (3) the two tube bridge circuit. Two "universal" shunts are described for controlling the galvanometer current. One of these is a "special shunt" which controls the sensitivity accurately and maintains the damping constant, while the other is the well-known Ayrton shunt. The disadvantages of using this shunt are discussed.

Part III. Complete circuits for the measurement of potentials and currents by direct deflection and null methods are discussed and some of the advantages and limitations of each are pointed out.

Part IV. Under this heading a few suggestions are given as to points of technical procedure.

A METHOD OF MEASURING THE OVERALL PERFORMANCE OF RADIO RECEIVERS.—H. A. Thomas. (*Journ. I.E.E.*, April, 1930, Vol. 68, pp. 475-490; Discussion, pp. 491-495.)
See April Abstracts, p. 226.

MEASUREMENT OF THE INTENSITY OF HIGH FREQUENCY MAGNETIC FIELDS.—R. H. Mortimore. (*Phys. Review*, 1st April, 1930, Series 2, Vol. 35, No. 7, pp. 753-762.)

THE VARIATION OF DIELECTRIC CONSTANT WITH TEMPERATURE. I. THE ELECTRIC MOMENTS OF THE CARBON BISULPHIDE AND NITROUS OXIDE MOLECULES.—C. H. Schwingel and J. W. Williams. (*Phys. Review*, 1st April, 1930, Vol. 35, No. 7, pp. 855-862.)

EINE HOCHSPANNUNGSBRÜCKE FÜR VERLUSTMESSUNGEN AN ISOLIERSTOFFEN (A High Voltage Bridge for Loss Measurements on Insulating Materials).—F. Beldi. (*Bull. Assoc. Suisse d'Élec.*, Vol. 21, No. 6, pp. 197-208.)

BRIDGE FOR THE MEASUREMENT OF DIELECTRIC LOSSES IN INSULATORS AND H.T. CONDENSERS.—E. Pugno-Vanoni. (*Elettrotec.*, 15th Jan., 1930, Vol. 17, pp. 37-41; summary in *Rev. Gén. de l'Élec.*, 26th April, 1930, Vol. 27, pp. 657-658.)

A method to replace the Schering bridge method, which has the objection that it needs a standard condenser which is liable to vary in its characteristics with atmospheric pressure. The new method is based on that used by Emanuelli for cables.

THE MEASUREMENT OF THE LOSS ANGLES OF DIELECTRICS IN TERMS OF FREQUENCY.—C. Chiodi. (*Rev. Gén. de l'Élec.*, 24th May, 1930, Vol. 27, pp. 815-818.)

Long summary of a paper in *L'Elettrotecnica*. For low frequencies the Schering bridge was used; for medium frequencies the same, also the Wien bridge and the Carey Foster method; for high frequencies (5,000 to 100,000 p.p.s.), after trying and rejecting a substitution method, the differential transformer method was adopted. From his results the writer concludes:—(a) for impregnated paper, the loss angle increases with the frequency; the increase is rapid for frequencies below 1,000 p.p.s. but slower for higher frequencies; these results contradict those found by other experimenters; (b) for mica, the loss angle decreases with [increase of] frequency. This applies to all samples tested, but for low frequencies the differences between different samples become far more marked. For mica condensers *in vacuo* the loss angle is almost inappreciable at all frequencies, and the anomalous charging and discharging currents can be considered to be zero. (c) For oil, the question is more complex since the loss angle depends not only on tension and frequency but also on the gap. But it has been shown that for a constant temperature it decreases with [increase of] frequency if the dielectric is homogeneous; if it is mixed, as in cables insulated with paper impregnated in oil, the angle increases—*vide* (a). (d) A homogeneous liquid dielectric deprived of impurities, at low temperatures and for a.c., presents only a very small loss angle while the electric field is below a certain limit. "This is probably due to ionisation phenomena in the dielectric and there is here a vast field for research."

For variable condensers in air, surprising results were obtained; commercial "radio" models, carefully made, gave very small loss angles, while a very good laboratory model gave a considerable angle which increased with the frequency. Apart from this last result, which requires checking, all the writer's results lead to the conclusion that in a homogeneous dielectric the loss angle δ is given by an expression which, for mica and oil, is of the form $\delta = \frac{k}{f^m}$, m being between 0 and 1. Assuming the temperature and tension to be constant, the power lost may be written very nearly accurately as $P = 2\pi CV^2 f \tan \delta = k'f\delta$, which gives, from the above relation, $P = k''f^{1-m}$. It thus always increases with the frequency, since $m < 1$.

Practical conclusions are:—the best type of condenser is the mica *in vacuo* type; for high

frequencies a standard may be provided by a good mica or oil condenser, without troubling about loss angle, which is absolutely negligible; for medium and low frequencies, on the other hand, it is best to use a condenser in oil (carefully freed from water) on condition that the ratio between effective applied tension (in volts) to distance between plates (in mm.) is not more than a value which can be fixed in practice at 100. See also Benedict, under "Subsid. App."

SUBSIDIARY APPARATUS AND MATERIALS.

OSCILLOGRAPHÉ CATHODIQUE TRANSPORTABLE, À DÉVELOPPEMENT SYNCHRONISÉ (C.-R. Oscillograph, Portable, with Synchronised Development).—Demontvignier and Touly. (*Bull. d. l. Soc. franç. d. Élec.*, May, 1930, Vol. 10, pp. 506-544.)

An equipment using a "Western" oscillograph, a time base of the "saw-tooth" form being provided by a combination of a diode, an argon discharge tube, and their associated circuits. Standing curves of frequencies up to 240,000 p.p.s. are given as examples of the work of this equipment.

The circuits can be modified so that recurrent transitory phenomena can be observed; thus oscillograms are given of the free oscillations of the windings of an amplifier transformer. A second argon tube is here used to excite the oscillations—4,000 p.p.s. for the secondary and 80,000 p.p.s. for the primary winding. For the study of an oscillatory circuit in free oscillation at 630 p.p.s., an arc relay with a control electrode is used.

SURGE-CONTROLLED C.-R. OSCILLOGRAPH.—H. Norinder. (See Abstract under "Atmos. and Atmos. Elec.")

THE MARCONI LOW VOLTAGE CATHODE RAY EQUIPMENT, AND ITS APPLICATION TO THE MEASUREMENT AND EXAMINATION OF THE MODULATION AND LINEARITY OF BROADCAST TRANSMITTERS.—O. S. Puckle. (*Marconi Review*, April, 1930, pp. 12-23.)

(1) The c.-r. tube unit. The tube itself is the low-voltage tube made by Standard Telephones and Cables, Ltd. Visual observation is employed, the light-proof container box being fitted with an eye-piece and a measuring device (two movable horizontal arms with their adjacent edges parallel each of which can be adjusted vertically). (2) Time base unit: a neon tube, a variable capacity, and a variable resistance in the form of a special diode "designed to obtain very smooth impedance control"—in the diagram it is shown as a triode with grid and plate joined. (3) Rectifier unit and protected pick-up coil, phase corrector and chokes, for measurement purposes.

The procedure is described for (a) examining the modulated output wave of a transmitter; (b) measurement of percentage modulation; (c) detection of lack of linearity; and (d) examination of wave form.

BETRIEBS-DIAGRAMME FÜR SYMMETRISCHE KETTENLEITER (Diagrams for the Computation of Artificial Lines).—Y. Watanabe. (*E.N.T.*, April, 1930, Vol. 7, No. 4, pp. 153-166.)

AN INSTRUMENT FOR PROJECTING AND RECORDING THE RESPONSE CURVES OF ELECTRICAL CIRCUITS.—C. L. Fortescue and F. Ralph. (*Journ. I.E.E.*, May, 1930, Vol. 68, pp. 583-586.) See April Abstracts, p. 228.

IL CLIDONOGRFO NELLA MISURA DELLA FRONTE D'ONDA DEGLI IMPULSI APERIODICI (The Klydonograph in the Measurement of the Wave Front of Aperiodic Impulses).—G. Someda. (*L'Elettrotec.*, 15th March, 1930, Vol. 17, pp. 173-176.)

FREQUENZTRANSFORMIERUNG MITTELS WECHSELSTROMMAGNETISIRTER DROSSELN (Frequency Transformation by A.C.-Magnetised Iron-cored Inductances).—K. Schmidt. (*E.T.Z.*, 22nd May, 1930, Vol. 51, pp. 729-732.)

The writer begins by distinguishing between his system of frequency multiplication, which is embodied in the h.f. generators of the C. Lorenz Company, and the ordinary magnetic (saturated iron) frequency-doublers. The latter merely function by a sifting-out of the harmonics from a distorted wave-form, whereas the writer's frequency-multiplication is a matter of shock-excitation. The fundamental conditions of his method are (i) that the frequency transformer should be so designed as to have very high iron induction, so that it may be worked in the region of unstable resonance ("Kippresonanz"), and (ii) that it should be so loosely coupled with the h.f. generator that it can build up its voltage curve freely and thus become an independent generator.

The second half of the paper deals with the difficulties in the design of suitable transformers, the development of the "shell" (iron-clad) transformer out of the original core transformer, and the designs of the most successful types. These are illustrated, and include transformers for multiplication up to 250 kilocycles per sec. and up to 1 megacycle per second. Efficiencies are of the order of 80-90% for a 10/90 kc. transformation and 60-70% for a 90/810 kc. transformation in two stages of 9 each [the wording here is ambiguous].

Examples are mentioned of sets already in use in Germany, ranging from 1 kw. aerial power on 900 m., through 12 kw. at 536 m. (Munich broadcasting station) to 50 kw. at 8,700 m. Comparing such sets with valve transmitters, the writer claims superiority for them for aerial powers from 10 kw. upwards on wavelengths above about 300 m.

AUTOMATIC VOLTAGE REGULATOR. (French Pat. 674354, Toulon, pub. 28th Jan., 1930.)

For a summary of this patent, based on the use of a neon tube as described in the inventor's paper (see 1929 Abstracts, pp. 583-584), see *Rev. Gén. de l'Élec.*, 29th March, 1930, Vol. 27, p. 116D. See also below.

SELBSTTÄTIGER SPANNUNGSREGLER (Automatic Voltage Regulator).—P. Toulon. (*E.T.Z.*, 6th Feb., 1930, Vol. 51, pp. 213-214.)

German summary of the French article dealt with in 1929 Abstracts, pp. 583-584. See also above.

A CONSTANT E.M.F. DEVICE.—A. C. Egerton and J. M. Mullaby. (*Journ. Scient. Instr.*, June, 1930, Vol. 7, pp. 203-204.)

A thermoelement arrangement to take the place of cells for balancing against various e.m.f.s over long periods of time.

AUTOMATIC NEUTRALIZATION OF THE VARIABLE GRID BIAS IN A DIRECT CURRENT FEED-BACK AMPLIFIER.—P. B. Carwile and F. A. Scott. (*Review Scient. Instr.*, April, 1930, Vol. 1, pp. 203-206.)

Continuing the work on this subject (see 1929 Abstracts, p. 570, and January Abstracts, p. 38), the paper now deals with the difficulty encountered with a simple amplifying circuit of this nature, that it is necessary to re-adjust the input grid bias each time the amplification is changed. It shows how this necessity can be abolished by the introduction of an auxiliary battery, a potentiometer, and a galvanometer.

EXACT COMPENSATION FOR THE EFFECT OF A AND B BATTERY CHANGES WHEN USING THE VACUUM TUBE AS A DC AMPLIFIER.—R. C. Dearle and L. A. Matheson. (*Review Scient. Instr.*, April, 1930, Vol. 1, pp. 215-226.)

Changes in the anode battery voltage of a resistance-coupled circuit are compensated for by shunting that battery by a high resistance potentiometer, whose slider is connected (through a bias battery when necessary) to the grid. Changes in the filament battery voltage are compensated for by a method depending on the fact that a change in filament current changes the grid potential relative to the filament, so that if the grid is connected to the negative end of the latter an increase in filament current causes a decrease in plate current. By inserting a compensating resistance R' in the negative filament lead, and connecting the grid return between R' and the filament rheostat, by a suitable choice of R' exact compensation can be obtained.

A HIGH RESISTANCE LEAK FOR ELECTROMETER USE.—A. K. Brewer. (*Review Scient. Instr.*, June, 1930, Vol. 1, pp. 325-328.)

After discussing the defects of various types of resistances of the order of 10^{10} to 11^{12} ohms, including the radioactive, liquid, and India ink or pencil line on paper, the writer describes the construction of a leak consisting of a lead pencil line on a polished amber rod; it "possesses none of the disadvantages enumerated above, and according to extensive tests . . . fulfils every demand for a satisfactory high resistance." The total resistance varies only 5% between room and liquid air temperatures, and remains practically constant for months.

A VARIABLE CAPACITIVE COUPLING CAPABLE OF REDUCTION TO ZERO.—L. Bainbridge-Bell. (*Journ. Scient. Instr.*, May, 1930, Vol. 7, pp. 162-164.)

An arrangement is described in which the capacitive coupling between two parts of a circuit

can be varied continuously down to a zero value by the use of a moving metallic screen. Suggestions for possible applications of the arrangement are put forward:—for neutralising the inter-electrode capacity of screened valves: as a variable attenuator.

THE PHOTOELECTRIC EFFECT IN DRY-PLATE RECTIFIERS.—Graffunder. (See under "Phototelegraphy and Television.")

ALCUNE RICERCHE SULLA PORCELLANA DA ISOLATORI (Some Researches on Insulator Porcelain).—G. Cossio. (*L'Elettrotec.*, 5th June, 1930. Vol. 17, pp. 373-376.)

BEHAVIOUR OF DIELECTRICS: A STUDY OF THE ANOMALOUS CHARGING CURRENT AND THE VARIATION OF DIELECTRIC ENERGY LOSS AND CAPACITANCE WITH FREQUENCY IN SOLID DIELECTRICS.—R. R. Benedict. (*Journ. Am.I.E.E.*, March, 1930, Vol. 49, pp. 221-224.)

THE MEASUREMENT OF THE LOSS ANGLES OF DIELECTRICS IN TERMS OF FREQUENCY.—Chiodi. (See under "Meas. and Stds.")

THE MANUFACTURE AND TESTING OF ELECTRICAL INSULATORS.—Steatite and Porcelain Products, Ltd. (*Engineer*, 16th May, 1930, Vol. 149, pp. 544-546 and 548.)

THE CONDUCTIVITY OF INSULATING OILS.—J. B. Whitehead and R. H. Marvin. (*Journ. Am.I.E.E.*, March, 1930, Vol. 49, pp. 182-186.)

WICKELKONDENSATOREN (Roll Type Condensers).—Nesper. (*E.T.Z.*, 27th March, 1930, Vol. 51, pp. 475-476.)

The writer emphasises the renewed importance of this type of condenser for broadcast receivers, particularly now that so many of these are mains-driven. He goes on to describe the higher requirements now demanded and the way in which they are met.

SOME TESTS ON "NON-TEMPERATURE COEFFICIENT" PAPER CONDENSERS.—D. C. Gall. (*Journ. Scient. Instr.*, May, 1930, Vol. 7, pp. 157-162.)

Contrary to general belief, the addition of resin to paraffin wax used for paper condenser impregnation was found to give no improvement in the temperature coefficient. But it produced a temporary "reflex" phenomenon in the dielectric losses during temperature changes, the losses increasing with great rapidity to a relatively high value, with either a rise or fall of temperature, finally settling down to a value very near that of the pure wax condenser.

MANUFACTURE AND PROPERTIES OF A CELLULOSE PRODUCT (MAIZOLITH) FROM CORNSTALKS AND CORNCOBS.—C. E. Hartford. (*Bur. of Sids. Miscell. Pub.* No. 108, 20th March, 1930, 10 pp.)

Maizolith is a dense, hard, bonelike material, somewhat heavier and stronger than the hardwoods,

and a good electrical insulator; its properties coincide closely with those of vulcanised fibre, to which it is chemically similar. It could probably be made at a lower figure than \$240 per ton.

SOME THERMOSTATIC PROPERTIES AND APPLICATIONS OF BIMETALLIC STRIPS.—J. K. Catterson-Smith. (*Electrotech.*, Bangalore, Feb., 1930, pp. 246-257.)

Bimetallic strips cut from commercial "thermostatic metal" are of the order of 20 mils in thickness and are sluggish in their response to heating—which is advantageous for time-lag apparatus. The writer, however, has succeeded in reducing the thickness to 2 or 3 mils (and even to 0.5 mil); the sluggishness decreases enormously, the sensitivity is greatly increased, and new possibilities are opened out.

As a sensitive thermostat, 3 mil strip will open or close a contact for a temperature change of 0.25° F. or less. "Hot-strip" ammeters have the advantage of great overload capacity. A "hot-strip" galvanometer with a 5-inch suspension would give about 1 degree deflection per milliampère—a useful sensitivity for high-frequency measurements. A 4 mil strip was used to form a novel type of heat motor.

STATIONS, DESIGN AND OPERATION.

A WIRELESS BROADCASTING TRANSMITTING STATION FOR DUAL-PROGRAMME SERVICE.—P. P. Eckersley and N. Ashbridge. (*E.W. & W.E.*, June, 1930, Vol. 7, pp. 324-327.)

Abstract of the I.E.E. (Wireless Section) paper, dealing with the Brookmans Park Station.

OM SYNKRONDRIFT AV RUNDRADIOSTATIONER (Synchronised Operation of Broadcasting Stations).—E. Esping. (*Teknisk Tidsk.*, 7th June, 1930, Vol. 60, pp. 109-112.)

TRANSOCEANIC TELEPHONE SERVICE—SHORT-WAVE EQUIPMENT.—A. A. Oswald. (*Bell Tech. Journ.*, April, 1930, Vol. 9, No. 2, pp. 270-289.)

Author's summary:—The application of short-wave radio transmission to transoceanic telephone circuits is developing apparatus and stations designed specifically to meet the needs of these services. This paper describes from the radio point of view the important technical features and developments incorporated in the new transmitting and receiving stations of the American Telephone and Telegraph Company, located respectively at Lawrenceville and Netcong, New Jersey, and it outlines some of the radio problems encountered in the station design. An abridgment of this paper was referred to in July Abstracts, p. 410.

SHORT WAVE COMMUNICATION INSIDE GERMANY: CHOICE OF WAVES.—Wagner. (See abstract under "Miscellaneous.")

GROSSRUNDFUNKSENDER (High Power Broadcasting Stations).—(*E.T.Z.*, 22nd May, 1930, Vol. 51, pp. 747-748.)

A list of some 46 European stations, with their aerial powers and wavelengths. Lists are also

given showing the number of licensed listeners in the various countries at the beginning of 1930; also the numbers in Germany and in the whole of the rest of Europe for each of the last eight years.

L'APPLICATION DE LA T.S.F. À BORD DES AVIONS, NOTAMMENT EN ALLEMAGNE (The Use of Wireless on Aircraft, particularly in Germany).—(*Génie Civil*, 31st May, 1930, Vol. 96, pp. 532-534.)

An article based on the Eisner-Fassbender paper, German and English versions of which have been dealt with in April and March Abstracts, pp. 230 and 174.

DER GEGENWÄRTIGE STAND DER TECHNIK UND DER BETRIEBSORGANISATION DES DEUTSCHEN FLUGFUNKWESENS (The Present Position of Technique and Service Organisation of German Aircraft Wireless).—F. Eisner and H. Fassbender. (*E.T.Z.*, 6th Feb., 1930, Vol. 51, pp. 201-206.)

Second and final part of the paper dealt with in April Abstracts, p. 230.

ZEITZEICHEN (Time Signals).—(*E.T.Z.*, 13th Feb., 1930, Vol. 51, p. 253.)

Details of the German time signals under the new arrangements.

DER DRAHTLOSE ZEITZEICHENDIENST (The Wireless Time Service).—F. Runkel. (*Zeitschr. f. tech. Phys.*, May, 1930, Vol. 11, No. 5, pp. 166-168.)

GENERAL PHYSICAL ARTICLES.

THE CONDUCTIVITY OF A HIGH FREQUENCY DISCHARGE IN HYDROGEN.—C. J. Brasefield. (*Phys. Review*, 1st May, 1930, Series 2, Vol. 35, No. 9, pp. 1073-1079.)

Author's abstract:—Measurements were made of the voltage between electrodes necessary to produce a current of 100 milliamperes in the discharge for gas pressures between 0.005 mm. and 1 mm. and for frequencies of oscillation between 1.25 and 20 million cycles/sec. (wavelengths between 240 and 15 metres). It was found that the discharge has its maximum conductivity when operated at a frequency of 15 megacycles (20 metres) and a pressure of 0.015 mm. A theory of the mechanism of the high frequency discharge indicates that, under these conditions, an electron makes an inelastic collision with a gas molecule every electronic mean free path, having been under the influence of the electric force for one half cycle. The theory also indicates that for any frequency of oscillation greater than 15 megacycles, both the electric force and the gas pressure for which the conductivity is a maximum will increase directly with the frequency of oscillation.

THEORETICAL CALCULATION OF ELECTRIC FIELD CAUSED BY PLANE OR CURVED ELECTRODES.—Y. Miyamoto. (*Journ. I.E.E., of Japan*, Supp. Issue, Nos. 486-487, pp. 14-20.)

In English. The electric fields produced by two semi-infinite curved plates, with or without

thickness, placed symmetrically face to face, and by semi-infinite flat plates with some thickness placed parallel to each other, are discussed mathematically by the use of the Schwarz-Cristoffel transformation.

THE INFLUENCE OF TEMPERATURE ON POLARISATION CAPACITY AND RESISTANCE.—E. E. Zimmerman. (*Phys. Review*, 1st Mar., 1930, Series 2, Vol. 35, No. 5, pp. 543-553.)

The temperature coefficients of polarisation capacity and resistance have been determined for gold and plain platinum electrodes in 0.63, 1.50 and 2.42 *N* solutions of sulphuric acid and also at different frequencies for 1.46 *N* concentration. Values of the angle of phase difference have been computed for the various conditions under which measurements were made.

THE POTENTIAL FALL BETWEEN STRIÆ IN ELECTRICAL DISCHARGES THROUGH RARIFIED HYDROGEN.—J. Zeleny. (*Journ. Franklin Inst.*, May, 1930, Vol. 209, No. 5, pp. 625-638.)

ON THE POTENTIAL RELATIONS IN THE STRIATED POSITIVE COLUMN OF ELECTRICAL DISCHARGES THROUGH HYDROGEN.—J. Zeleny. (*Phys. Review*, 1st April, 1930, Series 2, Vol. 35, No. 7, pp. 699-704.)

PLASMOIDAL HIGH-FREQUENCY OSCILLATORY DISCHARGES IN "NON-CONDUCTING" VACUA.—R. W. Wood. (*Phys. Review*, 1st April, 1930, Series 2, Vol. 35, No. 7, pp. 673-693.)

A full account of the phenomena of which a preliminary description was given in the summary referred to in April Abstracts, 1930, p. 231.

DER ELEKTRISCHE DURCHSCHLAG VON LUFT ZWISCHEN KONZENTRISCHEN ZYLINDERN (The Electrical Breakdown of Air between Concentric Cylinders).—E. Uhlmann. (*Archiv. f. Elektrol.*, 18th Jan., 1930, Vol. 23, No. 3, pp. 323-350.)

ABSORPTION OF RESONANCE RADIATION IN MERCURY VAPOR.—A. R. Thomas. (*Phys. Review*, 15th May, 1930, Series 2, Vol. 35, No. 10, pp. 1253-1261.)

LE PRINCIPE DE LA MOINDRE ACTION ET LE GRAVITATION (The Principle of Least Action and Gravitation).—G. Maneff. (*Comptes Rendus*, 23rd April, 1930, Vol. 190, pp. 963-965.)

THE ELECTRON AND RADIATION.—R. D. Kleeman. (*Science*, 28th March, 1930, Vol. 71, pp. 340-341.)

Another argument in support of the writer's thermodynamically derived ideas of electron properties—see 1929 Abstracts, p. 400.

THE MOBILITY OF IONS IN AIR.—J. L. Hamshere. (*Proc. Roy. Soc.*, May, 1930, Series A, Vol. 127, No. A805, pp. 298-314.)

The experimental method for measuring gas ion mobilities, described in a previous paper (1929

Abstracts, p. 567) has been improved in accuracy and resolving power, and applied to examine the effect of water vapour, methyl alcohol, and ethyl ether, on positive and negative ion mobilities in air.

An attempt is made to interpret the results in the light of a modified cluster theory.

ÜBER POLARISIERTE ELEKTRONENWELLEN (On Polarised Electron Waves).—E. Fues and H. Hellmann. (*Physik. Zeitschr.*, 15th May, 1930, Vol. 31, No. 10, pp. 465-478.)

ÜBER DIE BEWEGLICHKEIT VON IONEN IN IONENSTRAHLEN (On the Mobility of Ions in Ionic Rays).—W. Froberg. (*Ann. der Phys.*, 1st May, 1930, Series 5, Vol. 5, No. 1, pp. 59-72.)

ELEKTRISCHES UND OPTISCHES VERHALTEN VON HALBLEITERN. II.—ÄUSSERE LICHTELEKTRISCHE WIRKUNG AN HALBLEITERN (Electrical and Optical Behaviour of Semi-Conductors. II.—Photoelectric Effect of External Sources on Semi-Conductors).—R. Fleischmann. (*Ann. der Phys.*, 1st May, 1930, Series 5, Vol. 5, No. 1, pp. 73-106.)

MISCELLANEOUS.

A METHOD OF INVESTIGATING THE HIGHER ATMOSPHERE.—E. H. Syngé. (*Phil. Mag.*, May, 1930, Series 7, Vol. 9, pp. 1014-1020.)

A suggestion for a method of determining certain properties and variations of the upper atmosphere, as far as a density from 10^{-3} to 10^{-4} that at sea-level. The method depends in principle on the scattering of light by the molecules of a gas and the detection and measurement of the scattered light by photoelectric apparatus. A large number of search-lights are to be concentrated upon the same region in the upper atmosphere.

FORTSCHRITTE DES ELEKTRISCHEN NACHRICHTENWESENS IM JAHRE 1929 (Progress in Electrical Communication in 1929).—K. W. Wagner. (*E.N.T.*, March, 1930, Vol. 7, pp. 119-129.)

In Section III the writer deals with interference between power and communication currents. Among other points, measurements of the mutual induction between two lines with earth return have shown good agreement with the Pollaczek-Carson theory, provided a simple empirical law is used to allow for the variation of earth resistance with the frequency. Section IV deals with Wireless. Eilvese is out of action, since "the technical improvements obtained with short-waves make the running of this long-wave station appear no longer profitable." In short-wave work, the power on the shortest (15 m.) wave can be as much as 40 kw. A year's tests on short-wave telephony inside Germany showed that the best waves were under 40 m. for day and over 70 m. for night communication, but that a reliable 24-hours' service could not be guaranteed with two fixed wavelengths. Short wave duplex telephony on small powers can be

obtained on a common aerial for a wavelength difference of 10 per cent.

Weather chart picture-telegraphy to ships at sea uses chiefly the chemical method of recording; a new paper has been developed which will stand exposure to light and gives a recording speed of 50 cm. per sec. In television, new glow-discharge lamps have been developed, especially a high-frequency argon-mercury filled type. "Daylight" scanning is mentioned, in which the image of the whole subject is projected on to the Nipkow disc. Standardisation is outlined. Broadcasting:—The tendency has been towards fewer and more powerful stations and high aerials. 100 kw. transmitters are not yet out of the experimental stage. The Munich station has been successful in devising modulation methods to eliminate fading distortion due to frequency changes produced by phase displacement. Mobile short-wave sets are now used for communicating news items to broadcasting stations.

Wave propagation: systematic broadcast absorption measurements inside Germany show that even the greatest field strengths lag behind what would be expected for loss-free propagation according to Hertz' formula.

Atmospherics:—During measurements on the new Emden-Vigo cable, simultaneous records were taken of disturbances in the cable and in a wireless receiver. "It was found that on short radio waves only a few disturbances coincided, but on the longer waves almost all atmospherics were observed also in the cable."

Ultra-short waves:—The first application of practical 3-4 m. sets has been to goods trains, to communicate from front to rear. In larger ultra-short-wave sets a separate drive is used for the sake of perfect modulation. On waves under 1 m. intensive work has been done: spark and valve transmitters have been built, the latter up to 100 w. power on a 50 cm. wave. In addition to the several successful ordinary modulation methods available, tests with *multiple* modulation have been carried out. The first tests on reliable over-sea ranges [of waves under 1 m. ?] have been arranged. Attempts to utilise the infra-red rays for communication are "interesting."

ИНДУКТИРУЕМЫЕ ЭЛЕКТРОМАГНИТНЫЕ ВОЛНЫ НА ПРОВОДАХ СВЯЗИ—УСТАНОВИВШИИСЯ РЕЖИМ (The Distribution of Current and Potential in a Transmission Line subject to Induction—Steady State).—V. I. Kovalenkov. (*Westnik Elektrotechniki*, Leningrad, January, 1930, Part I, pp. 31-39.)

In Russian. A method is given for calculating the distribution of current and potential in a transmission line in a portion of which a definite electromotive force is induced. Two cases are considered (a) when the line is infinite, *i.e.*, when each element of the line is subject to current and voltage waves travelling in one direction only, and (b) when the line is finite, *i.e.*, when each element of the line is subject to both direct and reflected waves. The values of the potential and current at each point of the line are found by summing up those which would be produced by separate waves originating in the various elements of the line.

CHEMICAL STUDIES OF SYNTHETIC GALENA AS A RADIODETECTOR.—W. Ogawa. (*World Engineering Congress Abstracts*, 1929, Paper 30.)

The writer's analogy between crystal detectors and a thermionic valve has been dealt with in 1928 Abstracts, p. 527, and his work on the effect of chemical composition on the sensitivity of synthetic galena was referred to on p. 693. The paper now abstracted deals with these researches. The following points are made:—"High specific resistance of the crystal and smallness of true contact area hinder the metallic conduction through the true contact points. This difficulty of metallic conduction gives rise to the electron emissions from the electrode surfaces adjacent to the true contact points.

"Rectification is caused by the difference of numbers of electrons emitted from each electrode, crystals and metallic needles inclusive, by alternating electrical impulse. The possibility of rectification by the electron emissions from different substances in the cold state was proved experimentally by the valve and oscillograph methods. The order of metals and crystals with respect to the ease of electron emission was also determined by the same methods under various conditions and was proved to correspond to the order in the rectification series of the crystal detector."

In conclusion, the writer applies his theory to explain the mechanism of dry-plate, colloidal and electrolytic rectifiers, etc. "The complicated explanations for them hitherto tried by many investigators are simplified."

ÜBER DETEKTOREN (On Detectors).—J. Vrede. (*Physik. Zeitschr.*, 1st April, 1930, Vol. 31, No. 7, pp. 323-332.)

An investigation of the rectifying properties of lead sulphide and other manufactured chemicals. The rectifying action seems largely to depend on the presence of impurities in the substances investigated.

STRUCTURE AND NATURE OF TROOSTITE.—F. F. Lucas. (*Bell Tech. Journ.*, Jan., 1930, Vol. 9, No. 1, pp. 101-120.)

ÜBER DIE ELEKTRISCHEN EIGENSCHAFTEN DES BLEIGLANZKRISTALLES (On the Electrical Properties of the Galena Crystal).—F. Regler. (*Physik. Zeitschr.*, 15th Feb., 1930, Vol. 31, No. 4, pp. 168-172.)

A PROPOSITO DI UN SUPPOSTO EFFETTO DEI RAGGI X NEI RADDRIZZATORI A CRISTALLO (On a Supposed Effect of X-Rays on Crystal Rectification).—S. Oberto. (*Lincei Rend.*, No. 1/2, Vol. 10, 1929, pp. 89-92; summary in *Nature*, 30th Nov., 1929, Vol. 124, p. 862.)

Referring to Jackson's work (1929 Abstracts, p. 403) the writer describes repetitions which he has made (on copper oxide rectifiers and galena detectors) in which he also obtained effects which were, however, ultimately traced to coherer action produced by spark discharges.

AUFZEICHNUNG SCHNELLER SCHWINGUNGEN (The Recording of Rapid Vibrations [Ultra-Micrometer]).—H. Thoma. (*E.T.Z.*, 3rd April, 1930, Vol. 51, p. 510.)

See Jan. Abstracts, p. 56. A summary of the same *Ztschr. V.D.I.* article.

APPLICATION OF THE PHOTOELECTRIC CELL TO THE MEASUREMENT OF SMALL DISPLACEMENTS.—J. A. C. Teegan and K. G. Krishnan. (*Phil. Mag.*, April, 1930, Vol. 9, No. 58, pp. 589-592.)

THE MEASUREMENT OF SMALL CHANGES OF CAPACITY: AN ULTRA-SENSITIVE CIRCUIT.—Niemeyer. (See abstract under "Measurements and Standards.")

NEUE ANWENDUNGEN DES ELEKTRISCHEN MIKROMETERS (New Applications of the Electrical Micrometer).—A. V. Mershon. (*E.T.Z.*, 6th Feb., 1930, Vol. 51, pp. 214-215.)

German summary of a 1928 *Gen. Elec. Review* paper. Movements as small as 0.00025 mm., and as rapid as desired, are recorded on an oscillograph by means of an a.c. bridge including two iron-cored coils, the air-gap of one of which is altered by the movement in question. Applications include the study of the water pressure in the suction pipe of a turbine, and of the vibrations of its rotor.

ELEKTRISCHER GESCHWINDIGKEITSMESSER FÜR FLÜSSIGKEITEN (Electric Velocity Meter for Liquids).—(*E.T.Z.*, 17th October, 1929, Vol. 50, p. 1514.)

Description and illustration of a commercial form of the Dupin meter (1929 Abstracts, p. 286).

WIRELESS TELEPHONY AND DIRECTION FINDING IN THE FAR SOUTH [IN THE WHALING INDUSTRY].—(*Marconi Review*, December, 1929 and January, 1930.)

WIDERSTAND DES MENSCHLICHEN KÖRPERS BEI HOCHFREQUENTEN ELEKTRISCHEN STRÖMEN (The Resistance of the Human Body for H.F. Electric Currents).—N. N. Malov and S. N. Rschewkin. (*Zeitschr. f. hochf. Tech.*, May, 1930, Vol. 35, pp. 177-191.)

German version of the Russian paper referred to in July Abstracts, p. 413. Among the many conclusions reached the following may be mentioned:—(a) "There has recently been a tendency, based on D'Arsonval's work, to construct new theories as to the thermal effects of h.f. currents passing through the body. We think that our results suffice to show that the heating effect is simply and solely to be found in the form of Joulean heat. As regards the increase in substance changes which may take place under the influence of h.f. currents, and the additional heat associated with this, this question will not be investigated here." (b) In the frequency range used for diathermy ($4 \times 10^5 - 1.5 \times 10^6$ p.p.s.) the energy consumed inside the body for a constant value of current is almost independent of frequency in the case of widely separated electrodes, while for electrodes

close together it may fall to 60-70 per cent. at the higher frequencies. Thus much less heat-production may be attained by apparatus using the higher frequencies.

G.E.C. APPARATUS FOR ULTRA-SHORT WAVE MEDICAL RESEARCH.—(*Sci. News-Letter*, 3rd May, 1930, Vol. 17, p. 280.)

The germs of certain diseases can be killed in the body by high temperatures (thus it is probable that fever is not merely a sign of disease but a part of the body's defence against the invading germs). Treatment of paresis, by producing fever artificially by injection of malaria germs, has had some success—but the amount of fever is difficult to regulate, and the patient has then to be cured of malaria. "The new apparatus using short radio waves may overcome these objections and provide a practical means of using the fever treatment."

THE PRODUCTION OF FEVER IN MAN BY SHORT RADIO WAVES.—C. M. Carpenter and A. B. Page. (*Science*, 2nd May, 1930, Vol. 71, pp. 450-452.)

A paper by the two workers principally concerned in research with the apparatus mentioned in the above abstract. 6, 15 and 18 m. waves have been used, but the greatest heating was obtained with a 30 m. wave. The method of treatment is described: "we believe that the condition of our patients after treatment is much more satisfactory than that reported by investigators who have used other methods to produce artificial fevers."

CERTAIN BIOLOGICAL EFFECTS OF HIGH FREQUENCY FIELDS [VARIATION IN RESPONSE OF WASPS].—G. M. McKinley and D. R. Charles. (*Science*, 9th May, 1930, Vol. 71, p. 490.)

HIGH FREQUENCY EQUIPMENT FOR BIOLOGICAL EXPERIMENTATION.—McKinley. (*See under* "Transmission.")

DIE MEHRSPRACHEN-EINRICHTUNG DER BERLINER WELTKRAFTKONFERENZ (The Multilingual Installation at the Berlin World Power Conference).—W. Jaekel. (*Zeitschr. V.D.I.*, 31st May, 1930, Vol. 74, pp. 734-735.)

Connection diagram, description and photographs of the parts of this installation, which enabled the delegates to hear, in their head-gear telephones, either the original or a continuous

interpretation, in English, French or German, of the speech being made. Each of the three interpreters had a relief provided with a microphone in parallel, so as to avoid any pauses. The speakers' microphone was of the Siemens and Halske rod type "which ensures clear transmission even if the speaker does not speak directly into it." The interpreters themselves listened to the speakers directly. The complete installation can deal with six different languages, though only three were dealt with at the Conference.

EIN ELEKTROOPTISCHER MOMENTVERSCHLUSS MIT EXTREM KURZER EIGENZEIT ALS HILFSMITTEL ZUM STUDIUM RASCH VERÄNDERLICHER VORGÄNGE (VORLÄUFIGE MITTEILUNG) (An Electro-Optical Method of Making a Momentary Contact, with a Very Short Natural Time, as an Aid to the Study of Rapidly Varying Phenomena—Preliminary Account).—L. v. Hámos. (*Naturwiss.*, 21st Feb., 1930, Vol. 18, No. 8, pp. 181-182.)

The principle of the method is the action of a direct voltage impulse on two Kerr cells which are in the optical path of three successively crossed Nicol prisms. The arrangement becomes transparent for periods of the order of 10^{-9} to 10^{-7} seconds. Application may be made to the study of the initial stages of electric discharges or to voltage measurements. Cf. Beams, Lawrence and Beams, 1928 Abstracts, pp. 467 and 689; 1929, p. 344; see also Gaviola, 1929 Abstracts, p. 586, and Pungs and Vogler, these Abstracts, under "Measurements and Standards."

AN ELECTRIC EAR: THE "TELEFACTOR."—R. H. Gault. (*Engineer*, 14th March, 1930, Vol. 149, p. 299.)

A small instrument which substitutes the sensitiveness of the finger tips for the sensitiveness of the ear; the fingers "pick up stimulations of varying intensity and transmit them to the brain." It has been demonstrated before members of the Franklin Institute.

L'EMPLOI DU RADIUM DANS LES ÉCLATEURS DE MESURE ET LES APPAREILS DE PROTECTION CONTRE LES SURTENSIONS (The Use of Radium in [Improving the Performance of] Spherical Spark Gaps, for Measuring Purposes, and Lightning and Surge Protectors).—R. van Cauwenberghe and G. Marchal. (*Rev. Gen. de l'Élec.*, 1st March, 1930, Vol. 27, pp. 331-337.)

Some Recent Patents.

The following abstracts are prepared, with the permission of the Controller of H.M. Stationery Office, from Specifications obtainable at the Patent Office, 25, Southampton Buildings, London, W.C.2, price 1/- each.

GRAMOPHONE PICK-UPS.

Application date, 26th October, 1928. No. 324636.

The stylus-bar or armature *S* is made with an intermediate portion of rectangular cross-section which fits in a bearing in the cross rod *C* of slightly larger size, so as to allow the armature a limited

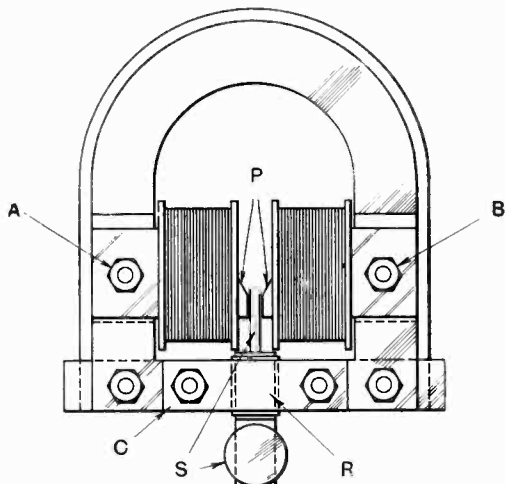

No. 324636.

amount of lateral movement which, however, is damped by an indiarubber-tube packing *R*. The polepieces *P* can be adjusted relatively to the upper limb of the armature *S* by slacking the fixing-screws *A*, *B*. Or a right and left hand screw-threaded rod may be fitted to the poles for this purpose.

Patent issued to C. Berrage Moulton.

Application date, 30th October, 1928. No. 324943.

The stylus forms part of the magnetic system carrying the flux, and is rigidly held in a carrier which vibrates with it. The parts are so dimensioned that the inertia of the stylus forms the major portion of the total inertia of the vibrating system, so that there is little tendency towards the setting-up of any inherent resonance effect.

Patent issued to Burndept Wireless (1928), Ltd. and J. H. D. Ridley.

Application date, 14th December, 1928. No. 325329.

A condenser is inserted in parallel, and a high resistance in series with the speech-coil of a pick-up. With this arrangement, needle vibrations due to scratch are bypassed across the condenser shunt. The series resistance prevents any possible resonance effect due to the introduction of the condenser.

Patent issued to S. G. S. Dicker.

THERMIONIC VALVES.

Application date, 29th October, 1928. No. 324653.

In order to increase the emission efficiency of a mains-fed valve, the cathode proper is heated by conduction from a resistance filament electrically connected in series with it. The heating-resistance is welded into the upper and lower ends of an oxide-coated nickel tube forming the cathode, the latter being made of sufficient cross-section to ensure that there is substantially no potential drop along its length.

Patent issued to the M.O. Valve Co., Ltd., and C. W. Cosgrove.

SUPERSONIC RECEIVERS.

Convention date (Germany), 1st December, 1927.

No. 391498.

In order to use only one tuning control in a superheterodyne receiver, the aerial or input circuit is deliberately made aperiodic, and tuning is effected solely on the local oscillator. Loss in aerial "pick-up" is compensated by increasing the sensitivity of the succeeding amplifiers, and loss in resonance by increasing the selectivity of the intermediate-frequency stages.

Patent issued to L. L. de Kramolin.

Convention date (Germany), 27th October, 1927.

No. 299469.

In order to ensure thorough evacuation of the bulb after the electrodes have been assembled, connections are made between certain of the electrodes in order to facilitate good conductivity both for heat and for the currents induced by the high-frequency furnace. Such connections only serve this temporary purpose and must be destroyed before the valve is completed. As shown in the drawing a bridge piece *B* connects two sets of electrodes *V*, *V*₁ in a multistage valve, a central hole *C* being punched out of such size as to ensure that the eddy currents induced during evacuation fuse through the margins and so destroy the connection.

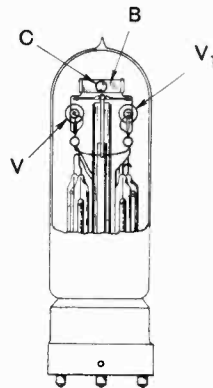

No. 299,469.

Patent issued to Loewe-Audion, G.M.B.H.

FREQUENCY MODULATION SYSTEMS.

Convention date (U.S.A.), 8th October, 1927. No. 298481.

Signalling is effected by varying the frequency of the oscillations generated by a piezo-electric controlled master-oscillator M.O. A frequency-changer FC selects a suitable harmonic from the output of the oscillator and feeds it to the aerial through an amplifier A and power amplifier PA.

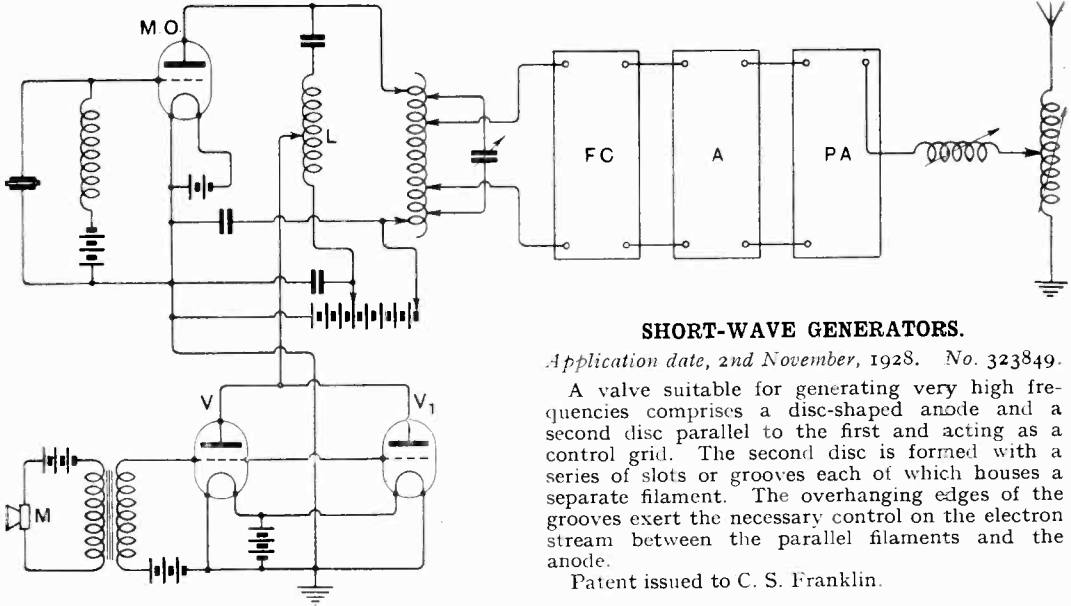

No. 298481.

Modulation is effected through a microphone M and a pair of "shifter" valves, V, V₁ which are shunted across part of a coil L forming a portion of the tuned output circuit of the master oscillator M.O. Any alteration in the constants of the output circuit, such as that caused by the amplified microphone voltages, has a proportional effect upon the frequency fed to the aerial. Since the anode potential of the valve M remains substantially constant, any amplitude variation is small in comparison with the frequency modulation.

Patent issued to Westinghouse Electric and Manufacturing Co.

PIEZO SYNCHRONISERS.

Application date, 20th October, 1928. No. 324080.

A piezo-electric crystal, back-coupling a thermionic valve, is inserted in the path of a ray of polarised light, between two crossed Nicols. The arrangement is initially set so that no light emerges from the second Nicol when the crystal is quiescent. If now the valve is switched on, so that the piezo-crystal starts to oscillate, flashes of light of a frequency corresponding to that of the piezo-oscillator are created. Frequencies have been

observed up to 168,800 flashes per second. These are drawn out into a luminous band of light and dark patches by a rotating-mirror system. Any variation in the frequency then gives rise to a "wandering" of the band, which can be detected by means of selenium cells. The arrangement is used for synchronising the scanning-devices at the transmitting and receiving ends of a television system.

Patent issued to A. Hilger, Ltd.

SHORT-WAVE GENERATORS.

Application date, 2nd November, 1928. No. 323849.

A valve suitable for generating very high frequencies comprises a disc-shaped anode and a second disc parallel to the first and acting as a control grid. The second disc is formed with a series of slots or grooves each of which houses a separate filament. The overhanging edges of the grooves exert the necessary control on the electron stream between the parallel filaments and the anode.

Patent issued to C. S. Franklin.

MINIMISING MAN-MADE STATIC.

Application date, 27th September, 1928. No. 323492.

In order to prevent radiation likely to interfere with Broadcast reception, from local dynamos, meters, electric sweepers, and similar apparatus, two branch circuits each containing a condenser in series with a fuse are shunted across the dynamo poles, and from the junction point of the two branches, a third lead containing another condenser is taken to earth or to the frame of the machine.

Patent issued to T. Dickenson.

Application date, 21st September, 1928. No. 323477.

A similar device, in this case designed to prevent the lighting-generator on a railway train from interfering with broadcast reception by the passengers, consists of air-cored chokes inserted between each of the brushes of the dynamo and the supply circuit, and also between the field magnet and one side of the supply. The chokes are so wound and arranged that their fields mutually neutralise each other.

Patent issued to State Railways Radio Co. and L. Zoltan.

TELEVISION RECEIVERS.

Application date, 26th October, 1928. No. 325854.

An exploring disc carrying a series of lenses is placed in front of a neon lamp controlled by the incoming signals. In front of the exploring disc is placed a large lens through which the fluctuating light is viewed. An observer looking through the lens sees a virtual image of the picture without the use of any ground-glass or other viewing-screen.

Patent issued to J. L. Baird and Television, Ltd.

INTERVALVE COUPLINGS.

Application date, 26th November, 1928. No. 325812.

To prevent saturation of the core of the coupling transformer *T*, the direct-current component is shut out by a blocking condenser *C* of low impedance to the audible-frequencies. At the same

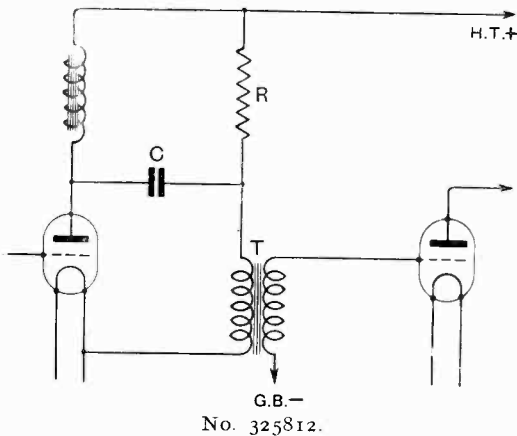

time, to ensure a desirable degree of magnetisation a steady magnetising current is fed to the core through a shunt resistance *R* from the high-tension supply.

Patent issued to F. W. W. Robinson and M.P.A. Wireless, Ltd.

ELECTROSTATIC LOUD SPEAKERS.

Application date, 1st November, 1928. No. 325868.

In order to allow the rapid dissipation of electric charges applied to the speaker diaphragm, the dielectric between the electrodes comprises a sheet or coating of gold or silver leaf, which has a slight amount of conductivity. This is stated to prevent the persistence of a residual charge, and to allow changes of polarity without appreciable lag.

Patent issued to C. Kyle.

MOVING-COIL SPEAKERS.

Convention date (U.S.A.), 14th February, 1928. No. 306044. (Addition to 250931.)

Conductive rings of copper have previously been embedded in the pole-pieces of the field-magnet so as to form low-resistance secondary circuits which reduce the reactive component of the driving-coil impedance and so increase the operating efficiency. According to the invention, this object is still further pursued by making the rings in the form of layers of conducting material which are rolled or electro-plated on the active surfaces of the pole pieces, thus permitting a very close coupling between the rings and the driving-coil.

Patent issued to British Thomson-Houston Co., Ltd.

DIRECTION FINDERS.

Convention date (Germany), 5th May, 1928. No. 311186.

In order to prevent the need for continual re-adjustment, when the ship or other vessel yaws or changes course, the spindle of the D.F. aerial or goniometer is geared or coupled to the compass, so that the former can be set once for all in the maximum or minimum direction, and is thereafter automatically maintained by the compass in that direction.

Patent issued to Telefunken Gesellschaft für Drahtlose Telegraphie m.b.H.

MICROPHONES.

Application date, 13th February, 1929. No. 326310.

In order to allow the diaphragm of a microphone adapted for throat operation to respond over a large surface to any applied vibrations, the movable electrode is carried by resilient means which bear against the central portion only of the diaphragm, instead of against a considerable portion of the diaphragm surface. The latter arrangement tends to confine the sensitivity of the instrument to the peripheral portions only of the diaphragm.

Patent issued to A. Graham & Co., Ltd., W. Stott, and W. J. Ricketts.

A.C. VALVE FILAMENTS.

Application date, 28th February, 1929. No. 326334.

Instead of using a thick filament in the case where heating-current is taken directly from a.c. mains, a parallel bundle of thin tungsten wires is held together by a wrapping of fine wire of the same material. This is stated to avoid difficulty in removing occluded gases in the process of evacuating the bulb.

Patent issued to The Mullard Radio Valve Co., Ltd., and B. Krol.