

EXPERIMENTAL WIRELESS & The WIRELESS ENGINEER

VOL. VI.

OCTOBER, 1929.

No. 73.

Editorial.

The Radio Exhibition at Olympia.

AT the time of writing the doors are open to the annual wireless exhibition organised by the Radio Manufacturers' Association of Great Britain. It is always of interest in connection with the annual show to observe what is the changing tendency in fashion or design of apparatus for broadcast reception. That fashions do change there can be no doubt, for at definite stages in the history of broadcasting some new product has gained for itself a reputation which has resulted in it being almost universally adopted amongst users of broadcast receiving apparatus. We have only to take one outstanding example and observe how the moving-coil loud speaker established itself within a short time and almost completely eclipsed the horn type of loud speaker which had been in vogue prior to its advent.

In looking round the Radio Show at Olympia this year the principal impression that one receives is that, due no doubt to the introduction of the Regional Scheme for distributing broadcasting in this country, manufacturers have turned their attention to increasing the selectivity of their receivers, for high-frequency stages employing screen-grid valves are much more in evidence than they have been previously. The tendency, too, is towards an increase in the number of receivers which are designed to operate direct from the electric supply mains, and there seems little doubt that within a very short while the change-over from battery-operated to mains-operated sets will become very general. In this country we are, of

course, largely handicapped because of the differences in the nature of the supply all over the country, but the efforts which are being made in the direction of standardising the voltage and periodicity of A.C. supply mains will contribute very largely to popularising the mains-operated broadcast receiver.

A recent visit to the Berlin Radio Exhibition left us with the impression that in our own country we are far ahead in the matter of actual circuit design of our receiving sets, but we could learn some useful lessons from the German manufacturer in regard to quantity production. Prices generally at the Berlin Show were lower than prices at our own exhibition, our better-class receivers being, in fact, little cheaper than they were last year. This is probably the direct result of the necessity which has arisen for greater selectivity and the use of screen-grid valves requiring more elaborate screening than was called for in earlier designs. Our designers have found it possible, in most cases, to dispense with one valve and yet get results at least equivalent to what was obtainable last year because of the increased efficiency of valves and the associated circuits. It is questionable whether, for commercial production, it is worth while to attempt to cut down the number of valves to a minimum and increase the efficiency of H.F. circuits, because by so doing the care needed in screening and other details becomes so important that from a manufacturing point of view it may entirely offset any saving effected.

A

Experimental Transmitting and Receiving Apparatus for Ultra Short Waves.

By *R. L. Smith-Rose, D.Sc., Ph.D., A.M.I.E.E., and J. S. McPetrie, B.Sc. (National Physical Laboratory).*

(Published by Permission of the Radio Research Board.)

Part I.

Retrospective and Summary of Other Work.

THE study of the behaviour of electromagnetic waves which have travelled through the ionised regions of the earth's atmosphere has attracted considerable attention during the past few years among investigators in the radio field. A discussion which took place at the Royal Society in March, 1926, made it evident that the use of electromagnetic waves within the band of wavelengths normally employed for radio communication provided a very powerful means of investigating the electrical state of the upper atmosphere. In the course of this discussion it was suggested by Smith-Rose and Barfield (1)* that some useful results might be obtained by carrying out experiments with a concentrated beam of radiation projected at definite angles of incidence towards the upper atmosphere and by locating and investigating the deflected waves on their return to the earth's surface.

If such experiments are to be made on normal wavelengths above say, 15 metres, it is evident that practical considerations necessitate the use of special aerial circuit arrangements at the transmitting station in order to obtain reasonable concentration of the radiation at various angles of elevation to the earth's surface. It was with the object of obtaining data for the design of such special aerial circuits that Wilmotte began the investigation of the characteristics of transmitting aerials a year or two ago. By confirming experimentally the theoretical distribution of current in an aerial system, Wilmotte (2) has been able to calculate the polar radiation diagrams of certain typical transmitting aerials; and experiments are now in progress to confirm these calculations by experimental measurements made in the air with appreciable angles of elevation at

the transmitter. This investigation has shown, however, that this method of studying the upper atmosphere imposes certain restrictions on the angle of elevation at which a reasonable concentration of the radiation can be obtained, particularly when the space available at the transmitting station is restricted.

The alternative method of attacking the problem is to employ a comparatively simple aerial arrangement in conjunction with a reflecting system to attain at least two-dimensional concentration of the emitted radiation. The simplest form which this system can take is that of a half-wave Hertzian rod situated at the focal line of a cylindrical parabolic reflector, but other arrangements are not outside the scope of the investigation. In order that the beam from such a source may be oriented and elevated as desired, it is evident that somewhat severe limitations will be imposed on the maximum wavelength which may be employed. It was realised at the outset that the mechanical design of such an arrangement would become simpler as the wavelength was reduced, so the initial experiments had for their object the study of the technique of working on wavelengths of only a few metres. At the commencement of this investigation some two years ago there was little, if any, published information on the generation, transmission and reception of wireless waves of lengths below about ten metres. In the interval a few workers have been experimenting in this region, usually with a more commercial end in view than that of the present authors and a brief summary of the published accounts of this work will be given in the next section.

(a) Damped Oscillations.

In the production of electromagnetic waves of two or three metres in length, Heinrich Hertz (3) was probably the first with his classical experiments carried out

* The figures in brackets refer to the Bibliography pp. 541 and 542.

in the years 1880-90. In this work and in that of his successors who worked on the problem and demonstrated the various properties of the waves, spark discharge oscillators were employed which gave intermittent groups of damped oscillations. Following the application of this work to practical wireless communication, the spark transmitter was developed to a high degree on the longer wavelengths of from 100 metres upwards. One of the most recent applications of damped waves of a few metres wavelength is the rotating beam transmitter described by Franklin (4) in 1922. Using a wavelength of about 6 metres, a Hertzian rod transmitting aerial was located at the focal line of a cylindrical parabolic reflector, the whole system being rotated continuously to enable ships to determine wireless bearings. Of recent years, also, the spark transmitter has been developed as a means of generating extremely short waves in an attempt to link up the electric wave spectrum with that of the infra-red. Among the earliest workers in this field may be mentioned Nichols and Tear (5) who, with the aid of small Hertzian oscillators formed of tungsten cylinders 0.5 to 0.2 mm. in diameter and 5 to 0.2 mm. long, generated electromagnetic waves less than 1 mm. in wavelength and measured the resulting radiation with a radiometer type of receiver. Measurements were also made on an electromagnetic wave receiver of Rubens' and von Baeyer's infra-red rays as obtained from a quartz enclosed mercury arc. The range of electromagnetic waves obtainable in this region has been considerably extended by the work of Arkadiew (6) and Glagolewa-Arkadiewa (7), who generated oscillations by discharging a high-tension source through a uniform paste made of an intimate mixture of brass or aluminium filings and viscous mineral oil. Such "paste" oscillators give electromagnetic waves whose wavelength is chiefly dependent upon the size of the filings; and in Glagolewa-Arkadiewa's experiments the wavelengths varied from 0.082 mm. up to 5 cms., thus overlapping the Rubens infra-red spectrum on the one side and the oscillations of Nichols and Tear on the other side. M. Lewitzky (8) has also worked on similar lines, using as the oscillators small lead spheres about 0.8 mm. diameter stuck in Canada balsam. By this means he

generated electric waves as short as 0.01 mm. and demonstrated their optical and heating properties with the aid of an ordinary diffraction grating and a sensitive thermojunction.

Quite recently, Busse (9) claims to have generated some 50 watts of energy on wavelengths of the order of 30 cms. by using a quenched spark-gap oscillator. The primary high-frequency current is supplied by a half-kilowatt valve working on 960 metres, and the quenched gap is included in a closed short-circuit to which a dipole oscillator is coupled.

(b) Ionic or Electronic Oscillations.

After the classical work of Hertz and his successors in the production of damped waves of a few metres wavelength, a period of nearly thirty years elapsed before it became possible to produce, even on a laboratory scale, undamped oscillations of the very high frequency corresponding to this short wavelength. This phase of the science had, in fact, to await the practical development of the thermionic valve.

When considering generally the use of valves for the generation of oscillations of extremely high frequencies, it is evident that the design and construction of the valve will set an upper limit to the frequency obtainable. For if the appropriate electrodes of the valve be connected by wires of the shortest possible length, the limiting frequency is determined by the inductance of the loop so formed and the capacity between the electrodes. By the use of specially designed valves, several investigators have reduced the inter-electrode capacity to such an extent as to enable them to obtain oscillations of a frequency up to nearly 300 megacycles per second (corresponding to a wavelength of one metre)*. If attempts are made to extend this process, a second limitation is soon reached, which is determined by the time of travel of the electrons from filament to anode inside the valve. Pfetscher (10) has investigated this point theoretically, and has shown that the lowest wavelength obtainable by the generation of oscillations in circuits by the use of valves and retro-

* See, for example, C. R. Englund, Bibliography, Ref. 34.

action is of the order of 1.2 m. (280 million cycles per second). Beyond this point it appears that an increase in frequency of the oscillations obtainable from thermionic valves can only be brought about by utilising the resonance properties of the ionic or electronic motions inside the valve. The possibility of producing such ionic oscillations in thermionic valves was first described by Whiddington in 1919 (11). Employing a soft valve in his experiments, Whiddington obtained oscillations having a maximum frequency of 4×10^5 cycles per second with gaseous ions, but he indicated the possibility of increasing this to 4×10^8 by confining the oscillations to electrons alone.

The realisation of these higher frequencies was described shortly afterwards by Barkhausen and Kurz (12), who employed hard valves operating at high grid potentials and so obtained oscillations at a frequency of 3×10^8 cycles per second corresponding to a wavelength of one metre. The existence of the oscillations was detected by connecting a Lecher wire system between the grid and anode of the valve, and the frequency obtained was found to depend upon the valve filament current and the grid and anode voltages. Investigations on these lines were continued by Schrenk (13) and by Shaefer and Merzkirch (14) who extended the available frequency range to 10^9 cycles per second (corresponding to a wavelength of 0.3 metre). Schiebe (15) has found that a valve can produce this type of oscillation at two frequencies which are nearly but not quite in the ratio of 1:2. He has also confirmed the dependence of the frequency upon the valve dimensions and the applied voltages. More recently, Hollmann (16) has worked on this problem, and has succeeded in modulating the oscillations and so producing a radio-telephony transmitter operating on wavelengths of from 0.30 to 1.0 metre.

Nettleton (17) has made an extensive study of the characteristics of a valve when producing electronic oscillations of the type described above, and has shown that there is an appreciable negative current to the anode during the process. By studying the dependence of this anode current upon the grid voltage, electron current and gas pressure, it became apparent that the phenomenon was not purely electronic:

in fact, a small amount of ionisation is necessary for the manifestation of oscillations which, together with the negative anode current, cease very suddenly at pressures of the order of 10^{-5} mm.

This appears to be somewhat in conflict with the previous work of Gill and Morrell (18a and 18b), who demonstrated and explained the possibility of obtaining oscillations in a gas-free tube as a direct result of the electronic motions between grid and anode, when the grid was at the higher potential. Gill and Morrell's experiments deal with wavelengths of from 2 to 6 metres and illustrate the dependence of the wavelength upon the grid and anode voltages and the filament heating current. In a later paper, Gill and Morrell (18c) describe the production of another type of oscillation arising from the secondary emission of electrons from the anode. More recently, Sahánek (19) has investigated both theoretically and experimentally the methods of obtaining the type of oscillations discussed above, and has established a common foundation for the different methods. Wechsung (20) has also studied the same type of oscillation produced with an applied A.C. instead of D.C. voltage; while Grechowa (21) has investigated the effect of working conditions upon the oscillations produced.

(c) Undamped Waves and their Applications.

Reverting to the more usual method of producing oscillations by the use of a three-electrode thermionic valve with retroactive coupling between its circuits, White (22) described in 1916 a circuit arrangement which gave satisfactory operation at 50 megacycles per second (*i.e.*, a wavelength of 6 metres). Three years later, Gutton and Touly (23) described experiments made with the ordinary type of triode in which the wavelength was reduced to 3 metres, and by the use of a special low-capacity type of valve this was lowered to 2 metres. These writers laid stress upon the fact that the oscillations were produced in the same manner as those of lower frequency, *i.e.*, by inductive retroaction between the external grid and anode circuits of the valve: they also indicated the advantages which continuous oscillations possessed over the intermittent damped oscillations for experimental research and measurement purposes.

The last-mentioned paper was followed by one by B. van der Pol, Jr. (24), also in 1919, describing the production of waves down to 3.6 metres wavelength. In these experiments two tuned circuits were employed connected to the grid and anode of the valve respectively, but with no external retroaction between them. The maintenance of oscillations was thus dependent upon internal coupling by means of the grid-anode capacity of the valve. By the aid of these oscillations van der Pol measured resonance curves for a Lecher wire system and obtained a value for the logarithmic decrement of the system. In a paper published in 1920, Southworth (25*a* and 25*b*) made a brief analysis of the general form of the circuit of an oscillating valve, and drew attention to the necessity of substituting for "lumped" inductances circuits having distributed inductance and capacity if successful operation at wavelengths below 10 metres is to be obtained. With the inductance in the form of a rectangle, with a length of side of the order of 3 inches, wavelengths below 2 metres were obtained with ordinary receiving valves. Both van der Pol and Southworth remarked upon the pure sinusoidal nature of the oscillations obtained and the difficulty of detecting the presence of any harmonics. In a later paper Southworth (25*c*) described the generation of waves varying from 1.24 to 2.76 metres in wavelength, and the use of such waves for studying the dielectric constant of water. In this connection it is interesting to mention the earlier paper of Tear (26) describing the measurement of the optical constants of water, glycerin, methyl and ethyl alcohol for damped trains of electric waves, of wavelength from 0.4 mm. to 40 mm.

In 1924, Mesny (27*a*) described the results of investigations on short waves carried out in the French Laboratory for Military Radio Telegraphy under the direction of General Ferrié. Arising out of a previous study of the generation of polyphase oscillations at high frequency, Mesny has given particular attention to the balanced two-valve type of circuit which was described by Eccles (28) in 1919. With this arrangement wavelengths as short as 1.5 metres were attained with low-power transmitters, and experiments were carried out on the telephone

modulation of such waves. Using the super-regenerative type of receiving circuit, satisfactory telephonic communication has been obtained over a distance of 280 kilometres between two mountain peaks in the Alps with a power supply of only 3 watts (27*b*). When the same experiment was attempted along flat ground, the distance of satisfactory transmission was reduced to 2 or 3 kilometres, thus illustrating the serious absorption effect of the earth for very short electromagnetic waves. Further tests on these lines have been described more recently by Ritz (29). Employing the same type of circuit, Gutton and Pierret (30) have isolated harmonics of the main oscillation and have thus succeeded in producing frequencies corresponding to wavelengths of the order of 0.35 metre.

An interesting extension of the symmetrical two-valve oscillating circuit discussed above was provided by Danilewsky (31), who used a single five-electrode (two grids and two anodes) valve with this circuit for generating oscillations of a few metres in wavelength.

Tykocinski-Tykociner (32) has described the development of low-power laboratory-type oscillators suitable for generating oscillations of frequencies from 50 to 100 million cycles per second (wavelengths 6 to 3 metres); and has used these for the study of antenna problems with the aid of scale models.

A good general account of the experimental investigation of the behaviour of transmitters and receivers on all wavelengths below 100 metres is given by Mesny (33) in a monograph published in 1927. In addition to a survey of the technique of the subject, this work discusses the existing knowledge of the propagation of wireless waves around the earth. As already mentioned, Englund (34) has investigated the short-wave limit of valve oscillators of the normal type, and has found this to be between 3.5 and 1.5 metres for ordinary commercial receiving valves. By means of a special valve a wavelength of 1.05 metres was reached.

Prominent among the more recent research on the subject of short-wave working, may be mentioned that carried out in Japan. Uda (35) has investigated in some detail the behaviour of antennæ and reflectors for use in beam transmission, while Yagi (36)

has carried out various experiments on wavelengths below 5 metres to show the effect of the earth in attenuating the waves, and of the directive properties of systems of inductively excited antennæ and reflector wires.

Okabe (37) also has applied the magnetron type of valve oscillator to the production of waves less than half a metre in length, and in a recent publication has discussed the relation of such oscillations to those of the Gill-Morrell and Barkhausen-Kurz type. In a more recent publication Žáček (38) has drawn attention to the fact that he described the use of the magnetron for the production of very short waves in 1922.

During the past year or so publication has been made of several researches conducted under the supervision of Professor Esau. In one paper, Cords (39) describes a detailed experimental study of the oscillating valve for wavelengths in the neighbourhood of 3 to 6 metres, and gives the results of the application of this work to a short-wave receiver using a single oscillating valve with critical control of retroaction. In a later paper, Wechsung (40) deals with the corresponding transmitting problems from both a theoretical and experimental viewpoint; and the results of this work are applied to the design of practical transmitters of from 150 to 2,000 watts rating, operating on wavelengths of 2.8 to 6 metres. Esau (41) has described the application of this apparatus to practical communication on wavelengths of the order of 3 metres. Tests gave good results with telephony transmission over ranges up to 130 kms., and freedom from atmospheric or other disturbances was observed.

Part II.

Analysis of Circuits Suitable for Short-wave Oscillators.

(a) Single-valve Circuits.

We may arrive at a general idea of the circuits suitable for work on short waves by a consideration of those commonly used on longer wavelengths. The usual method of making a valve oscillate at these wavelengths is to transfer energy from the anode circuit to the grid circuit of the valve until at least as much energy is taken from the anode current supply as that lost in the

valve and its attendant circuits. Figs. 1 and 2 represent two circuits typical of those popular in transmitters some years ago.* In these two transmitters the necessary energy required from the anode battery is obtained by mutual induction between the

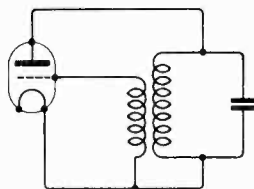

Fig. 1.

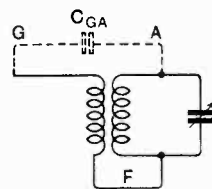

Fig. 1a.

anode and grid coils. These two circuits are closely similar although in Fig. 1 we have the tuned circuit between the anode and filament, while in Fig. 2 it is between the grid and filament.

These two circuits may be combined to make that of Fig. 3, in which both the grid and anode coils are tuned. This circuit is redrawn in a more suitable form in Fig. 4. Now, if the inductance of the grid coil L_1 is equal to the anode inductance L_2 and the capacities of C_1 and C_2 are also equal, the natural frequency of the grid and anode circuits is the same. Moreover, the natural frequency of the circuit $L_1 L_2 C_2 C_1$ is also the same as that of $L_1 C_1$ and $L_2 C_2$. This means that as far as the oscillatory current is concerned, we may omit the connection between the common point of the inductances $L_1 L_2$ and the condensers $C_1 C_2$ without altering the constants of the circuit. Fig. 5 shows such a circuit. In this we can obviously replace the double condenser $C_1 C_2$ by a single one C as shown in Fig. 6. This is commonly known as the Hartley circuit, but in accordance with the footnote below we shall refer to it as circuit number 6. If desired, the connection between the filament and the centre point of the coil may be omitted as shown in

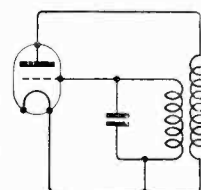

Fig. 2.

* In order to avoid ambiguity and the question of priority entailed when a circuit is named after someone intimately connected with it, we shall refer to all circuits by the number of the figure under which they appear in this paper.

Fig. 6(a); by this means, the oscillation is left free to locate its nodal point at or near the centre of the inductance. In some cases at short wavelengths this may be a definite advantage, since it is unnecessary to find the exact electrical centre of the inductance, which is the only point that should be held at the filament potential.

We may derive another circuit from Fig. 4 by omitting (as in Fig. 5) the connection between the centre point of $L_1 L_2$ and $C_1 C_2$, while leaving the filament connected to the common point of the condensers. This circuit, which is often called the Colpitts circuit, is shown in Fig. 7.

We have so far neglected the method of power supply to the valve. It is evident that in circuit No. 7, the only method of high-tension supply is through a choke coil to the anode: the choke is required in this case in order to prevent leakage of high-frequency current into the high-tension

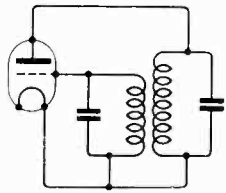

Fig. 3.

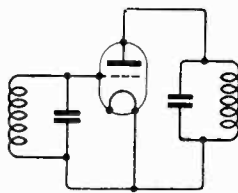

Fig. 3a.

supply. There are two methods by which power may be supplied to circuit No. 6. These are shown in Figs. 8 and 9 and are usually known as the shunt and series-feed systems respectively. This nomenclature is due to the fact that in circuit No. 8 the high-tension supply is in parallel with the oscillatory circuit, while in Fig. 9 these are in series. It is necessary in most of the circuits dealt with to insert a blocking condenser in series with the grid in order to render this independent of the direct-current H.T. supply. In the case of the circuit in Fig. 9, it will be noted that the high-tension supply has been inserted in the connection between the filament and the centre point of the inductance. This, together with the insertion of the blocking condenser, isolates the grid for D.C. voltages. A suitable leak R , must therefore be inserted as shown between the grid and filament in Fig. 9.

There may be a small difference in the behaviour of the above oscillators at long and short wavelengths. At medium and long wavelengths the coupling between the grid and anode coils is predominantly

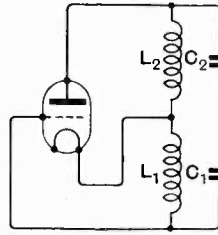

Fig. 4.

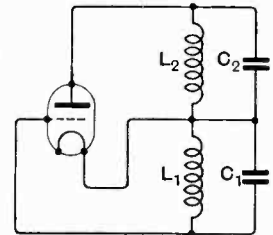

Fig. 5.

inductive. On shorter wavelengths, however, the electrostatic couplings between the coils and the valve electrodes become important and at very high frequencies may exceed the magnetic coupling. Care must, therefore, be taken in the layout for high frequencies as the electrostatic and magnetic couplings are usually of opposite sign.

It is the small capacity inside the valve between the grid and filament which determines the suitability or otherwise of the above circuits for work on short waves. If we take circuit No. 1 its equivalent circuit diagram may be drawn as in Fig. 1 (a), where C_{GA} represents the capacity between the grid and anode of the valve. A little consideration will show that in the condition for oscillation the condenser C_{GA} acts against the mutual induction between the grid and

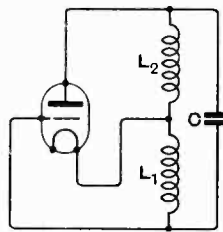

Fig. 6.

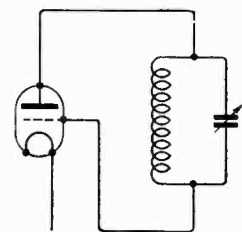

Fig. 6a.

anode coils. Suppose, for example, the grid G becomes temporarily of lower potential than its steady D.C. value. A pulse of current will flow from F to G . The resistance of the valve will increase and therefore diminish the anode current with consequent rise in anode voltage. The mutual in-

duction between the grid and anode coils should be such as to assist this action. When the grid G increases in potential, therefore, the anode voltage should fall. The capacity $C_{G,A}$ tends to stop this action, and in doing so decreases the amplitude of the oscillation. The effect of this capacity, however, is small, except at very high frequencies, and we are left with the result that circuits Nos. 1, 2 or 3 are suitable for work on medium and long waves, but unsuitable for the shorter wavelengths, say, below 100 metres. Incidentally, we thus see the possibility of deriving another generating circuit from Fig. 3, in which the inductive coupling between the tuned anode and grid circuits is replaced by the capacity coupling between the valve electrodes as in Fig. 3 (a).

For alternating current conditions the circuits 7, 8 and 9 deduced from the unsymmetrical circuits 1 and 2 are all symmetrical about the D.C. supply, and in each the grid-to-plate capacity is balanced by another condenser at the opposite end of the oscillatory circuit. This may be seen by considering Fig. 8 (a), which is the

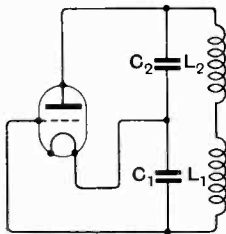

Fig. 7.

equivalent diagram of circuit No. 8. The input supply and output in this circuit are at opposite corners of a bridge circuit. This arrangement has been found advantageous in short-wave oscillators and has led automatically from the asymmetrical parent

circuits Nos. 1 and 2, suitable for long and medium wavelengths, to their symmetrical derivatives Nos. 7, 8 and 9. In actual practice the condenser PA is greater than GP in order not only to neutralise the anode-grid capacity, but also to provide reaction of the proper sign between the anode and the oscillatory circuit.

The single-valve circuits, given in Figs. 7, 8 and 9 can be made to oscillate at very short wavelengths by a careful selection of the inductance and condenser and adjustment of the D.C. supply circuits. While in most cases smooth and continuous alteration of wavelengths can be obtained by a variation of the tuning condenser, it is sometimes found that the oscillation

frequency suddenly jumps from one value to another and higher value not harmonically related to the first. This effect is probably due to the fact that the connecting leads to the tuned circuit are comparable in reactance to the inductance, and that the system really comprises two circuits coupled

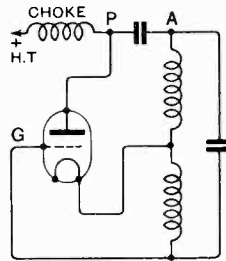

Fig. 8.

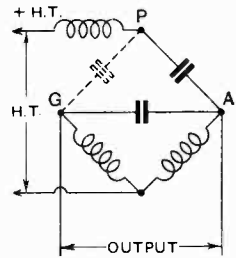

Fig. 8a.

by the main tuning condenser and having two degrees of freedom. For instance, in Fig. 9(a) we have the two tuned circuits $C_v C_1 L_1 C_3 L_2 C_2$ and $C_3 L_3$ coupled by the common condenser C_3 . The validity of this explanation is supported by the fact that the value of the second or higher frequency referred to above is dependent upon the capacity of any coupling condenser inserted in the connecting leads.

(b) Two-valve Circuits.

The full lines in Fig. 10 represent circuit No. 9. A little consideration will show that we may add another valve as shown by the dotted lines without upsetting the bridge arrangement of circuit No. 9. The valve shown by dotted lines forms with the main oscillatory circuit another No. 9 circuit.

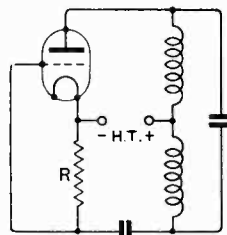

Fig. 9.

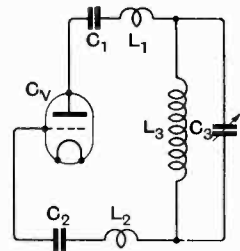

Fig. 9a.

Provided they have similar characteristics, both valves will tend to oscillate and it will be seen that they are so connected that they will mutually help one another to oscillate

in opposite phase. This oscillator circuit was first described by Eccles and Jordan* (28). In this R_1 and R_2 are the grid leaks fixing the D.C. potentials of the two grids. Fig. 10 (a) represents the equivalent circuit diagram of circuit No. 10. It will be seen that the input and output are again connected across oppo-

as the mutual induction between the anode and grid coils may be represented approximately by capacities between opposite ends of the two coils.

A simple explanation of the action taking place in such an oscillator as No. 11 may now be given. A slight modification will allow

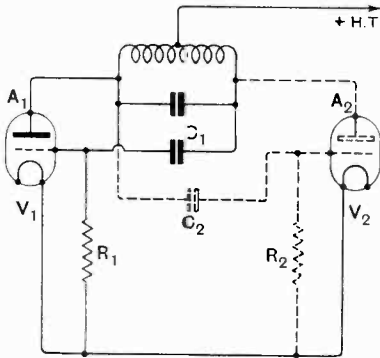

Fig. 10.

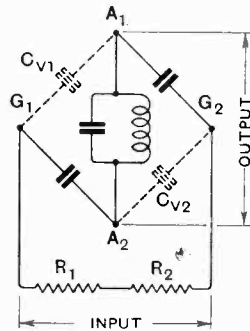

Fig. 10a.

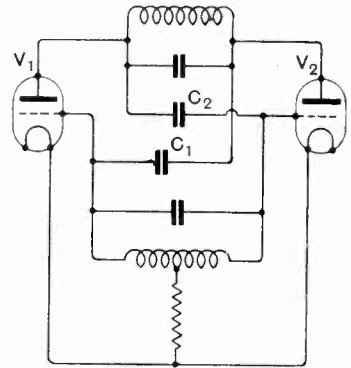

Fig. 10b.

site corners of the bridge. The circuit will obviously oscillate when R_1 and R_2 in series are replaced by any circuit which has a high impedance at the frequency of the oscillator. For example, R_1 and R_2 may be replaced by chokes, the D.C. potential of the grids being fixed by a suitable resistance in the common lead from the filament to the common point of R_1 and R_2 . Another method of having a high impedance between the two grids is to replace R_1 and R_2 by a tuned circuit, as shown in Fig. 10 (b), which is another of the two-valve balanced circuits described by Eccles and Jordan (*loc. cit.*). The connection to the filament in this case is made to the middle point of the inductance just as it was in Fig. 10 to the centre of R_1 and R_2 .

In the double valve oscillator of Fig. 10 the condensers C_1 and C_2 act as retroaction condensers from the anode of one valve to the grid of the other. In circuit 10 (b), however, these condensers are not required as the mutual induction between the anode and grid coils may be made to provide the necessary retroaction. The diagram of such a circuit is given in Fig. 11. Analytically this circuit is closely analogous to that of Fig. 10

the explanation to hold for any of the double valve oscillators described above. Suppose some small disturbance in the circuit of oscillator No. 11 causes the potential of the anode of the valve V_1 to drop below that of the positive terminal of the high-tension supply. A pulse of current will pass from O to A_1 in the anode coil. The mutual induction between the anode and grid coils may be made of such sign as to make the current from O to A_1 induce a current in the grid coil from G_2 to G_1 . This current from G_2 to G_1 raises the potential of G_1 and lowers that of G_2 . The fall in potential of G_2 increases the resistance of the valve V_2 and

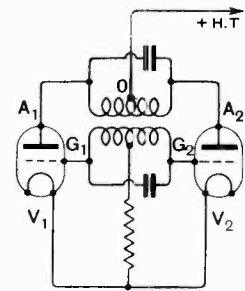

Fig. 11.

the anode current through V_2 will diminish, with the result that the potential of its anode A_2 will rise. Thus, the potentials of the anode A_2 and the grid G_1 are at greater than their D.C. potentials, while the anode A_1 and the grid G_2 are at lower potentials. The two valves, therefore, are in a condition for oscillation provided enough energy is supplied by the mutual induction from the

* W. H. Eccles and T. W. Jordan: "A Method of Using Two Triode Valves in Parallel for Generating Oscillations," *Radio Review*, 1919, Vol. 1, pp. 80-83.

anode coil to the grid coil to balance the loss in the latter circuit. The valves are in opposite phase as regards the oscillation and may be regarded as giving a pulse alternately to the oscillatory circuit.

(c) Practical Analysis of the Above Circuits.

The circuits described above are equally suitable for large- or small-power oscillators. The following practical analysis will apply more particularly to small-power oscillators using ordinary receiving valves.

It has been shown that there is a close connection between all the circuits and, as such, certain results apply to them all. For wavelengths in the region of about 10 metres a centre-tapped coil can most conveniently be made by a two-turn coil with a diameter of about 6 inches. The radiation from the oscillator decreases with the smaller coil but the two turns bring the centre-tap to a convenient position. No centre-tapped coil is required in circuit No. 7 and in this case the coil may be a single turn 10 inches in diameter. The size of the tuning condenser varies with the range of wavelengths required for each coil, but it should not be larger than $100\mu\text{F}$. The same capacity is suitable for the coupling condensers in circuits Nos. 8 and 10 and the grid condenser in No. 9.

Circuit No. 8 is suitable for use with low impedance valves as the high-tension supply is shunted across the oscillatory circuit. A choke is necessary in the anode lead to increase the impedance across the high-tension battery. Very little knowledge is available as to the behaviour of chokes at very high frequencies. A design used by us consists of from 100 to 150 turns of No. 47 S.W.G. copper wire wound uniformly on a 3-inch ebonite or American whitewood former 1 inch in diameter. The chief advantages of circuit No. 8 are that it is convenient to couple it to an amplifier and that there is no D.C. voltage on the coil.

In circuit No. 9 the high tension is connected to the centre of the oscillating coil. There is no oscillating potential at this point so that no choke is required to prevent high-frequency leakage through the high-tension supply. A high-impedance valve may be used with this circuit as the high-tension

supply is no longer directly across the oscillatory circuit. A grid leak and condenser are required. Part of the capacity of this condenser balances the grid-anode capacity and the remaining capacity acts as a reaction condenser. The maximum capacity of this condenser should be about $100\mu\text{F}$. The combination of grid leak and condenser may give rise to squegging, while another disadvantage of this circuit is that the coil is at the high-tension voltage.

Both terminals of the tuning condenser in the above two circuits are at oscillating potentials. Care must therefore be taken to minimise hand-capacity effects when tuning. A double condenser such as is used in circuit No. 7 would do away with this disadvantage as the centre of the double condenser is a point of non-oscillating potential. If we use a double condenser we may tap either the centre point of the coil or the condenser. The absence of a centre connection on the coil is particularly suitable in directional coil transmitters or receivers. This point will be noted later.

The two-valve two-coil oscillator circuit No. 11 has the disadvantage that there are two circuits to tune and that it is difficult to vary the coupling between the grid and anode coils when working on short wavelengths. At very high frequencies the electrostatic coupling between the two coils may become important, and this coupling is of opposite sign to that intentionally introduced by the magnetic induction. Circuit No. 10, on the other hand, requires only one circuit to be tuned. The capacity coupling between the anode and grid circuits in this case is particularly easy to vary by using variable condensers. This circuit, being equivalent to two circuits of type No. 9 has the same disadvantages, namely, the centre-tapped coil and the possibility of squegging.

In all the double-valve circuits the valves must be chosen carefully as the efficiency of such oscillators depends to a large extent on the similarity of the characteristics of the two valves. It is also advisable to have a separate filament current ammeter for each valve and to balance the filament currents before connecting up the high tension supply. In most cases the setting of the filament currents to obtain oscillations at the highest frequencies is fairly critical.

BIBLIOGRAPHY.

1. R. L. Smith-Rose and R. H. Barfield: "Discussion on the Electrical State of the Upper Atmosphere." *Proc. Roy. Soc. A.*, 1926, Vol. 111, p. 10.
2. R. M. Wilmotte: "The Distribution of Current in a Transmitting Antenna." *Journal I.E.E.*, 1928, Vol. 66, pp. 617-627.
3. H. Hertz: "Electric Waves." Translated by D. E. Jones, 1900.
4. C. S. Franklin: "Short Wave Directional Wireless Telegraphy." *Journal I.E.E.*, 1922, Vol. 60, pp. 930-934.
- 5a. E. F. Nichols and J. D. Tear: "Short Electric Waves." *Phys. Rev.*, 1923, Vol. 21, pp. 587-610.
- 5b. E. F. Nichols and J. D. Tear: "Short Electric Waves from the Hertzian Doublet and the Quartz Mercury Arc." *Phys. Rev.*, 1923, Vol. 21, p. 378.
- 5c. E. F. Nichols and J. D. Tear: "Joining the Infra-red and Electric Wave Spectra." *Astronomical Journal*, 1925, Vol. 61, pp. 17-37.
6. W. Arkadiew: "The Production of Feebly-damped Hertzian Waves." *Phys. Zeits.*, 1922, Vol. 23, pp. 35-36.
7. A. Glagolewa-Arkadiewa: "Short Electromagnetic Waves of Wavelength up to 82 Microns." *Nature*, 1924, Vol. 113, p. 640.
8. M. Lewitzky: "An Experiment to Pass Over from the Short Electric to the Long Heat Waves." *Phys. Zeits.*, 1924, Vol. 25, pp. 107-109.
9. E. Busse: "A Method of Generating Very Short Electric Waves by High-Frequency Spark." *Zeits. f. Hochf. Tech.*, 1928, Vol. 31, pp. 97-105.
10. O. Pfetscher: "Production of Short Electric Waves by Means of a Triode." *Phys. Zeits.*, 1928, Vol. 29, pp. 449-478.
11. R. Whiddington: "Ionic Oscillations in Three-electrode Thermionic Valves." *Radio Review*, 1919, Vol. 1, pp. 53-58.
12. H. Barkhausen and K. Kurz: "The Shortest Electric Waves obtainable with Valve Generators." *Phys. Zeits.*, 1920, Vol. 1, pp. 1-6.
13. — Schrenk: *Ibid.*
14. C. Shaefer and J. Merzkirch: "The Bending of Undamped Electric Waves by Dielectric Cylinders." *Zeits. fur Phys.*, 1923, Vol. 13, pp. 166-194.
15. A. Schiebe: "The Production of Very Short Waves with Valves after Barkhausen and Kurz." *Ann. der Phys.*, 1924, Vol. 73, pp. 54-58.
- 16a. H. E. Hollmann: "Mechanism of Electron Oscillations." *Ann. der Phys.*, 1928, Vol. 86, pp. 129-187.
- 16b. H. E. Hollmann: "Telephony on Very Short Waves." *E.N.T.*, 1928, Vol. 5, pp. 268-275.
- 16c. H. E. Hollmann: "A Valve Oscillator for Very Short Undamped Waves." *Ann. der Phys.*, 1928, Vol. 5, pp. 1062-1070.
17. L. L. Nettleton: "Characteristics of a Short Wave Oscillator." *Phys. Rev.*, 1923, Vol. 21, p. 208.
- 18a. E. W. B. Gill and J. H. Morrell: "Short Electric Waves obtained by Valves." *Phil. Mag.*, 1922, Vol. 44, pp. 161-178.
- 18b. E. W. B. Gill: "The Maintenance of High-Frequency Oscillations by Valves." *E.W. & W.E.*, 1923, Vol. 1, pp. 5-9.
- 18c. E. W. B. Gill and J. H. Morrell: "Short Electric Waves Obtained by the Use of Secondary Emission." *Phil. Mag.*, 1925, Vol. 49, pp. 369-379.
19. J. Sahnéek: "Theory of Valve Production of Ultra-short Electromagnetic Waves." *Phys. Zeits.*, 1925, pp. 368-376; and 1928, pp. 640-654.
20. W. Wechsung: "The Production of Very Short Waves with A.C. Voltage." *Zeits. f. Hochf. Tech.*, 1928, Vol. 32, pp. 15-18, 58-65.
21. M. Grechowa: "The Production of Short E.M. Waves." *Physik. Zeits.*, 1928, pp. 726-729.
22. D. C. White: "The Plotron Oscillator for Extreme Frequencies." *Gen. Elec. Rev.*, 1916, Vol. 19, pp. 774-5.
23. C. Gutton and — Touly: "Continuous Electric Oscillations of Short Wave-length." *Comptes Rendus*, 1919, Vol. 168, pp. 271-274.
24. B. van der Pol, Jun.: "The Production and Measurement of Short Continuous Electromagnetic Waves." *Phil. Mag.*, 1919, Vol. 38, pp. 90-97.
- 25a. G. C. Southworth: "Electron Tube Generators of Alternating Currents of Ultra-Radio Frequencies." *Radio Rev.*, 1920, Vol. 1, pp. 577-584.
- 25b. G. C. Southworth: "Electrical Measurements at Ultra-Radio Frequencies." *Radio Rev.*, 1921, Vol. 2, p. 25.
- 25c. G. C. Southworth: "The Dielectric Properties of Water for Continuous Waves." *Phys. Rev.*, 1924, Vol. 23, pp. 631-640.
26. J. D. Tear: "The Optical Constants of Certain Liquids for Short Electric Waves." *Phys. Rev.*, 1923, Vol. 21, pp. 611-622.
- 27a. R. Mesny: "Very Short Waves." *L'Onde Electrique*, 1924, Vol. 3, pp. 25-37, 99-110.
- 27b. R. Mesny: "Notes on Waves of a Few Metres." *U.R.S.I.*, 1928, Fascicule 1, pp. 42-44.
28. W. H. Eccles and T. W. Jordan: "A Method for Using Two Triode Valves in Parallel for Generating Oscillations." *Radio Rev.*, 1919, Vol. 1, pp. 80-83.
29. — Ritz: "Trials on Very Short Waves." *L'Onde Electrique*, 1928, pp. 488-499.
30. C. Gutton and E. Pierret: "On the Harmonics of Very Short Wave Oscillators." *L'Onde Electrique*, 1925, Vol. 4, pp. 387-393.
31. A. Danilewsky: "On a Method of Generating Oscillations with a Five-electrode Valve." *Jahr. d. Tel. u. Tel.*, 1923, Vol. 21, pp. 156-160.
32. J. Tykocinski-Tykociner: "Investigation of Antennæ by Means of Models." *Bulletin of University of Illinois*, No. 147, 1925.
33. R. Mesny: "Les Ondes Electrique Courtes." (*Les Presses Universitaires de France*, 1927.)
34. C. R. Englund: "The Short Wave Limit of Vacuum Tube Oscillators." *Proc. Inst. Rad. Engrs.*, 1927, Vol. 15, pp. 914-927.

35. S. Uda: "On the Wireless Beam of Short Electric Waves." 1927-28. *Journal of the Inst. of Elec. Engrs., Japan.* (Various papers.)
36. H. Yagi: "Beam Transmission of Ultra-Short Waves." *Proc. Inst. Rad. Engrs.*, 1928, Vol. 5, pp. 715-741.
- 37a. K. Okabe: "On the Production of Intense Undamped Electric Waves of Extra Short Wave-lengths." *Technology Reports of Tohoku University*, 1928, Vol. 7, No. 4, pp. 1-28.
- 37b. K. Okabe: "Production of Intense Extra-short Electromagnetic Waves by Split-anode Magnetron." *Journal Inst. Elec. Engrs., Japan*, March, 1928, pp. 284-290.
38. A. Žáček: "A Method for the Production of Very Short Electromagnetic Waves." *Zeits. f. Hochf. Tech.*, 1928, Vol. 32, p. 172.
39. O. Cords: "Investigations on a Receiver for Short Waves." *Zeits. fur Hoch.*, 1928, Vol. 31, pp. 1-7 and 39-43.
40. H. Wechsung: "Valve Generator of Large Capacity for Very Short Electric Waves." *Zeits. f. Hoch f. Tech.*, 1928, Vol. 31, pp. 176-183.
- 41a. A. Esau: "Ultra Short Waves." *Elektrot. u. Masch. bau*, 1928, pp. 78-79.
- 41b. A. Esau: "Range Tests and Damping Measurements for Very Short Waves." *E.T.Z.*, 1928, p. 1816.

(To be concluded.)

Brookman's Park Transmitter.

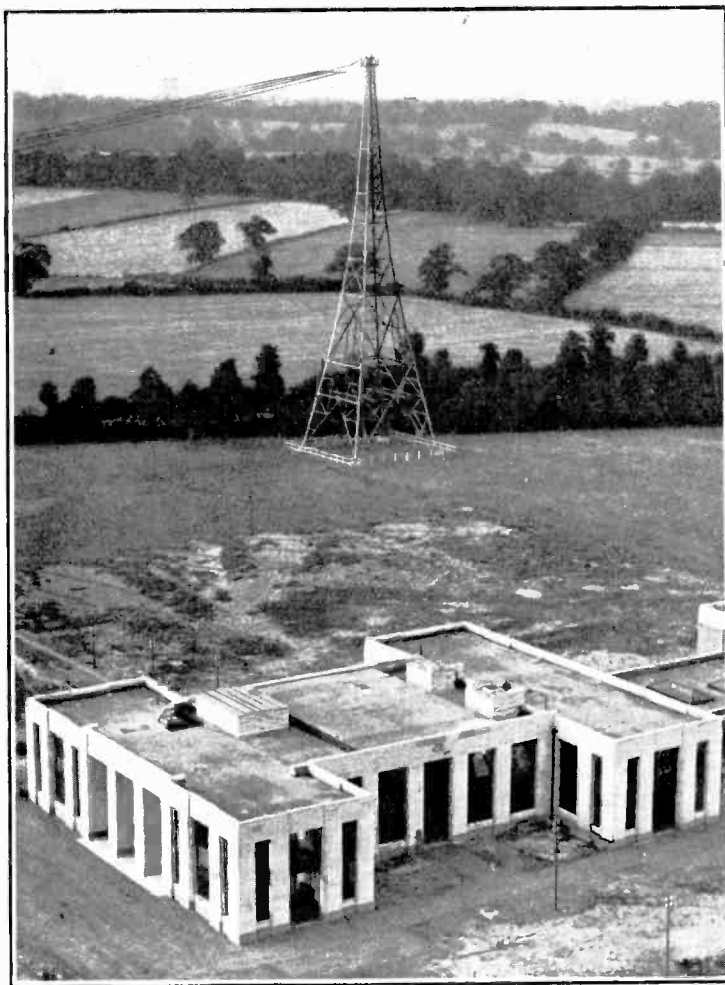

The First Two-Programme Regional Station.

THE accompanying illustration is a photograph taken from the top of one of the masts of the new London Broadcasting station near Potter's Bar.

The station is the first of its type designed to operate on two wavelengths and transmit alternative programmes under the Regional Scheme. Each of the two transmitters normally delivers 30 kw. to the aerial, and it is anticipated that under working conditions approximately full power will be used. Test transmissions on one wavelength have already commenced outside the normal broadcasting hours.

The station is connected to the Studios at Savoy Hill by underground cables and provision is made so that in the event of line failure wireless reception from the Daventry station is possible as an alternative source for supplying the programmes. The masts carrying the aerials are 200 ft. high; it is understood that in the design of the station the B.C.C. engineers would have preferred to have been able to increase this height but had to conform to Government restrictions. The general design of the building is particularly attractive and, as the photograph shows, the architecture is severe and unusual.

The circuit adopted is similar to that of 5GB at Daventry.

Notes on Standard Inductances for Wavemeters and Other Radio Frequency Purposes.

By *W. H. F. Griffiths, F.Inst.P., A.M.I.E.E., Mem.I.R.E.*

SUMMARY.—In this article are given methods of constructing inductances with a view to the elimination of sources of inconstancy of sub-standard wavemeter calibration which are attributable to these components of simple resonant circuits. Such sources of inconstancy have hitherto been unimportant but may now become appreciable owing to the reduction of other sources of inconstancy by recent improvements in variable condenser design.

In addition to inconstancy due to age, lack of robustness, and temperature-coefficient, that due to changes of self-capacity and effective resistance with variation of humidity is considered.

PRECISE standards of self and mutual inductance have for many years been specially constructed for use in alternating current determinations at audio-frequencies. Such standards have been designed to have a high degree of geometrical constancy and a very low temperature-coefficient of inductance, but the materials from which their formers are constructed are usually of sufficiently high power factor to preclude their use at radio-frequencies even if all other characteristics of their design were suitable for this purpose.

Moreover such precise standards have not been necessary hitherto in radio-frequency determinations (particularly in the measurement of wavelength) since the air condensers, either variable or fixed, with which inductances are associated in sub-standard wavemeters of the simple resonant circuit type are invariably the limiting factors in the constancy of the natural frequency of such a circuit. Small changes in the geometry of an ordinary condenser are of much greater importance than are changes of similar magnitude in the case of an inductance.

Recently, however, since standards of frequency such as fork-controlled multi-vibrator wavemeters have been available and since wavelength determinations have to be more precisely effected due to the fact that the wavebands commercially available have naturally become more and more crowded, attempts have been made to design variable air condensers of great permanency of value and freedom from temperature-coefficient. Such a condenser has been described in this journal by the author.*

* *E.W. & W.E.*, January, February and May, 1928; January and February, 1929.

With this advance in condenser design it is thought that the construction of sub-standard wavemeter inductances should receive attention with a view to improving their permanence of value and freedom from temperature coefficient. Such improvements must, of course, be effected without impairing the time constant of the coil.

Ordinary single-layered coils wound on ebonite cylindrical formers are unstable when raised to fairly high temperatures, since ebonite upon cooling does not necessarily return to its original form after being heated, especially if the temperature change takes place while the material is stressed in any way such as by being bound with turns of copper wire which is expanding to a much smaller extent than the insulator. If the former is constructed from a loaded ebonite† the coil is more stable, but it will still have a fairly high (though more definite) temperature-coefficient of inductance, and the copper winding will, upon cooling after a rise in temperature, tend to become slack due to its having been stretched by the greater expansion of the former. The temperature-coefficient of inductance of such a coil is approximately equal to that of the linear expansion of the insulator from which its former is constructed, and it will be seen later that this statement is also true of multi-layered coils whose formers are constructed throughout from one insulating material only.

In view of these uncertainties, the author

† Ebonite loaded with minerals which harden the material and usually impart a distinctive colour. The electrical properties of a loaded ebonite are not quite as good as those of true ebonite, but certain of its mechanical properties are better. A description of a particular loaded ebonite known as Keramot is given later in the article.

has recently designed coils of the single-layered helix and multi-layered helix type, the formers for which may be made from ordinary easily worked insulating materials, each of which has a fairly high temperature-coefficient of linear expansion. The general principle‡ followed is that of constructing a

in all dimensions in a plane normal to the axis of the coil.

The Construction of Compensating Formers.

In Figs. 1 and 2 is shown one method of former construction suitable for a single-layer helix. A stout walled tube "B" of ebonite or good low power factor loaded ebonite is reinforced at its ends by stout end cheeks "A" of Bakelite, which has a temperature-coefficient of linear expansion of the same order as that of copper. In order that the diameter of the winding shall be unaffected by the thermal changes of the tube, the circumferential continuity of the latter is destroyed by a number of radial saw-cuts S in the periphery of the coil.

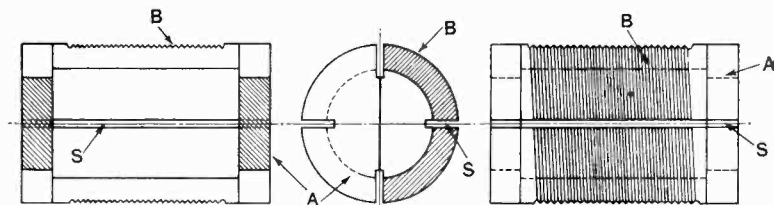

Fig. 1.

former from two insulating materials A and B, having different temperature-coefficients of linear expansion and different phase angles. The material A determining the mean diameter of the coil is selected to be of a very strong and permanent nature (usually such materials have a large power factor, so that electric fields must be kept from passing through them), and to have a temperature-coefficient of linear expansion equal to, or of the same order as, that of the conductor with which the coil is to be wound, so that the turns will not slacken or tighten on the formers with changes in temperature.

The material B on which the conductor is actually wound (usually in grooves or slots) is selected to have a lower power factor than that of A, in order that the dielectric loss due to the field between adjacent turns shall be small, and also to have a temperature-coefficient of linear expansion just sufficiently greater than that of the insulating material A, by which the mean diameter of the winding is determined so that the variation of inductance value due to the linear expansion of the former in an axial direction exactly compensates for the variation (of opposite sign) due to the area expansion of a mean turn due to the thermal changes in material A. In coils designed on this principle care must, of course, be taken to ensure that their diametrical dimensions are not in any way determined by the B material, which should be free to follow the expansions and contractions of the A material

One of the reasons for the choice of Bakelite for the A material is, as has been stated above, the closeness of its temperature-coefficient of expansion to that of copper, and it is fortunate that this is the case because of

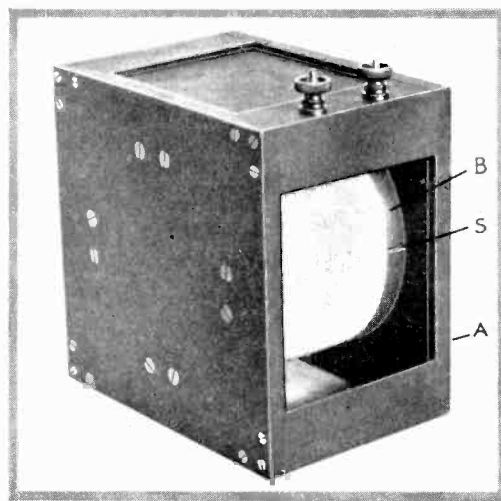

Fig. 2.

the mechanical suitability of this insulator for the framework of former constructions. A tabulation giving linear expansion coefficients of a few of the most practicable

‡ Patent application made by H. W. Sullivan, Ltd., and the author.

insulating materials for former construction will be found below, and it will be seen that the difference between the temperature-coefficients of Bakelite and copper (17×10^{-6}) is only 7×10^{-6} per degree centigrade,* a difference which would only produce a very small stretching of the conductor even were the temperature of the coil to be raised through, say, 30°C . In the case of a coil having a winding of silk-insulated wire such a dimensional difference would probably be taken up without stretching by a cushioning action of the wire covering and is therefore hardly worth considering. The relative linear dimensional changes with temperature of ebonite and copper are, however, seven times as great and cannot be neglected even for small changes of temperature, ebonite therefore being most unsuitable for use as an *A* material.

TABULATION.

Material.	Temperature-coefficient of Linear Expansion per Degree Centigrade.	Order of Power Factor.
Silica-quartz	1×10^{-6}	0.0002
Pyrex	3×10^{-6}	0.005
Micalex	9×10^{-6}	0.0015
Bakelite	24×10^{-6}	0.05
Loaded Ebonite (Keramot)	65×10^{-6}	0.01
Ebonite	70×10^{-6}	0.005
Copper	17×10^{-6}	—
Aluminium	23×10^{-6}	—

It is perhaps, interesting to note that aluminium has exactly the same temperature-coefficient of expansion as Bakelite and is therefore the ideal conductor with which to wind inductances whose formers are constructed from this latter material. Nor is this conductor entirely unsuitable for use in standard inductances for high radio-frequencies owing to the fact that, although the ratio of specific resistances of aluminium and copper is as high as 1.7, the ratio of their effective conductor resistances at high frequencies is only equal to the root of this figure (1.3), for wires of ample cross section,

* Since this article was written the author has discovered a Bakelite having practically the same temperature-coefficient of linear expansion as that of copper, the actual figure being 20×10^{-6} .

because "Skin-depth" is proportional to $\sqrt{\rho}$.

This form of construction, it will be seen, is very robust because of the strength of the Bakelite from which the end cheeks are

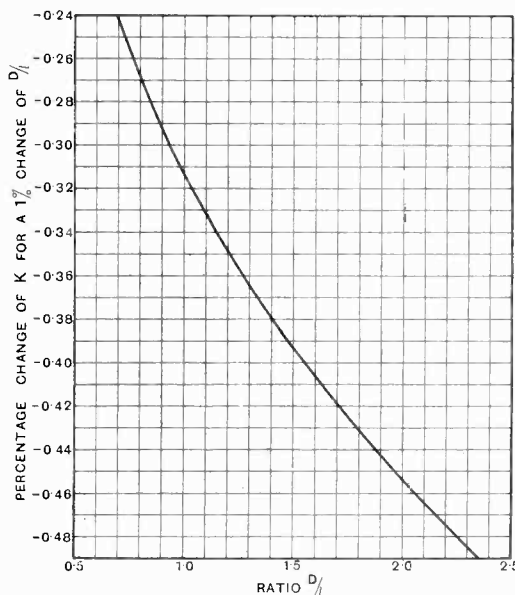

Fig. 3.

made, but the inter-turn field is kept well away from this material which has a high power factor. The power factor of the threaded cylindrical portion, being of ebonite or even of good loaded ebonite, is, on the other hand, very much lower than that of Bakelite, and so the turns of the winding may be allowed to rest in a screw thread groove without unduly increasing the dielectric losses of the completed inductance.

Moreover, the relative temperature-coefficients of linear expansion of ebonite (or loaded ebonite) and Bakelite are such that an almost complete compensation for thermal changes is obtained with this construction.

A good loaded ebonite to employ as a *B* material is that known as Keramot. This material although having relatively good electrical properties is much harder than pure ebonite and will withstand temperature changes much better. Although having a temperature-coefficient of expansion very nearly as high as ebonite, it has not the same tendency to distortion or "cold flow"

when subjected to moderately high temperatures.

The electric strength of Keramot is 55 k.v. per millimetre, compared with 100 k.v. for best ebonite, and its power factor about one per cent., compared with 0.3 per cent. to 0.5 per cent. for ebonite. The per-

in turn, will affect three factors d^2 , $1/l$ and K , of the formula for its inductance.

$$L = \pi^2 d^2 N^2 K/l.$$

For small temperature variations, therefore, the thermal changes of inductance value will be proportional to twice the linear expansion coefficient of the end cheek material, inversely proportional to the linear expansion coefficient of the axial framework material, and will also depend upon the factor K which will, of course, vary with the change of the ratio of d/l . The latter factor can, by suitably choosing the order of d/l , be made to augment the positive component of the thermal changes due to the A insulating material to such an extent that the resultant temperature-coefficient of inductance is almost negligible. Moreover, it is found that by employing two such materials as Bakelite and Keramot the order of the ratio d/l required for compensation is such as to satisfy also the conditions for an efficient inductance, *i.e.*, not small enough to reduce seriously its time constant and not large enough to increase seriously its self (distributed) capacity.

As an aid to the calculation of the resultant temperature-coefficient of inductance of a single-layered helical coil, the percentage change of the factor K for a given percentage change of the ratio d/l has been computed for all values of the latter ratio from 0.5 to 2.5: the results are plotted in the curve of Fig. 3.

By using this curve the resultant temperature-coefficient may rapidly be estimated with accuracy if the temperature-coefficients of linear expansion of the two insulating materials of the former are known.

If α = temperature-coefficient of linear expansion of A material and β = that of B material, then the temperature-coefficient of the ratio $d/l = \alpha - \beta$. The temperature-coefficient of K is therefore $\gamma (\alpha - \beta)$ where γ is read from Fig. 3 corresponding with the appropriate value of d/l .

The resultant temperature-coefficient of inductance

$$= 2\alpha + \gamma (\alpha - \beta) - \beta.$$

As an example, taking Bakelite for the A material, a good loaded ebonite for the B material, and a ratio of $d/l = 1.37$.

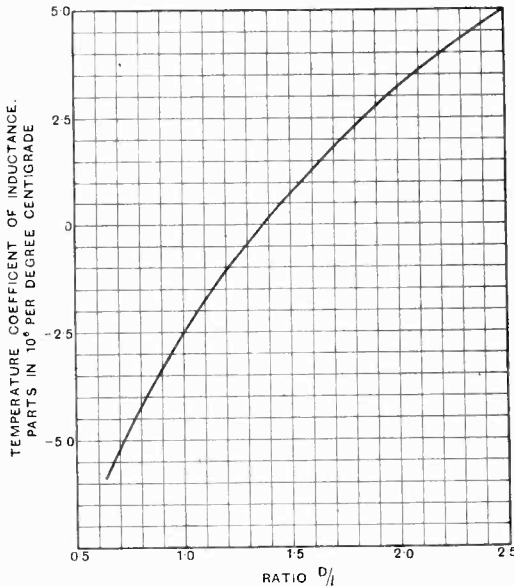

Fig. 4.

- A. Material Bakelite.
- B. Material ebonite or loaded ebonite.

mittivity of Keramot is not excessively high, being of the order 4.5.

The following comparison of best ebonite and Keramot is extracted from a tabulation of properties of ebonites supplied by the makers.

	Ebonite.	Keramot.
	Per cent.	Per cent.
Sulphur } Total ..	30.09	17.94
Content } Free ..	2.94	0.47
Acetone Extract ..	4.95	2.40
Ash ..	0.75	28.08
Specific gravity ..	1.19	1.66

The Extent of Compensation.

In a single-layered helical coil of this type, changes of temperature will alter the two dimensions of the former, the diameter d and the axial winding length l and these,

$$\alpha = 25 \times 10^{-6} \text{ per degree centigrade.}$$

$$\beta = 65 \times 10^{-6} \text{ ,, ,, ,,}$$

$$\gamma \text{ from curve} = -0.375.$$

∴ Resultant temperature-coefficient of inductance

$$= 50 \times 10^{-6} - 0.375(-40 \times 10^{-6}) - 65 \times 10^{-6} = 0.$$

It will be seen that the resultant temperature-coefficient of inductance can be positive or negative depending upon the shape of the coil in relation to the two insulating materials employed. For those materials for which the above example is given several values of overall temperature-coefficient of inductance have been computed and plotted against values of d/l . From the resulting curve (Fig. 4) it will be seen that coils widely differing in shape may be designed without appreciable temperature-coefficient: the ratio of d/l may vary between the limits of 0.7 and 2.5 without increasing the temperature-coefficient of inductance beyond $\pm 5 \times 10^{-6}$ per degree centigrade.

When considering this figure it is interesting to note that if the same material is used throughout for the construction of the coil former $\alpha = \beta$ and the temperature-coefficient of inductance becomes equal to that of linear expansion of the material used since d/l in this case remains constant. Thus

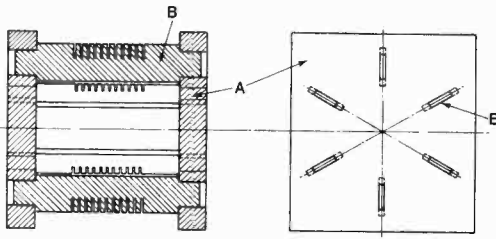

Fig. 5.

coils having formers constructed entirely from Bakelite and loaded ebonite, would have temperature-coefficients of inductance of the orders $+ 25 \times 10^{-6}$ and $+ 65 \times 10^{-6}$ per degree centigrade respectively.

The Compensation of Multi-layered Coil Formers.

Owing to the extreme difficulty of working materials whose temperature-coefficients are of a very low order, it becomes even more

necessary to employ the method of compensation for the more elaborate formers such as are required for coils of the multi-layered type.

For coils in which the depth of the winding is small in comparison with its mean diameter and length, the principle of compensation

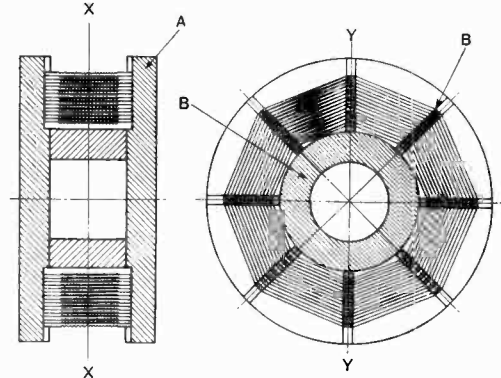

Fig. 6.

may be adhered to by employing the simple former construction indicated in Fig. 5. The A and B materials are in this case selected for compensation in exactly the same way as in the case of the single-layered helix; the same notation has been adopted.

For multi-layered coils of still greater inductance value, where the depth of winding is appreciable, the conductor is usually wound on a number of grooved distance pieces which are built up radially during winding to form spokes from a central hub. In this way each turn of the coil is air-spaced from all its neighbouring turns either of the same layer, or of adjacent layers. Such a coil is shown in Fig. 6.

This type of coil if constructed throughout from ebonite becomes very unstable when cycled through temperatures approaching those of tropical climates—with an increase of temperature the wire may cut more deeply into the grooves of the softened distance pieces, or the rapidly expanding former may stretch the conductor.

If this instability is more or less removed by constructing the former from loaded ebonite or even from Bakelite, an appreciable temperature-coefficient of inductance will still be present. If the former is constructed from the same material throughout it will have a temperature-coefficient equal

to temperature-coefficient of linear expansion of that material since in such coils :

$$L = \pi^2 d^2 N^2 K' / l \dagger$$

where K' is a factor which takes account not only of the ratio of the diameter to axial length, but also of the ratio of the axial length to the radial thickness of the winding. If all parts of the former are of the same material, these two ratios are, of course, unaltered by the expansion of its various

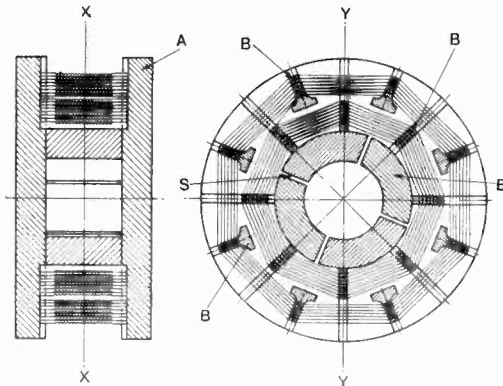

Fig. 7.

members due to a change of temperature, and K therefore remains constant for a given shape of coil.

By making a multi-layered air-spaced coil of this type from the two dissimilar insulators A and B as previously described, *instability* as well as excessive temperature coefficient can be eliminated provided that the winding is split up into two or more concentric sections as shown in Fig. 7 in order to reduce the extent to which the B material (from which the grooved distance pieces are made) affects the diametrical dimension of the winding. It will be seen from the drawing of Fig. 7 that the sets of grooved distance pieces of each section are built up radially independently of those of the other section or sections. In this manner the mean diameter of the outer section is not seriously affected by the thermal expansion of the distance pieces of the inner section, as would be the case were the coil to be built ordinarily in one section. The central hub of material B must, of course, be made discontinuous by the saw cuts S for

† Dr. F. W. Grover, Scientific Papers, Bureau of Standards, No. 455.

the reason already given in the description of the single-layer helical inductance former.

Other Sources of Inconstancy—The Effect of Humidity.

When a standard inductance is used as a component of a simple resonant circuit for wavelength determination there is, in addition to the inconstancy due to changes of inductance value with age, lack of robustness and with variation of temperature, a distinct possibility of further calibration inconstancy due to changes of self (distributed) capacity with variation of humidity.

When the degree of constancy of frequency calibration of a simple parallel resonant circuit approaches the order one part in 10,000, changes of coil self-capacity cannot be immediately dismissed as negligible even when the coils are of good design and are associated with condensers of high capacity value. More especially, of course, is this the case with coils in which insulating materials having a high degree of moisture absorption are employed in positions such that appreciable electric field passes through them. For this reason alone therefore *silk* covered wires of adjacent turns of coils should not be allowed to touch, and cotton covering must, of course, be avoided entirely.

The design of the multi-layered coil shown in Fig. 5 would more particularly appear to offend in this respect since the turns in each slot are separated only by their covering of silk. This type of coil should therefore, it is thought, be avoided unless a more or less constant order of humidity can be ensured in the laboratory in which it is to be set up. Multi-layered coils should, for this reason also, be of the completely air-spaced type and the wire with which they are wound should have as little absorbent insulating covering as possible, depending rather upon the tautness of the winding to preserve a uniform air insulation between adjacent turns and layers. Thus, with the formers for such coils made more robust and permanent as shown in Fig. 7, it should be possible to employ Litzendraht wire which is merely enamel-insulated provided the winding is well done.

In order to ascertain the effect of humidity on the self-capacity of a typical efficient multi-layered coil the following experiment was performed. A sub-standard wavemeter

inductance of about 20 millihenrys was chosen for the experiment. It was a large coil designed to be of low decrement and completely air-spaced between turns and between layers and wound with double-silk-covered Litzendraht wire. Its former was somewhat similar to that shown in Fig. 6. It was set up (at a fixed loose coupling position) to absorb energy from the oscillatory circuit of a heterodyne wavemeter when the latter was tuned to its natural frequency. For this test, of course, the coil under trial was open-circuited—the natural wavelength being of the order 840 metres—and the resonance absorption tuning was shown by the slight indication of a milliammeter included in the anode circuit of the wavemeter. A comparatively crude measurement of natural wavelength in this manner could be made to show changes in self-capacity.

The coil was subjected to extremes of humidity alternately for periods of 48 hours, the whole test occupying several weeks and a quite definite maximum natural wavelength change of 3 metres was obtained—this representing a 0.7 per cent. change in

effective self-capacity which would effect a maximum wavelength change considerably less than one part in 10,000 in a resonant circuit whose capacity was not reduced below 500 $\mu\mu\text{F}$. It would appear therefore that this type of coil is just good enough, from this point of view, for use in the very best sub-standard wavemeter circuit even under these extreme conditions of atmosphere.

Conclusion.

In conclusion it should, perhaps, be mentioned that the natural frequency of a simple parallel resonant circuit is dependent to some extent upon its resistance. Changes of dielectric loss in a sub-standard wavemeter inductance will therefore tend to produce changes of frequency calibration, and such changes must inevitably occur with variation of humidity. In almost any design of coil however, such changes are of a negligible order, while in well-designed efficient inductances such changes of natural frequency would never, it is thought, exceed a few parts in a million under laboratory conditions, even if the dielectric component of the loss was predominant in the design.

Correspondence.

Letters of interest to experimenters are always welcome. In publishing such communications the Editors do not necessarily endorse any technical or general statements which they may contain.

Frequency Modulation.

To the Editor, E.W. & W.E.

SIR,—In my letter on the above subject, published in the August issue of *E.W. & W.E.*, I made the statement that since the carrier current is going through the frequency value ω_3 (comprised between ω_1 and ω_2) twice during every cycle of the modulating vibration, it comprises a component current of frequency ω_3 flowing in the circuit $2m$ times per second and for but a few cycles every time, and having hence an amplitude which is modulated at the *fundamental* frequency $2m$ between zero and the constant maximum amplitude of the actual carrier current.

This strictly is true only for the high-frequency current component of frequency

$$(\omega_1 + \omega_2)/2$$

which is assumed by the high-frequency current at *regular* time intervals, equal to $1/2m$ seconds.

Any other frequency value comprised between

ω_1 and ω_2 will also recur $2m$ times per second, but at time intervals which are alternately greater and smaller than $1/2m$, the sum of two such successive time intervals remaining, however, equal to $1/m$. This introduces a component of frequency m in the amplitude modulating force of the high-frequency current component considered, but does not invalidate the conclusions of my previous letter. The reason is that this amplitude modulating force component of frequency m expresses the recurrence asymmetry of any frequency value of the high-frequency current (except of the value $(\omega_1 + \omega_2)/2$ for which the asymmetry disappears), while the modulating force component of frequency $2m$ represents the recurrence frequency of the particular carrier current frequency value considered.

Even a rough analysis of the frequency modulated current must at least take these two terms into consideration, and as shown in my previous letter, this leads to the conclusion that the frequency band width of the frequency modulated current is equal to $k + 4m$.

This, of course, does not take into account the fact that each frequency value between ω_1 and ω_2 is assumed by the high-frequency current for a very short time only. If this be considered, higher harmonics of m will enter into line, and the value found for the frequency band width will be correspondingly larger. But since the object of my last letter was to estimate a minimum value of this frequency band width, that is, the least value which it has if only the most essential factors are considered, the conclusions remain correct.

Paris.

H. LAUER.

Reduction of Distortion in Anode Rectification.

To the Editor, E.W. & W.E.

SIR,—The whole point of Mr. A. G. Warren's article under the above title in the August *E.W. & W.E.*, seems to depend on the "straightening effect" of the anode resistance on the static characteristic of the valve. That such an effect exists has been somewhat vaguely realised by experimenters for many years, it was the basis of an article by Dr. Kröncke in *The Wireless World* on September 23rd, 1925, and was mathematically demonstrated by Colebrook in *E.W. & W.E.* for April, 1927. The improvement can be seen by taking the anode current/grid voltage curve by the ordinary static method, and it can be taken advantage of in low frequency amplification. Unfortunately, however, the effect is not operative in the case of an anode bend rectifier with a plain anode resistance, for it is necessary that the impedance in the anode circuit should be large compared with that of the valve for the frequency under consideration, and as the rectifying valve may be regarded simply as an "asymmetrical H.F. amplifier," the presence of the by-pass condenser vitiates the whole argument, for it is the carrier frequency which must be considered.

Under the actual conditions of operation it is the ordinary static curve which must be taken, and among the large number of valves I have tested I have found none which deviates materially from the simple parabola within the limits of the useful part of the curve, which fact leads back to the conclusion that the distortion is a function of the percentage modulation only, and cannot be reduced by increasing the input. On the question of modulation depth, I fear that Mr. Warren is unduly optimistic in stating the maximum as 20 per cent. Peak values of something around 80 per cent. regularly occur. The B.B.C. have stated that the tendency will be for modulation percentage to increase, and that 5GB at present has provision for 100 per cent. It is probably true that the average modulation is around 20 per cent., but we certainly must provide for the peaks if we are aiming at anything like perfection. For some time past I have been conducting experiments on a system which includes a tuned circuit in series with the rectifier anode, as in the accompanying sketch. L_2C_2 is the circuit referred to, R is the anode resistance (whose value is fixed by considerations of amplification only) across which the L.F. voltages are developed. C_1L_1 is the usual grid circuit, and the by-pass condenser C_4 may be included if desired, although its function is not obvious in

such an arrangement. The system must be neutralised by means of the condenser C_3 . It is perhaps a disadvantage that the system introduces an extra tuning control, but as the tuning does not seem to be of great importance, and as, moreover, with the values mentioned below, the tuning is very flat (the circuit being shunted by a very low resistance valve) the process is very easy, and further, these facts immediately suggest "ganging" as a complete solution.

With individual control, the method is as follows: Having first tuned the preceding H.F. circuits, including C_1L_1 , upset the neutralising condenser C_3 by a small amount sufficient to produce oscillation on swinging C_2 , set C_2 to the middle of the oscillating range and then return C_3 to its correct position. This completes the adjustment, and the process is not nearly so complex as it sounds.

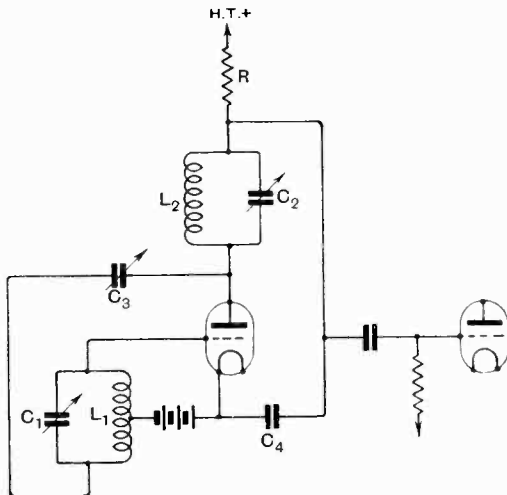

Using a P625A valve ($R = 1,650\omega$) in conjunction with a tuned circuit of high efficiency giving an impedance of about $250,000\omega$ at resonance, then when the unmodulated input has a peak voltage of 7, a modulation depth of 80 per cent. can be dealt with while the sensitivity for the troughs of the modulation remains 80 per cent. of that for the peaks, while with a modulation of 40 per cent. the ratio rises to 95 per cent. Better figures can be obtained with increased inputs. These figures are arrived at by calculation, of course, but it is demonstrable by shorting the tuned circuit that they are to a large extent realised in practice. While it is difficult to detect anything by setting C_2 off tune (owing partly to the flatness of tuning) there is an unmistakable difference on shorting the tuned circuit out, particularly on speech.

Stratford-on-Avon.

P. G. DAVIDSON.

P.D. and E.M.F.

To the Editor, E.W. & W.E.

SIR,—I. Definitions of quantities are purely matters of convenience, and two separate sets of definitions may be independently correct; they will be so long as they are self-consistent.

2. Any set of definitions must not only be mathematically rigorous, but also submit to the generally accepted conventions of the use of the terms defined.

These two statements were given at the beginning of my article on fundamental definitions, which has been subjected to considerable critical examination by Mr. Biederman. These two statements are, I believe, rigorously true, but their function is far from perfect, for they allow considerable variations depending on personal opinions.

According to the first statement, the best definition is that which is most convenient. It is unnecessary to emphasise how personal opinions may differ in using convenience as a criterion of the quality of a definition. In the second statement the bone of contention will be found in the phrase "... must submit to the generally accepted use of the terms defined." There exists, therefore, two important conditions of the suitability of a definition, which are essentially dependent on personal opinions. In this article I would like to make it perfectly clear that the difference between Mr. Biederman and myself is a difference of opinion, and is not due, as Mr. Biederman thinks, to an omission on my part of an important element of the problem.

The whole argument centres round the equation

$$\mu \frac{\delta A}{\delta t} + \frac{\delta \phi}{\delta s} + Ri = 0 \dots \dots (1)$$

where A is the vector potential and ϕ is the scalar potential.

The problem of satisfactorily defining potential difference and E.M.F. resolves itself in finding the best method of dividing the first two terms of the above equation into two parts, one of which will give the potential difference and the other the E.M.F.

I divided these two terms in the simplest possible way from a mathematical point of view. I divided the terms so that one part was produced by the distribution of charge alone and the other by the distribution of current. The charges alone are

responsible for the $\frac{\delta \phi}{\delta s}$ term, from which the potential difference could be calculated by simple addition, while the currents produce the $\frac{\delta A}{\delta t}$ term,

which gives the E.M.F. It is evident that the fact that the potentials are in reality retarded potentials does not affect the validity of such a definition. That is the reason why I did not emphasise the fact and simply inserted it as a footnote so as not to distract the attention from the main issue. The wording of that footnote may well have been unfortunate, since it forms the main basis of the destructive part of the criticism of Mr. Biederman. I said that at high frequencies it was sometimes necessary to take into account the fact that the potentials were retarded potentials. Rigorously, this fact must always be taken into account, but in practice this need only be done at high frequencies.

Though I disagree with the nature of Mr. Biederman's destructive criticism, my attitude to his constructive criticism is the exact opposite. I will not try to judge whether Mr. Biederman's

definition or mine is more suitable, for that is the duty of the users of the definitions and not of the proposers, who should only point out the advantages and disadvantages of the various definitions available.

Mr. Biederman ingeniously points out that the $\frac{\delta \phi}{\delta s}$ term of equation (1) can be split up into two parts, one of which reduces to zero, when the electrical conditions do not vary with time. This part he adds to the $\mu \frac{\delta A}{\delta t}$ term to produce the E.M.F.,

while the rest is the potential difference. His main argument for this is that forces of an electromagnetic nature are never associated with potential difference. That is, all the electric forces produced by electrical variations with regard to time are generally considered to produce E.M.F.s only. I would not like to state whether this is true or not, for it is largely a matter of opinion, yet it is of some importance, for it is the chief reason Mr. Biederman has for considering my definition as impossible. I may state this, however: Before writing my original article on the subject, I endeavoured to obtain an idea of what were the generally considered views on the meaning and use of the terms Potential Difference and E.M.F. I asked a number of physicists, mathematicians and engineers, and was very much astonished by the very great variety of views held. I think Professor Howe can confirm this statement from his own experience. The only general agreement I could find was that the potential difference was equal to the ohmic drop plus the E.M.F., and that Faraday's law played an important part in the definition of E.M.F. This allows considerable latitude in our definition, the remaining criterion, according to our first axiom, is convenience.

Before continuing, I would like to emphasise that these statements must not be taken as dogmas, but merely as my personal opinion and experience.

When dealing with mutual inductance, either between two circuits or two portions of the same circuit, the forces induced from one to the other can be split up to produce electric and magnetic couplings. In my definition I joined them into a single term, the total being an E.M.F., for I thought that this would be more convenient, although it departs from the usual conventions, but there is no reason why the electric and magnetic components should not be separated, if this is considered to be desirable. If my definition of E.M.F. be so divided into a potential difference for the electric coupling and an E.M.F. for the magnetic coupling, the nature of the coupling between two distant antennæ will be a combination of electric and magnetic couplings. The advantage of Mr. Biederman's definition is that, although the coupling in this case will also be a combination of electric and magnetic, the electric coupling will be negligibly small.

I think I have said enough to explain in what way the definition due to Mr. Biederman and mine differ. My reply to the various other points of criticism brought out by Mr. Biederman can be imagined by the reader, and I do not think it is necessary for me to enter more explicitly into the

details of the question in order to explain my point of view. There is one point, however, that I wish to consider. That is the argument at the end of Mr. Biederman's article. The definitions as he correctly states must be correct for all conditions including, therefore, the case of a direct current circuit. Mr. Biederman starts by pointing out that my definitions are physically incorrect in this case and then explains how they still remain consistent: hardly logical, yet it sounded conclusive. The argument turns, however, on the same criterion—What is the generally accepted meaning of the terms used? If we consider two parts of the same circuit and try to evaluate the potential difference between two extreme points *A* and *C* on the part *ABC*, is it not natural to consider the potential difference between *A* and *C* due to the electrical conditions on the part *ABC* alone and add to it that due to the electrical conditions on the remainder of the circuit, calling the latter an E.M.F.? This E.M.F., however, will become a potential difference, if, as suggested above, my definition of E.M.F. be divided into a potential difference due to electric coupling and an E.M.F. due to magnetic coupling. That is what my definition necessitates. It may be that Mr. Biederman and probably many others will not consider this procedure to be natural, but it may also be that many others will hold a different opinion.

I would like to emphasise one point in which the opinion generally held does not seem to me to be scientifically correct. That is the enormous difference which is supposed to exist in the mutual relation between parts of the same circuit and between two circuits coupled together. If a circuit contains two large condensers, although there is no metallic connection between the two parts of that circuit, the relation between these two parts is usually considered to be of a totally different nature to those that exist between two circuits that are at a greater distance apart. It appears to me that the difference is one of degree and not one of nature. That is the reason why I consider that definitions of potential difference and E.M.F. should be applicable to portions of circuits as well as to apparently separate circuits.

In concluding this reply to Mr. Biederman, I do not wish to be misunderstood. I consider Mr. Biederman's suggestion of the greatest interest and of considerable importance, but that is no reason why he should not consider the possibilities of other opinions. My definition possesses the advantage of considerable mathematical convenience, an important matter, since physical quantities in the present state of development of the art are not of great value unless they can be conveniently evaluated. The advantages of Mr. Biederman's definitions lie in the simplification of the type of coupling existing in certain cases. As I said previously, I do not think that it is for either of us to decide which definition agrees best with conventional ideas on the subject, or which is likely to be the most convenient to the majority of users.

R. M. WILMOTTE.

Radio Frequency Laboratories, Inc., Boonton,
New Jersey, U.S.A.

On the Writing of Scientific Papers.

To the Editor, *E.W. & W.E.*

SIR,—I read with considerable interest Mr. Colebrook's article under the above heading in the issue of *E.W. & W.E.* for June, 1929. Mr. Colebrook has given an able exposition of the important elements in the application of the scientific method and the writing of scientific papers. Often the responsibility of editing one's own paper devolves upon the scientific worker, and it is a long way from the manuscript to the final printed stage of a paper. In this connection may I draw the attention of the readers of your journal to a contribution from the distinguished pen of Dr. M. O. Forster, F.R.S., entitled "Preparing Papers for the Press" in "Electrotechnics No. 2," published in the Indian Institute of Science, Bangalore, India.

Piloting one's own paper from the manuscript to the print is a chastening experience. A close attention to detail is absolutely essential and this comes only with practice. It is astonishing to see the number of tiny errors which crop up in an apparently well-written manuscript, under the blue pencil of an experienced editor. Errors such as want of uniformity in giving references to the literature, unconscious change from capitals to the lower case and from Roman to Arabic numerals, inconsistencies like kilograms appearing in different places as kilos., kgm., kgs., and kg., etc., easily escape the eye of many. In a scientific paper italics must not find a place except for special reasons. Equally with italics, clichés must be avoided. A great pitfall is the person in which the paper is written, which, unless carefully watched, has a tendency to oscillate between first and third. One can easily imagine the impropriety of a modest beginning such as "the writer" or "the author" blossoming finally into "us" and "we."

Mr. Colebrook has chosen a happy example in the clay worker to illustrate how a scientific paper must take shape. The ideal to be aimed at is conciseness and freedom from ambiguity. It is a good plan to forget a paper once it is written and then come back to it with a fresh mind after an interval of time. Not only possibilities of clearer presentation but crucial experiments are likely to suggest themselves.

T. S. RANGACHARI.

Electrical Communication Laboratories, Indian
Institute of Science, Bangalore, 27th June, 1929.

The Definition of Selectivity.

To the Editor, *E.W. & W.E.*

SIR,—In his very interesting article on "The Definition of Selectivity," Mr. Colebrook has put forward as a basis for discussion the proposal that, when the amplitudes of two simple harmonic alternating electrical quantities in any network of conductors are related by an equation of the form $B = A/Z$, the selectivity of the circuit with respect to the quantity *B* shall be defined as the quantity

$\omega \sqrt{\frac{1}{Z} \left| \frac{\partial^2 Z}{\partial \omega^2} \right|}$. The radical sign has no doubt been introduced because actually the relation

between B and A is usually of the form $B = A/\sqrt{Z^2}$.

For a frequency differing by $\frac{\delta\omega}{2\pi}$ from that frequency $\frac{\omega_r}{2\pi}$ for which $\frac{\partial Z}{\partial \omega} = 0$, the value of B for the same value of A is given by

$$B' = A / \sqrt{Z_r^2 + \frac{1}{2} \frac{\partial^2(Z^2)}{\partial \omega_r^2} \delta\omega^2 + \text{etc.}}$$

so that

$$\frac{B}{B'} = \sqrt{1 + \frac{\omega_r^2 \partial^2 Z}{Z_r \partial \omega_r^2} \left(\frac{\delta\omega}{\omega_r}\right)^2 + \text{etc.}}$$

In many instances, no doubt, the series under the radical sign is a rapidly converging one, so that, for a given value of $\frac{\delta\omega}{\omega_r}$, the selectivity is practically

dependent only on the coefficient of $\left(\frac{\delta\omega}{\omega_r}\right)^2$, and it is the square root of this coefficient which Mr. Colebrook proposes as the definition of the selectivity of the circuit.

There are, however, cases of common occurrence where the series is not so rapidly convergent—where, in fact, terms involving higher powers of $\frac{\delta\omega}{\omega_r}$ may have values comparable with that involving $\left(\frac{\delta\omega}{\omega_r}\right)^2$ for such values of $\frac{\delta\omega}{\omega_r}$ as occur in practice. A case in point is that of two loosely coupled tuned circuits. It therefore seems a little arbitrary to define selectivity solely in terms of the coefficient of $\left(\frac{\delta\omega}{\omega_r}\right)^2$.

Again, even if we limit consideration to those cases where the terms involving higher powers of $\frac{\delta\omega}{\omega_r}$ than the second are negligible, is it not the coefficient of $\delta\omega^2$ rather than that of $\left(\frac{\delta\omega}{\omega_r}\right)^2$ which is the significant quantity in determining selectivity? For in practice we are concerned with the relation between signal strength at the resonant frequency and that at a frequency differing by some specified amount from the resonant frequency. We are not primarily concerned with the ratio of this frequency difference to the resonant frequency at all.

Take, for example, the case of current resonance in a simple series circuit as dealt with by Mr. Colebrook in the appendix. We have

$$\frac{I}{I'} = \sqrt{1 + \frac{4L}{CR^2} \left(\frac{\delta\omega}{\omega_r}\right)^2}$$

With Mr. Colebrook's definition the selectivity is equal to $2 \sqrt{\frac{L}{CR^2}}$, which decreases with increasing capacity for given values of L and R . But since the resonant frequency is given by $\omega_r^2 = 1/LC$, we have

$$\frac{I}{I'} = \sqrt{1 + 4 \frac{L^2}{R^2} \delta\omega^2}$$

which, for given values of L , R and $\delta\omega$, is independent of the capacity, and it is essentially by the

ratio $\frac{I}{I'}$ at some frequency difference that we judge of the degree of selectivity of the circuit.

Again, with Mr. Colebrook's proposed definition, the selectivity of a tuned anode circuit is greater the smaller the capacity (for a given frequency), whereas it is generally recognised that the reverse is the case.

If, therefore, we are to define selectivity in terms of one coefficient, it should be in terms of the coefficient of $\delta\omega^2$ rather than that of $\left(\frac{\delta\omega}{\omega_r}\right)^2$.

Since, however, as Mr. Colebrook admits, we cannot cover all cases by defining selectivity in terms of any one coefficient (in the series for Z^2), I suggest it would be preferable to define it as the ratio of the quantity concerned at the resonant frequency to that which it has at a frequency differing by some specified amount from the resonant frequency.

We might speak of the selectivity thus defined as having such and such values at frequency differences of 10, 15 or 20 kilocycles or some one standard frequency difference might be employed in the definition so that one definite numerical value could be assigned as specifying the selectivity of a circuit.

Incidentally, the inverse of the selectivity, so defined, for a frequency difference of 10 kilocycles is a measure of the extent of the cutting-off of the sidebands and might be termed the "quality factor" of the circuit.

E. A. BIEDERMANN.

Brighton.

August 7th, 1929.

L.F. Transformer Curves.

To the Editor, E.W. & W.E.

SIR,—The article in a recent issue on the Philips Transformer and the widespread publication of frequency response curves, certified and otherwise, raises a question as to whether these curves are taken under conditions which represent accurately the working conditions. All the curves which I have seen show the frequency response curves taken with a pure resistance load in the anode of the valve on the secondary side of the transformer. As this load under actual conditions is nearly always a reactive load (either predominantly inductive or capacitive, according to frequency), which is not of a reasonably constant value, it would appear that the input impedance of this output valve is not nearly the constant quantity obtained when a pure resistance load is used. The varying input impedance must therefore affect the transformer characteristic, particularly when the valve capacities are used to promote resonance and keep up the amplification of the higher audio-frequencies. Would it not be very interesting to have the characteristics taken with an actual loud speaker load in the anode circuit. We would then be able to obtain the curves under actual working conditions. I should, of course, be happy to be assured that the characteristics published are in close agreement with those obtained under actual working conditions.

W. SYMES.

The Frequency Departure of Thermionic Oscillators from the "LC" Value.

By Instructor Lieutenant S. W. C. Pack, A.C.G.I. M.Sc., R.N.

(Concluded from page 480 of September issue.)

Initial Tests. A few initial tests were made before the condensers had been calibrated by varying the filament current and also varying the capacity about a value which produced a frequency identical with f_0 .
 (Note.—In all subsequent conventional tests C was fixed at the assigned value of 116.51 jars and the beats counted.)
 In this previous test, however, it was meant to obtain a series of about seven curves, each for a particular filament current

latter tests referred to presently that it is introduced here. When the condensers had been calibrated, the C value of 116.51 jars was found to be off the range of the condenser readings of this test. This meant then that the curves had to be extrapolated to determine the frequency departure for each filament current at the $C = 116.51$ value. The curves are shown in Fig. 5. They have been assumed to be straight lines, and while not exactly true this is approxi-

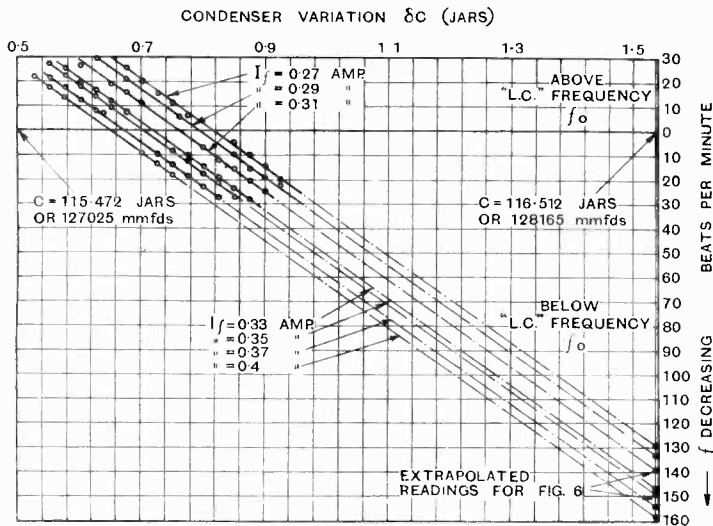

Fig. 5.—Rough test, frequency variation with small condenser variation δC for different filament currents I_f . V_a , 63 volts; $G.B.$, 1.5 volts; coupling, 21 cms.; $67.4^\circ F.$, room; $64.8^\circ F.$; fork.

indicating the beats above and below the resonant value as the capacity was varied. The capacity necessary to produce frequency f_0 was different for each value of filament current. It was then proposed to note the value of the beats on each curve at the particular point corresponding to $C = 116.51$ jars. The test is not referred to here as being one of the conventional tests, but it is because it serves to check up one of the

mately so over the range of capacity included in the graph, as may be seen from the following reasoning:—

$$f_0 = \frac{I}{2\pi\sqrt{LC}} \text{ is constant.}$$

The oscillator frequency

$$f = \frac{I}{2\pi\sqrt{L(C-\delta C)}} = \frac{I}{2\pi\sqrt{LC\left(1-\frac{\delta C}{C}\right)}}$$

Hence

$$\delta f = \frac{\delta C}{2C} \cdot f_0$$

∴ $\delta f/\delta C = f_0/2C = \text{constant}$, if we assume that the variation of C over this range is very small.

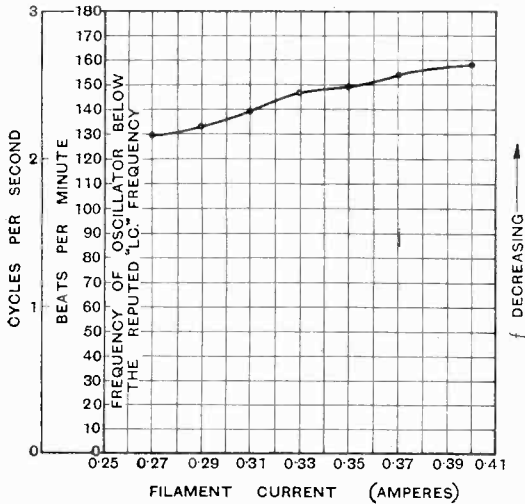

Fig. 6.—Deduced curve from curves in Fig. 5. Frequency variation with filament current. V_a , 63 volts; $G.B.$, 1.5 volts; coupling, 21 cms.; $67.4^\circ F.$, room; $64.8^\circ F.$, fork.

Hence by extrapolating the curves as straight lines we get an approximate value of frequency departure when $C = 116.51$ jars for each particular filament current.

These values are plotted in a curve in Fig. 6 and are seen to agree to some extent with the curve A in Fig. 11; the conditions of temperature and grid bias for the two curves are different. In this previous test the following were the conditions:—

- Anode voltage = 63 volts.
- Anode current = 1.6 mA.s (1.8 volts on filament).
- Grid bias = 1.5 volts.
- Grid coupling = 21 cms. (i.e., $M = 142$ mH.s).
- Fork temperature = 64.8 deg. F.
- Room temperature = 67.4 deg. F.

From this curve we find that the frequency f of the oscillator is below the "LC" frequency f_0 by an amount varying from 129 to 158 beats per minute according to the filament current, i.e., about $2\frac{1}{2}$ cycles per second below the "LC" frequency. We will discuss

this result in the light of the theory just evolved in a later sub-section.

(d) *Expected Accuracy of Results.*

The beats in the telephones can be heard distinctly and counted accurately up to about 180 beats per minute. This was found difficult at first, but by counting in tens and making a mark on paper for each ten the counting became automatic and fairly accurate. In the resistance adding test the frequency departure was as high as 256 beats per minute for some of the measurements. This required extreme concentration and was accomplished by counting consecutive fours up to ten so that pencil marks were made at each forty and counted afterwards. The third figure had to be guessed at in this case.

The experimental frequency departure from the reputed "LC" value was never much smaller than 120 beats per minute (i.e., 2 cycles per second), and the actual variation of frequency over one curve was never greater than 45 beats per minute (or 0.75 cycles per sec.) except in the case of resistance variation in the oscillatory circuit, when the frequency variation was as much as 110 beats per minute (or 1.8 cycles per second). For each curve the temperature

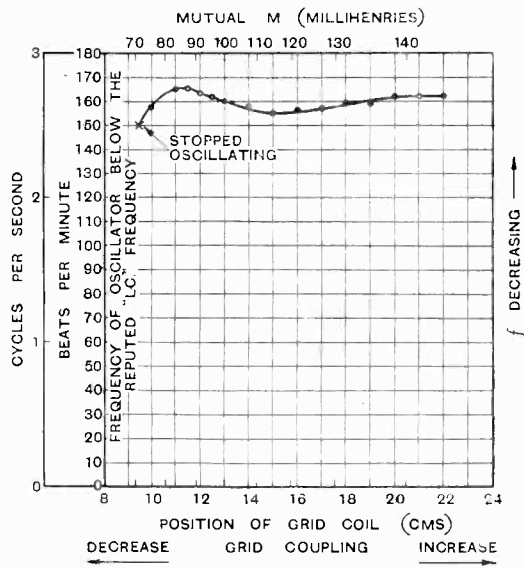

Fig. 7.—Frequency variation with grid coupling. $H.T.$, 60 volts; $L.T.$, 2 volts; $G.B.$, 1.5 volts; $65^\circ F.$, room; $63.2^\circ F.$, fork.

variation in the constant temperature cell was very small, as the whole curve was taken in about 20 minutes and so the error between consecutive readings on one curve may be considered negligible. Curves as a whole, however, and the frequency determination of the fork were taken on different days and the maximum temperature range in the cell over some weeks must now be considered, *i.e.*, about 6 deg. F. or 3.33 deg. C. Hence maximum frequency variation of fork in this time (taking Dye's figure) is 3.33×1.15 parts in 10,000, *i.e.*, 3.83 parts in 10,000, or 0.049 cycles in 128, *i.e.*, 0.245 cycles in 640 cycles.

Our minimum frequency departure obtained by experiment is 120 beats per minute (or 2 cycles per second), so that our possible error in frequency departure measurement due to temperature changes alone may amount to as much as 0.245 cycles in 2 cycles, *i.e.*, 12.25 per cent., which is quite considerable. The necessity for a really constant temperature cell in future investigations is again stressed in the light of these figures. We must remember at the same time that we assume our f_0 exactly correct (this depends on measurements of L and C). The frequency departure as we have just determined it is $2\frac{1}{2}$ cycles below the f_0 frequency. That is, we have measured $2\frac{1}{2}$ cycles in 640 or 0.39 per cent. So far we have assumed that L and C are set so that the reputed "LC" frequency will correspond exactly with 638,706... cycles; but can we measure L and C sufficiently closely to guarantee accuracy to within even 0.39 per cent., let alone exactness?

$$\text{Now } f_0 = \frac{1}{2\pi\sqrt{LC}}$$

$$\begin{aligned} \text{and } f_0 + \delta f_0 &= \frac{1}{2\pi\sqrt{(L + \delta L)(C + \delta C)}} \\ &= \frac{1}{2\pi\sqrt{LC}\sqrt{1 + \frac{\delta L}{L} + \frac{\delta C}{C}}} \\ &= f_0 \left\{ 1 - \frac{1}{2} \left(\frac{\delta L}{L} + \frac{\delta C}{C} \right) \right\} \end{aligned}$$

$$\therefore \delta f_0 = -\frac{1}{2} \left(\frac{\delta L}{L} + \frac{\delta C}{C} \right).$$

So if we have the true C and L values both greater than the measured values by 0.39 per cent. the real f_0 will be 0.39 per cent. lower than it was thought and our measured

frequency departure would be about zero. It is possible that even greater error exists in the L and C measurement so that although we find experimentally that the oscillator frequency is below the "LC" frequency, it may quite conceivably be above. If we are to be able to determine experimentally the exact frequency departure positive or negative we must have extremely accurate values of L and C , say 1 or 2 parts in 10,000. This would necessitate very refined work and would require a constancy of conditions, measurements all being made *in situ* and at the same temperature and frequency. The need for such extreme refinement was not realised at the time of measuring L and C , and so although very great care was taken in getting accurate values the foregoing precautions were not taken. The frequency at which the measurements were made was about 700 or 800, the temperature was not the same, and the measurements were not made with the whole apparatus assembled in position. The condensers were measured assembled together with the leads, and it had been thought that this would be sufficiently accurate. The method used was the Carey Foster Bridge and great care was taken to use suitable values of resistances as recommended in Hague's "A.C. Bridge Measurements." Readings were taken with the condensers in parallel adjusted to give a capacity near about the required C value. Any necessary adjustments could then be made on one of them (a finely variable 2-jar condenser, calibrated by comparison with a standard air condenser) to give as accurate a value as possible for the fixed C . The values were probably accurate to about 5 parts in 10,000. L was measured using a 100,000 μ H. mutual inductometer with a 10-to-1 step-up ratio. The mean of several readings was accepted and could be relied upon to about one part in 1,000 only, in spite of a well-tuned galvanometer and careful readings. Self-capacity of the inductance coil should not be large at this frequency especially as the windings are sectionalised.

Let S be the self capacity.

- L_m the measured value of L .
- C_m the measured value of C .

The effect of S is to make $L_m >$ true L , and $C_m <$ true C .

Hence the tendency to obtain a false "LC" value due to self-capacity should not be very great.

The foregoing remarks are fully stressed at this period so that when work is continued on this subject sufficient accuracy is made to determine with confidence the exact frequency departure above or below the "LC" frequency.

In Fig. 10 are shown 2 curves which were taken on different days, but with the same conditions, but for the fact that the temperature differed by 2 deg. F. If we adopt Dye's experimental value we would assume that the tuning fork frequency had decreased slightly by 0.082 cycles per sec., as the temperature had increased (since we have previously estimated a change of 0.245 cycles for 6 deg. F.). On day A the fork temperature was 67.0 deg. F., and on day B, 69.0 deg. F., and on day B, f_0 had decreased by $0.082 \times 60 = 4.9$ beats per minute. Now in all the curves obtained, the oscillator frequency is below the reputed "LC" frequency, f_0 . So if f_0 decreases slightly by 4.9 beats per minute on day B, we should expect curve B to be identical with curve A in shape, but nearer to the "LC" frequency by 4.9 beats per minute. In practice, the curves were not quite identical, probably owing to instability at the low coupling values, but at the stable end towards the right we see that the practical results do agree with our theoretical expectations, for the curve B is nearer to f_0 than curve A by about 5 beats per minute. This result lends some support to the use of Dye's figure in the case of low-frequency forks. In the absence of further information on low-frequency forks, we accept this figure as being applicable to the present 128 cycle fork in use, viz., 1.15 parts increase in 10,000 for 1 deg. C. decrease in temperature.

(e) Approximate Theoretical Values.

It will be helpful here to estimate roughly the numerical values of the various terms of the equation 7, given in the theory in sub-section (b).

Now $C = 0.128 \times 10^{-6}$ farads.

$L = 0.484$ henry.

$L_1 = 0.14$ henry.

$M = -0.073$ to -0.14 henry.

$$\left. \begin{aligned} \mu &= 7.4 \\ R_a &= 18,530 \text{ ohms.} \end{aligned} \right\} \begin{array}{l} \text{Particular values} \\ \text{from Static} \\ \text{Characteristic.} \end{array}$$

$$R_g = 10^4 \text{ to } 10^5 \text{ ohms (say).}$$

$$R = 19 \text{ ohms.}$$

Half of these figures are variable according to the conditions prevailing, so it is difficult to get any accurate calculations on the matter, but our purpose at present is to see the relative importance of the terms.

We will take M at the 0.14 value (corresponding to 21 cms.) and R_a at 20,000 ohms, though it is probable that this value increases considerably when oscillations are

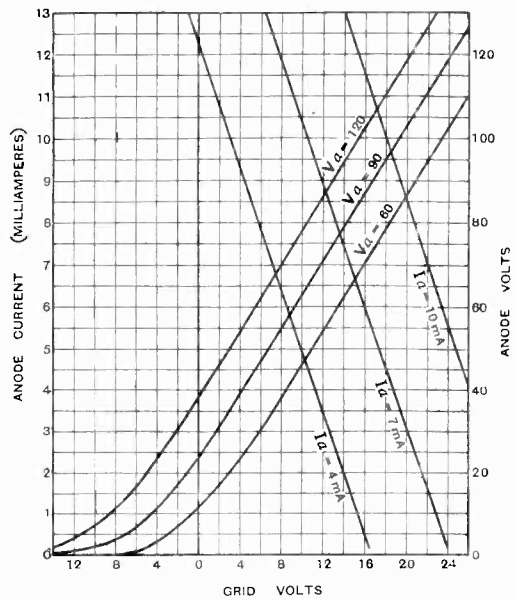

Fig. 8.—Characteristics of Marconi D.E.R. (The Thermionic Oscillator.)
 $\mu = 7.4, R_a = 18,530 \text{ ohms.}$

set up and the amplitude increases. Take R_g at 10^4 ohms, say. Then:—

$$\frac{R}{R_a} \approx 0.001.$$

$$\frac{M^2}{LCR_a R_g} \approx 0.0016.$$

$$-\frac{\mu}{R_a} \cdot \frac{ML_1}{R_g} \cdot \frac{1}{LC} \approx 0.0114.$$

It is thus obvious that the bottom right-hand term of the ω^2 equation is the important factor in the frequency variation.

We must bear in mind continually, however, that conditions are never constant, both R_a and R_g probably varying to a great extent as oscillations are set up. However, the aforementioned term will still be the important term, and we should look there mainly for an explanation of the various frequency changes. Frequency roughly estimated from above figures give :

$$\begin{aligned}
 f &= f_0 \sqrt{\frac{1 + .001}{1 - .0016 + .0114}} \\
 &= f_0 \sqrt{1 - .0088} \\
 f &= f_0 (1 - .0044)
 \end{aligned}$$

That is, if we were to rely upon the above approximations we should expect a frequency departure, under certain conditions, of :—

$$0.0044 \cdot f_0 \text{ below } f_0$$

i.e., about 0.0044×640
 $= 2.8 \sim$ or 170 beats per min. below f_0 .

In actual practice assuming the "LC" measurement to be sufficiently accurate, the frequency departure varied from about 120 to 160 beats per minute below the f_0 .

If we deduce the critical M from equation 2.

$$\begin{aligned}
 M &= -\frac{1}{\mu} (CRR_a + L) \text{ for no grid current.} \\
 &= -\frac{1}{7.4} (.0452 + .4845) \\
 M &= -0.073 \text{ henry}
 \end{aligned}$$

This agrees rather well with the experimental value, as we might expect seeing that conditions before oscillation are quite steady and therefore the above values apply. In Fig. 7 it may be seen that oscillations commence at 9.5 cms. grid coupling, or 71.5 mH.'s.

Assuming grid current the equation is as in 8.

$$M = -\frac{1}{\mu} \left(CRR_a + L + \frac{M^2 R_a}{LR_g} \right)$$

$\frac{M^2 R_a}{LR_g}$ is approximately 0.012 taking $R_g = 10^4$ and M about 0.073. Then $M = 0.0745$ henry.

(f) *Grid Coupling and Grid Bias.*

The first conventional test in which the frequency departure was measured direct,

the capacity being constant at C , was made while determining the effects of variable grid coupling. In this case the H.T. voltage was still only 60.

Conditions were :

$$\begin{aligned}
 V_a &= 60 \text{ volts.} \\
 V_f &= 2 \text{ volts.} \\
 I_a &= 1.68 \text{ mA.'s.} \\
 I_f &= 0.4 \text{ amp.}
 \end{aligned}$$

The curve is shown in Fig. 7. It is rather curious in virtue of the increase in the number of beats as the mutual increases, then the crevasse, and finally a rise in the curve to a more or less steady value. The oscillator ceased to oscillate when the grid coil was withdrawn as far as 9.5 cms. The corresponding mutual at 9.5 cms. is 71.5 mH.'s. A true explanation of the shape of the curve is not possible owing to the variability of the μ , R_a and R_g terms in the frequency equation :

$$f^2 = f_0^2 \frac{1 + R/R_a}{\left\{ 1 - \frac{M^2}{LCR_a R_g} + \frac{\mu}{R_a} \frac{(-M)L_1}{R_g} \frac{1}{LC} \right\}}$$

We can, however, assume certain changes and see whether the results based on these hypothetical occurrences agree with actual fact.

The chief point to bear in mind is that as the value of M increases, the amplitude of oscillation increases and R_a will increase, R_g will decrease, and $\frac{\mu}{R_a}$ or G will decrease.

When oscillating strongly, grid current will be increased, indicating that R_g is small, but when only just oscillating, R_g is probably large. Hence we may say generally that the importance of the $\frac{\mu}{R_a} \cdot \frac{ML_1}{R_g} \cdot \frac{1}{LC}$ term is considerably lessened when oscillations are weakened or when large grid bias is employed, but becomes quite important when oscillations are strengthened.

In the curve on Fig. 7 there is a sudden rise at the beginning when oscillations are just commencing, indicating a decrease in frequency. This is probably due to the increase in R_a which lessens the R/R_a term in the numerator. Now R_g decreases and so the effect of the $\frac{\mu}{R_a} \cdot \frac{ML_1}{R_g} \cdot \frac{1}{LC}$ term becomes felt. M is negative, so an increase in R_a will

cause an increase in f due to this term, and this term is becoming continually more important until R_g settles down to a steady value. Oscillations now being strong, there is probably little further change in R_g , and the

If we consider the R_g term in the critical M equation as negligible at 15 volts G.B. and work out the value of R_a corresponding to a critical value of $M = 92$ mH.'s we get 80,800 ohms for R_a ; but this is only true if μ remains constant, which it most probably does not. So that the calculation for the new R_a is not of much value. Looking at the D.E.R. characteristic for 120 volts we can see that at 15 volts G.B. the sphere of operations is well out on the bottom bend, and this would cause the average slope $\frac{di_a}{dv_g}$ to be very much decreased, i.e. G is decreased, or $\frac{\mu}{R_a}$.

Curves of frequency departure with varying grid coupling are shown for different values of grid bias in Fig. 9. The left-hand end of each curve indicates the point at which oscillation ceased. The curves were all taken at the same temperature, so we see that the effect of a very large grid bias is to decrease the frequency departure from the

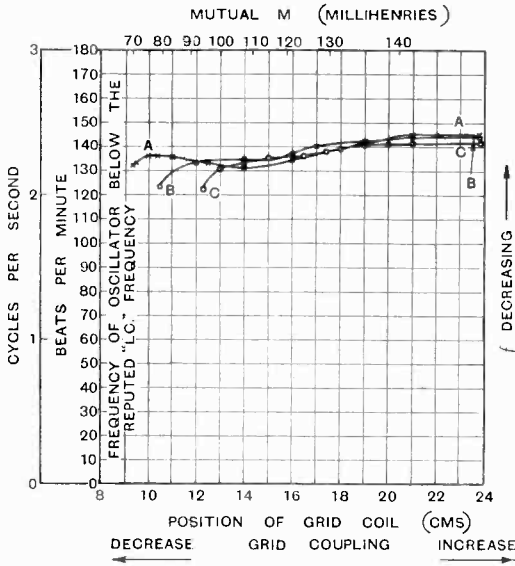

Fig. 9.—Frequency variation with grid coupling at different grid bias. H.T., 120 volts; L.T., 1.8 volts; 72.2° F., room; 69° F., cell. Curve A, G.B. 6 volts; Curve B, G.B. 9 volts; Curve C, G.B. 12 volts.

slight decrease in frequency which now takes place is due to the slight increase of $-M$ in the large term in the denominator as the coupling is increased.

The conditions of the circuit were now standardised so that there would be as few variables as possible at one time. The H.T. was made 120 volts (the dial boxes allowing for the required variations in anode potential), and in view of the appreciable grid current the grid bias was increased. With large grid bias the critical value of M is raised, due to increase of anode resistance, and the oscillator would only oscillate over a small range of variation of grid coupling.

At 15 volts G.B., 120 volts H.T., it would only oscillate above the 12 cms. setting; i.e., $M > 92$ mH.'s.

At 6 volts G.B., 120 volts H.T., it would oscillate as before above the 9.5 cms. setting; i.e., $M > 73$ mH.'s (grid current was about 13 μ A.).

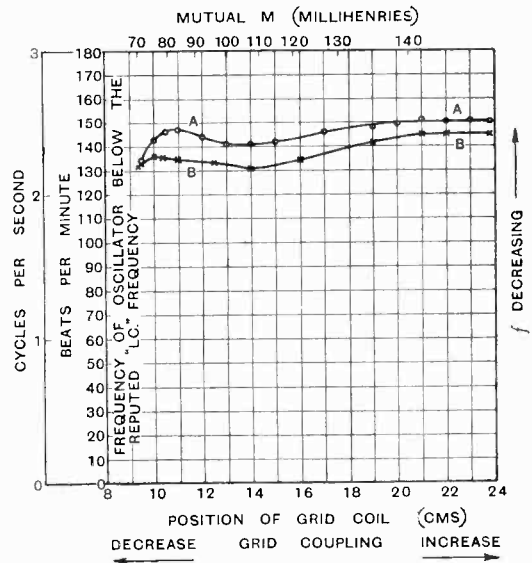

Fig. 10.—Frequency variation with grid coupling at different temperatures. H.T., 120 volts; L.T., 1.8 volts; G.B., 6 volts. Curve A, 69.5° F. room, 67.0° F. cell; Curve B, 72.2° F. room, 69.0° F. cell.

“LC” frequency f_0 ; that is, the frequency of oscillations is slightly higher. This is accounted for when we remember that

both R_a and R_v are larger at the big grid bias value, and this reduces the important term in the denominator and so decreases the frequency departure. Calculation of numerical values becomes difficult when we

for all other conditions were the same for both curves. The frequency difference has been previously dealt with and is accounted for by change in f_0 . If the tuning fork temperature had been kept absolutely constant while the room temperature had varied, a conclusive test could have been made as to whether the oscillator frequency was affected by temperature.

(g) Filament Current.

Tests were now made with filament current variations instead of grid coupling, and the curves are shown in Fig. 11 for the conditions:—

- H.T. volts = 60
- Grid Bias = 6 volts.
- Room Temperature = 72.2 deg. F.
- Fork Temperature = 69.0 deg. F.
- Grid Coupling = (A) 23 cms. and (B) 13 cms.

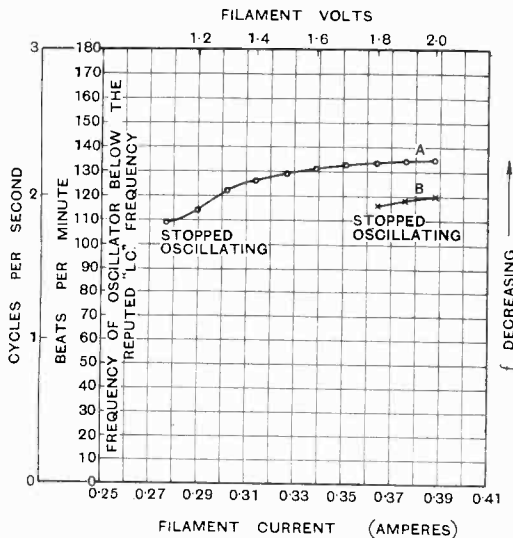

Fig. 11.—Frequency variation with filament current at different grid coupling. H.T., 60 volts; G.B., 6 volts; 69° F. fork; 72.2° F., room. Curve A, 23 cms. G.C.; Curve B, 13 cms. G.C.

consider that μ , R_a and R_v are all involved as well as M . The curves indicate that the conditions of larger grid bias lead to a smaller frequency variation.

In the case of a large grid bias curve there seems to be less instability, and readings when repeated proved to be almost identical.

Readings of anode current when oscillating gave:—

- 3.2 mA.'s at 6 volts G.B. } 120 volts
- 2.9 mA.'s at 9 volts G.B. } H.T.
- 2.4 mA.'s at 12 volts G.B. }

It is suggested that for future work accurate readings be taken of the anode milliammeter, so that every variation is recorded. At the time of taking the measurements the above readings seemed relatively unimportant, but a full set of readings would have given us the oscillating characteristic of the valve, and the R_a changes would have been made clearer when reference was made to both the static and oscillating characteristics.

The curves in Fig. 10 indicate the difference in frequency due to temperature change,

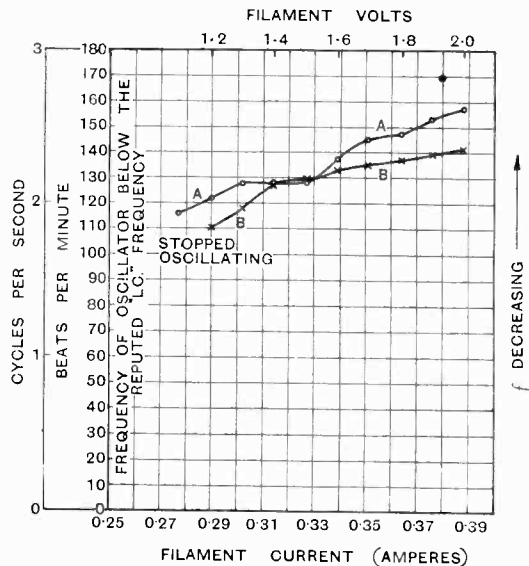

Fig. 12.—Frequency variation with filament current at different grid coupling. H.T., 120 volts; G.B., 6 volts; 69° F., fork; 72.2° F., room. Curve A, 23 cms. G.C.; Curve B, 12 cms. G.C.

Two more curves are given in Fig. 12, the conditions being:—

- H.T. volts = 120
- Grid Bias = 6 volts.
- Room Temperature = 72.2 deg. F.
- Fork Temperature = 69.0 deg. F.
- Grid Coupling = (A) 23 cms. and (B) 12 cms.

We see that the general tendency is for the frequency to decrease as the filament current increases. R_g decreases as the filament current increases and μ/R_a or G increases, provided that the amplitude of oscillations remains the same. When, however, the amplitude increases to a great extent, G will tend to decrease.

In curve *B* of Fig. 11, the circuit is only just oscillating, so that probably the amplitude is not forced to a great value, and G does not tend to decrease. Instead, G increases and R_g decreases as the filament current increases, and so $\frac{\mu M L_1}{R_a R_g} \cdot \frac{1}{LC}$ increases and the frequency decreases. The same is the case for curve *A* in Fig. 11, but more so at first owing to the increased value of M . As the oscillations become stronger the amplitude increases and G tends to decrease and counterbalance the decrease of R_g . The result is that the curve approaches the horizontal. It is probable that the peculiar shape of the curves in Fig. 12 is also accounted for in this manner, the horizontal portion may correspond to reduction in G due to increased amplitude, and the rising portions may correspond to increase in G as the amplitude remains steady for a time, tending to decrease as the filament temperature increases. Again, the frequency change is not so great at the lower coupling value.

(h) Anode Voltage.

The change of frequency with anode voltage variation is shown in Fig. 13. The conditions were:—

- Filament volts = 1.8
- Grid Bias = 6 volts.
- Room Temperature = 72.2 deg. F.
- Fork Temperature = 69.0 deg. F.
- Grid Coupling = 23 cms.

The oscillations are strong over the whole range, but die off rapidly at 50 volts, so that we may expect a constant value of G right from the time that the oscillations commence at the 50-volt value and the amplitude builds up. But if we look at the characteristic we note that increasing V_a tends to straighten out the curve and so G increases as V_a increases. In addition, R_g increases to a slight extent as V_a increases, and so diminishes the effect of G in

increasing the value of the term $G \cdot \frac{ML_1}{R_g LC}$.

Hence we should expect only a slight decrease of frequency as anode voltage increases, and this was obtained in the curve in Fig. 13. It would be interesting to see the effect at a smaller mutual value, and also at different values of grid bias; time, however, did not permit of further curves being taken. The anode current at 50 volts when not oscillating was 0.5 mA., and at 127 volts when oscillating very strongly was 3.4 mA.'s. Unfortunately, other readings were not obtained. Referring to the anode current figures referred to in sub-section (f) we see that at 120 volts the horizontal portion of the oscillating characteristic is about 3.3 mA.'s (obtained by

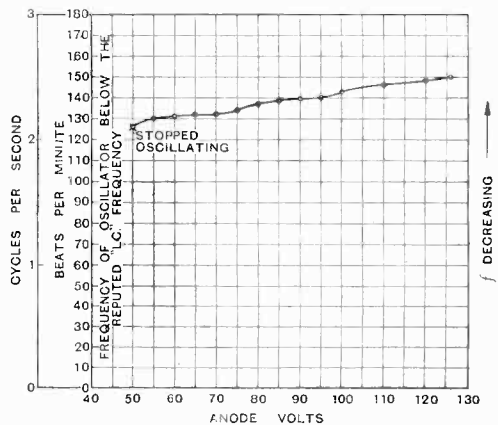

Fig. 13.—Frequency variation with anode voltage. L.T., 1.8 volts; G.B., 6 volts; 72.2° F., room; 69.0° F., cell; 23 cms. G.C.

plotting values given). It would have been useful to know the continuation of this horizontal portion for increasing positive grid potential.

(k) Resistance in the Oscillatory Circuit.

Curves were obtained by adding non-inductive H.F. resistances in the oscillatory circuit and noting the frequency variation. Curves were taken at two values of grid coupling, viz., 23 cms. (0.115 henry) and 13 cms. (0.1 henry). If R were the only alteration we should expect an increase in frequency, but from the maintenance equation: $M = -\frac{1}{\mu} \left(CRR_a + L + \frac{M^2 R_a}{LR_g} \right)$, we see that if R increases, then to maintain the

critical M at the same value a reduction must take place in R_a : this is accomplished by a reduction in the amplitude of oscillations. The result is that the frequency decreases due to the increase in the large term of the denominator of the equation 7. A reduction of the amplitude probably reduces the grid current and so increases R_g with further increase of R ; this tends to diminish the decrease in frequency, thus producing the horizontal portion of the curve. With still further increase of R , decrease of amplitude brings about no further reduction of R_a or increase of R_g , and so the critical value of M is not satisfied and oscillations cease.

The curve taken with a smaller grid coupling (13 cms.) indicates a higher frequency, as might be expected from foregoing results, and also indicates cessure of oscillation at a lower value of added resistance than in the case of the higher coupling (23 cms.). The frequency departure was too large to count above 70 ohms added resistance, so that actual value of added resistance at which oscillations ceased was not obtained for the higher coupling curve. The curves indicate how careful one must be in estimating frequency changes, to consider all the variations which are likely to take place. The general tendency would have been to expect a frequency increase

owing to the term $(1 + \frac{R}{R_a})$, and the more important term in the denominator not involving R might have been neglected. The effect of increasing grid bias and so increasing R_g to a large value would have been interesting to see, and it is expected that the slope of the curve would in consequence have been diminished or even reversed. Once again the effect of grid bias in reducing frequency variation is brought to light. The difficulty in making tests as desired above, lies in making the oscillator oscillate under non-favourable conditions. In this connection it would have been more suitable to have adopted a higher frequency than 640 cycles, say, 896 or 1,024 cycles, for the oscillator was more suitable for oscillating at such higher frequencies.

V.—Conclusion.

(a) *Criticism of the Method.*

The method has been established as a

practical one by the foregoing work, and results are readily obtainable; the investigations do not pretend, however, to be an exhaustive study in the vast field of valve oscillator frequencies, but a large amount of ground has been covered, and the ice broken for further research on this subject. The method is quite a new one, previous investigations being carried out by capacity variations, whereas in this case the practical condition has been satisfied of keeping the "LC" value constant and actually counting the frequency departure as different conditions are imposed. The method has

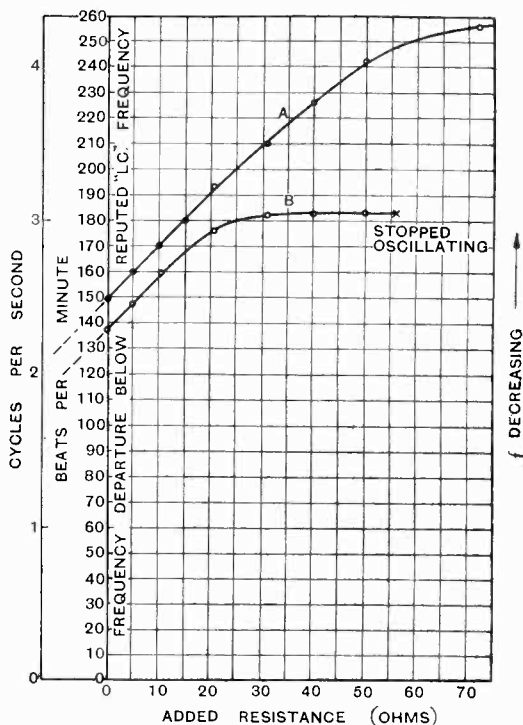

Fig. 14.—Frequency variation with added resistance in the oscillatory circuit. V_a , 120 volts; V_f , 1.8 volts; $G.B.$, 6 volts; $72.2^\circ F.$, room; $69^\circ F.$, fork. Curve A, 23 cms. G.C.; Curve B, 13 cms. G.C.

proved that the actual frequency variation can be determined very accurately. By taking one minute over each reading we can determine small changes of the order of 1 beat per minute if conditions are made suitable, i.e. $\frac{1}{80}$ cycle in 640, or 1 in 40,000 change. Hence we see the desirability of a constant frequency source which

TABLE OF RESULTS.

(a) GRID COUPLING.

FIG. 7.		FIG. 10A.		FIGS. 10B/9A.		FIG. 9B.		FIG. 9C.	
Cms.	Bts./Min.	Cms.	Bts./Min.	Cms.	Bts./Min.	Cms.	Bts./Min.	Cms.	Bts./Min.
9.5	150	9.5	134	9.4	132	—	—	—	—
10	157	10	143	9.5	133	10.5	123	12.3	122
	159								
10.5	157	11	147	10	136	12	133	13	130
	163	12	144	10.4	135.2	14	134	14	132.5
11	165	13	141	11	135	15	134	15	135
12	166	14	141			136	16.5	136	
13	163	15	142	12.5	133.2	16	137	17.4	138
14	160	17	146	14	131	17	140	18	138
14	158	19	148	16	134.5	19	142	19	141
15	154	20	149	19	141.5				
	155	21	151	21	145	141	20	141	
155.5	22	150	21	145	21	144	21	141.2	
17	157	23	150.3	22	145	23.8	144.5	23.8	141.5
18	159	23.8	150	23.8	145				
19	159								
20	162								
21	162								
22	162								

(b) ANODE VOLTAGE.

FIG. 13.	Volts	127	127	120	110	100	100	95	90	85	80
	Bts./Min.	152	150	148	146	142.5	143.5	140	139.5	138.5	136.5
	Volts	80	75	70	65	65	55	60	60	52	50
	Bts./Min.	137.5	134	132	133	132	130	131	130.5	124	126

(c) FILAMENT VOLTAGE.

FIG. 11A.		FIG. 11B.		FIG. 12A.		FIG. 12B.	
Volts.	Bts./Min.	Volts.	Bts./Min.	Volts.	Bts./Min.	Volts.	Bts./Min.
1.1	109	—	—	1.1	116	—	—
1.2	114	—	—	1.2	121.5	1.2	110
1.3	122	—	—	1.3	127.5	1.3	118
1.4	126	—	—	1.4	128	1.4	127
1.5	129	—	—	1.5	128	1.5	129
1.6	131	—	—	1.6	137	1.6	133
1.7	132.5	—	—	1.7	145	1.7	135
1.8	133.5	1.8	116	1.8	147.2	1.8	137
1.9	135	1.9	118.5	1.9	153	1.9	139
2.0	135	2.0	120	2.0	157	2.0	141.3

(d) RESISTANCE ADDING.

FIG. 14A.	Ohms	0	5	10.36	15.36	20.75	31	41.67	50	72
	Bts./Min.	149	160	170	180	193	205	226	242	256
FIG. 14B.	Ohms	0	5	10.36	—	20.75	31	41.67	—	—
	Bts./Min.	137	147	159	—	176	182	183	—	—

can be relied upon to 1 or 2 parts in 100,000. While there has been little doubt in the accuracy of the recorded frequency variation, there has been some doubt over the actual value of the frequency departure from the "LC" frequency, or, in other words, over the exact location of the base line in the curves, and this has been thoroughly dealt with in the article. Numerical values have been introduced in some cases to account for the practical results from the theoretical point of view, but in most cases these are not relied upon owing to complications arising from variations of R_a , R_v , and μ , and the consequent uncertainty in their actual value; they do agree, however, to a rough extent with the practical results. It is to be regretted that the oscillator was not worked at a higher frequency, so that variations of a greater range could have been imposed without causing the oscillations to cease.

(b) Suggestions for Further Research.

In the article various suggestions have been made on certain points in which experience has indicated the necessity for certain precautions or modifications. The chief suggestion is that the tuning fork should be of a non-expansible alloy and enclosed in a reliable constant temperature cell fitted with an automatic heat-regulating device. In this way one variable is eliminated and more direct results can be established.

The question as to whether a higher frequency fork is really desirable is a matter of compromise. It will be far easier to maintain the fork, but decidedly more difficult to synchronise the phonic wheel. It is true that only one or two readings would have to be made during which the phonic wheel will have to run, but it may take days or even weeks of trouble just to get these one or two readings. What is required is a light phonic wheel of rigid

construction, and a very small air gap between the rotor and stator poles. With a higher frequency fork the output voltage to the motor will be greater, and this will partly make up for the higher voltage necessary at the higher frequency of the motor supply. It is to be hoped that research may be made on the synchronous motor of this type, so that definite information is forthcoming as to the suitability of a distorted wave form or otherwise for the motor supply.

The influence of earth connections on the frequency of the maintained fork should be gone into thoroughly, and it is to be regretted that time did not permit of a further frequency determination at a suitably different temperature and circuit arrangement in the present case.

Emphasis is laid on the necessity for very refined measurements on the L and C values, so that dependable values for the actual frequency departure may be obtained.

In connection with the oscillator tests, there is a vast amount of work to be done. Continuing on this oscillator, the frequency could be increased to about 1,000 cycles, so that a larger range of variations could be imposed without the oscillations ceasing. The anode tap might be introduced arranging for L and C still to give the same value of f_0 the "LC" frequency and comparing with previous results. Following this, the frequency may be increased in stages up to the radio frequencies when new factors such as self-capacity would enter into consideration. Tuned grid circuits may be investigated in the same way. In working out numerical values, a knowledge of R_a and R_v would greatly help. A device in the form of an oscillograph might be arranged so that some idea of the R_a changes can be obtained; also anode current readings should be taken for every test made, and the oscillating characteristic of the valve obtained.

Abstracts and References.

Compiled by the Radio Research Board and reproduced by arrangement with the Department of Scientific and Industrial Research.

PROPAGATION OF WAVES.

KURZWELLENECHOS, DIE MEHRERE SEKUNDEN NACH DEM HAUPTSIGNAL EINTREFFEN, UND WIE SIE SICH AUS DER THEORIE DES POLARLICHTES ERKLÄREN LASSEN (Short Wave Echoes arriving Several Seconds after the Main Signal, and How they can be Explained by the Polar Light Theory).—C. Störmer. (*Naturwiss.*, 16th August, 1929, Vol. 17, pp. 643-651.)

This consecutive account of the incidents referred to in various previous Abstracts recalls how the writer's "toroidal space" theory led him to prophesy, in the issue of *Nature* for 5th January, 1929, that no more long-time echoes would be heard until mid-February (March Abstracts, p. 144). No echoes were heard until 14th and 18th February, when they were heard by Hals near Oslo, and in Bodö respectively, and on 16th February Appleton and Borrow in London heard echoes with delays up to 25 secs. and lasting over 2 secs. The writer not unnaturally concludes that these results confirm his theory. The rest of the paper deals with an exposition of this theory and the calculations on which it is based. The writer urges international co-operation in investigating the phenomena, on wavelengths other than 31.4 m., oscillographic methods being highly desirable. Observations during the occurrence of polar light and of magnetic storms would be especially valuable. A postscript announces that Ferrié reports numerous long-time echoes in Indo-China during and after the solar eclipse of 9th May. The delays were very often between 15 and 30 secs. and the echoes were sometimes very strong and often multiple.

LONG DELAYED RADIO ECHOES.—P. O. Pedersen. (*Nature*, 27th July, 1929, Vol. 124, p. 164.)

Summary of a paper in English communicated to the Danish Royal Society. According to the writer, Störmer, Wagner and he himself believe that the short-wave long-time echoes are caused by reflection from swarms of electrons out in space, whereas van der Pol, Appleton and Ardenne assume that the long delay is due to special conditions in the Heaviside layer, Ardenne assuming that in some cases the waves travel round the earth some hundreds of times. The writer gives mathematical proof to show that the long delayed echoes cannot arise either by the propagation of waves within the earth's atmosphere or by the waves travelling outside the latter in a medium so strongly ionised that the group velocity of the electrons approaches zero. The assumption is made that all waves shorter than about 3 m., will penetrate into space with very little attenuation. At noon, all waves longer than about 20 m. are completely reflected or refracted back to earth.

At midnight the waves must be longer than 70 m. to be reflected back. The lengths vary appreciably with the ionisation of the upper atmosphere. The writer concludes that echoes occurring after intervals from 10 up to 30 seconds are probably due to propagation along or reflection from Störmer's swarms or bands of electrons in space. In the case of intervals of several minutes, these bands must be outside the space in which the magnetic field of the earth exerts any appreciable direct influence.

PENETRATION OF ROCKS BY ELECTROMAGNETIC WAVES.—A. S. Eve, D. A. Keys, F. W. Lee. (*Nature*, 3rd August, 1929, Vol. 124, pp. 178-179.)

To settle the somewhat conflicting results in the Mount Royal Tunnel tests (May Abstracts, p. 263) where complications were introduced by the presence of wires, rails, etc., more researches were made in the Mammoth Cave, Kentucky. Waves of the broadcasting zone can certainly give good signals under 300 ft. of sand- and lime-stone, without possible entrance by an opening or by conductors. Long-wave stations gave the same bearings above ground and under 300 ft. of rock, so that apparently they travel through rock with front mainly vertical just as through the air. Preliminary results on waves of horizontal front strongly suggest that 20-30 kc. frequencies pass through the rock with much less absorption than 40-100 kc. Using audio-frequencies, it was found that the electromagnetic effects of a 500-cycle frequency passed through 900 ft. of continuous rock. The resistivities of these rocks *in situ* were found by electrical prospecting methods to be of the order of 10,000 to 20,000 ohm/cm.

SUR LA PROPAGATION ET LA DÉTECTION DES ONDES COURTES—10 À 18 CM. (The Propagation and Detection of Short Waves—10 to 18 cms.)—E. Pierret. (*Journ. de Phys. et le Rad.*, No. 2, 1929, Vol. 10, pp. 31 S-32 S.)

Experiments on absorption, reflection, stationary waves, polarisation by wire grids, refraction by paraffin prisms and glass lenses, total reflection, etc., etc. See same author and also Beauvais, March Abstracts, p. 149.

EXPERIMENTS IN RECORDING RADIO SIGNAL INTENSITY.—L. W. Austin. (*Proc. Inst. Rad. Eng.*, July, 1929, Vol. 17, pp. 1192-1205.)

The paper read at the 1928 U.R.S.I. meeting. Author's abstract:—"The paper describes briefly the method of recording the strength of long-wave radio signals used at the Bureau of Standards and gives some of the results obtained. The curves shown indicate the great variability of the wave

propagation both in regard to strength and the angle of incidence of the downcoming wave. This variability appears to be greater for transmission distances below 1,000 km. than for greater distances.

An apparent connection is shown in certain cases between the night signal variations and magnetic storms. The observations seem to indicate that the downcoming waves are reflected (or refracted) from rapidly changing masses of ionized gas," forming an irregular and shifting lower surface and possibly at times thinning out or forming openings so that the rays may then pass to higher levels before being turned back towards the earth. The writer adds, however, that there is a difficulty in accepting this conception, as it would seem to imply the occurrence of rays striking the receiving system at times from the side which is not in the great circle plane joining the sending and receiving stations: "such rays would produce deviations in direction finding of a type which, according to the experiments of Smith-Rose with the Adcock direction-finder, should not exist."

RADIO RECEPTION AND SUN SPOTS.—H. T. Stetson : G. W. Pickard. (*Sci. News-letter*, 3rd August, 1929, Vol. 16, pp. 59-61.)

A popular article based on interviews with the two workers named. The fifteen-month sun-spot maximum is due about October, when broadcast reception will be as poor as in July, 1928. The 11-year general minimum is due in 1934, when reception will be exceptionally good, as it was in 1923—when broadcasting was first coming into popularity. But with certain wavelengths, solar activity improves rather than spoils reception, as Pickard has observed on 18-kilocycle waves. The effect of direction of travel is referred to briefly.

RELATION OF RADIO WAVE PROPAGATION TO DISTURBANCES IN TERRESTRIAL MAGNETISM.—I. J. Wymore. (*Bur. of Stds. Journ. of Res.*, June, 1929, Vol. 2, pp. 1201-1211; also *Proc. Inst. Rad. Eng.*, July, 1929, Vol. 17, pp. 1206-1213.)

See September Abstracts, p. 500. Author's summary:—" . . . The results show that for long-wave daylight reception over great distances (4,000-7,100 km.) there is, in general, a variable but definite increase in the intensity of the received signal following the height of severe magnetic disturbance. This increase reaches its maximum in from one to two days and disappears in from four to five days. For moderate distances (250 to 459 km.) there is an increase in the intensity of the received signals noticeable before as well as after the magnetic storm reaches a maximum. These changes in intensity cover periods from two to four days, both before and after the magnetic storm reaches its height." This summary does not very clearly correspond with the statements in the paragraph previously abstracted; but at the end of the paper, after giving a number of curves, the writer says that as regards low-frequency waves (15-24 kc.), daylight signals tend to behave as follows:—over long distances the intensity falls below normal for several days before the maximum magnetic disturbance, which is followed by a definite increase in strength from one to four

days after the storm; over moderate distances there is an increase above the average strength from two to four days before the disturbance with values below normal during the height of the storm, followed by a strong increase from two to four days after the storm.

EAST-WEST AND NORTH-SOUTH ATTENUATIONS OF LONG RADIO WAVES ON THE PACIFIC.—E. Yokoyama and T. Nakai. (*Proc. Inst. Rad. Eng.*, July, 1929, Vol. 17, pp. 1240-1247.)

Authors' summary:—A comparative study of low-frequency signals of high power stations in the Pacific area has been made, with particular reference to relative attenuation in north and south directions as compared with attenuations in east and west directions. A comparison of observed field strengths in microvolts per meter with the results calculated by various proposed formulas has been made. While the agreement is none too good with any of the formulas, the results indicate that east and west attenuation is decidedly greater than north and south during the daylight hours in the fairly high latitudes. They also indicate that in comparing observed results with different transmission formulas, due account must be taken of the type of experiments upon which the formulas in question were based. It is suggested that by the inclusion of terms in the formulas, depending upon both direction and latitude, it might be possible to construct or modify some of the existing formulas to fit the general case.

THE MEASUREMENTS OF THE FIELD INTENSITIES OF SOME HIGH-POWER LONG-DISTANCE RADIO STATIONS. IV.—Warsaw, Tananarive and Monte Grande.—E. Yokoyama and T. Nakai. (*Electrotech. Lab.*, Tokio, April, 1929, No. 258, 78 pp.)

FIVE-METER WORK.—C. H. West. (*Rad. Engineering*, June, 1929, Vol. 9, pp. 53-56.)

In the course of this article the writer describes some experiments tending to show that sunlight, or powerful artificial light, affect the transmitting aerial so that the transmitter radiates more energy than when the aerial is in darkness. Alternatively, he seems to suggest that possibly sunlight causes a change in the wavelength radiated.

ÜBER DIE AUSBREITUNG ELEKTRISCHER WELLEN UM EINE LEITENDE KUGEL (The Propagation of Electric Waves on a Conducting Sphere).—F. Breisig. (*E.N.T.*, July, 1929, Vol. 6, pp. 268-271.)

A defence of the main points of Kiebitz' theory of the propagation of waves over the earth's surface, which was condemned by Mesny and by Willstädter on the grounds that (while correct in its mathematical development) it led to consequences which were contradicted by fact. The writer attacks the question in a different way and arrives at the same results as those reached by Kiebitz, e.g., for a point in or near the surface of the sphere,

$$\mathcal{G} = \frac{\omega^2 Q l}{\sqrt{2} \cdot p}$$

where l is the length of dipole and Q its charge.

A STUDY OF THE VERTICAL GRADIENT OF TEMPERATURE IN THE ATMOSPHERE NEAR THE GROUND.—N. K. Johnson. (*Geoph. Mem. of the Met. Office*, No. 46, 1929.)

The construction, use and results are described of an apparatus for measuring the temperature at three levels up to 17 metres from the ground. The writer, from his observations, supports Chapman's conclusion (from Eiffel Tower observations) that the temperature changes are largely influenced by long-wave radiation.

ON THE CRITERION FOR STABILITY OF A LAYER OF VISCOUS FLUID HEATED FROM BELOW.—A. R. Low. (*Proc. Roy. Soc.*, 1st August, 1929, Vol. 125A, pp. 180-195.)

LA FILTRATION DU RAYONNEMENT SOLAIRE PAR L'OZONE ATMOSPHERIQUE (The Filtration of Solar Radiation by Atmospheric Ozone).—G. Déjardin. (*C. R. Séance. Soc. de Phys. de Genève*, No. 1, 1928, Vol. 45, pp. 43-44.)

The writer's Mont Blanc observations lead to the height of about 45 km. for the most concentrated region of the absorbing substance (which between 43500 and 43090 appears to be ozone). Below 42100 he concludes that the absorption is by layers of oxygen.

FORMATION OF OZONE IN ELECTRICAL DISCHARGE AT PRESSURES BELOW 3 MILLIMETRES.—J. K. Hunt. (*Journ. Am. Chem. Soc.*, January, 1929, Vol. 51, pp. 30-38.)

Among the results of these experiments may be mentioned:—the highest yield was 26 gm. per kw.-hour: a calculation on the basis of ionisation potentials indicated that the number of pairs of ions and the number of molecules of ozone produced were of the same order of magnitude, suggesting that the predominating mechanism of ozone formation may be one involving collision between monatomic oxygen ions and neutral molecules.

THE ALTITUDE OF THE OZONE LAYER.—J. C. McLennan, R. Ruedy, and V. Krotkov. (*Roy. Soc. Canada*, May, 1928, Vol. 22, pp. 293-301.)

The heights found are slightly higher than those given by Cabannes and Dufay.

MESSUNGEN DES OZONGEHALTES ÜBER LINDENBERG (Measurements of Ozone Content over Lindenberg).—P. Duckert. (*Beitr. z. Phys. d. freien Atmos.*, No. 4, 1928, Vol. 14, pp. 219-239.)

A summary, quoting some values obtained, is in *Physik. Ber.*, 15th May, 1929.

RELATIONS ENTRE LES TITRES EN OZONE DE L'AIR DU SOL ET DE L'AIR DE LA HAUTE ATMOSPHERE (Relations between the Ozone Values of Air at Ground Level and of Air of the Upper Atmosphere).—A. Lepape and G. Colange. (*Comptes Rendus*, 1st July, 1929, Vol. 189, pp. 53-54.)

Measurements at ground level at Paris from

1875 to 1908 would give (if the proportion were supposed to be constant throughout the atmosphere) an equivalent layer 1-2 hundredths of a millimetre thick. Measurements in the upper atmosphere at Arosa in 1927 give 2-3 mm. In spite of the great difference thus indicated between the ozone values at the two levels, the two sets of observations are intimately connected, both showing an annual variation with a maximum in the spring and a minimum in autumn. A table of comparative values shows this relation. The authors conclude that if it is admitted that the layers of the upper atmosphere only mix very slowly with the troposphere, it seems that the lower layers of the stratosphere must contain appreciable quantities of ozone. Accordingly, measurements of the height of the ozone layer (40-50 km.—Cabannes and Dufay) merely indicate a maximum of the ozone content. The writers stress the important need of simultaneous observations at the same station of the values at the two levels, with a view to establishing a still closer relation.

VELOCITY OF LIGHT AND THE RATIO OF E.S. AND E.M. UNITS. (See Curtis, under "Measurements and Standards.")

DIE BESTIMMUNG DER LICHTGESCHWINDIGKEIT UNTER VERWENDUNG DES ELEKTRO-OPTISCHEN KERREFFEKTES (Determination of the Velocity of Light by the Use of the Electro-optical Kerr Effect).—O. Mittelstaedt. (*Ann. der Phys.*, 15th July, 1929, Series 5, Vol. 2, No. 3, pp. 285-312.)

By the latest compensation method the value comes out at 299778 km./sec. with a possible error of ± 20 km.

THE INFLUENCE OF AN ALTERNATING FIELD ON LIGHT TRANSMITTED THROUGH WATER.—W. F. G. Swann: A. Bramley. (*Journ. Franklin Inst.*, August, 1929, Vol. 208, pp. 222-228.)

SABINE'S LAW IN RELATION TO ELECTROMAGNETIC RADIATION IN CLOSED SPACES.—M. J. O. Strutt. (See under "Acoustics.")

THE MOBILITY DISTRIBUTION AND RATE OF FORMATION OF NEGATIVE IONS IN AIR.—J. L. Hamshere. (*Proc. Cambridge Phil. Soc.*, April, 1929, Vol. 25, Part II, pp. 205-217.)

ATMOSPHERICS AND ATMOSPHERIC ELECTRICITY.

ÜBER DIE FORTSETZUNG DER GENEROSO-VERSUCHE (On the Progress of the Mt. Generoso Experiments).—A. Brasch, F. Lange and C. Urban. (*Naturwiss.*, 5th April, 1929, Vol. 17, p. 228.)

These experiments on the obtaining of enormous voltages from the atmosphere during storms in Switzerland were referred to in Abstracts, 1928, Vol. 5, pp. 462 and 586 (Nernst). Latest results are the production of 18 metre sparks, corresponding to some thousands of amperes at voltages of about 8 million; apparently greater values still could

have been obtained if a larger spark-gap had been available, with corresponding increase of insulation. But the writers consider that the present results are good enough for their purpose—tests on atomic disintegration. The problem of designing discharge tubes to utilise the available power remains to be solved; at present, tests have been made with various tubes up to one million volts.

CONTRIBUTION À L'ÉTUDE DE LA MATIÈRE FULMINANTE (Contribution to the Study of Fulminant Matter).—E. Mathias. (*Comptes Rendus*, 27th May, 1929, Vol. 188, pp. 1355-1358.)

A new theory on the nature of lightning, ordinary and globular, which explains the failure of the usual lightning-conductor to protect against the latter. The "fulminant matter" of the ordinary flash decomposes instantaneously on contact with the conductor, while that of globular lightning—being comparatively cool and conducting heat and electricity only moderately well—is not thus dispersed. Its spherical shape, also, only gives a point contact with the conductor.

SPARK POTENTIALS AT PRESSURES BELOW ATMOSPHERIC PRESSURE, AND THE MINIMUM POTENTIAL WITH RESPECT TO THE ELECTRODE FUNCTION.—F. Klingelfuss. (*Zeitschr. f. Phys.*, December, 1928, and January, 1929, Vol. 52, Nos. 9/12, pp. 746-747 and 890-891.)

MEASUREMENTS OF ATMOSPHERIC ELECTRICITY.—G. Aliverti and A. Rostagni. (Summary in *Science Abstracts*, Sec. A, 25th May, 1929, Vol. 32, p. 452.)

CHARGES OF THUNDER CLOUDS.—D. Nukiyama and H. Noto. (*Ibid.*, p. 453.)

LA Foudre et les Lignes Électriques (Lightning and Electric Lines).—C. Dauzère. (*Bull. d.l. Soc. Franç. d. Élec.*, June, 1929, Vol. 9, pp. 575-598.)

One of the conclusions reached is that the approach and beginning of a storm are characterised by an increase in the total number of ions, positive and negative, per cubic centimetre of air, and by the predominance of the negative ions. It is also concluded that protective measures need not in general be taken all along a line; it is enough to localise them at the spots where lightning is likely to strike (see Abstracts, 1928, Vol. 5, p. 517). These spots should be avoided in planning a new line.

SOME THUNDERCLOUD PROBLEMS.—C. T. R. Wilson. (*Journ. Franklin Inst.*, July, 1929, Vol. 208, pp. 1-12.)

NEW USE FOR FULTOGRAPH.—(*Elec. Review*, 9th August, 1929, Vol. 105, p. 240.)

A paragraph on the special transmission now being carried on by collaboration between the B.B.C. and the Radio Research Board Station at Slough, for the recording of atmospherics on Fultograph receivers installed at various points over Britain and the Continent. Pictures of "squared

paper" are broadcast, and any atmospherics occurring during the transmission will be recorded. Since the drums of all the receiving sets will be running in synchrony, it will be possible, by comparing the results at the different places, to get valuable information as to the range of an individual atmospheric and as to the intensity of such interference in different localities.

CORRELATION OF DIRECTIONAL OBSERVATIONS OF ATMOSPHERICS WITH WEATHER PHENOMENA.—S. W. Dean. (*Proc. Inst. Rad. Eng.*, July, 1929, Vol. 17, pp. 1185-1191.)

The full paper, a report of which was dealt with in August Abstracts, pp. 444-445. The Houlton work was inspired by the similar observations of Watson Watt and his associates in England and Scotland, using a telephone connection between distant observation points. The same type of apparatus (cathode ray d.f.) was used at Houlton, and in spite of there being only a single station available, so that the triangulation obtained by the British workers was impossible, it was possible in the vast majority of cases to correlate the observations with weather conditions. Bi-directional ambiguity of the d.f. was removed by the installation of "a uni-directional feature."

SOME MEASUREMENTS ON THE DIRECTIONAL DISTRIBUTION OF STATIC.—A. E. Harper. (*Proc. Inst. Rad. Eng.*, July, 1929, Vol. 17, pp. 1214-1224.)

The full paper, a report of which was dealt with in August Abstracts, p. 444. A photograph, but no description, is given of the cathode ray d.f. modified to make it unidirectional "and to increase its ease of operation." Charts showing world-distribution of thunderstorms are reproduced from a British Air Ministry Memoir, and special charts for the United States are also given.

WEATHER ANALYSIS ASSOCIATED IN THREE DIMENSIONS. PART I.—MAIN INTRODUCTION TO THE PROBLEM OF AIR MASSES AND FRONT FORMATION.—T. Bergeron. (*Geophys. Publ. Oslo*, 5.6.1928, III pp.)

DIE MESSUNG DER HORIZONTAL- UND DER VERTIKALINTENSITÄT DES ERDMAGNETISCHEN FELDES MIT DEM MAGNETRON (The Use of the Magnetron for Measuring the Horizontal and Vertical Intensities of the Earth's Magnetic Field).—M. Rössiger. (*Zeitschr. f. Instr. u. Meß.,* No. 3, 1929, Vol. 49, pp. 105-113.)

L'HYPERATMOSPHÈRE ÉLECTRIQUE ET LE MAGNÉTISME TERRESTRE (The Electric Hyperatmosphere and Terrestrial Magnetism).—D. Grave. (*Bull. Acad. Sci. Leningrad*, No. 4/5, 1928, pp. 347-366.)

After a preliminary exposition of the relations between sunspots and terrestrial phenomena, the writer attempts to explain the known aberrations of the solar system from the Newtonian mechanics by the help of the assumption of an electrical (solar) hyperatmosphere. Variations of the earth's

magnetism are explained by an external, variable component originating in this hyperatmosphere.

ROTATION OF THE EARTH AND MAGNETOSTRICTION.—E. S. King; A. H. R. Gold. (*Nature*, 5th January and 24th August, 1929, Vols. 123 and 124, pp. 15 and 303.)

Letters on a possible relation between changes in the rate of the earth's rotation and changes in the magnetic declination.

THE SPECTRUM OF SUNLIT AURORA RAYS AS COMPARED WITH THE SPECTRUM OF LOW AURORA IN THE EARTH'S SHADOW.—Carl Störmer. (*Nature*, 17th August, 1929, Vol. 124, p. 264.)

The writer gives a preliminary announcement of results of observations in which he finds that the green auroral line 5577, which is very strong for the common aurora in the earth's shadow, is very much fainter for high sunlit aurora, as compared with the lines of ionised nitrogen 4728 and 3914. No lines of helium or hydrogen seem to occur in the spectrum of these high rays. The observations were made at a time when the Swedish Telegraphy Services were being disturbed by earth currents.

AN ENDEAVOR TO DETECT A CORPUSCULAR CURRENT ENTERING THE EARTH.—W. F. G. Swann and A. Longacre. (*Journ. Franklin Inst.*, August, 1929, Vol 208, pp. 275-282.)

This extension of an earlier investigation leads to the following conclusion:—that the absolute magnitude of the current absorbed by the copper cylinder employed is not more than 0.25 per cent. of that which would have been obtained by the complete absorption of a vertical corpuscular current density sufficient to account for the replenishment of the earth's charge.

The paper is preceded by one by Swann on the theory of the charging effect on an insulated body exposed to primary corpuscular radiation or to corpuscular radiation initiated by the cosmic radiation.

PROPERTIES OF CIRCUITS.

AN ANALYSIS OF TRIODE VALVE RECTIFICATION.—S. E. A. Landale. (*Proc. Cambridge Phil. Soc.*, July, 1929, Vol. 25, pp. 355-367.)

The writer remarks that Colebrook's treatment of the foot of the grid current curve, as approximating very closely to an exponential form, generally gives fairly accurate results for high temperature cathodes provided that $E + V$ is negative [V being the mean grid potential when an alternating voltage E is applied]. With thoriated or oxide-coated filaments run at a comparatively low temperature, however, the velocity of ejection of electrons is small, and experience shows that the curve has an exponential form only over so restricted a range that Colebrook's analysis is of little practical use. The writer has examined the foot of the curve of many dull filament valves and has found that it can be represented with great accuracy over a considerable range by a quartic equation. The coefficients of the quartic change widely for different valves, and also with age for the same valve, but

nevertheless the range of applicability of the quartic is roughly constant for all triodes. As can be seen from one of the diagrams given (*see* below) the exponential curve is fairly accurate up to 0.6 v., and so is the parabola from 0.4 to 1.2 v.

Expressions are given for calculating rectified current and the amplitude of harmonics produced by a simple [not cumulative] grid rectifier when

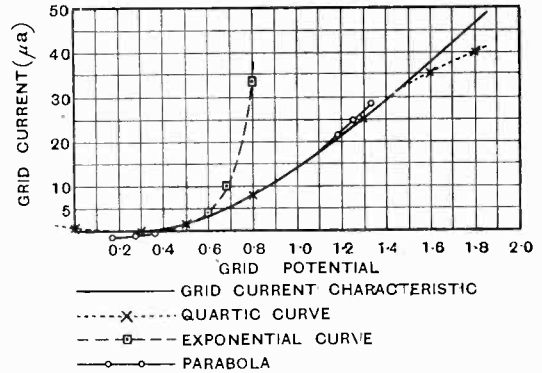

voltages of the following wave-forms are applied: $E \sin pt$, $(A + B \sin nt) \sin pt$, and $(A + B \cos mt + C \cos nt) \sin pt$. Further, a formula is given from which may be calculated the rectified current produced by a cumulative grid rectifier when a voltage $E \sin pt$ is applied.

All these formulæ are applicable if the grid characteristic is parabolic, cubic, quartic or quintic in form.

It is also shown that when an acoustically modulated r-f voltage is applied to a cumulative grid rectifier, even if the valve has a parabolic grid characteristic, an infinite number of harmonics of the modulation frequency are produced, which are due to the action of the grid leak and condenser. It appears, however, that in practice the amplitude of these harmonics will be very small compared with those produced, primarily, by the curvature of the grid characteristic.

REDUCTION OF DISTORTION IN ANODE RECTIFICATION.—A. G. Warren. (*E.W. & W.E.*, August, 1929, Vol. 6, pp. 425-437.)

The writer considers that although in modern loud-speakers the frequency response is by no means perfect, the more serious distortion which still persists in such loud-speakers is due to the presence in the reproduction of alien tones (enharmonic and harmonic) which render the reproduction unduly "stringy" and are introduced chiefly during rectification. He maintains that the reduction of this distortion due to rectification cannot be accomplished by the use of input grid potentials of the magnitudes usually advocated, 1 or 2 volts R.M.S., since over such a range the distortion is almost constant—it may even increase slightly with growth of the alternating grid potential; but that with a properly chosen grid bias and the use of grid-swings far in excess of those generally contemplated, the distortion can be reduced almost to

vanishing point. He advocates a peak value of swing of the order of 10 v., giving (with an average valve) a 1-f output of about 7 v. The subsequent 1-f amplification must be less than that usually adopted, part of the process of amplification being transferred to the ante-detector stages.

DETECTION AT HIGH SIGNAL VOLTAGES. PART I.—PLATE RECTIFICATION WITH THE HIGH-VACUUM TRIODE.—S. Ballantine. (*Proc. Inst. Rad. Eng.*, July, 1929, Vol. 17, pp. 1153-1177.)

After a preliminary exposition of the problem of linear detection at high signal voltages, the writer deals with his experimental study leading to the design of valve detectors capable of dealing with signal voltages of the order of 10 v. and upwards. Such valves may actually replace the output valve and operate the loud-speaker directly. This may properly be called "Power Detection"; a less extreme step consists in eliminating one audio stage, retaining the power valve [see Tanner, Sept. Abstracts, p. 510]. The need (for selectivity's sake) of a certain minimum number of tuned circuits, and the availability of tetrodes with an amplification of the order of 100 for these circuits, render the productions of these high signal voltages quite practicable. The signal voltage can be maintained at the optimum point of the characteristic either by automatic volume control or by manual control facilitated by extending the linear range of the detector by special devices which will be described in the fourth part of the series: other parts will deal with grid, grid-and-plate, diode and crystal rectification, all for high signal voltages.

RIVELAZIONE PER CARATTERISTICA DI GRIGLIA (Detection by Grid Characteristic).—M. Boella. (*Elektrotec.*, 5th August, 1929, Vol. 16, pp. 510-516.)

A description, fully illustrated by curves, of tests of detector efficiency of triodes under various conditions of functioning, when the signals have a considerable intensity, e.g., produce an a-c grid voltage above 0.2 to 0.3 v.

DAS RAUMLADENETZROHR ALS RÜCKGEKOPPELTER WIDERSTANDVERSTÄRKER IN THEORETISCHER BEHANDLUNG (The Space-Charge Valve as Resistance Amplifier with Reaction).—H. G. Baerwald. (*Arch. f. Elektrot.*, 15th July, 1929, Vol. 22, No. 3, pp. 325-336.)

A theoretical investigation to determine the design of such an amplifier, how to obtain effective compensation and what its limits are, and what precautions must be taken for stability. Among the section headings are:—The non-linearity produced by the grid space-charge: an equivalent circuit for the linearly functioning space-charge-grid valve: elementary amplification formulæ for the resistance-coupled s-c-g valve: circuit-values for the saturated and unsaturated valve—comparison of amplification: the influence of filament temperature variations—superiority of the oxide-coated filament: the influence of non-linearity on stability—prediction from static characteristics: dependence of amplification on frequency and its

"natural" compensation (a strong point in comparison with a two-valve reaction amplifier): a numerical example indicates that by suitable design the type in question can be made an efficient aperiodic h-f amplifier.

PUSH-PULL AMPLIFICATION: THE USE OF RESISTANCE-CAPACITY COUPLING.—F. Aughtie: P. G. Davidson. (*E.W. & W.E.*, August, 1929, Vol. 6, pp. 437-438.)

Referring to Aughtie's paper (Sept. Abstracts, p. 505) Davidson considers that the advantages there claimed for the arrangement do not include the most important ones, which in his opinion are (1) elimination of back-coupling through h-t supply, from both stages of 1-f; (2) h-t for all four 1-f valves may be taken direct from d-c mains without smoothing; (3) wave-form distortion due to characteristic curvature is cancelled out in the output stage. The writer uses a slightly different arrangement from those suggested by Aughtie, connecting a high resistance potentiometer (such as are used for volume control) between the two anodes V_1 and V_2 and taking the slider to the grid of V_2 through the usual condenser.

DOUBLE-VALUED CHARACTERISTICS OF A RESISTANCE-COUPLED FEED-BACK AMPLIFYING CIRCUIT.—P. B. Carwile. (*Phys. Review*, No. 2, 1929, Vol. 33, p. 284.)

Summary of an investigation of a resistance-coupled Hartley circuit under such conditions that the setting up of reaction does not affect the amplification factor without reaction. The total amplification is then a simple function of two independent variables. If the back-coupling is increased above a certain value, two points of irreversible instability appear in the input-output characteristic: between these points the characteristic has two branches, giving two possible values of output E.M.F. for every value of input. Explanations of these instabilities, their irreversibility, and double-valued characteristic, are given.

SUL FUNZIONAMENTO DEL TRIODO CON FORTE ACCOPPIAMENTO MAGNETICO A NUCLEO DI FERRO FRA CIRCUITO DI PLACCA E CIRCUITO DI GRIGLIA (On the Action of the Triode with Strong Magnetic Coupling through an Iron Core between Grid and Anode Circuits).—O. M. Corbino. (*Elektrotec.*, 25th July, 1929, Vol. 16, pp. 489-491.)

An investigation of the circuit used by Mazzotto for the production of oscillations of musical frequency, readily varied (Mazzotto's "melodious triode").

THE EFFECT OF REGENERATION ON THE RECEIVED SIGNAL STRENGTH.—B. van der Pol. (*Proc. Inst. Rad. Eng.*, February, 1929, Vol. 17, pp. 339-346.)

A reprint of the paper dealt with in Abstracts, 1928, Vol. 5, p. 638. The present version is free from certain ambiguities in symbolisation, etc. which occurred in the original paper.

THE TUNED GRID CIRCUIT: PARALLEL CHOKE FEED CIRCUIT IN H.F. AMPLIFIERS.—A. L. M. Sowerby. (*Wireless World*, 10th July, 1929, Vol. 25, pp. 24-26.)

GOOD RADIO REPRODUCTION (ANODE-FEED RESISTANCE SYSTEM).—(*Elec. Review*, 3rd May, 1929, Vol. 104, pp. 807-808.)

The claims of this system to be an important means of minimising the feed-back tendency of receivers (and the consequent distortion) are set out. The use of audio-frequency chokes instead of resistances is discussed. The development of the system is attributed largely to the Ferranti Company.

THE DESIGN OF WAVE FILTERS.—W. Proctor Wilson. (*Marconi Review*, July, 1929, No. 10, pp. 15-25.)

First part of a series by a B.B.C. engineer. "While professing no claim to originality, it is believed that this collection of material will be found to present, in a succinct form, much valuable data of use to the practical engineer interested in filter work from the Radio viewpoint."

FREQUENZRÜCKKOPPLUNG (Frequency Reaction).—H. E. Hollmann. (*É.N.T.*, July, 1929, Vol. 6, pp. 253-264.)

In normal circuits, reaction is a matter of energy interchange and involves a swinging to-and-fro of amplitudes, the frequency remaining constant. In certain circuits, however, an analogous swinging to-and-fro of frequency takes place, which has essential points in common with the former phenomenon (*e.g.*, the need for a "canal" for the reaction: the effect of damping, etc.) and which the writer designates "frequency reaction." He deals first with the case of electron oscillations in a retarding field (Barkhausen-Kurz circuit) and passes on to the audio-frequency relaxation oscillations (glow-discharge tube) of van der Pol and the multivibrator oscillations of Abraham and Bloch. In the first two examples, the frequency increases with the reaction ("positive" frequency reaction) while in the multivibrator it decreases ("negative" frequency reaction). But if the voltage vector introducing the reaction is rotated 180°, this negative reaction is converted into positive. The paper ends with the description and illustration of a hydrodynamic model representing all these types of oscillation.

PHASE COMPENSATION. I.—A SIMPLE ACCOUNT. II.—DESIGN OF PHASE COMPENSATING NETWORKS. III.—THE NYQUIST METHOD OF MEASURING TIME DELAY.—E. K. Sandeman, A. R. A. Rendall, Sandeman and I. L. Turnbull. (*Elec. Communication*, April, 1929, Vol. 7, pp. 309-330.)

FORCED UNDAMPED ELECTRIC OSCILLATIONS IN COUPLED CIRCUITS.—A. Petrowsky. (*Trans. Elec. Lab. Leningrad*, No. 5, 1927, 227 pp.)

In Russian. Divided into 5 sections:—Analytical treatment of the problem; investigation of the elements characterising the coupled oscillations;

vector diagram of undamped oscillations in coupled circuits; investigation of vector diagram; complex resonance (nature and conditions for its appearance: typical cases: magnitudes of currents and voltages: polar diagram: omega and lambda curves).

LES CARACTÉRISTIQUES ET LA STABILITÉ DES CIRCUITS FERRO-RÉSONANTS—CIRCUITS OSCILLANTS COMPORTANT DES BOBINES À NOYAUX DE FER (The Characteristics and Stability of "Ferro-resonant" Circuits—Oscillating Circuits including Iron-Cored Coils).—E. Rouelle. (*Comptes Rendus*, 27th May, 1929, Vol. 188, pp. 1392-1394.)

The writer points out certain further developments arising out of Kalantaroff's graphic method of investigating these complex circuits (see June Abstracts, p. 326.)

ERZWUNGENE SCHWINGUNGEN EINES LINEAREN SYSTEMS ZWEITER ORDNUNG (Forced Oscillations of a Linear System of the Second Order).—B. D. H. Tellegen. (*Arch. f. Elektrot.*, 8th May, 1929, Vol. 22, No. 1, pp. 62-80.)

A mathematical and graphic treatment, on the assumptions that the impressed voltage is of simple harmonic form and that the stationary condition has been reached.

TRANSMISSION.

ÜBER BARKHAUSEN-KURZ-WELEN (Barkhausen-Kurz Waves).—P. Knipping. (*Zeitschr. f. Hochf. Tech.*, July, 1929, Vol. 34, pp. 1-12.)

With a view to clearing up some of the discrepancies between experimental results and the theoretical ideas reached up to the present, the writer has approached the problem from the angle of atomic and electronic considerations, leaving entirely alone the usual questions of steepness of characteristic, reaction coupling, etc. His methods are indicated by his section headings, of which the following are examples:—The various zones at the filament; the position of the "ionisation zone"; the path-time of a H⁺ ion is equal to that of an electron; the electrons leave the filament in phase; influence of the grid; fate of the H⁺ ions; extreme vacuum in the neighbourhood of the grid [later on it is pointed out that this effect provides a means of obtaining vacua superior to those given by the best pumps: the latter vacua (*e.g.*, 10⁻⁸ mm.) contain about 3 × 10⁷ molecules per cm.³, most of which can thus be removed—more quickly and more completely the heavier the molecules. This may explain the success of Pirani's "washing out" of vacuum apparatus with mercury vapour and electrons, and other phenomena]; residual gases other than hydrogen; the effect of changing grid potential on the wavelength; of electrode diameter on the same; of filament current [the more electrons emitted, the further back will the space charge stretch, and with it the ionisation zone: following the writer's previous reasoning, this will cause a shortening of wavelength—as is actually found]; secondary and photo-emission.

From the above it will be gathered that the weight

of the process is laid on the residual gas and its ionisation. This gas is driven, when oscillation is set up, to cathode and anode, the space round the grid being thus rendered free of gas. The primary electrons emerge from the filament in time with the oscillations, and (on account of the extreme vacuum round the grid and the negative double layer at the wires of the grid) swing to and fro through the grid many times [of the order of 1000] before leaving it. With the same periodicity, the space-charge is destroyed by the ions, in such a phase in relation to the electron oscillation that the newly emerging electrons oscillate in phase with the old ones. Certain constants characteristic of the ions, combined with the grid and anode voltages, determine the wavelength, which is entirely independent of capacity and inductance. An emission of 50 ma. corresponds to an oscillating current, between cathode and anode, of no less than 50 A. By virtue of its oscillating anode voltage, the B-K valve behaves as a radiator of zero order, whose space radiation is spherically symmetrical even close to the valve: it thus differs fundamentally from ordinary transmitters. Accordingly, the usually employed Lecher wire system is not adapted to pick up these oscillations, and often gives failing signals at only a metre or two's distance; whereas Barkhausen and Kurz were able, by using a linear oscillator as receiver, to receive telegraphic signals over 600 m. and telephonic over 300 m. *without amplification.*

A section deals with the corresponding actions of electrons and ions in a diode. While a triode gives a more or less sinusoidal characteristic, the diode produces a more "notched" curve.

FREQUENZRÜCKKOPPLUNG (Frequency Reaction).—H. E. Hollmann. (*See under "Properties of Circuits."*)

PRINCIPLES OF THE CALCULATION OF GRID MODULATION.—Kliatskin and Minz. (*T. i. T. b. p.*, No. 1, 1929, Vol. 10, pp. 16-32.)

FREQUENCY MODULATION.—N. E. Holmblad: H. Lauer: G. H. Makey. (*E.W. and W.E.*, Aug. and Sept., 1929, Vol. 6, pp. 438 and 499.)

A continuation of the discussion (*see* July and Sept. Abstracts) on the claims of the Westinghouse patent dealt with in *E.W. and W.E.* for March, p. 170.

ENIGE EXPERIMENTEN IN VERBAND MET DE TOEPASSING VAN NIEUWERE TRIODENSCHEMAS BIJ ZENDERS (Some Experiments in connection with the Design of New Transmitting Valve Circuits).—G. W. White. (*Tijdschr. Ned. Radiogenoot*, July, 1929, Vol. 4, No. 2, pp. 17-33.)

In Dutch.

VARIOUS TRANSMITTER PATENTS.—Telefunken Company: J. Fuchs. (*Elektrot. u. Maschbau*, 11th Aug., 1929, Vol. 47, pp. 691-692.)

Short summaries of a number of Austrian patents, including one in which a number of spaced

aerials are fed separately, each by its own group of power amplifier valves; each valve of a group is excited by a common frequency in a different phase, the resulting frequency fed to the aerials being the common frequency multiplied by the number of valves connected to each aerial; the individual aerials are fed in such phase as to produce directional effects.

Another patent deals with telephone modulation by direct grid current; a modulating valve, through which the direct grid current of the valve to be controlled flows, influences the grid potentials of that valve. Since in short wave transmitters the d-c grid current often vanishes, a special "valve" valve is added with its anode connected to the grid of the controlled valve and its cathode to the cathode, while its grid is subjected to the same fluctuations as the grid of the modulating valve. Fuchs' patent concerns a H.F. generator circuit coupled to an intermediate circuit of similar dimensions; the aerial is directly connected to a potential antinode of this intermediate circuit, no earth or counterbalancing capacity being indicated.

OVERZICHT BETREFFENDE DE OPWEKKING VAN ULTRA-KORTE GOLVEN (Survey of Methods of Generating Ultra-short Waves).—B. D. H. Tellegen. (*Tijdschr. Ned. Radiogenoot.*, July, 1929, Vol. 4, No. 2, pp. 34-53.)

In Dutch. Many of the generating circuits are illustrated by diagrams; a very complete bibliography is appended, reaching from 1919 to 1929. Cf. Hollmann, June Abstracts, p. 326.

PUSH-PULL SHORT WAVE GENERATING CIRCUIT.—(German Patent 475568, Pohontsch, pub. 27th April, 1929.)

The push-pull circuit is much used for short wave generation in order to obtain the greatest possible symmetry. In the present invention, an oscillating circuit tuned approximately to the required frequency is connected in the lead between the common negative and the mid-point of the common primary of the r-f transformer. A great increase of oscillating power is claimed.

THE GENERATION OF OSCILLATIONS OF CONSTANT FREQUENCY.—(German Patent 475832, Lorenz, pub. 2nd May, 1929.)

If the field winding of a d-c generator is connected to an oscillatory circuit, the generator will produce oscillations dependent in frequency on the circuit and not on the r.p.m. of the machine. If this frequency is low—(e.g., 100 p.p.s.) the losses in the machine will not be excessive. The present patent uses this arrangement in combination with an iron-cored frequency-multiplier.

MULTIPHASE A.C. HIGH-FREQUENCY TRANSFORMER.—(German Patent 475833, Lorenz, published 3rd May, 1929.)

In a system of H.F. generation by feeding a number of valves with multiphase current, high negative anode voltages and positive grid voltages occur during the negative half-cycle, leading to heavy grid currents. To avoid this effect, the grids of each valve are so influenced by the feed

current (by the use of saturated iron-cored rectifiers) that they take on only very small positive potentials or none at all.

RECEPTION.

A REMOTE TUNING CONTROL FOR RADIO RECEIVERS.
—W. Faas. (*Rad. Engineering*, March, 1929, Vol. 9, pp. 30-31.)

An automatic tuning system, employing push-buttons, which operates on the gang condensers. It consists of two units—the actuating mechanism which is bolted to the back of the receiver or incorporated in the set itself, and the push-button control unit which includes on-and-off and volume control as well as 8 or more station-selector buttons.

RESISTANCE CONTROL OF REGENERATION.—B. Dudley. (*QST*, August, 1929, Vol. 13, pp. 23-28.)

An investigation into the comparative merits of different circuits embodying resistance control of reaction, and of different commercial variable resistances when used for this purpose. Those of the compressed-carbon type were found to be the best.

SHORT WAVE RECEPTION DIFFICULTIES ON AIRCRAFT. (*See v. Handel, Kruger and Plendl, below.*)

QUARZSTEUERUNG VON KURZWELLEN-EMPFÄNGERN. (Quartz Control of Short Wave Receivers.)—P. v. Handel, K. Kruger and H. Plendl. (*Zeitschr. f. Hochf. Tech.*, July 1929, Vol. 34, pp. 12-18.)

For reception in aircraft. The result of the tests here described may be summed up very briefly:—a quartz-controlled oscillating audion gave a too great decrease in signal-strength and too much sensitivity to vibration, while the use of a quartz-controlled separate heterodyne generator (to give beat-note reception) produced too great difficulties due to slight frequency variations caused by temperature changes, external and internal, which made the note rise to ultra-audibility, in spite of the provision of frequency adjustments. The final solution was the use of a quartz-controlled separate heterodyne generator to give, not beat-note reception, but an intermediate frequency, which was dealt with in a long-wave audion circuit and after rectification was amplified by 2 or 3 stages of 1-f magnification. By this plan, special precautions such as thermostats etc. were made superfluous. Moreover, if the aircraft was already provided with a long wave receiver (*e.g.* for d.f.) this could be adapted to the purpose of short wave reception by the addition of an audion circuit and heterodyne generator.

The above results could perhaps have been foreseen, but the paper includes an interesting introductory section on the difficulties of short wave reception on aircraft which led to the experiments. Aeroplane noises could only be combated by raising the strength of signals above the ear's altered threshold of perception—*e.g.* by the addition of another 1-f stage. Motor ignition noises proved of only slight importance in the case

of the metal aeroplanes used in the tests, and in any case were rendered still less troublesome by keeping the note constant by quartz control of the transmitter. The great trouble proved to be vibration. However carefully the receiver might be suspended, this caused a greater or less spoiling of the heterodyne note; those receivers which on ground tests had distinguished themselves most for sensitivity and constancy showed themselves most affected, giving signals whose note was so spoiled by vibration effects that they could hardly be distinguished from the background noises. Exhaustive tests showed that the vibration was carried not merely by the suspensions but also by the air; words spoken near the receiver casing could often be heard clearly in the telephone head-gear. This effect could be overcome by enclosing the receiver in lead or copper, but such a plan involved too great a weight. The careful design of components and the avoidance of connecting wires free to vibrate improved matters, but the effect was so difficult to avoid that of two exactly similar receivers thus carefully designed, one would prove vibration-proof and the other would be sensitive to vibration. Moreover, a perfectly good receiver would in time become sensitive to vibration, or would become so suddenly, on making some small change such as switching from one wave-range to another. Another effect was difficult to cure: if a vibration-proof receiver was tuned to a station and then moved slightly to and fro in its suspension, the heterodyne note would vary in time with its movement, even if the metal container was earthed. Everything, in fact, called for a stabilisation of receiver frequency, since in that case the note would remain pure and constant and only amplitude-variations would remain which would probably not be very serious.

RADIO RECEPTION AND SUN SPOTS.—H. T. Stetson: G. W. Pickard. (*See under "Propagation of Waves."*)

AERIALS AND AERIAL SYSTEMS.

TRANSMITTING ANTENNAS FOR BROADCASTING.—A. Meissner. (*Proc. Inst. Rad. Eng.*, July, 1929, Vol. 17, pp. 1178-1184.)

The paper begins by a short prophecy of future developments in broadcast transmission: frequencies from 20 to 20,000 kc.; modulation enlarged—ratios of amplitudes of 1:1000 are probable, with higher power of transmitter and consequent increased interference; this may make it necessary to couple many transmitters in groups giving a common programme on a common wave. "This will probably result in control of these transmitters by talking films running synchronously." Higher demands with regard to the reproduction of music may lead to the control of the transmitter without transmission cable between studio and transmitter, and the use of sound records on films operated in the transmitting station.

The rest of the paper concentrates on the transmitting aerial. The increase of the surface waves in proportion to the space waves is being developed in Germany as it is in England: the increased

horizontal radiation resulting from the use of a complete dipole suspended as high as possible instead of a quarter wavelength aerial is illustrated by a curve from the Eckersleys-Kirke paper (April Abstracts, p. 211). The necessity for insulating the high supporting mast at its base and (if it is of metal) for keeping its height below half the emitted wavelength is pointed out: the aerial must be designed so that the centre of capacity of the upper half is still situated at about the same height as in the case of an aerial wire stretched vertically: the length has to be $\lambda/2$. A formula of Beckmann's is quoted for calculating the influence of the mast.

The good results of these high dipoles are illustrated by quoting Eckersley's results and by results obtained by the broadcast transmitter at Budapest, where strength of fields are better than those given by other stations quoted with ordinary aeriels, and where fading only begins beyond 150 km.

There still remains to be decided whether a horizontal aerial fed at its centre by a feeder line is better than a vertical aerial.

VERSUCHE ÜBER RICHTANTENNEN BEI KURZEN WELLEN (Experiments with Short Wave Beam Aeriels).—W. Moser. (*Zeitschr. f. Hoch. f. Tech.*, July, 1929, Vol. 34, pp. 19-26.)

After preliminary discussion of the problem and of the various ways of dealing with it (Marconi-Franklin Beam, Chireix-Mesny "zig-zag," Meissner parabolic reflector) the paper deals with the Telefunken system of horizontal dipoles (see Feb. Abstracts, p. 104, 105, 106).

SYSTÈME FRANÇAIS D'AÉRIENS-PROJECTEURS POUR ÉMISSIONS SUR ONDES COURTES (French Beam System for Short Waves).—H. Chireix. (*Bull. de la S.F.R.*, May, 1929, Vol. 3, No. 4, pp. 79-96.)

In the course of this paper, dealing with the aerial systems for the Paris—South America service and the Paris—Batavia and Paris—Indo-China tests, the plan is mentioned of raising the aerial network for the day-wave some distance off the ground, utilising the resulting space for the night-wave network.

CALCULATION OF RADIATION RESISTANCE OF ANTENNÆ COMPOSED OF PERPENDICULAR OSCILLATORS.—A. Pistol Kors. (*T. i T. b. p.*, No. 1, 1929, Vol. 10, pp. 33-39.)

In Russian.

OM STAVFORMIGA HERTZ'SKA OSCILLATORERS SAMT RÄTLINIGA OCH RINGFORMIGA ELEKTRISKA RESONATORERS EGENSÄNGNINGAR (On the Natural Wavelengths of Hertz Rod Oscillators with Rectilinear or Cylindrical Resonators).—K. F. Lindman. (*Acta Abo*, No. 6, 1929, Vol. 5, p. 201S.)

One result is that a hollow cylinder of insulating material enclosing any part of the rod increases the period; the increase is proportional to the length of the cylinder and increases with the wall thickness up to a limit depending on the dielectric

constant, but is not appreciably dependent on the position of the cylinder on the rod, or on the original frequency.

A DIRECTIONAL UNTUNED SHORT WAVE RECEIVING ANTENNA.—G. A. Ostroumov. (*T. i T. b. p.*, No. 2, 1929, Vol. 10, pp. 111-124.)

In Russian.

WAVE REFLECTORS AND DIRECTORS.—(German Patent 475293, Yagi, pub. 25th April, 1929.)

The patent covering the directive system of vertical aeriels of various lengths, referred to in Abstracts, 1928, Vol. 5, p. 519.

VALVES AND THERMIONICS.

L'ÉTAT ACTUEL DE LA TECHNIQUE DES LAMPES À PLUSIEURS ÉLECTRODES (The Present Position in the Technique of Multi-Electrode Valves).—R. Jouaust. (*L'Onde Elec.*, June, 1929, Vol. 8, pp. 227-261.)

A review of the latest methods of calculation and design of receiving valves. As regards the coefficient of amplification, the writer uses the simplified formulæ given by King in 1920, for flat and cylindrical electrodes; these being derived from the first terms of the series developed from the more complex formulæ of Miller and J. J. Thomson. For the intensities of E.M.F. and current, he uses Kusunose's derivations from Langmuir's formulæ (June Abstracts, pp. 330-331.) He recalls Prince's demonstration that in considering the equivalent diode it is *not* the grid diameter which must be taken as the diameter of the equivalent anode, but the plate diameter of an imaginary triode having the same grid dimensions and unity amplification. He stresses the importance of the ratio anode radius to filament radius in the design of low resistance valves.

Dealing then with inter-electrode capacity and secondary emission, he mentions the results of Le Boiteux, van der Pol, Hull, Farnsworth and Podliasky in connection with the latter, and issues a warning that "the properties of valves based on secondary emission may be strongly modified by a liberation of gas. . . . One must not rely too much on these very fugitive phenomena." He then considers at considerable length the behaviour of electrons in a retarding field such as is produced by a grid potential higher than that of the plate: this leads to the idea of a "virtual cathode" and the work of Lewi Tonks (*Phys. Review*, Oct., 1927). This virtual cathode effect is important from the point of view of the construction of double-grid valves, dealt with in the next section. The writer lays particular stress on the true object of the space-charge grid valve:—it behaves like a diode having for cathode the filament and for anode the inner grid. The plate potential is not involved, and therefore may be very small. The true function of the valve is exemplified by the frame receivers which receive the American stations in France using a plate voltage only 1 v. higher than the positive end of the filament.

The next section deals with the screen-grid valve, beginning with the original idea of Schottky and showing how its revival by Hull was led up to by

Miller's results (which are treated in an appendix). After defining Hull's particular object as the series connection of amplifiers with resonance coupling, the writer examines the possibilities of screen-grid valves for other purposes—e.g. resistance-coupled amplifiers, and concludes that the full benefit of high amplification factor cannot thus be obtained. Moreover, he refers to a result un-noticed by many writers but noted by Decaux—the effect of the plate/screen grid capacity on certain frequencies, to which it may act as a practical short-circuit of the high resistance in the anode circuit.

The final sections deal with the protection of valves against secondary emissions, referring here to power-amplifier valves and transmitting valves (Podliasky, Abstracts, 1928, p. 580; Hanna and others, p. 344); with three-grid valves (as loud-speaker valves, of high internal resistance, but avoiding the distortion caused by a two-grid valve worked in this way, owing to the secondary electrons reaching the screen whenever the plate voltage swings below the screen voltage); and with valves with oxide-coated filaments and indirectly-heated filaments. Regarding the last, the writer considers their chief interest to lie in the large diameter of the cathode, making low valve internal resistance possible (see above) and leading to a consequent decrease of distortion. He illustrates this by the diagram given below, in which the top curve is that given by an indirectly-heated valve, the next by a valve with oxide-coated filament, the lowest by a two-grid valve, while the peaked curve represents the old T.M. type valve.

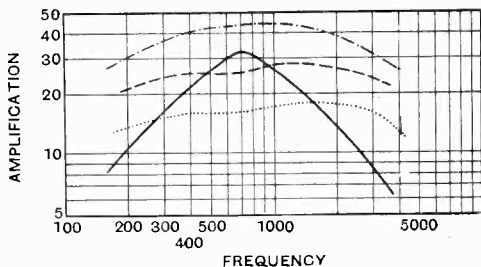

LES CARACTÉRISTIQUES DES LAMPES DE RÉCEPTION MODERNES ET LEUR CHOIX RATIONNEL (The Characteristics of Modern Receiving Valves, and their Selection for Various Purposes).—B. Decaux. (*L'Onde Elec.*, June, 1929, Vol. 8, pp. 262-281.)

Following on Jouaust's paper (see above) this article fills in certain gaps and gives details and values derived from various commercial types of modern valves. It also includes a bibliography of 28 items, English, American, French and German.

IONIC PROCESSES AND THEIR TECHNICAL APPLICATION.—M. M. Sitnikoff. (*Trans. Phys. Tech. Lab.*, Moscow, 1929, No. 7, 103 pp.)

An investigation into the conduction of electricity by free ions and electrons in a gas. The present paper deals with the case where l (the electron free path) $>$ or $= b$ (distance between the electrodes). The various means of control (magnetic, volume or thermal) and applications (gas

"convertor," rectifier, h-f and l-f oscillator) are discussed. Among the twelve points of the author's summary are the following:—the change of l is given as a function of the heating of a part volume of the gas; the length of trajectory between plane electrodes is expressed in terms of electric and magnetic fields; diagrams of the trajectory are plotted which serve to determine the conductivity of the zone of conduction, an approximation being also given for the trajectory in presence of a space charge. The theoretical results are confirmed by experiment. The phenomena of the mercury arc rectifier are examined. An approximate equality between electrical and thermal electron velocities corresponds to minimum losses in the arc: in this case $v_e + v_T = 1.4 \pm 0.15$ V. approx.

It is suggested that an important cause of ionisation by collision lies in the interaction between magnetic fields of moving electrons or ions (depending on their velocities) and the magnetic field of the system of electrons connected to a gas molecule. The phenomenon of the breakdown of thin solid dielectrics is considered, this being taken as a case where l is of the same order as b . The possible influence of a magnetic field on the breakdown is discussed (*cf.* Monkhouse, June Abstracts, p. 344). The paper is in Russian with an English summary.

THERMIONIC AND PHOTOELECTRIC EMISSION FROM CÆSIUM AT LOW TEMPERATURES.—L. R. Koller. (Summary in *Phys. Review*, June, 1929, Vol. 33, p. 1082.)

THE EFFECT OF HYDROGEN ON THE THERMIONIC EMISSION FROM POTASSIUM.—H. R. Laird. (*Phys. Review*, 1st Aug., 1929, Vol. 34, pp. 463-473.)

Fredenhagen's supposition that the thermionic currents frequently observed from potassium were due to hydrogen contamination is here confirmed by more rigorous test-methods. With the uniform fields of the writer's apparatus it was possible to saturate the thermionic currents observed from potassium at 150° to 185° C.; he suggests that the failure of Fredenhagen and of Richardson and Young to produce saturation was due to non-uniform field conditions. The hydrogen contamination appears to be in the form of a very thin coating of KH rather than of hydrogen physically absorbed; so that the emission seems due to decomposition of the KH rather than to true thermionic action.

LAYERS OF CÆSIUM AND NITROGEN ON TUNGSTEN.—N. A. de Bruyne. (*Proc. Cambridge Phil. Soc.*, July, 1929, Vol. 25, Part III, pp. 347-354.)

Investigation of the phenomenon of the appearance of two peaks on the filament-current/emission curve, before the setting in of the ordinary high temperature thermionic emission. The first peak is known to be the result of a cæsium layer on the tungsten; the second seems likely to be a combined effect of activated nitrogen and the cæsium, the nitrogen probably holding the cæsium atoms to the surface at a temperature above that at which a cæsium atom alone can stick.

THERMIONIC EMISSION THROUGH DOUBLE LAYERS.
—W. Georgeson. (*Proc. Cambridge Phil. Soc.*, April, 1929, Vol. 25, Part II, pp. 175-185.)

Most of the calculations on the connection between χ and $D(W)$ have been made, for simplicity, for the surface potential variation shown in Fig. 1. If, however, the surface layer behaves in any way like an ideal electrical double layer [Nordheim's explanation of the effect of surface layers in modifying the thermionic emission], the surface variation of potential energy will be much more nearly that shown in Fig. 2, and the writer has made calculations for this field, "which should represent the actual state of affairs quite closely."

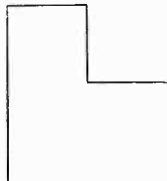

FIG. 1

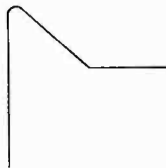

FIG. 2

General formulæ are obtained for the emission coefficients $D(W)$, and graphs are drawn connecting the energies (W) of the electrons with $D(W)$ for various thicknesses of layers, and for various values of the potential drops within them. It is shown that the emission coefficient does not vanish for $W = B$ as Nordheim states, but is of the order of $\frac{1}{2}$. The general Richardson formula for the thermionic current can be written $I = AT^2e^{-b/kT}$. It is shown theoretically that the presence of a layer on the metal, of thickness l , decreases the value of b by an amount equal to the drop of potential within the layer, while A depends upon l according to the relation $A = B\{l(\delta\chi)\}^{\frac{1}{2}}e^{-0.716\delta\chi/l}$, where $\delta\chi$ is the potential drop in volts, and l is measured in units of 10^{-8} cm. With observed values of A and $\delta\chi$, this formula gives reasonable values for l . In the seemingly impossible case of a layer as thin as 10^{-8} cm. or thinner, A is practically unchanged from its value for a clean metal.

NOTE ON "OSCILLATIONS IN IONIZED GASES."—L. Tonks and I. Langmuir. (*Phys. Review*, June, 1929, Vol. 33, p. 990.)

An explanatory note on the paper dealt with in May Abstracts, p. 273.

THERMIONIC EMISSION FROM TUNGSTEN AND THE SCHOTTKY EQUATION.—H. Van Velzer and W. R. Ham. (Summary in *Phys. Review*, June, 1929, Vol. 33, p. 1083.)

Values of the thermionic currents from tungsten filaments show that the Schottky relation can be verified with sufficient accuracy to furnish a satisfactory method of determining the electronic charge, e .

THERMIONIC EMISSION AS A FUNCTION OF THE AMOUNT OF ADSORBED MATERIAL.—J. A. Becker. (Summary in *Phys. Review*, June, 1929, Vol. 33, p. 1082.)

THE EMISSION OF POSITIVE IONS FROM TUNGSTEN AT HIGH TEMPERATURES.—L. P. Smith. (*Phys. Review*, No. 2, 1929, Vol. 33, pp. 279-280.)

A summary of tests carried out after a short over-heating to $3,000^\circ$ and a long run at $2,500^\circ$ absolute. It is concluded that the positive ions are tungsten ions. The ion current remains unchanged, for a given temperature, by the introduction of an inert gas such as argon, provided that this is not dense enough to cool the filament appreciably.

SHOT EFFECT OF SECONDARY ELECTRONS.—L. J. Hayner and A. W. Hull. (*Phys. Review*, No. 2, 1929, Vol. 33, p. 281.)

A summary of experiments on a number of valves. Among the various conclusions may be noted the deduction that the secondary emission occurs within 10^{-5} sec. after the impact of the primary electrons.

ÜBER IONENSTRAHLEN (On Beams of Ions).—M. Zentgraf. (*Ann. der Phys.*, 15th July, 1929, Series 5, Vol. 2, No. 3, pp. 313-333.)

A repetition (with improved methods) and extension of G. C. Schmidt's researches in 1924. The salts covering the heated platinum wire included CdI_2 , $PbCl_2$, thallium and silver salts. Among the results may be mentioned:—the beginning of emission depends on the pressure; for low pressures the first ions emerge for smaller voltages than for higher pressures, but a small +ve potential is always necessary to drive the ions out of the salts. Saturation occurs at very small voltages for small pressures, the voltage increasing with the pressure. In addition to the gradual decrease of the emission with time (which is part of an irreversible process) another variation with time can be found, due to deterioration and restoration of the surface. The deterioration is the more marked the higher the potential and the lower the temperature; recovery sets in the quicker, the lower the potential and the higher the temperature.

THE DISTRIBUTION OF ELECTRONS BETWEEN THE PLATE AND GRID OF A THREE ELECTRODE TUBE AS DETERMINED BY POSITIVE CÆSIUM IONS.—J. M. Hyatt. (*Phys. Review*, 1st Aug., 1929, Vol. 34, pp. 486-492.)

In a previous report (*ibid.*, Vol. 32, 1928, p. 922) experiments were described leading to the determination of the relative distribution of positive caesium ions between the cylindrical plate and grid of a triode. The fraction of + ions caught by grid and plate respectively was proportional to the area of the solid and open portions of the grid. Since theoretically the paths of positive ions in such a valve are the same as those of electrons at the same accelerating voltage, it was assumed that with positive voltages of grid and plate the fraction of electrons caught by the plate would be measured by the ratio of the projected area on the plate of the open portion of the grid to the total plate area. The present paper deals with similar experiments on a plane-anode type of valve. Corresponding results were obtained.

UNE EXPLICATION POSSIBLE DE QUELQUES PHÉNOMÈNES DANS LE TUBE À RAYONS X (A Possible Explanation of Certain Phenomena in X-Ray Tubes).—A. Janitzky. (*Journ. de Phys. et le Rad.*, No. 1, 1929, Vol. 10, pp. 13S-14S.)

The writer concludes that gases are set free from metals in the form of positive ions: under the influence of high potentials they emerge from the anode, not the cathode, of a discharge tube. Since Hughes and Klein and others have shown that the ionising powers of very fast electrons are only small, he assumes that the above ionisation process must be carried out chiefly by positive ions. It must therefore be possible, by out-gassing the anode, to obtain such a condition that in spite of the presence of gas in the tube no discharge can take place, and also to work a hot cathode tube by purely electronic processes in spite of a comparatively high gas pressure. He has confirmed this by actual tests.

THE PRODUCTION OF EMISSION FROM OXIDE COATED FILAMENTS: A PROCESS PHENOMENON.—V. C. Macnabb. (*Journ. Opt. Soc. Am.*, July, 1929, Vol. 19, pp. 33-41.)

Author's abstract:—The production of oxide filaments of barium and strontium in an emitting condition is investigated from the standpoint of determining the advantages of several apparently different methods of producing this type of cathode as used by several different companies. It is found that all methods amount to the same thing and are different only in degree.

The fundamental underlying action of all methods is that the filament to become emissive must undergo a gaseous bombardment, which presumably causes a breaking down of the higher oxides or compounds, as the carbonate, to the lower oxides or pure metal, and conversely, this breaking down must be caused by or accompanied by a gaseous discharge in order to produce an active filament. The gas most suitable for this action is best obtained from the filament and is best produced from a carbonate that has not been reduced until put *in vacuo*; the gas then liberated and used is probably CO₂.

These conclusions are arrived at by experiments on several different types of filaments containing relatively different amounts of combined or baked-on coating to uncombined coating and in every case results favor those filaments containing most uncombined coating.

Some secondary conclusions are that the baked-on coating serves little or no purpose except as a mechanical bond and that the core material on which the coating can be placed may be of a wide variety of material.

PRODUCTION TESTING OF VACUUM TUBES.—A. B. Du Mont. (*Rad. Engineering*, June, 1929, Vol. 9, pp. 47-49.)

Description, by the De Forest chief engineer, of an automatic tester capable of handling 8,000 valves per hour, sorting out defective ones and ejecting them into different chutes according to their particular defects.

DIE GRUNDLEGENDEN VERFAHREN DER GLÜH-LAMPEN-LEUCHTDRAHTECHNIK (The Fundamental Processes of Incandescent Filament Technique).—B. Duschnitz. (*E.T.Z.*, 18th July, 1929, Vol. 50, pp. 1049-1053.)

(1) The Coolidge process: (2) The Pintsch process.

PENTONE VALVES. (*Journ. Scient. Instr.*, Aug., 1929, Vol. 6, p. 263.)

The characteristics of three types of Mullard "Pentones" are given.

SIMPLIFIED CONSTRUCTION OF MULTI-GRID VALVES. (Austrian Patent 109346, Müller and Halberstadt.)

To avoid the complications involved in the mounting of each grid separately, the inventors propose to construct one grid of wire composed of a bundle of two or more wires insulated from each other.

SPECIAL DESIGN OF ANODE FOR COOLING PURPOSES. (Austrian Patent 112794, Jacobi and Deszö.)

The sides of the anode parallel with the filament are so shaped as to give the anode a star-shaped polygonal section with projecting angles yielding good heat-radiation.

DIRECTIONAL WIRELESS.

LES APPLICATIONS DE LA RADIO-ÉLECTRICITÉ DANS LA NAVIGATION AÉRIENNE (The Applications of Radio-electricity in Aerial Navigation).—J. Marique. (*Bull. de la Soc. belge des Ing. et Ind.*, April-May and June, 1929, Vol. 9, Nos. 3 and 4, pp. 235-261 and 371-384.)

A general survey. A final section deals with the organisation in Belgium. There is a short section on blind landing; for height above the ground, a patent by Leroy is mentioned, to make use of the increasing effect of the ground on the tuning of a very h-f oscillating circuit (French Patent 952075), while it is stated that Jenkins has proposed a system based on the reflection of very short waves (Papin, "Le Radioaltimètre," *T.S.F. Moderne*, 1926). Alexanderson's experiments are not mentioned. For picking up the landing ground, Loth's leader-cable system is mentioned, and Willoughley's [?] proposal of a system of horizontal frames one above the other to produce a reversed-cone-shaped upwards beam. The angle corresponding to maximum intensity is about 30 degrees on either side of the vertical, for a system of two frames: it can be reduced by increasing the number (Breit, *Scient. Papers B. of Stds.*, No. 413). "An analogous radiation diagram would be obtained with a vertical aerial vibrating to a harmonic." The Bureau of Standards' use of a small vertical aerial on the aeroplane, so that signals vanish suddenly when the machine is above the station, is also mentioned: "tests have shown that the beacon can be located within 30 metres by an aeroplane flying at 300 metres' height."

A COURSE-SHIFT INDICATOR FOR THE DOUBLE-MODULATION TYPE RADIOBEACON.—H. Diamond and F. W. Dunmore. (*Bur. of Stds. Journ. of Res.*, July, 1929, Vol. 3, pp. 1-10.)

To increase the reliability of the visual directive radiobeacon system, this indicator has been developed—primarily for station use—to indicate to a station operator whether a given course as laid out in space remains unchanged, and to facilitate a check of the beacon calibration. The apparatus consists essentially of an electrostatically shielded rotatable pick-up coil coupled magnetically to both loop aerials of the beacon and connected to a detector-amplifier unit. The output of this, containing both the beacon frequencies, branches through suitable filters to the two sets of windings of the indicating instrument, which is a modified form of a commercial frequency meter. The two windings are in opposition, so that when the course is set and the two filters properly adjusted, the instrument pointer assumes a mid-scale (zero) position. Any deviation from this indicates that the course is varying—a change of 0.1 degree being readily detected.

The use of the apparatus for easy re-calibration of the beacon is obvious. Another use still is as a visual course indicator, on aircraft large enough to put up with its extra weight, instead of the usual two-reed indicator. It has the advantage of giving extremely sharp indication of course, but it is less robust and more liable to interference than the reed instrument.

ACOUSTICS AND AUDIO-FREQUENCIES.

ON THE ACOUSTICS OF LARGE ROOMS.—M. J. O. Strutt. (*Phil. Mag.*, Aug., 1929, Vol. 8, No. 49, pp. 236-250.)

Author's abstract:—The theoretical proofs hitherto given in literature of Sabine's experimental result, that the duration of residual sound in a large room does not depend upon the shape but only on the volume and the absorbing power, and is the same (generally) if measured in different points with the source at different places, may be said to be incomplete. They start from considerations of reflection at the walls, but phase relations are left out. Moreover, often a homogeneous distribution of sound-energy over space at the moment the source stops is assumed, which will not be true in various cases that, on the other hand, experimentally check Sabine's law very well. The present treatment discusses the problem of forced oscillations in a continuous medium with arbitrarily distributed absorption, and shows Sabine's law to be a general asymptotic property of such oscillations, if the quotient of the forced frequency over the lowest free frequency of the system tends to infinity. In addition, various special experimental features are discussed from this point of view. The prevalence of Sabine's law in other departments of physics, e.g., with the electromagnetic radiation in closed spaces, is predicted from its general character.

CONDITIONS OF SECURING IDEAL ACOUSTICS IN AUDITORIUMS.—F. R. WATSON. (*Phys. Review*, No. 2, 1929, Vol. 33, p. 283.)

MESSUNG DER GESAMPTENERGIE VON SCHALLQUELLEN (Measurement of the Total Energy of Sound Producers).—E. Meyer and P. Just. (*Zeitschr. f. tech. Phys.*, Aug., 1929, Vol. 10, No. 8, pp. 309-316.)

Just as Ulbricht's sphere-photometer gives the integral value of the total light emission of a lamp without multiple measurements in various directions, so the writers devised a method for determining the total emission of a sound-producer. The measurement took place in a completely closed rectangular room of dimensions at least comparable with the longest wavelengths, and with as little absorption as possible. The absorption was measured by the objective method due to the writers (Sept. Abstracts, p. 513, and 1928, p. 649). The pressure-amplitudes were measured by a microphone calibrated electrostatically, a Reiss carbon microphone as well as a condenser microphone being used at different times. From the absorption and pressure-amplitude data thus obtained, the total output was calculated by the Jäger theory. The correctness of the method was tested by numerous preliminary experiments, and as examples of its usefulness various frequency curves and efficiency measurements of loud-speakers are given, and also some energy-measurements of human speech and of certain musical instruments.

SPEECH-POWER OF SPEAKERS IN AUDITORIUMS.—V. O. Knudsen. (*Phys. Review*, 1st August, 1929, Vol. 34, p. 549.)

Abstract only. Measurements indicate that the loudness of speech in auditoriums is considerably below the loudness level required for best hearing conditions. The probable loudness of the average speaker is 50.7 db and 45.7 db for a small and a large auditorium respectively: optimum loudness for the hearing of speech is 70 db. These and other data lead to the possibility of arriving at a quantitative rating of the hearing conditions in any auditorium.

BEITRÄGE ZUR RAUMAKUSTIK (Contributions to our Knowledge of the Acoustics of Rooms).—W. Schindelin: E. Scharstein: E. Scharstein and W. Schindelin. (*Ann. der Phys.*, 28th June, 1929, Series 5, Vol. 2, No. 2, pp. 129-162, 163-193, 194-200.)

A.E.G. COIL-DRIVEN LOUD SPEAKER (RICE-KELLOGG).—F. A. Fischer and H. Lichte. (*A.E.G. Mitt.*, Jan., 1929, No. 1, pp. 25-31.)

The loud speaker is described, and it is shown mathematically that below frequencies corresponding to wavelengths of the same order of magnitude as the diaphragm-diameter, the efficiency of conversion is independent of frequency, while above this critical zone the efficiency is proportional to the square of the wavelength.

IN SEARCH OF QUALITY: THE CONSTRUCTION AND PERFORMANCE OF A 25 FT. LOGARITHMIC HORN.—R. P. G. Denman. (*Wireless World*, 31st July, 1929, Vol. 25, pp. 97-101.)

The mouth of this horn was formed by an octagonal room whose ceiling sloped down to the walls

from a central horizontal portion: this horizontal portion was removed and the horn built above the gap thus left.

TRANSMISSION OF SOUND THROUGH WALL AND FLOOR STRUCTURES.—V. L. Chrisler and W. F. Snyder. (*Bur. of Stds. Journ. of Res.*, March, 1929, Vol. 2, pp. 541-559.)

ÜBER DIE EXPERIMENTELLE BESTIMMUNG DES WIRKUNGSRADES EINES BANDLAUTSPRECHERS (The Experimental Determination of the Efficiency of a Band Loud-speaker).—H. Graf. (*Zeitschr. f. tech. Phys.*, Aug., 1929, Vol. 10, No. 8, pp. 334-339.)

The writer employs a method analogous to that used by Barkhausen and others to measure the efficiency of submarine acoustic transmitters; but in his case the measurements of the ohmic resistance and the in-phase and wattless components of the band reactance are taken first in air and then in a vacuum, and instead of a wattmeter a Wheatstone bridge is used. As, however, the method is only applicable to an apparatus giving a fairly well-marked resonance curve (since it depends on a comparison between the decrements in air and *in vacuo*), a special band with a marked resonance point was substituted for the usual loud-speaker band. [It would thus seem that the title of the paper is somewhat misleading, since the apparatus tested was a note-generator rather than a loud-speaker.] Curves of results are given: a Vogt aluminium alloy proved the best material for the purpose.

THE KYLE CONDENSER LOUD SPEAKER.—V. F. Greaves, F. W. Kranz, and W. D. Crozier. (*Proc. Inst. Rad. Eng.*, July, 1929, Vol. 17, pp. 1142-1152.)

This paper presents some of the theoretical considerations involved in the design of the Kyle loud-speaker (see Sept. Abstracts, p. 514) together with a brief discussion of the practical problems met with in its design and application.

THE INDUCTOR DYNAMIC (FARRAND LOUD-SPEAKER MOVEMENT).—H. P. Westman. (*QST*, Aug., 1929, Vol. 13, pp. 29-30.)

A design is described and illustrated which is of the magnetic type but has the same kind of armature motion as a moving coil; the armature is allowed to "float" within the gap between opposing pole-pieces and yet moves parallel to these so that its motion does not alter the length of the gaps. Restoration is due entirely to the magnetic field caused by the permanent magnet.

MOUNTING THE GRAMOPHONE PICK-UP.—(*Wireless World*, 7th Aug., 1929, Vol. 25, pp. 132-133.)

"If an ordinary tone arm is correctly placed and the pick-up is properly adjusted thereon, the tracking can be made to approach very nearly to the ideal [a maximum departure from tangential tracking of below 2° is mentioned later] without the inclusion of special devices for ensuring a straight line motion or its equivalent. . . . The track of the needle should not pass through the

centre of the turntable." A simple formula for calculating the best position, for a tone arm of any length, is given.

TRANSIENTS IN LOUD SPEAKERS AND AMPLIFIERS: HOW SUDDEN CHANGES IN SOUND INTENSITY AFFECT THE AMPLIFIER: THE IMPORTANT EFFECT OF A CHOKE-FILTER OUTPUT.—N. W. McLachlan. (*Wireless World*, 7th and 14th Aug., 1929, Vol. 25, pp. 118-121 and 154-157.)

VERSTAANBAARHEID VAN LUIDSPREKERINSTALLATIES (The Intelligibility of a Loud Speaker). C. Zwikker. (*De Ingenieur*, S. Africa, No. 13, 1929; a rather full German Abstract of this paper is to be found in *Physik. Berichte*, 1st Aug., 1929, Vol. 10, No. 15, pp. 1537-1538.)

APPLICATION OF MICROPHOTOMETERS FOR THE ANALYSIS OF PHOTOGRAPHIC SOUND RECORDS.—J. T. Tykociner. (Summary in *Phys. Review*, June, 1929, Vol. 33, p. 1094.)

FREQUENZKURVEN VON ELEKTRISCHEN TONABNEHMERN UND MECHANISCHEN GRAMMOPHONEN (Frequency Curves of Electric Pick-Ups and Mechanical Gramophones).—E. Meyer and P. Just. (*E.N.T.*, July, 1929, Vol. 6, pp. 264-268.)

In order to make use of gramophone test-records giving pure notes varying from 6,000 to 100 p.p.s., or "howling" notes of a breadth of 100 p.p.s. whose mid-point varies from 150 to 6,000 p.p.s., the writers have devised a simple way of measuring the amplitudes communicated to the needle at different points on the record. An electrical pick-up is employed, and the speed of rotation is adjusted so that the different parts of the record, tested in turn, give—not their own special note—but a fixed deep note. The amplitude at each part is then measured by the voltage at the pick-up output terminals. In actual practice it is found best to cover the whole range of the record in two or more overlapping stages. The records, calibrated by this method, can then be used for plotting frequency curves, various examples of which are given.

STUDY ON THE CHARACTERISTICS OF ACOUSTIC TUBES.—K. Kobayasi. (*Tech. Rep. Tôhoku Univ.*, Sendai, 1929, Vol. 8, No. 3, pp. 65-119.)

In English. Part I. deals with acoustic wave filters (a) low-pass and band-pass, and (b) high-pass. The transmission characteristics of systems consisting of short tubes of various cross sections variously arranged are investigated by means of hyperbolic parameters, and the equivalent electrical circuits for class (a) are discussed. Procedure for the design of filters of both classes is outlined. Part II. deals with an investigation of the propagation of sound in hair-felt and such absorbent materials, a direct method of measuring extremely small acoustic impedances being described which enables such an investigation to be carried out. Part III. deals with the characteristics of a rubber

tube. A working theory of the rubber tube as an acoustic tube having a non-rigid wall is formulated, and confirmed practically exactly by tests using the above-mentioned method, and by other tests using the vibrometer method. It was thus found that the latter method, when combined with "an ideal acoustic transformer of high ratio and high primary stiffness" can also be used satisfactorily for measuring small acoustic impedances. A bibliography of 38 items ends the paper.

EXPERIMENTAL AND THEORETICAL MID-SERIES CHARACTERISTIC IMPEDANCE OF ACOUSTIC WAVE FILTERS.—G. W. Stewart and C. W. Sharp. (*Journ. Opt. Soc. Am.*, July, 1929, Vol. 19, pp. 17-28.)

A comparison between the simplified Stewart theory of these tube filters and the less approximate theory of Mason, made by checking the two theories against experimental results with high-pass, low-pass and single-band-pass filters. For ascertaining cut-offs, and the characteristic impedance of low-pass filters, the Stewart theory is more readily applicable and appears satisfactory.

EXPERIMENTAL ANALYSIS OF THE FORCE EXERTED BY SOUND WAVES ON AN AIR RESONATOR.—E. Waetzmann and K. Schuster. (*Ann. der Phys.*, 25th Feb., 1929, Vol. 1, No. 4, pp. 556-564.)

The three components are:—an attractive force independent of frequency; a phase force, attractive below resonance and repulsive above; a resonance force, repulsive for all frequencies and a maximum for the resonant frequency. Maximum attraction is separated from maximum repulsion by a very small range of frequency.

IMPROVED REPRODUCTION BY THE REDUCTION OF DISTORTION DUE TO ANODE RECTIFICATION.—A. G. Warren. (See under "Properties of Circuits.")

PHOTOTELEGRAPHY AND TELEVISION.

COLOUR TELEVISION. (*Nature*, 10th Aug., 1929, Vol. 124, p. 241.)

A paragraph dealing with the report of a demonstration of colour television by Ives. 3 groups of photoelectric cells are used, each covered with a primary colour filter; while at the receiver, the signal operates glow-lamps behind coloured screens.

RESEARCHES IN CATHODE RAY TUBE TELEVISION. L. B. Rosing. (*T. I. b. p.*, No. 2, 1929, Vol. 10, pp. 185-194.)

In Russian.

LE PROBLÈME DE LA TÉLÉVISION (The problem of Television).—B. Decaux. (*T.S.F. Moderne*, Feb., 1929, Vol. 10, pp. 63-76.)

The writer defines the problem, explains its difficulties and describes the present attempts to solve them—which he considers to be only provisional. He ends by giving his opinion that television is now in the position of radio-telephony before the introduction of valves, and that no

progress can be hoped for except from new methods—possibly connected with cathode rays and phenomena such as the Kerr effect.

PIEZOELECTRIC AIR CURRENTS USED FOR RELAY PURPOSES.—(German Patent 475374, Telefunken, published 24th April, 1929.)

The air currents produced by an oscillating piezoelectric crystal are used to deflect a mirror (for picture telegraphy) or a liquid jet, or to close a contact.

REFLEXIONSABTASTUNG BEI BILDTELEGRAPHEN (Reflection Scanning for Picture Telegraphy).—F. Schröter. (*Zeitschr. f. tech. Phys.*, Aug., 1929, Vol. 10, No. 8, pp. 323-327.)

The use of a paraboloid reflector to collect the rays diffused from the scanned picture is dealt with in February Abstracts, p. 108. The present paper gives a detailed account of the latest developments of this method, as used in the S.K.T. system. The paraboloid mirror is replaced by an ellipsoidal mirror, which gives better results.

SEPARATION OF PICTURE SIGNAL FROM SYNCHRONISING SIGNAL. (German Patent 475831, Lorenz, pub. 11th May, 1929.)

Difficulty in separating the modulation frequency representing the picture signals from the synchronising signal frequency is here avoided by suppressing one sideband of each, on opposite sides of the carrier frequency: the remaining modulated frequencies, being one on each side of the carrier, can readily be separated.

FIXING "FULTOGRAPH" PICTURES.—A. J. H. Iles. (*Electrician*, 23rd August, 1929, Vol. 103, p. 234.)

The permanent fixing of pictures on starch and potassium iodide sensitised paper is here stated to be possible by treatment with alum (one tea-spoonful to a pint of water).

THE MAGNETO-OPTICAL DISPERSION OF SOME ORGANIC LIQUIDS IN THE ULTRA-VIOLET REGION OF THE SPECTRUM.—C. C. Evans and E. J. Evans. (*Phil. Mag.*, August, 1929, Vol. 8, No. 49, pp. 137-158.)

The magneto-optical rotations of two alcohols and of methyl and ethyl acetate are investigated for various wavelengths in the violet and near ultra-violet regions, and equations obtained representing the magneto-rotary dispersions.

MICROSCOPIC STUDY OF ELECTRIC DOUBLE REFRACTION IN LIQUIDS.—M. Iwatake. (*Tech. Rep. Tôhoku Univ.*, Sendai, 1929, Vol. 8, No. 3, pp. 121-132 and 7 plates.)

In English. The Kerr effect is usually supposed to appear uniformly in the space between the plates of the condenser, but the writer has found certain complications of the phenomenon during his photo-micrographic study of the effect under a high continuous potential of several thousand volts: the effect, in nitrobenzene, nitrotoluol-ortho and pyridin (but apparently not in carbon

disulphide), does *not* appear uniformly in the space if it is between parallel plates, and less still if the electrodes are cylindrical. Results suggest that the field in the gap is not uniform, perhaps because of the stratified settling of an inhomogeneous liquid. A bibliography of 49 items is included in the paper.

RELATION BETWEEN BLACKENING OF PHOTOFILM AND POTENTIAL DIFFERENCE ON KERR CONDENSER IN PICTURE TRANSMISSION SYSTEMS USING PHOTOELECTRIC CELLS.—P. V. Shmakov. (*T. i T. b. p.*, No. 2, 1929, Vol. 10, pp. 147-152.)

In Russian.

NO TIME-LAG IN KERR EFFECT.—E. Gaviola. (See under "General Physical Articles.")

LIGHT-SENSITIVE CELLS.—J. P. Arnold. (*Rad. Engineering*, March, April, May and June, 1929, Vol. 9.)

(1) Construction of Alkali Metal Cells; Nature and Treatment of the Light-sensitive Material; (2) Characteristics of the Alkali Metal Cell; (3) Amplification, Measurement and Utilisation of Photoelectric Currents; (4) Practical Cells of Various Types.

EFFECTS OF A CRYSTALLOGRAPHIC TRANSFORMATION ON THE PHOTOELECTRIC AND THERMIONIC EMISSION FROM COBALT.—A. B. Cardwell. (*Proc. Nat. Acad. Sci.*, July, 1929, Vol. 15, pp. 544-551.)

THE USE OF DIELECTRICS TO SENSITIZE ALKALI METAL PHOTOELECTRIC CELLS TO RED AND INFRA-RED LIGHT.—A. R. Olpin. (*Phys. Review*, June, 1929, Vol. 33, p. 1081.)

A technique is described for increasing greatly the response (especially in the red) of sodium and potassium surfaces in a vacuum by the introduction of very small amounts of such dielectrics as sulphur vapour, water vapour, benzene, and organic dyes. A theory is proposed which suggests a modulation of the exciting light at the cathode surface, the incident frequency combining with the characteristic vibration frequency of the dielectric. See also the same author, *ibid.*, 1st Aug., 1929, p. 544. Experimental data confirm the various theoretical conclusions arrived at.

THE PHOTOELECTRIC AND THERMIONIC PROPERTIES OF MOLYBDENUM.—M. J. Martin. (*Phys. Review*, June, 1929, Vol. 33, pp. 991-997.)

UNTERSUCHUNGEN ÜBER DEN SELEKTIVEN LICHT-ELEKTRISCHEN EFFEKT AN DÜNNEN, AUF EINEM PLATINSPIEGEL ADSORBIERTEN KALIUMHÄUTEN (Investigations into the Selective Photoelectric Effect in Thin Potassium Films adsorbed on a Platinum Mirror).—R. Subramann and H. Theissing. (*Zeitschr. f. Phys.*, 5th July, 1929, Vol. 55, No. 11/12, pp. 701-716.)

Various thicknesses of film were used, from monatomic thickness upwards. A monatomic film

gave a normal sensitivity curve with normal ratio. A slightly thicker film gave a high spectral maximum with a strongly selective ratio, at 3.40 μ . With still thicker films the maximum moved towards the longer wavelengths and became distinctly smaller.

THE PREPARATION OF PHOTOELECTRIC CELLS WITH THIN FILMS OF LITHIUM AS THE PHOTOACTIVE MATERIAL.—H. E. Ives. (Summary in *Phys. Review*, June, 1929, Vol. 33, pp. 1081.)

THERMIONIC AND PHOTOELECTRIC EMISSION FROM CESIUM AT LOW TEMPERATURES.—L. R. Koller. (Summary in *Phys. Review*, June, 1929, Vol. 33, p. 1082.)

TALBOT'S LAW IN CONNEXION WITH PHOTO-ELECTRIC CELLS.—G. H. Carruthers. (*Phil. Mag.*, August, 1929, Vol. 8, No. 49, pp. 210-213.)

In connection with the difference of opinions referred to in September Abstracts, the writer describes some tests which confirm that the fatigue effect in question does not occur to any appreciable extent in any single exposure of a cell by a rotating sector, but takes place over a number of such exposures corresponding to a period of exposure of $\frac{1}{2}$ to 5 secs. The cell used was a caesium one exhibiting distinct non-proportionality.

PHOTOELEKTRISCHER EFFEKT VON DIELEKTRISCHEN OBERFLÄCHE NACH VORHERGEHENDER AUFLADUNG DURCH LANGSAME ELEKTRONEN (Photoelectric Effect of Dielectric Surfaces after a Preliminary Charging by Slow Electrons).—P. S. Tartakowsky (*Journ. Russ. Phys. Chem. Ges.*, 1927; long summary in *Physik. Berichte*, 15th June, 1929, Vol. 10, No. 12, pp. 1182-1183.)

MEASUREMENT OF THE PHOTOELECTRIC EFFECT DURING CHANGE OF STATE OF KATHODE.—A. Goetz. (*Zeitschr. f. Phys.*, Feb., 1929, No. 7/8, Vol. 53, pp. 494-525.)

Temperature range was from 50° to 550°. Among the results found was the conclusion that the photoelectric emission is independent of temperature so long as there is no change of state or allotropic form.

EXPERIMENTS ON THE PHOTOELECTRIC EFFECT IN THIN FILMS OF POTASSIUM AND SODIUM.—W. F. G. Swann: Nottingham. (*Journ. Franklin Inst.*, Aug., 1929, Vol. 208, pp. 235-244.)

MEASUREMENTS AND STANDARDS.

SUR LES VIBRATIONS SUIVANT L'AXE OPTIQUE DANS UN QUARTZ PIÉZO-ÉLECTRIQUE OSCILLANT (On the Vibrations following the Optical Axis in an Oscillating Piezoelectric Quartz Crystal).—E. P. Tawil. (*Comptes Rendus*, 22nd July, 1929, Vol. 189, pp. 163-164.)

According to Curie's laws there should be no piezoelectric deformation along the optical axis: recent work on oscillating quartz has shown the

existence of a fundamental frequency which seems to correspond to a mode of vibration along that axis, but there has been hesitation in accepting results which would contradict the theory, and various authors have proposed explanations based on no experimental facts. The writer's tests by his method using polarised light and by the use of ultra-audible waves convince him that undoubtedly such vibrations do take place.

ON THE MODES OF VIBRATION OF QUARTZ CRYSTAL.

—J. W. Harding and F. W. G. White. (*Phil. Mag.*, August, 1929, Vol. 8, No. 49, pp. 169-179.)

"The existence of nodes and antinodes on the surface of an oscillating quartz crystal has been demonstrated by A. Crossley [Abstracts, 1928, Vol. 5, p. 349] using ferro-ferricyanide solution as an indicator. It is stated that lycopodium powder was tried but was thrown off, leaving no trace on the crystal. Using a fairly thick crystal [$4 \times 3.5 \times 2.5$ cms.] the present writers have found lycopodium powder very effective, and a comprehensive study of the various patterns formed on the crystal surface for various modes of vibration has been carried out. Special care has been taken to trace the connection between the modes of vibration of the faces and the air-currents which may issue from those faces."

OBSERVATIONS ON MODES OF VIBRATION AND TEMPERATURE COEFFICIENTS OF QUARTZ CRYSTAL PLATES.—F. R. Lack. (*Proc. Inst. Rad. Eng.*, July, 1929, Vol. 17, pp. 1123-1141.) See Sept. Abstracts, p. 518.

PIEZOELECTRIC EFFECT OF DIAMOND.—W. A. Wooster. (*Min. Mag.*, March, 1929, Vol. 22, pp. 65-69.)

No effect could be detected; in any case it must be less than $1/200$ th of that of quartz.

THE PIEZOELECTRICAL PROPERTIES OF AMORPHOUS AND CRYSTALLINE SUBSTANCES IN AN ELECTRIC FIELD.—A. Subnikov and B. Bruno-vskij. (*Bull. Ac. Sc. Leningrad*, No. 4/5, 1928, pp. 367-374.)

Every dielectric whose particles (molecules or other structural elements) are subjected to displacements in an electric field are piezoelectric to a greater or less extent. If the particles are set into vibration by a mechanical shock, periodic compression and extension effects are produced which result in a supplementary field whose direction alternates in time with these vibrations: thus the external field is alternately increased and diminished. 84 minerals were examined; cinnabar gave the most marked, asbestos and barytes the least effect. Of artificial materials, impregnated wood gave the greatest result, and glass the least.

UNTERSUCHUNG ÜBER PYRO- UND PIEZOELEKTRIZITÄT (An Investigation into Pyro- and Piezoelectricity).—A. Meissner. (*Naturwiss.*, 11th Jan., 1929, Vol. 17, pp. 25-31.)

Part of this paper was dealt with in September Abstracts. It includes also an explanation of pyro-

and piezoelectric phenomena on the assumption that the smallest structural element in quartz possesses the same properties, in these ways, as a large crystal. It deals also with the pyroelectric moment of quartz after heating to various temperatures and subsequent cooling; the moment is found to be proportional to the temperature, and is upset by a crystal-conductivity which is dependent on the temperature. The writer goes on to refer to the artificial piezoelectric substances dealt with in March Abstracts, p. 159: no new progress of importance seems to have been made here.

GROWING CRYSTALS FOR PIEZOELECTRIC ELEMENTS. (German Patent 475567, Int. Gen. Elec. Co., published 30th April, 1929.)

A seed crystal is cut from the parent crystal so that one of its faces is parallel to a certain face of the complete crystal. The seed crystal is placed between two plates spaced the thickness of the required crystal, the special face lying against one plate. The whole is immersed in a mother liquor to grow till the required thickness is reached.

MEASUREMENT OF WAVELENGTHS OF BROADCASTING STATIONS.—R. Brailard and E. Divoire. (See under "Stations, Design and Operation.")

THE ROUTINE MEASUREMENT OF THE OPERATING FREQUENCIES OF BROADCAST STATIONS.—H. L. Bogardus and C. T. Manning. (See under "Stations, Design and Operation.")

NOTE ON THE RATIO OF THE ELECTROMAGNETIC TO THE ELECTROSTATIC UNIT OF ELECTRICITY AS COMPARED TO THE VELOCITY OF LIGHT.—H. L. Curtis. (*Bur. of Stds. Journ. of Res.*, July, 1929, Vol. 3, pp. 63-64.)

Gruneisen and Giebe in 1920 announced a determination of the absolute measurement of the international ohm which differed by only 1 part in 100,000 from the value found in 1913 by F. E. Smith. Recent tests at the Washington Bureau show that this value is not in error by as much as 1 part in 10,000. The best value to date for the ratio of electromagnetic to electrostatic unit is therefore 299,790 km./sec. Michelson's recent value of the velocity of light is $299,796 \pm 4$ km./sec., and a preliminary determination by Karolus and Mittelstaedt (see under "Prop. of Waves") gives $299,778 \pm 20$ km./sec. Thus the ratio of units agrees with the measured velocity within the limits of present measurement.

A COMPARISON OF THE FORMULAS FOR THE CALCULATION OF THE INDUCTANCE OF COILS AND SPIRALS WOUND WITH WIRE OF LARGE CROSS SECTION.—F. W. Grover. (*Bur. of Stds. Journ. of Res.*, July, 1929, Vol. 3, pp. 163-190.)

Author's summary:—Two methods have been used for the calculation of the inductance of coils of wire having a relatively large cross section. Of these, the summation method gives the inductance of the coil as the sum of the self-inductances of the turns and the mutual inductances of all the pairs of

turns. The Rosa method calculates the inductance of the equivalent current sheet as a first approximation to the inductance of the coil, and obtains the correction which must be applied by calculating (a) the differences between the self-inductance of the turns of wire and of the current sheet and (b) the differences of the mutual inductances of pairs of turns of wire and of the corresponding turns of the current sheet.

It is here shown that, contrary to previous opinions, the two methods give identical results, when terms of the same degree are retained in the series expressions.

The accurate formula of Snow for the inductance of a helix is written so as to include the Rosa correction terms, and it is proved that the error of the Rosa method may be neglected in all except the most precise work.

It is recommended that, lacking precision formulas, the Rosa method be used as giving a general solution of the problem in such cases where the current sheet formula is known. Certain important cases are reviewed briefly.

RESISTANCE OF AIR CONDENSERS.—R. R. Ramsey and B. D. Morris. (Summary in *Phys. Review*, June, 1929, Vol. 33, p. 1076.)

STUDIO DEL TRIODO COME AMPLIFICATORE BALLISTICO PER LA MISURA DI PICCOLE CAPACITÀ (Study of the Three-Electrode Valve as a Ballistic Amplifier for the Measurement of Small Capacities).—E. Cristofaro and G. Sacerdote. (*Elettrotec.*, 25th July, 1929, Vol. 16, pp. 494-498.)

The method consists essentially in charging the capacity to be measured to a known voltage and then discharging it through a resistance, one end of which is connected to the grid of a triode. Thus this grid (in whose circuit no current was flowing previously) is suddenly subjected to a change of potential. A ballistic galvanometer in the anode circuit integrates the corresponding change of anode current over the time of the discharge and thus gives a measure of the charge of the capacity.

ELECTRICAL WAVE ANALYZERS FOR POWER AND TELEPHONE SYSTEMS.—R. G. McCurdy and P. W. Blye. (*Journ. Am.I.E.E.*, June, 1929, Vol. 48, pp. 461-464.)

The telephone circuit analyser operates over a frequency range from 75-3,000 cycles and measures harmonic currents down to 0.05 microampere and voltages as small as 0.005 millivolt. It employs multi-stage valve amplifiers and two duplicate inter-stage selective circuits. Special devices for suppressing the fundamental component and for balancing out harmonics generated in the input transformers are provided.

EIN NEUER OHMSCHER SPANNUNGSTEILER FÜR HOCHFREQUENZ (A New Ohmic Potential Divider for H.F.).—M. v. Ardenne. (*Elektrot. u. Masch. bau*, 2nd June, 1929, Vol. 47, pp. 471-472.)

A discussion of the desirability of ohmic potential dividers in the test room, instead of those of

capacitive type or inductive couplings, leads to the remark that the first have scarcely been used in the past because of the lack of non-inductive and capacity-free resistances. The use of Loewe resistances, which with associated leads have a capacity of only 2 cms., is recommended.

GEKREUZTE ZYLINDER ALS FUNKENSTRECKE (Crossed Cylinders as Spark Gap).—E. Werner. (*Arch. f. Elektrot.*, 8th May, 1929, Vol. 22, No. 1, pp. 1-19.)

For high voltage measurements, crossed cylinders (suggested by Schwaiger) are shown to be superior to all other forms of spark gap hitherto used.

SHIELDING IN HIGH-FREQUENCY MEASUREMENTS.—J. G. Ferguson. (*Bell Tech. Journ.*, July, 1929, Vol. 8, pp. 560-575.)

MESURE DES VALEURS MAXIMA INSTANTANÉES DES TENSIONS À BRUSQUES VARIATIONS (Measurement of Instantaneous Maximum Values of Suddenly Varying Tensions).—H. André. (*Rev. Gén. de l'Élec.*, 29th June, 1929, Vol. 25, pp. 1013-1015.)

A paper on the use of a thermionic peak voltmeter comprising a triode, a condenser and a potentiometer.

SUBSIDIARY APPARATUS AND MATERIALS.

DIE DREHZAHLEGEUNG VON GLEICHSTROMMOTOREN MIT ELEKTROENRÖHREN (The Speed Regulation of D.C. Motors by Thermionic Valves).—E. Reimann. (*Wiss. Veröff. Siemens Konz.*, vi/2, 1928.)

A theoretical investigation of the method dealt with in February Abstracts, p. 111. For a summary, see E.u.M. bau, 14th July, 1929.

AN IMPROVED CONSTANT CURRENT REGULATOR.—L. G. Longworth and D. A. MacInnes. (*Journ. Opt. Soc. Am.*, July, 1929, Vol. 19, pp. 50-55.)

An arrangement involving a small continuously running motor driving a disc against which either of two clutch-discs can be pressed, one of which by its rotation increases the current while the other decreases it. By a galvanometer with a reflecting vane on its indicator, and a photoelectric cell with relay, the two opposing clutch-discs are kept so working that the galvanometer remains "hovering" about its zero point—which corresponds with the constant current required. For circuits subjected to small variations of resistance and E.M.F., the resulting constancy is within 0.01 per cent.

NOUVEAU RÉGULATEUR AUTOMATIQUE DE TENSION (A New Automatic Voltage Regulator).—P. Toulon. (*Rev. Gén. de l'Élec.*, 3rd Aug., 1929, Vol. 26, pp. 189-191.)

A regulator based on the different current/voltage curves of a simple ohmic resistance and of a neon tube, and therefore similar to the regulator dealt with by Roder in Germany (September Abstracts, p. 522) who used an ordinary metal filament lamp but who mentioned the equal suitability of neon

tubes. The present writer gives 0.2 per cent. as the approximate variation of voltage for a 10 per cent. variation of supply voltage. 20 neon lamps are used for an output power of 120 w. A practical portable form of the regulator is illustrated.

AUTOMATIC VOLTAGE REGULATOR FOR DIRECT CURRENT.—G. T. Winch and A. Bone. (*Journ. Scient. Instr.*, Aug., 1929, Vol. 6, pp. 247-249.)

An arrangement involving a constant voltage potentiometer in opposition to the fluctuating voltage, relays, and a small motor operating—through reduction gearing—a mercury resistance. It maintains a constancy of within $\pm \frac{1}{2}$ per cent.

A BATTERY REVOLUTION: THE DRUMM ACCUMULATOR.—(*Electrician*, 30th Aug., 1929, Vol. 103, p. 239.)

A paragraph on the reports from Ireland of this new accumulator, which, it is said, can be fully charged in a few minutes and which is to be used to electrify the main railway line between Dublin and Cork.

SPEED INDICATOR AND FREQUENCY METER.—E. H. Greibach. (*Journ. Am.I.E.E.*, August, 1929, Vol. 48, pp. 633-634.)

This simple mechanical speed indicator, which when driven positively by a synchronous motor can serve as an accurate frequency meter, consists of a transparent cup rotating about a vertical axis and containing one or more balls. The ball climbs along the inside wall until it is in equilibrium, when the centrifugal force and gravity give a resultant perpendicular to the tangent to the inside surface. With a cup designed to give precise indication through a range of ± 2 per cent. of a given speed, the order of precision is about one-tenth of 1 per cent. Much wider ranges of variation can be designed for.

A NEW TYPE OF HOT CATHODE OSCILLOGRAPH.—R. H. George. (*Journ. Am.I.E.E.*, July, 1929, Vol. 48, pp. 534-538.)

The paper describes a general purpose type, capable of operating at any potential from 500 to 20,000 volts or more, and a special portable type. Among special features are the following:—a "hot cathode electron gun" which makes possible automatic starting and stopping of the beam (e.g. by a lightning surge, within $\frac{1}{2}$ to $\frac{1}{4}$ microsecond after the surge voltage begins to rise from zero); a new electrostatic method of focusing the beam; the entire beam passes through the high-voltage anode, thus eliminating the problem of anode heating.

THE EFFECT OF GASES ON THE RESISTANCE OF GRANULAR CARBON CONTACTS.—P. S. Olmstead. (*Journ. Phys. Chem.*, No. 1, 1929, Vol. 33, pp. 69-80.)

Contact-resistance changes under variations of applied voltage and of surrounding gas pressure are explained on the assumption that the gas forms surface layers which take some of the total contact pressure and thus increase the resistance. The

pores of the carbon absorb gas which, on the reduction of pressure in the surrounding gas, emerge and penetrate into the contact-points.

REMOVAL OF FILMS AND PLATES FROM C-R OSCILLOGRAPH WITHOUT DISTURBING THE VACUUM.—P. Hochhäusler. (*E.T.Z.*, 8th Aug., 1929, Vol. 50, pp. 1175-1176.)

Discussion on the paper dealt with in September Abstracts, p. 520.

"PYREX" GLASS AS A DIELECTRIC.—C. L. Dawes and P. H. Humphries. (*Elec. World*, Vol. 91, p. 1331.)

NOTE ON HIGH VOLTAGE LEYDEN JARS.—P. P. QUAYLE. (*Journ. Opt. Soc. Am.*, May, 1929, Vol. 18, pp. 407-410.)

A jar of Pyrex glass is described. Many ordinary jars will break down if occasionally subjected to potentials of the order of 10^9 volts for a period of 4 to 6 months; but the pyrex jars have given no trouble during 14 months of use. They are said to be quite inexpensive.

HOCHLEISTUNGSSCHALTER OHNE ÖL (High-power Switches without Oil).—J. Biermanns. (*E.T.Z.*, 25th July, 1929, Vol. 50, pp. 1073-1079.)

First part of an article on the A.E.G. compressed air switch, capable of controlling up to 500,000 kva.

DIE NEUE ENTWICKLUNG DES GLIMMERKONDENSATORS (The New Development of the Mica Condenser).—F. Gerth and H. Gönningen. (*E.T.Z.*, 8th August, 1929, Vol. 50, pp. 1156-1159.)

Authors' summary:—After a short historical survey, the recent development of the mica condenser, particularly for use with high frequencies, is described. It is shown that with good mica the possible H.F. load is controlled not by the dielectric strength but by the appearance of brush discharge and by the heating caused by dielectric loss. A number of recent designs, based on the latest knowledge, are described and illustrated.

UNTERSUCHUNGEN ÜBER DEN DURCHSCHLAG UND DIE VERLUSTE EINIGER FESTER ISOLIERSTOFFE (Investigations into the Breakdown and Losses of Some Solid Insulating Materials).—K. Halbach. (*Arch. f. Elektrot.*, No. 6, 1929, Vol. 21, pp. 535-562.)

The materials included glass, steatite and paper. For a very slow increase of voltage (1 kv. per minute) the breakdown voltage is practically constant up to a certain temperature and then drops exponentially. The writer concludes that on the part of the curve which is independent of temperature, the breakdown is an entirely electrical effect, while on the other part it is a heat effect.

NEW INVESTIGATIONS INTO THE FUNCTIONING OF MERCURY RECTIFIERS.—J. v. Issendorff. (*E.T.Z.*, 25th July, 1929, Vol. 50, pp. 1079-1086; Discussion, pp. 1099-1101.)

RECTIFICATION OF HIGH TENSION ALTERNATING CURRENT BY MEANS OF A STRIATED-DISCHARGE CIRCUIT.—T. Itoh. (*Proc. Imp. Acad.*, Tokio, No. 1, 1929, Vol. 5, pp. 5-14.)

Description and investigation into the action of a special form of point-to-plate discharge gap with a circular glass plate between the electrodes, the whole being in an atmosphere of 6.20 cm. pressure. In another form, the glass plate is replaced by a liquid dielectric.

MODERN POWER RECTIFIERS (A.E.G.).—(*A.E.G. Mitt.*, March, 1929, No. 3, pp. 79-86.)

A series of papers on the glass-bulb and ironclad rectifiers, for currents up to 400 a. or thereabouts, now being produced.

HOCHSPANNUNGS-GLEICHSTROM-MASCHINEN DER A.-G. BAYERISCHE ELEKTRIZITÄTS-WERKE IN LANDSEUT (High Tension Direct Current Generators made by the Bavarian Electrical Works at Landshut).—(*Zeitschr. f. Hochf. Tech.*, July, 1929, Vol. 34, pp. 27-28.)

Among the types illustrated and briefly described are:—16 kw. at 1,440 r.p.m., 4,500 v., two poles only which gives several advantages, e.g., small diameter commutator which is strong mechanically; weight only 715 kg.; a complete motor-generator set, 3 kw. at 2,940 r.p.m., 3,000 v. generators with three commutators giving high, medium and low voltage d-c, two slip-rings giving 50 cycle a-c, and provision for a small supply of 800 cycle a-c; a filament supply motor-generator set giving 500 a. at 17 v.

SUR LES PILES À ÉLECTROLYTE FONDUE: LA PILE OXYDE DE CUIVRE-SOUDE CAUSTIQUE FONDUE-ZINC (Cells with Molten Electrolyte: the Copper Oxide—Molten Caustic Soda-Zinc Cell).—G. I. Costeanu. (*Comptes Rendus*, 1st July, 1929, Vol. 189, pp. 35-37.)

"This cell would be useful for its high E.M.F. [about 1.3 v.] and constant output, if the zinc were not strongly attacked even on open circuit."

DAS MINIMALIMPEDANZRELAIS (Minimum Impedance Relays).—H. Puppikofer. (*Bull. de l'Assoc. Suisse des Elec.*, 7th May, 1929, Vol. 20, pp. 249-267.)

EIN EINFACHES VERFAHREN ZUR ABKÜRZUNG DER BELICHTUNGSZEITEN BEI PHOTOGRAPHISCHEN AUFNAHMEN (A Simple Way of Shortening the Exposure in Photographic Recording).—F. Ebert. (*Zeitschr. f. anorg. Chem.*, No. 1/3, 1929, Vol. 179, pp. 279-280.)

A saving of 50 to 70 per cent. of the exposure can be obtained by warming the film to 40°.

A NEW SIGNAL RELAY.—C. T. Burke. (*Rad. Engineering*, March, 1929, Vol. 9, pp. 38-39.)

A relay operating on one milliampere (its d-c resistance being 1,500 ohms) and following impulses of frequency up to 125 per second. An unusual feature is the wide pole-gap (0.47 inch), giving a uniform field in the region through which the reed

moves, and making the adjustment to the neutral position less critical than in other relays. The tungsten point contacts will break one ampere without burning.

MACHINE FOR INTEGRATING A FUNCTIONAL PRODUCT.—K. E. Gould. (Abstract in *Science Abstracts*, Sec. B, 25th June, 1929, p. 332.)

MAGNETIC TESTING FURNACE FOR TOROIDAL CORES.—G. A. Kelsall. (*Journ. Opt. Soc. Am.*, July, 1929, Vol. 19, pp. 47-49.)

A furnace designed to eliminate the difficulty in maintaining the insulation between turns of the magnetising and exploring windings, and between the windings and the test sample, during tests at high temperatures.

STATIONS, DESIGN AND OPERATION.

THE PROBLEMS OF RADIO SERVICING.—J. F. Rider. (*Rad. Engineering*, June, 1929, Vol. 9, pp. 63-66.)

This the third paper of a series, deals with general valve voltage and current tests indicating specific faults in the receiver.

MEASUREMENT OF WAVELENGTHS OF BROADCASTING STATIONS.—R. Brillard and E. Divoire. (*E. W. & W. E.*, Aug., 1929, Vol. 6, pp. 412-421.)

An account of the work of the Brussels Checking Station of the U.I.R., with diagrams and photographs of the apparatus. There is a section on the Accuracy of Measurements (which points to an accuracy of the order of one or two parts in 10,000 in the measurement of wavelength) and on the Measurement of "Scintillation" or variation of carrier frequency due to modulation. This is dealt with by obtaining a heterodyne note of about 1000 p.p.s. and causing it to beat with a similar note from a tuning fork so as to give, not zero beat, but a note of a few cycles per second, which is rectified, amplified and recorded side by side with a seconds pendulum record.

THE ROUTINE MEASUREMENT OF THE OPERATING FREQUENCIES OF BROADCAST STATIONS.—H. L. Bogardus and C. T. Marning. (*Proc. Inst. Rad. Eng.*, July, 1929, Vol. 17, pp. 1225-1239.)

Authors' summary:—The method of making "zero beat" measurements of the operating frequencies of broadcast stations in the Second Radio District is described, showing the method of comparing the received signal from a broadcasting station with a signal of known frequency, obtained from a 10-kc multivibrator controlled by a 90-kc quartz crystal. There is also given a description of the method used in reducing the measurement to a flexible routine procedure while still maintaining an accuracy well within the 500-cycle limit established by the Federal Radio Commission.

THE PRAGUE CONFERENCE.—(*P.O. Elec. Eng. Journ.*, July, 1929, Vol. 22, pp. 126-128.)

This paper prefaces the reprint of the Prague allocation of wavelengths by a short history of the

preceding state of affairs, and remarks that "this is the first time that the Governments of European States have concurred in the wider, more humanitarian view that the last comer, or the smallest State, is entitled to share in the artistic and cultural benefits of Broadcasting, and that a distribution of wavelengths based on the essential needs of the countries concerned should take the place of the more crude policy of grab."

TOUR D'EUROPE RADIOPHONIQUE (A Tour of Broadcasting Europe).—A. Surchamp. (*QST Franç.*, Aug., 1929, Vol. 10, pp. 53-60.)

The countries dealt with in this instalment are Belgium, Holland, Denmark, Norway and Sweden.

COMMON WAVE BROADCASTING: PHASE-COMPENSATION OF THE CONNECTING LINES.—(German Patent 475375, Int. Stand. Elec. Corp., pub. 23rd April, 1929.)

Effects resembling fading may be caused by differences in the lines, etc., conveying the synchronising waves to the various stations. The invention deals with motor-driven phase-adjusters for insertion at suitable points between the stations.

COMPULSORY WIRELESS AT SEA.—(*Wireless World*, 31st July, 1929, Vol. 25, pp. 101-102.)

An article on the new International Convention recently drafted. The obligatory provision of d.f. apparatus, the importance attached by the Conference to the "automatic watcher" or auto-alarm, and the prohibition of telephony on waves near 600 metres, are referred to.

WIRELESS TELEPHONY DEVELOPMENTS.—(*Engineer*, 26th July, 1929, Vol. 148, p. 83.)

A paragraph dealing with the recent wireless telephone communication between the "Berengaria" and Paris, between the "Bremen" on her maiden voyage and Germany; with the projected installation of short-wave telephony on the "Leviathan," and with the opening of the service between London and Buenos Aires.

WIRELESS TELEPHONE SET FOR LIGHT AEROPLANES. (*Engineer*, 26th July, 1929, Vol. 148, p. 93.)

A paragraph on a set brought out by the Marconi Company "to enable owner-pilots and clubmen to communicate while in flight with ground stations." The set weighs about 60 lbs. complete, and uses 75 watts from a wind-driven generator.

RÉCEPTION À ONDES COURTES, TYPE S.F.R.—POUR GRAND TRAFIC TÉLÉGRAPHIQUE ET TÉLÉPHONIQUE (Type S.F.R. Short Wave Reception for Heavy Telegraphic and Telephonic Traffic).—(*Bull. de la S.F.R.*, March-April, 1929, No. 3, pp. 59-68.)

S.F.R. SHORT WAVE TRANSMITTER FOR LONG DISTANCE TELEGRAPHY (15 kw. TO THE AERIAL) AND TELEPHONY (9 kw.).—(*Bull. de la S.F.R.*, June and July, 1929, pp. 111-120 and 135-152.)

NEW SHORT WAVE STATIONS IN U.S.A.—(*Nature*, 10th Aug., 1929, Vol. 124, p. 241.)

A paragraph on the two new stations in New Jersey, giving 4 channels, 2 to Europe, 1 to S. America, and 1 for experimental purposes. Wavelengths are 16, 22 and 33 m. The receiving sets have 2 stages r-f, 6 of intermediate and one of l-f amplification. Limits are assigned to the closeness to which motor-cars can approach the stations.

INTERFERENCE-ELIMINATION BY THE BAUDOT-VERDAN SYSTEM.—(*Journ. Télégraph.*, March and April, 1929, Vol. 53, pp. 49-53 and 73-77). See Abstracts, 1928, Vol. 5, p. 406.

In the present paper Carpentier's modification of the Verdán apparatus, and the extension of the principle to the synchronising currents, are dealt with.

GENERAL PHYSICAL ARTICLES.

ON TIME-LAGS IN FLUORESCENCE AND IN THE KERR AND FARADAY EFFECTS.—E. Gaviola. (*Phys. Review*, June, 1929, Vol. 33, pp. 1023-1034.)

The following are some of the conclusions reached:—(a) The idea of the existence of time-lags in fluorescence was probably conceived because of a misunderstanding of the concept introduced by Bohr, that excited atoms can live for finite time without radiating. There is not a single experiment which shows the existence of such a lag. (b) The optical shutter of Beams, which was supposed to "open abruptly, remain open any desired time from 10^{-9} to 10^{-7} seconds and then close abruptly," is analysed and found to open and close during a time of the order of 10^{-8} sec. and to remain open for at least 10^{-8} sec. in the best case. The time during which it remains open does not depend in first approximation on the position of the "trolley" as was assumed. It is concluded that the light wave-trains assumed by Lawrence and Beams to be cut in pieces of 3 cm. length were really not shortened to less than 300 cm. in the best case. (c) The time-lags found for the Kerr effect in liquids with high dielectric constants were probably due to the fact that increase in dielectric constant means increase of the capacity of the Kerr condenser and consequently of the time that it takes to discharge [Beams and Lawrence have already stated that there is no evidence of a lag of Kerr effect behind rapidly changing electric fields—see Abstracts, 1928, Vol. 5, p. 587].

ON THE IONIZATION OF HYDROGEN BY ITS OWN RADIATIONS.—J. Thomson. (*Phil. Mag.*, June, 1929, Vol. 7, No. 46, pp. 970-980.)

REPORT ON THE WORK OF THE BARTOL RESEARCH FOUNDATION, 1928-9.—W. F. G. Swann. (*Journ. Franklin Inst.*, Aug., 1929, Vol. 208, pp. 189-258.)

ÜBER WIDERSTANDSÄNDERUNG VERSCHIEDENER METALLE IN MAGNETFELDERN (The Resistance-Change of Various Metals in Magnetic Fields).—F. Vilbig. (*Arch. f. Elektrot.*, 15th June, 1929, Vol. 22, No. 2, pp. 194-219.)

ANALYSE VON ABSORPTIONSKURVEN FÜR ALLSEITIGE INZIDENZ INHOMOGENER STRAHLUNG BEI EBENEN GRENZFLÄCHEN (Analysis of Absorption Curves for Incidence from every direction of inhomogeneous Radiation at Plane Surfaces of Separation).—H. Hellmann. (*Physik. Zeitschr.*, 1st June, 1929, Vol. 30, No. 11, pp. 357-360.)

DE VERHOUDING VAN IONISATIE EN AANSLAG BIJ DE BEWEGING VAN ELECTRONEN DOOR NEON (The Relation between Ionisation and Excitation by Electrons moving in Neon Gas).—F. M. Penning and M. C. Teves. (*Physica*, April, 1929, Vol. 9, pp. 97-110.)

Preliminary experiments are described concerning the number of excitations and the number of ionisations in neon gas caused by electrons moving in a homogeneous electric field. This relation is expressed as a function of the quotient of the electric field by the pressure of the gas.

THE SCATTERING OF FAST ELECTRONS BY ATOMIC NUCLEI.—N. F. Mott. (*Proc. Roy. Soc.*, 4th June, 1929, Vol. 124 A, pp. 425-442.)

The scattering of a beam of fast electrons by an atomic nucleus is investigated, using the wave equation of Dirac. A scattering formula is obtained, and it is found that the scattered beam is polarised. A method by which this polarisation could be detected is discussed.

A PROPERTY OF SUPERCONDUCTING METALS.—J. H. Bartlett. (*Nature*, 8th June, 1929, Vol. 123, pp. 869-870.)

A suggested explanation of the disappearance of the residual resistance at the threshold temperature. In a following letter, P. Kapitza comments on the suggestion.

DIE ROLLE DER LEITUNGSELEKTRONEN BEIM FERROMAGNETISMUS (The Role of the Conduction Electrons in Ferro-magnetism).—J. Dorfman and R. Jaanus. (*Zeitschr. f. Phys.*, 4th April, 1929, Vol. 54, No. 3/4, pp. 277-296.)

As a result of theoretical treatment of tests on the thermo-electric and magnetic properties of nickel, the ferro- and para-magnetic properties of this metal are found to depend entirely on the conduction electrons. "For the first time, the numerical value of the moment of spin of the conduction electron in a metal has been successfully measured. It comes out at one Bohr magneton, within 5 per cent." The number of conduction electrons in nickel depends on the temperature: this number can be directly calculated for various temperatures.

CRYSTAL STRUCTURE AND FERROMAGNETISM.—O. v. Auwers. (*Phys. Zeitschr.*, 15th December, 1928, Vol. 29, pp. 921-927.)

The Heisenberg quantum-mechanics theory of ferromagnetism is here considered in conjunction with a large number of published results, which are found to agree with the theory.

THE CORONA DISCHARGE IN NEON.—L. G. H. Huxley. (*Phil. Mag.*, July, 1929, Vol. 8, No. 48, pp. 128-129.)

Referring to Penning's paper (August Abstracts, p. 464) the writer quotes his own preliminary tests which suggest that Penning's methods must have led to results vitiated by impurities in the gas used.

PROEVEN OVER PERSISTEERENDE STROOMEN (Tests on Persistent Currents).—W. Tuyn. (*Physica*, May, 1929, Vol. 9, No. 5, pp. 145-160.)

A description of experiments on the persistent currents in supra-conductors.

SPARKING CONSTANT IN AIR.—M. Toepler: K. May. (*Arch. f. Elektrot.*, 15th February, 1929, Vol. 21, pp. 433-442 and 467-470.)

By keeping the electrode capacity as small as possible so as not to distort the surge wave form, Toepler reduces the sparking constant to 0.15×10^{-3} . May confirms that the constant is independent of atmospheric pressure from one to one-tenth atmosphere: his value agrees with the above.

FUNKENKONSTANTE UND LUFTTEMPERATUR (Spark-ing Constant and Air Temperature).—M. Toepler. (*Arch. f. Elektrot.*, 15th July, 1929, Vol. 22, No. 3, pp. 243-244.)

Continuing his previous work, the writer now finds that the sparking-constant k is approximately inversely proportional to the absolute temperature of the air surrounding the gap.

ÜBER DIE MÖGLICHKEIT EINES EXPERIMENTELLEN NACHWEISES DER GEGENSEITIGEN VERNICHTUNG VON ELEKTRONEN UND PROTONEN (On the Possibility of an Experimental Indication of the Mutual Destruction of Electrons and Protons).—C. Lönnqvist. (*Zeitschr. f. Phys.*, 5th July, 1929, Vol. 55, No. 11/12, pp. 789-800.)

The writer concludes that the idea of mutual destruction by collision of electrons and protons, suggested by Eddington as a hypothetical source of cosmic energy, could be tested in the laboratory by bombarding an acid with beta or cathode rays.

DAS WESEN DER HÖHENSTRAHLUNG (The Nature of the Cosmic Rays).—W. Bothe and W. Kolhörster. (*Zeitschr. f. Phys.*, 16th August, 1929, Vol. 56, No. 11/12, pp. 751-777.)

The full paper concerning the tests dealt with in September Abstracts, p. 523.

ÜBER MÖGLICHE URSACHEN DER VERWANDLUNG VON ENERGIE IN MATERIE (Possible Causes of the Transmutation of Energy into Matter).—G. I. Pokrowski. (*Zeitschr. f. Phys.*, 5th July, 1929, Vol. 55, No. 11/12, pp. 771-777.)

A continuation of the writer's work on the Synthesis of Elements (Sept. Abstracts, p. 523). "It is shown that in interstellar space about 10^{-10} of the total energy must be changed per second

into matter. It is also shown that the light from the spiral nebulae shows a displacement towards the red indicating a condensation of radiant energy into matter."

GAMMA AND COSMIC RAYS.—J. A. Gray and A. J. O'Leary. (*Phys. Review*, No. 2, 1929, Vol. 23, p. 292.)

Summarised report based on tests with gamma rays. One of the conclusions reached is that the methods of calculation from observed data, as usually applied, lead to too great values for the intensity of the cosmic rays.

THE SCATTERING OF RADIATION BY FREE ELECTRONS ON THE NEW RELATIVISTIC QUANTUM DYNAMICS OF DIRAC.—O. Klein and Y. Nishina. (*Zeitschr. f. Phys.*, No. 11/12, 1929, Vol. 52, pp. 853-868.)

The result obtained calls for a modification of the wavelengths of the cosmic rays estimated from the scattering coefficients on the assumption of the Dirac-Gordon result.

LIQUID DIELECTRICS UNDER HIGH FIELD STRENGTHS AND AT HIGH TEMPERATURE.—A. Nikuradse. (See two papers in *Arch. f. Elektrot.*, 15th July, 1929, Vol. 22, No. 3, pp. 283-324.)

ÜBER DIE DIELEKTRIZITÄTSKONSTANTEN EINIGER METALLDÄMPFE (On the Dielectric Constants of some Metal Vapours).—F. Krüger and F. Maske. (*Physik. Zeitschr.*, 15th May, 1929, Vol. 30, No. 10, pp. 314-320.)

NEW DIMENSIONAL EQUATIONS FOR ELECTRICAL AND MAGNETIC QUANTITIES.—P. Kalantaroff. (*Rev. Gén. de l'Élec.*, 16th February, 1929, Vol. 25, pp. 235-236.)

Instead of time, length and mass, the writer uses as dimensions time, length, quantity of electricity and magnetic flux, and evolves four groups of equations relating to electrical, magnetic, electromagnetic and some mechanical magnitudes. The forms of these new equations suggest certain fields of speculation which he discusses.

MISCELLANEOUS.

UNTERSUCHUNGEN AN DETEKTORKONTAKTEN (Investigations into Contact Detectors).—F. W. Kallmeyer. *Ann. der Phys.*, Series 4, Vol. 86, No. 12, 1928, pp. 547-586.)

The characteristics of a large number of contacts, crystal and also metal to metal, were plotted using chiefly a 50-cycle frequency and varying contact-pressures. The interesting results include the frequent occurrence of characteristics with hysteresis loops, the variation of characteristic when external conditions remain constant, and the frequent occurrence of negative contact-resistances.

NEUERE UNTERSUCHUNGEN ZUM DETEKTOR-PROBLEM (New Investigations into the Crystal Detector Problem). R. H. Elsner. (*Rad., B., F. für Alle*, Aug., 1929, pp. 342-347.)

The article begins with a description of Kallmeyer's work (see above) on the recording of the

dynamic characteristics of a number of crystal detectors. Ettenreich's results on the inertia-free working of a crystal lead one to expect practically no difference between the static and dynamic characteristics, so that Kallmeyer's records showing anomalies of the nature of hysteresis are surprising. The conclusions drawn by him from this and other results are discussed. The results of Beck (April Abstracts, p. 226), Habann (July, p. 403) and Reissaus (*ibid.*) are mentioned, and the writer sums up these recent results as confirming Schottky's electronic theory and extending it thus:—the detector current is a purely electronic flow which takes place between two electrodes separated by a dielectric inter-layer; the intermolecular processes have an important effect on the shape of the characteristic, in that materials with firmly attached ions give good rectification, while a wandering of ions within the contact-point weakens the rectifying property.

INFLUENCE OF TEMPERATURE ON LUMINOUS CARBORUNDUM CONTACT: ON THE APPLICATION OF THE QUANTUM THEORY TO THE PHENOMENON OF LUMINESCENCE OF A CRYSTAL DETECTOR.—O. V. Lossev. (*T. i. T. b. p.*, No. 2, 1929, Vol. 10, pp. 153-161.)

In Russian.

METALLIC CONTACT RESISTANCES: CHARACTERISTICS OF CONTACT RESISTANCES.—E. and R. Holm. (*Wiss. Veröffent. a. d. Siemens Konz.*, No. 2, 1929, Vol. 7, pp. 217-271 and 272-304.)

The full papers describing the exhaustive series of researches referred to in April Abstracts, p. 227.

ÜBER DIE BEEINFLUSSUNG DES MENSCHLICHEN ORGANISMUS BEIM ARBEITEN AM KURZWELLENSENDER (The Effect on the Human Organism of Work with Short Wave Transmitters).—K. Heinrich. (*E. T. Z.*, 25th July, 1929, Vol. 50, pp. 1088-1090.)

As a result of reports from America of disturbances to health resulting from such occupation, the writer carried out a series of tests independent of, but almost at the same time as, those of Schliephake (June Abstracts, p. 347). He worked with two transmitters, giving 44 m. and 2-4 m. waves; anode current 0.2 A. in both transmitters. The magnetic field, so far as could be detected, produced no effects—though in the case of the shorter waves this may possibly be due to the fact that the oscillating circuit contained only one half turn. The electric field between the condenser plates showed the usual marked biological effects. The distribution of the field between the plates was investigated by thermometers, and the effect of varying the gap was examined. Air and glass (in strips) were here used as dielectrics. Comparing these results with the biological tests, the author concludes that the biological effects must be due, *not* to the a-c field, but to radiation.

Röntgen ray effects from the valve filaments were investigated and found, more readily in the case of parallel plate anodes than for cylindrical anodes. But the most original result, confirmed

by repeated observations, was the disturbing effect on a water diviner who happened to be giving a demonstration near the aerial of the 44 m. transmitter. He could neither see nor hear the transmitter, and had no means of telling when it was off or on; but each time it transmitted it affected his divining twig.

BIOLOGICAL EFFECTS OF ULTRA-SHORT WAVES: DIELECTRIC LOSS IN ELECTROLYTE SOLUTIONS IN HIGH FREQUENCY FIELDS.—W. T. Richards and A. L. Loomis. (*Proc. Nat. Acad. Sci.*, July, 1929, Vol. 15, pp. 587-593.)

Schereschewski explains the lethal action of short waves (e.g. on mice) by the theory that certain wavelengths act specifically on cells, but Christie and Loomis and other workers believe that all effects produced on animals can be fully explained on the basis of heat generated by the h.f. currents induced in them. In support of this explanation, the present paper discusses the behaviour of electrolytes in h.f. fields. A simplified expression is derived (from an unpublished theorem of G. W. Pierce) connecting power loss in a liquid dielectric with its conductivity, dielectric constant, and the frequency of the field. This has been tested and verified, and its application to physiological behaviour in high frequency fields is suggested.

The approximate equation derived for the power loss, valid for dilute electrolytes, is $p = \frac{A\omega\kappa}{B + D\kappa^2}$ where κ is the specific conductivity, the dielectric constant being assumed (for simplicity) to be constant. In the tests, wavelengths from about 1 m. upwards were obtained by methods described by Christie and Loomis (*Journ. Exper. Medicine*, 1929, Vol. 49, p. 303) and by Wood and Loomis (*Phil. Mag.*, 1927, Vol. 7, No. 4, p. 417).

CHARACTERISTIC FREQUENCIES IN WATER: EFFECT OF ELECTROMAGNETIC RADIATION ON ANIMAL TISSUES.—W. F. G. Swann: McDonald. (*Journ. Franklin Inst.*, Aug., 1929, Vol. 208, pp. 227-228.)

Referring to Bramley's results (Abstracts, 1928, Vol. 5, p. 587) it is pointed out that the same effect might occur in the tissues (e.g. in treatment of cancer by electromagnetic radiation). If the frequencies used coincide with the fundamental frequencies inherent in the structure of the tissue, very much greater absorption may be expected, with a resulting enhancement of the heating effect. This seems to fit in with observed results with animals.

NATURAL IONISING RADIATION AND RATE OF MUTATION.—E. B. Babcock and J. L. Collins. (*Nature*, 10th Aug., 1929, Vol. 124, pp. 227-228.)

The suggestion of Olson and Lewis that the natural ionising radiation of the earth plays an important part in evolution was tested by the writers by comparing results in their laboratory and in a tunnel 15 miles away, where the radiation was found to be fully twice as great as in the laboratory. The tests so far performed were on the rates of occurrence of sex-linked lethal muta-

tions in *drosophila melanogaster*, and positive results were obtained. Even pending their further researches the writers consider it safe to conclude that this radiation is a very important factor controlling the rate at which new inherited characters originate in animals and plants.

SOME OF THE PSYCHOLOGICAL EFFECTS OF RADIANT ENERGY.—H. Laurens. (*Journ. Opt. Soc. Am.*, No. 3, 1929, Vol. 18, pp. 237-252.)

SUBSTRATUM COMMUNICATION AMONG WHITE ANTS.—A. E. Emerson and R. C. Simpson. (*Science*, 21st June, 1929, Vol. 69, pp. 648-649.)

Tests with a microphone and valve amplifier are described which convince the writers that ants communicate with each other (danger signals, etc.) by vibrations in the nest material produced by hammering their heads on it, possibly also by snapping their mandibles.

ALCUNE ESPERIENZE COLLE LAMPADE A NEON (Some Experiments with the Neon Lamp).—V. Ronchi. (*N. Cimento*, No. 1, 1929, Vol. 6, pp. 10-13.)

The experiments deal with the lighting-up of a neon lamp of medium candle-power merely by placing it in a variable field caused by electrical discharges. The sensitivity of the lamp, for the detection of such fields, is extraordinarily high.

SUDDEN UPWARD BEND OF CURRENT-VOLTAGE CURVE OF STRONGLY IONISED GAS AT ATMOSPHERIC PRESSURE.—R. Thaller. (*Physik. Zeitschr.*, 15th Jan., 1929, Vol. 30, No. 2, pp. 59-61.)

Usually the curve for a gas ionised by X-rays, ultra-violet light, etc., rises rapidly at first as the voltage increases, then more slowly till saturation is reached, and then becomes horizontal; for still higher voltages it rises rapidly again and a discharge takes place. The writer describes an experiment in which the gas was ionised very strongly by a Lenard tube: the curve started as a straight line sloping upwards, and then—without bending over to the horizontal—shot suddenly upwards and a discharge took place.

NOTE PRÉLIMINAIRE CONCERNANT MESURES DE LONGUEUR PAR ONDES STATIONNAIRES ÉLECTROMAGNÉTIQUES (Preliminary Note on the Measurement of Lengths by Stationary Electromagnetic Waves).—H. S. Jelstrup. (*Ash. Oslo*, No. 7, 1928, 9 pp.)

The note refers to a patented method of measuring bases for geodetic survey purposes. The theory and a description of the necessary apparatus is described.

DIE BEDEUTUNG DER DRAHTLOSEN TELEGRAPHIE FÜR DIE ANSTRICHTECHNIK (The Significance of Wireless Telegraphy in the Paint Industry).—P. Nettmann. (*Farben-Zeitung*, 22nd June, 1929, Vol. 34, pp. 2238-2239.)

The application of radio technique to tests on paints is discussed. The Whiddington ultra-

micrometer can be used to determine changes in thickness of paint films on exposure to air, expansion by heat, etc., etc. Thoma has modified the method so that it will measure rapid changes; he uses two oscillatory circuits nearly in resonance; a slight change in one produces a very large change of current and voltage in the other. "With such an apparatus it has become possible to study processes of whose existence we had no suspicion."

Utesch's apparatus (Faraday cage and amplifier, working with a cathode-ray oscillograph) similar to that employed by Sauerbruch and Schumann in their study of electric fields in the neighbourhood of living beings, can be used in the study of electrification effects in sprayed paint. The effect of various radiations on paint can be studied with the aid of the Geiger ion-counter.

THE THOMA MODIFICATION OF THE ULTRA-MICROMETER.—(*Elektrot. u. Masch. bau*, 11th August, 1929, Vol. 47, p. 690.)

A description of the circuit referred to in the above abstract.

THE PROGRESS OF TECHNICAL PHYSICS IN CENTRAL EUROPE. (*Zeitschr. f. tech. Phys.*, June, 1929, Vol. 10, pp. 193-262.)

The whole of this number is devoted to the celebration of the tenth year of the German Society for Technical Physics. It includes, among other articles, the following:—E. Warburg.—The Relations between Theoretical and Technical Physics; H. Konen.—The Effect of Technical Physics on Pure Physics; H. Gerdien.—Objects and Duties of Technical Physical Research Institutes in Industry; C. Ramsauer.—Should the T-Ph. Research Laboratories of Industry carry on purely scientific Research? Various other authors deal with T. Physics in relation to different subjects, such as the optical industry, the chemical, glass, and iron industries, medicine, communication technique, etc., etc.

THE AMATEUR AND THE NAVAL RESERVE.—R. H. G. Mathews. (*QST*, August, 1929, Vol. 13, pp. 17-19.)

An outline of the organisation of the U.S. Navy "Volunteer Communication Reserve," which is divided into 14 districts, each with its Commander.

THE RELATION BETWEEN THE ELECTRIC AND MAGNETIC FIELDS OF A WIRELESS WAVE.—F. C. Curtis. (*E.W. & W.E.*, Aug., 1929, Vol. 6, p. 439.)

The writer says that although the problem has been clearly discussed by Dellinger, Moullin and others, the old fallacies about these fields and particularly about their effects on loops and open aerials are astonishingly persistent: he quotes a number of ambiguous statements by various eminent authorities which are liable to encourage and prolong the life of these ancient heresies among students who read such statements—e.g., "One

responds to the electric, the other to the magnetic oscillation" (Lodge).

WIRELESS AT THE AERO SHOW.—(*Wireless World*, 7th Aug., 1929, Vol. 25, pp. 127-129.)

DAS TONTELEGRAPHIE-SYSTEM DER C. LORENZ AKTIENGESELLSCHAFT (The Lorenz Note-Telegraphy System).—W. Scheppmann and A. Eulenhöfer. (*E.T.Z.*, 6th June, 1929, Vol. 50, pp. 815-817.)

MUTUAL INDUCTION BETWEEN CONDUCTORS OF FINITE LENGTH CONVEYING ALTERNATING CURRENTS.—F. Pollaczek. (*Ann. der Physik*, 18th Dec., 1928, Vol. 87, pp. 965-999.)

BEKÄMPFUNG DER RADIOGERÄUSCHE BEI ALUMINIUMSCHLEIFBÜGELN VON STRASSENBAHNEN (The Prevention of Radio Interference from Aluminium Current Collectors on Tramways).—R. Wichmann. (*E.T.Z.*, 13th June, 1929, Vol. 50, pp. 855-857.)

Trouble encountered with these collectors is not due to the aluminium. A suitably designed and properly adjusted aluminium collector produces no interference. Such design and adjustment (which also increase the life of the collector) are here described.

DIE FERNSPRECHSTÖRWIRKUNG VON GLEICHRICHTERBAHNEN (Interference with Telephony caused by Railways, etc. using Rectified Currents).—L. Roehmann. (*E.N.T.*, July, 1929, Vol. 6, pp. 283-284.)

LA TRANSMISSION ÉLECTRIQUE À DISTANCE DES INDICATIONS DE MESURES, ET LA SYSTÈME À INDUCTION TÄUBER-GRETHER (Distance Transmission of Meter-readings, and the Täuber-Gretler System).—A. Imhof. (*Rev. Gén. de l'Élec.*, 10th August, 1929, Vol. 26, pp. 217-222.)

The principles involved in the 11 or more different systems at present existing are first enumerated, the rest of the paper dealing in detail with the induction dynamometer system of Trub, Täuber and Company.

DISTANCE TRANSMISSION OF INSTRUMENT READINGS.—C. H. Linder and others. (*Journ. Am.I.E.E.*, March, 1929, Vol. 48, pp. 183-185.)

Among the various systems described, that employing Selsyn motors is included. This "motor" has a 3-phase stator and a single phase rotor; if several of them have their stators connected together, and their rotors are supplied with the same single phase current, all the rotors take up relatively identical angular positions and follow any movements imposed on any one of them. The system has the disadvantage of requiring three wires between stators, and a common source of a.c.

Some Recent Patents.

The following abstracts are prepared, with the permission of the Controller of H.M. Stationery Office, from Specifications obtainable at the Patent Office, 25, Southampton Buildings, London, W.C.2, price 1/- each.

MINIMISING "NOISE" IN SUPPLY MAINS.

Convention date (Germany), 14th January, 1928.
No. 304148.

When high-frequency electro-medical apparatus, such as that used for diathermy, is energised from the electric light mains, it is apt to cause considerable disturbance to broadcast listeners in the vicinity. To minimise this source of disturbance, the supply leads to the spark-gap of the diathermy appliance are made electrically equal, for instance by inserting a choke-coil in one lead to compensate for the induction coil of the trembler contact in the other. Any high-frequency currents passing back into the mains accordingly flow in opposite directions and neutralise each other.

Patent issued to W. Otto.

LOUD SPEAKERS.

Application date, 25th January, 1928. No. 310441.

In a speaker of the moving-coil type, the coil *C*, together with the attached diaphragm *D*, is carried by one or more cords *A*, *B*, of silk from an ad-

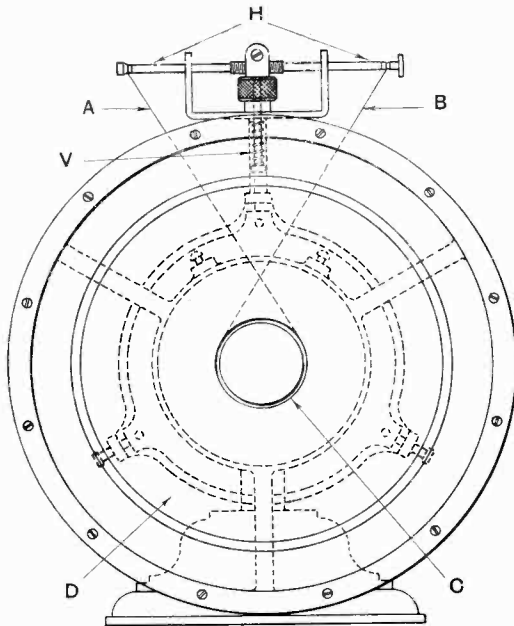

No. 310441.

justable suspension *V*, *H*. To damp the extreme freedom of axial movement, a steady-current component is superposed on the voice-frequency currents flowing in the coil windings. The ends of the suspension cords are secured to the opposite extremities of a horizontal pin *H*, which is screw-

threaded for axial adjustment and is mounted on an upright screw *V* for vertical adjustment.
Patent issued to O. D. Lucas.

TRANSFORMER COUPLINGS.

Application date, 20th March, 1928. No. 313229.

The presence of a direct-current component in the primary windings of the output transformer of a valve amplifier may cause the transformer to

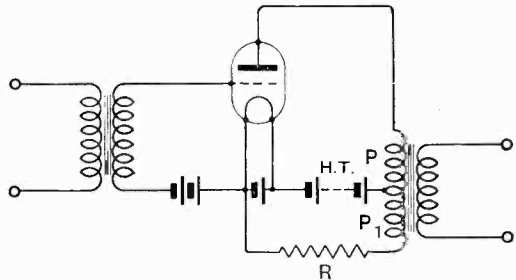

No. 313229.

operate at an unfavourable point on the magnetisation curve. Also it tends to create "noise" due to residual ripple when a mains eliminator is used for the high-tension supply. The circuit arrangement shown is designed to balance out the effect of the D.C. plate component. The output primary comprises two oppositely wound parts *P*, *P*₁, the latter being short-circuited around the high-tension supply in series with a high resistance *R*. The value of the resistance is chosen so that in normal operation the ampere-turns in *P* and *P*₁ are equal. The induction is therefore reduced to zero, whilst any "ripple" that may be present in the H.T. source can have no effect on the secondary of the transformer.

Patent issued to S. G. S. Dicker.

AN "ULTRADYNE" CIRCUIT.

Convention date (Germany), 28th October, 1926.
No. 279861.

In "ultradyné" reception a local oscillator valve is employed to provide the only high-tension applied to the modulator or first detector valve. It is distinguished from super-heterodyne reception where the combination between the incoming signal and local oscillation takes place in the grid circuit of the first detector. According to the invention a three-electrode valve is used as the local oscillator, whilst a tetrode valve, having a space-charge grid, and no direct supply of high-tension, operates as the modulator to create an intermediate frequency for further amplification. Both stages may be housed inside the same glass bulb.

Patent issued to S. Loewe and W. Kunze.

MICROPHONES.

Application date, 17th April, 1928. No. 313706.

A thermionic valve is utilised as a microphone by causing a pivoted plate, suspended inside the bulb, to act as a variable screen between the filament and anode of the valve. The pivoted screening plate is made of iron, and is normally held clear of the electron stream by an external magnet. When speech or other vibrations are applied to the valve, the bulb moves bodily, and the screening plate is accordingly swung more or less into the direct path of the electron stream from filament to plate. The corresponding variations in output current are passed through the primary windings of a low-frequency transformer for further amplification.

Patent issued to A. F. and D. A. Pollock.

D.C. ELIMINATOR UNITS.

Application date, 17th March, 1928. No. 313722.

In order to secure steady plate and grid-biasing voltages, irrespective of filament consumption, the D.C. mains are shunted by a comparatively low resistance, which takes a constant current of approximately half an ampere. The resistance is made up of a solid-core smoothing-choke *C* of 100 ohms (for a 220-volt supply) in series with a resistance *R* tapped to give suitable plate voltages, a resistance *R*₁ tapped for grid bias, and the resistance of the valve filaments connected in parallel between *R* and *R*₁, the total resistance in circuit approxi-

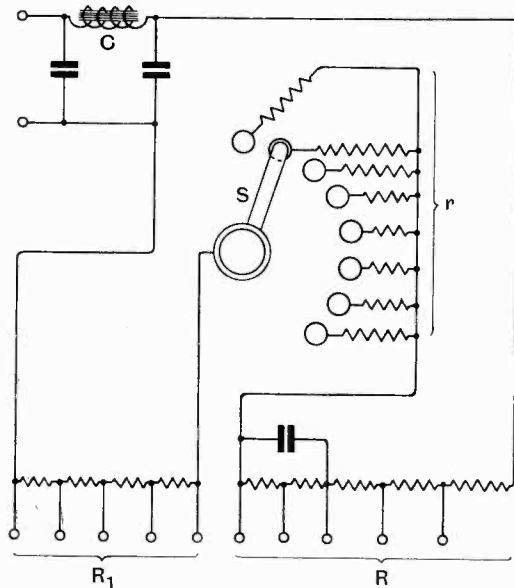

No. 313722.

imating to 500 ohms. In order to regulate the filament current taken by each valve, shunt resistances *r* are connected across the filaments, in combination with a regulating switch *S*. As the current drawn from the mains is constant under all

operating conditions, the voltage taps maintain a steady value.

Patent issued to P. Bruynseraede.

DISTRIBUTING BROADCAST PROGRAMMES.

Application date, 11th February, 1928. No. 311450.

A number of aerials *A* -- *A*₂ and selective receiving sets *R* -- *R*₂ are located at some central spot away from interference and under the charge

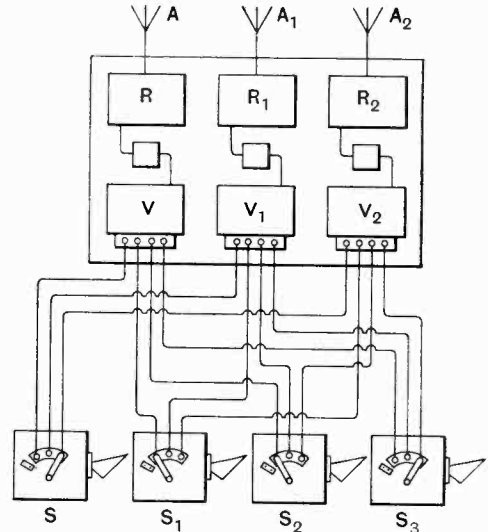

No. 311450.

of one or more skilled operators. Each receiver is tuned to a definite transmitting-station, and all are connected through amplifiers *V* -- *V*₂ and land-lines to a circle of subscribers *S* -- *S*₃ in such a way that each subscriber can switch in to any desired programme at will. It is pointed out that such a system would relieve listeners of the initial outlay on equipment as well as the trouble of maintenance. Local aerials and interference due to "oscillation" by unskilled listeners would accordingly disappear. Finally the reception of programmes would be limited to those who had duly paid for the service.

Patent issued to S. Richardson.

BAND-FILTER COUPLINGS.

Application date, 23rd April, 1928. No. 314167.

In order to cut out any high-frequency components present in the output from the detector valve, the latter is coupled to the low-frequency amplifier by a chain of series resistances shunted by condensers, the network forming a low-pass filter of economical construction. The condensers are ganged together for simultaneous control. The chain of resistances may consist of three elements of the order of 10,000 to 250,000 ohms. A construction of high-pass band filter consisting of a number of condensers in series each shunted by high resistances is also described.

Patent issued to E. Y. Robinson and Metropolitan Vickers Electrical Co., Ltd.

PIEZO-CRYSTAL RECEIVING CIRCUITS.

Convention date (U.S.A.), 29th December, 1927.
No. 303180.

A receiving circuit which will admit a band of frequencies comprising the carrier-wave and essential side-band components, but which has a sharp

mounted on the diaphragm *D* and co-operate with the pole pieces *P*, *P*₁ etc. of a 4-pole magnet. In this way the diaphragm is energised uniformly over a comparatively wide area. The coil windings may be connected in series or parallel. The diaphragm is suspended at its periphery by strips *S*, *S*₁ of thin leather, and is guided centrally by

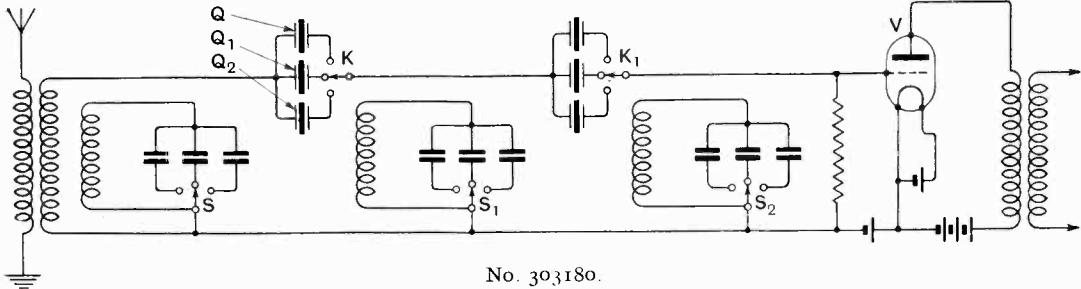

No. 303180.

“cut-off” for all frequencies lying outside this band, depends for its action upon the use of a number of piezo-electric crystals in combination with relatively simple filter circuits. The circuit is capable of adjustment up and down the frequency scale. As shown in the Figure, the input circuit to a valve *V* comprises two groups of differently tuned crystals, such as the group marked *Q*, *Q*₁, *Q*₂, inserted in series in the grid lead and combined with a number of tuned rejector circuits. Tuning is effected by means of switches *K*, *K*₁ controlling the selection of the appropriate crystal and by switches *S*, *S*₁, *S*₂ which select the corresponding condenser in the shunt rejector circuits. The use of the piezo-crystal units avoids difficulties inherent in the design of an equivalent inductance-capacity network, such as the standard type of Campbell band filter.

Patent issued to Standard Telephones and Cables, Ltd.

LOUD SPEAKERS.

Application date, 13th April, 1928. No. 312756.

In order to impart a true plunger action to the diaphragm of a moving-coil speaker over as large an amplitude of swing as possible, four separate coils are wound on cardboard cylinders *A* ... *A*₃

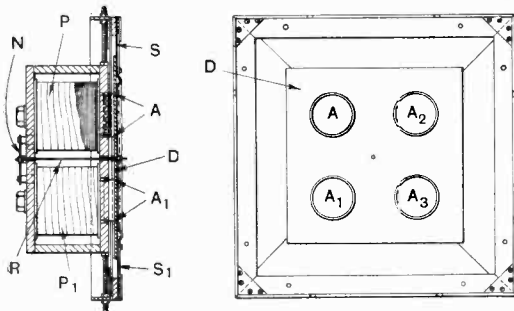

No. 312756.

a spindle *R* centred at one end by spiders *N* or by a system of strings.

Patent issued to C. J. Nesbitt-Dufort and The O. and S. Oilless Bearings Co., Ltd.

TELEVISION SYSTEMS.

Application date, 21st April, 1928. No. 311075.

Relates to television receivers of the type utilising a “glow light” board built up of a number of glow-lamps corresponding to each element of the picture and energised in synchronism with a pick-up device at the transmitting end. In order to secure intermediate light and shade effects, each of the lamp elements, when once illuminated by the incoming signals, is arranged to continue to glow for a short predetermined period after the cessation of the signal, so as to increase the light intensity. The frequency of illumination is varied as between the dark and light portions of the transmitted picture.

Patent issued to A. Carpmael.

VALVE CATHODES.

Convention date (Germany), 13th March, 1927.
No. 287098.

Cathodes for thermionic valves are manufactured by depositing barium oxide on a thin wire of platinum or nickel in the following way: a mixture of alkaline-earth carbonates is suspended in methyl alcohol, through which a stream of carbon dioxide is passed. This deposits a methyl compound which is filtered off and mixed with water so as to produce a colloidal dispersion of the alkaline-earth carbonate. The wire to be coated is dipped into this liquid preparation and then connected to an electric current source, in series with a tubular anode. A low terminal voltage is used so as to produce an “electrophoretic” action whereby the colloidal particles drift towards the wire cathode and form a strongly adherent coating of barium carbonate which is then “glowed” to convert it into the oxide.

Patent issued to E. Harsanyi.

DRY CONTACT RECTIFIERS.

Convention date (Germany), 24th May, 1927. No. 291026.

When using oxidized-metal rectifiers it is desirable that the applied pressure between the plates should remain constant, as otherwise the resistance of the surface-contact will change and so give rise to fluctuations in output. In practice it is difficult to maintain a steady pressure owing partly to temperature expansion and partly to the expansion caused by the flow of current when the rectifier is in operation. According to the invention this difficulty is overcome by making the central bolt, on which the rectifying elements are strung, of a bronze or nickel alloy, the temperature coefficient of which is identical with that of the copper-oxide rectifying elements.

Patent issued to Siemens and Halske, A.G.

QUARTZ OSCILLATORS.

Convention date (Germany), 18th March, 1927. No. 287175.

It is difficult to use quartz crystals for the direct control of high-powered transmitters owing to the deleterious effect of the heat generated upon the permanency of the crystal. According to the invention advantage is taken of the fact that the dimension of the crystal can be increased considerably in a direction at right-angles to the electric axis without affecting its fundamental frequency. A large crystal section cut in this fashion can accordingly be mounted between metal electrodes of considerable size, such electrodes owing to their comparatively large surface area will function effectively as cooling radiators.

Patent issued to H. Eberhard and Radio Frequenz, G.M.B.H.

OPTICAL GRAMOPHONE-REPRODUCER.

Application date, 31st October, 1928. No. 314126.

The movement of the stylus *S* is transmitted to a diaphragm *C* at the centre of which is deposited, chemically or electrically, a spot of silver which acts as a reflector. A lamp *L* is mounted in the centre of another disc *D* carrying a ring of light-sensitive cells *G*, and projects a ray of light on to

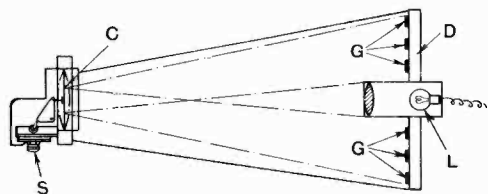

No. 314126.

the centre of the diaphragm *C*. As the stylus is vibrated by the record, variations occur in the intensity of the light reflected back from the diaphragm *C* to the light-sensitive cells *G*, so giving rise to corresponding electric currents. The various component parts are all mounted on the tone arm.

Patent issued to J. Neale.

LOUD SPEAKERS.

Application date, 15th March, 1928. No. 313646.

A conical diaphragm is supported by a system of tangential strings in such a way that it can move freely in an axial direction—i.e., parallel to the

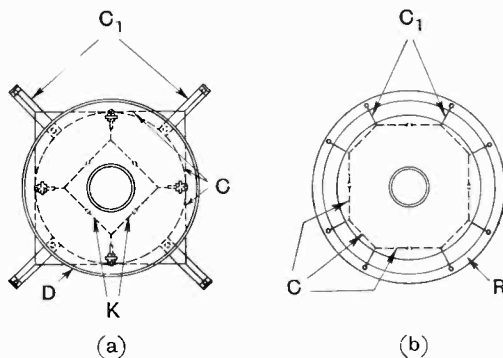

No. 313646.

impulses applied to it by the moving-coil or other driver, and at the same time is equally free to respond to flexural vibrations which take place in the material of the cone itself. The suspension prevents any movement as a whole in a direction at right-angles to the axis of the cone.

As shown in Fig. (a) the cone *D* is supported by an outer series of cords *C* lying tangential to a plane through the cone near its outer end. The string suspension *C* forms a square system, the four corners of which are connected by other cords *C*₁ to arms suitably mounted on the base plate. A second similar string suspension *K* may be arranged near the narrow end of the cone. In Fig. (b) the string suspension *C* is octagonal in shape, each corner being attached to a fixed ring *R* by strings *C*₁.

Patent issued to D. H. Johnson.

TELEVISION SYSTEMS.

Convention date (U.S.A.), 14th September, 1927. No. 297078.

In order to overcome the known difficulty of televising an extensive field of vision, such as a street scene or tennis match, where only natural lighting is available, a kinematographic film is first taken by photographic means, and, simultaneously, the photographic film is scanned by a rotating disc and a light-sensitive cell so as to transmit equivalent light-modulated signals to the distant receiving station, where the received signals are reassembled by a rotating-disc analyser and projected directly upon a viewing screen. Alternatively the received signals may first be impressed upon a kinematographic film and then projected optically. The whole process of transmission and reception is effected in a continuous train, the necessary photographic and television apparatus being assembled in both instances as a complete unit.

Patent issued to Electrical Research Products Inc.