

# EXPERIMENTAL WIRELESS & The WIRELESS ENGINEER

VOL. V.

JUNE, 1928.

No. 57.

## Editorial.

### The Equivalent Inductance and Capacity of an Aerial.

A VERTICAL wire connected to the earth at its lower end has a certain natural frequency of oscillation. An infinite number of oscillatory circuits could be made up to have the same natural frequency, the only necessary condition being that the product of the inductance and the capacity must be constant. Only one of these circuits, however, could be regarded as equivalent to the aerial and one practical test of this equivalence consists in finding the effect on the natural frequency of a variation of the inductance or capacity. In the case of the aerial it is assumed that the variation is produced by the insertion of an inductance or a condenser between the foot of the aerial and the earth; the simple oscillatory circuit in which the insertion of the same inductance or condenser produces exactly the same change of natural frequency can be regarded as equivalent to the aerial, and its inductance and capacity as being the equivalent inductance and capacity of the aerial.

If now the aerial be regarded as a transmission line, one may as an approximation assume it to have a constant inductance and capacity per unit length and from these values it is possible to calculate its equivalent inductance and capacity as above defined. In the Marconi "Year Book of Wireless Telegraphy and Telephony" for

1917 we described this in some detail and carried out the calculation. If the height of the aerial is  $h$  and the inductance and capacity per unit length  $L$  and  $C$  respectively, we showed that the equivalent inductance  $L_0 = hL/2$  and the equivalent capacity  $C_0 = 8hC/\pi^2$ . We also deduced approximate expressions for the somewhat elusive values of the inductance and capacity per unit length of such a transmission line, and thus, if  $r$  is the radius of the wire, showed that

$$L_0 = h \log_e \frac{h}{r} 10^{-9} \text{ henries,}$$

and

$$C_0 = \frac{1}{2.22} \cdot \frac{h}{\log_e \frac{h}{r}} \mu\mu \text{ F.}$$

In a recently published textbook entitled "Wireless Principles and Practice," by L. S. Palmer, a review of which appears on p. 338 of this number, a different result is obtained. It is stated on page 55 that the aerial reactance may be regarded as due to a capacity  $hC$  and to an inductance slightly larger than  $hL/3$ , the final value being given as  $hL/2.46$ . Since the underlying assumptions appear to be the same, it is interesting to examine how two different answers can be obtained to what appears to be a simple definite question, viz.: if a

transmission line of length  $h$  has inductance  $L$  and capacity  $C$  per unit length, what must be the inductance  $L_0$  and the capacity  $C_0$  of a simple oscillatory circuit which has the same resonant frequency and which has the same change of resonant frequency when a small inductance or capacity is inserted?

In the case of the simple circuit let the inductance be increased by an amount  $L_x$ , then the resonant wavelength will be increased from  $\lambda_0$  to  $\lambda$ , where

$$\frac{\lambda^2}{\lambda_0^2} = \frac{L_0 + L_x}{L_0}$$

If we put  $f/f_0 = \lambda_0/\lambda = \alpha = 1 - \delta$ , then for a small added  $L_x$ ,  $\alpha$  will be slightly less than 1,  $\delta$  will be a small fraction, and

$$1 + \frac{L_x}{L_0} = \frac{1}{\alpha^2} = \frac{1}{(1 - \delta)^2} = 1 + 2\delta$$

to a closer and closer degree of approximation as  $L_x$  is made smaller. Hence for very small values of  $L_x/L_0$  we have

$$L_0 = \frac{L_x}{2\delta}$$

where  $\delta = 1 - f/f_0 = \frac{f_0 - f}{f_0}$  = the proportional decrease of resonant frequency on inserting  $L_x$ .

Now, turning to the aerial or transmission line, it is shown in textbooks on the subject that the apparent impedance of such a line as measured at the sending end, that is, at the foot of the aerial, is given by the formula

$$\sqrt{\frac{L}{C}} \cdot \frac{1}{j \tan \omega h \sqrt{LC}} \text{ ohms}$$

where  $h$  is the length of the line or height of the aerial, and  $L$  and  $C$  are in henries and farads respectively.

The resonant frequency is the frequency which makes this impedance zero, that is, which makes  $\omega h \sqrt{LC}$  equal to  $\pi/2$ . Let us call this  $f_0 = \omega_0/2\pi$ .

If now an inductance  $L_x$  be inserted at the sending end, the frequency necessary to reduce the total impedance to zero will be changed to  $f = \omega/2\pi$ . The total impedance is now

$$j\omega L_x + \sqrt{\frac{L}{C}} \cdot \frac{1}{j \tan \omega h \sqrt{LC}} \text{ ohms,}$$

and since this is to be zero,

$$L_x = \frac{1}{\omega} \sqrt{\frac{L}{C}} \cdot \frac{1}{\tan \omega h \sqrt{LC}} \text{ henries.}$$

When an angle differs slightly from  $\pi/2$ , its cotangent is approximately equal to the small angle by which it differs from  $\pi/2$ ; hence, since  $\omega_0 h \sqrt{LC} = \pi/2$ ,

$$\begin{aligned} L_x &= \frac{1}{\omega} \sqrt{\frac{L}{C}} \cdot h \sqrt{LC} \cdot (\omega_0 - \omega) \\ &= \frac{\pi}{2} \cdot \sqrt{\frac{L}{C}} \cdot \frac{\omega_0 - \omega}{\omega \omega_0} \\ &= \frac{\pi}{2} \cdot \frac{\delta}{\omega} \sqrt{\frac{L}{C}}. \end{aligned}$$

Comparing this with the formula  $L_0 = \frac{L_x}{2\delta}$

found above for the simple circuit, we see that if a given  $L_x$  is to produce the same  $\delta$  in each case,

$$L_0 = \frac{\pi}{4\omega} \sqrt{\frac{L}{C}} \text{ henries}$$

and  $C_0 = \frac{1}{\omega^2 L_0} = \frac{4}{\pi\omega} \sqrt{\frac{C}{L}}$  farads.

If  $L_x/L_0$  is very small,  $\omega$  is approximately equal to  $\omega_0$  in these equations, and assuming that the natural wavelength is four times the height of the aerial, and putting

$$f_0 \lambda = 3 \times 10^{10};$$

then  $L_0 = \frac{\pi}{4\omega_0} \sqrt{\frac{L}{C}} = \frac{h}{6 \times 10^{10}} \sqrt{\frac{L}{C}}$  henries.

and  $C_0 = \frac{4}{\pi\omega_0} \sqrt{\frac{C}{L}} = \frac{8h}{\pi^2} \cdot \frac{1}{3 \times 10^{10}} \cdot \sqrt{\frac{C}{L}}$  farads.

It is very difficult to decide what values should be taken for the inductance and capacity per unit length of a vertical wire of height  $h$  and radius  $r$ , but in the article in the "Year Book" of 1917 we showed that as a close approximation it can be assumed that

$$L = 2 \log_e \frac{h}{r} \cdot 10^{-9} \text{ henries per cm.}$$

and  $C = \frac{1}{2 \log_e \frac{h}{r}} \cdot \frac{1}{9 \times 10^{11}}$  farads per cm.

whence  $LC = \frac{1}{9 \cdot 10^{20}}$ , which must, of course, be true however we determine  $L$  and  $C$ .

Inserting this value in the formulæ for  $L_0$  and  $C_0$ , we obtain

$$L_0 = \frac{hL}{2} \text{ and } C_0 = \frac{8}{\pi^2} hC,$$

which are independent of our approximations for  $L$  and  $C$ .

On inserting the approximate values for  $L$  and  $C$  we obtain

$$L_0 = h \log_e \frac{h}{r} \cdot 10^{-9} \text{ henries}$$

and 
$$C_0 = \frac{1}{2.22} \cdot \frac{h}{\log_e \frac{h}{r}} \cdot \mu\mu F.$$

as the equivalent inductance and capacity of the earthed vertical wire.

It was shown in the "Year Book" that the same results are obtained by assuming that a condenser is inserted at the foot of the aerial.

We shall now examine the method by which Dr. Palmer arrives at a different result. If, instead of adding a small inductance  $L_x$ , one changes the frequency from the resonant value  $f_0$  to some other value  $f$ , the reactance changes from zero to an amount which should be the same for the aerial and its equivalent circuit. In a simple circuit with inductance  $L_0$  and capacity  $C_0$ , the reactance becomes  $j\left(\omega L_0 - \frac{1}{\omega C_0}\right)$  or  $j\omega_0 L_0 \left(\frac{\omega^2 - \omega_0^2}{\omega \omega_0}\right)$ . In the aerial it becomes

$$\begin{aligned} X &= \sqrt{\frac{L}{C}} \cdot \frac{1}{j \tan \omega h \sqrt{LC}} \\ &= -j \sqrt{\frac{L}{C}} \cdot \cotan \omega h \sqrt{LC}. \end{aligned}$$

Now  $\cotan x = \frac{1}{x} - \frac{x}{3} - \frac{x^3}{45}$ , etc.

Hence

$$\begin{aligned} X &= -j \sqrt{\frac{L}{C}} \left\{ \frac{1}{\omega h \sqrt{LC}} \right. \\ &\quad \left. - \frac{\omega h \sqrt{LC}}{3} - \frac{(\omega h \sqrt{LC})^3}{45}, \text{ etc.} \right\} \end{aligned}$$

which may be written

$$\begin{aligned} X &= j \sqrt{\frac{L}{C}} \left\{ \omega \cdot \frac{h \sqrt{LC}}{3} \left( 1 + \frac{\omega^2 h^2 LC}{15} \right) \right. \\ &\quad \left. - \frac{1}{\omega h \sqrt{LC}} \right\} \end{aligned}$$

On comparing this with the formula for the reactance of the equivalent circuit, it is seen that it is somewhat similar in

form, but unfortunately the term  $\frac{\omega^2 h^2 LC}{15}$

is by no means negligible and varies as the square of the frequency. At resonance

$$\omega_0 h \sqrt{LC} = \pi/2, \text{ so that } \omega_0^2 h^2 \cdot LC/15 = \frac{1}{6}.$$

It must be remembered that the quantity in brackets is the small difference between two large reactances, and instead of one of them being directly proportional to  $\omega$  and the other inversely proportional to  $\omega$  as in the equivalent circuit, there is this disturbing term depending on  $\omega^3$  which makes it very difficult, if not impossible, to derive from a comparison of the equations any conclusion as to the values of the equivalent inductance and capacity. This is the reason for the erroneous result obtained by Dr. Palmer.

The correct result can, however, be obtained from the consideration of the effect of changing the applied frequency in the following manner. In a simple oscillatory

$$\text{circuit, } X = \omega L_0 - \frac{1}{\omega C_0} = \omega_0 L_0 \left( \frac{\omega^2 - \omega_0^2}{\omega \omega_0} \right)$$

and the change of reactance with frequency is found by differentiating, thus

$$\frac{dX}{d\omega} = L_0 \left( 1 + \frac{\omega_0}{\omega^2} \right).$$

In the neighbourhood of resonance  $\omega = \omega_0$ , and  $dX/d\omega = 2L_0$ .

In the case of the transmission line or aerial the apparent reactance is

$$- \sqrt{L/C} \cdot \cotan \omega h \sqrt{LC}$$

and the change of reactance with frequency is

$$\frac{dX}{d\omega} = \sqrt{\frac{L}{C}} \cdot \frac{1}{\sin^2 \omega h \sqrt{LC}} \cdot h \sqrt{LC}.$$

In the neighbourhood of resonance  $\omega = \omega_0$  and  $\omega_0 h \sqrt{LC} = \pi/2$ , whence

$$dX/d\omega = hL.$$

Hence, if the equivalent circuit is to have the same value of  $dX/d\omega$  as the aerial,  $L_0 = hL/2$ , as already found by the method of adding inductance.

# The Apparent Demodulation of a Weak Station by a Stronger One.

By R. T. Beatty, M.A., B.E., D.Sc.

## Introduction.

WHEN a stage of high-frequency amplification is used in a receiver a resonance curve can be drawn for the tuned circuit which gives by inspection the ratio of the amplification of an unwanted station to that of the station which is tuned in. For a tuned circuit (Fig. 1) a resonance curve (Fig. 2) can be drawn in which the voltage amplification at resonance is taken as unity.  $n$  is the resonance frequency;  $\delta n$  is the frequency difference between the wanted and unwanted stations, and  $m = L \cdot 2\pi n / r^*$  (reactance of coil divided by its high-frequency resistance).

If the coil is wound in a single layer with solid wire on a 2in. former its value of  $m$  at broadcast frequencies will be about 100. Let the frequency  $n$  of the wanted station be 1,000 kilocycles, and suppose that the unwanted station is 50 kilocycles distant and of strength equal to that of the wanted station. Then  $2m \cdot \delta n / n = 2 \times 100 \times 50 / 1000 = 10$ ; hence from the curve  $y =$

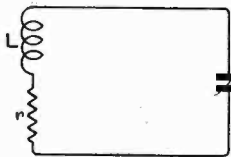

Fig. 1.

0.1, which means that the strength of the unwanted station has been reduced to one-tenth. Similarly, if the unwanted station is 200 kilocycles off tune we get  $y = 0.025$ .

But to eliminate interference completely we should have to cut down the off tune station much more drastically than this: a value of 0.0001 for  $y$  would be none too small. It would seem then from elementary theory that with the above circuit (which is a

\* This method of plotting the resonance curve for a single tuned circuit gives a single resonance curve which can be used for any values of  $L$ ,  $r$ , and  $n$ . It is accurate provided that the value of  $m$  remains constant as the incoming frequency moves away from the frequency to which the circuit is tuned. This proviso limits the use of the curve to values of  $\delta n / n$  not exceeding about 0.2.

good average one for H.F. amplification) selectivity should be very poor indeed.

Actually, however, we know that with such a circuit we can select between two

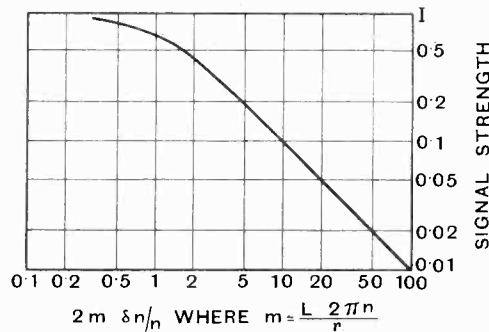

Fig. 2.

equally strong stations 50 kilocycles apart, and with the use of reaction the off tune station can be eliminated even though its strength at the receiving aerial is ten times that of the other. There must accordingly be some mutual action between the signals from the two stations which has not been taken into account in the simple theory of the tuned circuit.

## Supersonic Beats Between the Carrier Waves.

The cause of the unexpectedly selective behaviour of the circuit lies in the nature of the supersonic beats between the carrier waves of the two stations.\* The amplitude of the modulated wave from the unwanted station may be written

$$U \cdot \cos 2\pi n t + M \cdot \cos 2\pi n l \cdot \cos 2\pi a l$$

where  $U$  and  $M$  are the carrier and modulation

\* Though the phenomenon is known in a general way to radio engineers I have not been able to find any mathematical treatment of it in the literature: a qualitative account was given by Round in the *Wireless Weekly* in 1921, and mention is there made of its use by Franklin in duplex telephony.

amplitudes,  $n$  is the carrier frequency, and  $a$  is the modulation frequency. The peak carrier amplitude occurs when  $\cos 2\pi nt = 1$ , and hence the corresponding amplitude of the envelope is

$$U + M \cdot \cos 2\pi at.$$

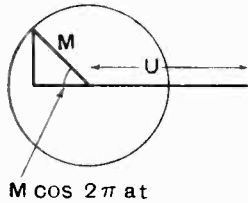

Fig. 3.

Fig. 3 shows that this is the sum of  $U$  and the projection on the horizontal of a vector  $M$  which rotates  $a$  times per second, and the amplitude of the envelope varies between  $U + M$  and  $U - M$ . In Fig. 4  $U$  is drawn to represent one peak volt and  $M$  is an amplitude of modulation of 0.2 peak volt: we may imagine that while  $U$  remains of unit length its left extremity slides to and fro at audio frequency on the horizontal diameter of the circle. As shown in the lower part of Fig. 4, the envelope when referred to its centre line will be a wave of amplitude  $M$ .

Next consider a pure carrier wave from the unwanted station  $U$  and a weaker one from the wanted station  $W$ . The resultant is

$$U \cdot \cos 2\pi nt + W \cdot \cos 2\pi(n+s)t$$

where  $s$  is the (supersonic) frequency differ-

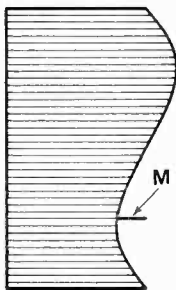
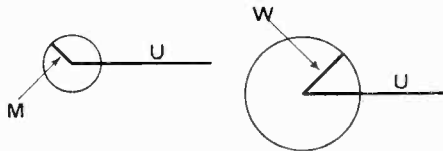

Fig. 4.

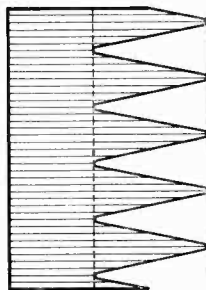

Fig. 5.

ence between the two waves. Considering

$$U + W \cdot \cos 2\pi st$$

which represents (Fig. 5) the sum of  $U$  and the projection on the horizontal of a vector  $W$  rotating  $s$  times per second: the envelope is a wave of frequency  $s$ .

Fig. 6 shows the result when  $U$  is modulated; it is obtained by combining Figs. 4 and 5.

Since  $W$  is rotating much more rapidly than  $M$ , the amplitude of the  $U$  envelope will remain at  $U + M \cos 2\pi at$ , while  $W$

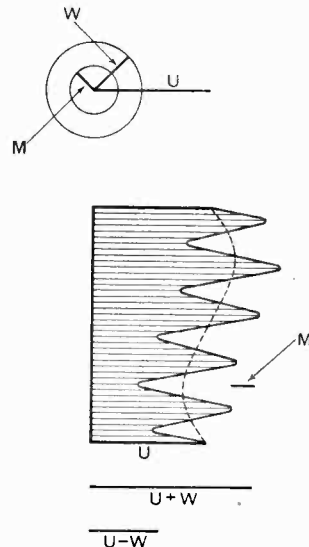

Fig. 6.

executes a few rotations and the whole amplitude will vary between

$$\left. \begin{aligned} U + M \cos 2\pi at + W \\ U + M \cos 2\pi at - W \end{aligned} \right\} \dots (1)$$

and while the average as shown by the dotted line in Fig. 6 is  $U + M \cos 2\pi at$ .

**Case when  $W$  is Greater than  $U + M$ .**

Since the amplitude can never become negative we must re-write (1) as

$$\left. \begin{aligned} W + U + M \cos 2\pi at \\ W - U - M \cos 2\pi at \end{aligned} \right\} \dots (2)$$

the average of which is  $W$ .

Fig. 7 shows this result: the straight dotted line is the average amplitude, and the peaks are symmetrically arranged on either side.

ence between the two waves. Considering

**Effect Due to a Straight Line Detector.**

When the voltages whose wave forms are shown in Figs. 6 and 7 are applied to the grid of an anode bend detector whose A.C. characteristic is a straight line, the envelope:

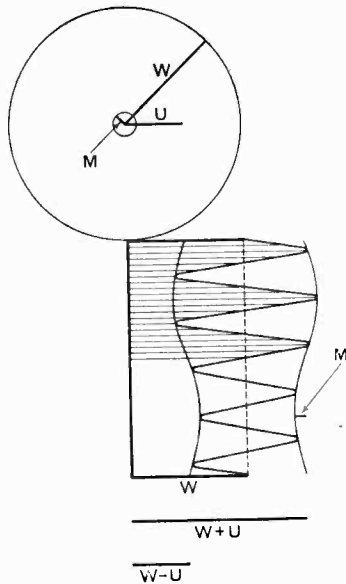

Fig. 7

indicated by curves 1 and 2 (Fig. 8) are rectified and produce A.C. voltages at the plate of supersonic frequency with audio modulation as in curves 1a and 2a. The supersonics can be eliminated by insertion of a stopper circuit, and in any case can produce no effect in the loud speaker, so that the final result will be the central wavy dotted line in curve 1a (when  $W$  is smaller than  $U$ ) or the central straight dotted line in 2a (when  $W$  is greater than  $U$ ).

It appears, therefore, that with a perfect detector the unwanted station would be completely demodulated by the slightly stronger wanted station, and it is easily seen that audio modulation of the wanted station would be unaffected by the carrier wave of the unwanted, since the length of  $W$  in Fig. 7 would then vary at audio frequency so that the centre dotted line would become wavy with an amplitude independent of the magnitude of  $U$ .

**Effect Due to an Imperfect Detector.**

The A.C. characteristic of an actual

anode bend detector is shown in Fig. 9. We assume that by H.F. amplification one volt (peak value) due to the carrier of the wanted station is impressed on the grid of the detector: then if  $U = W/2$  and if the modulation of  $U$  is 20 per cent., the plate volts will vary at audio frequency between the average of  $P$  and  $P_1$  and the average of  $Q$  and  $Q_1$ . The average of  $Q$  and  $Q_1$  is  $(8 + 0.72)/2 = 4.36$ , and the average of  $P$  and  $P_1$  is  $(6.6 + 1.42)/2 = 4.01$ . The difference between these is 0.35 volt, and this is the resultant audio frequency variation due to the unwanted station. If the characteristic had been a straight line between these limits the audio variation would have disappeared completely. If  $U = W/5$  the corresponding strips are  $P_2Q_2$  and  $P_3Q_3$ , and the difference between the average values of  $P_2$  and  $P_3$  and of  $Q_2$  and  $Q_3$  is 0.08 volt. Finally, if  $U = W/10$  the strips  $P_4Q_4$  and  $P_5Q_5$  are both on the straight part of the characteristic, so that the mean value of  $P_4$  and  $P_5$  is equal to the mean value of  $Q_4$  and  $Q_5$ : that is, the modulation of the

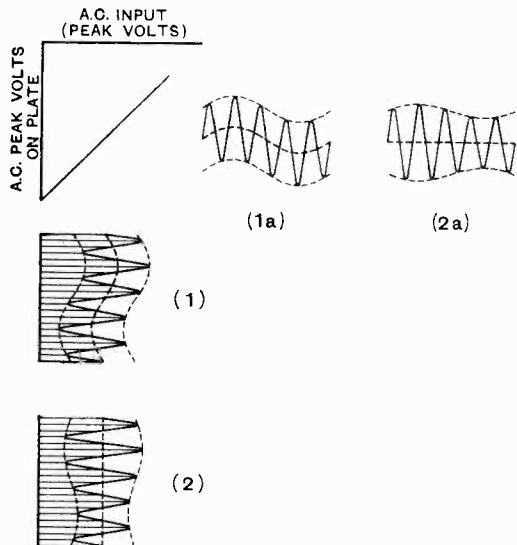

Fig. 8

unwanted station has disappeared as in the case of the straight dotted line in Fig. 7. This ratio between the strengths of the two stations of 10:1 agrees in a general way with the ratio found necessary in practice.

### Analogy with the Superheterodyne.

A little reflection will show that the effects described above are those which are produced in a superheterodyne when a local

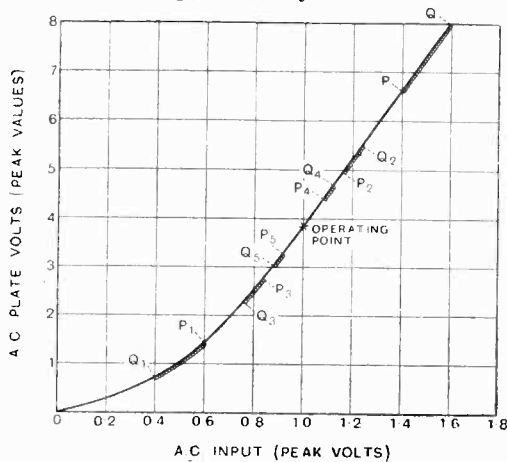

Fig. 9

oscillation is made to beat with the incoming signal: the wave carried through

the intermediate amplifier is of the type in Fig. 7: the audio component is borne on a supersonic carrier and can only be isolated by passing through a second detector.

### Conclusion.

A resonance curve (Fig. 2), though giving information as to the relative amplification of the CARRIER WAVES of the tuned-in station and the station off tune, does not give the relative amplification of the MODULATION: the latter depends on the curvature of the detector A.C. characteristic and the position of the operating point. With a truly linear A.C. characteristic the unwanted station would be silenced if its carrier were slightly weaker than that of the wanted station. Actual A.C. characteristics, however, almost invariably have an initial curvature, and it is necessary that neither of the two strips shown in Fig. 9 should lie on the curved portion. In practice it is found that the unwanted station can be silenced if its carrier wave does not exceed one-tenth that of the wanted station as measured at the grid of the detector valve.

## New Naval Apparatus.

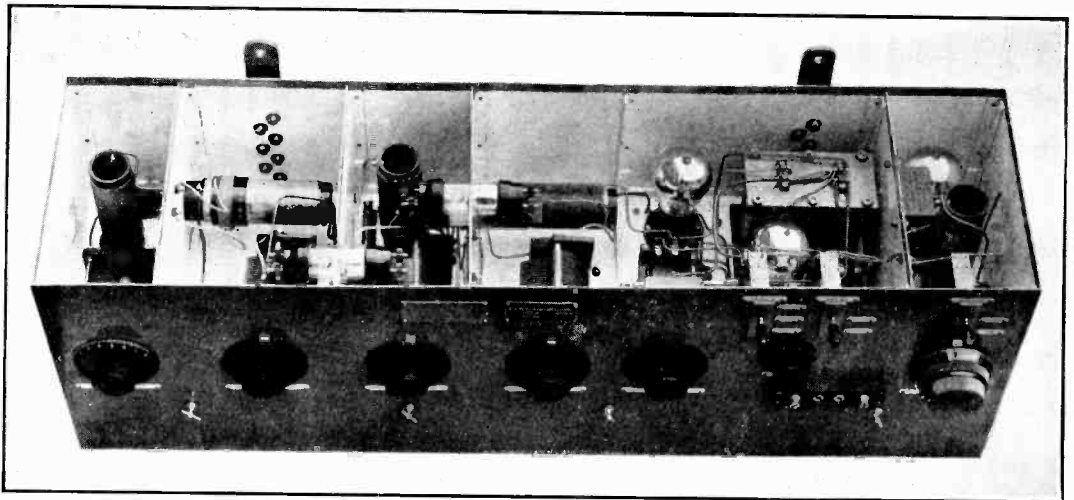

The Marconi Co. have recently introduced a new series of interesting receivers specially designed for naval service. Above is an interior view of one of these sets, which includes two screened-valve H.F. stages and a new form of partial gang control.

# Short-wave Aerial Systems.

## An Elementary Theory of the Transmission of High-frequency Energy along the Feeders.

By E. Green, M.Sc.

IN connection with the beam system and other systems of short-wave radiotelegraphy, it is necessary to supply the high-frequency energy through cables usually called feeders, several wavelengths long. In the beam system these feeders consist of concentric copper tubes, the inner tube being supported on porcelain insulators, so that the attenuation is very small. The theory of wave propagation in cables has been developed in many text-books in a complicated mathematical form suitable for application to the problems of cable telegraphy and telephony. The solutions so obtained can, of course, be simplified to deal with the problems that arise in the wireless case, but the author thought it worth while to develop a simpler treatment that should still be adequate. The author takes this opportunity of thanking the Marconi Company for permission to publish these notes which were developed in their service.

The first part of this treatment is based on that originally given by Heaviside in Vol. I "Electro Magnetic Theory" in the chapter on plane waves. There it is shown that the transmission of electro-magnetic disturbance along cables is analogous to the propagation of plane electro-magnetic waves in free space. We will therefore describe the

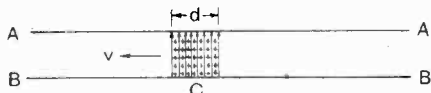

Fig. 1.

simplest type of plane electro-magnetic wave, and two of their fundamental properties.

In Fig. 1, *A* and *B* are two infinite, parallel, and perfectly conducting planes at any distance apart. The type of wave to be considered is shown at *C*, and consists of a thin sheet (thickness *d*) within which there is uniform intensity of electric force *X* (shown by the vertical lines) and the corresponding

intensity of magnetic force at right angles to the plane of the paper. Theory shows that this sheet moves through the dielectric between the planes *A B* with the velocity *v* characteristic of electro-magnetic waves in that dielectric. If  $\mu$  is the magnetic permeability and *k* the specific inductive capacity of the dielectric

$$v = \frac{3 \times 10^{10} \text{ cm per second}}{\sqrt{\mu k}}$$

In a true electro-magnetic wave, of which that described above is a type, half the total energy is in the form of electric strain, and half in the form of magnetic strain. So that per unit volume we have

$$\frac{kX^2}{8 \Pi} = \frac{\mu H^2}{8 \Pi}$$

Now provided there is no loss of energy in the medium or in the bounding planes *A B*, this equality of the two forms of energy persists. In this case the law of propagation of the disturbance is a simple one, *i.e.*, the wave sheet suffers no change in character but moves forward with the steady velocity *v*.

It will appear at a distance *x* further along at a time  $\frac{x}{v}$  later in its original form, as a

wave sheet of thickness *d* and uniform electric intensity *X*. We can build up any complex wave of a series of such elementary sheets, and each will preserve its independence so that the whole complex wave travels with velocity *v* without change of form, that is, it is propagated without distortion.

Let us now apply these ideas to the transmission of electro-magnetic disturbances along feeders.

The feeder is assumed to be of infinite length, and may consist of a pair of parallel wires, or concentric cylinders.



Let

- $L$  = inductance of feeder in henries per unit length (go and return).
- $C$  = capacity in farads per unit length.
- $\mu$  = magnetic permeability of the dielectric between the conductors.
- $K$  = specific inductive capacity of same.
- $v$  = velocity of propagation of electro-magnetic disturbance along the feeder.

**Infinitely Long Feeder of Negligible Resistance and Leakage.**

In Figs. 2(a) and (b),  $A$  and  $B$  represent the two conductors of a feeder. If an E.M.F.  $E$  is applied across the input end of the feeder, as shown in Fig. 2(a), it immediately charges up the initial portion of the feeder to this potential difference, and these charges with the corresponding lines of stress between them commence to move down the feeder with velocity  $v$ .

If the E.M.F. is removed after a short time  $dt$  no more charge enters the feeder,

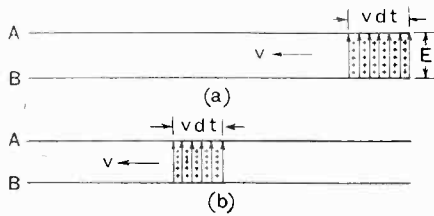

Fig. 2.

but that already existing continues to move along the feeder by virtue of its momentum with velocity  $v$ , as shown in Fig. 2(b). Regarded from the point of view of the dielectric (in which all the energy is located) it constitutes an approximately plane-electromagnetic wave sheet of the thickness  $v dt$ . It is therefore analogous to the wave sheet previously considered, but the guiding conductors  $A$  and  $B$  of the feeder take the place of the bounding planes. Hence all the remarks made concerning the plane wave sheet apply (with minor modifications) to the wave sheet in the feeder.

Hence :

(1) The energy in the electric field in the wave sheet is equal to that in the magnetic field.

(2) The wave sheet moves along the feeder without change in type at the constant

velocity  $v$ . Therefore if the input E.M.F. varies in any prescribed manner, we shall have a continuous wave travelling along the feeder without change of type, and reproducing at any point the corresponding

variations of the input E.M.F. at a time  $\frac{x}{v}$  later, where  $x$  is the distance of the point in question from the input terminals. Or in other words, electro-magnetic waves travel down such a feeder without attenuation or distortion.

**Relations of Current, Voltage and Energy in the Wave Sheet in the Feeder.**

At the input end, in the time  $dt$  when the E.M.F. is applied, a length  $v dt$  is charged to the potential  $E$ .

$\therefore$  charge entering feeder in time

$$dt = ECv dt.$$

$\therefore$  current entering feeder =  $ECv = I$ .

However the input E.M.F. varies, this relation must hold between the instantaneous values of  $E$  and  $I$ . The feeder behaves as a non-inductive resistance value

$$R_0 = \frac{E}{I} = \frac{1}{Cv},$$

and could be replaced by such a resistance so far as the external supply is concerned. The same relation will hold between voltage and current at any section of the wave. Hence current and voltage are in phase at any point in the feeder.

In unit thickness of the wave sheet the electric energy is  $\frac{1}{2}CE^2$  and the magnetic energy is  $\frac{1}{2}LI^2$ .

$$\therefore \text{total energy} = \frac{1}{2}LI^2 + \frac{1}{2}CE^2$$

But the total energy supplied from the source to unit thickness

$$= \frac{EI}{v} = E^2C$$

$$\therefore CE^2 = \frac{1}{2}LI^2 + \frac{1}{2}CE^2$$

$$\therefore \frac{1}{2}LI^2 = \frac{1}{2}CE^2$$

*i.e.*, the magnetic energy is equal to the electric energy, as it should be in an electro-magnetic wave.

From this last equation we get another expression for  $R_0$

$$R_0 = \frac{E}{I} = \sqrt{\frac{L}{C}}$$

The quantity  $R_0$  is known as the surge impedance of the feeder, since it is the instantaneous load which even a finite feeder offers to a suddenly applied E.M.F.

$$\text{From } R_0 = \sqrt{\frac{L}{C}} = \frac{I}{Cv}$$

$$\text{we find } v = \frac{I}{\sqrt{LC}} = \frac{3 \times 10^{10}}{\mu K}$$

by substituting the calculated values of  $L$  and  $C$ .

This is the theoretical velocity of electromagnetic waves in a medium of magnetic permeability  $\mu$  and specific inductive capacity  $K$ .

**Infinite Feeder with Sinusoidal E.M.F.**  
( $E_0 \sin \omega t$ ) applied to the Input Terminals.

We have seen that the input current will be in phase with the E.M.F. and will be

$$\frac{E_0}{R_0} \sin \omega t = I_0 \sin \omega t, \text{ where } R_0 = \sqrt{\frac{L}{C}}$$

and the waves travel down the feeder with velocity  $v = \frac{I}{\sqrt{LC}}$ , so that at a distance  $x$

from the input terminals we shall have

$$E_x = E_0 \sin \omega \left( t - \frac{x}{v} \right)$$

$$I_x = I_0 \sin \omega \left( t - \frac{x}{v} \right)$$

From this we see that at points separated

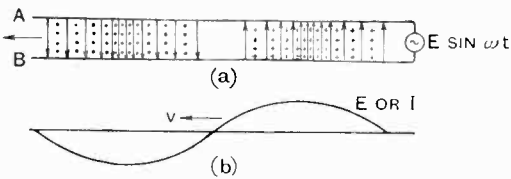

Fig. 3.

by a distance  $x$  given by

$$\frac{\omega x}{v} = 2\pi$$

the phase of the wave will be the same. This gives

$$x = \frac{v}{n} = \frac{I}{n\sqrt{LC}} = \lambda$$

where  $n$  is the frequency;  $\lambda$  is therefore the wavelength of the disturbance in the feeder. With air insulation this will not differ greatly from the wavelength in free space.

Diagrammatic representation of the series of waves travelling down the cable is shown in Fig. 3(a) and (b).

**Steady Conditions in Finite Feeder with a Sinusoidal E.M.F. at the Input End and Various Terminal Loads.**

**Surge Impedance—Non-Reflective Resistance.**

**Case I. Terminal Load a Pure Resistance =  $R_0$ .**

We saw that a uniform feeder of infinite length was equivalent so far as the applied E.M.F. was concerned to a non-inductive

resistance  $= R_0 = \sqrt{\frac{L}{C}}$ , known as the surge impedance. It follows therefore that if we

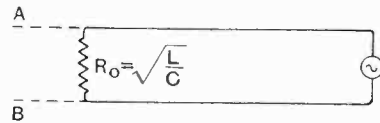

Fig. 4.

cut such a feeder at any point and the remainder of the feeder is replaced by a resistance of this value as shown in Fig. 4, the conditions obtaining in the first part of the feeder will not be affected, *i.e.*, there will be a wave travelling down the feeder from the input end, and the whole of its energy will be absorbed in the terminal resistance  $R_0$  without reflection. When transmitting power down a feeder several wavelengths long it will therefore be most efficient to arrange the conditions at the output terminals to give the equivalent of this resistance  $R_0$ , otherwise, as noted later, part of the wave will be reflected back and there will be bigger currents and voltages on the feeder resulting in greater losses.

**Case II. Terminal Load not equal to  $R_0$ .**

In the case of "free" electro-magnetic waves meeting a boundary where the medium changes, we know that the waves are so reflected as to fulfil both the boundary conditions and the conditions applying to waves in the medium. Thus if the boundary is a perfect conductor it gives rise to such a

reflected wave that the resultant voltage at the conducting surface is zero.

The same thing occurs to the bound waves in a feeder when the terminal load is not  $R_0$ . This case is shown in Fig. 5(a), where the terminal load is a resistance  $R$  in series with a reactance  $X$ . A sinusoidal E.M.F. at the input end of the feeder starts a train of waves down the feeder, and when the output end is reached a reflected wave is set up and travels back to the input end, there to be partly absorbed and partly reflected once more, until gradually a steady state is built up. In every case the reflected wave must be such as to satisfy two conditions.

(1) The relation of voltage and current in the load is determined by the impedance of the load in the normal way  $\bar{V} = (\overline{R + jX}) \bar{I}$ .

(2) Any wave travelling along the feeder must have voltage and current in phase and

$$\frac{V}{I} = R_0.$$

The steady condition at the output end is thus made up of an infinite series of advancing waves, each of which is affected similarly as regards division of current between the reflected wave and the load, and also as regards phase shift. We can therefore treat the two series of waves as a single resultant incident wave giving rise to a single resultant reflected wave, and a resultant current in the load, which can be calculated by the ordinary laws of reflection.

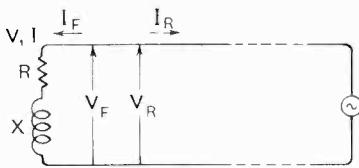

Fig. 5a.

Then the whole disturbance at any point of the feeder is the sum of these two resultant waves.

A simpler way of regarding the problem is this. Let the input terminals be at infinity. Then we can have an infinite train of sinusoidal waves advancing down the feeder, supplying current to the output circuit and being partially reflected. Then, once the reflected wave is passing a point in the feeder, the steady state will be estab-

lished at all points between that point and the output terminals. There will be a definite relation between  $I$  and  $V$  at that point as regards amplitude and phase, and if we cut the feeder there and provide these values of  $I$  and  $V$  from any combination of reactance and resistance with the necessary internal E.M.F., this steady state will be maintained.

If  $\bar{V} = \bar{I} Z_z$ ,  $Z_z$  may be called

the equivalent impedance of the load and feeder at this point. From this we see that the relative values of  $I$  and  $V$  and their phase relation at any point are determined entirely by the nature of load and the surge impedance of the feeder, and not at all by the input end. The absolute values of  $I$  and  $V$ , however, are determined by the E.M.F. at the input end, and the equivalent impedance of the load and feeder at the transmitter.

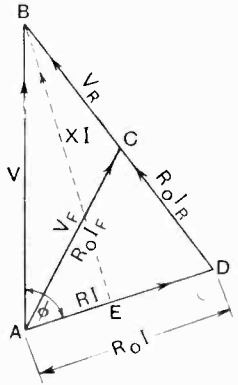

Fig. 5b.

Let  $R$  = Resistance of terminal load.

$X$  = Reactance of terminal load.

$R_0 = \sqrt{\frac{L}{C}}$  = surge impedance of feeder.

$V$  and  $I$  the amplitudes of voltage and current in the load.

$V_z$  and  $I_z$  the resultant voltage and current at any point.

$V_F$  and  $I_F$  amplitudes of voltage and current in the forward wave.

$V_R$  and  $I_R$  ditto for reflected wave.

Then calling  $I$  and  $V$  positive when they are in the directions indicated in Fig. 5(a).

$$\frac{V_F}{I_F} = \frac{V_R}{I_R} = R_0.$$

also  $V_F$  and  $I_F$  are in phase, and  $V_R$  and  $I_R$  are in phase.

$$\bar{V} = \text{vector sum of } V_F \text{ and } V_R \text{ at the load} \\ = \bar{V}_F + \bar{V}_R$$

$\bar{I}$  = vector diff. of  $I_F$  and  $V_R$  at the load  
 $= \bar{I}_F - \bar{I}_R$

In Fig. 5(b)  $AC$  represents  $\bar{V}_F$  at the load  
 $CB$  represents  $\bar{V}_R$  at the load  
 so that  $AB$  represents  $\bar{V}$

Similarly, if  $BC$  is produced to  $D$  making  
 $DC = CB = V_R = R_0 I_R$ .  
 the  $AD = AC - DC = R_0 (\bar{I}_F - \bar{I}_R) = R_0 \bar{I}$ ,  
 i.e.,  $AD$  represents  $R_0 I$  in magnitude and  
 phase; angle  $BAD = \phi$ , the angle of lag of  $I$   
 behind  $V$ .

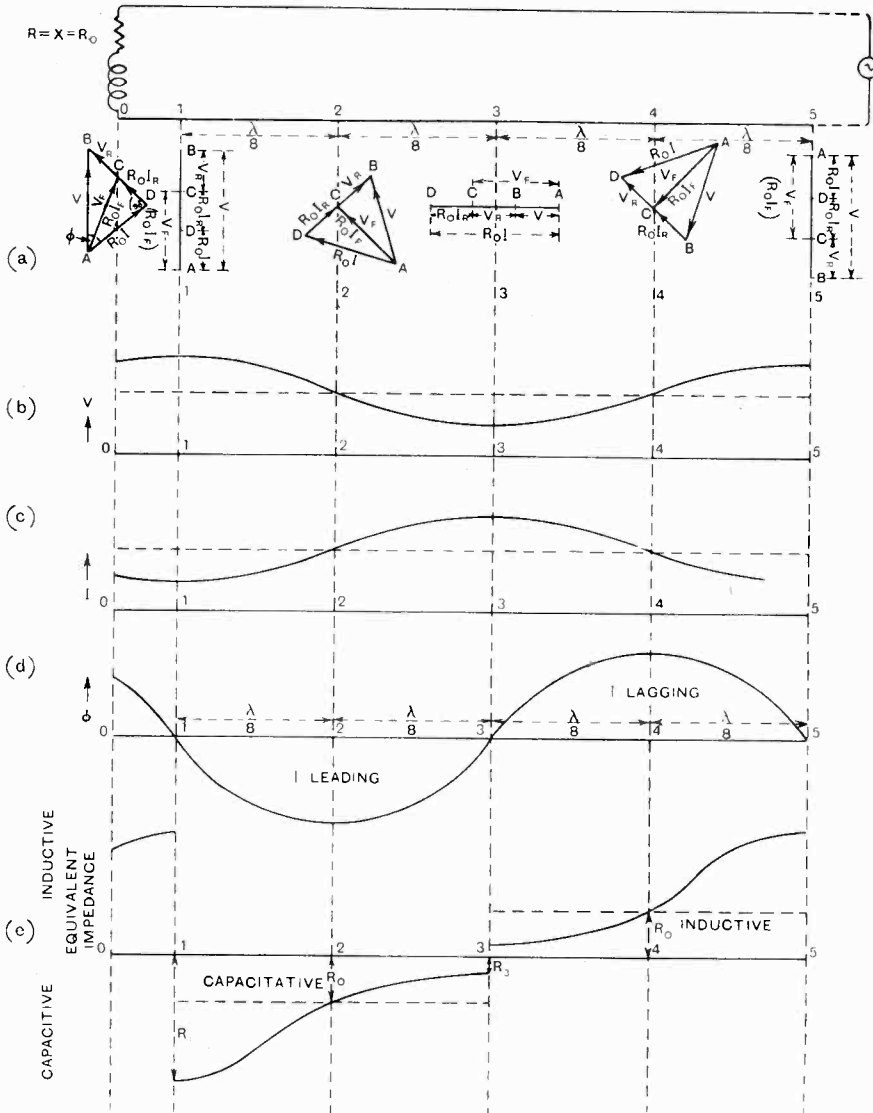

Fig. 6.

For the triangle of currents we know  
 $V_F = R_0 \cdot I_F$  and is in phase with  $I_F$ , so  
 that  $AC$  represents  $I_F$  multiplied by  $R_0$

If we are given the value of  $R$  and  $X$  at the  
 load, to construct this Fig. 5(b) we assume  
 a value for  $I$ . Then draw  $AE = RI$  and

$EB = XI$ . Then  $AB$  represents  $V$  and angle  $BAE =$  angle of lag of  $I$  behind  $V$ . Mark off along  $AE$   $AD = R_0 I$ . Join  $B$  to  $D$  and  $A$  to  $C$ , the mid-point of  $BD$ . Then, as before stated, we have

- $AB$  represents  $V$
- $AD$  "  $R_0 I$
- $AC$  "  $V_F$  and  $R_0 I_F$
- $CB$  "  $V_r$
- $DC$  "  $R_0 I_r$

This figure fully determines the conditions existing at the load.

only require the relations of  $V_x$  and  $I_x$ , and in this case it is easier to leave  $AC$  fixed and rotate  $BCD$  in a clockwise direction through  $\frac{4\pi x}{\lambda}$  radians.  $BCD$  will then

make a complete revolution for every  $\frac{\lambda}{2}$  of the feeder. The resultant  $V_x$  and  $I_x$  for this point are given by  $AB$  and  $AD$  as before.

Up to the present we have assumed that the transmitter is so far away that only a single incident wave and a single reflected wave exist at the points considered. But,

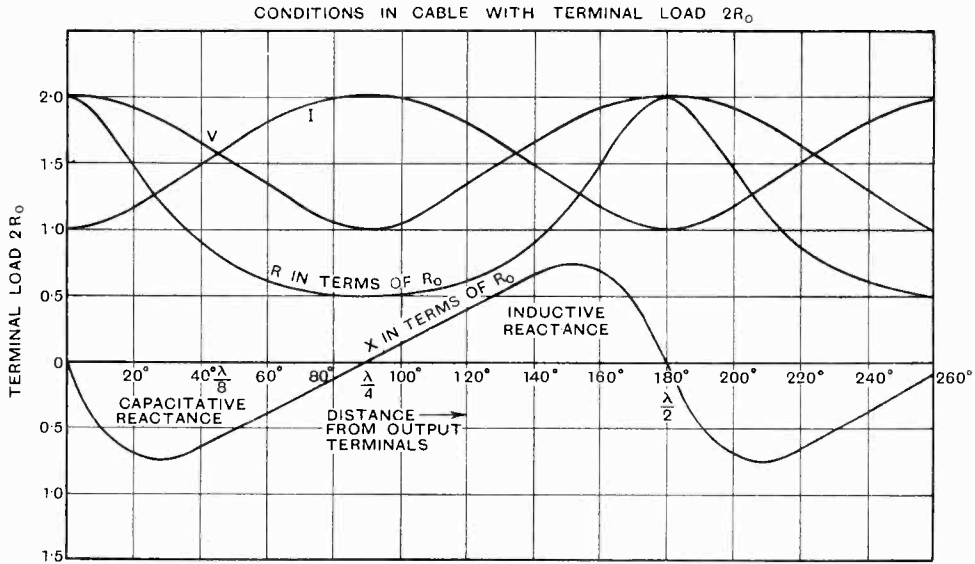

ELECTRO-MAGNETIC WAVES IN CABLES  
Fig. 7

To determine the conditions existing at a point in the feeder at a distance  $x$  from the load, we know the values of  $V_F$  and  $I_F$  existing at this point  $x$  will exist at the load  $\frac{x}{\lambda}$  periods later ( $\lambda$  being the wavelength in the feeder). Hence, if we rotate  $AC$  in a counter-clockwise direction about  $C$  through an angle  $\frac{2\pi x}{\lambda}$  radians (i.e.,  $\frac{360x}{\lambda}$  degrees) we get  $V_F$  and  $I_F$  for the point  $x$ . Similarly, for  $V_r$  and  $I_r$  the conditions at  $x$  are those existing at the load  $\frac{x}{\lambda}$  periods before; so that we must rotate  $BCD$  in a clockwise direction about  $C$  through  $\frac{2\pi x}{\lambda}$  radians. Usually we

as before mentioned, we can imagine a feeder cut at  $x$  and the transmitter connected there, and if this supplies the same values of  $V_x$  and  $I_x$  that already existed there the same state of things will be maintained. The feeder and load will therefore behave

as an impedance  $= \frac{\bar{V}}{I}$  as regards the transmitter. This may be termed the equivalent impedance of the feeder and load at the point  $x$ , and will obviously vary with the distance  $x$ . We can also imagine the feeder cut at  $x$ , and the feeder beyond this point, plus the load, replaced by the equivalent impedance, and the original state of things would persist in the remaining portion of the feeder.

An example is worked out in Fig. 6 for an inductive load in which  $R = X = R_0$ , but the remarks below apply to any inductive load.

At a distance less than  $\frac{\lambda}{4}$  from the load  $AC$  and  $BCD$  come into line as shown in (a) 1.  $V$  and  $I$  are in phase,  $V$  (i.e.,  $AB$ ) having its maximum value and  $I$  (i.e.,  $AD$ ) its minimum value. Hence the equivalent impedance is a maximum, and is a pure resistance. At the point 2,  $\frac{\lambda}{8}$  farther from the load  $AC$  is at right angles to  $BCD$ ; and  $\phi$  reaches its maximum negative value.  $AD = AB$ , i.e.,  $V = R_0 I$ . The equivalent impedance is equal to  $\frac{V}{I} = R_0$  in magnitude

but is capacitive.  $\frac{\lambda}{8}$  farther back at 3,  $AC$  and  $BCD$  are in line again, but now  $V$  has its minimum value, and  $I$  its maximum value. Hence the equivalent impedance is a minimum, and is a pure resistance. If  $R_1$  and  $R_3$  are the values at 1 and 3, then

$$\sqrt{R_1 R_3} = R_0.$$

Thus in Fig. 6 for the resistance  $R_1$  we have

$$R_1 = \frac{V}{I} = \frac{(AB)_1}{(AD)_1} R_0.$$

Whilst for the resistance  $R_3$  at point 3 we have

$$R_3 = \frac{V}{I} = \frac{(AB)_3}{(AD)_3} R_0$$

$$\therefore R_1 R_3 = \frac{(AB)_1}{(AD)_1} \cdot \frac{(AB)_3}{(AD)_3} R_0^2$$

but  $(AB)_1 = (AD)_3$  and  $(AD)_1 = (AB)_3$

$$\therefore \sqrt{R_1 R_3} = R_0.$$

$\frac{\lambda}{8}$  farther back at the point 4,  $AC$  and  $BCD$

are at right angles again; the equivalent impedance is equal to  $R_0$ , but this time it is

inductive. At the point 5,  $\frac{\lambda}{8}$  farther back still we get figure 5, which is similar to 1 except that all phases are reversed. Beyond this point the sequence will be repeated. Note that  $\phi$  reaches equal positive and negative values, and the curve for  $\phi$  is symmetrical about the maximum values.

The case for any other load can be similarly worked out, but the general sequence can be deduced from the present set of curves. Thus if the load is capacitive, it is equivalent to having the load situated in the section 1-3.

### Pure Resistance Load.

If the load is a pure resistance it must be situated at 1 or 3, according as it is greater or less than  $R_0$ . If it is equal to  $kR_0$ , then at points along the feeder whose distances from the load are  $\frac{1}{2}\lambda$ ,  $1\lambda$ ,  $1\frac{1}{2}\lambda$ , etc., the equivalent impedance is a pure resistance  $kR_0$ ; whilst at points whose distances from

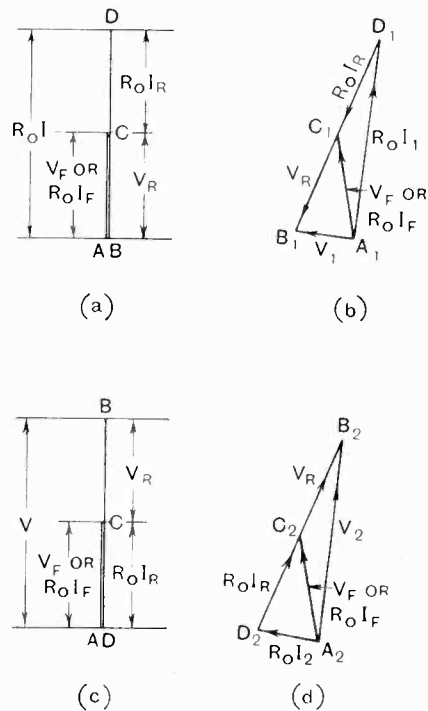

Fig. 8

the load are  $\frac{1}{4}\lambda$ ,  $\frac{3}{4}\lambda$ ,  $\frac{5}{4}\lambda$ , etc., it is a pure resistance  $= \frac{1}{k} R_0$ . This follows from

$$\sqrt{R_1 R_3} = R_0.$$

Fig. 7 shows the curves obtained for a terminal load of  $2R_0$ .

**Output Terminals on Short Circuit or on Open Circuit.**

These special cases are of some interest. With the output terminals short circuited, the resultant voltage there must be zero, the voltage of the reflected wave being exactly equal and opposite to that of the forward wave. Hence the vector diagram for this is shown in Fig. 8(a). It is clear from this that the resultant current at the end is double that in either wave. Fig. 8(b) shows the vector diagram for some definite distance  $x$  from the output terminals. Since  $AC = BC = CD$  the angle  $BAD$  between resultant current and resultant voltage will be a right angle whatever the value of  $x$ , i.e.,  $I$  and  $V$  are always in quadrature.

When the output terminals are open-circuited the resultant current must be zero, and the vector diagram takes the form of Fig. 8(c). As in the previous case, the reflected wave is equal in amplitude to the forward wave but is in opposite phase. The diagram of 8(c) is the same as 8(a) with the position of  $B$  and  $D$  interchanged. Hence at the same distance  $x$  from the output end the vector diagram becomes that of 8(d), which is a replica of 8(b) except that  $B$  and  $D$  are interchanged. Let the distance  $x$  be the distance of the input terminals,  $Z_1$ , the impedance of the feeder there for the case of short circuit, and  $Z_2$  that for open circuit.

Then we have

$$Z_1 = \frac{V_1}{I_1} = \frac{A_1 B_1}{A_1 D_1} R_0 \text{ from } 8(b)$$

$$Z_2 = \frac{V_2}{I_2} = \frac{A_2 B_2}{A_2 D_2} R_0 \text{ from } 8(d)$$

$$\therefore Z_1 Z_2 = \frac{A_1 B_1}{A_1 D_1} \cdot \frac{A_2 B_2}{A_2 D_2} R_0^2$$

and since  $A_1 B_1 = A_2 D_2$  and  $A_1 D_1 = A_2 B_2$

$$\frac{A_1 B_1}{A_1 D_1} \cdot \frac{A_2 B_2}{A_2 D_2} = 1$$

$$\therefore R_0 = \sqrt{Z_1 \cdot Z_2}$$

Hence, if we measure the impedance of a feeder both on open and short circuit, thus finding  $Z_1$  and  $Z_2$ , we can find  $R_0$ , the surge impedance of the feeder.

**Effect of Attenuation.**

So far we have neglected the effect of attenuation in the feeder. If it is small but is given by  $e^{-ax}$  in a distance  $x$ , we can proceed thus:  $V_F$  and  $I_F$  are the forward wave amplitudes at the load. For the point distance  $x$  from the output end they must be multiplied by  $e^{-ax}$  and are therefore  $V_F e^{-ax}$  and  $I_F e^{-ax}$ .  $V_R$  and  $I_R$  will be attenuated in ratio  $e^{-ax}$ , becoming  $V_R e^{-ax}$  and  $I_R e^{-ax}$ . Otherwise the construction of the vector diagrams is unchanged.

## Graphical Computation.

By *M. H. Ashworth, Wh.Ex., B.Sc.*

**M**ANY problems arise in connection with wireless calculations that are, in the ordinary way, difficult or laborious to solve. An example of this latter class occurred in connection with the article "An Experimenter's Wireless Laboratory" in the April, 1926, issue of *EXPERIMENTAL WIRELESS*—namely, the calibration of a Moullin Voltmeter from D.C. characteristic of a valve. It is proposed to show how to solve this problem by graphics and mental arithmetic.

The method which is well known in some branches of engineering is a process of graphical integration. This particular problem could, perhaps, be more readily solved by means of a planimeter; but not many experimenters have such an instrument, and the application of ordinary rules to obtain areas are themselves laborious and often give inaccurate results.

It is first necessary to obtain the current-time graph showing the current flowing at any instant during the cycle. This is easily

done if the grid-volts anode-current curve of the valve is arranged in the top left-hand corner of a sheet of squared paper, as shown in Fig. 1. The current axis produced to the

the method of obtaining the corresponding current-time curve is shown and is obvious. A horizontal line is drawn from *P* on the

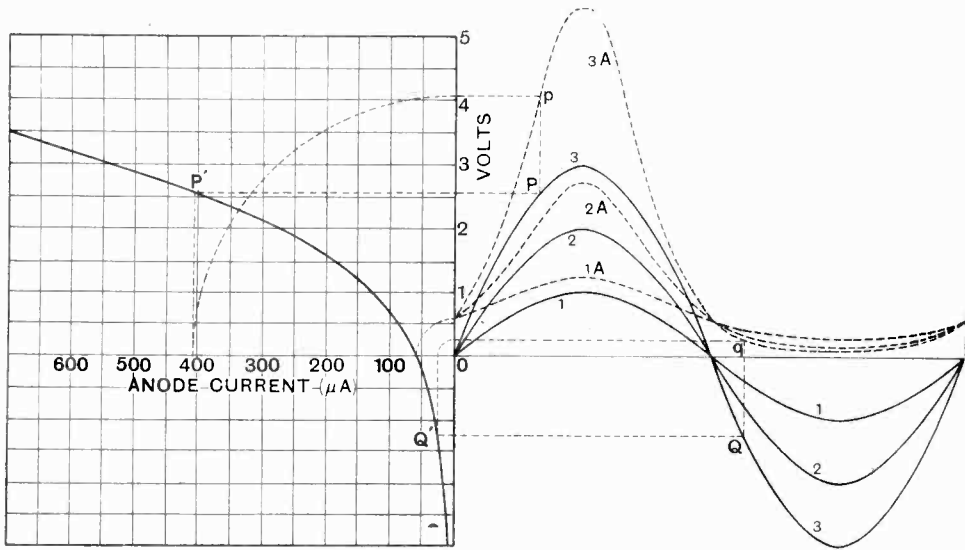

FIG. 1.

right is a time axis for the alternating voltage, and on this axis are plotted the necessary sine curves. Three such curves are shown, namely: for one, two and three volts (peak values). The scale of volts must be the same as for the grid volts already plotted.

at *P'*; a perpendicular is dropped from *P'* on the current axis, and with *O* as centre and with this current as radius an arc is struck through a right angle to bring the current at right angles to the time axis. This point is then projected to meet the vertical line through *P* and we have obtained a point *p* on the current-time curve.

Three current-time curves are shown corresponding to the three voltage-time curves. The problem is now to determine the area between each of these curves and the time axis so that the mean value of the current can be found. This could be done rapidly with a planimeter, as already pointed out, but Fig. 2 illustrates a graphical method.

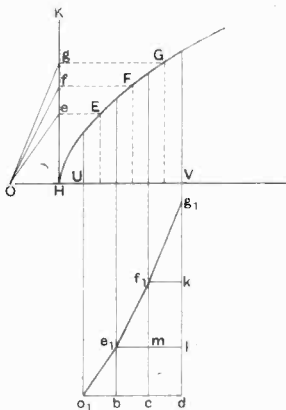

FIG. 2.

The current-time curve for any voltage curve can now be obtained with great ease and rapidity. From the two points *P* and *Q*, shown on the "three-volt" curve in Fig. 1,

In this case, let it be desired to find the area between the curve *EFG* and the axis (between points *U* and *V* on the latter). Divide *UV* into any number of parts (equal or unequal) and draw the mid-ordinate in each of these intervals as shown by the dotted lines. From the points where these mid-ordinates cut the curve draw horizontal lines *Ee*, *Ff*, etc., to cut a vertical line *HK*. Make *HO* (along the horizontal axis produced to the left) equal to one inch and join *Oe*, *Of*, etc.



Starting at any point on the vertical through  $U$ , draw  $o_1 e_1$  parallel to  $Oe$  across the space or interval  $E$ ; likewise draw  $e_1 f_1$  and  $f_1 g_1$  parallel to  $Of$  and  $Og$  respectively across the spaces  $F$  and  $G$ , as shown.

Then  $be_1$  measured in inches gives the area in square inches of the portion of the curve under  $E$  in interval 1;  $mf_1$  in the same way gives the area under  $F$  and similarly for any remaining intervals. The whole area is  $dg_1$ .

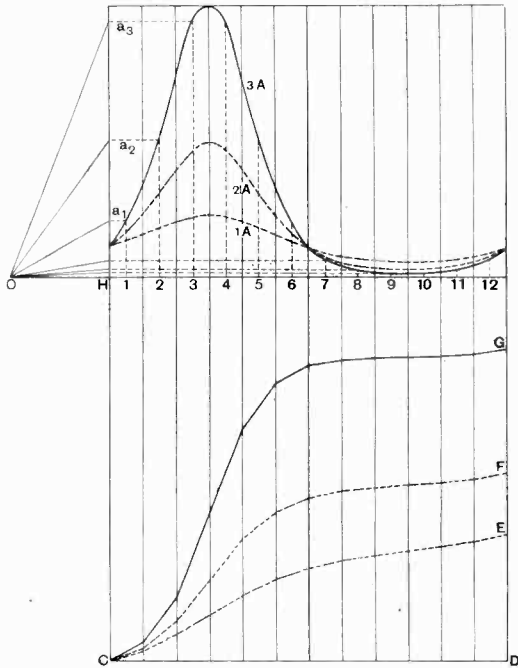

FIG. 3.

Consider the triangles  $OHe$  and  $o_1be_1$ . They are similar, therefore

$$\frac{OH}{He} = \frac{o_1b}{be_1} \text{ or } o_1b \times He = OH \times be_1,$$

but  $o_1b \times He = \text{area under } E$ ;

therefore,  $OH \times be_1 = \text{area under } E$ ,

and since  $OH$  equals one inch,  $be_1$  in inches gives numerically the area under  $E$  in square inches. If  $OH$  had been made 2 inches instead of 1 inch, then  $2 \times be_1$  would give the required area.

This method is applied in Fig. 3 to our current-time curves. In order to avoid complications these current curves have been redrawn on a new diagram. In practice

there is no need to do this, the lower part of Fig. 3 being drawn directly below the right hand portion of Fig. 1. One result and the necessary construction is shown in full for a current curve corresponding to 3 volts peak value. The results for the other two current curves are also shown dotted, but to avoid complications in illustrating this example the working is not shown for these two curves. The pole distance chosen is 2 inches and on measuring the ordinates  $DG$ ,  $DF$  and  $DE$  and multiplying each by  $OH$  ( $=2$  inches) we obtain the following areas:—

12.76 sq. inches, 7.70 sq. inches and 5.20 sq. inches respectively. Thus, since the period of one cycle is represented by 8 inches, the mean heights of the current curves are:—

1.59, 0.963 and 0.65 inches respectively, giving mean anode currents of:—

159, 96.3 and 65 micro-amps. respectively. Thus, since the current for zero volts is  $57 \mu A$ , the increase of anode current is:—

102, 39.3 and  $8 \mu A$  respectively (corresponding to cycles with peak voltages of 3, 2 and 1 volts).

Other curves may be drawn and more values obtained, and so the calibration curve drawn. A fair idea can, however, be obtained from the four values obtained, namely:—

Volts	..	0	1	2	3
Current	..	57	65	96	159

(The valve used is a Radio Micro with 44 volts on the anode, and 3.5 on the filament. A lower valve of about 33 volts on the anode would give equally good results and there would also be a lower current at zero volts. The bias is  $3\frac{1}{2}$  volts.)

It may possibly be thought by some that the method is not sufficiently accurate. A few examples will suffice to satisfy on this point. The area under each of the curves 1A, 2A and 3A was carefully measured by means of a planimeter, the mean of four readings being taken. These gave:—

5.21, 7.85 and 12.79 sq. inches.

On comparing these with our values, *i.e.*, with

5.20, 7.70 and 12.76 sq. inches,

we see that we can rely on our results to

about 1 per cent. (The middle result is abnormally far out.)

The great value of the method becomes more apparent when it is necessary to obtain successive integrations of a curve. Even with four such integrations an error exceeding 2 per cent. rarely occurs, and more often

than not the error is not more than 1 per cent. The method is rapid and two successive integrations over twelve intervals with the numerical results required can be obtained without fatigue in thirty minutes.

[Note.—MS. received by the Editors April, 1926.]

## Spot-welded Thermojunctions.

**M**ESSRS. COLLIER & STEPHENSON, 102, High Street, Hornsey, London, N.8, have recently produced a range of vacuum thermocouples possessing several advantages over the ordinary soldered junction. The couple, which consists of iron and constantan, is spot-welded to the heater wire, which is of nichrome, platinum or

the temperature of the heater wire may approach the melting point of the solder with disastrous results to the calibration if not permanent injury to the couple.

The vacuum thermocouples under review are mounted in ebonite bases which fit into standard "Wecovalve" holders. Four ranges are available

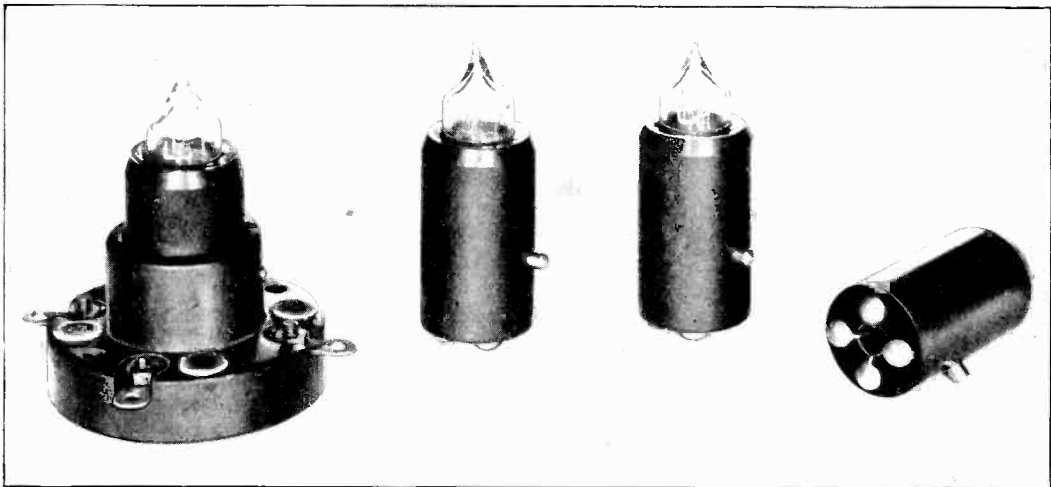

*A new range of thermocouples, by Messrs Collier & Stephenson, with spot-welded junctions; they fit into "Wecovalve" bases.*

constantan, depending on the current range of the junction.

With a spot-welded junction there is less risk of the couple wires including a short length of the heater, as frequently happens in the case of a soldered junction. There is thus an almost complete absence of the spurious E.M.F. in the couple circuit due to the voltage drop along the heater wire which is the cause, when calibrating with D.C., of the difference in scale reading sometimes experienced on reversing the current.

The spot-welded junction is also less susceptible to damage from overloading. Near the maximum current for which the junction has been designed,

and specimens submitted had the following characteristics:—

Couple No.	Range.	Heater Resistance.	Output.	
			3 mV.	3 ohms for
859	10 mA.	52.0 ohms	3 mV.	9.2 mA.
860	25 mA.	29.0 "	6 mV.	23.5 mA.
861	50 mA.	11.0 "	6 mA.	32.5 mA.
862	1 amp.	0.1 "	6 mA.	0.92 amp.

The junctions will take a 50 per cent. overload without damage or alteration of calibration. The couple resistance is of the order of 3 ohms in each case, and the vacuum is reduced to 0.0001 mm. Hg.

# On Banks of Paralleled Valves Feeding Resistive Loads Without Distorting the Wave Form.

By W. Baggally.

THE following paper deals with the problems which arise in the work of designing a bank of valves for supplying power to loud speakers, etc., in the form of undistorted speech and music, the treatment being confined to the case of a non-reactive load.

There are four conditions which must be fulfilled by a bank supplying power without distorting the wave form; they are:—

- (1) The anode current must not rise above the top of the straight part of the characteristic curve.
- (2) The anode current must not fall below the bottom end of the straight part of the characteristic curve.
- (3) The grids must never receive a positive charge.
- (4) The power dissipated at the anodes must not be greater than that for which the valves were designed.

The circuit to be considered is that shown in the diagram, Fig. 1, and usually known as

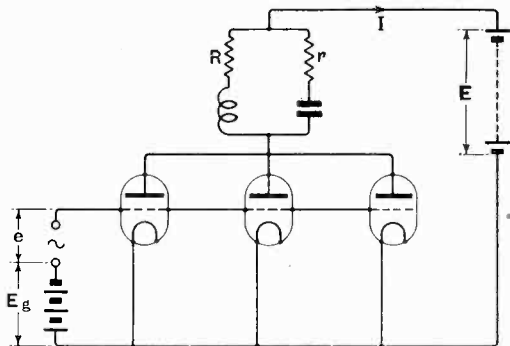

N VALVES  
Fig. 1.

choke feed; it is quite general and applies equally well to transformer or direct fed arrangements.

The inductance and capacity are both considered infinitely great.

In the case of transformer or direct feed,  $R$  will be the static resistance and  $r$  the

dynamic resistance of the transformer primary or loud speaker winding as the case might be.

The symbols used in the analysis are as follows:

- $a$  = anode current at bottom end of linear part of characteristic.
- $b$  = anode current at top end of linear part of characteristic.
- $D$  = allowable anode dissipation in each valve.
- $E$  = supply voltage.
- $E_a$  = steady anode voltage.
- $E_g$  = steady grid voltage.
- $e$  = maximum value of A.C. grid voltage.
- $\bar{E}_a$  = total instantaneous anode voltage.
- $\bar{E}_g$  = total instantaneous grid voltage.
- $I$  = D.C. feed current to bank.
- $i$  = current through load (A.C.).
- $\bar{I}$  = total instantaneous current to bank.
- $\bar{I}_a$  = total instantaneous anode current to each valve.
- $N$  = number of valves in parallel.
- $p$  = A.C. power in load.
- $R$  = resistance of feed choke.
- $r$  = resistance of load.
- $R_a$  = slope resistance of each valve.
- $m$  = voltage factor of each valve.
- $v$  = internal E.M.F. of valve (see appendix).
- $P$  = power supplied to the whole system.
- $P_R$  = power dissipated in  $R$ .
- $P_v$  = power dissipated in the bank.

The conditions for distortionless working can now be written as follows:—

- (1)  $\bar{I} \not\geq Nb$ .
- (2)  $\bar{I} \not\leq Na$ .
- (3)  $E_g + e \not\geq 0$ .
- (4)  $P_v \not\geq ND$ .

Now we have from energy considerations:

$$P = P_R + P_v + p \dots (1)$$

$$\text{also } P = \frac{I}{r} \int_0^r E(I + i \sin \omega t) dt = EI \dots (2)$$

and 
$$p = \frac{i^2 r}{2} \dots \dots \dots (3)$$

and 
$$P_R = I^2 R \dots \dots \dots (4)$$

therefore 
$$P_v = EI - I^2 R - \frac{i^2 r}{2} < EI - I^2 R (5)$$

It follows from this that the valves are more heavily loaded during periods of silence than when handling speech current, therefore it is necessary to design the bank so that it is safely loaded when quiescent, then *a fortiori* it will be safely loaded when handling A.C. power.

If, therefore, 
$$EI - I^2 R \leq ND \dots (6)$$
 condition 4 above will be satisfied.

For the linear part of the characteristic, we have

$$\bar{I}_a = \frac{m\bar{E}_g + \bar{E}_a + v}{R_a} \dots (7)$$

Referring to the diagram, the A.C. voltage across the condenser and  $r$  is  $ir \sin \omega t$ , while the D.C. voltage across the condenser and  $r$  is  $IR$ .

It follows from this that

$$\bar{E}_a = E - IR - ir \sin \omega t \dots (8)$$

We also have 
$$\bar{E}_g = E_g + e \sin \omega t \dots (9)$$

and 
$$\bar{I}_a = \frac{I}{N} + \frac{i}{N} \sin \omega t \dots \dots (10)$$

so that from (7), (8), (9) and (10) we obtain

$$\frac{I}{N} + \frac{i}{N} \sin \omega t = \frac{mE_g + me \sin \omega t + E - IR - ir \sin \omega t + v}{R_a} \dots (11)$$

By equating coefficients of unity and  $\sin \omega t$  we obtain

$$\frac{I}{N} = \frac{mE_g + E + v - IR}{R_a} \dots (12)$$

$$\frac{i}{N} = \frac{me - ir}{R_a} \dots \dots (13)$$

which on transposition become

$$I = \frac{mE_g + E + v}{\frac{R_a}{N} + R} \dots \dots (14)$$

$$i = \frac{me}{\frac{R_a}{N} + r} \dots \dots (15)$$

so that equation (6) becomes by substitution of (14)

$$E \frac{mE_g + E + v}{\frac{R_a}{N} + R} - R \left[ \frac{mE_g + E + v}{\frac{R_a}{N} + R} \right]^2 \leq ND \dots (16)$$

Now 
$$\bar{I}_{max} = I + i \dots \dots (17)$$

$$\bar{I}_{min} = I - i \dots \dots (18)$$

from which it follows that conditions 1, 2, 3 and 4 may be expressed as under :

$$1 \quad \frac{mE_g + E + v}{\frac{R_a}{N} + R} + \frac{me}{\frac{R_a}{N} + r} \leq Nb \dots (19)$$

$$2 \quad \frac{mE_g + E + v}{\frac{R_a}{N} + R} - \frac{me}{\frac{R_a}{N} + r} \geq Na \dots (20)$$

$$3 \quad E_g + e \leq 0 \dots \dots (21)$$

$$4 \quad E \frac{mE_g + E + v}{\frac{R_a}{N} + R} - R \left[ \frac{mE_g + E + v}{\frac{R_a}{N} + R} \right]^2 \leq ND \dots (22)$$

Now suppose that we start with such a large negative grid bias that the anode current is reduced to the value  $a$ , and that as the grid is made less negative,  $e$  is increased at the same rate so as always to cause the lower peaks of current to descend to the point  $a$ , then for a given value of  $E_g$  it will not be possible to increase  $e$  further without introducing distortion.

\* One of three things may occur to stop the extension of grid swing, the one supervening first being the limiting factor.

Either :

(a) The upper peaks of anode current reach  $b$ , in which case equations (20) and (19) hold simultaneously.

(b) The steady anode current reaches such a value that the anodes are dissipating the maximum permissible power, in which case equations (20) and (22) hold simultaneously.

(c) The upper peaks of grid potential reach zero, in which case equations (20) and (21) hold simultaneously.

Case a :

By adding (19) and (20) and rearranging terms we have

$$E_g = \frac{\frac{1}{2}(b+a)(R_a + NR) - E - v}{m} \quad \dots (23)$$

by subtracting and transposing

$$e = \frac{(b-a)(R_a + Nr)}{2m} \quad \dots (24)$$

and from (3), (15) and (24)

$$\begin{aligned} p &= \frac{m^2 r N^2}{2(R_a + Nr)^2} \cdot \frac{(b-a)^2 (R_a + Nr)^2}{4m^2} \\ &= \frac{N^2 r (b-a)^2}{8} \quad \dots (25) \end{aligned}$$

Case b :

By putting  $I = \frac{mE_g + E + v}{\frac{R_a}{N} + R}$  in (22) and

solving we have

$$I = \frac{E - \sqrt{E^2 - 4RDN}}{2R} \quad \dots (26)$$

which gives

$$\begin{aligned} E_a &= -\frac{E + v}{m} \\ &+ \frac{R_a + NR}{2mNR} (E - \sqrt{E^2 - 4RDN}) \quad \dots (27) \end{aligned}$$

Equation (20) may be written

$$\frac{me}{\frac{R_a}{N} + r} + Na = I \quad \dots (28)$$

and this, together with (26), when combined and transposed, gives

$$e = \frac{R_a}{N} + r \left[ \frac{E - \sqrt{E^2 - 4RDN}}{2R} - Na \right] \quad \dots (29)$$

and on combining this with (3) and (15) we obtain

$$p = \frac{r}{2} \left[ \frac{E - \sqrt{E^2 - 4RDN}}{2R} - Na \right]^2 \quad \dots (30)$$

Case c :

Substituting (21) in (20),

$$\frac{E + v - me}{\frac{R_a}{N} + R} - \frac{me}{\frac{R_a}{N} + r} = Na \quad \dots (31)$$

which on transposition gives

$$e = \frac{1}{m} \cdot \frac{R_a + Nr}{2R_a + NR + Nr} (E + v - a(R_a + NR)) \quad \dots (32)$$

This last equation together with (21) gives

$$E_g = -\frac{1}{m} \cdot \frac{R_a + Nr}{2R_a + NR + Nr} (E + v - a(R_a + NR)) \quad \dots (33)$$

Combining (32) with (3) and (15) gives

$$p = \frac{rN^2(E + v - a(R_a + NR))^2}{2(2R_a + NR + Nr)^2} \quad \dots (34)$$

Summarising, we have

$$p = \frac{N^2 r (b-a)^2}{8} = A \text{ for condition a.}$$

$$p = \frac{r}{2} \left[ \frac{E - \sqrt{E^2 - 4RDN}}{2R} - Na \right]^2 = B$$

for condition b.

$$p = \frac{rN^2(E + v - a(R_a + NR))^2}{2(2R_a + NR + Nr)^2} = C$$

for condition c.

The value of  $r$  which, other conditions remaining constant, gives the maximum value of  $p$  will now be determined.

First it is to be noted that if condition  $c$  is the limiting factor,  $p$  will be a maximum when  $r = 2 \frac{R_a}{N} + R$ , which is easily seen to be the case by differentiating  $C$  to  $r$  and equating to zero.

Again, the graphs of  $A$  and  $B$  plotted against  $r$  are straight lines passing through the origin, so that if we plot  $A$ ,  $B$  and  $C$  on the same diagram, it presents some such appearance as Fig. 2, the points  $X$ ,  $Y$  and  $Z$  being the intersection of  $A$  and  $C$ ,  $B$  and  $C$ , and the maximum point of  $C$ , respectively.

Whichever one of these three points has the greatest abscissa, by its ordinate represents the maximum power obtainable, and by its abscissa, the value of  $r$  necessary to obtain this power.

This is evident if we remember that that condition ( $A$ ,  $B$  or  $C$ ) is the governing one which puts the greatest restriction on  $p$ . Then, referring to Fig. 2, it is seen that as we increase  $r$ ,  $p$  increases until it reaches  $X$ ,  $Y$  or  $Z$ , whichever is furthest to the

right, *i.e.*, whichever has the greatest abscissa.

If we call the abscissæ of *X*, *Y*, and *Z*,  $r_1$ ,  $r_2$  and  $r_3$  respectively, by equating *A* and *C* and performing some reduction and simplification we obtain

$$r_1 = \frac{2(E + v - a\{R_a + NR\})}{N(b - a)} - \left(2\frac{R_a}{N} + R\right) \dots (35)$$

Similarly, by equating *B* and *C* and simplifying, we get

$$r_2 = \frac{2R(E + v - a\{R_a + NR\})}{E - \sqrt{E^2 - 4RDN} - 2NaR} - \left(2\frac{R_a}{N} + R\right) \dots (36)$$

while for the point *Z* we have

$$r_3 = 2\left(\frac{R_a}{N} + R\right) \dots (37)$$

so that the optimum value of *r* is obtained

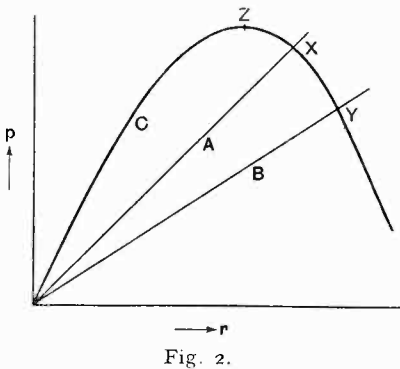

Fig. 2.

by working out  $r_1$ ,  $r_2$  and  $r_3$  and taking whichever is the greatest.

Since *X*, *Y* and *Z* all lie on the curve *C*, it follows that  $p$  and  $E_p$  will always be given by (34) and (33) respectively, irrespective of whether *r* is obtained from (35), (36) or (37).

If, on the other hand, *r* has some arbitrarily assigned value other than the optimum, it will be necessary to determine *A*, *B* and *C*, taking the one which is least as the value of  $p$ , afterwards calculating  $E_p$  from the appropriate formula corresponding to *A*, *B* or *C*.

In order to get a rough basis for design,

it is convenient to neglect *a*, *v* and *R*; this very greatly simplifies the above equations and also enables us to obtain an approximate expression for *N* in terms of  $p$ ,  $E$  and the constants of the valves.

Expanding by the binomial theorem we have

$$\frac{2R}{E - \sqrt{E^2 - 4RDN}} = \frac{2R}{E} \left[ \frac{kR}{2} + \frac{k^2R^2}{8} + \frac{k^3R^3}{16} + \text{etc.} \right]$$

where  $k = \frac{4DN}{E^2} \dots (38)$

therefore

$$\int_{r \rightarrow 0}^r \frac{2R}{E - \sqrt{E^2 - 4RDN}} = \frac{2R}{kR} \left[ \frac{4}{kE} = \frac{E}{DN} \right] \dots (39)$$

Putting  $a = 0$ ,  $v = 0$  and  $R = 0$  in (33), (34), (35), (36) and (37) we get (applying (39) where necessary):

$$E_p = -\frac{E}{m} \cdot \frac{R_a + Nr}{2R_a + Nr} \dots (40)$$

$$p = \frac{rN^2E^2}{2(2R_a + Nr)^2} \dots (41)$$

$$r_1 = \frac{2}{N} \left( \frac{E}{b} - R_a \right) \dots (42)$$

$$r_2 = \frac{1}{N} \left( \frac{E^2}{D} - 2R_a \right) \dots (43)$$

$$r_3 = \frac{2R_a}{N} \dots (44)$$

Now if we substitute  $r_1$ ,  $r_2$  and  $r_3$  in (41), calling the values of  $p$  so obtained  $p_1$ ,  $p_2$  and  $p_3$  respectively, we have:

$$p_1 = N \frac{b}{4} (E - bR_a) \dots (45)$$

$$p_2 = ND \left( \frac{1}{2} - \frac{DR_a}{E^2} \right) \dots (46)$$

$$p_3 = N \frac{E^2}{16R_a} \dots (47)$$

By transposition of these last three we get

$$N = \frac{4p_1}{b(E - bR_a)} \dots (48)$$

$$N = \frac{p_2}{D\left(\frac{1}{2} - \frac{DR_a}{E^2}\right)} \dots \dots (49)$$

$$N = \frac{16p_3R_a}{E^2} \dots \dots (50)$$

Since  $p_1$ ,  $p_2$  and  $p_3$  all increase with increase of  $N$ , and the least of these is the power obtainable, it follows that if we make  $p_1$ ,  $p_2$  and  $p_3$  all equal to  $p$  by putting different values of  $N$  in the three formulæ, the largest of these three values of  $N$  will make the power available equal to  $p$ , since it makes either  $p_1$  or  $p_2$  or  $p_3$  equal to  $p$ , and at the same time makes the other two larger than  $p$ .

The approximate determination of  $N$  when  $r$  has an arbitrarily assigned value other than the optimum may be accomplished in a similar manner as follows:

Putting  $a = 0$ ,  $v = 0$  and  $R = 0$  in (25), (30) and (34) gives

$$p = N^2 \frac{rb^2}{8} \dots \dots (51)$$

$$p = N^2 \frac{rD^2}{2E^2} \dots \dots (52)$$

$$p = N^2 \frac{rE^2}{2(2R_a + Nr)} \dots (53)$$

which all increase with increase of  $N$ .

Transposing them we have

$$N = \frac{2}{b} \sqrt{\frac{2p}{r}} \dots \dots (54)$$

$$N = \frac{E}{D} \sqrt{\frac{2p}{r}} \dots \dots (55)$$

$$N = \frac{2R_a \sqrt{\frac{2p}{r}}}{E - \sqrt{2pr}} \dots \dots (56)$$

and for reasons similar to the above, we select the largest of these three values of  $N$ .

The above results may be conveniently embodied in four Rules, which should suffice for the solution of most numerical problems on valve banks.

In a few special cases it may be necessary to rearrange or modify some of the equations given above so as to fit a particular problem.

**Rule 1.** To find the power available, the grid bias, and the amplitude of the applied alternating grid potential, given the valve constants, and  $R$ ,  $r$ ,  $E$  and  $N$ .

Find  $p$  from  $A_1$ ,  $B_1$  and  $C_1$ , and which ever is the least is the power, the other two members of the group giving the grid bias and amplitude of grid swing.

$$p = \frac{N^2 r (b - a)^2}{8} \dots \dots A_1$$

$$E_g = \frac{-I}{m} (E + v - \frac{1}{2} \{b + a\} \{R_a + Nr\}) \dots A_2$$

$$e = \frac{(b - a) \{R_a + Nr\}}{2m} \dots \dots A_3$$

$$p = \frac{r \left[ \frac{E - \sqrt{E^2 - 4RDN}}{2R} - Na \right]^2}{2} = \frac{rN^2 \left[ \frac{D}{E} - a \right]^2}{2} \text{ if } R = 0 \dots B_1$$

$$E_g = \frac{-I}{m} \left( E + v - \frac{R_a + Nr}{2NR} \{E - \sqrt{E^2 - 4RDN}\} \right)$$

$$= \frac{-I}{m} \left[ E + v - \frac{DR_a}{E} \right] \text{ if } R = 0 \dots B_2$$

$$e = \frac{R_a + Nr}{mN} \left[ \frac{E - \sqrt{E^2 - 4RDN}}{2R} - Na \right] = \frac{R_a + Nr}{m} \left( \frac{D}{E} - a \right) \text{ if } R = 0 \dots B_3$$

$$p = \frac{rN^2 (E + v - a \{R_a + Nr\})^2}{2 (2R_a + Nr + Nr)^2} \dots C_1$$

$$E_g = \frac{-I}{m} \cdot \frac{R_a + Nr}{2R_a + Nr + Nr} (E + v - a \{R_a + Nr\}) \dots C_2$$

$$e = \frac{I}{m} \cdot \frac{R_a + Nr}{2R_a + Nr + Nr} (E + v - a \{R_a + Nr\}) \dots C_3$$

**Example.** Find the power delivered to a 2,000 ohm load by a bank of 10 LS5a valves fed from a 400-volt supply through a choke whose resistance is 200 ohms. Find, also, the grid bias and amplitude of grid swing.

Take the valve constants as:  $b = 0.1$  amp.;  $a = 0.005$  amp.;  $v = 4$  volts negative;  $m = 2.5$ ;  $R_a = 2,750$  ohms;  $D = 10$  watts.

$A_1$  gives

$$p = \frac{10^2 \times 2000 \times (.1 - .005)^2}{8} = 225 \text{ watts.}$$

$B_1$  gives

$$p = \frac{2000}{2} \left[ \frac{400 - \sqrt{400^2 - 4 \times 200 \times 10 \times 10}}{2 \times 200} - 10 \times .005 \right]^2 = 60 \text{ watts.}$$

$C_1$  gives

$$p = \frac{2000 \times 10^2 (400 - 4 - .005 \{2750 + 10 \times 200\})^2}{2(2 \times 2750 + 10 \times 200 + 10 \times 2000)^2} = 18 \text{ watts.}$$

The least of these is 18 watts, so that this is the power, and since this is given by  $C_1$  we use  $C_2$  and  $C_3$  to determine the grid bias and amplitude of grid swing.

$C_2$  gives

$$E_g = \frac{-I}{2.5} \cdot \frac{2750 + 10 \times 200}{2 \times 2750 + 10 \times 200 + 10 \times 2000} [400 - 4 - .005(2750 + 10 \times 200)] = -123 \text{ volts.}$$

$C_3$  gives  $e = -E_g = 123 \text{ volts.}$

**Rule 2.** To find the value of  $r$  necessary to make the power delivered by a given bank a maximum, and to find the value of this power, also the grid bias, and the amplitude of the alternating grid potential, given the valve constants, and  $R$ ,  $E$  and  $N$ .

Find  $r$  from  $D_1$ ,  $D_2$  and  $D_3$ , then the greatest of these is the value of  $r$  which will make  $p$  a maximum.

Substitute this value of  $r$  in equations  $E$  and  $F$  to obtain  $p$ ,  $E_g$  and  $e$ .

$$r = \frac{2(E + v - a\{R_a + NR\})}{N(b - a)} - \left(2 \frac{R_a}{N} + R\right) \dots D_1$$

$$r = \frac{2R(E + v - a\{R_a + NR\})}{E - \sqrt{E^2 - 4RDN} - 2NaR} - \left(2 \frac{R_a}{N} + R\right) = \frac{E}{N(D - aE)} (E + v - aR_a) - 2 \frac{R_a}{N} \text{ if } R = 0 \dots D_2$$

$$r = 2 \frac{R_a}{N} + R \dots \dots \dots D_3$$

$$p = \frac{rN^2(E + v - a\{R_a + NR\})^2}{2(2R_a + NR + Nr)^2} \dots E$$

$$-e = E_g = \frac{-I}{m} \frac{R_a + Nr}{2R_a + NR + Nr} (E + v - a\{R_a + NR\}) \dots F$$

*Example.* Find the value of  $r$  for maximum power in the last example, also find this power, the grid bias and the amplitude of grid swing.

$D_1$  gives

$$2(400 - 4 - .005\{2750 + 10 \times 200\}) \frac{10(.1 - .005)}{10} - \left(\frac{2 \times 2750}{10} + 200\right) = 33.7 \text{ ohms.}$$

$D_2$  gives

$$2 \times 200(400 - 4 - .005\{2750 + 10 \times 200\}) \frac{400 - \sqrt{400^2 - 4 \times 200 \times 10 \times 10}}{-2 \times 10 \times 200 + .005} - \left(\frac{2 \times 2750}{10} + 200\right) = 769.4 \text{ ohms.}$$

$D_3$  gives  $\frac{2 \times 2750}{10} + 200 = 750 \text{ ohms.}$

The greatest of these is 769.4 ohms, say 770, so that this is the value of  $r$  required to make  $p$  a maximum.

Substituting it in equations  $E$  and  $F$ , we obtain  $p$ ,  $E_g$  and  $e$ .

$E$  gives

$$p = \frac{770 \times 10^2 (400 - 4 - .005\{2750 + 10 \times 200\})^2}{2(2 \times 2750 + 10 \times 200 + 10 \times 770)^2} = 23 \text{ watts.}$$

$F$  gives

$$-e = E_g = \frac{-I}{2.5} \cdot \frac{2750 + 10 \times 770}{2 \times 2750 + 10 \times 200 + 10 \times 770} (400 - 4 - .005(2750 + 10 \times 200)) = -125 \text{ volts.}$$

**Rule 3.** To find the approximate number of valves in parallel required to supply a given power to a given load, having given also the valve constants and the supply voltage.

Determine  $N$  from equations  $G_1$ ,  $G_2$  and  $G_3$ , then the largest of these is the number of valves required.

$$N = \frac{2}{b} \sqrt{\frac{2p}{r}} \dots \dots \dots G_1$$

$$N = \frac{E}{D} \sqrt{\frac{2p}{r}} \dots \dots \dots G_2$$

$$N = \frac{2R_a}{E - \sqrt{2pr}} \dots \dots \dots G_3$$

*Example.* It is required to drive a



phonic motor of dynamic resistance 1,000 ohms at the frequency to be used. The machine consumes 20 watts under the conditions of operation and the supply voltage available is 400. How many LS5a valves will be required?

$$G_1 \text{ gives } N = \frac{2}{.1} \sqrt{\frac{2 \times 20}{1000}} = 4$$

$$G_2 \text{ gives } N = \frac{400}{10} \sqrt{\frac{2 \times 20}{1000}} = 8$$

$$G_3 \text{ gives } N = \frac{2 \times 2750}{400 - \sqrt{2 \times 20 \times 1000}} \sqrt{\frac{2 \times 20}{1000}} = 5.5$$

We select the largest of these; therefore we require 8 valves.

*Rule 4.* To find the approximate number of valves in parallel required to supply a given power when the load is so adjusted as to make the number of valves a minimum.

Determine  $N$  from equations  $H_1$ ,  $H_2$  and  $H_3$ , then the largest of these is the number of valves required.

$$N = \frac{4\phi}{b(E - bR_a)} \dots \dots \dots H_1$$

$$N = \frac{\phi}{D\left(\frac{1}{2} - \frac{DR_a}{E^2}\right)} \dots \dots \dots H_2$$

$$N = \frac{16\phi R_a}{E^2} \dots \dots \dots H_3$$

*Example.* Suppose that in the last example we decide to economise valves by introducing a transformer between the bank and the motor.

Neglecting transformer losses, find the number of valves and the ratio of the transformer.

$$H_1 \text{ gives } \frac{4 \times 20}{.1(400 - .1 \times 2750)} = 6.4$$

$$H_2 \text{ gives } \frac{20}{10\left(\frac{1}{2} - \frac{10 \times 2750}{400^2}\right)} = 6.1$$

$$H_3 \text{ gives } \frac{16 \times 20 \times 2750}{400^2} = 5.5$$

The greatest of these is 6.4, therefore we require 7 valves.

To determine  $r$  we turn back to Rule 2, and on substituting in equations  $D_1$ ,  $D_2$  and  $D_3$ ,

$$D_1 \text{ gives } r = \frac{2(400 - .1 \times 2750)}{7(.1 - .005)} - \frac{2 \times 2750}{7} = 363 \text{ ohms.}$$

$$D_2 \text{ gives } r = \frac{400}{7(10 - 400 \times .005)} (400 - .1 \times 2750) - \frac{2 \times 2750}{7} = 1,928 \text{ ohms.}$$

$$D_3 \text{ gives } r = \frac{2 \times 2750}{7} = 786 \text{ ohms.}$$

Therefore the best value of  $r$  is about 2,000 ohms; this means that 1,000 ohms in the secondary is to be equivalent to 2,000 ohms in the primary, thus we require a step down transformer with ratio  $1 : \sqrt{2} = 1 : 1.41$ .

Since the error in  $N$  due to neglecting  $a$ ,  $v$ , and  $R$  in Rules 3 and 4 is always negative, and also any want of adjustment in the grid bias, etc., will always decrease  $\phi$  and never increase it, it is often advisable to allow one more valve than the number given by these formulæ so as not to run things too fine; for instance, in the last two examples, it would probably be advisable to use eight valves with the transformer or nine without.

If the value of the feed current is required, it may always be found from equation (14), having first determined  $E_p$  in the course of working out the design by the above rules.

*Appendix.*  $v$  may readily be derived from the grid-anode characteristic curve and the slope resistance as follows:

Let  $E_a$  be the anode voltage at which the curve was plotted; then if  $I_a$  is the anode current corresponding to zero grid volts, and if  $R_a$  is the slope resistance, it is easily seen that  $v = I_a R_a - E_a$ . It usually amounts to a few volts negative.

# Damping Due to Grid Current in the Case of a Valve Oscillator.

By M. Reed, B.Sc., A.C.G.I., D.I.C.

**I**N the following article a simple "tuned anode" oscillator is considered, and it is shown how to calculate the damping introduced into the oscillatory circuit owing to grid current.

Consider the oscillator shown in Fig. 1, where  $L$  = inductance of the anode coil, and  $M$  = mutual induction between the anode and grid coils.

Then if  $V_t$  = oscillatory voltage across  $L$  at any instant

and  $I_t$  = the corresponding current

we have that  $V_t = \omega LI_t$ ,

where  $\omega = 2\pi \times$  frequency of the oscillation. The resistance of  $L$  is neglected.

The E.M.F. induced in the grid coil

$$= V_g = \omega MI_t = \omega M \cdot \frac{V_t}{\omega L} = \frac{M}{L} \cdot V_t.$$

Now the condition for the maintenance of oscillations in the anode circuit demands that the anode and grid voltages should be 180 degrees out of phase. Therefore, if we assume that the oscillatory voltage varies sinusoidally, then the anode and grid voltages will be related in the manner indicated by Fig. 2.

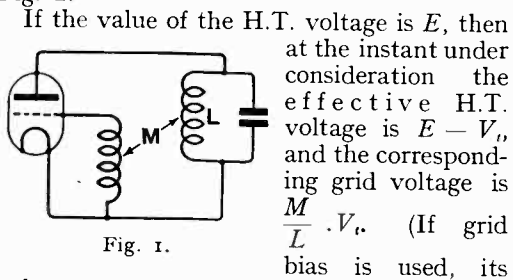

Fig. 1.

If the value of the H.T. voltage is  $E$ , then at the instant under consideration the effective H.T. voltage is  $E - V_t$ , and the corresponding grid voltage is  $\frac{M}{L} \cdot V_t$ . (If grid bias is used, its value must be deducted from the voltage  $\frac{M}{L} \cdot V_t$ .)

To obtain the corresponding grid current we may refer to the characteristics of the valve which give the relation between the plate and grid voltages for constant values of the grid current. Fig. 3 shows some of the

curves that have been obtained for an ordinary D.E.R. valve.

Now grid current will flow only when the grid is positive, *i.e.*, during the positive half-cycle of the grid voltage curve. Therefore, if one cycle of this curve is divided into 20 equi-distant intervals, it is only during 10 of these intervals (those belonging to the positive half-cycle) that we shall obtain grid current.

If the anode voltage curve is also divided into 20 equi-distant intervals, then the 10

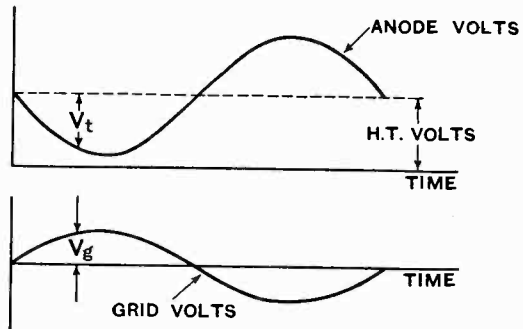

Fig. 2.

intervals contained in the negative half-cycle of this curve will correspond to the intervals of the grid voltage curve during which grid current will flow (see above). For each of the 10 intervals the corresponding H.T. and grid voltages can be calculated, and hence the corresponding value of the grid current can be obtained. From these 10 values of the grid current the mean power absorbed in the grid circuit can be calculated, and finally the effective resistance introduced into the oscillatory circuit because of the grid current can be determined.

The procedure will be understood from the following example.

### Example.

The valve used was of the ordinary D.E.R. type, having a resistance of 22,000 ohms and an amplification factor of 9.

The "anode volts-grid volts" curves at constant grid current for this valve are shown in Fig. 3. The curious shape of the

TABLE I.

Time.	Volts across Anode Coil.	Volts on Anode	Grid Volts $V_g$	Grid Current $I_g^*$	Power $V_g I_g$
0.0T	0	200	0	0	0
0.1T	56	144	20	2	40
0.2T	105.5	94.5	38.6	3	116
0.3T	146	54	52.5	4	210
0.4T	171	29	62	9	558
0.5T	180	20	65	9.5	618
0.6T	171	29	62	9	558
0.7T	146	54	52.5	4	210
0.8T	105.5	94.5	38.6	3	116
0.9T	56	144	20	2	40
1.0T	0	200	0	0	0
					2,466

2T = Period of oscillation.

A curve between grid current and volts during one cycle is shown in Fig. 4.

\* Assuming no grid bias.

curves for 8, 9 and 10 milli-amps. is probably due to ionisation taking place in the valve which is not absolutely "hard."

The constants of the oscillator are :-

- Inductance of the anode coil = 0.384 henry.
- Frequency of oscillation = 1000 cycles/sec.
- Mutual induction = 0.138 henry.
- H.T. voltage = 200 volts.

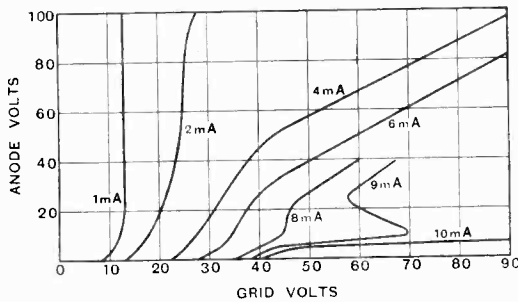

Fig. 3.—Anode volts-grid volts (grid current constant).

The peak voltage was measured across the anode coil and it was found to be 180 volts. Let this voltage be  $V_a$ .

Peak voltage across the grid coil

$$V_g = \frac{M}{L} \times V_a = \frac{0.138}{0.324} \times 180 = 65 \text{ volts.}$$

R.M.S. current through anode coil:

$$I = \frac{V_a}{\sqrt{2}} \times \frac{I}{\omega L}$$

$$= \frac{180}{\sqrt{2}} \times \frac{I}{0.384} \times \frac{I}{2\pi \times 1000}$$

$$= 0.053 \text{ amp.}$$

The anode and grid voltage cycles are divided into 20 equi-distant intervals, and the value of the grid current for each of the 10 intervals during the positive half-cycle of the grid voltage curve is given in Table I.

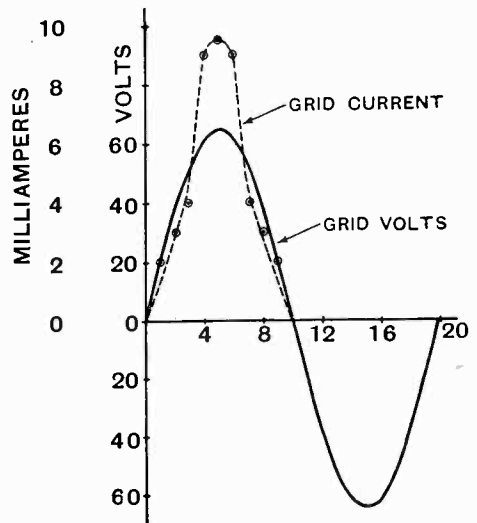

Fig. 4.—Curves showing grid current and volts during one cycle.

The voltage across the anode coil at any instant  $t$  is given by

$$V_t = V_a \sin \theta$$

where  $\theta = \epsilon/T \times 180^\circ$ , and  $T$  is the time of half-a-cycle.

From Table I. we have that

$$\sum_0^T V_g I_g = 2,466 \text{ watts}$$

∴ Mean power (for the whole cycle)

$$= \frac{I}{2T} \sum_0^T V_g I_g = 2,466/20 = 0.1233 \text{ watt.}$$

∴ Power absorbed in the grid circuit

$$= W_g = 0.1233 \text{ watt.}$$

∴ Effective resistance introduced into the

oscillatory circuit is given by

$$I^2 \times R_{\text{eff.}} = W_g$$

$$R_{\text{eff.}} = \frac{W_g}{I^2} = \frac{0.1233}{(0.053)^2} = 44 \text{ ohms.}$$

If greater accuracy is required, the number of equi-distant intervals taken should be increased.

The method given in this article does not pretend to give a high degree of accuracy. It can, however, be used to give a good indication of the damping due to grid current, and to determine when this damping is becoming excessive.

For greater accuracy the following must be taken into account:—

- (1) The distortion due to grid current. The true waveform of the anode oscillatory voltage would have to be determined and

analysed by means of Fourier series. Each of the resulting sine curves would then have to be treated separately in the manner indicated in this article.

(2) The voltage induced in the grid circuit owing to grid current. This would lower the effective voltage on the grid from the value that we have assumed, by the amount  $\omega L_2 I_2$ , where:

$$L_2 = \text{inductance of grid coil.}$$

$$I_2 = \text{grid current at the time } t.$$

The actual values of the grid current will therefore be lower than those which have been taken in this article.

The value of  $\omega L_2 I_2$  can best be determined by trial and error, since it depends on the value of  $I_2$ , which in turn depends on the value of the effective grid voltage.

## Substandard Wavemeter Design.

By *W. H. F. Griffiths, A.M.I.E.E., Mem.I.R.E.*

**T**HERE is a tendency among radio engineers whose chief design responsibilities lie in the direction of traffic rather than standardisation, to approach accurate wavemeter design from the viewpoints of wideness of range covered, decrement, and accuracy of *calibration*. This often leads to the construction of a wavemeter which, although having an extremely low decrement (and consequently a high *apparent* accuracy) and covering, with few range changing operations, an extremely wide range of wavelength, is incapable of *maintaining* the accuracy of its calibration.

Although decrement must, for the accurate *detection* of resonance, be kept low, this must not be accomplished at the expense of permanence of capacity by the simple expedient of maintaining a high ratio of  $L/C$ , but rather by keeping the resistance of the circuit as low as possible, so that, for a

given decrement,  $L$  may be low in order to make possible a high value of  $C$ .

The accuracy superiority of wavemeter circuits having high values of capacity cannot be stressed too much, but the temptation to avoid their use is admittedly great, owing to the ease with which inductances suitable for circuits of low capacity can be designed even for a low decrement. This is, of course, explained simply as follows:—

$$\delta \propto \frac{R}{\sqrt{L}}$$

and this may be re-written in the form

$$\delta \propto R \sqrt{\frac{C}{L}}$$

but, for a given frequency,  $\sqrt{\frac{C}{L}}$  is inversely

proportional to  $L$ , whereas the other factor of which the decrement is a function is

proportional only to the root of  $L$ .\*

$$\sqrt{\frac{C}{L}} \propto \frac{1}{L}$$

$$R \propto \sqrt{L}$$

$$\therefore \delta \propto \frac{\sqrt{L}}{L} \propto \frac{1}{\sqrt{L}}$$

**Short-wave Design.**

This easy method of design is frequently met with in short wave wavemeters, especially where attempts are made to employ, on these bands, a method of resonance detection which introduces a series resistance into the resonant circuit. It is fairly easy, one can see, to swamp the circuit resistance thus highly augmented, by a high value of inductance.

Moreover, in the case of ultra short wave circuits, the difficulty of keeping the capacity

decreased below  $240\mu\mu\text{F}$ . even at a frequency of 30,000 kilocycles, while the decrement at this frequency is not increased beyond the order 0.01.

In this wavemeter a precision variable air condenser is employed in association with two very compact fixed air condensers. Either of the fixed units may be paralleled with the variable unit (by swinging a strap between two terminals), giving two capacity ranges of  $220-440\mu\mu\text{F}$ . and  $380-600\mu\mu\text{F}$ . The capacity change obtained is  $1.5\mu\mu\text{F}$ . per degree throughout a scale of 180 degrees.

The variable condenser is of the very permanent silica-quartz insulation type, designed to have an extremely low effective resistance and, what is equally important for short-wave wavemeters, a low value of self-inductance. The fixed condensers are of the order 150 and  $300\mu\mu\text{F}$ ., and, since it is,

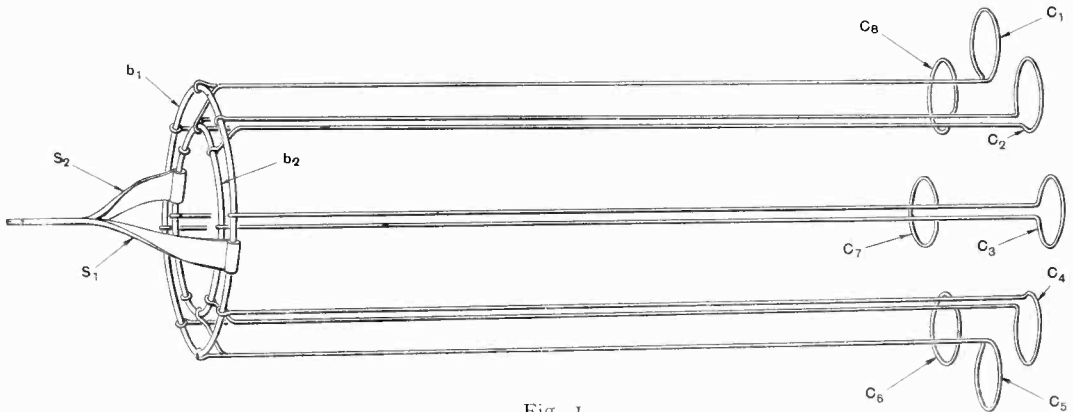

Fig. 1

high is greatly increased by the fact that the values of inductance required are comparable with, and even limited by, the effective inductance of the variable condenser itself.

That it is possible, however, to design a short-wave substandard wavemeter of comparatively high capacity by careful design of the inductances is shown by the following brief notes on a wavemeter designed recently by the author having a range down to 10 metres in which the capacity is not

\* Within limits of dimensions the inductance of an efficient coil is roughly proportional to the square of its number of turns, while the resistance of a coil at a given frequency is approximately proportional to its number of turns. From this it follows that, as an approximation,  $R$  is proportional to  $\sqrt{L}$ .

of course, impossible to construct really reliably constant condensers of such low values having mica dielectric, these have to be of air dielectric. Moreover, in order that the effective inductance of the variable condenser shall not be augmented to any great extent by that of the fixed condensers, the latter have to be of very compact and rigid construction. The screening case containing the two condensers is only 9.5 cms.  $\times$  7 cms.  $\times$  3 cms. and is secured to the main condenser screening case near to the terminals.

Even with this compact construction, however, the inductance of the complete condenser is of the order  $0.06\mu\text{H}$ .—a value quite high enough to render difficult the

design of coils suitable for association with the condenser at very low wavelengths.

A rigid self-supporting coil of 1 cm. diameter copper tube having a single turn 10 cms. in diameter and kept about 25 cms. away from the metallic mass of the condenser screens by parallel ends, is employed to take the wavelength down to 16 metres. This coil has a calculated inductance of about  $0.26\mu\text{H.}$ , which is augmented to the value  $0.32\mu\text{H.}$  upon its association with the condenser. The effective resistance of the whole circuit with this coil in use at 16 metres is only  $0.12\ \Omega$ , corresponding with a decrement of 0.01.

### A Novel Short-wave Inductance.

It will be seen, therefore, that in order to increase the range down to 10 metres without decreasing the capacity below  $240\mu\mu\text{F.}$  (the lower limit of the truly linear portion of the capacity scale) a coil having an inductance not greater than  $0.06\mu\text{H.}$  ( $0.12\mu\text{H.}$  when augmented by the inductance of the condenser) is required—an extremely low value for a low decrement coil with a good "pick-up."

The design of coil eventually decided upon takes the form of a number of comparatively fine wire circuits connected in parallel by means of two heavy concentric circular bus-bars  $b_1, b_2$  of Fig. 1. The bus-bars are connected to the terminals of the condenser by the straps  $S_1, S_2$ . Each of these circuits consists of slightly spaced parallel leads running for a distance of 28 cms. and terminated in a single turn loop of 2.5 cms. diameter which forms a very effective energy "pick-up" sufficiently far from the metallic mass of the condenser screens. Such a coil has a calculated inductance of about  $0.22\mu\text{H.}$  Eight such coils,  $C_1$  to  $C_8$ , are therefore led out horizontally from the bus-bars equally spaced round the circumference of an 8 cm. circle. Their terminating loops are bent up to be in one plane vertically as shown in the drawing.

The fine wire circuits are formed from very hard brass wire in order to obtain a fair degree of geometrical permanence and the whole inductance copper plated, after the parallel circuits were soldered to the bus-bars, to an appropriate thickness to reduce the high-frequency resistance of both wire and soldered joints to a minimum. The complete

coil is reinforced and protected by an insulating framework grooved to house the parallel wires.

The eight parallel circuits have a resultant inductance of about  $0.03\mu\text{H.}$ ; this added to  $0.03\mu\text{H.}$  in the bus-bars and main connecting straps and  $0.06\mu\text{H.}$  of the condenser gives a circuit inductance of  $0.12\mu\text{H.}$  This permits tuning to 10 metres with  $240\mu\mu\text{F.}$  The effective resistance of the circuit at 10 metres is of the order  $0.1\ \Omega$ , corresponding to a decrement of 0.012.

Even with this value of capacity it will be seen that a change of, say,  $\pm 0.5\mu\mu\text{F.}$  will produce a wavelength inaccuracy of about 1 part in 1000, and if the capacity had been reduced to about  $80\mu\mu\text{F.}$  in order to use for 10 metres an ordinary single turn coil such as that described for 16 metres, the corresponding probable wavelength uncertainty would have been 3 parts in 1000.

If a direct method of resonance detection must be employed in a wavemeter such as this, where the values of reactance are so low, it should take the form of a parallel load. With the values of reactance met with in this wavemeter, for instance, a load such as that of a thermionic voltmeter (of the order  $0.75 \times 10^6\ \Omega$ ) may be safely shunted across the entire circuit without augmenting, appreciably, its decrement. Even the dielectric losses due to a possible bad phase angle of the materials of valve and socket are not felt because of the high value of circuit capacity.

An objection, however, to the method is that of a possible change of inter-electrode capacity either with the age of the valve or its replacement. This is also, of course, rendered less serious by the high value of circuit capacity.

### Conclusion.

In conclusion, the author wishes to emphasise the fact that the foregoing notes assume the use of the best possible grade of variable condenser and if, for reasons of economy, the quality of the condenser is reduced as well as its value, nothing approaching accuracy may be expected.

The author's thanks are due to Messrs. H. W. Sullivan, Ltd., for permission to publish details of the short-wave coil and to W. G. Hill for much of the experimental work which led to its final design.

# Reactance and Admittance Curves.

Applied to Tuned Circuits With and Without Resistance.

By L. T. Bird.

PART I.—CIRCUITS WITHOUT RESISTANCE.

SINCE wireless energy is of an oscillatory nature it is inevitable that the tuning of circuits should be of fundamental importance in wireless engineering. Tuning, however, is so easily effected in simple cases in practice that the underlying theory is often somewhat neglected with the result that more complicated circuits present needless difficulties. What is very often needed is a ready mental picture of the behaviour of a given arrangement of apparatus over a certain range of radio frequencies. Reactance-frequency and Admittance-frequency curves provide such a picture. To draw these accurately may in some cases involve a certain amount of mental labour, but when their development is thoroughly understood it is nearly always

induce unit alternating voltage in a given inductance. The reactance and admittance of a given coil obviously vary with the

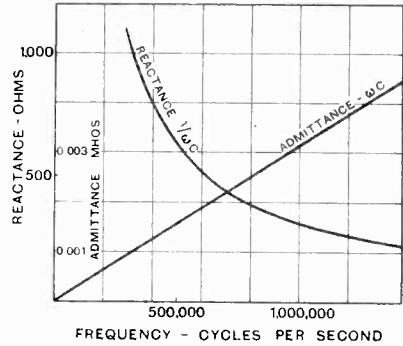

Fig. 2.

frequency, and the curves of Fig. 1 show this variation for an inductance of .0001 henries, or 100 μH., as the frequency is varied from 0 to 1,400,000 cycles per second.

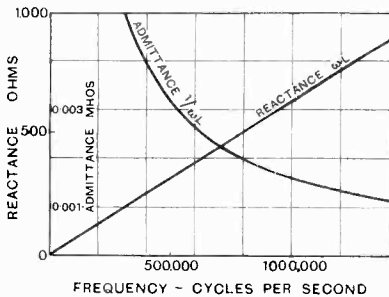

Fig. 1.

possible to make without any calculation a fairly correct rough sketch which will show in a general way what the characteristics of the circuit are. Very often this is all that is required.

Reactance and admittance curves are evolved from considerations of the fundamental properties inductance and capacity.

The inverse of reactance (*i.e.*  $\frac{I}{\text{reactance}}$ ) is called admittance. In a coil this is equal to  $\frac{I}{L\omega}$ , which is the value of the current to

The reactance of a condenser =  $\frac{I}{C\omega}$ . The

admittance is the inverse of this and hence is equal to  $C\omega$ . The curves of Fig. 2 show the variation in reactance and admittance of a capacity of .0005 μF. as the frequency increases from 0 to 1,400,000 cycles per second.

### Combinations of Inductance and Capacity.

For the purpose of tuning, inductance and capacity are used in combination, and it is in this connection that reactance and admittance curves prove to be of value.

### Inductance and Capacity in Series.

Whilst in the case of inductance the voltage vector is 90° ahead of the current vector, it is 90° behind in the case of capacity. If, therefore, a capacity is connected in series with an inductance the two pieces of apparatus will have a common current, and the vector diagram will be as shown in Fig. 3a.

In a series or parallel circuit either inductance or capacity may be made variable, and the circuit adjusted so that its resonant frequency is any desired figure. This is what is meant by tuning a circuit.

**More Complicated Circuits.**

This method of analysis is particularly well suited to more complicated circuits about which it is often difficult to formulate general ideas at first sight. Consider the arrangement (shown in Fig. 5a) of a rejector circuit connected in series with a condenser. It is perhaps difficult to say immediately how such a combination will behave over a range of frequencies without drawing reactance or admittance curves.

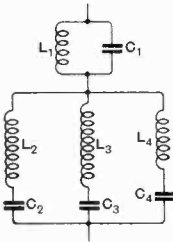

Fig. 6a.

- $L_1 = 62.5 \mu H.$
- $L_2 = 250 \mu H.$
- $L_3 = 250 \mu H.$
- $L_4 = 120 \mu H.$
- $C_1 = 0.001 \mu F.$
- $C_2 = 0.0002 \mu F.$
- $C_3 = 0.001 \mu F.$
- $C_4 = 0.0002 \mu F.$

It will have been observed that for a series arrangement reactance curves are combined and for a parallel arrangement admittance curves are combined. This is

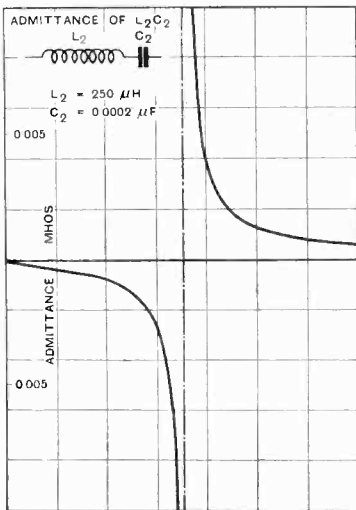

Fig. 6b.

because reactance curves do, in effect, show voltages for unit current, and in the series arrangement voltages add (the current being

the same for both pieces of apparatus). In the case of the parallel circuit it is the currents which combine, and hence admittance curves are added.

Bearing this in mind the circuit of Fig. 5a should not present any difficulty. Consider,

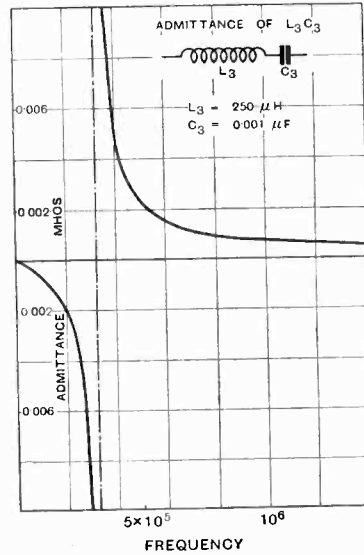

Fig. 6c.

first, that portion made up by the inductance  $L$  and capacity  $C_1$  in parallel. Addition of the admittance curves of  $L$  and  $C_1$  will give the admittance of the combination of these two. The inverse of this will as before, give the reactance curve of  $L$  and  $C_1$  in parallel. Circuit  $LC_1$  is in series with condenser  $C_2$ . It is therefore the reactance curve of  $C_2$  which should be combined with the reactance curve of  $LC_1$ . Exactly how the reactance curve of  $C_2$  should be treated is indicated by the vector diagrams of the circuit (Fig. 5a). Considering circuit  $LC_1$  it will be noted that for frequencies up to resonance the "supply current"  $I$  is  $\frac{1}{4}$  cycle behind the common voltage  $V_2$ . Beyond resonance it is  $\frac{1}{4}$  cycle ahead. This current is also the current through the condenser  $C_2$ . The voltage across condenser  $C_2$  lags behind this current by  $\frac{1}{4}$  cycle. Putting this voltage vector  $V_{c2}$  in its proper position in the diagram we find that up to the frequency of resonance in  $LC_1$  the two voltage vectors are  $\frac{1}{2}$  cycle out of phase, and therefore subtract giving the vector  $V$ .



For frequencies above this they are in phase and add. It will therefore be correct to show the reactance of  $C_2$  as negative throughout and to take the algebraic sum of the two reactance curves. (In general it may be said that admittance is shown as negative when the current leads and the reactance negative when the voltage lags.)

The final curve (Fig. 5b) is the required reactance curve of the whole circuit and shows immediately that the circuit is an acceptor to one frequency  $f_1$  and a rejector to another  $f_2$ , and may therefore be usefully employed for the purpose of suppressing undesired signals on a given wavelength in

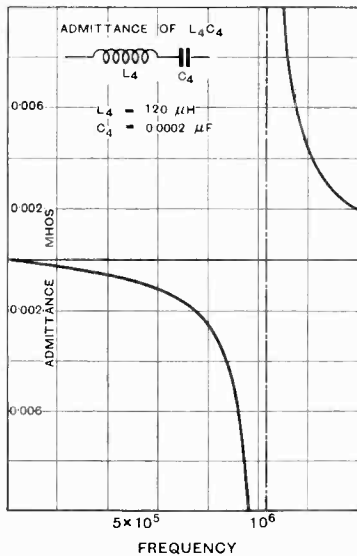

Fig. 6d.

favour of desired signals on a different wavelength provided correct values are chosen.

The reactance curve of a rather more complicated circuit (Fig. 6a) is developed in Figs. 6b to 6h, the process being as follows. The admittance curves of the acceptor circuits  $L_2C_2$ ,  $L_3C_3$  and  $L_4C_4$  are obtained in the manner already shown (Figs. 6b, 6c and 6d). As these circuits are in parallel their admittances are added, the resulting curve being shown as Fig. 6e. The inverse of this is taken, giving the reactance curve of Fig. 6f. The reactance curve of circuit  $L_1C_1$  is next drawn (Fig. 6g) and this on addition to curve of Fig. 6f gives the

reactance curve of the complete circuit (Fig. 6h).

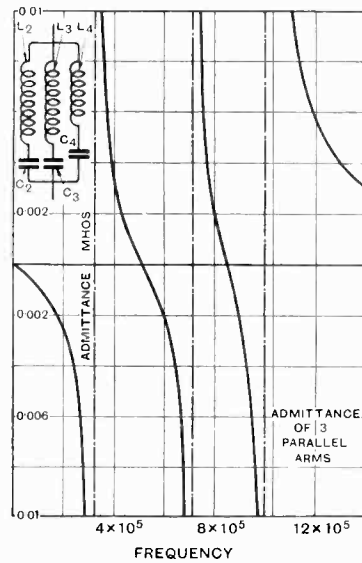

Fig. 6e.

This final diagram demonstrates quite a number of things. At a haphazard guess one might have said that such a circuit would have but four natural frequencies, three as an acceptor and one as a rejector. Actually, as the reactance diagram shows, it has seven natural frequencies, four as an acceptor and

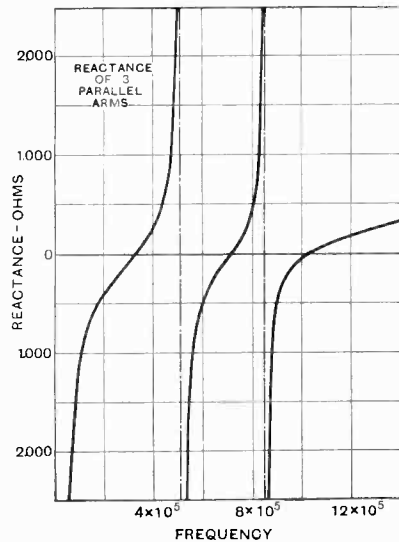

Fig. 6f.

three as a rejector. It should also be noted that none of the series resonant frequencies coincide with the tune of  $L_2C_2$ ,  $L_3C_3$  or  $L_4C_4$  separately, since the whole circuit is in series resonance, not when either of these circuits has zero reactance, but when the reactance of the three in parallel is equal and opposite to the reactance of circuit  $L_1C_1$ .

PART II.—RESONANT CIRCUITS WITH RESISTANCE.

Up to this point only those circuits have been considered which possess simply inductance and capacity. Actually every coil has a certain amount of resistance, and in every condenser the insulating medium possesses conductance. These quantities are usually small in comparison with the reactances or admittances with which they are combined and hence are often assumed to be zero. However, when these assump-

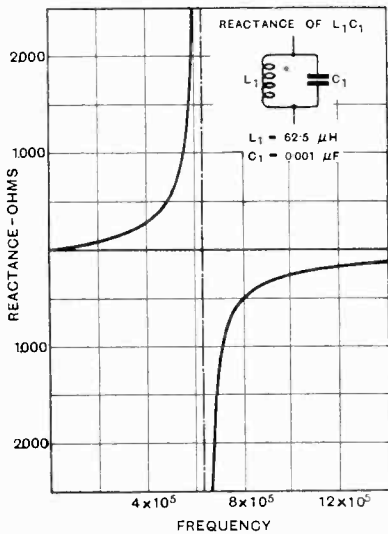

Fig. 6g.

tions are made in theory, strange conclusions are reached, such as infinitely large currents produced by zero voltages and *vice-versa*. To make theory fit more closely to practice it is necessary to take the effects of resistance into account.

Resistance in Series with an Inductance.

Case (a) when the current remains constant and the frequency varies.—Suppose the current to remain at one ampere and the frequency

to be increased.  $OA$  (Fig. 7a), representing the voltage across the resistance, will remain of constant length. The line  $AC$ ,

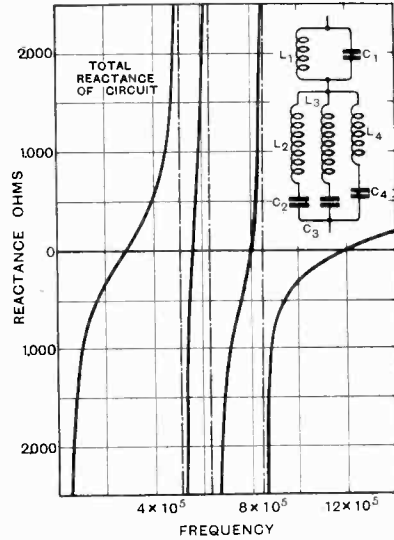

Fig. 6h.

however, representing the reactance voltage, will increase in length as the frequency increases to such a position as  $C'$ , with a consequent increase in the length of  $OC$ , and

an increase in  $\widehat{AOC}$  (the angle of phase difference between current and total voltage) to a limit of  $90^\circ$  (*i.e.*, in the case when the frequency is so high that  $AC$  is so long as to make  $OA$  negligible in comparison).

Since  $OC$  represents the value of the total voltage when the current is 1 ampere, its length is a measure of the ratio between voltage and current at the frequency chosen. This ratio is called the impedance of the arrangement (impedance corresponds to reactance, the latter word, however, being reserved for apparatus like pure capacity and inductance). This triangle may therefore be utilised as follows in plotting the impedance-frequency curve of the combination.

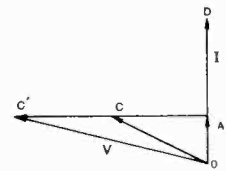

Fig. 7a.

Draw as before the reactance curve  $OB$  of the inductance (Fig. 7b). Now draw a line  $AA'$  parallel to the axis of frequency at

such a height  $AO$  above it as represents on the scale of the diagram the value of the resistance. Select a frequency and erect an ordinate  $FG$  mark off from  $A$  along  $AA'$  a length  $AC$  equal to  $FG$ . Then  $OC$  represents the impedance of the arrangement. Produce  $FG$  to  $H$  so that  $FH = OC$ .  $H$  is then a point on the impedance diagram. If this process be repeated for a number of points the impedance curve may be drawn through them.

Case (b) when the total voltage remains constant and the frequency varies.—Suppose

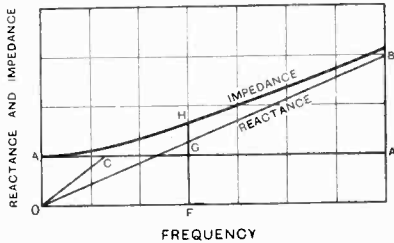

Fig. 7b.

the voltage remains constant at unity and the frequency increases. The shape of the triangle will vary, but this time the line  $OC$  representing the total voltage will remain of constant length. This line being constant

and  $\angle CAO$  being always a right-angle, point  $A$  will always be somewhere on a semi-circle having  $OC$  as a diameter (Fig. 7c). As the frequency increases the reactance becomes larger, whilst the resistance, of course, remains the same, *i.e.*,  $AC$  in the diagram becomes larger in comparison with  $AO$ .  $A$  therefore moves to such a point as  $A'$  on the semi-circle.

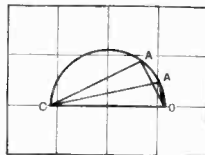

Fig. 7c.

So far this vector diagram is concerned only with voltages and gives no information about the resultant current. This latter is a most important quantity, since it is the ratio of applied voltage to resultant current with which we are concerned. The resultant current may be determined from the two following considerations:—

(1) The current must necessarily be in phase with the voltage it produces across the resistance.

(2) Its value may be found by dividing the value of this voltage by the resistance in ohms.

Hence for a given frequency the resultant current vector will lie in the same direction as  $OA$ , and its length will be found by multiplying the length of  $OA$  by the factor  $1/r$ ; such a current vector is shown as  $OD$  in Figs. 7a and 7d.

It is instructive to note what happens to the position of the point  $D$  as the frequency is changed.

(1) If the current remains constant  $D$  remains fixed (Fig. 7a), since  $OA$  is constant.

(2) If the voltage is constant the line  $OA$  (Fig. 7d) changes in both length and direction as the frequency changes.

To find the path of point  $D$ :

From  $D$  draw  $DE$  parallel to  $AC$  and cutting  $OC$  produced in  $E$ . Triangles  $EOD$  and  $COA$  will be similar, and hence

$$OE/OC = OD/OA$$

$$\therefore OE = \frac{OD \cdot OC}{OA}$$

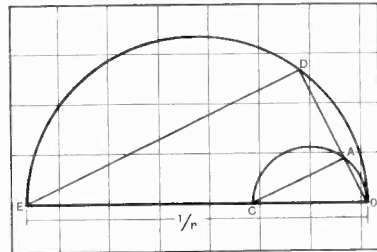

Fig. 7d.

Now  $OD = OA \times 1/r$  and  $OC = 1$

$$\therefore OE = \frac{OA \times 1/r \times 1}{OA} = 1/r$$

Now  $\angle EDO$  is always a right-angle, therefore  $D$  lies on the circumference of a semi-circle whose diameter is  $1/r$  units in length. This diagram will be referred to later, where it is used for the purpose of finding the direction of  $OD$  for different frequencies, its length having already been determined from an admittance diagram.

Resistance in parallel with a condenser.—The "leaking" of electricity from one

element of a condenser to another (this property is often referred to as "leakance") is treated as the combination of capacity and resistance in parallel, since the effect is the same as if the insulation were perfect but a high resistance were connected from one side of the condenser to the other.

Case (a).—If the voltage remains constant the current through the resistance will be the same whatever the frequency. Hence  $OP$  (Fig. 8a) will remain of constant length

( $I/R$  units) and  $PQ$  will increase as the frequency increases,  $OQ$  representing the total current. The drawing of the admittance curves of the arrangement is a similar process to

that of drawing the impedance curve of an inductance. The value of the current through the resistance being independent of the frequency it will appear (Fig. 8b) on the admittance curve as a straight line  $PP'$  parallel to the axis of frequency. By marking off along  $PP'$  the value  $PQ$  of the admittance of the condenser for a selected frequency, the value  $OQ$  of the total admittance may be obtained and plotted on the admittance curve. The impedance curve is obtained by calculating the inverse of a number of values of admittance and drawing a fair curve through the points so plotted.

Case (b).—If the total current remains constant the length of  $OQ$  (Fig. 8c) will remain the same,  $P$  will move on a semi-

circle described on  $OQ$ , and since  $OP$  represents the current through the resistance, the voltage across it (which is also the voltage

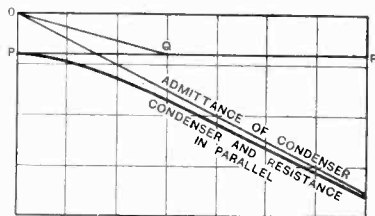

Fig. 8b.

across the condenser) will be represented by a line  $R$  times as long. By a construction similar to that used in the inductance case it will be found that  $S$ , the end of the voltage vector when the total current remains constant at unity, lies on a semi-circle whose diameter is  $R$  volts. Thus again a semi-circle diagram may be applied to determine the angle of phase difference between total

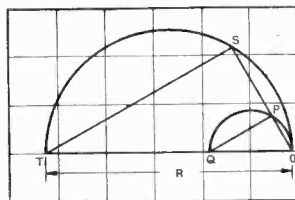

Fig. 8c.

current and applied voltage if the magnitude of the current be known (e.g., from an impedance diagram).

(To be concluded.)

## Screened-Grid Valves

### Informal Discussion at the I.E.E. Wireless Section.

#### ABSTRACT.

THE concluding meeting of the Session for the I.E.E. Wireless Section was held on Wednesday, 2nd May, Lt.-Col. A. G. Lee, O.B.E., M.C., the Section Chairman presiding, when the meeting took the form of an informal discussion on "Screened-Grid Valves."

In opening the meeting, the Chairman announced that Commander J. A. Slee, C.B.E., had been nominated as Chairman of the Section for the next session.

The discussion was opened by Mr. M. G. SCROGGIE, B.Sc., who said that the screened-grid valve had only attracted attention within the last eight months. Following on initial work by Schottky in 1919, Hull had shown in 1925 that very large high-frequency amplification could be obtained by means of screening. The patent of Round, of May, 1926, covered those in common use in this country.

The application which had received most attention was high-frequency amplification. Up to the advent of the screened-grid valve the only methods of high amplification were by neutrodyne and supersonic. With attention to detail of design, it was possible to get an amplification of 40 per stage with neutrodyne. Two stages were difficult to handle with the utmost efficiency. More than two stages were only practicable for increase of selectivity. The balance for neutrodyne adjustment was not constant over a band of frequencies. The supersonic gave greater amplification, but was not free from faults. Unless a high-frequency stage was interposed, there was liability to trouble due to interference at the frequency of the intermediate-frequency amplifier.

The screened-grid valve had brought back the straight amplifier. Whereas the triode had an anode-grid capacity of about  $6 \mu\mu\text{F}$ , the screened valve due to Hull had only one-thousandth of that value. Commercial products were intermediate. Each stage of the amplifier should approach complete metal enclosure, even the commencing of batteries was defective.

Although the usual practice of tuning was by fixed coil and variable condenser, R. T. Beatty had shown that fixed capacity and variable inductance gave better stability over the band.

The curve relating maximum amplification with frequency drooped towards the higher frequency, as in Fig. 1 (full line). The actual amplification used should be that of the lower curve (dotted). With a certain distance between these curves it was possible to get reasonable tuning and stability over the range. Tuning by variable inductance made this easier.

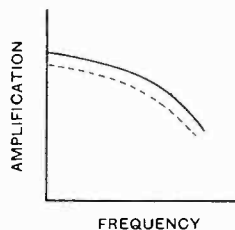

Fig. 1.

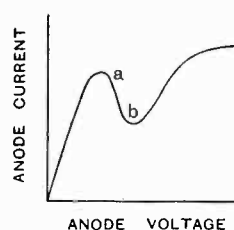

Fig. 2.

With the screened valve the amplification obtained was made up of two parts (a) due to the valve without reaction, and (b) that due to reaction. With a single stage, using the S.625 valve, the latter was less than the former. With two stages the latter tended to take charge and with three stages oscillations were liable to occur unless loss was introduced; he doubted if there was any need for more than three stages. For stability the inter-electrode capacity must go down.

The use of the screened valve for intermediate frequency amplification (of supersonic) was an obvious application.

The use of the screened valve at low frequencies had not been much dealt with. The anode-current, anode-voltage, characteristic curve of Fig. 2 suggested the region a-b as being suitable for resistance amplification with suitably chosen constants, as being capable of yielding very large amplification. The position of the portion of the curve to be used, however,

was liable to vary with different valves. The normal flat portion of the curve had not been much used for low-frequency. Single note amplification with S.625 had advantages, and it could obviously be used with a sharply tuned resonant circuit to give large amplification. The pentode type of valve recently introduced seemed, however, more adapted for use on the low frequency end.

Details of design of the valve itself the speaker left to valve designers and makers, but he would raise the query as to which electrode should be separated, pointing out the differences of practice that prevailed in this matter.

DR. J. ROBINSON, who continued the discussion, asked what was the screened-grid valve doing. Its curve was complicated, and he preferred simplicity. The screened valve could give huge amplification, but what trouble was involved? The tendency of design in broadcast receivers was towards simplicity. Mr. Scroggie's reference to the use of a limited part of the curve suggested difficulty. The screened valve eliminated internal capacity, but there were other ways of doing this. It was possible to do it by simpler and cheaper means—by the introduction of an equivalent capacity, identical with the grid-anode capacity. This could be done by duplication of the anode and grid, when it was possible to get, without neutrodyning, the performance of a valve free from capacity.

MR. C. F. PHILLIPS said that in normal operation of the screened valve—as in H.F. amplification—the flat portion of the curve was utilised. Mr. Scroggie's reference to the descending portion of the curve was only to its use with resistance coupling for low frequency. In using the flat portion with suitable valves, valves of widely differing characteristics could be interchanged without difficulty. The reason for the kink was obvious, and the introduction of the space-charge grid smoothed out this portion. The tetrode of to-day was the forerunner of future developments. The aim should be not to do fresh jobs, but to make one valve do its job better. Referring to the pentode with 20,000 ohms internal impedance for use as an output valve, he did not think this was dreadful. The behaviour on the flat top of the characteristic was

different from the triode, and he doubted if the high impedance of the pentode mattered much in practice.

The "mains" set had come to stay. The valve must become capable of operation from A.C. mains, and he hoped for information from valve makers as to the possibility of screened valves with cathodes heated either directly or indirectly by alternating current.

Referring to the matter of the separate lead, he said the Marconi S.625 had the anode and screen coming out together at one end. Hull led the screen out at the top alone and the anode at the bottom. The Mullard valve had the anode coming out at the top and the screen at the bottom.

CAPT. P. P. ECKERSLEY asked of what type would be the receiver of the future. The screened valve had made a revolution in high-frequency amplification. He suggested that the need was for a "trouble-free" receiver, listening to a transmitting station within its own service area. The future receiver should have a band-width giving  $7\frac{1}{2}$  or 10 kilocycles of sideband, the whole band being capable of moving across the spectrum. Did the screened grid valve help achievement of this?

LT.-COL. K. EDGEWORTH referred to conditions of reception in Khartoum. There being no local broadcast, he was interested in the picking up of broadcast on short waves—of 20 to 30 metres. Difficulties varied with different localities. Fading was a great trouble, but he believed there was a device to minimise fading by limiting the too-strong signals. There was a need in such places for a short-wave receiver giving an amplification of 40 in its H.F. stages. He invited information on the application of the screened valve to this problem.

MR. BAKER spoke of conditions in India, where the only hope was in short waves. It was essential to have some progress towards high-frequency amplification. He had found a Reinartz circuit was sometimes satisfactory on the short wave station of Chelmsford. He had one set using a Mullard screened-grid valve as a high-frequency amplifier, but found the amplification low. He was endeavouring to get a two-stage amplifier and would be glad of assistance.

MR. HARLEY said the screened-grid valve

had two properties. One was the elimination of internal capacity and the other was the enormous amplification. It was possible to use one without the other. An efficient H.F. amplifier could be made without using the screen, but it tended to be unstable unless damping was employed. A suitable arrangement might be two stages, the first orthodox and the second unscreened.

With reference to the three types, the Mullard valve was made to fit standard sockets. The anode *must* be spaced from the grid, while the screen could come out anywhere.

He also suggested combined capacity and inductance tuning by variometer and condenser coupled and operated together.

MR. J. H. REYNER, referring to the different types of screened valve, said he preferred the four pins at the bottom and anode at the top. The public hesitated to use those not applicable to an ordinary holder. From the designer's point of view, in arranging for two wavelength ranges (*e.g.*, London and Daventry), variometer tuning was not very practicable. It was possible to use combinations of capacity and inductance as in Loftin's circuit. He had used a smaller coil with reaction in this way and, the reaction varying with tune, the set remained below oscillation over its range. Any practical ideas of increasing selectivity would be welcomed. He found the amplification so large that combinations to help selectivity should be good. He suggested a tuned-anode stage coupled by a small condenser to a circuit of low damping.

MR. HENDERSON spoke of the help which the screened valve gave by removing reaction. Another point was that it used tuned anode coupling, and simplified change of wavelength range by the use of a single coil instead of a transformer or coils of many terminals.

LT.-COL. FULLER asked to what extent high-frequency amplification could be usefully obtained. He was interested in the independent cathode. Was it intended that this independence was only in the set, and did not involve independent sources?

MR. F. S. BARTON enquired as to the extent to which the screened valve could be used to prevent back coupling to the aerial, and how far it was commercially possible to "gang" high-frequency stages

to get satisfactory amplification over a band.

MR. S. R. MULLARD referred to differences in type. The various groups of makers differed in their practices, but he hoped for standardisation. He also hoped manufacturers would get together on main types. Type numbers meant little, and different practices in this respect should be brought into line.

MR. E. H. SHAUGHNESSY asked what was the amplification factor of the screened valve, and what was the amplification per stage for one, two, or three stages. Was there any reasonable limit to the number of stages that could be used efficiently?

MR. SOWTER enquired if, in carrying amplification beyond a limit, the introducer had come across the Schottky effect. The effect varied with the filament. Had Mr. Scroggie any information on the different types of filament?

MR. COSGROVE said that the anode and screen coming out together at one end had advantages for short waves on account of the low capacity between grid and screen. Such screened valves had been used on short waves, but he had no figures available.

MR. ROBINSON sought information as to the number of stages from the set-maker's point of view. Several stages tended to become too selective, or, if the coils had losses, to drop amplification. With two stages the selectivity was too great for use on broadcast with low-loss evils. More than two stages became difficult to tune.

MR. L. H. BAINBRIDGE BELL enquired as to the consistency of different types of screened valves. He was interested in two high-gain amplifiers, closely matched, and feared the possibility of complications due to lack of uniformity. The liability to non-uniformity seemed greater with the assembly of the Marconi type. This point was also important to set makers and users for replacements.

MR. SCROGGIE briefly replied to several of the points raised by other speakers in the discussion.

The reference to the use of the downward part of the curve only applied to resistance-capacity coupling for low-frequency work. For high-frequency amplification the screened valve gave definite simplification, especially from the user's point of view, and provided

stability with greatly increased amplification.

Dealing with the number of stages that were practicable, he said that if the stages were made inefficient more stages up to five or six could be used. If the selectivity of each coupling were so chosen as to give a cut-off at a suitable frequency, the whole amplifier gave a better band and cut-off than fewer sharply-tuned stages. They were also better for ganging than sharply-tuned amplifiers.

As regards Col. Edgeworth's query, the screened-grid valve was more efficient for short waves than were other types. A satisfactory amplification of 2 or 3 had been got on 20 metres. The fading control method needed large high-frequency amplification and the possibilities of the screened

valve in giving big amplification brought this nearer.

The advantage claimed for the 4-pin type was possibly a disadvantage if inserted into a wrong set.

In reply to Mr. Sowter, he had no note of the Schottky effect, although Hull had mentioned it, but Hull's valve had much lower internal capacity. He did not think the close uniformity desired by Mr. Bainbridge-Bell could be obtained at present.

In closing the discussion, the Chairman referred to the need for development of screened-grid valves, and considered that a very useful field was being opened up.

On the motion of the Chairman, Mr. Scroggie was cordially thanked for his introduction and summing up of the discussion.

## Book Reviews.

PITMAN'S TECHNICAL DICTIONARY of Engineering and Industrial Science in Seven Languages. To be completed in about 36 fortnightly parts. Published by Sir Isaac Pitman & Sons, Ltd., London. Price 2/6 each part.

The first number of this dictionary of technical terms is mainly of an introductory nature and includes a comprehensive section of alternatives, idioms and technical phrases peculiar to the different languages, a glossary of adopted words, phrases in common use in technical writing and in advertising, a list of abbreviations of technical and scientific terms, and the first instalment of a most valuable dictionary in English, French, Spanish, Italian, Portuguese, Russian, and German. If we may judge by the first number, this publication will prove one of the best and most comprehensive of foreign technical dictionaries that has yet been published.

WIRELESS PRINCIPLES AND PRACTICE. By L. S. Palmer, M.Sc., Ph.D., pp. xi.+504, with 307 Figs. Longmans, Green & Co., Ltd. 18s. net.

The author, who is now Head of the Department of Pure and Applied Physics at the Manchester College of Technology, was formerly a radio engineer in the Admiralty, and is thus well qualified both theoretically and practically to write an authoritative text-book on Wireless. There is a happy combination of theory and practice throughout the book. It is a book for the serious student who wishes to obtain a thorough knowledge of the subject and is not afraid of the necessary mathematics, and it should form an excellent text-book for students at those Universities and Technical Colleges at which Wireless Telegraphy can be studied either as a part of the graduate course or as a post-graduate subject. The book is well printed and well illustrated, and each chapter

concludes with an extensive bibliography. After two short chapters on wave motion and oscillatory circuits, Chapter III deals with wireless circuits and aeriels. We think that a page or two might have been profitably devoted to the A.C. transmission line as an introduction to the equivalent reactance of an aerial. Chapter IV deals mathematically with special circuits such as acceptors, rejectors, filters, etc.; coupled circuits are dealt with by the method devised by the reviewer and described by him in the *Electrical World* of New York in 1916 (p. 368, August 19). We think that a reference to this paper should have been given. The theory, design, and manufacture of valves, the spark, arc, and alternator methods of generating high-frequency current, the valve as an oscillator, detector, and amplifier are dealt with in succeeding chapters. The chapter on electromagnetic theory will prove the most difficult to most readers. We think that the following statement on page 249 is somewhat misleading: "Now, with a current in a wireless aerial or in a submarine cable, there is a sideways dissipation of energy, and consequently the current in the direction of the antenna or cable diminishes with distance along the wire. Maxwell considered the dissipation of energy in the surrounding dielectric medium as resulting from a 'displacement'  $\delta$  of the electric charges in the atoms of the dielectric." Displacement is not necessarily associated with dissipation of energy, but was conceived by Maxwell as an explanation of the capacity of the medium. The current along a submarine cable would vary from point to point even if the dielectric were perfect, that is, if it involved no dissipation of energy.

The book concludes with chapters on wireless telephony and directional wireless, the latter going into the subject very thoroughly.

In view of the extensive bibliographies, involving



many foreign references, the misprints appeared to be very few; we noticed Schälze, Moulin and Belleseize instead of Schulze, Moullin, and Bellesize. The author gets round the difficulty of finding an English equivalent for "Ziehen" by using it as if it were an English word. Why should we not use the good English word "pulling" for this phenomenon? One would soon get used to it, and it has the advantage that most English people can pronounce it.

G. W. O. H.

THE INSTRUMENT WORLD, a new journal for designers, makers, dealers, and users. Published monthly, price 6d.

The first number of this new publication, which is stated to be the first trade and technical journal in this country to be devoted exclusively to scientific and industrial instruments, contains an interesting article on the value of proper scientific instruments in industrial research, descriptions of recent improvements in surveying instruments, the theory of ultra-violet therapy and some of the apparatus used for the production of artificial sunlight, echo sounding gear, and other subjects. There is also the introductory portion of a dictionary of technological science, which will, no doubt, prove a valuable source of reference.

INTERMEDIATE ELECTRICITY AND MAGNETISM. By R. A. Houston, M.A., D.Sc., pp. x+170, with 155 Figs. Longmans. 4/6.

This book treats of the subject up to the Intermediate or First Science Standard of the different Universities. It is clearly written and well illustrated but in our opinion attempts too much. An elementary book of 154 pages (the remaining pages are devoted to examples and index) which commences with lodestones, iron filings, gold-leaf electrosopes and the electrophorus should not be tempted to deal even briefly with positive or canal rays nor with isotopes, and the page devoted to the test of a crystal detector might have been more profitably, if less popularly, devoted to a more detailed discussion of some of the fundamental principles of electricity and magnetism.

The author is a well-known teacher and writer on various branches of physics and we were especially interested to see how he dealt with the difficult problem of the magnetic properties of iron. We must confess, however, that we were very disappointed, the method adopted is self-contradictory and can only confuse any student who tries seriously to follow it. As this is a matter of some importance we may be excused for going into it in some detail. On page 4 we are told that the force between two poles of strength  $m$  and  $m'$  is expressed

by the formula  $F = \frac{1}{\mu} \frac{mm'}{d^2}$  where  $\mu$  is a factor of

proportionality depending on the medium. "The unit pole is defined so as to make  $\mu = 1$  for air." On page 5 the field strength  $H$  is defined as being equal to the force in dynes which acts on a unit pole placed at the point. Now, although this is not very helpful in defining what is meant by  $H$  inside a mass of iron, let us consider its application inside a gaseous or liquid medium of permeability  $\mu$  com-

parable with that of iron. We are faced at once with the difficulty that on taking the knitting needle, the pole strength of which we have carefully adjusted to unity in air, and immersing it in the medium, its pole strength will presumably increase. The analogy between the magnetic and the electric charge breaks down here since an electric charge can be transferred without change from one dielectric medium to another. Let us assume, however, that this difficulty is got over in some way and that the magnetic needles retain the same intensity and distribution of magnetisation when immersed in the new medium, then it is evident from the above formula that the force  $F$

on each pole will be reduced to  $\frac{1}{\mu}$  of its value in air

and that the field strength  $H$  due to each pole is at

any point reduced to  $\frac{1}{\mu}$  of its value in air. On page

6, we are told that the lines of force are drawn with such a density that the number per square centimetre is numerically equal to the field strength, so that the number of lines per sq. cm. is reduced in the ratio  $1/\mu$  by immersion in the new medium. When we come to induced currents in Chapter X, we read that the E.M.F. induced in a circuit is equal to the rate at which the number of magnetic lines of force passing through the circuit is altering. Now this does not fit in at all with the foregoing, since if we slip an exploring coil off one of the magnets or move the coil in any way in the magnetic field we shall find that the same E.M.F. is induced in it when immersed in the medium of permeability  $\mu$  as in the air, always assuming, as is necessary, that the magnets maintain a constant intensity of magnetisation. If the author had omitted the  $\mu$  in the fundamental equation and confined himself expressly to air he would have been numerically correct—but only numerically—in his statement of the law of induction of E.M.F., as we shall see in a moment. On page 121 it is pointed out that the induced E.M.F. is increased in the ratio  $1$  to  $\mu$  by inserting an iron core in the solenoid. "The number of lines of force per  $cm^2$  must consequently be increased in the ratio  $1$  to  $\mu$ . The number of lines of force per  $cm^2$  is called the magnetic induction in the iron and is always denoted by  $B$ ." "Magnetic induction has not the same dimensions as magnetic field intensity. . . . Hence  $B = H + 4\pi I$ ." Here is a pretty muddle. If  $B$  and  $H$  have different dimensions one dare not write this last equation; what dimensions has  $I$ , those of  $B$  or those of  $H$ ? This equation  $B = H + 4\pi I$  belongs to that school which maintains that  $B$  and  $H$  have the same dimensions and that  $\mu = B/H$  is a numeric. Again is  $B$  and  $H$  have different dimensions they must not be confused and used indiscriminately even in air, where they are numerically equal. The induction of E.M.F. depends on  $B$  and not on  $H$ , and even in a vacuum one must carefully discriminate between the flux density  $B$  upon which depends the induction of E.M.F., and the magnetic force  $H$  which presumably produces  $B$  and upon which depends the force on a unit pole. Much might be said on this subject but this is not the place to say it.

G. W. O. H.

# Correspondence.

*Letters of interest to experimenters are always welcome. In publishing such communications the Editors do not necessarily endorse any technical or general statements which they may contain.*

## Symbolical Algebra.

To the Editor, E.W. & W.E.

SIR,—In my recently completed series of articles on "Mathematics for Wireless Amateurs" (p. 413, July number, 1927), I wrote "The symbol 'j' is very widely employed in alternating current analysis, but there is a divergence of opinion as to its essential character and occasionally discussions arise as to the legitimacy of certain applications of it, or as to the interpretations of expressions in which it plays a part." The article on this subject in your last number and the Editorial comments thereon certainly bear out this quotation in a very gratifying manner. Like the Irishman in the story, I am going to assume that this is not a "private fight," and that anyone can join in. In fact, I should find it difficult not to, for I think I can claim to have contributed somewhat to the popularising of the term "vector operator" and the ideas associated therewith.

Actually a variety of interpretations, or at least shades of interpretation, can be placed upon "j," and one's individual choice will be largely a matter of temperament. I personally favour the simple "rotation through 90 degrees" definition on which I based my earliest book on "Alternating Currents and Transients" and the corresponding sections of the series of articles referred to above. It is clear, self-consistent, and sufficient, and Mr. Radcliffe is quite mistaken in assuming (as he appears to do) that the exponential form for the sine and cosine depends on the alternative algebraic definition  $j = \sqrt{-1}$ . (If he will pay me the compliment of glancing through the July, 1927, instalment of the above-mentioned articles he will see what I mean by this.)

It is quite clear that a self-consistent system can be based on the formal algebraic definition  $j = \sqrt{-1}$  (though the criticism in the May Editorial is very sound and must, I should think, have shaken Mr. Radcliffe somewhat), but any such proceeding would fairly be described as reactionary, for the present tendencies in mathematics are all the other way. The vogue of purely formal definitions and operations is passing. As Professor Whitehead has pointed out, a symbol that is not clearly defined is no more than a blot on paper. By a clear definition he means one that is easily comprehended, and that, at least, can be claimed for the rotation definition of "j."

F. M. COLEBROOK.

Teddington.

## Design of Choke Coils and Transformers.

To the Editor, E.W. & W.E.

SIR,—Your Editorial in the February number of E.W. & W.E. has just come to my notice. I wish to call attention to a slight error in Fig. 3. The minor loop in this figure has an impossible location if produced according to the description in the text. The right-hand tip of a minor loop

can never extend beyond the boundary of the normal induction curve except as noted below.

This loop should be located as indicated by position 2 instead of position 1, Fig. (a), where the H value for the upper tip of the minor loop corresponds to  $H_{dc} + \frac{H}{2}$ .

The only method of obtaining a minor loop as indicated in your Fig. 3 is by going through a cycle indicated by Fig. (b).

This is a minor matter, but this type of error

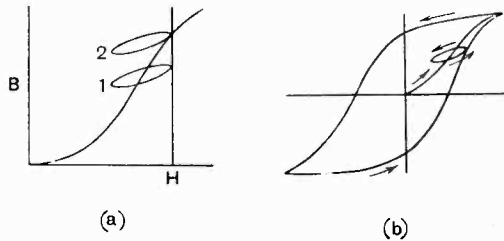

appears every once in a while in literature, and I thought it desirable to call the error to your attention in order that, in your magazine at least, it will not occur again.

THOMAS SPOONER.

East Pittsburgh, Pa.

[NOTE.—In the Editorial of our February number, we dealt with the design of choke coils which carry a direct current and we referred to the work of Mr. Thomas Spooner, of the Westinghouse Electric and Manufacturing Company on this subject. Mr. Spooner has drawn our attention to a slight error in Fig. 3 of the article. In this figure the small loop was shown with its centre on the direct-current magnetisation curve as in (1) of the figure accompanying this note.

As a matter of fact, if one starts at O with a piece of annealed iron which has never been magnetised, and applies a steadily increasing magnetising force, the relation between B and H is somewhat as shown by the curve OA; if now one halts at a point on this curve and superposes a small alternating current, the resulting loop will be

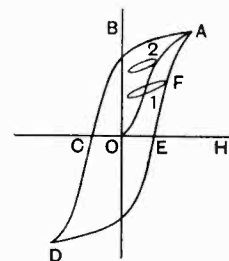

as shown at (2) and not as shown at (1); a little consideration will show that this must be so. In order to obtain the loop (1) it would be necessary to take the iron round the major loop ACDEF; then by halting at F and superposing the alternating current one might obtain loop (1).—E.D.]

## Abstracts and References.

Compiled by the Radio Research Board and reproduced by arrangement with the Department of Scientific and Industrial Research.

### PROPAGATION OF WAVES.

THE STUDY OF SIGNAL FADING. (*E.W. & W.E.*, 5, pp. 267-272, May, 1928.)

Abstract of a paper read by Prof. Appleton before the Wireless Section, I.E.E., on 4th April, dealing with work on the subject of fading carried out at the Peterborough Station of the D.S.I.R.

ÜBER DIE FORTPFLANZUNG ELEKTROMAGNETISCHER WELLEN. (On the propagation of electromagnetic waves.)—H. Benndorf and A. Székely. (*Zeitsch. f. Hochfrequenz*, 31, pp. 43-45, February, 1928.)

Note on a paper of this title by G. J. Elias (this *Zeitschrift*, 27, 66, 1926; these Abstracts, June 1926, p. 381), in which results for the conductivity and dielectric constants of an ionised gas are arrived at rather different from those found by Eccles and Salpeter (and, moreover, afterwards by Lassen). Elias knew of this difference, but attributed the discrepancy, in the case of Salpeter, to an error in his drawing up of the mean value. In view of the fact that Salpeter's formulæ are now used generally as the basis for calculations on the propagation of electric waves in ionised gases, the authors felt it incumbent on them to investigate whether Salpeter's results were really not correct and the exact reason why they were different from those of Elias. As the outcome of their investigation, they found themselves in agreement with Salpeter, and that the discrepancy in the results was due to Elias having employed an incorrect method of counting the ions with a certain free length of path and suffering their last impact within a given interval of time. In the present note a new and simple derivation is given of the formulæ for the conductivity and dielectric constants of an ionised gas, the formulæ so obtained being identical with those deduced by Salpeter by a different method.

The numerical values for the conductivity and dielectric constants resulting from the Salpeter formulæ are calculated and compared with those given by Elias. A table is given showing that the differences between the two are, fortunately, not so very great, so that the inferences drawn by Elias can be considered to hold good in all essentials.

WOODS AND WIRELESS.—B. Rolf. (*Nature*, 121, pp. 539-540, 7th April, 1928.)

A letter referring appreciatively to Mr. Barfield's paper on the attenuation of wireless waves over land (*Jour. Inst. Elect. Eng.*, 66, pp. 204-218, February, 1928).

The writer lays stress upon the fact that a tree cannot possibly be regarded as a pure resistance, except when emission takes place on the resonant frequency of the tree, and since this is generally higher than the frequency of the broadcasting transmitter, the tree acts as a condenser with big losses. In the language of Prof. Sommerfeld's

solution, this means that the "numerical distance" is not a positive real number but a complex one.

The damping curve is shown for the particular case when the capacity effect equals the conductivity effect, and explains the remarkable feature that the damping is *negative* for the first 20 or 30 kilometres, though becoming very positive farther away.

The writer states that, in Sweden, "wood" means nothing less than some 40,000 trees per square kilometre, and expresses the belief that a thorough investigation of the attenuation suffered by various wave-lengths would result in better legislation than that decreed by the Washington Conference of 1927 for the broadcasting band to be employed in such densely wooded countries as Sweden.

THE REFLECTING LAYER OF THE UPPER ATMOSPHERE.—G. H. Munro. (*E.W. & W.E.*, 5, pp. 242-244, May, 1928.)

PROPAGATION AROUND THE EARTH.—(*Post Office Elect. Eng. Journ.*, 20, pp. 307-308.)

Examples of the "echo-effect" are shown, which have been observed on the beam installation working between this country and South Africa and India.

RELATION ENTRE LES OSCILLATIONS RÉGULIÈRES DES CHAMPS ÉLECTRIQUES ET MAGNÉTIQUES TERRESTRES, ET LES FOYERS SOLAIRES DIAMÉTRAUX (The relation between the regular oscillations of the terrestrial electric and magnetic fields and the diametrical solar foci).—A. Nodon. (*Comptes Rendus*, 186, pp. 942-944, 2nd April, 1928.)

A brief account of observations which appear to show the existence of close relations between the activity of solar diametrical conjugate foci, the variations of terrestrial magnetic and electric fields, and the propagation of radio waves.

THE LORENTZ RECIPROCALITY THEOREM FOR ELECTRIC WAVES.—Stuart Ballantine. (*Proc. Inst. Radio Engineers*, April, 1928, V.16, pp. 513-518.)

Under the heading "Review of Current Literature," the writer says that "the following *résumé* of the theorem is based upon a recent article by A. Sommerfeld and will be of interest to radio engineers. The theorem itself has recently been applied to the calculation of the distribution of radiation about a transmitting aerial erected over an imperfect earth by T. L. Eckersley, and to the equivalent problem of the reception of waves arriving from various altitudinal angles, by L. Bouthillon." He also says "The results of the somewhat complicated mathematical analysis are quite amenable to calculation when expressed in simple series and in terms of the so-called 'numerical distance.' An excellent summary of them, with specimen calculations, has been given

by Smith-Rose and Barfield (Proc. Wireless Sect., I.E.E., 1, 182, Sept. 1926) which the non-mathematical reader will find especially entertaining and useful."

In the *résumé* the writer states that the results would suggest that communication at short wavelengths between aeroplanes might be feasible at medium distances when communication between ground stations over the same distances might be impossible due to the absorption of the ground wave: and that another practical consequence of these calculations, which was pointed out by Eckersley, is the advantage for ground communication of increasing the height of short-wave antennæ.

### ATMOSPHERICS AND ATMOSPHERIC ELECTRICITY.

THE EARTH'S ELECTRIC CHARGE.—W. F. G. Swann. (*Journ. A.I.E.E.*, 47, pp. 209-210, March, 1928.)

Our earth is not a neutral body, but is coated with a layer of negative electricity of such amount that, at the surface, there is an electrical potential gradient of the order of 150 volts per metre. This potential gradient diminishes with altitude until, at a height of 10 kilometres, it becomes insignificant compared with its value at the surface. The potential gradient, and so the negative charge on the earth's surface, goes through fairly regular variations throughout the day and throughout the year, variations amounting to 50 per cent. or more of its value. Although the atmosphere is only a very feeble conductor of electricity, this small conductivity, nevertheless, is sufficient to ensure that 90 per cent. of the earth's charge would disappear in 10 minutes if there were no means of replenishing the loss. The nature of this replenishment is the greatest of the outstanding problems of atmospheric electricity.

The author discusses the difficulties attending the explanation of the earth's charge as due to electrons shot into our earth from the sun. He then refers to an entirely different theory according to which a very slow but continual death of positive electricity occurs as a result of the earth's rotation, leaving a surplus of negative sufficient to provide for the atmospheric electric current. It has been possible to incorporate this idea of a slow death of electric charge as a result of the earth's rotation with a consistent scheme of electro-dynamics, the rotation at the same time providing an explanation for that other mystery, the earth's magnetic field.

### PROPERTIES OF CIRCUITS.

ÜBER STROMVERHÄLTNISSE IN EINEM INDUKTIONSFREIEN WIDERSTAND, DER PARALLEL ZU EINEM SCHWINGUNGSKREIS GESCHALTET IST (On the current relations in an inductance-free resistance, connected in parallel with an oscillatory circuit).—D. Doborzynski. (*Zeitschr. f. Hochfrequenz.*, 31, pp. 15-17, January, 1928.)

A formula is deduced for the amplitude of the sinusoidal alternating current in a resistance, connected in parallel with an oscillatory circuit. It

follows that the condition for this amplitude to be a maximum leads to the determination of the resonance capacity of the whole oscillatory circuit. The value of this capacity is entirely independent of the value of the resistance.

ÜBER ANODENGLEICHRICHTUNG (On anode rectification).—M. von Ardenne. (*Zeitschr. f. Hochfrequenz.*, 31, p. 51, February, 1928.)

Supplementing an earlier paper of the same title (*Zeitschr. f. Hochfrequenz.*, March, 1927, these Abstracts, July, 1927, p. 443), the author here investigates the sensitivity of anode rectification in relation to the value and nature of the anode resistance, on the supposition that, for the high-frequency to which adjustment is to be made, this resistance is short-circuited by the capacities in parallel and is very small compared with its value for low-frequency. This case is of importance for the determination of the rectifier effect in multiple amplifiers. It is found that the sensitivity is a maximum when valves with small "Durchgriff" ( $i\mu$ ) and high ohmic resistance are employed.

### TRANSMISSION.

FREQUENZDURCHGANG BEI MODULIERTEN FREMDGESTEUERTEN SENDERN MIT MEHREREN GEKOPPELTEN SCHWINGKREISEN (FREQUENZKURVEN) (Frequency variation in modulated externally controlled transmitters with several coupled oscillatory circuits (frequency curves).—P. v. Handel. (*Telefunken-Zeitung*, 9, pp. 53-63, January, 1928.)

A paper calculating the percentage modulation of the antenna current in dependence upon the modulation frequency in a three-cascade transmitter modulated in the second stage. The third stage is assumed to consist of three oscillatory circuits: the primary and secondary circuits and the antenna, the constants of which are supposed known. The calculation is carried out in the following steps:

- (1) Frequency relation in a single circuit connected to an oscillatory valve.
- (2) Frequency relation in a circuit on which a 100 per cent. modulated high frequency tension is superimposed (antenna coupled inductively).
- (3) Frequency relation in the secondary circuit.
- (4) Frequency relation in the primary circuit to which a secondary circuit is coupled.
- (5) Total frequency relation in a three-cascade transmitter modulated in the second stage.

ÜBER DEN VERLUSTWIDERSTAND BEI LEITUNG VON HOCHFREQUENTEM WECHSELSTROM DURCH ERDE (On the resistance loss when alternating current of high frequency is conducted through the earth).—R. Mayer. (*Telefunken-Zeitung*, 9, pp. 63-68, January, 1928.)

This subject is of importance for radio in connection with the earthing of high-power stations. In determining the losses that occur when alter-

nating currents are conducted through the earth three kinds of loss are differentiated:

- (1) Propagation loss due to current concentration in the neighbourhood of metal earths. This loss is identical for direct and alternating current.
- (2) Current displacement loss for the free currents through the earth.
- (3) Induced losses.

The subject has been treated fairly thoroughly theoretically, though there are important gaps experimentally, especially as concerns "induced losses."

(Cf. *Zeitschr. f. Hochfrequenz*, March, 1927, p. 71; these Abstracts, July, 1927, p. 444.)

STUDY OF MODULATION IN WIRELESS TELEPHONY.—S. Chiba. (*Journ. Inst. Elect. Eng. of Japan*, No. 474, pp. 53-69.)

The character of the modulation in some commonly employed systems is studied by means of the Braun tube. It is found that in the constant-current method, the stop condenser used in the ordinary oscillator circuit has considerable influence on the character of the modulation. Tests are also made on other methods of modulation, such as the grid control and the detuning, and an example of the characteristic given by a magnetic modulator is also described.

Ordinary grid control systems are more or less of the oscillation control type, which sometimes gives rise to serious distortion. The author tested a grid control method using a modulator which at the same time absorbs the high frequency power from the oscillation circuit. This system shows no distortion over the wide range of the modulator grid voltage and the circuit is easily adjusted to attain the distortionless condition. Further advantages are that it is found to be adapted to A.C. filament heating and is also suitable as the transmitter of duplex wireless telephony. A sensitive relay controlled by speech currents is used to open or short-circuit the grid bias battery of the modulator, which in turn starts or stops the oscillation.

THE POWER IN A MODULATED OSCILLATION.—E. Howard Robinson. (*E.W. & W.E.*, 5, pp. 252-254, May, 1928.)

DIE ELEKTRISCHEN EIGENSCHAFTEN DER RUND-FUNKSENDER-VORVERSTÄRKER IM HINBLICK AUF IHRE AKUSTISCHEN QUALITÄTEN (The electrical properties of broadcast transmitter preliminary amplifiers with a view to their acoustical qualities).—H. Rukop. (*Telefunken-Zeitung*, 9, pp. 10-32, January, 1928.)

A paper from the Telefunken laboratories presented before a meeting of the Association of German Electrical Engineers at Kiel, July, 1927.

After surveying the development of the low-frequency amplifier, consideration is made successively of: note frequency amplifiers with resistance coupling, amplifier output and grid transformers, circuit-arrangements for amplification reduction both automatic and by stages, and lastly, broadcast transmitter preliminary amplifiers in practice.

VACUUM TUBES AS OSCILLATION GENERATORS.—D. C. Prince and F. B. Vogdes. (*General Electric Review*, 31, 2 and 3, pp. 97 and 147 respectively, February and March, 1928.)

The third and fourth parts of a serial article on valve oscillators. Part III discusses the design of the simpler valve circuits, and Part IV special considerations bearing on the design and operation of oscillating circuits.

## RECEPTION.

ÜBER UNVERZERTE LEISTUNGSABGABE DURCH ELEKTRONENRÖHREN (On undistorted reproduction with valves).—A. Forstmann. (*Zeitschr. f. Hochfrequenz*, 31, pp. 45-50, February, 1928.)

The relation for the degree of efficiency of the valve as power amplifier is given, also the optimum load resistance and the useful effect in power amplification are determined. Further, the relations for optimum load, "Durchgriff" ( $1\mu$ ), and driving potentials are set out when distortion (both linear and non-linear) is absent.

DIE FERNBEDIENUNG VON FUNKSEMPFANGS-ANLAGEN (Attending to radio receiving installations from a distance).—A. Ristow. (*Zeitschr. f. Hochfrequenz*, 31, pp. 52-53, February, 1928.)

Description of an arrangement for switching on and off and tuning receivers which are not able to be set up in the service room, the chief merit of the arrangement being the economy in special personnel. In order not partly to defeat this object by going to the expense of special leads, use is made of the telephone wires presumed already to connect the service room and that containing the installation.

The arrangement is shown diagrammatically on the next page.

RETRO-ACTION IN AMPLIFIERS.—H. A. Thomas. (*E.W. & W.E.*, 5, pp. 245-251, May, 1928.)

THE CAUSES AND PREVENTION OF ACTUAL AND INCIPIENT L.F. OSCILLATION.—W. I. G. Page. (*Wireless World*, 22, pp. 439-444, 25th April, 1928.)

DISCUSSIONS ON THE DISTORTIONLESS RECEPTION OF A MODULATED WAVE AND ITS RELATION TO SELECTIVITY.—F. K. Vreeland. (*Proc. Inst. Radio Engineers*, April, 1928, V. 16, pp. 494-497.)

A short discussion on Dr. Vreeland's paper, which was published in the March number of the *Proc. Inst. Radio Engineers*, and was summarised in these abstracts May, 1928, p. 286.

## VALVES AND THERMIONICS.

APPLICATIONS NOUVELLES DES LAMPES À QUATRE ELECTRODES (New applications of four-electrode valves).—B. Decaux. (*L'Onde Electrique*, 7, pp. 119-124, March, 1928.)

SOME PAST DEVELOPMENTS AND FUTURE POSSIBILITIES IN VERY HIGH VOLTAGE VACUUM TUBES.—W. D. Coolidge. (*General Electric Review*, 31, pp. 184-185, April, 1928.)

REJUVENATING RECTIFYING VALVES. (*Wireless World*, 22, p. 445, 25th April, 1928.)

(thermions) as well as those which do not: in other words, at high enough temperatures the two effects are not independent. A general equation is obtained which seems to embrace all the facts of thermionic-currents and field-currents combined. The new results in this paper may be stated thus: The application of an external field

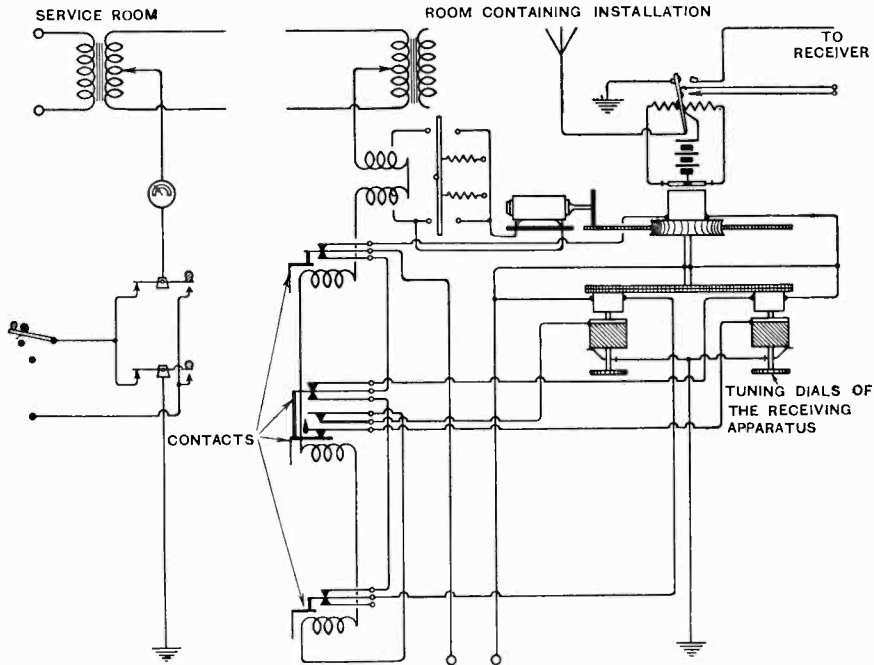

THE EFFECT OF RESIDUAL GAS IN A VALVE.—A. P. Castellain. (*Wireless World*, 22, pp. 385-388, 11th April, 1928.)

EINIGE ÜBERLEGUNGEN ZUR PHYSIKALISCHEN BEDEUTUNG DER GLÜHELEKTRONEN-EMMISSION (Some considerations on the physical significance of incandescent electron emission).—A. v. Hippel. (*Zeitschr. f. Physik*, 46, pp. 716-724.)

The theory is given for regarding incandescent electron emission as a question of temperature onisation through atomic impact.

RELATIONS OF FIELD-CURRENTS TO THERMIONIC-CURRENTS.—R. A. Millikan and C. C. Lauritsen. (*Proc. Nat. Acad. Sciences*, 14, pp. 45-49.)

In 1925 Millikan and Eyring first developed experimentally the quantitative laws governing the extraction of electrons from metals by fields alone, i.e., the laws of "field-currents." They proved that the electrons constituting these field-currents are not identical with thermions, as had hitherto been assumed.

The present paper shows, however, that at high enough temperatures the fields do extract electrons which share in the energy of thermal agitation

is equivalent to increasing the temperature of the electrons within the metal.

DEVELOPMENT OF A NEW POWER AMPLIFIER VALVE.—C. R. Hanna, L. Sutherlin, and C. B. Upp. (*Proc. Inst. Radio Engineers*, April, 1928, V. 16, pp. 462-475.)

This paper, from the Westinghouse Research Laboratory, is summarised as follows:—

A general rule for determining the best operating point and load impedance for any power amplifier, when anode voltage and dissipation limits must both be considered, is derived.

The effect of varying the voltage factor in a given sized valve, by changing the grid structure, is also considered with voltage and heating kept within safe limits.

The process of determining the desired characteristics for a given application is illustrated by describing the development of a new power-valve, Radiotron UX-250.

The writer states that the high output of this valve is the result of several features, the most important four of which he enumerates. He concludes that the output of this valve is about as great as may be obtained from a receiving valve of practical structure without requiring greater

grid swing or operating at excessive anode voltage or dissipation.

**SOME CHARACTERISTICS AND APPLICATIONS OF FOUR-ELECTRODE TUBES.**—J. C. Warner. (*Proc. Inst. Radio Engineers*, April, 1928, V. 16, pp. 424-446.)

This paper, from the Research Laboratory of the G.E.C., is summarised as follows:—

Four-electrode valves may be classified by their designs and uses as "screen-grid," "space-charge-grid," and "double function" valves.

In the screen-grid valve the inner grid is the control-electrode and the outer or screen-grid is kept at a fixed potential. The capacity between plate and control-grid is thereby reduced to an almost negligible value. A second result of the screen-grid is a large increase in amplification factor and plate resistance without reduction of mutual conductance. This permits high amplification in connection with high impedance coupling circuits, without undesired regeneration or oscillation. The screen-grid principle has been applied to transmitting as well as to receiving valves.

Characteristics of these valves are given in detail.

In the space-charge-grid valve, the outer grid is the control electrode and the inner grid is maintained at a fixed potential. The purpose of the inner grid is to reduce the effect of the space-charge around the filament and thereby to reduce the plate resistance of the valve. The space-charge-grid valve performs the same functions as ordinary three-electrode valves, but in general has higher mutual conductance than a three-electrode valve of similar design.

Several double-function valves and circuits are described in which both grids act as control electrodes, or in which one grid acts as control electrode and the other as a combination space-charge-grid and control or output electrode. These circuits are sometimes useful, but are subject to certain definite limitations.

The writer concludes: "The degree of general usefulness of the various four-electrode valves and circuits may perhaps be expressed by saying that the space-charge-grid valve performs the same kind of functions as the three-electrode valve but at lower plate voltages or with somewhat higher amplification; the double-function circuits, while often very interesting in themselves, accomplish with one valve what can often be done almost as simply, as effectively, and sometimes less expensively with two three-electrode valves; but the screen-grid valve not only permits a degree of radio-frequency amplification much greater than can be obtained with a three-electrode valve, but also eliminates the feed-back which is so often an unwanted function of the three-electrode valve."

### DIRECTIONAL WIRELESS.

**NOTE ON A SPECIAL DIAL FOR TIME-PIECES TO BE USED WITH ROTATING WIRELESS OR OTHER BEACONS.**—R. L. Smith-Rose. (*Journ. Scien. Instr.*, 5, pp. 93-96, March, 1928.)

The author states that in the near future it is probable that the rotating beacon transmitter will find wide application as a means of obtaining wireless bearings for navigation purposes. This

paper describes some specially designed "compass-card" dials for watches and chronographs used in connection with such beacons.

**LE RADIOCOMPAS ET LA NAVIGATION AÉRIENNE** (The radio compass and aerial navigation).—P. Franck. (*L'Onde Electrique*, 7, pp. 109-118, March, 1928.)

A lecture given to the S.A.T.S.F., 10th January, 1928.

The writer enumerates the several advantages, for aerial navigation, that a *direct-reading* radio direction-finder would have over the magnetic compass, but points out how many problems are involved, and have yet to be solved, before a really satisfactory instrument is perfected.

### MEASUREMENTS AND STANDARDS.

**MEASUREMENT OF FREQUENCY.**—S. Jimbo. (*Journ. Inst. Elect. Eng. of Japan*, No. 475, pp. 132-151, February, 1928.)

The contents of the paper are as follows:

- (1) Method of measurement of frequency.
  - (A) Absolute method.
  - (B) Relative method.
- (2) Standard frequency oscillator.
  - (A) Clock-controlled oscillator.
  - (B) Tuning-fork oscillator.
  - (C) Quartz oscillator.
  - (D) Valve oscillator.
- (3) Resonator.
  - (A) Electric resonator.
    - (a) Frequency bridge.
    - (b) Wavemeter.
  - (B) Mechanical resonator.
    - (a) Fork type resonator.
    - (b) Sonometer type resonator.
    - (c) Quartz resonator.

The author recommends the stroboscopic and phonic motor method as the most precise for the absolute measurement of frequency; with it he has obtained an accuracy of nearly 0.001 per cent. The clock-controlled oscillator is also favourably considered, and it is suggested that its operation can be theoretically explained by the "Ziehen" phenomenon and the equivalent electric circuit.

The fundamental equation for the frequency of the elastic wave in the mechanical vibrator is given and several factors affecting the frequency of the tuning-fork oscillator are enumerated and explained. A monochord oscillator is put forward. Resonant sharpness is discussed. A comprehensive bibliography is appended.

**A NEW UNIVERSAL LONG-WAVE RADIO INTENSITY MEASURING SET.**—J. Hollingworth. (*Journ. Sci. Instr.*, 5, pp. 1-9, January, 1928.)

A paper pointing out that the existing long-wave measuring apparatus is found not sufficiently refined for the more complicated observations now required in the study of the polarisation of radio waves, and giving a detailed description of new apparatus for the purpose, which is primarily designed to measure in rapid succession the E.M.Fs

in two coils oriented in different directions from the arriving signal, and the phase angle between these two E.M.Fs.

A SHORT SURVEY OF SOME METHODS OF RADIO SIGNAL MEASUREMENT.—K. Sreenivasan. (*E.W. & W.E.*, 5, pp. 273-278, May, 1928.)

Concluding part of a paper begun in the April issue.

THE DEMONSTRATION OF A NEW PRECISION WAVE-METER CONDENSER.—W. H. F. Griffiths. (*E.W. & W.E.*, 5, pp. 278-279, May, 1928.)

THE MEASUREMENT OF CHOKE COIL INDUCTANCE.—C. A. Wright and F. T. Bowditch. (*Proc. Inst. Radio Engineers*, 16, pp. 373-384, March, 1928.)

Description of an investigation that emphasizes the following facts:

(1) The inductance of the choke coil depends upon the degree to which its core is magnetically saturated because of direct current flowing through the winding of a choke coil.

(2) With a given direct current flowing through the winding of a choke coil, the inductance varies to a marked extent with the magnitude of the alternating current flowing through the winding. Methods of measurement which do not take into account or measure the magnitude of the alternating current are, therefore, unreliable.

(3) The inductance for given conditions may be determined from the saturation curve of the coil. It is determined by the average slope of the saturation curve over the range within which the current varies.

Three modifications of the ammeter-voltmeter method of measuring inductance are given.

THE ESTABLISHMENT OF FORMULÆ FOR THE SELF-INDUCTANCE OF SINGLE-TURN CIRCUITS OF VARIOUS SHAPES.—R. G. Allen. (*E.W. & W.E.*, 5, pp. 259-263, May, 1928.)

A BRIDGE FOR THE MEASUREMENT OF INDUCTANCE AND CAPACITY.—G. Zickner. (*E.W. & W.E.*, 5, pp. 280-282, May, 1928.)

METHODS, FORMULAS, AND TABLES FOR THE CALCULATION OF ANTENNA CAPACITY.—F. W. Grover. (*Scientific Papers of the Bureau of Standards*, No. 568.)

The capacity of an antenna is evaluated by assuming a certain charge upon it from which the resulting potential is calculated. As the law of the distribution of the charge is not known, difficulties are encountered. While the values obtained by this method and the published values for the same antennæ by the inductance methods differ, the author shows that if appropriate inductance formulæ are employed, the two methods will agree.

Formulæ are given for the common types of single and multiple wire antennæ, together with tables of constants, also tables of capacities of both horizontal and vertical single-wire antennæ and horizontal two-wire antennæ.

COIL CALCULATIONS.—(*Wireless World*, 22, pp. 394-395, 11th April, 1928.)

Useful design data for 2,000 and 3,000 microhenry coils.

DIELECTRIC LOSSES IN SINGLE LAYER COILS AT RADIO FREQUENCIES.—W. Jackson. (*E.W. & W.E.*, 5, pp. 255-258, May, 1928.)

THE HARMONIC COMPARISON OF RADIO-FREQUENCIES BY THE CATHODE-RAY OSCILLOGRAPH.—T. S. Rangachari. (*E.W. & W.E.*, 5, pp. 264-266, May, 1928.)

ON THE TESTING OF AUDIO-FREQUENCY TRANSFORMERS BY MEANS OF THE CATHODE-RAY OSCILLOGRAPH.—M. Kobayashi. (*Journ. Inst. Elect. Eng. of Japan*, No. 475, pp. 152-159, February, 1928.)

The cathode-ray oscillograph is very satisfactorily applied to the determination of the characteristics of apparatus which is to be used over a wide range of frequency. Here, in the application to the testing of the audio-frequency transformer, impedance and voltage frequency characteristics are obtained vectorially from the elliptic figure on the oscillograph, various points to be noticed being enumerated.

A DIRECT-CAPACITY BRIDGE FOR VACUUM-TUBE MEASUREMENTS.—Lincoln Walsh. (*Proc. Inst. Radio Engineers*, April, 1928, V.16, pp. 482-486.)

A direct-capacity bridge is described which permits the measurement at a single setting of a capacity associated with other capacities in a system having more than two terminals, such as the grid-plate capacity of a valve.

Two forms of the bridge are described. By making one connection, the standard form of capacity bridge already in use in many laboratories may be converted into a direct-capacity bridge.

The recommendation is made that valve interelement capacities be specified as direct capacities. Suggestions are made for other uses of the direct-capacity bridge in the laboratory.

MEASUREMENT OF VACUUM-TUBE CAPACITIES BY A TRANSFORMER BALANCE.—H. A. Wheeler. (*Proc. Inst. Radio Engineers*, April, 1928, V.16, pp. 476-481.)

A complete, portable equipment is described for the measurement of the direct capacities of valves in laboratory or factory testing. The valve capacity is compared with a standard variable condenser by means of a transformer-balance (Neutrodyne) circuit, whose balance is independent of the frequency (about 1,500 kc. being preferred). Designs are proposed for the standard condenser and the transformer, and suggestions are made for the further improvement of this equipment. The writer states that the total errors obtained should be very small, within 1 per cent. or  $0.1 \mu\mu\text{F}$ , and that they can be reduced further if required.

A BRIDGE METHOD FOR THE MEASUREMENT OF INTER-ELECTRODE ADMITTANCE IN VACUUM TUBES.—E. T. Hoch. (*Proc. Inst. Radio Engineers*, April, 1928, V.16, pp. 487-493.)

This paper, from the Bell Telephone Laboratories, gives a description of the Colpitts-Campbell bridge



as applied specifically to the measurement of direct admittances in vacuum tubes. Data on several vacuum tubes are given.

The writer concludes that the tests indicate that the method is applicable at radio frequencies although, on account of the very small quantities to be measured, great refinement is necessary in the physical construction of the bridge and accessory apparatus.

### SUBSIDIARY APPARATUS AND MATERIALS.

GENERATOR FOR AUDIO CURRENTS OF ADJUSTABLE FREQUENCY WITH PIEZO-ELECTRIC STABILISATION.—A. Hund. (*Scientific Papers of the Bureau of Standards*, No. 569.)

A beat-frequency generator for producing audio currents which are practically sinusoidal is described. The frequency is adjustable and stabilised by means of a piezo-electric quartz disk and can be directly read off on a scale. The piezo-electric control makes it possible to reset the calibration for the frequency, for almost any B voltage on the valves producing the two high-frequency currents which beat with each other. The resetting can be carried on without any standard by means of the filament rheostat common to both oscillator valves. The slow visible vibrations on the meter for the anode current of the piezo-electric oscillator are utilised for the resetting of the scale. A thermostatic control is provided for very accurate work. Two filter detector circuits are described for obtaining audio currents of a good wave shape and keeping any high-frequency currents away from the load branch. A specially designed power amplifier is also mentioned.

LOUD-SPEAKERS OF HIGH EFFICIENCY AND LOAD CAPACITY.—C. R. Hanna. (*Journ. Amer. Inst. Elect. Eng.*, 47, pp. 253-257, April, 1928.)

Abridgment of a paper presented at the winter convention of the A.I.E.E., New York, February, 1928.

The design of high-quality horn-type loud-speakers with moving coil drivers is considered, and the efficiency and maximum output capacity obtainable from this type of loud-speaker are calculated. Methods of providing loud capacity greater than that possible with a single loud-speaker are described.

ÜBER BAU UND ANWENDUNG VON GROSSLAUTSPRECHERN (Design and application of large loud-speakers).—F. Trendelenburg. (*E.T.Z.*, 48, pp. 1685-1691.)

Mathematical explanation is given of the phenomena involved when mechanical energy is transformed into acoustical energy. The ideal sound emitting surface is a sphere, but approximations to it are cones, circular diaphragms and large square surfaces. Characteristics of paper and metal horns are given, indicating their varying sensitiveness depending upon the sound frequency. It is claimed that for large sound energies, such as are required by public address speakers, the condenser type with an emitting sheet 20 x 20 in. gives best results with a minimum of distortion within a range of 50 to 8,000 cycles. Tests made

in the open country showed that such a hornless sheet speaker permitted the spoken word to be clearly understood over a distance of half a mile.

MOTIONAL IMPEDANCE CHARACTERISTICS OF A LOUD-SPEAKER WITH A VERY SMALL HORN.—S. Nakai. (*Journ. Inst. Elect. Eng. of Japan*, No. 474, pp. 26-37.)

The effect of the small horn upon the motional impedance, which is the measure of the velocity of the actuating element, is found to be limited to the narrow range of frequencies near the resonant frequency of the horn. When this resonant frequency coincides with that of the moving element, the addition of horn changes the shape of the frequency characteristics. It is concluded that a small horn contributes very little to the improvement of the frequency response.

A GERMAN H.T. MAINS UNIT WITH GLOW DISCHARGE RECTIFIER.—(*E.W. & W.E.*, 5, p. 251, May, 1928.)

EIN GLÜHKATHODENOSZILLOGRAPH FÜR VAKUUM-AUFNAHMEN (An incandescent cathode oscillograph for vacuum recording).—W. Rogowski and K. Baumgart. (*Archiv für Elektrotechnik*, 19, pp. 521-526, 15th March, 1928.)

Description of a new oscillograph with incandescent cathode which has several advantages over the cold cathode instrument devised previously—except that it is less easy to handle. Specimen oscillograms obtained within the tube are shown.

ÜBER DIE VERWENDUNG DER NEGATIVEN LADUNG DER KATHODENSTRAHLEN ALS SCHREIBMITTEL IM KATHODENOSZILLOGRAPHEN (On the employment of the negative charge of the cathode beam as the recording means in the cathode oscillograph).—P. Seléngi. (*Zeitschr. f. Physik*, 47, pp. 895-897, March, 1928.)

Description of a new principle in recording, employing the electric charge of the cathode beam, which is caught on an insulating plate, sprinkled over with an electroscopic powder to render the curve traced out visible. It is expected that a recording velocity of over 30 km./sec. will be attainable with this method.

NOTES ON THE DESIGN OF RADIO INSULATORS.—T. Walmsley. (*Proc. Inst. Radio Engineers*, 16, pp. 361-372, March, 1928.)

The writer states that there seems to be no general appreciation of the fact that better results can usually be obtained by proportioning insulators correctly than by increasing the quantity of material used. In fact, increased thickness of a dielectric, having a high dielectric constant, frequently causes a reduction in the breakdown voltage of the insulator.

Design problems are considered under the headings: quality of material, shape and arrangement of material, surface leakage, dome insulators, and sheds.

LIQUIDS AS INSULATORS.—F. M. Clark. (*General Electric Review*, 31, pp. 174-183, April, 1928.)

**THE INVERTED VACUUM TUBE, A VOLTAGE-REDUCING POWER AMPLIFIER.**—F. E. Terman. (*Proc. Inst. Radio Engineers*, April, 1928, V.16, pp. 447-461.)

By interchanging the functions of the grid and plate of the usual vacuum tube, a voltage-reducing power amplifier is obtained. The usual vacuum tube acts as a voltage-increasing power amplifier.

The static curves of the inverted vacuum tube are similar in form to the corresponding curves of the ordinary vacuum tube, and the theory of the inverted vacuum tube is analogous in all respects to the usual vacuum-tube theory, the only difference being reduction instead of amplification of voltage.

It is relatively simple to construct an inverted vacuum tube with wide clearances between plate and the rest of the tube, so that potentials of hundreds of thousands of volts can be applied to the plate, while the effect of this high voltage stepped down in almost any desired ratio is obtained in a low-potential circuit.

The writer considers various practical applications of the inverted vacuum tube and comes to the conclusion that its usefulness lies principally in oscillograph work, and in the measurement of A.C. and D.C. voltages of any magnitude without the consumption of power from the unknown potential.

#### STATIONS : DESIGN AND OPERATION.

**SEAFORTH RADIO STATION.**—W. M. Osborn. (*Post Office Elect. Eng. Journal*, 21, pp. 65-70, April, 1928.)

An illustrated description of this coast station near Liverpool, where, last August, the spark system of transmission was replaced by that of interrupted continuous waves. Following this successful installation, arrangements are in hand for the general adoption of the valve transmitter at all other coast radio stations in place of the existing spark transmitters.

**THE "EMPIRADIO" BEAM STATIONS.**—(*Post Office Elect. Eng. Journal*, 21, pp. 55-65, April, 1928.)

An illustrated account of the group of stations in this country operating on the beam system for communication with Canada, South Africa, India, and Australia.

**BROADCAST CONTROL OPERATION.**—Carl Dreher. (*Proc. Inst. Radio Engineers*, April, 1928, V.16, pp. 498-512.)

Mr. Dreher, of the National Broadcasting Company, New York City, summarises his paper as follows: This paper is limited to a consideration of the audio-frequency elements of a broadcast control system. A two-studio electrically interlocked plant suitable for network operation is described. The methods of specifying and measuring telephonic energy levels, arranging low impedance (as 500-ohm) and bridging apparatus, equalising lines, and maintaining the audio energy within permissible limits by means of amplifying and attenuating units, are described in connection with the specifications of the plant.

The co-ordinative and regulative functions of the technical staff of a broadcasting system, the relations of engineering and studio *personnel*, and typical precautions against breaks in programme-continuity are then discussed.

#### GENERAL PHYSICAL ARTICLES.

**QUELQUES MODES PARTICULIERS DE VIBRATION DES QUARTZ PIEZO-ELECTRIQUES** (Some particular modes of vibration of piezo-electric quartz plates).—R. Jouaust. (*L'Onde Electrique*, 7, pp. 125-128, March, 1928.)

The writer here supplements his lecture to the S.A.T.S.F., in May of last year, on the employment of piezo-electric quartz as a frequency standard (*O.E.*, Nov. and Dec., 1927), with an account of new modes of vibration (flexural and torsional), which have been produced since; as described by Giebe and Schiebe in the *Zeitschrift für Hochfrequenz*, of July, 1927, and by Harrison in the *Proc. Inst. Rad. Eng.* of December, 1927. With these more complicated deformations, lower frequencies can be obtained than when only transverse or longitudinal deformations are utilised, and thus the field over which quartz can be employed in radio measurements becomes extended.

**PIEZOELEKTRISCHE ERREGUNG VON DEHNUNGS-BIEGUNGS- UND DRILLUNGSSCHWINGUNGEN BEI QUARZSTÄBEN** (Piezo-electric excitation of extension, flexural and torsional oscillations in quartz rods).—E. Giebe and A. Scheibe. (*Zeitschr. f. Physik*, 46, pp. 607-652, January, 1928.)

**MECHANISCHE SCHWINGUNGEN PIEZOELEKTRISCH ANGEREGTER QUARZE** (Mechanical oscillations of piezo-electrically excited quartz).—R. Wachsmuth and H. Auer. (*Zeitschr. f. Physik*, 47, pp. 323-329, February, 1928.)

**BEEINFLUSSUNG DER DIELEKTRIZITÄTSKONSTANTEN DURCH ELEKTROSTATISCHE FELDER** (The influencing of dielectric constants by electrostatic fields).—F. Kautzsch. (*Physikalische Zeitschrift*, 29, pp. 105-117.)

**EIN VERSUCH DER ABLEITUNG DES MAXWELLSCHEN VERTEILUNGSGESETZES AUF THERMODYNAMISCHEM WEGE** (An attempt to deduce Maxwell's law of distribution by thermodynamical means).—A. Schükaren. (*Physikalische Zeitschrift*, 29, pp. 181-182.)

**ÉTUDE EXPÉRIMENTALE DES DÉFORMATIONS ET DES CHANGEMENTS DE PROPRIÉTÉS OPTIQUES DU QUARTZ SOUS L'INFLUENCE DU CHAMP ÉLECTRIQUE** (Experimental investigation of the deformations and change in optical properties of quartz under the influence of an electric field).—M. Ny Tsi Ze. (*Journal de Physique*, 9, pp. 13-37, January, 1928.)

**THÉORIE ELECTRO-OPTIQUE DU QUARTZ** (Electro-optical theory of quartz).—R. de Malle-mann. (*Comptes Rendus*, 186, pp. 853-855, 26th March, 1928.)

ZUR FELDTHEORIE VON ELEKTRIZITÄT UND GRAVITATION (On the field theory of electricity and gravitation).—L. Infeld. (*Physikalische Zeitschrift*, 29, pp. 145-147.)

THEORY OF THE MAGNETIC NATURE OF GRAVITY AND NEWTON'S LAWS.—C. L. Sagui. (*Physical Review*, 31, p. 715, April, 1928.)

Abstract of a paper presented at the New York meeting of the American Physical Society, February, 1928.

As in a gravitational field, the magnetic quanta of two electromagnetic fields spacially superposed, with one lagging behind the other, react elastically upon each other in such a way that those advancing meet those returning. The latter are pushed farther away and the former recede, and different magnetic densities result. An electron results as an assembly of a large number of elementary electromagnetic fields (energy-wave) with a gravitational atmosphere (gravity-wave). The repelling forces are explained and radiation connected with the oscillation of electrons between attractive and repelling forces.

BIBLIOGRAPHY ON PIEZO-ELECTRICITY.—W. G. Cady. (*Proc. Inst. Radio Engineers*, April, 1928, V.16, pp. 521-535.)

A general bibliography on Piezo-electricity and its applications. The writer hopes that it is fairly complete to the beginning of 1928.

Part I deals with Books and Periodical Literature, and includes over 200 references, with a Cross Index. Part II deals with Patents, the title of each patent being followed by a parenthetical note pointing out the distinguishing features from the point of view of piezo-electricity, without attempting to indicate the full scope of the invention.

MODES OF VIBRATION IN PIEZO-ELECTRIC CRYSTALS.—A. Crossley. (*Proc. Inst. Radio Engineers*, April, 1928, V.16, pp. 416-423.)

The paper, from the Naval Research Laboratory, Anacostia, D.C., is summarised as follows:—

The presence of nodes and antinodes on the surface of oscillating quartz crystals has been discovered. The symmetrical arrangement of these nodal points permits a study of the modes of vibration in the crystal plate and the use of the following formulæ for determination of the velocity of sound waves through quartz, and of Young's modulus.

$$V = F2T \quad e = V^2D$$

where  $V$  is the velocity,  $F$  the frequency,  $T$  the thickness of the plate,  $e$  Young's modulus, and  $D$  the density.

The value obtained for  $V$  was 5,733 metres per second, while  $8.785 \times 10^{11}$  c.g.s. units represents Young's modulus for plane parallel to X-axis dimension.

## MISCELLANEOUS.

AN INSTRUMENT FOR MEASURING VERY SMALL DISPLACEMENT OR MOTION AND ITS VARIOUS APPLICATIONS.—J. Obata. (*Journ. Inst. Elect. Eng. of Japan*, No. 474, pp. 38-52.)

Description of the construction and application of the "Ultramicrometer," a new instrument for measuring small displacement or motion, utilising a generating valve circuit. The displacement or motion to be measured is made to produce either a change in the capacity in the circuit or a change in the eddy-current loss, resulting in a corresponding change in the anode current, which is measured with a galvanometer or Duddell oscillograph.

DECREASING RADIO CONGESTION.—R. D. Duncan, Jr. (*Electrical World*, 91, pp. 195-197.)

An article directing attention to the advantages and possibilities that would accompany the use of single side-band (and carrier) transmission in space radio broadcasting as compared with double side-band transmission now employed.

FERNSTEUERUNG DURCH TONFREQUENZ (Remote control by means of note frequency).—F. J. Dommerque. (*Elekt. Nachr. Technik*, 5, p. 129, March, 1928.)

ÜBER ELEKTRISCHER FELDER IN DER UMGEBUNG LEBENDER WESEN (On electric fields in the neighbourhood of living beings).—F. Sauerbruch and W. Schumann. (*Zeitschr. f. Techn. Physik*, 9, pp. 96-98, March, 1928.)

Account of the graphical recording of varying electric distance effects produced by the physiological process of muscle stretching and contraction.

SCIENTIFIC WIRING.—W. B. Medlam. (*Wireless World*, 22, pp. 449-452, 25th April, 1928.)

A new viewpoint with regard to stray coupling caused by wiring.

THE CABLE WIRELESS MERGER.—F. J. Brown. (*Wireless World*, 22, pp. 389-392, 11th April, 1928.)

SYMBOLICAL ALGEBRA.—J. A. Ratcliffe. (*E.W. & W.E.*, 5, pp. 239-242, May, 1928.)

THE INTERNATIONAL RADIOTELEGRAPH CONFERENCE OF WASHINGTON, 1927.—W. D. Terrell. (*Proc. Inst. Radio Engineers*, April, 1928, V.16, pp. 409-415.)

This account of the purposes and results of the Conference is written by the Chief of Radio Division, U.S. Department of Commerce.

D. E. H.

## Esperanto Section.

Abstracts of the Technical Articles in Our Last Issue.

## Esperanto-Sekcio.

Resumoj de la Teknikaj Artikoloj en Nia Lasta Numero.

### PROPAGADO DE ONDOJ.

LA REFLEKTA TAVOLO DE LA SUPRA ATMOSFERO.—  
G. H. Munro.

La prelego traktas pri mezuradoj faritaj en Nova Zelando en Decembro, 1925a pri 600-metra sparka stacio de distanco 300-mejla. La mezuradoj estis faritaj je horoj antaŭ kaj ĉirkaŭ sunleviĝo. Oni donas tabelon montrantan la efekton de sunlumo ĉe signalforteco, kaj de l'alteco de sunlumo (laŭ mejloj) ĉe loko meze inter stacioj je diversaj horoj antaŭ sunleviĝo ĉe la riceva stacio. Oni deduktas altecon de 57 mejloj kiel la malsupran limon por la Tavolo Heaviside.

Aldonaĵo pritraktas la kalkuladon laŭ kio la suno brilas super loko sur la tera surfaco je difinita horo antaŭ sunleviĝo ĉe tiu loko, la latitudo estinte sciita. Oni donas kaj ilustras ekzemplon, la ekzemplo pritraktita estante por somermezo en la Suda Duonsfero.

LA STUDADO PRI SIGNALO-VELKADO.

Resumo de prelego legita de Prof. E. V. Appleton, F.R.S., ĉe la Senfadena Sekcio, Instituto de Elektraĵ Inĝenieroj, Londono, je la 4a Aprilo, 1928a.

La prelego estas rakonto pri la laborado de la Peterborough Radio-Esplorata Stacio de la Brita Registara Fako de Scienca & Industria Esplorado.

Ĝi unue diskutas la specon de la problemoj de signalaj variadoj, kaj poste pritraktas metodojn evoluigitajn de l'aŭtoro determini la karakterizojn de la malsuprenvenanta radiostrio, per observado ĉe la riceva stacio, dum la sendita ondolongo estas malrapide variigita ĉe la sendilo. La teorio de la metodo estas plene diskutita kaj eksperimentaj detaloj kaj rezultoj donitaj.

La dua duono de la prelego pritraktas observadojn faritajn je l'okazo de la suna eklipso de 29a Junio, 1927a, kiam serio de observadoj ĉi tiuspecaj estis farita, kune kun observadoj pri porta ondo de konstanta amplitudo kaj frekvenco.

Oni donas kaj komparas kurvojn de la diversaj rezultoj, montrantaj la starigon de noktaj efektoj dum la eklipso.

Raporto de la diskutado, kiu sekvis la legadon de la prelego, estas ankaŭ donita.

### PROPRECOJ DE CIRKVIITOJ.

REAKCIO ĈE AMPLIFIKATOROJ.—H. A. Thomas.

En la enkonduka sekcio, la aŭtoro aludas al la malfacileco analizi reakciajn efektojn. Li poste diskutas tipojn de reakcio, kaj intencas kaj akcidenta, kaj kondukas al detala matematika ekzamenado de la reakcia efekto. Esprimoj estas derivitaj por la *norma amplifa koeficiento*, la *reakcia koeficiento*, kaj la *fin amplifa koeficiento*, k.t.p. La argumento estas bone ilustrita per

vektoroj montrantaj la efekton de kelkaj reakcioj kaj ilia kombiniĝo. La maksimuma valoro de amplifado estas pritraktita kaj la kondiĉoj por stabileco kaj malstabileco ekzamenitaj.

Grafika ekzemplo de la reakcia efekto estas poste donita, ilustrita per vektoroj por kelkaj diversaj ekzemploj.

LA STARIGO DE FORMULARO POR LA MEM-INDUKTECO DE UNU-TURNAJ CIRKVIITOJ DE DIVERSAJ FORMOJ.—R. G. Allen.

Komencante per fundamentaj supozoj, la aŭtoro skizas la teorian evoluigon de l'esprimo por la indukteco de unusola ronda turno.

La rezonado estas poste etendita al la ekzemplo de kvadrata bobeno, rektangula bobeno, bobeno kun formo de egallatera triangulo kun unu turno de fadeno, kaj de bobeno sesangulforma.

Redakcia artikolo super la ĉefliteroj de Prof. Howe ankaŭ pritraktas ĉitium temon, aludante al prelego de Bashenoff, ĉe la Instituto de Elektraĵ Inĝenieroj, donanta oportunajn esprimojn por unu bobeno laŭ formo de rondo, oktangulo, kvinangulo, kvadrato, triangulo, k.c.

DIELEKTRIKAJ PERDOJ EN UNUTAVOLAJ BOBENOJ JE RADIO-FREKVENCOJ.—W. Jackson.

La artikolo priskribas eksperimentojn, dum kiuj altfrekvencaj rezistecaj komparoj estis faritaj inter norma desegno de bobeno (aerinterspacigita kaj vindita per minimumo de solida dielektriko), kaj bobenoj kun la samaj dimensioj vinditaj ĉirkaŭ tuboj de ebonito, mikarto, tektono, imita ledo, paksolino, kaj kartono. Oni priskribas la metodojn vindi la norman bobenon kaj ilustras la finitan bobenon. Altfrekvencaj rezistecaj mezuradoj estis faritaj laŭ la rezisteca variada metodo, kaj rezultaj kurvoj estas donitaj por la diversaj materialoj komparitaj kun la norma bobeno. La efekto de malseketeco en la tubo estas ankaŭ montrita pri la ekzemplo de l'kartona tubo.

Variado kun frekvenco de l'aldonita rezisteco kaŭze de dielektrika perdo estas ankaŭ pritraktita teorie kaj eksperimente, rezultaj kurvoj estante montritaj. La prelego finiĝas per komparode rezultoj de la norma bobeno kun teoriaj valoroj, kurvoj estante donitaj por la kalkulitaj valoroj kaj por observitaj valoroj kun kaj sen korekto por mem-kapacito.

### SENDADO.

LA POTENCO EN MODULITA OSCILADO.—E. Howard Robinson.

Oni atentigas, ke se la ĉefa frekvenca tensio (t.e. porta) ne estas de konstanta amplitudo sed

estas variigita harmonike laŭ alia frekvenco, la kutima alternkurenta kalkulado de potenco ne aplikas.

La kutima esprimo por modulita porta ondo estas poste donita kaj estas uzita por derivi esprimon por potenco. La argumento estas etendita al la pluaj ekzemploj de du flankistoj sen portanto kaj de unu flankistrio sole.

La diversaj rezultoj por Efika Valoro (tensio aŭ kurento), Potenco, kaj Proporcio de Maksimuma Pinto je Efika Valoro, estas resumita en tabelo.

Oni atentigas, ke eĉ je 100-procenta modulado en ordinara radio-telefono sendilo nur triono de la tuta altfrekvenca potenco estas sendita laŭ formo de utila modula komponero.

### RICEVADO.

GERMANA ALT-TENSIA ĈEFTUBA UKUO KUN ARDMALŜARGA REKTIFIKATORO.

Artikolo super la ĉeflitteroj de Prof. Howe pritraktanta germanan valvon, la "Anotron," ŝulditan al D-ro. George Seibt. Ĉi tio estas arda malŝarga valvo kun katodo supre kaj du anodoj malsupre, kaj oni pretendas pri ĝi konstantajn karakterizojn. Cirkvita diagramo por plenonda rektifado, glatigado kaj konektado por diversaj alt-tensiaj valoroj kaj por krada potencialo estas montrita, kun sekciaj bildoj de l' "Anotron" valvo.

### MEZUROJ KAJ NORMOJ.

LA HARMONIKA KOMPARO DE RADIO-FREKVENCOJ PER LA KATOD-RADIA OSCILOGRAFO.—T. S. Rangachari.

Post aludo al la malfacilaĵoj interpreti la ciferojn de Lissajon laŭ la altaj proporcioj de frekvenco, la aŭtoro aludas al aliaj metodoj. Unu, ŝuldita al Kipping (*Western Electric Company*), donas malaltfrekvencon rondon kun altfrekvencaj randoj. La rotacia radistria metodo, ŝuldita al D-ro. D. W. Dye, estas poste aludita, aparte utiligante aranĝojn por doni malgrandan rondan movadon al la katoda radistrio je radio-frekvenco, dum la pligranda ronda aŭ elipsa movado okazas je aŭd-frekvenco.

Cirkvitaj aranĝoj por ĉi tiu celo estas priskribitaj, la aŭtoro aparte pritraktante unu aranĝon, kiu, oni trovis, estas tre oportuna. La rezultanta modelo havas la formon de rondo aŭ elipso kun maŝoj, kaj ekzemploj de modeloj efektive obtenitaj estas donitaj.

MALLONGA PRISKRIBO DE KELKAJ METODOJ DE RADIO-SIGNALA MEZURADO.—K. Sreenivasan.

Finita el la antaŭa numero.

La nuna parto revuas la metodon de Baumler, okupita en Germanujo dum 1923-4a pri la ricevado de Tuckerton. Oni poste traktas pri la metodo de Austin, donante detalojn pri la ĝenerala aranĝoj kaj pri la elpensajo uzita por mezuri telefonan kurenton. La metodo de la Marconi-Kompanio (priskribita de Round, Eckersley, Tremellen, kaj Lunnon) estas poste diskutita. Ĉi tiu estinte uzita ĉe la vasta ekspedicio al kaj de Aŭstralio. La Metodo de la Nacia Fizika Laborejo (ŝuldita al J. Hollingworth) estas laste priskribita, kun cirkvitaj diagramoj de la ĝenerala skemo, antenaj

kaj agordaj cirkvitoj, altfrekvenca amplifikatoro, k.t.p.

Aparato, kiu plenumas ĉi tiun priskribon, estas instalita ĉe Bangalore kaj uzita por observadoj faritaj koncerne la fortoco de Madras-Radio.

### HELPA APARATO.

LA DEMONSTRACIO DE NOVA PRECIZECA KONDENSATORO.—W. H. F. Griffiths.

La artikolo aludas al la demonstracio (donita ĉe la Januara Ekspozicio de la Fizika Societo de Londono) de la nova modelo de precizeca kondensatoro priskribita de la aŭtoro en *E.W. & W.E.* de Januaro kaj Februaro, 1928a.

La demonstracio permesis la faron de 5-procenta dislokigo de la tuta dielektrika interspaco, kaj kurvoj estas donitaj montrantaj komparojn inter ĉi-tiu kondensatoro kaj kondensatoro de la ordinara paralel-interspaca modelo.

La efekto de intersekcia skrenado en la nova kondensatoro estas ankaŭ montrita.

PONTO POR LA MEZURADO DE INDUKTECO KAJ KAPACITO.—D-ro. G. Zickner.

Oni donas priskribon de ponta cirkvito, kiu estas uzibla por induktecoj de 10 ĝis 100,000  $\mu\text{H}$ , kaj, per simpla komutatoro, por kapacitoj de 500  $\mu\mu\text{F}$  ĝis ĉirkaŭ 1  $\mu\text{F}$ .

La principoj de la ponto estas diskutitaj kaj diagramoj donitaj pri ĝia konekta metodo por ĉiu celo, dum funkcigaj kaj aliaj notoj estas ankaŭ donitaj.

### DIVERSAĴOJ.

RESUMOJ KAJ ALUDOJ.

Kompilita de la *Radio Research Board* (Radio-Esplorada Komitato), kaj publikigita laŭ aranĝo kun la Brita Registara Fako de Scienca kaj Industria Esplorado.

SIMBOLA ALGEBRO.—J. A. Ratchiffe.

La artikolo traktas pri la operatoro  $j = \sqrt{-1}$ , kun celo pruvi, ke la ordinaraĵoj de algebro estas aplikebla al ĝi. La signifo de "imaga numero" estas pritraktita kaj aplikita al ĝenerala kompleksa numero, kiel ekzemple  $x + jy$ . La geometria signifo de tia esprimo kaj de plua multipliko de ĝi per  $j$  estas poste diskutita. La ekzemplo de simpla sinusa ondo estas poste konsiderita, kondukante al la kompleksa esprimo

$$\cos pt + j \sin pt = e^{jpt}$$

kaj la korekta traktado kaj interpretado de ĝi estas montrita.

Redakcia artikolo kritikis kelkajn el la opinioj esprimitaj en la ĉi-supra artikolo, kaj atentigas pri kelkaj el la malfacilaĵoj asociigitaj kun la esprimo  $j = \sqrt{-1}$ .

### LIBRO-RECENZOJ.

Recenzoj estas donitaj, super la ĉeflitteroj de Prof. Howe, de la jenaj verkoj:—

"Amatora Radio-Vortareto en Kvin Lingvoj," eldonita en Prago.

"Der Sprechende Film" (La Parolanta Filmo), de Dénes von Mihály, eldonita en Berlin.

## Some Recent Patents.

The following abstracts are prepared with the permission of the Controller of H.M. Stationery Office, from Specifications obtainable at the Patent Office, 25, Southampton Buildings, London, W.C.2, price 1s. each.

### METAL RECTIFIERS.

(Convention date (U.S.A.), 19th January, 1927. No. 283901.)

A circular copper blank 1 is heated in an atmosphere of oxygen so as to produce a thin surface layer 2 of red cuprous oxide. The oxidised disc has an asymmetrical resistance, current passing more readily from the oxide to the metal than in the reverse direction. Difficulty is however experienced when using the combination as a rectifier, in making good electrical contact with the oxide layer.

To overcome this drawback a part of the oxide layer is reduced electrolytically. The surface layer is first pierced and contact made with the pure copper. The combination is then immersed in an electrolytic bath containing a saturated solution of potassium fluoride through which an electric current is passed. This reduces part of the oxide, so that the treated blank 1 consists of the mother copper, laced with a thin layer of oxide 2, the latter being coated in turn with a fine deposit 2a of oxide reduced to the pure metal, thus giving a good

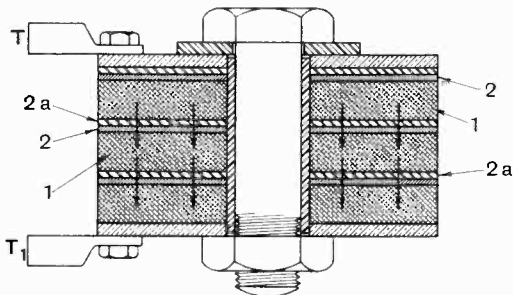

electrical contact on both sides of the rectifying layer. A number of treated blanks are then bolted together to form a rectifying unit, which is provided with terminals  $T$ ,  $T_1$  as shown in the figure.

Patent issued to Metropolitan Vickers Electrical Co., Ltd.

### STABILISING AMPLIFIERS.

(Application date, 20th January, 1927. No. 285,229.)

In order to counterbalance any tendency to instability caused by a common impedance in the H.T. supply to a multistage amplifier, additional impedances are inserted tending to set up reaction effects in opposition to the undesired back-coupling. As shown in the case of an amplifying set drawing H.T. supply from the mains, two impedances  $M$ ,  $M_1$ , the first consisting of a large capacity of 1 microfarad and the second of a high resistance up to 1 megohm, are shunted in series across the potentiometer resistance  $R$ .

The mid-point is connected to the grid of one of the valves, preferably the first, so that a fraction of the total H.T. voltage is applied to that valve.

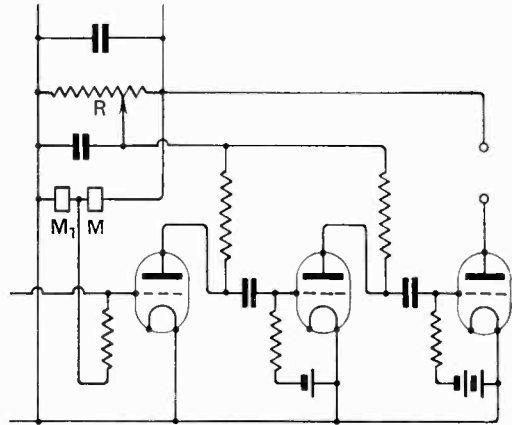

By regulating the resistance  $M_1$ , the applied grid-voltage, derived from the H.T. supply, can be adjusted to oppose the inherent back-coupling, both in phase and value, and so ensure stability.

Patent issued to Igranic Electric Co.

### CONSTANT-CAPACITY COUPLING.

(Application date, 15th November, 1927. No. 286578.)

The coupling condenser comprises two separate sets of fixed vanes  $C_1$ ,  $C_2$ , and movable vanes  $C_3$ , the shape of the plates being such that as the capacity, say, between the vanes  $C_3$  and  $C_2$  increases, that between  $C_3$  and  $C_1$  decreases by a corresponding amount. The two ends of the reaction coil  $R$  are connected to the fixed vanes  $C_1$ ,  $C_2$ , so that whilst

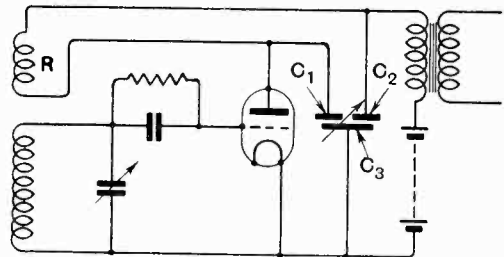

the value of the high frequency current flowing in the reaction coil can be suitably controlled, the overall shunt capacity from plate to filament remains constant.

This permits the degree of reaction to be varied

without affecting the external capacity of the valve, and consequently without de-tuning the grid circuit. The three-plate condenser also provides a constant-capacity path to by-pass high-frequency components away from the low-frequency stages of the amplifier.

Patent issued to The Igranic Electric Co., Ltd.

**PHOTO-ELECTRIC MODULATION.**

(Convention date (U.S.A.), 16th February, 1926. No. 266288.)

In television or picture-transmission systems the usual procedure is to sub-divide the picture into a number of isolated points and to transmit signal impulses corresponding to the consecutive changes in light intensity of these points. This normally involves the amplification by thermionic valves of the changes in current output from a photo-electric cell subject to a light-ray of varying intensity, the amplified current then being utilised to modulate a separate radio-frequency source or carrier-wave. In such a system, a sequence of uniform light intensity would not give rise to current variation unless a suitable analysing frequency is employed to cut up the otherwise "blank" interval.

The present method of modulation ensures that a dark stretch in the transmitted picture is indicated

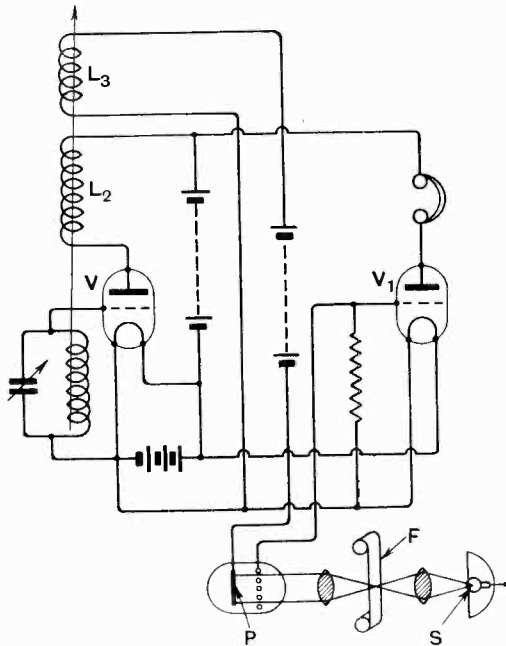

not by a "blank" interval but by a continuous weak signal, whilst bright stretches of picture are transmitted as stronger signals. The valve oscillator  $V$  generates a continuous carrier-wave. Coupled to the output coil  $L_2$  is a coil  $L_3$  inserted in series with a photo-electric cell  $P$  in the grid of an amplifying valve  $V_1$ .

Light from a source  $S$  passes through a photographic film  $F$  on to the photo-electric cell and so increases or diminishes the effective impedance of the input circuit  $L_3, P$ . The output from the amplifier  $V_1$  accordingly varies in proportion to the light and shade effects existing on the film  $F$  or other picture to be transmitted.

Patent issued to The Dubilier Condenser Co.

**SHORT-WAVE SIGNALLING.**

(Convention date (Germany), 29th October, 1926. No. 279823.)

Apart from temporary disturbances due to magnetic storms, serious difficulty in the reception of short-wave signals arises from fading and from static impulses which are known to have a pre-



dominantly vertical polarisation, *i.e.*, the electrical vector is directed at right-angles to the earth's surface. In order to minimise both these factors an horizontal loop aerial  $R$  is used for reception, so that vertically-polarised static is cut out. The transmitter  $T$  consists of a dipole oscillator mounted so that it can be set at any desired angle, in order to compensate for fading due to changes of polarisation in the wave-front during reflection at the Heaviside layer. This ensures that the incoming signals are horizontally polarised when they impinge on the frame aerial  $R$ , so that they produce a maximum effect on the receiver.

Patent issued to Dr. A. Esau.

**TELEVISION SYSTEMS.**

(Application date, 24th December, 1926. No. 287643.)

An image  $O_1$  of the object to be transmitted is projected by a lens  $L$  into the interior of a photo-electric cell  $V$ , the light-rays passing through a pierced or perforated anode  $A$ . The image is then scanned by a light-sensitive point  $g$  mounted at the end of a vibrating system comprising two flat springs  $a, b$ , joined end to end. The springs are vibrated individually by two external electromagnets  $M, M_1$ , fed by currents having frequencies of 1,000 and 10 cycles per second respectively. The same synchronising currents control a similar vibrating spring system at the receiving end  $R$ .

The sensitised point  $g$  is connected to the negative and the anode  $A$  to the positive pole of a high-tension battery  $B$ . The resulting variations of photo-electric current are amplified at  $N$  and are then transmitted, either by wire or through the ether, to the receiver where, after passing through an amplifier  $N_1$ , they are applied to the grid  $S$  of a tube  $V_1$  and so control the emission of electrons from a heated cathode  $K$ .

For reception the vibrating spring system  $a_1$ ,

$b_1$  is fitted with a fluorescent or luminous point  $g_1$ , forming the anode of the thermionic tube  $V_1$ . The bombardment of electrons on the sensitised point  $g_1$ , as it moves in synchronism with the

or by a metallic shield, which is connected to the H.T. positive and also to the laminated core  $C$ , as shown at the right hand. Any electrolytic leakage which may exist will now leave the high potential

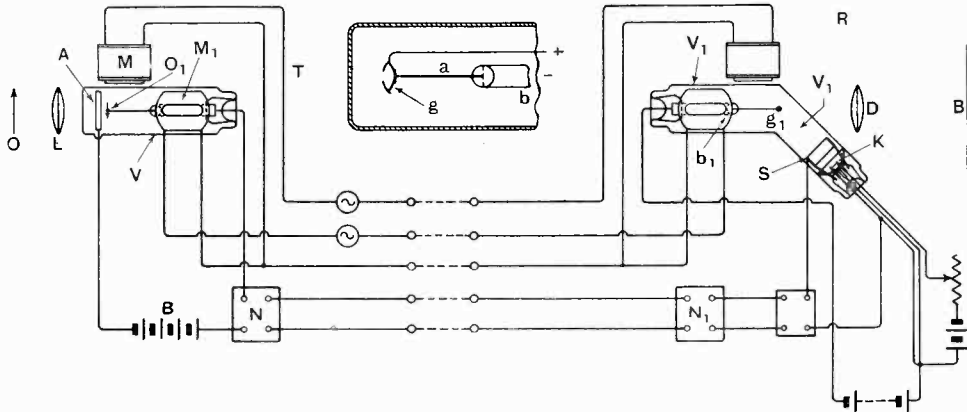

corresponding point  $g$  at the transmitting end, reconstitutes the original image, which is then projected by a lens  $D$  on to a viewing-screen  $B$ .

Patent issued to B. Rtcheouloff.

level from the metal screen  $M$ , which is made sufficiently substantial to withstand the resulting corrosion. The plate and grid terminals are shown at  $A$  and  $G$  respectively.

Patent issued to Burndept Wireless, Ltd.

**PROTECTING TRANSFORMERS.**

(Application date, 18th October, 1926. No. 287191.)

It is assumed that transformer breakdown is due not to excessive current or mechanical vibration, as is generally assumed, but rather to the effect of electrolytic leakage, whereby current tends to pass through the insulation layers and thus sets up corrosion at the point where it leaves the metal wire. In this connection it is pointed out that a certain amount of moisture is bound to be present during the process of manufacture of the insulating compound. In addition it is impossible to avoid the formation of minute pinholes in the layer protecting the finished wire.

These factors tend to set up a small electrolytic "leakage" current under the pressure of the high-tension voltage across the primary and secondary windings. In the arrangement shown in the figure, the primary winding  $P$  is separated from the secondary  $S$  by a layer  $M$  of thicker-gauge wire,

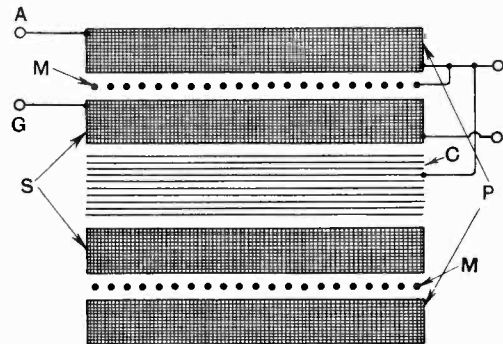

**LOUD-SPEAKERS.**

(Application date, 23rd December, 1926. No. 287631.)

Loud-speakers may be divided into two types according as the elastic restraint upon the diaphragm is (a) sufficient to ensure that the "natural"

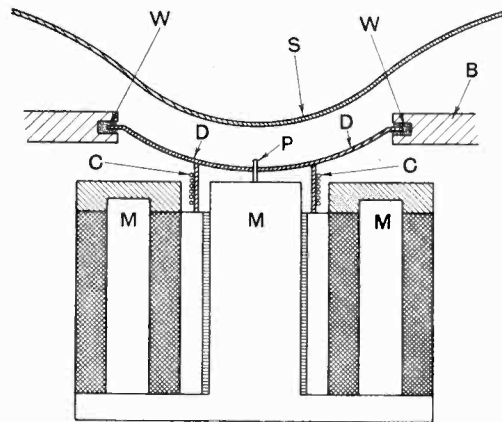

frequency of vibration is above the useful acoustic range, or (b) so small that the fundamental frequency falls below audibility. In the latter or inertia-controlled type, the weight of the vibratory element becomes an important factor, though when the diaphragm movement takes place in a horizontal plane the effect of weight can be compensated by a restraint at right-angles so that it does not directly affect the line of vibration.



The present invention is intended to compensate for the weight of the vibratory parts in the case where a moving-coil instrument, such as the well-known R.K. speaker, is mounted for vertical operation. As shown in the figure, a saucer-shaped diaphragm *D* is energised by means of a coil *C* located in the air-gap of a magnetic system *M*. The diaphragm is loosely mounted in cotton-wool packing *W* in an annular baffle-board *B*, and is centred by means of a pin *P*.

In addition to the normal output current from the amplifier, the coil *C* is supplied with a direct-current component of such strength that its reaction with the magnetic field exactly counter-balances the weight of the moving system. The emerging sound waves are dispersed radially by a sound-board *S* arranged parallel with the diaphragm *D*.

Patent issued to The British Thomson-Houston Co., Ltd.

**HIGH-FREQUENCY AMPLIFIERS.**

(Application date, 19th September, 1927. No. 286991.)

The input circuit, which comprises a potentiometer arrangement of condensers, is tuned by a variometer. Both the stages of valve amplification are tuned by a variometer *M* in series with an adjustable condenser *C*. Stability is ensured by keeping the value of the coupling-condensers below a certain critical point. Under these conditions the inductive reactance in the anode circuit is kept too low to allow self-oscillation to be set up through the valve capacities.

Each of the variometers *M* comprises three coils, the centre one being adjustable relatively to the other two. By a slight readjustment of the condensers *C* the sensitivity of the receiver can be maintained uniform over a wide band of wave-

**INTERVALVE COUPLINGS.**

(Application date, 9th March, 1927. No. 287312.)

In order to secure a voltage step-up, the capacity in the tuned-anode circuit of the valve *V* consists of three series connected condensers *C*<sub>1</sub>, *C*<sub>2</sub>, *C*<sub>3</sub>, the

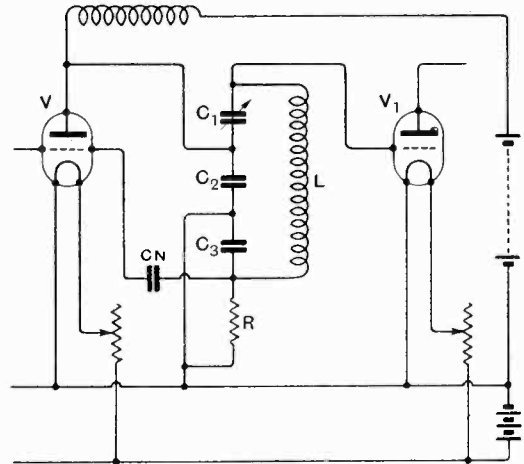

anode connection being taken to a point between the first two, whilst the common cathode connection goes to a point between the last two, as shown. When the circuit is tuned by means of the condenser *C*<sub>1</sub>, the voltage difference across the terminals of the condensers *C*<sub>1</sub> and *C*<sub>2</sub> in series will be greater than that across the variable condenser alone.

This higher voltage variation is accordingly applied to the input circuit of the next valve *V*<sub>1</sub>. A balancing condenser *C*<sub>N</sub> minimises inter-

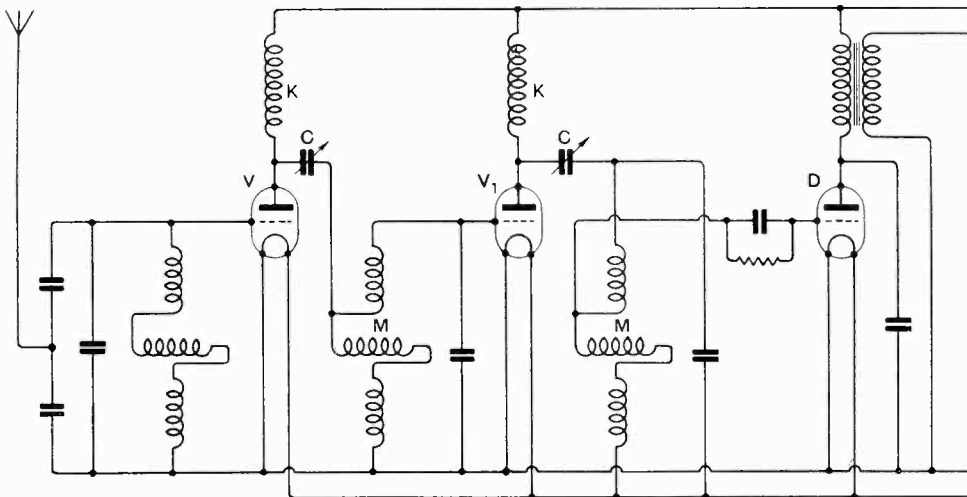

lengths. The tuned coupling-circuits *C*, *M* are dissociated from the high-tension supply through choke coils *K*.

Patent issued to Igranic Electric Co., Ltd.

electrode capacity coupling, its point of connection to the coil *L* being joined to the common cathode circuit by a high-resistance *R*. Any residual inter-electrode coupling, as the frequency increases, is

automatically compensated by the decrease in overall amplification due to the effective shifting of the anode tapping point as the capacity of the tuning condenser  $C_1$  is diminished.

Patent issued to W. J. Brown and Metropolitan Vickers, Ltd.

**MULTIPLE-STAGE VALVE SETS.**

(Convention date (Germany), 26th October, 1926\* No. 279843.)

The drawing shows one multiple valve stage  $A$  comprising two high-frequency four-electrode units  $V, V_1$ , followed by a multiple valve  $B$  comprising a detector  $V_2$ , low-frequency amplifier  $V_3$ , and power amplifier  $V_4$ . The inventor states that such a combination is peculiarly liable to feed-back effects of an obscure nature. Though the causes are difficult to identify, he has discovered that a simple and effective remedy consists in shielding the input condensers and leads of the two separate stages as indicated by the hatched area at  $S$  and  $S_1$ .

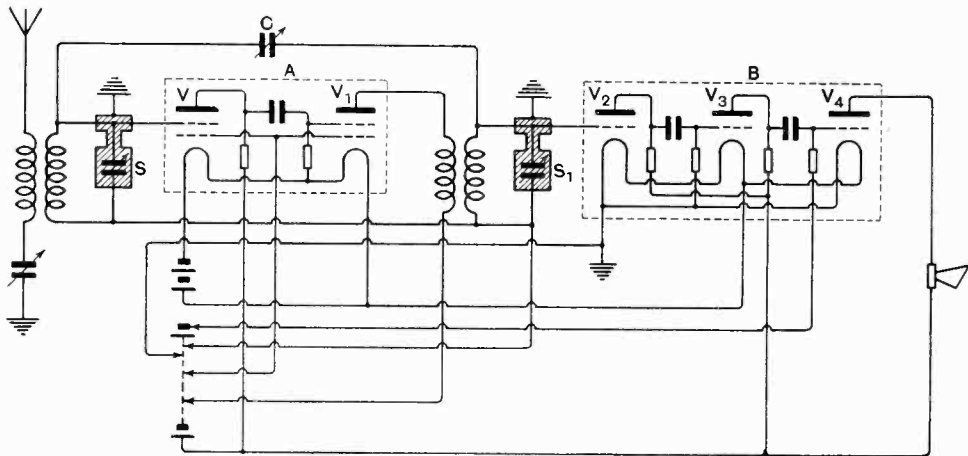

In addition the multiple valves  $A$  and  $B$  are also preferable enclosed in earthed metal screening cylinders (not shown). A small condenser  $C$  provides an adjustable reaction control.

Patent issued to Dr. S. Loewe.

**PHOTO-ELECTRIC MODULATORS.**

(Convention date (Germany), 15th October, 1926. No. 279068.)

The modulation of a carrier-wave by the feeble currents derived from a photo-electric cell offers considerable difficulties, particularly when it is necessary to cover a wide frequency range as in television systems or in the transmission of still-life photographs by line-wire or wireless.

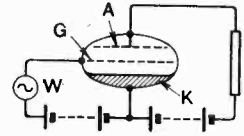

The single-stage photo-electric modulator shown in the figure comprises a light-sensitive cathode  $K$ , a control grid  $G$ , and an anode  $A$  which is perforated so that an incident ray of light can fall directly on to the cathode  $K$ .

The carrier-wave frequency is applied directly to the photo-electric cell from a separate source  $W$  connected across the grid and cathode. On exposure to light the carrier-wave is modulated in

accordance with the varying intensity of illumination, and the resultant complex current created in the output circuit of the cell can be amplified in any known manner without difficulty.

Patent issued to the Telefunken Co.