

WILSON AUL... WILSON FULL, JR.

EXPERIMENTAL WIRELESS & The WIRELESS ENGINEER

*A Journal of
Radio Research
and Progress*

Vol. IV IN THIS ISSUE APRIL
No. 43. 1927.

NEW DEVELOPMENT IN
RESISTANCE AMPLIFICATION.

PHOTO-TELEGRAPHY.

CAPACITY OF AERIAL SYSTEMS
WITH SERIES CONDENSERS.

AND OTHER

FEATURES.

2 1/6
NET

Publishers

BOOKS

that will help you!

You may have been looking for a set of advanced books. If you do not find the titles here, send a post card for complete list.

FREE ON REQUEST.

"Wireless Valve Transmitters." By W. James.

This is the first and only practical book on transmitting. It thoroughly covers the subject from A to Z, and each component is treated in detail. 270 pages, and over 210 figures and diagrams.

PRICE, 9/- net. By post, 9/6

"The Radio Experimenter's Handbook." Parts I. and II. By P. R. Coursey, B.Sc., F.Inst.P., A.M.I.E.E.

Part I. deals with the General Principles underlying the design of radio receiving equipment, and the second part is devoted to data and actual quantitative design, as well as to the description of many simple high-frequency measurements which can readily be carried out by the experimenter.

PRICE, 3/6 each net. By post, 3/10 each.

"Calculation and Measurement of Inductance and Capacity." By W. H. Nottage, B.Sc.

The more generally useful formulæ and methods of measurements for inductance and capacity are herein brought together in a convenient form. 224 pages. Over 80 illustrations and diagrams.

PRICE, 7/6 net. By post, 8/-

"Wireless Telephony and Telegraphy" —First Principles, Present Practice and Testing. By H. M. Dowsett, M.I.E.E.

Contents: The Nature of Electricity and of the Atom; Phase Displacement Effects in Elementary Circuits; Spark Discharge; Continuous Wave Transmitters; Thermo-Ionic Effects and Oscillation Valve

Phenomena; Special Apparatus used for High-speed Transmission and Reception; Measurement of Electric Current and Electro Motive Force; Measurement of Resistance, Capacity, Inductance and Frequency; Measurement of Direction, and the Distance of Transmitting Stations and the Intensity of Received Signals.

PRICE, 9/- net. By post, 9/6

"The Handbook of Technical Instruction for Wireless Telegraphists." By J. C. Hawkhead and H. M. Dowsett, M.I.E.E.

This book provides a complete theoretical course for the Postmaster-General's Certificate and deals particularly with apparatus used on board various ships. 406 pages. 316 diagrams and illustrations.

PRICE, 7/6 net. By post, 8/-

"The Wireless Telegraphist's Pocket Book of Notes, Formulæ and Calculations." By J. A. Fleming, M.A., D.Sc., F.R.S., M.Inst. E.E.

352 pages. 39 diagrams and illustrations. Contents: Mathematical Notes, Units, Dimensions and Systems of Measurement. High-frequency Resistance and Inductance Measurement. High-frequency Current and Voltage Measurement. Capacity Measurement and Predetermination. Bridge Methods of Measurement of Resistance and Inductance. High-frequency Cymometer Measurements, Wave-lengths and Decrements. Aerials and Electric Radiation. Transmitters and Transmitting Circuits. Receiving Circuits and Detectors. Practical Information for Wireless Operators. Various Mathematical Tables.

PRICE, 9/- net. By post, 9/5

*Obtainable from all booksellers
or direct from the Publishers:*

ILIFFE & SONS LTD., Dorset House, Tudor Street, London, E.C.4

Kindly mention "Experimental Wireless" when replying to advertisers.

21 days test at our expense



**"ACTON" RANGE
L.T. ACCUMULATORS**



"Acton" Celluloid

Offered at prices which are strictly competitive with the lowest on the market, the "Acton Range" represents remarkable value. Each is soundly designed and well made, and maintains the high standard of performance for which all C.A.V. Accumulators are well known.

2A. 5	2-vlt.	20-amp. hrs.	(Act.)	11/0
*2A. 7	"	30 "	"	13/6
*2A. 9	"	40 "	"	16/0
2A. 11	"	50 "	"	18/6
2A. 13	"	60 "	"	21/0

4 and 6-volt assemblies at pro rata prices.

* These models are repeated in moulded glass containers at the same price.

H.T. RADIO ACCUMULATORS

To prove our absolute confidence in these accumulators, we guarantee, if you are not satisfied, to accept return within 21 days from purchase date, and refund money in full provided battery is returned intact to the Agent from whom it was purchased.

C.A.V. H.T. Accumulators represent an epoch-making advance as compared with dry batteries. When dry batteries are down, they are done, and frequent renewals make them more expensive. C.A.V. H.T. Accumulators will last for years, and only need recharging, approximately, every four months. They give bigger volume and are silent in operation.

Size: 8½" × 7" × 7½" High.

Supplied fully charged, ready for use, and with distilled water filler

Also supplied in 30 & 90-Volts at pro rata prices.

60 VOLTS.

60/-

Price in U.K

OBTAINABLE FROM ALL RADIO SUPPLIERS

CAVandervell & Co., Ltd;
ACTON, LONDON, W. 3.

Telegrams :
"VANERIA, ACT.
LONDON."

Telephone :
CHISWICK 3801
(Private Branch Exchange)

Kindly mention "Experimental Wireless" when replying to advertisers.

ANOTHER
TRIBUTE

*JUST ONE AMONG MANY..... BUT.....
BEING WELL EARNED..... IS JUSTLY
TREASURED..... ADDING TO THE
FAME OF THE..... ALREADY FAMOUS.....*

LOW FREQUENCY  **TRANSFORMER**

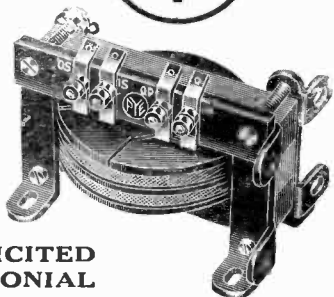

2.5 : 1 17/6
4 : 1 17/6
6 : 1 20/-

**ALSO WITH
TAPPED
SECONDARY**

**UNSOLICITED
TESTIMONIAL**

*received by Mr. H. T. Knight, Wireless Retailer,
Westcliff-on-Sea.*

Dear Sir,

I am very glad I took your advice on Saturday last, when I purchased a Pye L.F. transformer.

After having trouble with my set due to faulty resistance coupling and indifferent transformers, it is now quite refreshing to listen to a broadcast which is free from any distortion coupled with a silent background.

At the reduced price of 17/6 I consider this transformer excels in quality any 25/- or 30/- transformer on the market.

Again thanking you,

223. Leigh Road,
Leigh-on-Sea.

I am, Yours Faithfully,
(Sga.) G. Boreham.

8th February, 1927.

**MAKE CHOKES TOO.....
BOTH GUARANTEED 1 YEAR**

32, 110, 150 HENRIES 12/6
200 or 300 HENRIES 17/6
With two tappings 2/6 extra.

*Illustrated descriptive literature sent post free on application to
Dept. E,*

**W. G. PYE & CO.,
CAMBRIDGE, ENGLAND.**

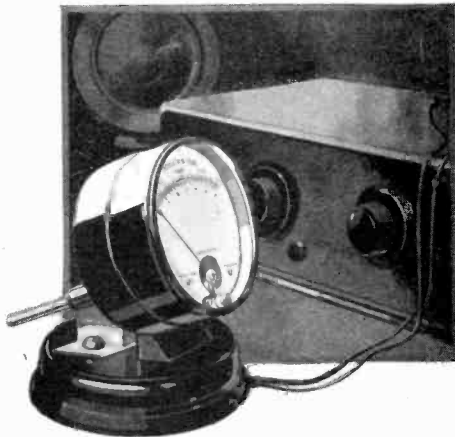

**TEST UNDER
WORKING CONDITIONS**

IT is essential that the three variable voltages applied to a radio set, which are under your own control, must be regulated while the set is actually in operation.

Open circuit tests, that is, tests made direct from the battery terminals, are useless, as the voltage drop due to resistance in the circuit is very misleading.

In order to ascertain correctly the actual voltage applied to the valve electrodes readings must be taken from different points in the circuit, with a Weston Model 506 Pin Jack Voltmeter which is supplied with a high range stand, Pin Jacks and long testing cables. These enable you to reach any part of the set and take accurate high and low tension readings.

For voltage adjustments which, you must remember, are equally as important as tuning adjustments, only a Weston Instrument is sufficiently accurate to be of any use to you. Weston Instruments are standard the world over and on their unvarying reliability you may depend entirely for more economical and efficient operation of your set.

Weston Model 506 Pin Jack Voltmeter.
Price complete with testing cables, £2.0s.

WESTON
STANDARD THE WORLD OVER
Pioneers since 1888

Weston Electrical Instrument Co. Ltd.
15, Gt. Safron Hill,
London, E.C. 1

Kindly mention "Experimental Wireless" when replying to advertisers.

THE OFFICIAL ORGAN of the RADIO SOCIETY OF GREAT BRITAIN

EXPERIMENTAL WIRELESS

and The WIRELESS ENGINEER

A Journal of Radio Research and Progress

Technical Editor : Prof. G. W. O. HOWE, D.Sc., M.k.E.E. Editor : HUGH S. POCOCK. Assistant Editors : W. JAMES and F. H. HAYNES.

VOL. IV. No. 43.

APRIL 1927.

MONTHLY.

CONTENTS OF THIS ISSUE.

	PAGE
EDITORIALS	193
A NEW DEVELOPMENT IN RESISTANCE AMPLIFICATION. By F. M. COLEBROOK, B.Sc., A.C.G.I., D.I.C.	195
BOOK REVIEW	205
THE RESULTANT CAPACITY OF AERIAL SYSTEMS EMPLOYING SERIES TUNING CONDENSERS. By W. H. F. GRIFFITHS	206
SHORT-WAVE WIRELESS TELEGRAPHY. ABSTRACT OF A PAPER READ BEFORE THE WIRELESS SECTION, I.E.E., by T. L. ECKERSLEY	213
MATHEMATICS FOR WIRELESS AMATEURS. By F. M. COLEBROOK, B.Sc., A.C.G.I., D.I.C.	223
PHOTOTELEGRAPHY. A LECTURE AND DEMONSTRATION BEFORE THE R.S.G.B. by T. THORNE-BAKER, M.I.R.E., F.Inst.P., F.R.P.S.	229
TELEVISION. A CONTRIBUTED DISCUSSION BY DÉNES VON MIHÁLY ON THE PAPER RECENTLY READ BEFORE THE R.S.G.B.	239
CORRESPONDENCE	241
ABSTRACTS AND REFERENCES	242
ESPERANTO SECTION	251
SOME RECENT PATENTS	253

The Editor is always prepared to consider suitable articles with a view to publication. MSS. should be addressed to the Editor, "Experimental Wireless and the Wireless Engineer," Dorset House, Tudor St., London, E.C.4. Especial care should be taken as to the legibility of MSS. including mathematical work.

Published Monthly, on the first of each month.

Editorial Offices : 139-40, FLEET STREET, LONDON, E.C.4. Telephone : City 4011 (3 lines).

Advertising and Publishing Offices : DORSET HOUSE, TUDOR STREET, LONDON, E.C.4.

Telegrams : "Experiwyr, Fleet, London." Telephone : City 2847 (13 lines).

COVENTRY : Hertford St. BIRMINGHAM : Guildhall Buildings, Navigation St. MANCHESTER : 199, Deansgate.

Telegrams : "Cyclist, Coventry."
Telephone : 5210 Coventry.

Telegrams : "Autopress, Birmingham."
Telephone : 2970 and 2971 Midland.

Telegrams : "Iliffe, Manchester."
Telephone : 8070 and 8071 City

Subscription Rates, Home and Abroad : One Year, **32/-** ; six months, **16/-**, post free ;
single copies, **2/8**, post free.

Kindly mention "Experimental Wireless" when replying to advertisers.

DO YOU KNOW THE THERMIONIC VOLTMETER?

(Moullin Patent)

It measures high-frequency voltages as low as 0.25 volt with an absorption of power less than one micro-watt.

Give readings that are independent of frequency up to at least one million p.p.s.

Is many times more sensitive than any other A.C. pointer instrument.

Cannot be damaged by overloading.



Full particulars sent on request.

—A FEW APPLICATIONS—

- Measurement of wireless signal strength.
- Determination of losses in insulators.
- Measurement of high frequency resistance.
- Harmonic analysis of alternating wave forms.
- Measurement of the amplification produced by triode amplifiers.

CAMBRIDGE INSTRUMENT CO LTD

WORKS - LONDON. A. CAMBRIDGE Head Office & Showrooms - 45, GROSVENOR PLACE LONDON. S. W. 1

STANDARD TABLES and EQUATIONS in RADIO - TELEGRAPHY

By Bertram Hoyle, M.Sc.Tech., A.M.I.E.E.

THIS BOOK is extremely valuable to the advanced radio worker. It saves time and ensures a high degree of accuracy in working out all the necessary mathematical calculations after obtaining experimental data. Many of the tables have never been published in so complete a form before, and all of them can be relied upon to be absolutely accurate within the limits indicated. The volume is undoubtedly of the greatest assistance to the busy radio research worker.

Price 9/- Post Free 9/5

Obtainable from the Publishers of "EXPERIMENTAL WIRELESS"

ILIFFE & SONS LTD., Dorset House, Tudor St., London, E.C.4.

DICTIONARY OF WIRELESS TECHNICAL TERMS

Definitions of Terms and Expressions commonly used in Wireless Telephony & Telegraphy

Compiled by S. O. PEARSON, B.Sc., A.M.I.E.E.

For all those experimenters and research workers who are accustomed to read widely in wireless subjects, the **DICTIONARY OF WIRELESS TECHNICAL TERMS** will prove a valuable little book of handy reference. The volume is well-illustrated and can be recommended to every young student.

PRICE 2/- BY POST 2/3

From all leading booksellers or direct from:
ILIFFE & SONS LTD.,
Dorset House, Tudor Street, London, E.C.4

EXPERIMENTAL WIRELESS & The WIRELESS ENGINEER

VOL. IV.

APRIL, 1927.

No. 43.

Editorials.

Effect of Natural Phenomena on Signal Strength.

SINCE the first transatlantic transmissions twenty-five years ago attempts have been made to correlate the fluctuations in the strength of the received signals with various natural phenomena. In addition to the position of the sun, the effect of which is beyond all doubt, the phases of the moon, the height of the barometer, the humidity, the temperature, the earth's magnetic field and sun spots have all been regarded as possible causes of fluctuation. Even if some correlation appears to exist between signal strength and any of these variables, it does not follow that that meteorological condition has any direct effect on the electromagnetic waves; they may both be due to some other cause. Dr. L. W. Austin has recently reported that, as the result of tests made at Washington on signals from stations between 100 and 200 miles away, he has come to the conclusion that whenever the temperature rises along the signal path there is a tendency for the strength of the signal to drop, and conversely a falling temperature tends to produce a stronger signal, although the temperature effects are often masked by other unknown influences. It must be remembered that these results were only obtained for ranges between 100 and 200 miles over which the temperature would be fairly uniform. Assuming that the correlation really exists and is not merely

accidental it seems useless to try to find an explanation unless one knows what other meteorological changes are associated with a rise or fall of temperature and what effect these changes will have on the ionisation of the upper atmosphere. In case any enthusiastic amateur experimenter thinks of making similar observations we would point out that Dr. Austin's conclusions were based on two years' observations; to be of value the tests must cover a long period and the results must be carefully analysed before one can say whether any relation exists between the two phenomena. The same remarks apply to observations of the effect of other meteorological variables such as the phases of the moon.

Transmitter Frequency Control.

ONE of the problems of C.W. transmission has always been the maintenance of a constant frequency. Very ingenious and elaborate apparatus has been developed for enabling high frequency alternators to maintain a reasonable constancy of speed during transmission. With valve generators the frequency depends primarily on circuit conditions which can be maintained constant to a high degree of accuracy, but not to a sufficiently high degree to meet the ever increasing requirements of modern developments. It is not merely a question of maintaining the frequency constant but of maintaining it at a definite value. To make the frequency more definite than it

would be if controlled entirely by electrical constants, a lightly damped mechanical oscillatory system is employed to control the electrical oscillations. In some cases this is a tuning fork, in others it is a piezo-electric crystal. In either case the frequency can be maintained at a definite value to a high degree of accuracy, provided the mechanical oscillator is maintained at a constant temperature.

At the recent exhibition held by the Physical Society of London an ingenious device was shown in operation by Dr. Dye which opens up a further possibility in the control of frequency. A tuning fork which is adjusted as nearly as possible to 50 oscillations per second receives every second an impulse from a clock, the pendulum of which operates a contact and causes a momentary current to flow in the iron-cored coil which acts on the fork. Any slight departure of the fork from the phase corresponding to a frequency of exactly 50 oscillations per second is rectified every second by the impulse from the clock. If the oscillations over a period of several seconds are analysed the principal component will be found to have a frequency exactly 50 times that of the clock impulses.

It is not easy to foresee the effect of trying to use such a device to control the frequency of a transmitting station, but the possibility is suggested of controlling the frequency, say, of the Rugby Station from a clock in Greenwich Observatory.

Variable Air Condensers.

WHEN the variable air condenser was first introduced in the early days of radio-telegraphy it was invariably contained in a glass jar with a massive ebonite top. In the ebonite top was a groove into which the jar was fitted with india-rubber packing. The condenser was as air-tight and dust-tight as it was possible to make it. The glass jar had the advantage of enabling one to inspect the spacing between the fixed and moving plates; it also made it possible to convert the air condenser into an oil condenser when it was desired to employ higher voltages, but it made the condenser very bulky and cumbersome. Often, moreover, the glass jar was subsequently lined with tinfoil to make its calibration independent of external influences. For small

condensers the glass jars were sometimes replaced by cylindrical brass cases and for larger sizes metal lined wooden boxes replaced the jars.

In those days nobody ever dreamt of using a variable air condenser in its naked condition, in fact, one hesitated to remove it from its case once it had been cleared and put in, for fear that fluffy material floating about the room might get between the plates and thus impair the insulation. Great care was taken to clean the plates and remove any such foreign material either by washing in spirit, or by an air-blast or by sweeping a long pointed flame between the plates, and the condenser was then hurriedly put into its case.

With the advent of broadcasting and the set builder, however, the air condenser entered on a new phase. Tens of thousands of variable air condensers have been built into sets without any protection whatever, although the distance between the fixed and moving plates has been cut down to the absolute minimum. If the set were contained in a dust-proof case, which was rarely opened, the danger of the condensers becoming dirty would be small, but this is very seldom done. Many an experimenter who regards with satisfaction the obvious insulation between the fixed and moving system of his condensers, would be very surprised if he held them up to the light and saw the collection of atmospheric flotsam and jetsam adhering to the plates. The danger is greater with fixed air condensers and we have noted with satisfaction that at least one manufacturer has recently enclosed these in a dust cover. We recently met a case in which reception was being spoilt by a background of noise; after much time had been spent in testing batteries, valves, and other components, the trouble was instantly cured by a puff of the bellows on the air condenser.

In view of the large amount of work which has recently been put into the design of the variable air condenser, it is surprising that more attention has not been paid to the problem of enclosing it in a light metal cover which would serve at the same time as an electrostatic screen and thus prevent any interaction between the condenser and other parts of the apparatus.

A New Development in Resistance Amplification.

By F. M. Colebrook, B.Sc., A.C.G.I., D.I.C.

THERE appeared in *The Wireless World* for 23rd September, 1925 (No. 319, Vol. XVII., No. 13, pp. 395-398), a descriptive account by Dr. H. Kröncke of a new development in resistance amplification due to Von Ardenne and Heinert. The distinctive feature of the new method is the employment of anode resistances of much greater magnitude than those which have hitherto been considered suitable. In place of the customary resistances of 50,000 to 100,000 ohms, Von Ardenne and Heinert advocate the use of resistances of the order of megohms.

This drastic departure from former practice is calculated to raise a number of questions in the minds of those who have considered this subject in any detail, and the account

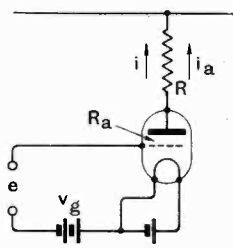

Fig. 1.

given by Dr. Kröncke, clear and explicit though it is, does not really answer these questions.

Hitherto it has been assumed by all those who have written on the subject of the design of resistance-capacity amplifiers (the present writer included) that the anode resistances used should be of such magnitude that the fall of potential in the resistance would still leave sufficient voltage at the anode to ensure that the valve will operate in the straight-line region of its characteristics, even with a negative grid voltage. This condition restricts the magnitude of the anode resistances to about 50,000 ohms for moderate anode battery voltages (150-

200). With such comparatively low anode resistances it is easy to show, on the assumption of approximately straight line characteristics for the valve, that the voltage amplification obtainable by the usual circuit arrangement (illustrated in Fig. 1) is

$$\frac{R}{R + R_a} \mu$$

where R_a and μ are respectively the internal resistance and the voltage factor of the valve.

Now it is clear that if anode resistances of 1 to 3 megohms are used, with moderate anode battery voltages of say 50-100 volts, as recommended in the description referred to above, practically the whole of the anode battery voltage will be absorbed in the resistances, leaving a very low voltage, 10 to 20 volts or so, on the anode. Under these conditions the valve will certainly not be operating in the straight-line region of its characteristics, and it might therefore be anticipated that the anode current-grid voltage characteristic with the resistance in circuit (termed by Von Ardenne and Heinert "working characteristic"), would show a pronounced curvature, which curvature would cause partial rectification and distortion in the amplification of low frequency E.M.F.s. Actually, however, the working characteristics obtained under these conditions are remarkably straight over quite useful ranges of grid voltage. A typical example is reproduced from Dr. Kröncke's account in Fig. 2. The question therefore arises, how is it that these working characteristics do not show the curvature that one might anticipate from such low anode voltages? Is it explainable in terms of the known forms of characteristics of ordinary triode valves, or is it possibly a special feature of the type of valve used by these two experimenters?

The object of the present paper is to answer the above questions and to analyse

in general terms the operation of a triode valve with a very high resistance in the anode circuit, illustrating the analysis by reference to typical valves of standard British make. This will make possible a critical discussion of the possibilities of this method of amplification and the determination of the most

Triode Valve with Resistance in the Anode Circuit.

For the purposes of the analysis it will be assumed that the anode current of a triode valve can be very approximately represented over the whole practicable range of grid and anode voltages (below saturation) by an equation of the form

$$i_a = f(v_a + \mu v_g) = f(V),$$

where

$$V = v_a + \mu v_g.$$

Some experimental confirmation of this will be given later. The idea is one with which readers of this journal are already familiar, for it is implicit in the method of description adopted in the section headed "Some Valves Tested." The "lumped volt" characteristic of a valve, of which a typical example is reproduced in Fig. 3 from p. 968 of No. 27, Vol. II. of this journal, is in fact a curve

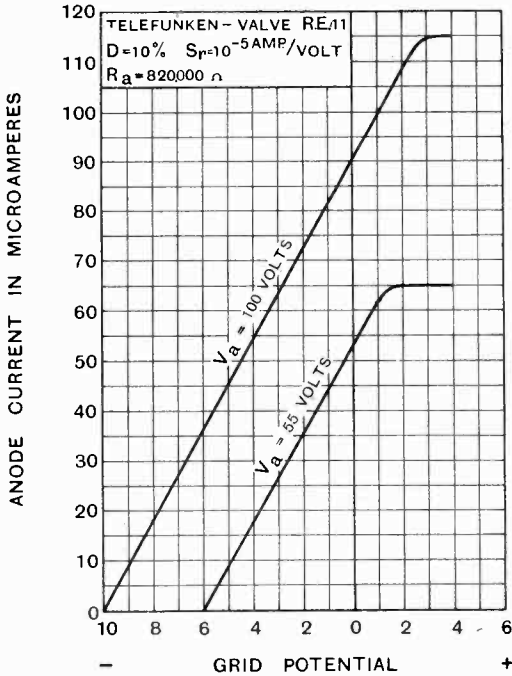

Fig. 2.

suitable magnitudes of the component elements.

It may be stated in advance that the method appears to be very satisfactory, giving a high degree of amplification per stage with a good degree of freedom from distortion. It appears in fact to have all the well-known advantages of resistance capacity amplification combined with a higher degree of amplification per stage than has hitherto been conveniently obtainable, at the same time avoiding the necessity for high anode battery voltages. In qualification of this it should be stated that the claims made for the method in the original paper cannot be fully maintained in practice, and that the estimate of the possibilities of further development are a little over-enthusiastic.

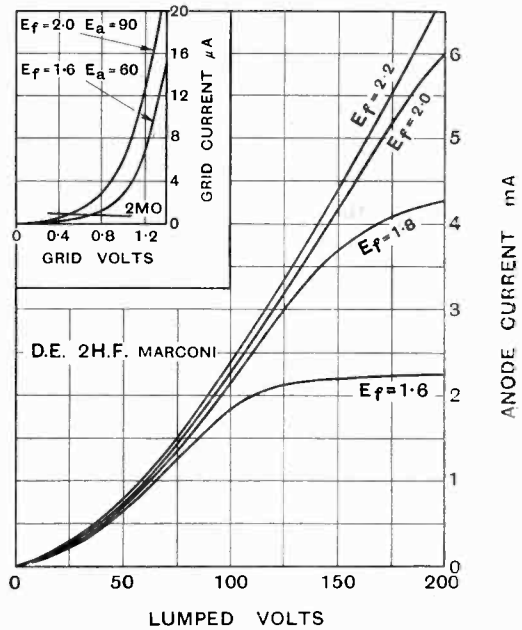

Fig. 3.

showing the variation of the anode current with the lumped voltage V . It has the obvious advantage of describing the valve for a very wide range of grid and anode voltages by means of a single curve, with an accuracy which is quite sufficient for most practical purposes.

The slope of this characteristic is an important quantity in relation to small changes of v_a and v_g . For any given value of V the slope is

$$\frac{\partial i_a}{\partial V} = \frac{\partial f(V)}{\partial V} = f'(V),$$

but since

$$V = v_a + \mu v_g$$

$f'(V)$ is the same as $\partial i_a / \partial v_a$. For a small change δv_a in the anode voltage the corresponding change δi_a in the anode current is given by

$$\begin{aligned} \delta i_a &= \frac{\partial i_a}{\partial v_a} \delta v_a \\ &= \delta v_a \left/ \frac{\partial v_a}{\partial i_a} \right. \end{aligned}$$

so that with respect to these small changes of current and potential the quantity $\partial v_a / \partial i_a$ is in effect a resistance and is usually written R_a . Thus

$$f'(V) = 1/R_a$$

Referring to the typical lumped volt characteristic of Fig. 3, it is seen that in general R_a will not be constant with respect to V . In fact, from $V = 0$ to about $V = 80$ the slope of the characteristic increases steadily, and R_a , which is the reciprocal of the slope, will therefore decrease. From about $V = 80$ up to the saturation point the slope remains very nearly constant. The range of anode and grid voltages, included in the range $V = 80$ upwards to the saturation value of V , correspond to what is known as the straight-line region of the valve characteristics. It is the approximately constant value of R_a corresponding to this region that is intended by the term "internal resistance" in the usual specification of a valve.

In the straight-line region the second differential coefficient of the lumped volt characteristic, *i.e.*,

$$\frac{\partial^2 f(V)}{\partial V^2} = f''(V)$$

is negligibly small. The higher derivatives will also be negligibly small in consequence. For the region corresponding to the lower values of V , the second and higher derivatives of the lumped volt characteristic will have values which are by no means negligibly small.

Consider now the effect of inserting a resistance R in the anode circuit. The anode

current will fall to a new value which, since it will be regarded as an initial value with respect to subsequent changes, will be written i_0 . There will be a corresponding fall of potential Ri_0 in the anode resistance, and the value of i_0 is therefore given by the implicit relation

$$\begin{aligned} i_0 &= f(v_a - i_0 R + \mu v_g) \\ &= f(V_0) \end{aligned}$$

Suppose now that a small E.M.F. e is added to v_g . There will be a consequent change in the anode current which can be represented as the addition of a small current i , so that the new value for the anode current is $i_0 + i$. (The symbols e and i are used in preference to the more usual but rather more cumbersome symbols δv_g and δi_a , since these changes can be quite legitimately regarded as additional terms superimposed on the existing terms.) The new value of the anode current is related to the anode and grid voltages by the equation

$$\begin{aligned} i_0 + i &= f\{v_a - (i_0 + i)R + \mu(v_g + e)\} \\ &= f\{V_0 + (\mu e - iR)\} \end{aligned}$$

Now the function on the right-hand side can be expanded by Taylor's Theorem into the series

$$\begin{aligned} i_0 + i &= f(V_0) + (\mu e - iR)f'(V_0) \\ &+ \left(\frac{\mu e - iR}{2}\right)^2 f''(V_0) + \left(\frac{\mu e - iR}{6}\right)^3 f'''(V_0) + \text{etc.}, \end{aligned}$$

and since

$$i_0 = f(V_0)$$

the value of i alone is given by

$$\begin{aligned} i &= (\mu e - iR)f'(V_0) \\ &+ \left(\frac{\mu e - iR}{2}\right)^2 f''(V_0) + \left(\frac{\mu e - iR}{6}\right)^3 f'''(V_0) \text{ etc.} \end{aligned}$$

The change of potential across the anode resistance due to this change of grid voltage is $v = iR$. The potential amplification given by the system is therefore v/e . Now for distortionless amplification it is necessary that v/e should not vary with e , *i.e.*, there must be straight-line relationship between v and e . The above equation for i shows, however, that this straight-line relationship between v and e can only be obtained if all the terms beyond the first on the right-hand side are negligibly small. Otherwise the solution for i will clearly contain terms in e^2 and higher powers of e .

Now the terms beyond the first on the right-hand side can be made negligibly small in two ways. In the first place, the initial

value V_0 can be made so large that it falls within the straight-line range of values for V . Under this condition $f''(V_0)$ and the higher derivatives will be negligibly small, and the equation for i will reduce to

$$i = \frac{(\mu e - iR) f'(V_0)}{(\mu e - iR) / R_a}$$

R_a being the approximately constant minimum value of this quantity. It is about 25,000 ohms for the valve having the lumped volt characteristic shown in Fig. 3. The solution of the above equation for i gives the well-known form

$$i = \frac{I}{R + R_a} \mu e$$

whence

$$Ri = v = \frac{R}{R + R_a} \mu e$$

the valve. A higher value than this can only be obtained by increasing R , which will call for a correspondingly higher anode battery voltage. This has always been a disadvantage inherent in the resistance-capacity amplifier designed to operate in the straight-line region of the valve characteristics.

It appears from the straightness of the working characteristics obtained by Von Ardenne and Heinert with anode resistances of the order of megohms that this restriction to the straight-line region of the valve characteristics is not in fact necessary. A further examination of the equation for i will show the reason for this. It will be seen that the coefficients of $f''(V_0)$ and the higher derivatives of the characteristic are $(\mu e - iR)^2$ and higher powers of $(\mu e - iR)$.

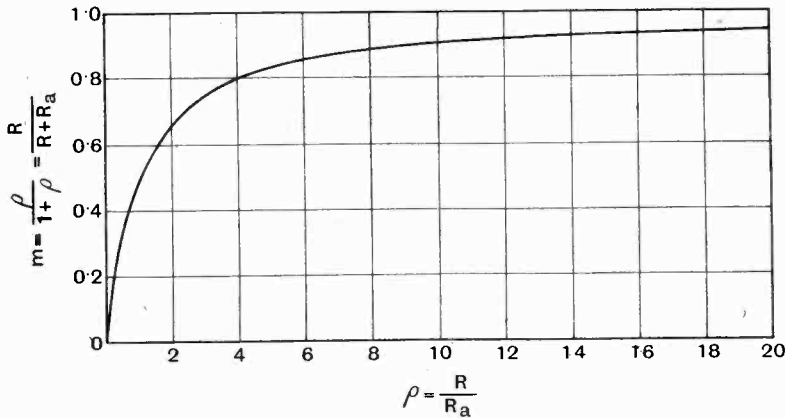

Fig. 4.

The amplification factor is therefore

$$\frac{R}{R + R_a} \mu = \frac{\rho}{1 + \rho} \mu = m \mu$$

where ρ is written for R/R_a . The variation of m with ρ is shown in the curve of Fig. 4.

Now a reference to the typical lumped volt characteristic will show that, even if the anode battery voltage is rather inconveniently high (150 to 200), R cannot be made much greater than about 40,000 ohms if the straight-line condition is to be satisfied over a useful range of negative grid voltage. This will give about 1.5 for ρ , for which the corresponding value of m is only 0.6. Thus the amplification obtainable free from distortion is only 0.6 of the voltage factor of

If therefore $(\mu e - iR)$ can be made a small quantity, even though μe is not small, then the first term of the series will be large compared with the remaining terms, and there will be in consequence an approximately straight-line relationship between i and e . Now if the terms in $f''(V_0)$, etc., are negligibly small

$$iR = \frac{R}{R + R_a} \mu e$$

as already shown, and

$$(\mu e - iR) = \frac{R_a}{R + R_a} \cdot \mu e$$

The expression $(\mu e - iR)$ will therefore be small, provided R is made very large

compared with R_a . This of course is precisely what Von Ardenne and Heinert have done. By making R very large, then in spite of the fact that V_0 is now very small and R_a correspondingly larger than its straight-line magnitude, R will still be large enough compared with R_a to satisfy the above

condition, and a very approximately straight line working characteristic will result.

Notice also that the amplification factor under these conditions will be, as before,

$$\frac{R}{R_a + R} \mu$$

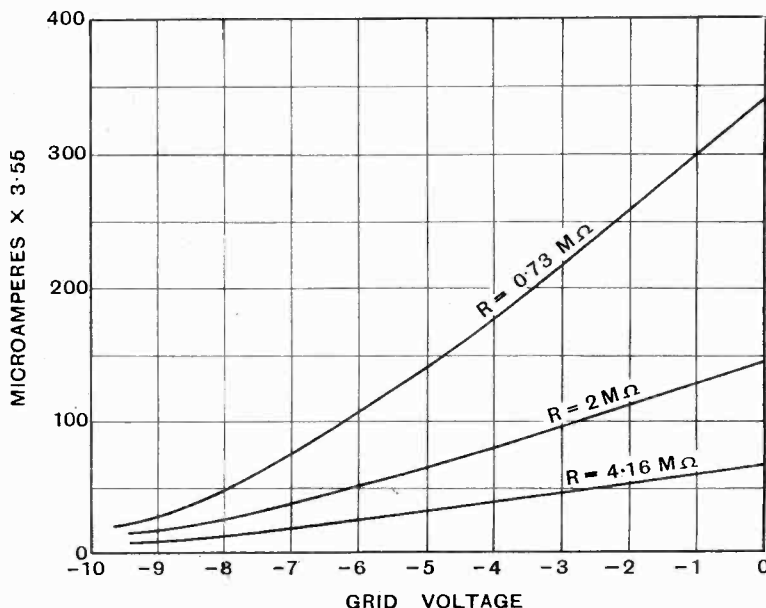

Fig. 5. Valve DE₂HF.; Anode battery voltage, 100; Normal filament voltage, 1.8; Actual filament voltage, 1.18; Voltage factor (normal filament) 9.5; Amplification factors (mean values), R = .73 MΩ 8.0; R = 2 MΩ, 8.44; R = 4.16 MΩ, 8.1.

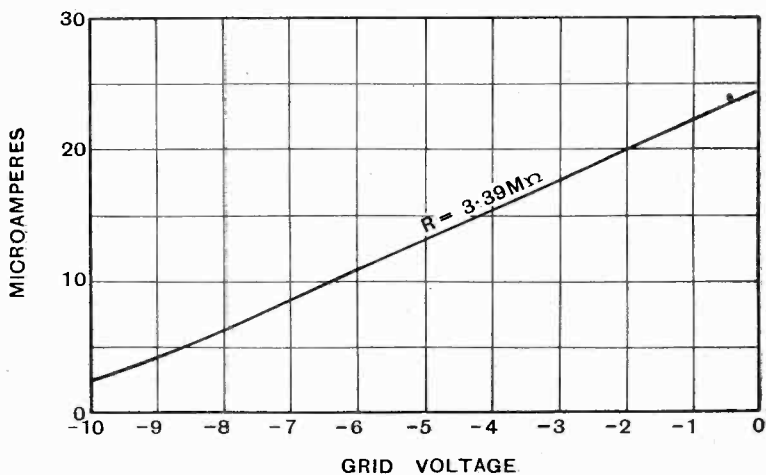

Fig. 6. Valve DER; Anode battery voltage, 100; Normal filament voltage, 1.8; Actual filament voltage, 1.2; Voltage factor (normal filament), 7.8; Amplification factor, 7.4.

and since R is now very large compared with R_a this will be nearly equal to μ so that nearly the full voltage factor is operative.

It is found that the condition can be fulfilled satisfactorily in practice by making R from 1 to 3 or 4 megohms according to the type of valve used. It must be remembered that the approximate rectilinearity will only obtain as long as R is large compared with R_a . Now R_a will increase continuously as the grid is made more and more negative so that the foot of the working characteristic will necessarily be curved as it is in the normal characteristic, approaching

does not in any way imply any special merit or even special suitability in the valves specified. They are simply taken as typical of valves of their respective kinds, and any others having similar characteristics would do equally well.)

It will be seen that the lines are sensibly straight over quite considerable ranges of negative grid voltage, and that in general the higher the value of R the straighter the characteristic. (There is, however, an upper limit for R which will be discussed later.) In estimating the useful range of grid voltage variation it must be remembered that about

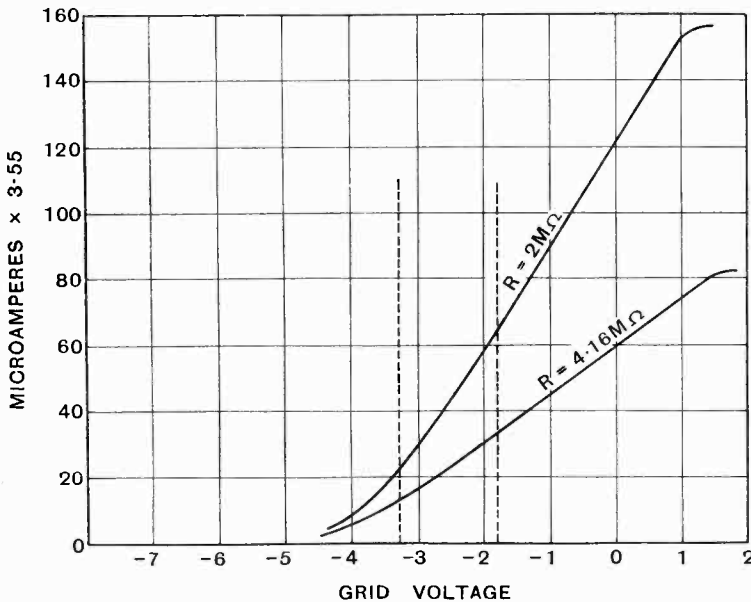

Fig. 7. Valve DE_5B ; Anode battery voltage, 100; Normal filament voltage, 5; Actual filament voltage, 2.4; Voltage factor (normal filament), 18.8; Amplification factor (mean values), $R = 2.0 M\Omega$, 16.7; $R = 4.16 M\Omega$, 17.2.

the axis tangentially. The curves published in Dr. Kröncke's account are misleading in this respect. They are shown as cutting the bottom axis at quite a sharp angle, a fact which suggests a certain amount of unjustifiable extrapolation with a straight-edge. However, the actual curves, plotted point by point, show a satisfactory rectilinearity over a very useful range of negative grid voltage (about -2 to -8 in some cases).

The curves of Figs. 5, 6 and 7 show the actual characteristics obtained with very high anode resistances for valves of various well-known types. (The actual selection

-2 must be taken as a permissible upper limit, at least as far as any multi-stage arrangement is concerned. This is a very important point, and one which is not sufficiently emphasised in Dr. Kröncke's paper. It is due to the fact that in any multi-stage arrangement the grid-filament path is virtually a shunt across the anode resistance of the preceding valve (a fact which was strongly emphasised by the present writer some three years ago.)*

* "Grid-filament Conductivity: Its Effect on Amplification." *Electrician*, Nov., 1923.

Grid-filament conductivity must therefore be avoided, especially when, as in the present case, the anode resistance is of the order of megohms. The circuit illustrated in Fig. 7 in Dr. Kröncke's account is wrong in this respect.

The lower limit of the permissible voltage range is fixed by the curvature of the foot of the working characteristic. It will be observed that there is not a very wide range left between these limits in the case of the high voltage factor valve. This consideration sets a limit to the amplification obtainable by specially designed triode valves unless very high anode battery voltages are available, or unless the signal amplitude is small, a fact which should be borne in mind in connection with the somewhat enthusiastic estimates of future possibilities contained in the paper referred to above.

An additional useful feature of the method can be noted at this point. Valves operating under these conditions, with anode currents of the order of micro-amperes, require much less than normal filament emission, and it is found in practice that a reduction of the filament current to something like 60 per cent. of its normal value is not only harmless, but actually beneficial. Von Ardenne and Heinert appear to attribute the straightness of the working characteristics in part to this lowering of the filament current, and the consequent reduction of the space charge in the valve. This does not seem at all clear to the present writer. The comparative straightness of the working characteristics is due to the reason given above, of which experimental confirmation will be given. It seems more probable that any effect of the reduction in the filament current will be a secondary one due to the fact that the filament will now approximate more closely to an equipotential surface. There is, in fact, a small increase in the voltage factor with the lower filament current which may be attributable to this cause. Apart from these theoretical considerations, however, the permissible reduction in the filament current is undoubtedly a very useful feature of the method, making for longer life of the valves and for convenience in the low tension supply.

Some degree of confirmation of the above analysis, at least in respect of the fundamental assumptions on which it is based, is

obtainable in the following manner. If

$$i_0 = f(v_a - Ri_0 + \mu v_g)$$

as assumed, then it is easy to show that

$$\partial i_0 / \partial v_a = 1 / (R + R_a)$$

and

$$\partial i_0 / \partial v_g = \mu / (R + R_a)$$

where R_a has the meaning already attached to it.

The slope $\partial i_0 / \partial v_g$ can be measured directly from the working characteristic. Values of $\partial i_0 / \partial v_a$ for various values of v_g were obtained by making small variations in v_a when the working characteristics were being determined. (There is no need to specify the experimental details. The measurements involved are of a very simple character, and do not require any special precautions beyond those implied in any work with valves and with high resistances.) From these two terms, both μ and R_a can be calculated, though since it is a feature of the method that the slope of the working characteristic should not vary much with R_a , it is not a very accurate way of determining the latter. The important factor, however, is μ , for the method assumes that this will not vary appreciably even in the rather extreme conditions of operation of the valve. Some typical results are exhibited in the following table. It will be seen that the calculated values of μ show a satisfactory constancy as the theory requires; also that the values are in every case somewhat higher than those corresponding to normal filament heating.

Valve.	R (meg-ohms)	V_g	$\frac{\mu \times 10}{R + R_a}$	$\frac{10^6}{R + R_a}$	R_a (meg-ohms)	μ	μ (Norm. Fil. Curr.).
DE2HF	.73	+1	12.4	1.2	.103	10.33	9.5
"	"	-3	10.95	1.09	.118	10.05	"
"	"	-6	9.42	.928	.347	10.15	"
"	4.16	0	1.99	.198	1.05	10.04	"
"	"	-3	1.91	.191	1.07	10.02	"
"	"	-6	1.83	.185	1.26	10.05	"
SP18	2	0	6.82	.478	.09	14.25	13.06
"	"	-3	6.37	.443	.31	14.40	"
"	.73	0	17.3	1.26	.06	13.7	"
"	"	-3	15.5	1.12	.16	13.8	"
DE5B	2	0	8.8	.44	.26	19.9	18.8
"	2	-3	7.9	.37	.73	21.5	18.8

The Effect of a Small Degree of Curvature.

The rectilinearity obtained by making R large compared with R_a is not perfect, as inspection of the experimental curves will show. It is therefore desirable to consider the effect of the residual slight curvature. For this purpose it will be sufficiently accurate to assume that the relationship between i and e can be expressed in the form

$$i = \frac{\partial i_0}{\partial v_g} e + \frac{1}{2} \frac{\partial^2 i_0}{\partial v_g^2} e^2$$

since the curvature of the working characteristic is sufficiently small to be representable as a square law over the range e of grid voltage variation. Suppose now that e is a simple sine function of time, *i.e.*, that the variation of grid potential is a pure low frequency tone

$$e = \hat{e} \sin nt.$$

A full analysis should now take account of the effect of the inter-electrode and other stray capacities in the system, the effect of which, as shown later, will not be negligible in general. This would, however, rather obscure the present issue, so it will be assumed that the frequency is low enough to minimise any such secondary effects. The equation for i now becomes

$$i = \frac{\partial i_0}{\partial v_g} \hat{e} \sin nt + \frac{1}{2} \frac{\partial^2 i_0}{\partial v_g^2} \hat{e}^2 \sin^2 nt$$

$$= \frac{\partial i_0}{\partial v_g} \hat{e} \sin nt + \frac{\partial^2 i_0}{\partial v_g^2} \frac{\hat{e}^2}{4} - \frac{\partial^2 i_0}{\partial v_g^2} \frac{\hat{e}^2}{4} \cos 2nt$$

From this it appears that i will consist of three terms—a continuous component i_c , a fundamental frequency component i_n , and a double frequency component i_{2n} , *i.e.*,

$$i = i_c + i_n + i_{2n} = \frac{\partial i_0}{\partial v_g} \hat{e} \sin nt$$

$$+ \frac{\partial^2 i_0}{\partial v_g^2} \frac{\hat{e}^2}{4} - \frac{\partial^2 i_0}{\partial v_g^2} \frac{\hat{e}^2}{4} \cos 2nt.$$

By a well-known principle the above single equation can now be broken up into three separate equations, containing respectively continuous, single frequency, and double frequency terms. This will lead to the following results for the amplitudes of the various components of the current :

$$i_c = \hat{i}_{2n} = \frac{\partial^2 i_0}{\partial v_g^2} \frac{\hat{e}^2}{4}$$

$$\hat{i}_n = \frac{\partial i_0}{\partial v_g} \hat{e}$$

It should be observed that the expression for i_n is consistent with that deduced from first principles above, for, as already shown,

$$\frac{\partial i_0}{\partial v_g} = \frac{\mu}{R + R_a}$$

so that

$$\hat{i}_n = R \hat{i}_n = R \frac{\partial i_0}{\partial v_g} \hat{e} = \frac{R}{R + R_a} \mu \hat{e}$$

The important thing to notice is that the curvature of the working characteristic introduces a double frequency term present in the original E.M.F., so that the potential difference across the anode resistance is no longer that corresponding to a single pure tone. The fair estimate of this frequency distortion will be the ratio of this extraneous double frequency potential difference to the single frequency potential difference. From the above equations,

$$\hat{v}_{2n}/\hat{v}_n = \frac{1}{2} \left(\frac{\partial^2 i_0}{\partial v_g^2} / \frac{\partial i_0}{\partial v_g} \right) \hat{e}$$

For any given case the ratio of the differential coefficients can be determined by actual measurement of the working characteristic. For instance, for the DE2HF valve with 2 megohms in the anode circuit and $v_g = -6$ (see Fig. 5).

$$\partial^2 i_0 / \partial v_g^2 = .172 \times 10^{-6}$$

$$\partial i_0 / \partial v_g = 39.7 \times 10^{-6}$$

so that

$$\hat{v}_{2n}/\hat{v}_n = .011 \hat{e}$$

Thus the ratio of the extraneous to the true frequency is about 1.1 per cent. per volt (amplitude). This will almost certainly be quite inappreciable by ear, so that the residual curvature in this fairly typical case should not cause any noticeable frequency distortion. It will in any case be negligible compared with frequency distortion associated with other elements of the complete receiving circuit. In general, it would appear that the effect of small degrees of curvature in producing double frequency tones is less than one would imagine without a detailed analysis.

Multi-stage Amplifiers.

The discussion so far has been concerned with a single valve only. It remains to be considered briefly to what extent the useful features of this method can be maintained when more than one stage of amplification is

required. It will be assumed that the potential change across the anode resistance of the valve is transferred to the grid of the next valve by means of the usual capacity and grid-leak arrangement illustrated in Fig. 8.

The first thing to notice is that the effect of the inter-electrode and other stray capacities (indicated by dotted lines in Fig. 8) will certainly not be negligible, even though only audible frequencies are contemplated. For

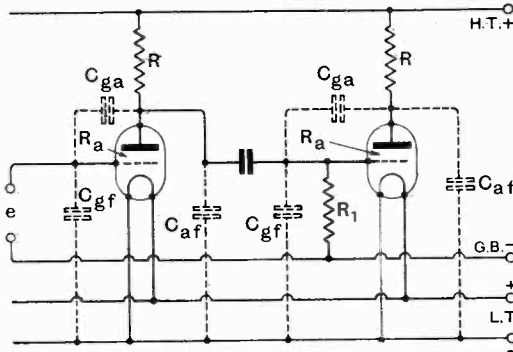

Fig. 8.

instance, assuming only 5 micro-microfarads for C_{gf} , which is a shunt on the grid-leak, the reactance of this capacity at a frequency of about 8,000 will only be about 4 megohms. Thus, over the whole audible frequency range the effective impedance of the grid-leak will vary from its direct current value to something less than 4 megohms. To limit the effect of this variation the grid leak should not exceed 5 or 6 megohms. The permissible value for the anode resistance is limited by similar considerations. In general 1 to 2 megohms is the most suitable value for this, though a somewhat higher value is more suitable for a high voltage factor valve, such as the DE5B, the internal resistance of which will itself be considerably higher under the conditions of operation than that of an ordinary general-purpose valve.

It seems to be generally thought, and the writer confesses that he himself was under the same impression until he examined the matter more closely, that the grid-leak must be made large compared with anode resistance. Actually this is not the case, as will be demonstrated later. What is required is that the grid resistance shall be large compared with the internal slope resistance of

the preceding valve, which is a very different matter.

For a complete analysis of the coupling conditions it would be necessary to take into account all the inter-electrode and other stray capacities. This makes a very complicated problem, and will not be attempted here. As far as the coupling condenser is concerned, the lowest audible frequency required to be transmitted will be the most exacting case, and its suitable value will be deduced for this condition, which will permit of the effect of stray capacities being neglected. On this assumption a single valve with its associated coupling condenser and grid-leak can be represented very approximately by the network shown in Fig. 9. The potential transmitted to the grid of the next valve at a frequency $n/2\pi$ will be V , for the determination of which we have the vector equations

$$I(R_a + R) - RI_1 = \mu E$$

$$I_1(R + R_1 + 1/jnC) - RI = 0$$

The solution of these two simultaneous equations presents no difficulty, and will lead to the result for V , *i.e.*, for R_1I_1 ,

$$R_1I_1 = V = \left(\frac{R_1}{R_1 + Z} \right) \left(\frac{R}{R + R_a} \right) \mu E$$

where

$$Z = \frac{RR_a}{R + R_a} + \frac{1}{j\omega C}$$

It should be noted that the resistance term of Z is the resistance of R and R_a in parallel.

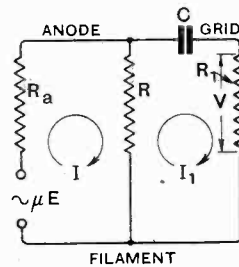

Fig. 9.

The form of the expression for V is interesting. It shows that the original magnification factor $R/(R_a + R)$ has to be multiplied by another factor of the same form as a result of the coupling, the only difference being that this factor is one involving both magnitude and phase. It shows that even if the value of C be so chosen that Z does not

differ much in magnitude from its resistance component, there will still be a reduction of the effective magnification factor, given by $R_1/(R_1 + R_0)$ where R_0 is the resistance of R and R_a in parallel. The reduction will be small provided R_1 is large compared with R_0 , *i.e.*, provided R_1 is large compared with R_a , since R is large compared with R_a .

The determination of the suitable value for C is now quite simple. It depends only on the permissible variation of the coupling factor with frequency. The maximum value of the latter, at high frequencies, when the reactance of the condenser will be negligibly small, is $R_1/(R_1 + R_0)$. Suppose it is required that the coupling factor shall not vary by more than 5 per cent. down to a frequency of about 80 per second, for which n can be taken as 500. It is only a question of solving graphically or otherwise

$$| R_1 + R_0 + 1/jnC | = 1.05(R_1 + R_0),$$

the vertical strokes indicating that the magnitude of the complex expression is

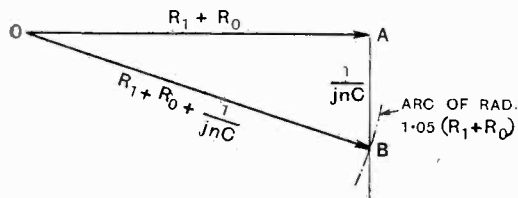

Fig. 10.

$$OA = R_1 + R_0 = R_1 + \frac{RR_a}{R + R_a} = 5.33M\Omega$$

$$OB = 1.05 (R_1 + R_0) = 5.6M\Omega$$

$$AB = 1/jnC = 1.75M\Omega$$

considered. The graphical calculation is illustrated in Fig. 10 for the following values:

$$R = 2 \text{ megohms}$$

$$R_1 = 5 \text{ megohms}$$

$$R_a = .4 \text{ megohm.}$$

It is found that $1/jnC$ must not exceed 1.75 megohms, which gives a minimum value of about 1,200 micro-microfarads for C . In general, anything from one to two thousand micro-microfarads will probably be a suitable value. The coupling capacity should not be made larger than is necessary, as this will increase unnecessarily the time constants of the various parts of the amplifier. Von Ardenne and Heinert give 500 micro-microfarads as a suitable value, and state that the criterion is that this capacity should be large compared with the grid-filament

capacity. This, however, is not the true criterion and would lead to an under-estimation of the right value for C .

It might be mentioned at this point that the insulation resistance of the coupling condenser is a very important matter, particularly with a high value for the grid resistance. It must be at least 500 megohms.

Limitations on the Maximum Amplification obtainable.

In the account given by Dr. Kröncke it is stated that it is hoped to obtain an amplification factor of 70 with a single stage by this method, using valves having a very small "Durchgriff," *i.e.*, a very large voltage factor. There is, however, a limiting factor here. A very large voltage factor cannot be obtained without a corresponding increase in the internal slope resistance of the valve, which requires a correspondingly larger value of the anode resistance if the full value of the voltage factor is to be obtained. The upper limit of the value of this anode resistance is, however, already fixed by the inter-electrode and other stray capacities necessarily involved in the system. It is doubtful if a higher value than four megohms can be used without introducing the possibility of considerable variation in amplification with frequency, particularly at the higher frequencies, when the shunting effect of the stray capacities will be more pronounced. Further, the steepness of the working characteristic implied by the large voltage factor greatly reduces the permissible range of grid voltage variation unless a high voltage anode battery is used (see Fig. 5), so that even if these high magnifications can be obtained they would in general only be available for the first stage with comparatively small voltage amplitudes. Subject to this limitation, however, amplifications of seventeen to twenty-five per stage can be obtained by means of high voltage factor triodes and possibly even greater amplification per stage if four-electrode valves are used.

Conclusions.

Low frequency amplification by means of resistance capacity couplings with anode resistances of the order of megohms can be stated to have the following characteristics:—

1. An amplification per stage amounting to from 80 to 95 per cent. of the voltage

factor of the valve used. For small amplitudes (up to about one volt) an amplification of at least twenty per stage can be obtained by means of high voltage factor triodes. These results can be obtained with comparatively low anode battery voltages, say, seventy to one hundred volts.

2. Valves used in this way require in most cases considerably less than normal filament current. This makes for longer life in the valves and for convenience of low tension supply.

3. Low frequency amplification by this method will be practically free from amplitude or frequency distortion, if the component magnitudes are suitably chosen.

The following are suggested :—

Anode resistances—1 to 2 megohms, for normal H.F. valves ; 2 to 3 megohms for high voltage factor valves.

Grid-leaks—3 to 5 megohms.

Coupling condensers—1,000 to 2,000 μF .

The following precautions must be observed in the design of any amplifying system using this method :—

1. Sufficient negative grid bias must be applied to each valve following a resistance stage to ensure that the grid voltage does not at any time rise above about two volts negative.

2. The insulation resistance of all components used must be as high as possible.

3. The wiring and valve sockets must be such as to reduce to a minimum the stray capacities of the system. The resistances used must also be of low self-capacity. The "Loewe" resistances mentioned in the

account by Dr. Kröncke are suitable in this respect, but the ordinary grid leaks of standard make appear to be satisfactory also.

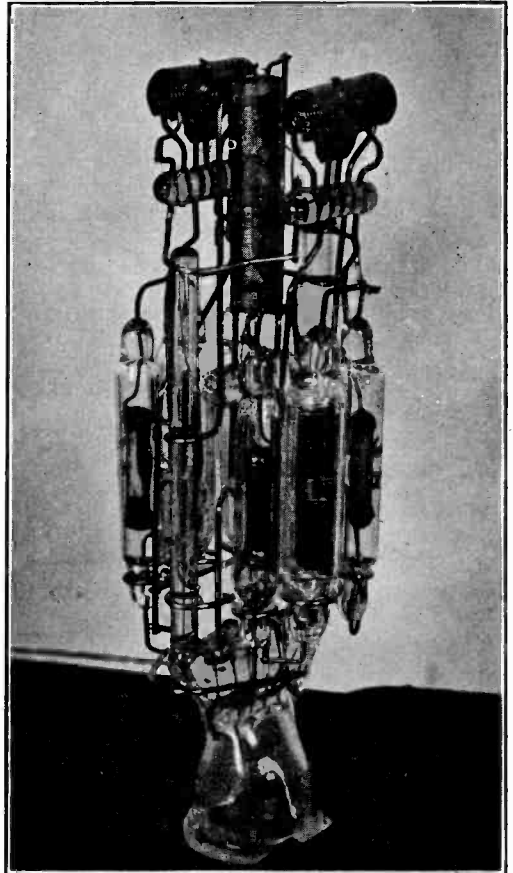

Fig. 11. Photograph showing the assembly of the elements in the Loewe multiple valve.

The Resultant Capacity of Aerial Systems Employing Series Tuning Condensers.

By W. H. F. Griffiths.

IN a recent article in this journal* the author developed a number of formulæ for the design of variable air condensers to have certain definite laws connecting resultant capacity change and angular displacement when in series with fixed value condensers. Among the cases in which the design of such condensers becomes of importance is that of the *series* aerial tuning condenser of a wireless receiving system. In this particular case, however, it is impossible to design variable condensers which will *always*, when connected as continuously variable tuning adjusters in series with given aerials, have definitely uniform and pre-determined scale laws irrespective of other aerial circuit conditions. In other words, even though the effective aerial capacity is known, the case of the aerial series condenser cannot *always* be treated as simply

$$C_R = C_f C / C_f + C \quad \dots \quad (I)$$

where C_f = fixed series capacity (aerial capacity),

C = variable tuning capacity,

and C_R = resultant capacity of C and C_f in series.

The operation of "tuning" a circuit to resonance with the frequency of an impressed electromotive force is merely one of adjusting the total inductance or total capacity of that circuit so that the algebraic sum of all the reactances is zero at that frequency. If two capacities are in series in the circuit being tuned, their reactances are simply added arithmetically in order to obtain the total *capacitive* or *negative* reactance. The reactance of the series aerial tuning condenser cannot, however, be added to the *negative* reactance of the aerial because the latter has its capacity and inductance distributed more or less evenly throughout its length; it has no "lumped" capacity the reactance of which can be separately expressed quantitatively without reference to its distributed

inductance. Its reactance cannot, in other words, be stated as

$$j\omega L_f + \frac{-j}{\omega C_f} \quad \dots \quad (2)$$

The reactance $1/\omega C$ of the tuning condenser cannot therefore be directly added arithmetically to $1/\omega C_f$, in order to obtain the total capacitive reactance of the aerial *circuit* for the evaluation of ω for "reactance balance" or resonance.

Particularly is it incorrect to add the capacitive reactances of aerial and series condenser when the aerial system is tuned only by that condenser, no loading inductance being employed (see Fig. 1a); in this case the wavelength of the aerial cannot be reduced to less than half its natural (unloaded) wavelength however high the reactance of the condenser be made.

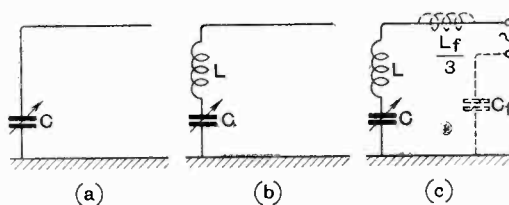

Fig. 1.

In most practical cases of receiving aerial tuning (Fig. 1b) in which there exists a loading inductance of over twice the value of the aerial inductance, it is permissible, however, to treat the aerial capacity as merely a fixed value condenser in series with the variable tuning condenser as shown in Fig. 1c. The resultant capacity is given by (I) and the formulæ given in the previous article may therefore be used in the design of the variable condenser.

In practice the condition

$$L > 2L_f$$

is fulfilled for small aerials for all but the shortest wavelengths. A loading coil, L , of twice the value of the aerial inductance, is

* December, 1926.

required to raise the wavelength to about 2.4 times that of an unloaded aerial and if a series tuning condenser is then introduced the wavelength may again be reduced to the original unloaded value. The unloaded wavelengths of small receiving aerials may be from 100 to 200 metres, and for all wavelengths above this order therefore the condition $L > 2L_f$ may be fulfilled by suitably proportioning L and C . For wavelengths above $2.4 \times (100 \text{ to } 200)$ the condition *must* be fulfilled irrespective of the proportioning of L and C .

The reactance of an unloaded aerial having uniformly distributed inductance and capacity can be shown to be—

$$X_f = -\sqrt{\frac{L_f}{C_f}} \cdot \text{Cot } \omega\sqrt{C_f L_f} \dots (3)$$

an expression which, if the cotangent is expanded into a series omitting all terms after the second, gives the usual approximation of the equivalent circuit of Fig. 1C:—

$$X_f = -\sqrt{\frac{L_f}{C_f}} \left(\frac{1}{\omega\sqrt{C_f L_f}} - \frac{\omega\sqrt{C_f L_f}}{3} \dots \right)$$

$$= -\frac{1}{\omega C_f} + \frac{\omega L_f}{3}$$

In practice, when tuning with a variable condenser in series with the receiving aerial, the reactance of the latter, X_f , is fixed for a given wavelength of signal to be received, the reactance, X_L , of the inserted loading coil is also fixed by selection and the reactance X_C of the variable condenser is adjusted until the algebraic sum of X_f , X_L and X_C is reduced to zero.

As an example of this "reactance balancing," a case equivalent to those given in the design examples of the previous article will be taken, using values of $500\mu\text{F}$ aerial capacity (150 feet long and 206.5 metres natural, unloaded, wavelength) and a variable tuning condenser of $500\mu\text{F}$ maximum capacity and $36\mu\text{F}$ minimum capacity. The inductance of the aerial is $59\mu\text{H}$, and when a loading coil of $680\mu\text{H}$ is inserted in the downlead in addition to the variable condenser, the wavelength curve $\lambda = 50\sqrt{C_R}$ given in Fig. 8 of the previous article is obtained.

In Fig. 2 are plotted curves giving the reactance values of aerial, loading inductance

and tuning condenser for various frequencies. The reactance curve for the unloaded aerial appears as the cotangent curve plotted from the expression for X_f (3) above, for values of the angle $\omega\sqrt{C_f L_f}$ from 0 to π , the natural unloaded frequency being indicated at the zero reactance portion of the curve as 1.45×10^6 cycles = 206.5 metres at the point where angle $\omega\sqrt{C_f L_f} = \pi/2$.

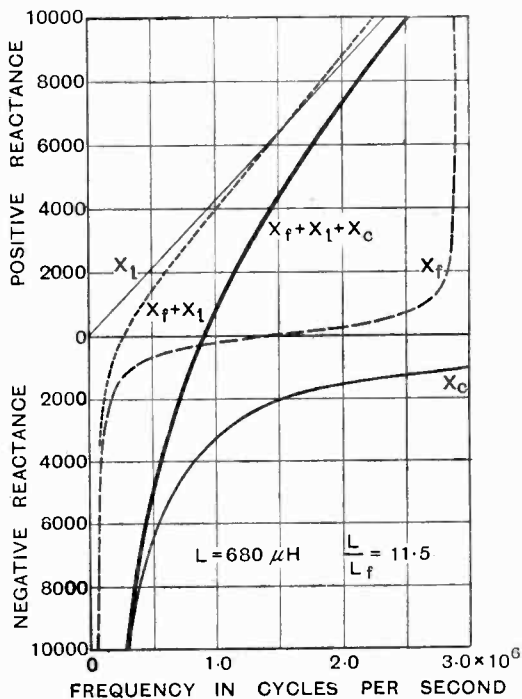

Fig. 2.

Frequencies less than the natural frequency give the angle $\omega\sqrt{C_f L_f}$ values less than a right angle and its cotangent is therefore positive, making the reactance negative, whereas frequencies greater than the natural frequency (but less than twice this value) make the angle greater than a right angle, so that, its cotangent being negative, the reactance becomes positive.

The reactance X_L of the loading inductance is a straight line, being directly proportional to frequency and the reactance X_C of the series tuning condenser, adjusted to $50\mu\text{F}$ capacity—one-tenth of its maximum value—is a hyperbola since it is inversely proportional to frequency.

The resultant reactance for the complete aerial system $X_f + X_L + X_C$ is the algebraic sum of the three curves at any frequency and

In the same figure is given the reactance curve $X_f + X_L$ of the aerial and loading inductance in series when the series capacity

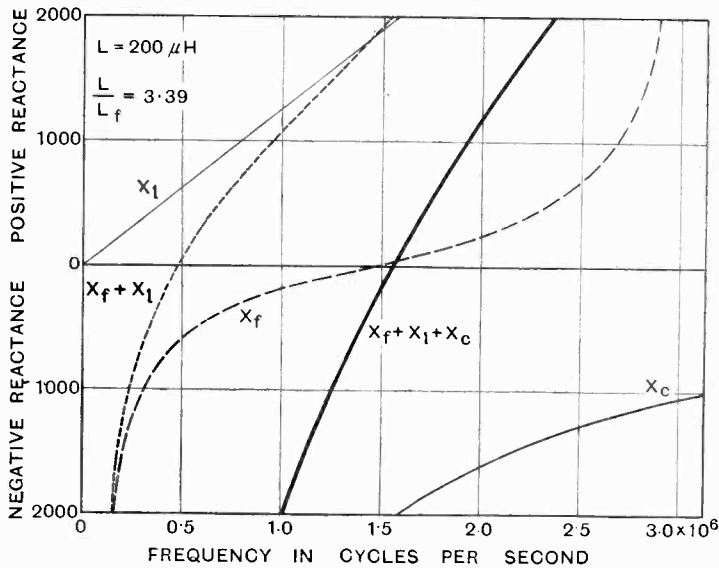

Fig. 3.

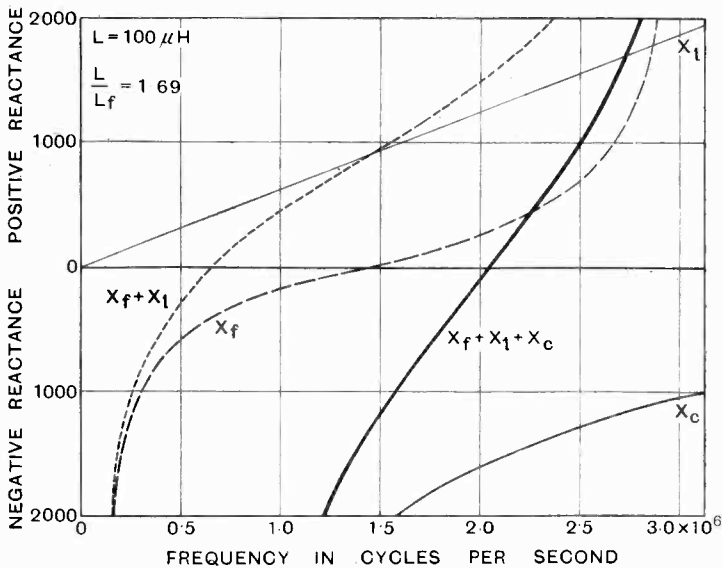

Fig. 4.

the frequency of the point at which the curve representing this resultant reactance crosses the zero reactance ordinate corresponds to the resultant resonant wavelength of the system.

is increased to infinity (short-circuited) and for this condition the frequency at which the positive reactance of the loading inductance is arithmetically equal to the negative reactance of the aerial is shown by the

intersection between the resultant reactance curve and the zero reactance ordinate.

In this way, from these two resultant reactance curves $X_f + X_L + X_C$ and $X_f + X_L$, two values of resonant frequency are obtained—one with a series condenser of one-tenth of the aerial capacity, and the other without that condenser. From the ratio of these two

From the two resultant reactance curves of Fig. 2 the two resonant frequencies are seen to be 9×10^5 and 2.71×10^5 , giving a ratio of 3.32. In this case therefore the assumption is justified, but if this process is repeated for values of loading inductance $200 \mu\text{H}$ (Fig. 3), $100 \mu\text{H}$ (Fig. 4), $68 \mu\text{H}$ (Fig. 5), $34 \mu\text{H}$ (Fig. 6) and zero (Fig. 7),

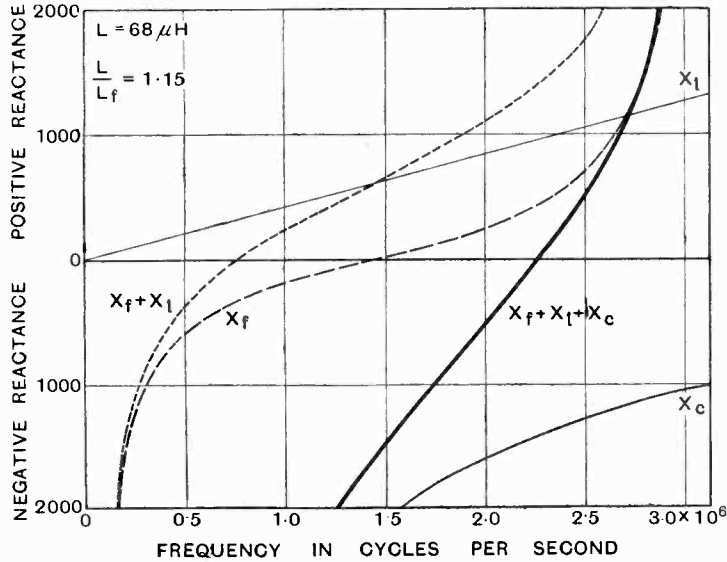

Fig. 5.

frequencies it is possible therefore to find the error introduced by assuming that

$$C_R = \frac{C_f C}{C_f + C}$$

For the case for which the curves of Fig. 2 are plotted $C = 0.1 C_f$

and
$$C_R = \frac{500 \times 50}{550} = 45.5 \mu\text{F}$$

∴ the ratio of resultant capacities computed in this way with series condenser and without

$$= \frac{500}{45.5} = 11.0$$

The ratio therefore of resonant frequencies or wavelengths calculated on this assumption would be $\sqrt{11.0} = 3.32$ whatever the value of L .

keeping constant, at $50 \mu\text{F}$, the value to which the series tuning condenser is adjusted, the frequency ratios given in the following table are obtained.

L μH	Ratio $\frac{L}{L_f}$	Resonant frequencies		$f_1 = \frac{\lambda_2}{\lambda_1}$	Resonant frequencies obtained from reactance curves of:
		With $50 \mu\text{F}$ Series Condenser f_1	Without Condenser f_2		
680	11.5	9.0×10^5	2.71×10^5	3.32	Fig. 2
200	3.39	1.56×10^6	4.82×10^5	3.24	Fig. 3
100	1.69	2.05×10^6	6.50×10^5	3.15	Fig. 4
68	1.15	2.26×10^6	7.50×10^5	3.01	Fig. 5
34	0.58	2.51×10^6	9.50×10^5	2.60	Fig. 6
0	0	2.62×10^6	1.45×10^6	1.87	Fig. 7

It is seen from this table that as the ratio L/L_f of loading inductance to aerial inductance is reduced the error introduced by the assumption of "lumped" negative aerial reactance becomes apparent, until, when

L/L_f is less than 2 the error ceases to be negligible.

In Fig. 8 these results have been plotted

inductance to aerial inductance. This figure also shows the percentage error of wavelength ratio obtained for various values of

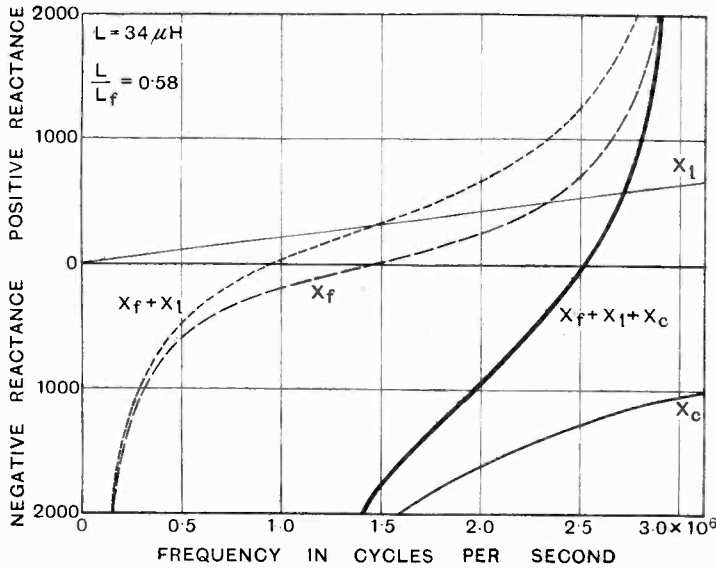

Fig. 6.

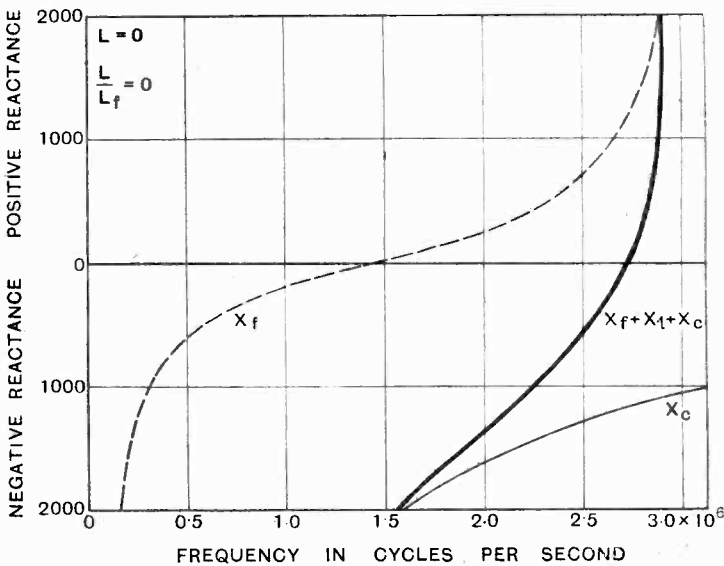

Fig. 7.

as wavelength (or frequency) ratios (when a series aerial tuning condenser of one-tenth of the aerial capacity is switched in or short-circuited) against ratios of added loading

L/L_f when the assumption

$$C_R = \frac{C_f C}{C_f + C} \text{ is made.}$$

Since these curves are plotted for ratios of L/L_f they are correct for aerials of any natural wavelength or capacity, but it should

be noted that L_f is the total value of aerial distributed inductance and not one-third of the latter as is used in the approximate

formulae for the determination of the wavelength of an inductance loaded aerial.

A careful study of the reactance curves of

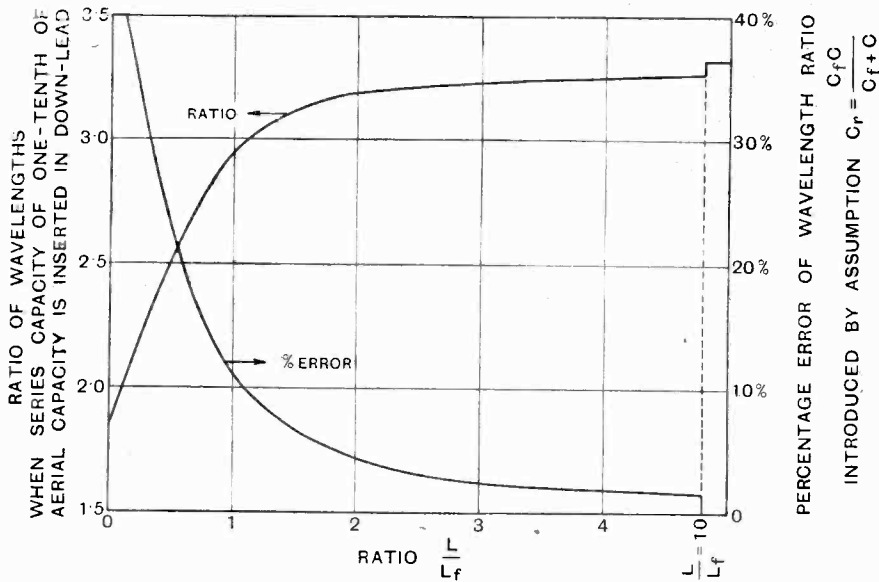

Fig. 8.

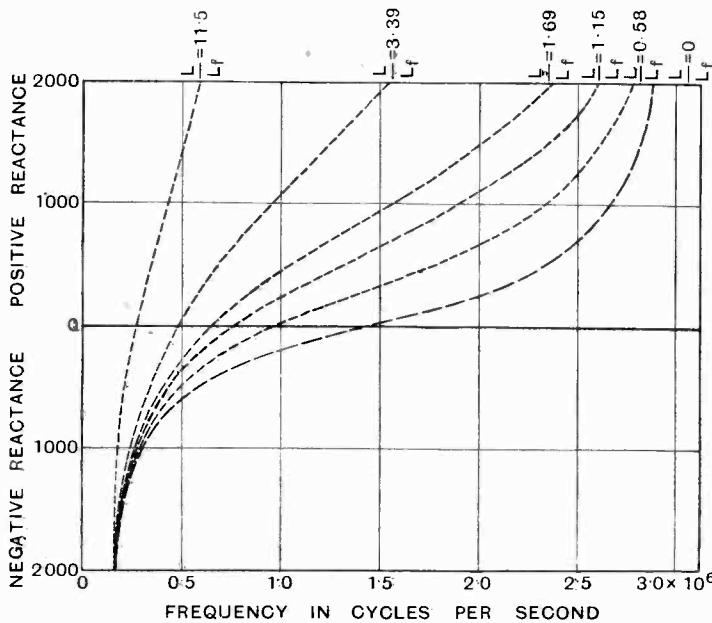

Fig. 9.

be noted that L_f is the total value of aerial distributed inductance and not one-third of the latter as is used in the approximate

Figs. 3, 4, 5, 6 and 7, all plotted to the same scales of frequency and reactance, will provide a good mental picture of the effect of

varying the value of the loading inductance upon the tuning of an aerial by a series condenser.

It will be observed from Fig. 7 that, when there is no loading inductance in series with the aerial, even if the reactance X_c of the series condenser is increased to infinity, the wavelength cannot, by its use, be reduced to less than one-half the unloaded value, since the two frequencies at which reactance balance occurs in this case are for angles $(\omega\sqrt{C_f L_f})$ having values of π and $\pi/2$.

The straightening of the curve $X_f + X_L$ of the combined reactance of aerial and loading inductance as the ratio L/L_f is increased is shown in Fig. 9, the cotangent curve character becoming less evident with increasing ratios.

In conclusion, it should be stated that there are several other sources of error due

to the self-capacity of loading inductance and stray capacities from various high potential points, etc., but these, although affecting the resultant wavelength *value*, are generally insufficient to affect appreciably the *law* of a variable condenser designed on the assumption justified by this article, more especially as, in practice, the lower limit of resultant capacity is generally greater than $50\mu\mu\text{F}$. It is seen therefore that if a series aerial tuning condenser is designed, treating the aerial capacity merely as a fixed value condenser in series, its "design law" will, in general, be approximately correct for all values of loading inductance greater than twice the inductance of the aerial and very closely correct when used in conjunction with loading coils of over ten times the aerial inductance.

Book Review.

THE ELEMENTS OF RADIO-COMMUNICATION. By O. F. BROWN. Pp. 213, with 146 illustrations and diagrams. Oxford University Press 1927. 10s. 6d.

It is a remarkable thing that the intensive study of wireless phenomena during the last few years has not been accompanied by a corresponding intensive production of wireless handbooks embodying the phenomenal progress of the period. Much has been written in a simple, popular, and often very attractive way, about wireless receiving circuits and the way they function, but of more ambitious text-books there have appeared hardly any. There seem to be two possible reasons for this. In the first place we are not a nation of text-book writers. To realise this we have only to compare the enormous output of text-books in German on such a subject as Relativity compared with the meagre output of works of similar character in this country. Secondly, a not unimportant reason, the writing of satisfactory text-books is by no means easy.

It is for the above reasons that Mr. Brown is to be warmly congratulated on his volume, which should find a wide public. The amateur who is keen on extending his knowledge will find it readable and instructive, the mathematics used being simple but necessary for quantitative work. As a preliminary course for the future radio-engineer there is no volume that could be so confidently

recommended, while the physicist, who, leaving awhile his more theoretical studies, wishes to know more about the subject matter of wireless will find the information very readily accessible in this volume.

The first seven chapters of the book deal with the fundamental theory of transmitting and receiving circuits and with what might be called pre-war wireless. As Mr. Brown does not give too much space to the older branches of the subject, such as spark and arc generators, he is able to devote the main body of the volume (ten chapters) to thermionic valves, radio telephony and the newer branches of the subject such as directional wireless, short wave transmission, the propagation of waves through space, and atmospherics.

Although the author obviously did not set out on the impossible task of giving an exhaustive account of all the receiving circuits now in use there is throughout the volume no dearth of diagrams which embody most directly the essentials of any particular method of reception. Indeed, in summarising the characteristics of this volume, one might say that Mr. Brown's success lies in his ability to give the essentials of any of the wireless problems dealt with, without overloading his description with extraneous matter which so often confuses the beginner.

E. V. APPLETON.

Short-Wave Wireless Telegraphy.

Paper read by Mr. T. L. ECKERSLEY before the Wireless Section, I.E.E., on 2nd March, 1927.

ABSTRACT.

THE paper* deals with short wave practice and theory, the discussion falling into four sections: 1. The aerial transmission characteristics, in particular the computation of vertical polar diagrams; 2. Results of experiments with short-wave direction finding; 3. Results of a series of long-distance transmission tests, on waves between 25 and 10 metres; 4. General theory of ionic refraction, etc.

Vertical Polar Diagrams of Transmitter.

It is important to decide whether the horizontal or vertical rays are the more effective in transmission and to design aerials which will radiate efficiently in the direction required. In previous attempts to calculate transmitter polar diagrams, it has been assumed for simplification that the earth is a perfect conductor. This may lead to considerable error, because the corrections due to the imperfect conductivity of the earth involve the product of frequency and resistivity, which may become significant at the frequencies of short waves. The author then deals with the case of a vertical doublet *A* at a height *h* above the earth, as in Fig. 1.†

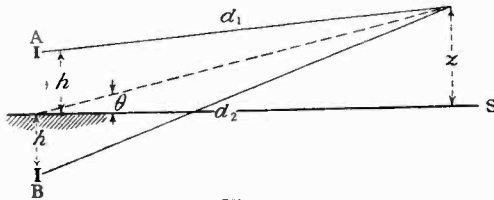

Fig. 1.

It is shown that the field at *d*₁ is given by the field due to *A* together with the effect of a negative image of *A* situated at a distance *h* below the surface of the earth, *i.e.*, it is that which would be produced by the oscillator at *A* together with another oscillator at *B* in which the current is 180° out of phase with the oscillator at *A*. It is also shown that there is a critical value of the angle θ above which the polar diagram is that appropriate to a perfectly conducting earth, and below which it is appropriate to a perfectly resisting earth. In general, for resistivities such as are usually found, the earth angle θ is of the order of 10° on the short-wave range, say 15 to 50 metres. Figs. 6, 7 and 8 show the calculated polar diagrams for various heights *h*.

The full curves represent the opposed doublets, and are appropriate for small angles. The dotted curves represent the effect of adding doublets and are appropriate for high angle transmission. The critical polarising angle is represented by the line *OP* at an angle θ . This angle varies with the wavelength and earth constants.

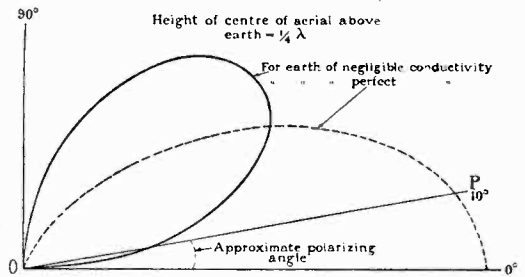

Fig. 6.

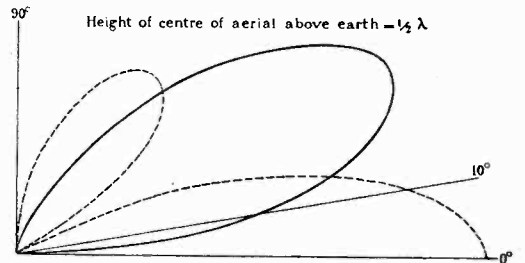

Fig. 7.

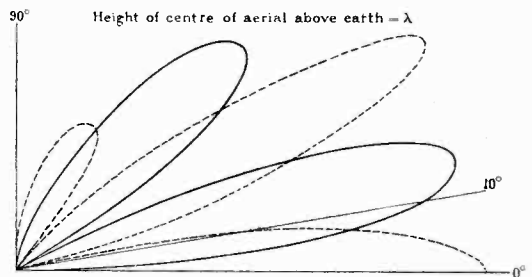

Fig. 8.

Polar diagrams for a horizontal aerial are similarly shown in Figs. 9, 10 and 11.

Since there is no polarising angle in the case of a horizontally polarised ray there is no critical angle where the polar diagram changes. It is obvious that if horizontal radiation is necessary for long-distance transmission the aerials must be raised to

* The paper was first received on 1st December, 1926, and in final form on 21st January, 1927, and thus represents an up-to-date review of the subject of short waves.

† The Author's original figure numbers are adhered to throughout this abstract.

an height. On the other hand, for high angle transmission a half-wave aerial situated near the earth's surface is practically as good as any other.

Short-Wave Radio Direction Finding.

In the second section direction finding experiments are discussed. The circuits for a figure-of-eight diagram are shown in Figs. 12 and 13, and for

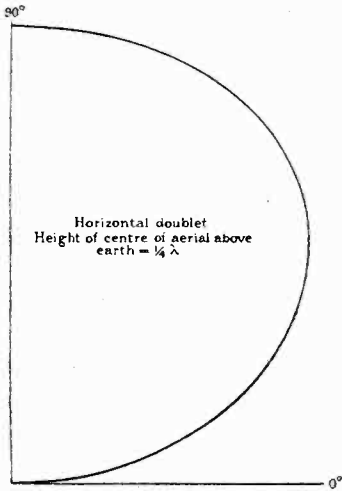

Fig. 9.

a cardioid in Fig. 14. The circuit is strictly symmetrical, and shielded as shown. Tested on local stations (distances up to a couple of miles), the arrangement gave excellent figure-of-eight diagrams with minima 180° apart. On more distant stations it was apparent that the frame alone was inadequate.

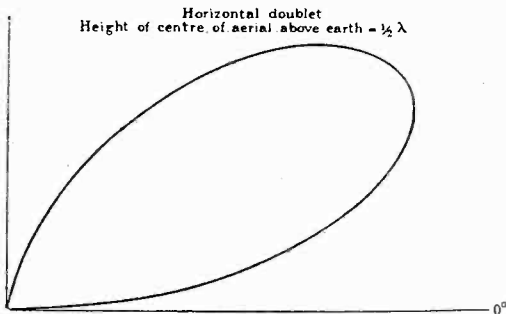

Fig. 10.

As a rule, there were no signs of minima at all, and what minimum there was from time to time varied, although giving, on a rough average, something like the correct position. It was impossible to avoid being impressed by the similarity to the conditions when bearings on longer waves suffer from

“night effect.” Conditions were complicated by rapid fading, so that it was difficult to tell whether a minimum was due to turning of the frame or to a fade.

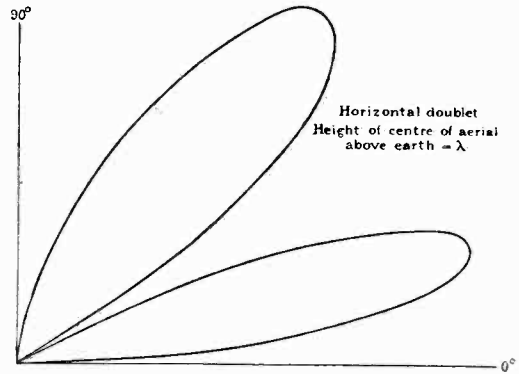

Fig. 11.

The cardioid arrangement of Fig. 14 was found to give very accurate balance on local stations. On distant stations—in particular, Nauen (AGB), Paris (FW) and an R.C.A. station in America

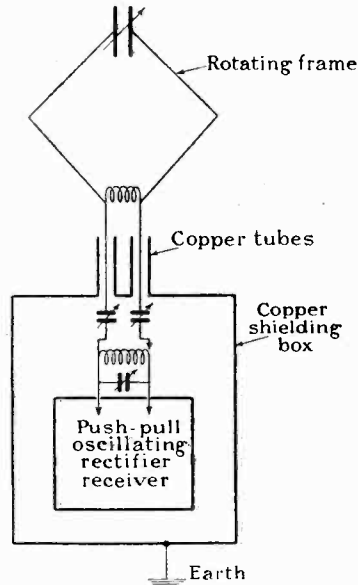

Fig. 12.

(WLL)—it was possible to obtain a fair cardioid diagram giving a minimum in approximately the right direction, and one, moreover, which did not vary.

The minima were by no means as perfect as those obtained on local stations, but were sufficiently definite and constant to permit the

inferences: (1) That the absence of minima on the frame is chiefly due to a horizontally polarised ray as in the case of long waves; (2) that the bulk of the rays follow the great circle path and strike the receiver nearly parallel to the earth's surface. Amongst other causes it is suggested that the lack of balance may be due to a scattering of rays

being more or less musical, in a similar manner to "squeak X's." It is suggested that this is due to a dispersion of the pulse in the ionised medium, as elsewhere suggested by the author.

The general conclusions which can be drawn from this work are more or less as follows: During the day and night the main flow of energy at distances where the direct ray is feeble is along rays which lie in the plane of the great circle joining transmitter and receiver, and these rays come in at a more or less glancing angle to the earth's surface.

The main ray is not subject to more than a slight scattering. The latter only becomes the main factor within the "jump over" distance, when the main ray skips its objective and comes down at greater distances. Fading is mostly due to the interference of the two or more rays which probably exist at distances greater than the skip distance. Signals at 14 to 26 metres may traverse practically the whole circumference of the earth at certain times and produce an echo effect. The long distance signals show evidence of the dispersive effect of the medium through which they travel.

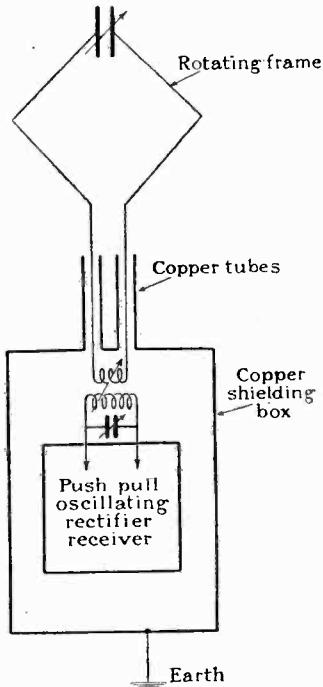

Fig. 13.

at the upper layer. In connection with scattering, it was observed that about 20.00 to 21.00 G.M.T. in July, signals from AGB were observed to fall almost to nothing, although apparently being strongly received in Buenos Ayres. The cardioid seemed to lose its characteristics, not by an increase of the signals at the minimum, but by a decrease at the maximum, suggesting that the main signal was removed leaving only scattered rays.

Examples have also been noted of signals from AGB coming by the long path round the other side of the earth, a phenomenon already described by the author in connection with work on long waves. In this case the main signal goes west with a wavering note, and following each dot or dash there is a distinct echo, which is estimated to lag about 1/7 second behind the main signal. The relative strength of signal and echo vary from time to time, and sometimes the echo has been so strong as to make the main signal practically unreadable.

With sufficient amplification it has been found possible to get the key clicks alone in which case they are doubled, with the second one following the first after an interval of about one second. The character of the second click is different,

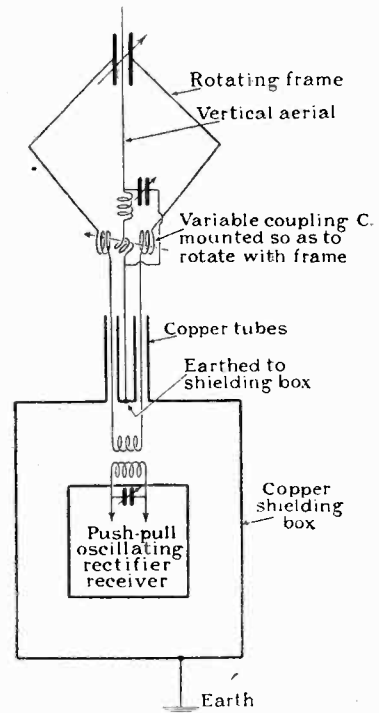

Fig. 14.

Transmission Tests.

The third section describes tests on transmission, with many curves of results under different conditions. The tests were made partly with the desire to explore the range below 25 metres, and partly to test the effect of raising the transmitting aerial. Tests were made on 24, 20, 17, 15, 13.5, 11 and 10

metres, the signals being received mainly in Sydney, Montreal, Buenos Ayres, South Africa and on S.S. *Glenamoy en route* for Hong Kong. The tests covered the period July, 1925, to May, 1926, but do not indicate the seasonal effect (except in the case of 17 metres), since the wavelength was progressively reduced during the period. The result

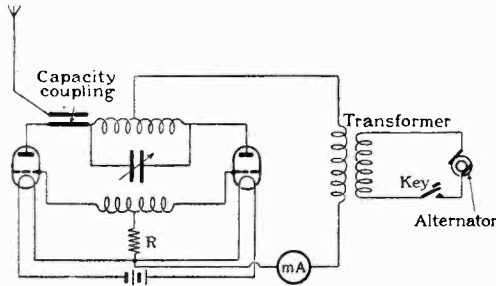

Fig. 15.

curves represent the diurnal run of signal strengths, but are not accurate measures of the signal field strengths.

At the transmitting end (Chelmsford) arrangements were made to sling a half-wave aerial on a triatic between the Chelmsford masts at a height of 80 metres, *i.e.*, approximately three wavelengths for

Twenty-four Metre Tests.—A typical result curve obtained at Sydney is shown in Fig. 17. These curves are similar to those obtained on long waves (15 kilometres), and there is therefore reason to believe that the causes contributing to this form are almost identical, *i.e.*, small attenuation at night and large attenuation in daytime. The peak at 20.00 G.M.T. is no doubt due to the fact that the short path (over Europe and India) is then wholly in darkness. The peak at 05.00 G.M.T., on the other hand, occurs when the long path (over Atlantic and Pacific Oceans) is almost wholly in darkness. The weaker peak at this time is naturally accounted for on this supposition for the ray path is longer and partly in daylight.

Montreal results are shown in Fig. 18, while Fig. 19 is given as a companion, showing the variation of signal strength of the Canadian beam received in Chelmsford on 1st October, 1926.

As regards results on and below 20 metres, the author states that it is difficult to generalise on the large mass of data obtained, but it is clear that in general a decrease of wavelength tends to decrease night signals and increase day signals. Thus below 17 metres there are no signals when the path is wholly in darkness. Another general fact emerges, that as the wavelength is reduced the time during which signals can be received gets less and less, and appears to tend towards the times during which the ray is wholly in the light. It is, of course, difficult to estimate the relative strengths on different waves,

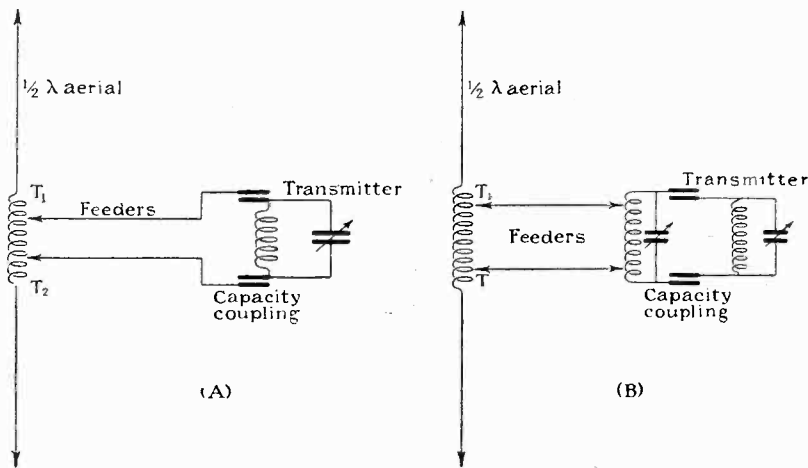

Fig. 16.

$\lambda = 25$ metres, above the ground. The original purpose was to compare the signals from this raised aerial with those from Poldhu with a low aerial. A duplicate aerial attached to a 40 foot mast on the earth's surface was also constructed with a view to making a comparison between the raised and lowered aeriels. The transmitter arrangements are shown in Figs. 15 and 16. With 550 to 750 watts input it was possible to get between 2 and 3 amperes in the half wavelength aerial.

since the receiver characteristics are likely to control the changes, but it appears likely that below about 17 metres the maximum signal strengths obtainable decrease with the wavelength.

Twenty Metre Tests.— These indicate an intermediate condition between all night and all day transmissions. At Sydney the chief difference between this and the 24-metre test is the increase in strength in the half light and half dark periods. This is a favourable condition, as the attenuation

over the first half of the path in daylight is not too great, and the bending is probably greater than in the all night condition, when the total attenuation is less. At Buenos Ayres the strength is sufficient to

The actual observed results imply an irreversibility in signal transmissions or a seasonal effect, implying a difference in the state of the upper atmosphere in the northern and southern hemi-

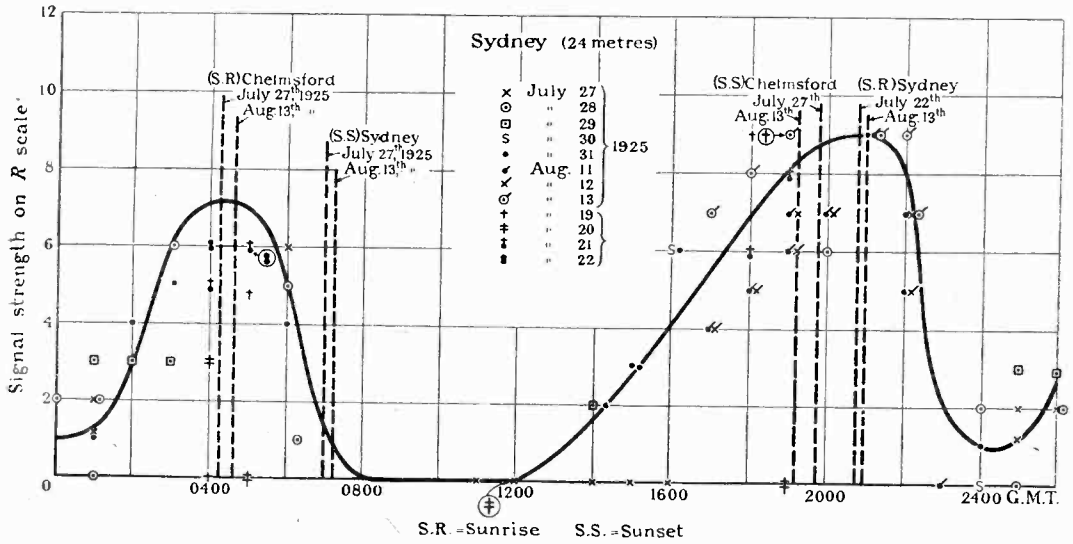

Fig. 17.

give signals at 25 to 30 w.p.m. throughout the dark period but tails off during the half light half dark periods.

Seventeen Metre Tests.—These were carried out at various times between 9th September, 1925, and

spheres. Since seasonal effects do not appear to make any marked difference, the evidence is in favour of some irreversible effect. No direct test of this could, however, be made on account of the absence of a suitable transmitter in Australia.

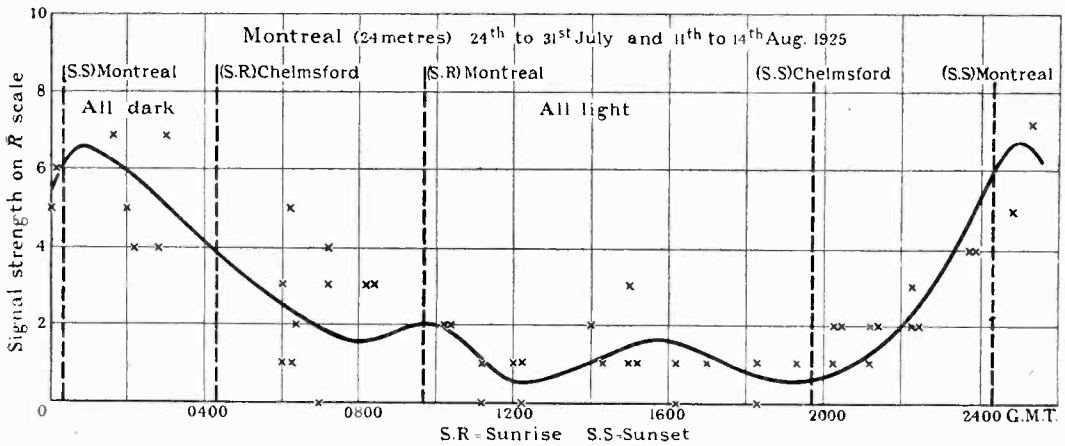

Fig. 18.

8th January, 1926, so that there is an indication of seasonal as well as other changes. The tendencies exhibited in the 20-metre tests are exaggerated. Thus there is an improvement in daylight transmissions and a deterioration in night transmissions.

On this wavelength all day signals began to appear at Buenos Ayres. This suggests that the wavelength is so short that there is insufficient bending at night to bring down any of the rays at Buenos Ayres. This is in agreement with the fact

that all-night signals have practically disappeared in Australia on this wavelength.

Fifteen Metre Tests.—Fifteen metre tests were also carried out at various times between 15th Septem-

19.00 signals were heard only very weakly throughout the whole period. Nothing was received in Montreal.

From these tests it is concluded that all-night

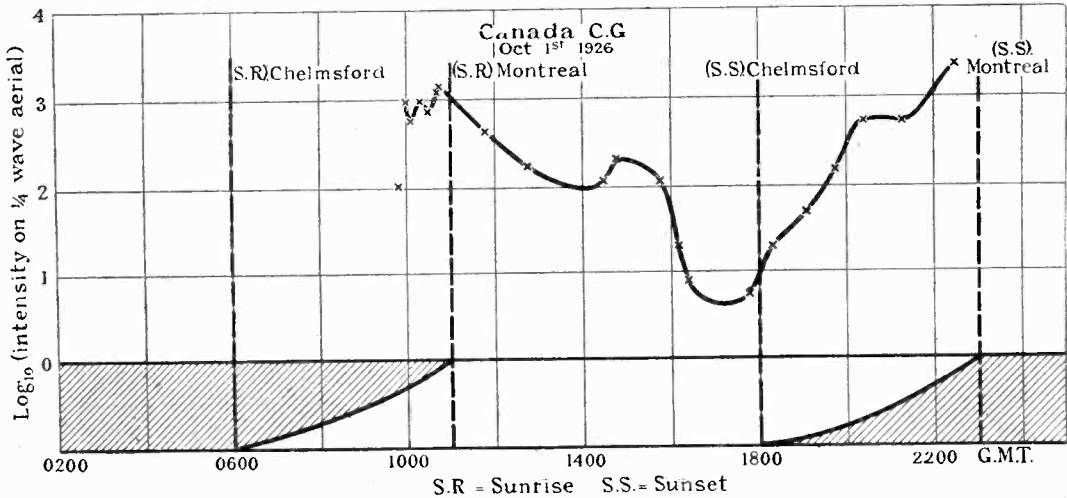

Fig. 19.

ber and 29th January. The transmission characteristics are similar to those on 17 metres, and the same argument as regards irreversibility applies on this wavelength.

Ten-Metre Tests.—Transmissions on 13.5 and on 12 metres gave characteristics generally similar to

transmission is impossible below about 17 metres, and that the daylight range increases with decreasing wavelength.

Aerial Height Tests.—Some of the later tests also included a comparison of the transmissions from the aerial at different heights. The aerials were

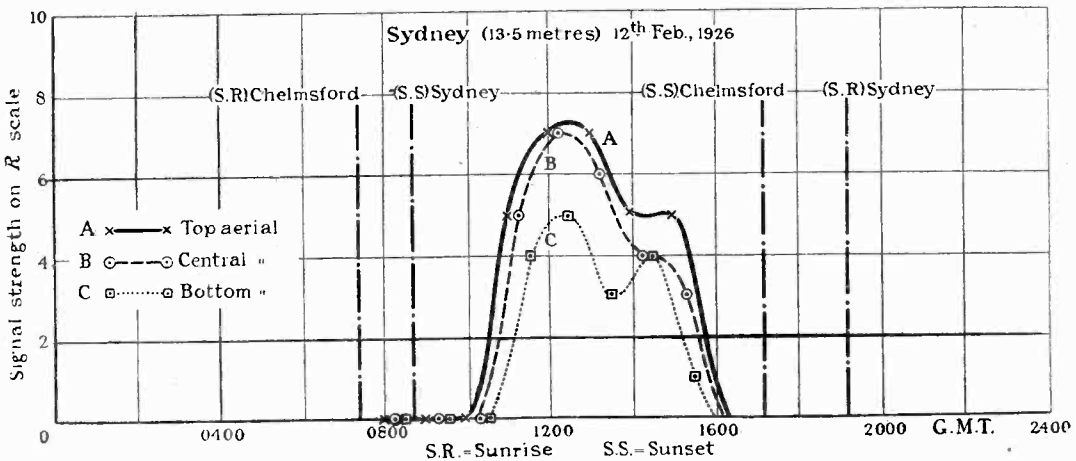

Fig. 33.

those of 15 metres. Final tests on 10 metres were made, the curve of Fig. 38 showing Australian results. Good signals were received at Buenos Ayres during the all-day light period between 12.15 and 14.40, but in later tests from 12.00 to

arranged one at an approximate height of 70 metres, another at half the height, and the third just above the surface of the earth, a mean height of about 7 metres. A very clear case of the effect of height is shown in Fig. 33, and also in Fig. 38. The author

summarises that the lowest aerial is always the worst, and that there is not much difference between the two upper aerials. The contrast in strength between the upper and the lowest aerials increases as the wavelength is reduced.

the frequency. Some results from Poldhu have also been examined giving the curve of Fig. 40, which is of similar form (on log. scale of ordinate). It appears possible to the author that we are approaching the daylight limit at 10 metres, for

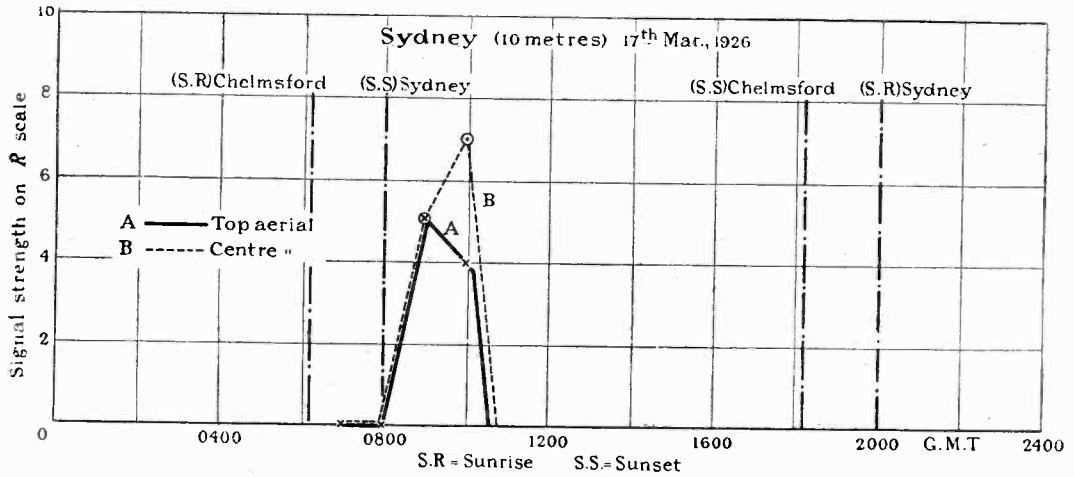

Fig. 38.

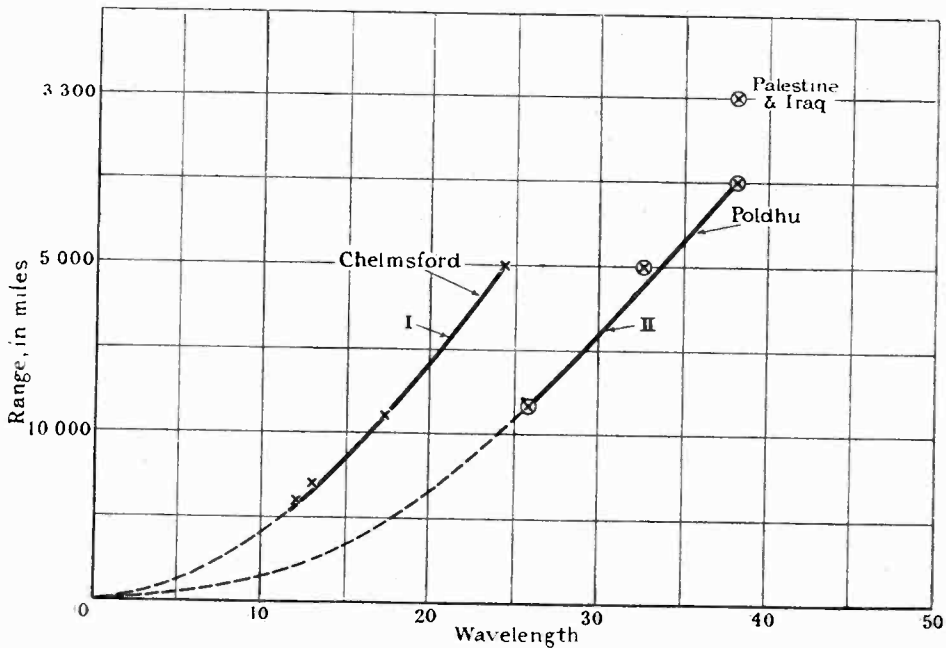

Fig. 39.

Daylight Range.—From the results obtained a rough estimate can be made of the daylight range in the region 24 to 10 metres. These are plotted in Fig. 39, where it is seen that the range increases very approximately in proportion to the square of

the signals from the lowest aerial which are projected at a fairly high angle do not appear to return to earth, or only very weakly, at Buenos Ayres, and a slight reduction in wavelength should be sufficient to cut off the rays even from the upper aerial,

Theory.

The remainder of the paper is devoted to theoretical considerations, more especially of the author's theory of attenuation in the upper atmosphere.

Losses may be attributed to three possible causes: 1. Energy lost by attenuation in the earth's surface; 2. Energy lost by attenuation in the Heaviside layer; 3. Energy lost by escape through the layer.

All the energy lost due to the last cause occurs in the first few hundred miles, and a gradual energy loss increasing with the distance is foreign to the whole idea of refractive bending. The energy lost

From a consideration of ray paths between two stations *A* and *B*, the author concludes that the paths are reversible, and that—

1. Absorption is the chief factor controlling the range of daylight signals.
2. The effect of raising the aerial is in general beneficial.
3. Long distance transmission is effected by rays the trajectory of which makes a small angle with the earth's surface, say, less than 20 degrees.
4. The trajectories follow great-circle paths (except possibly within the "jump over" distance, where there may be high angle reflections together with scattered radiation).

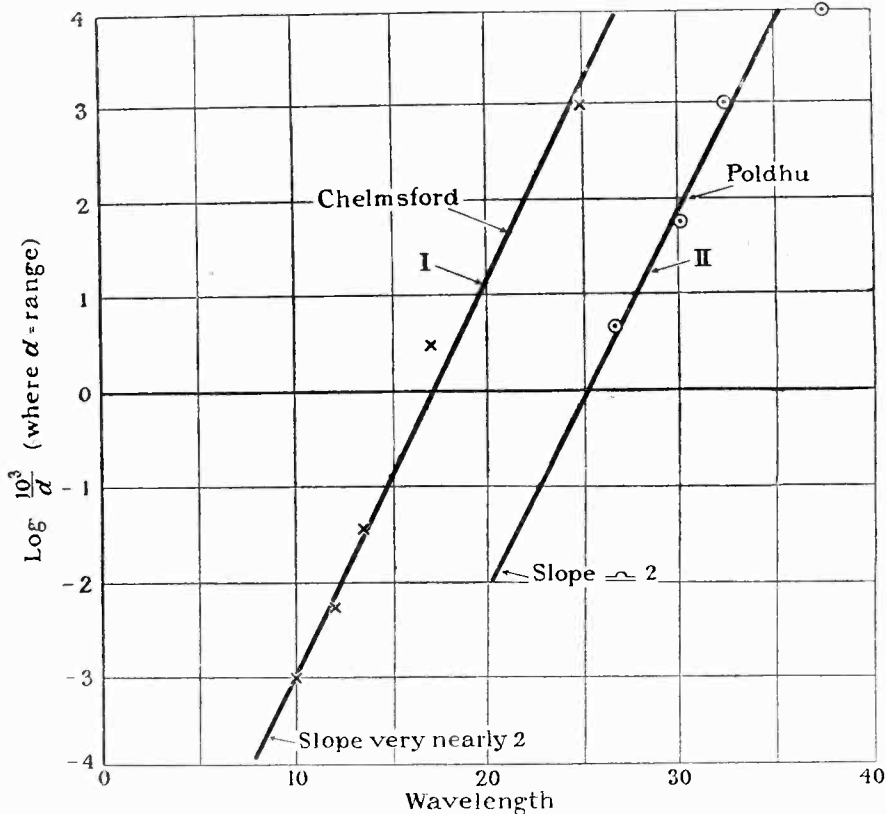

Fig. 40.

in earth attenuation cannot be a very serious factor, as far as the author can see, except in the near neighbourhood of the transmitter and the receiver. Finally we are left with attenuation in the upper layer, which the author considers must be taken into account in building up a comprehensive theory of short wave transmission. Although the ray bending theory explains the fact that signals can be heard at the other side of the world, it fails to explain many other facts; for instance, a range proportional to f^2 .

There seems little doubt that, in the main, ionic refraction is responsible for bending the short waves round the earth, but, in the author's opinion, results on this theory are largely discounted by the neglect of absorption.

He then proceeds to consider the loss of energy encountered at the layer, and derives an attenuation coefficient which varies inversely as the square of the frequency. It is on these grounds that the experiments which showed $\text{Range} \propto f^2$ indicate the important part played by attenuation in long

distance transmission. It should be noted that attenuation will only vary as f^2 if the ray path is the same in two transmissions. Again, since the attenuation is proportional to electronic density, it is to be expected that ionisation, and therefore density, should be greater (with increased attenuation) in summer than in winter. It is also significant that short wave transmission has been affected unfavourably in times of magnetic storms, when the ionic density is greatly increased.

He then discusses the effect of the average time between collisions (of ions in the layer), and shows that if the time period of the waves is long compared to the effective mean time between collisions the "metallic conduction" type, appropriate to long-wave transmissions, occurs. If the time period is short so that electrons or ions can execute many free oscillations before colliding with a molecule, the "dielectric" type of transmission, appropriate to short waves, occurs, characterised by a decrease of attenuation with increasing frequency.

From these arguments a line of distinction can be drawn between long and short waves.

The author is of opinion that we may safely class all waves longer than 1,000 metres, say, as long waves and all waves shorter than 100 metres, as short-waves, that is to say, any increase of wavelength at 1,000 metres produces a corresponding decrease of attenuation, and conversely any decrease of wavelength at 100 metres produces a decrease of absorption.

The distinction between long and short waves is summed up as follows:—

Long Waves.—

Summer attenuation less than winter.

Low-latitude attenuation less than high-latitude.

Decrease of attenuation under magnetic storm conditions.

Short Waves.—

Summer attenuation greater than winter.

Low-latitude attenuation greater than high-latitude.

Increase of attenuation under magnetic storm conditions.

After a brief discussion of the various estimates of the daylight height of the layer, the author states that the preponderance of evidence seems to put it at a height of about 50 kilometres, probably varying slightly between summer and winter and in different latitudes.

As regards the night layer, its position is more definitely determined, and from consideration of the interval between collisions, the author deduces that the transmission in practically the whole of the radio range would be entirely of the dielectric type, *i.e.*, of short wave daylight type. Evidence during magnetic storms is quoted to show that night transmission on 15,000 metres is of the "dielectric" type, whereas day transmission is of the "conduction" type.

Summary of Evidence.—The general radio evidence seems to be to the effect that the refraction theory refers to short waves in which $\lambda < 100$ metres in daylight, and to practically all waves during the night. Long-wave transmission in which $\lambda > 1,000$ metres in daylight is characterised by metallic conduction transmission (between layers).

The author then proceeds to discuss skip distance. It is known that in the neighbourhood of a short-wave transmitter signals fall off very rapidly with distance, may disappear entirely at 100 or 200 miles, and then begin to increase again to a maximum, and finally die away at very great distances.

According to the ray theory, apart from the direct ray, nothing should be obtained within the skip distance, and there is practically a discontinuity in this region. In actual fact conditions are nothing like this.

Whatever the ratio of signals within and without the skip distance may be, the form of the Intensity/Distance curve seems to be smooth, and there is indication of high angle reflected or scattered energy within the skip distance, contrary to the ray theory. The only evidence, according to the author, is that within the skip the indirect rays (reflected or refracted) are either not present or are present with very diminished intensity.

The author again considers loss due to attenuation at the layer, and calculates the attenuation of a ray as in Fig. 47.



Fig. 47.

It is clear that the greater the angle the greater the depth of penetration, and the greater the attenuation. Again, the greater the gradient of density the shorter the path in the medium and the less the total attenuation.

The calculated values are shown in Fig. 48 (not reproduced), along with experimental results made in America, where the calculated values allowing for attenuation are seen to be in close agreement with measured values.

Short-Wave Limit.

It seems to be an undoubted fact that there is a short-wave limit below which it is impossible to get long-distance transmission.

On the evidence of the transmission experiments cited here, as well as other evidence of the same sort, it seems probable that the short-wave limit for night transmission is somewhere in the neighbourhood of 17 metres, although the echo effect seems to show that under certain conditions waves as short as 14 or 15 metres may get through 20,000 kilometres of darkness.

In daytime the short-wave limit does not seem to have been reached at 10 metres. A recent experiment on 8 metres (using the same transmitter and power as in the other short-wave experiments) seems to indicate that this is below the limit, as nothing was received in Sydney, Montreal, New York, or South Africa, so that the limit appears to lie between 8 and 10 metres. This short-wave limit has received a very natural explanation on the ray theory, *i.e.*, it is supposed that the density in the upper layer is not sufficient to bend even the horizontally transmitted rays back to earth, so that all the rays escape. The author is not inclined to accept this explanation, chiefly on the ground that there is evidence of high-angle rays, within the

skip distance, of even the shorter waves (λ 20 to 25 metres), which on the ray theory should be entirely absent.

The picture that the author has of the transmission on different wavelengths is this: For waves above the limiting wavelength this attenuation constant is small, and long-distance glancing-incidence transmission takes place in the space between this main layer and the earth. Penetration into the main layer is small, and the whole attenuation is small and caused by the sparsely populated fringe below the layer, but directly the wavelength is made shorter than this short-wave limit, and the main ray penetrates well into the main layer, absorption sets in and further long-distance transmission is impossible. This theory applies to both day and night transmission with suitable values for the average time between collisions in each case. This is essentially a modified form of layer theory.

DISCUSSION.

A lengthy discussion followed the reading of the paper.

The discussion was opened by the President of the Institution, **Dr. W. H. Eccles**, who expressed thanks for the paper. He considered that important points had been made by the author in the image of opposite phase, and in the variation of range as the square of the wavelength. As regards travel of rays round the earth, would not these be returning in all directions, and how would this affect a directional receiver in the region of the transmitter? He also sought information about the actual arrangement of the raised aeriels.

Admiral of the Fleet Sir Henry Jackson expressed admiration of the author's work and treatment, and referred to the difficulties of short-wave work. He thought it would be some time before results could be checked.

Lt.-Col. A. G. Lee said he was glad of the author's suggested theories. As regards the D.F. experiments, he thought there was no proof of the absence of scatter outside the skipped distance, and was of opinion that this existed. He discussed the polar diagrams of the transmitter and the effect of the

method of excitation, *e.g.*, the use of harmonics, on the angle of transmission, and finally quoted some comparisons of the beam transmissions working to Canada and Australia respectively.

Mr. J. Hollingworth spoke of the difficulty of elucidating theory. Referring to the reversibility of the ray path, suggested by the author, he did not think it should be expected that the path should be reversible. It appeared important to consider the direction of the ray with respect to the earth's magnetic field. Amongst other measurements on Rugby he had already experienced quite high angle reflection on this wavelength.

Prof. S. Chapman hoped that in time wireless transmission would add to the knowledge of the upper atmosphere. The conductivity of the layer was due to the effects of ionisation and aurora. There were many complexities in the upper atmosphere, and the author's paper was a step forward in the presentation of results.

Prof. E. V. Appleton said that the paper abounded in material to check our existing speculations. There were two ways of explaining the skipped distance. One was absorption limitation. The other was electronic limitation, *i.e.*, that there were not sufficient electrons to bend back the beam at short distances. From available data, he estimated that the density would require to be of the order of 10^7 electrons per cubic centimetre. He thought that down to 1 metre wavelength could be done without limitation due to this cause. This theory seemed to him more probable than the first, and was in agreement with the quantum theory.

Mr. R. A. Wilmotte discussed the image and the phase relations between it and the elevated aerial.

Mr. Wells considered the radiation from a vertical aerial as raised from the ground, and suggested aerial schemes to give maximum horizontal radiation.

The author briefly replied to several of the points raised in the discussion, when the Chairman, **Prof. C. L. Fortescue**, moved a vote of thanks, which was heartily accorded.

Mathematics for Wireless Amateurs.

By F. M. Colebrook, B.Sc., A.C.G.I., D.I.C.

(Continued from page 174 of March issue.)

10. The Binomial Theorem.

THE Binomial Series has already been introduced. It is

$$1, mx, \frac{m(m-1)x^2}{2!}, \frac{m(m-1)(m-2)x^3}{3!} \text{ etc., etc.,}$$

the general or n th term being

$$\frac{m(m-1)(m-2)\dots(m-n+2)x^{n-1}}{(n-1)!}$$

The further discussion of this series will lead us to one of the most famous theorems in the whole of mathematics and certainly one of the most useful—the Binomial Theorem.

The name sounds rather impressive, and the series itself looks very complicated and mathematical; but, after all, it is only a number, or rather a set of numbers. To make sure that our feet are still on solid ground, let us materialise this airy spirit and give it a substantial form by putting $m=5$ and $x=2$. The numbers then become

$$1, 5 \times 2, \frac{5 \times 4 \times 4}{2} \frac{5 \times 4 \times 3 \times 8}{3 \times 2}$$

$$\frac{5 \times 4 \times 3 \times 2 \times 16}{4 \times 3 \times 2} \frac{5 \times 4 \times 3 \times 2 \times 1 \times 32}{5 \times 4 \times 3 \times 2}$$

i.e., 1, 10, 40, 80, 80, 32.

There are only six terms to the series in this case, for the seventh and all subsequent terms contain the factor 0 in the numerator. The sum of the six terms is 243.

So much by way of reassurance, in case it was necessary. Now we can return to the symbols and try to find some simple formula for the sum of the series when m is a positive integer. We have already seen that in all such cases the series is finite and terminates at the $(m+1)$ th term. The sum of the series is clearly a function of x and of m , so we can write

$$f(x, m) = 1 + mx + \frac{m(m-1)x^2}{2!} + \frac{m(m-1)(m-2)x^3}{3!} \text{ etc., etc.}$$

Now multiply each side by $(1+x)$ and arrange the right-hand side in ascending powers of x , as in the original series. The multiplication is quite a simple and straightforward process and the reader will have no difficulty in showing that

$$\{f(x, m)\}(1+x) = 1 + (m+1)x + \frac{(m+1)mx^2}{2!} + \frac{(m+1)m(m-1)}{3!}x^3, \text{ etc., etc.}$$

Now the right-hand side is the original series but with $(m+1)$ written everywhere instead of m , i.e., it is $f(x, 1+m)$,* so that

$$\{f(x, m)\}(1+x) = f(x, 1+m)$$

It follows from this that

$$f(x, m) = (1+x)^m$$

but it is rather a long jump so we will come to it in smaller steps. Since m is any positive integer, put

$$m+1=r.$$

Then

$$m=r-1$$

and we have $(1+x)f(x, r-1) = f(x, r)$

$$\text{or } \frac{f(x, r)}{(1+x)} = f(x, r-1)$$

Since this is a perfectly general formula, we may say that

$$\frac{f(x, r)}{(1+x)^2} = \frac{f(x, r-1)}{(1+x)} = f(x, r-1-1) = f(x, r-2)$$

The process can be continued, giving

$$\frac{f(x, r)}{(1+x)^3} = f(x, r-3)$$

and so on, up to r times, which will lead to

$$\frac{f(x, r)}{(1+x)^r} = f(x, r-r) = f(x, 0)$$

But

$$f(x, 0) = 1$$

* To make this entirely complete and convincing it should be proved for the general term in each case. This can be done but is a rather lengthy business. The reader should be able to do it for himself.

Therefore
$$\frac{f(x,r)}{(1+x)^r} = 1$$

so that

$$(1+x)^r = f(x,r) = 1 + rx + \frac{r(r-1)x^2}{2!} + \frac{r(r-1)(r-2)x^3}{3!} \text{ etc., etc.}$$

which is what we set out to prove. The symbol m has got changed on the way, but that doesn't matter.

If $m=5$ and $x=2$, the sum of the series is therefore $(1+2)^5 = 3^5 = 243$, a result which has already been demonstrated above.

So much for positive integral values of m ; but the series is not inherently limited in the values that m may take, so it will be necessary to carry the investigation one stage further and find what the series means when m is negative or fractional.

It has already been shown that in such cases the series is infinite, and that it is convergent when x is less than 1 numerically, which condition will be assumed in all that follows.

Without assuming anything at all about u and v , take the two binomial series

$$f(x,u) = 1 + ux + \frac{u(u-1)x^2}{2!} + \frac{u(u-1)(u-2)x^3}{3!} \text{ etc., etc.}$$

$$f(x,v) = 1 + vx + \frac{v(v-1)x^2}{2!} + \frac{v(v-1)(v-2)x^3}{3!} \text{ etc., etc.}$$

multiply them together, and arrange the product in ascending powers of x . As before, the operation should really be carried out for the general term, but this would take rather too much of our limited space. Taking any finite number of terms the reader will have no difficulty in showing that the product can be put in the form

$$\begin{aligned} & f(x,u) f(x,v) \\ &= 1 + (u+v)x + \frac{(u+v)(u+v-1)x^2}{2!} + \\ & \frac{(u+v)(u+v-1)(u+v-2)x^3}{3!} \text{ etc., etc.} \\ &= f(x,u+v) \end{aligned}$$

This is the important step, and the full interpretation of the series is implicit in this equation, for we can use it to show that

$$f(x,m) = (1+x)^m$$

even when m is negative or fractional, provided x is less than 1 numerically.

Suppose first that u is a positive integer, and that v is a negative integer equal to u in magnitude (*i.e.*, $v = -u$). Then since

$$f(x,u) = (1+x)^u$$

u being a positive integer, and since it has been shown that

$$f(x,u) f(x,v) = f(x,u+v)$$

for any values of u and v , then if $v = -u$,

$$\begin{aligned} f(x,u) f(x,v) &= (1+x)^u f(x,-u) \\ &= f(x,u+v) = f(x,u-u) = f(x,0) \end{aligned}$$

But $f(x,0) = 1$

Therefore $(1+x)^u f(x,-u) = 1$

or $f(x,-u) = 1/(1+x)^u = (1+x)^{-u}$

which establishes the result for a negative value of m .

From the general result

$$f(x,u) f(x,v) = f(x,u+v)$$

it is easy to show (as on p. 560 in the issue of *E.W. & W.E.* for September, 1926) that

$$\{f(x,u)\}^q = f(x,uq)$$

where u has any value, and q is a positive integer.

Since u can have any value, let it be a fraction p/q , so that uq is a positive integer p . Then the equation

$$\{f(x,u)\}^q = f(x,uq)$$

becomes

$$\{f(x,p/q)\}^q = f(x,p) = (1+x)^p$$

Therefore (see p. 561, September 1926)

$$f(x,p/q) = (1+x)^{p/q}$$

which proves the result for a fractional index.

To sum up,

$$\begin{aligned} (1+x)^m &= 1 + mx + \frac{m(m-1)x^2}{2!} + \\ & \frac{m(m-1)(m-2)x^3}{3!} + \text{etc., etc.,} \\ & + \frac{m(m-1)(m-2) \dots (m-n+2)x^{n-1}}{n-1!} \dots \end{aligned}$$

for all values of x if m is a positive integer,

and for all values of m provided x is less than 1 numerically. This is known as the Binomial Theorem.

It is obvious that there are many useful and important applications for this result. Take for instance the general solution of a quadratic equation:—

$$x = \frac{-b \pm \sqrt{b^2 - 4ac}}{2a}$$

which can be put in the form

$$x = \frac{-b}{2a} \left\{ 1 \mp \left(1 - \frac{4ac}{b^2} \right)^{\frac{1}{2}} \right\}$$

Now if $4ac$ is less than b^2 numerically, so that $b^2/4ac$ is less than 1 numerically, putting $x = -4ac/b^2$ and $m = \frac{1}{2}$ in the Binomial expansion gives

$$\begin{aligned} & \left(1 - \frac{4ac}{b^2} \right)^{\frac{1}{2}} \\ = & 1 - \frac{2ac}{b^2} - \frac{2a^2c^2}{b^4} - \frac{4a^3c^3}{b^6} - \frac{10a^4c^4}{b^8} - \end{aligned}$$

etc., etc., *ad. inf.*

so that the solutions are

$$x = -\frac{b}{2a} \pm \frac{b}{2a} \mp \frac{c}{b} \mp \frac{ac^2}{b^3} \mp \frac{2a^2c^3}{b^5} \mp \frac{5a^3c^4}{b^7}$$

etc., etc., *ad. inf.*

In terms of actual numerical values this series solution may not be any simpler for computation than the original form of solution, but since the successive terms will decrease in magnitude more or less rapidly according to the magnitude of $4ac/b^2$, this form of statement facilitates a process of approximation, and if $4ac/b^2$ is very small compared with 1, so that powers above the second can be neglected, it gives a very closely approximate solution in a very simple form.

Again, the binomial theorem is very useful for the approximate calculation of certain numerical expressions. The n th root of a number, for instance, can be obtained by a general method which can best be explained by a simple illustration. Find to four places of decimals the fifth root of 3031. First find by guessing and trial the nearest whole number—in this case it is 5, for $5^5 = 3025$. Then

$$3031 = 5^5 + 6 = 5^5(1 + 6/3025).$$

Notice as a further simplification that

$$6/3025 = 6/5^5 = 6 \times 2^5/10^5 = 6 \times 32/10^5$$

$$\begin{aligned} \text{Then } \sqrt[5]{3031} &= 5(1 + 6 \times 32 \times 10^{-5})^{\frac{1}{5}} \\ &= 5 \left\{ 1 + \frac{6 \times 32 \times 10^{-5}}{5} \right. \\ &\quad \left. - \frac{4 \times 6^2 \times 32^2 \times 10^{-10}}{25 \times 2} + \text{etc., etc.} \right\} \\ &= 5(1 + .00038) \end{aligned}$$

taking the first two terms only. (A little consideration will show that the third term will not affect the fourth place of decimals.) Finally

$$\sqrt[5]{3031} = 5.0019.$$

Certain power calculations can be very considerably simplified in a similar manner, e.g., $(3.03)^{10}$. This can be put in the form

$$\begin{aligned} (3.03)^{10} &= 3^{10}(1 + 10^{-2})^{10} \\ &= 3^{10}(1 + 10 \times 10^{-2} + 45 \times 10^{-4} \\ &\quad + 120 \times 10^{-6} + 210 \times 10^{-8} \text{ etc., etc.}) \\ &= 3^{10} \times (1.10462) \\ &= 59049 \times 1.10462 \end{aligned}$$

correct to five figures. The last multiplication will be a rather long business but the whole calculation will be very much shorter than the direct working out of the original expression.

Apart from these immediate and practical uses the Binomial Theorem plays a large part in the development of other important series. This is illustrated in the Exponential Series, of which mention has been made already in the preceding instalment.

11. The Exponential Series.

It has been shown that the series of numbers

$$1, x, \frac{x^2}{2!}, \frac{x^3}{3!}, \frac{x^4}{4!}, \frac{x^5}{5!}, \dots, \frac{x^{n-1}}{(n-1)!}$$

known as the Exponential Series, is convergent for all values of x . The series is really a special case of the Binomial Series, and can be derived in this way.

$$\begin{aligned} \left(1 + \frac{x}{n} \right)^{nx} &= 1 + \frac{nx}{n} + \frac{nx(nx-1)}{2! n^2} \\ &\quad + \frac{nx(nx-1)(nx-2)}{3! n^3} + \text{etc., etc.} \\ &= 1 + x + \frac{x(x-1/n)}{2!} \\ &\quad + \frac{x(x-1/n)(x-2/n)}{3!} + \text{etc., etc.} \end{aligned}$$

Now by sufficiently increasing n , the series on the right can be made to differ by as little as we please from the series

$$1 + x + \frac{x^2}{2!} + \frac{x^3}{3!} + \text{etc., etc., ad. inf.}$$

In other words, this series is the limit of the original series when n tends to infinity, and we have

$$\lim_{n \rightarrow \infty} \left(1 + \frac{x}{n} \right)^{nx} = 1 + x + \frac{x^2}{2!} + \frac{x^3}{3!} + \frac{x^4}{4!} + \dots + \frac{x^{n-1}}{(n-1)!} + \dots \text{etc., etc., ad. inf.}$$

(This, by the way, though it is given in this form in some text-books, cannot be regarded as a rigid proof. The limit of the sum of an infinite number of quantities is *not necessarily* the same as the sum of their limits, as the above proof assumes. However, it serves to demonstrate the connection between the Binomial and the Exponential Series. A completely rigid proof would take rather more space than can be allowed to it.)

An important special case of this series is that in which $x=1$. The series then becomes

$$\lim_{n \rightarrow \infty} \left(1 + \frac{1}{n} \right)^n = 1 + 1 + \frac{1}{2!} + \frac{1}{3!} + \frac{1}{4!} + \dots + \frac{1}{(n-1)!} + \dots \text{etc., etc., ad. inf.}$$

The number represented by the series on the right-hand side plays a very large part in physics, particularly in electricity. It is called ϵ , and its magnitude to ten places of decimals is 2.7182818285. Readers have already made the acquaintance of this number in the section dealing with logarithms where it was introduced as the base of the system of Napierian or Natural Logarithms. It was remarked at the time that nothing could seem more arbitrary and unnatural than this awkward looking number, but we see now that there is at least nothing arbitrary about it, and a little further consideration will show that there is very good reason for calling it "natural." The reason is that it symbolises a process of growth or change which is of very frequent occurrence in natural phenomena.

Consider, for instance, what happens when a condenser of capacity C is given a charge of amount Q_0 and then allowed to discharge through a resistance R as shown in Fig. 16.

The charge on the positive plate of the condenser will flow away in the form of a current through the resistance, and the magnitude of this current will depend on the potential of the condenser, *i.e.*, on the charge on the condenser. Thus the condenser discharges at a rate which is proportional to the charge, or, in other words, the charge disappears at a rate which is proportional to itself. This means that the rate of discharge will not be constant for any finite interval of time, but decreases continually as the charge leaks away. The determination of the charge left on the condenser after any given interval thus appears to be a very difficult matter. In fact, it cannot be solved directly without the aid of the Differential Calculus. The following method can be made to give the right answer, however, and is a very good example of the part played by ϵ in all such phenomena.

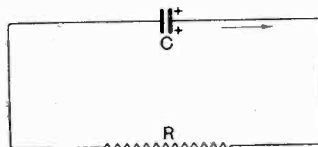

Fig. 16.

We will assume that the rate of discharge varies not continuously, but by sudden steps. That is, we will assume that the condenser discharges for an interval of time δt at the rate corresponding to the initial conditions, and then for a second interval δt it discharges at the rate corresponding to the conditions at the end of the first interval, and so on. The initial potential of the condenser is Q_0/C , and the initial current is therefore this potential divided by the resistance, *i.e.*, Q_0/CR . Since a current is the rate of flow of electricity, the quantity of electricity that leaves the condenser at this rate in the time δt is $Q_0\delta t/CR$, and the charge left on the condenser at the end of the first interval (call it Q_1) is $Q_0 - Q_0\delta t/CR$, *i.e.*,

$$Q_1 = Q_0 - Q_0\delta t/CR = Q_0(1 - \delta t/CR).$$

Similarly, Q_1 being the charge at the beginning of the second interval, the charge at the end of the second interval will be

$$Q_2 = Q_1(1 - \delta t/CR) = Q_0(1 - \delta t/CR)^2$$

and so on. After n such intervals the charge will be

$$Q_n = Q_0(1 - \delta t/CR)^n.$$

Assuming that we want to determine the charge after an interval t we can consider that this interval is divided up into n smaller intervals δt , i.e., $t = n\delta t$, and writing Q_t for this remaining charge

$$Q_t = Q_0(1 - \delta t/CR)^n = Q_0(1 - t/nCR)^n$$

But this is admittedly an approximate solution. The rate of discharge does not remain constant during the interval δt , however short that interval may be; but it is clear that the shorter the interval, the more correct the solution will be. That is, for a given interval t , the larger n becomes the more nearly correct will be the solution. In fact the approximation can be made as close as we please by sufficiently increasing n , and the exact solution is therefore the limit of the above expression when n tends to infinity, i.e.,

$$Q_t = Q_0 \lim_{n \rightarrow \infty} (1 - t/nCR)^n$$

This can also be written

$$Q_t = Q_0 \lim_{n \rightarrow \infty} (1 - t/nCR)^{\{1 - t/nCR\}^{-nCR/t} \cdot t/CR}$$

and, writing $1/m$ for $-t/nCR$ (notice that m and n will tend to infinity together)

$$Q_t = Q_0 \lim_{m \rightarrow \infty} (1 + 1/m)^{m \cdot t/CR} = Q_0 e^{-t/CR}$$

The reader should put in some actual values in order to get some idea of the scale of the phenomenon. How long will it take the condenser to discharge completely, that is, for what value of t is $Q_t = Q_0 e^{-t/CR}$ zero? The answer is that there is no finite value for t which makes Q_t zero. The condenser is never discharged. Think of it! All the condensers in the world are still trying to get rid of their last charge and not succeeding. Actually, of course, the charge falls to an immeasurably small quantity in a very short time, fractions of a second in general, and can be made smaller than any given quantity by making t sufficiently large. Mathematically speaking complete discharge of the condenser is represented by

$$\lim_{t \rightarrow \infty} Q_t = \lim_{t \rightarrow \infty} Q_0 e^{-t/CR} = 0$$

Nature abounds in instances similar to the

above, where a quantity changes at a rate which is proportional to the magnitude of the quantity. In all such cases ϵ , generally with a negative index, will appear in the mathematical representation of the process. In fact ϵ turns up nearly as often as π , which is saying a good deal. An instance of special interest to readers of this journal is one which the writer was the first to publish as far as he is aware. The grid current of any ordinary small receiving valve for negative values of the grid voltage can be represented very closely by a curve having the equation

$$i_g = a \epsilon^{bv_g}$$

(See *E.W. & W.E.*, November 1925, p. 867 *et seq.*). This can be taken as showing that the emission must involve in some way a change which occurs at a rate proportional to the magnitude of the quantity that changes.

Conclusion of Part I.

So much by way of an introduction to Algebra (for even at the risk of discouraging the reader it is well to remind him that it is only a bucketful out of the ocean; but it should prove sufficient for most of the practical requirements of readers of this journal). The writer can only hope that a fair proportion of readers have found it to be what they were needing. The only published comment has been favourable, and one Continental wireless paper has thought the articles worth translating and reproducing in full, but the writer does not flatter himself that everyone has been pleased. To parody an historic phrase—he may have pleased some readers all the time and all readers some of the time, but certainly not all the readers all the time.

One final word of advice will not be out of place before we leave this part of the subject and proceed on the next stage of the journey towards the calculus. Mathematics, like mankind, is a mystic duality of body and soul. Algebra is the soul of arithmetic. Its intimate association with, and, in a certain sense, dependence upon, concrete reality should never be forgotten. A comprehensible numerical or physical interpretation is the ultimate sanction of any algebraical operation, and only within the limits of this sanction can the wonderful labour and thought-saving devices of

algebraic symbolism be employed with perfect confidence. Even practised mathematicians are liable to be pulled up short by the sudden materialisation of a grinning absurdity out of a mist of ill-defined symbols, as when, for instance, to quote an example that recently came to the writer's notice, a few pages of apparently unimpeachable analysis led to the conclusion that the height of the Heaviside layer could be expressed as a complex number. As the Duchess would have said to Alice, the moral of that is,—take care of your grounds, and the sense will take care of itself.

Examples.—Binomial and Exponential Series.

1. Expand to the first five terms
 - (a) $1/(1+x)$
 - (b) $1/(a^5-x^5)^{1/2}$
 - (c) $(1-x)^{-3}$
2. Show that the n th terms of $(1-x)^{-n}$ and $(1+x)^{2n-2}$ are equal.
3. Find $6\sqrt{719}$ to four places of decimals by the Binomial Theorem. (Note.— $3^6=729$.)
4. Find $7\sqrt{108}$ to four places of decimals by the Binomial Theorem. (Note.— $2^7=128$.)
5. Show that

$$a^x = 1 + x \log_e a + \frac{x^2(\log_e a)^2}{2!} + \frac{x^3(\log_e a)^3}{3!} + \dots, \text{ etc., etc., ad. inf.}$$
 (Note.—Put $a = e^m$, i.e., $m = \log_e a$.)

6. Show that

$$\frac{e^x + e^{-x}}{2} = 1 + \frac{x^2}{2!} + \frac{x^4}{4!} + \frac{x^6}{6!} + \frac{x^8}{8!} \text{ etc., etc., ad. inf.}$$

$$\frac{e^x - e^{-x}}{2} = x + \frac{x^3}{3!} + \frac{x^5}{5!} + \frac{x^7}{7!} + \frac{x^9}{9!} \text{ etc., etc., ad. inf.}$$

7. Show that

$$\frac{1}{e} = \frac{2}{3!} + \frac{4}{5!} + \frac{6}{7!} + \frac{8}{9!} + \text{etc., etc., ad. inf.}$$

Answers to Examples in March Issue.

1. The $(n+1)$ th term is $an+a+b$. Therefore $(n+1)$ th term — n th term = a , which is constant. First term is $(a+b)$. Sum of second fifty terms is $3775a+50b$.
3. If sum of n terms is $a(r^n-1)$, the sum of $(n-1)$ terms is $a(r^{n-1}-1)$. Therefore the n th term is $a(r^n-r^{n-1})$. Therefore $(n-1)$ th term is $a(r^{n-1}-r^{n-2})$, and the ratio of n th term to $(n-1)$ th term is r (const.).
4. If the n th term is ar^{n-1} , the sum of all subsequent terms is $ar^n/(1-r)$. Ratio of n th term to sum of subsequent terms is $(1-r)/r$.
5. Convergent by comparison with series $1/n$. If x is r^2 the n th term is infinite.
6. Divergent for all values of x , by comparison with $1/n$ series.
7. Divergent, by comparison with $1/n$ series.
8. Ratio of $(n+1)$ th term to n th term is $(2n+3)x/(3n+4)$, therefore series is convergent if x is less than $3/2$ numerically.

Phototelegraphy.

A Lecture and Demonstration before the Radio Society of Great Britain by
T. THORNE-BAKER, M.I.R.E., F.Inst.P., F.R.P.S., delivered at the
Institution of Technical Engineers, on Wednesday, 23rd February, 1927.

IT is a great pleasure to me to accept the invitation to come and show these instruments at work and also to give an account, in a brief way, of the work of a very large number of men who have taken part, in this country and elsewhere, in bringing the problem of phototelegraphy to maturity, because this branch of work has now reached a certain stage of maturity. Their work has led up to phototelegraphy and the transmission of images, writings, etc., as it is to-day. I have been associated with picture-telegraphy since 1907, just over 20 years. In 1907 I went over to Paris to study the subject with Professor Korn, who was one of the colleagues of Professor Rontgen, and it has been my good fortune during those 20 years to come into contact with almost everyone who has been concerned with this development. Therefore, I want to let you see in the right perspective the part that each of these people have played, because all their systems are the germs of the systems in use to-day, and I think you will find it is a matter of instrumentation and adaptation to modern telegraphic work, modern physics, and modern radiotelegraphy that has just bridged over the gulf between the old experiments and some of the excellent transmissions we have to-day.

I would first like to show you a slide (not reproduced*) which is familiar; it is the ordinary coloured photograph of the spectrum, beginning at the blue end with waves about $400\mu\mu$ † through the various colours running up into the extreme red, which is about $800\mu\mu$.

In the next slide (showing the relationship between the visible band of frequencies and the entire range of known ether oscillations)

* Space does not permit of the reproduction of all of the slides accompanying the paper. This slide, and several others which illustrate well-known scientific facts, have been omitted as well as certain of the slides showing transmitted pictures in which the line or dot formations of the image would be lost in the photomechanical process used for reproduction.

† $\mu\mu = 10^{-7}\text{cm}$.

the small range of radiation of the visible spectrum is shown. If you take the shortest *gamma* rays emitted by radium, the wavelength of which is about half an Angström unit, and you pass through X-rays and the ultra-violet rays, you come to the visible range of colour from red to violet, and then on through the infra red into the wireless radiations which may run up to the large dimensions of miles-long waves that are being used at stations like Bordeaux. The point of interest is that we are only turning one unit into another, that we are dealing with a picture which reflects more or less light radiation, *i.e.*, visible radiation of 400 to $800\mu\mu$. You are merely employing exactly the same type of ether motion converted into an enormously greater wavelength in order to carry these shades of light and dark to a distant station where they are reconstructed into visible light gradations by suitable mechanism.

There are various ways of using this light energy. It is quite obvious that if you want to transmit a picture made up of certain light parts, dark parts and grey parts, and you have to make an exchange with these tones or densities into a wireless signal of either long or short period, or of large or small amplitude, proportional to the tones of the picture, you need to make use of some light sensitive substance in order to absorb the light energy.

I have here a slide (view of light operated apparatus, not reproduced) showing one of the practical ways in which light is used. There are two small glass elliptical-shaped vessels one of which is black and the other is white. There is a little ether in both, and the light rays are absorbed by the blackened substance. The ether is thereby warmed and distils over; the balance is upset and the thing goes over to the other angle. It is a system which has been developed by Messrs. Chance Bros. of Birmingham, and is used in a large number of lighthouses to control the switching on and off of the light automatically by the energy of the light.

As you know, the name of the selenium cell is almost synonymous with phototelegraphy. The sensitiveness to light of selenium was discovered as you know by Shelford Bidwell. This extraordinary element, just warmed to a critical temperature of 207 degrees C., goes through an allotropic modification and becomes somewhat crystalline, and in that form it is extraordinarily sensitive to light, though its resistance is enormous. Two spirals of flattened wire are wound round a plate of steatite; these are dusted over with selenium, which is then melted, and the "cell" is put into an oven and annealed. By just flashing an eight-candle-power lamp at a distance of about one foot on to a cell of this type it is possible to reduce its resistance from possibly 500,000 to about 10,000 ohms. The light is able to change the resistance of the cell in this extraordinary way, and you can see how the idea was suggested to the early experimenters to take a transparent photograph on celluloid, wind it round a glass cylinder with a light in the middle, and by making use of the variation of the resistance of the cell, according to the light and dark parts of the picture, to get a picture transmitted and modulated in conformity with the tones of the original. Selenium was found a great deal too slow, because when you suddenly reduce the light, its resistance does not increase sufficiently fast. There is thus a considerable amount of "lag," and you will see how in these little machines which I am going to demonstrate that lag has been eliminated. The selenium cell, therefore, except for the simplest types of picture, is out of the question.

The latest type of photoelectric cell in its simplest form is an exhausted bulb on one side of which is deposited a little metallic potassium, sodium or rubidium, which is turned into the hydride. A little argon is then introduced into the bulb. There is a quartz window to allow ultra-violet rays from the source of light to strike the metal, and there is a ring anode. When the potassium hydride is influenced by light, a stream of electrons is given off and is collected by the anode. The cell can be used as a grid-leak. It is possible, with the photographic cylinder which is giving out small amounts of light of varying intensity, to arrange a method of transmission, and the photoelectric cell

seems at present to be the "be all and end all" of phototelegraphic work, although I think we shall hear quite a lot more about selenium in the course of a year or two. This cell was invented by Mr. Zworykin, in the United States, and besides being a photoelectric cell, it has the advantage of being a valve as well, so that the feeble current of 10^{-13} amperes is amplified by 10,000 or 100,000 times. The great difficulty with the selenium cell is the excessively small amount of current, which means you have to submit it to very large amplification before you can use it in a practical way.



Fig. 1. *Half-tone picture greatly magnified.*

To come now to mechanical methods of transmission. This slide (Fig. 1) illustrates an ordinary half-tone photograph such as you see in any newspaper, very much enlarged. It is composed, as you see, of dots of large and small diameter, the dark parts of the picture being made up of dots of large diameter and the light parts of dots of small diameter. If you take a piece of this photograph and enlarge it still more (Fig. 2), you will see that some dots are square and some are round. You can really divide these dots into half-a-dozen different sizes, comparable to the dots and dashes of the morse code, except that instead of either a dot and a

dash, you have dots of several different sizes. If you take a half-tone photograph and are prepared to sit up over it for two or three nights—and this has been done a good many times—you can, by studying these dots with a magnifying glass, write out a

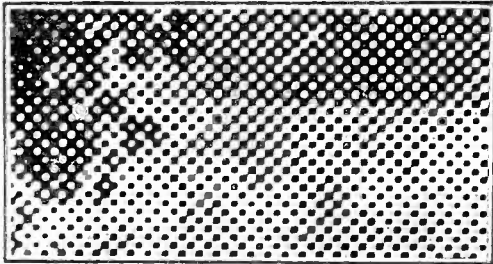

Fig. 2. Still further enlarged piece of half-tone image, showing how the diameters of the dots are comparable with a morse signalling system.

telegram describing the consecutive dots in order of diameter. This telegram can be sent by wire or wireless. With the aid of a piece of squared paper the picture is reproduced by filling in the squares more or less according to the letters in the telegram. This is a very laborious process. I once sat

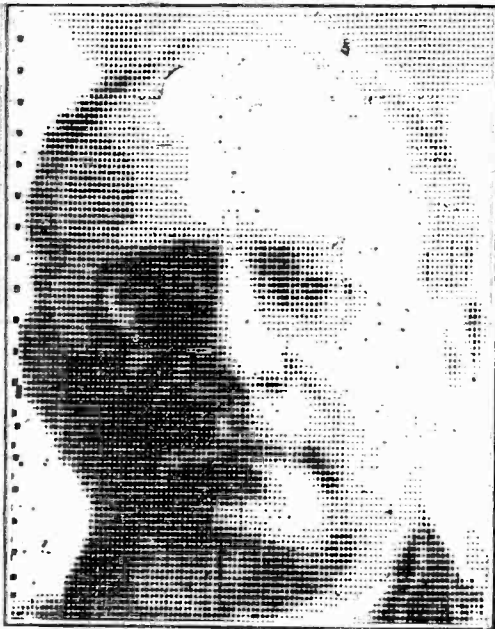

Fig. 3. A "code" picture sent by Korn from the U.S. to Rome by wireless telegram.

through a day and night with a Chinaman who came over here to demonstrate this system to a London newspaper, but after he had got a plausibly good photograph from America I almost broke his heart by showing him that the thing had been done 25 years before. It is one of the oldest ideas of phototelegraphy, and is due to Mr. William Gamble, the well-known photoengraving expert. To show you how this "code" method can be done, I will show you a photograph transmitted from New York to Rome by this system. (Fig. 3.) There are only three sizes of dots in this case, *a*, *b* and *c*. Professor Korn invented a sort of decoding apparatus, and he took his telegram and worked on a typewriter for two or three hours and built up the picture. This is one of

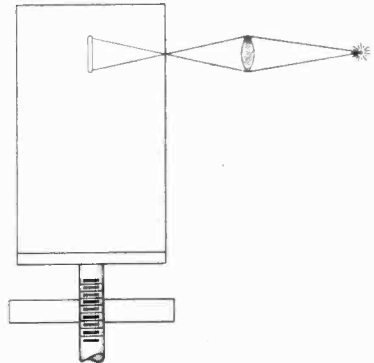

Fig. 4. Principle of the Korn transmitter, with selenium cell within the glass cylinder.

the first wireless photographs transmitted, and is, in fact, the only one I have seen transmitted by the code method.

We will now go on to 1905 or 1906 and see by a diagram how the method in which the selenium cell is used came into practice. A photographic film wrapped round a glass cylinder was rotated by an electric motor, a spiral shaft being used so that as the cylinder revolved it rose up and the spot of light passed through the photograph in a spiral fashion. (Fig. 4.) Thus, as the cylinder was turning and rising, this spot of light would explore the whole of the photograph, bit by bit. The light was passed on to a selenium cell, so that as dark parts of the picture passed before the rays the cell was altered in resistance, and so on.

The current fluctuations were applied to a telephone line between London and Paris.

the received current being passed through a string galvanometer of the Einthoven type. (Fig. 5.) The string or ribbon moves in a magnetic field, and for small currents the displacement of the string is directly proportional to the current, so that the tones of the photograph will be faithfully recorded. There is a

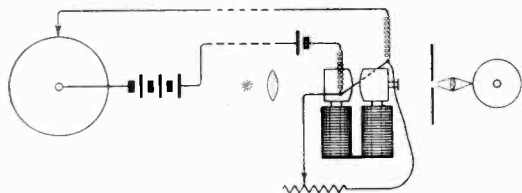

Fig. 5. Korn's telautograph. The photographic film for reception is mounted on the small cylinder in a dark chamber.

Nernst lamp and a lens, and a beam of light passes through a hole in the poles of the magnet and through a slit, and is focused on to the photographic film in a dark chamber. According to whether the tones in the photograph are light or dark so the current is greater or smaller, the string acting as a shutter, allowing more or less light to fall upon the sensitive film.

The silver string is represented in Fig. 6. It was not quite large enough, so finally Korn employed two silver wires $\frac{1}{1000}$ inch diameter, with a little magnesium shutter $\frac{1}{50}$ inch square to cut off the light.

This is the first photograph (a portrait of King Edward) sent with Professor Korn's apparatus from Paris to London in 1907. Owing to the receiving cylinder running too fast, we unfortunately lost a portion of the King's head. The synchronism has

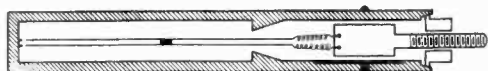

Fig. 6. The magnesium shutter on parallel strings, as used in Korn's galvanometer.

to be of an accuracy of about half per cent., otherwise an elongation of the face results.

This is another photograph (Fig. 7) of a lady who was claimed to be at that time the prettiest girl in Paris. You will see that the dark lines have widened a little, showing that the mechanism of the shutter has been shifted slightly with the increases in current,

allowing a wider beam of light to affect the film. I regard Professor Korn as one of the greatest pioneers in commercial phototelegraphy.

Now I come to the important question of synchronisation. The transmitting and receiving cylinders must run at nearly identical speeds, an elementary fact which must be admitted when first devising any system of phototelegraphy. Most of the machines were driven—some of them are now—by high speed motors running at about 3,000 r.p.m., geared down by a worm drive in oil so as to



Fig. 7. News portrait transmitted from Paris to London.

run the actual cylinder one revolution in three to five seconds. In order to get the motors at each end running approximately at the same rate, frequency meters are used, working from slip rings fitted to the motors giving alternating current. A small variation from 97 periods to 103 periods gives a range of 3 per cent. either way. Actually you have to keep within a half per cent. accuracy and make up for any losses in the running rate at

the end of each revolution. Fig. 8 gives an idea of the synchronising apparatus. The receiving cylinder is always run at a higher rate than the transmitting cylinder, and is stopped at the end of every revolution by a little check

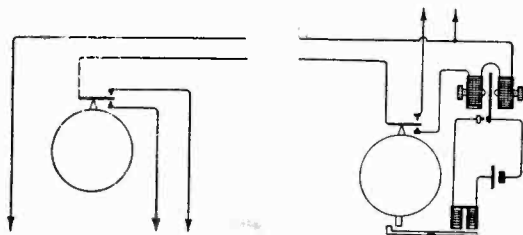

Fig. 8. Scheme of synchronisation. The transmitter is on the left.

which works against a catch. The transmitting drum, which is running slower, works at the end of each revolution a reverse-current contact, which in turn operates a polarised relay. That relay throws in another magnet, which draws away the check, and the result is that however much the two cylinders may be out of step in one revolution, they are bound to start off at the beginning of the next revolution at exactly the same instant. How we have got over the synchronising of two instruments not connected with wires will be seen when I start the wireless machines up later on.

Now we come to a mechanical method of picture transmission which is of great interest, and that is the Belin method, of which I am quite sure you have heard a great deal. You may remember that M. Belin was

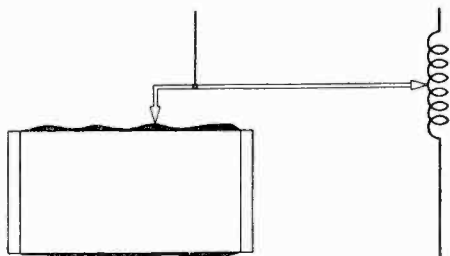

Fig. 9. Belin's relief method in principle.

over here a year or two ago giving a lecture at the Royal Society of Arts. He and Professor Tschörner have both worked out processes in which the image to be transmitted is in relief. Those of you who are photographers will know the carbon process,

in which a photographic print is made in gelatine. It is washed with hot water after exposure and all the gelatine which has not had sufficient exposure to light remains soluble and is washed away. When the print is made you get it in relief, the dark parts being raised.

If you can imagine the view shown in Fig. 9 to represent a section of one of these carbon photographs, there is a little stylus riding over the surface, and as the cylinder turns round, the hills and dales of the relief picture come round and raise the stylus up and down, operating a rheostat through which the telegraphic current is passing. It is not quite as simple as that in actual practice, however. Belin's first idea was to have a little wheel which ran over a rheostat made up like a commutator, but he finally

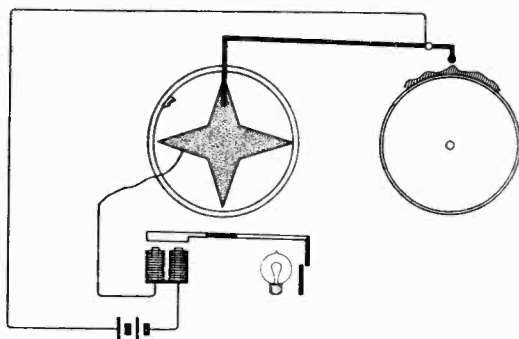

Fig. 10. Tschörner's relief method.

abandoned that and now he uses a special form of microphone, the pressure due to the varying thickness of the picture operating the microphone. In this case he uses an alternating telephonic current which acts as a carrier.

Tschörner's method is somewhat similar. He gets the motion by means of a metal star (Fig. 10) which is put on to a fibre disc and turns in conjunction with the cylinder. As this needle is raised and lowered, so the point on the star gets higher or lower, and as you see it gives a longer period contact or a shorter one. Therefore, whilst Belin gets a varying amplified current, Tschörner gets a difference in period in consecutive signals.

It is rather interesting to consider some of these early pictures of 1906, because it is just as well that some of us who might think

we are now doing rather well should be reminded of the remarkably good things that were done 20 years ago.

Now we are going a little farther back still, to the days of Casselli, because his transmitter is used by me and by a number of other people. It is used by the Telefunken people, by Dr. Alexanderson of the General Electric Co. of America, and was also used

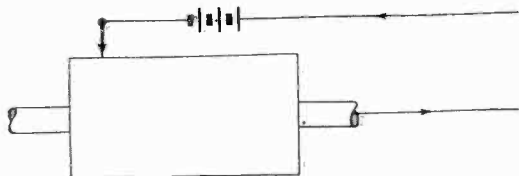

Fig. 11. Diagram of the Casselli transmitter.

by Korn in making his first attempts at transmitting half-tone photographs. It is a plain cylinder (Fig. 11) with a plain gramophone needle or stylus, and it is just a make-and-break process, similar to a morse key in result. You have an electric current passing through the drum, which is generally earthed in the case of telegraphy, and from the stylus is the wire going to the distant station. If you fold a piece of tin or copper foil round the cylinder upon which is written or drawn a sketch in some kind of insulating ink, then as the insulating lines pass under the needle the circuit will be broken and the interruptions of the current can be made to operate a relay at the other end of the line and record the signals either photographically or mechanically. Professor Korn used the Casselli transmitter with one of his string galvanometers.

We now come to the method that I have adopted for sending wireless pictures by broadcast. This photograph (Fig. 12) consists of thick or thin lines, wide lines for dark parts, and fine lines for light ones. If you take any photograph and put it on a copy-board and photograph it through a screen with diamond lines ruled 50 or 60 to the inch, you get a negative in which the photograph is broken up into parallel lines of varying thickness according to the brightness or darkness of the particular part of the picture. You can print these pictures in fish glue, which is highly insulating, on copper foil. These line pictures are then simply slipped over the Casselli cylinder, the

current is switched on and the transmitter acts as a morse key. The advantage is, however, that it is truly photographic and you have currents varying in duration. You would think, perhaps, that there are only about half-a-dozen different widths of line, but careful microscopic examination shows that you can count up to 30 or 40 widths with the eye, and there must be many more actually that you cannot differentiate, but which actually come into photographic reproduction by this method.

This shows the first photograph (not suitable for reproduction owing to the nature of the screen) I sent with my original machine from Manchester to London. It is a photograph of the first lady councillor in Liverpool, and you will notice how the mouth and the eyebrow have been put out of shape, as well as the collar. These things are simply due to lack of proper synchronism. The motors



[By courtesy of Bell Telephone Co.]

Fig. 12. Formation of a "line" half-tone image.

ran a little too fast, but generally in those days these defects were not removed to make people realise that the pictures had actually been telegraphed. Many people thought them fakes at the time.

I am now going to pay a tribute to the two

American systems of which we are hearing a good deal. This is a photograph taken (of good definition and resembling an ordinary half-tone illustration) by the Bell system, which is operated over telephone lines, and synchronised by alternating current synchronous motors. The photoelectric cell is employed here, and one of the men who was

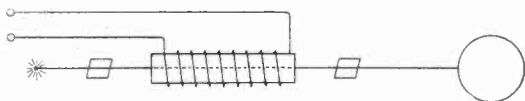

Fig. 13. *Rignoux and Fournier's nicol prism and carbon disulphide receiver.*

responsible for this admirable process is Mr. Herbert Ives, whose name I do not think is so well known in the electrical world as it is in connection with photography, and that is important because successful picture telegraphy is not a subject which can be tackled only by the electrical engineer. It wants the co-operation of the process man, it wants the electrical engineer and also the telegraph man, but it wants, above all, the photographer. The Bell telephone system involves a number of valves to amplify up the very feeble current of the photoelectric cell, and precautions are taken to use only the straight line characteristics of the valves. There are a thousand machines employing the Bell system of phototelegraphy under construction for America.

This is another receiving system which I should like to show because it is an ingenious and easy one. (Fig. 13.) Two nicol prisms are so displaced that the light is plane polarised through the first prism, and then passes through a tube to the second prism, where it is completely polarised. It is well known that when the electric current passes through a coil and exerts a magnetic field around certain liquids, the plane of polarisation is altered. When the current passes through the spiral, the effect of the rotation of the plane of polarisation is to alter the illumination. This system, which was devised many years ago by Rignoux and Fournier, has been adopted in one of the new phototelegraphic systems, of which we are likely to hear a good deal more before long.

I want now to refer to the Ranger method of reception. A photoelectric cell is used for transmission, but in reception there is an

inkpot and pen, which taps a spot of ink on a sheet of paper and the received image is built up in that way. Very great difficulty was experienced in finding an ink which would set quickly enough not to smear. A wax ink was employed, and now an ink holder is used in which an electric heater is placed to keep the wax melted. The moment the pen taps a spot of the ink on to the paper it sets. It took many months before the problem of obtaining the right ink was solved. I only mention this because there are many details in working out these apparently simple systems, and a matter like this of the ink, although so trifling to the onlooker, had the effect of keeping the invention back for months.

A portrait of President Coolidge transmitted by the system is shown in Fig. 14. All the dots in this system are the same size, but in my system and most other systems the dots or signals vary in size according to the tones in the picture. It is a very peculiar thing how effective is the result in the case



Fig. 14. *A picture transmitted on the Ranger system from New York to London.*

of the Ranger system, because theoretically such results should not be obtained. With dots all of the same size it is surprising that a half-tone effect should result. However, it does so very effectively.

up a picture. This paper is put on a cylinder and every time the gramophone needle of the sender comes into contact with a clear part of the picture to be sent, actually between the fish glue lines, it gives a signal

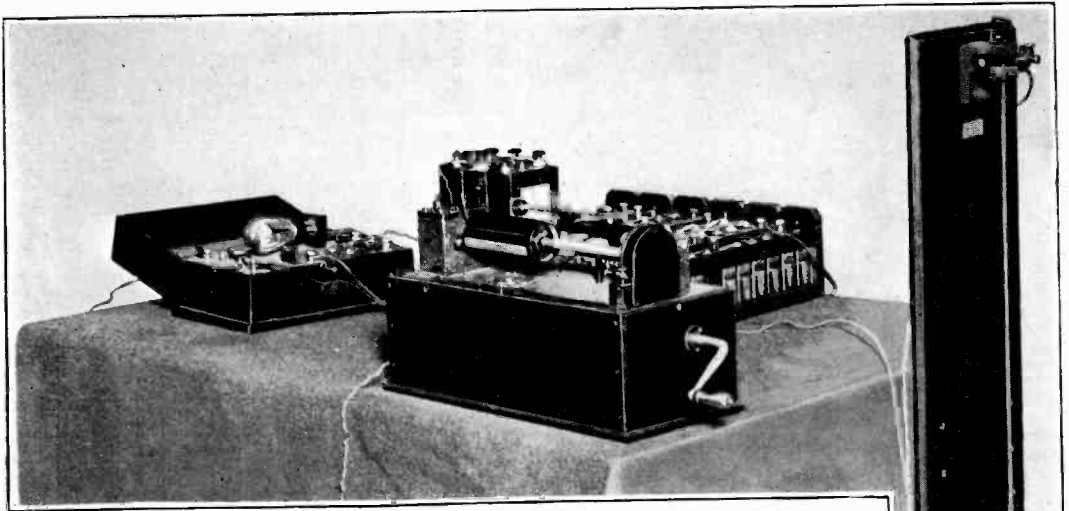

Fig. 15. *The transmitting apparatus.*

Having completed his list of lantern slides, Mr. THORNE - BAKER continued : These little machines of mine (Figs. 15 and 16) have been designed on general lines which have long been known. There is no originality in the system as a system. It is the type which I hope will be available in Austria shortly for receiving broadcast photographs. It comprises a brass cylinder, a holder with the gramophone needle, a special form of clockwork motor, wound up like a gramophone, a spiral shaft and a steel knife edge. As the shaft drives the cylinder, this knife edge travels across and brings the stylus with it, and in this way the spiral motion of the shaft over the surface of the picture is obtained. I use for receiving a piece of chemical paper very like pole-finding paper, although I am sure I spent more time finding it than the man who discovered poie-finding paper! The point is that it is excessively sensitive. It is used slightly damp and 0.5mA will give a perfectly satisfactory result at the rate of 500 signals per second, so that with 1/500th of a second and so small a current as half a milliampere current you get a satisfactory mark with which to build

which is picked up by the radio receiving set and operates it direct. There is no mechanical relaying. It is amplified by valves, and that gives sufficient current for the platinum needle attached to the receiving cylinder to produce the chemical stains which build up the image, so that you can watch the actual reproduction of the picture. I have arranged for several photographs to be sent across the hall, so that you can watch the building up of the image on the receiver. I think you will then appreciate how simple it is.

I will take the opportunity of saying that with the exception of one very great advance made by my colleague, Captain Oito Fulton, which does away with the pendulum for synchronising the machines, and which therefore makes the system much simpler for the amateur, the machines are exactly

as they have been for the past 18 months. A large number of most successful demonstrations have been given with the apparatus, yet I have found it absolutely impossible to get any pictures broadcast in

Mr. THORNE-BAKER: The solution is starch-iodide. The starch is a particular type which gives a permanent image. Ordinary starch solution is very unsatisfactory because the picture fades almost immediately.

Question: Is there any reason why the period

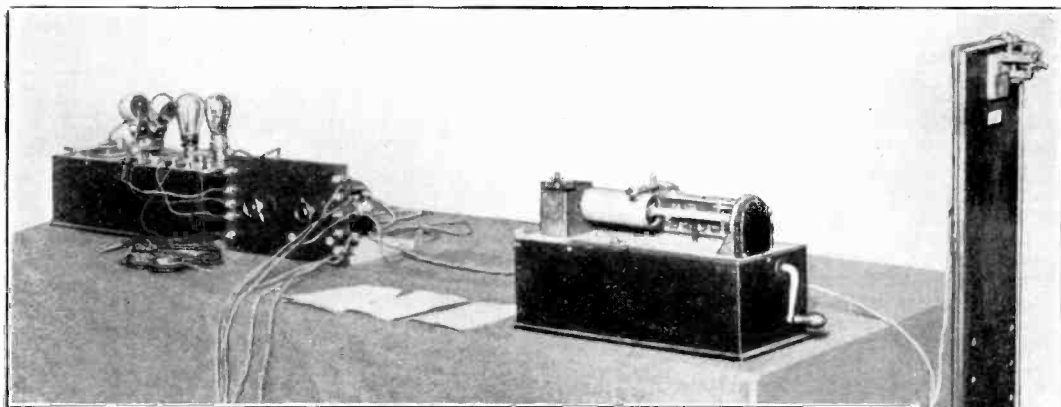

Fig. 16. The receiving apparatus.

this country, although every amateur who has seen the machine at work seems to be intensely interested, and many hundreds of people have asked where they can buy the apparatus. There is no point in making the receiving apparatus available if there are to be no pictures broadcast, and it seems to me rather sad that Austria is going to be the first country to operate this machine. As soon as the necessary arrangements are completed, three pictures a night are to be broadcast by the Ravag in Vienna. It is only through the work of my colleague, Captain Fulton, who has been over to Vienna and given demonstrations, that we have been able to get the Vienna broadcast people to start, and I hope a little later on we shall be able to do something here.

A picture (Fig. 17) was then transmitted wirelessly across the hall of the Institution of Electrical Engineers although at one time the lecturer was compelled to ask the audience not to crowd round the receiver as the capacity effects of their bodies rendered some of the signals difficult of reception and broken lines resulted.

A series of questions were asked Mr. Thorne-Baker at the conclusion of the lecture. We give the questions *seriatim* with Mr. Thorne-Baker's replies.

Question: What is the solution used for the paper?

of vibration of the pendulum should not be speeded up to get a picture more quickly?

Mr. THORNE-BAKER: With a 6½ in. by 4½ in. photograph we are recording 375 signals per second, but it is not so much the receiving as in the transmission that the difficulty arises of speeding up. The fish glue lines are rather apt to make a gramophone needle "chatter," and it does not then respond to the exact distances between lines of varying width. I remember some years ago making these transmitting foils of tinfoil and clamping them between steel plates under high pressure to get a sort of smooth commutator surface, but even then there was a distinct limit to the rate at which the needle will pick up signals with sufficient accuracy to record the proper width of line.

Question: Do you think it would be possible to adapt this machine to an ordinary gramophone, with a disc instead of a cylinder? I suppose this apparatus is not expensive and for an ordinary amateur transmitter would it be possible to adapt it to the gramophone?

Mr. THORNE-BAKER: It would be for a series of photographs, otherwise you would have a nasty hole in the centre of the picture. That is the mechanical difficulty. There is one rather interesting point in connection with that. Captain Fulton has for some time been working on a flat

receiver which could be operated from one of these cylinder machines and the latest development in that way is to make the flat plate a sort of lantern slide of an epidiascope and the image can be thrown on a lantern screen so that an audience can watch the picture coming. I hope it will be possible to demonstrate that in two or three months' time.

Question : I should like some information on the subject of the patent of Hardy in 1923 in regard to selenium, which he claimed to be a considerable advance. It reminds one of the old tinfoil condenser construction but I have not any further details. I should be glad to know what kind of speed one can get with such a cell or is there any more rapid type?

Mr. THORNE-BAKER : I do not know of any more rapid method than the selenium cell method of Korn in which two cells with complementary characteristics are used on each side of a Wheatstone Bridge. You can get 50 to 60 signals per second with that arrangement. On the other hand, it is very difficult to understand how in the case of selenium cells for recording music you can get up to as many as 8,000 signals per second. I did some work some years ago with an American in connection with a talking cinematograph, in which he was recording sound on a moving band of cinematograph film, using a selenium cell. We got exquisite reproductions, except that we marred it by dynamo vibrations. Yet in phototelegraphy it has not been possible to get more than 50 or 60 signals per second. I think it is because in recording a picture you have to go over the whole range of intensity of illumination of the selenium cell whereas in reproducing the voice you are using just the peaks of the curves and you do not get the blur as you do in pictures.

Question : Has the cathode ray oscillograph been developed into picture writing to any extent?

Mr. THORNE-BAKER : Yes, it is being used by Belin and Dauvillier in Paris for television, but television is rather a difficult subject to discuss and I would rather not say anything about it.

Question : Is the electron discharge in the photoelectric cell proportional to the amount of light passing?

Mr. THORNE-BAKER : Yes, provided there is no inert gas in it it is absolutely proportional to the intensity of the light. There is no time lag. At any rate, the response is under a millionth of a second with the photoelectric cell. But you can easily get two milliamperes through a selenium cell, and only 10^{-13} milliamperes from a photoelectric cell of this type.

Question : What about capacity effects?

Mr. THORNE-BAKER : If the capacity effect is too great one signal will lag into the next and you will get a continuous tone for the whole picture.

Question : The capacity of the ordinary line from London to Paris is considerable and would presumably have some effect?

Mr. THORNE-BAKER : Yes, but you get over it by the usual telegraphic tricks of reverse or "wiping out" currents and so on.



Fig. 17. A reproduction of the actual picture transmitted during the demonstration using the Thorne-Baker apparatus.

Television.

The following contribution to the discussion of a paper by Mr. J. L. Baird before the Radio Society of Great Britain, which was published in our December issue, has been received from Mr. Dénes von Mihály, of Hungary.

DURING the past two years various articles describing Mr. Baird's experiments in Television have appeared in different publications, from which it would appear that he is actively engaged in the problem of television. As I have also been deeply absorbed in this problem for the last fourteen years, these articles have been of great interest to me.

Almost every day fresh reports concerning television are published, some of which may be taken seriously, whilst others are merely amusing. In any case there is an indication that this problem is engaging universal attention, and a keen desire to see expectations materialise is widely entertained.

The newspaper articles concerning Mr. Baird's work, savouring more of propaganda than science, and presenting picturesque visions of the future rather than technical details, have made it impossible for me to judge the value of his work.

In the December issue of *E.W. & W.E.* (pages 730 to 737) there is, however, published a paper read before the Radio Society of Great Britain. The paper is of a technical nature, and as it is headed by the name of Mr. J. L. Baird, I presume that he was responsible for its preparation.

In his introduction he makes a comparison between television and the working of the human eye which tallies exactly with the words written on the subject in *The Handbook of Phototelegraphy and Teleautography*, by Korn and Glatzel (Nemnich, Leipzig, 1911). The conclusions, however, which he draws concerning the action of visual purple are fundamentally wrong, for otherwise he would never have attempted to prepare a light sensitive cell of this substance. The disintegration of visual purple is indeed like an electro-chemical process, but in character approaches far more that of a photographic plate. The valuable research work of v. Kriess has gone to prove that visual purple does not recuperate, but must be continually generated anew, and this process, as is well known, can hardly be imitated. Also the process is an organic chemical one and requires a comparatively long time—one-eighth of a second—for its completion. The human eye is, therefore, slow in its response, and it is due to this fact alone that the transmission of pictures, such as by cinematography and television, becomes possible. It is obvious that were it possible to reproduce this organic substance, and by its use to influence electrical circuits, it would at least be as sluggish in its operation as the eye itself.

* [D. v. Mihály is one of the leading European authorities on the subject. The second edition of his book, *Das Elektrische Fernsehen*, was reviewed in our February number.—Ed.]

The apparatus which Mr. Baird employs for analysing the picture comprises discs which are provided with various slits, intercrossing each other, and through which light from single small points of the picture are successively allowed to pass. This device presents nothing essentially new, for it is almost exactly the same as proposed by Brillionin in 1891 and again by Majorana in 1894, only to be rejected by them as quite unsuited for practical purposes. Apparatus of this nature only serves to demonstrate the principle and is satisfactory only so long as one is content with a transmission of 60 to 100 spots of light. But if we wish to transmit a picture measuring only 10 cm. by 10 cm. and to divide it into areas of only 1 square millimetre we find that this already means 10,000 light spot elements per picture. To transmit the 10,000 light spots within the time period of the inertia of the human eye, which is about one-tenth of a second, we must divide up the picture into 100 strips and each strip must be again crosswise or diagonally divided into 100 sections within the brief period of time of one-tenth of a second.

The first division of the image into strips is usually termed the "primary analysis" and the cross-wise subdivision the "secondary analysis." The primary analysis presents no difficulty and is accomplished by means of a disc which is provided with a slit, which in rotating traverses the picture every tenth of a second. Using a single slit, as in Mr. Baird's apparatus, this disc would have to make 600 revolutions a minute, but if one takes a disc with 10 slits then 60 revolutions a minute will suffice, but the diameter of the disc in this case must be ten times as great.

The secondary analysis, however, presents serious difficulties. It is obvious that, as the primary slit is making a movement of 1 millimetre across the face of the image, it must be crossed over by a secondary slit subdividing it into 100 sections. If the picture is 10 centimetres, *i.e.*, 100 millimetres, wide, then the primary slit will occupy 100 positions. In each position a transversal secondary slit must pass, *i.e.*, 100 secondary slits within one-tenth of a second. These secondary slits must be arranged around the edge of a second analysing disc in such a manner that between each successive slit there is a space corresponding to the height of the picture, so that two light spots do not simultaneously pass through. This circumstance gives rise to a very difficult problem of construction, even with the above-mentioned most primitive demands. In the case of a picture 10×10 centimetres, if one has, as indicated in Mr. Baird's drawing, 50 secondary slits on the disc it is obvious that its circumference must be fifty times 10 centimetres, making the diameter of this disc about 5½ feet.

Now in order to allow 100 secondary slits to intersect in every tenth of a second, this secondary disc would have to rotate twice in that time, that is, 1,200 times a second. If, on the other hand, the disc is provided with only 10 slits, one would have to contend with a disagreeably high speed of rotation. As in any case the stability of the disc is very much impaired by the slits near the edge, it hardly seems advisable to revert to such a high speed of rotation.

This, then, is the case with a primitive minimum of only 10,000 picture elements. I would, however, draw attention to the fact that the poorest newspaper blocks have a screen which represents a division of three points per millimetre. Therefore, in order to produce a result which has any practical value, we require, not 10,000 picture elements as suggested by Mr. Baird, but at least 90,000.

Another shortcoming appears to be the fact that the slits in the revolving discs being narrow and one behind the other, occasion an enormous loss of light.

Further, I am of opinion that Mr. Baird's movable set of lenses, even with only 16 lenses, presents the most formidable manufacturing difficulties inasmuch as the lenses must "keep the track" with optical exactitude. An insurmountable obstacle is raised with the question as to how the number of these lenses can be increased to meet practical requirements.

Now, I would like to mention briefly one of the most important of all television problems about which Mr. Baird makes no statement. It is in the matter of synchronisation. He must not forget that in practice the transmitter and receiver discs are completely separated from one another, and yet must rotate in such absolute synchronism that within the period of one second, a variation of one-hundred-thousandth of a revolution must not occur. This means that his picture analysers must synchronise to one-hundred-thousandth part of a second and must do this without connection by wire.

And here I must refer to a curious statement on his part (page 735, line 29) that "this fluctuating current is transmitted to the receiving station by wire or by wireless."

I should regard this extraordinary assertion as an oversight were it not for the fact that two lines further on he states "at the receiving station the

current is amplified by a three-valve *low* frequency amplifier."

Every well-versed wireless amateur knows that in the case of long distance transmission, the higher speech frequencies (harmonic oscillations, character oscillations of 12,000 to 14,000 per second) cause enormous difficulties, and when one has to deal with over 20,000 impulses to the second, transmission becomes impossible.

Mr. Baird will actually require to transmit, as a minimum, at an oscillation frequency of 100,000 and yet he makes the suggestion of amplifying the current impulses at the receiving station by means of a low frequency amplifier. That he is not thinking of high frequency wire transmission follows from the fact that he speaks of amplifying by means of a *low* frequency amplifier.

What Mr. Baird represents as an important problem, viz., the necessary artificial illumination of the person to be transmitted is not pertinent, though, of course, the person whose image is to be transmitted should not be subjected to the disagreeable warmth produced by the close proximity of incandescent lamps. Actually, one of the approved methods of lighting, such as is employed, in the production of cinematograph pictures, may be adopted, and suitable light sensitive cells employed. According to determinations which I have carried out, the sensitiveness of such cells when used with an intensity of light, such as is adopted for the taking of cinematograph films, proves to be ample.

And here I would like to add a few words about invisible rays. It may be known to Mr. Baird that in the year 1890 Pontois discovered that all light sensitive cells are influenced just as much by direct or reflected infra red rays as they are by ordinary light rays. During the past 37 years this discovery has been confirmed by hundreds of those who have been engaged in scientific research work. That these infra red rays can be projected or reflected in the same way as ordinary light rays is well known.

In view of the considerable amount of publicity which has been given to Mr. Baird's work and the far-reaching importance of television to civilisation generally, I think it only fair in his own interests, as well as in those of the public and technically interested persons, that he should be good enough to give his observations on the problems I have raised.

Correspondence.

Letters of interest to experimenters are always welcome. In publishing such communications the Editors do not necessarily endorse any technical or general statements which they may contain.

That Audio-Frequency Problem.

To the Editor, E.W. & W.E.

SIR,—In the current issue of *E.W. & W.E.*, Mr. E. Fowler Clark proceeds to clear up the question of the audio-frequency transformer, but I am afraid that in a "rather lengthy contribution" he simply begs the question.

His statements relative to the transformer may be correct, but are not the questions at issue, for the discussion was originally, not the design of the most efficient transformer, but as to whether the maximum amplification attainable with a valve plus transformer is given with a transformer having an impedance equal to that of the valve, or is given when the transformer has an impedance much greater than that of the valve?

Mr. Fowler Clark's statements Nos. 1, 2, and 3, do not seem to lead up to or explain his statement No. 4, which is the only one in which he mentions transformer plus valve. The two must be taken into consideration together, otherwise the line of reasoning is useless.

It would be much more to the point if we could have the "definitely erroneous" part of the "recent advertisements" explained. As Mr. Albert Hall pointed out, this little portion of mathematics does not apply to the last or output stage where one requires power, but at intermediate stages where voltage amplification is needed, surely it is better to have the largest portion of the impedance drop—if I may use the expression—of the valve plus transformer primary circuit occur across the transformer primary to be transformed up on to the grid circuit rather than have only half the available impedance volts applied to the primary and the remaining half wasted across the valve impedance.

I wonder what a power-transformer designer would have to say to Mr. Fowler Clark's remarks that, presumably in order to obtain maximum secondary volts, one has to use as many volt-amperes as possible. From my knowledge of transformer design, the amperes taken by the primary when the secondary is on open circuit are kept down to the minimum if the transformer has to work on open circuit for a length of time which is large compared with its "on load"

periods, and the secondary voltage is dependent—neglecting losses—only upon the primary voltage and the step up. Therefore one must use the maximum possible primary volts and a suitable step-up ratio.

In conclusion I would like to add that increasing the primary impedance a long way towards its technical limit in laboratory experiments does improve results from the intervalve transformer and valve combination which, to me at any rate, goes a long way to proving its correctness.

T. R. LUPTON,
M.Sc.(Tech.).

"Delineation of A.C. Wave Forms."

To the Editor, E.W. & W.E.

SIR,—The analysis of the Lissajous figure on p. 18 is not correct. For the position OP of the tune vector, the length pM is transferred to

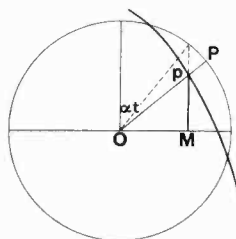

Fig. 5.

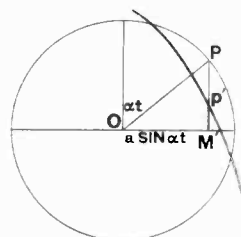

Fig. 5a.

the wave form figure. This length corresponds, of course, to tune $\frac{1}{a} \sin^{-1} \frac{OM}{a}$. The correct ordinate is as shown in my second figure (5a).

If Mr. Thomas is not clear about this he may find the analysis of the Lissajous figure $x=y=a \sin \omega t$ will help to make things plain.

E. C. ATKINSON.
Northwood, Middlesex.

Abstracts and References.

Compiled by the Radio Research Board and reproduced by arrangement with the Department of Scientific and Industrial Research.

PROPAGATION OF WAVES.

DIE AUSBREITUNG DER ELEKTROMAGNETISCHEN WELLEN (The propagation of electromagnetic waves).—A. Sacklowski. (*Elektrische Nachrichten-Technik*, 4, January, 1927, pp. 31-74.)

At a discussion on propagation phenomena by the scientific committee of the Heinrich Hertz Society, it was decided to compile a list of references to the literature of the subject, the task being undertaken by Dr. Sacklowski. In addition to this bibliography, it was also thought desirable to make a concise survey of the results of the more important papers, particularly those appearing in the less easily accessible foreign journals. This summary is given here, followed by the exhaustive bibliography of the subject containing 474 references.

The survey considers in successive sections: field strength measurements, including methods, results and inferences; the propagation of long and medium waves, with the drawing up of transmission formulæ; the propagation of short waves and fading phenomena, polarisation and directional reception; theories on wave propagation both without and with a conducting layer, and in the latter case, without and with taking account of the earth's magnetic field; and lastly, experiments for the direct proof of the conducting layer.

EIN SENDEVERFAHREN FÜR KURZE WELLEN (A method of transmitting for short waves).—N. von Korshenewsky. (*Zeit. f. techn. Physik*, 7, December, 1926, pp. 594-598.)

Lecture delivered at the 89th meeting of German scientists at Düsseldorf last September.

By short waves here is understood the whole range of wavelengths whose propagations from transmitter to receiver is effected essentially by means of normal reflection and refraction in the upper layers of the atmosphere. We know that the geometrical configuration of these layers and their electric and magnetic constants can differ very much and that they are subject to continual change. Now the intensity at the receiver depends not only on the direction of the radiation sent out, but also on the orientation of the plane of polarisation relatively to the position and condition of the refracting and reflecting surfaces in the atmosphere, and since these are continually changing, transmitting with waves linearly polarised always in one plane, as is usual in radio communication, cannot but be unsatisfactory, since an unfavourable orientation of the plane of polarisation relatively to the plane of incidence will produce extinction in the receiver. This follows from Fresnel's equations, also from the other laws of the electromagnetic theory of light which come into consideration for short wave transmission.

In order to avoid these diminutions in intensity (fading phenomena), the author recommends the employment of circularly polarised waves, since with these there is no preference for a certain direction of polarisation. To generate these waves two antennæ are used arranged at right

angles to one another, excited with a phase difference of 90° , so that the field sent out is circularly polarised, i.e., a rotatory field. A diagram of the circuit arrangement is shown below:—

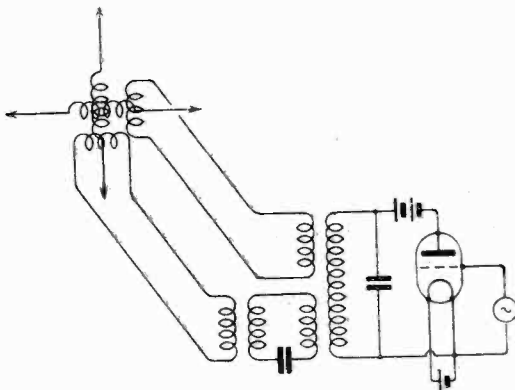

Fig. 2.

The employment of circularly polarised waves will also reduce variations in the intensity received that arise from alterations in direction of the plane of polarisation relatively to the direction of the receiving antenna.

A further cause of fading is interference between two or more rays that have travelled from transmitter to receiver by different paths, as represented in the figure below:—

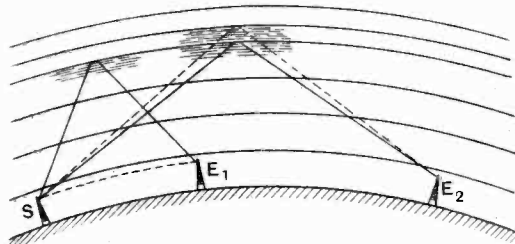

Fig. 3.

When the receiver is at E_1 , a relatively short distance from the transmitter at S , interference can occur between direct and indirect rays, while when the receiver is at E_2 which is far enough away for the direct ray to have become quite absorbed, interference can take place between two rays reflected at different surfaces of separation.

Fading of this origin as well as that previously referred to can be eliminated by employing linearly polarised waves whose direction of polarisation is continually changing. In order to produce such waves a right-handed and a left-handed circularly polarised field are combined, the resulting field being linearly polarised with its plane of polarisation determined by the initial phases of the two rotatory fields. The oscillations of one

or both fields are interrupted in high frequency rhythm, so that the phase difference of the fields is continually changing, and thus a linearly polarised field is obtained with its direction of polarisation constantly varying. The technical solution consists in employing two ionised pairs of antennæ oscillating with a phase displacement of 90° or 270° , the oscillators being interrupted by means of a valve arrangement working at high frequency. The oscillators of wave trains produced in this way, with the relatively great differences of path that occur, are no longer coherent and consequently no longer able to interfere.

ÜBER DIE AUSBREITUNG DER WELLEN IN DER DRAHTLOSEN TELEGRAPHIE (The propagation of waves in wireless telegraphy).—A. SOMMERFELD. (*Annalen der Physik*, 81, 1926, pp. 1135-1153.)

In a work of this same title in volume 28 of these *Annalen* (pp. 665-736, 1909), the author dealt with the problem of the vertical antenna, with any kind of homogeneous ground, and a flat earth, and the antenna idealised as a simple Hertzian dipole for its effect at great distances. H. v. Hoerschelmann (*Jahrbuch d. drahtl. Tel.*, 5, pp. 14 and 188, 1912) then investigated the problem of the horizontal antenna, more exactly the Marconi bent antenna, the essential part of which is the horizontal arm. In this article the results of both papers are systematically summarised and simplified. Further, the author shows that the so-to-speak dual problem of a "magnetic antenna" of vertical or horizontal axis—i.e., a frame with the windings in a horizontal or vertical plane—is capable of entirely corresponding treatment, the possibility of regarding frame antennæ as magnetic linear antennæ having been pointed out by Barkhausen. Of course, the frame antenna could also be represented by four electric dipoles in the plane of the frame displaced in phase, corresponding to the four sides of the frame, but this representation would be less simple mathematically and would not express clearly the analogy to the electric antenna. The mathematical treatment is divided into five parts, headed as follows:—

1. The electric and magnetic vertical antenna.
2. Discussion on surface waves and the formulæ for small numerical distance.
3. The electric and magnetic horizontal antenna.
4. Discussion on surface waves, the directional effect and its explanation by means of vertical earth currents.
5. The field of the electric and magnetic horizontal antenna.

EINE ERGÄNZUNG ZUR THEORIE DES ROTATIONS-SYMMETRISCHEN STRAHLUNGSFELDES (Supplement to the theory of the radiation field of rotational symmetry).—E. Spenke. (*Annalen der Physik*, 82, pp. 155-160.)

Kiebitz has deduced the differential equation for the direction of the electric field in the general case of the radiation field of rotational symmetry from Maxwell's field equations (*Ann. d. Phys.*, 80, p. 728, these abstracts *E.W. & W.E.*, January, 1927, p. 49). The differential equation for the case of the conducting sphere was strictly solved

and it was found that the field direction could be represented by circles with their centres on the axis of symmetry, cutting the sphere at right angles. In the present investigation it is shown that the circular form of the field lines is not limited to the case of the conducting sphere, but holds quite good generally for all conductors of rotational symmetry. This is of importance for the application of the theory, since it enables the field lines to be constructed for every individual case and therefore also the paths of their perpendicular trajectories, the rays.

RADIO BROADCAST COVERAGE OF CITY AREAS (Abridged).—L. Espenschied. (*Journ. Amer. Inst. Elect. Engineers*, 46, January, 1927, pp. 25-32. *Bell System Technical Journal*, 6, January, 1927, pp. 117-141.)

An article dealing with the attenuation and fading which attend the spreading out of broadcast waves. A field strength contour map is shown of the measured distribution of waves broadcast by Station WEAF over the New York metropolitan area. A rough correlation is given between measured field strengths and the serviceability of the reception in yielding good quality reproduction. The range of a station as estimated in terms of year-round reliability is found to be relatively small. The question of the preferred location of a transmitting station with respect to a city area is considered. It is shown that an antenna located upon a tall building may radiate poorly at certain wavelengths and well at others. Surveys are presented of the distribution effected by an experimental transmitting station located in each of several suburban points. The locations are compared upon the basis of the "coverage" of receiving sets which they affect. The relation which exists regarding interference between a plurality of broadcast transmitting stations operating in the same service area is also considered. The importance of high selectivity in receiving sets is emphasised and measured selectivity characteristics for receivers having different types of circuits are shown.

TESTS OF RADIO PROPAGATION ON SHORT WAVELENGTHS.—M. Prescott. (*General Electric Review*, 30, February, 1927, pp. 113-116.)

A brief account of propagation tests recently conducted by the General Electric Company to determine the usefulness of short waves for spanning distances of one or two hundred miles. The wavelengths used were representative of those that have been allocated for point to point commercial work. The following conclusions are drawn with reference to these tests only, and without taking into account the two important factors of seasonal variation and the nature of the intervening country.

1. Channels comprising wavelengths shorter than those of the 66.3 to 75 metre channel will not give economical service at points within 100 miles of the transmitter.
2. The 66.3 to 75 metre channel, the 85.7 to 105 metre channel, and the 133 to 150-metre channel are capable of rendering economical service at points within 100 miles of the transmitter.

3. For daylight communication at distances not greater than 90 miles from the transmitter, the 133 to 150 metre channel will give better satisfaction than the 85.7 to 105 metre channel. Similarly the 85.7 metre channel will give better service than that which can be obtained under the same conditions using the 66.3 to 75-metre channel.

4. The above conditions are reversed when distances between 90 and 200 miles are considered. In this case, the 66.3 to 75-metre channel will give better service during daylight than the 85.7 to 105 or 133 to 150 metre channel.

FURTHER MEASUREMENTS ON WIRELESS WAVEFRONTS.—R. Smith-Rose and R. Barfield. (*E.W. & W.E.*, 4, March, 1927, pp. 130-139.)

The authors explain how they obtained direct evidence of the existence of downcoming waves at the earth's surface, and were able to make fairly accurate measurements of the angle of incidence or elevation at which such waves arrive.

EFFECT OF A LARGE NUMBER OF RECEIVING AERIALS ON THE PROPAGATION OF WIRELESS WAVES.—R. Barfield. (*Nature*, 119, 5th February, 1927, p. 195.)

Evidence is given for the conclusion that the large number of receiving aerials in the London area have a very marked absorbing effect on the waves passing over them, an increase in intensity of the order of 90 per cent. having been observed at Slough, on transmissions from 2LO, for a variation of only 5 per cent. in the normal wavelength (to which the majority of the aerials may be considered tuned).

REFRACTION OF ELECTROMAGNETIC WAVES ROUND THE EARTH'S SURFACE.—J. McPetrie and R. Wilmotte. (*Nature*, 26th February, 1927, p. 317.)

The authors arrive at the result that the general condition under which a ray can return from the upper atmosphere is that the second differential of the dielectric constant with regard to height should be negative. It is also shown that, in the case of the earth's atmosphere, the density on the assumption made varies in such a manner that this differential is positive. The conclusion does not hold for rays at angles of elevation of less than 1° or 2° .

REPORT CONCERNING THE OBSERVATION OF THE INFLUENCE ON THE PROPAGATION OF RADIO WAVES, OF THE SUN ECLIPSE OF THE 14TH OF JANUARY, 1925, IN THE DUTCH EAST INDIES.—E. Holtzappel. (*Proc. Inst. Radio Engineers*, 15, January, 1927, pp. 61-62.)

AN ATTEMPT TO DETECT A CORPUSCULAR RADIATION OF COSMIC ORIGIN.—W. Swann. (*Journ. Franklin Institute*, 203, January, 1927, pp. 11-33.)

Experiments are described the results of which indicate that the absolute magnitude of the current absorbed by a solid copper cylinder 20.6 cm. in diameter and 19.3 cm. high is no more than 1.5 per cent. of that which would have been obtained by the complete absorption of a vertical corpuscular current of density sufficient

to account for the replenishment of the earth's charge. Incidentally, moreover, such small effect as is found in these experiments represents a rate of acquirement of positive charge, and is thus of the wrong sign to participate in the replenishment of the earth's charge. This however is not thought to present us necessarily with an anomalous situation, since the charging may be brought about by the ejection of electrons from the air by the penetrating radiation, those ejected within striking distance of the earth entering it and charging it up until equilibrium is established with the atmospheric-electric conduction current.

ATMOSPHERICS.

OBSERVATIONS ON THE ATMOSPHERIC DISTURBANCES.—T. Nakagami and K. Kaneko. (*Journ. Inst. Elect. Engineers of Japan*, December, 1926, pp. 1423-1436.)

An account of the investigation of atmospheric disturbances at Osaka, with the apparatus and method employed, and giving the results obtained. The conclusions arrived at from the observations are as follows:—

1. Atmospheric disturbances increase when it is sunset at the receiving station, high values prevail during the night, decreasing fairly rapidly after sunrise.

2. The directions from which atmospheric disturbances are observed to come seems to warrant the conclusions that they originate in general over land rather than over the ocean.

3. In summer atmospheric disturbances come from the north-east and in winter from the south-west, showing that the sun has an important bearing upon the sources of atmospheric disturbances. These appear to the author to follow the sun in its changing path between the northern and southern hemispheres. Besides local disturbances from the mountain range known as the "Japanese Alps," there are also atmospheric disturbances from a distance. This fact is shown by the directional observations made at Iwatuki near Tokio where atmospheric disturbances were found to come from the north to the north-west.

4. Measurements made at Pekin during October and November, combined with the data obtained at Osaka, indicate that at this season atmospheric disturbances originate in the tropical region of the Dutch Indies.

UN ENREGISTREUR DE LA FRÉQUENCE DES ATMOSPHERIQUES; SON UTILISATION EN MÉTÉOROLOGIE (A recorder of the frequency of atmospheric disturbances and its use in meteorology).—R. Bureau, A. Viant and A. Gret. (*Comptes Rendus*, 184, 17th January, 1927, pp. 157-158.)

Recording apparatus has been devised that traces a curve the ordinate of which is proportional to the frequency of atmospheric disturbances. A radio receiver attached to a relay picks up disturbances, the relay at each disturbance received sending a current through the electro-magnet of a Richard wind recorder, which traces a curve whose ordinate is proportional to the frequency of the electric contacts thus produced. An analysis of the curves obtained shows the closest connection between the variation of the frequency of atmospheric disturbances and the passing over of continuities which

cause them. Two conclusions are drawn from this relationship:—

1. A large number of atmospheric have their source in the physical properties of the air in the *immediate* neighbourhood of the receiver.
2. The recording of the frequency of atmospheric is one of the most potent means of analysing the detailed structure of meteorological discontinuities, in particular those of principal and secondary cold fronts.

SIMULTANEOUS ATMOSPHERIC DISTURBANCES IN RADIO TELEGRAPHY.—M. Bäumler. (*Proc. Inst. Radio Engineers*, 14, December, 1926, pp. 765-771.)

A translation of the paper in *Elek. Nachr. Technik.*, 3, 11, pp. 429-433, of which there was an abstract in *E.W. & W.E.*, February, 1927, p. 116.

PROGRESSIVE LIGHTNING.—C. Perrine. (*Nature*, 19th February, 1927, p. 278.)

In *Nature* of 20th November last, Prof. Boys refers to observations of "multiple flashes"—that is, flashes succeeding one another along the same path (these abstracts, *E.W. & W.E.*, January, 1927, p. 50).

The writer of the present letter states that while there is no doubt of the reality of these *appearances* of multiple flashes, he has very serious doubts of there being more than one flash in reality.

From the fact that the multiple flashes he has observed at Cordoba have always been at a great distance and never near by, he concludes that they are due in some way to erratic refraction in the atmosphere.

In reply, Prof. Boys writes that these observations are interesting as indicating a difference in the appearance of lightning in the Argentine, where the strokes are exceptionally strong, and in Great Britain. Here, without any question, the appearance of the multiple flash is found when the distance is very small indeed.

PROPERTIES OF CIRCUITS.

FORCED OSCILLATIONS IN A CIRCUIT WITH NON-LINEAR RESISTANCE (Reception with reactive triode.)—B. van der Pol, Jun. (*Philosophical Magazine*, 3, January, 1927, pp. 65-80.)

Seven years ago the problem of forced oscillations in a circuit with non-linear resistance was investigated for the first time by the author (*Tijdschr. v. h. Ned. Radiogen.*, 1, 1920, p. 1). The differential equation

$$\ddot{v} + \phi(v)\dot{v} + \omega_0^2 v = \omega_1^2 B \sin \omega_1 t$$

deduced at the time, again forms the basis of the present investigation. The remarks, however, were then confined solely to dealing with the case where the resistance remained positive. Three years later the general theoretical problem where the resistance could also be negative was investigated in collaboration with Dr. Appleton (*Proc. Cam. Phil. Soc.*, 23, 1923, p. 231). The present article is still more general and gives a more detailed account of the experiments.

A MODIFIED BEAT METHOD OF COMPARING TWO HIGH-FREQUENCY OSCILLATIONS.—(*E.W. & W.E.*, 4, March, 1927, p. 174.)

FURTHER NOTES ON SIMPLE RESONANCE CURVES.—E. Mallett. (*E.W. & W.E.*, 4, March, 1927, pp. 151-159.)

TRANSMISSION.

SIMULTANEOUS PRODUCTION OF A FUNDAMENTAL AND A HARMONIC IN A TUBE GENERATOR.—H. Walls. (*Proc. Inst. Radio Engineers*, 15, January, 1927, pp. 37-39.)

The published methods for transmitting and receiving two or more frequencies from a single antenna contemplate independent modulation of the several frequencies and require a separate generating valve for each frequency. The method described here involves only a single valve. The immediate application intended was the simultaneous transmission of several standard frequencies, the work being part of the standard frequency transmission programme of the Bureau of Standards, but other applications are pointed out.

ÜBER STEUERUNG MIT EISENDROSSELN (On modulation with iron chokes).—R. Strigel. (*Zeitsch. f. Hochfrequenz*, 29, January, 1927, pp. 10-20.)

Description of research carried out under the direction of Prof. Zenneck on oscillatory circuits which contain an iron choke with superimposed direct current. Investigation is made of:—

- I. The tension appearing at the iron choke with the different circuits.
- II. The inductance and loss resistance of the iron choke in relation to the superimposed direct current with the various arrangements.
- III. The influence of tuning the circuit on the modulation characteristic.

The results are shown by means of oscillograms and plotted curves.

PIEZO-ELECTRIC CRYSTAL-CONTROLLED TRANSMITTERS.—A. Crossley. (*Proc. Inst. Radio Engineers*, 15, January, 1927, pp. 9-36.)

After describing the piezo-electric crystal and the history of its discovery and application, the author outlines the development of crystal-controlled valve oscillators by the Naval Research Laboratory of the United States. Various means of amplifying the output of a crystal-controlled oscillator are mentioned, a description being given of the best method, which consists of balancing or neutralising the various stages of amplification and also observing proper precautions for reducing grid-circuit losses by using high values of biasing voltage. A complete high-power low-frequency crystal-controlled transmitter is described and a schematic wiring diagram of circuits employed in this transmitter shown, also a diagram and illustrations are given of one type of low-power high-frequency transmitter.

A D.C.-A.C. CRYSTAL-CONTROLLED TRANSMITTER.—J. Clayton. (*Q.S.T.*, 11, February, 1927, pp. 31-33.)

DIE STRAHLUNG DER LUFTLEITERANLAGE AM HERZOGSTAND (The radiation of the aerial arrangement at Herzogstand).—M. Bäumler. (*Elektr. Nachr. Technik*, 3, December, 1926, pp. 467-473.)

An account of field strength measurements carried out at various places around the aerial.

DER WIDERSTAND DER LÜFTLEITERANLAGE AM HERZOGSTAND (The resistance of the aerial system at Herzogstand).—W. Fischer. (*Elekt. Nachr. Technik*, 3, December, 1926, pp. 462-466.)

In spite of the high resistances measured in the first stages of the antenna construction, it is here described how experimental tests have shown that by extending the antenna arrangement to at least five lines and leaving a corresponding distance between the terminal insulators of the antenna and the rocky sides of the summit, a final value of less than 2 ohms is anticipated for the overall resistance.

THE HORIZONTAL HERTZIAN AERIAL FOR TRANSMISSION.—M. Scroggie. (*E.W. & W.E.*, 4, March, 1927, pp. 143-147.)

WEITERE UNTERSUCHUNGEN MIT DEM ZWEIRÖHREN- UND VIELRÖHRENGENERATOR KURZER ELEKTRISCHER WELLEN (Further investigations with the two and multiple valve generator of short electric waves).—M. Grechowa. (*Zeitschr. f. Physik*, 38, pp. 621-634.)

Continuing previous work (*Zeitschr. f. Phys.*, 35, 1925, pp. 50 and 59), the author studies the dependence of the wavelength and intensity of the oscillations on the working conditions and arrangement of the external oscillating circuit, and shows the results graphically. Wavelengths down to 18 cm. were obtained. Experiments with valves numbering up to even showed that the oscillation intensity increases more rapidly than the number of valves.

RECEPTION.

PROGRESS IN RADIO RECEIVING DURING 1926.—A. Goldsmith. (*General Electric Review*, 30, January, 1927, pp. 67-72.)

A survey of the development of broadcast reception in the United States during the past year. The most conspicuous alterations in radio conditions are stated to be the advent of the higher power broadcasting station and the increased congestion in the ether resulting from the haphazard selection of modified or new wave frequencies that has followed the Government's recent attitude that the present radio law is inadequate for the control of broadcasting wave frequency assignments. Another marked change during the last year or two is said to be a greatly increased musical discrimination on the part of the public, and a correspondingly increased demand for high quality acoustic reproduction as based on the amplifiers and loud-speakers used. This article describes some of the constructional and electrical features that have evolved to meet this demand.

A NEW RELAY FOR MORSE RECORDING. (*Wireless World*, 2nd March, 1927, p. 262.)

An account of a new relay, details of which were disclosed by Dr. Richter and Dr. Geffcken at the meeting of the Association of German Scientists at Düsseldorf last September. The relay, which utilises a well-known property of the Neon lamp, is remarkably sensitive for the reception of wireless signals.

THE TUCKER MICROPHONE FOR RECEPTION.—H. Watson. (*E.W. & W.E.*, 4, March, 1926, pp. 148-150.)

UN AMPLIFICATEUR H.F. À BIGNILLES À COMMANDE UNIQUE (A double-grid H.F. amplifier with a single control).—R. Barthélemy. (*Radio Revue*, February, 1927, pp. 291-294.)

Lecture given to the "Radio Club de France," 4th November, 1926.

THE PURPOSE AND DESIGN OF BROADCAST RECEIVERS. (*E.W. & W.E.*, 4, March, 1927, pp. 166-168.)

Informal discussion at I.E.E. Wireless Section.

ÉTUDE DES FILTRES POUR L'ALIMENTATION DES POSTES DE T.S.F. (Investigation of filters for supplying radio receivers from the mains).—R. Barthélemy. (*Q.S.T., Français et Radio Electricité Réunis*, 8, January, 1927, pp. 25-29.)

TRANSFORMERS FOR THE NEW A.C. VALVE (*Wireless World*, 9th February, 1927, pp. 177-178.)

TWO-RANGE RADIO-FREQUENCY TRANSFORMER. (*Wireless World*, 2nd March, 1927, p. 261.)

Description of a radio-frequency transformer of sound construction marketed by the British Radio Corporation at Weybridge.

NEUE BEOBACHTUNGEN AM SELBST-TÖNENDEN KRISTALL (New observations on the spontaneously oscillating crystal).—F. Seidl. (*Physik Zeitschr.*, 27, 15th December, 1926, pp. 816-819.)

Description of experiments with the zincite-steel combination. The same circuit arrangement was used that Lossev (*W.W.*, 22nd Oct., 1924, p. 93, and *Radio Electricité*, 25th July, 1924, p. 181) employed for the crystal as oscillation generator, the crystal and counter-electrode being joined up in parallel with an oscillatory circuit.

LES CRISTAUX EN T.S.F. (Crystals in radio).—J. Vivie. (*Q.S.T. Français et Radio Electricité Réunis*, 8, January, 1927, pp. 17-24.)

This first instalment concerns the elements of crystallography. Two succeeding parts will deal respectively with galena and theories of detection and with quartz employed as an oscillator.

DIRECTIONAL WIRELESS.

ÜBER DIE VOM SCHIFF HERVORGERUFENE FUNKFEHLWEISUNG UND IHRE BESEITIGUNG (Errors in wireless bearings caused by the ship and their elimination).—F. Fischer. (*Zeits. f. techn. Physik*, 7, 10, 1926, pp. 490-492.)

A theory is given of the systematic error introduced into bearings due to the presence of the ship and methods of compensation are described. The analogy with the deviation theory of the magnetic compass is pointed out. The influence of listing and the ship's inclination lengthwise is also examined.

PORTABLE RADIO DIRECTION FINDER FOR 90 TO 7,700 KILOCYCLES.—F. Dummore. (*Bulletin* No. 536, United States Bureau of Standards.)

Description of the development of a portable direction finder with but two controls—balancing and tuning—operating over a wide frequency band. This wide range is made possible by a set of seven interchangeable plug-in direction-finder coils, each with a corresponding heterodyne generator coil and a cam for operating the auxiliary tuning condenser. Another automatic condenser is connected in parallel with the main tuning condenser and is operated by a second cam of a shaft of the balancing condenser. Its function is to compensate for the detuning effect produced at the higher frequencies when the balancing condenser is operated. A shielding aluminium box contains all the receiving apparatus, including batteries, with the exception of the direction-finder coil, which is supported on a bakelite shaft extending through the box and rotated by means of a hand wheel.

VALVES AND THERMIONICS.

THE K.L.I VALVE.—(*Electrician*, 98, 4th February, 1927, p. 118.)

An account of this new design of valve with indirectly heated cathode, dispensing with the need of the L.T. accumulator, also effecting increased efficiency and amplification without distortion by the employment of a cylindrical cathode. The valve characteristics are given.

BEHAVIOUR OF ALKALI VAPOUR DETECTOR TUBES.—H. Brown and C. Knipp. (*Proc. Inst. Radio Engineers*, 15, January, 1927, pp. 49-55.)

Since the original investigation of certain alkali vapour valves, used as detectors, was completed (*Bulletin* 147, Eng. Exp. Sta., Univ. of Illinois), new and more sensitive types of valves have been developed and put on the market. Interest has centred around comparing the efficiency of these later valves with the supersensitive ones (potassium sodium alloy) previously produced. An account is given here of how the comparative tests were carried out and the results obtained. The efficiency of the alloy detector was found to be approached only by the new radiotron UX200—A. Some peculiar features of behaviour of the alkali valves are also described and represented graphically. It is stated that these valves have proved ideal for durability, true tone reproduction, and non-critical adjustment of plate and filament voltages.

ZUR THEORIE DES THERMIONENEFFEKTES II. (On the theory of the thermionic effect, II.)—N. v. Raschevsky. (*Zeitschr. f. Physik*, 39, pp. 159-171.)

STEUERUNGSVORGÄNGE DURCH "FELDERFALL" UND KIPPSCHWINGUNGEN IN ELEKTRO-NENRÖHREN (Modulation phenomena through "field decay" and tilting oscillations in valves).—E. Friedländer. (*Zeits. f. Techn. Physik*, 7, 10, 1926, pp. 481-484.)

The tilting phenomena which occur in a valve with the appearance of secondary electrons, when

there is ohmic connection between grid and anode, can be employed to produce periodic alterations of charge in an inductance or a condenser. Circuit arrangements are shown and the oscillation phenomena discussed.

UNTERSUCHUNGEN ÜBER DEN GLÜHELEKTRISCHEN ELEKTRONENAUSTRITT BEI ZUSTANDSÄNDERUNGEN DES KATHODENMATERIALS (Investigations on incandescent electric electron emission with alteration of state of the cathode material).—A. Goetz. (*Physik. Zeitschr.*, 27, 1st December, 1926, pp. 795-796.)

MEASUREMENTS AND STANDARDS.

FREQUENCY MEASUREMENTS WITH THE CATHODE RAY OSCILLOGRAPH.—F. Rasmussen. (*Journ. Amer. Inst. Elect. Engineers*, 46, January, 1927, pp. 3-12.)

The oscillograph frequency measurement circuit described differs from previous circuits in the use of by-pass condensers and plate leaks which permit the connection of the oscillograph to A.C. circuits having large D.C. components and which allow the use of biasing controls for shifting the position of patterns on the screen. Reference oscillators, chosen for their high stability, are used in conjunction with the frequency standards. The well-known properties of Lissajous figures are developed for cases in which only one term of their ratios may be determined from the oscillograph pattern. The calibration of oscillators is discussed in detail. Interpolation formulæ are derived for use in making interpolations on the reference oscillators. Several special circuits are described.

ÜBER PIEZO-ELEKTRISCHE KRISTALLE BEI HOCHFREQUENZ (On piezo-electric crystals at high-frequency).—A. Meissner. (*Zeits. f. Techn. Physik*, 7, December, 1926, pp. 585-592; *Zeitschr. f. Hochfrequenz*, 29, January, 1927, pp. 20-24.)

Lecture delivered at the 89th meeting of German scientists at Düsseldorf last September.

A method is given for recording the resonance curves of quartz, and a new method of wave control employing the helium tube, also the quartz crystal is considered as a generator of oscillations. With plates cut in the plane of the optic axis, dissymmetry and air currents were detected, investigation of which led to the construction of a small quartz motor and also to a structural model for the quartz crystal. The relations between the optical and mechanical directions of rotation were determined.

A brief account of the generation of air currents and the rotation of the crystal is to be found in the *Wireless World* of 16th February, 1927, p. 202.

MEASUREMENTS ON RADIO-FREQUENCY AMPLIFIERS.—R. Smith-Rose and H. Thomas. (*Wireless World*, 2nd, 9th, 16th and 23rd February, 1927.)

A series of articles on the measurement of amplifier performance, the first being a review of present methods, and the subsequent articles dealing respectively with voltage amplification, the input

impedance of an amplifier, and intermediate amplifiers for supersonic heterodyne receivers.

TELEPHONE TRANSMITTER MODULATION MEASURED AT THE RECEIVING STATION.—B. van der Pol and K. Posthumus. (*E.W. & W.E.*, 4, March, 1927, pp. 140-141.)

A short account of a method of modulation measurement used at Eindhoven, which differs somewhat from that described by Mr. L. B. Turner, under the same title, in the January number of *E.W. & W.E.*

AN AUTOMATIC FADING RECORDER.—T. Smith and G. Rodwin. (*Proc. Inst. Radio Engineers*, 15, January, 1927, pp. 41-47.)

A device for automatically recording signal intensities is described with the method employed to amplify the signal sufficiently to operate a commercial type of graphic meter. Sample fading records of various transmissions are shown.

MESSUNGEN AN MIKROPHONEN UND TELEPHONEN (Measurements on microphones and telephones).—C. Hartmann. (*Elekt. Nachr. Technik*, 3, December, 1926, pp. 458-461.)

Discussion of objective methods of comparison.

LE CALCUL DES SELFS (Calculation of inductances).—Y. Doucet. (*Q.S.T. Français et Radio Electricité Réunis*, January, 1927, pp. 32-33.)

Continuation of a mathematical discussion begun in the previous issue.

A SHIELDED BRIDGE FOR INDUCTIVE IMPEDANCE MEASUREMENTS AT SPEECH AND CARRIER FREQUENCIES.—W. Shackleton. (*Bell System Technical Journal*, 6, January, 1927, pp. 142-171.)

Description of a shielded alternating-current inductance bridge adapted to the measurement of inductive impedances at frequencies up to 50,000 cycles.

A.C. MEASURING INSTRUMENTS.—K. Edgcombe and F. Ockenden. (*Electrician*, 98, 11th February, 1927, pp. 140-141; *Electrical Review*, 11th February, 1927, pp. 232-235.)

Abstract of a paper read before the Institution of Electrical Engineers on 3rd February.

DIE WAHRSCHEINLICHKEITSRECHNUNG IN DER FERNSPRECHTECHNIK. (Calculation of probability in telephone technique).—F. Lubberger. (*Zeits. f. Techn. Physik*, 8, 1, 1927, pp. 17-25.)

GENERAL PHYSICAL ARTICLES.

AN INVESTIGATION INTO THE NATURE AND OCCURRENCE OF THE AURORAL GREEN LINE λ 577 Å.—J. McLennan, J. McLeod and W. McQuarrie. (*Proc. Royal Society*, 114A, February, 1927, pp. 1-22.)

Description of recent work resulting in the conclusion that this green line is due to oxygen and occurs with greatest intensity when the oxygen is at a pressure equivalent to 2 mm. of mercury, the intensity being also increased when the oxygen

is mixed with one or other of the gases: helium, neon or argon.

PHOTOELECTRIC EMISSION AS A FUNCTION OF COMPOSITION IN SODIUM-POTASSIUM ALLOYS.—H. Ives and G. Stilwell. (*Physical Review*, 29, February, 1927, pp. 252-261.)

BEITRÄGE ZUR ERKLÄRUNG DER ERSCHEINUNGEN BEI DER KATHODENZERSTÄUBUNG. (Contributions to the elucidation of cathode sputtering phenomena).—T. Baum. (*Zeitschr. f. Physik*, 40, pp. 686-707.)

DIE REFLEXION HERTZSCHER WELLEN AN FERROMAGNETISCHEN DRAHTGITTERN. (The reflection of Hertzian waves at ferromagnetic wire gratings).—W. Arkadiew. (*Annalen der Physik*, 81, pp. 649-665.)

Owing to the impossibility of measuring the absorption of Hertzian waves when they are reflected from metal reflectors, the reflection at Hertzian gratings is investigated. The magnetic properties for rapid electrical oscillations can be calculated from the theory that is extended here for the case of the ferromagnetic wire grating. The permeability and conductivity worked out here from experiment coincide with the curves constructed from the theory of magnetic dispersion, the parameters necessary being taken from observations of the absorption of electric waves at magnetic wires.

DIE REFLEXION ELEKTROMAGNETISCHER WELLEN AN FERROMAGNETISCHEN OBERFLÄCHEN (The reflection of electromagnetic waves at ferromagnetic surfaces).—W. Arkadiew. (*Zeitschr. f. Physik*, 38, pp. 908-919.)

AN ANALYSIS OF THE ELECTROMAGNETIC FIELD INTO MOVING ELEMENTS.—S. Milner. (*Proc. Royal Society*, 114, A, February, 1927, pp. 23-46.)

SUR LA POSSIBILITÉ DE METTRE EN ACCORD LA THÉORIE ELECTROMAGNETIQUE AVEC LA NOUVELLE MÉCANIQUE ONDULATOIRE (On the possibility of reconciling the electromagnetic theory with the new undulatory mechanics).—L. de Broglie. (*Comptes Rendus*, 184, 10th January, 1927, pp. 81-82.)

LA STRUCTURE ATOMIQUE DE LA MATIÈRE ET DU RAYONNEMENT ET LA MÉCANIQUE ONDULATOIRE. (The atomic structure of matter and radiation and undulatory mechanics).—L. de Broglie. (*Comptes Rendus*, 184, 31st January, 1927, pp. 273-274.)

ELECTROMAGNETIC THEORY AND THE FOUNDATIONS OF ELECTRIC CIRCUIT THEORY.—J. Carson. (*Bell System Technical Journal*, 6, January, 1927, pp. 1-17.)

An example of the type of problem to which the analysis presented is applicable is the coil antenna. The fact that the current depends not only on the line integral of the impressed electric intensity, but also on its mode of distribution along the length of the coil, may possibly have practical significance in the design of coil antennæ and their calibration at very short wavelengths.

PEUT-ON DÉCELER DIRECTEMENT LE MOMENT MAGNÉTIQUE DE L'ÉLECTRON ? Is it possible to find the magnetic moment of the electron directly?—L. Brillouin. (*Comptes Rendus*, 184, 10th January, 1927, pp. 82-84.)

Experimental conditions are outlined which, although difficult, it is thought are not impossible to realise.

A QUANTUM RELATION IN LARGE SCALE ELECTRIC WAVE PHENOMENA.—T. Eckersley. (*Nature*, 119, 12th February, 1927, p. 234.)

ÜBER DIE DÄMPFUNG VON KLEINEN HERTZSCHEN VIBRATOREN (On the damping of small Hertzian vibrators).—W. Arkadiew and A. Leontiewa. (*Zeitschr. f. Physik*, 38, pp. 706-715.)

The observation of interference with Hertzian waves, with very great path differences, shows that extremely weak damped harmonics exist in addition to the strong damped fundamental oscillations in a Hertzian vibrator.

ÜBER DIE NATUR DER DIELEKTRISCHEN VERLUSTE (On the nature of dielectric losses).—K. Sinjelnikoff and A. Walther. (*Zeitschr. f. Physik*, 40, pp. 786-803.)

A theory of dielectric losses is constructed from the results of experiments on insulators. The problem is treated mathematically, and it is shown that the theory not only explains the dependence upon frequency and temperature that is found experimentally, but also makes a calculation of the absolute values of the dielectric losses possible.

DISCUSSION ON THE MECHANISM OF BREAKDOWN OF DIELECTRICS.—Hoover. (*Journ. Amer. Inst. Elect. Engineers*, 46, January, 1927, pp. 70-74.)

Mr. Hoover's paper appeared in the September number of this Journal, pp. 824-831 (these abstracts, *E.W. & W.E.*, November, 1926, p. 703).

DYNAMICAL STUDY OF THE VOWEL SOUNDS.—II.—I. Crandall. (*Bell System Technical Journal*, 6, January, 1927, pp. 100-116.)

Analyses of the frequency spectra of vowels show almost invariably two principal resonance peaks, which fact is suggestive of a double resonator to produce them. The present paper is concerned with the mechanism of the double resonator system and a mathematical treatment thereof.

THE PERFORMANCE AND DESIGN OF THE SOUND RADIATOR CONSISTING OF THE ACOUSTIC TRANSFORMER AND THE HORN.—K. Kobayashi. (*Journ. Inst. Elect. Engineers of Japan*, December, 1926, pp. 1437-1444.)

OPTIMUM CONDITIONS FOR MUSIC IN ROOMS.—F. Watson. (*Physical Review*, 29, January, 1927, p. 220.)

Abstract of a paper presented at the Chicago

meeting of the American Physical Society, November, 1926. Musicians prefer rooms for playing that are reverberant, while listeners are better pleased with deadened rooms. A series of experiments was conducted to adjust these apparently contradictory conditions. After investigating a number of rooms of widely different volumes that varied in reverberant qualities, a final experiment gave the solution. A room adjusted for "perfect" conditions was found unsatisfactory for both playing and listening, but on transferring the absorbing material from the end of the room occupied by the players to the end used for listening, the conditions were regarded as very acceptable both for playing and listening.

A CONTINUOUS INTEGRAPH.—V. Bush, F. Gage and H. Stewart. (*Journ. Franklin Institute*, 203, January, 1927, pp. 63-84.)

Description of a mathematical instrument which is a continuously recording integraph and multiplier. It will multiply together two curves, or will integrate the product and will plot the resulting function; it will also solve certain types of integral equations directly, without the necessity of evaluating the terms of a series.

DISCUSSION OF A METHOD FOR MAXIMISATION IN CIRCUIT CALCULATIONS (ROBERTS).—O. Roos. (*Proc. Inst. Radio Engineers*, 15, January, 1927, pp. 57-59.)

Mr. Roberts' paper appeared in *Proc. Inst. Radio Engineers*, 14, October, 1926, pp. 689-693; of which there was an abstract in *E.W. & W.E.* of December, 1926, p. 770.

STATIONS: DESIGN AND OPERATION.

DIE FUNKSENDESTELLE STUTTGART-DEGERLOCH (The radio transmitting station Stuttgart-Degerloch). (*Elekt. Nachr. Technik*, 4, January, 1927, pp. 76-77.)

An account of the new German transmitting station erected by the Reichspost to replace the temporary structure near Feuerbach and increase the broadcasting range of the South German Company. The new station is situated about 1½ km. to the south of Degerloch, at a height of 445 m. above the sea level, with open country in almost every direction, so that the conditions are favourable for good transmission. The studio remains in the Charlottenplatz, being connected with the transmitter by an underground lead about 6 km. long. The two iron towers carrying the T-shaped aerial are each 100 m. high and 138 m. apart. The equipment comprises a valve transmitter with outside control and intermediate circuit, three modulating valves, one control valve and six oscillating valves. The control and oscillating valves each take 1.5kW and work with 4,000 volts anode tension. The station was officially opened on 28th November last.

GERMANY—POWER RATING.—(*Electrical Review*, 28th January, 1927, p. 141.)

In accordance with the agreement recently concluded at Geneva, the transmitting strength of

the following German stations will be reduced as shown below:—

	Wave-length.	Old kW figure.	New kW figure.
Koenigswusterhausen	1,300	10	8
Frankfurt (Main)	428.6	10	4
Hamburg	394.7	10	4
Leipzig	365.8	9	4
Münster	241.9	3	1.5

The Langenberg station, which was officially inaugurated on 15th January, will have 25kW, instead of 60 on the old basis.

POLAND. NEW SERVICES.—(*Electrical Review*, 11th February, 1927, p. 219.)

Direct wireless communication has been opened between Poland and Syria, the Lebanon, Transjordan, Palestine, Egypt, Eritrea, and Abyssinia, and *vice versa*. Regular exchanges have been arranged between the central wireless station at Warsaw and the Orient Radio Co.'s station at Beirut.

SPANISH HIGH-POWER STATION.—(*E.W. & W.E.*, 4, March, 1927, p. 142.)

Some particulars of the transmitting station at Prado del Rey, about five miles west of Madrid, and the receiving station at Morata, some sixteen miles south-east of Madrid, to which both stations are connected by overhead wires and controlled from a central office.

BROADCASTING STATION KODR.—E. Turl. (*Wireless World*, 2nd March, 1927, p. 259.)

An illustrated description of the Radioperedacha Station set up at Kiev, under licence of the Soviet Government, and constructed principally by amateurs.

CHINA—NEW STATIONS.—(*Electrical Review*, 11th February, 1927, p. 219.)

The contract for a 2kW station with a wave-length of 250 to 550 metres, for installation at Mukden, has been awarded to a French firm, and that for a 1kW station with a similar wavelength, in Harbin, to an American firm. These two broadcasting stations are expected to be in operation early this year. Receiving sets will be taxed and licensed according to type and size: the licence fee for crystal sets to be about \$3 a year, valve sets \$6 a year, and a tax of 10 per cent. imposed on imported sets in addition to the regular Customs duties.

AUSTRALIA. NEW STATION.—(*Electrical Review*, 21st January, 1927, p. 101.)

At present Melbourne has two "A" class broadcasting stations (3LO and 3AR) and one "B" class station (3UZ). The erection of another "B" class station is contemplated, which will receive no revenue from licence fees, but will rely solely on advertising for its income. Suitable programmes of music and other special features are being arranged with one minute's advertising between each item!

NEW ZEALAND. NEW STATIONS.—(*Electrical Review*, 11th February, 1927, p. 219.)

The installation of powerful broadcasting stations at Auckland and Christchurch has been completed by the Radio Broadcasting Co. of New Zealand, Ltd., a subsidised company organised to operate a chain of broadcasting stations throughout New Zealand on a uniform basis. The Auckland station is already in service and those at Christchurch, Wellington, and Dunedin are expected to be ready shortly. Practically all of the equipment used in this area is American.

MISCELLANEOUS.

FIFTY YEARS' PROGRESS IN ELECTRICAL COMMUNICATIONS.—M. Pupin. (*Journ. Amer. Inst. Elect. Engineers*, January and February, 1927, pp. 59 and 171 respectively.)

The Presidential Address, delivered 27th December, 1926, by Prof. M. I. Pupin, retiring President of American Association for the Advancement of Science.

Stress is laid on the important part played by Maxwell's electromagnetic theory in the development of telegraphic and telephonic science. It is stated that, since Faraday, every great advancement in the art of electrical communication has originated in the research laboratories of the universities, and not in the test-rooms or research laboratories of manufacturing companies. The lecturer also points out that the natural electrical disturbances taking place in electrical circuits, such as static disturbances, fading, earth currents in cables, etc., deserve close study, as they may enable us to find the secrets of the natural processes going on in the sun, the central power-station which supplies the moving power to all our activities.

SOME DEVELOPMENTS IN THE ELECTRICAL INDUSTRY DURING 1926.—J. Liston. (*General Electric Review*, 30, January, 1927, pp. 4-66.)

In the section on radio transmission, p. 34, some new types of transmitters are described, produced on a commercial scale for operation at high power and short wavelengths, also a dummy antenna capacitor for testing high-power radio transmitters, and a spray insulator for insulating the anodes of high-power water-cooled vacuum tubes from the supply of cooling water. Mention is also made of a new insulating material with low dielectric loss, "Mycalex," which has proved valuable in the construction of transmitters operating at high power and short wavelengths.

PAST AND PRESENT: A FEW NOTES.—(*E.W. & W.E.*, 4, March, 1927, pp. 160-166.)

Presidential address to the R.S.G.B., by Brig.-General Sir H. Holden, delivered at the Institute of Electrical Engineers, on 26th January, 1927.

RADIO AT SEA—RECORD SHORT-WAVE TRAFFIC.—(*Electrical Review*, 28th January, 1927, p. 140.)

The Cunard liner *Carinthia* has just achieved record-breaking commercial communication between

ship and shore. When off Cape Leeuwin, Australia, she worked with the New Brunswick station, New Jersey, a distance of nearly 12,500 miles. The transmitter has a wave range of from 25 to 50 metres and employs a specially-constructed 500-watt anode dissipation valve, capacity-reaction being employed to control the oscillations. The receiver consists of a simple single-valve circuit thoroughly screened, which can be coupled with the ship's low-frequency amplifier to intensify signal strength if necessary.

TWO-WAY COMMUNICATION WITH THE ANTARCTIC.—W. Brown. (*Nature*, 12th February, 1927, p. 238.)

Contact with the Norwegian whaler, *Sir James Clark Ross*, call sign AQE, by the south shore of the Ross Sea, 78° 30' south latitude, was obtained by C. W. Govder from the Mill Hill School station, 2SZ, on 30th January, the messages exchanged constituting the first two-way communication with the Antarctic.

RADIO IN THE WHALING INDUSTRY.—(*Nature*, 12th February, 1927, p. 255.)

The use of radio telephony by fleets of whaling ships has made the whaling industry a much less strenuous one. Radio direction finders have also proved of great value, particularly as the magnetic compass is of little use in the Antarctic regions.

LA NOUVELLE RÉGLEMENTATION DE LA T.S.F. (New regulation of wireless telegraphy).—(*Radio-Revue*, February, 1927, pp. 302-307.)

Enumeration of the new radio laws in France, made last December, after the publication of which all stations will be subject to the control of "l'Administration des postes, télégraphes et téléphones et du Ministre de l'Intérieur."

RADIO PHOTOGRAPHY AND TELEVISION.—E. F. W. Alexanderson. (*General Electric Review*, 30, February, 1927, pp. 78-84.)

Radio photography is an accomplished fact and good reproductions are shown of photographs that have been broadcast. Transmission by continuous and interrupted waves is discussed, and the multi-shade process. The television problem is outlined, the solution of which is considered possible when higher speed and more brilliant receiving projectors have been developed.

A TOUR ROUND SAVOY HILL.—A. West. (*Wireless World*, 9th February, 1927, pp. 154-158.)

The first article of a series dealing with problems of sound in relation to broadcasting studios. The articles in the three succeeding issues consider, respectively, the application of acoustic principles in the development of broadcasting studios, the production of echo effects by variable draping and by artificial methods, and studio equipment.

Esperanto Section.

Abstracts of the Technical Articles in our last Issue.

Esperanto - Sekcio.

Resumoj de la Teknikaj Artikoloj en nia lasta Numero.

PROPAGADO DE ONDOJ.

PLUAJ MEZUROJ ĈE SENFADENAJ OND-FRONTOJ.—D-ro. R. L. Smith-Rose kaj S-ro. R. H. Barfield.

La artikolo traktas daŭrigon de laborado de la samaj aŭtoroj priskribita en ĉi tiu gazeto je Septembro 1925a. Oni jam evoluigis aparaton por mallongaj ondolongoj, ekz., brodkastaj, kaj mezuroj estas priskribitaj ĉe ondofrontoj, t.e., diversaj kliniĝoj de la elektra kaj magnetaj kampoj. La mezuroj estis faritaj per kliniĝanta Hertza vergo por flankaj kampoj kaj antaŭena kliniĝo de la elektra kampo, kaj per kliniĝbobena ricevilo por la magnetaj kampoj. Oni donas rezultantaj kurvojn, kun tabeloj montrantaj variadon de la anguloj de incidenceco de malsuprenirantaj ondoj, k.t.p.

Kiel klarigo pri la rezultoj, oni sugestas, ke multoblaj reflektadoj okazas el la supra tavolo. La pligrandaj anguloj de incidenceco observitaj respondas al unuoblaj reflektadoj el la tavolo, kaj la malpligrandaj anguloj al reflektadoj alterne ĉe la tavolo

kaj ĉe la tera surfaco. La altecon de la tavolo oni taksas je 90 kilometroj.

PROPRECOJ DE CIRKVITOJ.

PLUAJ NOTOJ PRI SIMPLAJ REZONANCAJ KURVOJ.—Prof. E. Mallett.

La artikolo estas daŭrigo de tiu en la antaŭa numero. La nuna artikolo pritraktas la okazojn de du cirkvitoj kuplitaj aŭ magnetite aŭ elektrostatiĝe. Oni montras, ke kurvoj povas esti aŭ de la ordinara speco aŭ de la "zigzaga" speco. Diversaj aplikadoj de ĉi tiuj estas priskribitaj. La temo estas traktita laŭ la rubrikoj, (1) Unu cirkvito agordita, kuplita per komuna indukteco, aŭ la frekvenco aŭ la agorda kapacito estante variigita, (2) La sama kun kondensatora kuplo, (3) Du cirkvitoj agorditaj, kuplitaj per komuna indukteco, la kondensatoroj estante variigitaj, (4) Dinamometra efekto, kaj (5) Aplikadoj, t.e., determinoj de frekvenco, altfrekvenca rezisteco, indukta kapacito, k.t.p.

SENDADO.

LA HORIZONTALA HERTZA ANTENO POR SENDADO.
—M. G. Scroggie.

La artikolo diskutas la plej taŭgan tipon de radiadaj sistemoj por utiligo je mallongaj ondoj, kaj sugestas simplan Hertzan oscilatoron. Oni scias, ke la polarizo de mallongaj ondoj ĉe la ricevilo estas malsama je tiu ĉe la sendilo, kaj la ricevado per horizontalaj Hertzaj vergoj estas jam priskribitaj.

Oni tial sugestas horizontalan Hertzan vergon, kiel sendan antenon, kun la ekscito aplikita ĉe ĝia mezo. Oni poste diskutas la utiligon de Lecher'aj fadenoj kiel proviziloj, bone ilustritaj per diagramoj de nodaj pintoj por diversaj rilatoj de linia longeco kaj ondolongo. Praktika formo de Hertz anteno estas montrita, kaj kelkaj ekzperimentaj rezultoj priskribitaj.

RICEVADO.

LA CELO KAJ DESEGNO DE BRODKASTAJ RICEVILOJ.

Resumo de neformala diskutado ĉe la Senfadena Sekcio de la Instituto de Elektraĵ Ingenieroj, Londono, je 2a Februaro, 1927a. La diskutadon malfermis C. F. Phillips, kaj daŭrigis S-roj. L. C. Pöcock, P. W. Williams, P. K. Turner, kaj aliaj.

LA MIKROFONO "TUCKER" POR RICEVADO.—Prof. H. E. Watson.

Post mallonga priskribo kaj diskutado pri la principoj de la mikrofono, oni sugestas ĝian utiligon kiel sentemegan kunigilon je ricevado. La mikrofono konsistas el varmigita fadeno en sonora ĉambro, kaj la artikolo priskribas ĝian utiligon kiel malalt-frekvencan tonselektilon. Tial, ke la pli kutima mikrofona frekvenco de 250 voltaj ne estis konsiderita taŭga, oni faris eksperimentojn per diversaj fadenoj por funkcii je 1 000 cikloj kune kun taŭga resonatoro. Priskriboj kaj ilustraĵoj estas donitaj pri diversaj resonatoroj uzitaj, kaj oni diras, ke konsiderinda plibonigo okazis ĉe la proporcio de signalo je atmosfera forto. Oni ankaŭ priskribas eksperimentojn rilate plialtajn rapidecojn de funkciado kaj la utiligon de la mikrofono kiel tonselektilon por signala interfero. Oni povas apartigi du staciojn funkciajn, ĉiu 200 metrojn aparte de l'alia, je 20,000 metroj, aŭ 0.02 metro aparte je 200 metroj.

TELEFONSENDILA MODULADO MEZURITA ĈE LA RICEVA STACIO.—D-ro. B. van der Pol and K. Posthumus.

Rilate al artikolo pri la sama temo en ĉi tiu gazeto, Januaro 1927a, alia metodo de mezurado estas priskribita. La elmeto el altfrekvenca amplifikatoro estas rektifita per diodo kun kondensatoro kaj rezistanco kiel ĉe krada rektifado. La aŭdfrekvenca tensio trans la kondensatoro estas mezurita per dua diodo uzanta retrogliteblan metodon kaj retrogan komutatoron, tiel, ke la

supra kaj malsupra limoj de la modulado estas aparte mezuritaj. La procenta modulado estas poste facile kalkulebla.

MEZUROJ KAJ NORMOJ.

MODIFITA BAT-METODO POR KOMPARI DU ALTFREKVENCAJN OSCILATOROJN.

La metodo priskribita traktas la utiligon de tria aŭ helpa oscilatoro, uzita kiel aŭtodino kaj kunigita al la telefon-aŭskultiloj aŭ malaltfrekvenca amplifikatoro laŭokaze. Norma oscilatoro kaj la oscilatoro normigota estas ambaŭ kuplitaj al la aŭtodino, kiu estas alĝustigita por heterodini ĉi tiujn signalojn je oportuna frekvenco. Tiuj-ĉi donos aŭdeblajn tonojn, kiuj estos kunagordeblaj, ĝis la battoj malaperos, kiam la norma oscilatoro kaj la oscilatoro provata kunagordas. Praktikaj notoj pri la funkciado estas ankaŭ donitaj.

DIVERSAĴOJ.

MATEMATIKO POR SENFADENAJ AMATOROJ.—F. M. Colebrook.

Daŭrigita el antaŭaj numeroj. La nuna parto traktas Seriojn, enhavante la signifon de serio, la sumon de serio, konvergecon kaj divergecon, provojn por konvergeco, kaj kelkajn gravajn seriojn, k.t.p.

LA ESTINTECO KAJ LA ESTANTECO: KELKAJ NOTOJ.

Prezidanta parolado al la Radio-Societo de Granda Britujo de Brig-Generalo Sir H. C. L. Holden, K.C.B., F.R.S., M.I.E.E., je 26a Januaro 1927a.

La parolanto revuis la fruan historion de la Societo kaj diskutis modernajn evoluigojn, aparte rilate al valvoj, mallongaj ondoj, frekvenca stabileco, telefoniloj, rektifikatoroj por provizo per la elektraĵ ĉeftuboj, normigado. La aktiveco de la Societo kune kun aliaj societoj estis ankaŭ pri-traktita.

RESUMUOJ KAJ ALUDOJ.

Kompilata de la *Radio Research Board* (Radio-Esplorada Komitato) kaj publikigita laŭ arango kun la Brita Registara Fako de Scienca kaj Industria Esplorado.

HISPANA ALTPOTENCA STACIO.—Prof. G. W. O. Howe.

Mallonga priskribo pri la nova Hispana Altpotencia Stacio ĉe Prado de Rey, apud Madrido. La ricevado okazas ĉe Morata, dum kaj senda kaj riceva stacioj estas funkciigataj el centra oficejo en Madrido. La sendilo liveras 150 Kilovatojn, kun ondolongoj de 13,870, 10,560, kaj 8,340 metroj.

Some Recent Patents.

The following abstracts are prepared, with the permission of the Controller of H.M. Stationery Office, from Specifications obtainable at the Patent Office, 25, Southampton Buildings, London, W.C.2, price 1/- each

FREQUENCY BAND TRANSMISSION.

(Convention date (U.S.A.), 6th November, 1924.
No. 242,653.)

Some very interesting hypotheses to account for fading phenomena are given in the above British Patent, which gives details of a scheme for overcoming these defects. Marconi's Wireless Telegraph Company, Limited, and A. N. Goldsmith claim a method of short wave transmission in which

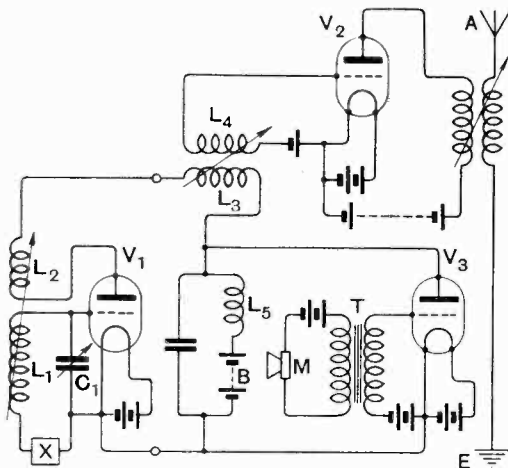

the frequency of the generated waves is periodically changed. Briefly, the specification points out that with short wave transmission there may be an earth wave and a reflected wave from the Heaviside layer. Simultaneous signal voltages occur from both paths at a receiving station, there being a phase difference between the two. This phase difference constantly varying owing to alteration in the Heaviside layer causes the magnitude of received potentials to vary correspondingly. However, if the frequency of the waves is altered there will be an alteration in the instantaneous values in the received potentials from the earth wave and the Heaviside layer reflected wave. The invention therefore consists in speech modulating a short wave, the frequency of which is continuously varied over small limits. The accompanying illustration shows one method of accomplishing this. The valve V_1 is provided with a grid inductance L_1 , a capacity C_1 , an anode inductance L_2 , and the two are coupled together so as to produce continuous oscillations of very high frequency. The anode circuit also contains an inductance L_3 coupled to the grid inductance L_4 of a power amplifier

valve V_2 , which is coupled through the usual coils to an aerial system AE . A speech modulator valve is shown at V_3 , and is provided with the usual microphone M and speech transformer T . The anode supply for the valves V_1 and V_3 is shown at B , and is connected through the usual choke L_5 . The arrangement of the valves V_1 and V_3 is, of course, an ordinary choke control or constant current modulator system. Connected in the grid circuit of the generator V_1 is a device X which is used continuously to vary the frequency of the oscillations. The remainder of the circuit is quite straightforward, and will not be described in detail. The specification states that the frequency may be changed by a rotating condenser plate or mechanically adjusted variable inductance, but details are also given of a method of varying the constants of the grid circuit by the use of two oscillating valves which are caused to vary with the constants of the grid circuit of the valve V_1 by altering its inductance value.

A TOROIDAL COIL.

(Convention date (U.S.A.), 31st August, 1925.
No. 257,564.)

The Coto-Coil Company and E. F. Parks describe in the above British Patent the construction of a toroidal inductance suitable for high frequency circuits. The accompanying diagram should make the invention quite clear. M represents the

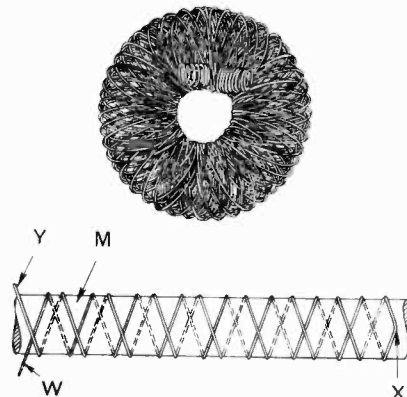

mandrel or axially rotated spindle of the winding machine on which the wire W is wound, the turns being spaced and wound with a definite pitch until they reach a point X , when the direction is reversed so that the wire returns at Y . Successive layers

may be wound if desired in this manner so that the coil is somewhat similar to the well-known honey-comb or duolateral type. The winding is then removed from the mandrel, and the completed coil is bent into a ring so that a toroidal coil results, having an appearance similar to that shown in the illustration.

ATMOSPHERIC ELIMINATION.

(Convention date (France), 15th November, 1924. No. 243,003.)

An atmospheric eliminating system is described in the above British Patent by L. Levy. The method employed consists in introducing some form of modulation which has the effect of modulating the amplitude of the desired signals and the frequency of the atmospheric signals. The atmospheric in this way produce very low frequency

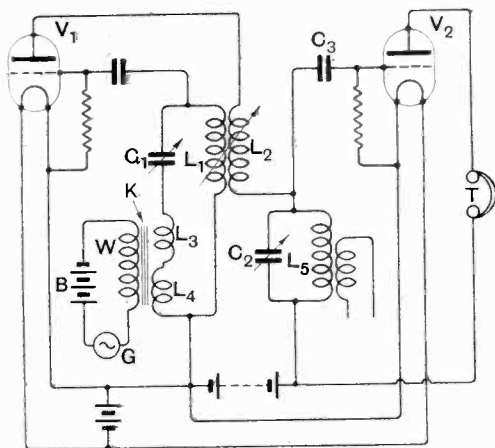

impulses which can be readily separated from the desired signals. The accompanying diagram shows one form of the apparatus. A valve V_1 is used as a first detector valve, the grid current containing an inductance L_1 and a capacity C_1 , a reaction coil L_2 being coupled to the grid coil. In series with the tuned circuit $L_1 C_1$ are two inductances L_3 and L_4 , which are wound over a core K , which is provided with a winding W in series with a battery B and an alternating supply or generator G . The two inductances L_3 and L_4 are wound in opposite directions. The direct current from the battery B produces in the core K a magnetic flux, the value of which can be so adjusted that any increase or decrease of the flux due to the alternating current from the generator G alters the permeability of the core. According to the variation of permeability there will be a variation in the inductance of the two coils L_3 and L_4 . Since the inductance of these coils is changing, and, further, since they form part of the circuit connected to the grid of the valve, the natural frequency of the input circuit of the valve will vary. The anode circuit of this valve in addition to containing the reaction coil L_2 , contains the tuned circuit $L_3 C_2$, which is coupled through a condenser C_3 to the

input circuit of another detector valve V_2 , the anode circuit of which contains the telephone receivers. The tuned circuit $L_5 C_2$ is tuned to double the frequency of the current supplied by the generator G . The input circuit of the first valve may be either directly or inductively coupled to an aerial system. Considering the effect of signal voltages upon the system, these will be detected in known manner and will give rise to audible signals in the telephones T . Since, however, the action of the special transformer and generator is to vary the constants of the input circuit of the valve V_1 it will mean that the effective voltage applied by the signal between the grid and filament of the first valve will vary, since it may be regarded as a circuit which is being periodically detuned. In other words, the amplitude of the received signals is modulated. In the case of an atmospheric, however, the effect is different. The effect of an atmospheric discharge is primarily to produce a voltage across the tuned input circuit by virtue of shock excitation, i.e., oscillations are produced across the tuned circuit irrespective of the frequency to which it may be tuned. Each atmospheric discharge will cause in the circuit $L_1 C_1$ a series of wave trains, each modulated in frequency by the device $W L_3 L_4$, and slowly damped. If they are detected by the valve V_1 each damped wave train will cause the anode current of that valve to diminish. This diminution in anode current is periodic, and its frequency is very low. In fact it will be equal to the frequency of several wave trains caused by the atmospheric discharges, and is of the order of about fifteen or twenty per second. It states in the specification that it has been proved both theoretically and experimentally that impulses of this frequency upon the circuit $L_2 C_3$ do not produce any appreciable effect upon the detector valve containing the telephones, and in this way it is claimed that the effect of atmospheric is very materially reduced. The specification is extremely detailed, and contains a mathematical consideration of the various circuits, and also gives other modifications and arrangements.

ELECTRIC REPRODUCTION OF SOUND RECORDS.

(Convention date (U.S.A.), 2nd June, 1925. No. 253,096.)

Marconi's Wireless Telegraph Company, Limited, and J. Weinberger describe in the above British Patent Specification an arrangement which can be used for the reproduction of broadcast signals, or gramophone records by means of an electrical pick-up device. Dealing first with the pick-up arrangement, the normal gramophone sound box and needle are dispensed with, and are substituted by a needle or stylus N , which works on the face of the record, and communicates with a balanced electromagnetic system comprising an armature A pivoted about its centre point and working between a pair of poles at each end. A valve V_1 is arranged as an oscillator, and contains an anode inductance L_1 and a grid inductance L_2 , a portion of which is tuned by a condenser C_1 . The anode circuit of the valve contains the windings W of the magnetic system which are shunted by a

by-pass condenser C_2 to pass the high frequency currents occurring in the anode circuit of the generator valve V_1 . A battery B_1 is used to supply both filament and anode voltages, the filament current being controlled by a resistance R_1 . Movement of the needle N will be transferred to the pivoted armature which works in a strong

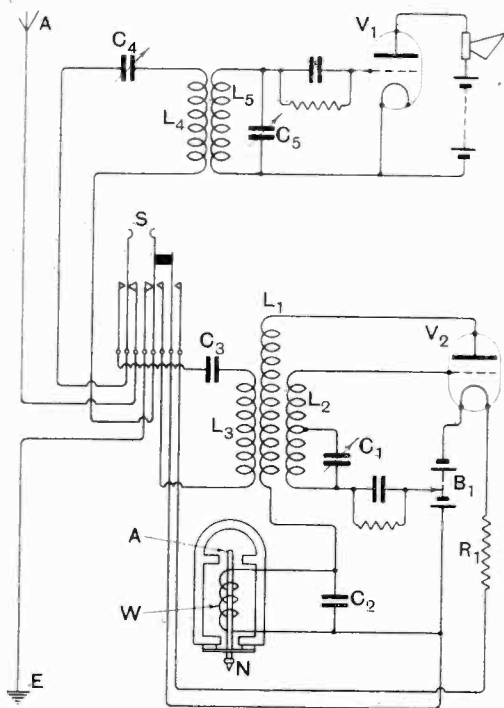

magnetic field. This will cause a change in flux which will produce potentials across the windings W . Since these are in the anode circuit of the valve they will vary the anode potential, and, therefore, modulate the high frequency current existing in the system. The output from this oscillator is transferred through an inductance L_3 and a capacity C_3 to another circuit $L_4 C_4$, which is coupled to a tuned circuit $L_5 C_5$, connected to the input of a detector valve V_2 . When the valve V_1 is oscillating the high frequency current will be transferred through the circuit $L_3 C_3$ to the circuit $L_4 C_4$, and, in turn, to the circuit $L_5 C_5$, where it will be rectified. The detector valve contains the telephone receivers. Under normal conditions nothing will be heard in the telephones. When, however, the stylus is set into vibration by the sound trace of the record the potentials set up in the windings will modulate the high frequency current, and the modulated output will be detected by the valve, thereby energising the telephones or loud-speaker. The system may also be used for ordinary broadcast reception, in which case an aerial and earth system AE is included, and a master switch S is used to connect either the oscillator valve or the aerial system to the detector valve V_2 .

A TRANSMISSION SYSTEM.

(Convention date (U.S.A.), 11th May, 1925.
No. 252,027.)

A transmission system suitable for quiescent work, particularly useful for duplex telephony, is described in the above British Patent by the British Thomson-Houston Company, Limited, and I. F. Byrnes. The telephony system illustrated is one in which the main valves connected to the aerial system only radiate to any appreciable extent so long as there are any microphone potentials. How this is accomplished can be readily understood by examining the accompanying diagram, which shows a schematic arrangement of the system. The high frequency arrangement comprises a main amplifier, a sub-amplifier, and a drive. The drive or master amplifier valve V_1 is provided with a tuned circuit $L_1 C_1 C_2$, one end being connected to the grid and the other to the anode through another condenser C_3 , the centre point of the condensers C_1 and C_2 being connected to the filament. The output of the oscillator is coupled to the first amplifier V_2 through a condenser C_4 and grid choke L_2 . The anode circuit

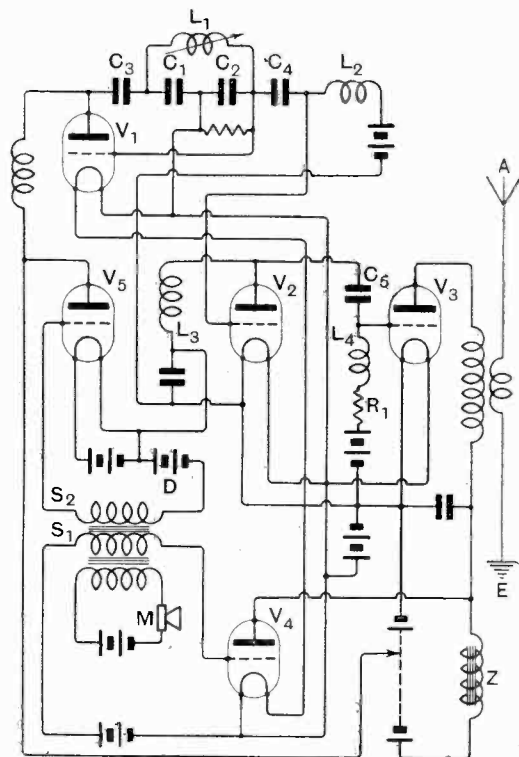

of the amplifier valve V_2 contains an inductance L_3 and is coupled through a capacity C_5 to the grid of the main amplifier V_3 , which contains a grid choke and resistance $L_4 R_1$. The anode circuit of the amplifier valve V_3 is coupled in the usual manner to the aerial system AE . The

microphone *M* is connected to the primary winding of a microphone transformer provided with two secondaries S_1 and S_2 . The secondary S_1 is connected to the grid and filament of the modulator valve V_1 , the anode of which is connected through a modulation choke Z to the source of anode supply B . The other secondary S_2 is connected between the grid and filament of another valve V_2 , the grid of which is negatively biased with respect to the filament by means of a battery D . The valve V_2 is in series with the anode supply to the valve V_1 , *i.e.*, the first amplifier. Obviously, if the grid of this valve is made sufficiently negative the impedance will be so high that practically no voltage will be applied to the anode of the valve V_2 . As soon as voltages are impressed on the grid of the valve V_2 these voltages will overcome the negative voltage of the battery D and the impedance of the valve V_2 will be lowered, thereby permitting an appreciable current to flow to the anode circuit of the valve V_1 . At the same time, however, the amplified high frequency oscillations from the valve V_2 will be impressed upon the valve V_3 , thus rendering the aerial operative, but they will be modulated by the valve V_5 , which is deriving audio-frequency potentials from the secondary S_1 of the microphone transformer. In this way there is only appreciable radiation from the aerial system when the microphone is actually being used, and a convenient duplex system can, therefore, readily be obtained.

A SHORT WAVE OSCILLATOR.

(Convention date (Germany), 10th November, No. 261,350.)

An interesting form of short wave oscillator is described in the above British Patent by Dr. A. Esau. The invention, which is illustrated in the accompanying diagram, consists in utilising a pair of valves connected in the manner indicated. The

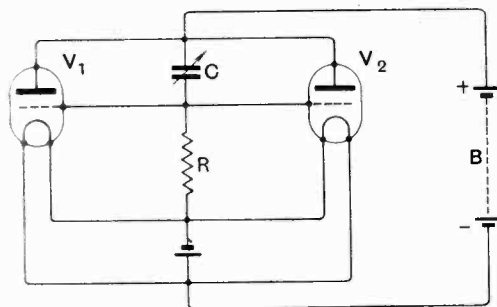

two valves V_1 and V_2 have their anodes connected together and connected to the filament through a source of positive potential B . The two grids are also joined together and connected to the filament

through a resistance R . The specification states that the waves can be still further shortened by connecting a variable condenser C between the two anodes and the two grids. The specification also states that two similar oscillatory circuits are provided each constituted by the inter-electrode capacity of one valve, *i.e.*, the grid-anode capacity, the variable capacity C and the leads connecting the anode and grid to the condenser C . An aerial system may be either directly or inductively coupled to the system.

AN INTERESTING VALVE GENERATOR.

(Convention date (Germany), 11th September, 1925. No. 258,257.)

A very interesting form of valve generator is described in the above British Patent by Telefunken Gesellschaft für Drahtlose Telegraphie. The generator is of the type in which the grid is given a

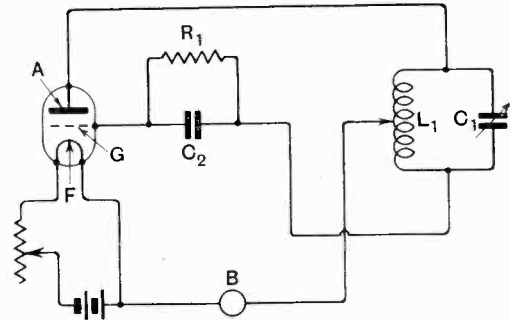

permanent positive potential. The accompanying diagram shows the method in which the circuit is arranged. Here the oscillatory circuit comprises an inductance L_1 tuned by a capacity C_1 . One end of the oscillatory circuit is connected to the anode A , while the other end is connected to the grid G through condenser C_2 shunted by a resistance R_1 . A tapping on the inductance L_1 is connected to a source of positive potential B , the negative end of which is connected to the filament F of the valve. In this manner it will be seen that the anode and grid are both given a positive potential. Since the grid is positive there will be grid current flowing in the grid circuit, and this will cause a fall of potential along the resistance R_1 , thereby maintaining the grid at a lower positive potential than that of the anode. It is stated that this circuit is conducive to the production of more gentle oscillations, and also does not give rise to the generation of undesired oscillations. The circuit is also claimed to be particularly efficient when the anode potential is derived from a source of alternating current.

The Wonderful P.M. Filament

serves you a thousand times round the clock and continues its high performance long afterwards the same as when new

Even a year's broadcasting service will not impair the original perfect results given by Mullard P.M. Valves with the wonderful P.M. Filament. This fact was convincingly proved by the test report of the National Physical Laboratory. After 1,000 hours' rigorous life test the operating characteristics of P.M. Valves with the unique P.M. Filament were the same as before the test.

This unequalled performance is due, without question, to the gigantic emission of the P.M. Filament. Vastly increased emission from the P.M. Filament means more than long useful valve life, it secures greater sensitivity, greater volume and purer reproduction.

Enjoy the fullest possibilities of your radio receiver.

Bring in stations you have never heard before, and obtain really pure, musical reception by asking for valves that have an official Government Laboratory Test Report—

Ask for Mullard P.M. Valves with the wonderful P.M. Filament.

Mullard

THE · MASTER · VALVE

Advt. The Mullard Wireless Service Co., Ltd., Mullard House, Denmark Street, London, W.C.2

Kindly mention "Experimental Wireless" when replying to advertisers.

D

BUYERS' GUIDE.

ACCUMULATORS.—C. A. Vandervell & Co, Ltd., Acton, London, W.3.

COILS.—Graham-Farish Manufacturing Co., 17, Mason's Hill, Bromley, Kent. Igranic Electric Co., Ltd., 149, Queen Victoria Street, E.C.; Pettygrew & Merriman (1925) Ltd., 2 & 4, Bucknall Street, New Oxford Street, W.C.1.

COIL HOLDERS.—Igranic Electric Co., Ltd., 149, Queen Victoria Street, E.C., Pettygrew & Merriman (1925), Ltd., 2 & 4, Bucknall Street, New Oxford Street, W.C.1.

CONDENSERS (GENERAL).—Autoveyors, Ltd., 84, Victoria Street, S.W.1. Bowyer-Lowe Co., Ltd., Letchworth. Dubilier Condenser Co. (1925), Ltd., Goldhawk Road, W.12. Graham-Farish Manufacturing Co., 17, Mason's Hill, Bromley, Kent. Igranic Electric Co., Ltd., 149, Queen Victoria Street, E.C. M.A.P. Ltd., 246, Gt. Lister Street, Birmingham. Marconiphone Co., Ltd., 210, Tottenham Court Road, W.1. Pettygrew & Merriman, (1925), Ltd., 2 & 4, Bucknall Street, New Oxford Street, W.C.1. W. G. Pye & Co., "Granta Works," Montague Road, Cambridge.

EBONITE.—Trelleborgs Ebonite Works, Ltd., Audrey House, E.C.2.

GALVANOMETERS (CAMBRIDGE UNIPIVOT).—Cambridge Instrument Co., Ltd., 45, Grosvenor Place, S.W.1.

GRID LEAKS.—Igranic Electric Co., Ltd., 149, Queen Victoria Street, E.C. Watmel Wireless Co., 332a, Goswell Road, E.C.4.

LOUD SPEAKERS.—Alfred Graham & Co., St. Andrew's Works, Crofton Park, S.E.4.

LOUD SPEAKER HORNS.—H. Maddison, 2a, Ronald's Road, Holloway Road, N.5.

MEASURING INSTRUMENTS.—F. C. Heayberd & Co., 9, Talbot Court, Eastcheap, E.C. Sifam Electrical Instrument Co., 10a, Page Street, Westminster, S.W.1. Weston Electrical Instrument Co. Ltd., 15, Great Saffron Hill, E.C.1.

PERIODICALS.—"Journal of Scientific Instruments," "Institute of Physics," 90, Great Russell Street, W.C.1. Printing Craft, Ltd., 34, Red Lion Square, W.C.

QSL CARDS.—E. H. Appleby, The Croft, Willesden, N.W.10.

RESISTANCES (ANODE).—Varley Magnet Co., Woolwich, S.E.18.

RESISTANCES (FILAMENT).—Igranic Electric Co., Ltd., 149, Queen Victoria Street, E.C.

TERMINALS (SPECIAL TYPE).—Igranic Electric Co., Ltd., 149, Queen Victoria Street, E.C. M.A.P., Ltd., 246, Great Lister Street, Birmingham. Pettygrew & Merriman (1925), Ltd., 2 & 4, Bucknall Street, New Oxford Street, W.C.1.

TOOLS.—Ardea Vulcaniser Syn, Ltd., 318, King Street, Hammersmith, W. Goodwins M.A. Ltd., 2-4, Edmund Street, Birmingham.

TRANSFORMERS.—Ferranti Ltd., Hollinwood, Lancs. W. G. Pye & Co., "Granta Works," Montague Road, Cambridge.

TRANSFORMERS (L.F.).—Igranic Electric Co., Ltd., 149, Queen Victoria Street, E.C. W. G. Pye & Co., "Granta Works," Montague Road, Cambridge.

VALVES.—A. C. Cossor, Ltd., Highbury Grove, London, N.5. General Electric Co., Ltd., Kingsway, W.C. Marconiphone Co., Ltd., 210, Tottenham Court Road, W.1. Metro-Vick Supplies, Ltd., 145/147, Charing Cross Road, W.C.1. The Mullard Wireless Service Co., Ltd., Mullard House, Denmark Street, London, W.C.2.

VERNIER ATTACHMENTS.—Igranic Electric Co., Ltd., 149, Queen Victoria Street, E.C. M.A.P., Ltd., 246, Great Lister Street, Birmingham.

VOLTMETERS.—Cambridge Instrument Co., Ltd., 45, Grosvenor Place, S.W.1. Radios, 218, Upper Thames Street, E.C.4. Sifam Electrical Instrument Co., 10a, Page Street, Westminster, S.W.1.

Wireless Constructors!

Here is a British made and guaranteed Soldering Iron that you must have. Even temperature maintained. Low current consumption. Perfect in design and construction.

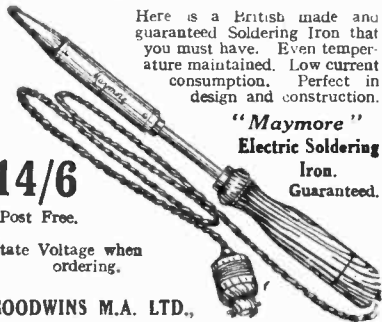

"Maymore" Electric Soldering Iron. Guaranteed.

14/6

Post Free.

State Voltage when ordering.

GOODWINS M.A. LTD.,
2-4, Edmund St., Birmingham.

YOU CAN EARN MORE MONEY NOW! Competent Men Wanted Spare time or Full-time Work

A few vacancies still exist for competent men to represent us in certain districts where we are not at present fully represented.

Applicants must be capable of making a first-class job of installing wireless sets; have selling ability and initiative; be able to provide satisfactory references.

This is a splendid opportunity for the right men to make a large income or substantially supplement their present one. Full or spare time work will be accepted. Many of our Representatives draw weekly cheques of from £5 to £12 a week for part-time work.

The unprecedented demand for the popular and efficient General Radio sets has necessitated our increasing the staff and doubling production several times over in the last few months, and a great number of our representatives in all parts of the country have doubled and trebled their incomes at the same time. Further great developments in the Company are taking place every week and present unique opportunities for highly remunerative work for able and enthusiastic men.

All applications will be regarded in confidence.
Apply to our Service Department:

GENERAL RADIO COMPANY, Ltd.,
Radio House, 235, Regent Street, W.1

LISTENING-IN

to foreign stations is spoiled by the language difficulty, the only practical solution to which is Esperanto.

Send 6d. for the "Radio Packet," which contains full particulars and a copy of the International Radio Manual, to the

BRITISH ESPERANTO ASSOCIATION,
142, High Holborn, London, W.C.1



Trelleborgs
GENUINE EBONITE
Experts choose it - its Choice!

STOCKED BY ALL THE BEST DEALERS
TRELLEBORGS EBONITE WORKS Ltd. Audrey House, E.C.1

WOOD-HORNS

The Manufacturer is

H. MADDISON

2a, Ronald's Rd., Holloway Rd., HIGHBURY, N.5
There's only one best, "THE ALLWOODORN" is that one. Send for list, Lissenola-Amplion —T.M.C. units supplied complete with horn if desired.

The
Wireless
AND
RADIO REVIEW
World
EVERY WEDNESDAY 3d.

Kindly mention "Experimental Wireless" when replying to advertisers.

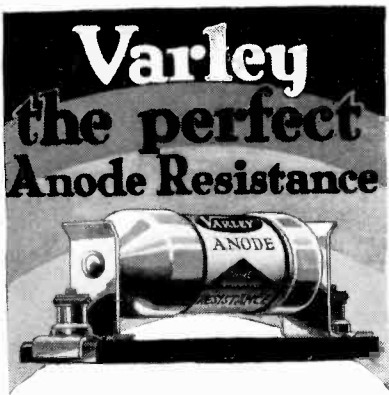

Real purity of tone and absolute constancy under all conditions are the factors that constitute perfection in Anode Resistances.

Varley Bi-Duplex Wire-Wound Anode Resistances are wound in several sections with a special alloy wire, the tension of which is carefully pre-determined. Each section is wound alternately clockwise and anti-clockwise with the same length of wire, thereby completely eliminating the inductance of that section. The famous Varley Bi-Duplex winding, in which each turn of bare wire is separated by specially spun silk thread, and each layer of wire and silk separated from the next by micanite paper, ensures maximum air spacing consistent with mechanical stability, and reduces the self-capacity to a minimum. Current is passed through the resistances when wound in order to relieve all stresses in the winding, and to drive out the last remnants of moisture that may have gathered during manufacture. They are stoved for three days to age, and then enveloped with a special dope which precludes any chance of moisture re-penetrating the winding, setting up electrolyses, and short-circuiting the turns and layers of wire. Very briefly, these are a few of the reasons why you can be sure of real tonal purity with Varley Anode Resistances.

Made in a complete range of sizes up to 500,000 ohms.

Prices 4/- to 16.-. Clips and base 1/6 extra.

Full particulars of Varley Tapped Resistances and H.F. Chokes, on application.

THE VARLEY MAGNET CO.
Proprietors—
Oliver Fell
Control, Ltd.



Telephone—
City 3393.
Granville House
Arundel Street
London, W.C.2

PREPAID PARAGRAPH ADVERTISEMENTS.

The charges for prepaid advertisements are as follows—

AUCTIONEERS' & OFFICIAL ANNOUNCEMENTS.—Advertisements under this heading are inserted at a charge of 11s. per single column inch.

TRADE & MISCELLANEOUS.—2s. for 12 words and 2d. for each additional word.

PRIVATE SALE & EXCHANGE.—Advertisements are inserted in this section at the rate of One Penny per word: minimum charge per advertisement One Shilling. All advertisements, without exception, must be prepaid to ensure insertion. Single letters or figures are charged as words, and a compound word as two words. The advertiser's name and address are charged for.

"Box" replies, care of these offices, are charged 6d. extra to cover postages. The following words must appear at end of advertisement: "Box—EXPERIMENTAL WIRELESS OFFICES," for which usual rate will be charged. (Advertisers need not include our full address.) When replying to a "Box No." adv., address your envelope: Advertiser, Box —, EXPERIMENTAL WIRELESS & WIRELESS ENGINEER, Dorset House, Tudor Street, London, E.C.4.

Advertisers who wish to separate their advertisements into distinct paragraphs must have not less than 12 words in any one paragraph, followed by the word "Below"—which is charged for.

Remittances should be made by Postal Order or Stamps, and sent to the Advertisement Manager, EXPERIMENTAL WIRELESS & WIRELESS ENGINEER, Dorset House, Tudor Street, London, E.C.4.

PRESS DAY.—EXPERIMENTAL WIRELESS & WIRELESS ENGINEER is published on the first of each month, and copy for advertisements should reach the Advertisement Manager, Dorset House, Tudor Street, London, E.C.4, not later than first post on the 16th of the month preceding.

COPY FOR ADVERTISEMENTS is subject to the approval of the Proprietors, who retain the liberty to withhold any advertisement which they regard as unsuitable for publication in this journal. The Proprietors are not responsible for clerical or printers' errors, although every care is taken to avoid mistakes, nor will they accept responsibility for any blocks left in their possession for a period of more than 12 months.

ORDERS & CHEQUES should be made payable to LIFFE & SONS, LTD., and crossed "and Co." Treasury Notes, being untraceable if lost in transit, should not be sent as remittances.

ALL ADVERTISEMENTS MUST BE PREPAID.

OUR DEPOSIT SYSTEM.

We will receive from intending purchasers the purchase money of any article advertised or sold by our advertisers, and will acknowledge its receipt to both the Depositor and the Vendor, whose full names and addresses must be given. Unless otherwise arranged beforehand between the parties, it is understood that all goods are sent on approval, and that each person pays carriage one way if the goods are returned. The deposit is retained by us until we are advised of the completion of the purchase, or of the articles having been returned and accepted. In addition to the amount of the deposit, a fee of 1s. for the sum of £1 and under, and 1s. 6d. for amounts in excess of £1 to cover postage, etc., must be remitted at the same time, and sent to the Advertisement Manager, EXPERIMENTAL WIRELESS & WIRELESS ENGINEER, Dorset House, Tudor Street, London, E.C.4. In cases of persons not resident within the United Kingdom, double fees are charged.

The fee should be sent in Stamps or by Postal Order as a separate amount.

The amount of the deposit must be sent either by Postal Order or Registered Letter. (Cheques cannot be accepted.)

In cases of exchanges, money to the value of the article should be deposited by each party. We cannot receive the articles themselves.

PATENT AGENTS.

A. P. Thurston, D.Sc., M.I.A.E., F.R.Ae.S., 369, High Holborn, W.C.1.
Phone: Holborn 2542. Patents, Trade Marks, Designs. [0122]

Patents and Trade Marks—British and Foreign—Gee & Co., (H. T. P. Gee, Member R.S.G.B., and A.M.I.R.E.)—51-52, Chancery Lane, London, W.C.2.
Phone: Holborn 1525. [0139]

WANTED.

Wanted for next season suitable wireless or sound-reproducing inventions. Reply by letter in first instance giving full particulars to Box No. 1481, E.W.&W.E. [0140]

"Keeps hotter than any other"

The TRUMP
ELECTRIC SOLDERING IRON

The unique construction of the porcelain insulated slip-in element prevents fusing. Reliability and satisfaction Guaranteed. Please state voltage.

Bit projects 3 in. PRICE 22/6
Diam. only 1/2 in.
Loading 240 watts. 1/2 in. or 3/4 in. dia. bit.

ARDEA VULCANIZER SYNDICATE LTD.,
318, King Street, Hammersmith, W.6.

INDEX TO ADVERTISERS.

	PAGE
Ardea Vulcanizer Syn. Ltd.	8
British Esperanto Association	6
Cambridge Instrument Co., Ltd.	4
Budilier Condenser Co. (1925), Ltd.	7
Electradix Radios	
Ferranti, Ltd.	Cover iv
General Radio Co., Ltd.	6
Goodwins, M.A., Ltd.	6
Igranie Electric Co., Ltd.	
"Journal of Scientific Instruments"	7
Maddison, H.	6
Metro-Viek Supplies, Ltd.	
Mullard Wireless Service Co., Ltd., The	5
P.T.P. & W.N.P.A.	Cover iii
Pye, W. G., & Co.	2
Sifam Electrical Instrument Co., The	7
Trelleborgs Ebonite Works, Ltd.	6
Vandervell, C. A., & Co., Ltd.	1
Varley Magnet Co., The	8
Weston Electrical Instrument Co., Ltd.	2
Wilkins & Wright, Ltd.	

Kindly mention "Experimental Wireless" when replying to advertisers.

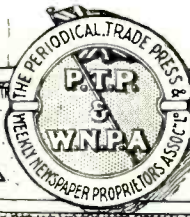

THE DOOR TO MANY TRADES

These journals will open up to you the possibilities of any of the industries they represent. They will put you in direct contact with current trade problems and developments and will assist you successfully to market your products economically and effectively with a minimum of effort.

VALUABLE
TRADE NEWS

ADVICE ON
MARKETING
PROBLEMS

BEST SOURCES
OF SUPPLIES

EXPERT
INFORMATION

ASSISTANCE
IN SALES
DEVELOPMENT

BUSINESS
IDEAS

Amateur Photographer.
Architects' Journal.
Architectural Review.
Art Trade Journal.
Autocar.
Automobile Engineer.
Auto-Motor Journal (Yellow Cover).

Bakers' & Confectioners' National Association Review.
Brewing Trade Review.
British & South African Export Gazette.
British Baker.
British Engineers' Export Journal.
British Export Gazette.
British Journal of Photography.
British Printer.
British Trade Journal.
British Trade Review.
Broadcaster & Wireless Retailer.

Caterer, Hotel Keeper & Restaurateurs' Gazette.
Commercial Motor.
Compendium of Commerce.
Confectionery Journal.
Contractors' Record.

Dairyman.
Electrical Industries & Investments.
Electrical Review.
Electrical Times.
Electricity.
Electrics.
Electric Vehicle.
Electro-Farming—including Agricultural Machinery.

Empire Commercial Guide.
Empire Mail & Overseas Trade.

Engineering & Boiler House Review.
Experimental Wireless.
Export Trader.

Fancy Goods Record.
Fertiliser, Feeding-Stuffs & Farm Supplies Journal.
Flight.

Fruit, Flower & Vegetable Trades Journal.

Games & Toys.
Grocer & Oil Trade Review.
Grocers' Gazette.

Hardwareman & Builders' Merchant.

Ice & Cold Storage.
India-Rubber Journal.
International Patents Journal

Journal of Decorative Art.
Kinematograph Weekly.

Leather Trades' Review.
Licensing World.
Light Car & Cyclecar.
Locomotive, Railway Carriage & Wagon Review.

Mechanical World.
Miller.
Mining Journal, Railway & Commercial Gazette.

Model Engineer & Light Machinery Review.

Motor.
Motor Body Building.
Motor Cycle.
Motor Cycle & Cycle Trader.

Motor Cycling.
Motor Trader.
Motor Transport.

National Builder.
Oil & Colour Trades Journal.
Optician & Scientific Instrument Maker.
Outfitter.

Packing Gazette.
Paper Box & Bag Maker.
Paper Container.
Paper-Maker & British Paper Trade Journal.

Perfumery & Essential Oil Record.

Photographic Dealer.
Plumbing Trade Journal.
Pottery Gazette & Glass Trade Review.

Property Market Journal.

Roads & Road Construction.

Specification.
Sports Trades' Journal.
Stationery World & Paper Market.

Stone Trades Journal.
Talking Machine & Wireless Trade News.

Textile Manufacturer.
Tobacco Trade Review.

Waste Trade World.
Wine Trade Review.
Wireless Export Trader.

Wireless Trader.
Wireless World.
World's Carriers & Carrying Trades' Review.

TECHNICAL ADVICE.

Any of these journals can supply you with fullest details of the trades they serve. They offer expert and reliable technical or trade information to all their subscribers, a service which alone is worth many times the cost of the subscription.

The address of any paper in this list may be obtained from the:—

Telephone:
Central
2441

PERIODICAL, TRADE PRESS, & WEEKLY NEWSPAPER
PROPRIETORS' ASSOCIATION, LTD., 6, BOUVERIE STREET,
LONDON E.C.4.

Telegrams:
"Wenappa,
Fleet, London."

Official Handbook, giving particulars of nearly 600 papers Post free 1s.

Kindly mention "Experimental Wireless" when replying to advertisers.

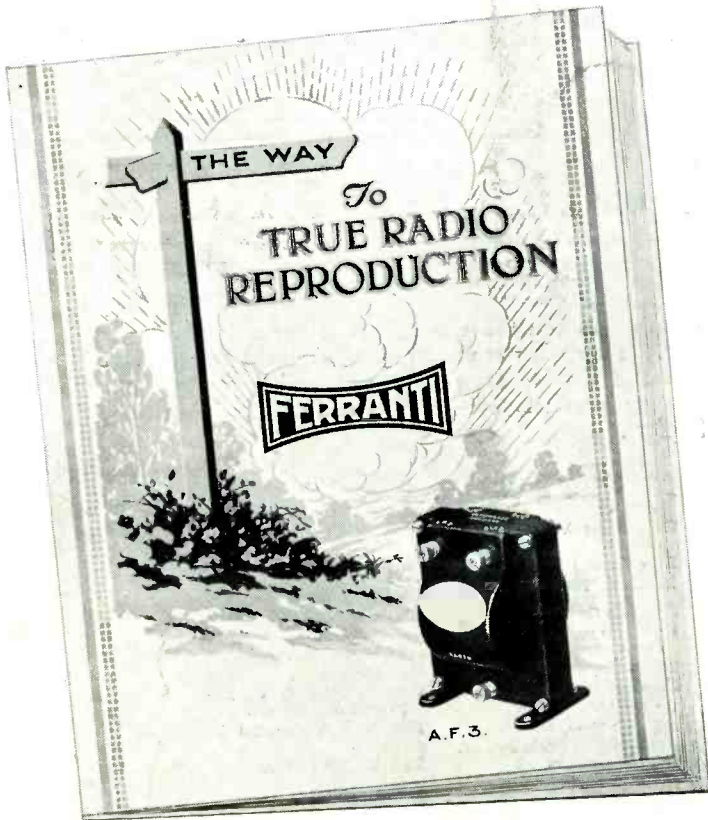

Get this
Booklet
at your
Dealer's

THE contents include hints on the construction and operation of wireless sets, notes on valves with a comprehensive list of valves recommended for each stage, and diagrams of connections for eleven different circuits.

FERRANTI

LTD.

HOLLINWOOD, LANCASHIRE

FERRANTI ELECTRIC, LIMITED.

Toronto,
Canada

FERRANTI, INCORPORATED,

140, W. 42nd Street,
New York.