

# EXPERIMENTAL WIRELESS & The WIRELESS ENGINEER

VOL. II.

JANUARY, 1925.

No. 16.

## Editorial Views.

### Appreciation.

**A**MONG our tasks this month is the pleasant one of expressing to many readers hearty thanks for very kind letters of appreciation. We feel particularly indebted to readers who have written to signify their approval of our series on the B.S. Dewey extension for classifying wireless matters, and of our Esperanto grammar.

We are particularly glad to receive these letters because (to be perfectly frank) it was with a certain diffidence that we introduced these subjects. For our own part, we were quite convinced of their value; but we were uncertain whether our readers would appreciate articles not dealing directly with wireless technical matters.

However, there is no doubt that these innovations are popular, and we shall see that they are kept in view in future issues. The Dewey extension, of course, will not be complete for a few months yet; and as regards Esperanto we have plans to continue our journal's usefulness to those readers interested. In this issue we publish an English-Esperanto dictionary of wireless technical terms, and before long we hope to publish its natural supplement, an Esperanto-English dictionary.

Last, but not least, we have to thank some readers who, in their close study of E.W. & W.E., have come across errors, and have pointed them out to us. In spite of the utmost care, it seems almost impossible to avoid these from time to time. Even the most skilled compositors are not necessarily skilled mathematicians nor wireless experts, and it only takes a very small accident (from

the printing point of view) to make a large error in mathematical work.

Such accidents occur in most journalistic work, and in many cases are discreetly ignored. But in a journal of our standing it is, we feel, of importance that they should be corrected, and we are always grateful to correspondents who point them out.

### Crystals.

As indicated in this page of our last issue, we have now tested out some crystals on the new lines then suggested, and the results will be found further on. As those of our readers who have not had experience of quantitative work may be interested to have some idea of what it involves, we have also included in this issue a fairly full description of how the preliminary work was carried through and what it meant.

It must be realised, of course, that the tests which we report cannot claim to be a final verdict on the merits of these crystals. Firstly, individual samples of the same crystal vary enormously; and secondly, individual points on the same sample sometimes vary equally widely. Conditions of time available limit us to testing a few points on one sample, and we are unable to state that these points necessarily give a fair average indication.

Thirdly, there is the question as to whether the method, as a whole, is a sound one giving a valid result! Our own opinion, naturally, is that the method is sound, or we should not have adopted it. But there are very many points to be considered in measurements of this kind, and we quite expect to

receive some criticism of the method—in fact we hope for it if it is constructive.

One critic, whose opinions we value highly, and whose hitherto unpublished work on crystals is of quite exceptional value, has written: “. . . I think you are tackling a rather desperate proposition. . . . So do we! But it will not be the first we have tried, and we hope not the last.

On the other hand, there may be many readers who will take up the attitude of another friendly critic: “Why all this fuss about crystals? They’re dying fast, anyway!” (It might be noted that this friend is connected with the manufacture of valves.) This raises a point of fundamental importance. It is true that much of the amateur work of to-day—the serious long-distance amateur work—is done on valve detectors. But there is an increasing proportion of those whose experiments lie in the direction of the distortionless reception of telephony, and for this purpose the crystal has important advantages. Again, there are those of our readers who are engineers practically engaged in the design of broadcast sets: and the crystal is of undoubted importance here. In our opinion there is only one cause which may cause a drop in the use of crystals: high price owing to scarcity!

#### Receiving Aerials.

Our readers will undoubtedly be greatly interested in the description by Dr. Smith-Rose and Mr. Colebrook of their experiments on P.M.G. aerials, earths, and counterpoises, at Teddington. For a personal reason we are glad to note therein some remarks as to the extreme difficulty in mathematical analysis of the conditions in a receiving aerial—for we have tried it and given it up in despair. Apart from this, there are three most interesting conclusions: the suggestion—it is only put forward as such—that there may be an optimum height for a P.M.G. aerial, and that a 100 ft. vertical

one is not necessarily the best; the great advantage of a counterpoise for reception; and the fact that a quite efficient counterpoise can be erected under “garden” conditions.

#### Measurement.

Two articles in this issue are devoted to means of getting the greatest amount of work out of measuring instruments. This is, we consider, a very important subject, for it is an unfortunate fact that such instruments are usually expensive.

We forget who was the great scientist who stated, “He discovers who measures.” But he must have been one of the very greatest. It is more and more evident as time goes on that progress in science is essentially a matter of measurement. It is not until we have accurate quantitative data on any subject that we can check our hypotheses and proceed to deeper investigation. As a classical modern example we have the work of Einstein—entirely based on the apparently contradictory results of a measurement of great difficulty, and so far-reaching in its results as to be likely to alter our whole point of view in looking at fundamentals, although it may not directly affect everyday life.

There is a natural disposition in amateur or “hobby” work of any kind to go out after spectacular results. But, interesting and useful as such work is, we doubt whether its result as regards general progress is any more important than the sometimes laborious job of delving after exact quantitative data. It is delightful to get loud-speaker results all over the house, and dull to try and measure the actual power in the loud-speaker. But sometimes the latter is the more important task.

For this reason we have always given freely of our space to matter connected with measurement, and articles showing how measurement can be done at moderate financial cost are especially valuable.

# The Arrangement of Wireless Books and Information.

## Part IV: R300—Apparatus and Equipment.

[R025·4

This month we come to R300, the division dealing with Apparatus and Equipment generally. This has been a difficult section. There is no doubt that at the moment America as a whole and England as a whole are approaching the problems of wireless from rather different angles. They are investigating problems that we are leaving alone, and *vice versa*. The natural result is that certain branches of the subject, of great interest to us, are dismissed rather lightly in the B.S. extension, while others are dealt with perhaps more fully than we should have handled them.

In re-writing this section, therefore, we have extended some parts considerably.

### R300 Apparatus and Equipment.

For matters of theory, reference should be made to R100, while descriptions of operation, and certain other aspects, will be found under R400, Systems.

Under the "general" heading, R300 to R309, will come, as usual, such matters as are conveniently dealt with under the "form" division (see E.W. & W.E., Oct., p. 760). The heading R310 is also left blank.

- R320 Aerial design and construction.
- In the B.S. Extension, two headings are given under R320, viz.:—  
*R320·6 Aerial switches.*  
*R320·8 Masts.*
- For the same reasons as indicated in dealing with R201 last month (E.W. & W.E., p. 131)—possibility of confusion with the form division—we suggest that these numbers be allowed to drop, and we have found room elsewhere for such items.
- R321 Ordinary elevated aerials.  
 \*R321·8 Masts and towers.  
 \*R321·9 Ammeters, switchgear, protective devices, etc.
- R323 Earth aerials (*i.e.*, lying on ground) and underground aerials (see also R536, Mining, in connection with the latter). The beverage aerial is dealt with here.
- R324 Frame aerials.  
 R325 Directional aerials generally.  
 R325·1 D.F. aerials for reception—Bellini-Tosi, Robinson, and frames designed for this purpose.  
 ·6 "Directive" aerials, *i.e.*, those designed for directed transmission, excepting Beam systems, which will be found under R329.
- R326 Earths and earth connections, including counterpoise design.  
 \*R326·5 counterpoises.
- R327 Artificial aerials.  
 R328 Multiple-tuned aerials.  
 R329 Other special aerials.  
 \*R329·1 Beam systems.
- R330 Thermionic Valves: design and construction. (For theory, see R130.)
- This section deals with the valve itself. For valve sets and circuits, and the *use* of valves generally, see R340.
- \*R330·04 The design of valves. Effect of constructional design on performance, etc.
- R331 Manufacture of valves.  
 \*R331·1 Construction of electrodes, and metal-work generally.

\* These subdivisions are proposed by us as a tentative further extension.

- \* .2 Filament manufacture, including thoriating, coating, etc.
- \* .3 Bulb and foot work, and glass work generally.
- \* .4 Assembly, sealing, etc.
- \* .5 Evacuation: for pumps, etc., see under R800; 533-85, Vacuum apparatus.
- \* .51 Bombardment and similar processes.
- \* .52 "Getters": phosphorus, magnesium, and similar devices.
- R332 Two-electrode valves.
- R333 Three-electrode valves.
- R334 Four-electrode valves.
- \*R335 "Soft" valves of ordinary types.
- \*R336 Thermionic valves working on special principles, differing from the normal, *e.g.*, Magnetron, Dynatron, Sodian, etc. Note that Neon tubes, "S"-tubes, etc., are hardly thermionic valves. They should really go under R800, at 621-327; but it seems more convenient to find room for them here, so we suggest doing so as in the next class.
- \*R337 Special valve-like devices, not depending essentially on thermionic electron emission, *e.g.*, Neon tubes, "S"-tubes. We propose to assign the Mercury Arc to this class on the ground of convenience, although it is an open question whether it should not logically be placed under R332.

### R340 Valve apparatus and circuits.

In this class, we only deal with those parts of the apparatus actually and intimately concerned with the valve. The following sections (R350-380) deal with other parts of such installations.

- R341 Devices using the valve as a rectifier.
  - \*R341-1 Detectors. (For theory see R134.)
  - \*R341-6 Rectifiers for supply purposes. (For theory, see R140. See also R355, where devices using such valves are discussed.)
- R342 Valve amplifiers. (For theory, see R132.)
  - R342-1-3 Couplings.
    - R342-1 Inductive coupling generally.
    - \* .11 Choke coupling.
    - .15 Transformer coupling.
  - R342-2 Resistance coupling.
  - .3 Capacity coupling.
  - R342-4-7 Types of amplifier.
    - .4 Reflex amplifiers.
    - .5 Power amplifiers.
    - .6 Radio-frequency amplifiers (including "intermediate" amplifiers for supersonic sets).
    - .7 Audio-frequency amplifiers.
- R343 Valve receiving sets.
 

This heading is specially suited to special sets in which the distinguishing features cannot be separated into "detector," "amplifier," etc.

  - \*R343-4 Superregenerators. (For theory, see R134-45.)
  - .5 Heterodyne sets. (For theory, see R134-7.)
  - \* .6 Supersonic sets. (For theory, see R134-75.)
  - .7 Sets using A.C. supply.
- R344 Valve generators. (For theory, see R133.)
  - \*R344-1 Audio-frequency oscillators.
  - \* .2 Radio-frequency oscillators of simple type. (For accurate wave-meters, see R210.)
  - .3 Transmitting sets.
  - .4 Extra short-wave oscillators.
  - .5 Oscillators for A.C. supply.
  - .6 High-power valve generators.
  - .7 Multivibrators and similar instruments.
- R345 Modulators. (For theory, and different systems of modulation, see R135.)
- R346 Complete telephony sets.
- R348 Uses of valves in wire systems (telephone repeaters, etc.), and other devices.

\* These subdivisions are proposed by us as a tentative further extension.

- R350 Transmitting apparatus, apart from valves and valve circuits.  
(For theory, see R150.)
- In many cases information on these subjects will go more conveniently under R400. Generally, details of apparatus and components will go here, the functioning of the whole installation under R400, and its theory under R150.
- R351 Simple Oscillators, including oscillating crystals. Such crystals, of the American quartz type, are also dealt with under R800: 537-65, Piezo-Electric Phenomena.
- R352 Spark gaps. (See also R152 and R411.)
- R352·2 Quenched gaps.  
·4 Synchronous rotary gaps.  
·6 Asynchronous gaps.  
·8 Timed spark gaps for C.W. (See also R424.)
- R353 Arcs. (See also R153 and R422.)
- R354 H.F. Alternators. (See also R154 and R421.)  
When dealing with Goldschmidt alternators note also R357.
- R355 High-voltage generators.  
Details of such apparatus really form a well-known part of electrical engineering, and might accordingly be placed under R800: 621-313. But as they are of considerable importance, and special work has been done in providing high direct voltage for wireless purposes, we have inserted an extension.
- \*R355·1 Simple D.C. generators.  
\* ·2 D.C. to D.C. converters and motor-generators.  
\* ·3 A.C. to D.C. converters.  
\* ·4 Systems utilising A.C.  
\* ·41 Alternators.  
\* ·42 D.C. to A.C. rotary converters and motor-generators.  
\* ·43 Make-and-break systems for converting to A.C., including rotary commutators.  
\* ·5 Re-conversion to D.C.  
This is, of course, rectification, and is also dealt with elsewhere. See especially R341·6.  
\* ·51 Synchronous commutators.  
\* ·52 Arc rectifiers.  
\* ·54 Electrolytic rectifiers.  
\* ·55 Rectifiers using valves.
- R356 Transformers (power).  
Interval and radio-frequency transformers are dealt with elsewhere.
- R356·5 Induction coils.
- R357 Frequency transformers.
- R358 Protective devices.
- R359 Automatic transmitters.
- R360 Receiving sets, complete.  
This should be kept for descriptions, etc., of complete sets: details of apparatus will be found under R370.
- R370 Receiving apparatus, apart from the valve circuits. (For theory, see R160.)  
See also the note under R350 above, with regard to entries under R400.
- R373 Amplifiers.  
R373·1 The magnetic amplifier.  
·2 Microphone amplifiers.
- R374 Crystal Detectors. Note that oscillating crystals are dealt with under R351.  
R374·1 Theory of action. This applies to such questions as: why crystals rectify? The theory of the action of rectifiers in a circuit is covered under R149.  
R374·2 Crystals in practice; notes on use and so forth.  
R374·3 Balanced crystal circuits.  
\*R374·4 Other unusual crystal circuits.

\* These subdivisions are proposed by us as a tentative further extension.



- \*R374.5 Details of various types of crystal: galena, carborundum, etc.
- R375 Miscellaneous detectors.
- R375.1 The magnetic detector.
- .2 Coherers.
- .3 Electrolytic detectors.
- R376 Telephones (including loud-speakers).
- R376.3 Loud-speakers.
- R377 Recording devices.
- R377.1 Photographic recorders.
- .2 The jet relay.
- .3 Electro-magnetic recorders.
- .4 The Telegraphone.
- .5 Phonograph recording.
- .6 Automatic printers.
- R378 Audibility meters.
- R380 Parts of circuits, components, etc.
- It should be noted that the vacant numbers towards the end of this section must be kept more or less open for new devices as they come to light.
- R381 Condensers. Precision condensers will be found under R228, standards.
- \*R381.1 Qualities of a condenser: power factor, constancy, strength, etc.
- \* .2 Fixed condensers.
- \* .3 Variable condensers, interleaved semi-circular type.
- \* .4 Interleaved variable condensers with special shaped plates.
- \* .5 Other types of variable condenser.
- R382 Inductors.
- We have adopted the word used in the B.S. extension—a far better word than "inductance" to describe an actual component.
- \*R382.1 Qualities of an inductor: power factor, constancy, strength, etc.
- \* .2 Single-layer coils.
- \* .3 Pile-wound coils.
- .4 Open-wound coils (honeycomb, Morecroft, etc.).
- .5 Couplers, H.F. transformers, etc.
- \* .7 Variometers.
- \* .8 Tappings, dead-end switches, etc.
- R383 Resistors.
- (See note to "Inductors" above *re* use of word.)
- R383.1 Grid-leaks.
- \* .2 Anode resistances.
- \* .3 Filament Rheostats.
- \* .4 Special materials (other than wire), for resistance manufacture.
- R384 Special meters.
- Meters generally are covered under R200, but as that section is devoted largely to *methods* of measurement, room is also found here for description of complete instruments as components or accessories.
- R384.1 Wave-meters.
- .3 Frequency-meters.
- .5 Decremeters.
- \* .6 Ammeters.
- \* .7 Voltmeters.
- R385 Modulating devices, including keys, etc.
- R385.1 Keys.
- .2 Buzzers.
- .3 Rotary interrupters.
- .5 Microphones.
- \* .51 Carbon microphones.
- \* .52 Magnetophone types.
- \* .53 Condenser types.
- \* .54 Jet and similar types for high current.
- R386 Filters.
- R387 Sundries.
- R387.1 Shields.
- .5 Earthing of apparatus.
- .7 Insulators.
- R388 Oseillographs.

\* These subdivisions are proposed by us as a tentative further extension.

# The Inter-Electrode Capacities of a Valve.

By *H. J. Barton Chapple, Wh.Sch., B.Sc. (Hons.), A.C.G.I., D.I.C., A.M.I.E.E.*

[R131

This article deals with a subject of great importance to all research Workers.

THE inter-electrode capacities in a thermionic valve often have considerable influence on the design of accurate receiving and transmitting sets on short waves, while for quantitative measurements at high frequencies a knowledge of these values becomes imperative. Again, the capacities in the valve holder itself often account for peculiar results, and this matter calls for great care in the design of a good holder with highly efficient insulating material in order to obviate the possibility of a low resistance leakage path. In many receiving sets signals are obtained when the grid-leak is absent, and this is often accounted for by the fact that a leakage path for the electrons is provided in the holder itself between A and B, Fig. 1, so that R is unnecessary. Measurements have been made by the writer where the resistance between A and B has only been of the order of two or three megohms, from which obvious conclusions may be drawn. Other cases will no doubt suggest themselves to the reader.

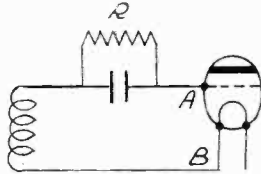

Fig. 1.

Using a simple capacity resistance bridge to balance out the quantities in question,

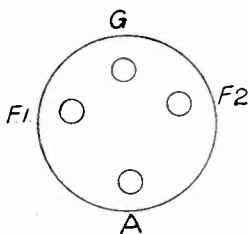

Fig. 2.

varying results were secured. With valve holders of reputed make, however, the resistance previously mentioned was of a very high order, above 20 megohms, but the capacities were quite appreciable. Referring

to Fig. 2, which shows a plan of the holder, the following average results were obtained.

Between A & F <sub>1</sub>	Capacity =	34 μμF
" A & F <sub>2</sub>	" =	34 "
" G & F <sub>1</sub>	" =	35 "
" G & F <sub>2</sub>	" =	35 "
" A & G	" =	30 "

Upon inserting an ordinary R type thermionic valve into the sockets and repeating the measurements, average inter electrode capacities were found to be, after subtracting the capacity due to the holder :—

Between A & F <sub>1</sub>	Capacity =	9 μμF
" A & F <sub>2</sub>	" =	6 "
" G & F <sub>1</sub>	" =	8 "
" G & F <sub>2</sub>	" =	9 "
" A & G	" =	10 "

The total capacities of holder and thermionic valve, therefore, should be borne in mind when making such calculations for wireless circuits as indicated by P. K. Turner in the November issue of E.W. & W.E.

To ascertain what modification was introduced by employing a low capacity type valve, viz. :—Marconi's V24, new measurements were made with a good quality holder—Fig. 3.

The capacities found were :—

Between A & F <sub>1</sub>	Capacity =	21 μμF
" A & F <sub>2</sub>	" =	23 "
" G & F <sub>1</sub>	" =	21 "
" G & F <sub>2</sub>	" =	23 "
" A & G	" =	23 "

For the valve alone the only capacity that could be detected was that between A & G, of 3 μμF, so that the advantage of this type is readily appreciated.

In an ordinary valve the capacities are due mainly to the manner in which the connections are brought out at the "pinch." Complications are possible owing to F<sub>1</sub> and F<sub>2</sub> being joined by a low resistance path when the valve is inserted, thus giving parallel capacities.

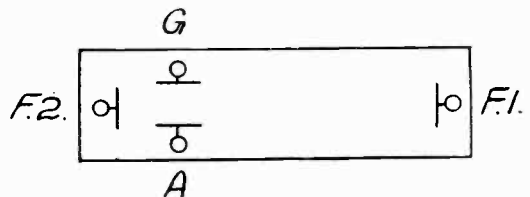

Fig. 3.

## A Test for Crystals.

[R374]

We have given rather full details of the work of devising and carrying out this test, as we think readers may be surprised at the large amount of time and labour required for what seems at first a very simple business.

**F**OR many months now we have been faced with the problem of finding a fair test for the comparative merits of crystals—and a very difficult problem it is; even now our solution is only a rough and ready one.

It was obvious from the first that the simple method of putting the crystal in circuit and listening, or even measuring the output, was unfair; for firstly it indicates rather whether the crystal suits the circuit than whether it is a good one; and secondly there is no guarantee that the incoming signal will always be of the same strength.

For some time we have used a method, based on direct current characteristics, by which we found the proportion between the currents in the two directions at various voltages. But while this gave a certain amount of information it was far from satisfactory. Many samples of galena gave extraordinarily good results in this way. A ratio of 2000 to 1 between the two currents was found once or twice, and 500 to 1 was common. Thus, as far as reverse current is concerned, we may consider picked galena practically perfect, and we decided to find a method which would test other characteristics as well.

We considered the idea of applying a measured H.F. current, and noting the D.C. current given out. But further consideration showed that this was hardly a fair test; for a high-resistance crystal would absorb more power than a low for the same input current, and would hence be favoured by the test.

Finally, we decided on applying measured H.F. power, finding the output power, and rating the crystal on its actual efficiency.

It was thought that there might be some constants for each crystal which would give a complete guide to its quality. But some confidential results which have come into our hands indicate that the problems of naming such constants, and of finding them in practice, are so excessively difficult as

to be impracticable for our purpose, which necessitates a reasonably quick test. The same results showed quite clearly that the behaviour of a crystal depends very largely on the "output load"—the resistance of telephones, etc., across it; so that really every crystal should be tested, not only with varying applied voltage, but with varying load.

Now (as will be explained later) the actual test is not an absolutely simple matter. To test out a crystal on the lines indicated above would involve a trial at say five voltages, each with five loads, or 25 tests for each point; and as one must try at least five points the work would be impossibly heavy.

It must also be realised that, strictly speaking, the efficiency of a crystal in giving large D.C. output from steady H.F. is *not* the same as its efficiency in giving audio-frequency output from modulated input. But without the resources of a full-blown laboratory the latter test is quite impossible; it needs an instrument to measure less than one microamp of current at audio-frequency, among other things. Actually, good D.C. and audio-frequency efficiency are usually found together, so that the former is at any rate an indication of the latter.

So we have compromised as follows. A fixed load of 10 000 ohms is used, roughly corresponding to the impedance of ordinary high resistance 'phones. Five different points, taken as they come, are tested at an applied voltage of 5. Another point, of good quality as compared with the average of the five, is tested at various voltages varying from 0.1 to 1 volt. All the work is done at one wave-length of 377 metres, or 795 000 cycles—this wave is chosen as it gives  $\omega$ , or  $2\pi \times$  frequency, equal to  $5 \times 10^8$ .

### Some Preliminary Tasks.

As we have indicated, the test is simply to measure the input and output power. We wonder whether all our readers, especially the less technical, realise quite what that has involved!



The output power is easy. The load resistance is known, and the current can be measured. The calculation is too simple to be transferred to the Appendix at the end: it is simply (calling  $P_0$  the output power)

$$P_0 = I_d^2 R_l,$$

where  $I_d$  is the steady detector current and  $R_l$  the load resistance.

The input power is a far more tricky problem. The trouble is that the detector must be tested at an input voltage such as is likely to be applied to it in service, otherwise the results are useless. In practice this means a voltage of 1 to 1 volt. But at these voltages the crystal appears (as we shall show) to have a resistance of 5 000 ohms or so, which obviously means that we must measure a current of 20 microamps at radio-frequency. This cannot be done with any reasonably robust and cheap instruments. So we gave up all idea of measuring the actual crystal current, and fell back on another method. This was to find the "equivalent series resistance" of the detector when across a given tuned circuit, from which the power is easily found.

The general idea of this method is easily explained. The fundamental circuit is shown in Fig. 1. Here the source sets up an H.F. voltage in  $L$ , and a current flows through  $L$  and  $C$ , also through  $R_0$ , which represents the resistance of the coil. If now the coupling and source are unaltered, the actual E.M.F. induced is constant.

As the circuit is tuned the reactances of  $L$  and  $C$  cancel one another, and the current depends only on the resistance. If now we insert a resistance  $R_a$  the current will decrease, and it can easily be shown that if instead we close the switch  $B$ , placing the resistance  $S$  across the condenser, the current will again decrease. This seems contradictory at first, but is none the less true, the reason being that the flow of current through  $S$  means a loss of power, which naturally diminishes the current: if there were no resistance at all in any part of the circuit, there would be no power loss, and no limit to the current in it.

Since either a series or a shunt resistance, or in fact any source of power loss, causes a drop in current, one can find a series resistance which would give the same drop of current as any power loss, and this is its "equivalent series resistance." Its value depends not

only on how big is the source of loss, but also on the frequency.

Summing up the last few paragraphs, the detector absorbs power from the circuit, and hence causes a drop in the current from which, if the circuit resistance is known, the input power can be calculated. The details of calculation are given in the appendix.

In actual practice, bearing in mind that the voltage is to be 1 to 1 across the circuit, and that the usual sizes of condenser  $C$  have a reactance of some hundreds of ohms at 377 metres, the current in the oscillating circuit, though much larger than that through the detector itself, will still be only a milliamp or less, and this is not too easy to measure. So instead we decided to

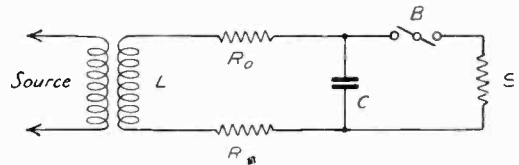

Fig. 1.

measure the voltage itself, which is just as useful if the capacity of the condenser is known accurately.

Thus we have now converted our problem to that of measuring voltages of say 1 to 1 volt at radio-frequency. Luckily, the Moullin voltmeter enables us to do this easily.

#### The Moullin Voltmeter.

This simple device was described quite recently in our pages,\* but for those who missed this article one need only explain that it is simply a calibrated valve detector. Two types may be used. The more sensitive has a leak and grid condenser, but has the disadvantage of putting a quite measurable load or power loss in the circuit. The other or "anode" type uses (as its name indicates) anode rectification, and if proper grid bias is used takes so little power as to be negligible. It is, however, less sensitive. Our own gives reliable readings from about 0.3 to 3.6 volts, and by a simple trick we used it to measure voltages as low as 0.1 applied to the detector.

But before going into this, we will describe the calibration of the Moullin, as it had to

\* G. W. Sutton, B.Sc. "Some Measurements on a Broadcast Receiver." *E.W. & W.E.*, Nov., 1924.

be done before the tests could be commenced. Incidentally, the calibration of the Moullin itself involved a previous job, so we will take that first: it was the fairly simple one of calibrating a sensitive thermo-junction.

#### Calibrating the H.F. Milliammeter.

This was done on direct current. A dry cell, a high variable resistance (2 000 ohms max.), a D.C. milliammeter, and the thermo-junction were connected in series, with a Paul Unipivot microammeter across the junction. Actually, a reversing switch was inserted, as sometimes a thermo-junction gives different readings when the same current goes through it in opposite directions, in which case the average reading is the correct one. The circuit was that of Fig. 2.

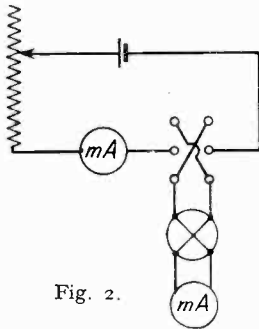

Fig. 2.

The resistance was adjusted so that the milliammeter read each half-milliamper from 1 to 9, at which latter figure the microammeter was full over. At each value the reversing switch was thrown over. The whole was repeated thrice, with extra checks at low currents, and careful note taken of all readings. A curve was then drawn giving actual mA for all microammeter readings. The inductance and capacity of the junction is so low that the calibration can probably be considered accurate to 1 per cent. even at radio-frequencies, if the rest of the circuit is handled skilfully as regards screening, etc. But for the particular job of calibrating the Moullin we only wanted 100 cycles or so.

#### An Audio-Frequency Source.

The next task was to produce this. Luckily, it did not involve much work. We had a simple separate heterodyne, using spare plug-in transformers from our set, as its coils. We also use the same type of 4-pin socket for our L.F. transformers; and on plugging one in, with a condenser of .001

across the secondary, at once got somewhere about 75 cycles. The oscillator has the plate circuit broken for an output coil, but as it only uses one Wecovalve the output was not enough. But we connected it to a two-stage L.F. amplifier (one D.E.5 and one L.S.5) which gave plenty.

#### Calibrating the Moullin.

The output was connected as in Fig. 3. A telephone transformer stepped down to get fairly large current, which was applied to a rheostat R (20 ohms by 1 ohm steps) and another B, which was actually a Post Office Bridge, using the low resistance coils (20 ohms by 1 ohm). These resistances are not, of course, absolutely pure resistance: they have small inductance and capacity; but at 75 to 100 cycles this is negligible. The two were adjusted by steps, keeping the sum constant. This kept a constant load and steady current in the thermo-junction, and the current shown, multiplied by each value of the resistance B, gave the actual voltage on the Moullin corresponding to the deflection in the plate circuit galvo (a Paul Unipivot). Actually, the same instrument was switched from one position to the other. With a Mullard D.F. Ora valve, and the plate and grid voltages shown, about 2.6 volts on the filament gave  $10\mu\text{A}$  plate current, which was adopted as the zero value.

#### The Detector Test Circuit.

At last we were ready to think about

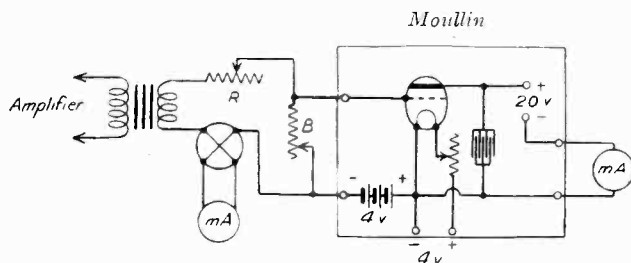

Fig. 3.

detector tests, and after some preliminary experiments we set up the circuit shown in Fig. 4. Various points call for notice. The coil is in two parts, of 40 and 80  $\mu\text{H}$ , and by means of switch A the crystal can be cut out altogether, or put across either all or one-third of the total inductance. The voltmeter is always across the whole.

In this way one can get a step-down, the minimum measurable voltage of .3 volt across the whole giving .1 volt across the

This is repeated for five consecutive points taken just as they come. Then another good point is found and tested not only at .5 volt, but at 1, .7, .5, .3, .2 and .1 volts.

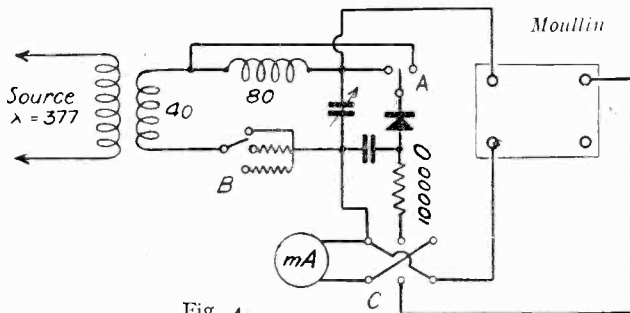

Fig. 4.

crystal circuit. Switch B cuts out or inserts a resistance in the oscillating circuit. This is necessary to find the circuit's own resistance, and is also useful for some crystals. The resistances are 42 Eureka, straight, so as to be of practically the same resistance at H.F. as for D.C., on which they were measured. Switch C was made necessary by the fact that only the one microammeter is at present available to measure both crystal current and the plate current of the voltmeter.

**The Procedure.**

One begins operations by finding the resistance of the oscillating circuit. The crystal is switched out, the voltmeter put on, and the circuit accurately tuned; and the source adjusted to give a full deflection with no resistance at B. When a resistance is inserted here, the voltage falls off, as already explained. If the circuit were already of fairly high resistance an ohm or two at B would make little difference; but if it is of low resistance the same "ohm or two" will cause a large drop. Hence the voltages with and without resistance enable one to calculate the circuit resistance (see Appendix).

Next the crystal is switched in and the tuning adjusted. The coupling to the source is adjusted to give .5 volt on the crystal, and the crystal current read. Without altering the source, the crystal is switched out, the circuit re-tuned, and the voltage noted. The change of voltage between "crystal in" and "crystal out" gives the key to the input power; the crystal current itself, flowing through the 10 000 ohms load, represents the output power.

It may be stated at once that it is extremely tricky to get really close results, even more so than is always the case in high-frequency resistance measurements. Outside of a high-class laboratory, an accuracy of 10 per cent. is probably about what one can get. But as will be seen from the results, this is much better than nothing. In addition to the actual efficiency, it is useful

to have an idea of the high-frequency resistance of the crystal, for a crystal of low input resistance may, even if very efficient, be undesirable, as it damps the receiving circuit heavily, and may give unduly flat tuning. The method of calculating this is also shown in the Appendix.

**APPENDIX.**

**High-Frequency Resistance Measurement.**

In the circuit of Fig. 5, if the source is supplying power at a frequency *f*, and  $\omega = 2\pi f$  as usual, then *E*, the induced E.M.F. in *L*, is

$$E = j\omega M I_1 \dots \dots (1)$$

and if *M* and *I*<sub>1</sub> are maintained constant during a test, *E* is constant.

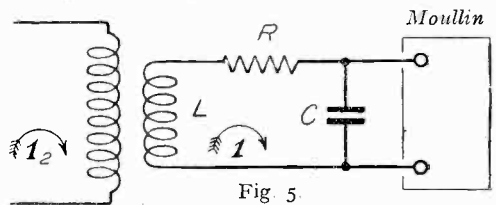

Fig. 5.

If the circuit is tuned

$$I = \frac{E}{R} \dots \dots (2)$$

If *E*<sub>m</sub> is the voltage at the meter,

$$E_m = \frac{I}{j\omega C} = \frac{E}{j\omega CR} \dots \dots (3)$$

Hence  $R = \frac{E}{j\omega C} \frac{I}{E_m} = A \frac{I}{E_m} \dots \dots (4)$   
 where *A* is constant.

Now *R* may be the resistance of the circuit itself (*R*<sub>0</sub>) or may contain an added resistance. If we take two measurements, one with *R*<sub>0</sub> only, and one with a known *R*<sub>1</sub> in addition, we have

$$R_0 = \frac{A}{E_0} \dots \dots (5)$$

$$R_0 + R_1 = \frac{A}{E_1} \dots \dots (6)$$

Substituting from (5) in (6)

$$R_1 + \frac{A}{E_0} = \frac{A}{E_1} \quad \dots \quad (7)$$

$$R_1 = A \left( \frac{1}{E_1} - \frac{1}{E_0} \right) \quad \dots \quad (8)$$

$$A = \frac{R_1 E_1 E_0}{E_0 - E_1} \quad \dots \quad (9)$$

inserting this in (5)

$$R_0 = \frac{A}{E_0} = \frac{E_1}{E_0 - E_1} R_1 \dots \quad (10)$$

In practice, one reads with several values of  $R_1$ , and the tabular calculation for a typical case is shown in the following table:—

RESISTANCE OF CIRCUIT.  
(35-TURN COIL, CONDENSER AND WIRING.)

$R_1$	$E_1$	$\frac{I}{E}$	diff. $\frac{I}{E}$	diff. $R_1$	diff. $R_1$ diff. $1/E$	av. $A$ $\frac{E}{R_0 + R_1}$	$R_0$
0	3.60	.278				3.08	3.08
.59	3.06	.327	.049	.59	12.0	3.62	3.03
1.74	2.28	.439	.112	1.15	10.25	4.87	3.13
6.00	1.21	.826	.387	4.26	11.0	9.16	3.16
					av. $A$ 11.08		av. $R_0$ 3.10

This may be called an excellent result, as it can easily be proved, from the amount of variation in the various values for  $R_0$ , that the probable error of the average, 3.10, is  $\pm .02$ , so that the proportionate error is .65 of 1 per cent.

**Detector Efficiency.**

The first matter, the effective resistance thrown into the circuit by putting the detector across it, is got by a simple transposition of equation (10) above; for  $R_0$  is supposed to have been found, and we want  $R_1$ , or  $R_a$  as we shall call it.

We already have  $R_0 = \frac{E_1}{E_0 - E_1} R_1 \dots \quad (10)$

so  $R_a = \frac{E_0 - E_1}{E_1} R_0 \dots \quad (11)$

Now if  $P_1$  = input power,

$$P_1 = R_a I^2 \dots \quad (12)$$

but, from equation (3)

$$I = f \omega C E_m \dots \quad (13)$$

we may drop the  $f$ , as no question of phase arises, so

$$P_1 = R_a (\omega C E_m)^2 \dots \quad (14)$$

also, if  $P_0$  is output power,

$$P_0 = I_d^2 R_d \dots \quad (15)$$

and  $\eta$  = efficiency =  $\frac{P_0}{P_1} \dots \quad (16)$

Lastly, a resistance  $R_a$ , in series with a condenser C or inductance L, is equivalent to a resistance S across it, for a frequency  $f$  ( $\omega = 2\pi f$ ), when

$$S = \frac{1}{(\omega C)^2 R_a} \text{ or } = \frac{(\omega L)^2}{R_a} \dots \quad (17)$$

provided that  $R_a$  is small compared with  $\frac{1}{\omega C}$  or  $\omega L$ .

The following is a typical calculation; in actual practice, of course, it would form one table.

The value of  $\omega$  was  $5 \times 10^6$ , and the resistance of circuit itself 6.5 ohms. Capacity of tuning condenser .0004,

$$\text{so that } \omega C = \frac{1}{500} = 2 \times 10^{-3}.$$

With detector across both coils,  $E_m$  is adjusted to 1.  $I_d$  found to be  $85 \mu A$ .  $E_0$  (*i.e.*, voltage on switching out detector and retuning) 2.35. To keep  $E_0$  down, both tests were made with 26.3 extra ohms in circuit, giving 32.8 in all.

$$E_0 - E_m = 1.35$$

$$\frac{E_0 - E_m}{E_m} = 1.35$$

$$R_a = 1.35 R_0 = 1.35 \times 32.8 = 44.2$$

$$\omega C E_m = 2 \times 10^{-3}$$

$$(\omega C E_m)^2 = 4 \times 10^{-6}$$

$$P_1 = 44.2 \times 4 \times 10^{-6} = 1.77 \times 10^{-6}$$

$$R_d = 10\ 000 = 10^4$$

$$I_d = 85 \mu A = 8.5 \times 10^{-5}$$

$$P_0 = I_d^2 R_d = 72.2 \times 10^{-10} \times 10^4 = 72.2 \times 10^{-6}$$

$$\eta = \frac{P_0}{P_1} = \frac{72.2}{1.77} = 40\%$$

$$S = \frac{1}{(\omega C)^2 R_a} = \frac{250\ 000}{44.2} = 5\ 650\ \Omega.$$

In the other tests the detector was across only one-third of the inductance, so that  $E_m = 3E_d$ . This only affects the calculation of S.

$E_m = 2.1$  ( $E_d = .7$ ),  $I = 50 \mu A$ ,  $E_0 = 3.33$ , circuit resistance 6.5  $\Omega$ .

$$E_0 - E_m = 1.23.$$

$$\frac{E_0 - E_m}{E_m} = .58$$

$$R_a = .58 \times 6.5 = 3.8$$

$$\omega C E_m = 2 \times 10^{-3} \times 2.1 = 4.2 \times 10^{-3}$$

$$(\omega C E_m)^2 = 17.7 \times 10^{-6}$$

$$P_1 = 3.8 \times 17.7 \times 10^{-6} = 67 \times 10^{-6}$$

$$R_d = 10\ 000$$

$$P_0 = (5 \times 10^{-5})^2 \times 10^4 = 25 \times 10^{-6}$$

$$\eta = 37\%$$

As regards S, we must remember that it is across only one-third of the total inductance. We know the total value of  $\omega L$ , because, the circuit being

tuned, it must equal  $\frac{1}{\omega C}$ ;

$$\text{so } \omega L \text{ (total)} = 500.$$

$\omega L_d = \frac{500}{3}$  where  $L_d$  is that part across the detector,

$$\text{hence } S = \frac{(\omega L)^2}{R_a} = \frac{250\ 000}{9 \times 3.8} = 7\ 300\ \Omega$$



# Measuring Instruments for Wireless Circuits.

By C. H. Stephenson.

[R201

Showing how, by the use of switches, one instrument may be made to do the work of several.

THE use of measuring instruments in wireless circuits gives the experimenter much useful and interesting information. Unfortunately, so far as anode circuits are concerned, the necessary apparatus is somewhat expensive, and this often prevents the purchase of a milliammeter and high tension voltmeter or, at any rate, limits the equipment to either one or the other. The following notes describe a means whereby a high tension voltmeter of suitable type may be made to serve the purpose of a milliammeter, and details are given of simple switching gear, so that the instrument may be permanently connected in an experimental circuit without risk of damage.

It is a basic fact that all measuring instruments in general use, with the exception of the electrostatic type, are current operated; that is to say, their readings are dependent on the strength of the current flowing through them. A voltmeter does not, in fact, directly indicate pressure. The displacement of the needle is an indication of the current passing through the instrument, which, in accordance with Ohm's Law, is proportional to the difference of potential or pressure between its terminals. The resistance of a voltmeter is made high so as to keep the passing current down to a minimum.

In the anode circuit of the receiver we wish to measure voltages of 100 to 200 and currents of 3 to 15 mA. In order to use a single instrument for these two purposes we require one which, when used as a voltmeter, passes about 15 mA at full scale reading, whilst its resistance must not be so high as to produce any serious drop of voltage when inserted in series with the anode circuit. Fortunately, such an instrument is readily available at a reasonable price in the Weston Model 301 voltmeter.

The writer uses one reading from 0 to 100 volts. It is provided with an external series resistance, and if the instrument alone, *i.e.*, without the series resistance, be connected in the circuit, it gives full scale reading when current of approximately 15 m.a. is passing. The resistance of the instrument alone is certainly quite negligible compared with that

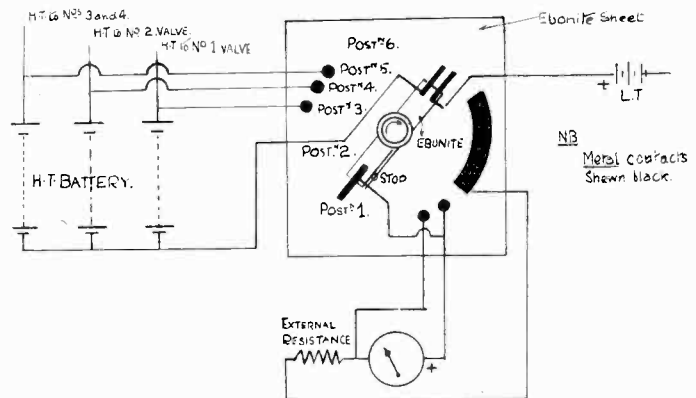

Fig. 1.

of the rest of the anode circuit, so no material drop of potential due to its use occurs.

It should be noted that the current is not exactly 15 m.a. for full scale reading, but it is so nearly so as to be sufficiently accurate for the purpose in view, and if greater accuracy be required an exact calibration is easily made by means of another accurate milliammeter or by a single accurate resistance of suitable valve and dry cell or accumulator of known voltage. It is also interesting to note that a similar model Weston voltmeter reading 0.5 volts gave full scale readings at almost exactly 15 m.a. There would seem to be a standard sensitivity for the movements of these voltmeters, the scaling being determined by the value of the series resistance.

After having proved the suitability of the instrument, it was found desirable to construct switch gear so as to permit a rapid change over of connection, bearing in mind the importance of making certain



that the meter, without its series resistance, could not accidentally be connected across the H.T. supply.

The writer's experimental receiver consists of four valves so arranged that the detector may be used alone or in combination with one H.F. and one or two L.F. The H.T. supply is derived from three separate batteries, the two L.F. valves being fed from a common battery. It was necessary, therefore, to arrange matters so that the voltage on any valve plate and the current through any or all of the plate circuits could be read. The switch adopted is shown diagrammatically in Fig. 1, which includes the circuit connections. The following positions and readings were obtained :—

Switch Position.	Reading.
1	H.T. OFF.
2	H.T. ON.
3	H.T. voltage on valve 1
4	" " " 2
5	" " " 3 & 4
6	Total H.T. current.

As regards position 5 it will be clear that the H.T. current of any one valve may easily be arrived at. Suppose, for example, we require to know the current through valve 3 when valves 2 and 3 are in use, we should proceed as follows: Switch on to position 5; note current. Turn out filament 3 and switch receiver connections so that valve 2 only is operating. Note new current. The difference between the two currents is that taken by valve 3.

The arrangement may, of course, be used for obtaining the characteristic curves of valves of various types.

It has already been mentioned that the 0—5 voltmeter Weston type 301 in the writer's possession gives almost the same scale reading as does the 0—100 voltmeter when used. Probably the most generally useful single instrument is a voltmeter of this kind, and not until one is used across the filament terminals can it be appreciated how very inaccurate is the optical adjustment of filament temperature. It would not be difficult to arrange similar gear so as to connect a meter of this type across the filaments of any valves, or to put it in circuit as a milliammeter. If a suitable external resistance were made, the meter could be used as an H.T. voltmeter in addition so that a single instrument would very well serve three purposes.

As regards the actual design of the switch which the writer made, this is not advanced as being by any means the most suitable. It was made from parts available at the time, few tools being used, and, in practice, works quite well. The usefulness could have been extended had provision been made for reading the transmitting valve plate current and voltage. An extra series resistance would be necessary to extend the voltage reading to 300, or more.

Note.—The H.T. voltmeter should not be left switched in circuit, as the current passing through it will exceed that taken by the plate circuit and the life of the H.T. battery will be seriously reduced. This applies only when the meter is used for measuring the H.T. voltage.

**WIRELESS WAVES AND PIGEONS.**

A wireless experimenter at Paterna, near Valencia, Spain, recently made some observations on the apparent effect of wireless waves on the locational powers of carrier pigeons. During a transmission he released several of his pigeons, who circled over the station. He noticed that each time a pigeon passed over the aerial it faltered in its flight and, until it had staggered out of the electrified area, showed absolutely no recognition of the location of the house. Immediately it passed out of the charged area it resumed its flight to the pigeon cote. The effect was the same whatever the wave-length, although at less than 100W radiation the effect was less noticeable and the pigeons were quickly able to pick up their location.

**AN ULTRA-SENSITIVE ELECTROMETER.**

Monsieur C. Gutton (Professor of the Faculty of Nancy) and M. Laville have just presented to the Academy of Science, Paris, a new ultra-sensitive electrometer, which holds promise of great utility in the measurement of high frequency and small electric impulses. Using a 5mm. wide aluminium band suspended from a quartz "thread" 3mm. long, the inventors have an instrument which is easily portable (the mobile part weighing only 15 milligrams) and highly sensitive. The variation of a spot of light thrown on a scale at six feet is 100mm. for a volt; in fact, it may be said that the sensitivity of the electrometer is about 1/100 of a volt, irrespective of what difference of frequencies are measured.

# Some Experiments with Aerial and Earth Systems for Reception. [R321: R326

By *R. L. Smith Rose, Ph.D., M.Sc., A.M.I.E.E. and  
F. M. Colebrook, B.Sc. (Lond.), D.I.C., A.C.G.I.*

The following paper, contributed by two experts having the resources of the N.P.L. at their disposal for their researches, clears up several doubtful points and gives some information particularly valuable to the ordinary licensee.

**T**HE following is a description of some measurements carried out at the National Physical Laboratory, Teddington, with a view to determining the most efficient aerial and earthing systems for short wave reception, with particular reference to the use of an earth-screen for reception.

At the present time, the terms "counter-poise," "balancing capacity" and "earth-screen" appear to be used as if they were synonymous, whereas there is, in fact, a very definite distinction between the first two and the last. It will therefore be as well briefly to review the development of the technique of earthing systems in general with the object of emphasising the modern conception of the term "earth-screen."

## Part I.—The Development of Earth-screens for Transmission.

The earliest type of oscillator with which Hertz first demonstrated the existence of electro-magnetic waves consisted of two metallic plates in the same plane, connected by a rod in which there was a small gap, each half of the rod terminating at the gap with a spark ball. All the experimenters who worked on the subject after Hertz used a similar form of oscillator (with its axis either vertical or horizontal) at both the receiving and the transmitting ends. This use of the simple form of Hertzian oscillator continued until Marconi discovered that by earthing one side of the spark gap, and retaining the other half of the oscillator as a vertical wire with a capacity plate or a network at the top, the distance to which signals could be transmitted was very much greater than had been obtained with the double plate oscillator. The explanation

of the action of this earthed aerial system was based on the assumption that the earth, being a moderately good, if not perfect, conductor, gave rise to an image of the aerial with its elevated capacity, which image virtually took the place of the other half of the oscillator. On this assumption, much calculation and discussion has taken place on the subject of radiation and the propagation of waves generally.

The next step in the progress of aerial-earth systems was the introduction of tuning or, as it was termed at the time, "syntononic telegraphy." At this point a claim was made by Lodge and Muirhead (about 1909)\* that the use of a Hertzian oscillator in the form of "upper and lower capacity" areas possessed advantages over an earth connection in the matter of selectivity and range of communication. Owing to the difficulty of making measurements in connection with wireless telegraphy as then practised, the relative advantages of the two methods of arranging the transmitter were not fully appreciated.

With continued practice and experience in the operation of stations, it was realised that to obtain the maximum radiated energy it was necessary to keep as low as possible the ohmic resistance of the aerial-earth circuit. As the efficiency of the other parts of the transmitter improved, it began to be appreciated that the greater part of the energy loss was centred in the earth connection, and from this was deduced the fact that the earth's crust is not such a good conductor of electricity, particularly at high frequencies, as many had previously supposed. This was confirmed by the marked superiority of many ship transmitting sets

\* Proc. Roy. Soc., 82, p. 227.

over corresponding stations on land, the superiority being due to the low resistance earth connection obtainable between the hull of the ship and the sea water, which is a moderately good conductor.

The earliest method of obtaining an earth connection at a land station was to run a single cable from the set to a buried metal plate. This, however, resulted in a comparatively high current density in the earth surrounding the plate, with consequent large localised losses. To reduce these it became the practice to run a number of feeders radially to a ring of metal plates buried, where possible, to the depth of the permanent ground water. In certain exceptional cases of high-power transmitting stations in localities where the ground was known to be of poor conductivity, the ring of plates was omitted and the radial wires extended to form the original type of counterpoise. A somewhat similar method was adopted for certain military sets, where, on account of its portability and ease of erection, an earth mat of wire gauze was used, laid on or pegged down to the ground.

Until recently, however, these counterpoise arrangements were looked upon as merely providing a low resistance path for the aerial currents to flow to, or as forming a condenser of considerable capacity to earth through which the earth connection for the high-frequency currents was established.

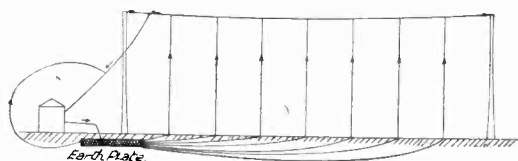

Fig. 1.

The dimensions of the counterpoise and its position relative to the aerial were not considered very important, and its size was usually cut down to the minimum from considerations of cost of land, etc.

That there were still large but avoidable losses taking place in such arrangements was first pointed out by T. L. Eckersley\*, to whom the modern conception of the earth-screen is due. In the paper referred to he

gave a theoretical analysis of the losses inherent in an aerial-earth transmitting system. He showed that the earth was the seat of ordinary ohmic resistance loss, eddy current loss, and dielectric loss, and that all of these could be minimised by the use of a properly designed earth-screen, the function of which is not only the provision of a low resistance path for the feet of the lines of force, but also the screening of the earth from the concentrated electric fields which would otherwise give rise to eddy current and dielectric losses. The basic principles can be simply explained by the aid of the three diagrams, Fig. 1, Fig. 2 and Fig. 3, which illustrate the directions of flow of the oscillatory currents in the aerial circuit. In Fig. 1 an inverted L-shaped aerial is shown connected to a buried earth-plate. It will be seen that the currents passing to the earth-plate have to flow through considerable portions of the earth material to various points under the aerial, whence the circuit is completed by capacity currents from the aerial wires to the earth's surface. In Fig. 2 the buried earth plate is shown replaced by a counterpoise network, situated on the side of the transmitter opposite to the aerial. It will be appreciated that although a large part of the earth-plate resistance is reduced by the distribution of the current over a larger area of copper, there are still considerable losses due to the return currents flowing through the earth. This, therefore, is an unfavourable position for the network. In Fig. 3 is shown the network in its most favourable position, *i.e.*, immediately under the aerial. With sufficient overlap provided on the screen beyond the horizontal projection of the aerial, all the lines of force due to currents in the aerial circuit are located in the air space between the aerial and the screen, and the dielectric losses previously taking place in the earth are thus avoided. Furthermore, if the currents are suitably distributed in the screen network, the eddy current losses which formerly occurred in the earth (due to the downward radiation from the horizontal part of the aerial) are largely if not entirely prevented by a similar radiation, opposite in phase, from the wires of the earth-screen.

In the paper by Eckersley referred to above, the theoretical analysis was confirmed by experiments carried out with small aeriels. The results indicate very clearly

\* T. L. Eckersley. "An Investigation of Transmitting Aerial Resistances," *Journal I.E.E.*, 1922, Vol. 60, pp. 581-594.

the principles to be followed in the design of large transmitting aerials and earth-screens. For the benefit of those experimenters who are interested in transmission on a small scale, these underlying principles may be broadly described in the following brief résumé.

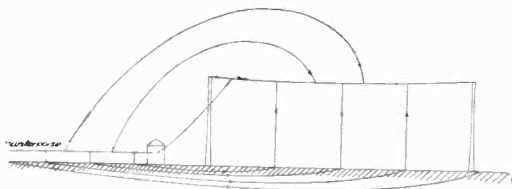

Fig. 2.

The screen is composed of a number of wires parallel to the direction of the aerial and supported in a horizontal plane symmetrically beneath the aerial. If space permits, the earth screen should overlap in every direction beyond the horizontal projection of the aerial for a distance at least equal to the height of the aerial above the screen. This means that for a flat-topped aerial of length 60 feet, total spread 10 feet, and mean height 40 feet, the dimensions of the earth-screen should be at least 140 feet by 90 feet. This may seem rather excessive to many owners of transmitting aerials, but the experimental results show quite clearly that a loss of span of the screen cannot be compensated by an increase in the number of wires.

The spacing of the wires running the length of the screen, and hence the number of wires, is chiefly dependent on the height of the screen above the ground, and a good working rule appears to be that the distance between the wires should be less than three times the height of the screen above the ground. To arrive at the best height of the screen above the ground a compromise must be made between various factors. If the ground beneath the screen is not required for any other purpose, the height may be reduced to about 3 feet (assuming that the vegetation can be kept down to a negligible height). For a screen of the dimensions given above, therefore, ten or twelve wires spaced 8 feet apart and 3 feet above the ground would be very suitable. More wires may be interspaced between these if desired, but even if the number of wires were increased up to 91, at 1 foot apart,

the consequent additional reduction of resistance would be relatively small.

In many cases, however, it is not possible, for economic or other reasons, to monopolise all the ground under the earth-screen, and it will then be necessary to raise the screen to a height of 7 or 8 feet. The only objections to this are that the difficulty and cost of erection of the screen are thereby increased, and that the actual, and hence the effective, height of the aerial is reduced, since this is calculated from the level of the screen and not from that of the ground. If in the case above cited the height of the aerial is assumed to be 40 feet above the screen, which is 8 feet above the ground, a suitable arrangement would be six wires equally spaced at 18 feet apart. In considering the spacing of the wires, it should be remembered that such objects as iron and wooden fences and brick walls may be regarded as the ground and therefore as the seat of possible losses, and the screen wires should therefore be kept well away from such objects. The whole of the screen should be very well insulated, and, for the reason just given, the number of supporting posts should be reduced to a minimum. Unless they are absolutely necessary, no cross wires should be used in the screen, and the distant ends of the screen wires may be left free as in the case of aerials. In considering the leading-in arrangements of the screen, it is to be noted that in general the current passing from the transmitter to the screen will be somewhat greater than that passing to the aerial, so that careful arrange-

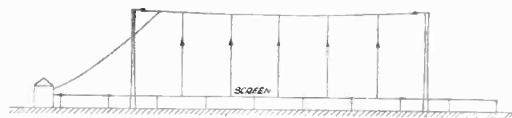

Fig. 3.

ment of the feeder wires is necessary in *both* cases. The lead-in insulators are preferably situated at the centre of a glass or ebonite panel mounted in the wall of the building.

To illustrate the effect of the substitution of a screen designed on the above lines for a buried earth connection of the usual type, the case of the Clifden high-power station may be quoted. The total resistance of the aerial circuit was here reduced to one-sixth of its former value by the installation of a screen. This means that either 2.44 times



the original aerial current can be obtained for the same input power, or that the same aerial current can be obtained with one-sixth of the input power formerly required. To those who wish to inquire more fully into the subject, the writers would recommend reference to Eckersley's original paper, and the discussion thereon.

In concluding this section of the paper, it should be mentioned that although the earth-screen gives the most complete solution of the problem of the reduction of the losses in the aerial circuit, the screens necessary for large transmitting systems (and the ground occupied by them) are so extensive and so costly that quite frequently a more economical—even though less efficient—solution has to be obtained. The most general solution at the present time is some sort of combination of the earth-screen with the multiple earth system originally devised by Alexanderson\* and used at Rocky Point. The reader interested in further details of these arrangements may be referred to the original paper\* and the later contributions of Meissner† and Bouvier‡. The last-mentioned writer in particular discusses the whole question of earth connections in some detail, and describes the arrangements which were adopted at the high-power station at Sainte Assise, where the resistance of the aerial was reduced from 1.9 ohms with a buried earth connection, to 0.54 ohms, with a consequent increase of radiation efficiency of from 10% to 35%.

## Part II.—Measurements on the use of an Earth-screen in Reception.

In connection with certain investigations which had to be carried out at the National Physical Laboratory on wavelengths in the neighbourhood of 300 metres, it was decided to try whether the use of an earth-screen would afford any improvement in reception comparable with that obtained by the same means in the case of transmission.

It should be pointed out that there is no *a priori* justification for assuming that there

will necessarily be any such improvement, since the conditions which obtain in the two operations are fundamentally different. In the first place it is only in certain cases, namely those in which there is no local source of energy associated with the reception process, as in crystal reception for instance, that the resistance of the aerial circuit plays a very important part. Again, the distribution of the electric fields involved will be very different in the two cases of transmission and reception. In the former case the field will be that due to a concentrated electromotive-force acting at one point in the aerial circuit. In the latter case there is, properly speaking, no electromotive-force in the aerial circuit at all, but instead a distributed potential gradient due to the line integration of a more or less uniform vertical electric field with respect to which the induced potential gradient is of the nature of a back E.M.F. of mutual induction. The fields in the two cases will differ both in distribution and, in general, very greatly in intensity, the received field being very small indeed compared with that usually associated with the transmitting aerial. However, the resistance losses will be essentially of the same kind, and some diminution of them can reasonably be anticipated, as the result of using an earth screen, though this diminution is not likely to be so striking as in the case of transmission.

At the outset of the measurements, certain factors were fixed as definite limitations, these being, first, the erection of any aerial which could be accommodated between two masts 30 feet high and about 80 feet apart; second, the use of a piece of ground 100 feet long by 30 feet wide quite free from any obstacles, but bounded on one side and end by an iron fence and on the other side by a wooden hut. A place was chosen in the hut near one of the masts, where the receiver could be erected and the measurements carried out. At this point there was also convenient access to both water and gas mains, and as these passed immediately underground for an uninterrupted length of about 100 yards they were representative of the usual type of such earth connections as employed for reception purposes. To complete the selection of earth connections available, a large sheet of tinned iron, about

\* E. F. W. Alexanderson. *Proc. Inst. Radio Engns.* 1920, Vol. 8, p. 279.

† A. Meissner. "The Earthing Resistance." *Year Book Wireless Telegraphy and Telephony*, 1922, pp. 1,235-44.

‡ P. Bouvier. "Multiple Earth Antennæ," *Radio Elec.*, 1922, Vol. III., pp. 456-466, 523-530.



4 feet by 3 feet, was buried at a depth of about 3 feet immediately under the aerial and near the receiver. Two heavy stranded copper feeders were brought from this plate to a lead-in connection. Similar well insulated lead-in arrangements were provided for the aerial and the earth-screen. The aerial was maintained fixed in the form of two wires of 3/19 enamelled copper about 70 feet long, stretched between the tops of the masts, with a vertical down lead brought to within 6 feet of the ground and then carried horizontally to the lead-in insulator. In this, as in all the measurements the aerial was strained at the necessary points by insulated guys so as to keep its position fixed, thus avoiding any erratic changes of observed signal strength.

The actual measurement circuit employed is illustrated schematically in Fig. 4. The tuning arrangement is seen to consist of a variable condenser in series with a fixed inductance of suitable magnitude, followed by another small inductance across which is connected the rectifying unit. Between the latter inductance and earth is included a variable resistance box specially constructed for use at high frequencies.

The rectifying unit consists of a dull-emitter valve, in the anode circuit of which is connected a sensitive reflecting galvanometer. The normal anode current of the valve is balanced out of the galvanometer circuit by means of the potentiometer shown in the diagram. The grid circuit of the valve is the ordinary grid-condenser and resistance arrangement. The sensitivity is such that for a tenth of a volt applied between the grid and filament terminals a galvanometer deflection of about 1 metre is obtained. The calibration showed that for voltages up to about .1 the galvanometer deflection was fairly accurately proportional to the square of the voltage. In the measurements, therefore the square root of the galvanometer deflection was taken as a measure of the radio-frequency potential difference due to the received current flowing through the fixed small inductance, and, since all the measurements were taken at a single constant frequency, that of the broadcast transmission from 2LO, this potential difference is itself a measure of the received aerial current. The actual magnitudes of the aerial currents were not determined, since only relative magnitudes were

required for the purpose of the experiments.

In addition to the comparison of the aerial currents obtained with the various earthing arrangements, the total apparent resistance of the aerial circuit was also measured in each case. This was done by observing the changes of aerial current produced by the addition of known resistances. The method of calculating the total resistance of the aerial circuit from these observations may perhaps be new to some readers.

Since the circuit is tuned to resonance, we have, for an assumed E.M.F.  $E$ , an aerial circuit resistance  $R_0$ , and an added resistance  $R$ .

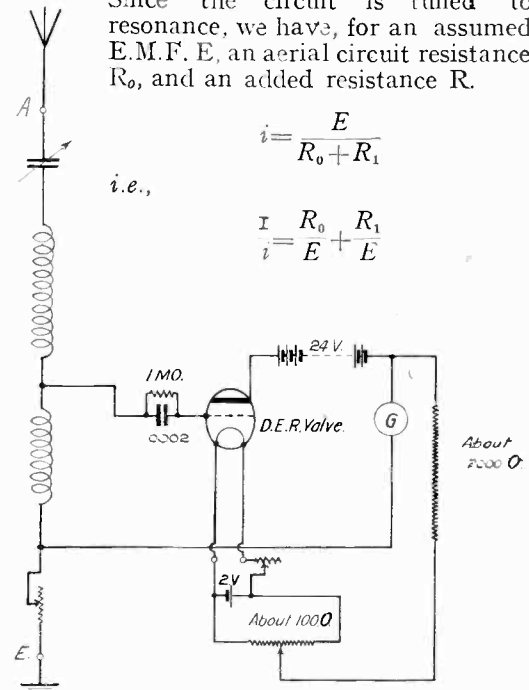

Fig. 4.

Thus if  $\tau/i$  be plotted against  $R$ , the result should be a straight line. This line when produced backwards will cut the resistance axis at a point  $-R_1$  such that

$$\frac{\tau}{i} = 0 = \frac{R_0}{E} - \frac{R_1}{E}$$

i.e.,

$$R_1 = R_0$$

It is interesting to note that this process is really the graphical determination of the negative resistance which must be inserted in the aerial circuit in order to make the aerial current infinite.

The constant part of the aerial circuit resistance which is due to the tuning circuit

plus the small load effect of the rectifying unit can be determined by disconnecting the tuning circuit from the aerial, short-circuiting it upon itself, and then measuring its resistance in same manner as described above, using a local oscillator of the same frequency as the source of E.M.F.

In the actual measurements fairly good straight lines were obtained in the resistance determinations, the reciprocal of the square root of the galvanometer deflections being plotted against the added resistance. The above method of calculation has an advantage over the ordinary in that it shows up at once any errors of observation, and enables an accurate mean value to be obtained for all the observations.

Another quantity determined in each case was the reactance required to tune the aerial to the given frequency, *i.e.*, the total reactance of the tuning circuit between the aerial and earth terminals. All that is required for this is a knowledge of the inductance and the self-capacity of each of the two coils and the magnitude of the variable series tuning capacity. At a frequency  $\omega/2\pi$  the reactance of a coil of inductance  $L$  and self-capacity  $C_0$  will be :

$$X = X_1 + X_2 - \frac{1}{\omega C}$$

(The values of  $L$  and  $C_0$  for the two coils were found by plotting the square of the wave-length against the added capacity in the usual way.)

In order that a variety of earth screen arrangements could be tested, two triatic wires were erected across each end of the rectangular ground space, these wires being about thirty feet long, a hundred feet apart, and about three feet above the ground. (The aerial had previously been erected symmetrically over the ground space covered by the screen.) From these supporting wires any number of parallel screen wires could be hung, each separately insulated at the ends, and readily movable or detachable. In every case connection to the screen wires was made by means of a transverse wire about fifteen feet from the receiving end.

For the first set of measurements a screen of eleven No. 20 bare copper wires was erected, the space between them being about three feet. Readings were taken for the whole screen and compared with the corresponding readings obtained with various

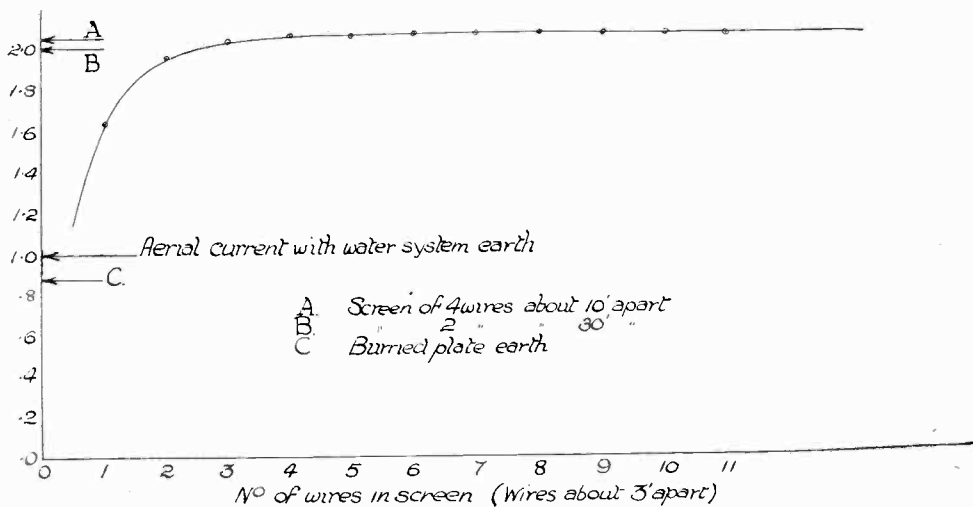

Fig. 5.

$$X = \frac{\omega L}{1 - \omega^2 L C_0}$$

If  $X_1$  and  $X_2$  be the reactances of the two coils calculated in this way, and if  $C$  be the series tuning capacity, then the reactance of the tuning circuit will be :

alternative earth connections. The screen wires were then removed and disconnected one at a time (the outer wire being removed from each side alternately), and the readings repeated. The results of this set of measurements are recorded in curves of Fig. 5 and

Fig. 6. The conclusions to be drawn are as follows:—

1. With the screen the received current is approximately twice, and the aerial resistance just under a half the corresponding quantities when the water system is used as the earth connection.

the screen will be somewhat less than the capacity of the aerial to the earth. It will be noticed that as the number of screen wires increases, the tuning reactance decreases, approaching that required for the water system earth.

Since in many practical cases a screen of

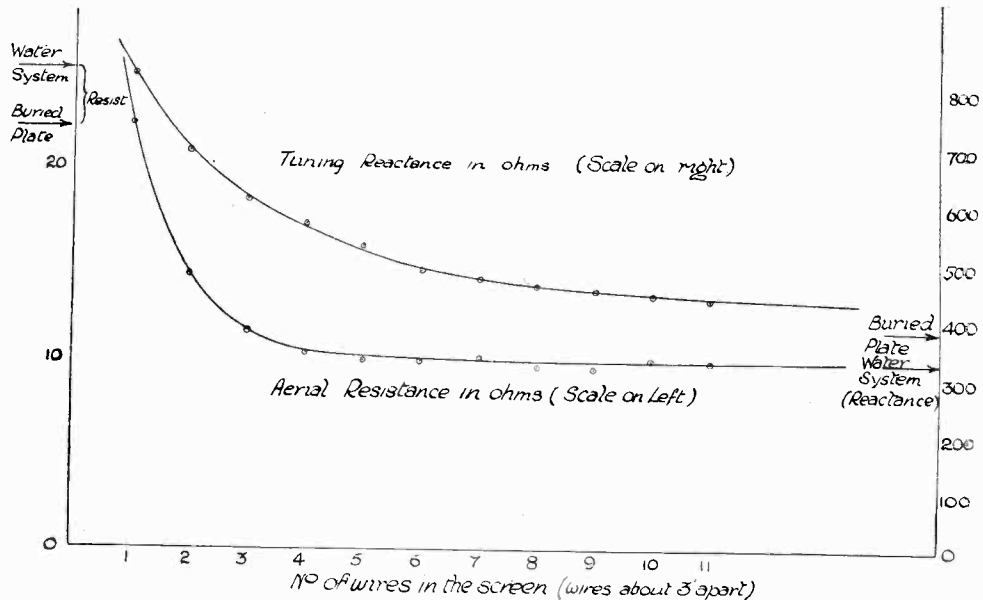

Fig. 6.

2. This result can be obtained by using a screen of three or four wires, and practically nothing is to be gained by increasing the number of wires beyond this point.

3. Earthing to the water system gives a slightly greater received current and a slightly lower aerial resistance than earthing to the buried plate. Earthing to the gas main was, in this particular case, very ineffective. This must not be taken as a general conclusion, since it was probably due to high resistance joints in the system. This result, however, emphasises the fact that earth connection to a gas system, apart from the disapproval of the gas and insurance companies, is always liable to this trouble, and that the water system is therefore preferable.

4. The tuning reactance required when using the screen is greater than that when using the water system or buried plate as earth connection. This is what one might anticipate, since the capacity of the aerial to

even as few as three wires arranged as described above will be impracticable, some additional measurements were made with a view to finding a more convenient disposition of the screen wires. First, four wires were distributed equally over the whole space, *i.e.*, about ten feet apart, and second, the two inner wires were removed, leaving a screen of only two wires running parallel to the aerial along the edges of the thirty foot space available. In each case the height of the wires was about three feet, as in the first series of measurements. The results are shown in the following table.

Screen.	Aerial resist.	Tuning react.	Ratio.
4 wires, 10 ft. apart	10 ohms	548 ohms	2.05
2 wires, 30 ft. apart	13.5 ohms	680 ohms	2.00

(The figures given under the heading "ratio" indicate the ratio of the received current to that obtained with earth connection to the water system.)

It will be seen that two wires running down the edges of the available space form a screen which is only slightly inferior to the eleven-wire screen covering the whole space. The two-wire screen has the considerable practical advantage that it leaves unobstructed the whole of the space under the aerial, and thus brings the use of a screen in many cases in the sphere of practical politics. For instance, where an aerial is erected more or less centrally above the longest dimension of a garden, two well-insulated wires running parallel with it down the extreme sides of the garden will form an efficient earth screen.

A further measurement was made to decide whether the size of the wire used for the screen was a factor of any importance.

For the two wires of No. 20 gauge used in the last measurement, two other wires of 3/19 aerial wire was substituted. It was found that there was no appreciable difference in the results obtained.

Finally, the effect of using the earth screen and the water-system earth together was observed. It was found that if the water system was directly connected to the screen the tuning reactance was about the same as that for the water-system earth only but that the received current was considerably less than that obtained with the water-system

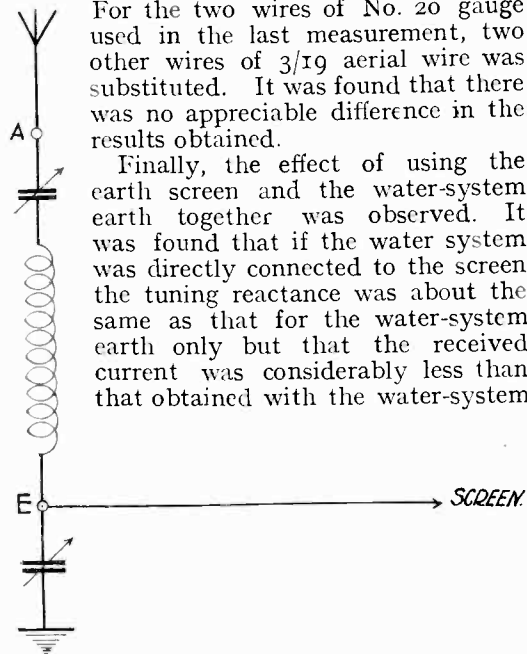

Fig. 7.

earth. This result is curious, and not easily explained. The difference in the tuning reactance required for the screen and the water-system earth might certainly account for the two not working well together when directly connected, but it is difficult to see why the maximum received current

when the two are connected should be associated with the same tuning reactance as for the water-system earth alone, this maximum being considerably less than that given by the water-system earth alone.

The difference between the tuning reactances associated with the two systems suggested that when the two are combined together some separate tuning arrangement should be used. Since, of the two, the water-system earth required the smaller reactance the use of an additional series condenser between the earth and the screen, as shown in Fig. 7, seemed the most simple method of obtaining the necessary compensation. For the first measurement this condenser was adjusted until the combination tuned with the same setting of the main tuning condenser as with the earth screen alone. This arrangement gave a received current only slightly greater than that obtained with the water-system earth alone. However, it was found that by a simultaneous variation of the main tuning condenser and the additional tuning condenser in series with the earth lead it was possible to find an arrangement which gave a greater received current than that obtained with either separately. The results are exhibited in the following table:—

Arrangement.	Tuning reactance.	Recd. current.
Water system earth ..	336 ohms	1
Screen of 4 wires, 10 ft. apart .. ..	548 ohms	2.05
Screen and earth directly connected .. ..	338 ohms	.65
Earth connected to screen through 800 $\mu$ F ..	542 ohms	1.19
Earth connected to screen through 300 $\mu$ F ..	497 ohms	2.32

It appears, therefore, that if an earth screen and an ordinary earth connection are used together, it is essential that the earth screen lead and the earth lead should be tuned separately. Under the usual conditions of broadcast reception, this will require a separate tuning condenser in series with the earth lead. Alternatively, it is probable that a small variable inductance in series with the earth-screen lead would be equally effective.

**Part III.—Experiments with various aerial arrangements.**

The experiments already described showed conclusively that in all cases where aerial resistance is a matter of importance the use of an earth screen for reception will afford a very great improvement over any of the more usual alternative earth connections.

Attention was now devoted to the other half of the problem, *i.e.*, the most suitable design of aerial within the limits already specified, and subject to the post-office regulations relating to small aerials for broadcast reception.

distribution in terms of the constants of the aerial remains a very difficult problem, since we have to deal not only with a distributed inductance and a distributed capacity, but also with a distributed E.M.F. The question of re-radiation will also complicate the complete discussion.

However, certain conclusions can be reached from general principles. For instance, the received current at the base of an aerial will increase with the height of the aerial, and, for a given height, will also increase up to a definite limit with the increase of the top capacity. The object of the following measurements was to deter-

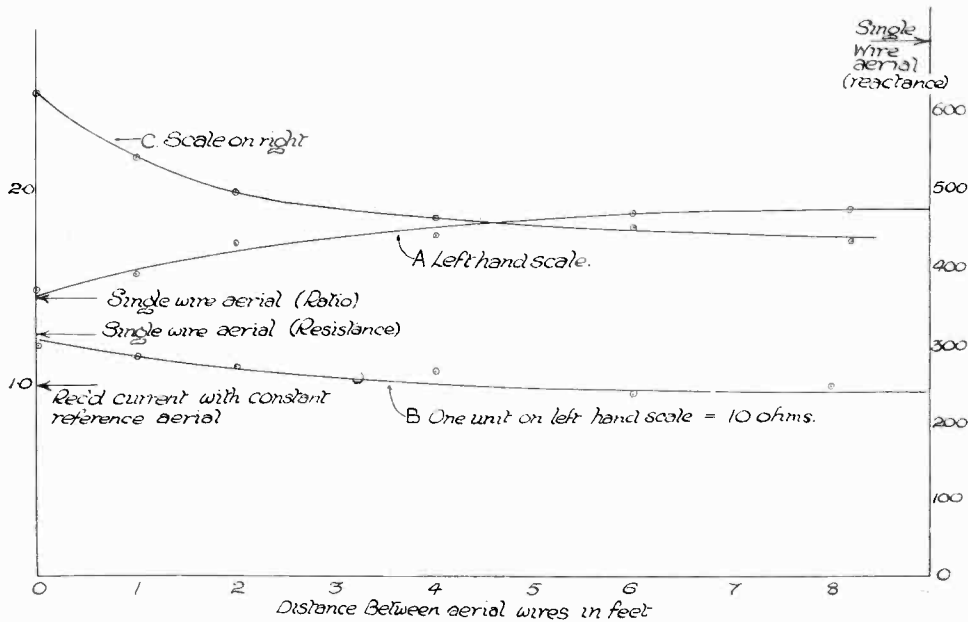

Fig. 8. Effect of distance between wires. A, signal strength ratio; B, aerial resistance; C, tuning reactance required.

Before describing the experimental work carried out on this subject it will be well to point out that the theoretical analysis of aerial reception is at present conspicuously incomplete—probably because of the inherent complexity of the subject. Information is lacking, for instance, on the matter of the effect of a receiving aerial on the shape and distribution of the electric field in its immediate vicinity. Moreover, even on the simplest assumption of a uniform vertical electric field, the determination of the current

mine relative importance of the above factors in the case of aerials used for broadcast reception.

The methods of measurement employed were the same as those already described in connection with the previous part of the paper. Throughout the whole of the measurements with various aerial forms the earthing system used was a screen of eleven wires about three feet apart and about three feet above the ground. This was done in order to reduce as low as possible the part



of the aerial resistance associated with the earthing system, and so give greater prominence to resistance changes associated with variation of aerial form. In order to eliminate the effect of possible variations of the electric field from the source of the observed transmissions (*i.e.*, from 2L.O), the received current was in every case compared with that given by a single wire aerial erected in the neighbourhood of the experimental aerial, this constant single wire aerial being used as a fixed standard of reference. The figures given for aerial current are therefore expressed in terms of the received current obtained with this reference aerial as unity.

amount. To complete this series of measurements a three and a four-wire aerial were erected, each occupying the full eight-foot spreader space. The results are shown in the following table.

Aerial.	Aerial resist.	Tuning react.	Recd. current.
4 wires, 2 ft. 8 in. apart ..	11 ohms	315 ohms	1.78
3 wires, 4 ft. apart ..	10.5 ohms	365 ohms	1.75

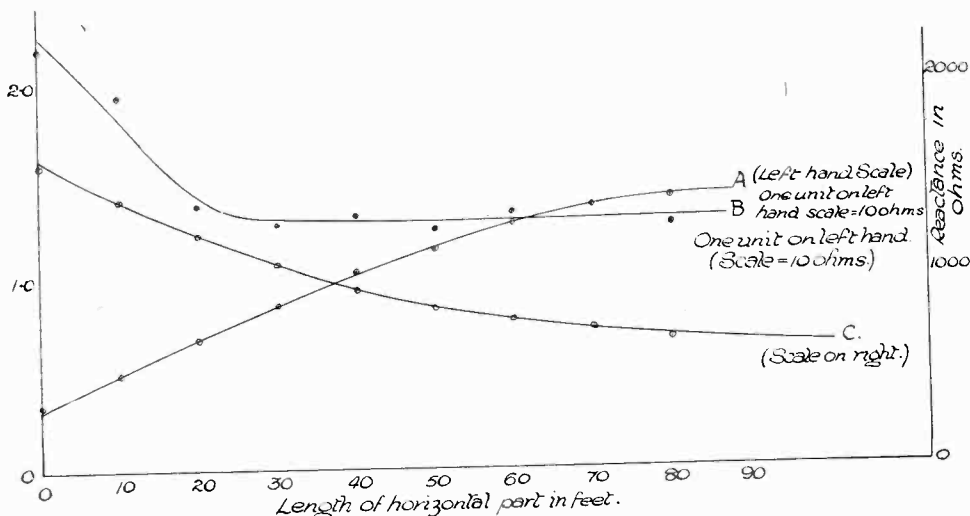

Fig. 9. Effect of varying length of Top. A, signal strength ratio; B, aerial resistance; C, tuning reactance required.

For the first set of measurements the aerial was in the form of two wires of 3/19 enamelled copper about 25 feet above the screen and about 75 feet long. The distance between these wires was decreased from 8 feet to zero and, finally, a single wire was substituted for the two adjacent wires. The results are shown in Fig. 8. It will be seen that if two wires are used they should be at least 6 feet apart, and preferably 8 feet. The most noticeable feature of the results is the comparatively small increase of received current obtained by using two top wires instead of one, the increase being only about 23 per cent. with a corresponding decrease in resistance of about the same

It will be seen on comparison with Fig. 8 that nothing is to be gained by increasing the number of wires in this way.

The next series of measurements was made with a single wire aerial of constant height, the horizontal part being about 25 feet above the earth screen. The length of the horizontal part was varied from zero to 80 feet. The results are shown in Fig. 9. As the length of the horizontal part is increased from zero to about 40 feet the received current increases according to a straight line law, the tuning reactance decreasing in a similar manner. Beyond this point the rates of change of these quantities decrease somewhat. It appears

that little is to be gained by increasing the length of the horizontal part beyond about 80 feet. This indicates that up to about 40 feet of horizontal length the effective height increases uniformly with the length of the horizontal part, and that beyond about 80 feet of horizontal length the increase of horizontal length does not greatly increase the effective height.

For the last series of measurements a single wire aerial of constant total length was used (about 90 feet), and the height of the horizontal part above the earth screen was varied from  $7\frac{1}{2}$  feet to 25 feet. The results are shown in Fig. 10. Up to a height of about 20 feet the received current increases uniformly and is proportional to the height.

the maximum height of the masts. From the above experiments, however, certain definite conclusions can be drawn. Of these the chief is that actual height and top capacity are of comparable importance. From the results of the last two sets of measurements it would seem probable that the most favourable distribution of a given total length of 100 feet of aerial wire would be about 40 or 50 feet of vertical height, the remainder being horizontal. A little can be gained by duplicating the horizontal part (*i.e.*, two wires in parallel) but not more than about a 20 per cent. increase in received current.

In conclusion it might be well to point out that while the advantages associated

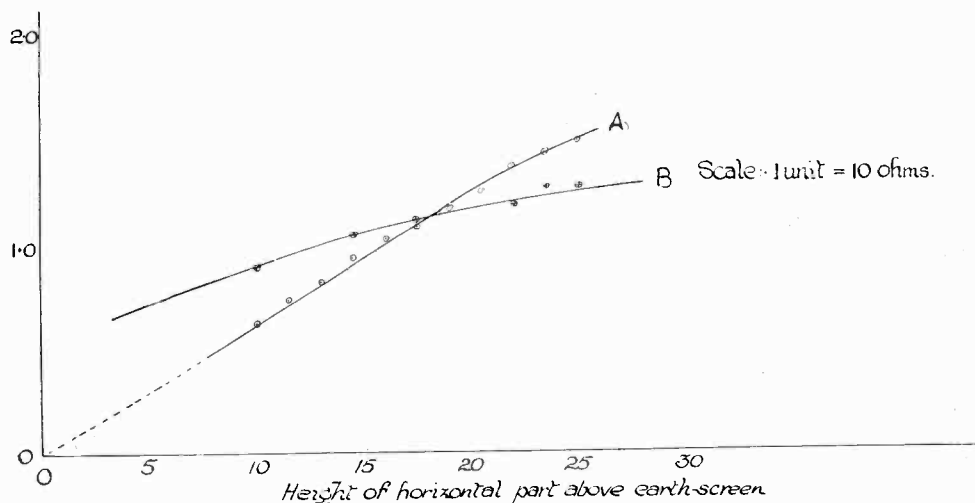

Fig. 10. Effect of varying height. A, signal strength ratio. B, aerial resistance.

Beyond this point it still increases, but not so rapidly. The comparison of these results with those of the preceding set indicates that there will probably be an optimum height for a given total length of aerial wire, and that this height is greater than thirty feet. The aerial resistance is seen to increase somewhat with the height, as might be anticipated.

It is hoped that later on there may be an opportunity of extending the scope of some of the above measurements by increasing

with the use of an earth-screen are chiefly important in the case of direct crystal reception, the best design of aerial within any given limitations is important both in crystal and in valve reception, since in each case it is desirable that as large as possible an E.M.F. shall be available in the aerial circuit. The main distinction between the two cases is that with valve reception a low aerial resistance is not so essential, since the proper use of reaction permits of independent control of this factor.

# The Theory of the Lead Accumulator.

By *N. A. de Bruyne.*

[R800

*Student Member of the Faraday Society; Author of "Electrolytic Rectifiers."*

**I**N the majority of practical books and papers on the action of the lead cell, the theory is dismissed in a few lines dealing with the fundamental cell reaction— $\text{Pb} + \text{PbO}_2 + 2\text{H}_2\text{SO}_4 = 2\text{PbSO}_4 + 2\text{H}_2\text{O}$ . There is a great deal to be learnt, however, about the action of the cell by looking at it from the point of view of energy, or thermodynamics. We will begin by seeing how the E.M.F. of the cell can be calculated from the fundamental cell reaction.

## Calculation of the E.M.F. of the Cell.

All chemical actions are accompanied by a rise or fall of temperature. The particular chemical action which goes on in an accumulator, if carried out in a beaker, gives rise to 120 860 calories of heat, if we use certain specified quantities of the reacting substances. When the reaction takes place in an accumulator the energy does not appear as heat, but as electrical energy. An accumulator is an apparatus for turning chemical energy into electrical energy; in the ordinary way, chemical energy gets transformed into heat energy.

We may express the production of heat by the fundamental reaction in the following equation:—

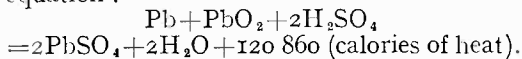

The above equation is merely a chemical way of saying that when 207 grams of lead, 239 grams of lead peroxide and 196 grams of sulphuric acid combine together to form 606 grams of lead sulphate and 36 grams of water, then 120 860 calories of heat are evolved. Now Joule showed that 1 calorie is equivalent to 4.2 watts per second; the cell reaction therefore gives  $120\ 860 \times 4.2$  watt-seconds of electrical energy when it takes place in an accumulator. By Faraday's law, however,  $2 \times 96\ 540$  Coulombs of electricity will pass through the cell during the action between the above quantities of lead, lead peroxide and sulphuric acid. Thus,  $4.2 \times 120\ 860$  watt-seconds and  $2 \times 96\ 540$

Coulombs of electricity are produced by the cell reaction. Remembering that watts equal volts multiplied by ampères and that Coulombs are ampères multiplied by seconds, we obtain the E.M.F. of the cell by dividing the number of watt-seconds by the number of Coulombs, thus:—

$$\frac{4.2 \times 120\ 860}{2 \times 96\ 540} = 2.6 \text{ volts approx.}$$

By actual experiment it has been found that the voltage of an accumulator using strong acid is 2.6 volts, correct to the nearest tenth of a volt.

## Effect of Dilute Acid.

If we use dilute acid (that is to say, a mixture of pure acid and water) the amount of heat evolved will be less than in the case considered above, because of the heat of solution of the acid. Everyone knows that when strong acid is dissolved in water the solution heats appreciably; conversely if we could get the acid out of the water again the solution would be cooled. When we allow lead, lead peroxide and dilute sulphuric acid to react together, the chemical action takes the pure acid away from the water, forming lead sulphate; thus, part of the energy of the reaction is used up in giving back the heat of solution to the water. Therefore, instead of getting the full 120 860 calories, we only get part of this heat, the E.M.F. of a cell decreasing with increase in dilution of electrolyte. Therefore, to obtain a high voltage we must use a strong solution of sulphuric acid; unfortunately, if we increase the strength of the acid much beyond a specific gravity of 1.215 sulphation takes place very easily.

## Effect of the Heating and Cooling of the Cell when in use.

We saw above that we could calculate the E.M.F. of a cell correct to a tenth of a volt by using the heat of the reaction. If we make our calculations to a hundredth of a

volt, however, we find that they no longer agree with experimental results; that is to say, the theory outlined above only gives approximate results. The reason for this is that the cell cools on charge and heats on discharge. Now, since the cell cools on charge, it takes in heat from its surroundings, thus it will have a higher E.M.F. than that calculated from the heat of the reaction; and on the other hand, since it heats on discharge it will have a lower E.M.F. than that calculated from the heat of the reaction, because part of the electrical energy is being wasted as heat energy.

Gibbs, Helmholtz and Kelvin have shown how this heating and cooling may be taken into account in the calculation of the E.M.F. The accurate E.M.F. is given by the following expression, whose derivation is too long to be given here:—

$$E = \frac{Q}{46\,000} + T \frac{dE}{dT}$$

where  $Q$  = Quantity of heat in calories evolved by chemical action.

$T = 273 + \text{Temp. in degrees Centigrade.}$

$\frac{dE}{dT}$  = Rate of variation of the E.M.F. per degree Centigrade.

$E$  = E.M.F. in volts.

Therefore, if we can determine experimentally the numerical value of  $\frac{dE}{dT}$ , we shall be able accurately to calculate the E.M.F. This is not easy to do, since the term is very small; its value and sign also depend on the concentration of the acid used. For acid of density 1.156 Streintz has found  $\frac{dE}{dT} = .000\,335$ ; if we take the temperature as  $17^{\circ}\text{C.}$ , the second term of the expression equals .0971 volts. With acid of density 1.156 the heat of reaction is 88 800 calories; substituting these values in the equation, we find  $E = 2.0275$  volts. Actually, the value is 2.030 volts; thus, the agreement between theory and practice is good.

### The Solution Pressure Hypothesis.

In the preceding paragraphs we have regarded the lead accumulator as a machine for turning chemical energy into electrical

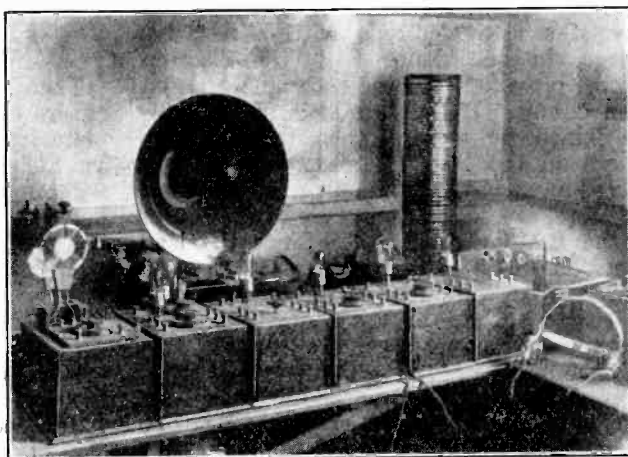

AN AMATEUR STATION.

*Our photograph shows the arrangement of Mr. A. Acland's set on which he has received 80 American C.W. stations. Amateur stations in New Zealand and the Argentine have also been logged. The Helix in the background consists of 96 turns of copper tape, and is used as an artificial aerial.*

energy; and it has been shown how the E.M.F. can be calculated by the aid of this conception. We will now turn our attention to another way of looking at the action of the cell, and see how the E.M.F. can be calculated (theoretically, at any rate) by a new method. This new view of the working of the cell is given by Nernst's "Solution Pressure Theory."

According to the Ionic theory, electrolytes are split up into ions, and electrolysis is a process which consists in attracting these ions to the respective electrodes. Thus, salt (sodium chloride, NaCl) when dissolved in water is split up into sodium ions which are positively charged, and chlorine ions which are negatively charged. When a current is passed through the solution, the sodium ions are attracted to the cathode, and the chlorine ions to the anode. Now, the chemical action that goes on in an accumulator is almost certainly a reaction between ions, not an action between compounds. For instance, the lead takes part



in the action as lead ions ; that is to say, is the form of small positively charged particles in the solution.

#### Action at the Negative Electrode.

Thus, the lead electrode sends ions into solution. These positively charged lead ions leave the lead electrode with a negative charge, in accordance with the electron theory, provided that the accumulator is on open circuit. If the terminals of the cells are joined by a wire, then this negative charge on the lead electrode will be conducted away. The solution pressure theory, therefore, gives a vivid picture of the source of the E.M.F. of the cell. Since the lead electrode is negatively charged, it will attract a large number of the ions back to its surface, while, at the same time, it is continually sending ions into solution. In this manner, a state of equilibrium is reached between the lead ions and the lead electrode ; that is to say, the lead electrode does not go on sending ions into solution indefinitely.

This equilibrium is upset when the accumulator is connected to a circuit, and when a current flows more ions are sent into solution. By Faraday's law, the passage of 96 540 Coulombs through the cell will cause 103.5 grams of lead to go into solution as ions. We can think of the lead electrode as having a definite pressure which drives the ions into solution. When there is equilibrium (when the cell is on open circuit) this solution pressure of the lead electrode is balanced by the pressure of the ions round the electrode.

Call the solution pressure of the lead electrode  $p_1$ . Then the work done at the lead electrode when 96 540 Coulombs are discharged from the cell can be calculated by the following expression :—

$$W = RT \log_e \frac{p_1}{p_2}$$

where  $W$  = Work done.

$R$  = A constant.

$T$  = Absolute Temp. (That is 273 + Temp. in degrees Centigrade.)

$p_1$  = Solution pressure of electrode.

$p_2$  = Concentration of lead ions in main body of electrolyte.

Knowing the work done at the electrode, we can easily calculate the E.M.F. due to the lead electrode in much the same way as we calculated the E.M.F. of the cell from the

heat of the reaction. Putting in a numerical value for  $R$ , taking the temperature at 17° C., the expression for the E.M.F. due to the lead electrode becomes :—

$$E = .0288 \log_e \frac{p_1}{p_2}$$

#### Action at the Positive Electrode.

There are two theories respecting the nature of the ions which the lead peroxide plate sends into solution. They are known as Liebenow's and Le Blanc's theories ; without going into these theories or deciding between them we can say that the E.M.F. due to the positive electrode is given by the following expression :—

$$E = .0288 \log_e \frac{p_3}{p_4}$$

where  $p_3$  = Solution pressure of lead peroxide plate.

$p_4$  = Concentration of anions, whatever those anions may be, in main body of electrolyte.

The E.M.F. of the whole cell will be due to the combined effects of the separate E.M.F.s. of the lead and lead peroxide electrodes.

The E.M.F. of the whole cell will therefore be :—

$$E = .0288 \log_e \frac{p_1 \times p_3}{p_2 \times p_4}$$

#### Deductions from the Solution Pressure Theory.

From the above expression for the E.M.F. of the cell we can draw a number of interesting conclusions. We see from the expression that if  $E$  is to be large  $p_1$  and  $p_3$  must be big, and that  $p_2$  and  $p_4$  must be small. Now we cannot alter the solution pressures of the lead electrode or the lead peroxide electrode, but we can alter the values of  $p_2$  and  $p_4$ . For instance, if we use an electrolyte in which lead is very soluble, then  $p_2$  will be large and the E.M.F. of the cell will be correspondingly small (since the term  $p_2$  occurs in the denominator of the expression). In the same way if we use an electrolyte in which lead peroxide is very soluble,  $p_4$  will also be large and the voltage of the accumulator will be reduced. Lead peroxide is comparatively soluble in caustic soda ; and we find that a lead cell with a caustic soda solution does have a very small E.M.F.



# The Effect of a Shunt Detector in Aerial Tuning.

[R144]

By *F. M. Colebrook, B.Sc. (Lond.), D.I.C., A.C.G.I.*

This note forms an interesting example of the application of the Author's article on Impedance Calculation in our last issue.

**A**ERIAL tuning is a very difficult subject to handle mathematically. The fact that the aerial inductance, capacity and resistance, and also the E.M.F. induced in the aerial, are all distributed quantities makes the received current at the base of the aerial a complicated function of the aerial constants. Failing an exact analysis, however, the following more or less empirical presentation of the case will enable some useful deductions to be made with regard to the association of a crystal or other relatively low resistance shunt detector with an aerial tuning circuit.

Assuming that the aerial and earth terminals are fixed in position relative to the aerial and the earthing system, it will be found that in order to tune the aerial to any given frequency a certain definite reactance  $X_a$  must be introduced in some way between these terminals. Over the range of values likely to occur in practice this reactance  $X_a$  will be found to be independent of the magnitude of the resistance associated with it, provided the latter is kept constant during the tuning process, and also independent of the manner in which it is introduced, whether it be by variometer, series or parallel condenser tuning, or any combination of these. Again, it will be found on applying the usual method of inserting known resistances directly in series with the aerial and observing the consequent changes of aerial current, that the part of the aerial external to the aerial and earth terminals appears to have a definite resistance at any given frequency. Let us call this resistance  $R_a$ . Two cases now present themselves. If the detecting arrangement be one which consumes an inappreciable amount of power (a condition which can be realised by the right use of valve apparatus), then the best tuning circuit is the one which introduces the

necessary reactance  $X_a$  with the minimum of resistance. If, on the other hand, the detecting arrangement is one which operates by the consumption of power, then the correct tuning arrangement is that which introduces the necessary reactance  $X_a$ , together with a power consuming term, *i.e.*, an effective resistance, of magnitude  $R_a$ . The condition is in fact analogous to any case in which power is taken from a source of E.M.F. having a certain internal resistance, the optimum condition in all such cases being that the load resistance is equal to the internal resistance. We see from the above that the ideal variable reactance-crystal detector combination is that which introduces into the aerial an effective impedance  $R_a + jX_a$ .

## Tests with Standard Aerial.

It will be of practical interest to relate this to the standard P.O. aerial and the reception of broadcast transmission. The reactance required to tune a standard aerial to the transmission from 2LO, for instance, will vary somewhat with local conditions, such as the height of the horizontal part of the aerial, but it will generally lie between 400 and 600 ohms (positive). The effective resistance of the aerial is also a very variable factor, depending chiefly on the quality of the earth connection. Probable limits for this quantity are 10 ohms in favourable conditions to 80 or even 100 ohms in cases where the earth connection is of small area in dry soil.

It can now be shown, by means of the circle diagrams described in the author's recent article\*, that the ideal tuning conditions specified above are very unlikely to be realised in the usual form of crystal

\* E.W. & W.E. Dec., 1924, p. 140.

receiving circuit, of which three common types are illustrated in Fig. 1, *a*, *b* and *c*. In cases *a* and *b*, the crystal and telephones are in shunt to the whole of the variable tuning reactance. These cases are therefore identical in type with that considered in the diagram of Fig. 11 of that article, the

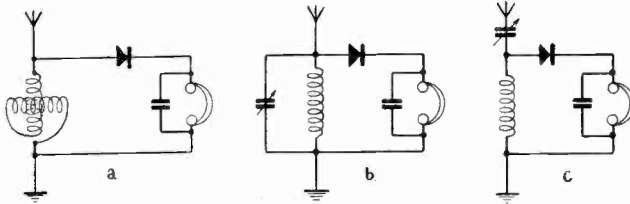

Fig. 1.

constant shunt resistance being that of the crystal. (It is here assumed that the effect of the wire resistance of the coil is relatively negligible.) The high frequency resistance of a crystal detector may be anything from 1 000 to 5 000 ohms, varying with the type and specimen of the crystal. The resistance of a telephone or other apparatus in series with the detector does not enter into the calculation, since any such apparatus should be short-circuited by a condenser for the high frequency component of the current in the detector circuit. To obtain some idea of the order of the load imposed on the aerial by a crystal receiving circuit of a usual type we can therefore take as representative values:  $X_a$ , 500 ohms;  $R_a$ , 50 ohms; shunt detector circuit, 2 000 ohms. The diagram corresponding to these values is shown in Fig. 2. The measured value of  $R_0$ , the effective resistance introduced into the aerial circuit, is seen to be about 140 ohms, more than two and a half times the desired value.

If the crystal resistance were lower, say, 1 000 ohms, the conditions would be even worse, for the effective resistance load would then be as high as 500 ohms. In such a case as this the point of maximum signal intensity would probably not be the real tuning point of the aerial, since the process of tuning would increase the effective resistance at a rate that more than balanced the decrease in reactance.

The series condenser case illustrated in Fig. 1c is likely to be even less efficient than the others unless a correspondingly high resistance crystal is used, for, whatever negative reactance is introduced by the condenser has to be balanced by a correspondingly increased positive reactance introduced by the inductance. Thus, if the series condenser is about 1 000  $\mu\mu\text{F}$ , giving a negative reactance of about 200 ohms at the frequency of the 2LO transmission, the effective reactance of the inductance-crystal circuit combination must be 700 ohms, in order to give a resultant effective reactance of 500 ohms between the aerial and earth terminals. The diagram shows that under these conditions a 2 000 ohm crystal would introduce a load of nearly 290 ohms into the aerial circuit.

This overloading of the aerial with resistance is undesirable for two reasons. Firstly, it is inefficient from an energy point of view, resulting in a lower signal intensity than could be obtained under the correct conditions; secondly, it gives rise to unnecessarily flat tuning, with a corresponding decrease in selectivity. It will be preferable, therefore, to use some type of circuit which permits of the control of the resistance load introduced into the aerial independently of

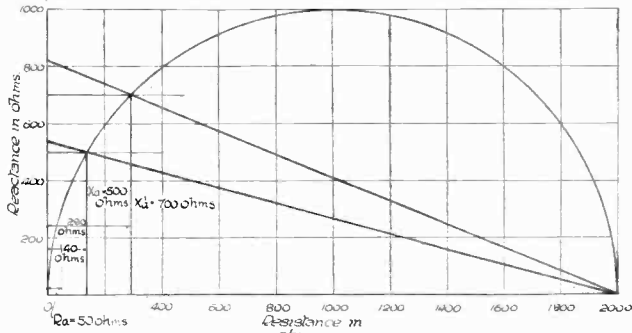

Fig. 2.

the tuning conditions and the crystal resistance.

A simple and effective means of obtaining this control is afforded by what was originally the general practice with crystal circuits, namely, to connect the detector circuit in parallel with a part only of the tuning

reactance, the proportion of this part to the whole being variable.

It will be seen on reference to Fig. 11 in the article already mentioned, that the smaller the reactance associated with a given shunt resistance the less will be the effective resistance of the combination. With either of the circuits illustrated in Fig. 3, the amount of the reactance in parallel with the detector circuit can be varied independently of the variation of reactance necessary for tuning the aerial. Either of these circuits will, therefore, give control of the effective resistance introduced into the aerial by the detector circuit. Of the two circuits illustrated, the first is slightly the more efficient, but the second is considerably more convenient to manipulate.

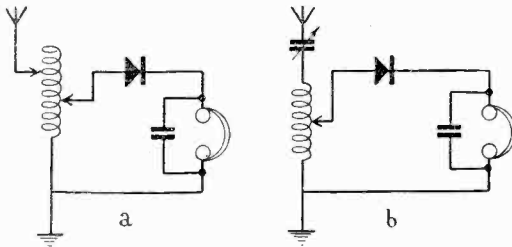

Fig. 3.

In either case the coil should be wound with bare wire of about No. 18 or 16 gauge, on some form of insulating frame which reduces as far as possible the proximity of solid dielectric to the wire. The turns should be not less than two or three wire diameters apart.

It may be of interest to describe some experiments carried out by the writer which furnish a qualitative confirmation of the theoretical discussion given above. It was shown in the article to which reference has already been made that, in the reception of modulated high frequency waves by means of a crystal detector, there will flow through the crystal a continuous current of magnitude proportional to the square of the high frequency E.M.F. acting across the detector. The energy consumed in the detector is also proportional to the square of this E.M.F. Thus, the continuous current through the crystal will serve as a measure of the energy being absorbed by it. At distances up to 15 miles or so from 2LO the continuous current through the crystal can be measured by means of a reflecting galvanometer of

moderate sensitivity. A simple and convenient means of comparing different arrangements or of analysing the behaviour of any given circuit is to insert such a galvanometer in series with the telephones (both galvanometer and telephones being shunted by a condenser to provide a low impedance path for the high frequency components of the current). This was done by the writer for a number of different cases. In particular, the effect of varying the tapping point of the detector circuit was investigated for the case illustrated in Fig. 3a. The curves shown in Fig. 4 can be taken as typical of the results obtained. The coil consisted of about 20 turns of No. 16 copper wire, of about 10 inches diameter. The abscissæ indicate the number of turns included in the detector circuit, and the ordinates are the corresponding galvanometer deflections (proportional to the continuous current through the detector). It will be seen that, in the case of a galena crystal, the optimum condition was reached when only four turns of the coil were included in the detector circuit, the galvanometer deflection being then four times as large as it was when the whole coil was included in the detector circuit. It was noticed, moreover, that the tuning of the aerial became very much flatter as the number of turns included in the detector circuit increased.

The curve corresponding to the perikon detector differed from the former curve in a manner consistent with the fact that the

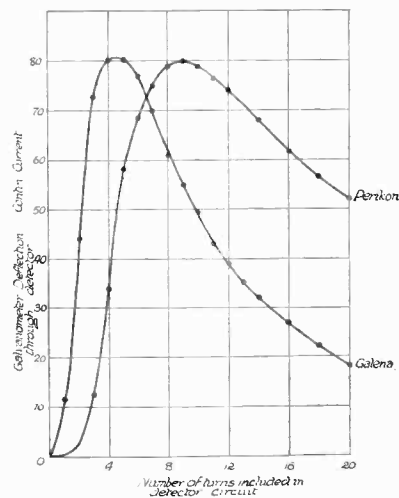

Fig. 4.

resistance of a detector of this type is, usually, four or five times as large as that of a galena crystal, the differences being that a larger number of turns can be included in the detector circuit before the resistance thus introduced into the aerial exceeds the optimum value, and that the falling off beyond the optimum condition is less rapid than in the case of the lower resistance detector. (The curves must not be taken as indicative of the relative sensitivities of the two detectors, since the galvanometer sensitivity was in each case adjusted so as to give deflections of convenient magnitude.) It is clear that whatever type of detector is used its full sensitivity will not be obtained unless it is suitably connected to the circuit. It is desirable that a detector should have a low resistance. In this respect galena has

the advantage over perikon, but, as will be seen in the curves of Fig. 4, this characteristic makes it all the more important that the correct load conditions should be realised. With a circuit of either of the types illustrated in Fig. 3, the optimum condition can easily be found by trial.

It should be pointed out that the measurements were made with a standard P.O. aerial of very low resistance. If the aerial and earthing system have a high resistance, the correct detector conditions will be much less critical, but the overall efficiency will be correspondingly reduced. On the other hand, the advantage of low aerial and earth resistance will be completely lost unless the load introduced by the detector circuit is controlled in some such manner as that indicated above.

## A Great Swedish Station.

[R611

**M**ANY interesting features are attached to the Grimeton Station—the largest radio station in Sweden—which has been completed recently in spite of various difficulties.

Actually the system comprises two separate stations, one at Grimeton being used for transmission, the other at Kungsbacka being used solely for reception. Both stations are handled from a remote control centre at Göteborg.

The Kungsbacka station was completed last spring and, in a series of tests, gave very satisfactory results. The aerial is on a large scale and consists of 13 kilometres of copper wire supported by 90 posts. It is suspended between the station and the far side of a valley and has been specially erected with the object of being directional so far as New York is concerned.

The Grimeton transmission station, which is housed in a two-storey concrete building, is equipped with duplicate plant which can be operated separately or jointly. Each unit consists of an Alexanderson type of high-frequency generator having a capacity of 200 kW and a periodicity of 17 400.

It is expected that, in the normal course of working, only one unit will be employed and that the other will be held in reserve so that, in the event of a breakdown, there will be no serious interruption of the service.

The wave-length of 18 000 metres has been selected, not particularly as a matter of convenience, but because it is not commonly used by other European stations.

The power supplied to Grimeton will come from turbo-generators at Yngaredsfors and Trolhaettan. This will be supplied at a pressure of 40 000 volts and will be stepped down at the station to 2 000 volts for the transmission sets and 120 volts for the lighting circuits.

The height of the masts supporting the transmitting aerial varies from 110 to 130 metres according to the nature of the ground so that the aerial may be perfectly horizontal at a uniform distance of 110 metres above the ground level. The erection of the masts has proved quite an interesting engineering problem. Over 900 tons of timber and iron have been used in their construction and each mast has been built up *in situ*. Cross arms at the top of each mast carry the 12 wires of the aerial and the masts are spaced at intervals of 380 metres.

The earth system consists of a network containing 200 kilometres of 3 millimetre copper wire. It is 500 metres wide and is buried at a depth of 50 centimetres.

The total cost of the plant is estimated at 4,850,000 Swedish kroner, but it is believed that the outlay will be amply justified.



# The Perfect Set.

## Part IV: L.F. Amplification: the Coupling.

[R342·7

In continuation of our last article we have a few more points about valve handling, followed by a discussion of the three best-known types of coupling.

**I**N the last instalment of this series we began the consideration of L.F. amplification, and tried to show how one could ensure by a simple and systematic method that there should not be distortion in the valves themselves, whatever occurred elsewhere. There was not space to indicate how the requirements there laid down would react on the design of the set.

We will now tackle this point, for it can be covered in not too many words. First, we cannot ensure correct filament heat except by putting an instrument in circuit. In these days of bright, thoriated and oxide-coated filaments, it is becoming quite impracticable to judge by eye. The writer's method is to bring out a lead from between rheostat and filament of each valve to a separate socket (Clix), and plug the voltmeter into each as required; the other side of the meter is, of course, connected to the common filament return.

Second, unless we propose to use similar valves throughout, we must provide separate grid and anode battery tappings. For work up to room strength, it will hardly be necessary to have *more* than one power valve; and the author refuses to consider seriously any telephony set not using one for the last stage. So that one is very likely to have two types for L.F. work. In practice, one can often work off one value of *either* H.T. or G.B. (grid bias), for there is no serious objection to using extra H.T. on an ordinary valve, providing the output is kept reasonable by correct bias, and the anode voltage is not *too* high.

At this point, perhaps one may mention a practical point which, though hardly a matter of principle or theory, is of great assistance. If it can possibly be afforded, keep a milliammeter in the plate circuit of any broadcast set. The writer has one which originally cost about 30s., and reads 10mA for full deflection. It is placed in the common return to the H.T. battery. An accurate instrument is not necessary, though very

nice to have. Its advantages are two. Any distortion *due to the valves* will show at once, for such distortion means a partial rectification of audio-frequency currents to D.C., and the pointer will swing. This ammeter is a more sensitive indicator than even a trained ear. Also, it is a valuable indicator in case of breakdown. If signals fail, but the ammeter shows its normal reading, we know at once that all plate, grid and filament circuits are intact, or, at any rate, continuous. We have only to look for coil and condenser shorts or a fallen aerial, or ring up the studio and tell them *they* have broken down.

### The Coupling.

Now, still dealing with attempted distortionless telephony amplification, we come to the intervalve coupling. For L.F. work, there are just three familiar methods:—

- (1) Resistance.
- (2) Choke.
- (3) Transformer.

It is in order to discuss shortly the relative merits of the three. Transformer coupling is generally considered to give high amplification, but to introduce distortion. There are, however, one or two transformers now available which give extremely little distortion when properly used; and there is another point to be considered. Most loud-speakers (and to a less extent, telephones) have a lower limit of frequency below which they do little, and it is of little use to make terrific efforts to get full amplification at such frequencies. If it were only a matter of a few per cent., one could find a coupling which would sufficiently emphasise the low tones to compensate. But we believe that in many cases the loudness of the loud-speaker at 50 cycles is only about one-tenth of that at 300 or 400, with the same input. In such a case, one must give up all attempts to reproduce, and can, with regret, sacrifice this part of the scale in the amplifier.

The resistance-coupled amplifier is supposed to be quiet but distortionless. In practice, it may be louder than a transformer set if there is not proper grid bias in the latter (King Charles' head again!), and a resistance amplifier may distort, howl and perform every conceivable beastliness if not properly designed.

Lastly, the choke set is described as having the advantages of both and the disadvantages of neither (by its friends) and exactly the opposite (by its enemies). In practice, it has the advantage of requiring less H.T.; but the design of the chokes (though not so difficult as the design of a transformer) is by no means so simple as sometimes thought.

### Resistance Amplification.

Dealing with the resistance amplifier, we need say comparatively little, for the subject was admirably covered by Mr. F. M. Colebrook in an earlier issue.\*

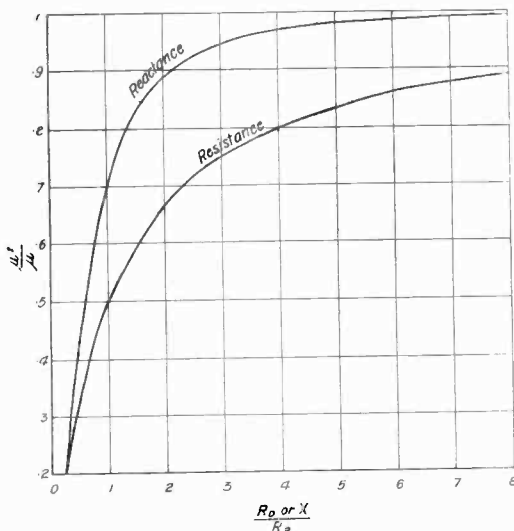

Fig. 1.

In this article Mr. Colebrook puts forward certain criticisms of transformer amplifiers which in our own opinion are unduly severe as regards sets using some of the latest designs. But as far as the resistance coupling itself is concerned there is not much to add to his article. Grid-leaks of low value

\* F. M. Colebrook. "Further Notes on Resistance-Capacity Amplification." E.W. & W.E., Sept. 1924, p. 712 *et seq.*

(250 000Ω) are recommended, and grid condensers of not less than  $.05\mu F$ : it is stated that larger condensers are not necessary, but attention is called to the very great importance of really high insulation in these condensers. Mr. Colebrook had not at the time of writing that article found satisfactory anode resistances of compact type, and was using wire-wound coils of 47 s.w.g. Eureka (constructional details were given). It is, of course, necessary to keep the self-capacity low. Personally, the writer, though not a great user of resistance amplifiers, has found a proprietary anode resistance containing a sticky liquid (nature unknown) quite reasonably satisfactory.

It is most important to realise that grid bias (again!) is even more important than ever in these amplifiers. The "time-period" of the condensers and leaks used is of the order of  $\frac{1}{50}$  second; i.e., if the condenser ever gets charged up it will take about  $\frac{1}{50}$  second to get nearly discharged, and during this period amplification will be upset. So it must never get any "permanent" charge, i.e., there must never be any grid current.

One should remember that in resistance amplifiers it is the *ratio* of outside anode resistance to valve anode impedance that matters. Hence care should be taken to use valves of impedance suited to the resistances in hand, etc. Since all the amplification in each stage has to be done by the valve, one is tempted to use valves of high  $\mu$ ; but it is well to remember that in the ordinary way such valves have also a high  $R_a$ , and hence need high resistances. An exception, of course, is the new power type especially designed for this work, with a  $\mu$  of 20 and  $R_a$  of only 20 000Ω. It is also worth remembering that modern power valves of the B4, D.E.5, or D.F.A. types, with  $\mu$  of 7 or so, have values of  $R_a$  down to 5 000Ω or less, and hence can be used with resistances of 20 000Ω. If they are used with the usual 60 000Ω or the like, it will be necessary to provide very high voltages—something like 1 000 volts. In designing anode resistances for power valves, do not forget that they may have to carry say 15mA: 47 s.w.g. wire is barely heavy enough for real safety.

### Choke Coupling.

The essential point about the choke amplifier is that it is meant to behave like the resistance type. The choke is intended

to offer to *all* audio-frequency currents an impedance nearly equal to the resistance in the other type, while having a comparatively low actual D.C. resistance. We say "nearly" equal because (as may easily be proved mathematically) we can get the same amplification with rather less impedance in a choke amplifier than resistance in a resistance amplifier. Fig. 1, for example, shows the results to be expected from each. The horizontal axis shows different ratios of external resistance or reactance to the anode impedance of the valve; the vertical axis shows the ratio of  $\mu'$ , the actual amplification theoretically obtainable for the stage, to  $\mu$ , the amplification factor of the valve; in other words the approximate efficiency of the coupling. You will notice at once that the choke coupling appears much more efficient.

But there are complications. For the choke coupling to be efficient, the reactance must be large—not so large as the resistance, but still large. But the reactance is not a constant. It is 6.28 times the frequency multiplied by the inductance in henries. So that the inductance must be so large as to give almost the full effect *at the lowest frequency we wish to reproduce*. Suppose we say that an efficiency of .9 at 50 cycles will suffice. Then if the anode impedance of the valve is 20 000 $\Omega$ , we must have a choke of about 128 henries.

This means a winding of about the same character as the secondary of an intervalve transformer. If it is to be confined in a reasonable space it will behave in a somewhat similar way to a 1 to 1 transformer; that is, it will not be a pure inductance. It will have an ohmic resistance of 1 000—2 000 $\Omega$ , and an additional effective resistance representing losses in the core. It will also have a self-capacity, which may be comparatively large. In fact, it will have (to a lesser degree, because it resembles a 1 to 1 ratio) all the peculiarities of transformers. It will *not* be free from distortion unless the skill of a transformer designer is put into it; but, even if badly designed, it will not distort so much as a bad transformer.

No detailed design can possibly be given in the space available, but the following is a basis for experiment. Choose the type of transformer you like best (or dislike least). Build a similar core of Stalloy. Wind on 10 000 turns, in four or five sections with a clear space of 1 mm. to 1/16 in. between

them, of the largest wire that will go in, the wire to be enamelled and D.S.C. if available, otherwise S.S.C. Fig. 2 shows the sort of thing, about natural size.

Apart from the choke, and the fact that normal H.T. is used instead of extra high values, the design of such a set is essentially that of a resistance amplifier.

### Transformer Sets.

As regards the transformer-coupled amplifier, the problem resolves itself into the design of the transformer in itself, on the

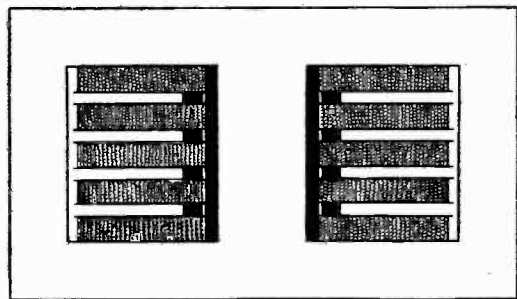

Fig. 2.

one hand, and in using a transformer suited to the valve, on the other. The question of transformer design is an extremely difficult one, but will not directly concern our readers, who will almost certainly buy their transformers. In fact, about the only item left to the user is the choice of ratio. This is simple in theory. To a first approximation, the turns ratio should be the square root of the ratio of secondary load to primary outside impedance. For example, if the load on the secondary were one megohm and the primary impedance (i.e., the anode impedance of the preceding valve) were 20 000 $\Omega$ , the ratio of these would be 50, and the turns ratio should be about 7. But there are enormous difficulties. The load put on the transformer by the grid circuit of the next valve depends not only on the valve and its adjustments, but also on the output load on that valve. Further, the transformer's own self-capacity may put a heavier load on it than the valve circuit itself.

The net result of all this is that the user can only be guided by rough approximate considerations founded on practical experience. A good empirical rule to find a

suitable ratio is : find the output impedance of the previous valve. Divide 250 000 by it. Take the square root of the result.

Thus with the average modern British dull-emitter, having an impedance of about 16 000Ω, we get  $250\ 000 \div 16\ 000$  about 16, so the turns ratio should be about 4. The next main point about a transformer is to see that it has plenty of iron in the core. This is, of course, only one of many points, but it is one that can usually be seen. The best transformer we know has a core about 1 in. square. There are few as large as this, but—unless you have definite proof of good performance—avoid transformers with mean cores.

Readers who are not advanced in their knowledge will perhaps find the long and masterly article by D. W. Dye (E. W. & W. E., Sept., Oct., Nov.), rather too much for them. But, leaving aside his argument, they would derive immense benefit by studying the conclusions, on p. 80 of the Nov. issue. Also a short non-technical abstract of the article will be found in the Sept. issue, p. 687.

In practice, the comparative strength of high and low tones, as reproduced by a transformer-coupled amplifier, may be changed easily by loading the transformer, either primary or secondary, with resistances or condensers or both.

A load on the secondary will produce the same result as a *different* load on the primary, according to the following rule : if  $r$  is the turns ratio, a condenser  $C$  on the secondary produces the same effect as a condenser  $r^2C$  on the primary ; a resistance  $R$  on the primary equals a resistance  $r^2R$  on the secondary (note the opposite effects). Hence one uses a large resistance and small condenser on the secondary. It will usually be found that a resistance below 1 megohm or a condenser above .001 will produce either loss of strength or serious muffling ; any reasonably good transformer will give its best with less loading than this.

If there are several stages, it is as a rule not necessary to load each stage individually. Obviously the desirable thing is to use such good transformers that none at all is needed.

#### Different Forms of Distortion.

Perhaps this is the place to make the general point that there are at least two totally distinct types of distortion (they may, of course, occur together, which we will call,

for lack of better terms, "wave form distortion" and "amplitude distortion." The former consists in changing the form of the audio-frequency wave, by the introduction of harmonics, or the partial suppression of those rightly present. The latter consists in a different degree of amplification for different frequencies, as for example inferior amplification of bass notes—a very common fault. Strictly speaking, these two forms are not entirely distinct, for since a harmonic is a note of higher frequency than the fundamental, "amplitude distortion" will either increase it or diminish it, and so cause "wave-form distortion." But the broad distinction is a useful one, for they sound different, and are usually caused in different ways.

Amplitude distortion makes the general tone sound high or low, or in some cases causes a very clear loss of extreme notes, such as the deep notes of an organ or the top ones of a piccolo. But the notes produced may be perfectly sweet and clear.

Wave-form distortion, if, as is most common, it is enhancing the harmonics, makes nearly every note have a shrill sound—a sort of rasp, as it were. If the reverse is happening, it gives a muffled, booming effect.

As to causes, in the vast majority of cases the valves cause wave-form distortion and the couplings amplitude distortion. The valves cause wave-form distortion (excess of harmonics) if there are any of the troubles described last month, and the couplings may cause it if there is too little iron in transformer cores (excess of harmonics), or if excessive loading condensers are used (harmonics lost). The couplings will almost always cause some amplitude distortion, though perhaps only at the extreme end of the scale. It is *possible*, using a resistance coupling and skill, to get practically even amplification from 50 to 10 000 cycles. It is not unduly difficult, using transformers and skill, to get a *sufficiently* even result from 200 to 10 000.

To sum up : *For practical domestic work* there is not a great deal between the three types ; one can be guided by the practical needs of the case.

No type is fool-proof. The resistance type, however, does not place one entirely in the hands of the transformer maker.

As a personal opinion of the writer, the matters in *last* month's article are more important than those in *this* month's !



# The Efficiency of the Counterpoise.

By *M. C. Ellison.*

[R326

Our contributor brings some evidence tending to show that the counterpoise is not so efficient as earth.

## EDITORIAL NOTE.

We publish this article with pleasure, in the hope that it may lead to discussion. The views are our contributor's, and he expressly states that he realises that the tests are not conclusive. Perhaps some readers may be able to show a fallacy.

**T**HE counterpoise has always been a sort of talisman to the transmitting amateur, as by erecting one he can nearly always greatly increase his radiation over that obtainable with the ordinary earth and consequently he imagines that his signals are carrying a correspondingly greater distance. I say "imagines" because I consider, after careful tests, that the reverse is the case. In order to carry out these tests a portable high frequency voltage measuring set was made up, consisting of a simple oscillating circuit supplying a Moullin valve voltmeter properly calibrated.

In order effectively to compare the efficiency of a transmitter using a counterpoise with one using an earth, the field strength must be measured. This was done by measuring the voltage induced in a coil tuned to the transmitted wave. The measuring set was accordingly set up first in the same room as the transmitter, which was started up, first with the counterpoise and afterwards with the earth, great care being taken to keep the radiation and the wave-length, which was 185 metres, constant the whole time. With a radiation of half an ampère the following readings were obtained: with the counterpoise 1·3 volts, with the earth 2·55 volts. The apparatus was then taken into the garden and set up about 50 yards from the aerial, a small aerial and an earth pin being used in order to get larger readings.

With a radiation of half an ampère and the transmitter connected to the counterpoise a voltage of ·3 volt was obtained,

whereas with the transmitter connected to earth the reading was ·7 volt.

As the radiation that could be obtained with a given power was greater with the counterpoise than with the earth, a test was made keeping the power constant, the radiation with the counterpoise being ·65 amp and with the earth ·58 amp. The voltages obtained were ·8 with the counterpoise and 1·35 with the earth.

It is, of course, realised that these tests are not by any means conclusive, as readings ought to be taken at long ranges and under every conceivable condition before the matter can be regarded as settled.

It would be very interesting to have the opinions of other transmitting amateurs as to the value of the counterpoise. One prominent amateur, who, by the way, was successful in the Transatlantic tests, on being shown the above figures, remarked, firstly, that he doubted them, and, secondly, that whereas using a counterpoise he could radiate three ampères, using an earth the radiation fell to one ampère.

Be this as it may, the author has certainly found that a counterpoise is a disadvantage both in transmission and reception, the only advantage apparent being the reduction of the fundamental wave-length of the aerial, which is a distinct help when working on very short waves.

## COUNTERPOISE EXPERIMENTS.

### TABLE OF RESULTS.

Position of voltmeter.	Radiation.	Voltage obtained.	
		Counterpoise.	Earth.
In transmitting room	·5	1·3	2·55
50 yds. from aerial	·5	·3	·7
" " "	·65	·8	} Constant power.
" " "	·58	—	

Wave-length 185 metres.

# The Graphical Analysis of Composite Impedances.

## Supplementary Note.

ON page 143 of our last issue, in the article by Mr. F. M. Colebrook, there will be found, at the top of col. 2, the statement that "from the geometry of similar figures it follows that

$$\begin{aligned} OC &= R_0 \\ CD &= X_0, \end{aligned}$$

in the figure given there and reproduced here.

It appears that some readers have not realised the reasons for this, so we give the proof herewith.

In justice to Mr. Colebrook, we should like to make it clear that the proof was in his original MS., but was omitted by us to save space.

In the circuit of Fig. 9 of the article (also reproduced here), call  $Z$  the true impedance between P and Q. Then,  $R_0$  and  $X_0$  being the equivalent resistance and reactance,

$$Z = R_0 + jX_0 \dots (9)$$

But from the actual circuit,

$$\frac{I}{Z} = \frac{I}{S} + \frac{I}{jX} = \frac{I}{S} - \frac{j}{X} \dots (10)$$

But from (9),

$$\frac{I}{Z} = \frac{I}{R_0 + jX_0} \dots (14)$$

Multiplying top and bottom by  $R_0 - jX_0$ , and remembering that the amplitude of  $Z$ , which we will call  $Z$ , is given by

$$Z^2 = R_0^2 + X_0^2 \dots (15)$$

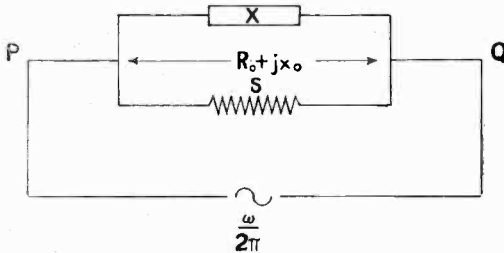

Fig. 9.

we have

$$\frac{I}{Z} = \frac{R_0 - jX_0}{R_0^2 + X_0^2} = \frac{R_0}{Z^2} - \frac{jX_0}{Z^2} \dots (16)$$

From (16) and (10), we have

$$\frac{R_0}{Z^2} - \frac{jX_0}{Z^2} = \frac{I}{S} - \frac{j}{X} \dots (17)$$

From the known properties of complex quantities, we thus have

$$\frac{R_0}{Z^2} = \frac{I}{S} \dots (18)$$

$$\frac{X_0}{Z^2} = \frac{I}{X} \dots (19)$$

or

$$\frac{S}{Z} = \frac{Z}{R_0} \dots (20)$$

$$\frac{X}{Z} = \frac{Z}{X_0} \dots (21)$$

Now in Fig. 10, by similar triangles,

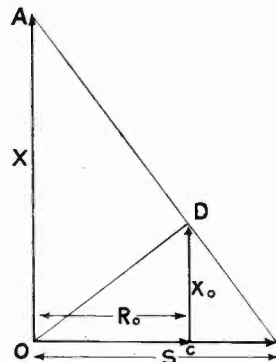

Fig. 10.

$$\frac{OB}{OD} = \frac{OD}{OC} \text{ and } \frac{OA}{OD} = \frac{OD}{CD} \dots (22)$$

hence

$$\frac{S}{OD} = \frac{OD}{OC} \dots (23)$$

$$\frac{X}{OD} = \frac{OD}{CD} \dots (24)$$

Comparing equations (20) and (21) with (23) and (24), we see that (20) and (21) are satisfied by

$$OD = Z \dots (25)$$

$$OC = R_0 \dots (26)$$

$$CD = X_0 \dots (27)$$

## Re-opening CKAC—Montreal

By E. H. Turle, A.M.I.E.E.

[R612

THE re-opening of CKAC, with its new and enlarged transmitting plant, making it one of the largest broadcasting stations in the British Empire, was followed with interest by experimenters throughout the world, and already some remarkable reports of reception have been received.

The apparatus at the station embodies many recent improvements, and Captain P. P. Eckersley, of the British Broadcasting Co., who recently visited the station, expressed the opinion that, in view of the great difficulties that had to be overcome, a most gratifying result had been achieved.

Although the new apparatus at CKAC was manufactured by the Canadian Marconi Company, Montreal, it is interesting to note that all the fourteen 2 000-watt valves used are of English make. The arrangement includes one power amplifier, three oscillators, four modulators and six rectifiers.

A special feature of this station is that the energy, before going to the modulators, is subjected to three-phase double-wave rectification by means of six valves. The ordinary public lighting supply is thus used to operate the transmitter—eliminating any motor generator—and the particular form of rectification ensures absolute clarity and tone purity in the broadcasting.

Special care has been taken that no carrier-wave noise and no generator hum of any kind can cause distortion or interfere with the faithful reproduction of voice and music, whether transmitted direct from the elaborately-arranged studio of the great Canadian newspaper, *La Presse*—which both owns and controls the station—or brought in, through remote control, from various points.

Fig. 1 shows the Marconi rectifying unit which supplies 12 000 volts to the modulators and oscillators. These six rectifying valves are mounted on a separate panel and are operated by remote control, the unit being located two floors below the operating room.

Before the converted sound energy from the magnetic type microphones reaches the actual transmitting apparatus, it is treated

to five stages of voltage amplification and also power amplification. After passing through this amplifying stage, it is passed into the transmitting power amplifiers, whence it is fed through modulators to the three oscillators and then radiated from the aerial. The aerial is suspended from towers erected on the roof of the *La Presse* Building.

The set operates on choke control, and is extremely simple to manage. In spite of its 14 valves, one operator only is required to keep the set functioning after it has been brought into action by the closing of a single switch.

The new studio has been most carefully designed and is considered acoustically perfect. An elaborate system of sliding

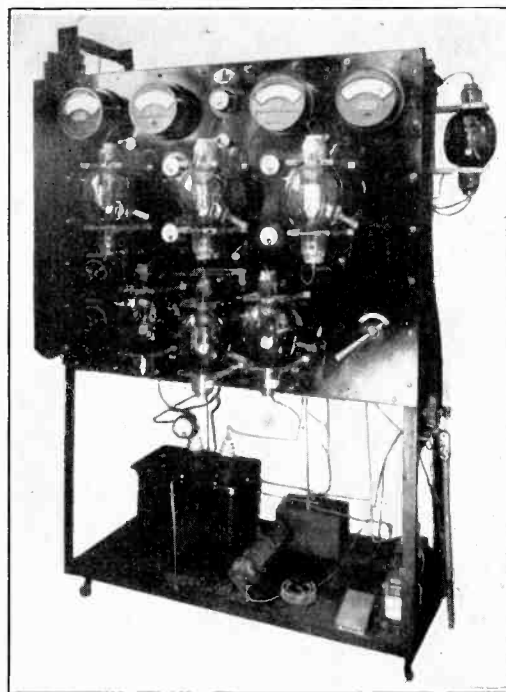

Fig. 1.  
The three-phase, double-wave rectifier, which supplies 12 000 volts to the modulators and oscillators.

curtains brings in echoes at will or deadens the studio to absolute silence when required.

Blue-lined plush curtains, Chinese reed furniture, and old ivory-finish make the studio combination. The microphone seen in the photograph (Fig. 2) is of the Marconi magnetic special type used exclusively by CKAC.

Blue, white and red lights keep the Director, Mr. Jacques N. Cartier, and also the announcers and operator in communication with each other at all times.

Although primarily intended to cater for some five millions of French-speaking people scattered throughout the various Provinces of the Dominion, several States of the Union,



Fig. 2.

Part of the luxurious studio at CDKA.

the island of St. Pierre Miquelon, the West Indies and the Guianas, with the new plant in use, there will be practically no limit to the distance which CKAC can reach. Consequently, it has of necessity become the only tri-lingual station in the world, and uses French, English and an international language — unfortunately, in spite of the ARRL decision as regards amateur work, Esperanto is not the one used.

Recently, with the courteous co-operation of the British Broadcasting Co., experimenters throughout Great Britain were invited to assist in a test reception, and among the large number of reports sent in to the writer the following may be mentioned:—

At Lelant, Cornwall, using a three-valve set, Mr. W. W. Bastain was able to follow the programme from 1.15 G.M.T. onwards, despite atmospherics, which everyone agrees were particularly bad. At Northampton Mr. S. R. Lenton, using two H.F., det. and one L.F., at 2.0 a.m. received the concert at loud-speaker strength. At Barmouth, Wales, Mr. E. G. Owen, using a two-valve reflex set, and at Bridgend Mr. David Thomas, using I-V-I, were also successful.

Under favourable conditions, CKAC is also regularly heard in Alaska, Denmark, France, Italy, etc., and is now reported to have been heard in New Zealand and, it is said, even in India.

## A Well-Equipped Ship.

[R610

IT is interesting to compare the wireless equipment of ships nowadays with the pre-war standard of one spark set with emergency gear. A case in point is R.M.S. *Aorangi*, now being built for the Union Steamship Co. of New Zealand, the equipment of which will comprise both spark and C.W. transmitters (the latter having a range of 2 000 miles), an automatic call device, direction finding instruments, and a wireless telephony set for ship to shore communication with a range of 50 miles. A special aerial is to be provided for broadcast reception, and in connection with this 17 loud-

speakers are to be installed. Two motor lifeboats will be fitted with  $\frac{1}{4}$ kW spark sets having a range of from 50 to 60 miles.

Spark transmission will be handled by a  $1\frac{1}{2}$ kW Polar synchronous set with a range of 800 miles and this will have an emergency stand-by gear. Other features include a special receiving set, employing the latest receiver and oscillator and a new note-tuned amplifier, which it is claimed is highly selective and immune from atmospheric disturbances, and covers all waves up to 20 000 metres. The whole of the apparatus is being supplied and fitted by the Radio Communication Co.



# The Rejector Circuit—its Theory and some Applications. [R140

By O. F. Brown, M.A., B.Sc.

**R**EJECTOR circuits consisting of a coil in parallel with a variable condenser across which high frequency alternating potentials can be applied, have been used since the days of crystal reception; and the introduction of the three-electrode valve has still further extended their application. Nevertheless the explanation of their action as given in popular text books is often very inadequate. In the present article the theory of such circuits is considered both in the case when the resistance of the coil is neglected and in the case when this resistance, still assumed small, is taken into account. Some applications of such circuits in modern receiving apparatus are then described and explained.

Let us consider an alternating high frequency E.M.F. of maximum value  $E$  applied to the circuit of Fig. 1 consisting of a coil of self-induction  $L$  and a condenser of capacity  $C$ . Let the frequency of the

applied E.M.F. be given by  $n = \frac{\omega}{2\pi}$ .

Assuming that the circuit  $LC$  has no resistance losses, then the maximum current in the coil is

$$I_L = \frac{E}{\omega L}$$

This current will lag behind the applied voltage by an angle of  $90^\circ$ .

The maximum value of the current in the condenser will be given by

$$I_C = \omega CE$$

and this current will be leading the applied voltage by an angle of  $90^\circ$ .

The two currents  $I_L$  and  $I_C$  are thus  $180^\circ$  out of phase and the current in the leads to the source of the alternating applied voltage is given by

$$I = I_L - I_C = \frac{E}{\omega L} - \omega CE.$$

If the circuit is tuned to the frequency of the applied E.M.F., then  $\omega^2 LC = 1$  and therefore  $I_L = I_C$ , and current  $I$  is zero. The rejector circuit  $LC$  therefore acts to the applied E.M.F. as if it had an infinite impedance.

The application of the E.M.F. to the rejector circuit, since there are no ohmic losses, will result in an oscillation being built up in the circuit itself. The energy for this oscillation will be stored alternatively as magnetic energy round the coil and as electrostatic energy in the condenser. The maximum value of this large oscillating current will be, since  $\omega^2 LC = 1$ .

$$I_L = I_C = \omega CE = E \sqrt{\frac{C}{L}}$$

If the rejector circuit is not tuned to the same frequency

$\frac{\omega}{2\pi}$  as the applied

E.M.F., but to some other frequency, the difference between  $I_L$  and  $I_C$  is no longer zero, and the

rejector circuit will now allow a current  $I$  in the outside connections. It can easily be seen that the current through the condenser will be greater than that through the coil if the frequency of the applied E.M.F. is *greater* than that to which the rejector circuit is tuned, and conversely that the current through the condenser will be less than that through the coil if the frequency of the applied E.M.F. is *less* than that to which the rejector circuit is tuned.

If the rejector circuit is tuned for a particular frequency, the values of the capacity of the condenser and the self-induction of the coil can be varied so long

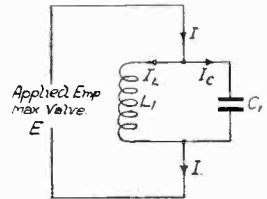

Fig. 1.

as their product  $LC$  retains its proper value. For a frequency of the applied E.M.F. not equal to that for which the rejector is tuned the difference between the currents  $\omega CE$  and  $\frac{E}{\omega L}$  will be larger, the greater the ratio  $\frac{C}{L}$  and therefore the larger will be the current  $I$  passing through the circuit. Thus the greater the ratio  $\frac{C}{L}$  the less is the impedance offered by the rejector to an E.M.F. of non-resonant frequency.

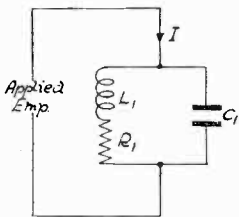

Fig. 2.

We have hitherto considered the rejector to be entirely without resistance losses. If, however, the coil has an ohmic resistance  $R$  the circuit can be represented as shown in Fig. 2. In this case the current  $I_L$  will

be equal  $\frac{E}{\sqrt{R^2 + \omega^2 L^2}}$ . This current will not now be lagging  $90^\circ$  behind  $E$ , but will lag by an angle  $\phi$  given by  $\phi = \frac{L\omega}{R}$ . If it is assumed

that the condenser possesses no resistance the current through it will, as before, be given by  $I_C = \omega CE$ , and it will lead the applied voltage by  $90^\circ$ . The magnitudes and phases of  $I_L$  and  $I_C$  can be represented by a vector diagram as shown in Fig. 3. It is seen from this diagram that current  $I_L$  can be resolved into two components: (1)  $I_L \cos \phi$  in phase with the applied E.M.F., and (2)  $I_L \sin \phi$   $180^\circ$  out of phase with the condenser current.  $\sin \phi$  and  $\cos \phi$  being given by

$$\sin \phi = \frac{L\omega}{\sqrt{R^2 + \omega^2 L^2}} \text{ and } \cos \phi = \frac{R}{\sqrt{R^2 + \omega^2 L^2}}$$

If now the rejector circuit is tuned to the frequency of the applied E.M.F. then the component  $I_L \cos \phi$  represents the current flowing through the circuit from without, while the component  $I_L \sin \phi$ , which is opposed to the condenser current makes up the oscillating current in the rejector circuit itself.

The current in the outside circuit is thus given by  $I = I_L \cos \phi$ .

$$\begin{aligned} &= \frac{E}{\sqrt{R^2 + \omega^2 L^2}} \cdot \frac{R}{\sqrt{R^2 + \omega^2 L^2}} \\ &= E \cdot \frac{R}{\omega^2 L^2} \text{ approximately, if } R \text{ is small} \\ &= E \cdot \frac{RC}{L} \text{ since } \omega^2 LC = 1. \end{aligned}$$

Similarly  $I_C \sin \phi = \frac{E}{\omega L}$  approximately.

Thus the circuit acts to the applied E.M.F. as if it were a non-inductive resistance of value  $\frac{L}{RC}$  ohms.

The oscillating current as before is given by  $E \sqrt{\frac{C}{L}}$

In cases where the frequency or the applied E.M.F. is not equal to the frequency for which the rejector is tuned, there will flow in the outside circuit the same current as found above in phase with the applied voltage, and in addition a current out of phase by  $90^\circ$  with the applied voltage and equal to the difference between  $I_C$  and  $I_L \sin \phi$ .

Rejector circuits have been and still are largely used in receiving apparatus as devices for reducing interference. A method of so using the rejector is shown in Fig. 4. The rejector circuit  $L_2 C_2$  is connected or disconnected from the aerial circuit by the switch  $K$ . The aerial circuit  $L_1 C_1$  is first tuned,  $K$  being open, to the wave it is desired to receive.

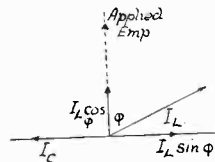

Fig. 3.

The circuit  $L_2 C_2$  is then similarly tuned. These two circuits are then connected in series as shown. Since the inductances  $L_1, L_2$  and the condensers  $C_1, C_2$  are both connected in series it can be easily seen since  $L_1 C_1 = L_2 C_2$  that the whole aerial circuit thus formed is still tuned for the frequency for which the separate circuits  $L_2 C_2$  and  $L_1 C_1$  were previously adjusted.

The rejector circuit is now adjusted to the frequency for which the aerial has been tuned and key  $K$  is closed. Then any signal for

which the aerial has been tuned will find an easy path through the circuit  $L_1C_1$  while the retractor circuit, assuming that its resistance losses are low, will present a very high impedance to the signal. On the other hand interfering signals find an easy path through the retractor, while the circuit  $L_2C_2$  offers a high impedance to them. Interference is therefore eliminated to a large extent.

From what has already been said it is clear that in order to design the retractor circuit so as to act most efficiently as a preventer of interference it is necessary that the coil and condenser should have as low losses as possible. The presence of the

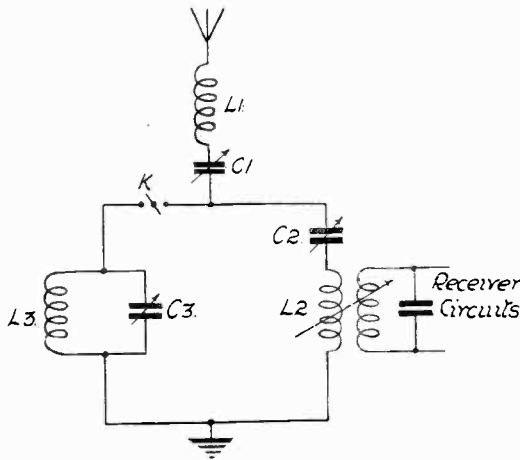

Fig. 4.

retractor circuit will reduce somewhat the strength of the current through the circuit  $L_2C_2$  due to the signal it is desired to receive. Since the effective resistance of the retractor

circuit is given by  $\frac{L}{RC}$  it is clear that an easier path to earth is provided for the interfering signals when the circuit is so

designed that the ratio  $\frac{L}{C}$  is made as small as possible. Unfortunately, however, when this is done the effect of any resistance in the retractor circuit causes a greater loss of current in the circuit  $L_2C_2$  than is caused for

larger ratios of  $\frac{L}{C}$ . This is a further reason for keeping the losses in the circuit as low as possible.

When a particular signal only is to be eliminated a retractor circuit is sometimes introduced in series in the aerial circuit as shown in Fig. 5.

In this case the retractor circuit is tuned to the wavelength of the signal it is desired to cut out. The circuit then imposes a high impedance for the waves of the undesired frequency, which are accordingly damped out.

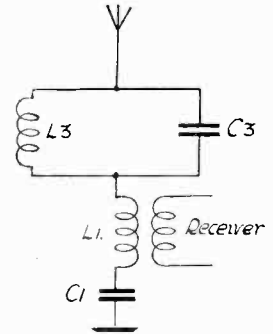

Fig. 5.

The use of reaction by a thermionic valve obviously provides a means of reducing the resistance of a retractor circuit; although it need hardly be said that such reaction will not entirely compensate for a badly-designed retractor circuit. The method is illustrated in Fig. 6, where the resistance of the retractor circuit  $L_3C_3$  is reduced to practically zero by adjustment of the reaction coil M.

This method of reaction reduction of the retractor resistance is employed in the Hinton receiver, which has recently been patented. Receivers on this principle are largely used at Post Office high-power stations. The aerial is coupled to a tuned receiving circuit and the oscillations induced are led to the grid of the first valve. The applied voltage then produced acts across a retractor circuit (tuned to the frequency of the wave it is desired to receive) which is connected between the grid and filament of the first valve as shown in Fig. 7. The resistance of the retractor is reduced by

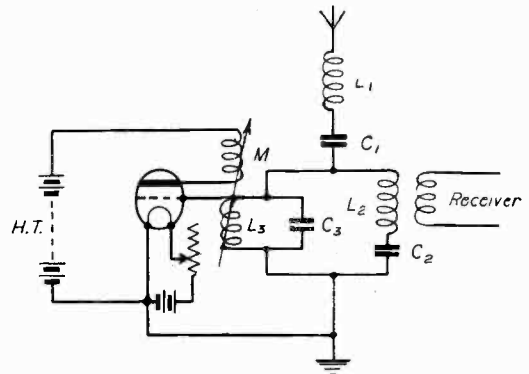

Fig. 6.

means of a reaction coil brought from the plate circuit of the second valve. The rejector thus possesses a very high impedance

This arrangement has the advantage of allowing the high-tension battery to be connected to the plate through the low resistance of the coil instead of by the high resistance R. But in addition it allows the amplifier to be made more selective, since, as we have seen, the impedance offered by the rejector depends on the tuning of the circuit. As already pointed out the tuning of the rejector circuit becomes critical when the resistance of the coil is decreased. Professor Fortescue\*

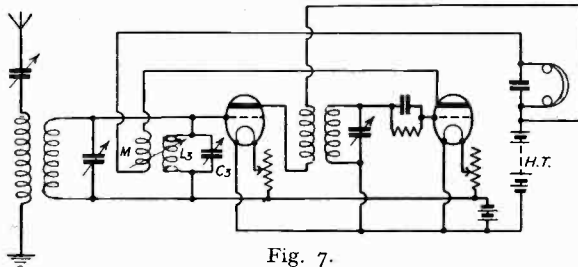

Fig. 7.

for signals of the desired frequency, while for other signals it practically short circuits the grid and filament of the first valve. The apparatus is thus highly selective.

Apart from its use as an anti-jamming device, the principle of the rejector is largely employed in radio frequency amplifiers as the well-known tuned anode method of coupling. Fig. 8 represents the first three valves of a resistance-capacity coupled amplifier. The effect of a high-frequency potential applied to grid G, is to cause a variation of the plate current in accordance with the anode current grid voltage characteristic. There is therefore a corresponding change in the potential of the plate which is equivalent to the drop in voltage across R. Thus if  $e_p$  and  $i_p$  are the instantaneous values of the change of plate voltage and current  $e_p = i_p R$ . This variation of voltage is, of course, transferred to the next grid by the condenser C. Now we have seen that the rejector circuit behaves as if it had a non-inductive resistance

given by  $\frac{L}{RC}$ , hence a properly-designed rejector circuit can be substituted for the high resistance R.

has pointed out that the more critical this tuning the less will be the amplification at other frequencies than that for which the rejector is tuned, and that with large values of  $\frac{L}{C}$  the damping due to the rejector may render the circuit practically aperiodic. Thus a circuit having a high ratio  $\frac{L}{C}$  provides the reverse of a selective amplifier. If on the other hand it is desired to make the amplifier selective this ratio must be decreased.

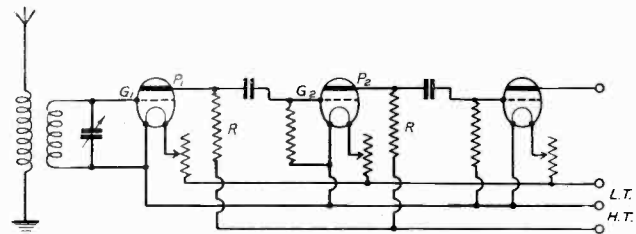

Fig. 8.

\* Fortescue; "Design of Multiple-Stage Amplifiers," *Journal of Inst. of Electrical Engineers*, 58, page 66, 1920.

**VALVE TESTS.**

We have received a number of interesting valves for test this month, but owing to extreme pressure on space we are unable to publish the reports. Records of some crystals tested by our new method will be found on page 242.

**LOW POWER TRANSMISSION.**

Monsieur Perroux (8BV) has reported that he has succeeded in being heard in England by 5KO whilst using only .003 watt input, with 3.5 volts on 1 filament, instead of the normal 5.6 volts. He is shortly going to attempt to reach England with an oscillating regenerative receiving circuit.



## Remarkable Reception of "KDKA" in Johannesburg.

[R540

*By Victor Hart.*

**I**N the first week of October the wireless enthusiasts of South Africa were astonished to learn that two Johannesburg men had been receiving KDKA—the Westinghouse Electric Manufacturing Co.'s station at East Pittsburg, U.S.A.—on a loud-speaker. Messrs G. Boot and M. F. Lowe have been experimenting for a considerable period and long before the first broadcasting station in South Africa was opened in July, 1924 had worked conjointly in picking up morse from widely distant stations all over the world. Although satisfactory, such reception of dot and dash *via* headphones was just personal to themselves and it seemed a selfish form of amusement unless their friends could also participate. Moreover any listening-in to morse had reached the ordinary stage for hundreds of other experimenters in South Africa so that the logging of results led no further than friendly enthusiasts elsewhere.

Messrs. Boot and Lowe had read much concerning KDKA and of how this station had been received by British amateurs. What Britain had achieved ought surely to be possible for earnest investigators 5 000 miles from London and approximately 7 500 miles wireless distance from Pittsburg. So argued these gentlemen; and in recounting the steps which led finally to success it must not be forgotten that the definite aim was *loud-speaker* reception, of sufficient strength to be heard in every room of any ordinary house. Both are young men, neither wealthy nor with leisure from their ordinary occupations than evenings and week-ends.

Deciding upon a five-valve set (two H.F. one D. and two L.F.), the experiments to "secure" KDKA commenced in January, 1924 and several circuits were temporarily wired to discover which would best bring

in Cape Town regularly on an amateur's transmission at the approximate distance of 850 miles. Each of these experiments involved complete dismantling of any rejected circuit and building up afresh with pretty well the same components, and at that early stage many uncanny peculiarities surrounding the use of ebonite were brought to light. The presumably best circuit—not the one given in the accompanying theoretical circuit—having been selected, there came the nerve-racking experience of all-night watches undertaken alternately by Mr. Boot and Mr. Lowe. Johannesburg is, to the nearest fraction of a second, seven hours in advance of Pittsburg time of day; this important fact was settled recently by regular comparison between the Pittsburg time-signal at that station's local time of 10 p.m. and the Union's Government Observatory time sent our daily from Johannesburg. (By courtesy of the astronomers on night duty in Johannesburg it was found by aid of the ordinary telephone service that the last stroke of Pittsburg 10 p.m. signal coincided with the dead fifth of a second last stroke of the official time clock in Johannesburg at 5 a.m.) The difficulty of trying for KDKA was that no definite information was then available as to what time in the evening the program commenced and finished. Nor was the exact wave-length known to anybody here other than a low wave somewhere between 100 and 120 metres.

For morning after morning from 2 a.m. until dawn attempts were made to bring in the elusive sounds, no small task when the experimenter's daily work had to be faced with but two or three hours' sleep. Convinced that the final circuit selected was correct, the next stage in progress was to modify details, step by step, so every possible arrangement of aerial was tried and then

all the different commercial types of coils. Eventually they were reduced to winding their own coils, and between 70 and 80 were tried out up to July, 1924, when, in the early hours one morning, success was attained on one pair of phones. To bring in a loud-speaker was next tackled, and here came one of the greatest difficulties, by reason of the difficulty of procuring any satisfactory variable grid-leak. Experiments in this direction are being continued, combined with reducing capacity to the absolute minimum. Ebonite leakage has proved a stumbling block against killing capacity, and Messrs. Boot and Lowe contend attention should be concentrated by all experimenters on this important subject. The quantity of current coming through from so distant a station as KDKA is so small that no loss in the receiving set can be afforded. (Despite the universal popularity of ebonite and kindred substances for reasonable insulative purposes and ease of working in the hands of amateurs, the writer holds the opinion that porcelain or some other proved insulator may supplant ebonite).

Three days prior to forwarding these notes a few well-known wireless men were invited to a demonstration at the house, which is situated some four miles from Johannesburg Town Hall and partially screened by a hill immediately at the rear. The height of the house above sea level is, approximately, 5,800 feet. In the following remarks the corresponding Pittsburg times are given by P and figures in brackets. At 12.55 a.m. (P 5.55 p.m.) KDKA was tuned in as easily as JB (Johannesburg) the item received being a Spanish dance by the Westinghouse band: at 1.8 a.m. (P 6.8 p.m.) came a cornet solo, remarkably clear, practically perfect in purity and without distortion. At 1.15 a.m. (P 6.15 p.m.) came an orchestral selection from Mendelssohn's "Midsummer Night's Dream"; for this item the aerial lead-in was cut out of circuit and the terminal on the set joined up to a 10-foot length of ordinary 16 gauge wire slung across the room to the wood picture rails by a couple of nails, and reception was just as perfect. The announcer then gave several baseball scores, his voice in natural tones sounded as though he was speaking loudly in some other room in the house, the American accent being very noticeable; for this item the piece of strung wire was retained but the earth wire

disconnected altogether without making any difference to reception. Pittsburg's afternoon session concluded just on 1.30 a.m. (P 6.30 p.m.) with a children's song, "How do you do-de-do," every word clearly rendered. This was, perhaps, the most remarkable item so far, because none of the local audience had heard this before, yet could understand all words in the refrain and chorus. This finished for a short while the demonstration until 3.5 a.m. (P 8.5 p.m.), when Mr. Lowe quickly adjusted for a few moments and a lady sang an unknown solo. Other items followed, and at 3.40 a.m. (P 8.40 p.m.) the Westinghouse band sent a splendid selection announced as "Plantation Melodies," which literally filled the house, the local audience doing their utmost to drown the band by voicing all the old choruses. Just before 5 a.m. (P 10 p.m.) the single inside house wire was cut out and an ordinary frame or loop aerial was joined up, the time signal coming over so clear and loud that it seemed incredible that the bell strokes were annihilating the thousands of miles distance; the last stroke agreed with Johannesburg local time to a second. So reception continued on the frame aerial until after sunrise at 5.30 a.m.

#### Some Technical Details.

Since the first week of August, 1924, Messrs. Boot and Lowe have not experienced a single failure to get Pittsburg whenever they desired, and on this point the type, height or length of aerial seemingly makes not the slightest difference. A very amateurish aerial, in form of a few yards of uncovered single wire carried a few feet above the ground and just an ordinary shell insulator each end with a roughly improvised earth connection from set to an externally dry waterpipe going into dead dry ground was equally successful, with 30 volts high tension in circuit. A lead-in from the centre of this rough aerial could not alter reception. Nor does "direction" of the frame aerial make any audible distinction, any way giving good results. The regular outside aerial has a length of 60 feet including lead-in, at a height of 35 feet and is composed of 7/22 bare copper.

The theoretical diagram provides full information of the lay-out, connections and values of components. Four tuning coils are fitted, and the equipment includes a grid bias battery, shown on the diagram between

the fourth and fifth valves. At the bottom left corner is a somewhat unusual addition: in circuit with the "earth" is a 300-ohm variable resistance, with a short-circuiting switch. (An ordinary potentiometer is used.) By means of a two-way switch the coil can be put either directly to earth or through the 300 ohm potentiometer. The experimenters state that the "mystery box," so named by their friends, may be used with advantage on a 10-foot indoor aerial or frame aerial.

As regards easy tuning in of KDKA, Messrs. Boot and Lowe kindly give the following hints applicable to South African

strength or loudness the music or speech increases in speed in a series of waves, becoming faster and faster, just as though the conductor of the band or the singer in a solo had accelerated the pace. Presently, speed of reception goes back to normal and soon after the speed is reduced below the regular standard and may perhaps return to normal, or may go up and down, still in wave-like form. Any attempt to follow these speed variations by the slightest motion of the tuning controls instantly cuts out KDKA, and experience on many mornings has definitely proved it best temporarily

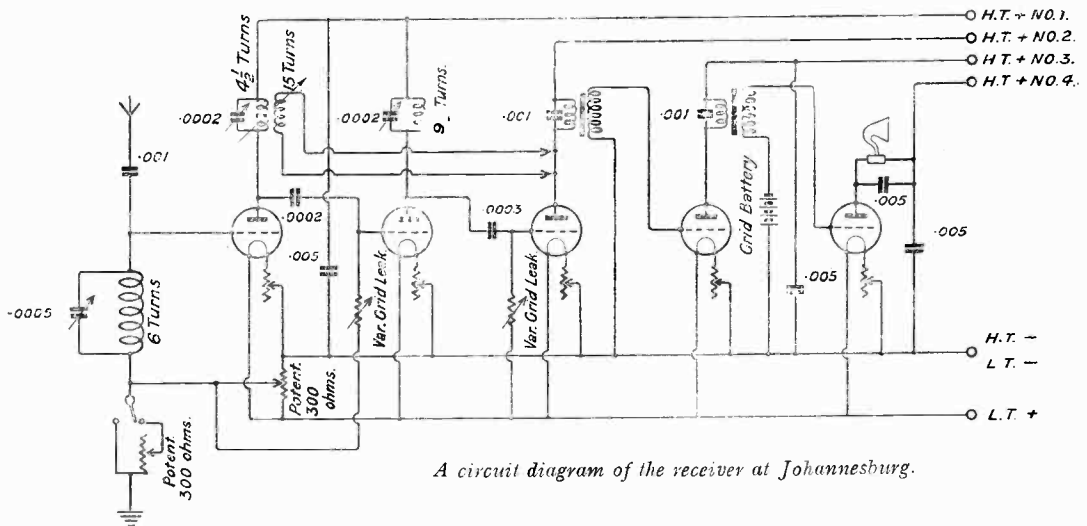

A circuit diagram of the receiver at Johannesburg.

experimenters, and such may be equally useful to British enthusiasts. In this matter particular regard must be paid to the fact that the wave-length of JB (Johannesburg) is 450 metres. Insert in the three-coil holder a set of low wave-length coils and tune in JB on these coils. Leave at this setting and it will be discovered that there are two or three positions where JB comes in and disappears when the tuning condenser knobs are moved. Leave JB tuned in at any one of these "in" positions and almost exactly at that spot or position the KDKA wave-length will come in. If the set oscillates too much, reverse the reaction coil. The Pittsburgh wave-length is 102 metres.

On some occasions a most peculiar effect has been observed which is distinct from fading or dying away. Without variation in

to put up with the slight annoyance and just not attempt adjustments. The type of "fading" that so many South African experimenters have frequently noticed as regards Johannesburg and Cape Town broadcasting stations, has not been noticed on a single occasion from KDKA. Other than the rise and fall of speed above mentioned, continuous reception is invariable. Still another peculiarity relates to night and daylight reception. Most people assert that reception from distant stations is best during darkness, but the Johannesburg experimenters are positive that strength appears to be better from 4.30 a.m. to 6 a.m. corresponding to Pittsburgh 9.30 p.m. and 11 p.m. At the time of writing, in Johannesburg dawn is about 5.0 and sun rises a very few minutes later.

## Long-Distance Work.

By *Hugh N. Ryan (5BV)*.

[R009·2

Work with Australia and New Zealand, and extra-low-power transatlantics, are the most notable features.

**L**AST month I reported in detail our first work with New Zealand, and a hurried "Stop Press" note was included about the similar contact with Australia. At that time, the New Zealanders were still coming in well and regularly, whereas the Australians were only heard occasionally, and not too well.

Soon afterwards, however, the New Zealanders almost disappeared and it became a daily practice for most of our stations (as one of them expressed it) to "come on and listen to 2OD working Australia." This is practically what did happen. 2OD, having once "hooked" Australian 3BQ, worked him easily every evening for some time, while the rest of the gang listened in silent wonder.

The wonder lasted a long time, but it was not silent for long, and soon one could listen in the early evening any night, and hear, apparently, every station in Europe calling Australia.

In this connection one very curious (and happy) event took place. British 5LF had listened to the noise for several evenings, and was considerably amused at the random way in which every Continental station called Australia at once.

Most of our stations were also calling Australia, without any success. 5LF himself had never heard an Australian, and doubted the ability of anyone else (except 2OD) to do so.

However, wishing to test the transmitter one night, he started it up during this time. Instead of calling "Test"—having heard all the others doing the same—he called Australian 3BQ. He then changed over to listen to the noise again—and heard 3BQ answering him!

This would appear to be the approved method of accomplishing super-DX this year!

While the New Zealanders were, in their time, best heard at about 7 a.m., and

occasionally at about 7 p.m., the Australians appear the other way round, but their best time by far is the evening. As far as I know, two-way work between here and Australia has never been accomplished in the morning, though the Australians are sometimes heard then, as, indeed, they appear to be at all sorts of queer times during the day. 6FG reports hearing a 3VV at 2 p.m., and 6LJ once heard A2DS at 4.30 p.m.!

Reception of the Australians seems to be good all over the country, most of our well-known stations regularly receiving 3BQ quite well.

A2DS has also been heard by a number of stations, though reports seem to indicate that he is not so well heard in London as elsewhere. I have not yet heard him myself. A2CM is one of the best stations in Australia, but apparently does not reach this country very well. I have heard him once myself, but I have no other reports of him. 3AL has been received by 5MO and myself.

Compared with the number of our stations who worked New Zealand, very few have worked Australia. 2OD has done by far the best work in this direction, and I think the only other successful stations, so far, are 2KF, 2SZ, 2NM and 5LF. The great trouble, of course, is that the period during which the Australians can be worked falls in broadcasting hours, and anyone who transmits on full power (or, for that matter, any power) at this time brings down upon his head the concentrated wrath of numberless people. The Post Office have given permission to most of us to use full power in the evenings, so long as no broadcasting station is on at the time, but such a time does not exist. It happens that the best time for Australian work falls between 6.30 p.m. and 7 p.m., when, hitherto, there was often an interval in the programs, but immediately the Australian work started this interval seemed to cease.



A coincidence, doubtless, but one would have thought it a courteous action on the part of the B.B.C. to allow us that half-hour interval. It is difficult to imagine the Americans being prevented by broadcasting from working the Antipodes. As it is, we can only work Australia on Sundays.

American and Canadian work is now going on regularly. It may be my imagination, but somehow this work does not seem so satisfactory as it was last year. I suppose the difference in wave-length accounts for it. When we are listening to Americans we don't hear our own stations if they call us, and similarly, the Americans don't hear us when they are only listening for their own men. This has its great advantage in minimising QRM once we are connected, but it seems very difficult to attract the attention of the man you want.

However, judging by reports, others are not finding this as bad as I do. 5LF worked 40 Americans in the 40 days ending December 8. He has also worked an Australian and two New Zealanders in this time.

2JF is doing splendid work this winter on a hastily-assembled station. He has worked 40 times across the Atlantic, with 26 different stations, in a month, and has also worked New Zealand 4AG and received Cuban DZ and the U.S. Airship *Shenandoah*.

6NF is now QSO America and Canada, as are 6LJ, 5MO and 6VP, thus bringing several of our well-known lower-power stations of last year into the transatlantic "gang."

6LJ is now heard all over America, even on the Pacific coast, and the number of Americans he has heard approaches a thousand.

5RZ, the famous "unsuccessful transatlantic station," has forfeited his right to this title, having worked a number of Americans during December. Denmark is at last in touch with America, 7EC having worked in 1BDT several times.

One of the strongest of the Americans now working on 80 metres is 4SA. This station is in Porto Rico, which, though a considerable distance from the mainland, is included in the American fourth district. British 6NF has the distinction of being the first European to work with Porto Rico. 6NF has also, by the way, been heard in Iraq, Asia.

The record of my own transatlantic work this month is best kept well in the back-

ground, as I have been altering my transmitter, and have not sufficient time yet to do it properly. Its range at present does not seem to be as great as might be desired, judging by results across the "Pond."

While all this work has been conducted by the higher-powered stations, some interesting low-power work has also been going on in Europe, and also some very good results obtained on the reception side.

6XG is reaching out well with a T.V.T. unit as H.T., and works Finland regularly in daylight. He is receiving Americans in large numbers, and also hears Australia 3BQ.

5KO, once in the first flight of "high-power" men, is now a zero-power station as far as transmitting is concerned, but is on the air again with a receiver, and hears all there is to hear, including Australia and New Zealand. He particularly wishes me to state that his absence from the transmitting ranks is not due to his recent marriage, as the "OW" is a keen "lady Op."

6QB has managed to reach the American fifth district with  $3\frac{1}{2}$  watts input! 6NH is working Finland and Luxemburg on low power and has heard A3BQ.

Mr. F. R. Neill, of Co. Antrim, Ireland, who did some very good reception of low-power English phone stations last year, is now obtaining equally good results from Americans, Australians and New Zealanders.

Before concluding, I must thank all those who have sent me in reports. The response to my request for these was very good indeed, but I hope to get even more next month. For some reason I have heard nothing from Scotland. Our old friend 5JX has now come to London, and, as far as I know, 2OA is the only active transmitter left up there.

Will someone please step into the gap and let me know what is happening in that part of the world?

Some of the northern English stations have taken to sending me weekly reports, which help me considerably. I should be grateful for more such.

What is happening in the Irish Free State? I suppose there are some enthusiasts there, and I shall be very glad to hear from them, for personal as well as public reasons. It grieves me to think that the "little bit of Heaven" knows not of DX.

Don't forget those reports. Let me have them by the 10th of each month. Foreign reports are as welcome as British ones.

## Some Crystal Test Results. [R374·009

Below we give the first results of tests on the new system explained elsewhere in this issue. Many other crystals are in hand, and will be reported as soon as possible.

**W**E give, in the following paragraphs, some results of crystal tests by the method now adopted. Reference to the tests is made in our "Editorial Views" and also in our article on p. 200. But we should like to repeat that the results must be considered provisional at present. Recapitulating briefly, the method is to apply an H.F. voltage of frequency about 795 000 (377 metres), to measure the input and output power, and to find from these the equivalent H.F. resistance (considered as a shunt across the circuit) and the actual efficiency as a power transformer. The crystal works into a load of 10 000 ohms, which we consider an average figure for the audio-frequency impedance of average present-day phones; and voltages varying from 1·0 to 0·1 are applied. Five points, taken as they come, are tested at 5V, and a sixth is tested at various voltages.

### Exolo.

A nice clean-looking galena, grain about 30 to the inch. Two samples supplied by Messrs. H. De Kanningh, 14-15, D'Arblay St., W.1, sold at 1s. One sample tested. Five points, taken as they came and tested at 5V input, gave percentage efficiencies of 31, 22, 32, 31, 22 (av. 29). The H.F. resistance was fairly high for most points, being 27 000, 21 000, 11 000, 70 000, 5 500 for the five points. A sixth point tested at varying voltage, gave 28 per cent. at 1V and 24 at 3V, the H.F. resistance varying from 13 000 to 34 000. Owing to the comparatively high resistance, we could not get figures for 1V, as the input was too low to measure. The output was

about  $\frac{1}{10\ 000\ 000}$  watt: the input was, of course, larger, but as explained in our article on the subject, measurements at high frequency are not so easy as for D.C.

### Radiolyte (long range.)

One sample of each two types, submitted by H. Renshaw, 174, Oxford Rd., Manchester. Test of the other type deferred to a later issue. Sample about  $\frac{1}{4} \times \frac{1}{4} \times \frac{3}{8}$  in., supplied in tube at 1s. 6d. Of typical appearance; grain about 40 to the inch. Five points taken as they came gave percentage efficiencies of 33, 54, 51, 40, 45 (av. 45); the H.F. resistances were

8 800, 12 500, 14 000, 21 000, 11 500. A sixth point tested at various voltages was free from the usual pronounced tendency to exhibit a falling off in efficiency at lower voltages: it ranged between 40 and 50 per cent. throughout. The H.F. resistance, on the other hand, rose in the usual manner from 5 400Ω at 1V to 25 000Ω at 0·1V.

### Dearnite.

Sample submitted by Mr. J. A. Dearnley, 8, Belle Vue Street, West Gorton, Manchester. Sample about  $\frac{1}{4}$  in. cube, ready-mounted in Woods' metal, supplied at 1s. 6d. A lustrous large-grained galena (16 or 20 to the inch). Five points, taken as they came, showed a most excellent per cent. efficiency, the values being 20, 75, 61, 60, 72 (av. 58). Leaving out the one comparatively poor point, the average was 67 per cent. The resistances were 7 000, 13 000, 13 000, 17 000, 14 000: it is obvious that the point of lower efficiency was passing too much reverse current. A sixth point tested at various voltages gave an almost constant efficiency of 65-75 per cent. right down to 2V: the input power at 1V was below measurement with present apparatus. H.F. resistance varied between 10 000Ω and 27 000Ω, increasing steadily as the applied voltage fell.

### Ethita.

Submitted by "Bright" Co., Crouch End, N.8. A fairly lustrous galena of large grain (16 or less to the inch.) Sample about  $\frac{5}{16} \times \frac{5}{16} \times \frac{3}{8}$  in., supplied at 6d.—1s 6d. Five samples submitted, one taken at random. Five points taken as they came and tested at 5V showed percentage efficiencies of 85, 64, 93, 55, and 96 (av. 75). Some of these were so exceedingly high that we suspected an error somewhere, but we could detect nothing wrong. The H.F. resistances were 21 000, 24 000, 31 000, 16 000, and 27 000. A sixth point tested at various voltages gave rather lower efficiencies, with the peculiarity that the efficiency *increased* at low voltage: it varied between 48 and 87. The H.F. resistance was low at large voltages (7 100) and increased to 47 000 at 1V. It would seem that the higher voltages caused reverse current.

An exceptionally efficient crystal.

# A Short English-Esperanto Dictionary of Radio Terms.

[R800

(Reprinted from "International Language" by permission.)

With the aid of this comparatively small list of words, readers who mastered the grammatical construction of the language given in our last issue, will realise that they can express much more than might appear to be the case, since, by substituting the adjectival ending "a" for the noun ending "o," and so on, many words may be added to the vocabulary.

**T**HE following Dictionary contains most of the words and phrases used in amateur radio, with their Esperanto equivalents. Acknowledgment is made to the *Radio Annuaire*, published in Paris, whose five-language supplement of radio terms, with Esperanto addition compiled by Dr. P. Corret, was of great assistance.

**A**

**Accumulator**, akumulato.  
**adjustable**, alĝustebla, variigebla.  
**aerial, antenna**, anteno; **artificial**, artefarita; **cage**, kaĝforma; **directional (fixed)**, direktita; **frame**, kadra anteno, kadro; **funnel-shaped**, funela; **horizontal**, horizonta; **L-shaped**, L-forma; **open**, nefermita; **receiving**, riceva; **sausage**, kolbasa; **sending, transmitting**, senda; **trailing**, pendanta; **T-shaped**, T-forma; **umbrella-shaped**, ombrela; **vertical**, vertikala.  
**alternating**, alterna; — **current**, alterna kurento.  
**alternator**, alternatoro, alternilo; **high-frequency** —, altfrekvenca a.; **induction** —, a. kun turna fero; **motor alternator disc set**, motoralternatora grupo kun diska sparkilo; **multiphase, polyphase** —, multifaza a.; **turbine** —, turbo-alternatoro; **two-phase** —, du-faza a.  
**aluminium**, aluminio.  
**amateur**, amato; **wireless, radio** —, senfadena, radio-amato.  
**ammeter**, ampermetro; **alternating current** —, alternkurenta a.; **direct current** —, kontinukurenta a.; **moving coil** —, movbobena a.  
**ampere**, ampero; **milli** —, miliampero; — **turns**, amperturnoj.  
**amplification**, (*action*) amplifo, amplifado, (*state*) amplifeco; **high frequency**, altfrekvenca; **low frequency**, malaltfrekvenca; **dual**, duala.  
**amplifier**, amplifikatoro, amplifilo; **high, low, frequency** —, altfrekvenca, malaltfrekvenca, amplifikatoro; **magnetic** —, magneta a.; **resistance** —, rezistanca a.; **transformer** —, transformatora a.  
**amplify, to**, amplifi.  
**amplitude**, amplitudo.  
**anode**, anodo; **tuned** —, agordita anodo.  
**antenna**, anteno, (*see* Aerial); **damping of** —, antena amortizo; **radiating** —, radianta anteno; — **support**, antena portilo.  
**aperiodic**, aperioda.  
**apparatus**, aparato.  
**arc**, arko.  
**asynchronous**, asinkrona.  
**atmospheres**, atmosferaĵoj, atmosferaj perturboj.  
**audio-frequency**, malalta frekvenco.  
**audible**, aŭdebla; **audibility**, aŭdebleco.

**audion**, aŭdiono, valvo.  
**autodyne**, aŭtodino.  
**automatic**, aŭtomata.

**B**

**Bakelite**, bakelito.  
**balanced**, kompensita; — **crystal detector**, kompensita kristala detektoro; — **receiver**, kompensita ricevilo.  
**balancing signals**, kompensitaj, (*or* ekvilibrataj) signaloj.  
**bare wire**, nuda fadeno.  
**battery**, baterio, pilaro; **anode, filament** —, anoda, filamanta baterio; **high tension, low tension** —, altatensia, malaltatensia, baterio; **storage** —, akumulato.  
**beats**, batoj.  
**broadcast, to**, brodkasti, disaŭdigi, dissendi.  
**broadcasting** (*noun*), brodkasto, brodkastado; (*adj.*) brodkasta; — **station**, brodkasta stacio.  
**buzzer**, zunilo.

**C**

**Calibrate, to**, kalibri; **calibration**, kalibro, kalibraĵo.  
**call, to**, voki; — **sign**, voksignalo.  
**capacitance**, kapacitanco.  
**capacity**, kapacito; **aerial** —, antena k.; **resistance** —, rezistanca k.; **self** —, mem-k.; **stray capacities**, superfluaĵaj kapacitoj.  
**capacity earth, counterpoise**, kontraŭpezo.  
**carbon**, karbono.  
**carborundum**, karborundo.  
**carrier wave**, portanta ondo.  
**cascade**, kaskado; — **formation**, kaskada formo; **in** —, kaskade.  
**cathode**, katodo; **incandescent** —, inkandeska katodo.  
**cat-whisker**, kontakt-fadeneto por kristalo, "kat-lipharo."  
**cell**, pilo; **battery**, pilaro, baterio; **dry cell**, seka pilo.  
**change of connections**, komuto; — **for receiving**, k. por ricevo; — **for transmitting**, k. por sendo.  
**change-over switch**, komutatoro, komutilo.  
**charge to**, ŝarĝi.  
**charging switch**, interuptoro por ŝarĝo, ŝarĝinteruptoro.  
**choke coil**, reaktanca bobeno, ŝokbobeno; **air core protecting** —, aerkerna —.  
**choking coil**, indukta bobeno.  
**circuit**, cirkuito; **closed oscillating** —, fermita oscila c.; **grid** —, krada c.; **intermediate** —, intera (*or* pera) c.; **open oscillation** —, nefermita oscila r.; **short** —, mallonga c.  
**circuit breaker**, cirkuita interuptoro.  
**close (or tight) coupling**, apuda kupleco.  
**coarse**, kruda.  
**coefficient**, koeficiento, grado; **coupling** —, kupla g.  
**coherer**, koheroro, koherilo; **filings** —, fajlajfa k.; **granular** —, grajna k.

**coil**, bobeno, spulo; **air core protecting choke**—, aerkerna reaktanca b.; **anode**—, anoda b.; **basket (or spiderweb)**—, korba (araneaĵa) b.; **choking**—, indukta b.; **coupling**—, kupla b.; **cylindrical**—, cilindra b.; **honeycomb**—, ĉelara, b.; **induction**—, indukta b.; **loading**—, aldona (longiga) b.; **measuring**—, mezura b.; **plug-in**—, enŝtopa b.; **solenoid**—, solenoida b.; **Tesla**—, Tesla b.

**coil-holder-stand**, bobenujo, boben-tenilo.

**commutator**, komutatoro, komutilo.

**compensator**, kompensatoro, kompensilo.

**component (part)**, komponaĵo.

**compound**, komputa, malsimpla.

**condenser**, kondensatoro, kondensilo; **adjustable**—, alĝustigebla k.; **aerial tuning**—, antenagorda k.; **blocking**—, bloka k.; **closed circuit**—, ĵermita k. cirkuita; **secondary circuit**—, sekundaria k. cirkuita; **twin-coupled**—, duopa k.; **variable**—, varia, variigebla k.; **vernier**—, verniera k.

**conduct, to**, konduki; **conductive**, kondukiva; **conductivity**, kondukiveco.

**connect, to**, konekti; **connection (action)** konekto; **(thing)** konektaĵo.

**constant**, konstanto; **dielectric**—, dielektrika k.

**continuous wave**, kontinua onda.

**control, to**, kontroli.

**converter**, konvertitoro konvertilo.

**copper**, kupro; **tinned**—, stanita k.; —**pyrites**, kupra pirito.

**coulomb**, kulombo.

**counterpoise, capacity earth**, kontraŭpezo.

**couple, to**, kupli; **coupled**, kuplita; **inductively**—, induktokuplita.

**coupler**, kuplilo; **vario-coupler**, vario-kuplilo.

**coupling, (action)** kuplo, kuplado, (state) kupleco; **close (or tight)**—, apuda k.; **electromagnetic, electrostatic**—, elektromagneta, elektrostatika, k.; **fixed**—, fiksa k.; **inductive**—, indukta k.; **loose**—, malapuda k.; **reaction**—, reakcia k.; **variable**—, varia, variigebla k.

**coupling coefficient**, kupla koeficiento.

**crystal**, kristalo; —**detector**, kristala detektoro.

**current**, kurento; **alternating**—, alterna k.; **direct**—, kontinua k.; **high frequency**—, altfrekvenca k.; **low frequency**—, malaltfrekvenca k.; **primary alternating**—, primaria alterna k.

**current interrupter**, kurenta interuptoro

**current loop**, ventro de intenseco; **current node**, nodo de intenseco.

**curve (graph)**, kurvo; **characteristic**—, karakteriza k.

**cycle**, ciklo.

## D

**Damped waves**, amortizaj ondoj.

**damper**, silentigilo.

**damping**, amortizo; **high**—, granda a.; —**of antenna**, antena a.

**decohere, to**, malkoheri; **decoherer**, malkoherilo, dekoherero.

**decrement**, dekremento.

**decimeter**, dekremetro.

**detector**, detektoro, detektilo; **balanced crystal**—, kompensita kristala d.; **crystal**—, kristala d.; **magnetic**—, magneta d.; **perikon**—, perikona d.; **thermo**—, termo-d.; **thermo-electric**—, termo-elektra d.; **valve**—, valv-d.

**device**, aranĝo.

**dial**, ciferplato.

**diaphragm (of telephone receiver)**, plato (de telefonilo).

**dielectric**, dielektriko (noun).

**dielectric (adj.)**, dielektrika; —**constant (specific inductive capacity)**, d. konstanto; —**strength**, d. firmeco; —**stress**, d. streco.

**diode (two-electrode valve)**, diodo.

**diplex**, dipleksa.

**direct current**, kontinua kurento.

**directional aerial (fixed)**, direkta anteno; (*moveable*) direktelebla anteno.

**direction finder**, direkto-trovilo.

**disc**, disko.

**discharger, sparkilo; asynchronous**—, asinkrona s.; **synchronous**—, sinkrona s.

**distort, to**, distordi; **distortion**, distordo.

**disturbances**, perturboj.

**double-pole**, dupolusa.

**double-throw**, duvoĵa.

**dual amplification**, duala amplif-o, -ado, -eco.

**dull emitter (valve)**, malhela (valvo).

**duplex**, dupleksa.

**dynamo**, dinamo; **compound**—, komputa d.; **self-excited**—, memekscita do; **separately excited**—, d. kun sendependa ekscito; **shunt**—, ŝunta (or deriva) d.

## E

**Earpiece (of telephone receiver)**, orelpeco; —**cap**, ĉapo de o.

**earth, tero; capacity**—, kontraŭpezo; —**connection**, t. konektaĵo.

**ebonite**, ebonito.

**effective**, efektiva.

**efficiency**, rendimento, efikeco.

**electricity**, elektro.

**electrode**, elektrodo.

**electrolytic**, elektroliza.

**electromagnetic**, elektromagneta.

**electron**, elektrono; —**emission**, elektrona elsendo.

**electrostatic**, elektrostatika.

**emission**, elsendo.

**endodyne**, aŭtodino.

**energy**, energio.

**ether, aether, etero**.

**excite, to**, eksciti; **exciter**, ekscitatoro, ekscitilo.

**experiment, to**, eksperimenti; **experimenter**, eksperimentisto.

## F

**Factor**, faktoro; **power**—, f. de potenco.

**farad**, farado; **microfarad**, mikrofarado.

**feed-back**, reakcio.

**fibre**, fibro.

**field**, kampo; **electric, magnetic**—; elektra, magnetak.

**field break switch**, interuptoro de kampo.

**filament**, filamento; **bright, dull**—; hela, malhela, f.

**filter**, filtrilo.

**fine tuning**, delikata (or subtila) agordo.

**flat tuning**, neakuta agordo.

**flexible**, fleksebla.

**formula**, formulo.

**frame (aerial)**, kadro, kadra anteno.

**frequency**, frekvenco; **group**—, ondara f.; **high (or radio)**—, alta f.; **low (or audio)**—, malalta f.; **wave**—, onda f.

**function, to**, funkcii.

## G

**Galena**, galeno.

**galvanometer**, galvanometro.

**generate, to**, generi.

**generator**, generatoro, generilo; **continuous current**—, g. de kontinua kurento.



grid, krado; —circuit, krada cirkuito; —leak, krada rezistanco.  
ground, tero.

## H

**Hammer break**, martela interruptoro.  
**harmonic**, harmoniko.  
**henry**, henrio; **microhenry**, mikrohenrio.  
**Hertzian wave**, Hertza ondo, elektromagneta ondo.  
**heterodyne**, heterodino; **self—**, mem-heterodino, aŭtodino.  
**high damping**, granda amortizo.  
**high frequency**, alta frekvenco; —group, alt-frekvenca grupo.  
**high tension**, alta tensio.  
**hook-up**, cirkuito.  
**hot-wire ammeter**, varmfadena ampermetro.  
**howl**, to, ululi; **howling**, ululado.

## I

**Impedance**, impedanco.  
**Inductance**, induktanco; **aerial—**, antena i.; **aerial tuning—**, antenagorda i.; **primary, secondary—**, primaria, sekundaria i.  
**induction**, indukto; **self—**, mem- i.; —**alternator**, alternatoro kun turna fero.  
**inductive**, indukta; —**transmitter**, induktotuplita sendilo.  
**inert**, inerta; **inertia**, inerteco.  
**inner primary** (of transformer), eniro de primario.  
**inner secondary** (of transformer), eniro de sekundario.  
**input**, enmeto.  
**insulate**, to, izoli; **insulated**, izolita; **insulation**, izoleco.  
**insulator**, izolatoro, izolilo; **flexible—**, fleksebla i.; **leading-in—**, i. de eniro.  
**interference**, interfero.  
**interruptor**, interruptoro, interrompilo; **current—**, i. de kurento; **electrolytic—**, elektroliza i.; **induction—**, i. de indukta bobeno; **mercury—**, hidrarga i.; **mercury turbine—**, hidrarga turbo-i.  
**interval**, intervalva.  
**iron core**, fera kerno, ferkerno.  
**iron pyrites**, ferpirito.

## J

**Jack**, ĵako.  
**jam**, to, interferi, ĵami; **jamming**, interfero, ĵamo, -ado.  
**jigger**, oscila transformatoro, ĝigero.  
**joule**, julo.

## K

**Key**, manipulatoro, senda klavo.

## L

**Laminations**, lamenaĵoj; **laminated**, lamenita.  
**lead** (wire connection), konduktoro, kondukilo.  
**lead-in**, enira fadeno.  
**Leyden jar**, Lejdna botelo.  
**licence**, permeso; **receiving, transmitting—**, riceva, senda p.  
**lightning arrester**, fulmsirmilo.  
**log**, to, registri; —**book**, registro-libro.  
**loop** (antenna), kadro.  
**loud-speaker**, laŭtparolilo; laŭtigilo.  
**low frequency**, malalta frekvenco.  
**low-loss (condenser)**, (kondensatoro kun) malgranda perdo.

## M

**Magnet**, magneto.  
**make and break**, interruptoro.  
**mast**, masto; **compound—**, dismuntebla m.; **portable—**, portebla m.

**maximum**, maksimumo.  
**measuring coil**, mezura bobeno.  
**mercury**, hidrargo.  
**meter**, metro; **frequency—**, frekvenco m.  
**mica**, glimo.  
**micrometer**, mikrometro.  
**microphone**, mikrofono; **carbon disc—**, karbon-diska m.; **carbon rod—**, karboncilindra m.; **contact—**, kontakta m.; **granular—**, grajna m.; **powder—**, pulvora m.  
**minimum**, minimumo.  
**modulate**, to, moduli; **modulation**, modulo, modulado, moduleco.  
**Morse code**, Morsa kodo.  
**motor**, motoro; **alternating current—**, alternkurenta m.; **asynchronous—**, asinkrona m.; **induction—**, indukta m.  
**motor alternator disc set**, motor-alternatora grupo kun diska sparkilo.  
**mount**, to, munti; **to dismount**, dismunti.  
**moving coil ammeter**, movbobena ampermetro.  
**multiphase**, multfaza.  
**multiple**, multopa, multobla.  
**multi-stage**, multopa, multetaĝa.  
**multi-vibrator**, multivibrilo.  
**mutual conductance**, komuna konduktanco.

## N

**Natural oscillation**, fundamenta oscilo.  
**negative**, negativa.  
**neon**, neono; **neon tube**, neona tubo.  
**node**, nodo; **current—**, n. de intenseco; **potential—**, n. de tensio.  
**non-inductive shunt**, neindukta, senindukta, ŝunto.  
**note magnifier**, sonfortigilo, malalfrekvenca amplifikatoro.

## O

**Ohm**, omo; **megohm**, megomo.  
**operate**, to, funkciigi; **wireless operator**, senfadentisto, radiisto.  
**open radiating circuit**, nefermita radianta cirkuito.  
**oscillate**, to, oscili.  
**oscillation**, oscilo; **to break into—**, ekoscili; **fundamental (natural)—**, fundamenta o.; **self—**, mem-o.; —**transformer**, oscila transformatoro; **open—circuit**, nefermita oscila cirkuito; **closed—circuit**, fermita o. cirkuito.  
**oscillator**, oscilatoro, oscililo.  
**outer primary** (of transformer), eliro de primario.  
**outer secondary** (of transformer), eliro de sekundario.  
**output**, elmeto.  
**overload**, troŝarĝo.

## P

**Panel**, panelo; **control—**, kontrol-panelo.  
**parallel**, paralela; **connected in—**, konektita paralele.  
**perikon**, perikono.  
**phase**, fazo.  
**plate**, plato, anodo; —**circuit**, plata cirkuito.  
**plug**, ŝtopilo; **coil—**, bobena ŝ.  
**plug-in**, to, enŝtopi; **plug-in coil**, enŝtopa bobeno.  
**pole**, poluso.  
**polyphase**, multfaza.  
**porcelain**, porcelano.  
**positive**, pozitiva.  
**potential**, tensio; —**loop**, ventro de t.; —**node**, nodo de t.  
**potentiometer**, potenciometro.  
**power factor**, faktoro de potenco.

primary, primario, primaria.  
propagation of waves, propagado de ondoj.

## Q

Quenched spark, estingita sparko; —gap, estinga sparkilo.

## R

Radiate, to, radii, radiadi; radiating, radianta.  
radiation, radiado.  
radio, radio; —amateur, r.-amatoro, radiulo; —“fan,” radiamanto; —operator, radiisto; —telegraphy, r.-telegrafio; —telephony, r.-telefonio; —station, r.-stacio, radiejo.  
radio-frequency, radio-frekvenco, alta frekvenco.  
radiogoniometer, radiogoniometro.  
range, traŭpovo.  
ratio, proporcio.  
reactance, reaktanco.  
reaction, reakcio.  
receiver (*person*), ricevanto, ricevisto.  
receiver (*object*), ricevilo, ricevaraparato; balanced—, kompensita r.; continuous wave—, r. por kontinuaj ondoj.  
receiver arrangement, riceva aranĝo.  
receiving apparatus, set, ricevilo, ricevaraparato.  
reception, ricevo, ricevado.  
recorder, recording apparatus, mem-skribanta aparato, mem-skribilo.  
rectification, rektifio, rektifado.  
rectifier, rektifikatoro, rektifilo.  
rectify, to, rektifi.  
reflex, refleksa.  
regeneration, regenero, reakcio.  
regulating resistance, reostato de kampo.  
rejector (*adj.*), rejeta.  
relay, to, relaji.  
relay, relajo; high tension—, altatensia r.; key—, r. de la manipulatoro, senda klavo.  
resistance, rezistanco; grid—, krada r.; high, low—, alta, malalta r.; insulation—, izola r.; regulating—, reostato de kampo; variable—, varia r., reostato; starting—, starta reostato.  
resonance, resonanco; —curve, resonanca kurvo.  
resonator, resonatoro.  
rheostat, reostato; filament—, filamenta r.  
ripple, subondeto; —elimination, subondeta elimino.  
root mean square (value), efika (valoro).  
rotary spark gap, turna sparkilo.  
rotor, rotoro, turnbobeno.

## S

Saturation, satureco.  
screened, ŝirmita.  
secondary, sekundario, sekundaria.  
selective, selektiva; selectivity, selektiveco.  
self-excited dynamo, mem-ekscita dinamo.  
self-capacity, mem-kapacito.  
self-induction, mem-indukto.  
self-oscillation, mem-oscilo.  
send out waves, to, elsendi ondojn.  
sending apparatus, sendilo, sendaparato.  
sending key, manipulatoro, senda klavo.  
series (*adj.*), seria; connected in—, konektita serie.  
sharp tuning, akuta agordo.  
shellac, ŝelako.  
short circuit, mallonga cirkuito.  
shunt, ŝunto; highly inductive—, altindukta ŝ.; non-inductive—, neindukta, senindukta, ŝ.  
signals, signaloj; balancing—, kompensitaj, ekvilibritaj, s.

sliding contact, ŝova kontakto.  
smooth, to, glatigi.  
solder, to, soldo, brazo.  
span, vantaro.  
spark, sparko; quenched—, estingita s.; rotary—, turna s.  
spark gap, sparkilo; multiple—, multopa s.; quenched—, estinga s.  
sparking distance, sparka distanco.  
specific inductive capacity (dielectric constant), dielektrika konstanto.  
spindle, spindelo.  
spreader, apartiga stango.  
stable, stabila; stability, stabileco; stabiliser, stabiligilo.  
standard, normo; standardise, to, normigi.  
starter, startilo.  
static, atmosferaĵoj.  
station, stacio.  
stator, statoro, fiksbobeno.  
storage battery, akumulatoro.  
strays, atmosferaĵoj, atmosferaĵoj.  
strength, firmeco, forteco; dielectric—, dielektrika f.  
stress, streĉo; dielectric—, dielektrika s.  
super-heterodyne, super-heterodino.  
super-regeneration, super-reakcio.  
supersonic, supersona.  
sustained wave, kontinua ondo.  
switch, to, (*general term*) ŝalti (*change-over*) komuti, (*cut out*) interupti.  
switch (*general term*), ŝaltilo; change-over—, komutatoro, komutilo; cut-out—, interuptoro, interuptilo; automatic-cut-out, aŭtomata i.; charging—, ŝarĝ-i.; field break—, i. de kampo; high tension—, altatensia i.; double-pole—, dupolusa k.; double-throw—, duvoja k.; wave-changing—, ondŝanĝa k.; rotary—, turna k.  
switchboard, ŝalta, komutatora, interuptora, tabulo.  
synchronous discharger, sinkrona sparkilo.  
synthetic, sinteza.  
syntonisation, sintonizo, agordo.  
syntonise, to, sintonizi, agordi.  
syntony, sintonio.

## T

Tap, to (a coil), pili, tapi; tappings, spilaĵoj, tapaĵoj.  
tapper, frapilo.  
telautograph, telaŭtografo.  
telegraph, telegrafo.  
telephone, telefono; —receiver, telefonilo.  
tension, tensio; high, low—, alta, malalta t.; high-relay, altatensia relajo.  
terminal binding post, borno, klemo.  
tetrode (*four-electrode valve*), tetraodo.  
thermionic, termiona.  
thermo-couple, termo-kuplo.  
Thomson's formula, formulo de Thomson.  
three-electrode valve, trielektroda valvo, triodo.  
tickler, tiklilo.  
transformer, transformatoro, transformilo; air-core—, aerkerna t.; high frequency—, altfrekvenco—; low frequency—, malaltfrekvenco—; high ratio—, altproporcio t.; low ratio—, malaltproporcio t.; oscillation—(jigger), oscila t. (ĝigero); plug-in—, enŝtopa t.  
transmission, sendo, elsendo, sendado, elsendado.  
transmit, to, sendi, elsendi.  
transmitter, (*person*), sendanto, sendisto.  
transmitter (*object*), sendilo, sendaparato.  
transmitting apparatus, sendaparato, sendilo.

**trembler**, martela interruptoro.  
**triode** (*three-electrode valve*), triodo.  
**tube** (*valve*), valvo, tubo, lampo.  
**tune, to**, agordi, sintonizi; **to re-tune**, reagordi; **to tune out**, foragordi, malagordi.  
**tuned**, agordita, sintonzita; **flatly**—, neakute a.; **sharply**—, akute a.; **untuned**, neagordita.  
**tuner**, agordilo, sintonizilo.  
**tuning**, agordo, sintonizo; **coarse**—, kruda a.; **fine**—, delikata, (*or* subtila); **flat**—, neakuta a.; **sharp**—, akuta a.; —**coil**, agorda bobeno.  
**turn** (*of a coil*), volvo (de bobeno).

## U

**Undamped wave**, kontinua ondo.

## V

**Vacuum tube**, vakua tubo.  
**valve**; valvo, tubo, lampo; **2-electrode**—, diodo; **3-electrode**—, triodo; **4-electrode**—, tetraodo;  
**bright emitter**—, hela v.; **dull emitter**—, malhela v.  
**variable**, varia, variigebla, alĝustigebla.  
**variometer**, variometro; **vario-coupler**, vario-kupilo.

**vary, to**, varii.  
**velocity**, rapideco.  
**vernier**, verniera.  
**volt, volto**; **voltage**, tensio.

## W

**Watt**, vato; **kilowatt**, kilovato.  
**wave, ondo**; **carrier**—, portanta o.; **continuous waves**, kontinuaĵ ondoj; **damped**—s, amortizaj o.; **electromagnetic**—s, elektromagnetaj o.; **Hertzian**—s, Hertzaj o.; **undamped**—s, kontinuaĵ o.  
**wave frequency**, ondfrekvenco.  
**wavemeter**, ondometro.  
**wire**, fadeno, drato; **bare**—, nuda f.; **flexible**—, fleksebla f.; **insulated**—, izolita f.; **solid**—, solida f.; **stranded**—, dividita f.  
**wiring** (*collection of wires*), fadenaro; (*method of wiring*), fadenarango; (*action*), fadenado.  
**wireless**, senfadena.

## X

**X's**, atmosferaĵoj.

## An Imaginary Conversation between two Amateur Transmitters.

### ENGLISH.

#### Imaginary Conversation.

Hullo! 6CV, Hullo! Hullo! 8CF replying. I have been trying to raise you all night. Your speech is quite clear but under-modulated. Before we start on radiation tests you had better increase it a little. You are R5 and being jammed pretty badly by two other British stations both working on the same wave-length and grinding out gramophone records. I am being troubled by my generator, I think the commutator requires attention. Do you notice any ripple? 8CF over to 6CV.

Hullo! 8CF, 6CV replying. Thanks very much for report. Please stand by for one minute and I will try and increase modulation a little. The wave length will alter slightly. Hullo! Hullo! I hope that is better. With the particular system of control I am employing at the moment, modulation cannot be increased any more without speech breaking. No, I can hear no generator noise from you. 6CV over for you.

Hullo! 6CV, 8CF replying. I am sorry, but you are still jammed. I managed to get your first remarks and you have increased modulation satisfactorily. Will you please try again? 8CF over to 6CV.

Hullo! 8CF, 6CV answering. Thanks very much. This represents twenty minutes wasted. I am going to try and stop some of these gramophones. Please stand by and I will call you later. 6CV switching off to you.

### ESPERANTO.

#### Imaga Konversacio.

Halo, C6V, Halo! Halo! 8CF respondas. Mi penis trafi vin dum la tuta nokto. Via parolo estas tute klara sed sub-modulata. Antaŭ ol ni komencos provojn pri radiado, vi devus preferinde iom plifortigi ĝin. Vi estas R5 kaj sufiĉe forte ĵamata de du aliaj Britaj stacioj, kiuj ambaŭ uzas la saman ondolongon kaj elgrincigas gramofonojn. Mi estas ĝenata per mia generatoro; mi kredas, ke mia komutatoro bezonas atenton. Ĉu vi rimarkas ian subondeton? 8CF aŭskultas al 6CV.

Halo, 8CF, 6CV respondas. Dankon multe pro raporto. Bonvolu atendi dum unu minuto, kaj mi provos plifortigi modulon iomete. La onda longo estos iom ŝanĝita. Halo! Halo! Mi esperas, ke tio estas plibona. Per la aparta kontrol-sistemo, kiun mi uzas nunmomente, la modulo ne estas plifortigebla sen rompo de la parole. Ne, mi aŭdas nenian generatoran bruon de vi. 6CV aŭskultas al vi.

Halo, 6CV, 8CF respondas. Bedaŭrinde, vi estas ankoraŭ ĵamata. Mi kaptis viajn unuajn rimarkojn, kaj vi kontentige plifortigis vian modulon. Bonvolu provi denove. 8CF aŭskultas al 6CV.

Halo, 8CF, 6CV respondas. Dankon multe. Jen dudek minutoj perditaj. Mi penas silentigi kelkajn el tiuj gramofonoj. Volu atendi, kaj mi vokos vin poste. 6CV finis kun vi.



*Letters of interest to experimenters are always welcome. In publishing such communications the Editors do not necessarily endorse any technical or general statements which they may contain.*

### International Radio Week.

*The Editor, E.W. & W.E.*

#### REPORTS ON EVENING TRANSMISSIONS.

SIR,—May we beg your readers, while the impressions are still fresh in memory, to forward brief reports on the quality of reception they experienced of the 10.30—11.30 p.m. transmissions, whether such reception was:—

- (A) Direct from the country broadcasting;
- (B) *Via* the B.B.C. relays.

Observations, opinions, and criticisms (especially constructive) are invited, since such comment will be invaluable.

Out of deference to the expressed wish of the B.B.C. practically no preliminary publicity was given to the institution of these evening transmissions. Consequently, great numbers of the public are doubtless quite unaware of the aims and objects of the movement, and it may be desirable here to mention that the aim is to bring nations into closer touch by means of national programmes broadcast by each country in turn for the benefit of other participating countries. Such programmes, containing amongst other items addresses by leading personalities, native music by native composers, and other material peculiar to the country broadcasting, will, it is hoped, tend towards the creation of better international understanding and goodwill.

These transmissions must not be confused with the 3—5 a.m. scientific tests, with which they have little in common. The evening transmissions were designed for the purpose stated, rather than for their scientific value, and were arranged so that even the crystal-user might enjoy a "glimpse" of foreign lands.

The criticism of the lady who has written charging the promoters with causing the bad weather and consequent loss of life through storm-havoc is unkind, but everyone is entitled to his, or her, own opinion.

All communications then will be welcomed—even a line on a postcard.

THE WIRELESS RETAILERS' ASSOCIATION.  
CLIFFORD & CLIFFORD,  
Hon. Secretaries.

[Will readers please apply direct to the Association, at 70, Finsbury Pavement, E.C.2.—ED., E.W. & W.E.]

### Grid Rectification.

*The Editor, E.W. & W.E.*

SIR,—Might I be allowed to venture a few remarks on the very interesting article in your December issue by H. J. Barton Chapple on Grid Rectification?

In the first place it would have been interesting to have had a series of curves substituting a broadcast station for the buzzer used in his tests. The great majority of the valves in use are not concerned with buzzers. If distortion by any chance were introduced by the use of a grid-leak of high value it would pass unnoticed—not so in the case of voice or music.

The characteristics of the valve used by Mr. Chapple, shown in Fig. 3, seems to me to have a very low mA emission. Many of the valves to-day run much higher, from 4 to 10, with 100 volts on the anode; and a series of curves with such a valve would have been interesting.

Lastly, I should be curious to know if Mr. Chapple would get the same results on a multi-valve set. Let him put, say five valves ahead of his detector and then try a 5MO grid-leak. I believe he would find that except for very DX work the results would not be satisfactory.

I made a few experiments last summer with a superheterodyne to test the relative merits of grid-leak and anode current rectification: using in the latter case a grid-biasing arrangement through potentiometer similar to that shown by Mr. Chapple in Fig. 7.

With fixed grid-leaks I got the best results with one of a valve  $\frac{1}{2}$ MO; but working on the lower bend of characteristic with negative bias gave still better results—the mA emission of my valves at 100V being never less than four.

Cannes.

H. EMMONS.

*The Editor, E.W. & W.E.*

SIR,—*Re* article in December number on rectification, I think the conclusions drawn by the author as to optimum values of grid leak, grid condenser and anode voltage for the Ora valve, must be accepted with a certain amount of caution. In the first place "spark" signals were used for the tests, whereas a set is usually required almost exclusively for reception of C.W. and telephony.



Secondly, I can find no mention of the wave-length employed, which will obviously affect the optimum value of grid condenser.

In connection with the article on a 3—5 metre receiver, the author says: "Once a set is just on the point of oscillating . . . the open question remains—Is it worth while reducing the losses any further?" Now what is the general opinion on this point? Does the use of reaction up to oscillation point compensate for all losses in a single valve set, e.g., dielectric losses, eddy current losses, etc., or only for that due to H.F. resistance? If so, it seems rather a waste of time to design super-efficient inductances, etc., for short-wave work.

Earlsfield.

E. LESTER SMITH.

### Co-operation Needed.

*The Editor, E.W. & W.E.*

SIR,—I have just returned from a business trip to America in connection with Radio, and naturally met a number of the leading Radio enthusiasts in U.S.A. This morning I have received a letter from Mr. E. T. Flewelling, whom no doubt your readers are fully aware is the inventor of the famous Flewelling Super-Regenerative Circuit.

He wishes to know if any amateurs on this side would listen-in for his station, 9XEG (Chicago, Ill.) on a wave-length of 70 metres, as he is confident he can get his signals over to this side, it being only necessary to have a prearranged time for working.

If any amateurs interested would care to communicate with me, I shall be very pleased to send Mr. Flewelling their names and addresses and also forward to them the times and dates arranged.

J. H. E.

c/o The General Radio Company, Ltd.,  
6, Imperial Buildings,  
Oxford Road,  
Manchester.

### The Numans Oscillator.

*The Editor E.W. & W.E.*

SIR,—With reference to my article, "The Numans Oscillator," which appeared in your December number. In order to avoid any misunderstanding that might arise, I should like to emphasise the fact that the principle described does not depend upon the use of a double grid. Theoretically a correctly-proportioned valve with a single grid should function with equal efficiency. In practice, however, one seldom is fortunate enough to find such a valve, and, as a result, experimenters who adhere to the single grid type must be prepared to overcome various difficulties in adjustment and also, in the case of *some* valves, for complete failure to obtain satisfactory results.

The Hague.

K. C. VAN RYN.

### Low Power Tests.

*The Editor, E.W. & W.E.*

SIR,—I have read your criticism concerning the radio tests recently carried out by me on the R.M.S. *Tahiti*.

You are quite right in suggesting that of the figures shown something seemed doubtful. The radiation of the small transmitter should have read .8 amps., instead of 1.8. The input power, however, is absolutely correct, as this was very carefully measured by the Amalgamated Wireless Co. with their own instruments.

With this radiation and an aerial resistance of 7.5 ohms at 235 metres the power in the aerial would be 4.8 watts.

CHAS. MACLURCAN  
(Radio A2CM.)

Sydney.

### Esperanto.

Translation.

*The Editor, E.W. & W.E.*

SIR,—I have read with great interest the short course in Esperanto published in the December issue of your journal.

This publication comes most happily at the moment, when although wireless telephony is making the voices of all people heard beyond their frontiers, these voices are too often without useful effect, since they cannot be understood; and it is also especially appropriate since the first International Wireless Congress is about to bring together at Paris amateurs from all the world over, who will certainly have some difficulty in understanding one another.

I hope that your journal will not be content with what it has already accomplished, and that it will continue to assist the movement which is trying to propagate the use of Esperanto among amateurs and other users of wireless telegraphy and telephony.

DR. PIERRE CORRET,

Vice-President of the Société  
Française de l'Etude de Télégraphie  
et de Téléphonie sans Fil.

Vice-President of the Organisation  
Committee of the First Inter-  
national Congress on Wireless  
Telegraphy.

Versailles.

Translation.

*The Editor, E.W. & W.E.*

SIR,—Allow me to congratulate you most sincerely on your enterprise in inserting in your journal such a complete exposition of the grammar and principles of Esperanto.

You have shown very clearly the reasons which should lead a large number of wireless enthusiasts to make use of an auxiliary international language, and your article will make it possible for all readers to understand fully the exceptional ease of learning Esperanto, and will consequently make them appreciate the advantages which they may obtain by studying it.

Might I draw your attention to one aspect of the question which was not dealt with in the article in question, and which seems to me likely to interest many of the readers of a journal which, like yours, devotes itself to the technical and scientific side of wireless? It might be noted that this point applies not only to wireless, but to all scientific and other activities.

Periodicals of all kinds are becoming daily more

numerous and more widely spread. They are written in so many different languages that the study of them is impossible for many, and very troublesome for all.

Further, as regards wireless, many very expensive publications, such as *The Philosophical Magazine*, *The Proceedings of the Royal Society*, *The Electrician*, *Journal of the Institute of Electrical Engineers* (to give only a few examples of English publications), contain from time to time articles of the greatest interest; but to obtain them all for the sake of their occasional interesting contents would cost a small fortune. In spite of every effort, it is becoming impossible to keep oneself completely abreast of current progress, and the position is becoming worse; specialisation is rapidly becoming indispensable, and the time which one is able to devote to the study of foreign languages is getting less.

The adoption of an international auxiliary language would be an effective remedy for this situation. It would abolish the very considerable effort necessary to learn existing languages, and it would allow—by reason of the larger number of readers—publication at a cheaper price of technical journals adapted for the needs of the whole world.

Sooner or later this change will come, but as it is already of real necessity, it is most important

that all those interested in scientific matters, or even simply in progress, should make a personal effort to hasten it.

RÉNÉ MESNY,  
Officier de Marine Attaché au  
Laboratoire de la Radiotélégraphie  
Militaire.

Paris.

---

### Soldering.

*The Editor, E.W. & W.E.*

SIR,—I have read quite a lot of correspondence in various papers recently about soldering, but nothing about a good way of reaching difficult places.

In a medium sized iron I have screwed three inches of 2B.A. clearance rod (copper) the end of which is rounded off.

The iron is heated in the usual manner and tinned, including the extension, owing to the heat escaping through the least resistance the extreme end of the rod receives all the heat, and what is usually a ticklish job, becomes easy, especially for getting at connections of multi circuits.

Bournemouth.

J. P. J. CHAPMAN.

---

## International Radio Week.

**T**HE full official reports of the results obtained during the International Radio Week are not yet available, but there is no doubt that when all the information from the logs of serious observers is collated, a mass of valuable data will be compiled that will afford a useful basis for similar experiments in future. The transmissions excited widespread interest, and, although some reports require more complete verification, there is no doubt that, on the whole, the results were sufficiently successful to justify the efforts.

An interesting feature was the great interest shown by the lay Press in the progress of wireless in general and broadcasting in particular. Practically every daily paper in Britain gave a column or more to reports from correspondents in Europe and America telling of good or indifferent reception. The latter country seems to have been the chief focus of attention, and KDKA (Pittsburg) to have been the principal centre of interest.

The full story of the romance of wireless yet remains to be told, but one event, at least, must make a direct appeal to every Londoner. For the first time, the solemn chimes of Big Ben were broadcast to the world, and thousands of people in many countries were able to hear the actual sound

of the great bells that hitherto have meant nothing more than a name to them. It is also interesting to reflect that, owing to the enormous speed of electro-magnetic radiation, the chimes were heard in Pittsburg before they could be heard by an observer standing at the foot of the clock tower.

The Wireless Retailers' Association and the B.B.C. are chiefly entitled to credit for arranging the Radio Week. It was thoroughly international in character, and all countries, from South America to Northern and Central Europe, took part in it. This is only a beginning, and it may well be that broadcasting in the future will prove itself to be a greater influence in promoting good feeling among the peoples of the world and a better mutual understanding than has yet been accomplished by diplomatists or politicians.

---

### Correction.

Owing to a mistake for which we were not responsible the price of Messrs. Mullard's valves as advertised in our December issue was given as 25/- for the types D3 and D.06, H.F. and L.F. valves. They now inform us that the price of the D.3 is 21/- and that of the D.06 25/-.

[R050

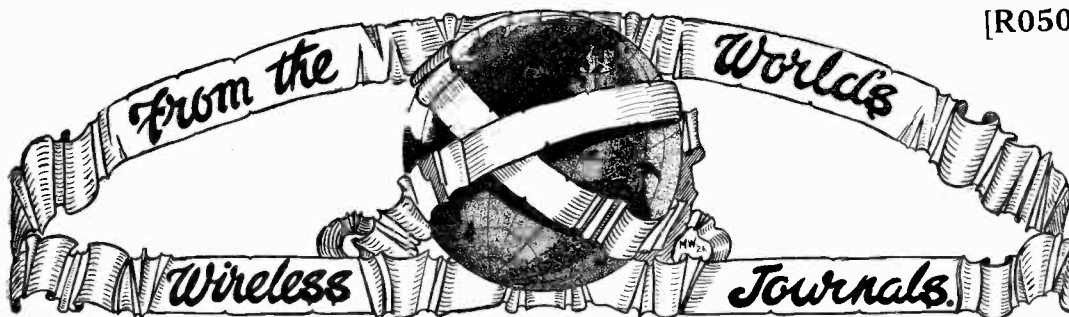
**R100.—GENERAL PRINCIPLES AND THEORY.**

R113.3.—RELÈVEMENTS RADIOGONIOMÉTRIQUES À CHANGHA.—E. Gherzi, S. J. (*Onde Elec.*, Nov., 1924).

Some observations made at Shanghai on the direction of arrival of radio signals from various long-wave stations of the world.

R113.6.—WHY WIRELESS ELECTRIC RAYS CAN BEND ROUND THE EARTH.—Sir Joseph Harmor, F.R.S. (*Phil. Mag.*, Dec., 1924).

A theoretical discussion of the process by which electromagnetic waves may be caused to follow the curvature of the earth. The simple dispersion of waves emitted from a point on the surface of a sphere would not give rise to the observed amount of bending. The effect of the upper ionised atmosphere of the earth is therefore taken into account.

R125.1.—ETUDE D'UN CAS PARTICULIER D'EFFET ANTENNE SUR UN CADRE DE RADIOGONIOMETRE.—B. Hyot (*Onde Elec.*, Nov., 1924).

A study of the combination of the electrostatic and electromagnetic pick-up effects of a frame aerial to give a "heartshape" polar reception curve.

R131.—AN INDIRECT METHOD OF DETERMINING THE GRID CHARACTERISTIC.—M. E. Janmouille, B.Sc. (*W. World*, Nov. 19, 1924).

A simple method, requiring only easily-procurable apparatus, of plotting the grid-volts, grid-current curve of a valve.

R134.—CUMULATIVE GRID AND ANODE CURRENT RECTIFICATION.—H. J. Barton Chapple, Wh.Sch., B.Sc.(Hons.) (*Exp. W.*, Dec., 1924).

Results of some quantitative tests, showing the degree of rectification obtained with various values of grid resistance, grid and anode voltages.

R138.—L'INFLUENCE DE LA TEMPÉRATURE SUR LES TUBES THERMIQUES.—M. Courtines (*Onde Elec.*, Nov., 1924).

A study in anomalies in emission found in thermionic valves. It has been found that emission of a filament supplied with a constant heating power

does not remain constant, but may fall off appreciably within the period of half an hour or even a few minutes.

R141.—THE GRAPHICAL ANALYSIS OF COMPOSITE IMPEDANCES.—F. M. Colebrook (*Exp. W.*, Dec., 1924).

In this paper the author considers some of the important arrangements of impedances met with in practical wireless work, and shows their characteristics graphically.

R144.—EFFECTIVE RESISTANCE.—M. G. Scroggie, B.Sc. (*Exp. W.*, Dec., 1924).

This article deals with sources of loss which can often be considered as if produced by a resistance.

**R200.—MEASUREMENTS AND STANDARDISATION.**

R250.—MEASUREMENT OF AERIAL CURRENT.—N. W. McLachlan, D.Sc. (*W. World*, Dec. 3, 1924).

The method described involves the use of a low reading H.F. ammeter in conjunction with an iron cored current transformer.

R251.2.—SUR LES PRECAUTIONS QU'IL CONVIENT DE PRENDRE DANS L'UTILISATION DES THERMOCOUPLES À FILS CROISÉS EN RADIOTECHNIQUE.—J. Cayrel (*Onde Elec.*, Nov., 1924).

Note on precautions to observe when using thermocouples of the crossed-wire type.

**R300.—APPARATUS AND EQUIPMENT.**

R342.7.—THE PERFECT SET. PART III.: L.F. AMPLIFICATION.—(*Exp. W.*, Dec., 1924.)

The article states clearly the fundamental working conditions and the requisite adjustments for a three-electrode valve working as a low-frequency amplifier.

R343.—A RECEIVER FOR WAVE-LENGTHS OF 3 TO 5 METRES.—E. H. Robinson (*Exp. W.*, Dec., 1924).

Description of a simple and robust regenerative receiver for ultra-short radio waves.

R344.—THE NUMANS OSCILLATOR.—K. C. van Ryn (*Exp. W.*, Nov., 1924.)

Description of a new valve oscillatory circuit, which requires only one tuned circuit without any extra tappings or reaction coil.

R351.—GENERATEUR-AMPLIFICATEUR SANS LAMPE.—O. Lossev (*R. Elec.*, Nov. 10, 1924.)

An original article dealing with the practical use of crystal contacts for generating oscillations and producing amplification.

R375<sup>2</sup>.—LES PHÉNOMÈNES ELECTROSTATIQUES DANS LES DÉTECTEURS A LIMAILLE ET A CONTACTS IMPARFAITS.—Joseph Waszik (*Onde Elec.*, Nov., 1924.)

Description of some experiments made to ascertain some of the electrical properties of coherers and loose-contact detectors.

R382<sup>1</sup>.—SHORT-CIRCUITED TURNS AS AN AID TO RECEPTION ON SHORT WAVES.—W. E. Benham (*Exp. W.*, Dec., 1924.)

By short-circuiting a few turns in the reaction coil of a short-wave receiver it has been found possible to increase the effective mutual coupling to the grid circuit without bringing the reaction coil above resonance.

R382<sup>5</sup>.—SUPERHETERODYNE TRANSFORMERS.—(*Q.S.T.*, Dec., 1924.)

An article discussing the construction and desirable properties for "intermediate frequency" transformers in supersonic heterodyne receivers. Frequency-amplification characteristics of iron and

air-cored and iron-cored intervalve transformers respectively. The undesirability of excessively sharp resonance in such transformers is explained.

R385<sup>52</sup>.—THE MARCONI-SYKES MAGNETOPHONE.—H. J. Round, M.I.E.E. (*W. World*, Nov. 26, 1924.)

A detailed description of the Sykes microphone and its associated amplifying circuits as used in British Broadcasting Stations.

**R600.—STATIONS: DESIGN, OPERATION AND MANAGEMENT.**

R620<sup>068</sup>.—FAULT TRACING.—L. R. Gleason (*Exp. W.*, Dec., 1924.)

Methods of diagnosing defects without measuring instruments.

**R800.—NON-RADIO SUBJECTS.**

R800.—A SHORT COURSE OF ESPERANTO, THE INTERNATIONAL LANGUAGE (*Exp. W.*, Dec., 1924.)

An introduction to the grammar, vocabulary and pronunciation of Esperanto, especially arranged to be of immediate use to the radio experimenter.

R800.—ELECTRON EMISSION FROM ADSORBED FILMS ON TUNGSTEN.—K. H. Kingdom (*Phys. Rev.*, Nov., 1924.)

Some experimentally-determined data showing how the constants of the Richardson emission formula are affected by the presence of layers of certain substances on tungsten filaments, particularly oxygen, nitrogen, caesium and thorium.

## More about Valve Testing.

Two errors of a rather serious nature occurred in the article under the above heading in last month's issue.

On page 180, by a printer's error, the number 80 appeared instead of 70 for the anode voltage for which the curve B in Fig. 2 was plotted.

Moreover, through circumstances beyond our control, a block from an entirely different article was published as Fig. 2. The correct set of curves is given herewith.

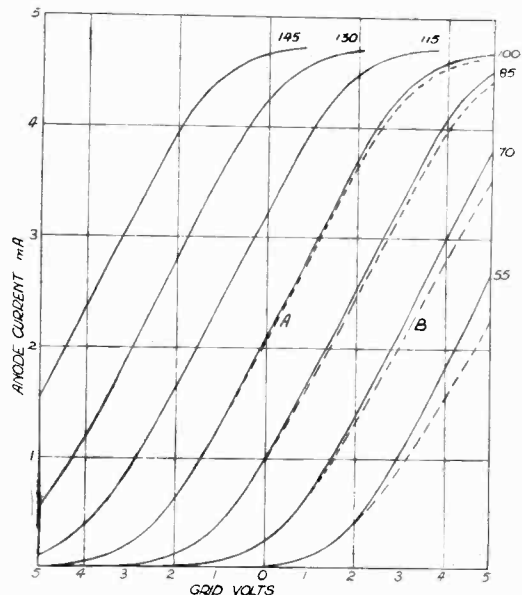



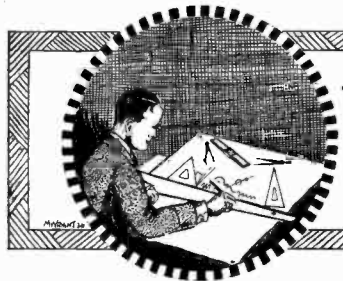

# Some Recent Patents

(The following notes are based on information supplied by Mr. Eric Potter  
Patent Agent, Lonsdale Chambers, 27, Chancery Lane, W.C.2.)

[R008]

## VALVE PROTECTION.

THE Edison-Swan Electric Co., Ltd., and T.C. Black, described in British Patent No. 220,498, Application Date, October 10, 1923, the construction of a valve which cannot be damaged by momentary incorrect insertion in a valve holder. Should an attempt be made to insert an ordinary valve in the incorrect sockets it frequently happens that almost the full voltage of the high tension battery is applied to the filament. This eventuality is obviated by the special construction shown in the accompanying illustration. It will be noticed that two of the valve legs, A and B, are of dissimilar length, and each is shorter than the other two, which are of normal dimensions. The two special legs correspond to the ends of the filament while the ordinary ones are connected respectively to the grid and anode, shown at C and D. It will be apparent that it is absolutely impossible for the filament to be connected across the high tension supply, however the valve may be held above the holder. We should imagine that the device would not be so protective in the case of a valve-holder consisting of long, exposed brass legs, as experience shows that it is quite easy to place a valve amongst the sockets without any of the legs entering them.

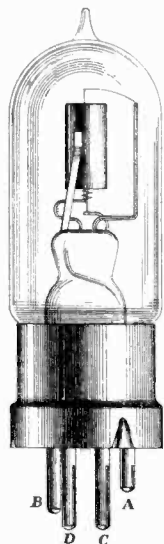

## AN IMPROVED ELECTROLYTIC CONDENSER

British Patent No. 216,139, Convention Date, May 14, 1923 granted to A. Soulier, claims that the functioning of an electrolytic condenser can be materially improved by the use of picric acid or trinitrophenol, preferably mixed with an alkaline base such as caustic soda. The invention also claims the addition of a tartrate, citrate, or borate which allows the use of a higher voltage.

## A MODIFICATION OF THE DYNATRON.

Some very interesting details are disclosed in British Patent No. 214,262, Convention Date, April 11, 1923, granted to the N. V. Philips Gloeilampfabrieken Co., and relate to a valve generator operating on the dynatron principle. The accompanying illustration shows a normal dynatron circuit which, of course, operates by virtue of secondary emission. The inner electrode B is made more positive than the external electrode or anode A. The inner electrode is of grid formation and owing to its high positive potential with respect to the filament, primary electrons from the filament pass through it at very high speeds impinging on the surface of the anode A. The velocity of the electrons at impact is sufficient to cause secondary electrons to be knocked out of the anode which then go towards the grid. One primary electron will dislodge several secondary electrons and consequently the characteristic of the grid anode circuit is falling, or shows a negative resistance effect. Hence if an oscillatory circuit is included in the anode circuit as at LC, oscillations will be set up at a frequency depending upon the constants of that circuit. This process is materially improved according to this invention, by utilising a rather different construction for the anode, and is intimately connected with the Richardson constant of the material of which the electrode is composed. The Richardson constant of a material is merely a measure of the quantity of work required to dislodge an electron from the surface of any given substance. Metals, such as tungsten, have been previously employed for the electrode of which the constant has been of the order of 4.5. This invention claims the use of materials of which the constant is smaller than 3, such as the alkali-metals or their oxides. Accordingly the electrode may be coated in a somewhat similar manner to the dull-emitter filament. It is therefore obvious that the use of an electrode of the coated type just described gives a very greatly increased efficiency.

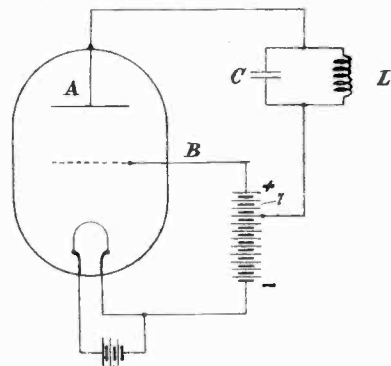

**A PECULIAR RESISTANCE AMPLIFIER.**

**SECRET TELEPHONY.**

H. Lloyd, E. B. Homer and A. Dilger have been granted British Patent No. 220,488, Application Date, September 28, 1923, for a rather peculiar form of resistance-coupled amplifier. The circuit is shown in the accompanying figure and is, of course, quite normal, the invention lying in the particular values chosen for the resistances. The object of the invention is to cause the first valve to operate as a detector-amplifier and the subsequent valves as amplifiers. The scheme is said to be operative with R type valves using a high

"Narrowcast Transmission" appears to be the latest addition to our radio vocabulary according to British Patent No. 198,368, Convention Date, May 26, 1922, owned by the Marconi Co., Ltd. The idea of the invention is to provide a transmission which can only be received by authorised stations. The scheme is illustrated by the accompanying figure. The object of the arrangement is to introduce undesired frequencies into the modulation, and then to remove them at the receiving end, so that to any but an authorised receiving station the transmission would be absolutely unintelligible. Referring to the figure, the apparatus on the left represents an ordinary choke control telephony transmitter, while that on the right represents an ordinary receiver. In the modulation circuit M of the transmitter, there is included an auxiliary modulator A, which is coupled to the normal circuit by the transformer B. The auxiliary modulator is in constant operation, and the speech or music frequencies are imposed upon the steady modulation. Between the telephones and the anode circuit of the last valve of the receiver it will be seen that there is a device E which is merely some form of filter, tuned to cut out the frequency supplied by the auxiliary modulator. The frequency of the steady modulation has to be chosen with great care so as not to render successful filtering difficult. The specification states that the best frequencies to employ are those below about 30 cycles per second, or above 2 500, *i.e.*, outside the normal speech range. Other arrangements provide for the less important frequencies within the speech range, and also sets of tones which will give a discordant resultant, together with combinations and variations of the above. The filtering devices used in the receivers are essentially high and low pass filters or band pass filters. In practice, the filter element is set in cement so as to render the operation of investiga-

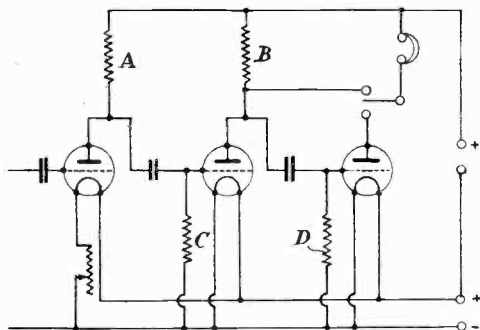

tension battery of 60 to 100 volts, thereby dispensing with the extra large battery usually required for resistance-amplifiers. The first peculiar feature is the value of the anode resistance A in the anode circuit of the detector valve which is as high as 5 megohms. This anode is capacity coupled to the grid of the first amplifier which has a grid-leak as high as 20 megohms. The anode resistance B in the anode circuit of the second valve is also very high, of the order of 3 megohms, while the last grid-leak D is from 10-15 megohms. It is stated that owing to the values chosen the first two valves operate on the bottom bend of the characteristic, while the third valve operates on the straight portion of the characteristic. Further, it is stated that the first valve operates as a detector while the second operates as an amplifier. A characteristic curve for the first two valves is shown without any values of anode current and grid volts and is identical in shape with the ordinary static characteristic for an R type valve without any load in the anode circuit. It would be very interesting to take the characteristic of an R valve with an anode battery voltage of 60 volts and a series resistance of 5 000 000 ohms.

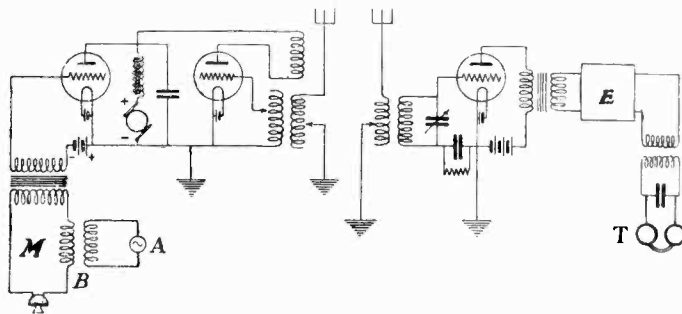

tion and duplication exceedingly difficult by any unauthorised person. One can picture the day when the receipt for a yearly broadcast licence takes the form of a band pass filter set in cement, which automatically burns out after twelve months' use.

**MODIFICATION OF THE LUMIÈRE DIAPHRAGM.**

The Société des Etablissements Gaumont in British Patent No. 210,405, Convention Date, January 27, 1923, give some constructional details of a modification of the well-known pleated diaphragm type of loud-speaker originally developed by Lumière. The loud-speaker, it will be remembered, consists essentially of a large pleated diaphragm supported at its periphery by a heavy ring. It is now proposed to add a diametric cross member to which can be attached a microphone or hand receiver. Various modifications and combinations are described and it would appear that the arrangement is primarily intended for office use.

**A BATTERY PATENT.**

The Marconi Co., Ltd., in British Patent 209,740, Convention Date, January 9, 1923, give details of the construction of a self-contained power unit suitable for supplying current to a broadcast receiver. The invention really consists in placing in one box the high and low tension batteries and so proportioning the size of the cells that they all cease to function at substantially the same time.

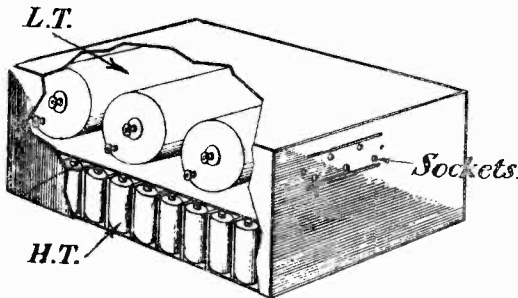

Larger cells are therefore used for the power stages than for the amplifiers and detector. The first claim of the patent is extremely broad and covers the use of a single power unit comprising filament and anode batteries together with a plug and socket device for simultaneous connection to the associated receiver. The use of separate anode and filament batteries mounted in one box with a plug connection has been used, we believe, for some considerable time and would not appear to be covered by this patent.

**CRYSTAL DETECTOR.**

(Application date, July 5, 1923.)

The crystal detector described in British Patent 217,066 of Messrs. H. H. Parkin, G. Parkin, W. Parkin and F. Parkin and already on sale as the "Climax," is characterised by the simplicity of the crystal mounting. Instead of being held in the usual cup the crystal is gripped between the jaws of a spring clip. A firm contact with the crystal is thus secured, while at the same time an interchange of crystals can very readily be

effected or the disposition of the same crystal may be varied to bring any desired part of its surface in contact with the cat-whisker.

**A FRAME AERIAL CABINET.**

E. A. Graham claims in British Patent No. 220,352, Application Date, April 18, 1923, the use of a frame aerial associated with a cabinet according to the following scheme: One side

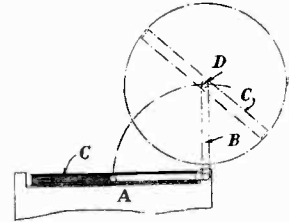

of the cabinet A in the accompanying illustration is recessed and is provided with two movable arms, one of which is shown at B. The frame aerial C is pivoted at D at the ends of the arms and may thus be turned about a vertical axis through 360 degrees. An alternative arrangement, which is preferable from an electrical point of view, provides for the use of extensible arms B and therefore enables the frame to be swung out farther into space and is not so liable to be affected by the presence of the apparatus within the cabinet. The frame aerial when not in use folds away into the side of the cabinet as shown in the illustration.

**AN INTERNALLY COUPLED VALVE.**

A rather peculiar valve is described in British Patent No. 220,388, Application Date, May 17, 1923, granted to J. Robinson and W. H. Derriman. The object of the invention appears to be to provide a receiver which is as light and compact as possible. This is accomplished by eliminating the coupling coils between the anode and grid circuits. The coupling is obtained between the actual grid and anode of the valve which are made in spiral formation and arranged concentrically. Both ends of the anode and grid spirals are, of course, provided with terminals. A modification of the invention provides for additional magnetic coupling within the valve by the provision of auxiliary inductances arranged round the anode. Fine adjustment of the coupling is arranged externally in the ordinary manner, either electro-magnetically or electrostatically.

**AN INDOOR AERIAL SUPPORT.**

An ingenious aerial support is described in British Patent No. 220,459, Application Date, August 10, 1923, by R. B. Gill. It will be seen from the accompanying illustration that it consists essentially of an ordinary picture hook with an additional lug X bent upwards at the top. The weight of the picture hanging from Y keeps the device rigidly in position, while the aerial wire is hooked round the projecting lug.

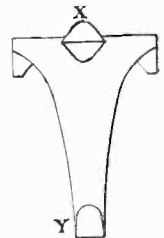

**CONDENSER CONSTRUCTION.**

W. Dubilier has been granted British Patent No. 198,362, Convention Date, May 23, 1922, for a method of condenser construction which is

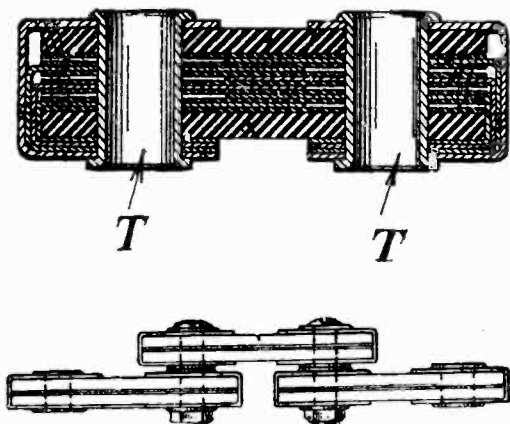

illustrated by the accompanying drawing. It will be seen that the elements of the condenser are clamped together by means of hollow tubes, T, the ends of which are riveted over. This type of construction enables the condenser to be connected in series for high voltage work merely by passing bolts through the tubes, as shown in the lower half of the illustration.

**THE "POLAR BLOK" PATENT.**

The well-known "Polar" unit system is described in British Patent No. 220,354, Application date May 2, 1923, and is due to R. Ferguson and R. E. Beswick and the Radio Communication Co., Ltd. The system is no doubt too well known to need lengthy description, and the essence of the invention is probably best summarised by quoting the first claim which reads as follows: "An extensible frame for a sectional panel board, wherein the frame members and junction pieces

**STANDARDS ASSOCIATION.**

The Main Committee of the British Engineering Standards Association have recently authorised the Secretary, Mr. le Maistre, to accept the cordial invitation of the German Standards Committee (the N.D.I.) to be present at their annual meeting on December 13th. He is also going to Prague to give an address on Industrial Standardisation before the recently-formed Czechoslovakian Standards Committee.

are secured in the assembled position by a spring or snap locking connection which also definitely positions the co-operating elements with respect to each other."

**AN IMPROVED BEVERAGE AERIAL.**

Le Société Française Radio-Électrique describe in British Patent No. 215,014, Convention Date, April 26, 1923, an improved form of Beverage aerial. It has been found that when the ground beneath the aerial is a very good conductor, the directive property of each element of the conductor is affected and maximum radiation is likely to occur towards the zenith. This defect is obviated by the scheme shown in the accompanying illustration, in which a number of frames are combined with each element. The aerial, which is one wavelength long is shown at XX, while S denotes the receiver and R the non-reflection resistance. The whole aerial is divided, for example, into five sections or elements each of which is coupled to a frame F. Considering each element separately it

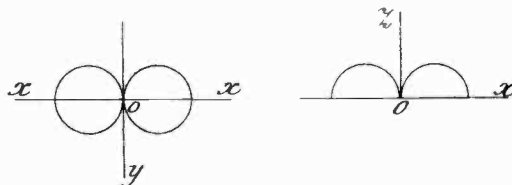
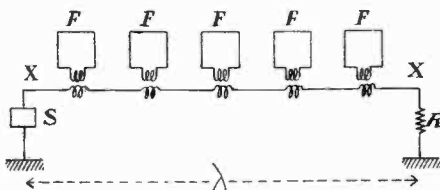

is seen that it will have no radiation in the direction of the zenith, while radiation in the direction of the conductor will be a maximum, which therefore results in a more efficient arrangement.

**2KK.**

The above call sign, originally the property of a London transmitter, is now owned by Mr. Ralph H. Parker, Wilson Road, Smethwick, Staffs. 2KK welcomes reports of transmissions on short waves.

**THE ROMAN STATION.**

The Marconi Company advise us that the call letters allotted officially to the Broadcasting Station at Rome are **1RO**.