

EVERYDAY

JANUARY 1990

ELECTRONICS

INCORPORATING ELECTRONICS MONTHLY

£1.40

LIGHT CHASER

BIOGEN

GAME TIMER

POSSESSION ALARM

ISSN 0262-3617



The Magazine for Electronic & Computer Projects



BAKERS DOZEN PACKS

All packs are £1 each, if you order 12 then you are entitled to another free. Please state which one you want. Note the figure on the extreme left of the pack ref number and the next figure is the quantity of items in the pack, finally a short description.

- BD2 5 13A spurs provide a fused outlet to a ring main where devices such as a clock must not be switched off.
- BD7 4 In flex switches with neon on/off lights, saves leaving things switched on.
- BD9 2 6V 1A mains transformers upright mounting with fixing clamps.
- BD11 1 6 $\frac{1}{2}$ "in speaker cabinet ideal for extensions, takes our speaker. Ref BD137.
- BD13 12 30 watt reed switches, it's surprising what you can make with these—burglar alarms, secret switches, relay, etc., etc.
- BD22 2 25 watt loudspeaker two unit crossovers.
- BD29 1 B.O.A.C. stereo unit is wonderful breakdown value.
- BD30 2 Nicad constant current chargers adapt to charge almost any nicad battery.
- BD32 2 Humidity switches, as the air becomes damper the membrane stretches and operates a microswitch.
- BD42 5 13A rocker switch three tags so on/off, or change over with centre off.
- BD45 1 24hr time switch, ex-Electricity Board, automatically adjust for lengthening and shortening day. Original cost £40 each.
- BD49 10 Neon valves, with series resistor, these make good night lights.
- BD56 1 Mini uniselector, one use is for an electric jigsaw puzzle, we give circuit diagram for this. One pulse into motor, moves switch through one pole.
- BD59 2 Flat solenoids—you could make your multi-tester read AC amps with this.
- BD67 1 Suck or blow operated pressure switch, or it can be operated by any low pressure variation such as water level in water tanks.
- BD103A 1 6V 750mA power supply, nicely cased with mains input and 6V output leads.
- BD120 2 Stripper boards, each contains a 400V 2A bridge rectifier and 14 other diodes and rectifiers as well as dozens of condensers, etc.
- BD128 10 Very fine drills for pcb boards etc. Normal cost about 80p each.
- BD132 2 Plastic boxes approx 3in cube with square hole through top so ideal for interrupted beam switch.
- BD134 10 Motors for model aeroplanes, spin to start so needs no switch.
- BD139 6 Microphone inserts—magnetic 400 ohm also act as speakers.
- BD148 4 Reed relay kits, you get 16 reed switches and 4 coil sets with notes on making c/o relays and other gadgets.
- BD149 6 Safety cover for 13A sockets—prevent those inquisitive little fingers getting nasty shocks.
- BD180 6 Neon indicators in panel mounting holders with lenses.
- BD193 6 5 amp 3 pin flush mounting sockets make a low cost disco panel.
- BD196 1 In flex simmerstat—keeps your soldering iron etc. always at the ready.
- BD199 1 Mains solenoid, very powerful, has 1in pull or could push if modified.
- BD201 8 Keyboard switches—made for computers but have many other applications.
- BD211 1 Electric clock, mains operated, put this in a box and you need never be late.
- BD221 5 12V alarms, make a noise about as loud as a car horn. Slightly soiled but OK.
- BD242 2 6in x 4in speakers, 4 ohm made from Radiomobile so very good quality.
- BD252 1 Panostat, controls output of boiling ring from simmer up boil.
- BD259 50 Leads with push-on $\frac{1}{4}$ in tags—a must for hook-ups—mains connections etc.
- BD263 2 Oblong push switches for bell or chimes, these can mains up to 5 amps so could be foot switch if fitted into patress.
- BD268 1 Mini 1 watt amp for record player. Will also change speed of record player motor.
- BD283 3 Mild steel boxes approx 3in x 3in x 1in deep—standard electrical.
- BD293 50 Mixed silicon diodes.
- BD305 1 Tubular dynamic mic with optional table rest.
- BO400 4 Books, useful for beginners, describes amplifiers equipment and kits.
- BD653 2 Miniature driver transformers. Ref. LT44. 20k to 1k centre tapped.
- BD548 2 3.5V relays each with 2 pairs changeover contacts.
- BD667 2 4.7 μ f non-polarised block capacitors, pcb mounting. There are over 1,000 items in our Bakers Dozen List. If you want a complete copy please request this when ordering.

EQUIPMENT WALL MOUNT It is a multi-adjustable metal bracket that could be used for mounting flood light, loudspeaker, TV camera, even a fan and on almost any sort of wall or ceiling even between wall and ceiling. The main fixing brackets rotate such that an inward or an outward corner can be accommodated. Front panel also tilts upward or downward to a reasonable angle and can be easily removed separately for wiring. A very useful bracket. Regular price would be around £6 each. Our price only £3. Our ref 3P72. Or 2 for £5. Our ref 5P152.

SUB-MIN TOGGLE SWITCH Body size 8mm x 4mm x 7mm SBDT with chrome dolly fixing nuts. 3 for £1. Order ref BD649.

COPPER CLAD PANEL for making PCB. Size approx 12in long x 8 $\frac{1}{2}$ in wide. Double-sided on fibreglass middle which is quite thick (about 1/16in) so this would support quite heavy components and could even form a chassis to hold a mains transformer, etc. Price £1 each. Our ref BD683.

POWERFUL IONISER

Generates approx. 10 times more IONS than the ET1 and similar circuits. Will refresh your home, office, workroom etc. Makes you feel better and work harder—a complete mains operated kit, case included. £12.50 + £2 P&P. Our ref 12P51.

REAL POWER AMPLIFIER for your car, it has 150 watts output. Frequency response 20hz to 20Khz and signal to noise ratio better than 60dB. Has built in short circuit protection and adjustable input level to suit your existing car stereo, so needs no pre-amp. Works into speakers ref 5P71 described below. A real bargain at only £57.50. Order ref: 57P1.

REAL POWER CAR SPEAKERS. Stereo pair output 100W each. 4-Ohm impedance and consisting of 6 $\frac{1}{2}$ " woofer, 2" mid range and 1" tweeter. Each set in a compact purpose built shelf mounting unit. Ideal to work with the amplifier described above. Price per pair £29.96. Order ref: 30P7.

STEREO CAR SPEAKERS. Not quite so powerful—70w per channel. 3" woofer, 2" mid range and 1" tweeter. Again, in a super purpose built shelf mounting unit. Price per pair: £27.95. Order ref: 28P1.

VIDEO TAPES These are three hour tapes of superior quality, made under licence from the famous JVC Company. Offered at only £3 each. Our ref 3P63. Or 5 for £11. Our ref 11P3. Or for the really big value 10 for £20. Our ref 20P20.



ELECTRONIC SPACESHIP.

Sound and impact controlled, responds to claps and shouts and reverses when it hits anything. Kit with really detailed instructions. Ideal present for budding young electrician. A youngster should be able to assemble but you may have to help with the soldering of the components on the pcb. Complete kit £10. Our ref. 10P81

12" HIGH RESOLUTION MONITOR Black and white screen, beautifully cased for free standing, needs only a 12v 1.5 amp supply. Technical data is on its way but we understand these are TTL input. Brand new in makers cartons. Price: £22.00 Free delivery. Order ref: 25P10.

14" COLOUR MONITOR made by the American Display Tek Company. Uses high resolution tube made by the famous Japanese Toshiba company. Beautifully made unit intended for console mounting, but top and sides adequately covered by plated metal panels. Full technical spec. on its way to us. We have a limited number of these. All brand new still in maker's cartons. Price: £83 each plus £6 insured carriage. Order ref: 89P1.

BUSH RADIO MIDI SPEAKERS Stereo pair. BASS reflex system, using a full range 4in driver of 4ohms impedance. Mounted in very nicely made black fronted walnut finish cabinets. Cabinet size approx 8 $\frac{1}{2}$ in wide, 14in high and 3 $\frac{1}{2}$ in deep. Fitted with a good length of speaker flex and terminating with a normal audio plug. Price £5 the pair plus £1 post. Our ref 5P141.

3 $\frac{1}{2}$ " FLOPPY DRIVES We still have two models in stock: Single sided, 80 track, by Chinson. This is in the manufacturers metal case with leads and IDC connectors. Price £40, reference 40P1. Also a double sided, 80 track, by NEC. This is uncased. Price £59.50, reference 60P2. Both are brand new. Insured delivery £3 on each or both.



ATARI 65XE COMPUTER

At 64K this is most powerful and suitable for home and business. Brand new, complete with PSU, TV lead, owner's manual and six games. Can be yours for only £45 plus £3 delivery

65 XE COMPENDIUM Contains: 65XE Computer, its Data Recorder XCI2 and its joystick with TEN games. £62.50 + £4 insured delivery.

REMOTE CONTROL FOR YOUR 65XE COMPUTER With this outfit you can be as much as 20 feet away as you will have a joystick that can transmit and a receiver to plug into and operate your computer and TV. This is also just right if you want to use it with a big screen TV. The joystick has two fire buttons and is of a really superior quality, with four suction cups for additional control and one handed play. Price £15 for the radio controlled pair. Our ref 15P27.

ASTECP.SU. Mains operated switch mode, so very compact. Outputs +12v 2.5A, +5v 6A, \pm 5v 5A, \pm 12v 5A. Size: 7 $\frac{1}{2}$ in long x 4 $\frac{1}{2}$ in wide x 2 $\frac{1}{4}$ in high. Cased ready for use. Brand new. Normal price £30+, our price only £12.95. Order ref 13P2.

VERY POWERFUL 12 VOLT MOTORS. $\frac{1}{2}$ hp Horsepower. Made to drive the Sinclair CS electric car but adaptable to power a go-kart, a mower, a rail car, model railway, etc. Brand new. Price £20 plus £2 postage. Our ref. 20P22.

PHILIPS LASER

This is helium-neon and has a power rating of 2mW. Completely safe as long as you do not look directly into the beam when eye damage could result. Brand new, full spec. £30 plus £3 insured delivery. Mains operated power supply for this tube gives 8kv striking and 1.25kv at 5mA running. Complete kit with case £15. As above for 12V battery. Also £15. Our ref 15P22.

ORGAN MASTER is a three octave musical keyboard. It is beautifully made, has full size (piano size) keys, has gold plated contacts and is complete with ribbon cable and edge connector. Can be used with many computers, request information sheet. Brand new, only £15 plus £3 postage. Our ref 15P15.

FULL RANGE OF COMPONENTS at very keen prices are available from our associate company SC5 COMPONENTS. You may already have their catalogue, if not request one and we will send it FOC with your goods.

HIGH RESOLUTION MONITOR. 9in black and white, used Philips tube M24/306W. Made up in a lacquered frame and has open sides. Made for use with OPD computer but suitable for most others. Brand new. £16 plus £5 post. Our ref 16P1.

12 VOLT BRUSHLESS FAN. Japanese made. The popular square shape (4 $\frac{1}{2}$ in x 4 $\frac{1}{2}$ in x 1 $\frac{1}{2}$ in). The electronically run fans not only consume very little current but also they do not cause interference as the brush type motors do. Ideal for cooling computers, etc., or for a caravan. £8 each. Our ref 8P26.

MINI MONO AMP on p.c.b. size 4" x 2" (app.) Fitted Volume control and a hole for a tone control should you require it. The amplifier has three transistors and we estimate the output to be 3W rms. More technical data will be included with the amp. Brand new, perfect condition, offered at the very low price of £1.15 each, or 13 for £12.00.



J & N BULL ELECTRICAL

Dept. EE 250 PORTLAND ROAD, HOVE, BRIGHTON, SUSSEX BN3 5QT.

MAIL ORDER TERMS: Cash, PO or cheque with order. Orders under £20 add £2.50 service charge. Monthly account orders accepted from schools and public companies. Access and B/Card orders accepted—minimum £5. Phone (0273) 734648 or 203500.

POPULAR ITEMS — MANY NEW THIS MONTH

JOYSTICKS for BBC Atari, Dragon Commodore, etc. All £5.00 each. All brand new, state which required.

TELEPHONE TYPE KEYPAD. Really first class rear mounting unit. White lettering on black buttons. Has conductive rubber contacts with soft click operation. Circuit arranged in telephone type array. Requires 70mm by 55mm cutout and has a 10 IDC connector. Price £2.00. Ref. 2P251.

SUB-MIN PUSH SWITCHES Not much bigger than a plastic transistor but double pole PCB mounting. 3 for £1.00. Our ref BD688.

AA CELLS Probably the most popular of the rechargeable NICAD types. 4 for £4.00. Our ref 4P44.

20 WATT 4 OHM SPEAKER With built in tweeter. Really well made unit which has the power and the quality for hifi 6 $\frac{1}{2}$ " dia. Price £5.00. Our ref. 5P155 or 10 for £40.00 ref. 40P7.

MINI RADIO MODULE Only 2in square with ferrite arial and solid dia. tuner with own knob. It is superhet and operates from a PP3 battery and would drive a crystal headphone. Price £1.00. Our ref. BD716.

BULGIN MAINS PLUG AND SOCKET The old and faithful 3 pin with screw terminals. The plug is plastic mounted and the socket is cable mounted. 2 pairs for £1.00 or 4 plugs or 4 sockets for £1.00. Our ref. BD715, BD715P, or BD715S.

MICROPHONE Low cost hand held dynamic microphone with on/off switch in handle. Lead terminates in 1.35mm and 1.25mm plug. Only £1.00. Our ref. BD711.

MOSFETS FOR POWER AMPLIFIERS AND HIGH CURRENT DEVICES 140v 100watt pair made by Hitachi. Ref. 25K413 and its complement 2S118. Only £4.00 a pair. Our Ref. 4P42. Also available in H pack Ref. 2S199 and 2SK343 £4.00 a pair. Ref. 4P51.

TIME AND TEMPERATURE LCD MODULE A 12 hour clock a Celsius and Fahrenheit thermometer a too hot alarm and a too cold alarm. Approx 50x20mm with 12.7mm digits. Requires 1AA battery and a few switches. Comes with full data and diagram. Price £6.00. Our ref. 6P12.

REMOTE TEMPERATURE PROBE FOR ABOVE. £3.00. Our ref. 3P60.

A REAL AIR MOVER Circular axial fan moves 205 cubic foot per min which is about twice as much as our standard 4 $\frac{1}{2}$ " fans. Low noise mains operated 6 $\frac{1}{2}$ " dia, brand new. Regular price offered £3.00. Our price only £1.00. Our ref 10P71.

600 WATT AIR OR LIQUID MAINS HEATER Small coil heater made for heating air or liquids. Will not corrode, lasts for years. Coil size 3" x 2" mounted on a metal plate for easy fixing. 4" dia. Price £3.00. Ref. 3P78 or 4 for £10.00. Our ref. 10P76.

EX-EQUIPMENT SWITCHED MODE POWER SUPPLIES Various makes and specs but generally +5, +12v ideal bench supply. Only £8.00. Our ref. 8P36.

ACORN DATA RECORDER Made for the Electron or BBC computer but suitable for others. Includes mains adaptor, leads and book. £12.00. Ref. 12P15.

PTFE COATED SILVER PLATED CABLE 19 strands of 2mm copper will carry up to 30A and is virtually indestructible. Available in red or black. Regular price is over £120 per reel. Our price only £200 for 100m reel. Ref. 20P21 or 1 of each for £35.00. Ref 35P2. Makes absolutely superb speaker cable!

NEW PIR SENSORS Infra red movement sensors will switch up to 500w mains, UK made, 12 month manufacturers warranty, 15-20m range with a 0-10min timer, adjustable wall bracket. Only £20.00. Ref. 20P24.

MITSUBISHI 3 $\frac{1}{2}$ " DISC DRIVES Brand new drives, $\frac{1}{2}$ height double sided, double density warranted. Our price £60.00. Ref. 60P5.

10 MEMORY PUSHBUTTON TELEPHONES These are customer returns and "sold as seen" but are generally complete and generally need attention. Price £6.00. Ref. 6P16 or 2 for £10.00. Ref. 10P77. BT approved.

NON-MEMORY PUSHBUTTON TELEPHONES. Same condition as above with redial £3.00. Our ref. 3P79. BT approved.

DEHUMIDIFIERS Domestic mains powered dehumidifiers these are customer returns and sold as seen. Price £30.00. Our ref 30P9. Callers only please.

SPECTRUM PRINTER INTERFACE Add a ctronics interface to your Spectrum complete with printer cable for only £4.00. Our ref. 4P52.

SPECTRUM SOUND BOX Add sound to your Spectrum with this device. Just plug in. Complete with speaker, volume control and nicely boxed. A snip at only £4.00. Our ref. 4P53.

BBC JOYSTICK INTERFACE Converts a BBC joystick port to an Atari type port. Price £2.00. Our ref. 2P261.

TELEPHONE EXTENSION LEAD 5m phone extension lead with plug on one end, socket on the other. White. Price £3.00. Our ref. 3P70 or 10 leads for only £19.00! Ref. 19P2.

LCD DISPLAY 4 $\frac{1}{2}$ " digits supplied with connection data £3.00. Ref. 3P77 or 5 for £10. Ref. 10P78.

CROSS OVER NETWORK 8 Ohm 3 way for tweeter midrange and woofer nicely cased with connections marked. Only £2.00. Our ref. 2P255 or 10 for £15.00. Ref. 15P32.

REVERSING LIGHT ALARM Fits to car reversing light and sounds when reversing. Only £2.00. Our ref. 2P248.

BASE STATION MICROPHONE Top quality uni-directional electret condenser mic 600r impedance sensitivity 16-18kHz—68db built in chime complete with mic stand bracket. £15.00. Ref. 15P28.

MICROPHONE STAND Very heavy chromed mic stand, magnetic base 4" high. £3.00 if ordered with above mic. Our ref. 3P80.

SOLAR POWERED NICAD CHARGER 4 Nicad AA battery charger. Charges 4 batteries in 8 hours. Price £6.00. Our ref. 6P3.

MAINS SOLDERING IRON Price £3.00. Our ref. 3P65.

SOLDERING IRON STAND Price £3.00. Our ref. 3P66.

PIR SENSORS Suitable for alarm systems etc. Nicely boxed. Priced at only £10.00. Our ref. 10P79.

SHARP PLOTTER PRINTER New 4 colour printer originally intended for Sharp computers but may be adaptable for other machines. Complete with pens, paper etc. Price £16.00. Our ref. 16P3.

CAR IONIZER KIT Improve the air in your car, clears smoke and helps prevent fatigue. Case req. Price £12.00. Our ref. 12P8.

NEW FM BUG KIT New design with PCB embedded coil 9v operation. Priced at £5.00. Our ref. 5P158.

NEW PANEL METERS 50uA movement with three different scales that are brought into view with a lever. Price only £3.00. Ref. 3P81.

STROBE LIGHTS Fit a standard edition screw light fitting 240V 40/min. flash rate available in yellow, blue, green and red. Complete with socket. Price £10 each. Ref. 10P80 (state colour required).

ELECTRONIC SPEED CONTROL KIT Suitable for controlling our powerful 12v motors. Price £17.00. Ref. 17P3 (heatsink required).

EXTENSION CABLE WITH A DIFFERENCE It is flat on one side making it easy to fix and look tidy. 4 core, suitable for alarms, phones etc. Our price only £5.00 for 50m reel. Ref. 5P153.

METAL PROJECT BOX Ideal for battery charger, power supply etc. Sprayed grey size 8" x 4" x 4 $\frac{1}{2}$ ". Louvered for ventilation. Price £3.00. Ref. 3P75.

EVERYDAY ELECTRONICS

INCORPORATING ELECTRONICS MONTHLY

ABC

VOL 19 No 1 JANUARY 1990

The Magazine for Electronic & Computer Projects

ISSN 0262-3617

PROJECTS ... THEORY ... NEWS ...
COMMENT ... POPULAR FEATURES ...



Best wishes for Christmas and the new year from the staff of Everyday Electronics



© Wimborne Publishing Ltd 1990. Copyright in all drawings, photographs and articles published in EVERYDAY ELECTRONICS is fully protected, and reproduction or imitations in whole or in part are expressly forbidden.

Our February '90 Issue will be published on Friday, 5 January 1990. See page 3 for details.
Everyday Electronics, January 1990

Projects

- | | |
|---|----|
| FOUR-CHANNEL LIGHT CHASER
by Mark Stuart | 12 |
| A hard fired sound triggered value for money design | |
| POSSESSION LOOP ALARM by Chris Bowes | 18 |
| A simple loop alarm designed for Easiwire construction | |
| GAME TIMER by Chris Bowes | 40 |
| Prevent the arguments with this easy to build unit | |
| CHRISTMAS CANDLE by Chris Walker | 44 |
| An interesting and unusual project with a Christmas flavour | |
| BIOFEEDBACK SIGNAL GENERATOR by Andy Flind | 58 |
| Generate test signals for Biofeedback equipment | |

Series

- | | |
|---|----|
| AMATEUR RADIO by Tony Smith G4FA1 | 24 |
| Young Amateur of the Year, Amateur Satellites | |
| ROBOT ROUNDUP by Nigel Clark | 32 |
| Investigating the world of robots | |
| MICRO IN CONTROL — PART 2 by John Hughes | 34 |
| We investigate the transistor | |
| BBC MICRO by R. A. Penfold | 51 |
| Regular spot for Beeb Micro fanatics | |
| ACTUALLY DOING IT by R. A. Penfold | 55 |
| Fitting components to circuit boards | |
| ON SPEC by Mike Tooley | 62 |
| Spectrum, Sam Coupé and all that | |

Features

- | | |
|--|----|
| EDITORIAL | 11 |
| MARKET PLACE | 21 |
| Readers free buy, sell and swop spot | |
| FOR YOUR ENTERTAINMENT by Barry Fox | 22 |
| Dallas quality, video tuning and delay lines | |
| MATSUSHITA ELECTRIC by Barry Fox | 26 |
| Barry visits the Far East and reports on the worlds largest electronics manufacturer | |
| PLEASE TAKE NOTE | 56 |
| Two Tone Siren | |
| SPECIAL OSCILLOSCOPE OFFER | 57 |
| NEWS | 63 |
| What's happening in the world of electronics | |
| SHOPTALK by David Barrington | 64 |
| Component buying for project building | |
| DIRECT BOOK SERVICE | 66 |
| Technical books by mail order | |
| PRINTED CIRCUIT BOARD SERVICE | 70 |
| ADVERTISERS INDEX | 76 |

Readers' Services • Editorial and Advertisement Departments

11

THE RTC MONITOR II

100 WATT SPEAKER KIT £60.00 +£3.50 P&P (pair)
RESPONSE: 55Hz-20kHz
BASS POLYMER CONE D: 22cm
DOME TWEETER: 14mm

OVERALL SIZE
(HWD): 382,252,204mm

RECOMMENDED AMP POWER:
10-100 watts per channel

The performance standard achieved in this compact design is distinctively superior to anything else available at the price. The drive units used are of sophisticated design and have been carefully integrated with a Complex Crossover. Stereo performance is exceptionally good with a well focussed sound stage and sharp resolution of detail. Distortion throughout the frequency range is low even at quite high power input and this gives a great sense of dynamic range and openness especially when used in bi-wired mode.

Supplied with:— 2 READY CUT BAFFLES, ALL CROSSOVER COMPONENTS, 2 BASS MID-RANGE, 2 DOME TWEETERS, HOOK UP WIRE, GRILLE CLOTH, SCREW TERMINALS AND SCREWS.

CROSSOVER KIT. To build 2 sets of crossovers £11+£1.75 post. (Featured in *Everyday Electronics*—May 1989 issue). Reprint Free with Kits



AMPHONIC 125+125 POWER AMPLIFIER



125 watt per channel stereo power amplifier with independent volume controls, professional 19" rack mount and silent running cooling fan for extra reliability.

Output power 125W RMS max. per channel

Output impedance 4 to 16 ohms (max. power into 4 ohms)

Sensitivity 450V at 22K ohms

Protection Electronic short-circuit and fuses

Power 220-240V a.c. 50Hz

Chassis dim 435x125x280mm

£124.99+£7.00 p&p

GOODMANS 60W CAR GRAPHIC



As new condition but have been returned by customers or shops, so they may need some attention. Hence the price of only £8.00 each. Order six of these units and you get the seventh one free. Postage £2.90

LCD DIGITAL MULTI TEST METER AC DC Volts resistance and DC Amps. Most of these units are new but have been returned or rejected by the store and sold with all faults at £11.00 each. Postage £1.00. (Made by Ross Electronics).

ROSS DYNAMIC MICROPHONE BALL TYPE

General purpose in light weight case with wire mesh grill, and on/off switch fitted with lead and jack plug. These units have been returned and may need repairing. Price £2.50 each. Order ten of these units and you get one free. Postage 80p.

J.B.L. BOLIVAR COMPONENT SPEAKERS

4½" 100W HI-FI MID RANGE 1" VOICE COIL, PAPER CONED AND DOPED CAMBRIC EDGE FITTED WITH A 3½" MAGNET. 6Ω IMPEDANCE £5.33

4½" HI-FI TWEETER ¾" VOICE COIL, 1¼" CONE WITH FOAM EDGE, 2½" MAGNET, 6Ω IMPEDANCE £6.33

POSTAGE £4.70 PER ORDER

52W 2-WAY COMPONENT SPEAKER SYSTEM £3.95

Comprises 8in rolled surround bass unit and 2½in tweeter for In-Car or Hi-Fi use. 4 ohm. Made by Sanyo.

8in SOUND LAB COMPONENT SPEAKER 60W

£12.95
Res freq. 38Hz full range
12in DANTEX 100W £21.75
Res freq. 23Hz bass unit

Postage £3.20 each order

SPECIAL PURCHASES

Batteries C size NiCad 2.2 Ah EVERY-READY AN220 £1.98 each

Our most popular size of rechargeable battery: 4AA size Japanese made batteries—£3.90 for four.

HILLS KITS IN STOCK ★ SEND FOR CATALOGUE

MAIL ORDER £1 BARGAIN PACKS BUY 10 GET 1 FREE

Please state pack(s) required

No	Qty.	per pack
BP010	2	6½" Speaker 8Ω 10 watt
BP012	2	6½" Speaker 4Ω 10 watt
BP013	3	8" x 5" Speaker 4Ω 6 watt made by E.M.I.
BP015B	1	30 watt, dome tweeter. Size 90x66mil JAPAN made
BP016	6	2200µf can type Electrolytic 25V d.c. computer grade made in UK by PHILIPS
BP017	3	33000µf 16V d.c. electrolytic high quality computer grade UK made
BP018	3	2000µf 50V d.c. electrolytic high quality computer grade made in USA
BP019	20	20 ceramic trimmers
BP020	4	Tuning capacitors, 2 gang dielectric a.m. type
BP021	10	3 position, 8 tag slide switch 3 amp rated 125V a.c. made in USA
BP022	5	Push-button switches, push on push off, 2 pole change over. PC mount JAPAN made
BP023	6	2 pole 2 way rotary switch
BP024	2	Right angle, PCB mounting rotary switch, 4 pole, 3 way rotary switch UK made by LORLIN
BP025	4	3 pole, 3 way miniature rotary switch with one extra position off (open frame YAXLEY type)
BP026	4	4 pole, 2 way rotary switch UK made by LORLIN
BP027	30	Mixed control knobs
BP028	10	Slide potentiometers (popular values)
BP029	6	Stereo rotary potentiometers
BP030	2	100k wire wound double precision potentiometers UK made
BP031	6	Single 100k multi-tune pots, ideal for varicap tuners UK made by PHILIPS
BP032	4	UHF varicap tuner heads, unboxed and untested UK made by PHILIPS
BP033	2	FM stereo decoder modules with diagram UK made by PHILIPS
BP033A	4	6"x¾" High grade Ferrite rod. U.K. made.
BP034	3	AM IF modules with diagram UK made by PHILIPS
BP034A	2	AM-FM tuner head modules. UK made by MULLARD
BP034B	1	Hi-Fi stereo pre-amp module inputs for CD, tuner tape, magnetic cartridge with diagram. UK made by MULLARD
BP035	6	All metal co-axial aerial plugs
BP036	6	Fuse holders, panel mounting 20mm type JAPAN made
BP037	6	In line fuse holders 20mm type UK made by BULGIN
BP038	20	5 pin din, 180° chassis socket
BP039	6	Double phono sockets, Paxolin mounted
BP041	3	2.8m lengths of 3 core 5 amp mains flex
BP042	2	Large VU meters JAPAN made
BP043	30	4V miniature bulbs, wire ended, new untested
BP044	2	Sonotone stereo crystal cartridge with 78 and LP styli JAPAN made
BP045A	2	Mono Cassette Record and play heads. (Japan Made)
BP046	4	6-0-6 4VA mains transformers, P.C. mount UK made
BP047	1	24V 750mA mains power supply. Brand new boxed UK made by MULLARD
BP049	10	OC44 transistors. Remove paint from top and it becomes a photo-electric cell (or P12) UK made by MULLARD
BP050	30	Low signal transistors n.p.n., p.n.p. types
BP051	6	14 watt output transistors. 3 complimentary pairs in T066 case (Ideal replacement for AD161 and 162s)
BP052A	1	Tape deck pre-amp IC with record/replay switching No LM1818 with diagram
BP053	5	5 watt audio ICs. No TBA800 (ATEZ)
BP054	10	Motor speed control ICs, as used with most cassette and record player motors
BP055	1	Digital DVM meter I.C. made by PLESSEY as used by THANDAR with diagram
BP056	4	7 segment 0.3 LED display (R.E.D.)
BP057	8	Bridge rectifiers, 1 amp, 24V
BP058	200	Assorted carbon resistors
BP059	1	Power supply PCB with 30V 4VA transformer. MC7818CT IC & bridge rectifier: Size 4" x 2½"
BP060	1	Transcription record player motor 1500rpm 240V a.c.
BP061	5	6.35mm Mono jack plugs
BP063	5	6.35mm stereo switched jack sockets
BP064	12	Coax chassis mount sockets
BP065	1	3mtr Euro-mains lead with a matching chassis socket

MULTIBAND RADIO

VHF 54-176 MHz + AM CB BANDS 1-80
Listen to: AIR TRAFFIC CONTROL,
AIRCRAFT, RADAR
PUBLIC UTILITIES
RADIO AMATEURS AND
MANY MANY MORE

£15.95

POSTAGE £2.85

SQUELCH CONTROL
"RUBBER DUCK AERIAL"

RADIO AND TV COMPONENTS ACTON LTD

21 HIGH STREET, ACTON LONDON W3 6NG
MAIL ORDER TERMS, POSTAL ORDERS and/or CHEQUES with orders. Orders under £20 add £3.00 service charge. Net monthly accounts to Schools, Colleges and P.L.C. only. ACCESS = VISA. Phone orders between 9.30 & 12pm please. Overseas readers write for quote on delivery.
Phone: 01-723 8432 or 01-992 8430.
Callers 323 Edgware Road, London W2

30+30 WATT AMPLIFIER KIT



An easy to build amplifier with a good specification. All the components are mounted on the single P.C.B. which is already punched and backprinted.

- 30W x 2 (DIN 4 ohm)
 - CD/Aux, tape I, tape II, tuner and phono inputs.
 - Separate treble and bass
 - Headphone jack
- Size (H.W.D.) 75x400x195mm
Kit enclosed: case, P.C.B., all components, scale and knobs £36.80, post £3.50
(Featured project in *Everyday Electronics* April 1989 issue). Reprint Free with kit.

TV SOUND TUNER



In the cut-throat world of consumer electronics, one of the questions designers apparently ponder over is "Will anyone notice if we save money by chopping this out?" In the domestic TV set, one of the first casualties seems to be the sound quality. Small speakers and no tone controls are quite common and that really is quite sad, as the TV companies do their best to transmit the highest quality sound. Given this background a compact independent TV tuner that connects direct to your Hi-Fi is a must for quality reproduction. The unit is mains operated. This TV SOUND TUNER offers full UHF coverage with 5 pre-selected tuning controls. It can also be used in conjunction with your video recorder.

£29.50 +£2.50 p&p

As above but with built-in stereo headphone amplifier for the hard of hearing

You can tune into the TV channel you want while still receiving the picture on your TV set. In fact it is rather like a second television, but without the screen. So that the ordinary TV can be placed for everyone to see, and the volume on it can be comfortable for others, while the sound tuner can be placed where you can control it. You will need to plug in one of your own listening aids such as headphones or an induction loop to hear the sound. The tuner is mains operated, has 5 pre-selected tuning controls and can be used in conjunction with a video recorder.

Size: 270x192x65mm. £35.90 +£2.50 p&p

TV SOUND TUNER KIT £11.50+£1.30 P&P

All parts including Varicap tuner, mains transformer, PCB with IC's capacitors and coils etc., to build the unit illustrated above; without case and scale.

SHURE HIFI STEREO MAGNETIC CARTRIDGE

Fitted with an elliptical diamond stylus supplied with fitting kit and instructions. A good quality unit made to sell for well over twenty pounds due to scoop purchase, we are able to offer these at a fraction of the manufacturers price. All units are brand new and boxed. £7.20 each. If you order in multiples of five you get one free. Postage £1.30 (Made in U.S.A.)

ROSS STEREO HEADPHONES High quality light weight stereo headphones fitted 3.5mm jack with adaptor to 6.4mm jack. Ideal use Hi-Fi or personal stereos. Made to sell for nine pounds. Our price for this unit £4.25. Postage 60p.

Hi-Fi stereo cassette deck transport mechanism, complete with 3 digit rev counter and tape heads, 12V d.c. operation. Unused manufacturers surplus JAPAN made
£6.20 +£1.50 P&P 2 for £10 +£2.50 P&P

EXTRACTABLE HOUSING FOR YOUR CAR STEREO ★ SIZE DIN E
★ HANDLE INCLUDED ★ SPACE FOR MEMORY BATTERY ★ 4 OR 2 SPEAKER SYSTEM.
ENABLES YOU TO REMOVE YOUR VALUED STEREO FROM YOUR CAR (WITHOUT THE AID OF A HAMMER AND CHISEL, CHAINSAW ETC).
£9.95 postage £2.50

PROPHET IN-CAR IONISER

What would you say to a project that filled you with energy, made you bounce with health, and even improved your brain power? All these claims and more have been made at one time and another for air ionisers.

In fact, the Prophet aims to do more than restore the balance: it super-saturates the air with ions. And it does it in the place where the effects of ion boosting will have the most effect: in your car. The importance of a proper ion level for drivers has been recognised by such diverse bodies as NASA (who were keen that their astronauts shouldn't fall asleep at the wheel of the spacecraft) and Mercedes Benz. It is said that astronauts and motorists alike need a healthy dose of ions to remain alert, maintain fast reaction times, and drive to the best of their abilities.



WEATHER STATION

Following a request from a school Geography department for the development of some form of electronic anemometer, the author began to investigate what other meteorological "quantities" might be measured using electronic techniques.

The electronic weather station to be described is the culmination of the work of these investigations. A short series of articles will describe projects to measure the following quantities: Wind Speed, Wind Direction, Temperature and Humidity. Other quantities will be dealt with in future articles.



FIRST STEPS IN PROJECT BUILDING

Setting about building your first project can be a very daunting task, with so many unfamiliar terms, names, and tools to contend with. Knowing where to start can be difficult. Where do you buy the components, what tools do you need, how much will it all cost, and what do you do once you have assembled everything you need? Reassurance from the experts that it is all quite straightforward is probably not all that reassuring! Like many hobbies, electronic project construction is not a highly complex task requiring years of training, but it does require a certain amount of skill and knowledge. We hope this article will help those that need it.

QUICK CAP TEST

A cheap, handheld unit which can identify short, open and working capacitors quickly, and with a minimum amount of fuss. The design not only does this, both audibly and visually, in a matter of seconds, but also gives some indication of leakage current, especially useful for electrolytic capacitors and also for diodes and transistor junctions.

EVERYDAY ELECTRONICS

FEBRUARY ISSUE ON SALE JANUARY 5 1990

THE
WORLD
OF
EXPERIMENTAL

We deliver from stock - The fastest way to order is a fax !

ULTRASONIC CAR ALARM



Complete Kit including case
44.367BKL £ 30.40

This system is specially designed to protect your car and its contents against potential thieves. Low current consumption and high noise immunity are just two of its distinguishing features.

In addition the system has a voltage sensing device i.e. the alarm is also triggered if appliances are switched on by an unauthorised person (e.g. the interior lighting when the door is opened).

DIGITAL PROFESSIONAL ECHO 1000

(Elektronik June 89)

This low cost echo unit is certain to impress music lovers - amateur and professional - everywhere. Excellent specification and top performance make the EU 1000 a winner and despite meeting professional requirements the unit will not make too big a hole in your pocket.

Working on the delta modulation principle on a digital base, delay times up to one second are possible at full bandwidth and large signal to noise ratio.

EU 1000, complete kit
44.255BKL £ 99.50
EU 1000, ready assembled
44.255F £ 134.50



Specification

Input sensitivity:
Input 1 : 2 mV
Input 2 : 200 mV

Delay Time:
variable from 60 ms to 1 s

Bandwidth :
100 Hz to 12 kHz

Additional features:

- inputs mixable
- single and multiple echo
- adjustable delay level
- switchable vibrator
- switch-controlled noise suppression

SPM 130 Decibel Meter

(Elektronik September 89)

Depending on their physical and mental state, human beings respond subjectively to ambient noise. Objective, absolute sound pressure level measurements therefore invariably require a specially designed test instrument, the decibel meter.

This portable instrument gives an accurate indication of the sound pressure level (SPL). The three SPL ranges (40 to 130 dB), three response modes,

and linear or A-weighted filtering provided by the meter enable many types of measurement to be carried out, from the tracing of ambient noise sources to establishing the sensitivity of a loudspeaker.

Complete kit
44.472BKL £ 99.50
Ready assembled module
44.472F £ 160.50

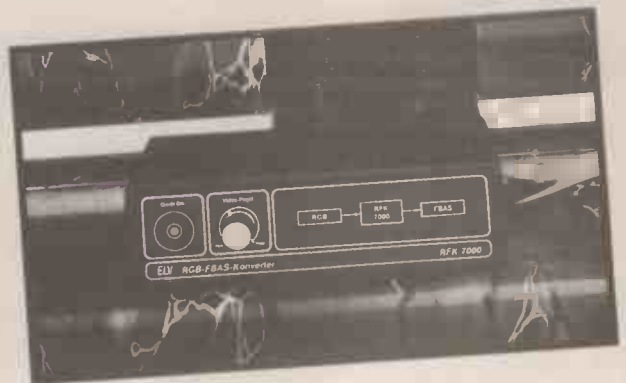

RFK 700 RGB-CVBS Converter

(Elektronik October 89)

Nearly all computers supply as an output signal for colour monitors RGB signals. With the help of the RFK 7000 it is possible to record this signals with a videorecorder or to give them onto a

colour TV.
The voltage supply is gained from a 12V/300mA-DC voltage mains adaptor.

Complete kit
44.525BKL £ 66.50

Ready assembled module
44.525F £ 119.50

Ordering and payment:

- all prices excluding V.A.T. (french customers add 18.6%T.V.A.)
- send Euro-cheque, Bank Draft or Visa card number with order. Please add £ 3.00 for p & p (up to 2 kg total weight)
- postage charged at cost at helgher weight Air/Surface -
- we deliver worldwide except USA and Canada
- dealer inquiries welcome

We deliver from stock - The fastest way to order is a fax !

S-VHS-RGB-CONVERTER SVR 7000

(Elektor Electronics May 89)

Superb picture quality!

With the SVR 7000 video recorders and cameras of the new super VHS generation can be connected to colour TV sets which have a scart input socket, without adjusting the TV set itself. Connected between the S-VHS and TV, the SVR 7000 converts the separate luminance and chrominance signals of a super VHS into an equivalent, high-quality RGB signal.

Three controllers for contrast, colour and brightness optimise the picture quality even if input signals deviate from the norm.

A 4-pole mini-DIN input socket for the S-VHS picture signal, two BNC input sockets for left and right stereo-audio sound channels (only one BNC socket is required for mono) and a scart output socket are available to connect the unit. The voltage supply is gained from a 12V/300mA-DC voltage mains adaptor.



Complete Kit
Ready Assembled Module

44.497BKL	£	76.25
44.497F	£	176.00

VIDEO RECORDING AMPLIFIER

(Elektor Electronics April 89)

Losses can easily occur when copying video tapes resulting in a distinct reduction in quality. By using this video recording amplifier, with no less than four (!) outputs, the modulation range is enlarged and the contrast range of the copy increases.

Two level controllers for edge definition (contour) and amplification (contrast range) allow individual and precise adaptation.



Complete Kit
(including Box, PCB and all parts)
44.324BKL £ 14.75

MG 7000 MINI-FUNCTION GENERATOR



Complete Kit
Ready Assembled Module

44.238BKL	£	62.15
44.238F	£	123.95

- Frequency Range: 0.2Hz to 200kHz
- Functions: Sine, Triangular, Saw-Tooth Square Wave
- Output Voltage: max. 10V - adjustable via attenuator
- Distortion Factor: approx. 0.5% (1kHz)
- Power Supply: via 2 x 9V block batteries

GLP 7000 TRACKING TESTER

(Elektor Electronics July/August 89)

Complete kit 44.385BKL £ 49.80
Ready assembled modul 44.385F £ 119.50

Wow and Flutter Test Cassette
Side A: 3150Hz - 10dB (DIN)
Side B: white noise - 10dB for adjusting the sound head by ear
44.385MK £ 11.00



Good wow and flutter characteristics are a mark of quality in tape decks, reel-to-reel tape and VCRs. This tester not only allows you to take quick and exact measurements of wow and flutter, but also of drift.

- Here are the main features in brief:
- built-in, quartz-stabilised reference tone generator
 - switchable frequencies for wow and flutter measurements for DIN (3150Hz) and CCIR (3000Hz)
 - 1 additional range for drift measurements (+/-5%)

IC TESTER FOR IBM-PC-XT/AT

With the ELV IC tester logic function tests can be carried out on nearly all CMOS and TTL standard components, accommodated in DIL packages up to 20 pin. The tester is designed as an insertion card for IBM-PC-XT/AT and compatibles. A small ZIF test socket PCB is connected via a flat band cable. Over 500 standard components can be tested using the accompanying comprehensive test software.

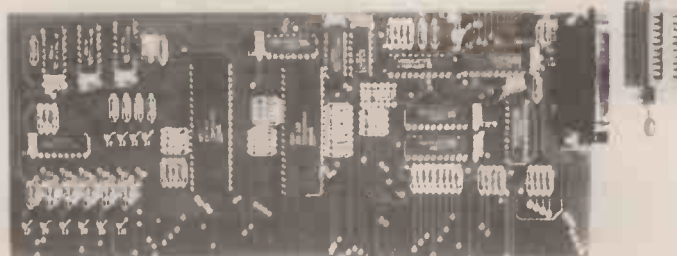

Complete Kit including Textool socket, connectors, sockets, Flat band cable, PCB, Software
44.474BKL £ 60.85
Ready Assembled Module GB474F £ 113.00
Software, single 44.474SW £ 17.85

NEW COMPONENT PACKS

New components, lots of new packs, and a better selection than ever in the old favourites. If you haven't yet sampled these delicious component assortments, you just don't know what you're missing! All the packs are **£1 (+VAT)** each, but if you order five packs you can select an extra one FREE. Order ten packs and you can have three extra packs FREE. Go for it!

PASSIVE COMPONENTS

PACK 1 - 200 RESISTORS. Finest carbon film, with lots of E12 values and a few precision.
PACK 2 - 100 CAPACITORS. Polystyrene, ceramics, metallised film. A fine selection!
PACK 3 - 30 ELECTROLYTICS. Values to 470µF.
PACK 4 - 15 LARGE ELECTROLYTICS. Values to 4,700µF.
PACK 5 - 10 TANTALUM CAPACITORS. Values from 0.1µF to 68µF.
PACK 6 - 20 HIGH VALUE POLYESTER CAPACITORS. Values to at least 3µ3.
PACK 7 - 15 DIL RESISTOR NETWORKS. Lots of values.
PACK 8 - 50 POWER RESISTORS. 1W and above.
PACK 9 - 30 SUB-MINIATURE CAPACITORS. Look like diodes!

OPTO ELECTRONICS & DISPLAYS

PACK 11 - 10 5mm LEDs: 4 red, 2 yellow, 2 orange, 2 green.
PACK 12 - 10 3mm LEDs: 4 red, 2 yellow, 2 orange, 2 green.
PACK 13 - 10 Rectangular LEDs. Mixed red and green.
PACK 14 - 10 Mixed LEDs. All shapes, sizes, colours.
PACK 15 - 2 DUAL 0.3" CA 7-seg displays (panel type).
PACK 16 - 1 DUAL 0.5" CC 7-seg display (panel type).
PACK 17 - 1 QUAD 0.3" CA 7-seg display (panel type).
PACK 18 - 2 INFRA-RED COMPONENTS. Emitter and receiver.
PACK 20 - 1 CALCULATOR DISPLAY, eight digits.
PACK 23 - 2 PHOTOTRANSISTORS. Respond to visible and IR light.

SEMICONDUCTORS

PACK 26 - 3 TAG136D MAINS TRIACS (400V, 4A).
PACK 27 - 30 IN4000-SERIES RECTIFIERS.
PACK 28 - 30 MIXED SEMICONDUCTORS. Diodes, transistors, ICs, triacs, all sorts.
PACK 29 - 20 ASSORTED ICs. CMOS, TTL, linear, memory, as available. Changes daily!
PACK 30 - 20 TRANSISTORS. High grade general purpose NPN.
PACK 31 - 12 BC212 TRANSISTORS. High grade general purpose PNP.
PACK 32 - 12 BC213 TRANSISTORS. High grade general purpose PNP.
PACK 33 - 3 DUAL OP-AMPS MC1458. With data.
PACK 35 - 20 RECTIFIERS. Studs, high current, glass bead, top hat, IN4000, etc.
PACK 36 - 50 DIODES 1N4148. The most popular type for projects!
PACK 39 - 10 SURFACE MOUNT AND LCC ICs. Special hi-tech pack!

MISCELLANEOUS

PACK 41 - 4 POWER MICROSWITCHES. Push to break.
PACK 42 - 8 SPST STANDARD MICROSWITCHES (V3).
PACK 43 - 5 SPST ROLLER-OPERATED MICROSWITCHES (V3).
PACK 44 - 1 MINI BIO-FEEDBACK KIT. With PCB, components and instructions.
PACK 45 - 1 MINI DREAM-MACHINE KIT. With PCB, components and instructions.
PACK 46 - 1 MINI BURGLAR ALARM KIT. With PCB, components and instructions.
PACK 47 - 6 AUDIO TRANSFORMERS.
PACK 48 - 200 CABLE CLIPS to attach alarm or doorbell wires to wall.
PACK 51 - 1 CRYSTAL OSCILLATOR MODULE, 19.6608MHz.
PACK 52 - 12 PP3 BATTERY CLIPS.
PACK 53 - 2 PIEZO TRANSDUCERS. Use as microphone or speaker.
PACK 60 - 100 MYSTERY PACK of at least 100 components. The most popular pack of all!

AUTUMN COLLECTION

Buzz like a butterfly, hoot like a bee; the computer you pay for, but the switches are free! Match this famous quotation with our equally famous sound effects computer, and you could be on your way to a fortnight's holiday in the Canary Islands. On the other hand, you're much more likely to be sitting in your front room. But you never can tell where people read their electronics mags, can you?



SOUND EFFECTS COMPUTER

Take a powerful PIC655A single chip computer, mask program it to produce the most outrageously realistic sound effects, add an audio amplifier to bring them up to loudspeaker level, and you have the Highgrade Sound Effects Computer. How about a motor rally, complete with gear changes? Or a ship hooting its mournful way through the fog? Or a fly so realistic it'll have you running for the swat! Sirens, helicopters, steam trains, aliens - you name it, it's in there. The

computer is easily programmed with the thirteen switches supplied. In one mode you can even play it like a synthesizer! I have to admit, it's my favourite project of the moment. With your computer we also give you: a battery connector, a loudspeaker, thirteen switches, and a wiring diagram and programming instructions. You add a PP3 battery, a length of connecting wire and ten minutes of your time to connect it all together.

SOUND EFFECTS COMPUTER KIT **£12.80!** (+VAT)



LCD DISPLAY MODULES

On one side of the PCB is an LCD which displays two lines of text and symbols. On the back there's a powerful surface-mount drive IC to take in data, store it, and drive the display. Interface is through an eight-way connector for the power supply and data signals. We supply full data on the IC, which should be enough for you to get it up and running!
LCD DISPLAY MODULE **£6.60** (+VAT) 10 DISPLAYS **£54!** (+VAT)

LED DISPLAYS

TYPE 1: DUAL 0.56" COMMON ANODE

Large, high brightness digits for displays that have to be visible at some distance. Each display has two digits, but the connections to each are entirely separate. They can be butted up to each other to make a display as long as you choose! And just look at the price:

10 0.56" DUAL CA DISPLAYS **£4.80!** (+VAT) 50 DISPLAYS FOR **£22!** (+VAT)



TYPE 2: 1½ DIGIT 0.5" COMMON CATHODE

Another two digit display, with the left-hand one lighting up as ±1. Once again, connections to the two digits are entirely separate.

PACK OF 10 1½ DIGIT 0.5" CC DISPLAYS **£3.80!** (+VAT) 50 DISPLAYS FOR **£17!** (+VAT)

BAR-GRAPH LED MODULE

Eleven rectangular green LEDs assembled as a bar graph display. The central LED is turned edge-on to indicate the 'normal' position, or for centre-zero or tuning indicator displays. All LED leads are individually available at the rear of the assembly.
BAR GRAPH MODULE **£1.40** (+VAT) 10 MODULES **£11.80!** (+VAT)



LEDs

Rectangular LEDs in a tasteful shade of green, or a violent primary red. Bring some colour into your life! The prices ARE genuine.

PACK OF 100 RED, GREEN OR MIXED (you choose) RECTANGULAR LEDs **£3!** (+VAT)

PACK OF 500 RED, GREEN OR MIXED LED'S **£14!** (+VAT)



BUFFER AMP

Elantec EL2033 damn fast (100MHz) buffer amplifiers. Equivalent to National LH0033C. Current list price is **£28.50** each, 1 kid you not. With data.
EL2033 100MHz BUFFER AMP **£2.80!** (+VAT)

KEYBOARDS

Full size QWERTY keyboard units with separate numeric pad and function keys. Exactly 100 keys in all. Must be good value just for the switches!

COMPUTER KEYBOARD **£4.80!** (+VAT)

POWER METERS

Meter movement scaled 0-10 with red pointer against a green scale which can be back lit for glowing effect. Full scale approx. 1mA.

POWER METER **£1.80!** (+VAT) 5 METERS **£7.80** (+VAT)

MONSTER PARCELS

PARCEL 3 Lots and lots of ICs. Who knows what might turn up? Into the parcel go all the remainders from past lists, ICs we haven't got enough of to advertise separately, all the CMOS and TTL, and lots more. Some IC's will be common and familiar, some won't. Some have data and some don't. Some you'll recognise at once, others you'll have to do some detective work on.

A fascinating mixture with lots of nice surprises for you if you know your ICs.

PARCEL 3A: 100 ICs for **£12!** (+VAT) PARCEL 3B: 500 ICs for **£49!** (+VAT)

PARCEL 4 Tants. So much nicer than common old electrolytics, I always think. An excellent range of values, now reaching as high as 68µF (all parcels) and up to 100µF if you're lucky!

PARCEL 4A: 100 TANTS FOR **£6.80!** (+VAT) PARCEL 4B: 500 TANTS FOR **£29!** (+VAT)

PARCEL 6 Transistors. A useful selection of general purpose types, with a few exotics to keep you on your toes. Lots of BC212s, BC548s, and other common types.

PARCEL 6A: 200 TRANSISTORS for **£7.80!** (+VAT)

PARCEL 7 LEDs! All kinds of shapes, sizes, styles and colours. How about making an LED garden? During the day, flowers. At night, a spectacular display of coloured LEDs!

PARCEL 7A: 100 LEDs for **£5.90!** (+VAT)

PARCEL 7B: 500 LEDs for **£24.90!** (+VAT)

UK Orders: Please add **£1** postage and packing and **15% VAT** to the total (including postage).
Europe and Eire: Please add **£2.50** carriage and insurance. No VAT.
Outside Europe: Please add **£4.80** carriage and insurance. No VAT.
Access Orders Please phone 0600 3715 for immediate attention to your order.

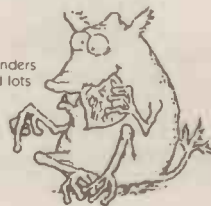

FLASH GUN RETURNS

Hanimex electronic flash units that have been returned by the consumer to the place where purchased. These are offered complete & in good condition (many in original boxes) but have not been tested by us, so are offered without any guarantee. 4 models available, as listed: Z4259 Type X140. Hot shoe attachment. Size 75x60x25mm off/on switch & test button. Takes 2xHP7. Originally sold at £7-£10. £3.00
Z4260 Type X215. Similar to above £3.20
Z4261 Type CX330. Another with same features, + auto/manual switch size 70x65x35mm. £3.50
Z4262 Type TC1.25. Much more sophisticated "Thyristor computer". Fully dedicated for a whole range of cameras, including Canon A1, AE1, AV1, Olympus OM2, Nikon EM/FE, Contax, Yashica, Minolta etc. 20m ISO 100 on normal. Wide angle diffuser included. 1 manual 2 auto settings. Can be switched from ISO 25-1000. Takes, 4xHP7. Originally sold at £19.95. Comprehensive instruction book included. £8.50

BREADBOARDS



PROTOBLOC 1

G708 Protobloc 1 has a total of 400 tie points consisting of two sets of 30 rows of 5 interconnected sockets plus 4 rows of interconnected sockets running alongside, suitable for use as power supply rails. All contact positions are clearly defined on an alphanumeric grid. ABS polymer board mounted on an adhesive foam base. Will accommodate up to three 16 pin devices. An ideal introduction to solderless circuit development systems. Size 80x60mm

£2.50

PROTOBLOC 2

G711 Protobloc 2 has a total of 840 tie points consisting of two sets of 64 rows of 5 interconnected sockets plus 4 rows of 50 interconnected sockets running alongside, suitable for use as power supply rails. All contact positions are clearly defined on an alphanumeric grid. ABS polymer board mounted on an adhesive foam base. Will accommodate up to seven 16 pin devices.

Size 172x64mm £3.95

PROTOBLOC 2A

G712 As above, but the ABS polymer board is mounted onto a rigid base plate complete with three 4mm terminals in red, black and green for power connections. A mounting bracket which clips into the base is also provided to accept a variety of components including switches and potentiometers, etc.

Price £6.95

PROJECT BOARD GL24

G724 2 of type G711 mounted onto a rigid baseplate with 3 coloured terminals, for power connections. Over-all size 225x150mm

£13.95

PROJECT BOARD GL36

G736 3 of type G711 and an additional strip of 100 tie points mounted onto a rigid base plate with 4 coloured terminals. Overall size 242x195mm

Price £19.95

POWER SUPPLIES



0-24V DC 3A

A112 Variable stabilized power supply with over-load protection. Meter reads voltage or current (switched). Two voltage ranges; 0-12V and 12-24Vd.c. Ideal for laboratory use.

Input voltage:- 240V a.c. 50Hz

Output voltage:- 0-24Vd.c. (2 ranges)

Stability:- 0.2%

Ripple:- 2.5mV

Dims:- 180 x 110 x 180mm

Price £64.50

0-24V DC 5A

A113 Variable stabilized power supply with overload protection. Meter reads voltage or current (switched). Two voltage ranges; 0-12V and 12-24Vd.c. Ideal for laboratory use.

Input voltage:- 240V a.c. 50Hz

Output voltage:- 0-24Vd.c. (2 ranges)

Stability:- 0.2%

Ripple:- 4mV

Dims:- 180 x 180 x 110mm

Price £85.00

1990 CATALOGUE

128 PAGES OF ELECTRONIC COMPONENTS AND EQUIPMENT. HUGE RANGE! AMAZING VALUE! DON'T MISS OUT — GET YOUR COPY NOW — ONLY £1.50 POST FREE!!!

HITACHI OSCILLOSCOPES FOR QUALITY AND VALUE



V223 DC-20MHz, dual Channel, single time base delayed sweep, DC offset, alternate magnifier, 6in screen, 5mV/div vest. sensitivity 0.2µs/div-0.2s/div sweep time. Complete with 2 probes, manual, mains lead. £475

Other models from £339 — full details in catalogue.

SWITCH MODE POWER SUPPLIES



ASTEC Model AA12531

I/P: 115/230V ac 50/60Hz

O/P: V1 + 5v 5A

V2 + 12v 0.15A

Size: 160 x 104 x 45mm

Partially enclosed panel with fixing holes in steel case on

120 x 125mm centres.

Inputs and Outputs are on colour

coded leads; there is also an EEC

socket on a flying lead £6.95.

ASTEC Model AC9231

I/P: 115/230V ac 50/60Hz

O/P: 50Watt max:

V1 + 12v 2.5A

V2 + 5v 6.0A

V3 12v 0.5A (+ or -)

V4 5v 0.5A (+ or -)

Size: 203 x 112 x 60mm

Fully enclosed case with built in

tapped mounting holes.

Inputs and Output pins on edge of

panel £12.95.

MICRO IN CONTROL

An exciting new series, which started last month. We can supply all the parts for the 'Starter Kit' at a special low price:

Power Supply 5V 2 1/2A DC £3.95

Small breadboard (400 holes) £2.50

Larger breadboard (840 holes) £3.95

10m asstd coloured wire, 22 resistors, 3 pots, 10 capacitors, 4 LED's 2 diodes, 2 transistors, photo-resistor, 12 IC's, 2 bulbs, 4 slide switches, 1 relay, 1 motor and 1 battery holder, all as specified in the article £7.95

METEX METERS

8 different models in our catalogue!!

- ★ 4 1/2 digit 12mm LCD display
- ★ 30 ranges including 20A ac/dc
- ★ Frequency counter
- ★ Capacitance test with zero adjust
- ★ Data hold switch
- ★ Transistor test
- ★ Diode test
- ★ Continuity test
- ★ Test leads with 4mm plugs
- ★ Rugged yellow case
- ★ Carrying case

Battery and instruction manual included.

AC volts 0-200m-2-20-200-750Vac ±0.5%

DC volts 0-200m-2-20-200-1000Vdc ±0.5%

AC current 0-2m-200m-20Aac ±1.0%

DC current 0-200µ-2m-200m-20Adc ±0.5%

Resistance 0-200-2k-20k-200k-2M-20MΩ ±0.15%

Capacitance 0-20p-200n-20µF ±2.0%

Frequency 0-20k-200kHz ±2.0%

Transistor hFE 0-1000 NPN/PNP

Dims 176 x 90 x 36mm



M4650 £94.00

GREENWELD
ELECTRONIC
COMPONENTS

All prices include VAT; P&P £2.00 per order. Min Credit Card £5. No CWO min. Official Orders from Education welcome & min invoice charge £10.00 Our shop has enormous stocks of components and is open from 9-5.30 from Mon-Sat. Come and see us!
HOW TO CONTACT GREENWELD: By Post: Use the address below: By Phone: (0703) 772501/783740 (ansaphone out of business hours): By Fax: (0703) 787555: By Email: MAG36026: By Telex: 94081101 GWELD

Payment is accepted by cheque, postal order, cash inc. foreign currency bank notes/book tokens/Access/Visa/Connect.



443D MILLBROOK ROAD, SOUTHAMPTON, SO1 0HX:

MUSIC SOFTWARE — 75% OFF!!

Superb quality software for learning music on the BBC 'B' computer.

Recorder Tutor by Mupados. Large format spiral bound 16 page handbook, an hour long cassette with 52 tunes and 40 track disk — originally sold for £30.95.

Our price £7.95

Ensemble pack and Duet pack £2.95

MUSIC MASTER A sophisticated recorder tutoring system, comprising a microphone, a processing device and software designed to develop recorder playing skills. Originally sold for £52.78. Available in either 40 or 80 track for just £14.95

MICRO MAESTRO Put the fun back into music!! This program links the BBC Micro to turn the screen into a music stand. Scroll music. Practice aids. Separate audio cassette with backing tracks. 3 versions, originally selling for £17.25 each.

Keyboard £4.95

Concert Pitch £4.95

B^b £4.95

DISK DRIVE PSU KIT

Ideal for powering single 3 1/2in or 5 1/4in drive. Mains input, stabilized smoothed outputs, 5V at 1A + 12V at 1A. Simple, easy to assemble kit with all parts and full instructions. £4.95

FREE SOFTWARE!!

To introduce our NEW software service, featuring all the best public domain and shareware, we're giving away, absolutely free, a 5 1/4in disk containing a complete catalogue of over 500 programs together with 2 FREE games.

To obtain your free copy, simply add to your order "FREE DISK". Don't forget to add £2.00 post, even if you order nothing else! Please note all available software, plus this free disk is only for IBM PC compatible machines using MS.DOS.

The catalogue on disk contains brief information on all software available.

BIB ACCESSORIES

BCC11 Liquid Static Eliminator. A spray can of special formula liquid giving long term neutralisation of all harmful static charges from all glass and plastic surfaces. Comes complete with cloth. £1.

BCC8 Computer terminal maintenance kit for screen, keyboard and printer. Contents: Soft brush for keyboard and stiff brush for printer and print cleaning fluid. Aerosol can of air-blast. Kleen-Screen, an antistatic liquid; cleaning cloths. All this is contained in a presentation pack for just £2.95.

VE13 Lens Care Kit — High quality brush with dust protector, a bottle of antistatic lens cleaning fluid and a super soft lint free cleaning cloth, all contained in a handy storage wallet. Ideal for all still and movie/video cameras — plus of course, spectacles. Offered at the exceptionally low price of just £1.50.

ANTEX SOLDERING EQUIPMENT

We stock the full range of Antex Soldering Irons, all at discounted prices.

Model C Popular basic 15 watt model.

Price £7.95.

Model CS 17 watt model with leakage less than 2µA £7.95.

Model XS 25 watt general purpose iron, with a wide range of bits available.

Price £7.95.

Model MLXS For car/boat/caravan, this 12V model with large clips to connect on battery is rated 25 watts £10.95.

STEREO VIDEO SOUND MIXER



MX300 This versatile mixer is an essential part of editing videotapes. It allows audio inputs from camcorder or second video recorder (phono), cassette recorder or other music source (phono), and 2 microphones (3.5mm). The original soundtrack can be monitored and there is a master output (phono) to the VCR. Power can be a PP3 battery of an external 9V source. Smartly styled in a sloping front case with a matt black finish the overall dimensions are 175 x 110 x 55mm £19.95.

MAGENTA ELECTRONICS LTD

MAIL ORDER AND SHOP:
EE84 135 Hunter Street,
Burton-on-Trent,
Staffs. DE14 2ST
Tel: 0283 65435
Fax: 0283 46932



All prices include VAT
Shop open 9-5 Mon-Fri;
9-2 Saturday
Official orders welcome

Add £1
p&p to
all orders

4 CHANNEL LIGHT CHASER

EE JAN '90

As featured in this issue a 1000 watt per channel chaser with zero volt switching, hard drive, inductive load capability, microphone sound sensor and sophisticated 'beat' detector. Chase steps to music or automatically when quiet. Variable speed and mic. sensitivity. LED mimic on front panel. Switchable for 3 or 4 channels. Standard P552 output. Ideal for rope lights, pin spots, disco and display lighting.
KIT REF 833

£29.95

D.C. MOTOR GEARBOXES

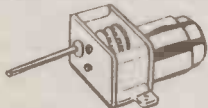

Ideal for Robots and Buggies. A miniature plastic reduction gearbox coupled with a 1.5-4.5 Volt mini motor. Variable gearbox reduction ratios are obtained by fitting from 1 to 6 gearwheels (supplied). Two types available:
SMALL UNIT TYPE MGS £3.99
Speed range 3-2200 rpm. Size 37x43x25mm
LARGE UNIT TYPE MGL £4.55
Speed range 2-1150 rpm. Size 57x43x29mm

Supplying Electronics
for Education,
Robotics, Music,
Computing and much,
much more!

Send NOW for our
illustrated
CATALOGUE
Only £1.00!

STEPPING MOTORS

A range of top quality stepping motors suitable for driving a wide range of mechanisms under computer control using simple interfacing techniques.

ID35 PERMANENT MAGNET MOTOR — 48 steps per rev. £16.50
MD200 HYBRID MOTOR — 200 steps per rev. £16.80
MD35 1/4 PERMANENT MAGNET MOTOR — 48 steps per rev. £12.70
MD38 PERMANENT MAGNET MOTOR — 48 steps per rev. £8.95

MICRO IN CONTROL NEW SERIES STARTED EE DEC '89 STARTER KIT £21.95

ALL PARTS LISTED IN TABLE 1
INCLUDING 5V 250mA SUPPLY
AND K12 840 PIN BREADBOARD

EDUCATIONAL BOOKS & BOOK PROJECTS

ADVENTURES WITH ELECTRONICS

The classic Easy to Follow book suitable for all ages. Ideal for beginners. No soldering, uses an S-DEC breadboard. Gives clear instructions with lots of pictures. 16 projects — including three radios, siren, metronome, organ, intercom, timer, etc. Helps you learn about electronic components and how circuits work. Component pack includes an S-DEC breadboard and all the components for the series.

ADVENTURES WITH ELECTRONICS COMPONENT PACK (less book) £4.75 £22.35

FUN WITH ELECTRONICS

From the USBORNE Pocket Scientist series — An enjoyable introduction to electronics. Full of very clear full colour pictures accompanied by easy to follow text. Ideal for all beginners — children and adults. Only basic tools are needed. 64 full colour pages cover all aspects — soldering — fault finding — components (identification & how they work). Also full details of how to build 6 projects — burglar alarm, radio, game, etc. Requires soldering — 4 pages clearly show you how.

The components supplied in our pack allows all the projects to be built and kept. The book is available separately.
FUN WITH ELECTRONICS Book £2.25
COMPONENT PACK (less book) £17.55

30 SOLDERLESS BREADBOARD PROJECTS

A book of projects by R. A. Penfold covering a wide range of interests. All projects are built on a Verobloc breadboard. Full layout drawings and component identification diagrams enable the projects to be built by beginners. Each circuit can be dismantled and rebuilt several times using the same components. The component pack allows all projects in the book to be built one at a time.

Projects covered include amplifiers, light actuated switches, timers, metronome, touch switch, sound activated switch, moisture detector, M.W. Radio, Fuzz unit, etc.
30 SOLDERLESS BREADBOARD PROJECTS Book 1 £2.95
COMPONENT PACK £27.15
VEROBLOC £7.49

ENJOYING ELECTRONICS

A more advanced book which introduces some arithmetic and calculations to electronic circuits. 48 chapters covering elements of electronics such as current, transistor switches, flip-flops, oscillators, charge, pulses, etc. An excellent follow-up to Teach-in or any other of our series. Extremely well explained by Owen Bishop who has written many excellent beginners' articles in numerous electronics magazines.

ENJOYING ELECTRONICS Book £3.60
COMPONENT PACK £14.31
VEROBLOC £7.49
Note — A simple multimeter is needed to fully follow this book. The M102 BZ is ideal. £13.98

A FIRST ELECTRONICS COURSE

A copiously illustrated book that explains the principles of electronics by relating them to everyday objects. At the end of each chapter a set of questions and word puzzles allow progress to be checked in an entertaining way. An S-DEC breadboard is used for this series — soldering is not required.
A FIRST ELECTRONIC COURSE BOOK £3.75
PACK £22.35

EVERYDAY ELECTRONICS KIT PROJECTS

PLEASE NOTE

ALL KITS HERE HAVE BEEN FEATURED IN EE. IF YOU DO NOT HAVE THE MAGAZINE WITH THE ORIGINAL ARTICLE, YOU WILL NEED TO ORDER THE REPRINT FOR 80p EXTRA. REPRINTS ALSO AVAILABLE SEPARATELY. KITS INCLUDE CASES, PCB'S, HARDWARE AND ALL COMPONENTS (UNLESS STATED OTHERWISE) CASES ARE NOT DRILLED, LABELS ARE NOT SUPPLIED.

Ref	Price	Ref	Price
833 EE 4 CHANNEL LIGHT CHASER Jan 90	£29.95	563 200MHz DIG. FREQUENCY METER Nov 86	£67.98
815 EE TREASURE HUNTER Aug 89	Full Kit £39.95	561 LIGHT RIDER LAPEL BADGE Oct 86	£10.86
814 BAT DETECTOR Jun 89	£19.98	560 LIGHT RIDER DISCO VERSION	£20.89
812 ULTRASONIC PET SCARER May 89	£13.80	559 LIGHT RIDER 16 LED VERSION	£14.52
807 MINI PSU Feb 89	£22.71	556 INFRA-RED BEAM ALARM Sept 86	£30.19
806 CONTINUITY TESTER Feb 89	£10.28	544 TILT ALARM July 86	£8.33
803 REACTION TIMER Dec 88	£31.93	542 PERSONAL RADIO June 86	£12.28
800 SPECTRUM EPROM PROGRAMMER Dec 88	£28.72	528 PA AMPLIFIER May 86	£28.70
796 SEASHELL SYNTHESIZER Nov 88	£26.61	523 STEREO REVERB Apr 86	£28.16
790 EPROM ERASER Oct 88	£26.57	513 BBC MIDI INTERFACE Mar 86	£29.76
786 UNIVERSAL NICAD CHARGER July 88	£7.44	512 MAINS TESTER & FUSE FINDER Mar 86	£9.39
780 CABLE & PIPE LOCATOR April 88	£16.35	497 MUSICAL DOOR BELL Jan 86	£19.95
769 VARIABLE 25V-2A BENCH POWER SUPPLY Feb 88	£52.95	493 DIGITAL CAPACITANCE METER Dec 85	£44.25
763 AUDIO SIGNAL GENERATOR Dec 87	£14.53	481 SOLDERING IRON CONTROLLER Oct 85	£5.83
739 ACCENTED BEAT METRONOME Nov 87	£22.31	464 STEPPER MOTOR INTERFACE FOR THE BBC COMPUTER less case Aug 85	£8.95
740 ACOUSTIC PROBE Nov 87 (less bolt & probe)	£18.65	464 1D35 STEPPER MOTOR EXTRA	£8.95
744 VIDEO CONTROLLER Oct 87	£31.03	OPTIONAL POWER SUPPLY PARTS	£5.47
734 AUTOMATIC PORCH LIGHT Oct 87	£18.29	461 CONTINUITY TESTER July 85	£6.60
728 PERSONAL STEREO AMP Sept 87	£15.24	455 ELECTRONIC DOORBELL June 85	£8.05
730 BURST-FIRE MAINS CONTROLLER Sept 87	£14.45	453 GRAPHIC EQUALISER June 85	£26.89
724 SUPER SOUND ADAPTOR Aug 87	£40.89	444 INSULATION TESTER Apr 85	£20.85
718 3 BAND 1.6-300MHz RADIO Aug 87	£28.25	430 SPECTRUM AMPLIFIER Jan 85	£7.36
719 BUCCANEER I.B. METAL DETECTOR inc. coils and case, less handle and hardware July 87	£28.17	392 BBC MICRO AUDIO STORAGE SCOPE INTERFACE Nov 84	£38.61
720 DIGITAL COUNTER/FREQ METER (10MHz) inc. case July 87	£71.43	387 MAINS CABLE DETECTOR Oct 84	£5.89
722 FERMOSTAT July 87	£12.93	386 DRILL SPEED CONTROLLER Oct 84	£9.24
711 VISUAL GUITAR TUNER Jun 87	£24.48	362 VARICAP AM RADIO May 84	£14.00
715 MINI DISCO LIGHT Jun 87	£13.41	337 BIOLOGICAL AMPLIFIER Jan 84	£25.71
707 EQUALIZER (IONISER) May 87	£16.54	263 BUZZ OFF Mar 83	£6.05
700 ACTIVE I/R BURGULAR ALARM Mar 87	£37.97	242 INTERCOM no case July 82	£6.06
581 VIDEO GUARD Feb 87	£8.94	240 EGG TIMER June 82	£7.31
584 SPECTRUM SPEECH SYNTH. (no case) Feb 87	£22.28	205 SUSTAIN UNIT Oct 81	£18.78
578 SPECTRUM I/O PORT less case Feb 87	£10.05	108 IN SITU TRANSISTOR TESTER June 78	£10.03
569 CAR ALARM Dec 86	£13.24	106 WEIRD SOUND EFFECTS Gen Mar 78	£8.33
		101 ELECTRONIC DICE Mar 77	£6.67

INSULATION TESTER

EE APRIL 85



A reliable electronic tester which checks insulation resistance of wiring appliances etc., at 500 volts. The unit is battery powered simple and safe to operate. Leakage resistance of up to 100 Megohms can be read easily. One of our own designs and extremely popular.

KIT REF 444

£20.85

PET SCARER

EE MAY 89

Produces high power ultrasound pulses. L.E.D. flashes to indicate power output and level. Battery powered (9V-12V or via Mains Adaptor).

KIT REF 812

Mains Adaptor £1.98

£13.80

DIGITAL FREQUENCY 200 MHz METER

EE NOV 86

An 8 digit meter reading from AF up to 200 MHz in two ranges. Large 0.5" Red LED display. Ideal for AF and RF measurements. Amateur and C.B. frequencies.

KIT REF 563

£62.98

DIGITAL CAPACITANCE METER

EE DEC 85

Simple and accurate (1%) measurement of capacitors from a few pF up to 1,000 μ F. Clear 5-digit LED display indicates exact value. Three ranges - pF, nF, and μ F. Just connect the capacitor, press the button and read the value.

KIT REF 493

£44.25

3 BAND SHORT WAVE RADIO

EE AUG 87

Covers 1.6-30 MHz in 3 bands using modern miniature coils. Audio output is via a built-in loudspeaker. Advanced design gives excellent stability, sensitivity and selectivity. Simple to build.

KIT REF 718

£28.25

MOSFET VARIABLE BENCH 25V 2.5A POWER SUPPLY

EE FEB 88

A superb design giving 0.25V and 0-2.5A. Twin panel meters indicate Voltage and Current. Voltage is variable from zero to 25V. A Toroidal transformer MOSFET power output device, and Quad op-amp IC design give excellent performance.

KIT REF 769

£52.96

MINI STROBE

EE MAY '86

A hand held stroboscope which uses 6 "ultra bright" LEDs as the light source. Designed to demonstrate the principles of stroboscope examination, the unit is also suitable for measuring the speed of moving shafts etc. The flash rate control covers 170-20,000 RPM in two ranges.

KIT REF 529

£14.76

ACOUSTIC PROBE

EE NOV '87

A very popular project which picks up vibrations by means of a contact probe and passes them on to a pair of headphones or an amplifier. Sounds from engines, watches and speech travelling through walls can be amplified and heard clearly. Useful for mechanics, instrument engineers and nosey parkers!

KIT REF 740

£18.65

MAINS TESTER & FUSE FINDER

EE MARCH '86

A handy unit which sounds an audible warning when the mains supply is disconnected and gives visual indication on three neon lamps of the connections to mains sockets. Designed for checking correct connections of mains wiring and for tracing which socket connects to which fuse in fusebox. Can detect no live, no neutral, no earth, L/N reversal, L/E reversal.

KIT REF 512

£9.39

EE EQUALISER

EE MAY '87

A mains powered ioniser with an output of negative ions that give a refreshing feeling to the surrounding atmosphere. Negligible current consumption and all-insulated construction ensure that the unit is safe and economical in use. Easy to build on a simple PCB.

KIT REF 707

£16.54

MUSICAL DOORBELL

EE JAN '86

This project uses a special I.C. pre-programmed with 25 tunes and 3 chimes. A Magenta design, the circuit is battery powered and only draws current whilst producing sounds. Two rotary switches select the tune required. Provision is made for three bell pushes, each of which sounds a different tune, so that three points of entry can be identified.

KIT REF 497

£19.95

EPROM ERASER

EE OCT '88

Safe low-cost unit capable of erasing up to four EPROM's simultaneously in less than twenty minutes. Operates from a 12V supply. Safety interlock. Convenient and simple to build and use.

KIT REF 790

£26.57

LIGHT RIDERS

EE OCT '86

Three projects under one title - all simulations of the Knight Rider lights from the TV series. The three are a lapel badge using six LEDs, a larger LED unit with 16 LEDs and a mains version capable of driving six main lamps totalling over 500 watts.

KIT REF 559 CHASER LIGHT

£14.52

KIT REF 560 DISCO LIGHTS

£20.89

KIT REF 561 LAPEL BADGE

£10.86

EE TREASURE HUNTER

EE AUG '89

A sensitive pulse induction Metal Detector. Picks up coins and rings etc., up to 20cms deep. Low "ground effect". Can be used with search-head underwater. Easy to use and build, kit includes search-head, handle, case, PCB and all parts as shown.

KIT REF 815

Headphones

£39.95

£1.99

STEPPING MOTOR INTERFACE

EE AUG '85

This interface enables 4 phase unipolar stepping motors to be driven from four output lines of any computer user port. The circuit is especially suitable for the ID35 motor and our MD200 which are commonly used in buggies and robot arms. Supplied complete with ribbon cable and connector for the BBC user port.

KIT REF 464

£8.95

KITS & COMPONENTS

ELECTRONIC GUARD DOG



One of the best burglar deterrents is a guard dog and this kit provides the barking. Can be connected to a doorbell, pressure mat or any other intruder detector and produces random threatening barks. All you need is a mains supply, intruder detector and a little time.
XK125..... £24.00

DISCO LIGHTING KITS



DL8000K 8-way sequencer kit with built-in opto-isolated sound to light input. Only requires a box and control knob to complete..... £34.50
DL1000K 4-way chaser features bi-directional sequence and dimming 1kW per channel..... £21.00
DLZ1000K Uni-directional version of the above. Zero switching to reduce interference..... £11.80
DLA/1 (for DL & DLZ1000K) Optional opto input allowing audio 'beat'/light response..... 80p
DL3000K 3-channel sound to light kit, zero voltage switching, automatic level control and built-in mic. 1kW per channel..... £17.00

POWER STROBE KIT

Produces an intense light pulse at a variable frequency of 1 to 15Hz. Includes high quality PCB, components, connectors, 5Ws strobe tube and assembly instructions. Supply: 240V ac. Size: 80x50x45.
XK124 STROBOSCOPE KIT..... £15.00



VOICE RECORD/PLAYBACK KIT

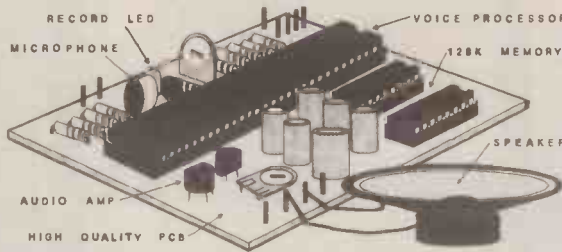

This simple to construct and even simpler to operate kit will record and playback short messages or tunes. It has many uses - seatbelt or lights reminder in the car, welcome messages to visitors at home or at work, warning messages in factories and public places, in fact anywhere where a spoken message is announced and which needs to be changed from time to time. Also suitable for toys - why not convert your daughter's £8 doll to an £80 talking doll!!

Size..... 78x60x15 mm
Message time..... 1-5 secs normal speed, 2-10 secs slow speed
XK129..... £22.50

TEN EXCITING PROJECTS FOR BEGINNERS

This kit contains a solderless breadboard, components and a booklet with instructions to enable the absolute novice to build ten fascinating projects including a light operated switch, intercom, burglar alarm and electronic lock. Each project includes a circuit diagram, description of operation and an easy to follow layout diagram. A section on component identification and function is included, enabling the beginner to build the circuits with confidence.
XK118..... £15.00

MULTIMETER BARGAINS

A high accuracy Autoranging meter with Display Hold, Memory features.
AC volts..... 0-2-200-750 1.2%
DC volts..... 0-0.2-2-200-1000 0.8%
AC current 0-2m-200mA 1.2% 0-10A 2%
DC current..... as for AC
Resistance: 0-200-2K-20K-200K-2M 1%
Continuity..... Buzzer sounds at ≥ 20 ohms
Size..... 127x69x25mm
405 207..... £31.75
A 15 range Autoranging multimeter with 4AC, 5DC and 6 resistance ranges. Only 8x55x108mm. Complete with wallet.
405 206..... £19.50
Ask for a leaflet on our range of meters

ELECTRONIC WEIGHING SCALES



Kit contains a single chip microprocessor, PCB, displays and all electronics to produce a digital LED readout of weight in Kgs or Sts/lbs. A PCB link selects the scale - bathroom/ two types of kitchen scales. A low cost digital ruler could also be made.
ES1..... £7.20

SIMPLE KITS FOR BEGINNERS

Kits include all components (inc. speaker where used) and full instructions.
SK1 DOOR CHIME play a tune when activated by a pushbutton..... £3.90
SK2 WHISTLE SWITCH switches a relay on and off in response to whistle command..... £3.90
SK3 SOUND GENERATOR produces FOUR different sounds, including police/ambulance/fire-engine siren and machine gun..... £3.90

SPECIAL OFFERS ON KITS FOR SCHOOLS AND TRAINING CENTRES - contact Sales Office for discounts and samples

ELECTRONIC LOCK KIT



XK121
£15.95

Don't lock yourself out! This high security lock kit will secure doors to sheds, garages or your front door and the built-in alarm will deter would be prowlers. Scores of uses including area access preventing unauthorised use of machinery or even disabling your car. One correct 4 digit code (out of 5000) will open the lock. Incorrect entries sound the alarm and disable the keyboard for up to 3 mins. Kit includes 12-way keypad, and operates from 9 to 15V (50uA) supply. Will drive relay or 701 150 lock mechanism.

SUPER-SENSITIVE MICROBUG

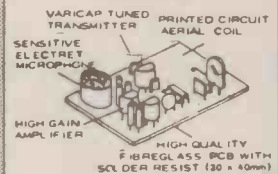

Only 45x25x15mm, including built-in mic. 88-100MHz (standard FM radio). Range approx. 300m depending on terrain. Powered by 9V PP3 (7mA). Ideal for surveillance, baby alarm etc..... £5.50

VERSATILE REMOTE CONTROL KIT



Includes all components (+transformer) for a sensitive IR receiver with 16 logic outputs (0-15V) which with suitable interface circuitry (relays, triacs, etc - details supplied) can switch up to 16 items of equipment on or off remotely. Outputs may be latched to the last received code or momentary (on during transmission) by specifying the decoder IC and a 15V stabilised supply is available to power external circuits. Supply: 240V AC or 15-24V DC at 10mA. Size (exc. transformer) 9x4x2 cms. Companion transmitter is the MK18 which operates from a 9V PP3 battery and gives a range of up to 60ft. Two keyboards are available - MK9 (4-way) and MK10 (16-way).
MK12 IR Receiver (inc transformer)..... £17.00
MK18 Transmitter..... £7.80
MK9 4-way Keyboard..... £2.40
MK10 16-way Keyboard..... £7.00
601133 Box for Transmitter..... £2.60

MICROPROCESSOR TIMER

Kit controls 4 outputs independently switching on/off at 18 preset times over a 7-day cycle. LED display of time/day easily programmed. Includes box.
CT6000K..... £49.50
XK114 Relay kit for CT6000 includes PCB, connectors and one relay. Will accept up to 4 relays. 3A/240V c/o contacts..... £4.75
701115 Additional relays..... £1.80

TK ELECTRONICS
13 Boston Road
London W7 3SJ
Tel: 01-567 8910
Fax: 01-566 1916

ORDERING INFORMATION All prices exclude VAT. Free p&p on orders over £50 (UK only), otherwise add £1+VAT. Overseas p&p: Europe £3.50 elsewhere £10.00. Send cheque/PO/Barclaycard/Access No. with order. Giro No. 529314002. Local authority and export orders welcome. Goods by return subject to availability.

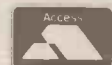

ORDERS: 01-5678910 * 24 HOURS

EVERYDAY ELECTRONICS

INCORPORATING ELECTRONICS MONTHLY

The Magazine for Electronic & Computer Projects
VOL. 19 No. 1 January '90

BARRED

You may have noticed that, along with most other publications, EE is now bar coded. This is mainly because it allows the trade to monitor sales and returns better and should lead to a quicker, more efficient flow of sales information to us. The code is made up of the EE ISSN number (without the check digit) plus the European Article Numbering prefix, a sequence variant, the EAN check digit and finally an issue number (1 to 12 for each year). It does not enhance the cover but it is now necessary.

Another change some of you may have noticed is that each copy is now a few millimeters wider. While this does not make any difference to the quantity of text you get, it does make the magazine a standard size and overcomes some production problems we occasionally had with the smaller size. The new size will fit the old binders if necessary. For information on binders to protect and tidy your copies of EE see below.

RED FACED

Well we all make mistakes sometimes don't we? By now you will have gathered that my face is red! Normally of course we would have put in a *Please Take Note* and not made further mention (thankfully we do not have to publish very many corrections) however this "mistake" has brought out a little design trick which might interest other readers.

In our *Two Tone Siren* project (one of our *Pocket Money Projects* published in the Nov. '89 issue) I changed TR1 from an *npn* type to *pnP* type at the very last minute before printing — see diagram on page 56 of this issue — thinking that the circuit as we had originally drawn it would not work. However as the project designer Chris Bowes has pointed out I was wrong. For a full explanation please see page 56, I think many readers will find this interesting.

I don't intend to sack myself over this one, but I do apologise to any confused or frustrated readers. We do try hard to get everything correct and believe we do have a good record on this — pity its the Editor making things worse!

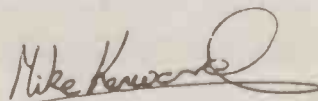

SUBSCRIPTIONS

Annual subscriptions for delivery direct to any address in the UK: £16.00. Overseas: £19.50 (£37 airmail). Cheques or bank drafts (in £ sterling only) payable to Everyday Electronics and sent to EE Subscriptions Dept., 6 Church Street, Wimborne, Dorset

BH21 1JH. Subscriptions can only start with the next available issue. For back numbers see below.

BACK ISSUES

Certain back issues of EVERYDAY ELECTRONICS are available price £1.50 (£2.00 overseas surface mail—£ sterling only please) inclusive of postage and packing per copy. Enquiries with remittance, made payable to Everyday Electronics, should be sent to Post Sales Department, Everyday Electronics, 6 Church Street, Wimborne, Dorset BH21 1JH. In the event of non-availability remittance will be returned. *Please allow 28 days for delivery. We have sold out of Sept. Oct. & Dec. 85, April, May, Oct. & Dec. 86, Jan., April, May & Nov. 87, Jan., March, April, June & Oct. 88.*

BINDERS

Binders to hold one volume (12 issues) are available from the above address for £4.95 (£6.95 to European countries and £9.00 to other countries, surface mail) inclusive of postage and packing. *Please allow 28 days for delivery. Payment in £ sterling only please.*

Editorial Offices

EVERYDAY ELECTRONICS EDITORIAL,
6 CHURCH STREET, WIMBORNE,
DORSET BH21 1JH

Phone: Wimborne (0202) 881749

FAX: (0202) 841692

See notes on **Readers' Enquiries** below—we regret that lengthy technical enquiries cannot be answered over the telephone

Advertisement Offices

EVERYDAY ELECTRONICS ADVERTISEMENTS
HOLLAND WOOD HOUSE, CHURCH LANE,
GREAT HOLLAND, ESSEX CO13 0JS.
Frinton (0255) 850596

Editor MIKE KENWARD

Secretary PAMELA BROWN

Deputy Editor

DAVID BARRINGTON

Business Manager

DAVID J. LEAVER

Editorial: WIMBORNE (0202) 881749

Advertisement Manager

PETER J. MEW Frinton (0255) 850596.

Classified Advertisements

Wimborne (0202) 881749

READERS' ENQUIRIES

We are unable to offer any advice on the use, purchase, repair or modification of commercial equipment or the incorporation or modification of designs published in the magazine. We regret that we cannot provide data or answer queries on articles or projects that are more than five years old. Letters requiring a personal reply **must** be accompanied by a **stamped self-addressed envelope** or a **self-addressed envelope and international reply coupons**.

All reasonable precautions are taken to ensure that the advice and data given to readers is reliable. We cannot, however, guarantee it and we cannot accept legal responsibility for it.

COMPONENT SUPPLIES

We do not supply electronic components or kits for building the projects featured, these can be supplied by advertisers.

We advise readers to check that all parts are still available before commencing any project in a back-dated issue.

We regret that **we cannot provide data or answer queries on projects that are more than five years old.**

ADVERTISEMENTS

Although the proprietors and staff of EVERYDAY ELECTRONICS take reasonable precautions to protect the interests of readers by ensuring as far as practicable that advertisements are *bona fide*, the magazine and its Publishers cannot give any undertakings in respect of statements or claims made by advertisers, whether these advertisements are printed as part of the magazine, or are in the form of inserts.

The Publishers regret that under no circumstances will the magazine accept liability for non-receipt of goods ordered, or for late delivery, or for faults in manufacture. Legal remedies are available in respect of some of these circumstances, and readers who have complaints should address them to the advertiser or should consult a local trading standards office, or a Citizen's Advice Bureau, or a solicitor.

TRANSMITTERS/BUGS/ TELEPHONE EQUIPMENT

We would like to advise readers that certain items of radio transmitting and telephone equipment which may be advertised in our pages cannot be legally used in the U.K. Readers should check the law before using any transmitting or telephone equipment as a fine, confiscation of equipment and/or imprisonment can result from illegal use. The laws vary from country to country; overseas readers should check local laws.



FOUR CHANNEL LIGHT CHASER

MARK STUART

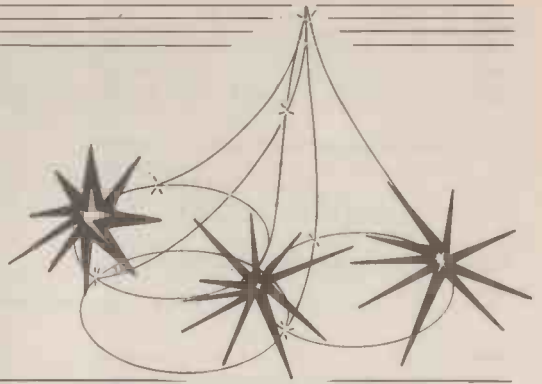

An all-powerful, sound triggered or variable speed, chaser capable of switching up to 1000W per channel — 4000W total! Will drive Rope Lights and Pin Spots.

THIS light chaser combines the most sought after features for Disco, Display, and Entertainment applications. These are:

- 1000W per channel power rating.
- Hard fired triac outputs for full Inductive load capability.
- Zero volt switching for minimum interference and high reliability.
- Three/Four Channels, switch selectable.
- MIMIC on front panel.
- MIC. built-in for Beat Synchronised chase.
- MIC. sensitivity control.
- Speed control for free running.
- Standard 8-pin connector as fitted to most lighting sets.

This combination of features makes the Four-Channel Light Chaser able to drive a wide range of loads including "Rope Lights" and transformer coupled "Pin Spots", as well as the full range of "standard" tungsten and tungsten halogen lamps. It is also capable of driving some suitable types of fluorescent lighting. It should find many uses where a reliable and versatile light controller is required.

DESIGN

A block diagram of the Four-Channel Light Chaser is shown in Fig. 1, and the complete circuit diagram in Fig. 2.

Four 600V 8A triacs switch the mains Live to the lamp loads. The triacs are driven from a sequence generator which produces the correct chase patterns. This can be switched to produce a four state sequence or, by closing a switch, a shortened sequence of three states.

In three state operation the fourth output remains permanently off. The sequence generator advances its output by one step each time it receives an input pulse.

The variable frequency oscillator generates step pulses at a rate which is set by the speed control or by incoming beat pulses. Step pulses are next combined with "zero volt" pulses in the zero volt synchroniser.

This block holds each incoming pulse until part of the mains cycle where the voltage is practically zero. The pulse is then passed on to the sequence generator. In this way each step of the sequence only takes place when the mains voltage is near to zero, so eliminating surges and interference.

The zero volt detector produces the sharp, narrow zero volt pulses from the

rectified output of the low voltage supply transformer each time the voltage falls to zero between half cycles.

Beat detection allows the chaser to step in time to the low frequency content of music. Sound is picked up by a small microphone and amplified to a level set by the sensitivity control. The beat detector circuit senses the peaks in the sound and automatically adjusts itself to ignore the lower sound levels in between.

For each peak in the sound, a beat pulse is produced which forces the variable frequency oscillator to produce a step pulse. If the oscillator is running faster than the beat, it will ignore the beat pulses. If it is running slower, the beat pulses will take over completely.

CIRCUIT DESCRIPTION

The full circuit diagram for the Four-Channel Light Chaser unit is shown in Fig. 2. The circuit is powered by a small 12V-0V-12V or 15V-0V-15V transformer. This provides all of the drive current for the triac gates (CSR1-CSR4) as well as power to the rest of the circuit via voltage regulator IC5.

The available drive current to the triacs is set to 40mA so a transformer rated at 50mA or greater is required. The transformer output is rectified by diodes D6 and D7 and passes through a further diode D5 to the smoothing capacitor C11. The reason for this extra diode is so that a full wave rectified but unsmoothed output is available for the zero volt crossing detector circuit.

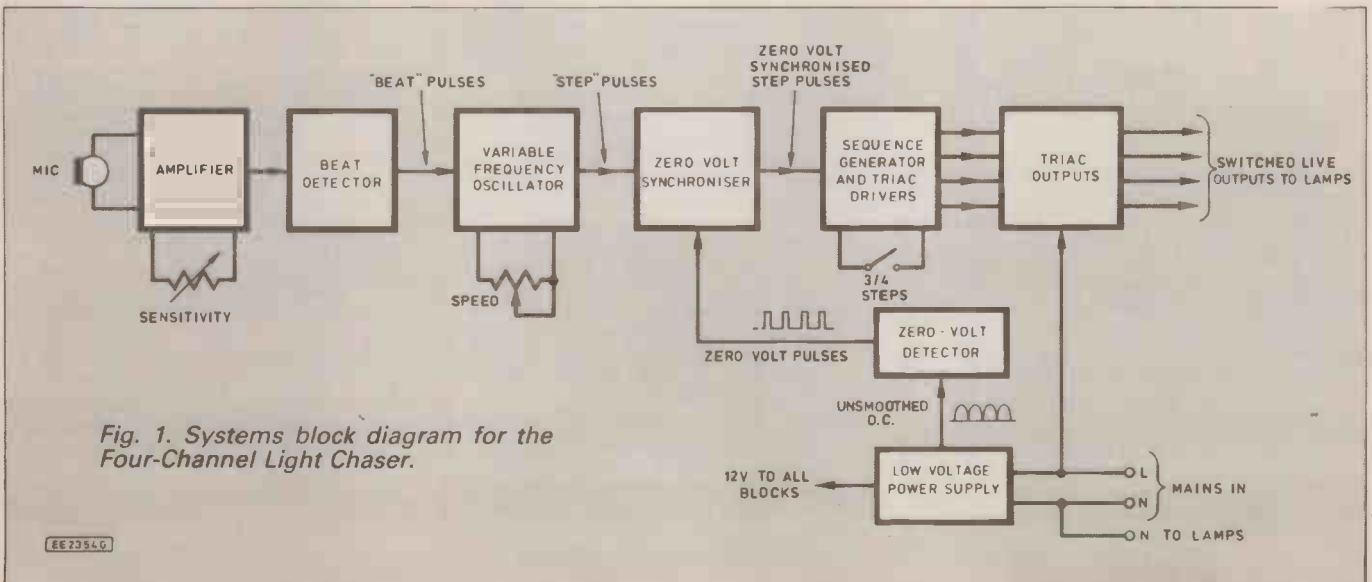

Fig. 1. Systems block diagram for the Four-Channel Light Chaser.

The smoothed unregulated positive output is connected directly to the mains LIVE at the triac "common" MT1 terminals. This means that as with almost all other chaser units *the whole circuit must be considered LIVE at all times*. To help with fault finding and testing it is possible to remove this connection so that the circuit may be tested in complete safety, *but once in use it is essential that the circuit is built into either a fully INSULATED BOX or, as the prototype, an EARTHED metal case.*

As the triac common terminals are connected to positive, the triac gate current is provided from the negative side of the supply. This may appear unusual but is not. Triacs are quite happily triggered by either positive or negative gate currents. Indeed there are some technical advantages in using negative trigger currents.

One of the main reasons negative triggering has been used in this circuit is that it allows a simple low cost Darlington transistor driver array (IC4) to be used. IC4 contains seven separate Darlington transistors, three of which are unused in this circuit. These transistors take the low level CMOS outputs from the sequence generator (IC3) and switch the gate current to the triacs via resistor R22/1.e.d D8, R23/D9, etc. The gate current is limited only by the resistor values, which may be altered if triacs other than those specified are used. As the gate current flows through the l.e.d.s these give a matching mimic pattern to the main light display and indicate that the circuit is working properly.

SEQUENCE GENERATOR

The sequence generator IC3 is a 4022 CMOS octal counter/divider i.e. It has eight outputs which switch from low (0V) to high (12V) one by one in turn on receipt of a clock pulse on pin 14. Only one output is high at a time, the first output returning to the low state as the second output is switched high, and so on



Fig. 2. Complete circuit diagram for the Four-Channel Light Chaser. The thick lines represent heavy duty wiring. This circuit must be housed in a well earthed metal case.

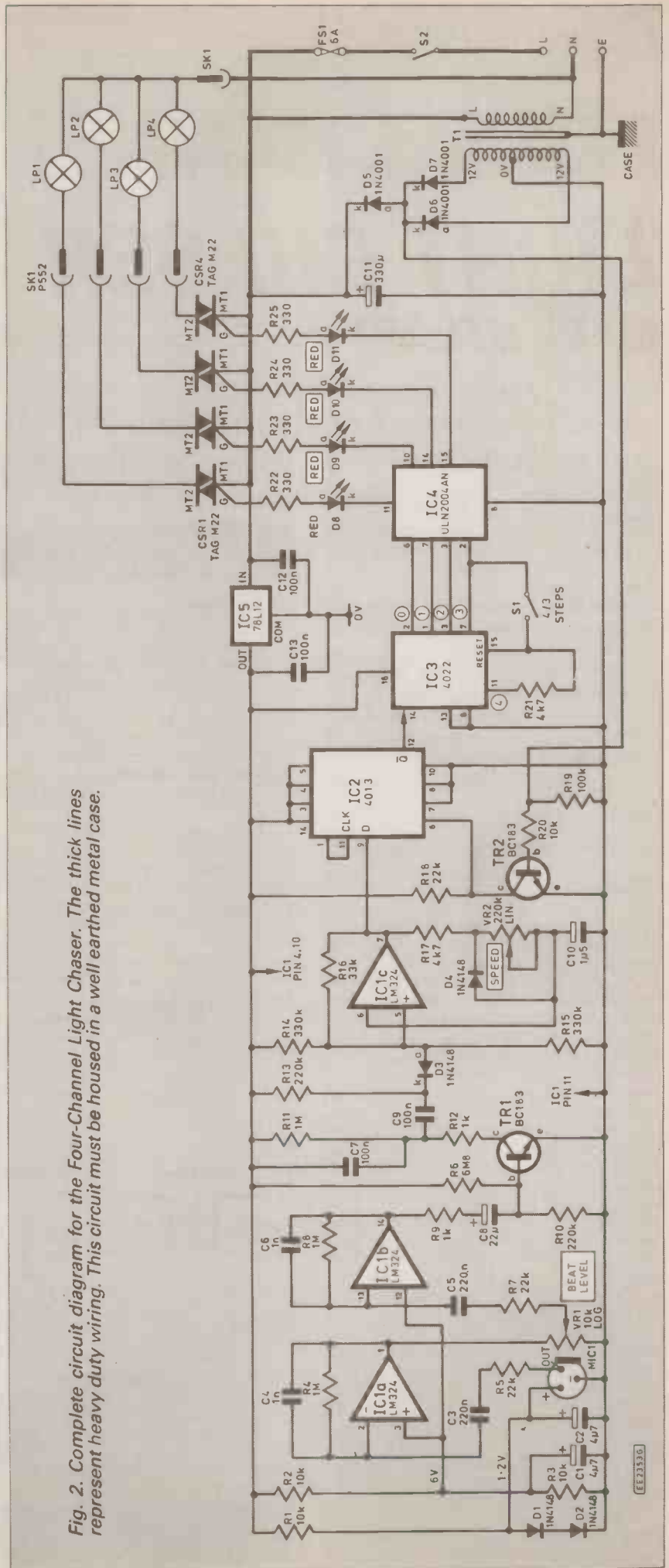

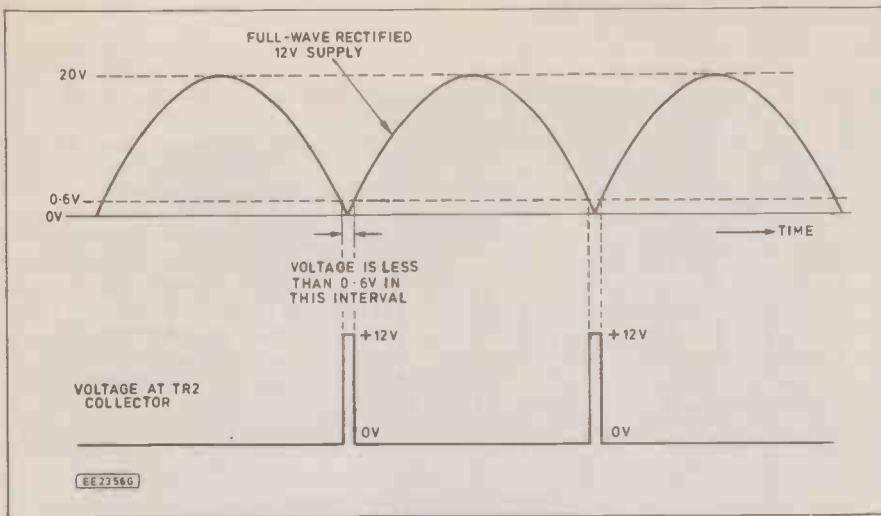

Fig. 3. Zero voltage crossing detector waveforms.

until all eight outputs have been high for one clock pulse each.

As it stands the i.c. would produce a standard eight channel chase pattern, this is impractical and unnecessarily long, and so a means of shortening the cycle length is needed. This is achieved very simply by employing pin 15 of the i.c. which, when it is taken high, resets the counter to the initial state (in which the first output is high).

By connecting the reset pin to the fifth output, the counter will reset each time that the fifth output switches high. As this happens practically instantaneously the effect is as if the fifth state does not exist and a new cycle begins. This produces the required four state chase cycle.

Resistor R21 connects the fifth output (pin 11) to the reset pin. To get a three state chase, the counter is reset by the fourth output when switch S1 is closed.

ZERO CROSSING

The function of IC2 is to ensure that the clock pulses are only passed to IC3 when the mains is at or close to zero (the zero crossing interval). Zero crossing is detected by transistor TR2 which is turned on whenever the base voltage exceeds 0.6V. The base voltage is obtained from the unsmoothed full-wave rectified output of the transformer. Fig. 3 shows the waveforms in this part of the circuit.

When transistor TR2 is turned on its collector voltage is very close to 0V. This occurs for most of the mains cycle, TR2 is turned off only in the narrow intervals when the voltage falls below 0.6V. In these intervals the collector voltage rises to 12V producing the pulse waveform shown. Each pulse occurs at the time during which the triacs gate current must be turned on to guarantee zero volt switching.

Pulses from TR2 collector are first passed through part of IC2 which is connected rather unconventionally as a Schmitt trigger. This "squares up" the pulses and gives them very fast rising and falling edges which are necessary for the next part of the circuit. The squared up pulses appear on pin 1 of IC1 and are connected to pin 11 which is the clock input of a D-type flip-flop, a block diagram of which is shown in Fig. 4 with some typical circuit waveforms.

Briefly stated, the D-type flip-flop works as follows. Data arriving at the D input (pin 9) is transferred to the Q output

(pin 13) on the rising edge of the clock pulses (pin 11). An inverted form of the output is also available on pin 12. The

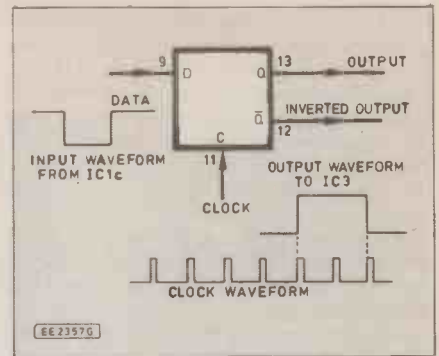

Fig. 4. D-type flip-flop and typical waveforms.

important thing about this is that the output only changes when the clock pulse rises. It cannot change at any other time, even if the signal on the D input changes.

This is perfect for this application because it allows randomly timed input pulses to be synchronised with the mains zero crossing pulses. The waveforms shown in Fig. 4 show the effect more

COMPONENTS

Resistors

R1, R2, R3, R20	10k (4 off)	R14, R15	330k (2 off)
R4, R8, R11	1M (3 off)	R16	33k (2 off)
R5, R7, R18	22k (3 off)	R17, R21	4k7 (2 off)
R6	6M8	R19	100k
R9, R12	1k (2 off)	R22, R23,	
R10, R13	220k (2 off)	R24, R25	330 (4 off)

All 0.25W 5% carbon film

Potentiometers

VR1,	10k log. rotary, with long Plastic spindle
VR2	220k lin. rotary, with long Plastic spindle

Capacitors

C1, C2	4 μ 7 radial elec. 40V (2 off)
C3, C5	220n polyester or multilayer ceramic 50V (2 off)
C4, C6	1n plate ceramic 50V (2 off)
C7, C9, C12, C13	100n disc ceramic 50V (4 off)
C8	22 μ radial elec. 50V
C10	1 μ 5 radial elec. 63V
C11	330 μ radial elec. 25V

Semiconductors

D1, D2, D3, D4	1N4148 (4 off)
D5, D6, D7	1N4001 (3 off)
D8-D11	red 5mm l.e.d.s (standard brightness — 4 off)
TR1, TR2	BC183 npn silicon, general purpose (2 off)
CSR1-CSR4	TAG M22 triac (4 off)
IC1	LM324 quad op. amp
IC2	4013 CMOS dual D-type flip flop
IC3	4022 CMOS divide by 8 counter
IC4	ULN2004AN Darlington array switch
IC5	78L12 +12V 100mA voltage regulator

Miscellaneous

MIC. 1	Electret microphone insert, three terminal 1.5V
T1	Mains transformer 12V-0V-12V secondary, 50mA or more
S1	S.P.S.T. 1A min. rocker switch
S2	S.P.D.T. 6A mains rated rocker switch
SK1	8-pin chassis socket (Bulgin P552)

Printed circuit board, available from the *EE PCB Service* code EE667; aluminium case, 225mm x 125mm x 55mm; 14-pin i.c. socket (2 off); 16-pin i.c. socket (2 off); 20mm 6A quick blow fuse and panel fuseholder; plastic control knobs (2 off); 18mm mounting pillar; mains cable, 1.5m 6A 3-core; cable clamp; triac mounting bar, 50mm x 20mm x 9mm aluminium; stick-on feet for case; 16/0.2 wire, 200mm each of five colours; 7/0.2 wire, 400mm one colour; insulated sleeving; screws, nuts and washers; solder etc.

Approx. cost
Guidance only **£29.95**

**Shop
Talk**
see page 64

clearly. As it happens, IC1c produces negative pulses and IC3 requires positive ones. Use of the inverted output of IC2 on pin 12 is an easy way of making the change.

IC1c is a simple oscillator circuit of the Schmitt trigger type. Capacitor C10 charges via resistor R17 and potentiometer VR2, and discharges more rapidly via R17 and diode D4. The circuit oscillates because of positive feedback via resistor R16 which makes the output switch sharply between the supply rails and makes the non-inverting input switch between two voltage levels approximately one volt above and one volt below half of the supply voltage.

Capacitor C10 is alternately charged and discharged between these two voltage "threshold" levels. Altering the value of VR2 changes the charge time of C10 and so changes the oscillator speed. The discharge time remains constant however so that the negative output pulses are always the same length. The length of these pulses is important because they must be at least one mains cycle long for the zero crossing synchroniser to work properly.

As well as being able to "free-run" IC1c can also be triggered via diode D3 by negative signals. A short trigger at this point causes a single negative output pulse to be produced which will step on the chase sequence.

These trigger pulses are produced at the collector of transistor TR1 whenever a large enough signal is present at the output of the microphone amplifier. C7, R11, R12, C9, and R13 ensure that only genuine "beat" pulses are passed and not other changes in sound level.

MICROPHONE AMPLIFIER

Sounds are picked up by a small electret microphone insert, MIC1, and amplified by IC1a and IC1b. The microphone requires a low voltage supply which is provided from the 12V supply via resistor R1 and stabilised to 1.2V by the drop across diodes D1 and D2 in series. Capacitor C2 is a decoupling capacitor for this supply.

The output from the microphone is coupled to IC1a via resistor R5 and capacitor C3 the values of which are chosen to give a good low frequency response. Feedback components R4 and C4 set the gain of this stage and provide a high frequency roll off since the beat detector is only interested in bass frequencies.

The sensitivity control VR1 allows the audio level to be adjusted for ideal beat synchronisation or can be set to zero to eliminate the beat effect completely. IC1b, C5, R7, C6, and R8 form a second stage of amplification which is practically the same as the first stage. Resistors R2 and R3 split the supply voltage which is decoupled by capacitor C2 to provide a mid rail bias voltage for the two stages.

The audio output from IC1b is coupled via R9 and C8 to transistor TR1. This transistor is turned on during low frequency peaks in the incoming audio signal which in most types of disco music correspond to beats. These are passed via the pulse forming components and diode D3 to IC1c to advance the chase sequence. Resistors R6 and R10 provide a small standing bias voltage to TR1 to increase the sensitivity of the stage.

An interesting aspect of the circuit is the way in which capacitor C8 is charged via TR1 base-emitter junction to a voltage dependent upon the peak level of the music. This deceptively simple circuit provides a dynamic automatic level control which allows beats in the music to be separated extremely effectively.

CONSTRUCTION

Almost all of the components are mounted on a single printed circuit board. This board is available through the EE PCB Service, code EE667. The component layout and full size, copperfoil, master pattern is shown in Fig. 5. The l.e.d.s., potentiometers, triacs, and capacitor C1 should be fitted last.

The board has been designed to fit into a variety of cases, and to be mounted either horizontally or vertically. The options used in the prototype are ideal for the case used and make it easy to maintain good insulation between the case and board.

Before beginning the assembly check that all board holes are drilled and clear, and that the holes for the bushes of VR1 and VR2 are drilled to the correct size. At this stage it may be useful to use the board as a template to mark out the front panel. Refer to the later assembly instructions in the section headed "Board Mounting" for details of this before assembling the board.

Once the board is ready, fit all of the resistors and diodes and the wire link. The

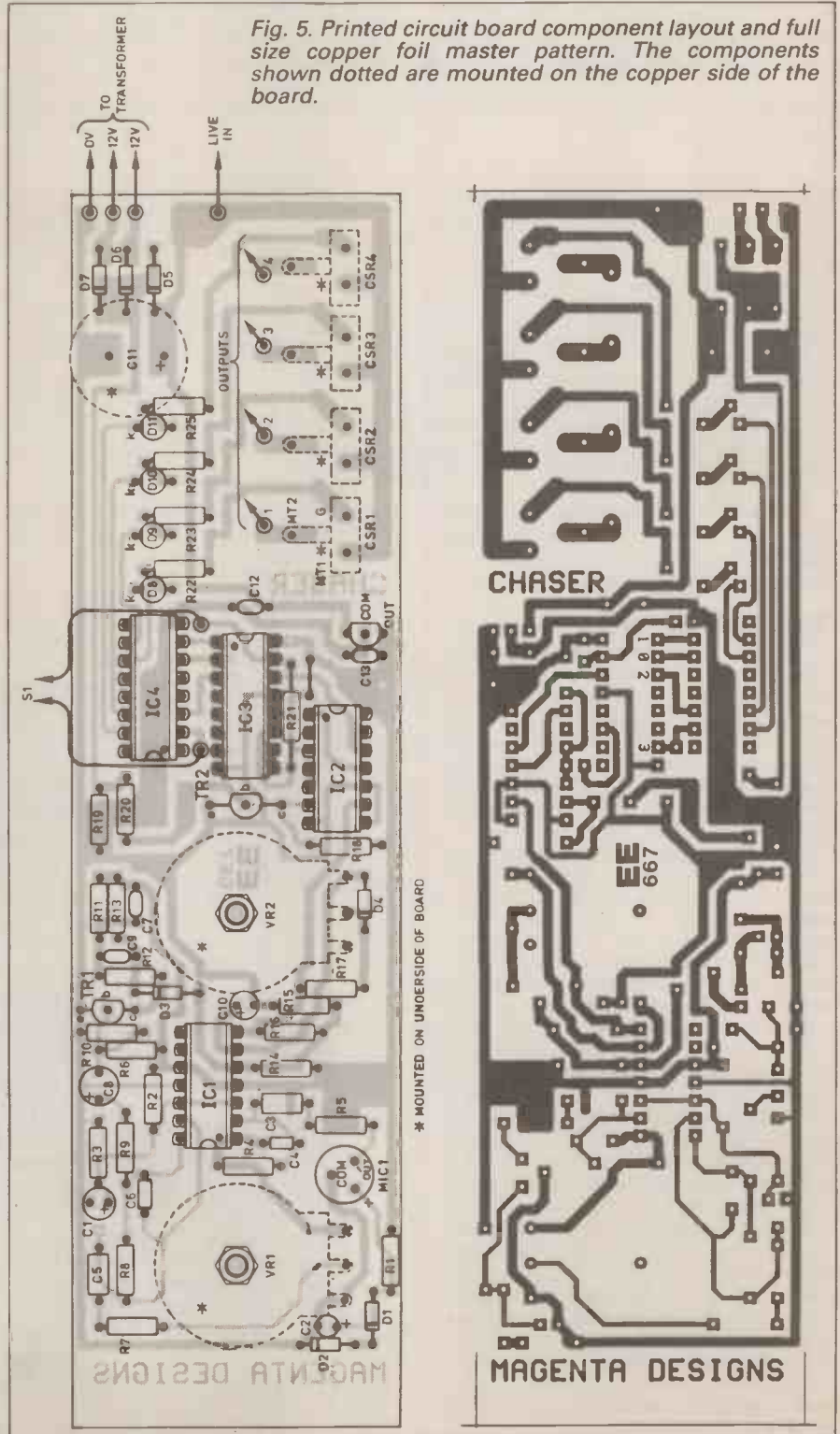

Fig. 5. Printed circuit board component layout and full size copper foil master pattern. The components shown dotted are mounted on the copper side of the board.

resistors can go either way round but the diodes must have their polarity as shown. Usually a bold band around the body indicates the cathode (k) end.

Next fit sockets for all of the i.c.s (except IC5). Most sockets have some sort of indication which way to put the i.c. and it is advisable to get this right to save mistakes later.

Capacitors C1, C2, C8 and C10 are polarised so take care to identify the negative leads. Most small capacitors with radial leads are marked along the side adjacent to the negative lead with a row of arrows containing "—" signs or a thick black band. An increasing number of small capacitors are now non polarised and can be fitted either way round but these are invariably marked with the letters BP and have no polarity indication. All of the other capacitors except C11 can be fitted either way round.

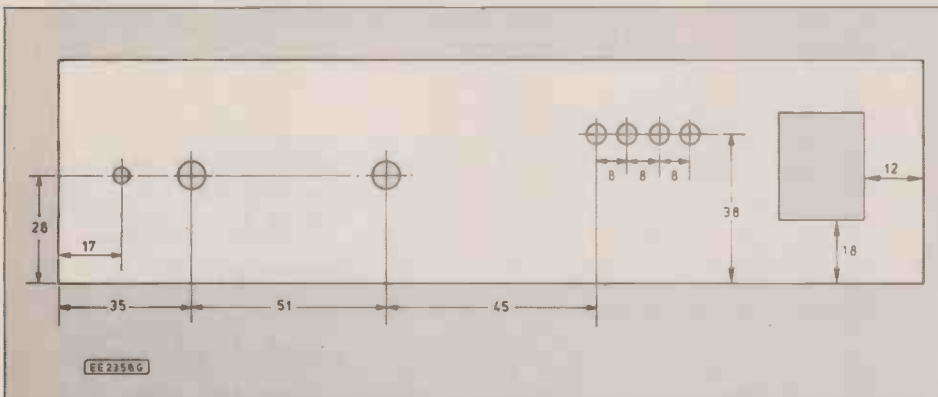

Fig. 6. Front panel dimensions and drilling details. A guide for positioning of components on the rear panel can be seen in Fig. 7 and photographs.

The transistors and voltage regulator i.c. are shaped to indicate their polarity. Take care not to mix them up as they are very similar in appearance.

MICROPHONE

The microphone insert has three solder pads for making connections. The larger one is the Common or Negative connection. If this is fitted as shown the other two pads will automatically be positioned in the correct places. It is necessary to solder a short length of wire to each solder pad so that the MIC. can be fitted straight to the board.

Note the earlier warning about the microphone case being live — it must NOT be possible to touch the microphone in the finished unit. Do not be tempted to mount it through a hole in the case. It will pick up all the sound necessary when mounted directly onto the printed circuit board.

The two potentiometers should next be fitted to the board. These are inserted from the copper track side with their spindles protruding on the component side. Make sure that the metal bodies of the controls do not touch or short-circuit any tracks on the board. Extra washers can be used between them and the board if this is a problem.

The three tags on each potentiometer should line up with their connecting points on the board. With some types it will be possible to bend the tags forward and solder them directly onto the board, other types will require short wire links to be fitted. Whichever type is used it is essential to have an insulated shaft. Metal shafted pots are unusual, but must NOT be used in any circumstances.

Wires for the 3/4 step switch S1, the mains live input, and the four triac outputs should next be fitted to the board. Two lengths of 7/0.2 wire 200mm long are needed for the switch and five 200mm lengths of 16/0.2 wire for the other connections. Fit the wires by stripping 5mm and passing this through the board from the component side and soldering on the track side. This makes the most reliable connections. The wires can be led around the board to make the necessary connections later.

Capacitor C11 is larger than most of the other components and so is best fitted on the track side of the board. Its leads can still be inserted into the mounting holes, but the body of the capacitor must stand far enough from the board to allow in a soldering iron tip. It is best to fit this when the board is mounted in the case after the triacs and l.e.d.s have been fitted. Fitting

pillar and screw. At the other end of the case the board is supported by means of the four triacs and their mounting bar, which also conducts heat to the bottom of the case. This arrangement gives excellent heat sinking for high reliability.

As the triacs are mounted on the rear of the board they can be fitted last and can be changed easily without disturbing the assembly. Fig. 6 shows the dimensions for drilling the front panel when the specified case is used. The switch cut-out shown will vary as alternative types of switch may be used.

The triacs are on 12.7mm (0.5in) centres, the distance of their mounting holes from the inside of the front case is 40mm provided a 18mm (3/4in) pillar has been used at the other end of the board. There is some tolerance possible in the triac mountings because their leads can be bent to make up for minor differences before soldering them into position.

The holes for mounting the l.e.d.s are 5mm in diameter. As with the rest of the circuit the leads of the l.e.d.s are at mains voltage and so should be mounted so that their ends just fill the panel holes. Panel mounting clips may also be used but some types are fiddly and look worse than a bare l.e.d. in a clean hole.

When the holes for the potentiometers, l.e.d.s, and mounting pillar have been drilled, fit the l.e.d.s into position on the board but do not solder them or cut down their leads yet. Next mount the board in position and fit and tighten the mounting screw through the case pillar and board.

Make sure that the board is level and parallel, and position the l.e.d.s one by one in their holes. Carefully solder the l.e.d.s in position taking care to re-check their alignment and level after each joint. A little time spent getting this just right is very worthwhile.

BOARD MOUNTING

The board is mounted to the front of the case using a single 18mm (3/4in) insulating

TRIAC MOUNTING

The next job is to drill the triac mounting bar or bracket with four 3mm holes.



The completed prototype circuit board and below the finished unit showing method of mounting the board by the triacs and below also layout of components on the rear of the circuit board.

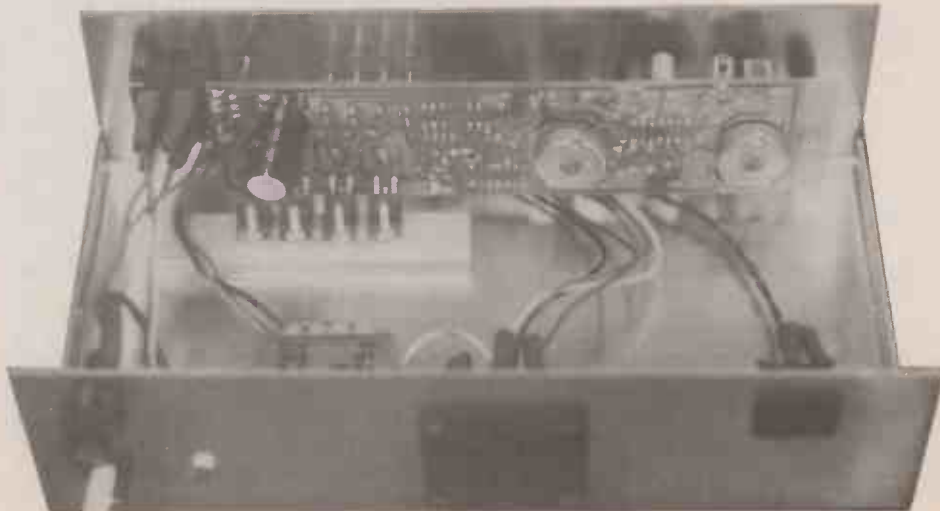

The position of the row of holes must be 10mm from the side of the bar so that the mounting bar does not extend underneath the triac leads. **It is IMPORTANT that the triacs MUST be of the type with ISO-LATED TABS.**

Provided the type specified are used there will be no problems, but a lot of non isolated triacs are around and will cause an immediate short circuit to the case if used. To test whether a triac is isolated or not, check the resistance (using a multimeter set to ohms) between the tab and the centre lead. **SHORT CIRCUIT = NON ISOLATED, OPEN CIRCUIT = ISOLATED.**

Bend up the centre leads of the triacs approximately 4mm from the body and fit the other two leads of each triac into the board from the copper side. Put the mounting bar loosely in position and position the triacs over it so that the holes align. Check that the board is in the correct position, mark the position of the triac mounting bar on the inside of the case, and mark the hole positions through the mounting bar.

Remove the triacs, the bar and the board if necessary and carefully drill the four 3mm holes in the bottom of the case. It is easier to align the holes if the mounting bar is fixed in position with a screw and nut after the first hole has been drilled and used as a drill guide for the remaining three holes.

Now re-assemble everything as before and screw the triacs in position through the case and mounting bar. Carefully solder each of the two outer triac leads in place making sure that the board remains in the correct position. The centre lead of each triac is connected by being bent to lie along the p.c.b. track.

Once all this is done the board can be removed from the case whilst the switches, transformer, output socket, fuse and cable entry are fitted. These can be positioned as preferred but make sure that the transformer wires can reach their destinations.

A separate M4 screw should be fitted in the case rear for an earth terminal. This should be fitted with a shakeproof washer, a nut, two plain washers, and another nut to make a sound Earth connection point. The wires to be earthed are connected to tags between the plain washers.

INTERWIRING

A wiring diagram of the Four Channel Light Chaser is shown in Fig. 7. This is relatively simple because all of the work has been done on the p.c.b.

The main requirement is that a sound Earth connection is made and that all mains connections are made mechanically good by wrapping wires around before soldering and protected with insulating sleeving. The connection between the "live in" wire from the board and the fuseholder terminal should not be made until the circuit has been tested.

TESTING

Ensure that the board "live in" wire is disconnected, fit a fuse, carefully fit all the i.c.s the right way round, and plug the unit in. If you have been careful (or lucky) the l.e.d.s should light and begin to chase immediately. If not, try turning the two controls VR1, VR2 in case this helps.

One l.e.d. should be alight even if the chase sequence does not occur. If all l.e.d.s. are out then you have either made

the same mistake as the author and put them all in backwards (nobody's perfect!) or there could be a power supply fault.

An ordinary multimeter should be used to check for 20V to 25V across capacitor C11, and very close to 12V between pins 8 and 16 of IC3. It should be just possible to see the voltage on pin 7 of IC1 pulsing up and down and to trace this through to pin 14 of IC3.

If the pulses are at IC1 and not IC3 try checking transistor TR2 and associated components. The base voltage should read 0.6V and the collector 0.5V normally because the pulses are too fast and narrow for the meter to see.

It is possible to remove IC2 and by-pass it by linking pins 9 and 12 of the socket if the fault is suspected in this area. The chase will then occur without the zero volt feature. Check resistor values and transistor types etc. if things are still troublesome.

Once the oscillator section is up and running it is time to check the beat detector section. Check first for 6V across capacitor C1 and 1.2V across C2. Then check that pins 1 and 14 of IC1 are at half supply voltage.

Turn VR1 about half way and set VR2 to the slowest setting. It should now be possible to step the chaser by tapping the board. Transistor TR1, diode D3 and associated parts should be checked for faults in this area. If this part also works check that the sensitivity control VR1 has

the expected effect before switching off and disconnecting the mains.

LIVE WIRE

The only thing left to do is connect the mains live from the board to the fuseholder. It is worth doing a quick ohms test between the live wire and the case before applying the mains voltage just in case there are any earth faults. The reading should, of course, be a complete open circuit. It is also a good time to check continuity between the mains plug Earth pin and the case, and also the centre Earth pin on the output socket.

A suitable load for the chaser should next be made up and connected. This may be no more than four ordinary lamps, or alternatively just one lamp could be used connected to each channel in turn.

Once the wire has been soldered to the fuseholder, connect the mains and the load. Fit the case lid and switch on. The lamps should now copy the l.e.d. mimic and be at full brightness.

If any of the lamps seem to be dim or flickering, but the chase sequence is correct, check the values of the triac gate resistors R22 to R25. If these are correct there is the possibility of a faulty triac.

Once all is well check that the ¼ switch S1 operation is correct and switch off. A final check over the wiring to make sure all joints are sound and insulated is a good idea before closing the lid and putting the unit to work. □

Fig. 7. Interwiring from the circuit board to case mounted components. The board has been removed from the front panel to clarify the wiring.

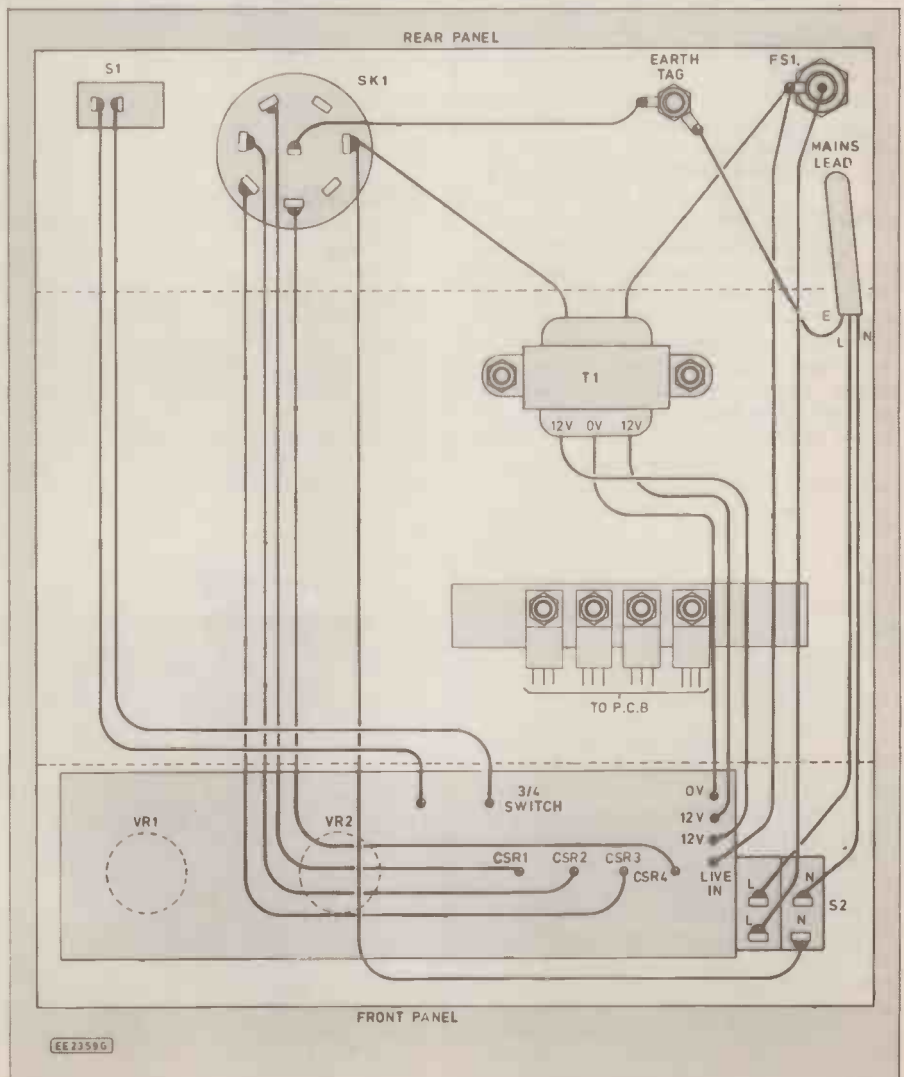

POSSESSION LOOP ALARM



CHRIS BOWES

Guard your possessions with this inexpensive loop alarm.

THIS circuit is designed to operate in the same way as the alarms you will find in shops where valuable items are linked together by a wire which is passed through the items and which causes an alarm to go off if the continuity of the loop is broken. Although this circuit is not as invincible as the more sophisticated systems found in the shops it should provide sufficient security to prevent casual removal of items by the opportunist.

THEORY

The heart of the circuit is a latch made up of two, two input, NAND gates in a "cross coupled" configuration. Logic circuits are so called because they have inbuilt into them a "logic" which decides what state the output of the device will be for all of the possible combinations of input conditions. Unlike other types of circuit logic circuits operate with only two input/output voltage conditions. These are the logic "1" state which is the same as whatever the battery voltage happens to be, in other words an "On" state or the logic "0" state which is 0 volts or an "Off" state.

The input and output states of logic circuits are usually shown in a format known as a Truth Table. For a two input NAND gate such as the ones we are using this is:

Table 1.
Truth Table for Two Input NAND Gate

Inputs		Output
B	A	Z
0	0	1
0	1	1
1	0	1
1	1	0

This may look slightly complicated but what is really shown is that the output of the NAND gate is in the logic 1 (on) state except for the one combination when both of the inputs are in the logic 1 state in which case the output goes to the logic 0 (off) state.

In this circuit two, two input, NAND gates are connected into a cross coupled arrangement which makes the circuit operate so that when the available input to one gate is made to go briefly to the logic 0 state (0 volts) then the latch is triggered, going to the logic 1 state, and will remain in that state until the

spare input to other latch is made to go to the logic 0 state. The characteristic of this cross coupled gate circuit is that the two gates operate so that when the output of one of the gates is at logic 0 the output of the other gate is at the logic 1 state.

In the circuit used for this project the spare input to one of the cross coupled gates is held in the logic 1 state by being connected to the battery positive supply rail through the alarm linking wire. If this connection is broken the spare input is pulled down to the logic 0 state, by a "pull down" resistor connected to the 0 volt rail. Thus breaking this connection by attempting to remove a protected article causes the input to the gate to fall to the logic 0 state which immediately triggers the alarm.

The other input to the cross coupled gates is a circuit which provides a very short, negative pulse. This circuit automatically sets the latch to the correct state, as soon as power is applied to the circuit.

The output from the latch circuit is of a relatively low current handling capacity so the alarm is actually switched off and on by a simple transistor switch.

CIRCUIT DESCRIPTION

The circuit diagram for the project is shown in Fig. 1. The latch circuit is made up of the two NAND gates IC1a, IC1b, which are each one quarter of a 4011, quad, two input, NAND gate. The other two NAND gates available in the 4011 integrated circuit are not used and, in order to prevent them from interfering with the operation of the circuit, their inputs are connected to 0 volts.

Resistor R1 is a pull down resistor which is attached to the input of IC1a which is not cross coupled with the output of IC1b. This input is held in the logic 1 state by being connected, through the protection link, to the positive battery voltage via the two sockets SK1 and SK2. As long as a sound connection exists between SK1 and SK2 then this input is held at the logic 1 state and the latch remains in the untriggered state.

As soon as the link through the protected possessions is broken then the state of this input falls to the logic 0 state, by virtue of it being connected to 0 volts via R1. This causes the circuit to trigger, with the outputs of IC1a and IC1b switching states so that the output of IC1a goes to the logic 1 state.

Resistor R2 and capacitor C1 form a negative pulse trigger circuit which is connected to the input of IC1b so as to reset the latch as soon as power is supplied to the circuit. Initially, with the power supply to the circuit switched off, C1 is discharged. This



COMPONENTS

Shop
Talk

Resistors

R1, R2 10k (2 off) see page 64
R3 27k
All ¼ watt 5%

Capacitors

C1 0µ1 MDC
C2 2µ2 Tantalum 10V

Semiconductors

TR1 BC108 (or similar)
IC1 4011 quad, two input NAND gate

Miscellaneous

S1 s.p.s.t. key operated switch
SK1, SK2 single connection sockets (see text)
B1 PP3 battery plus connector
WD1 audible warning device, 9V operation

Easiwire board 38 × 19 holes;
Easiwire connectors (4 off each type); case to suit.

Approx. cost
guidance only

£7

with a further set of turns of wire being wrapped around the component tail on top of those already sited there.

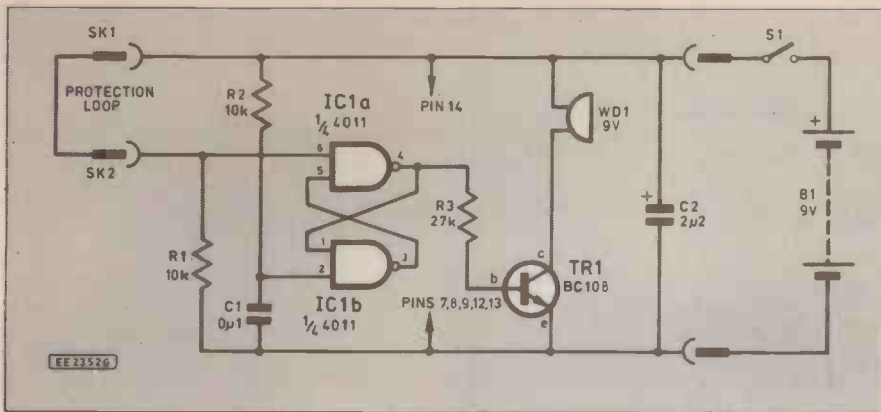

Fig. 1 Circuit diagram of the Possession Alarm

causes the input to IC1b to be in the logic 0 state immediately the circuit is switched on. However, as soon as power is supplied to the circuit, C1 starts to charge rapidly through R2. This causes the input to IC1b to rise to the logic 1 state. The effect of this is to cause the output of IC1a to go to the logic 0 state immediately the circuit is switched on and to remain in that state until triggered by the breaking of the circuit between SK1 and SK2.

The output from the logic circuit is capable of handling only a relatively small output current and, in order to ensure reliable operation of a loud alarm buzzer, a simple transistor switching circuit comprising TR1 and R3 is used. When a current is allowed to flow through the base/emitter connection of a transistor it allows a much larger current to be drawn through the emitter/collector circuit. In the case of the transistor chosen the current which may be drawn through the collector/emitter circuit is approximately 150 to 200 times the current which is required to flow through the base/emitter junction in order to switch the transistor on.

A current flows through the base/emitter junction as soon as the voltage between the base and emitter exceeds 0.7 volts. As the logic 1 state of the output from IC1a is equivalent to a voltage of 9 volts, R3 is included in series with the base TR1 so as to prevent a voltage in excess of 0.7 volts appearing across the base/emitter junction. If R3 were not included in the base circuit of TR1 then the action of the transistor would be to attempt to reduce the battery voltage to 0.7 volts, by dissipating the excess voltage as heat. This would cause failure of the transistor.

CAPACITOR

C2 is a 2µ2 tantalum capacitor which is included in the circuit to smooth out any power surges which can be generated in the power supply whenever the gates change state. S1 is a key operated switch which is incorporated into the circuit to turn the alarm off and on as required. It enables the system to be disarmed when an authorised person wishes to remove items from the protection of the security loop.

CONSTRUCTION

This project has been designed to be constructed using the Easiwire system, it can be built on the *Free Easiwire Circuit Board* given away with last month's issue. The layout of the components on the board is shown in Fig. 2 with the components being simply inserted into the appropriate hole in the board from the side with the wider holes.

When all of the components have been inserted into it the board should be turned over and the protruding component tails trimmed to a length of 3mm using cutters. It is important to ensure that any polarity sensitive components, such as TR1, IC1 and C2 are inserted into the board the correct way round. This must be checked thoroughly before wiring the board up.

The components are then connected, using the Easiwire wiring system to produce the connections as shown in Fig. 3. The wiring layout has been designed on the basis that the buzzer is not polarised, if the buzzer is polarised then the wiring layout may have to be redesigned to accommodate the polarity of this component.

Where the wiring chain has to break, as in the case of the link to the negative battery connection to pin 7 of IC1 which is spurred off the negative end of R1, this is simply achieved by connecting a new run of wire

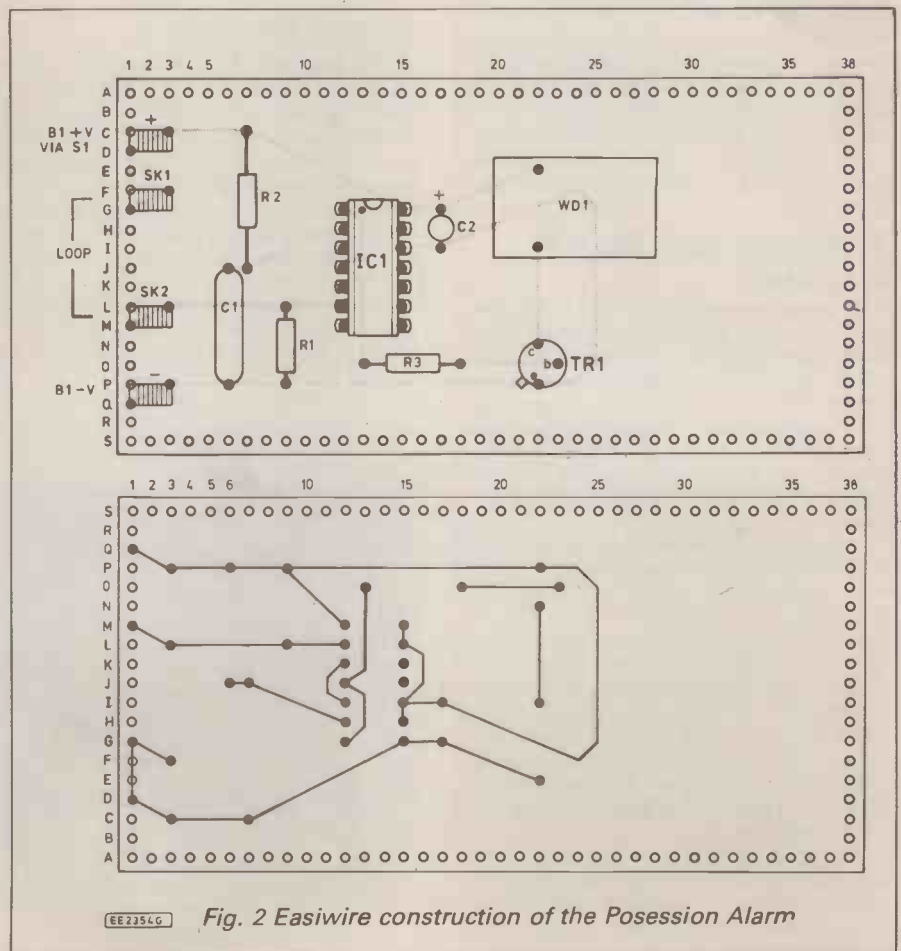
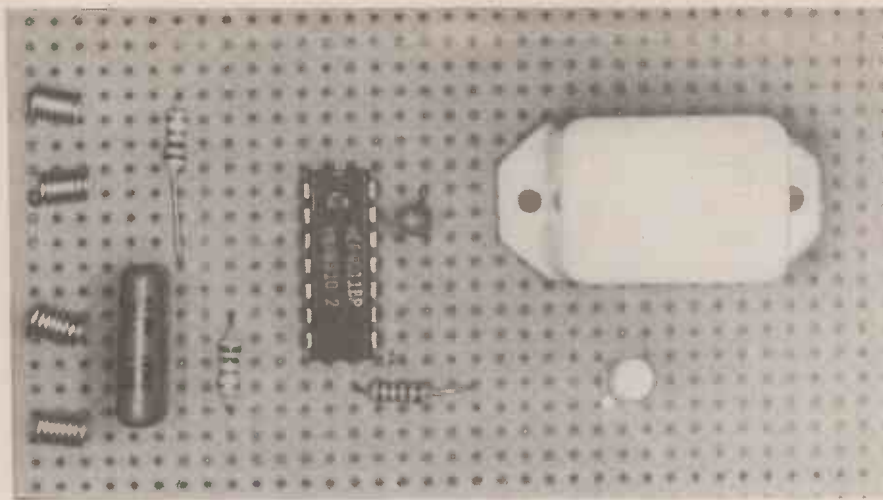

Fig. 2 Easiwire construction of the Possession Alarm



As this circuit is somewhat complex there are a number of occasions where the wiring cannot be achieved by straight line connections between the points. The introduction of curved wiring paths is achieved by applying a large piece of the double sided adhesive film, supplied with the Easiwire system for just such a purpose, to the underside of the whole board area before inserting the components or connecting them with the wiring pen.

The sheet should firstly be cut to the size required. The white film is then removed and the sheet stuck to the back of the board by means of the exposed adhesive. The brown film is then peeled off before the wiring run is made and the wire pressed onto the adhesive sheet to hold it firmly in place away from possible points at which a short circuit could occur.

Once the board has been completed then the necessary wires required to connect the circuit board to the case mounted components (S1, SK1 and SK2) can be prepared with the correct terminations to mate up with the on board connectors. In the case of the end of the wire which is connected to the board this is a simple matter of crimping on the connectors with pliers to the bared end of the wire. The other ends of the wire will, however, need to be soldered onto the components.

TESTING AND FAULT FINDING

Before proceeding any further it is necessary to visually check for short circuits or components installed in the wrong places or with reversed polarity before connecting the battery. The battery can then be installed and the circuit tested. If the circuit works as described then isolation varnish can be brushed over all of the connections to make the circuit permanent before installing the board in its case.

If the circuit does not operate as described it will be necessary to search for the fault(s) which are causing the problem. The first step is to repeat the visual checks on the circuit to ensure that it actually conforms to the circuit diagram and that, where appropriate, components are connected with the correct polarity. If the visual check produces no indication of what the fault may be then the battery should be checked with a voltmeter to ensure that it is providing adequate output both when disconnected from the circuit and when connected to it.

If connection of the circuit results in a marked fall in battery voltage the most likely cause is either a wiring fault causing a short circuit between the two battery supply rails, or that a polarity sensitive component has

been connected into the circuit with reverse polarity. In this circuit the most likely components to exhibit this fault are IC1, TR1 or C2 and these should be carefully checked. If any of these components have been found to be incorrectly connected then it may be necessary to replace that component as irreparable damage may have been caused.

The next step in fault finding on this circuit is to check that the battery voltage is measurable across all of the correct points in the circuit. This is most easily checked by connecting the negative lead of the voltmeter to the negative input connection and checking that the battery voltage can be measured at those points in the circuit diagram to which the battery positive wire should be connected. Make similar checks for the negative connection points with the positive lead connected to the positive battery terminal.

LOGIC LEVELS

The next step is to check logic states present at the inputs and outputs of IC1. Once the power has been applied to the circuit for long enough for C1 to charge then pin 2 of IC1 should be at the logic 1 (9V) state. If this point is found to be at the logic 0 (0V) state then the most likely causes are: a short circuit in or across C1; a poor connection between the positive power supply rail and the positive end of R2, a poor or missing connection between the negative end of R2 and the positive end of C1, or a poor or missing connection between the junction of R2 and C1 with pin 2 of IC1.

A similar check should be carried out on

the logic state at pin 6 of IC1. With a sound connection between SK1 and SK2 the state of pin 6 should be at logic 1 but this should fall to the logic 0 state when the link between SK1 and SK2 is removed. If this does not happen then the connections between SK1 and the positive power supply rail and those between SK2, R1 and pin 6 of IC1 should be checked, as should the voltage present at the negative end of R1, which should remain at 0 volts in all circumstances.

The output states of the two gates at pins 3 and 4 of IC1 should also be checked. These two pins should always be at opposite logic states with pin 4 being at logic 0 if the circuit is switched on with the protective link intact and going to the logic 1 state as soon as the connection between SK1 and SK2 is broken. If this does not occur then the connections between pins 3 and 5 and between pins 1 and 4 of IC1 should be checked. Pins 7, 8, 9, 12 and 13 of IC1 should also be checked to ensure that they are at the logic 0 state.

If the logic states of the inputs are correct but the logic states of the output are not then a check for short circuits across or between pins 3 and 4 and their neighbours should be made. If no problem is found with these connections then it is most probable that the i.c. is faulty and it should be replaced.

BUZZER

If the output states of IC1 check out correctly but the buzzer does not sound when pin 6 of IC1 is in the logic 1 state then the transistor output circuit should be checked. To test the buzzer it is necessary to briefly short out the emitter and collector of TR1 which should cause the buzzer to sound. If this does not occur then the connections from the positive power supply rail through the buzzer to the collector of TR1 and between the emitter of TR1 and the negative power supply rail should be checked. If these connections are sound and the polarity of the buzzer (if any) is correct but the buzzer does not sound then the buzzer should be removed from the circuit and tested independently across the disconnected battery.

If the buzzer sounds when the emitter and collector of TR1 are shorted out but does not sound when the output of IC1a goes to the logic 1 state then the connection between pin 4 of IC1 and the base of TR1 through R3 should be checked to ensure that they are sound. When the output of IC1a is in the logic 1 state then the battery voltage (measured with respect to the negative power supply connection) should be measurable at the top of R3 and approximately 0.7 volts should be measurable both at the

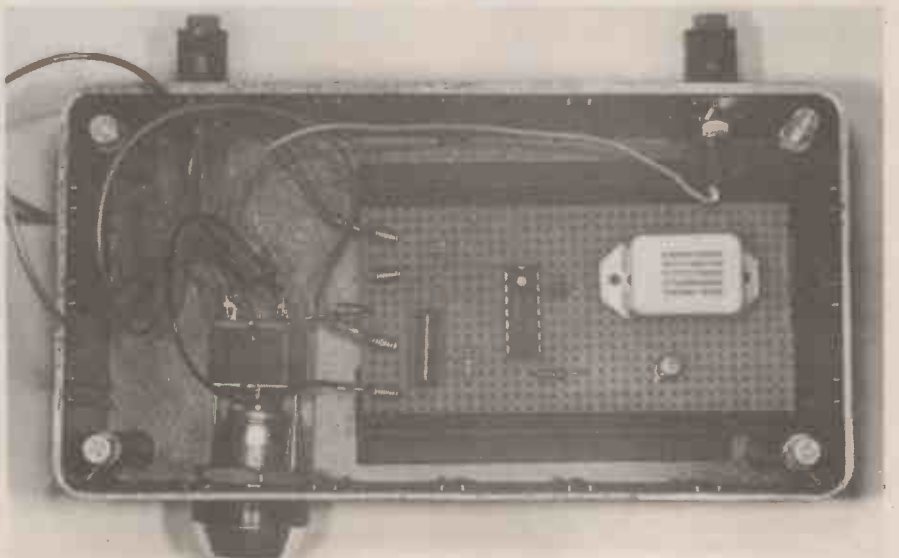

negative end of R3 and at the base of TR1. If no voltage is measurable at the base of TR1 but the battery voltage is measured at the end of R3 which is connected to pin 4 of IC1 then the resistance of R3 should be measured to make sure that it is correct. If all is correct but either no voltage is measurable between the base and emitter, or a voltage of 0.7 volts or more is measurable between the base and emitter of TR1, but the buzzer does not sound then it may be assumed that TR1 is faulty and should be replaced.

HOUSING

This circuit must be enclosed in a case in order to prevent unauthorised tampering which might destroy its effectiveness. Ideally the switch S1 should be mounted in an easily accessible position with the sockets SK1 and

SK2 similarly mounted where the wire protection loop may be easily disconnected or connected by an authorised person. It is however important when selecting SK1 and SK2 to ensure that it is not possible for SK1 and SK2 to be shorted out without the unit being turned off.

Once a suitable case has been obtained then the necessary holes must be made to mount SK1, SK2 and S1. It will also be necessary to consider how the case can be securely attached to a suitable surface so that it may not be removed along with the possession that it is intended to protect. If necessary drill suitable fixing holes in the case.

Once the enclosure has been prepared then the case mounted components can be installed along with the circuit board and the case mounted components connected to the board. The circuit should be tested once

more to ensure correct operation before the lid is screwed shut and the alarm used in earnest.

IN USE

To use the *Possession Alarm* it is necessary to securely fix the device to a suitably immovable part of the building or a heavy piece of furniture close to the articles you wish to protect. A single core wire is then connected between SK1 and SK2, it being threaded through holes in the devices or equipment that you wish to protect.

Once the loop of wire is in place the key switch can be turned on. As long as the connection between SK1 and SK2 remains intact the alarm will not sound. As soon as the circuit is broken then the buzzer will sound and remain on until either the battery wears out or the alarm is switched off by turning the key switch. □

MARKET PLACE

FOR SALE Tectronics 647 oscilloscope, dual beam 100MHz plus probes and circuit diagram £300 o.n.o. Tel: Winsford 552 828
WANTED good standby battery for Ferguson Video Star 3V23 video recorder Tel: 0942 891004.

AVO Multiminor £20. Fluke digital meter £50. HV probe £16. 01 554 2913.

WANTED for radio control receiver. Stockist of the TBA651 i.c. Tel: 0272 69876.

TESTGEAR, electronic comps; audio osc; breadboards; digital test gear. Nothing over £25. Example oscilloscope £15 working. Tel: 0622 831142 evenings.

WANTED circuit diagram of Walkman style three band graphic equaliser. Mr. M. Waite, 60 Greenford Close, Orrell, Wigan, Lancs, WN5 8RH.

ARCADE machine p.c.b.s Donkey Kong £50, Moon Patrol £75. Karate Champ £100. Also some full machines. Tel: 0865 63744.

UK 101 WANTED preferably mint in S.E. England. Superboard or faulty unit considered. Tel: 0483 32275.

E & MM Spectrum synth £100 or swap anything electronic considered w.h.y. Tel: 0705 253595.

SINCLAIR Spectrum 48K with printer, masses of good software and books. v.g.c. £78. tel: 0525 375780.

WANTED cheap sig/gen, scope wattmeter etc., also pair walkie talkies lcomms or similar. Tel: 091 5640559.

WANTED JVC-Victor RN 300 stereo cassette mechanism, made for Tandberg, surplus market 1979-80, with or without electronics. Tel: 0208 873067.

ROBOTEK I/O Port for Spectrum £10 plus post. Mr. M. Waite, 60 Greenford Close, Orrell, Wigan, Lancs. WN5 8RN.

T.V. TUNER/TIMER, provides composite video sound plus switched mains output £30. Tel: Steve 0732 351919.

LAFAYETTE communication receiver for sale any sensible offers or will swap for working multimode s.s.b. transceiver. Mr. B.J. Gould, 156, Mountstevens Ave, Walton, Peterborough, Cambs, PE4 6HN.

HEATH KIT EE3140 electronics course with trainer console £50. Tel: 01 451 3093.

INDEPENDENT ICL users club models 15/25/26/35 CPM/MPM information, spares. No subscriptions. Tel: Nigel 0293 513354.

PRINTER Newbury 8840, Serial, wide, 240cps. buyer collects. Tel: 0604 44005 eves.

FOR SALE back issues Aviation Week magazine, various p.s.u.s coutant A series. Offers, please phone 0734 782236.

WANTED sig-generator, scope, freq. counter and audion-gen. Cheap please for student. 091 5640559.

SPECTRUM + joystick, interface p.s.u. and software. £80 excellent condition. Scott, 50 Tarnbrook Drive, Blackpool, Lancs PY3 7QA.

HITACHI double beam VZ12. Unused — probes — handbook. £250. Exchange Communication Receiver. Tel: 0875 811816.

CAR ALARM unit wanted with full wiring data. J O'Neill, 39 Wolfe-Tone St, Kilkenny City, Eire.

WANTED info on how to connect Burroughs TD019 keyboard and TD832J monitor to outside world. Help. Mr. M. R. Day, 39 Valnord Lane, St. Peter Port, Guernsey, Channel Islands.

WANTED FDK750 spare parts or p.c.b for this model transceiver 2m w.h.y. write with prices. George Haylock, 28 Longlands Road, Sidcup, Kent, DA15 7LT.

WANTED instructions/data for Digital Microsystems DMS 5000 monitor. Will pay postage etc., 01 429 1599 evenings.

FOR SALE Yamaha PSS170 electronic keyboard, 100 pre-set voices + sound effects + mains adaptor £70. Tel: Cradley Heath 410150.

FOR SALE model aircraft equipment and accessories, computers, components etc., phone for details. 0438 720910.

FREE READERS ADS.

RULES Maximum of 16 words plus address and/or phone no. Private advertisers only (trade or business ads. can be placed in our classified columns). Pen pals or items related to electronics only. No computer software. EE cannot accept responsibility for the accuracy of ads, or for any transaction arising between readers as a result of a free ad. We reserve the right to refuse advertisements. Each ad. must be accompanied by a cut-out valid "date corner". Ads. will not appear (or be returned) if these rules are broken.

CLEAROUT i.c.'s passives, transistors, i.e.d.s. Send s.a.e. for list. Nicholas Paul, 6 Marvens Galleywood, Chelmsford, Essex CM2 8YB.

WANTED discriptions, books or magazine articles dealing with hardware projects for Spectrum or any related correspondence. Robert Kaminsky, 96 Killigraw Street, Falmouth, Cornwall TR11 3PU

FLUKE 77 multimeter £50; clamp meter £25; small, Avo £20; HV probe £10. Tel: 01 554 2913 6-8pm.

SINCLAIR ZX Spectrum 48K, boxed, joystick and games G.W.O. Tel: Worcester 0905 358458 after 4pm.

WANTED oscilloscope no dealers. Cash waiting, no fancy price 01 631 0300.

WANTED Sinclair/Binatone Micro TV. Not flat screen, good condition, working order. Tel: 0502 501693. Evenings.

EINSTEIN computer keyboard case plus mother board, working but no p.s.u. or D/D £20. 0928 581429.

P.E. 81 Car Ignition contact version using 555 timer. Built and working O.K. £5. P.O. £1. L.T. Hill, 29 Stead Lane, Bedlington, Northumberland.

ADVANCE DB'scope 0S1000A immac, £180. Radio mags 340 PE/PWR/RC 62/73 £35. Want Rampacks for Yamaha DJR 1000. Tel: 0744 27067.

OFFERS for approx 300 once used MEL 12 phototransistors, TTL logic gates, red i.e.d.s. Mr. A. Tonkin, Wayside Cottage, Belmont Road, Uckfield, East Sussex TN22 1BP.

COMMODORE 64 computer with many games + utilities + books + joysticks + tape recorder. Mint condition £90. Tel: 0732 356612.

BLOCK CAPITALS PLEASE

Please read the **RULES** then write your advertisement here — one word to each box. Add your name, address and/or phone no. Please publish the following small ad. **FREE** in the next available issue. I am not a dealer in electronics or associated equipment. I have read the rules. I enclose a cut-out valid date corner.

Signature Date

COUPON VALID FOR POSTING BEFORE 5 JANUARY '90
(One month later for overseas readers)

**SEND TO: EE MARKET PLACE, EVERYDAY ELECTRONICS,
6 CHURCH STREET, WIMBORNE, DORSET BH21 1JH.**

Name & Address:			

For readers who don't want to ruin the issue send a photostat or a copy of the coupon (filled in of course) with a cut-out valid "date corner"

FOR YOUR ENTERTAINMENT

BY BARRY FOX

That'll teach 'em

The BBC has for two years been deluged with complaints about the dramatic drop in technical quality of the soap series *Dallas*. In the end the BBC's viewer and listener correspondence department resorted to replying to complaints by quoting Worldvision, the distributors of *Dallas*, as admitting that "the producers of the series have been aware of the technical difficulties for a time and have been trying to find ways and means of improving the quality". Worldvision promised "considerable improvement" for the last episode of the current series (transmitted June 28), and all episodes of the next season. "I am sorry you found it so bad that you had to turn off" said Worldvision glumly.

The solution took no "finding". All Worldvision had to do was tell the producers of *Dallas* to stop penny-pinching. Like most Hollywood soaps, *Dallas* is shot on 35mm cinema film at 25 frames per second. In the good old days the studio edited on film, and sent a final version on 35mm film to Europe. The BBC then ran the film through a telecine machine to produce 625 line, 25Hz PAL TV pictures for transmission.

Then the accountants in Hollywood had a bright idea for saving costs. They shot on film, but immediately transferred the images to video tape, inevitably of the 525 line, 30Hz NTSC standard used in North America. They edited on NTSC tape, electronically converted the final version to 625/25 PAL and sent it to Europe. The result was that British viewers got rotten pictures with poor definition and smear and blur on motion, instead of the original quality.

At long last, under what the BBC describes as "tremendous pressure from European broadcasters", the makers of *Dallas* have now made a major and welcome step backwards. They now edit on film, instead of tape.

All is not quite back to square one however. The producers do their own transfer from film to video tape, so instead of getting a reel of 35mm cinema film, the BBC now gets a reel of video tape. This should not matter — but if it does the BBC expects more complaints. They know that *Dallas* addicts are curiously sensitive to picture quality.

Don't kid yourself into thinking this step back to quality was taken simply for the benefit of European viewers. The Americans woke up to the fact that if they continued editing on NTSC tape, with only the original uncut rushes on film, they would have nothing to re-run in HDTV if and when the US starts a broadcast service. By cutting film they have a print worthy of HDTV.

Tuned in

Why, oh why, do the makers of video recorders make tuning them to off-air stations so absurdly difficult. In the good old days of the early 80s (remember Sony's wonderful C7 Beta recor-

der?) you tuned a VCR by turning little knobs which moved small red pointers across simple scales marked with the u.h.f. TV transmission channel numbers, 21-68. Fine tuning was by fine turning the knob.

This analogue system worked perfectly, because humans are analogue by design. Eight pre-sets were plenty; four for off-air reception (five for some parts of the country with access to a couple of ITV networks), another pre-set for connecting external equipment (like another VCR, video games unit or satellite tuner) and a couple spare.

Now the world has gone electronics mad. Tuning is automatic, with invisible circuits scanning an invisible dial. You only know you have reached a station when it appears on screen. Often there's no indication of where that station sits on the scale between channels 21 and 68. And to confuse things further, the VCR programme number settings are called "channels".

Most people want BBC 1, which in London is transmitted on TV Channel 26, to be set on VCR Channel 1. But because ITV is on TV Channel 23, automatic tuning is more likely to put it on VCR Channel 2. Then you are into altering or cancelling tuning settings and re-tuning — which is now more difficult, because you don't know where you are on the dial.

One VCR I tried recently only did a one-way fast tuning sweep. I never did find out how to go backwards down the dial and start again without either using the slow fine tune control or cancelling everything and starting from the beginning.

This otherwise lovely machine offered me the chance to pre-tune up to 100 stations. Who the heck needs to tune 100 stations in the u.h.f. band?

I would like to see the people who designed these daft systems, locked in the departure lounge at Gatwick Airport for a week as punishment. Why don't the manufacturers try giving the machine and an instruction book to a novice, and watching how they get on?

If we can't go back to the good old mechanical analogue knob and dial system (which of course is gloriously immune to long term power failure), let's at least have an electronic ana-

Double Take

Before electronic standards converters became available, TV companies used to convert 525 line/60Hz programmes from the USA to 625 line/50Hz for Europe, and vice-versa, by the simple expedient of displaying pictures from one standard on a TV screen and pointing a TV camera of a different standard at it. This grew out of the method used to make TV recordings before video recorders were available. Engineers would just point a film camera at a TV screen.

A TV engineer recalled recently how British TV companies used to make recordings for sale to America, without

logue of it. All it needs is a simple numbered display — either on screen or the VCR panel — depicting the tuning range between TV Channels 21 and 68 and two buttons, with left and right arrows, to move a dot backwards and forwards across this display.

When you get the station you want, you select the appropriate VCR channel button and press "store". Hey presto. It's done.

Now I know someone is going to tell me that some machines work in this way and are very easy to use. My question is, why don't they *all* — and why are some VCRs (and TV sets) still pigs to tune?

Still Working!

They say the best jokes are the old jokes. It sometimes goes for electronics too.

In the early 70s, the Mullard division of Philips (now just called Philips), started producing a vital component for PAL TV sets. It was a delay line that stored one line of the picture to let the PAL circuitry play its trick of compensating the colour for phase errors in the received signal.

The delay line worked on a principle also used by the BBC, for a TV standards converter. The electrical picture signal is converted into ultrasound, by a tiny piezo loudspeaker. This sound is then fired down a glass rod, and picked off at the other end by a tiny microphone which converts it back into an electrical signal. Because sound travels slowly in glass, the picture signal is delayed. If the length of the glass is carefully chosen the delay is the time span of one picture line, 64 μ s.

Someone who worked at the Mullard factory in Blackburn which made these glass lines told me recently how he was warned in the early 70's that it was only a short-lived product. Integrated circuits were being developed which would do the job much more efficiently, without converting an electronics signal into sound and back again.

But even now, getting on for twenty years later, the same factories in Blackburn are still producing glass delay lines, and selling them to TV manufacturers all round the world, including Philips's rivals in Japan. The basic technology is still the same.

The only difference is that what was once a lengthy strip of glass is now a small rectangle. The signal is fired in at an angle, and bounced several times from side to side, thanks to internal reflection. So a long path fits into a small length.

going through the clumsy process of shooting on film. Quite simply they would do the whole thing twice!

In the early days of video recording, ATV bought a truck and installed a 60 cycle generator and American standard 525/60 Ampex video recorder. This truck was parked outside the studio. Actors and crew would rehearse a TV play and then shoot it on in-house 625/50 video equipment. Then, the same day, they would go through the whole play again, recording it onto 525/60 tape in the truck. On one occasion ATV engineers worked 36 hours without stopping, to get two tapes.

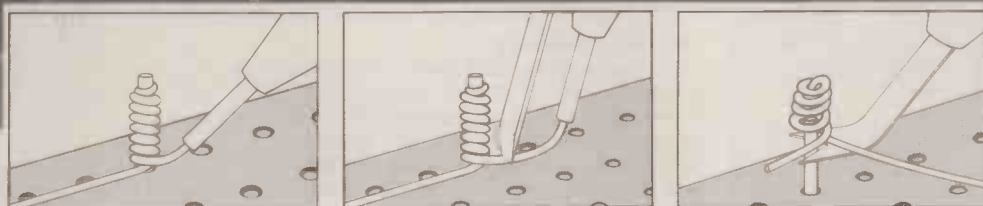
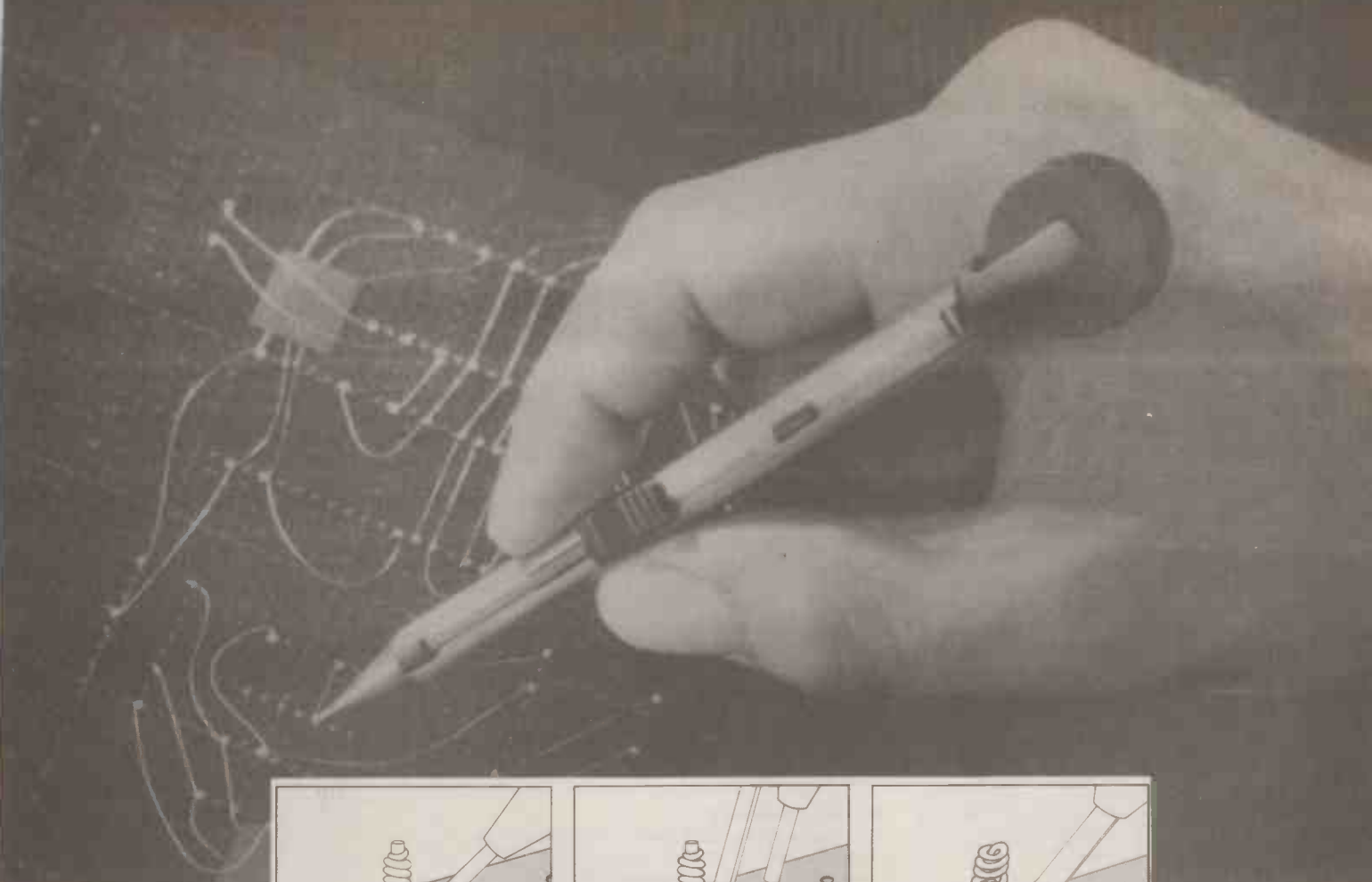

EASIWIRE

Circuit construction the easy way.

Solderless, quick and easy to learn. That's Circuigraph Easiwire from BICC-VERO. From now on you'll wonder why you ever used solder to construct your electronic circuits!

Consider the benefits Easiwire offers:

- You need no solder, no chemicals
- You simply wind the circuit wire around the pins
- You can re-use components
- It's easy to change
- The cost is low

What's more, Easiwire is ideal for circuit repairs.

In kit form, Easiwire comes complete with everything you need to construct circuits. That includes a wiring pen with integral cutter, two reels of wire, a component positioning and removal tool – and an instruction book. Of course kit items are available separately too.

Take advantage of the special offer price now. Complete the coupon below and send it to:

BICC-VERO Electronics Limited,
Flanders Road,
Hedge End,
Southampton, SO3 3LG.

or phone 0489 788774 now with your credit card number
(24-hour answering service)



Please rush me.....Easiwire kits.
Special offer price £15. – (includes p & p and VAT).

I enclose cheque/postal order for
made payable to BICC-VERO Electronics Limited.

Card number

Expiry date

Name

Address

.....Postcode

Signature.....Date

...REPORTING AMATEUR RADIO...

TONY SMITH G4FAI

YOUNG AMATEUR OF THE YEAR

Sixteen-year-old schoolboy Ted Walker, from Warwick, received the DTI-sponsored *Young Amateur of the Year Award* at the Radio Society of Great Britain's HF Convention held in Oxfordshire on 1 October. He was presented with a £250 prize and certificate and, together with the runners up, will be invited to visit the DTI's radio monitoring centre at Baldock in Hertfordshire.

The award is aimed at encouraging interest in amateur radio as an early training ground for future communications engineers in the UK's booming electronics industry. It is an important adjunct to the RSGB's Project YEAR (Youth into Electronics via Amateur Radio).

Chosen from a shortlist of six, Ted is a keen user of radio. He has restored old equipment and built his own antennas. He is active in radio clubs and in the Radio Amateur Emergency Network (RAYNET).

Runners up were Rachel Oakley, 14, from Gateshead, and Paul Moss, 17, from Evesham. Rachel was the first Guide to qualify for the new Radio-communications Badge (see this column, August '89), she has coached other guides and taken part in *Thinking Day on the Air*. She passed the Radio Amateurs Examination and Morse test at the age of 12 and has built her own radio equipment. Paul is a successful radio contester, has built his own antennas and uses computers for radio communications.

AMATEUR SATELLITES

In 1979 the World Administrative Radio Conference officially recognised the amateur satellite service, designating and reserving various radio bands for satellite use. Experimental amateur satellites go back long before that, however, and today there are ambitious and on-going amateur radio space programmes in a number of countries.

The first satellite, *OSCAR 1* (Orbital Satellite Carrying Amateur Radio), was built by radio amateurs working at the Jet Propulsion Laboratories in Southern California and had a life of only two weeks. This was followed by the formation of AMSAT (the Radio Amateur Satellite Corporation), with associated organisations around the world. Five experimental *OSCARs* were launched between 1961 and 1970, the fifth being built in Australia although launched, like the others, by NASA in the USA.

Based on experience gained from the experimental satellites, *OSCARs* 6, 7, and 8 were launched in 1972, 1974 and 1978, each as a result of considerable international co-operation. *OSCAR 8*, for example, took two years to build by amateurs in the U.S., Canada, West Germany and Japan.

There have been setbacks as well as

successes. A new satellite was due to be put in orbit by the European Space Agency's experimental *Ariane L02* rocket in 1980. This failed shortly after launch from the ESA space centre at Kourou in French Guiana, and plunged to the bottom of the sea taking the amateur satellite with it.

The Soviet Union sent up its first amateur satellites in 1978, designated *RS1* and *RS2*. These were launched together and lasted about five months. Six more satellites, *RS3* to *RS8*, were put into orbit in December 1981 by a Soviet launch vehicle over Antarctica and within a week amateurs around the world were using these for long distance contacts.

This series of satellites was designed to be used by earth-bound stations operating with very low power and relatively simple antennas.

UK INVOLVEMENT

In Britain, the University of Surrey provides a European control station for the *OSCAR* satellites. It built a research/educational satellite *UOSAT-1* (*OSCAR 9*), launched by NASA in October 1981. Again there was a setback, this time successfully overcome.

A few months after launch the on-board computer inadvertently switched two beacon stations on at the same time. Normally while one beacon was operating the other functioned as a receiver for command signals from the control centre. With both beacons transmitting, the receivers were desensitized and essential control instructions could not be received.

A signal was needed strong enough to break through and activate one of the disabled receivers. A great deal of power was needed for this purpose and eventually a transmitter and giant antenna, controlled by a team of American amateurs at Stanford Research Institute in California, was brought into use enabling the University of Surrey to resume control of *OSCAR 9*.

FRACTION OF THE COST

The building and launching of a commercial or military satellite runs into millions of pounds and obviously the amateur service could not meet expenditure of this order. Fortunately there are many radio amateurs working in space programmes who are prepared to give their time and expertise freely to amateur projects. Their efforts, coupled with those of other amateur enthusiasts with special skills, plus support from the space agencies and scientific and educational institutions, have enabled amateur satellites to be constructed and launched at a fraction of the cost of their professional counterparts, although very large sums of money are still involved.

The design, development and construction of an amateur satellite is

clearly not an activity for the everyday amateur radio hobbyist. The efforts of those involved, however, have enabled amateurs not possessing such specialist skills to make increasing use of satellites for long-distance radio communication.

ACQUIRED KNOWLEDGE

A certain amount of knowledge does, of course, have to be acquired to operate through a satellite. The operator needs to know when a satellite will appear over the horizon so that he can aim his antenna in the right direction and be ready to transmit when it comes in range.

He needs to have suitable antennas and equipment for the different radio bands used, he needs to know how much power to transmit (too much can affect the performance of the satellite), and to have a sensitive enough receiver. Plus, of course, he needs to know the proper operating procedures.

All of this is well within the ability of the average radio amateur, including those relatively new to the hobby. Much information and assistance is available from AMSAT-UK including advice and help on an individual basis. It publishes its own journal, "Oscar News". It has a "hot news" service on an ad hoc basis and prepares a list of orbital predictions for current satellites every two months.

There is a range of software and hardware available for a variety of home computers to assist and improve satellite operation. A special (earth bound) net is held on the 80m band (3.780MHz SSB) at 7.00p.m. on Mondays and Wednesdays and 10.15a.m. on Sundays, where those interested can call in for information or clarification on satellite matters.

MORE TO COME

Amateur satellites have continued to be launched over the years, including *UOSAT-2* (*OSCAR 11*) and Japan's *JAS-1*, while a number of earlier ones have remained operational. At the time of writing *OSCAR* satellites have reached No. 13 and the Russian *RS* series Nos. 10/11 (actually two transponders on one spacecraft).

In January 1990 AMSAT is due to launch another six satellites from Kourou, including *UOSATS 3* and *4*, while the Russians are due to put up *RS12* and *RS13* sometime soon.

Eventually amateur satellites in geostationary orbit will permit 24-hours-a-day uninterrupted communications to take place and satellite operating will then be as normal a means of communication as any other in the world of amateur radio. Further information about AMSAT and amateur satellite operation can be obtained from **Mr R. Broadbent G3AAJ, Hon. Secretary AMSAT-UK, 94 Herongate Road, London E12 5EQ**, (Send a large s.a.e.)

The Archer Z80 SBC

The SDS ARCHER – The Z80 based single board computer chosen by professionals and OEM users.

- ★ Top quality board with 4 parallel and 2 serial ports, counter-timers, power-fail interrupt, watchdog timer, EPROM & battery backed RAM.
- ★ **OPTIONS:** on board power supply, smart case, ROMable BASIC, Debug Monitor, wide range of I/O & memory extension cards.

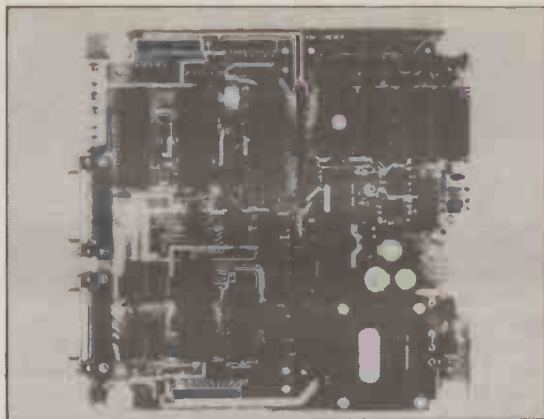

The Bowman 68000 SBC

The SDS BOWMAN – The 68000 based single board computer for advanced high speed applications.

- ★ Extended double Eurocard with 2 parallel & 2 serial ports, battery backed CMOS RAM, EPROM, 2 counter-timers, watchdog timer, powerfail interrupt, & an optional zero wait state half megabyte D-RAM.
- ★ Extended width versions with on board power supply and case.

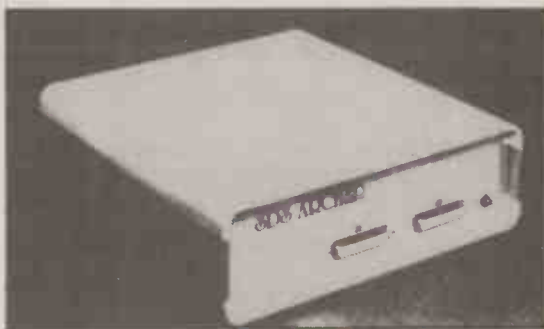

Sherwood Data Systems Ltd

Sherwood House, Unit 6, York Way, Cressex Industrial Estate, High Wycombe, Bucks HP12 3PY. Tel: 0494 464264



HART AUDIO KITS

— YOUR VALUE FOR MONEY ROUTE TO ULTIMATE HI-FI

HART KITS give you the opportunity to build the very best engineered hi-fi equipment there is, designed by the leaders in their field, using the best components that are available.

With a HART KIT you have direct access to the friendly HART service, you are not dealing through, or paying for, any middlemen.

Every HART KIT is not just a new equipment acquisition but a valuable investment in knowledge, giving you guided hands-on experience of modern electronic techniques.

Telephone or write for our FREE LISTS giving full details of all our Kits, components and special offers. Here are a few selected items.

AUDIO DESIGN 80 WATT POWER AMPLIFIER



This fantastic amplifier is the flagship of our range, and the ideal powerhouse for your ultimate hi-fi system. Featured on the front cover of the May issue of 'Electronics Today International' this complete stereo power amplifier offers World Class performance with the option of a stereo LED power meter and a versatile passive front end giving switched inputs, volume and balance controls. Tape, CD players, or indeed any 'flat' input may therefore be directly connected to bypass tone controls or give a 'stand-alone' facility. The amplifier can also be supplied in 'slave' and 'monobloc' versions without the passive input stage and power meter. All versions fit within the standard 420x260x75mm case to match our 400 Series Tuner range. ALL power supplies are stabilised, the heavy current supplies using the same motorised devices as the amplifier. The power supply, using a toroidal transformer, is in fact a complete module contained within a heavy gauge aluminium chassis/heat-sink and fitted with IEC mains input and output sockets. All the circuitry is on a proper printed circuit with low-resistance blade connectors for the six stabilised DC outputs. HART KITS don't leave you to fasten a few capacitors to the floor of the main chassis and wire the power supply the hard way! Remember with a HART KIT you get the performance you want at the price quoted through proper engineering design and the right components. We do not insult your intelligence by offering a kit at what seems a fair price and then tell you that you have to spend three times as much to get an upgraded model.

K1100 Complete Stereo Amplifier Kit with LED Power Meter and 3-input Passive Stage. Total cost of all parts is £418.88

Our Discount Price for the Complete Kit £365.98

K1100S Stereo Slave Version, with plain Front Plate £309.43

K1100M 'Monobloc' mono version, with plain Front Plate £224.15

RLH10 Reprints of latest 'Audio Design Amplifier' articles £2.70

K1100CM HART Construction Manual with full parts lists £4.50

Reprints and construction manual can be purchased separately and their cost credited against subsequent kit purchase.

All versions are supplied with dual primary mains transformers for use on 220/240v or 110/115v mains. Monobloc price does not include the construction manual.

SPECIAL OFFER until the end of November the K1100 kit will be supplied with the new ALPS low noise precision pots at NO EXTRA CHARGE

LINSLEY-HOOD 400 SERIES SUPER HIGH QUALITY AM/FM TUNER SYSTEM

This is the ideal companion tuner to the 80W Audio Design Amplifier in any ultimate hi-fi system with case size, front plate layout and even control pitches unified for stacking. Like the 80W Audio Design Amplifier this is your route to EK+ performance for a few tenths of the cost! Two designs by John Linsley Hood make up this combination of his ultra high quality FM tuner and stereo decoder described in 'Electronics Today International' and the Synchrondyne AM receiver described in 'Wireless World'. Novel circuit features in the FM section include ready built pre-aligned front end, phase locked loop demodulator with a response down to DC and advanced sample and hold stereo decoder together making a tuner which sounds better than the best of the high-priced exotica but, thanks to HART engineering, remains very easy to build and set up. The Synchrondyne section with its selectable band width provides the best possible results from Long and Medium wave channels, so necessary in these days of split programming. If you want the very best in real HiFi listening then this is the tuner for you. Since all components are selected by the designer, to give the very best sound this tuner is not cheap, but in terms of its sheer sound quality, it is incredible value for money. To cater for all needs AM only and FM only versions are available as well as the full AM/FM model, with any unit being upgradable at any time. For further details see our fully illustrated lists.

K400 FM Only version, total cost of all parts is £211.90.
Our special discount price for complete kit only £169.52
K400 AM/FM version, Discount Price for complete kit £249.08

ALPS PRECISION LOW-NOISE STEREO POTS

Square type range of famous precision audio pots all in 2-gang stereo format, with 20mm long 6mm dia. steel shafts. These are the smooth rotation type with no indents.

Now you can throw out those noisy ill-matched carbon pots and replace with these, their improved track matching giving better tonal balance between channels and rock solid image stability.

Value available are 10K and 100K Log, 100K 1m and 10K Special Balance. (Zero loss in centre position).

2-Gang Lin £6.30

2-Gang Log £7.20

2-Gang Special Balance, zero crosstalk and zero centre loss £7.80

Our Autumn '89 list gives full details of all our kits as well as our range of component leads, cassette decks and seasonal special offers. Write or telephone for your FREE copy.

HIGH QUALITY REPLACEMENT CASSETTE HEADS



Do your tapes lack treble? A worn head could be the problem. Fitting one of our replacement heads could restore performance to better than new! Standard inductances and mountings make fitting easy on nearly all machines and our TC1 Test Cassette helps you set the azimuth spot on. As we are the actual importers you get prime parts at lower prices, compare our prices with other suppliers and see! All our heads are suitable for use with any Dolby system and are normally available ex stock. We also stock a wide range of special heads for home construction and industrial users.

HS16 Sendust Alloy Stereo Head. High quality head with excellent frequency response and hyperbolic face for good tape contact. £17.85
HC40 NEW RANGE High Beta Permalloy Stereo head. Modern space saver design gives excellent high-frequency response with easy fitting and lower cost. Suitable for chrome, metal and ferric tapes, truly a universal replacement head, with ample quality for Hi Fi decks and cheap enough for car players! £6.65
HX100 Special Offer Stereo Permalloy Head £2.86
HRP373 Downstream Monitor Stereo Combination Head £44.39
HQ651 4-Track Record & Play Permalloy Head for auto-reverse car players or quadrasonic recording £16.79
H524 Standard Erase Head £2.59
SM166 2/2 AC Erase Head, Standard Mount £12.80
HS9510 2/4 Stereo DC Erase Head £8.70
HQ751E 4/4 AC Erase Head, tracks compatible with HQ651 £57.06
We can supply card reader heads for OEMs at very keen prices.

REEL TO REEL HEADS

999R 2/4 Record/Play 110mH. Suits Stuart tape Circuits £13.34
998E 2/4 Erase Head 1mH. Universal Mount. Suits Stuart £11.96

TAPE RECORDER CARE PRODUCTS

HART TC1 TEST CASSETTE. Our famous triple purpose test cassette. Sets tape azimuth, VU level and tape speed £5.36

DEM1 Mains Powered Tape Head Demagnetizer, prevents noise on playback due to residual head magnetisation £4.08

DEM115 Electronic, Cassette Type, demagnetizer £8.61

Our new Autumn '89 price list is FREE. Send for your copy now. Overseas customers welcome, please send 2 IRCs to cover surface post, or 5 for Airmail. We accept Access/Mastercharge orders by phone or post from inland or overseas. Visa facilities soon.

Please add part cost of carriage and insurance as follows:-

INLAND

Orders up to £20 — £1.

Over £20 — £2.50.

Next Day — £9.

OVERSEAS

Please see the ordering

information with

our lists.

QUALITY AUDIO KITS

24hr SALES LINE
(0691) 652894

ALL PRICES INCLUDE VAT





MATSUSHITA ELECTRIC

EXHIBITION OF TECHNOLOGY

Matsushita, largest consumer electronics company in the world, recently celebrated its seventieth anniversary. Shortly after the celebration, the company founder Konosuke Matsushita died at the age of ninety-four. Barry Fox visited Japan to see the exhibition, talk with Matsushita's top management about the future of consumer electronics and see some of the most highly automated production lines in the world.

THE Japanese electronics industry grew strong by using the home market as a proving ground for new products. Because the country is horribly tight for space, homes are small. Money which westerners would use to buy a newer and larger house goes on gadgetry to make life in a small home more enjoyable. This is what made Japan the ultimate consumer society.

Both Tokyo and Osaka, the two main industrial cities, have areas where literally dozens of shops and multi-storey department stores offer identical electronic gadgetry at identical prices. Anyone visiting Tokyo just has to visit the Akihabara district; in Osaka it's the area round Namba. There you can buy anything from integrated circuits to heated toilet seats, as well as all the latest hi-fi, video and TV hardware.

FREE RESEARCH

This pilgrimage gives the manufacturers a wonderful opportunity for free consumer research. If a new product sells well on the home market, the makers know it is likely to sell well abroad. If it fails at home they are likely to kill it before even trying to export.

The classic example in hi-fi was a major push, nearly ten years ago to make the microcassette, which was developed by Olympus for dictation, a new standard for domestic hi-fi. The tiny cassette proved unsuitable. The moving parts are so small that they have insufficient inertia to give the smooth motion needed for wow and flutter-free sound reproduction.

The microcassette stereo system was never launched in the West, and it soon disappeared from Japanese shops. The cassette returned to its origins, and remains a dictation tool.

Finally there comes a time when the arrival of a new product with only marginal fresh benefits no longer warrants the junking of serviceable gear. And this is now happening in Japan. The unthinkable is a reality. The ever-obliging consumer is saying "no".

DAT

Most homes that want a video recorder now have several. LP record players have been replaced with compact disc players. The

great white hope, digital audio tape, has been killed by the Japanese government's decision to bow to the record industry—the electronics companies obediently crippled their DAT recorders with technical limitations which effectively make DAT a digital recorder which cannot record digitally. Not surprisingly DAT recorders now gather dust on shop shelves.

The next great white hope, high definition TV, has been savaged by political forces in Europe and the USA which insist that if these continents are to have an HDTV system, it must be home-grown—not imported from Japan. Even in Japan there are growing doubts over whether the public really wants—and can afford—the high priced, bulky HDTV technology on offer.

INDUSTRIAL/CONSUMER

In 1970 35 per cent of the production from the Japanese electronics industry was aimed at the consumer; in 1975 it was 31 per cent, in 1985 it was 26 per cent, in 1988 it was 22 per cent and this year it looks like being 21 per cent. Some companies, notably Sony which took over CBS, have bought into software. All are expanding their interest in industrial electronics. Although the border lines between consumer and industrial products are fuzzy, with more and more homes using computers and fax machines, the trend is clear.

At the same time, there has been a major swing to the production of raw components, especially integrated circuits, which are now incorporated in everything from toasters to bombs. In 1970, industrial production accounted for 18 per cent, components for 15 per cent; in 1985, 28 per cent and 21 per cent; in 1988, 30 per cent and 25 per cent. The prediction for 1989 is 30 per cent and 26 per cent.

The picture gets clearer, if you look closer. In 1987, production of consumer electronics for the Japanese home market grew by 11 per cent, and exports fell by 17 per cent. In 1988, production for Japanese consumers grew by 7 per cent and exports dropped by 1 per cent. This year it looks likely that the production growth figure for the Japanese market will be 5 per cent, and exports will have fallen by 3 per cent.

What the Japanese fear most is zero growth. That awful time when sales one year only match those of the year before, despite tougher competition which means falling prices and reduced profits.

FALLING SALES

Matsushita, maker of Technics and Panasonic brand equipment, is the largest consumer electronics manufacturer in the world—and in the top 20 largest companies in the world. Matsushita is also a typical example of the problems facing the Japanese electronics industry, and how it is facing them.

Matsushita's sales of video peaked to 37 per cent of the company's total, thanks to the success of VHS, invented by subsidiary company JVC. Now video sales have fallen to 30 per cent. Audio sales have slumped from 16 per cent of the company's total in 1980, to 8 per cent in 1987. Industrial product sales however rose from 13 per cent in 1980 to 21 per cent in 1987.

As Matsushita has nearly 60,000 salaries to pay worldwide, the company cannot afford to ignore the writing on the wall. To stay on top it has to look for new markets in the 21st Century. The most sobering sight is the explosion of Japanese growth in the personal computer market.

Just as happened with hi-fi, when the Japanese majors watched the market for the LP disc, compact disc and compact cassette mature, and then steamed in with low cost mass-production, so they have waited until the computer market matures round the IBM PC. Now the shops, both in Japan and the West are filling with laptop PC's, a technology which lets the Japanese exploit their talent for miniaturising a format which someone else has specified. The days when Tandy's portables (made in Japan but designed in the US) ruled the roost are long gone.

MEET

Recently Matsushita celebrated its 70th anniversary with *MEET*, the Matsushita Electric Exhibition of Technology. The object was to show corporate strength and preview technologies for the 1990s and 21st century.

The Matsushita empire started from humble beginnings, in 1918, when 23 year old Konosuke Matsushita quit the Osaka Electric Light Company and opened his own factory to manufacture mains plugs. He hit on a clever idea for making plugs far more cheaply than anyone else. He collected old, burned out light bulbs, stripped out the screw cap (in Japan they use screw rather than bayonet light fittings) and glued on a connector cap.

Out of this simple beginning grew the largest consumer electronic manufacturer in the world. Matsushita Electric now employs nearly 60,000 people worldwide and is firmly placed in the top twenty biggest industrial corporations listed by *Fortune Magazine*.

KONOSUKE

Konosuke Matsushita was 94 when he died in April '89. He had for many years been only peripherally involved in running Matsushita, best known for its National, Panasonic and Technics brand names.

After the war he started to devote more and more of his time to philosophy. In 1946, he founded the PHP Institute, which was aimed at achieving "frank communication and deeper understanding of human nature". KM said he believed these to be "indispensable to the realisation of our common goals of peace, happiness and prosperity". The *PHP Magazine*, now re-titled *PHP Intersect*, is distributed round the world. It always contains a philosophical article by the founder. The last was on "workaholic reconsidered". He had written several books in similar vein.

Whereas Akio Morita of Sony has lived in the West, learned good English, and for many years jetted round the world with charismatic style, pulling new products out of his briefcase like rabbits out of a hat, K. Matsushita never even tried a similar approach. His meetings with the press, which not surprisingly became fewer and fewer, were more like audiences with royalty.

MUSEUM

In 1968 the company built a museum at its headquarters in Osaka, which 60,000 people a year visit. The museum is an odd place. Even when K. Matsushita was still alive, the place had an air of a shrine about it, with a tactful gap in the early 1940s. Alongside that original plug and socket connector there is a quote from K. Matsushita. "I was convinced that a product which is convenient to use and of high quality will sell".

That conviction sums up the strength not just of Matsushita, but the entire Japanese consumer electronics industry. Think about it, seventy years later. Products which are complicated to use, like reel-to-reel recorders, quadraphonic sound systems and comput-

ers that need a clumsy Christmas tree of plug-in peripherals have all fallen by the wayside. Simple-to-use technology, like a video cassette recorder, compact disc player and plug-in-and-go computers have sold like hot cakes.

Konosuke Matsushita's 1918 conviction explains why the satellite TV revolution in Britain is taking off far slower than the pundits predicted. For many people setting up a satellite system is just more trouble than it is worth.

The *MEET* exhibition took place in Japan just before K. Matsushita died. For the exhibition Matsushita coined a new phrase for its spread out of consumer electronics—"human electronics". Out of over 200 "HE" exhibits, new developments in computer data recording and flat TV screens stand out as pointers to the 21st Century.

OPTICAL DISC

Matsushita is hedging its bets on the techniques available for recording computer data, digital sound and TV pictures on an optical disc. The company has taken licences on the technology to make two competing types of erasable disc, magneto-optical and phase change. Matsushita already has a licence from Philips to use the basic technology whereby an optical disc is read with a laser.

Now Matsushita has taken a licence from US company Energy Conversion Devices, to allow the use of phase change recording. To record data, a disc coated with a metal compound is exposed to the beam from a 18mW solid state laser of 780 nanometre wavelength. The beam is rapidly switched between full and half power, to heat and cool spots of the metal. This switches it from crystalline state, which reflects light well, to amorphous state, which is a poor reflector.

To read the recording, the same laser is run at 2mW. To erase the disc, the laser is run continuously at full power. This switches the material back to its original state.

A 3.5 inch disc stores 280 Mbytes. Although Matsushita has not yet announced plans to market the device, the company has attracted attention by showing a working prototype no larger than a conventional floppy disc drive. Philips and 3M have for many years worked along similar lines but expressed reservations over the number of times the disc can be reused. Matsushita claims 10 year life.

Matsushita has also taken a licence from Kokusai Denshin Denwa, or KDD, Japan's international telephone agency, to use magneto optical disc technology—the technology preferred by Philips and 3M. In this system the disc is coated with rare earth alloy which switches its magnetic state when heated with a similar solid state laser. The switched state spots change the polarisation of a laser beam, so again there is an effect of changed reflectivity.

Matsushita uses this system to record half an hour of moving colour TV pictures on a 30cm disc. The technology is not new but the recorded pictures are of higher quality than previously demonstrated, for instance by Philips. The company claims that

each disc can be re-used a million times. Both systems are too expensive to use for domestic video or audio recording the 3.5 disc is best suited to use in computers.



The founder Konosuke Matsushita and the Matsushita Museum



TAPE

Until now optical discs have been able to pack information tighter than magnetic tape, and so store more data. Now tape looks like catching up and taking the lead, thanks to technology known as vertical or perpendicular recording.

Conventional magnetic recordings, whether on tape or computer disc, change the magnetic state of horizontally aligned particles. The length of the particles limits the density with which information can be packed. If the particles can be aligned vertically i.e. perpendicular to the surface, they can be packed far closer together—just as more people can gather in a room if they stand up rather than lie down.

Perpendicular recording has so far not been a practical possibility because the tape is too difficult to make in bulk, and too unstable to use as a data store. Dr Shigeru Hayakawa, Managing Director in charge of research at Matsushita, claims his laboratory has now cracked the problem. He has demonstrated a conventional video recorder mechanism which records digital audio, video or computer signals vertically down into the tape, and achieves twice the highest packing so far available from optical disc, one bit per square micrometre, instead of two bit/sq micrometre.

The trick is in the tape. An electron beam vapourises cobalt-chromium alloy in a vacuum chamber, and a non particulate 0.2 micrometre coating deposited on heat resistant polymer base film. Because the material has no particles, tiny vertical areas can be magnetised by a finely focussed magnetic field directed vertically down from above.

LCD SCREENS

Head of research Dr Shigeru Hayakawa knocks on the head the idea that LCD screens will soon take over from conventional cathode ray tubes. He believes that large screen pictures can be produced far better by using back projection, with bright source lights shone through three LCD masks, one red, one green and one blue.

So far LCD projectors of this type have given unsatisfactory results, with the mosaic of cells that make up the liquid crystal masks all too obvious when the image is projected on a large screen. But prototypes shown recently by Matsushita, produce remarkably clear pictures, with almost no sign of the telltale mosaic.

Matsushita is also working on two alternative technologies for flat screen TV, beam index and beam matrix. Both use a modified cathode ray tube, formed as a flat sandwich, rather than a conventional lamp-like tube.

"Beam-matrix" looks likely to do the job better. The screen is a hybrid mix of liquid crystal and conventional cathode ray tube technologies. It is as flat and thin as an LCD but produces far brighter pictures.

The screen is a sandwich of metal grids, topped with a transparent plate coated with red, green and blue phosphor stripes. The sandwich is in a vacuum and when electric current is fed through a mesh of wires at the bottom it produces a cloud of electrons which are attracted by a charged plate at the top of the sandwich. The only way the electrons can get to the top plate is through a grid of perforated plates which focus them into fine beams. These beams strike the phosphors to produce a very bright colour picture.

Although Matsushita will not say when the system will be ready for sale, the company has demonstrated a bank of 30 identical TV sets, not much larger than a paperback book and with a 150mm beam matrix screen in the centre.

FLOPPIES

Personal computers should soon be able to store as much on a single 3.5 floppy disc as they currently can on a hard Winchester disc. Conventional floppy discs currently store around 2 Megabytes. They do this by recording data on both sides of the disc, in concentric tracks. The standard spacing is 135 per inch. Matsushita has now squeezed the tracks closer together so that there are 542TPI, at the same time making each recorded bit of information half the length. This increases disc capacity by a factor of eight, to store 16 Megabytes on a single disk.

The secret is to coat the disc with fine particles of pure magnetic metal powder, instead of the relatively coarse magnetic oxide as used on all conventional floppy discs.

Matsushita is now experimenting with 813 TPI, which would increase the recording capacity by another 50 per cent. The penalty is that because the metal powder is more difficult to magnetise, the new discs will not work in existing computers.

The company says it is ready to manufacture the discs and drives, and can sell the drives for less than 400 dollars and the discs for twice the price of conventional floppies.

VIDEO CAMERAS

Already on sale in Japan and the USA, and due soon to go on sale in Britain, is the new generation of video cameras with "electronic image stabilisation". The idea is to steady the picture on screen when shots are taken with a long focus telephoto lens.

Normally any slight handshake will cause a marked wobble on screen. The EIS system continually monitors horizontal and vertical movement of the camera, and applies electronic compensation to the image so that it appears to remain stationary on screen. Cost of a camcorder with EIS in America is around \$2,000.

HOME AUTOMATION

The Japanese are still plugging away at home automation. Their dream is to create a new market for domestic appliances. But without an agreed bus control standard that lets people buy any domestic appliance from any manufacturer, without worrying about whether it will work with their particular home automation system, the idea will never take off. Recognising this, the Japanese electronics industry is working towards an agreed standard.

MULTI-STANDARD TV

Perhaps the most significant pointer to the future which came from Matsushita's exhibition, was the interest shown in multi-standard video equipment. Until now the world has been divided into blocks by TV standards barriers. There are of course three main formats in use today, Secam (France and the Eastern bloc), PAL (Europe) and NTSC (Japan and USA). Unless a multi-standard TV set, and video recorder is used, it is not possible to replay and display programmes in a different format.

Matsushita has made a first step in the direction of breaking down the barriers, by announcing a domestic PAL video recorder which will also replay NTSC tapes through most PAL TV sets. The recorder converts the NTSC colour signal to PAL, but can do nothing to alter the number of lines (625 for PAL, 525 for NTSC) or the number of pictures per second (25 for PAL, 30 for NTSC). By a happy coincidence, however, most modern domestic TV sets will cope with either 625/25 or 525/30 picture formats. This follows from the fact that many TV factory production lines use multi-standard chips for convenience of manufacture.

But this is obviously a short term compromise answer. Not all PAL TV sets can cope with 525/30 pictures; although some will expand the 525 lines to fill the full screen size, others will display a letterbox shaped picture. Older sets may display no picture at all. Matsushita has now developed a true multi-standard VTR, using digital technology which reads a tape of any format, and replays it back as any format.

Computer intelligence and memory chips convert 625 lines into 525 or vice-versa. At the same time it converts the 25Hz picture rate to 30Hz and vice-versa by adding together groups of half pictures or "fields", either throwing away some information to create five PAL fields from six NTSC fields, or adding information by interpolation to create six NTSC fields from five PAL fields.

The prototype multi-standard video recorder has a control panel on the front, which is an illuminated map of the world. You press the country from which the tape originates, and press the country where you want to view it. The machine does the rest.

DVR

Expect also, to see a digital video recorder in the not too distant future. Matsushita was showing a prototype, which records up to three hours of video in digital code which matches the professional format; the luminance or black and white signal is sampled at 13.5MHz and the two colour difference signals sampled at 3.375MHz each. The three groups of samples are then converted to 8 bit code.

Normally this gives a data rate of 160 megabits per second but data compression reduces the rate to 19 megabits per second. With the addition of digital audio, and error correction, the data rate ends up at 27 megabits per second. This is recorded on tape, with very narrow tracks (a track pitch of 6.8 microns) which allows a short length of tape in a small cassette to hold three hours. Again for political reasons, Matsushita will not show the cassette but it is the same size or smaller than VHS.



Dr. Shigeru Hayakawa

THE FUTURE

During the exhibition I asked Matsushita's top management about the future.

Mr Tsutomu Fukuhara, Member of the Board on Overall Management Matters explained in high flown terms, which echo the founder's philosophy:

"Our goal is to contribute to the people of the world with electronics—we have more operational bases outside Japan than any other company in Japan. We want to contribute to the people in those countries by shifting production, sales and purchasing. We would like to shift design, research and development and exploit the wisdom of the people of the world. We would like to shift technology, but it is not possible yet.

"We are not moving away from the consumer electronics, we will expand beyond the consumer market, into new areas. Products like the fax machine, personal computer, they were office products, now they are used in the home. It's the same technology, but a different market. We call it human electronics."

Will Matsushita buy into the software industry, like Sony which recently bought the sound and picture vaults of CBS?

"No, our subsidiary Japanese Victor (JVC) is already a software company, so we shall strengthen Victor's position rather than move into software ourselves."

On the future of DAT?

"The situation is different here in Japan, because recording for personal use is not prohibited. Even in Japan, sales are very slow, but we see a big possibility for the future. We think it will become one of the major products in the future when the American consumer is able to buy it. The situation was the same when we first developed the video recorder.

"We spend 5.8 per cent of our turnover on research and development, and 70 per cent of that is in the seven new areas earmarked for the future; information technology, communications, factory automation, new audio-visual technology, air conditioning, automation of electronics and semiconductors. These are the key, because there is a semiconductor in every piece of equipment now."

Kiyoshi Seki, Managing Director of Overseas Operations also talks about foreign production:

"We have a positive attitude to technology transfer. Overseas production accounts for 13 per cent of our sales output and we hope that in five years it will be 20 per cent or 25 per cent."

R&D IN EUROPE

When asked the direct question—why has Matsushita not yet opened a research and development centre in Europe, as promised four years earlier, Seki can only waffle and refer the matter to Dr Shigeru Hayakawa, Matsushita's Senior Managing Director in charge of all Research and Development.

It was Hayakawa who, four years ago, made a firm commitment to opening an R&D centre in Europe. I was there when he said it. I heard him, and like others who were present, reported it at the time.

So I put the question to Hayakawa, along with another senior management director Dr. Hiroyuki Mizuno. The reply is infuriatingly vague.

"We have been thinking about this," says Hayakawa. "But we do not have any definite plans. We have an intention, but we do not know where, when or what form the centre will take."

AUTOMATION

Matsushita's factories are arguably the most highly automated in the world. Japanese television station NHK recently made a documentary about automation, taking Matsushita's new factory complex at Sendai as the model example.

Sendai is where Matsushita builds and experiments with robots on the production line. When the technology is proven, more of the same robots are built and sent to other factories around the world—Matsushita has 69 factories in 28 countries outside Japan. On the NHK programme, a Matsushita manager said something very significant.

"We have built factories in countries like Singapore, where labour is cheap. But now labour costs are rising. So we have to export equipment to automate the production line if we are to remain competitive."



Tsutomu Fukuhara

In Japan, the trend to automation is still welcomed, because it is seen as a way of liberating workers from laborious conveyor belt tasks, so that they can do other work. But this presupposes that there are other tasks to do. In other words sales continually increase, with a constant stream of new products which will initially be made by human workers on a production line until the product is proven and selling in sufficiently large numbers to justify automation.

Small wonder, then, that all the Japanese electronics companies are so worried about saturation in the consumer electronics market, and are moving into the industrial and business sectors ahead of the dreaded zero growth in consumer electronics.

WORKERS?

When Prince Charles and Princess Diana toured Japan, a couple of years ago, Matsushita was over the moon at being given the chance to show them the factory at Ibaraki near Osaka, which makes Panasonic TV sets. The company still shows visitors a high definition video film of the happy couple arriving for their factory tour.

At Ibaraki a total staff of 2,500 make 100,000 TV sets a month. Eight production lines can each make up to 1,000 sets a day. It is hard to know where all the workers are, because many of the production lines are staffed entirely by machines, with articulated arms which do the job of human hands.

Human supervisors stand in attention watching the machines work, ready to run across the factory floor whenever a red light flashes the alarm that a machine has developed a fault, usually by fumbling the insertion of a component into a socket.

Over the factory floor, a large sign "Respond quickly with all our hearts to achieve our targets" encourages any English-speaking robots to keep on working.

Between 75 per cent and 80 per cent of the factory processes are now fully automated. So what do the rest of the workers do? Engineers maintain the robots, and women with nimble fingers do the more tricky assembly jobs, for instance inserting large and clumsy components, which it is not yet cost effective to automate.



Kiyoshi Seki

DEVELOPMENT

Behind closed doors, roomfuls of engineers develop the next generation products. In all Matsushita employs 22,000 researchers and engineers. Average salary is around 230,000 yen a month (around £1,000) not including overtime. Highschool graduates start work on the production line at around half that wage.

Since 1964 Japanese factories have worked a five day week, with between 10 and 22 days of annual holiday, depending on length of service.

VIDEO FACTORY

Matsushita's video factory, up in the mountains near Okayama is if anything an even more impressive sight with 2,000 workers, half of which have engineering qualifications, and the capacity to

Matsushita seven-axis, dual arm robot with coordinated visual and tactile sensors

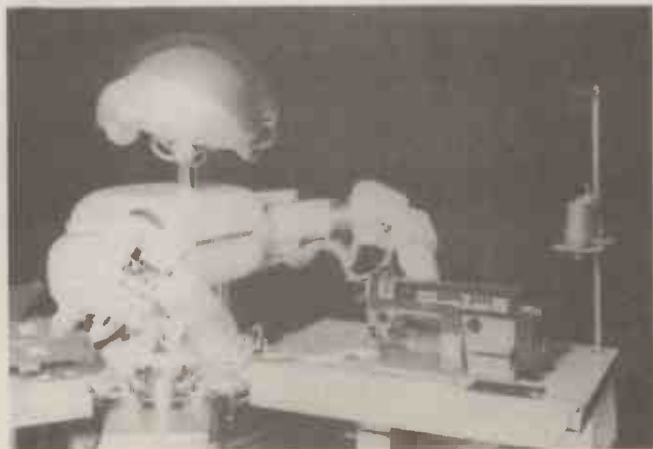

produce 110,000 table-top VHS decks every month, and 150,000 camcorders. There are now around 3,000 components in a table-top recorder, and 4,000 in a camcorder. The factory makes half a million video head drums a month which it sells to other companies around the world.

The most extraordinary sight, is a row of machines, each connected to the next by a conveyor, which grind and polish the high precision aluminium head drums on which every video recorder depends. Each drum must be machined to size, with two micron accuracy. Another line of machines makes the tiny video heads and fits them to the drums.

These machines run 24 hours a day, completely unattended for two shifts. The only workers on site, are security staff who are forbidden to touch the machinery, other than to turn it off in an emergency. Together the machines make a million video heads every month. The coil for the head is wound by machine, 24 turns of wire 40 microns thick, thinner than a human hair. The only human labour is on the final assembly line, where all the large component modules are brought together and a few awkward tasks, for instance latching springs over guide pins need human finger skills.

DIGITAL RULES

Virtually all the new audio and video technology on demonstration at MEET, worked in the digital domain. Matsushita, like all major Japanese companies, regards analogue technology as nearing the end of the line.

The single most important advantage of digital technology is that it enables signals to be copied any number of times without degradation. Whereas a computer program, which is digital, can be copied from disc to disc, virtually an infinite number of times, and the last copy still works as well as the original, analogue audio and video recordings can only be copied a few times before accumulative distortion makes the copy unusable.

This advantage of digital recording, the ability to "clone", is what the record companies and film companies abhor. They fear that the introduction of digital recording systems will make home copying too easy. So the absurd situation has arisen, that while the Japanese electronics industry concentrates on the development of digital systems, the software industry is fighting tooth and nail to block their commercial introduction.

DOMESTIC DIGITAL

Akio Tani, President of Matsushita is the top man in the company. I asked him about Matsushita's plans to launch digital recording systems for domestic use.

His reply was long and vague, even by Japanese standards.

"It is desirable to seek advancement of the technology, but we need peaceful coexistence with the record industry. The IFPI has asked the hardware industry to protect copyright. Unfortunately there is no convenient solution. But we take part in the round table discussions and I hear there is progress."

I pushed Tani on this point. For over two years the Japanese electronics companies have allowed the IFPI to call the shots; the hardware companies have lain down and let the record companies walk all over them. DAT was put on hold and effectively killed as a domestic product. There is impasse, because the record industry does not want the electronics industry to sell a recorder that records digitally and the electronics industry, including Matsushita, is concentrating on the development of digital recorders.

Is Matsushita prepared to freeze technology at the analogue stage, just to keep the record industry happy?

The VHS video format has been highly profitable for Mat-

sushita. What would have happened if the Japanese electronics industry had bowed to the film industry, and withdrawn home video from the market when the film companies sued Sony in America many years ago?

In short, is Matsushita prepared to sacrifice future profits for the benefit of the record companies?

Tani answers at length, but still inconclusively.

"Humans seek better products. So there is endless development. The trend is from analogue to digital with the excellent results it gives. The consumer has the right to have this excellent technology and it will be welcomed.

"On the other hand, copyright holders, musicians and artists, do not want consumers to copy what they produce. They worry about future sales. We agree that the software industry should have the right to protect their rights. The hardware and software industries can be likened to two wheels in one vehicle. They must go forward together, to keep in balance.

"There must be peaceful coexistence. Some countries prohibit home copying, others impose a levy on recording equipment. It is desirable to solve this issue by discussion and negotiation. Is DAT dead? The consumer will decide on that."

Make of all that what you will. Our blunt question, is Matsushita prepared to freeze recording technology at the analogue stage and sacrifice future profits to keep the record companies happy, was never answered.



Akio Tani

TRANSLATION

I learned afterwards, from another journalist present who speaks fluent Japanese, that this essential part of the question was never translated and thus never put to President Tani. Likewise, the tone of the question had been changed. None of the bluntness had got through. President Tani was giving a bland answer to what he thought was a bland question. Quite simply the official translator had not dared to relay a blunt question to his boss.

This straw in the wind raises an interesting question. All the round table conferences between the Japanese electronic companies and the record companies and all press conferences called to discuss issues like DAT and recordable disc rely on translators to convey both questions and answers. If the translators are filtering the questions so as not to appear rude to their bosses, then no wonder there have been more than two years of fruitless negotiations. There never can be agreement if the people round the table do not know what the others really think.

Round off, President Tani dropped an interesting pointer to the future.

"I have spoken for seventy minutes," he told the press, "but because of the need for translation I have really only spoken for 35 minutes. Instantaneous translation could have saved that time. We are already developing such a machine. I strongly feel it is a necessity. I want our engineers to deliver a simultaneous translation machine."

It will take time, but if one thing in this world is certain, they will produce it. All we can hope is that the system will not be programmed to edit out blunt questions and frank statements. □

EVERYDAY ELECTRONICS

BINDERS

Binders to hold one volume (12 issues) are available from Everyday Electronics, 6 Church St., Wimborne, Dorset BH21 1JH for £4.95 (£6.95 to European countries and £9.00 to other countries, surface mail) inclusive of postage and packing. Payment in £ sterling only please.

Binders are normally sent within seven days of receipt of your order but please allow up to 28 days for UK delivery — more for overseas.

CAMBRIDGE COMPUTER SCIENCE LIMITED

☆ 10MByte Winchester, used, 3 months Wty	£42.00 each
☆ 5.25" Disk Drives, 80 Tk, DSDD	£34.00 each
☆ 5.25" Disk Drives, 80 Tk, DSDD Used, No Wty	£15.00 each
☆ 5.25" Disks, DSDD, 48 tpi boxes of 10	£3.00 box
☆ 50W PSU 5V 6A, 12V 2.5A, -5V 0.5A, -12V 0.5A	£16.00 each
☆ Gould PSU 0-30V @5A Limited quantity only at	£45.00 each
☆ Dual Data Lead (BBC Micro to 2 Disk Drives)	£2.00 each
☆ Power lead (BBC Micro to Disk Drive)	£2.00 each
☆ Dual power lead (BBC Micro to 2 Disk Drives)	£4.00 each
☆ 68000 CPUs (The first orders get 10MHz chips)	£3.50 each
☆ Z80A CPU, CTC, PIO £1.20 each; DMA £2.00	£4.50 all 4
☆ 74LS TTL, pick and mix, buy 10 or more for	£0.12 each
Types available: '00' '02' '04' '08' '11' '13' '20' '21' '26' '27' '30' '32' '38' '42' '74' '83' '96	
☆ 107' 109' 122' 132' 136' 139' 145' 151' 153' 157' 163' 164' 191' 193' 298' 365' 670	
☆ EPROMS 27128	used £1.50 each; new 27128-25 £2.50 each
☆ 6264 8K Byte SRAM	-15 £3.00 each -12 £3.80 each
☆ 65256 32K Byte rams	£7.00 each
☆ 8K Byte NV ram chips	£3.00 each £10.00 four
☆ 20 pin dill low profile IC sockets	£0.50/10 £4.00/100
☆ 40 pin dill low profile IC sockets	£0.60/10 £5.00/100
☆ Keyboard, 100 keys on board LCD & micro I/O	£8.00 each
☆ Toroidal mains transformer, 12V 4A & 0.4A, 12-0-12, 1A & 2A, 9-0-9, 2A	£4.00/1 £6.00/2 £8.00/3

All items new unless stated. Add 15% VAT to all prices.
Prices include postage. Add 50p to orders below £5.00
(Please Note mail order only)

Send an SAE for our latest list or for more info.
Dept EE, 374 Milton Road, Cambridge, CB4 1SU Tel: 0223 424602

MICRONTA
 30-RANGE DIGITAL MULTIMETER
 PROBE STYLE AUTORANGING MULTIMETER
 REGULATED POWER SUPPLY

High Technology Test Equipment

30-Range Digital Multimeter

£69⁹⁵

Features front-panel socket for transistor and capacitor tests. Low battery indicator, diode check function and continuity sounder. Measures to 1000 VDC, 750 VAC, 10 amps AC/DC current, 20 megohms resistance. 20 μ F capacitance and transistor gain. Requires 9v battery. 22-194



Probe Style Autoranging Multimeter

£29⁹⁵

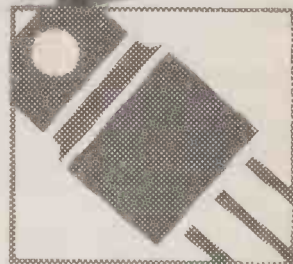

Data hold function enables you to freeze the display and to remove it from the circuit for more convenient reading. Measures to 400 volts AC/DC and resistance in K-ohms up to 2 megohms. Includes 2 button batteries. Overload protected. With carrying case 22-165

Regulated Power Supply

£59⁹⁵



13.8 VDC Regulated Supply. Ideal for use with HAM transceivers. 5A continuous. 12A intermittent. 15A surge. 240 VAC, 50 Hz. Fused 22-7001

Tandy®

For The Best In High Quality Electronics

Over 400 Tandy Stores And Dealerships Nationwide. See Yellow Pages For Address Of Store Nearest You.

InterTAN U.K. Ltd., Tandy Centre, Leamore Lane, Walsall, West Midlands, WS2 7PS. Tel: 0922 710000

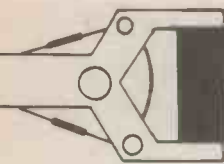

Robot Roundup



NIGEL CLARK

NATIONAL CURRICULUM

The introduction of the craft and design section of the National Curriculum at the beginning of the present school year has encouraged an increase in demand for equipment at the less expensive end of the market, particularly kits.

Many suppliers, including Commotion and Economatics (Education), have seen a large expansion in sales. And there has been an increase in the items available.

Economatics has introduced an extension to its Project 2000 Fischertechnik kits, Commotion is supplying a Nimbus version of the Barnet Box, Testbed Technologies has added a control system and Lasy has introduced motors for its kits.

CONTROL BY DESIGN

Economatics has developed new computer control software, called Control By Design, which, it is claimed, will make the designing of control systems more accessible. It allows pupils to design their systems in the form of flow charts on screen, which can then be activated without the need for programming (see photo).

This increases the age and ability range of pupils who can design systems and see them working. As Economatics claims: "With the emphasis on systems design rather than unravelling code, pupils' progress and development are no longer limited by their ability to program."

Packages are available for the RML Nimbus and the BBC Master micros.

They are part of a group of four Project 2000 integration kits. The others cover structures, pneumatics and electrical control. They come complete with extra components, instructions, teachers' and pupils' kit and a teacher guide. They are intended for children between the ages of nine and 16.

Unlike Lego Technic's education kits the integration kits have been developed

in-house by Economatics specially for the British market. The company has already developed close links with Scottish schools, for which it has provided an extended Project 2000 kit, including an extra box of components designed to meet the requirements of the Standard Grade Technological Studies course.

The Project 2000 kits were developed by Fischertechnik specifically for education and are part of its range which also includes the Computing kit, from which can be built arms and a plotter among other things, and the Computing Experimental kit, which includes a buggy as well as the ingenious welding simulator.

BARNET BOX

The Barnet Box, not surprisingly, was developed for use in Barnet primary schools as a starter-level interface. Originally for the BBC B a version is now available for the Nimbus.

At the same time other developments have been taking place to improve the use which can be made of the eight inputs and eight switched outputs by the Logo-like language, with several new commands having been added.

Commotion sells the box, which was first introduced four years ago, with an accessory pack including two d.c. motors, bulbs in holders and a variety of switches.

WELL DUNN!

Commotion has also taken on the distribution of a new set of kits developed by Stuart Dunn, a teacher from Milton Keynes. Known as Ezi-Dunn there are four kits including the specially-created Ezi-Dunn board which has a grid allowing components from almost any of the usual construction kits to be used and little plugs which will accept the bared ends of single strand equipment wire, thus doing away with the need for soldering. It is similar to a system created in France which was being sold by Shesto-tech at one stage.

Dunn has also created a "computer simulator" which has two reverse switches and three push-button switches. The idea is that the panel can be connected to a model and a programme of movements worked out on paper, these can later be entered into the computer proper in the correct control language.

Dunn said he made the simulator because he was tired of waiting for his turn on the school computer. This device enabled preliminary work to be carried out ready for when the computer was available.

POLY MAKER

Testbed Technology, a subsidiary of Unilab of Blackburn, which make electronic equipment, has added computer control to its Polymek construction system, which apparently has been around for some time.

The Polymek range includes a number of tools and a manual which covers the linking of the models to computer control. There are "recipes" for simple models but anything more complex has to be worked out by the model builders.

For use in control Testbed supplies the "Control Pathways" set of peripherals, including interfaces, switches, sensors, motors and sounds. Course materials have been developed including pupils' texts and teacher guides. The materials can make use of the Control Logo and Control Basic languages as well as Testbed's own Micro Control Language (MCL) which is available on ROM chip for the BBC series of machines.

LASY

Lasy is another kit new to me but which is said to have been around for a couple of years in this country. Pronounced "larsy" in honour of its German creator, it is based on the concept of having very few different building blocks (available in four different sizes, to suit different levels of dexterity) which are all compatible with each other.

Motors have now been added and interfaces and programs are being developed which could be ready during 1990.

MOVIT

Remember the Movits? They were little kits from which small mobiles could be made. They moved in response to a variety of inputs. Some just followed programmed routes when they were switched on but the most complex machine was controlled by a keypad held in the hand.

The main interest was in the building, learning a little about electronic construction along the way, rather than operating the completed device.

One of them was started and stopped in response to a sharp noise, like a handclap, and JPR Electronics is now supplying a similar mobile, called the Sonic Buggy, for about £7.

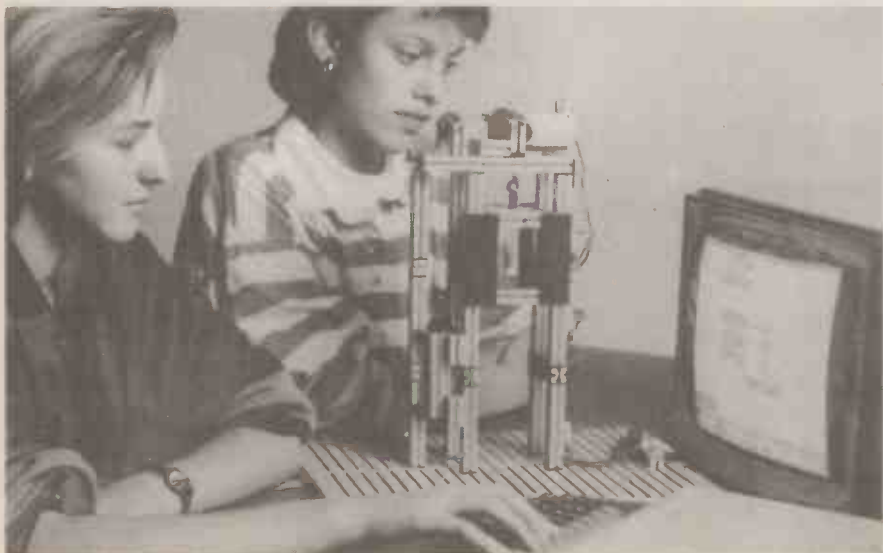

PUBLIC ADDRESS AND DISCO EQUIPMENT

YOU PAY TRADE PRICES!



MIXERS

Choose from 25 models ■ Mixers for home use, disco's, public address and studio use ■ From 4 to 16 channels ■ Also 6 and 8 ch midi systems ■ Equalizer mixers MRT60 and many more.

ECHO'S

■ VC1 analogue ■ 6040 stereo amplifier ■ 8040 digital echo ■ Also mini echo's.

DIGITAL DELAY/REVERB

■ 19" rack systems ■ Digital reverb with 63 user programs ■ Digital delay up to infinite repeat ■ Also multi-effects programmable unit.

GRAPHICS

■ 19" rack systems ■ 31 band single channel ■ 2 x 15 band two channel, and 2 x 31 band two channel.

CHASSIS SPEAKERS/ CABINETS

■ PA speakers 5 1/4" to 12" ■ Twin cone from 40 to 100 Watts ■ Various models disco/group speakers 10" to 18" various types ■ Bass speakers ■ Bass mids and mids ■ Also Rexine cabinets 10", 12" & 15" ■ Plus range of cabinet fittings and portable speaker stands and brackets.

PIEZO TWEETERS

■ 10 models stocked from £2.95 to £7.95 ■ Square piezo £4.95.

PUBLIC ADDRESS SPEAKERS

■ For PA and background music system with and without 100 volt line ■ OUTDOOR. Range of weatherproof systems at various power ratings ■ INDOOR. Columns for speech, columns for music ceiling speakers, suspension speakers, corridor speakers, wall speakers, music speakers - various sizes and types.



DECKS

3 models heavy duty top quality with plinth/cover. ■ DLP1 belt drive quick start. ■ DLP2 direct drive system. ■ DLP3 quartz controlled quickstart direct drive.



POWER AMPLIFIERS

■ Power boosters single channel: 100W, 175W and 2kW. 2-ch/stereo: 135 + 135W, 160 + 160 Watt and 1500 + 1500 Watt.

AMPLIFIERS

■ With preamps ■ 240V AC models and 12V DC/240V AC or 24V DC/240V AC ■ From 15 Watts up to 175 Watts ■ Also background music tape amplifiers and paging amplifiers. ■ Plus range of mixer-amplifiers. ■ Choose from 25 models.

MOBILE AMPLIFIERS

■ Range of 12 volt amplifiers up to 100 Watts ■ Also portable megaphones stocked and 12 volt power boosters.

MICROPHONES/ STANDS

■ XLR/Jack etc ■ Mics for disco, public address and Hi-Fi ■ Good quality at low cost ■ Also stands, booms etc. and wireless microphone system

OUTDOOR HORNS

■ Various models up to 12" with or without 100 volt line with drivers ■ Also range of horns with choice of drive units. ■ Accessories: Leads ■ Plugs ■ Adaptors ■ Transformers etc, for all PA requirements.

HORN/ CROSSOVERS

■ 100 Watt midrange and tweeter horns ■ Also matching crossovers and filters up to 300 Watts.

CALL IN OR PHONE FOR BEST PRICES
OPEN 6 DAYS A WEEK



AUDIO ELECTRONICS

301 Edgware Road, London, W2 1BN
Tel: 01-724 3564 Fax: 01-724 0322
SALES OFFICE 01-258 1831
Also at HENRY'S 404 Edgware Road, W2
TRADE/EDUCATION ORDERS ACCEPTED

PA - DISCO CATALOGUE WITH DISCOUNT VOUCHERS Ref PA1

Send A4 SAE (£1.00 UK) or £2 UK full products catalogue

D-MM GOOD VALUE!

Cirkit's new range of Digital Multimeters offer a quite unbeatable combination of features and value:



- Ranges include: frequency, capacitance and temperature
- Housed in strong ABS cases
- Overload protection on all ranges
- Full one year warranty
- 3 1/2 digit, auto zero, auto polarity LCD, plus low batt indication
- 200 hour battery life
- All meters supplied with test leads, battery and manual

TM5315B

- Remarkable value
- 18 ranges
- 10A dc current

dc volts: 200mV-1kV
ac volts: 200V, 750V
dc current: 200uA-10A
resistance: 200Ω-20MΩ

Continuity and diode test
Basic dc accuracy: ±0.8%
Size: 128 x 72 x 33mm

Price £19.99

TM5375

- Frequency measurement to 20MHz
- ac/dc current to 10A
- 24 ranges

dc volts: 200mV-1kV
ac volts: 200mV-750V
dc current: 200uA-10A
ac current: 200uA-10A

Resistance: 200Ω-20MΩ
Frequency: 2kHz-20MHz
Continuity, diode & HFE test
Basic dc accuracy ±0.5%

Price £36.75

TM5365

- 30 ranges
- Frequency & capacitance measurement
- Compact size

dc volts: 200mV-1kV
ac volts: 200mV-750V
dc current: 200uA-10A
ac current: 200uA-10A

Resistance: 200Ω-2000MΩ
Frequency: 2kHz-200kHz
Capacitance: 2nF-20uF
Logic, continuity, diode and HFE test

Price £37.90

TM175

- Freq. measurement to 10MHz
- Capacitance measurement 1pF to 20uF
- 39 ranges

dc volts: 200mV-1kV
ac volts: 200mV-750V
dc current: 200uA-10A
ac current: 200uA-10A
Resistance: 200Ω-2000MΩ

Capacitance: 2nF-20uF
Frequency: 2kHz-200kHz
Continuity, diode, HFE, logic & LED test.

Price £57.49

TM135

- Temp. measurement
- Capacitance measurement
- 40 ranges

dc volts: 200mV-1kV
ac volts: 200mV-750V
dc current: 200uA-10A
ac current: 200uA-10A

Resistance: 200Ω-2000MΩ
Temperature: 200°-750°C
Capacitance: 2nF-20uF
Diode, HFE & continuity test

Price £45.95

TM115

- 0.5% accuracy
- Transistor HFE test
- 26 ranges

dc volts: 200mV-1kV
ac volts: 200mV-750V
dc current: 200uA-10A
ac current: 200uA-10A

Resistance: 200Ω-2000MΩ
Continuity, diode & HFE test
Basic dc accuracy ±0.5

Price £33.67

Prices Inc VAT.

Please add 90p for p&p.

Cirkit



Cirkit Distribution Ltd.
Park Lane, Broxbourne, Herts EN10 7NQ.
Telephone (0992) 444111.

MICRO IN CONTROL

JOHN HUGHES

Part Two



Starting from very basic principles this series quickly builds through logic to simple microprocessor control. It is based on the experiences gained through teaching courses on the subject.

T HIS MONTH **T** shows **S** a transistor and a light dependent resistor.

EXERCISE 4 A three-legged friend.

T Now we can look at the component to which we owe so much of our modern electronic magic – the TRANSISTOR. You'll find one easily because it has THREE leads. It's essential, however to know which lead is which BEFORE we

wire it up (shows diagram and explains names of terminals).

Now plug it across the gap EXACTLY as in the picture (Fig. 2.1). Note how the COLLECTOR and EMITTER leads bridge the gap (if the gap is where originally suggested), and how the BASE isn't as yet linked to anything at all. DOES IT CONDUCT?

S (mostly) No.

T (hastily) No, and I don't expect it to, so there's no need to bash it or re-arrange it. It's not SUPPOSED to conduct until it's told to. And it's not by shouting at it.

No, the "magic" of the transistor lies in the fact that we can control it, that is, we can make it conduct as we wish.

In order to make the transistor conduct, we have to allow a small TRICKLE of current to flow into the BASE of the transistor, and complete its path via the EMITTER.

We COULD use a separate battery or PSU, but it's easier to use the supply we've already got.

We'll use a high value resistor to keep the current to a trickle, so select 10k (found it?), and plug it carefully between the BASE of the transistor and the positive (+5V) supply line, as in the diagram (Fig. 2.2).

S That's done it/It's lit, etc.

T Yes, the transistor is now conducting, and quite well, you'll agree, as the lamp is bright.

Just check that it IS possible to stop it from conducting by momentarily removing the link (it only needs "breaking" at ONE end, right?).

S Like a switch, again.

T Exactly. It's now possible to control a fairly LARGE current flow in the COLLECTOR circuit by switching a VERY small current in the BASE circuit. This is the secret of the transistor, so keep it in mind.

Can we now consider for a moment just how the two current values (the collector and base values) actually compare with each other? Let's think of the collector current first. Could it be measured?

S Use a meter.

T Sure, we COULD stick a meter (a "milliammeter") in SERIES with the collector lead, and there may come a time when we need to do just that. But, for now, let's take the easy way. The lamp is labelled 6V 0.06A. What does this mean?

S It needs a 6V supply, and takes point oh six of an amp to light it.

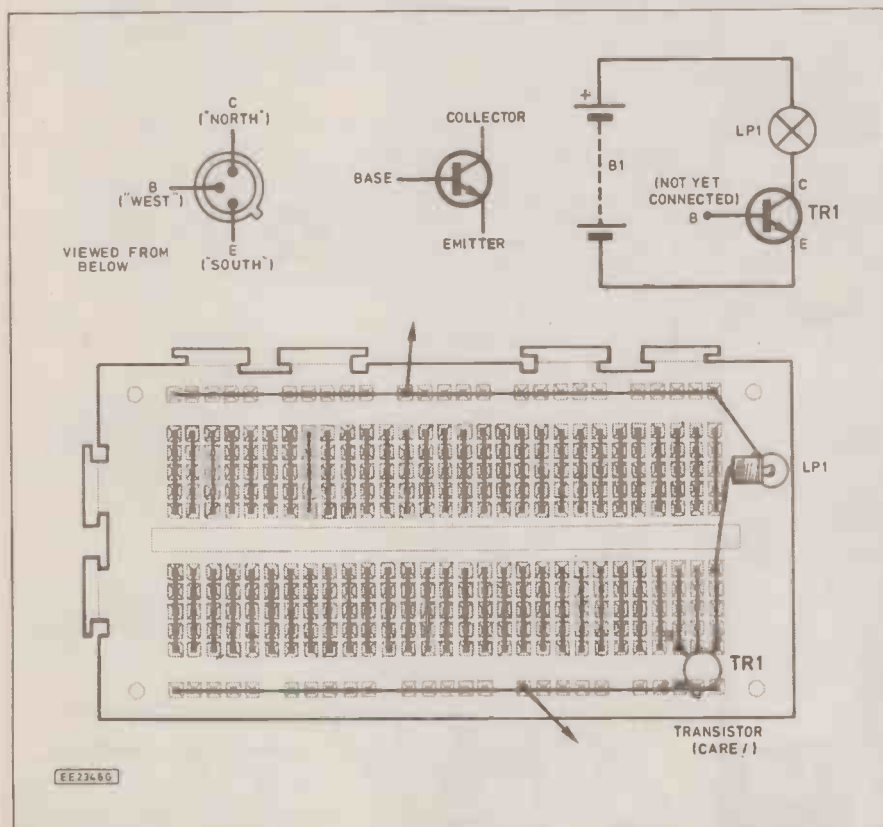

Fig. 2.1. Transistor symbol and connections. Note that some transistors have different lead-out patterns so take care to identify them before plugging in.

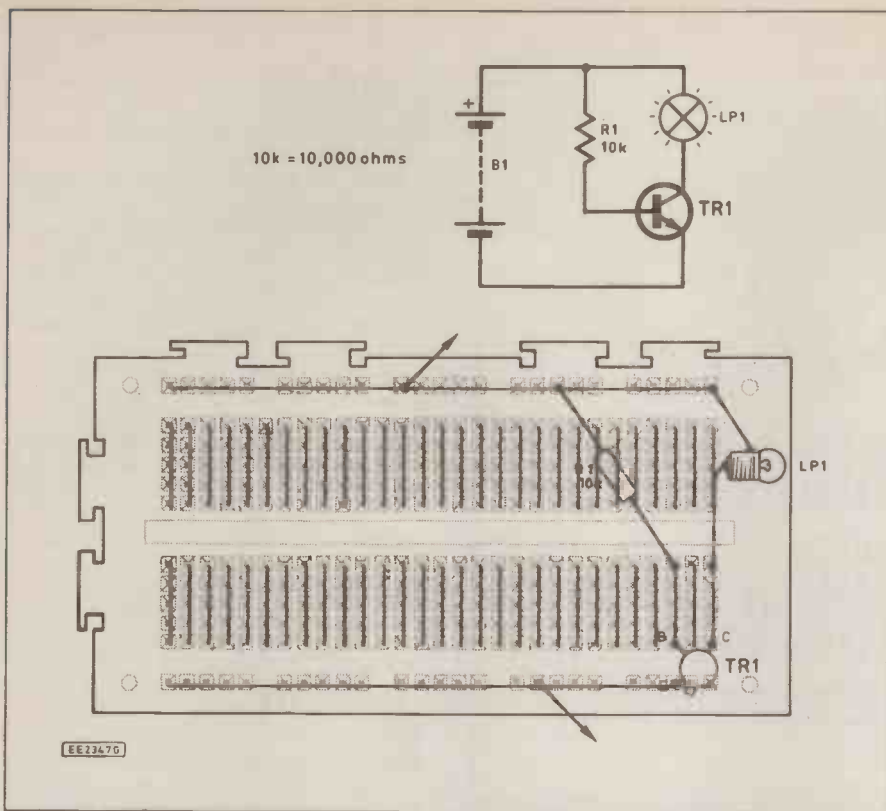

Fig. 2.2. Base resistor connected, to allow a trickle of current into the base and cause collector circuit to conduct.

T Couldn't be put better. What would 0.06A be in milliamps?

S (hesitantly) sixty?

T Just sixty milliamps, fine. Now that's what the lamp takes on a SIX VOLT supply. But what are we using?

S Five volts

T So, would anyone care to "estimate" what current is actually flowing through the lamp at this moment.

(Rapidly, the students come up with "about 50mA" as a reasonable approximation).

T So let's write, while we have hold of it: "Collector current (approx.) = 50mA"

Now we need to estimate the BASE current. Again, we COULD measure it, but consider, what's the VOLTAGE across the circuit?

S (confidently) Five volts!

T OK, and what is the RESISTANCE in the base circuit, at the LEAST guess?

S More than ten thousand ohms.

T Right. Now, who remembers how to work out the CURRENT in a circuit, given the VOLTAGE and the RESISTANCE? Any offers?

S Is this Ohm's Law?

T It's often called that, though strictly not so. However, I'm sure you are thinking of the correct relationship. Like to tell us?

S Amps equals Volts over Ohms?

T Just the job in our case. If we put in the values, what does this make the value of the current? Remember to change to ohms and, if you can, express the result in milliamps.

(After a little prompting, students agree on half a milliamp as the approximate value, and write it down)

"Base current (approx.) = 0.5mA"

T Right, so we can now estimate what is called the "Current Gain" of our transistor, at least in this circuit. It's simply the

RATIO of collector current to base current, and for us, is . . . ?

S Fifty to a half — a hundred to one

T Yes, 100 (it's just a number). It means the number of times the Collector current is as great as the Base current.

It also means that a "lampworth" of current in the collector circuit can be

controlled by only a hundredth of its value in the Base circuit. So you can see why the transistor is important in control applications.

It enables a very small trickle of current to, as it were, control a "flood" of current.

S Could we use the transistor to "dim" the lamp? Or control it gradually?

T How might we try?

S A variable resistor?

T Sounds promising, but we'd better keep a bit of "fixed" resistance in series with it to set a lower limit to the base current, in case we blow up our transistor! You're thinking of a circuit something like this? (shows diagram of variable + fixed base resistor circuit). Shall we try it now? (Fig. 2.3).

S Seems to work OK

S (another) My transistor's getting a bit warm.

T If you think about it, you'll realise that, at the "intermediate" settings, the transistor is being called upon to work harder than when it's fully "on" or fully "off". That's when it may overheat, and need a "heat sink" to get rid of the heat generated.

When it's fully "off", there's no current flow and when fully "on", there's no pressure across it, so these are the "easy" states to leave it in. We haven't needed to think about it before, but it's as well to note that the POWER in a circuit (measured in "Watts", remember?) can be calculated as the PRODUCT "Volts times Amps", so if EITHER of these is zero (or very small), so is the power.

When the transistor is, say "halfway on", there's a half-value current through it AND a half-value voltage across it, which means in fact just about the maximum power. As I said, think about it, and if necessary, try some sums.

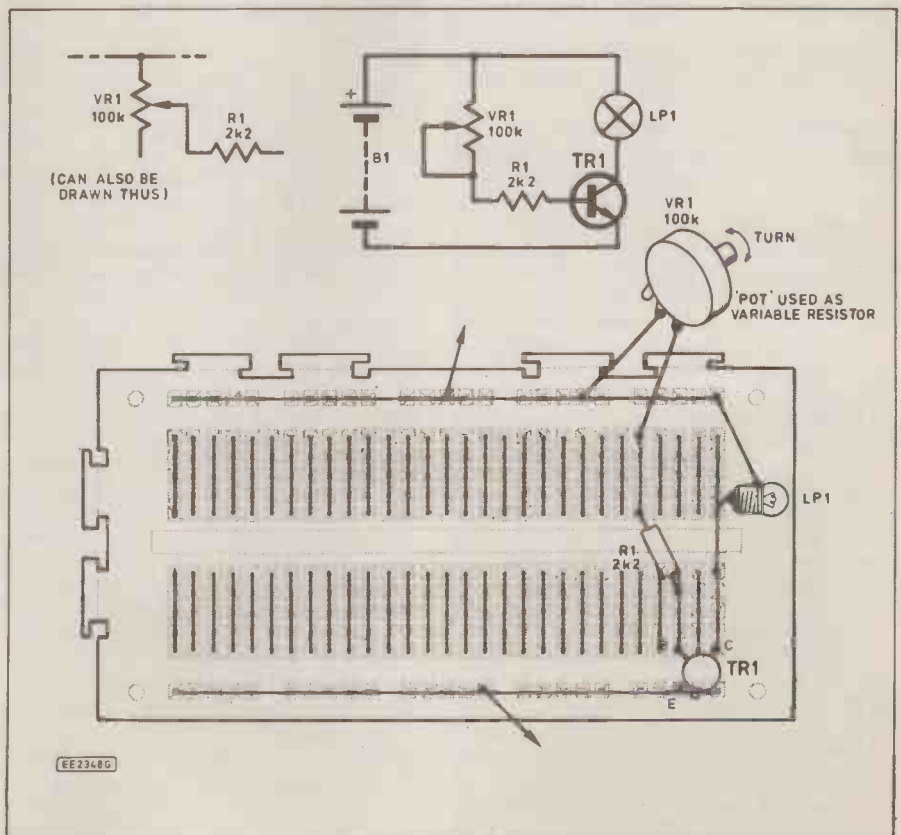

Fig. 2.3. "Dimmer" control using a variable resistor.

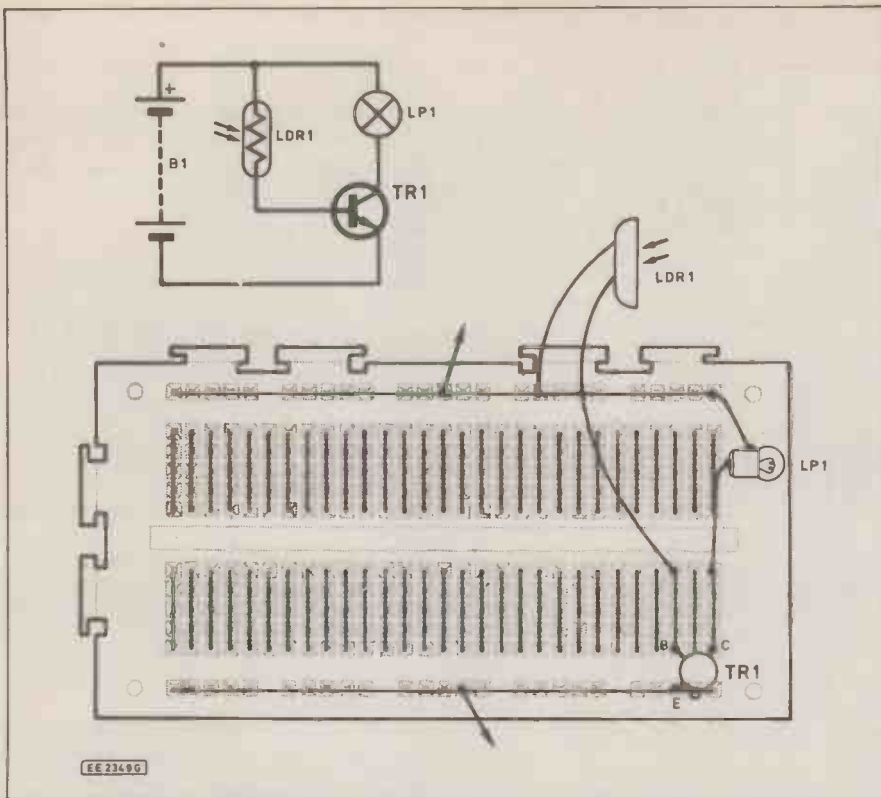

Fig. 2.4. Light dependent resistor controlling the transistor. This is also the circuit for the "Electronic Candle".

S Some time ago, we looked at two lamps in series. They would have been sharing the POWER, not the current, wouldn't they?

T It was several exercises back, wasn't it? Yes, the PRESSURE and POWER were being shared, but, in a SERIES circuit, there can be only a single current, the same all the way round, as you point out.

I don't think there will be any more need to do sums, at least, let's hope not.

EXERCISE 5 Electronic candles?

T I'd like to introduce another useful device. It too is made of semiconductor material, and its special feature is its sensitivity to light. In fact it is a resistor, in the form of a fine grid of Gallium Arsenide on an insulating surface, as you may see if you look closely at its sensitive face (points to LDR cell in simple mounting).

It has been put into this simple holder with leads ready connected to it. If you are using such a cell on its own, take care not to break off the short leads. The mounting also helps to shield it from unwanted light.

Now, we'll substitute this light-dependent resistor (l.d.r. for short) in place of the resistor in the BASE circuit of our transistor (Fig. 2.4). It happens to have a pretty high resistance, so a "safety" series resistor is hardly necessary this time.

Can you now carry out a simple test to see if it IS sensitive to the light falling on its surface?

S Yes it is, look.

T Yes, just by covering up or uncovering the cell, the effect can be seen on the lamp in the COLLECTOR circuit. Now can you tell me, is the l.d.r. resistance INCREASED or DECREASED when light reaches it?

S (mostly) Decreased.

T OK, it conducts better under the action of light, so its resistance decreases.

S Why?

T Because the light energy is able to loosen some of the electrons in the atoms of the semiconductor, and they are then free to help to carry the current through the material.

S Is this what we mean by "semi-conductor"?

T Yes, it's one possible way to look at it. You see, in a "good" conductor such as a metal, there are plenty of "free" electrons available. In an insulator there are none, or hardly any.

In so-called "semi-conductors" there are very few free electrons, but we can get some into the material in various ways. This is what makes the materials useful.

Electrons require energy to release them. Light can sometimes do it. So can heat energy, and you may know that a device called a "thermistor" can be used to detect temperature changes. Its resistance drops when it is heated.

S But doesn't the resistance of a wire INCREASE when it is hot?

T It does, but remember, a wire is a GOOD conductor, and has ample free electrons. What happens in this case is that the increased agitation of the atoms when heated seems to get in the way of these free electrons, causing a slight INCREASE in the resistance. But in a SEMICONDUCTOR, the main effect of heat is to release many more electrons, thus REDUCING the resistance. OK?

S What do we mean by "doping" a semiconductor?

T Briefly, it's this: A pure semiconductor material, as we've just seen, is a

poor conductor, because all its electrons are neatly bound into their places in the atomic pattern ("lattice"). The technology of making such pure materials has had to be developed, as you probably know, but it can now be done by such methods as "zone refining".

Now, the "doping" process can be done on TWO ways. One way is to introduce (to "diffuse") into the pure semiconductor a VERY small amount of a substance with ONE extra electron on each of its atoms. These extra electrons don't fit the lattice pattern, and are left free, to conduct electricity.

The alternative way is to introduce instead a substance which is SHORT of one electron per atom, leaving "holes" in the lattice. If an electron from another atom moves into a hole (which can happen), then this leaves a hole elsewhere, so the holes appear to move (rather like shifting one's overdraft from bank to bank?)

In either case, the result of doping is to allow some conduction to take place. In the first case, electrons move. They are negatively charged, so we call this *n*-type semiconductor, the other type, where holes seem to move, is called *p*-type.

S Presumably *p* for positive?

T Yes, the ABSENCE of an electron implies a positive charge. Note, however that the material itself is NOT given an overall charge, because each atom is normally neutral.

Now I think we should move on, away from "physical electronics", interesting as it is, and get back to our circuits.

S But I've heard of npn and pnp transistors. Is it like a sandwich?

T Exactly. if time permits later, we'll talk some more about this. Now let's finish our exercise with the l.d.r. or "photoresistor" as it can also be called.

Without altering the circuit (Fig. 2.4), try this. Position the cell so that the light from the lamp itself falls upon it. I'll darken the room so that there's not much other light around.

What we've made could be called an "electronic candle", for it is possible to "snuff" it out (put your thumb and fingers around the lamp so as to cut off the light to the cell). We can then "light" the candle using any light source such as a lit bulb. A match is more effective, but take care.

After trying it a few times, make sure you can explain how it works.

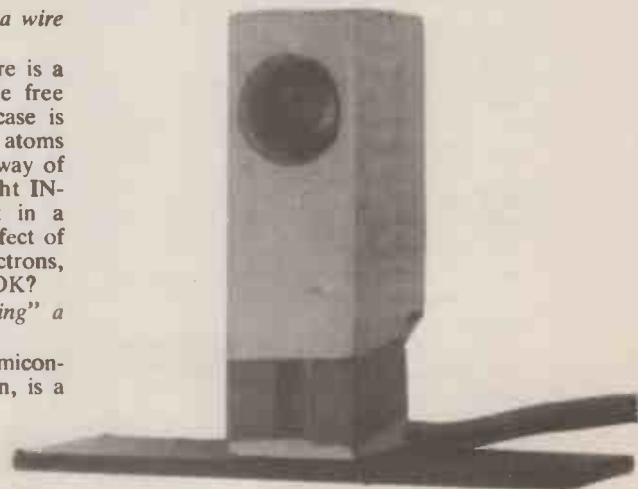

A simple way of mounting the l.d.n.

S The output is being fed back to the input.

T Well done. It's an example of "feedback", and has very important implications for control systems. It's also a kind of "bistable" circuit, with TWO stable states. More about these later on.

Could we use this circuit as a sort of automatic parking light on a car?

S No, because it works the wrong way round/the light should come ON when it gets dark/etc.

T Right. Let's see if we can modify our circuit to get the result we want. Start with the lamp ON, and see if we can make the cell put it OFF. Let's use the 10k resistor to the base, as before, to make the transistor conduct.

S Could we make the cell short out the transistor?

T Good idea, though I suspect it's resistance won't get low enough to do so. Tell you what. If we add an extra resistor in the transistor base circuit, it'll help (Fig. 2.5). Try it on your breadboard.

S You have to cover the cell completely to make the light come on. It's too sensitive.

T Well, it works, though. You could experiment a little with various resistor values to suit the light levels of you like. You could use a variable resistor too as a sensitivity or level control.

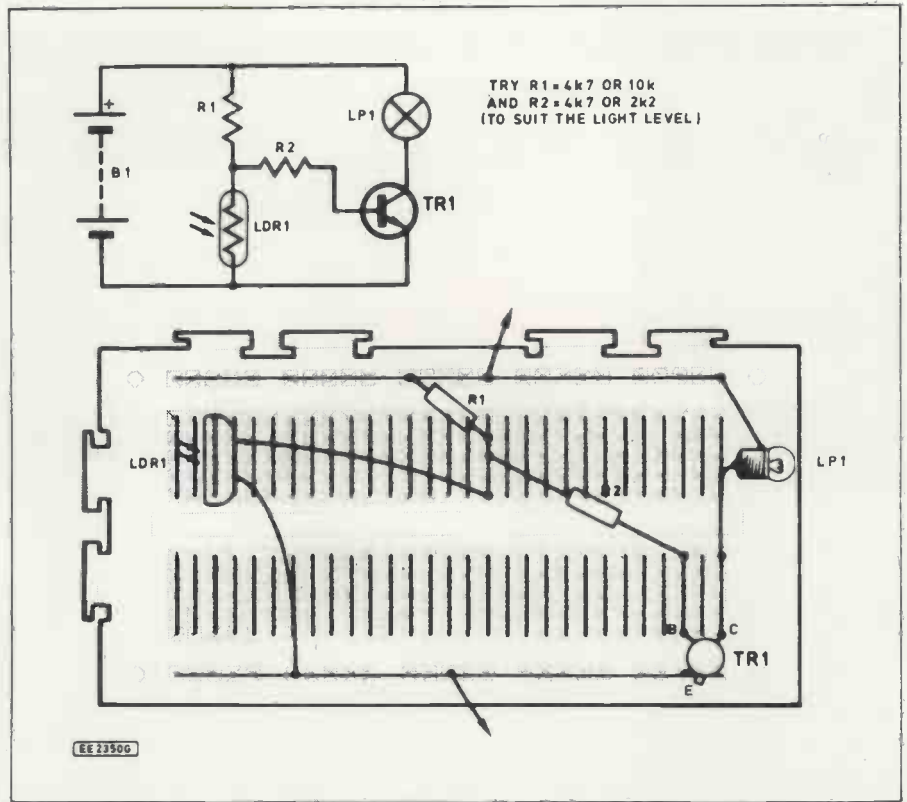



Fig. 2.5. A simple "parking light" circuit.

Next month: Logic.



HILLS COMPONENTS
established since 1973

can offer the trade a selection of nearly 4,000 product lines covering the following ranges

- Aerials & Accessories
- Batteries & Accessories
- Cables & Accessories
- Computer Accessories
- Connectors (all types)
- Electronic kits/Modules
- Filters/Fuses
- Hardware/Fixings
- Headphones/Intercoms
- Connecting leads (all types)
- Microphones
- Multimeters
- Passive Components
- P.C. Boards
- Relays
- Speakers
- Switches
- Service Aids
- Soldering Equipment
- Telephones & Accessories
- Transformers

TRADE ENQUIRIES ONLY
Please phone or write quoting your company name & address for a copy of our 1990 catalogue

TRADE ONLY



ELECTRONIC KITS & MODULES

FOR HOBBYISTS ELECTRONICS ENTHUSIASTS
EDUCATIONAL ESTABLISHMENTS ETC.

Build your own:
Geiger-Mueller Indicator, Metal Detector,
Stereo Amplifier, Digital Combination Lock, or
any of the many other kits available for numerous applications

Each kit comes in component form with easy to follow instructions for assembly

OVER 100 KITS TO CHOOSE FROM
Some of the popular kits include

- * Antenna Amplifiers
- * Lie Detectors
- * Alarm Systems & Monitors
- * Infra-Red Light Barriers
- * Sirens - Kojak-Warship-FBI-Ships-Space
- * Micro-Wave Indicators
- * Radios & Receivers
- * Electronic Barking Dog
- * Lighting Consoles
- * Amplifiers (up to 200w)
- * Car Aerial Amplifiers

PLUS MANY MANY MORE

Call us now for details of your local Stockist

HILLS COMPONENTS LTD
Units 5 & 6
Melinite Industrial Estate
Brixton Road, Watford
Herts WD2 5SL
0923 52000

The Essential Reference Work for Everyone

Project work made easy with removeable pages



3/3.1 Resistance and Potentiometer

Resistance determines the flow of current in an electric circuit. The current flow is inversely proportional to the resistance. High resistance—low current flow, low resistance—high current flow. Resistance, voltage and current are interrelated according to Ohm's law:

$$R = \frac{U}{I} \text{ or } I = \frac{U}{R} \text{ or } U = R \cdot I$$

Conductance $G = \frac{I}{U}$ (Siemens)

The most important defining values for a resistance are:

- Resistance value (ohms, kΩ, MΩ)
- Load capacity (W)
- Temperature coefficient

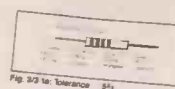

Fig. 3/3.1a: tolerance 5%



Fig. 3/3.1b: tolerance 2%

Figs. 3/3.1a and b: Indications for colour-coding according to IEC 62 or DIN 41 429

3/3.2 Capacitors

Capacitors are electrical energy storage devices which consist of two metal plates with a dielectric placed between them (to the metal plates, an electric field occurs. The exchange of electric energy is determined by the dielectric constant.

- the acceptable operating voltage, indicated in volts (depending on the dielectric)
- the polarity, indicated on the housing (depending on the construction)

According to the application, three types of capacitor are available: fixed capacitors (the capacity is a fixed value), variable capacitors (capacity is adjustable) and electrolytic capacitors (capacity is determined). Dependence on the dielectric constant.



3/3.3 Coils/Inductance

Coils, simply stated, are wires wound on synthetic spools. They are used for various purposes in electronics. As coils they operate as inductance in an alternating current circuit. Together with capacitors they constitute a parallel resonant circuit for the generation of a particular frequency, though in fact an active construction element is necessary in addition. Through a series connection and/or paralleling of coils and capacitors, frequency channels are formed, which block certain frequencies or pass a frequency, if several turnings serve as a transformer. Distinctions are made between the following types of construction:

- Air coils—consisting of the turnings and a hollow spool, for coil inductance equation is used.

The equation leads to a sufficiently precise result if the proportion between length and diameter of the coil is 5. If the proportion between length and diameter is less than 5, the above equation is not applicable. This is expressed by the number of turns which is indicated in the following table:

$$L = \frac{N^2 \cdot d^2}{18 \cdot n}$$

$$N = \frac{L \cdot 18 \cdot n}{d^2}$$

$$n = \frac{L \cdot d^2}{18 \cdot N^2}$$

$$d = \sqrt{\frac{L \cdot 18 \cdot N^2}{n}}$$

$$n = \frac{L \cdot d^2}{18 \cdot N^2}$$

$$d = \sqrt{\frac{L \cdot 18 \cdot N^2}{n}}$$

$$n = \frac{L \cdot d^2}{18 \cdot N^2}$$

$$d = \sqrt{\frac{L \cdot 18 \cdot N^2}{n}}$$

3/3.1 Resistance and Potentiometer

Resistance determines the flow of current in an electric circuit. The current flow is inversely proportional to the resistance. High resistance—low current flow, low resistance—high current flow. Resistance, voltage and current are interrelated according to Ohm's law:

$$R = \frac{U}{I} \text{ or } I = \frac{U}{R} \text{ or } U = R \cdot I$$

Conductance $G = \frac{I}{U}$ (Siemens)

The most important defining values for a resistance are:

- Resistance value (ohms, kΩ, MΩ)
- Load capacity (W)
- Temperature coefficient

As a resistance value of 1% and a tolerance of 10%, resistances are indicated by a colour code. From 2% load capacity and 0.5% tolerance upwards, the values are indicated as figures.

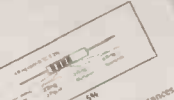

Fig. 3/3.1a: tolerance 5%



Fig. 3/3.1b: tolerance 2%

Figs. 3/3.1a and b: Indications for colour-coding according to IEC 62 or DIN 41 429

Table 3/3.1: Indications for Resistance according to IEC 62 (DIN 41 429)

Colour	Value	Multiplier	Tolerance
Black	0,01	1	±1%
Brown	0,1	10	±1%
Red	1	100	±1%
Orange	10	1.000	±1%
Yellow	100	10.000	±1%
Green	1.000	100.000	±0,5%
Blue	10.000	1.000.000	±0,5%
Purple	100.000	10.000.000	±0,5%
Grey	1.000.000	100.000.000	±0,5%
White	10.000.000	1.000.000.000	±0,5%

The Modern Amateur Electronics Manual
A Practical Reference Manual on Electronics Technology Today.



Sturdy ring-binder

THE MODERN AMATEUR ELECTRONICS MANUAL

Volume: Basic Edition contain essential information — over 900 pages.

Plus Updating Supplements: containing additional information which are forwarded to you immediately on publication. Supplements are billed separately and can be discontinued at any time.

Presentation: Looseleaf system in sturdy large A4 format (297mm x 210mm).

Price of the Basic Work: £39.95 & p.p.

Interested in Everyday Electronics



There are five good reasons why **The Modern Amateur Electronics Manual** is THE all round electronics guide for amateur and professional alike.

- (1) For all enthusiasts who want to assemble their own circuit boards you will find a complete range of practical designs, even for double sided PCBs. Ready to use PCB layouts are provided on rigid detail paper for immediate transfer onto copper-clad boards covering measuring instruments, power supplies and many more useful construction projects.
- (2) The practical and easy to use **Modern Amateur Electronics Manual** is packaged within an attractive, sturdy binder with clearly marked sections. Topics are readily accessible and because of WEKA's unique numbering system information is literally at your fingertips (no more fruitless searching through old magazines for that MPS 65 project or digital electronics article.
- (3) Your loose-leaf guide also includes comprehensive data sheets, carefully selected and compiled by experts. Recent supplements have included digital C-MOS, optoelectronic and MCS 48 data.
- (4) The automatic up-dating supplement, and back-issue service means that you can receive information on new electronic developments and also purchase older supplements at a discounted price. The manual consists of 900 essential pages, but with back issues extends beyond 2,500 pages!
- (5) Altogether **Modern Amateur Electronics Manual** builds up into probably the most detailed electronic work now available; computing, repairs and maintenance, communication systems, tables of data, PCBs, component checklists, suppliers, future developments and much more. . . .

**FREEPOST
NO STAMP
REQUIRED**

Cut out coupon and forward IMMEDIATELY to:
WEKA Publishing Limited, FREEPOST, The Forum,
74-80 Camden Street, London NW1 1YW
Freephone hotline: 0800 289762 (credit card payment only)

YES please send me immediately on 10 days free approval, **THE MODERN AMATEUR ELECTRONICS MANUAL**, (Order No. 12000). If I decide to keep the manual, I shall then pay only £39.95 plus postage and packing at the end of the 10 day approval period. I shall also receive the appropriate Updating Supplements several times a year. These can be discontinued at any time and I will also be able to purchase back issue supplements at a special discount price.

FULL NAME (PLEASE PRINT) _____
ADDRESS _____

CITY/TOWN _____

COUNTY _____ POST CODE _____

SIGNATURE _____ AGE (if under 18) _____

Overseas Orders

All overseas orders have to be prepaid but will be supplied under a Money-Back Guarantee of Satisfaction. If you are an overseas customer, send no money at this stage, but return the completed order form. Upon receipt of this we will issue a pro forma invoice for you to pay against. Payment must be made in sterling.

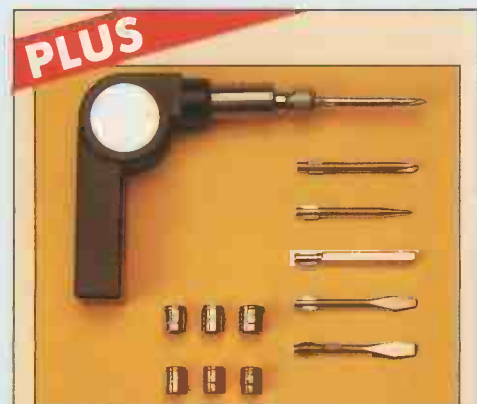

YOUR FREE GIFT IF YOU ORDER TODAY

Simply complete and return the order form below and we will send you a copy of the **MODERN AMATEUR ELECTRONICS MANUAL** plus a handy 13 piece collapsible ratchet screwdriver set as a **FREE** gift. This neat, pocket-sized set includes everything you need for those last minute repairs.

YOUR FREE TRIAL GUARANTEE

THE MODERN AMATEUR ELECTRONICS MANUAL will be sent to you on 10 days' free approval to enable you to examine the work before you decide to buy.

If it does not meet your requirements simply return it at the end of the 10 days and the order will be cancelled.

CP/39 160334



GAME TIMER

CHRIS BOWES

Speed up the moves or quell the arguments with this simple, easy to build, timer

WHEN playing a game where one person has to make a move at a time disputes sometime arise because one player seems to take very much longer to make their move than the other players. This timer has been designed to prevent strife in such circumstances by indicating that a set time has expired after the unit has been switched on before sounding a buzzer.

THEORY

This circuit uses the 555 timer i.c. but in this project it is used in a different mode from that which has been previously used in the projects featured in this series. This time the circuit is used in the monostable mode with the integrated circuit connected as shown in Fig. 1. In this mode the output from integrated circuit is in the "off" state until the circuit is triggered by a negative going pulse applied to pin 2. Immediately this occurs the output from the integrated circuit goes to the "on" state and remains there (provided that pin 2 has been

returned to a state where it is not connected to 0 volts before the expiry of the timed period) for a period determined by the values of *R* and *C* according to the following formula:—

$$T = 1.1 \times R \times C$$

(Where *T* equals the time in seconds, *R* equals the value of the resistance in Ohms and *C* equals the value of the capacitor in Farrads).

CIRCUIT DESCRIPTION

The circuit diagram for the games timer is shown in Fig. 2. VR1 and R1 form the timing resistor which is equivalent to *R* in Fig. 1. The inclusion of VR1 in series with R1 provides the facility for the circuit to be adjusted so that timings of different lengths can be set. C1 is the timing capacitor which is equivalent to *C* in Fig. 1. With the component values as shown Fig. 2 the timer is adjustable between a minimum setting of approximately 10 seconds and a maximum setting of approximately 1 minute.

COMPONENTS

R2 and C2 form a negative pulse generating circuit which is used to trigger the integrated circuit as soon as power is applied to the circuit when S1 is closed. When the circuit is first turned on C2 is discharged, which causes the voltage at pin 2 of IC1 to be at ground (0 volts) potential. As soon as the circuit is switched on current from the battery flows through R2 to C2 causing the capacitor to rapidly charge thus bringing the voltage at pin 2 of IC1 to the power supply voltage. This causes a very short negative going pulse to be applied to pin 2 which is sufficient to trigger the circuit

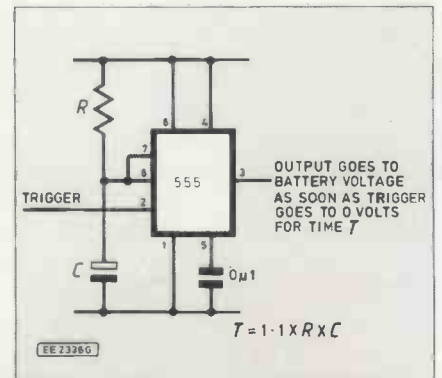

Fig. 1. Basic 555 timer arrangement.

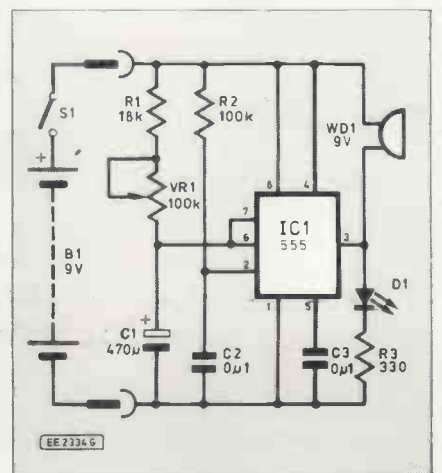

Fig. 2. Circuit diagram of the Game Timer.

but also ensures that the voltage at pin 2 has risen above 0 volts before the circuit times out. C3 is a decoupling capacitor connected between the ground (0 volts) power supply rail and pin 5 of the integrated circuit in order to set the control voltage of the circuit to the optimum value.

As soon as IC1 has been triggered the output voltage at pin 3 goes to the battery voltage. This in effect shorts out WD1 which is thus made inactive and causes a current to flow through D1 via R3. This causes the l.e.d. to glow; R3 restricts the current flowing through the l.e.d. to a safe level. When the circuit times out at the end of the timing period set by VR1, R1 and C1, the output voltage at pin 3 falls to 0 volts. This effectively shorts out the l.e.d. so that it ceases to glow but allows a current to flow through WD1 which sounds.

Switch S1 is a standard on/off switch which is used to turn the circuit on and off as required. As with most of the *Pocket Money Projects* this circuit is designed to run off a standard 9 volt battery which is shown as B1 in the circuit diagram.

CONSTRUCTION

This project has been designed to be constructed using the Easiwire system and it will fit on the *Free Easiwire Circuit Board* given away with last month's issue. The first stage of construction is to obtain a board which is 38 by 14 holes, if necessary this can be obtained by cutting down a larger board to suit. The layout of the components on the board is shown in Fig. 3. Construction begins with the components being simply inserted into the appropriate hole in the board from the side of the board with the wider holes.

When all of the components have been inserted into it the board can be turned over and the protruding component tails trimmed to a length of 3mm using cutters. It is important to ensure that any polarity

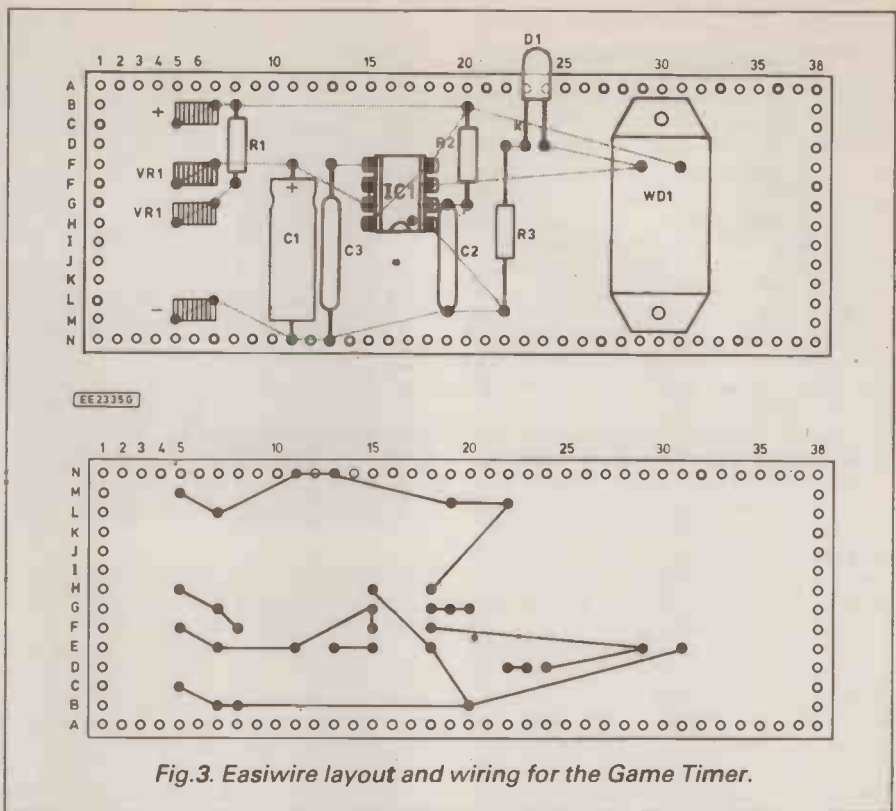

Fig. 3. Easiwire layout and wiring for the Game Timer.

sensitive components, such as IC1, C1 and D1, are inserted into the board the correct way round. This must be checked thoroughly before the wiring up of the board commences, since moving components after they have been wired tends to require the complete replacement of all the connections made with that piece of wire.

The components are then connected, using an Easiwire pen, to produce the connections as shown in Fig. 3. This process is fairly simple. At the start of a wiring run a short length of wire from the wiring tool is held on the board near to the first component pin with the finger. The tool is then used to roll the wire up the pin, under light tension, for four or five turns and roll it back down again with another four or five turns around the component tail. The wire should now be at the bottom of the component tail and should also now be in contact with the surface of the board. The wire is then pulled along to the next component by means of the wiring pen, keeping a small amount of tension on the wire, where the process is repeated again, rolling the wire up and down the component tail before continuing to the next component.

At the end of the wiring run the wire is run up and down the last component as before and then cut, close to the pin, using the cutter on the tool. The extra piece of wire at the beginning of the wiring run can be similarly cut off using the cutter blade. The wiring layout shown in Fig. 3 has been designed on the basis that the buzzer used is not polarised. If the buzzer has a polarity indicated then it may be necessary to alter the wiring layout to accommodate this.

Where the wiring chain has to break, as in the case of the connection to pin 4 of IC1 which is tied off the positive power supply rail at its connection to R2 this is simply achieved by wiring a further set of turns of wire around the component tail on top of those already sited there at the junction point and then continue as before.

After completion of the circuit board wiring has been done then the connections between the battery S1 and VR1 to the spe-

cial connectors used with the Easiwire system should be completed. Where the wiring has to connect to the Easiwire board then the wires should be fitted with the special connectors, which may be simply crimped onto the bared wire with pliers. Where connections are to be made to the case mounted components, such as the connection of the positive battery wire to S1, then these must be soldered in the conventional manner.

Before testing or installing the battery the circuit board should be carefully inspected for wiring errors or components being inserted or connected with the wrong polarity.

TESTING AND FAULT FINDING

Before the circuit can be installed into its case it should be tested to ensure that it works as described in the circuit description. If the circuit works correctly isolation varnish can be brushed over all of the connections to make the circuit permanent.

If the circuit does not work correctly then it will be necessary to check logically through the circuit in order to find where the fault(s) preventing the circuit from working lie. The first step is to repeat the visual checks on the circuit to ensure that the circuit actually conforms to the circuit diagram and that, where required, the polarity of the components is correct.

If the visual check produces no indication of what the fault may be then the battery should be checked with a meter to ensure that it is providing adequate output both when disconnected from the circuit and connected to it. If the battery voltage is noticeably lower than expected when not connected to the circuit then the battery should be replaced with a fresh one. However, if the measured voltage is correct with the battery disconnected from the circuit but a marked fall in voltage is noted when the battery is connected to the circuit, then the most likely cause is either a wiring fault, causing a short circuit between the two bat-

COMPONENTS

Resistors

R1	18k
R2	100k
R3	330
All	1/4 watt 5%

**Shop
Talk**
see page 64

Potentiometer

VR1	100k linear
-----	-------------

Capacitors

C1	470µ elect. 10V
C2, C3	0µ1 MDC (2 off)

Semiconductors

D1	standard light emitting diode
IC1	555 i.c. timer

Miscellaneous

S1	s.p.s.t. switch
B1	PP3 battery and connector
WD1	low power 9 volt buzzer

Easiwire board 14 x 38 holes; Easiwire connectors (4 off each type); Case to suit; connecting wire; knob to suit VR1.

Approx. cost guidance only

£5

tery supply rails, or that a polarity sensitive component has been connected into the circuit with reverse polarity. In this circuit the most likely components to exhibit this fault are IC1 and C1 and these should be carefully checked. If IC1 is found to be incorrectly connected then it may be necessary to replace it as irreparable damage may have been caused.

The first stage of circuit testing is to check out the circuitry associated with IC1; check that the battery voltage is measurable between pin 1 and pins 8 and 4 of IC1. If these checks do not reveal the presence of battery voltage then the connections between these points and the battery should be carefully checked for continuity with the test meter. All of the connections to IC1 should also be carefully checked for errors and short circuits.

The next stage is to check that a voltage of approximately $\frac{2}{3}$ of the battery supply voltage can be measured between pins 1 and 5 of IC1. If this voltage cannot be measured then the connections to and through C3 should be checked.

Next check that the circuit through R1 and VR1 to pins 6 and 7 of IC1 is correctly made, remembering that these connections also pass through the connectors on the board and the wires connecting them to VR1. If these connections are correct then the voltage across C1 should be seen to rise steadily, to the same voltage as that measured across C3, when the circuit is turned on. If this is not seen to happen then a temporary short circuit should be made between pins 1 and 2 of IC1 to see if this starts the circuit operating. If this technique does cause the circuit to start this indicates that the connections associated with R2, C2 and pin 2 of IC1 are faulty or that one or more of these components is not according to specification and these should be carefully checked.

If a rising voltage can be measured across C1 then the voltage at the output (pin 3) should switch from 0 volts to the battery voltage as soon as the circuit is switched on and should drop to, 0 volts as soon as the voltage measured at pins 6 and 7 rises to approximately $\frac{2}{3}$ of the battery voltage. If this is not seen to happen despite a rising voltage being observed across C1 then the connections associated with pin 3 of IC1

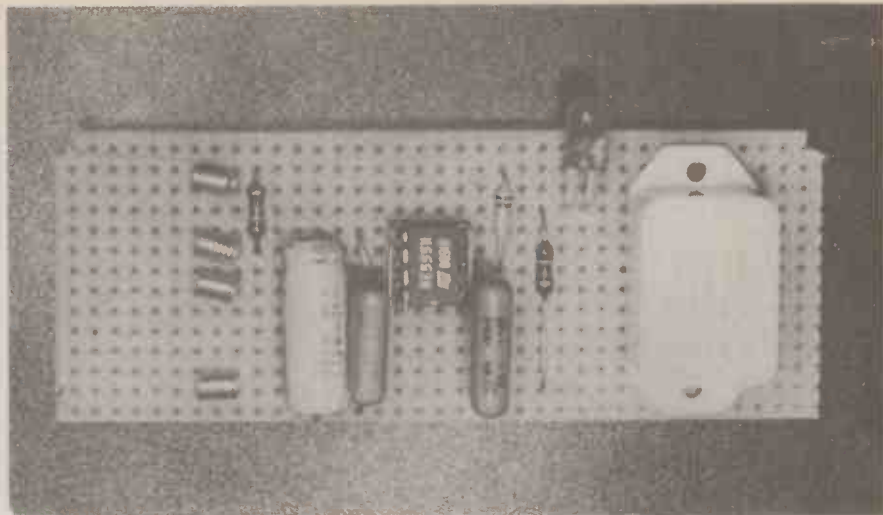

should be checked to ensure that there are no wiring errors or short circuits to either of the power supply rails.

If the output of IC1 switches between 0 volts and the battery voltage correctly, but one or more of the output devices does not operate correctly, then the connections between pin 3 and the inoperative device and the connection of that device to the power supply rail should be checked. If the buzzer is polarised then the polarity should be checked also.

The most likely causes of the l.e.d. not working are either that it has been inserted with its polarity reversed or that there is a poor connection between the l.e.d. and R3. If necessary the output components can be tested directly by shorting out the connection to pin 3 of IC1 to the opposite power rail to that which the suspect output device is connected. If this course is adopted then it is suggested the IC1 should be removed from the circuit before this test is undertaken.

CASE MOUNTING

Once the project has been constructed and tested it can be mounted in a suitable case. In the prototype version the Easiwire board was cut to the correct size to fit in the slots of a suitable case and D1 was mounted in a position so that, by cutting the leads at an appropriate length and bending them at right angles immediately after they exited from the circuit board, the l.e.d. could be made to protrude through the case lid.

The position where the l.e.d. will show

exit through the case should be carefully measured prior to drilling a hole the correct size and fitting it with a bezel. Once the position for D1 has been finalised then suitable holes should be marked and drilled to accommodate S1 and VR1. The spindle of VR1 should be cut to the correct length to accommodate the control knob prior to fitting VR1.

Once the case holes have been drilled suitable lettering may be applied to the case and protected by several layers of clear, spray-on varnish. Once the varnish has dried the case mounted components (with the exception of D1) should be installed in the correct places in the case. The connections from S1 to VR1 and those from the negative side of the battery to the circuit should be fitted with the correct connectors and the connection to the positive side of B1 should be soldered to S1. The Easiwire board should then be slid carefully into the correct slot in the case and the battery installed in the battery clip. Test the circuit to ensure that it is working correctly before fitting the case lid, taking care to install D1 in the hole drilled for it.

IN USE

To use the circuit it is necessary to set VR1 to an appropriate setting and operate S1 at the appropriate time (usually the end of the previous person's go). At this stage D1 should illuminate and the buzzer should not sound. After the timing period has elapsed D1 will go out and the buzzer should sound until the timer is switched off. □

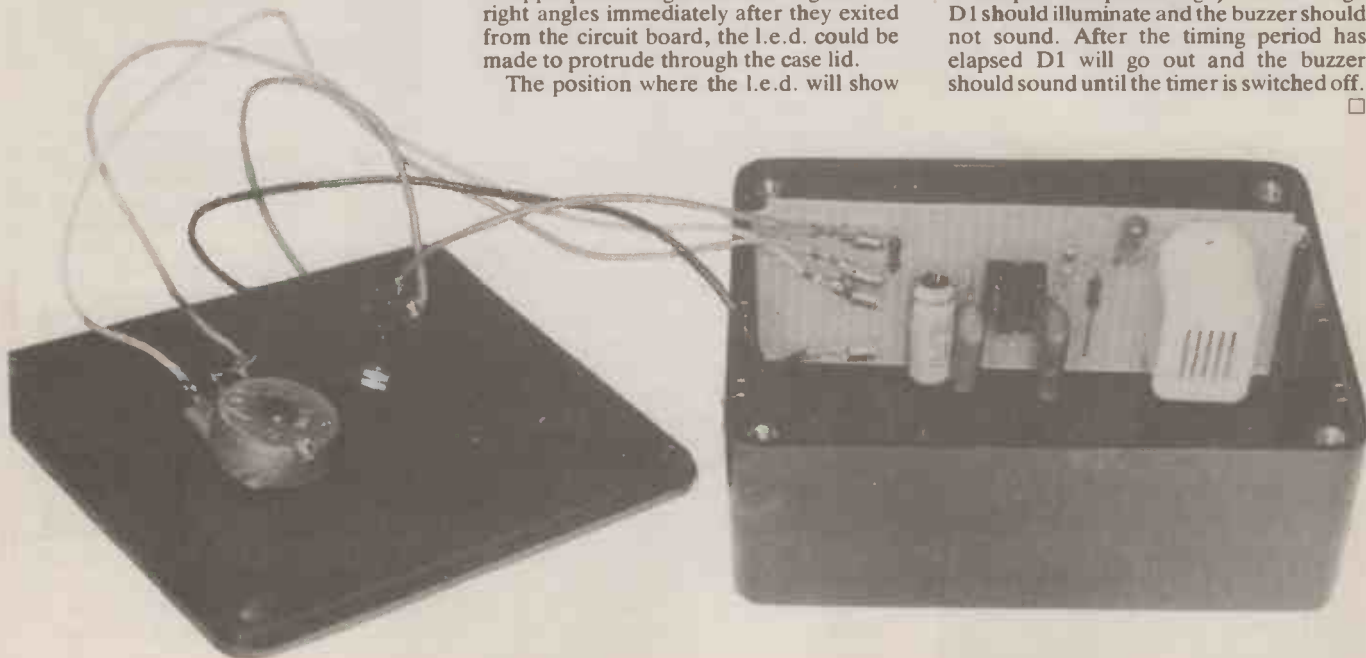

JANUARY — SPECIAL OFFER

"EXTERIOR FLOOD LIGHT"

WITH HALOGEN BULB 500W
WEATHERPROOF, SAFEGUARD YOUR HOUSE



MADE OF BLACK ALUMINIUM
RUBBER SEALED CONNECTION BOX,
HINGED GLASS FRONTED BULB
PROTECTION TO IP44, ADJUSTABLE
MOUNTING BRACKET

ONLY £16.99

SURVEILLANCE SCOOP!!

LOWEST PRICES



ALL PRICES INCL. VAT

CAMERA IMPACT & WEATHER RESISTANT.

LOWEST PRICES

TWO TYPES AVAILABLE

VR100 - INCLUDES Camera, Monitor, Camera Bracket, Power Supply and 40 metres of cable.

PRICE ONLY **£149.99**

Simply Add **£12 P&P** to each order.
Nothing More to add - V.A.T. Included in price.

PROFESSIONAL WIRELESS MIC SYSTEM



A complete wireless microphone system comprising a G201 receiver with matching G202 microphone, windshield, 1.4m patch lead for connection of receiver to amp/mixer and one pair of racking brackets for the receiver. All packed in a tough vinyl case. Tie-clip mic. available with single receiver. Also guitar transmitter. Please ring for further information.

HOME ALARM PACKAGE

- ★ Optima Alarm Control Panel
- ★ External Red Bell Box
- ★ 2 x 1 Internal Passive I.R.
- ★ 2 x Door Contacts
- ★ Siren for bell box
- ★ 100 mtrs. cable and clips
- ★ Full fitting instructions

ONLY £115 + £2.50 CARRIAGE
(Phone for further details)

SPECIAL OFFER PRICE £150.00

12V RECHARGEABLE UNITS

10 x 'D' size ni-cads (4 Ah) encapsulated in a black plastic case. Fuse holder. Gives 1.4 Output when charged. Ex-equipment, fully guaranteed. Dimensional 245 x 75 x 75mm

* THIS UNIT IS SUPPLIED, DEPENDING ON AVAILABILITY, EITHER IN 4-PIN VERSION OR 6-PIN VERSION. THE PRICE IS THE SAME FOR EITHER VERSION.

PRICE
£9.20



ORDER CODE
50/132

PRICE - 1x £9.20 (+£2.12 P&P)
10x £8.05 (P&P £4.50 PER 10)

LOGIC PROBE

Logic probe suitable for displaying the logic state of each gate of TTL, CMOS, etc. devices. Logic state displayed in light and sound. Pulse enlargement capability allows pulse detection down to 25nsec. Supplied with comprehensive instruction manual.

Working voltage 4-16V d.c.
Thresholds: High 70% Vcc
Low 30% Vcc
Input impedance 1Mohm
Max. input frequency 20MHz

ORDER CODE
TEST/LOGIC **£9.99**

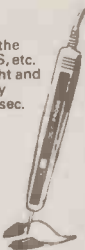

ANTEX IRONS

- C-15W IRON **£7.65**
- CS-17W IRON **£7.75**
- XS-25W IRON **£7.85**
- XS KIT 25W **£10.85**
- CS KIT 17W **£10.75**
- C-KIT 15W **£10.75**

ALL BITS FOR IRONS — **£1.60**
ELEMENTS **£3.95**
STANDS **£2.99**

ORYX PORTASOL GAS
SOLDERING IRON
£18.75 TIPS £5.50

MARCO KITS

- Ceramic 50V (125) **£3.99**
- Electrolytics Rad. (100) **£8.50**
- Fuse 20mm Q B (80) **£4.75**
- Fuse 20mm A/S (80) **£8.50**
- Pre-set Pots. Horiz. (120) **£7.75**
- Pre-set Pots. Vert. (120) **£7.75**

RESISTORS

- 0.25W Popular (1000) **£6.99**
- 0.25W 5 off (305) **£3.75**
- 0.25W 10 off (610) **£5.10**
- 0.5W Popular (1000) **£10.75**
- 0.5W 5 off (365) **£5.40**
- 0.5W 10 off (730) **£8.75**
- 1W5 off (365) **£15.25**
- 2W5 off (365) **£25.50**
- Zener Diodes 5 off (55) **£3.99**

FM TRANSMITTER

Dimensions 4.25 x 2.25 **£9.99**

LOUDSPEAKERS

LSP/8LUX 8in ROUND
8 OHM FULL RANGE
40W-60W MAX
£12.65 EACH

LSP/525LUX 5 1/4in
ROUND 8 OHM FULL
RANGE 45W-60W MAX
£9.95 EACH



4 WAY EX-SOCKET

A 4-way 13A socket, fused and with neon indicator. Colour available: white.



ORDER CODE
ELKX/MS/4 **£3.99**

19" RACKS

WE OFFER A GOOD RANGE OF SIZES AT VERY COMPETITIVE PRICES.
7-piece construction with 3mm aluminium front panel.
Top and bottom covers removable for easy access.
Supplied as separate parts for easy drilling, machining etc.

PANEL DIMENSIONS WIDTH INCHES	CASE DIMENSIONS HEIGHT INCHES	WIDTH INCHES	DEPTH INCHES	HEIGHT INCHES	ORDER CODE	PRICE	CASE WIDTH	CASE DEPTH	PANEL WIDTH	PANEL HEIGHT
19.0	1.75	16.75	6.0	1.375	BOX/U106	£12.30				
19.0	1.75	16.75	9.0	1.375	BOX/U109	£13.70				
19.0	1.75	16.75	12.0	1.375	BOX/U112	£15.20				
19.0	3.5	16.75	6.0	3.125	BOX/U206	£14.90				
19.0	3.5	16.75	9.0	3.125	BOX/U209	£16.70				
19.0	3.5	16.75	12.0	3.125	BOX/U212	£18.50				
19.0	5.25	16.75	6.0	4.875	BOX/U306	£19.50				
19.0	5.25	16.75	9.0	4.875	BOX/U309	£21.60				
19.0	5.25	16.75	12.0	4.875	BOX/U312	£23.60				
19.0	7.0	16.75	6.0	6.625	BOX/U406	£23.50				
19.0	7.0	16.75	9.0	6.625	BOX/U409	£25.90				
19.0	7.0	16.75	12.0	6.625	BOX/U412	£28.30				

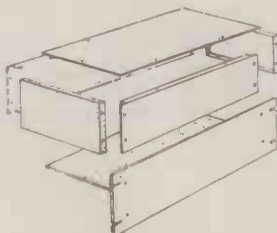

MULTIMETER

Y123EB
AC volts 0-200-200-150VAC 0-75%
DC volts 0-200m-200-1000VDC 0-5%
AC current 0-200m-1000mA 0-75%
DC current 0-200m-1000mA 0-10%
Resistance 0-2k-20k-200k-2M-20MΩ 0-75%
Transistor h_{FE} 0-1000 NPN PNP
150 x 75 x 36mm

- 3 1/2 digit LCD display
- Autorange voltage and resistance measurement
- 10kΩ ΩC
- Memory function
- Display hold
- Transistor test
- Diode test
- Continuity buzzer
- Easy to use clips

ONLY **£29-85**



HELPING HANDS WITH MAGNIFIER **£4.50**

QUARTZ HALOGEN SPOT-LIGHT

Hand-held or hanging, 12ft. Curly cable, 5 times normal headlamp intensity. On off switch. Simply plugs into cigar lighter socket.

£5.99



CAR POWER SUPPLY

Simply plug into cigar lighter socket. Outputs 3, 4.5, 6, 7.5, 9 & 12V at 800mA, via spider plug, 9v battery snap. Polarity reversing facility.

£2.75



POST & PACKING £1.00 — UNLESS ADDITIONAL AMOUNT STATED

CHRISTMAS CANDLE

CHRIS WALKER



*"Blow me down it's Christmas"
Some favourite tunes at the puff of wind!*

THE CHRISTMAS tree, mistletoe, mince pies, turkey and a steaming pudding are all traditional signs of a good old family Christmas. In our household over the past few years, in addition to these traditions it has also become expected that I annually design a new "electronically-augmented" Christmas decoration to add a little festive cheer to the house.

Without fail, visitors show interest in these novelty items and the questions asked are always the same: "Where did you get it? How much? Can I have one?". To which the answer is always the same: "Get in the queue!".

The latest addition is the Christmas Candle which brightens up the room with its colourful l.e.d. flame, flickering and billowing away; and when you blow the flame out, "hey presto" it plays a medley of Christmas tunes — how cheery!

HOW IT WORKS

The Christmas Candle really contains two discrete circuits, the flame display and the music generator as shown in the block diagram Fig. 1.

The oscillator runs continuously at a frequency of a few hertz and causes the Johnson counter to increment on every pulse and sequentially light the yellow l.e.d's around the edge of the flame from bottom to top. This gives the flame a billowing effect. Meanwhile the same oscillator signal is used to rapidly flash on and off the central cone of orange l.e.d's and the eye perceives this as a gentle flicker, which adds greater realism than a steady light.

SOUND TRIGGER

The microphone, placed near the flame, picks up sound from the room and converts it into an electrical signal so that when someone blows on the flame a wide range of low and high frequencies is presented to the high-pass amplifier. This latter stage filters out the low frequency signals which are present in ordinary household noises such as talking, bumps and bangs and therefore such sounds will not trigger the music generator. Actually, loud hand claps contain high frequencies, as do Christmas crackers and popping Champagne corks (only

the best!) and these sounds sometimes trigger the prototype into song, but it all adds to the festive spirit!

The amplifier output is compared to a fixed reference voltage and when the high frequencies picked up by the microphone reach a certain amplitude the voltage output from the amplifier exceeds the reference voltage and the voltage comparator triggers the monostable. A monostable is a circuit which produces a voltage pulse of fixed duration and in this application it is used to activate the music i.c. just long enough to play its tune, after which the monostable resets.

The music i.c. itself is a plastic packaged version of the chip used to play tunes in Christmas cards; it is very easy to use with only three connections. Four types are commonly available for Christmas, Valentine, Birthday and Wedding cards. Why, you could even convert the unit into a birthday candle, or how about a Valentine candle for the light of your life?

CIRCUIT DESCRIPTION

The full circuit diagram of the Christmas Candle is shown in Fig. 2. IC1a is one half of a 556 dual timer wired as a multivibrator running at a few hertz. The output from pin 5 is used to clock the Johnson counter IC2.

IC1 should be a CMOS version of the 556 so that its output is suitable to drive the 4017 (IC2) clock input (pin 14), but when using a 9V supply the output from the more easily available bipolar version is just about compatible with CMOS and so the constructor may use the bipolar type 556 if difficulty is experienced buying a CMOS type. The prototype unit runs quite happily on either and they are pin-for-pin compatible.

Each 4017 output is connected to a pair of l.e.d's placed at opposite sides of the flame; there are 13 l.e.d's around the sides, notice that there is only one at the top (D21), see Fig. 3. The standard buffered output version of the 4017 will supply about 10mA to 15mA through a pair of l.e.d's connected in series and no current limiting resistor is required. Power dissipation in the i.c. remains within the recommended limit.

The oscillator output is also used to switch transistor TR1 which in turn switches on and off the l.e.d's in the core of the flame diodes D1 to D8. Resistors R13 and R14 are current limiting resistors and these are mounted on the flame circuit board.

Fig. 1. System block diagram for the Christmas Candle.

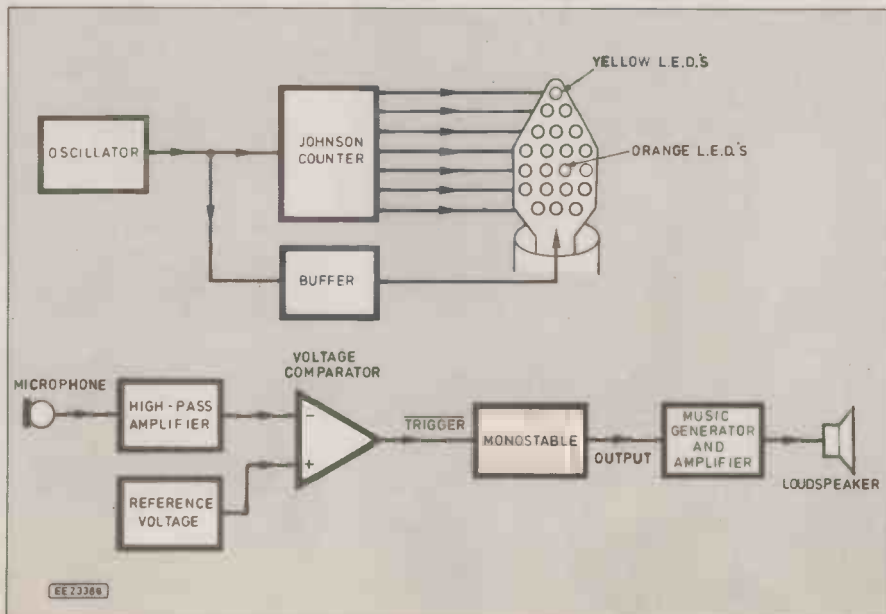

Resistors

R1, R4	1k (2 off)	R9	2M2
R2, R6	470k (2 off)	R10	560
R3	10k	R11	150
R5, R12	4k7 (2 off)	R13, R14	100 (2 off)
R7, R8	560k (2 off)	R15	220

All 0.25W 5% carbon.

Capacitors

C1	0µ1 polyester
C2	0µ01 monolithic ceramic
C3	0µ1 disc ceramic
C4, C5	10µ radial elec. 25V (2 off)
C6	1000µF axial elec. 16V

Semiconductors

TR1	BC548 npn silicon
TR2	2N3706 npn silicon
TR3	BFY51 npn silicon
IC1	TLC555CN CMOS dual timer
IC2	4017BE CMOS counter

IC3	1458C dual op-amp
IC4	UM66/1 melody generator
D1 to D8	3mm orange l.e.d. (8 off)
D9 to D21	3mm yellow l.e.d. (13 off)
D22, D23	1N4001 silicon rectifier (2 off)
D24	BZY88C9V1 9.1V Zener diode

Miscellaneous

T1	Miniature transformer: 240V/9-0-9V at 100mA
MIC1	Type EM-4 sub-miniature electret condenser microphone
LS1	64 ohm (approx.) loudspeaker 66mm diameter
SK1	Miniature 3-pin mains socket and plug to suit

Stripboards, 0.1in matrix 20 strips x 33 holes and 29 strips x 16 holes (one piece 36 strips by 50 holes is sufficient); plain 0.1in matrix board 25mm x 102mm (1in x 4in); d.i.l. sockets: 8-pin, 14-pin, 16-pin (1 off each); plastic case 150mm x 80mm x 50mm; four rubber feet; 20mm (¾in) diameter white plastic pipe; terminal pins (21 off); thin 3-core mains cable; 10-way multicoloured ribbon cable; solid core wire; stranded core wire; solder; decoration for case.

Shop Talk

see page 64

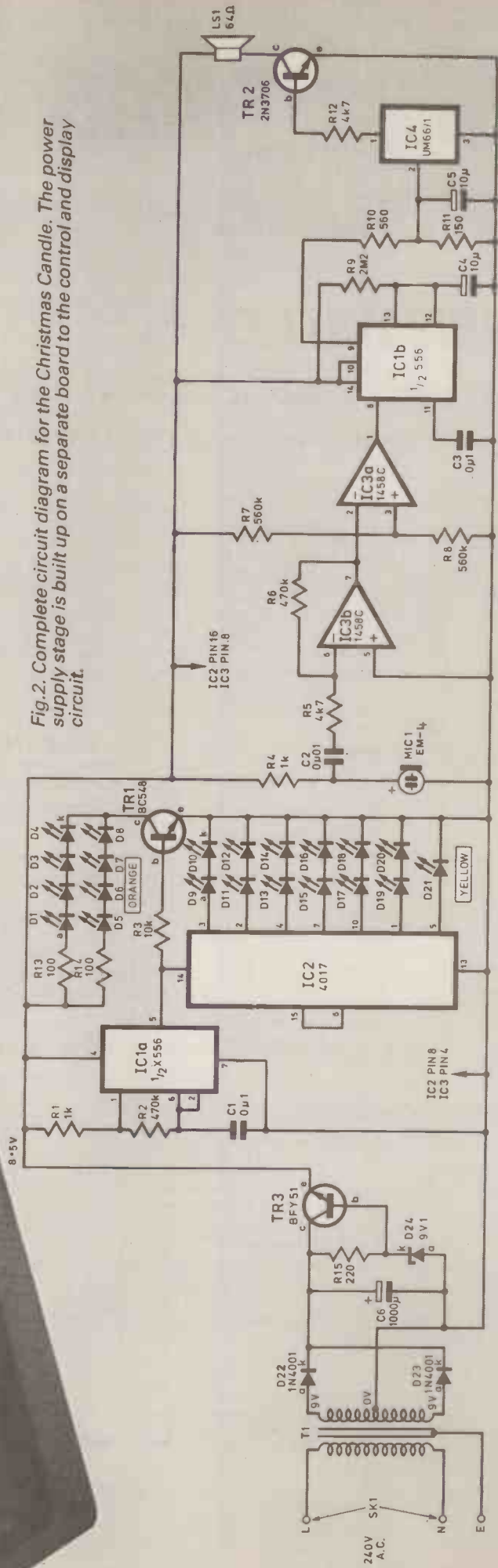
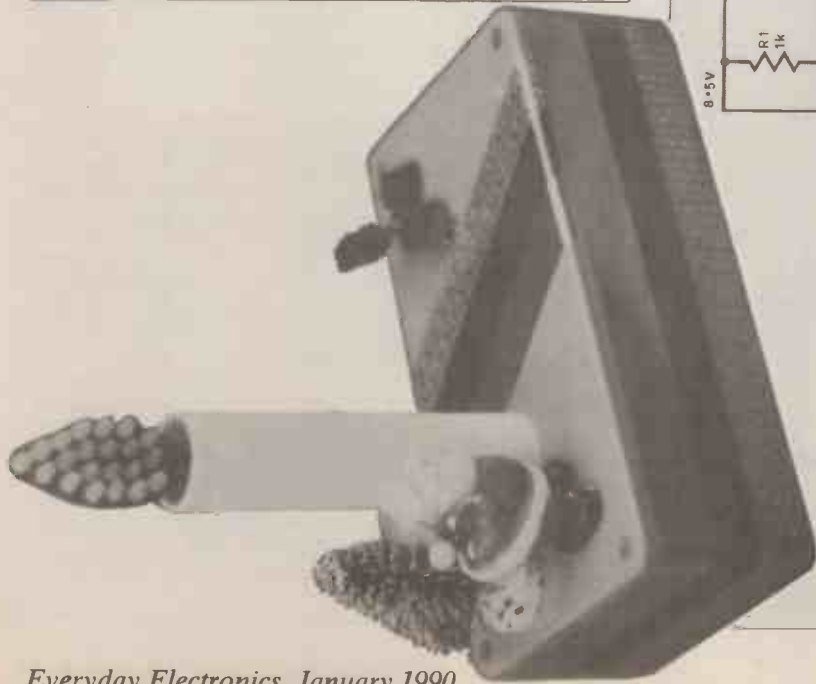

Fig.2. Complete circuit diagram for the Christmas Candle. The power supply stage is built up on a separate board to the control and display circuit.

EE2339G

MUSIC GENERATOR

Microphone MIC1 is an electret condenser type EM-4 chosen because of its small size compared to dynamic types; it fits conveniently near the flame. Electret microphones require a d.c. source to power their internal f.e.t. pre-amplifier and this is supplied via resistor R4.

Capacitor C2, resistors R5 and R6 and operational amplifier IC3b form a simple high-pass amplifier with a gain of about 100 for frequencies above 3kHz. A sharp blow of air near the microphone causes it to produce noise signals of about 50mV amplitude. These appear as 5V spikes at the output of IC3b where they are fed to the inverting input (pin 2) of IC3a which is wired as a voltage comparator.

Resistors R7 and R8 produce a reference of 4.5V at the non-inverting input of IC3a and as long as the spikes have an amplitude less than this the comparator output is saturated high (about 7.5V). A spike exceeding 4.5V causes IC3a output to saturate low (about 1V) and trigger the monostable IC1b where output goes high for the time period governed by capacitor C4 and resistor R9.

The output of IC1b (pin 9) supplies power to the music generator IC4 via resistors R10 and R11. The music generator takes about 20 seconds to play its tunes and the monostable output remains high for about 30 seconds. Hence there is a short delay after the music stops before the monostable can be re-triggered again.

Transistor TR2 is a simple amplifier which ensures a good volume from the miniature loudspeaker LS1.

POWER SUPPLY

The Christmas Candle is designed as a decoration to be run continuously and since it is quite a current gobbler, about 30mA due to the multi-l.e.d. display, battery operation is rather uneconomical (3 hours from a PP3) so a mains power supply is included.

Transformer T1 steps down the 240V a.c. mains and after rectification and smoothing 10.5V d.c. is present at transistor TR3 collector. A constant p.d. of 9.1V is present across the Zener diode D24 and after allowing for the 0.6V base-emitter voltage drop this means there is a stabilised 8.5V at the emitter of TR3 over a wide range of currents and this is used to power the rest of the circuit

FLAME CONSTRUCTION

We may as well get the fiddly part done first before the seasonal lethargy sets in! You will need a piece of 0.1in plain matrix board (i.e. holes but no copper strips) initially about 1in. by 4in. Plain board has become rarer over recent years; if you have trouble obtaining some you can always remove the copper strips from ordinary stripboard with a ferric chloride etching solution. You can, of course, tailor the piece of Easiwire board given free with last month's issue.

Cut the matrix board to the flame shape shown in Fig. 3a, this is actual size and may be used as a template. File the edges smooth, round off the corners and then cover one side of the board with red p.v.c. adhesive tape to create a coloured background to the flame.

The "flame" consists of 21 3mm l.e.d.'s. Diodes D1 to D8 are orange l.e.d.'s in the centre (core) of the flame whilst D9 to D21 are yellow l.e.d.'s situated around the edge of the flame. Check that you know which

lead of each l.e.d. is the cathode (negative) marked 'k' on the diagrams. It is wise to check this using a 3V battery and 100 ohm resistor in series as mistakes in flame construction are difficult to rectify!

The central (orange) l.e.d.'s must be inserted first, refer to Fig. 3b. Push their leads through the p.v.c. tape which will then hold them in place. Bend the leads flat against the board, trim to length and solder.

Since the leads are so short you are soldering close to the l.e.d. itself and it is easy to overheat and destroy the device if care is not taken. As a guide, the iron should be in contact with the joint for no longer than two seconds. If the joint is not made by this time remove the iron, allow the joint to cool and then re-solder.

Insert resistors R13 and R14 on the board (l.e.d. side) and solder to the anodes of D1 and D5. Use sleeving on one lead to prevent any possibility of shorting together. Solder the other ends of the resistors together.

Do not attach any flying leads yet but continue by inserting the yellow l.e.d.'s around the edge of the flame: Fig. 3c. Notice that all the cathodes (k) are soldered together down the left side (rear view) and then l.e.d.'s on opposing sides are soldered cathode-to-anode. Sleeving must be used where appropriate to prevent short circuits with the orange l.e.d.'s.

A 30cm length of 10-way ribbon cable is probably the neatest way to connect the "flame" to the main circuit board with the added advantage of colour coding. Solder the wires to the flame as detailed in Fig. 3.

It is now a good idea to test each group of l.e.d.'s as follows; using a 9V battery connect the negative terminal to the grey wire and positive to white, no resistor is required. All eight orange l.e.d.'s should light. Next, connect the negative battery terminal to the black wire and in turn touch the wires coloured brown to violet via a 470 ohm resistor to the positive terminal and check that opposite pairs of yellow l.e.d.'s light.

If all is well the flame can be finished off by backing it with red heat-shrink plastic film (the type used to cover model aeroplanes) to cover the connecting wires. Alternatively, wrapping paper or coloured plastic film could be used but take care to avoid metallic foil which would cause short circuits. Since the flame is the focus of attention it is worth spending some time and care on this part of construction.

A 10cm length of 22mm (3/4in) diameter white plastic overflow pipe forms the body of the candle and the flame assembly is inserted into one end of this with the ribbon cable running through to the other, see Fig. 4a.

CIRCUIT BOARDS

The main circuit board is a piece of 0.1in stripboard, 33 holes by 20 copper strips. The first stage is to make the 29 cuts in the tracks as shown in Fig. 5. Use a 1/64in drill bit if you don't have the proper tool. Fit the i.c. sockets and then the 15 wire links using solid core wire.

The remainder of the components should now be soldered into place, noting the polarity of the capacitors C4 and C5

Fig.3. Construction and wiring of the l.e.d. "flame" display.

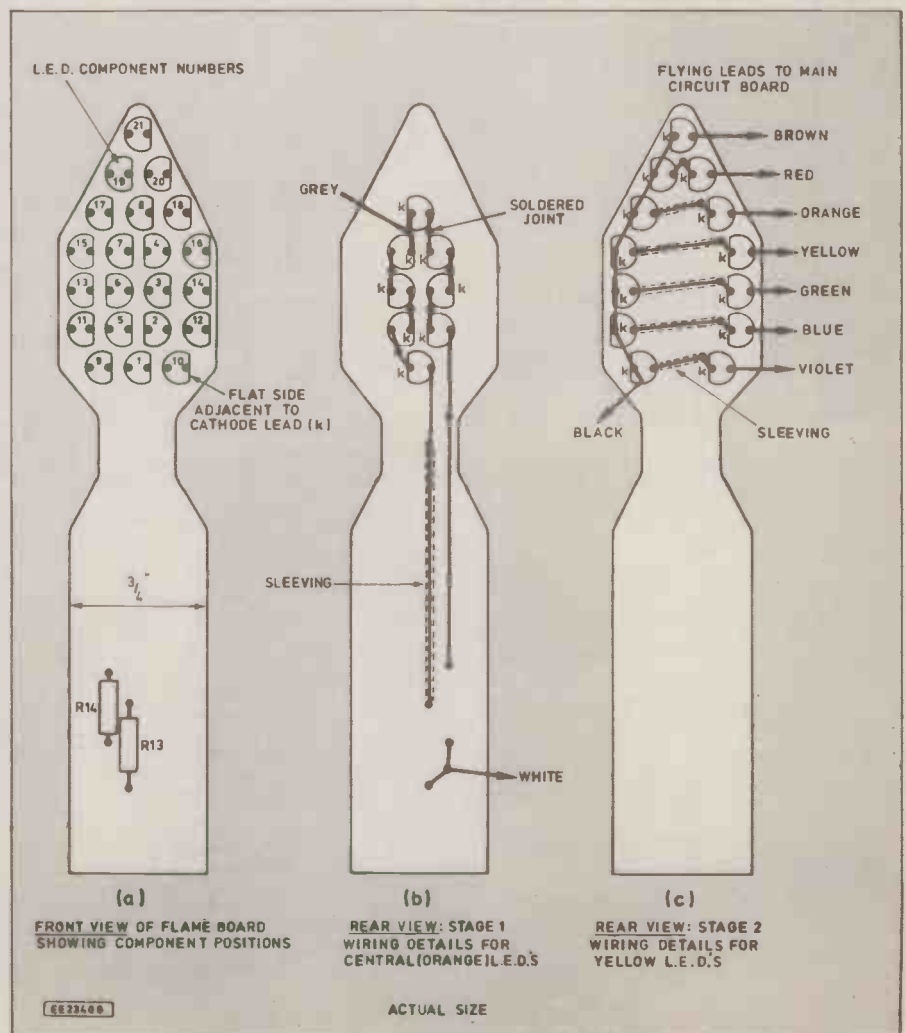

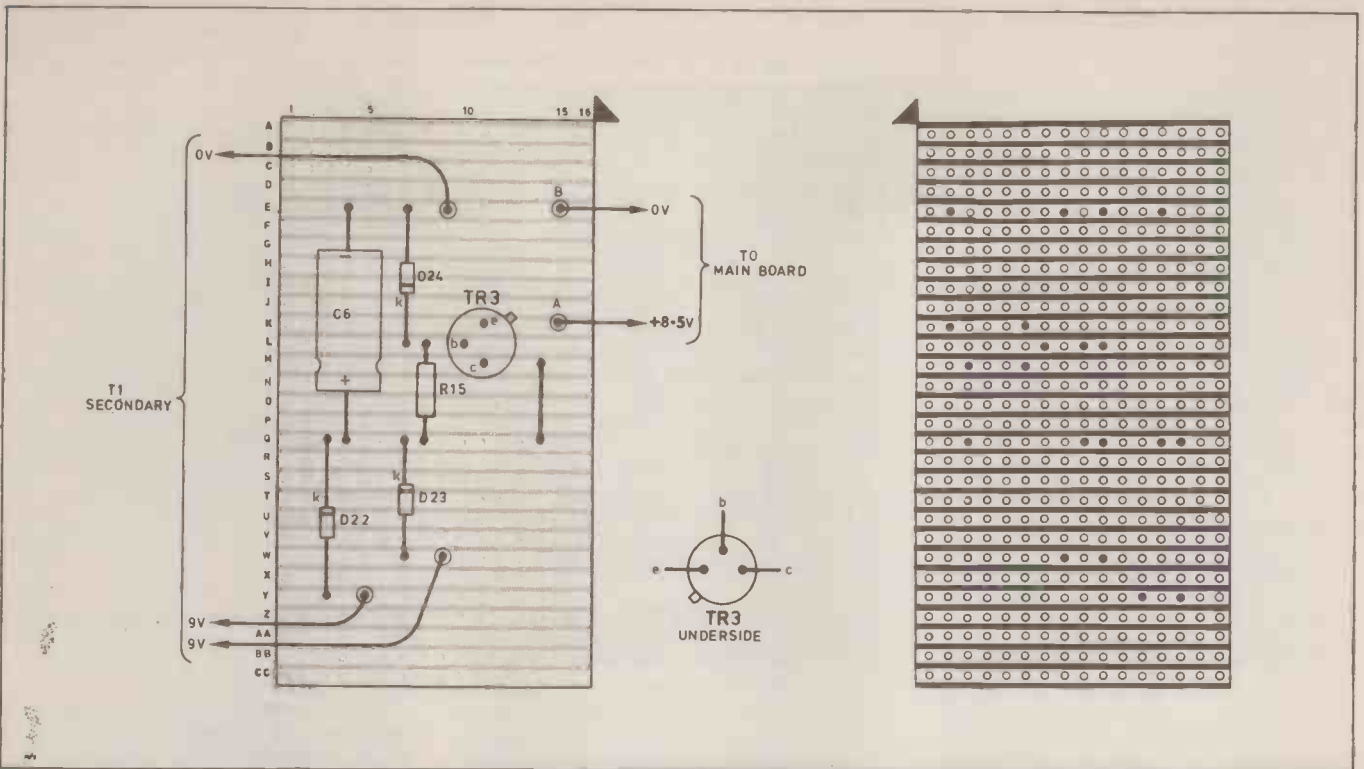

Fig. 6. Stripboard component layout and wiring for the power supply. The mains transformer T1 is mounted on the base of the case, see Fig. 7.

Fig. 5 (below right). Main stripboard component layout, wiring and details of breaks required in the underside copper tracks.

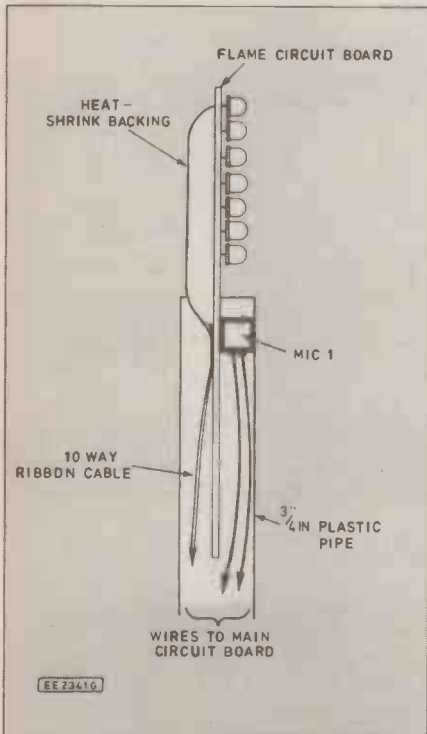
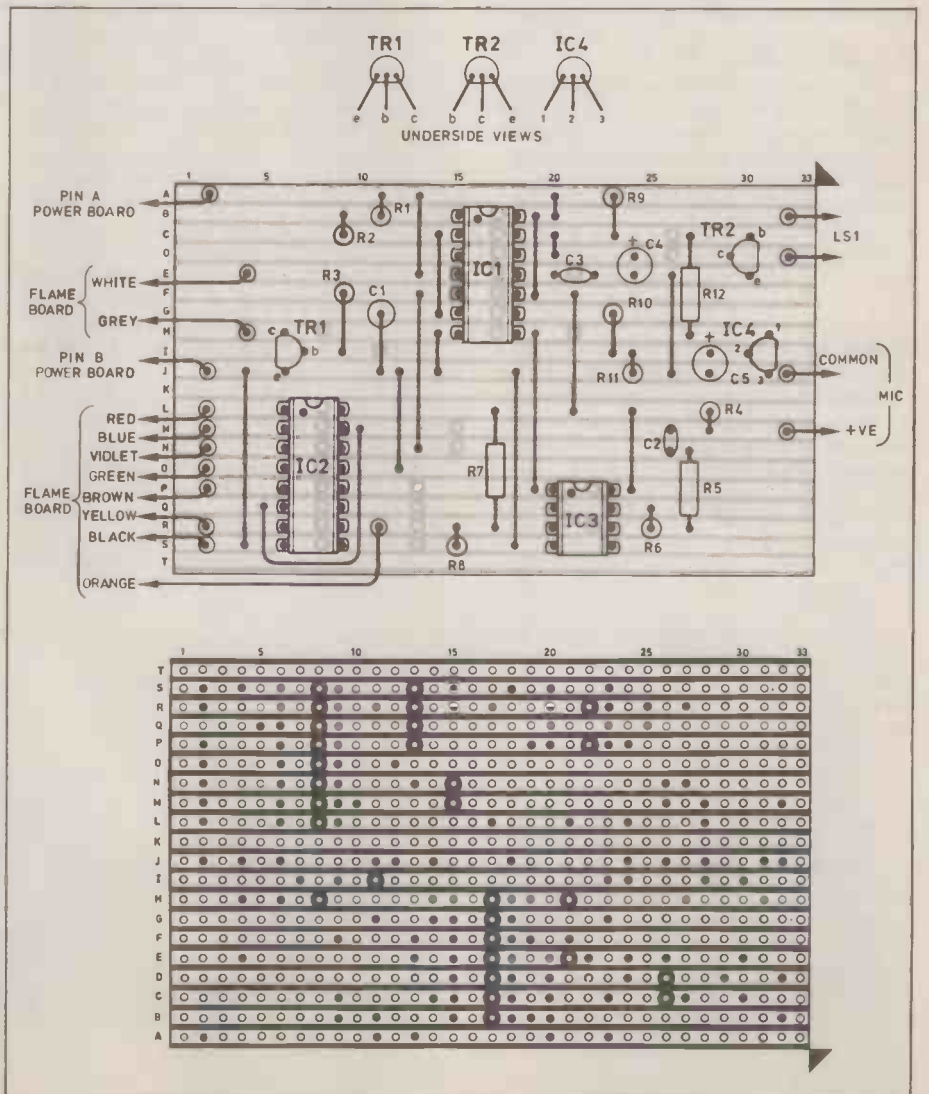
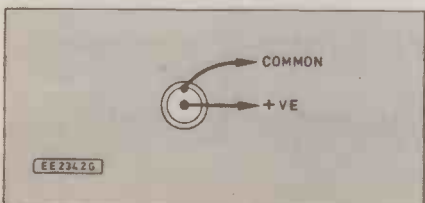

Fig. 4a. Method of mounting the flame and microphone in the "candle" stem.

Fig. 4b. Electret microphone connection details.



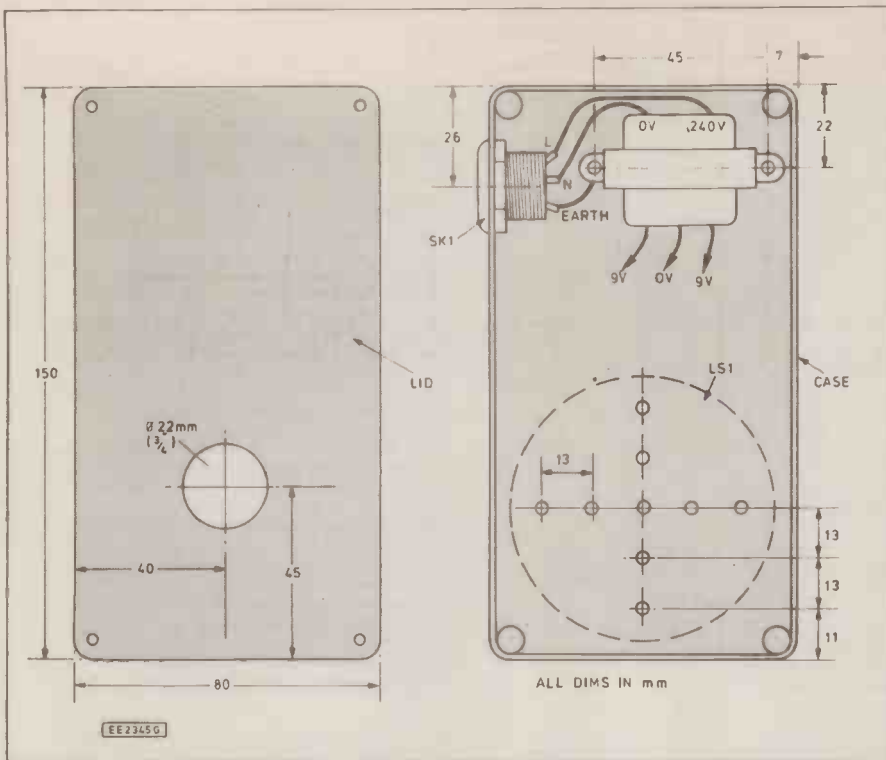

Fig. 7. Drilling details and component layout in the case.

and the transistors; the latter are also sensitive to excess heat when soldering — heed the advice given earlier.

Insert terminal pins for all the flying lead connections to be made later. Do not insert the i.c.'s into their sockets at this stage, with the exception of IC4 which is soldered directly to the board.

The power supply is constructed on a separate piece of stripboard 16 holes by 29 strips. Insert the components as shown in Fig. 6, everything except the resistor R15 must be fitted the correct way round. Insert five terminal pins and the single wire link.

Check both boards carefully for mistakes and inadvertent solder bridges across adjacent copper strips.

CASE

An ABS plastic box type 2005 measuring 150mm×80mm×50mm is used to house the circuit and act as a base for the candle. After construction the case can be decorated in appropriate Christmas style.

Holes need to be drilled in the case body for the mains socket SK1 and transformer mounting bolts, see Fig. 7; a pattern of small holes should also be drilled and four

rubber feet used to allow sound to escape from the loudspeaker which is later positioned in the bottom of the case. In the case lid, a 3/4in hole needs to be drilled and filed out to take the candle tube.

Bolt in the transformer and mains socket and wire as shown — for safety use sleeving over the mains connections. The mains Earth wire should be trapped under a transformer mounting tag. A thin 3-core mains lead needs to be made up with a 13A plug (fitted with 3A fuse) on one end and the plug to mate with SK1 on the other.

Solder the transformer secondary winding to the power supply board ensuring that the 0V centre tap is connected to the correct pin, apply power and use a voltmeter to check for about 8.4V between pins A and B on this board. Do not connect the power supply to the main board until this check has been passed.

Solder two 30cm long stranded core wires to the microphone noting the polarity (see Fig. 4b) and slide it into the top of the candle tube, threading the wires through to the opposite end. Screened wires are not needed for the mic. connection as the high pass filter of IC3b effectively removes any 50Hz mains hum picked up by these wires.

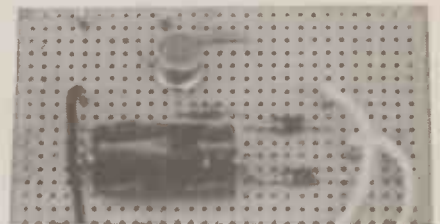
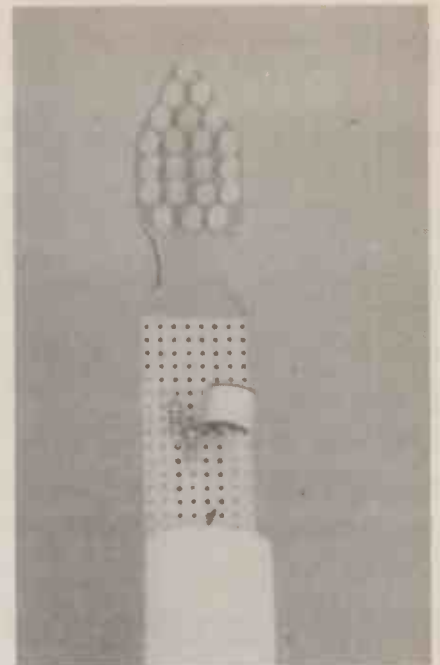

The completed candle can then be inserted through the 3/4in hole in the case lid. In the prototype the tube is a tight fit in this hole and no adhesive is required.

Glue the loudspeaker in the case over its holes and complete the wiring by interconnecting all the flying leads from the flame, microphone, loudspeaker and power supply leaving enough surplus wire to manipulate the boards easily. Use flexible stranded core wire for these connections.

Insert the three i.c.'s into their sockets. IC1 and IC2 are CMOS devices and prone to damage by static electricity. Actually, I find CMOS chips far tougher than many people suspect but it is best to be wise when handling them: try not to touch the pins and remember to discharge yourself by touching an earthed metal object (e.g. copper water pipe) before picking them up.

Finally, if the recommended case is used the power supply circuit board slides vertically into slots in the case walls whilst the main circuit board is mounted horizontally above the speaker on p.c.b. guide strips. Alternatively it could be fastened to the top of the speaker using double-sided adhesive pads.

Merry Christmas!

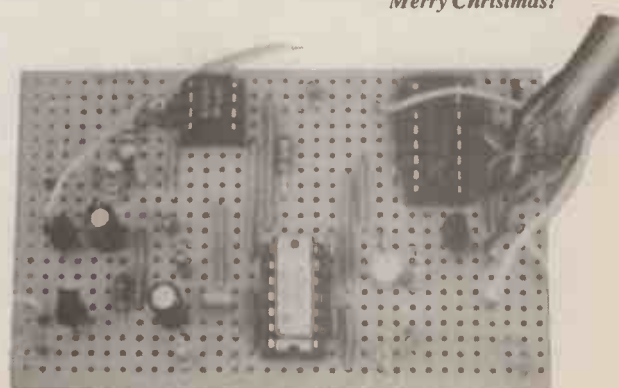
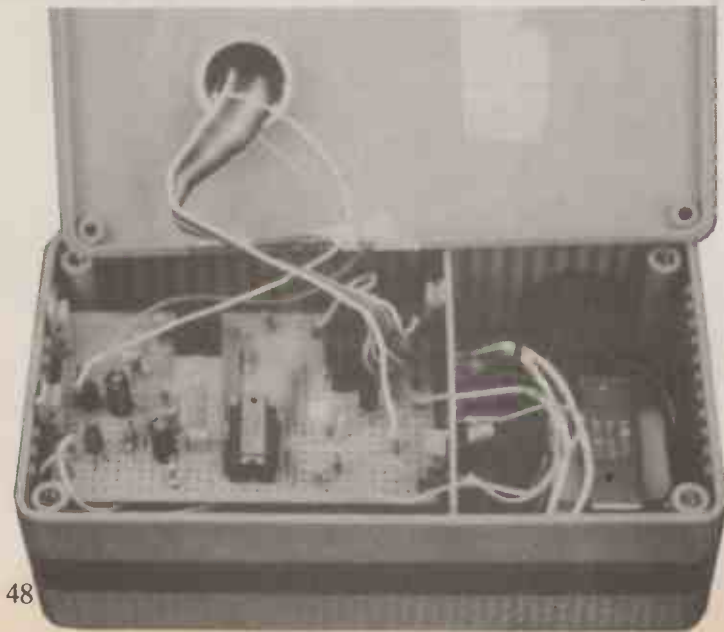

TASPA LTD

THE SERVICE THAT'S
TODAY NOT TOMORROW

FOR ALL YOUR

- ELECTRICAL COMPONENTS • PASSIVES • LEADS
- TELEPHONE ACCESSORIES • SECURITY SYSTEMS
- SEMI CONDUCTORS • CAPACITORS • METERS
- POWER SUPPLIES • SERVICE AIDS • INDICATORS
- CONNECTORS • HARDWARE • ENCLOSURES • TOOLS
- AUDIO EQUIPMENT AND MUCH MUCH MORE!!!!

Road Alert®

ROAD ALERT is unique. It's the first car alarm to incorporate a sensitive air pressure monitor. It possesses a siren so loud and penetrating that it will delay the coolest car thief. It's a portable, self-contained unit, that can be fitted by yourself in 10 minutes, there are no wires, no plugs, and no complications.

- IT'S EASY TO FIT • ITS SIREN IS A POWERFUL DETERRENT
- IT'S EFFECTIVE IN ANY INTERIOR • IT'S TRIGGERED BY AIR PRESSURE • IT'S COMPACT PORTABLE SECURITY

THIS UNIQUE ALARM COMES TO YOU AT JUST
£39.95 INC. P&P OR BUY TWO FOR £70.00



CAPACITORS ELECTROLYTIC

ORD No.	Our Price	RRP
16 Volts		
CT1	47uf .09	.10
CT2	100uf .11	.14
CT3	220uf .13	.14
CT4	470uf .22	.24
CT5	1000uf .28	.34
CT6	2200uf .46	.88
53 Volts		
CT7	1uf .10	.11
CT8	2.2uf .11	.14
CT9	4.7uf .09	.10
CT10	10uf .11	.12
CT11	22uf .13	.14
CT12	47uf .13	.14
CT13	100uf .20	.28
CT14	220uf .33	.66
CT15	470uf .47	.82
TRANSISTORS		
T1 BF199	.46	.23
T2 BD507	.68	.34
T3 BC547	.14	.07
T4 BCX36	.16	.08
T5 BD608	.68	.34
T6 BD2788 C10	.50	.25

SPECIAL OFFERS — (Subject to availability while stocks last)

ORD. No	DESCRIPTION	OUR PRICE	RRP	ORD. No	DESCRIPTION	OUR PRICE	RRP
S1	1/4W Resistors Ass'd. (1100)	1.00	2.00	A1	2m Audio Lead mirror image	1.00	2.00
S2	Good quality mains tester screwdriver	1.00	1.80	A2	5 Pin DIN to 5 Pin DIN leads	2m 1.00	1.95
S3	20mm Quick blow fuses 100 amps, 2.5 amps, 3.15 amps, 5 amps lamp Single	0.06	0.12	A3	5 Pin DIN plug to one 3.5mm jack plug. Pins 1 & 4 connected. Length: 1.2m	0.88	1.50
		0.50	1.20			5m 2.50	6.00
		0.50	2.00			2m Telephone extn. lead plug to socket, BT approved coiled or straight	1.00
S4	Personal Stereo Headphones Hi-Fi quality	1.00	2.95	A5	5 pin DIN plug to one 3.5mm jack plug 3 & 5 connected. Length: 1.2m	0.54	1.10
S5	T.V. Monitor (Black & White)	42.00	60.00	A6	5 pin DIN plug to four phono sockets. Length: 1.2m	1.19	2.25
S6	Battery Snaps for PP3 Batteries	0.15	0.50	A7	5 pin DIN socket to four phono plugs. Length: 1.2m	1.19	2.25
S7	Insulation Tape	0.15	0.24	A8	5 pin DIN plug to two phono sockets. Pins 3 & 5 connected. Length: 23cm	0.71	1.60
S8	5 amp Lighting Terminal Strip (10 Connectors)	0.50	2.00	A9	Two phono plugs to two phono sockets Length: 1.2m	0.71	1.60
S9	DIY Speaker Kit	Send for Details		A10	Two phono plugs to two phono plugs 90's Length: 1.2m	0.72	1.70
S10	VHS Video Tape (E180)	2.00	3.80	A11	3.5mm Jack plug to phono plug. Length: 1.2m	0.47	1.00
S11	50m Speaker Cable	3.00	5.00	A12	Mini headphone extension 3.5mm stereo jack plug to 3.5mm stereo jack socket. Length: 3m	0.72	2.00
S12	Battery Operated Scissors	1.99	5.00				

SEND NOW FOR YOUR FREE CATALOGUE

Please include a large stamped SAE

Please add £1 P&P — Orders over £30

Postage and packing free

P.O. or Cheque to:

TASPA LTD Leekbrook Industrial Estate, Leek,
Staffordshire ST13 7AP

We now accept Access — phone (0538) 399144
Allow 28 days for delivery

BANKRUPT AND SURPLUS STOCK BOUGHT

QUALITY ...

SECURITY SUPPLIES

FOR
DIY &
TRADE

...AT LOWEST PRICES

CONTROL UNITS

- Automatic
- Modular
- Lighting
- Timer

SENSORS

- Passive Infra-Red
- Ultrasonic
- Infra-Red Beam

ACCESSORIES

- Contacts
- Pressure Pads

CARS &
VANS

- Security Lighting
- Cable Etc. Etc.

HOMES &
FACTORIES

PRODUCT OF THE MONTH



MINIATURE PASSIVE INFRA-RED SENSOR RP33

Detects intruders up to 12 metres away.

- Size only 80x60x40mm.
- Switchable detection indicator.
- Wide 85° coverage.

- Suitable for use with most security systems. ONLY £23.95 +VAT

Quality discounts start at only 3 units

The Security Specialist

RISCOMP LIMITED

Dept. EE1, 51 Poppy Road, Callers by Appointment
Princes Risborough, Bucks. Office hours Mon - Fri
9am - 5pm
HP17 9DB

(084 44) 6326

BANKCARD
VISA

TELEPHONE
OR SEND FOR
FREE
LITERATURE
TODAY.

Hobby Kit Electronics

JUST A SMALL
SELECTION OF KITS
FROM OUR EVER
INCREASING RANGE

Kit No.	Description	Price (each) £ (incl. VAT)
1001	0.2 WATT FM TRANSMITTER	4.16
1004	LIGHT SWITCH	5.83
1013	AM-FM-VHF RECEIVER	13.33
1018	GUITAR TREMOLO	7.08
1022	METAL DETECTOR	4.16
1026	RUNNING LIGHTS	8.33
1029	4 SOUNDS ELECTRIC SIREN	4.99
1034	CAR BATTERY CHECKER	2.92
1036	TRANSISTOR TESTER	3.75
1044	GRAPHIC EQUALIZER	12.91
1047	SOUND SWITCH	9.58
1059	TELEPHONE AMPLIFIER	8.33
1069	12V DC FLUORESCENT TUBE UNIT	5.42
1073	VOICE ACTIVATED SWITCH	6.24
1075	ELECTRONIC DICE WITH LED's	6.66
1098	DIGITAL THERMOMETER WITH LCD DISPLAY	20.82
1114	ELECTRONIC LOCK	7.50
1117	TV PATTERN GENERATOR	9.17
1125	TELEPHONE LOCK	6.66
1129	NEGATIVE ION GENERATOR	14.16
1133	STEREO SOUND TO LIGHT	9.52
1203	MINI FM TRANSMITTER WITH MICROPHONE	4.16

All kits are supplied complete including
Silk Screened pcb, Components, Solder,
Wire and full instruction sheet.



CREDIT CARD HOTLINE
☎ 01-205 7485



LARGE STOCKS OF INTEGRATED CIRCUITS,
SEMI'S, OTPO ELECTRONICS, CAPACITORS,
RESISTORS, SWITCHES AND OTHER
MISCELLANEOUS PRODUCTS
ARE ALSO AVAILABLE FROM
Hobbykit

For latest kit catalogue and price list
send a large 45p S.A.E. to:

Hobbykit Ltd.

UNIT 19, CAPITOL INDUSTRIAL PARK
CAPITOL WAY,
LONDON NW9 0EQ
FAX NO: 01-205 0603

TEACH-IN SERIES & PROJECTS

FOUR SPECIAL PUBLICATIONS

FROM EVERYDAY ELECTRONICS



SEE DIRECT BOOK SERVICE pages—for full ordering details

THE FIRST "TEACH-IN" BOOK

ONLY £1.95 plus P & P

By Michael Tooley BA and
David Whitfield MA MSc CEng MIEE

A comprehensive background to modern electronics including test gear projects. This 104 page, A4 size book forms a complete course in basic electronics; designed for the complete newcomer it will, however, also be of value to those with some previous experience of electronics. Wherever possible the course is related to "real life" working circuits and each part includes a set of detailed practical assignments.

This book is an excellent companion for anyone interested in electronics and will be invaluable for those taking G.C.S.E. or B.T.E.C. electronics courses. **ORDER CODE: EET-1**

TEACH-IN 88/89 BOOK

£2.45 plus P & P

A complete City and Guilds
Certificate Course for 726/303
Introductory Microprocessors

Written by Mike Tooley BA this course can lead successful readers to a City and Guilds Certificate. Everything you need to know is included—even pre-test papers, etc.

From Terminology, Integrated Circuits and Logic Families in Part One, the course progresses in easy stages up to High- and Low-level Languages, Flow Charts and Assembly Language. Also featured is a range of eight Data Pages giving information on popular microprocessor chips. A comprehensive index is included, making this a valuable reference manual. **ORDER CODE: TI 88/89**

NEW

**TEACH-IN No. 3
EXPLORING ELECTRONICS**

£2.45 plus P & P

By Owen Bishop

Designed to explain the workings of electronic components and circuits by involving the reader in experimenting with them. The book does not contain masses of theory or formulae but straightforward explanations and circuits to build and experiment with.

The text is split into 28 easily digestible sections, each with a separate project. The breadboard experiments assume no previous knowledge, start at Semiconductor Diodes and progress through bistables, timers, amplifiers, binary etc up to f.e.t.s and shift registers.

The projects include radio receivers, various timers and alarms, plus temperature sensors and water detectors etc.

An excellent source book for GCSE courses.

Available from Direct Book Service
ORDER CODE T13

SEE DIRECT BOOK SERVICE pages—for full ordering details

ON SALE — NOW!

ELECTRONIC PROJECTS Book 1

£2.45 plus P & P

Contains twenty of our best projects from previous issues of EE, each backed with a kit of components. The projects are:

Seashell Sea Synthesiser, EE Treasure Hunter, Mini Strobe, Digital Capacitance Meter, Three Channel Sound to Light, BBC 16K Sideways Ram, Simple Short Wave Radio, Insulation Tester, Visual Guitar/Instrument Tuner, Stepper Motor Interface, Eprom Eraser, 200MHz Digital Frequency Meter, Infra Red Alarm, EE Equaliser Ioniser, Bat Detector, Acoustic Probe, Mains Tester and Fuse Finder, Light Rider — (Lapel Badge, Disco Lights, Chaser Light), Musical Doorbell, Function Generator, Tilt Alarm, 10W Audio Amplifier, EE Buccaneer Induction Balance Metal Detector, BBC Midi Interface, Variable Bench Power Supply, Pet Scarer, Audio Signal Generator.

Available from Direct Book Service
ORDER CODE EP1

... Computer Aided Design ... Circuit Analyser Software ...

ONE OF the great advantages of the BBC micros over other home computers of the same vintage is their large and varied software base. There are plenty of games and word processor programs available if that is what you want, but there are also numerous programs filling more specialised niches.

In this respect the BBC computers still out-gun most 16-bit computers, with the IBM PC probably representing the only computer which has a greater choice of applications programmes. Much of the specialised BBC software programs are probably of little interest to most electronics enthusiasts, but there are some available which cover aspects of electronics.

Simulating Stuff

One of the more interesting of these is CAD (computer aided design) software of the circuit modelling type. I believe that there is more than one program of this type available for the BBC micro, but the only one of which I have first hand experience is the "Analyser II" program from Number One Systems, who are probably the best known source for this type of software in the U.K. Their Analyser II program for the BBC computers (disk based B, B+, and Master systems) is a linear circuit analyser which can be used to model just about anything from loudspeaker cross-over networks to wideband amplifiers.

An unfortunate fact about this type of software is that it is not particularly cheap. The price of Analyser II is £130 plus VAT, which makes it by no means the most expensive program of this type. Although you could take the view that at that price you might as well build the circuits and test them.

In practice, matters are not really as simple as that. A circuit analyser provides information such as frequency response, phase response, group delay, input impedance, and output impedance. Equipment to measure all these parameters at frequencies from infra-audio through to V.H.F. would cost at least a few hundred pounds, and would probably cost thousands.

One of the selling points of circuit analyser software is that it is so accurate that the need to build and test circuits is removed. You analyse the circuit, modify it if necessary, analyse it again, and so on until satisfactory results are predicted. You can then go ahead and build the real thing, confident that it will work perfectly!

This may seem a bit far fetched, but in my experience of these programs they are remarkably good. In practice there are a couple of opportunities for errors to creep in, but provided you are careful these programs usually give very accurate performance predictions, and are of tremendous help.

The first problem is that while resistors, capacitors, inductors, and even transformers are easy enough to model accurately, active devices such as transistors and oper-

ational amplifiers are not. Factors such as the input capacitance of an operational amplifier can have a significant affect on its high frequency performance, and must be taken into account.

Circuit analysers are normally able to allow for all the important factors, as well as some relatively minor ones. The main difficulty is in finding all the information you need in order to provide the circuit with an accurate model of a particular device. Fortunately, most of these programs (including Analyser II) are supplied with a good library of component models. These will satisfy most requirements.

Problem number two is that of stray feedback over a circuit. The performance of high frequency and high gain audio circuits depends to a large extent on how well (or otherwise) the circuit board is designed.

A circuit analyser program will tell you how well a circuit should perform with a properly designed circuit board. It is up to you to ensure that the practical unit lives up to the theoretical possibilities. You can, of course, include stray capacitance and inductance in the circuit model, to determine how critical the layout of a circuit board will be.

including the input, output and earth nodes.

The source and load impedances are crucial to the performance of a circuit of this type. These cannot be set as such in Analyser II, and are preset at zero and infinity respectively. However, additional resistors (R1 and R2 in this case) can be used to effectively set either impedance at any desired level.

In the "components list" you first specify the component number. This is really just telling the program what type of component it must model (resistor, capacitor, etc.), and is for the benefit of the user (making it easier to check that the finished components list is correct). The next two columns specify the numbers of the two nodes the component is connected between, followed by the component's value.

Active devices (operational amplifiers, bipolar transistors etc.) will have three terminals rather than two. The first column must have a component number that refers to the component model stored on disk, rather than the usual TR1, IC2, etc. The next three columns are then the nodes to which the terminals connect, and these must be in a specific order. For an operational amplifier for example, the correct

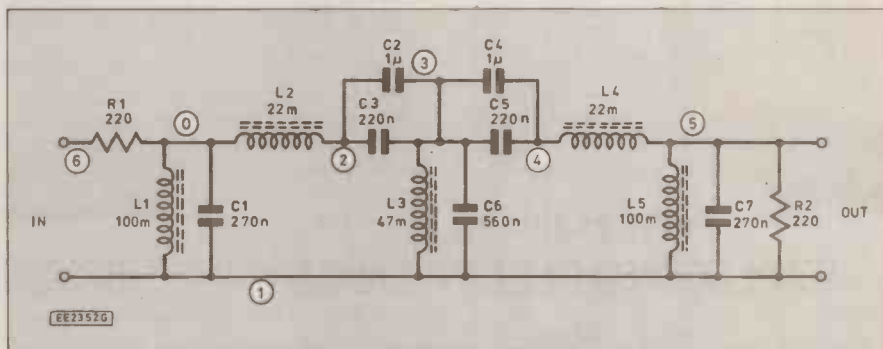

Nodes

One obvious problem with any circuit analyser is just how do you enter the circuit into the computer. This is actually a lot easier than you might think, and it does not involve any computer graphics.

The circuit is entered as what is really a form of components list, but with interconnection information in addition to component numbers and values. The interconnection data is entered in a delightfully simple manner, using a system of numbered nodes. A node is merely a group of connections on the circuit.

The circuit diagram above is part of a proposed *Everyday Electronics* Shortwave Receiver design. It is an audio bandpass filter based on a design from "The ARRL Handbook", and designed to sharply filter frequencies below about 300Hz and above 2.5kHz.

There are seven groups of interconnections, labelled "0" to "6". The numbering used is up to the user, and you do not have to use particular numbers for any nodes,

order is the non-inverting input, inverting input and output.

When all the components have been entered, the final step is to identify the input, output, and earth nodes. This is done by entering "P" (for port) as the component number, followed by the node numbers in the appropriate order.

Provided you mark the node numbers onto a copy of the circuit diagram, entering the components list and checking it for errors is a fairly straightforward business. You are then ready to analyse the circuit.

There are various options here, but normally it is absolute or relative gain that will be computed, together with phase angle. Group delay can also be computed if desired, but will make calculations take about twice as long.

There are two alternative modes available, and these permit input or output impedance to be calculated. Logarithmic or linear frequency scaling can be used, with up to 45 frequencies being used.

Programs of this type are something less

Number One Systems Linear Circuit
Analysis Program ANALYSER II (C) 1984

CIRCUIT NAME APILTBB 21/9/89

Passive B.P. Filter Response

Component list:

L1	0	1	188
C1	0	1	2.7E-7
L2	0	2	2.2E-2
C2	2	3	1E-6
C3	2	3	2.2E-7
L3	3	1	4.7E-2
C6	3	1	5.6E-7
C4	3	4	1E-6
C5	3	4	2.2E-7
L4	4	5	2.2E-2
L5	5	1	0.1
C7	5	1	2.7E-7
B1	0	6	220
B2	5	1	220
P.	6	5	1

TEST RESULTS

Frequency	Gain(dB abs)	Phase (deg)
100.00	-58.59	-28.87
111.03	-54.80	-32.26
123.28	-50.97	-36.09
136.89	-47.09	-40.47
151.99	-43.15	-45.50
168.76	-39.12	-51.34
187.38	-35.00	-58.23
208.06	-30.74	-66.51
231.01	-26.32	-76.77
256.50	-21.70	-89.99
284.80	-16.92	-107.98
316.23	-12.28	-133.50
351.12	-8.70	-167.65
389.86	-7.05	-203.41
432.88	-6.65	-232.84
480.64	-6.55	-256.24
533.67	-6.46	-276.21
592.55	-6.34	-294.37
657.93	-6.24	-311.46
730.53	-6.17	-327.81
811.13	-6.14	-343.59
900.63	-6.14	-358.95
1.00k	-6.16	-374.11
1.11k	-6.16	-389.30
1.23k	-6.16	-404.86
1.37k	-6.13	-421.13
1.52k	-6.09	-438.53
1.69k	-6.07	-457.46
1.87k	-6.07	-478.31
2.08k	-6.09	-501.58
2.31k	-6.06	-528.55
2.57k	-6.05	-563.13
2.85k	-7.36	-611.29
3.16k	-12.28	-660.03
3.51k	-18.86	-691.89
3.90k	-25.25	-712.20
4.33k	-31.21	-726.63
4.81k	-36.83	-737.72
5.34k	-42.20	-746.67
5.93k	-47.38	-754.13
6.58k	-52.42	-760.47
7.31k	-57.36	-765.93
8.11k	-62.22	-770.69
9.01k	-67.01	-774.86
10.00k	-71.76	-778.54

than instant even on quite simple circuits. Circuits with up to 100 components and 27 nodes can be accommodated, and circuits approaching these limits would take several minutes to analyse. With the demonstration filter circuit it took only a second or two per test frequency.

Analysers circuits that run on 16-bit computers (including the PC version of Analyser II) are certainly much faster, but being realistic about it, waiting a few minutes for test results is not likely to be a major problem.

It would only be a real nuisance if you needed to keep "fine tuning" a complex circuit which needed to be checked at a large number of test frequencies. This would still be much quicker than building the circuit and then making lots of component changes with a new set of tests being made after each modification.

Results are displayed in the form of a simple list of test frequencies, plus gain and phase figures for each frequency. A simple graph of results can also be displayed, and results in both forms can optionally be printed out.

Circuit values are easily changed if you should wish to make adjustments to the circuit and analyse it again. Additions to or deletions from the circuit can mostly be handled without too much difficulty as well.

The Analyser II and similar programs are certainly the type of software which the average electronics experimenter would find very useful. It is a great pity that specialised programs of this type are (understandably) quite expensive. They are complex programs which clearly lack mass appeal, and are never likely to be available at games software prices.

Master 512 users might like to note that there is a "shareware" disk called "ACIRAN" which is available from a number of IBM PC PD/shareware distributors. I do not know if this program is compatible with the Master 512, but it would be worth a try.

It is quite a fast and very accurate circuit modeller, and it only costs £10 if you decide to go on using it and register your copy (or £50 if you purchase the "mega" version which can handle vast circuits). It is certainly one of the better shareware programs available, and unlike many, it does seem to be fully operational!

Compatibility

It became something of a bad joke some years ago when virtually every computer project that was published had a line in the

article or heading piece that ran something like "easily adapted to suit other computers." In some cases it was probably true, but the fact of the matter is that the ports present on various computers tend to be substantially different. If you look at the expansion ports of two computers based on the same microprocessor you might reasonably expect them to be very similar, with the method of interfacing to them being exactly the same.

In practice most home computers seem to use slightly non-standard methods of interfacing, a factor which tends to give severe difficulties when trying to interface an add-on for one computer to what superficially seems to be a similar machine. I suppose that the BBC computers fall into this category to some extent, with a 2MHz microprocessor and a 1MHz expansion bus. However, provided the page select clean-up circuits are included where appropriate, the 1MHz Bus can be treated as a standard 6502 1MHz buffered expansion bus.

The projects that are most easily "ported" from one computer to another are those that fit onto a standard port such as an RS232C/RS423 type. These should work with any computer that has sufficient computing power to utilize them properly, but do not overlook the fact that any software for such an add-on will almost certainly have to be totally rewritten to suit the BBC computer.

The next most easy to accommodate are those that fit onto a user port. Unfortunately, few home computers have something comparable to the BBC computer's user port. The Commodore VIC-20 has an almost identical port, and I believe that some of the PET computers do as well.

The Commodore 64 and its derivatives also have a user port, but this is based on a modified 6522 VIA, the 6526 CIA (complex interface adaptor). This has the usual eight bit parallel input/output port, but the handshake lines are slightly different to those of the 6522. The timer/counters are also implemented in a slightly different fashion. In most cases there should be little difficulty in setting up the BBC computer's 6522 to mimic the 6526.

The following table lists the addresses for the VIC-20 and BBC model B user port registers. It also gives the data direction register and port B register addresses for the Commodore 64's 6526, which are the only two registers that are directly comparable to those of the 6522:

REGISTER	BBC B	VIC-20	C64
Port B	&FE60	37136	56576
Port A	&FE61	37137	56577
Data Direction B	&FE62	37138	56578
Data Direction A	&FE63	37139	56579
Timer 1 Counter Low Byte	&FE64	37140	
Timer 1 Counter High Byte	&FE65	37141	
Timer 1 Low Byte	&FE66	37142	
Timer 1 High Byte	&FE67	37143	
Timer 2 Low Byte	&FE68	37144	
Timer 2 High Byte	&FE69	37145	
Shift Register	&FE6A	37146	
Auxiliary Control	&FE6B	37147	
Peripheral Control	&FE6C	37148	
Interrupt Flags	&FE6D	37149	
Interrupt Enable	&FE6E	37150	
Port A (No Handshake)	&FE6F	37151	

Next Month: We will take a more detailed look at adding add-ons for other computers to the BBC machines.

MAKING ELECTRONICS C.A.D. AFFORDABLE

TINY PC

PCB CAD, FOR THE PC/XT/AT

EASY-PC

- Are you still using tapes and a light box?
- Have you been putting off buying PCB CAD software?
- Have you access to an IBM PC/XT/AT or clone?
- Would you like to be able to produce PCB layouts up to 17" square?
- With up to 8 track layers and 2 silk screen layers?
- Plus drill template and solder resist?
- With up to eight different track widths anywhere in the range .002 to .531"?
- With up to 16 different pad sizes from the same range?
- With pad shapes including round, oval, square, with or without hole and edge connector fingers?
- With up to 1500 IC's per board, from up to 100 different outlines?
- With auto repeat on tracks or other features — ideal for memory planes?
- That can be used for surface mount components?
- With the ability to locate components and pads on grid or to .002" resolution?
- With an optional auto via facility for multilayer boards?
- With the ability to create and save your own symbols?
- That can be used with either cursor keys or mouse?
- That is as good at circuit diagrams as it is at PCB's?
- Which outputs to dot matrix printer, pen-plotter or photo-plotter (via bureaux)?
- Where you can learn how to use it in around an hour?

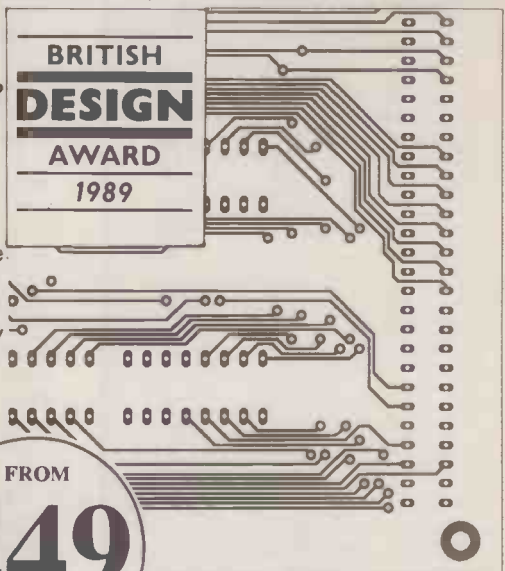

FROM
£49
inc VAT

SMITH CHART PROGRAM —

ZMATCH

CIRCUIT ANALYSIS BY COMPUTER —

ANALYSER II

For IBM, PC/XT/AT and clones inc. Amstrad 1512 and 1640 and BBC B, B+ and Master.

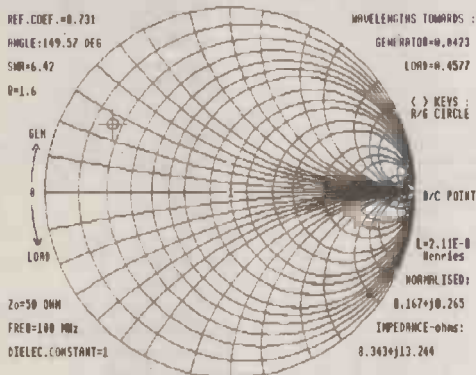

Z-MATCH — Takes the drudgery out of R.F. matching problems. Includes many more features than the standard Smith Chart.

Provides solutions to problems such as TRANSMISSION LINE MATCHING for AERIALS and RF AMPLIFIERS with TRANSMISSION LINE, TRANSFORMER and STUB MATCHING methods using COAXIAL LINES, MICROSTRIP, STRIPLINE and WAVEGUIDES. The program takes account of TRANSMISSION LINE LOSS, DIELECTRIC CONSTANT, VELOCITY FACTOR and FREQUENCY.

Z-MATCH is supplied with a COMPREHENSIVE USER MANUAL which contains a range of WORKED EXAMPLES.

£130 ex VAT for PC/XT/AT etc.
£65.00 ex VAT for BBC B, B+ and Master

For IBM, PC/XT/AT and clones inc. Amstrad 1512 1640, R.M. NIMBUS, and BBC B, B+ and Master.

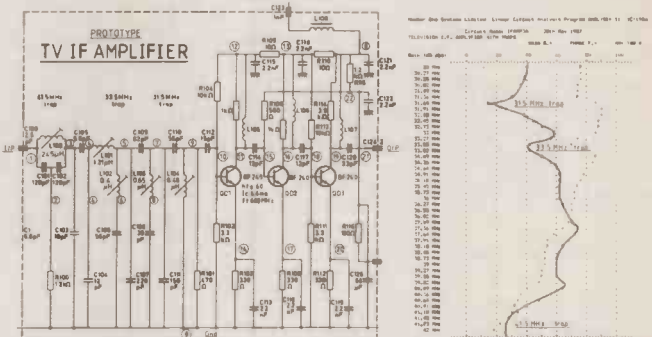

"ANALYSER II" — Analyses complex circuits for GAIN, PHASE, INPUT IMPEDENCE, OUTPUT IMPEDENCE and GROUP DELAY over a very wide frequency range.

Ideal for the analysis of ACTIVE and PASSIVE FILTER CIRCUITS, AUDIO AMPLIFIERS, LOUDSPEAKER CROSS-OVER NETWORKS, WIDE BAND AMPLIFIERS, TUNED R.F. AMPLIFIERS, AERIAL MATCHING NETWORKS, TV I.F. and CHROMA FILTER CIRCUITS, LINEAR INTEGRATED CIRCUITS etc.

STABILITY CRITERIA AND OSCILLATOR CIRCUITS can be evaluated by "breaking the loop"

Can save days breadboarding and thousands of pounds worth of equipment.

£195 ex VAT for PC/XT/AT etc.
£130 ex VAT for BBC B, B+ and Master

All major credit cards accepted
WRITE OR PHONE FOR FULL DETAILS:- REF: EVD

Number One Systems Ltd

Harding Way, St Ives, Huntingdon, Cambs. PE17 4WR
Tel: St Ives (0480) 61778 (5 lines)

We provide full after-sales support with free telephone 'hotline help' service.

Software updates are free within 6 months of purchase date.

EVERYDAY ELECTRONICS



INCORPORATING ELECTRONICS MONTHLY

SUBSCRIPTION ORDER FORM

Annual subscription rates (1990): UK £16.00. Overseas £19.50 (surface mail) £37 (air mail)
 To: Everyday Electronics, Subs. Dept., 6 Church Street, Wimborne, Dorset BH21 1JH.

Name.....

Address.....

I enclose payment of £..... (cheque/PO in £ sterling only payable to Everyday Electronics)
 Access or Barclaycard/Visa No.  

--	--	--	--	--	--	--	--	--	--	--	--	--	--	--	--	--	--	--	--

Signature..... Card Ex. Date.....

Please supply name and address of card-holder if different from the subscription address shown above.

Subscriptions can only start with the next available issue

SURVEILLANCE

PROFESSIONAL QUALITY KITS

A range of high quality kits as supplied to leading UK security companies, all in-house designed and produced, not to be confused with cheap imports. All kits come fully documented with concise assembly and setting-up details, fibreglass PCB and all components. All transmitters are fully tuneable and can be monitored on a normal VHF radio or tuned higher for greater security. Build up service available if required.

- MTX. Micro-miniature audio transmitter. 17mm x 17mm. 9V operation. 1000m range **£12.95**
- VT500. Hi-power audio transmitter. 250mW output. 20mm x 40mm 9-12V operation. 2-3000m range **£15.95**
- VOX75. Voice activated transmitter. Variable sensitivity. 30mm x 40mm. 9V operation. 1000m range **£18.95**
- CTX900. Sub-carrier scrambled audio transmitter. Cannot be monitored without decoder fitted to radio. 30mm x 40mm. 9V operation. 1000m range **£21.95**
- DSX900. Sub-carrier decoder unit for monitoring CTX900. Connects to radio earphone socket. Provides output for headphones. 35mm x 50mm. 9-12V operation **£21.95**
- HVX400. Mains powered audio transmitter. Connects directly to 240V AC supply. 30mm x 35mm. 500m range **£18.95**
- XT89. Crystal controlled audio transmitter. High performance. 100mW output. Supplied with xtal for 108MHz. Others available to 116MHz. 85mm x 28mm. 9V operation. 2-3000m range **£36.95**
- TKX900. Tracker/Beeper transmitter. Transmits continuous stream of audio pulses. Variable tone and rate. Powerful 200mW output. 63mm x 25mm. 9V operation. 2-3000m range **£21.95**
- ATR2. Micro size telephone recording interface. Connects between telephone line (anywhere) and cassette recorder. Tape switches automatically with use of phone. All conversations recorded. Powered from line 10mm x 35mm **£12.95**
- TLX700. Micro miniature telephone transmitter. Connects to line (anywhere) switches on and off with phone use. All conversations transmitted. 20mm x 20mm. Powered from line 1000m range **£12.95**
- XML900. RF bug detector. Variable sensitivity. Triggers LED and beeper when in presence of RF field. Detects MTX 15-20 feet. 55mm x 55mm. 9V operation **£26.95**
- XL7000. Professional bug detector locator. Variable sensitivity. Twin mode ten segment LED readout of signal strength with variable rate beeper. Second mode AUDIO CONFIRM distinguishes between localised bug transmission and normal legitimate signal such as pagers, cellular etc. 70mm x 100mm. 9V operation **£54.95**

UK customers please send cheques, PO's or registered cash. Please add £1.50 per order for P&P. Goods despatched ASAP allowing for cheque clearance. Overseas customers send sterling bank draft or Eurocheque and add £5.00 per order for shipment. Credit card orders accepted on 0827 714476. Full catalogue available on receipt of 28p stamp. Trade enquiries welcome.



The Workshops, 95 Main Rd
 Baxterley, Nr. Atherstone
 Warks CV9 2LE



0827 714476

Remember the new
 Component Catalogue
 available from
 early 1990

CRICKLEWOOD ELECTRONICS

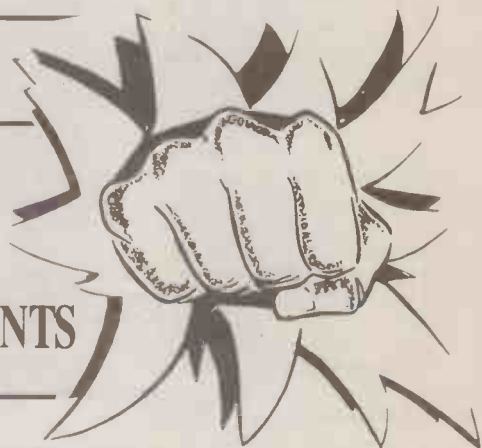

THE BIG PUNCH IN ELECTRONIC COMPONENTS

- ONE OF THE LARGEST RANGES OF COMPONENTS IN THE UK
- FAST AND EFFICIENT SAME DAY PERSONAL SERVICE
- VERY COMPETITIVE PRICES; QUANTITY DISCOUNTS AVAILABLE
- DISCOUNT VOUCHERS INCLUDED
- NO MINIMUM ORDER

FILL IN THE COUPON AND POST IT WITH YOUR CHEQUE, PO ETC FOR £1.50 TO RECEIVE YOUR 1990 CRICKLEWOOD ELECTRONICS CATALOGUE AND VOUCHERS WHICH YOU CAN USE AGAINST YOUR NEXT PURCHASE

Cricklewood Electronics Ltd
 40 CRICKLEWOOD BROADWAY, LONDON, NW2 3ET
 Tel: 01-450 0995/452 0161
 Fax: 01-208 1441 Telex: 914977

CRICKLEWOOD ELECTRONICS 1990 COMPONENTS CATALOGUE

PLEASE SEND COPIES OF THE 1990 CRICKLEWOOD ELECTRONICS CATALOGUE AT £1.50 TO:

NAME.....

ADDRESS.....

.....

.....

.....

Remittance enclosed £.....

ACTUALLY DOING IT!

by Robert Penfold

WHAT PROBABLY rates as the most difficult problem when soldering components onto a circuit board is that of finding enough hands to hold everything. You need one hand to hold the soldering iron, a second to feed in the solder, and at least one more to hold everything in place!

You would think that by now there would be no end of gadgets which solved the problem by one means or another, including at least one perfect solution. There are certainly items of equipment which go some way to solving this difficulty, but I have yet to come across a piece of equipment that I could honestly describe as a complete solution.

Many project constructors devise their own answer to the problem. A method I often use is to hold the soldering iron in one hand and the circuit board plus component in the other. This does not leave a hand free to hold the solder, but I get around this problem by having several inches of solder pulled out from the reel. This is left sticking out over the edge of the workbench, and I take the board and soldering iron to the solder, rather than the other way round.

This may seem to be a slightly cumbersome method of working, which I suppose in truth it is. I still find it to be what is in many cases the easiest method of putting circuit boards together. Plenty of other people opt for this, or some similar method of soldering, and systems of this type become quite fast and efficient once you have become used to them.

FRAME UP

The most sophisticated solution to the problem is to use a printed circuit assembly frame. The exact form these take varies from one unit to another, but

they all consist of some form of adjustable frame into which the board is fitted, plus a thick piece of soft plastic foam material.

The printed circuit board is fitted into the frame with its component side towards the foam material, and the foam is clipped firmly down onto the board. This should hold all the components firmly in place, when the board is turned copper side uppermost so that the soldered joints can be made.

An attraction of this method is that you do not have to fit and solder the components one at a time. It is quite possible to fit all the components, mount the board in the printed circuit frame, trim the leadout wires, and then complete all the soldered joints in one sustained operation.

On the face of it this might not seem to offer any great advantage, but in practice it is much quicker. You do not spend a lot of time swopping between using the wire cutters and the soldering iron. Printed circuit frames are much used in the production of ready-made electronic equipment which is hand soldered, and a similar technique is used for boards that are built using some form of automatic soldering.

Printed circuit frames are very useful tools, but they do not always give the desired result. Some printed circuit frames are better than others, and it is generally the ones which have thick but highly compressible pieces of foam that work best.

The most common problem is illustrated in Fig. 1. In (a) the printed circuit frame works well because the components are of uniform height. In (b) there is a large radial electrolytic capacitor which is more than the foam can cope with. The foam is held clear of any small components which may well fall out of

place when the board is turned copper side uppermost.

Obviously not all boards include tall components which will give this problem. There is a simple solution anyway, which is to fit and solder in place all the small components first. Then the larger components are fitted and connected. If there are components covering a wide variety of sizes, then it might be necessary to add them in three or four batches, starting with the smallest components and working up to the largest.

The biggest drawback of using a printed circuit frame is probably the cost. A good quality frame can easily cost as much as two or three average size projects.

For a company assembling printed circuit boards it is a case of "time is money", and the cost of a printed circuit frame will soon be recouped. The home constructor is not necessarily in any great hurry to complete each project.

If you can afford one, and you are likely to build a large number of circuit boards over a period of time, then it is probably worth buying one. Surplus printed circuit frames at low prices turn up from time to time, and it is well worth buying one of these if the opportunity arises.

WIRE BENDING

If funds will not stretch to the purchase of a printed circuit frame, or the number of projects you build simply does not justify the cost, there are some low cost alternatives. One of these is to improvise your own printed circuit frame. It does not need to be anything particularly sophisticated.

Something suitable can probably be put together from a couple of sheets of aluminium, a piece of foam material, and some G-clamps. Make sure that the unit does reliably hold the components firmly against the board though. As I have pointed out before, leaving a gap between a component and the board is asking for trouble. Any pressure on the component could break the pad away from the board, probably breaking one or two tracks in the process as well.

A very basic method I have found to be quite successful is to use some Bostik Blue-Tack or a similar material to temporarily fix components in position while you solder them to the board. With a printed circuit frame you can fit all the components to the board and then start connecting them, but with this simplified method it is probably best to deal with the board on the basis of a few square inches at a time.

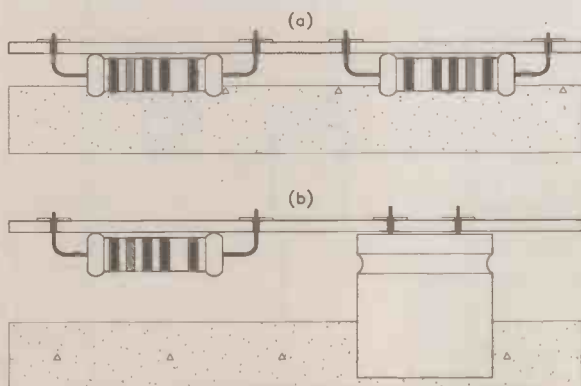
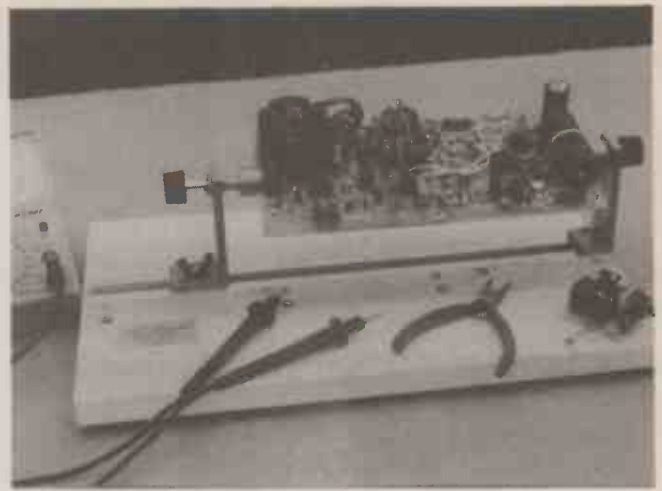

Fig. 2. By cutting and kinking lead-out wires, a special wire cutting tool fixes components in position.

Fig. 1 (left). In (a) the printed circuit frame gives the desired result, but in (b) the height of the radial capacitor is giving problems.



The Dymo labelling gun plus some example labels.



A useful "third hand" from Everett Workshop Accessories.

A wire cutting tool which makes building printed circuit boards a relatively simple task was obtained recently. The idea of the tool is that it not only cuts the wire when you trim the leadouts, but it also bends the end of the wire at right angles (as in Fig. 2.).

The illustration on the box suggests that this tool is meant to be used in conjunction with a printed circuit frame. However, there seems to be no problem if you hold a component in position, trim off its leadout wires, and then turn the board over while you solder it in place.

The bent-over leadout ends hold the component in position while you complete the joints. In fact it seems to be quite possible to fit a number of components, then turn the board over and connect them all.

This is quite a quick and convenient method of working, but there are one or two points to keep in mind. It is unlikely to work with d.i.l. integrated circuits, since these mostly have short pins which do not need trimming on the underside of the board. The same problem exists even if you fit them in holders, which mostly have short pins.

Printed circuit mounting relays and a few other components also have short pins and will presumably be subject to the same problem. Some other method would therefore have to be adopted for these components.

Many modern printed circuit boards have extremely small pads. You need to

be careful that the bent-over piece of wire does not bridge over to the next pad. This means cutting the wire so that the bent-over section runs along a track leading into the pad, but this is only necessary when dealing with wires that connect to really small pads. It is also advisable to have the ends of the leadout wires going "with the grain" when using stripboard.

One further slight drawback is that removing components will be relatively difficult, if this should become necessary at some time. The kinked leadout wires will tend to hold the components in place even when the solder has been removed.

However, it is not excessively difficult to remove components fitted in this way, especially if you have proper desoldering equipment (something every constructor should try to get at an early stage). With the solder removed the leadout wires can be straightened using the blade of a small screwdriver, taking care not to damage any of the pads or tracks.

Although I have not yet used this type of wire clipper extensively, it certainly seems to be a good idea. It is a tool I have no hesitation in recommending.

LABELLING POSTSCRIPT

In the previous *Actually Doing It* article I mentioned tools for making inexpensive self-adhesive labels. At that time I had been unable to obtain one of

these. A more recent attempt was more fruitful, and I managed to track down one of these "Dymo" labellers at a local Woolworths store.

The labels are produced on six millimetre wide self-adhesive tape, and the lettering is about three millimetres high. This is about right for labelling controls, sockets, etc.

The tape is available in several colours, but there is an inverse Ford choice for the embossed lettering (which is always white). Making the labels is about as simple as it could be — you simply dial up the first letter, press a lever, dial up the next letter, press the lever again, and so on.

It has to be pointed out that the quality of the lettering is not equal to that obtained using rub-on lettering, or most of the other methods mentioned in the previous article. On the other hand, the labelling tool plus a two metre reel of tape costs only a couple of pounds or so, and extra reels of tape cost under a pound. It represents a very quick and inexpensive method of making labels of reasonable quality. In fact, it must be the quickest and easiest method yet devised.

It is certainly something worth considering if you are not keen on this aspect of construction, and normally do not bother fitting panels with legends. With this system it should take no more than a few minutes of not particularly skilled work in order to produce a fully labelled panel.

PLEASE TAKE NOTE

TWO TONE SIREN (November 1989)

Transistor TR1 in Fig. 2 and the components list should be a BC107. This was changed from the original — see the Editorial in this issue. The designer Chris Bowes writes;

"The BC107 (TR1) specified by me is correct and the circuit as drawn and constructed by me works as described in the text. Indeed the whole principal of the operation of this part of the circuit relies on the use of an *npn* transistor in this rather unusual configuration, (ie. with its emitter connected to the more positive voltage rail) in which case it acts as a saturable switch instead of the more conventional common emitter connection, as substituted.

The whole basis for the action of the transistor in this configuration is that the base has to be driven so that the collector of the *npn* transistor is negative with respect to the base. This causes the base/collector junction to be forward biased. Thus, with both of the transistor's junctions forward biased, the transistor is virtually a short circuit and can be used to switch out VR2. It is because of the unusual configuration of this transistor that we can dispense with the base resistor commonly associated with the emitter follower type circuit. In the circuit as substituted the transistor is not in fact shorting out VR2 when the output IC1a goes to + volts but is acting as an emitter follower reducing the voltage across VR2, VR3, R4 and C3 to 0.7 volts (with respect to ground) when the output of IC1a goes to 0 volts.

A section of the correct circuit

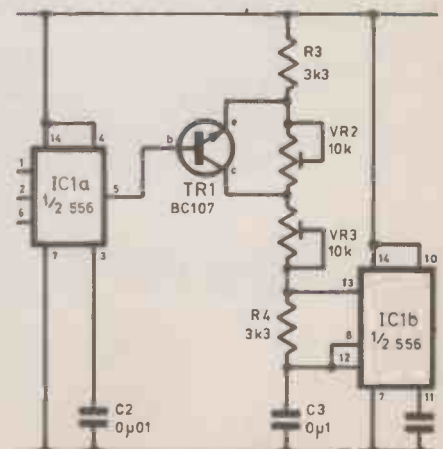

JUST RELEASED!



TESTATION 4445 £525

Now you don't have to take up valuable bench space as the Crotech 4445 gives you a 25MHz Dual Trace Scope, DC Power Supply, Component Comparator, 35MHz Frequency Counter, and 100kHz Function Generator all in one instrument.

OSCILLOSCOPE: As per 3133 Dual Trace 25MHz Oscilloscope.

100kHz FUNCTION GENERATOR

FREQUENCY RANGE: 1Hz-100kHz in 5 decade ranges, push switch selectable
 FREQUENCY ACCURACY: +/- 10%
 WAVEFORMS: Sine, Square, Triangular and TTL
 AMPLITUDE: 7.5V P-P into 600Ω (max)
 15V P-P open circuit

35MHz FREQUENCY COUNTER

DISPLAY: 8 digit I.e.d. display, indicates frequency in MHz
 RANGE: 20Hz-35MHz
 RESOLUTION: 1Hz and 10Hz selected by push button control
 ACCURACY: +/- 20 PPM at 25°C



TYPE 3133 DUAL TRACE 25MHz £299

- ★ D.C. — 25MHz
- ★ 2 mV/div Calibrated
- ★ Algebraic Addition and Subtraction
- ★ X-Y operation
- ★ 40ns/div to 0.2s/div Timebase
- ★ Triggering to 40MHz
- ★ TV Frame + Line Trigger
- ★ Z Modulation
- ★ 10 x 8 Div Display
- ★ Variable Hold Off
- ★ Component Comparator
- ★ Triple Output D.C. Source

3133 is value engineered to combine a sleek elegant style and meet the stringent specification requirements of a laboratory standard Dual Trace Oscilloscope. The vertical Bandwidth of 25MHz is complimented by 12 position attenuator giving fully calibrated deflection coefficients from 2mV to 10V/Div. Both vertical channels can be added whilst inversion of channel 2 gives algebraic subtraction, the vertical operating modes also include X-Y. The 3133 incorporates a wide range timebase from 40ns to 0.2s/Div, with triggering to 40MHz. A further benefit of the timebase is the variable Hold Off which facilitates reliable triggering on complex and aperiodic waveforms. Crotech's well proven Component Comparator, for the in or out of circuit testing of both active and passive devices, is a built-in feature. A further plus is the Triple Output DC Source with +5V/1A and ± 12V/200mA rating. All these benefits give the 3133 an excellent performance/cost ratio.

EVERYDAY ELECTRONICS is pleased to be able to offer these quality CROTECH oscilloscopes to readers at special discount prices which include VAT and delivery. The 'scopes can be purchased using Access/Visa/ American Express to spread the load.

Any of these three items could be an invaluable addition to the test gear used by an amateur or professional engineer. Each unit is supplied with an input lead, instruction manual and a free copy of "Getting The Best From Your Scope" (36 page booklet.) Additional probes and accessories are also available including type 307 switched probes at £10 each if ordered with an oscilloscope.

ALL CROTECH PRODUCTS ARE COVERED BY A TWO YEAR GUARANTEE.

Unfortunately we can only make this offer to UK readers, overseas readers write for quote on delivery.



TYPE 3031 SINGLE TRACE 20MHz £250

- ★ D.C.-20MHz Bandwidth
- ★ 2mV/div Sensitivity
- ★ 40ns/div Timebase
- ★ Triggering to 25MHz
- ★ 10 x 8 Div. Display
- ★ Regulated D.C. Supplies, including E.H.T.
- ★ Built-in Component Tester

Designed to meet today's demand for high performance from a Single Trace Oscilloscope, while maintaining the optimum in styling and a compact size. The full Bandwidth of 20MHz is ideally complimented by Deflection Coefficient from 2mV to 10V/div allowing the investigation of a very wide range of circuits. Timebase is specified from 40ns to 0.2s/div with comprehensive trigger facilities up to 25MHz.

The built-in Component Tester allows the in or out of circuit testing of both active and passive components, such as FET's Bipolars, Zeners, along with capacitors and inductors. This facility extends the use of the 3031 beyond the capabilities of just a normal scope.

Post to: Crotech Instruments Ltd., 2 Stephenson Road, St. Ives, Huntingdon, Cambridgeshire PE17 4WJ. Tel: 0480 301818.

EE/CROTECH OSCILLOSCOPE OFFER (UK READERS ONLY)

Please Supply		Total Value
Quantity		
	4445 @ £525	£
	3133 @ £299	£
	3031 @ £250	£
	Probes @ £10	£
TOTAL		£

Prices include VAT and delivery

Card Ex. Date

Access/Visa/Am. Ex. No.

Signature

I enclose cheque No.

Name

Address

Please allow 28 days for delivery
OFFER CLOSES Friday 27 January 1990

PLUS 7½% DISCOUNT on any other Crotech products (not on special offer) until January 27, 1990.

BIOFEEDBACK SIGNAL GENERATOR

ANDY FLIND

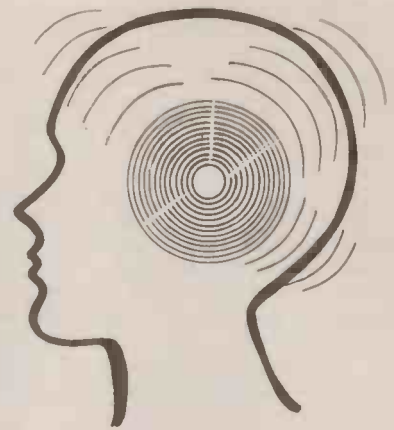

Provides suitable test signals at the correct amplitude to enable "brainwave" equipment to be tested.

A PROBLEM for biofeedback enthusiasts, especially those working with EEG (Electroencephalograph) "brainwave" instruments, is the generation of suitable test signals. These should be sub-audio in frequency, from almost zero to about thirty Hertz, and of sinusoidal waveform. A particular difficulty is that where the signals are to be applied to the input of the circuit, they will need to simulate the very low amplitude of the real thing, usually about five to fifty microvolts r.m.s.

Simple resistive dividers may not deliver the expected level due to stray capacitive coupling, and the equipment available to most amateurs is not capable

Since much EEG equipment design centres around the filters, the capacitors or resistors in these can usually be scaled by a factor of ten for a corresponding shift in operating frequency, making their action much easier to observe and measure with standard test equipment. Once a filter's action is satisfactory, it can be set to the correct operating frequency by replacing the appropriate components.

A low-level output, of zero to a hundred microvolts, simulates genuine EEG signals. Two higher level outputs, to a hundred millivolts and one volt, enable testing of parts of the circuit operating at such levels. The output is controlled by a log potentiometer, giving a useful

The classic op-amp integrator circuit also inverts, meaning that the output ramps at a rate directly proportional to the input voltage, but opposite in polarity. The rate at which the output of A2 ramps in this circuit is set by C and R. The Schmitt trigger A1's output changes state when the input, from A2, exceeds the fixed voltage level, positive and negative, set by RA and RB.

The circuit looks a bit like the classic "inverting amplifier", but the op-amp inputs are reversed so the feedback is positive, giving a "snap" output action. It has only two states, high and low. A proportion of this output is returned to the integrator input from frequency control VR.

If it is assumed that the output of A1 is high, or positive, the output of A2 will ramp down until it reaches the point where the output of A1 switches low. Then it will ramp up again until A1 goes high, and so on.

The output from A2 is therefore a triangle wave with an amplitude set by the switching points of A1 and with frequency controlled by VR. The advantages of the circuit, apart from simplicity, are a constant amplitude output and an almost linear control of frequency with the variable resistor VR, providing it is a linear type and the value of R is high in comparison with it.

CIRCUIT DESCRIPTION

Moving to the full circuit of the Biogen generator, Fig. 2, IC1 produces a 5V reference from the 9V battery supply. IC2a, with divider resistors R1 and R2, creates a second reference of 2.5V, which becomes the "ground" for the rest of the circuit.

With the ability of its output to switch all the way from rail to rail, the CA3130 CMOS op. amp was chosen for the Schmitt trigger circuit IC3. Since this chip is powered from the 5V supply the output effectively swings plus and minus 2.5 volts about "ground".

Frequency control VR1 passes a proportion of this to IC2b, the integrator. Resistor R5, with capacitor C6 or C7, sets the integrator response rate, selectable by switch S1b. Its output ramps between plus and minus half a volt about the 2.5V

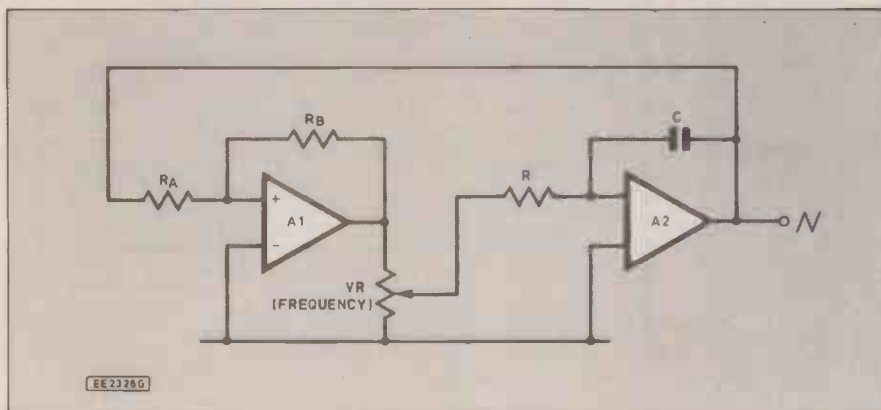

Fig. 1. Simplified circuit of the Biogen oscillator.

of measuring such tiny amplitudes at low frequencies to verify that the test signals are indeed what they should be. To overcome this problem before commencing the design of some EEG equipment, this purpose-built signal generator was constructed.

Two frequency ranges are provided. The first is from zero to around thirty-five Hertz, the range required for EEG signal simulation. The second multiplies this by ten, giving zero to three hundred and fifty Hertz.

"spread" to the lower part of the ranges, up to about thirty. All these amplitudes are "RMS", their "peak-to-peak" values being nearly three times higher.

HOW IT WORKS

The heart of the circuit is an oscillator which may be familiar to readers from previous projects by this author. The arrangement is shown in simplified form in Fig. 1. Two op-amps are used, the first, A1, forming a "Schmitt trigger" and the second, A2, an integrator.

ground rail, so the input signal to resistor R6 is a triangle wave of about one volt peak-to-peak.

As stated earlier, the output should be a sinewave. Shaping of the triangular waveform into a sine is achieved by IC2c, with a non-linear diode feedback network.

Three diodes are effectively in series in the feedback path for either input polarity, and their forward conformance characteristics shape the output very close to the waveform required. It isn't perfect, and is slightly temperature sensitive due to diode characteristics, but it is quite sufficient for the intended use. Potentiometer VR2 controls output level.

The low-pass passive filter resistor R8 and capacitor C8 removes residual spikes and glitches whilst IC2d buffers the signal and amplifies it slightly, to bring it to the final level required, adjustable with preset VR3. IC2, a TL064 quad op-amp, is a device with a low operating current, very high input impedance, and fairly low noise characteristics, making it an ideal choice for this project.

The output signal from the p.c.b. from resistor R11, is a one volt r.m.s. sinewave. Divider stages produce the lower level outputs from this. As well as resistors, these dividers include capacitors (C9-C12) to swamp possible errors from stray capacitance.

These components are mounted directly onto the output sockets to minimise stray coupling to their low-level sides. If care is taken with layout it is reasonable to assume that the 0 to 100 microvolt range will be correct, and experience with the prototype suggest that this is indeed so.

COMPONENTS

Resistors

R1, R2,		R9	56k
R8, R14	10k (4 off)	R10	6k8
R3, R15	100k (2 off)	R11	220
R4, R6	22k (2off)	R12	1M
R5	330k	R13	100
R7	82k	R16	1k

All 0.6W 1% metal film

Potentiometers

VR1	10k rotary carbon, lin
VR2	10k rotary carbon, log
VR3	10k min. skeleton preset, hor.

Capacitors

C1	470 μ axial elec. 10V
C2, C3,	
C7, C11	100n polyester layer (4 off)
C4	100 μ axial ld elec. 10V
C5	10 μ axial ld elec. 25V
C6	10n polyester layer.
C8	22n polyester layer.
C9	100p polystyrene
C10, C12	1 μ polyester layer (2 off)

**Shop
Talk**
see page 64

Semiconductors

D1, D2,	1N4148 silicon diode (5 off)
D3, D4, D5	
IC1	μ A78L05 5V 100mA positive regulator
IC2	TL064 quad op-amp, f.e.t. inputs.
IC3	CA3130E CMOS op-amp

Miscellaneous

S1	2-pole 3-way rotary switch
SK1-SK3	Phono chassis sockets (3 off)

Printed circuit board, available from *EE PCB Service*, code EE666; case, ABS box 150mm x 80mm x 50mm; pointer knobs (3 off); 8-pin d.i.l. socket; 14-pin d.i.l. socket; battery holder for 6 "AA" cells, with connector; double-sided adhesive foam tape; connecting wire; solder, etc.

Approx. cost
Guidance only

£15

Fig. 2. Full circuit diagram for the Biofeedback Signal Generator (Biogen).

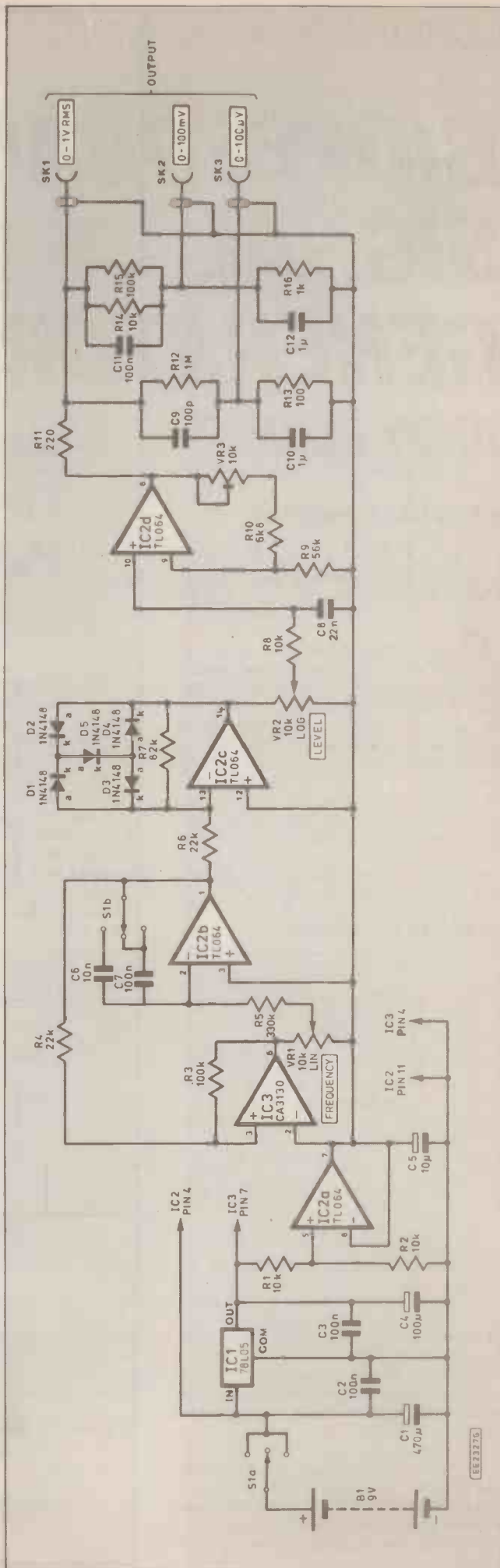

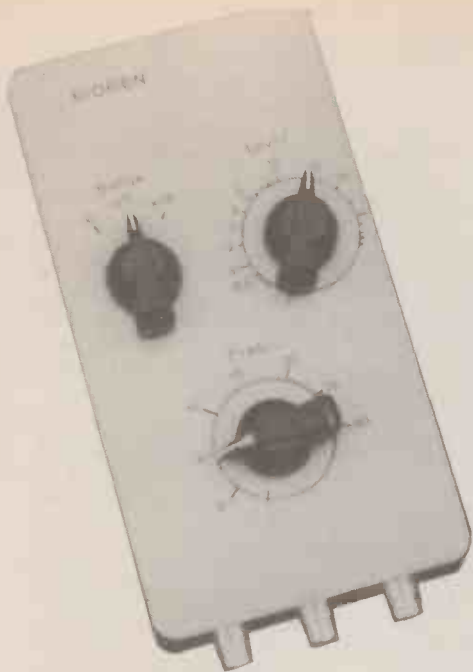

CONSTRUCTION

Most of the components for the Biogen project are mounted on a small, single-sided printed circuit board, the layout of which is shown in Fig. 3. This board is available from the *EE PCB Service*, code EE666.

Construction should present no special problems. There are two wire links on the board. The polyester capacitors are the silver-coloured, miniature layer type. In the author's experience the 22p (C8) version of these may be one of two sizes, so the board has hole spacings to suit either.

Care should be taken to ensure diodes D1 and D5 are mounted the correct way round. As always, sockets are advisable for the d.i.l. i.c.s, IC2 and IC3. IC3 is a CMOS component, so precautions against static damage should be observed.

BOARD TESTING

For testing, potentiometer controls VR1 and VR2 and capacitor selection switch S1b should be connected to the board as shown in Fig. 5. IC2 and IC3 should not be fitted yet.

If a 9V supply is applied to the board the drain, following the initial surge as the capacitors charge, should be about 2.5mA. A check across capacitor C4 should reveal the presence of the 5V reference supply.

Following this the remaining two i.c.s can be inserted in their sockets and the board powered again. The drain should now be about 3.5mA.

The output can be viewed either on a 'scope or, if the frequency is set just above zero with VR1, it can be seen on an analogue voltmeter! If it fails to appear, a few simple checks may help. IC2 pin 7 should be 2.5V above negative supply. This will also appear across C5, the 10µF capacitor.

IC2 pin 1 should be ramping to half a volt above and below the "ground", or between 2V and 3V above the negative supply and 5V.

An output variation of about a volt to each side of ground should be apparent at pin 14 of IC2. Finally, if VR2 (Level) is turned right up, IC2 pin 8 should swing around 1.4V to each side of "ground", though the exact value will be set up later with preset VR3.

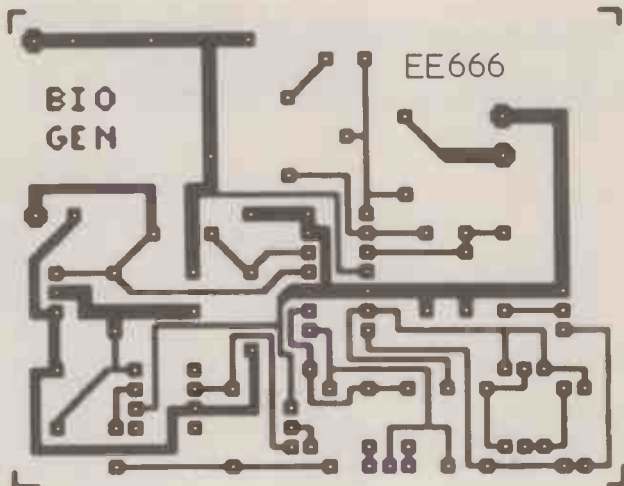
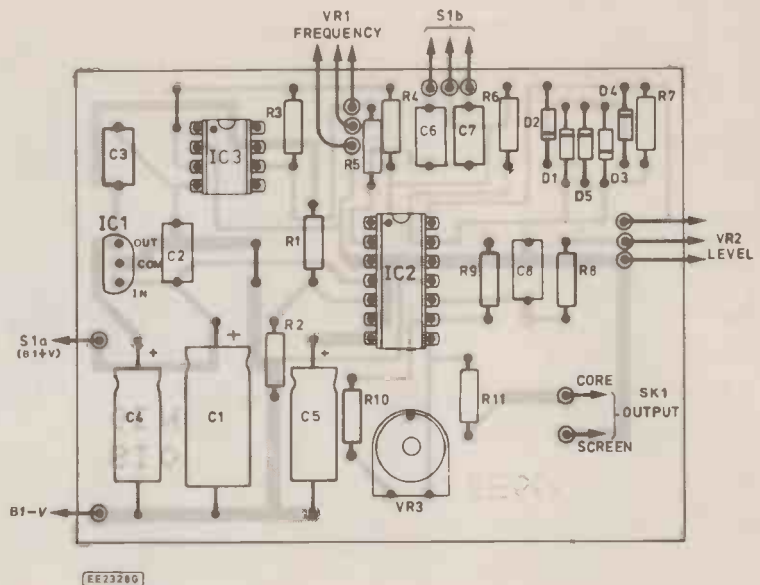
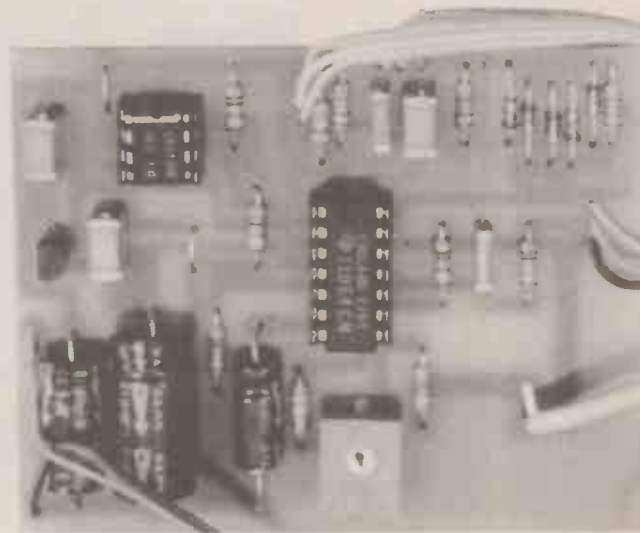

Fig. 3. Printed circuit board component layout and full size copper foil master pattern. This board is available from the *EE PCB Service*, code EE666.



Components mounted on the completed circuit board. The i.c.s should be mounted in sockets as shown here.

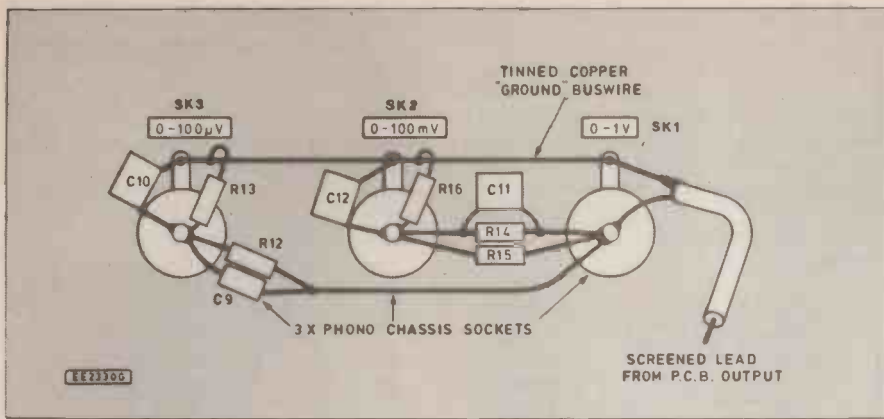

Fig. 4. Wiring the output attenuator components on the rear of the phono sockets SK1, SK2 SK3.

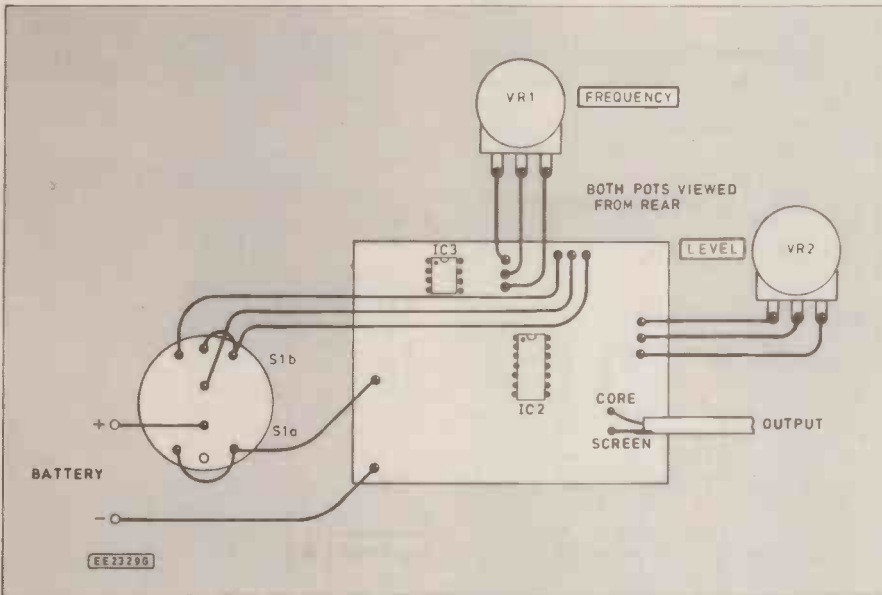

Fig. 5. Wiring from the circuit board to case mounted components.

CASE

The case for this project is a 150mm x 80mm x 50mm ABS plastic box. To keep stray coupling to a minimum, the output attenuators are constructed directly onto the rear of the three phono output sockets as shown in Fig. 4.

The p.c.b. is attached to the lid of the box with a piece of double-sided adhesive foam tape, and connected to switch S1 and the controls as shown in Fig. 5. The prototype switch provided three positions, Zero to 35Hz, Zero to 350Hz, and a central "Off". Other arrangements may be used if preferred.

Completed interwiring

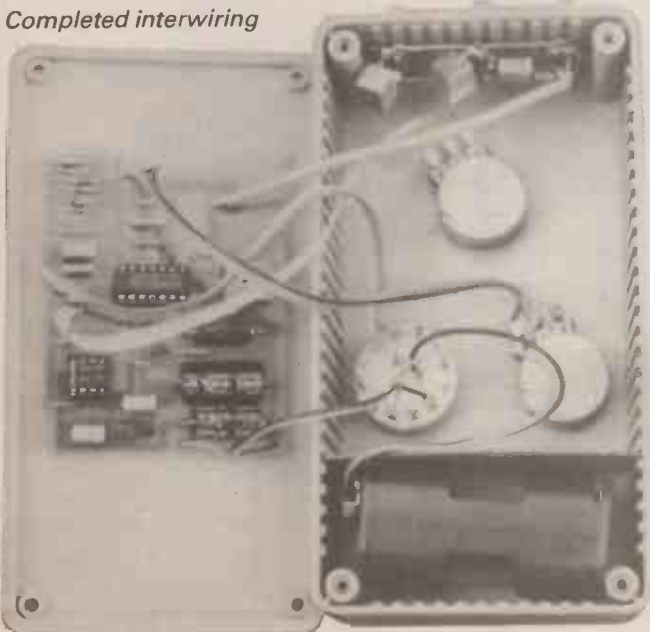

Components mounted on the output sockets

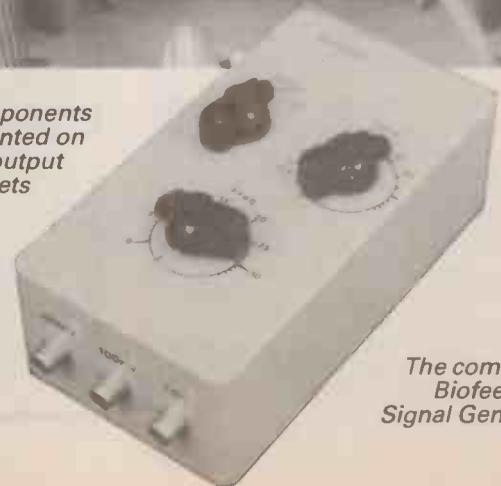

The completed Biofeedback Signal Generator

Battery operation was considered essential for this generator, as mains power would inevitably introduce enough noise and stray 50Hz coupling to distort the results obtained from the equipment on test. Whilst the relatively low current drawn by this project would permit operation from a PP3 battery, protracted use was expected of the prototype so it was fitted with a pack of six "AA" cells. This has a PP3 type connector anyway, so a later change can easily be made. It is held in place with a piece of foam plastic and a bit of paxolin slotted into the mouldings in the case.

SETTING UP

With the unit completed, setting up consists of turning the output right up and adjusting prest VR3 for 1V r.m.s. as measured on a millivoltmeter. Most DVM's have a suitable a.c. range. The frequency is best set to around 70Hz for this, fast enough for an accurate reading, but well away from the mains 50Hz to avoid interference.

Control calibration will need suitable equipment, a DVM again for the output level, which can be calibrated on the 1V range, and a frequency meter for VR1. It may be easier in some cases to measure "period" at the low frequencies involved, using a calculator for the necessary "1/t" calculations.

In use, the higher output level may be used to assist with testing of the active filters employed in an EEG biofeedback instrument. If these are being designed or modified in some way, reducing the frequency determining capacitors to a tenth of their final value and using the higher frequency range of the generator will make the filter action much easier to observe on most oscilloscopes. When the performance is satisfactory, replacing the capacitors with their correct values should ensure correct final frequency operation.

The output level selected from the 100 μ V range may not be totally accurate from an instrument of this simplicity, but will be quite good enough for functional checks on an EEG biofeedback instrument. It will at least ensure that such equipment is doing it's job correctly, a valuable aid for experimenters having difficulty producing those elusive "Alpha waves". □



*a regular
feature for
the Spectrum
Owner...*

by Mike Tooley BA

THIS month we shall be taking a look at the BASIC interpreter provided with the MGT SAM Coupe. We also have some more hints and tips provided by readers (including a somewhat surprising POKE!). For good measure, we also have some information concerning the latest version of the excellent Electrodraw package. We begin, however, with an important correction to the modification to *E.E. Printer Interface* (*On Spec*, November 1989).

E.E. Printer Interface

From correspondence received, it appears that many of you have been tempted to build the Centronics parallel printer interface described by Ken Taylor in the January 1989 issue of *Everyday Electronics*. In *On Spec* for November 1989, I printed a small modification to the original circuit. Unfortunately, the information given in the text is incorrect. Constructors should note that R2 (4k7) should remain in place (it should not be removed, as suggested in *On Spec*) whilst R1 (1k8) is the component which should be removed. The circuit diagram is, however, correct — humble apologies for any confusion!

SAM BASIC

The BASIC provided by MGT with the SAM Coupe was written by Dr Andrew Wright. Andy Wright will be well known to many readers as the author of the excellent software package, Beta BASIC, I must admit to being a great fan of this particular software and use it regularly to develop BASIC applications for the Spectrum.

SAM BASIC offers many of the facilities provided by Beta BASIC but also contains many new keywords which relate to the graphics capabilities of the SAM Coupe. Notable amongst these are commands (such as OPEN SCREEN and CLOSE SCREEN) which relate to the machine's ability to support up to 16 display screens. You can even display a screen whilst building another one invisibly. This feature allows the programmer to produce some complex and virtually instantaneous screen graphics!

As with Beta BASIC, screen windows

may easily be implemented and text (of various character sizes) may be printed within them. The MODE command may be used to select the particular screen mode employed. MODE 1 is the conventional Spectrum mode whilst MODE 2 offers higher attribute resolution. MODES 3 and 4 provide 512x192 pixels in four colours and 256x192 pixels in sixteen colours respectively (the SAM Coupe defaults to the latter mode during start-up).

GRAB and PUT can be used for storing and restoring areas of the screen. Areas are assigned to strings and masks can be used when restoring stored areas to determine which pixels will actually be affected. PALETTE allows users to set up a colour palette and, since everything displayed within a screen can be altered instantly in response to a PALETTE command, some very impressive effects can be obtained!

RECORD and BLITZ provide a means of recording and replaying a series of graphics commands stored at a string. Operation is extremely fast. BLITZ works in all modes and responds to the graphics scaling variables so that a shape can be blitzed back anywhere by altering XOS and YOS. The size of the BLITZed shape can be altered by simply changing XRG and YRG.

Control Structures

Several powerful control structures are available to the programmer. These include the DO...WHILE, DO...UNTIL, LOOP...WHILE, and LOOP...UNTIL constructs. The familiar IF...THEN construct offers several new permutations, including ELSE IF (which allows code to be developed and behaves in a similar manner to the SWITCH...CASE construct available in some other languages).

ON...GOSUB and the less structured ON...GO TO is supported as are procedures (using DEF PROC and END PROC). Error handling and trapping is made possible by ON ERROR...GOTO and ON ERROR...GOSUB. When error trapping has been enabled, the variables ERROR (error number), LINEO (line number at which the error has occurred), and STAT (statement where the error has occurred) are created. This allows software to be developed which can very effectively respond to errors rather than die in a somewhat undignified manner!

Machine Code

Finally, the machine code programmer is well catered for and the BASIC/machine code interface has been greatly improved. PEEK and POKE have been extended to cope with two and three bytes using DPEEK, DPOKE, TPEEK and TPOKE. It is possible to CALL machine code from BASIC as well as to call BASIC from machine code. This latter facility allows programmers to handle nasty things like INPUT and SAVE more easily!

Those of you who have now upgraded to the MGT machine may be interested to learn that we shall be featuring some simple BASIC and machine code routines for controlling hardware and screen output in future instalments of *On Spec*. In particular, we shall aim to show how CALLS should be set up (in both directions) and how SAM BASIC can offer much more effective control over hardware than was previously possible within the Spectrum.

Super POKE

N. Allen from Alcester has written in response to my request for readers' POKES. Mr Allen's POKE came as a complete surprise to me and is certainly one of the most interesting that I have seen for a long time. Indeed, in six years of using the Spectrum, I must confess to being totally unaware of this strange but useful yet undocumented facility.

Mr Allen's POKE involves the Spectrum System Variable located at address 23681. This variable is listed as "not used" in the Spectrum manual. Nevertheless, it can be put to some excellent use for those looking for a neat and simple way of dressing-up text output. It is well worth the effort of trying out the demonstration routine which follows before reading further — you may be as surprised as I was!

```
10 FOR a=64 TO 71
20 POKE 23681,a
30 LPRINT "Everyday Electronics"
40 NEXT a
50 GO SUB 1000
110 FOR a=72 TO 79
120 POKE 23681,a
130 LPRINT "On Spec"
140 NEXT a
150 GO SUB 1000
210 FOR a=80 TO 87
220 POKE 23681,a
230 LPRINT "presents..."
240 NEXT a
250 GO SUB 1000
260 CLS
270 STOP
1000 FOR z=1 TO 400
1010 NEXT z
1020 RETURN
```

The foregoing program is an extension of a simple four-line demonstration routine suggested by Mr Allen. For convenience, the program can be divided into four blocks (commencing at lines 10, 110, 210 and 1000).

Lines 10 to 40 are responsible for the display of the first string of text in the upper third of the screen (variable a takes values from 64 to 71). Lines 110 to 140 are responsible for the display of the second string of text (variable a takes values from 72 to 79). Lines 210 to 240 are responsible for the display of the third string of text (variable a takes values from 80 to 87). The subroutine formed by lines 1000 to 1020 provide a short delay. Despite the use of LPRINT, text output is directed to the screen (a ZX printer should not be connected) but in a much enlarged format.

Points from the post

Richard Wildash has had some problems with the EPROM programmer which we described some time ago. Other readers have reported that the programmer has a tendency to "lock up" when trying to blow an EPROM. I recall suggesting in a previous *On Spec*, that this problem may be caused by the power supply and Richard has been able to confirm this. Richard writes:

"Taking your guess as being a problem with the power supply, I disconnected the internal power supply and connected a stand-alone bench power supply. Bingo — it now operates well, but I still do not have any idea what is wrong with the internal PSU!"

N. Allen has provided some additional information concerning the double Micro-drive units which are available from J. and

N. Bull. Apparently, these units will operate with both the QL and the Spectrum. In both cases an appropriate cable will be required. Information on connection is supplied by J. and N. Bull and the necessary 16-way IDC connector can be obtained from Brookhill Enterprises Ltd, Nateby Road, Kirkby Steven, Cumbria, CA17 4QD (telephone 07683 72027). Mr Allen also mentions that J. and N. Bull can also supply Microdrive cartridges at £5 for four (plus postage), saving £3 on Sinclair's price.

Paul Hubbard writes from Herne Hill with a different problem relating to the Plus 3 expansion bus. Paul is using the I/O address selector which was featured in an earlier *On Spec*. Paul writes:

'In E.E. September 1988, a circuit was published for an I/O address selector. I was pleased because I could now select between eight I/O board (E.E. March 1988). I would have 8x3 programmable ports — enough to automate a model railway layout.

I set up a test circuit using the 74LS138 with I.e.d's connected to CS0-CS7 and plugged it into my ZX Spectrum Plus 3. (I require the Plus 3 so that different I/O programs can be loaded quickly). On testing, nothing happened for several attempts at using the OUT command. When connected to my old 48K Spectrum, the circuit worked. On the Plus 3, nothing!'

Mr Hubbard has taken a look at the Plus 3 manual and compared it with the manual for the 48K Spectrum. The expansion port is similar but with the following exceptions:

+9V, -5V, IORQGE, VIDEO, Y, V, U and ROMCS are missing.

ROM1 OE, ROM2 OE, DISK RD, DISK WR and MOTOR ON are new.

None of the above signals are pertinent to the operation of the address selector

(which has been tested with the 48K, 128K and Plus 2 machines). Mr Hubbard is wondering whether any other Plus 3 users have had the same problem. Unfortunately, I do not own a Plus 3 and cannot, therefore, offer any immediate help with this problem. Perhaps another reader can throw some light on this problem? Please drop me a line if you can help!

Electrodraw revisited

It is always good to learn of a software package which is being well supported. Past experience has shown that many software products are released in an unrefined (partly working!) state and often lack crucial features.

I can remember spending a great deal of money on one package (a BASIC compiler) which proved to be unusable. The company promised support for the package and, in fairness, did supply a somewhat improved version. Unfortunately, this also had some severe shortcomings which greatly limited the usefulness of the package. No further support was forthcoming and, not surprisingly, the suppliers soon went out of business.

This sad and sorry saga has been repeated time and again and seems to typify a certain sector of the software market whose motto would appear to be "sell it fast and never mind the bugs!". Despite this, a number of software suppliers and developers are prepared to commit themselves to continuous upgrading and enhancement of their products. One such company is BESoft which has recently announced an updated version of their excellent ELECTRODRAW package. This latest version (V1.2) has a BASIC loader which employs standard Microdrive syntax for all SAVE and LOAD functions. It is, therefore compatible with

most disk drive systems currently available for the Spectrum.

An extra option has been added to the Main Menu. This option places a chequerboard pattern of BRIGHT and plain colour squares on the drawing area to aid positioning of symbols and conductors. The new version is slightly faster, however the prices remain the same and it is now easy to transfer the program from tape to drive. BESoft are currently working on a 128K version which will offer smoother scrolling of the paper, a larger paper area, joystick compatibility, cut and paste (up to a whole screen) and increased printer and interface options. I, for one, am eagerly awaiting the arrival of this particular package and promise to bring you full details within a future instalment of *On Spec*. BESoft can be contacted at 20, Ashville Road, Leytonstone, London, E11 4DT (tel: 01-558 3469 evenings only).

Next Month: My appeal for details of Morse decoding hardware/software has prompted many of you to write in with ideas and suggestions. Indeed, this particular topic has generated more correspondence than any other during the past two years and thus I intend to devote all of next month's instalment of *On Spec* to radio applications generally.

In the meantime, if you would like to receive a copy of our Update sheets, please drop me a line enclosing a large (250mm x 300mm) and adequately stamped (currently 42p for UK postage) and addressed envelope. Please note that I am unable to provide individual replies to readers' queries. Instead, I will do my best to provide answers in future instalments of *On Spec*.

Mike Tooley, Faculty of Technology, Brooklands College, Heath Road, Weybridge, Surrey, KT13 8TT.

NEWS

... from the world of electronics



FAST COUPÉ

Readers of *On Spec* will already know plenty about the SAM Coupé. We have now received some publicity information on this interesting new machine together with the photographs shown. Manufacture was scheduled to start in early November so you should be able to order one now for early delivery. In depth technical information on the Coupé can be obtained by buying a technical manual from MGT — send them a cheque or postal order for £8.95 (includes postage). They are at Miles Gordon Technology Plc, Lakeside, Phoenix Way, Swansea SA7 9EH. Tel. (0792) 791100.



The Coupé has a Z80B microprocessor running at 6MHz and is supplied with 256K of RAM (upgradeable to 512K). Control is provided by a single custom 10,000 gate ASIC chip — this keeps the chip count for the whole computer down to just eight chips. It employs a Philips SAA1099 synthesiser for sound generation and a Motorola MC1377P video chip with four graphics modes, giving up to 256 x 192 pixel graphics with each pixel selectable for colour and up to 16 colours per line, selected from 128 possible colours. Built in interfaces are: u.h.f., colour composite video, digital and linear RGB (all through SCART); Atari-standard joystick (dual capability with splitter cable); mouse; light pen or light gun; cassette recorder; MIDI; Network; audio output; RS232 and parallel printed; 64 pin expansion port.

One or two removable disk drives can be fitted and are neatly housed in the slim front of the case. They can provide 1Mbyte of unformatted memory or 780K formatted.

The keyboard has 72 full travel membrane type keys including 10 software defined function keys. It all looks good and of course it can run most of your old 48K Spectrum software. Prices are around £160 for the standard Coupé, £250 with one disk drive or £330 with two disk drives.



SHOP TALK

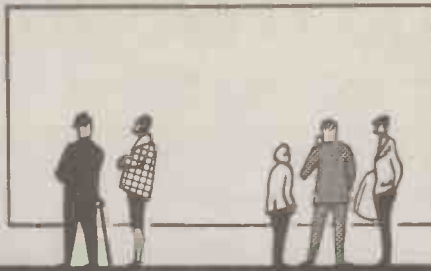

BY DAVID BARRINGTON

Gifts

Before we commence looking at component buying for this month's projects, and being the festive season, we would like to make a few last minute suggestions.

With the long hot summer now just a memory, many readers must have wished they had remembered to close their car windows or had some security for the car radio/cassette player on returning to their vehicle and finding their radio gone. Well, **R & TV Components Acton Ltd.** are currently selling a neat car radio "cage" which when installed allows the owner to take the radio/cassette player with them on leaving their vehicle.

The Automelody consists of a rigid plastic framework and a removable carrier. The frame has a power supply bus and aerial socket and is fixed to the vehicle permanently.

The carrier, which has a mating connector, is wired to the radio supply leads and is just inserted into the cage to form a complete unit in the car. You simply remove the radio by sliding out the carrier. For prices and further details contact **R & TV Components Acton** on ☎01-723 8432.

For the young, the same company are selling some intriguing wooden electric powered models. The model helicopter comes with a small electric motor and is powered by a solar panel.

Reverting back to the security aspect, the lady of the house would certainly welcome a surveillance system for the home. It does mean however that the "fix-it person" will have to do the installing.

One such package on special offer at the moment is a monitoring system from **Marco Trading** (☎0939 32763). The VM100 (£150) includes camera, monitor and mounting brackets. The VM200 at about £200 also includes a built-in intercom. They are also offering as their "special of the month" an exterior floodlight, with 500W halogen bulb for the sum of £16.99. Post and packing has to be added to all items; ring for details.

Most constructors and DIY enthusiasts own a power drill, so an attachment would not go amiss as a gift. The latest "Dial-a-Drill" from **Free-trade (TEP) Ltd.** (☎021-766 6142), con-



verts any power drill into a six-piece self-contained screwdriver and drill set.

The unit contains four drill bits in the most common sizes of: $\frac{1}{16}$ in, $\frac{1}{8}$ in, $\frac{3}{16}$ in, $\frac{1}{4}$ in and two screwdriver bits, No. 2 Philips and $\frac{1}{4}$ in slotted. All are heat treated for strength.

Catalogues Received

With all the new catalogues being announced by the week, we are surprised to report that we have only received two in the office this month. Catalogues are probably the most useful acquisition for both us and the constructor, so we would be pleased to receive any new additions as they become available.

Coinciding with their announcement as sole U.K. distributor of Smart Kit range of electronic kits, **Hobbykit Ltd.** (☎01-205 7485) have issued an 18-page colour brochure containing such kits as a motorbike intercom to a 12V d.c. low power fluorescent tube light. The kits manufactured in the EEC, have proved popular in many European countries.

Over 130 tried and tested kits are available from Hobbykit and each kit is supplied individually blister packed. The circuit boards are all silk screened printed with component positions and each kit comes with an instruction sheet and circuit description. All that is required is a low power soldering iron.

For details contact **Hobbykit Ltd.**, Dept. EE, Unit 19, Capitol Industrial Park, Capitol Way, London NW9 0EQ.

Four-Channel Light Chaser

A suitable microphone insert for the *Four-Channel Light Chaser* should be available from most component suppliers, but the Darlington array type ULN2004AN and the triac type TAG M22 may prove a little difficult to locate locally. The ones used in the prototype model were purchased from **Magenta Electronics**. The mic. insert should be the three terminal type.

The triacs used are rated at 600V 8A and suitable equivalents may be suggested by component stockists. However, it is most important that only triacs which have *isolated* tabs be used in this circuit.

The Bulgin 8-pin chassis socket (P552) is listed in most of our components catalogues and should not cause any concern. When ordering the potentiometers remember to specify a "log" pot for VR1 and also to make sure that both controls have plastic spindles.

For those readers who may have difficulties in obtaining parts for this project, a complete kit (£29.95), including p.c.b., may be purchased from **Magenta Electronics, Dept EE, 135 Hunter Street, Burton on Trent, Staffs, DE14 2ST**. Add £1 for p&p per order.

The small printed circuit board is available through the *EE PCB Service*, code EE667 (see page 70).

Possession Loop Alarm

If you have not already used your piece of Easiwire board given away with last month's issue, then the *Possession Loop Alarm* is the ideal project for this piece of circuit board. If you have, not to worry, this board is now stocked by several of our advertisers in varying sizes. Any readers experiencing difficulty in sourcing the wiring connectors or special pen should contact **BICC-Vero** (☎0489 788774) direct for details of nearest stockists.

The key operated switch should be carried by most of our component advertisers and should be readily available. If you do have trouble locating this item then one of the security specialists who advertise, such as **Riscomp** or **Suma Designs**, may be able to help.

Christmas Candle

The only source of supply we have been able to find for the melody generator chip type UM66/1 used in the *Christmas Candle* has been **Maplin**. This i.c. comes in four versions ranging from favourite Christmas melodies to one with an "Elvis" melody.

When ordering the melody generator chip, it is important to quote the suffix 1 if you require the "Christmas melodies" or simply give the Maplin code, UJ40T (UM66/1). The other versions available are numbered from 2 to 4 and are as follows: type 2 = birthday; type 3 = wedding march and type 4 = Elvis' Love Me Tender.

The electret condenser microphone insert, type EM-4, should be available from most advertisers. The one used in our model was obtained from **Maplin**, code FS43W (Submin. Omni Insert).

Biogen

Looking through the requirements for the *Biofeedback Signal Generator* we cannot foresee any component buying problems as they seem to be all "off-the-shelf" items.

The printed circuit board for the *Biogen* is available from the *EE PCB Service*, code EE666.

Game Timer

We do not expect any component sourcing problems to arise for readers undertaking the construction of the *Games Timer*. The 9V, low power, solid state buzzer is available in various forms and most of these should work in this circuit.

Quite a few of our advertisers now stock Easiwire wiring kits, including supplies of board, and it should not be hard to find a local stockist. For information on nearest supplier you can contact **BICC-Vero** direct on (☎0489 788774).



SOLAR POWERED WOODEN MODELS

ATTRACTIVE AND EDUCATIONAL



Now you can experiment with solar energy ... the energy source of the future!

Our solar powered static wooden model kits are designed to let you build your own models. Everything is supplied;

A set of pre-cut and marked plywood; PVA cement; instruction sheet; solar cell module; a "music" i.c. (for the gramophone model) or a small d.c. motor (for the helicopter and aeroplane models); connecting leads and sandpaper.

Gramophone model with "music" i.c.
£8.40 plus £1 p&p

Helicopter with motor
£8.40 plus £1 p&p

Aeroplane with motor
£8.40 plus £1 p&p

SPECIAL OFFER — BUY ALL THREE and get the postage FREE

RADIO and TV COMPONENTS ACTON LTD., 21 HIGH STREET, ACTON LONDON W3 6NG

MAIL ORDER TERMS, POSTAL ORDERS and or CHEQUES with orders. Nett monthly accounts to Schools, Colleges and P.L.C. only. ACCESS & VISA. Phone orders between 9.30 & 12pm Please phone 01-723 8432 or 01-992 8430. Overseas readers write for quote on delivery. Callers 323 Edgware Road, London W2



SATURN Systems

3, Whites Lane
Torrington
N. Devon EX38 8DS
Telephone (enquiries) 0805 24245
(between 6pm and 8pm)

ZX Spectrum 32k EPROM card Memory expansion unit

DIY KIT with instructions **£16.95**
Built Unit **£19.95**

- 7 different control ports to suit your system
- LED mode indication
- Rear edge connector Included
- Instruction booklet included
- Ideal for machine code programmers
- Compatible with all ZX Spectrums
- Compatible with 16k and 32k EPROMS

Arranged as two 16k pages in the address regions
0000h to 3FFFh (0 to 16383)



EPROM PROGRAMMING SERVICE
Send us your programmes on a cassette with clear written instructions & £2.95
EPROMS must be supplied separately.
WRITE FOR MORE DETAILS

EPROMS available
27128 **£6.95**
27256 **£6.95**

Please send me one 32k EPROM Card For

(please tick) ZX Spectrum 16/48

ZX Spectrum 128

ZX Spectrum + 2 IN GREY CASE

ZX Spectrum + 3

ZX Spectrum + 2 IN BLACK CASE

In kit form £16.95

Built Unit £19.95

I enclose

£

including £1.00 p + p

Your name

Your address

12 months repair Guarantee

Casing may vary

Allow 28days for delivery

DIRECT BOOK SERVICE

The books listed have been selected as being of special interest to everyone involved in electronics and computing. They are supplied by mail order direct to your door. Full ordering details are given on the last book page.

MORE BOOKS NEXT MONTH—MORE BOOKS NEXT MONTH

AUDIO & MUSIC

SYNTHESIZERS FOR MUSICIANS

R. A. Penfold

Modern synthesizers are extremely complex, but they mostly work on principles that are not too difficult to understand. If you want to go beyond using the factory presets or the random poking of buttons, this is the book for you.

It covers the principles of modern synthesis—linear arithmetic as used by Roland, phase distortion (Casio), Yamaha's frequency modulation, and sampling—and then describes how the instruments are adjusted to produce various types of sound—strings, brass, percussion, etc. The theoretical side of synthesis is treated in an easy to understand way—the technical information being restricted to what you need to know to use your instrument effectively.

168 pages Order code PC105 £6.95

AUDIO

F. A. Wilson, C.G.I.A., C.Eng., F.I.E.E., F.I.E.R.E., F.B.I.M.

Analysis of the sound wave and an explanation of acoustical quantities prepare the way. These are followed by a study of the mechanism of hearing and examination of the various sounds we hear. A look at room acoustics with a subsequent chapter on microphones and loudspeakers then sets the scene for the main chapter on audio systems—amplifiers, oscillators, disc and magnetic recording and electronic music.

320 pages Temporarily out of print

INTRODUCTION TO DIGITAL AUDIO

Ian Sinclair

Digital recording methods have existed for many years and have become familiar to the professional recording engineer, but the compact disc (CD) was the first device to bring digital audio methods into the home. The next step is the appearance of digital audio tape (DAT) equipment.

All this development has involved methods and circuits that are totally alien to the technician or keen amateur who has previously worked with audio circuits. The principles and practices of digital audio owe little or nothing to the traditional linear circuits of the past, and are much more comprehensible to today's computer engineer than the older generation of audio engineers.

This book is intended to bridge the gap of understanding for the technician and enthusiast. The principles and methods are explained, but the mathematical background and theory is avoided, other than to state the end product.

128 pages Order code PC102 £5.95

MAKE MONEY FROM HOME RECORDING

Clive Brooks

Now that you've spent a fortune on all that recording gear, MIDI and all, wouldn't it be nice to get some of it back? Well here's the book to show you how.

It's packed with money making ideas, any one of which will recoup the price of the book many times over. Whether you have a fully fledged recording studio at home, or just a couple of stereo cassette recorders and a microphone, you'll be able to put the ideas in this book into practice and make money.

105 pages Order code PC104 £5.95

TESTING & TEST GEAR

HOW TO TEST ALMOST EVERYTHING ELECTRONIC—2nd EDITION

Jack Darr and Delton T. Horn

Describes electronic tests and measurements—how to make them with all kinds of test equipment, and how to interpret the results. New sections in this edition include logic probes, frequency counters, capacitance meters, and more. (An American book.)

190 pages Order code T2925 £9.05

GETTING THE MOST FROM YOUR MULTIMETER

R.A. Penfold

This book is primarily aimed at beginners and those of limited experience of electronics. Chapter 1 covers the basics of analogue and digital multimeters, discussing the relative merits and the limitations of the two types. In Chapter 2 various methods of component checking are described, including tests for transistors, thyristors, resistors, capacitors and diodes. Circuit testing is covered in Chapter 3, with subjects such as voltage, current and continuity checks being discussed.

In the main little or no previous knowledge or experience is assumed. Using these simple component and circuit testing techniques the reader should be able to confidently tackle servicing of most electronic projects.

96 pages Order code BP239 £2.95

NEW

MORE ADVANCED USES OF THE MULTIMETER

R.A. Penfold

This book is primarily intended as a follow-up to BP239, (see above), and should also be of value to anyone who already understands the basics of voltage testing and simple component testing. By using the techniques described in chapter 1 you can test and analyse the performance of a range of components with just a multimeter (plus a very few inexpensive components in some cases). Some useful quick check methods are also covered.

While a multimeter is supremely versatile, it does have its limitations. The simple add-ons described in chapter 2 extend the capabilities of a multimeter to make it even more useful. The add-ons described include an active r.f. probe, a high resistance probe, an a.c. sensitivity booster, and a current tracer unit.

84 pages Order code BP265 £2.95

TEACH-IN THEORY & REFERENCE



NEW

ELECTRONICS TEACH-IN

Michael Tooley BA and David Whitfield MA MSC CEng MIEE (published by *Everyday Electronics*)

This value for money *EE* book provides a comprehensive background to modern electronics including test gear projects. A complete course in basic electronics; designed for the complete newcomer it will however also be of value to those with some previous experience of electronics. Wherever possible the course is related to "real life" working circuits and each part includes a set of detailed practical assignments. Includes details of eight items of related test gear giving full constructional information and diagrams for each one. They are: Safe Power Supply; Universal LCR Bridge; Diode/Transistor Tester; Audio Signal Tracer; Audio Signal Generator; RF Signal Generator; FET Voltmeter; Pulse Generator. An excellent companion for anyone interested in electronics and invaluable for those taking G.C.S.E. and BTEC electronics courses.

104 pages (A4 size) Order code EE/T-1 £1.95

ELECTRONICS TEACH-IN 88/89—

INTRODUCING MICROPROCESSORS

Mike Tooley BA (published by *Everyday Electronics*)

A complete course that can lead successful readers to the award of a City and Guilds Certificate in Introductory Microprocessors (726/303). The book contains everything you need to know including full details on registering for assessment, etc.

80 pages (A4 size) Order code TI-88/89 £2.45

THE ILLUSTRATED DICTIONARY OF ELECTRONICS—

4th EDITION

Rufus P. Turner and Stan Gibilisco

With more than 27,000 terms used in electronics today, this collection is THE most comprehensive dictionary available. Including all practical electronics and computer terms, it is as up-to-date as the latest advances in the field itself! Tables and data on subjects most often consulted for projects and experiments are included. Other conversion tables include English/metric and metric/English conversions for units of measurement of energy, power and volume, and Fahrenheit/Celsius temperature conversion charts.

Setting this edition apart from other electronic dictionaries is its emphasis on illustration. Featuring more than complete definitions, this fourth edition includes over 450 detailed drawings and diagrams.

All entries are listed in alphabetical order. Abbreviations and initials are listed in sequence with whole words. All terms of more than one word are treated as one word. (An American book.)

648 pages Order code T2900 £18.75

MICROPROCESSING SYSTEMS AND CIRCUITS

F. A. Wilson, C.G.I.A., C.Eng., F.I.E.E., F.I.E.R.E., F.B.I.M.

A truly comprehensive guide to the elements of micro-processing systems which really starts at the beginning. Teaches the reader the essential fundamentals that are so important for a sound understanding of the subject.

256 pages Temporarily out of print

ELECTRONICS TEACH-IN No. 3 — EXPLORING

ELECTRONICS (published by *Everyday Electronics*)

Owen Bishop

Another *EE* value for money publication aimed at students of electronics. The course is designed to explain the workings of electronic components and circuits by involving the reader in experimenting with them. The book does not contain masses of theory or formulae but straightforward explanations and circuits to build and experiment with.

Exploring Electronics contains more than 25 useful projects, assumes no previous knowledge of electronics and is split into 28 easily digestible sections.

88 pages (A4 size) Order code TI3 £2.45*

ELECTRONICS—A "MADE SIMPLE" BOOK

G. H. Olsen

This book provides excellent background reading for our *Introducing Digital Electronics* series and will be of interest to everyone studying electronics. The subject is simply explained and well illustrated and the book assumes only a very basic knowledge of electricity.

330 pages Order code NE10 £4.95

PRACTICAL ELECTRONICS

CALCULATIONS AND FORMULAE

F. A. Wilson, C.G.I.A., C.Eng., F.I.E.E., F.I.E.R.E., F.B.I.M.

Bridges the gap between complicated technical theory, and "cut-and-try" methods which may bring success in design but leave the experimenter unfulfilled. A strong practical bias—tedious and higher mathematics have been avoided where possible and many tables have been included.

The book is divided into six basic sections: Units and Constants, Direct-current Circuits, Passive Components, Alternating-current Circuits, Networks and Theorems, Measurements.

256 pages Order code BP53 £3.95

MICROELECTRONIC SYSTEMS N2 CHECKBOOK

R. Vears

The aim of this book is to provide a foundation in microcomputer hardware, software and interfacing techniques. Each topic is presented in a way that assumes only an elementary knowledge of microelectronic systems and logic functions. The book concentrates on 6502, Z80 and 6800 microprocessors and contains 60 tested programs, 160 worked problems and 250 further problems.

Order code NE04N £6.95

ELECTRONICS-BUILD AND LEARN

R. A. Penfold

The first chapter gives full constructional details of a circuit demonstrator unit that is used in subsequent chapters to introduce common electronic components—resistors, capacitors, transformers, diodes, transistors, thyristors, fets and op amps. Later chapters go on to describe how these components are built up into useful circuits, oscillators, multivibrators, bistables and logic circuits.

At every stage in the book there are practical tests and experiments that you can carry out on the demonstrator unit to investigate the points described and to help you understand the principles involved. You will soon be able to go on to more complex circuits and tackle fault finding logically in other circuits you build.

120 pages Order Code PC103 £5.95

PRACTICAL ELECTRONICS HANDBOOK

Ian Sinclair

Ian Sinclair has now revised this useful and carefully selected collection of standard circuits, rules-of-thumb, and design data for professional engineers, students and enthusiasts involved in radio and electronics. Covering passive and active components, discrete component circuits (such as amplifiers, filters and oscillators) and linear and digital i.c.s, the book includes many items which are not elsewhere available in a single handy volume. The operation and functions of typical circuits are described, while mathematics is limited to that necessary for deciding component values for any application.

This revised edition contains more details on computers and microprocessors and has been brought up to date throughout.

199 pages Order Code NE06 £7.95

DATA & COMPONENT IDENTIFICATION

TRANSISTOR SELECTOR GUIDE

This unique guide offers a range of selection tables compiled so as to be of maximum use to all electronics engineers, designers and hobbyists.

Section 1: Covers component markings, codings and standards, as well as explaining the symbols used.

Section 2: Tabulates in alpha-numeric sequence the comprehensive specifications of over 1400 devices.

Section 3: Tabulates the devices by case type.

Section 4: Considers particular limits to the electrical parameters when compiling the tables.

Section 5: Illustrates package outlines and leadouts.

Section 6: Consists of a surface mounting device markings conversion list.

192 pages Temporarily out of print

CIRCUITS & DESIGN

ELECTRONIC CIRCUITS FOR THE COMPUTER CONTROL OF MODEL RAILWAYS

R.A. Penfold

Home computers may easily be applied to the control of model railways and really quite sophisticated control, which needs only simple programming, is not too difficult to achieve. The main problem lies in interfacing the computer to the layout, but fortunately it is not too difficult or expensive to build suitable interfaces, and this book shows you how.

The projects consist of various types of controller, including a high quality pulse type, as well as circuits for train position sensing, signal and electric points control etc. The use of computers does not have to be restricted to massive layouts. Something as simple as an oval of track with a single siding can be given a new dimension by adding computer control and much fun can be had from these relatively simple setups.

88 pages Order code BP180 £2.95

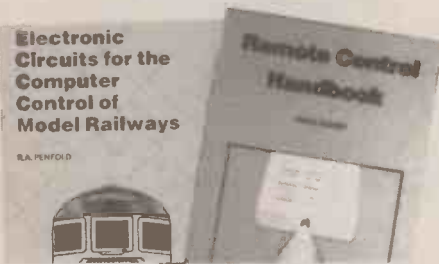

REMOTE CONTROL HANDBOOK

Owen Bishop

Remote control systems lend themselves to a modular approach. This makes it possible for a wide range of systems, from the simplest to the most complex, to be built up from a number of relatively simple modules. The author has tried to ensure that, as far as possible, the circuit modules in this book are compatible with one another. They can be linked together in many different configurations to produce remote control systems tailored to individual requirements. Whether you wish simply to switch a table lamp on and off, or to operate an industrial robot, this book should provide the circuit you require.

226 pages Order code BP240 £3.95

COIL DESIGN AND CONSTRUCTION MANUAL

B. B. Babani

A complete book for the home constructor on "how to make" RF, IF, audio and power coils, chokes and transformers. Practically every possible type is discussed and calculations necessary are given and explained in detail. Although this book is now rather old, with the exception of torroids and pulse transformers little has changed in coil design since it was written.

96 pages Order Code 160 £2.50



30 SOLDERLESS BREADBOARD PROJECTS - BOOK 1

R. A. Penfold

Each project, which is designed to be built on a "Verobloc" breadboard, is presented in a similar fashion with a brief circuit description, circuit diagram, component layout diagram, components list and notes on construction and use where necessary. Wherever possible, the components used are common to several projects, hence with only a modest number of reasonably inexpensive components, it is possible to build in turn, every project shown. Recommended by BICC-Verobloc.

160 pages Order Code BM107 £2.25

BOOK 2—All projects use CMOS i.c.s but the items on component identification etc., are not repeated from Book 1.

160 pages Order code BP113 £2.25

ELECTRONIC CIRCUITS HANDBOOK

Michael Tooley BA

This book aims to explode two popular misconceptions concerning the design of electronic circuits: that only those with many years of experience should undertake circuit design and that the process relies on an understanding of advanced mathematics. Provided one is not too ambitious, neither of these popularly held beliefs is true.

Specifically, this book aims to provide the reader with a unique collection of practical working circuits together with supporting information so that circuits can be produced in the shortest possible time and without recourse to theoretical texts.

Furthermore, information has been included so that the circuits can readily be modified and extended by readers to meet their own individual needs. Related circuits have been grouped together and cross-referenced within the text (and also in the index) so that readers are aware of which circuits can be readily connected together to form more complex systems. As far as possible, a common range of supply voltages, signal levels and impedances has been adopted.

As a bonus, ten test gear projects have been included. These not only serve to illustrate the techniques described but also provide a range of test equipment which is useful in its own right.

277 pages Order code NE05 £14.95

AUDIO IC CIRCUITS MANUAL

R. M. Marston

A vast range of audio and audio-associated i.c.s are readily available for use by amateur and professional design engineers and technicians. This manual is a guide to the most popular and useful of these devices, with over 240 diagrams. It deals with i.c.s such as low frequency linear amplifiers, dual pre-amplifiers, audio power amplifiers, charge coupled device delay lines, bar-graph display drivers, and power supply regulators, and shows how to use these devices in circuits ranging from simple signal conditioners and filters to complex graphic equalizers, stereo amplifier systems, and echo/reverb delay line systems etc.

168 pages Order code NE13 £11.95

HOW TO DESIGN ELECTRONIC PROJECTS

R. A. Penfold

The aim of this book is to help the reader to put together projects from standard circuit blocks with a minimum of trial and error, but without resorting to any advanced mathematics. Hints on designing circuit blocks to meet your special requirements are also provided.

128 pages Order code BP127 £2.25

50 CIRCUITS USING GERMANIUM SILICON AND ZENER DIODES

R. N. Soar

Contains 50 interesting and useful circuits and applications, covering many different branches of electronics, using one of the most simple and inexpensive of components—the diode. Includes the use of germanium and silicon signal diodes, silicon rectifier diodes and Zener diodes, etc.

64 pages Order Code BP36 £1.50

KEY TECHNIQUES FOR CIRCUIT DESIGN

C. G. Loveday C.Eng MIERE

Deals with designing electronic circuits from scratch covering concepts such as target specifications, component selection (passive, discrete and i.c.s), the design cycle, derating and so on. Numerous design examples are given and several reader exercises all with fully worked solutions. The approach is essentially non-mathematical.

128 pages Order code BM1 £6.95

DESIGNING WITH LINEAR ICs

G.C. Loveday

A book that deals with the design of the vital area of analog circuitry covering design with modern linear integrated circuit devices. The first chapter introduces the reader to important design techniques, test strategies, layout, and protection and also includes a section on the use of a typical CAD tool. There are separate chapters that cover in depth the use of op-amps, comparators and timers each with detailed design examples and reader exercises. A final chapter brings all the previous work together in a number of complete design problems with fully worked solutions. The text is essentially non-mathematical and is supported by many diagrams.

180 pages Order code BM3 £8.75

NEW

DIGITAL IC EQUIVALENTS AND PIN CONNECTIONS

A. Michaels

Shows equivalents and pin connections of a popular selection of European, American and Japanese digital i.c.s. Also includes details of packaging, families, functions, manufacturer and country of origin.

256 pages Order code BP140 £5.95

INTERNATIONAL TRANSISTOR EQUIVALENTS GUIDE

A. Michaels

Helps the reader to find possible substitutes for a popular selection of European, American and Japanese transistors. Also shows material type, polarity, manufacturer and use.

320 pages Order code BP85 £3.50

CHART OF RADIO, ELECTRONIC, SEMICONDUCTOR AND LOGIC SYMBOLS

M. H. Banani, B.Sc.(Eng.)

Illustrates the common, and many of the not-so-common, radio, electronic, semiconductor and logic symbols that are used in books, magazines and instruction manuals, etc., in most countries throughout the world.

Chart Order Code BP27 £0.95

OPTOELECTRONICS CIRCUITS MANUAL

R. M. Marston

A useful single-volume guide to the optoelectronics device user, specifically aimed at the practical design engineer, technician, and the experimenter, as well as the electronics student and amateur. It deals with the subject in an easy-to-read, down-to-earth, and non-mathematical yet comprehensive manner, explaining the basic principles and characteristics of the best known devices, and presenting the reader with many practical applications and over 200 circuits. Most of the i.c.s and other devices used are inexpensive and readily available types, with universally recognised type numbers.

182 pages Order code NE14 £10.95

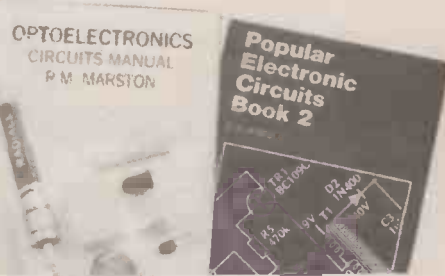

A MICROPROCESSOR PRIMER

E. A. Parr, B.Sc., C.Eng., M.I.E.E.

Starts by designing a small computer which, because of its simplicity and logical structure, enables the language to be easily learnt and understood. The shortcomings are then discussed and the reader is shown how these can be overcome by changes and additions to the instruction set. In this way, such ideas as relative addressing, index registers, etc., are developed.

96 pages Order code BP72 £1.75

POPULAR ELECTRONIC CIRCUITS

—BOOK 1

POPULAR ELECTRONIC CIRCUITS

—BOOK 2

R. A. Penfold

Each book provides a wide range of designs for electronic enthusiasts who are capable of producing working projects from just a circuit diagram without the aid of detailed construction information. Any special setting-up procedures are described.

BOOK 1 160 pages Order code BP80 £2.95

BOOK 2 160 pages Order code BP98 £2.95

CMOS CIRCUITS MANUAL

R. M. Marston

Written for the professional engineer, student or enthusiast. It describes the basic principles and characteristics of these devices and includes over 200 circuits.

All the circuits have been designed, built and fully evaluated by the author; all use inexpensive and internationally available devices.

pages Order code NE12 £9.95

ELECTRONIC PROJECTS — BOOK 1

Published by *Everyday Electronics* in association with *Magenta Electronics*.

Contains twenty of the best projects from previous issues of *EE* each backed with a kit of components. The projects are: Seashell Sea Synthesiser, *EE* Treasure Hunter, Mini Strobe, Digital Capacitance Meter, Three Channel Sound to Light, BBC 16k Sideways Ram, Simple Short Wave Radio, Insulation Tester, Visual Guitar/Instrument Tuner, Stepper Motor Interface, Eprom Eraser, 200MHz Digital Frequency Meter, Infra Red Alarm, *EE* Equaliser Ioniser, Bat Detector, Acoustic Probe, Mainstester and Fuse Finder, Light Rider — (Lapel Badge, Disco Lights, Chaser Light), Musical Doorbell, Function Generator, Tilt Alarm, 10W Audio Amplifier, *EE* Buccaneer Induction Balance Metal Detector, BBC Midi Interface, Variable Bench Power Supply, Pet Scarer, Audio Signal Generator.

128 pages (A4 size) Order Code EP1 £2.45

HOW TO DESIGN AND MAKE YOUR OWN P.C.B.s

R. A. Penfold

Deals with the simple methods of copying printed circuit

RADIO, TV, SATELLITE

BEGINNER'S GUIDE TO RADIO—9th EDITION

Gordon J. King

Radio signals, transmitters, receivers, antennas, components, valves and semiconductors, CB and amateur radio.

266 pages Order code NE08 £6.95

AN INTRODUCTION TO RADIO DXING

R. A. Penfold

Anyone can switch on a short wave receiver and play with the controls until they pick up something, but to find a particular station, country or type of broadcast and to receive it as clearly as possible requires a little more skill and knowledge. The object of this book is to help the reader to do just that, which in essence is the fascinating hobby of radio DXing.

112 pages Order code BP91 £1.95

A TV-DXERS HANDBOOK

R. Bunney

Roger Bunney is probably one of the leading authorities in this country on the subject. Includes many units and devices which have been designed and used by active enthusiasts, and often, considerable ingenuity and thought have gone into the development of such units to overcome individual problems. A practical and authoritative reference to this unusual aspect of electronics.

128 pages Order code BP176 £5.95

board designs from magazines and books and covers all aspects of simple p.c.b. construction including photographic methods and designing your own p.c.b.s.

80 pages Order code BP121 £2.50

HOW TO GET YOUR ELECTRONIC PROJECTS WORKING

R. A. Penfold

We have all built projects only to find that they did not work correctly, or at all, when first switched on. The aim of this book is to help the reader overcome just these problems by indicating how and where to start looking for many of the common faults that can occur when building up projects.

96 pages Order code BP110 £2.50

ELECTRONIC SCIENCE PROJECTS

O. Bishop

These projects range in complexity from a simple colour temperature meter to an infra-red laser. There are novelties such as an electronic clock regulated by a resonating spring, and an oscilloscope with solid-state display. There are scientific measuring instruments such as a pH meter and an electro-cardiometer. All projects have a strong scientific flavour. The way they work, and how to build and use them are fully explained.

144 pages Order code BP104 £2.95

SATELLITE TELEVISION INSTALLATION GUIDE—

2nd EDITION

John Breeds

This book is now firmly established as a leading study manual for satellite TV installers, technical colleges who run City & Guilds courses, and training schools in major companies. It will be invaluable to anyone who wants to set up a dish receiver.

It covers all aspects of satellite dish installation: Installation of indoor unit, Geostationary satellites, Site survey, Dish assembly, Signal polarisation, Setting up the dish, Polar mount dish, TV download and relay cable and F-connectors, EIRP footprint contours, Trouble-shooting guide, Glossary of terms and Useful addresses.

56 pages (large format) Order code JB1 £11.95

NEWNES SHORTWAVE LISTENING HANDBOOK

Joe Pritchard G1UQW

Part One covers the "science" side of the subject, going from a few simple electrical "first principles", through a brief treatment of radio transmission methods to simple receivers. The emphasis is on practical receiver designs and how to build and modify them, with several circuits in the book.

Part Two covers the use of sets, what can be heard, the various bands, propagation, identification of stations, sources of information, QSLing of stations and listening to amateurs. Some computer techniques, such as computer morse decoding and radio teletype decoding are also covered.

224 pages Order code NE16 £12.95

BEGINNER'S GUIDE TO BUILDING

ELECTRONIC PROJECTS

R. A. Penfold

Shows the complete beginner how to tackle the practical side of electronics, so that he or she can confidently build the electronic projects that are regularly featured in magazines and books. Also includes examples in the form of simple projects.

112 pages Order code No. 227 £2.25

TEST EQUIPMENT CONSTRUCTION

R. A. Penfold

This book describes in detail how to construct some simple and inexpensive but extremely useful, pieces of test equipment. Stripboard layouts are provided for all designs, together with wiring diagrams where appropriate, plus notes on construction and use.

The following designs are included:- AF Generator, Capacitance Meter, Test Bench Amplifier, AF Frequency Meter, Audio Millivoltmeter, Analogue Probe, High Resistance Voltmeter, CMOS Probe, Transistor Tester, TTL Probe. The designs are suitable for both newcomers and more experienced hobbyists.

104 pages Order code BP248 £2.95

DIRECT BOOK SERVICE

(A Division of Wimborne Publishing Ltd.)

TO ORDER

Please state the title and order code clearly, print your name and address and add the required postage to the total order.

Add 75p to your total order for postage and packing (overseas readers add £1.50 for countries in Europe, or add £2.00 for all countries outside Europe, surface mail postage) and send a PO, cheque or international money order (£ sterling only) made payable to *Direct Book Service* quoting your name and address, the order code and quantities required to *DIRECT BOOK SERVICE, 33 GRAVEL HILL, MERLEY, WIMBORNE, DORSET, BH21 1RW* (mail order only).

See next month's issue for another three page selection of books.

Although books are normally sent within seven days of receipt of your order, please allow a maximum of 28 days for delivery. Overseas readers allow extra time for surface mail post.

Please check price and availability (see latest issue of *Everyday Electronics*) before ordering from old lists.

Note—our postage charge is the same for one book or one hundred books!

SATELLITE TELEVISION
Installation Guide

All Introduction to
Satellite Television

International
Radio Stations
Guide

COMPUTING

SERVICING PERSONAL COMPUTERS—2nd EDITION

Mike Tooley BA

The revised and enlarged second edition contains a new chapter on the IBM PC, AT, TX and compatibles. It is essential for anyone concerned with the maintenance of personal computer equipment or peripherals, whether professional service technician, student or enthusiast.

240 pages (hard cover) Order code NE15 £20

AN INTRODUCTION TO PROGRAMMING THE BBC MODEL B MICRO

R. A. & J. W. Penfold

Written for readers wanting to learn more about programming and how to make best use of the incredibly powerful model B's versatile features. Most aspects of the BBC micro are covered, the omissions being where little could usefully be added to the information provided by the manufacturer's own manual.

144 pages Order code BP139 £1.95

AN INTRODUCTION TO COMPUTER COMMUNICATIONS

R. A. Penfold

Provides details of the various types of modem and their suitability for specific applications, plus details of connecting various computers to modems, and modems to the telephone system. Also information on common networking systems and RTTY.

96 pages Order code BP177 £2.95

AN INTRODUCTION TO COMPUTER PERIPHERALS

J. W. Penfold

Covers such items as monitors, printers, disc drives, cassette recorders, modems, etc., explaining what they are, how to use them and the various types and standards. Helps you to make sure that the peripherals you buy will work with your computer.

80 pages Order code BP170 £2.50

HOW TO GET YOUR COMPUTER PROGRAMS RUNNING

J. W. Penfold

Have you ever written your own programs only to find that they did not work! Help is now at hand with this book which shows you how to go about looking for your errors, and helps you to avoid the common bugs and pitfalls of program writing. Applicable to all dialects of the BASIC language.

144 pages Order code BP169 £2.50

AN INTRODUCTION TO 6502 MACHINE CODE

R. A. & J. W. Penfold

No previous knowledge of microprocessors or machine code is assumed. Topics covered are: assembly language and assemblers, the register set and memory, binary and hexadecimal numbering systems, addressing modes and the instruction set, and also mixing machine code with BASIC. Some simple programming examples are given for 6502-based home computers like the VIC-20, ORIC-1/Atmos, Electron, BCC and also the Commodore 64.

112 pages Order code BP147 £2.95

THE PRE-BASIC BOOK

F. A. Wilson, C.G.I.A., C.ENG., F.I.E.E., F.I.E.R.E., F.B.I.M.

Another book on BASIC but with a difference. This one does not skip through the whole of the subject and thereby leave many would-be programmers floundering but instead concentrates on introducing the technique by looking in depth at the most frequently used and more easily understood computer instructions. For all new and potential micro users.

192 pages Order code BP146 £2.95

electronize Car Electronics

MICRO-PRESSURE CAR ALARM

This new type of alarm is triggered by a unique pressure sensing system. As any vehicle door is opened, air is drawn out, causing a minute drop in air pressure. A sensor detects this sudden pressure change and sets off the alarm.

A sophisticated arrangement of electronic filters and timers provide features to match ultra-sonic systems but at a fraction of the cost.

- ★ 1 Micro-Pressure intruder detection.
- ★ 2 Operates on all doors and tailgate.
- ★ 3 No door switches needed.
- ★ 4 Automatically armed 1 minute after leaving vehicle.
- ★ 5 10 second entry delay with audible warning.
- ★ 6 Sounds horn intermittently for 1 minute.
- ★ 7 Easy fitting - only 3 wires to connect - no holes to drill.
- ★ 8 Compact design can be hidden below dashboard.
- ★ 9 All solid state Power MOSFET output - on relays.

MICRO-PRESSURE ALARM KIT £12.95
ASSEMBLED READY TO FIT £18.95

VOLT DROP CAR ALARM

Our latest alarm using the popular voltage drop method of triggering. Based on the timers of the micro-pressure alarm it offers features 4 to 9 above but relies on the existing door switch operation for triggering.

VOLT DROP ALARM KIT £11.75
ASSEMBLED READY TO FIT £17.75

TOTAL ENERGY DISCHARGE IGNITION

Our long established Extended CDI system retains the contacts to allow easy fitting whilst the electronics removes the adverse effects. The unique spark generating system still out performs the latest all electronic systems.

TOTAL ENERGY DISCHARGE IGNITION £18.95
ASSEMBLED READY TO FIT £24.90

All Electronize kits include clear, easy to follow instructions, quality components and everything needed, right down to solder and heatsink compound.

Order direct (Please quote Ref. C02 and add
or send for more details from:- £1 post and packing per item.)

ELECTRONIZE DESIGN tel. 021 308 5877
2 Hillside Road, Four Oaks, Sutton Coldfield, B74 4DQ

74HC series ICs		
74HC00 19p	74HC02 19p	74HC03 19p
74HC04 19p	74HC08 19p	74HC10 19p
74HC11 26p	74HC14 39p	74HC20 19p
74HC27 31p	74HC30 35p	74HC74 38p
74HC86 29p	74HC107 36p	74HC138 41p
74HC161 48p	74HC175 52p	74HC393 69p
74LS series ICs		
74LS00 20p	74LS02 20p	74LS05 20p
74LS30 20p	74LS32 20p	74LS51 20p
74LS90 30p	74LS93 30p	74LS107 23p
74LS112 23p	74LS138 35p	74LS139 35p
74LS151 38p	74LS164 38p	74LS193 55p
74LS245 58p	74LS374 52p	74LS375 64p
CMOS 4000 series ICs		
4001 19p	4002 19p	4011 19p
4012 25p	4013 26p	4014 45p
4015 56p	4016 91p	4017 40p
4018 63p	4019 29p	4020 45p
4023 19p	4027 36p	4040 45p
4046 51p	4049 29p	4066 29p
4070 21p	4071 19p	4075 19p
4076 74p	4081 19p	4082 19p
4510 47p	4511 47p	4514 £1.06

We can supply a wide range of components and TTL, CMOS and ECL ICs. We also supply PC, XT and AT spares at LOW PRICES. Write or phone for our FREE catalogue.

Serial I/O card for XT or AT only £16.00

Resistors at bulk prices *Your Mix*
Carbon film, 0.25W, 5% 1p each or 45p for 50
Metal film, 0.25W, 1% 3p each or £1.35 for 50
Bargain pack, 100 mixed common value 0.25W 90p

IC sockets, solder type (pin:price)
14:10p, 16:11p, 20:14p, 24(0.6 or 0.3):16p.

Prototyping boards (Vero)
IBM XT £45.00, IBM AT £52.00

ACCESS or AMERICAN EXPRESS welcome by post or phone. Callers by appointment please. VAT INCLUDED. Please add £1 for post and packing. Catalogue free. No minimum order charge.

BLACKMORE ELECTRONICS LTD.
FREEPOST, Blandford Forum
Dorset DT11 7BR
Office address: 4 The Plocks, Blandford

0258 451347 (24hr answerphone)

NEW PRODUCT!

If you want a PC that can't afford one, or perhaps you want to upgrade yours but don't know how, send for our NEW book "PC-DIY" which explains all about how to build, upgrade and fault-find PC XT and AT computers at LOW COST. "PC-DIY" suits beginners and is a valuable reference for experts too! We list all the parts you need, suggest sources of supply and give detailed descriptions of how to assemble a PC XT or AT to your specification. With "PC-DIY" it's easier than you might think!

For your copy of "PC-DIY" send a cheque for £7.95. (postage included) to Blackmore Electronics or phone our 24 hour hotline with your access card details. Available only from us! Order today!

SPECIAL OFFER!

COMPUTER BITS
Special offer! Floppy drive cleaning kits only 2.70 postage included (State 5¼ or 3½). We also sell markers, pens, labels, binders, spares etc. etc.



The UK Distributor for the complete ILP Audio Range



BIPOLAR AND MOSFET MODULES

The unique range of encapsulated amplifier modules with integral heatsink.

HY30 15W Bipolar amp.	£11.50	HY248 120W Bipolar amp (8ohm)	£25.20
HY60 30W Bipolar amp	£11.50	HY364 180W Bipolar amp (4ohm)	£39.25
HY6060 30W Stereo Bipolar amp	£24.45	HY368 180W Bipolar amp (8ohm)	£39.25
HY124 60W Bipolar amp (4ohm)	£19.00	MOS128 60W Mosfet amp	£40.70
HY128 60W Bipolar amp (8ohm)	£19.00	MOS248 120W Mosfet amp	£46.35
HY244 120W Bipolar amp (4ohm)	£25.20	MOS364 180W Mosfet amp	£75.75

PLATE AMPLIFIERS

Bipolar and Mosfet modules with the same electronics as above amplifiers housed in a different extrusion without heatsink.

HY6060P 30W Stereo Bipolar amp.	£20.10	HY364P 180W Bipolar amp (4 ohm)	£25.99
HY124P 60W Bipolar amp (4 ohm)	£14.85	HY368P 180W Bipolar amp (8 ohm)	£25.99
HY128P 60W Bipolar amp (8 ohm)	£14.85	MOS128P 60W Mosfet amp	£36.60
HY244P 120W Bipolar amp (4 ohm)	£20.10	MOS248P 120W Mosfet amp	£39.95
HY248P 120W Bipolar amp (8 ohm)	£20.10	MOS364P 180W Mosfet amp	£66.65

Note: These modules require additional heatsinks

POWER SUPPLIES

Comprising toroidal transformer and DC board to power the ILP amplifier modules.

PSU30 Pre-amplifier	£10.80	PSU542 HY248	£27.40
PSU212 1 or 2 HY30	£19.25	PSU562 MOS248	£29.60
PSU412 HY6060, HY124, 1 or 2 HY60	£21.45	PSU712 HY244 (2)	£31.75
PSU422 HY128	£23.70	PSU722 HY248 (2)	£32.80
PSU432 MOS128	£24.75	PSU732 HY364	£32.80
PSU512 HY244, HY128 (2)	£26.35	PSU742 HY368	£34.95
PSU522 HY124 (2)	£26.35	PSU752 MOS364, MOS248 (2)	£34.95
PSU532 MOS128 (2)	£27.40		

PRE-AMP AND MIXER MODULES

These encapsulated modules are supplied with in-line connectors but require potentiometers, switches etc.

HY6 Mono pre-amp with bass and treble	£9.30
HY66 Stereo pre-amp with bass and treble	£15.50
HY83 Guitar pre-amp with special effects	£18.95
B6 Mounting board for HY6	£1.15
B66 Mounting board for HY66 or HY83	£1.75

POWER SLAVES

These cased amplifiers are supplied assembled and tested in 60 and 120 watt Bipolar or Mosfet versions.

US12 60 watt Bipolar (4ohm)	£77.50	US32 60 watt Mosfet	£105.95
US22 120 watt Bipolar (4ohm)	£85.95	US42 120 watt Mosfet	£115.95

Prices include VAT and carriage



Quantity prices available on request
Write or phone for free Data Pack

Jaytee Electronic Services

143 Reculver Road, Beltinge, Herne Bay, Kent CT6 6PL
Telephone: (0227) 375254 Fax: 0227 365104

PCB SERVICE

Printed circuit boards for certain constructional projects are available from the PCB Service, see list. These are fabricated in glass fibre, and are fully drilled and roller tinned. All prices include VAT and postage and packing. Add £1 per board for overseas airmail. Remittances should be sent to **The PCB Service Everyday Electronics, 6 Church Street, Wimborne, Dorset BH21 1JH.** Cheques should be crossed and made payable to **Everyday Electronics (Payment in £ sterling only).**

Boards for some older projects – not listed here – can often be obtained from Magenta Electronics, 135 Hunter St., Burton-on-Trent, Staffs DE14 2ST. Tel: 0283 65435 or Lake Electronics, 7 Middleton Close, Nuthall, Nottingham NG16 1BX. Tel: 0602 382509.

NOTE: While 90% of our boards are now held in stock and are dispatched within seven days of receipt of order, please allow a maximum of 28 days for delivery – overseas readers allow extra if ordered by surface mail. Please check price and availability in the latest issue before ordering. We can only supply boards listed in the latest issue. Boards can only be supplied on a payment with order basis.

PROJECT TITLE		Order Code	Cost
Automatic Car Alarm	DEC '86	550	£3.00
BBC 16K Sideways RAM (Software Cassette)		551	£3.00
		551S	£3.88
Mini Amp	FEB '87	554 & 555	£5.68
Video Guard		556	£3.80
Spectrum I/O		557	£5.35
Computer Buffer/Interface	MAR '87	558	£3.32
Infra-Red Alarm: Sensor Head		561	£4.19
PSU/Relay Driver		562	£4.50
Bulb Life Extender	APR '87	564	£3.00
Fridge Alarm	MAY '87	565	£3.00
EE Equaliser-Ioniser		566	£4.10
Mini Disco Light	JUNE '87	567	£3.00
Fermostat	JULY '87	569	£3.34
EE Buccaneer Metal Detector		570	£4.10
Monomix		571	£4.75
Super Sound Adaptor Main Board	AUG '87	572	£4.21
PSU Board		573	£3.32
Simple Shortwave Radio, Tuner & Amplifier		575/576	£4.90
Noise Gate	SEPT '87	577	£4.41
Burst Fire Mains Controller		578	£3.31
Electronic Analogue/Digital Multimeter		579	£6.40
Transtest	OCT '87	580	£3.32
Accented Metronome	NOV '87	582	£3.77
Acoustic Probe		584	£3.00
BBC Sideways RAM/ROM		585	£4.10
Twinkling Star	DEC '87	588	£3.00
Audio Sine Wave Generator		589	£3.03
Capacitance Meter	JAN '88	590	£4.10
Bench Amplifier		591	£5.51
Transistor Curve Tracer		592	£3.00
Bench Power Supply Unit	FEB '88	593	£4.01
Game Timer		583	£3.55
Semiconductor Tester	MAR '88	594	£3.19
SOS Alert		595	£3.00
Guitar/Keyboard Envelope Shaper		596	£4.23
Stereo Noise Gate	APR '88	597	£6.65
Pipe & Cable Locator		598	£3.00
Inductive Proximity Detector		574	£3.00
Multi-Chan Remote Light Dim	MAY '88		
Transmitter		599	£3.00
Receiver		600	£3.07
Door Sentinel		605	£3.00
Function Generator – Main Board		606	£5.91
Function Generator – Power Supply		607	£4.19
Multi-Chan Remote Light Dim	JUNE '88		
Relay/Decoder		601	£4.86
Dimmer Board		602	£3.07
Power Supply		603	£3.00
Mother Board		604	£7.76
Headlight Reminder		611	£3.00
Video Wiper	JULY '88	612	£6.75
Isolink		613	£4.21

Tea Tune	AUG '88	609	£3.00
Time Switch		614	£4.84
Suntan Timer		610	£3.07
Car Alarm		615	£3.12
Breaking Glass Alarm	SEPT '88	617	£4.27
Amstrad PIO		618	£6.77
Eprom Eraser	OCT '88	620	£4.07
Doorbell Delay	NOV '88	616	£3.56
Micro Alarm		621	£3.12
Infra-Red Object Counter Trans	} £9.28 as a set	622	£4.61
Receiver		623	£3.23
Display		624	£3.05
		625	£4.84
Seashell Sea Synthesiser			
Reaction Timer Main Board	DEC '88	626	£3.46
Display Board		627	£3.00
Downbeat Metronome		629	£4.84
EPROM Programmer (On Spec)		630	£8.29
Phasor		631	£5.64
Monkey/Hunter Game	JAN '89	634	£3.36
Continuity Tester	FEB '89	619	£2.67
4-Channel Light Dimmer		635	£7.67
Mini PSU		636	£3.23
Sound-to-Light Interface	MAR '89	637	£6.24
Midi Pedal		639	£7.00
Midi Merge		640	£3.00
Audio Lead Tester		641	£5.77
Light Sentinel	APR '89		
Main Control Board		632	£9.20
Remote Interface (4 boards)		633	£4.59
Electron User Port		638	£6.64
4-Channel Auto-Fader Interface		642	£6.80
Pet Scarer	MAY '89	644	£3.00
Electron A/D Interface		645	£4.84
Spectrum EPROM Programmer	JUNE '89	628	£7.87
Bat Detector		647	£4.95
Programmable Pocket Timer	JULY '89	648	£3.82
Electronic Spirit Level	AUG '89	649	£3.85
Distance Recorder		651	£5.23
Treasure Hunter		652	£3.73
Xenon Beacon	SEPT '89	650	£4.13
Probe Pocket Treasure Finder		653	£4.12
Power Supplies { – Fixed Voltage		654	£4.08
{ – Variable Voltage		655	£4.48
Music on Hold	OCT '89	646	£3.85
Power Supplies – 25V 700mA		656	£4.35
– 30V 1A		657	£4.55
EE Seismograph – Control		658	£4.08
– Detector		659	£4.22
Lego/Logo & Spectrum		660	£6.49
Wash Pro	NOV '89		£3.83
Biofeedback Monitor – Front End		661	£4.52
– Processor		662	£4.56
Power Supplies – 1.5V–25V 2A		663	£4.78
Logo/Lego & Spectrum Interface		664	£5.60
EEG Electrode Impedance Meter	DEC '89	665	£3.98
Biofeedback Signal Generator	JAN '90	666	£4.08
Four-Channel Light Chaser		667	£6.70

Please note that when ordering it is important to give project title as well as order code. Please print name and address in Block Caps. Do not send any other correspondence with your order.

EE PRINTED CIRCUIT BOARD SERVICE

Please send me the following p.c.b.s.
Make cheques/PO payable to: **Everyday Electronics**
(payment in £ sterling only)

Order Code	Project	Quantity	Price
------------	---------	----------	-------

.....

.....

.....

I enclose cheque/PO for £.....

Name.....

Address.....

Please allow 28 days for delivery (see note above)

BLOCK CAPITALS PLEASE

JIDENCO CD



The Components Division of Jidenco Machines International Ltd
 Vale Road, Windsor, Berks SL4 5JW. Tel 0753 869723 Telex 847046 Fax 0753 830107
 Mon/Fri 8.00am-5.30pm. Monitored Answerphone evenings/weekend.

ALARMS		FUSES		NEON INDICATORS.	
WITH BUILT-IN DRIVE		GLASS QUICK BLOW		ROUND, SQUARE, 9, 12mm, 110v, 240v.	
REED BUZZER PCB/LEADS 3,6,9,12,24v	79p	50mA-6.3A (5x20)	10p	RED, GREEN, AMBER, CLEAR	50p
PIEZO DISC PCB/LEADS 3-28v	97p	100mA-15A (1/4x1 1/4)	10p		
PIEZO DISC PCB/LEADS 5-15v	95p				
COIL AND DIAPHRAGM PCB 6,12v	98p	GLASS TIME DELAY		RELAYS.	
		50mA-6.3A (5x20)	12p	4PDT	24VDC 3A 14 PIN PLUG-IN £3.36
WITHOUT INTERNAL DRIVE		100mA-16A (1/4x1 1/4)	12p		48VDC 3A 14 PIN PLUG-IN £3.59
PIEZO CERAMIC PCB/LEADS	51p				240VAC 3A 14 PIN PLUG-IN £3.98
COIL AND DIAPHRAGM PCB 6,12v	48p	MAINS FUSES TO BS 1362 ASTA APPROVED		SCREW TERMINAL BASE FOR ABOVE	£2.78
		3,5,13A	PACK 10	DPDT	12VDC 10A ROUND 8 PIN PLUG-IN £4.08
BULB HOLDERS					24VDC 10A ROUND 8 PIN PLUG-IN £4.08
FOR T3 1/4 (10mm) WEDGE BASE BULBS		FUSE HOLDERS			48VAC 10A ROUND 8 PIN PLUG-IN £4.08
PANEL MOUNT (20mm CUTOUT) SPADE TERMS.	18p	PCB CLIP HOLDER	7p		110VAC 10A ROUND 8 PIN PLUG-IN £4.13
PCB MOUNT	29p	HOOD FOR PCB CLIP HOLDER	4p		220VAC 10A ROUND 8 PIN PLUG-IN £4.20
BULBS FOR THE ABOVE 6.5/12/24/28v	15p	PANEL MOUNT (SCREWDRIVER RELEASE)	42p		240VAC 10A ROUND 8 PIN PLUG-IN £4.20
		PANEL MOUNT (FINGER RELEASE)	29p	SCREW TERMINAL BASE FOR ABOVE	£1.87
CAPACITORS		PCB MOUNT - VERTICAL, HORIZONTAL	39p	3PDT	12VDC 10A ROUND 11 PIN PLUG-IN £4.49
CERAMIC DISC		INSTRUMENT CASE HANDLES			24VDC 10A ROUND 11 PIN PLUG-IN £4.49
50v 22/27/150/470/2000/5000pF	PACK 50	POLISHED CHROME-PLATED MILD STEEL			48VDC 10A ROUND 11 PIN PLUG-IN £4.49
CERAMIC PLATE 1nF	PACK 50	W.111.1, H.33.5, DIA.9.5, FC.101.6	£2.69		24VAC 10A ROUND 11 PIN PLUG-IN £4.49
ELECTROLYTIC RADIAL		LEDS.			48VAC 10A ROUND 11 PIN PLUG-IN £4.49
35v 2200µF	40p	LOW COST 3 or 5mm			110VAC 10A ROUND 11 PIN PLUG-IN £4.61
50v 2200µF	40p	RED, GREEN, AMBER, YELLOW	PACK 20		220VAC 10A ROUND 11 PIN PLUG-IN £4.68
25v 10µF	PACK 10	BICOLOUR 5mm RED/GREEN 3 LEADS	45p	SCREW TERMINAL BASE FOR ABOVE	£2.24
16v 220µF	PACK 10	SUPERBRIGHT 3 OR 5mm	10p	PCB SPDT 8A 24VDC FLATPACK	£2.00
16v 4700µF	40p	RED, GREEN, AMBER, YELLOW	38p	PCB SPDT 16A 24VDC UPRIGHT	£2.13
ELECTROLYTIC AXIAL		8mm RED, GREEN, AMBER, YELLOW		RESISTORS.	
16v 100µF	PACK 10	LED MOUNTING CLIPS.		CARBON FILM	
16v 2200µF	PACK 5	FOR 3 OR 5mm LEADS	PACK 10	1/4 WATT 5% 1R1/10M SINGLE VAL. PACK 50	50p
16v 4700µF	40p	FOR 8mm LEADS	PACK 10		
TANT BEADS 16v 2, 2.4, 7/10µF	PACK 20	LED INDICATORS.		ROCKER SWITCHES WITH BLACK BEZELS.	
MONOLITHIC 50v 1µF	PACK 10	3mm LED IN 6mm CHROME PROMINENT HOUSING		DPST SUBMINATURE (15.9 x 13.3 CUTOUT)	43p
POLYESTER RAD (5mm) 100µF 5% 63v	PACK 10	RED, GREEN, YELLOW	73p	SPST MINATURE (19.5 x 13.3 CUTOUT)	35p
		3mm LED IN 6mm CHROME RECESSED HOUSING		SPST MINATURE ILLUMINATED	87p
CRYSTALS		RED, GREEN, YELLOW	73p	SPST STANDARD (28.5 x 11.7 CUTOUT)	33p
MICROPROCESSOR QUARTZ		5mm LED IN 8mm CHROME PROMINENT HOUSING		SPST STANDARD ILLUMINATED	88p
32.768KHZ TO 116.00MHZ	P.O.A.	RED, GREEN, YELLOW	55p	DPST STANDARD (27.5 x 22.4 CUTOUT)	44p
TTL CLOCK OSCILLATORS		5mm LED IN 8mm CHROME RECESSED HOUSING		DPST STANDARD ILLUMINATED	£1.22
1.00MHZ TO 82.3782MHZ	P.O.A.	7-SEGMENT DISPLAYS AND DOT MATRIX.		INDICATOR SUBMINATURE RED, GREEN	63p
PLEASE SPECIFY PACKAGE SIZE AND TOLERANCE		8mm SINGLE DIGIT		INDICATOR STANDARD SINGLE RD/GN/AMB	48p
VERY LOW PRICES - PLEASE ENQUIRE		14.22mm SINGLE AND DOUBLE DIGIT		INDICATOR STANDARD DOUBLE RD/GN/AMB	80p
DIP SWITCHES		6.4mm DOUBLE DIGIT		TOGGLE SWITCHES.	
PIANO DIP 2 POLE	46p	6.4mm TRIPLE DIGIT		12mm DIA CUTOUT	
SLIDE DIP 2 POLE	38p	6mm 4-DIGIT	ALL POA	SPDT	53p
4 POLE	62p	20 x 14 DOT MATRIX		DPDT	95p
6 POLE	72p	SPECIFY COMMON ANODE/CATHODE			
8 POLE	80p	SPECIFY BLACK/GREY FACE		MISCELLANEOUS.	
ALL SWITCHES HAVE GOLD CONTACTS.		SPECIFY COLOUR		R105 THERMAL CUTOUT 3A 250v 110°C	
DISC DRIVES		MONITORS		RADIAL LEADS 5mm PITCH	45p
5.25" 80 TRACK DS 1/2 HEIGHT		MONOCHROME		TIL139/OPB703A REFLECTIVE OPTO SWITCH	
TOSHIBA ND04DT 0.5MB	£85.15	TAXAN KX 118 12" GREEN	£88.00	TRANSISTOR OUTPUT IR FILTER 30v MAX	£1.50
NEC FC1057 1MB	£76.00	TAXAN KX 123 12" GREEN (IBM COMPAT)	£100.80	PCB CERMET TRIMMER 1 TURN 1K	35p
SWITCHABLE		TAXAN KX 124 12" AMBER (IBM COMPAT)	£100.80	DIN 41612 RIGHT ANGLE CONN 2 x 32 WAY	£1.00
TOSHIBA ND08DE 1MB-1.6MB	£93.75	COLOUR		TIP 31 POWER TRANSISTOR NPN 40v	16p
MITSUBISHI MF504C-312M 1MB-1.6MB	£82.00	TAXAN SUPERVISION 625 12" HIGH RES.	£303.60	MBM27C512-25 FUJITSU 64K x 8 EPROM	£5.75
		TAXAN SUPERVISION 760 14" EGA	£451.00	CHERRY PEFA 3000 SUBMINATURE PANEL	
3.5" DS		N.B. CARRIAGE IS £8.00 ON ALL MDNITORS		MOUNT PUSH BUTTON COUNTER. MODULAR	
TOSHIBA ND 352T 1MB	£76.00			TO MAKE 2-5 DIGITS. CUTOUT 22 x 7.62	£3.45
NEC FD 1037A 1MB	£71.42				
FANS - DC AXIAL BRUSHLESS					
40 x 40 x 10mm 12vdc	★£7.00				
40 x 40 x 20mm 12, 24vdc	★£7.00				
62 x 62 x 15mm 12, 24vdc	★£7.00				
80 x 80 x 20mm 12, 24vdc	★£7.00				
90 x 90 x 20mm 12, 24vdc	★£7.00				
VERY QUIET					
BIG DISCOUNTS FOR LARGER QUANTITIES - POA.					

Order by Access or Visa or in writing enclosing cash, cheque or PO. No minimum cash order. Minimum credit card or account order £10.00. Account applications from approved organisations and companies welcome, as are trade enquiries.

Payment:- Add £1.00 P&P (unless otherwise shown) to all orders and then add VAT (15%). Prices:- Are for 1 off unless a Pack Qty is shown. Discounts for larger Qtys. See our catalogue or phone. All components are brand new.

Send £1.50 for our full catalogue which includes discount vouchers - 50p off £5.00+ order, £1.00 off £10.00+ order, £5.00 off £50.00+ order. Prices valid on all orders received before 31st December 1989. Our product range is continually increasing - please enquire for other items.

ZENITH KITS - FOR THE ELECTRONICS ENTHUSIAST



The following is a selection from our catalogue:

- Black Ice Alarm (for Winter Motorists)..... **Kit £17.53**
- Negative Ion Machine, complete with case..... **Kit £24.11**
- Miniature F.M. 'BUG' transmitter 60-145MHz..... **Kit £6.95**
- 3-Watt F.M. transmitter 80-108MHz 12-Volt..... **Kit £13.99**
- Running light sequencer 10-channel, varispeed..... **Kit £15.89**
- Audio Power Meter 10-LED indication..... **Kit £12.94**
- VU-Meter 10-LED indication P.P.M. display..... **Kit £13.63**
- Electronic Door chime 3-note - variable freq..... **Kit £9.85**
- Infrared transmitter/receiver system..... **Kit £33.09**
- Light Activated Relay, 9-12Volt opp..... **Kit £8.91**
- Metal and Voltage Detector..... **R/Built £11.00**
- Tone Generator - Pulse or Warble tones..... **Kit £5.50**
- Loudspeaker Protector 5-100Watts..... **Kit £11.40**

■ All Kits are available **READY BUILT** please see latest Catalogue.

■ All Kits contain full instructions PCBs and components ■ All prices include VAT and postage and packing ■ Overseas orders add 10% to above prices ■ Please send Cheque or Postal Order with Order.

ZENITH ELECTRONICS Dept. 2
Cortlandt Business Centre
Hailsham, East Sussex, UK BN27 1AE
Telephone (0323) 847973
Telex 878334 Fax 647204



Access & Barclaycard Orders
Telephone (0323) 847973

S.A.E.
(A4 + 26p)
for
FREE
Catalogue

- Carbon Film resistors 1/4W 5% E24 series 0.51R to 10MΩ 1p
- 100 off per value - 75p, even hundreds per value totalling 1000 £6.00p
- Metal Film resistors 1/4W 10R to 1MΩ 5% E12 series - 2p, 1% E24 series 3p
- Mixed metal/carbon film resistors 1/2W E24 series 1R0 to 10MΩ 1 1/2p
- 1 watt mixed metal/Carbon Film 5% E12 series 4R7 to 10 Megohms 5p
- Linear Carbon pre-sets 100mW and 1/4W 100R to 4M7 E6 series 7p
- Miniature polyester capacitors 250V working for vertical mounting**
- .015, .022, .033, .047, .068-4p, 0.1-5p, 0.12, 0.15, 0.22-6p, 0.47-8p, 0.68-8p, 1.0-12p
- Mylar (polyester) capacitors 100V working E12 series vertical mounting**
- 1000p to 8200p - 3p, .01 to .068 - 4p, 0.1 - 5p, 0.12, 0.15, 0.22-6p, 0.47/50V-8p
- Submin ceramic plate capacitors 100V wkg vertical mountings. E12 series**
- 2% 1.8pf to 47pf - 3p, 2% 56 pf to 330pf - 4p, 10% 390p - 4700p 4p
- Disc/plate ceramics 50V E12 series 1P0 to 1000P, E6 Series 1500P to 47000P 2p
- Polystyrene capacitors 63V working E12 series long axial wires**
- 10pf to 820pf - 3p, 1000 pf to 10,000pf - 4p, 12,000 pf 5p
- 741 Op Amp - 20p, 555 Timer 22p
- cmos 4001 - 20p, 4011 - 22p, 4017 40p
- ALUMINIUM ELECTROLYTICS (Mfids/Volts)**
- 1/50, 2/250, 4/750, 10/25, 10/50 5p
- 22/16, 22/25, 22/50, 47/16, 47/25, 47/50 6p
- 100/16, 100/25 7p; 100/50 12p; 100/100 10p
- 220/16 8p; 220/25, 220/50 10p; 470/16, 470/25 11p
- 1000/25 25p; 1000/35, 2200 25 35p; 4700/25 70p
- Submin, tantalum bead electrolytics (Mfids/Volts)**
- 0.1/35, 0.22/35, 0.47/35, 1.0/35, 3.3/16, 4.7/16 14p
- 2.2/35, 4.7/25, 4.7/35, 6.8/16 15p; 10/16, 22/16 20p
- 33/10, 47/6, 22/16 30p; 47/10 35p; 47/16 60p; 47/35 80p
- VOLTAGE REGULATORS**
- 1A + or - 5V, 8V, 12V, 15V, 18V & 24V 55p
- DIODES (piv/amps)**
- 75/25mA 1N4148 2p, 800/1A 1N4006 6p, 400/3A 1N5404 14p, 115/15mA OA9† 6p
- 100/1A 1N4002 4p, 1000/1A 1N4007 7p, 60/1.5A SIM1 5p, 100/1A bridge 25p
- 400/1A 1N 4004 5p, 1250/1A BY127 10p, 30/15A OA47 8p
- Zener diodes E24 series 3V3 to 33V 400 mW - 8p, 1 watt 12p
- Battery snaps for PP3 - 6p for PP9 12p
- L.E.D.'s 3mm. & 5mm. Red, Green, Yellow - 10p, Grommets 3mm - 2p, 5mm 2p
- Red flashing L.E.D.'s require 5V supply only 50p
- Mains indicator neons with 220k resistor 10p
- 20mm fuses 100mA to 5A Q/blast 5p, A/size 8p, Holders pc or chassis 5p
- High speed pc drill 0.8, 1.0, 1.3, 1.5, 2.0mm - 30p, Machines 12V dc £7.00
- HELPING HANDS 6 ball joints and 2 croc clips to hold awkward jobs £3.50p
- AA/HP7 Nicad rechargeable cells 80p each, Universal charger unit £6.50p
- Glass reed switches with single pole make contacts - 8p, Magnets 12p
- TRANSISTORS**
- BC107/8/9-12p, BC547/8/9-8p, BC557/8/9-8p, BC182, 182L, BC183, 183L, BC184, 184L, BC212, 212L-10p, BC327, 337, 337L-12p, BC727, 737-12p, BD135/67/8/9-25p, BCY70-15p, BFY50/51/52-20p, BFX88-15p, 2N3055-50p, TIP31, 32-30p, TIP41, 42-40p, BU208A-E1.20, B195, 197-12p

THE CR SUPPLY CO
127 Chesterfield Rd., Sheffield S8 0RN
Tel: 0742 557771 Return posting

VARIABLE VOLTAGE TRANSFORMERS

INPUT 220/240V AC 50/60Hz OUTPUT 0-260V
200W 0.1 amp max £24.00 p&p £3.00 (£31.05 inc VAT)
0.5KVA 2.5 amp max £26.50 £3.75 (£34.79 inc VAT)
1KVA 5 amp max £34.00 £4.25 (£43.99 inc VAT)
2KVA 10 amp max £49.00 £5.50 (£62.68 inc VAT)
3KVA 15 amp max £65.00 £6.25 (£81.94 inc VAT)
5KVA 25 amp max £115.00
Carriage on request



VOLTAGE CHANGING TRANSFORMER

1250 Watt auto. Tapped 0 90V, 100, 110, 115, 120, twice to obtain voltages between 90 and 240V Fitted in heavy duty louvered metal case, Fused Input. Price incl VAT & p&p £39.50.

COMPREHENSIVE RANGE OF TRANSFORMERS-IT-ISOLATION & AUTO (110-240V Auto transfer either cased with American socket and mains lead or open frame type. Available for immediate delivery.

ULTRA VIOLET BLACK LIGHT FLUORESCENT TUBES

4ft 40 watt £10.44 (£12.00 inc VAT) Caller only
2ft 20 watt £7.44 + £1.25 p&p (£9.99 inc VAT)
13in 10 watt £5.90 + 75p p&p (£7.53 inc VAT)
12in 8 watt £4.80 + 75p p&p (£6.38 inc VAT)
9in 6 watt £3.96 + 50p p&p (£5.12 inc VAT)
6in 4 watt £3.96 + 50p p&p (£5.12 inc VAT)



230V AC BALLAST KIT for either 6in, 9in or 12in tubes £5.50 + 55p p&p (£6.96 inc VAT)
For 13in tubes £6.00 + 75p p&p (£7.75 inc VAT)

400 WATT UV LAMP
Only £34.00 + £2.50 p&p (£41.98 inc VAT)
175 WATT SELF BALLASTED BLACK LIGHT MERCURY BULBS Available with BC or ES fitting. Price incl VAT & p&p £19.84.

12 VOLT BILGE PUMPS

Buy direct from the importers
500 GPH 15ft head 3 amp
£16.00 inc.
1750 GPH 15ft head 9 amp
£20.18 + £2.00 p&p (£25.50 inc VAT)



EPROM ERASURE KIT

Build your own EPROM ERASURE for a fraction of the price of a make-up unit kit of parts less case includes 12in 8 watt 2537 Angst Tube Ballast unit pair of bi-pin leads neon indicator on/off switch safety microswitch and circuit £14.00 + £2.00 p&p (£18.40 inc VAT)

SUPER HY-LIGHT STROBE KIT

Designed for Disco, Theatrical users etc.
Approx 16 joules. Adjustable speed £48.00 + £2.00 p&p (£57.50 inc VAT)

Case and reflector £22.00 + £2.00 p&p (£27.60 inc VAT)
SAE for further details including Hy-Light and Industrial Strobe Kits.

WIDE RANGE OF XENON FLASH TUBES

Write/Phone your enquiries

EXTENSIVE RANGE OF DIFFERENT TYPES OF GEARED MOTORS AVAILABLE FROM STOCK

WASHING MACHINE WATER PUMP
Brand new 240V AC fan cooled can be used for a variety of purposes. Inlets 1 1/2 ins. Outlet 1 inch. Price including p&p and VAT - £10.95 or 2 for £20 including p&p and VAT.

SPECIAL OFFER AC CAPACITORS

1.5 MFD 440V £2.00	5 MFD 440V £4.00
2 MFD 440V £2.50	5.4 MFD 280V £2.00
4.1 MFD 440V £3.50	5 MFD 660V £3.00
	12 MFD 440V £4.00

p->p 50p per unit plus VAT to be added to total.

TORIN CENTRIFUGAL BLOWER
230V ac 2,800 RPM 0.9amp 130mm diameter Impeller outlet 63 x 37mm overall size 195 x 160 x 150mm long. Price £17.50 + £2.50 p&p (£23 inc VAT)

SHADED POLE GEAR MOTORS
In the following sizes:
9 RPM 12 RPM 80 RPM 160 RPM 110V AC or 240V AC with capacitors (supplied). Price incl VAT & p&p £12.85

GEARED MOTORS
71 RPM 20lb inch torque reversible 115V AC Input including capacitor and transformer for 240V AC operation. Price incl VAT & p&p £23.00.

12V DC COOLER EXTRACTOR FAN
New brushless motor 82mm sq. Price incl VAT & p&p £11.50.

SOLID STATE EMT UNIT
Input 230/240V AC, Output approx 15KV. Producing 10mm spark. Built-in 10 sec timer. Easily modified for 20 sec, 30 sec to continuous. Designed for boiler ignition. Dozens of uses in the field of physics and electronics, eg supplying neon or argon tubes etc. Price less case £8.50 + £1.00 p&p (£10.93 inc VAT) NMS

COOLING FANS-BRAND NEW!
200/400V AC American Boxer 'Peewee' 7-bladed high efficiency cooling unit 80mm sq x 40mm deep 40cmm approx. Price incl VAT & p&p £10.35.

EX-EQUIPMENT FANS 120mm sq x 38mm deep in either 115V or 230V AC Tested and guaranteed. Price incl VAT & p&p £7.76.

Large selection of various speed geared motors from stock. Phone or write for details.

From stock at prices that defy competition
C/F Blowers Program Timers
Microswitches Synch Motors
write/phone your enquiries

NMS = NEW MANUF SURPLUS
R&T = RECONDITIONED AND TESTED

SERVICE TRADING CO
57 BRIDGMAN ROAD, CHISWICK, LONDON W4 5BB
01-995 1560
ACCOUNT CUSTOMERS MIN. ORDER £10

FRASER ELECTRONICS

42 Elm Grove Southsea Hants PO5 1JG

BUDGET PACK SELECTION

The packs listed below are selected from our full list of 140 packs (sent free with all orders). Note that our prices include VAT and carriage charges—NO HIDDEN EXTRAS. All orders subject to a minimum value of £3.00. Access and Barclaycard accepted—and you can 'phone orders to
Portsmouth (0705) 815584
from 9.00am 'till 5.30pm any weekday

Qty.	Device	Description	Cost
50	1N4004	Rectifier diode 1A/400V	£2.00
100	1N4148	Signal/switch diode	£2.00
12	BC327	PNP 0.8A transistor	£1.00
12	BC337	NPN 0.8A transistor	£1.00
14	LED MIX	7 ea .3mm red & green LED	£1.00
2	ORP12	Light dependent resistor	£1.80
10	555	8-pin DIP timer	£1.80
10	741	8-pin DIP op.-amp	£1.80
5	SB1	9tX24h. stripboard	£1.00
12	DIL-14	14-pin DIL socket	£1.00

THE DREAM MACHINE ▷

Adjust the controls to suit your mood and let the gentle, relaxing sound drift over you. At first you might hear soft rain, sea surf, or the wind through distant trees. Almost hypnotic, the sound draws you irresistibly into a deep, refreshing sleep.

For many the thought of waking refreshed and alert from perhaps the first truly restful sleep in years is exciting enough in itself. For more adventurous souls there are strange and mysterious dream experiences waiting. Take lucid dreams, for instance. Imagine being in control of your dreams and able to act out your most secret wishes and fantasies. With the Dream Machine anything is possible.

DREAM MACHINE PARTS SET **£22.77**

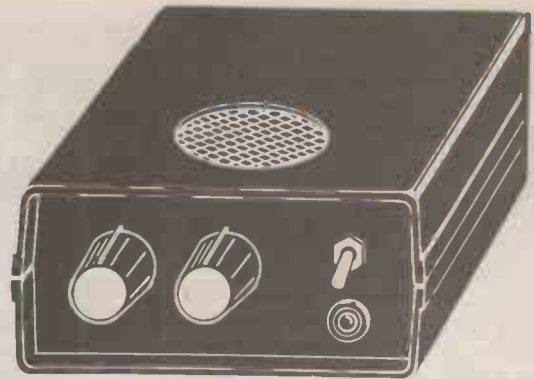

▷ POWER CONDITIONER

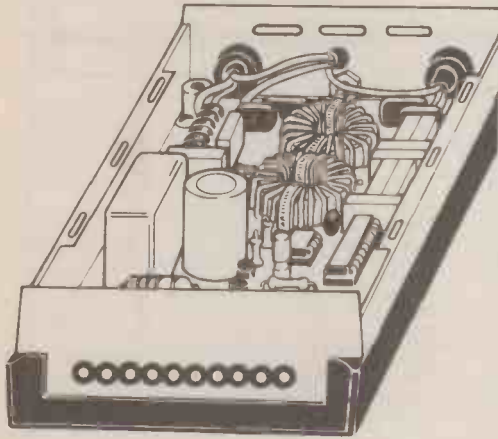

You don't have to be a hi-fi nut to notice the huge improvement in sound quality when you run your music system from a clean mains supply. How do you describe the difference? It's as if all this time your favourite artists have been playing and singing inside a wardrobe . . . and someone just opened the door and let them out. You could spend twenty times as much on special cables, plugs, mats and stuff without achieving a tenth of the difference. But don't take my word for it. Try it for yourself.

The sophisticated circuitry of the Power Conditioner begins with a bank of six VDRs to eliminate impulsive spikes. Then comes a massive filter with thirteen capacitors and two current-balanced inductors to smooth away every trace of noise and interference. A ten LED logarithmic display flicks up and down as each spike is eliminated, and gives a second by second account of the interference removed. Maximum load 1.5kW.

POWER CONDITIONER PARTS SET **£34.27**

MAINS CONDITIONER ▷

A general purpose workhorse for cleaning up the mains supply to computers, hi-fi, television sets, and any other electronic equipment that might be disturbed by mains interference. The solid, no-nonsense circuit will handle loads up to 1kW, and the PCB can be built into the equipment to be protected or housed in the optional case.

MAINS CONDITIONER PARTS SET (no case) **£6.21**

RUGGED CASE (optional) **£2.07**

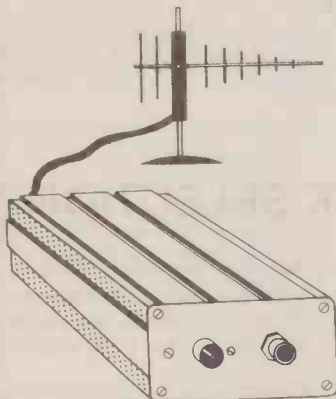
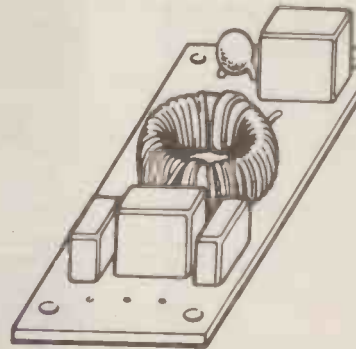

▷ AERIAL BOOSTER

Good TV pictures from an indoor aerial, from a caravan aerial, or in areas of poor reception. This booster ranks with the very best, giving wideband operation from 10MHz to 1.4GHz (it will boost FM radio signals too), mid-band gain of up to 26dB, and a wide supply voltage range of 9V to 26V. It will run from car batteries for caravanners, dry batteries for campers, or a battery eliminator for use in the home.

There are two parts sets for the project. AA1 gives you the PCB, hybrid amplifier, components and instructions. AA2 is the optional case set: rugged screened box, front and rear panels, waterproofing gaskets, feet, sockets and hardware.

AA1 PARTS SET **£14.72** AA2 PARTS SET **£5.52**

KNIGHT RAIDER ▷

The ultimate lighting effect for your car. Picture this: eight powerful lights in line along the front and eight along the rear. You flick a switch on the dashboard control box and a point of light moves lazily from left to right leaving a comet's tail behind it. Flip another switch and the point becomes a bar, bouncing backwards and forwards along the row. Now try one of the other six patterns. An LED display on the console lets you see what the main lights are doing.

The Knight Raider parts set contains the case and all components for the control box. The pattern generator and lamp driver is supplied as a PCB with all components for you to mount anywhere convenient. We supply the electronics, you supply the lamps (from any car accessories shop).

KNIGHT RAIDER PARTS SET **£28.52**



Specialist
SEMICONDUCTORS

Tel: (0600) 3715 LIMITED
SALES DEPT., ROOM 111, FOUNDERS HOUSE, REDBROOK, MONMOUTH, GWENT.

ORDERING

All prices include VAT
UK orders: please add £1.15 postage and packing.
Eire and overseas: please deduct VAT and add
£5.00 carriage and insurance.



ACCESS

Phone 0600 3715 for immediate
attention to your Access order.

Reach effectively and economically today's enthusiasts anxious to know of your products and services through our semi-display and classified pages. The prepaid rate for semi-display spaces is £8.00 (plus VAT) per single column centimetre (minimum 2.5 cm). The prepaid rate for classified advertisements is 30 pence (plus VAT) per word (minimum 12 words).

All cheques, postal orders, etc., to be made payable to Everyday Electronics. VAT must be added. Advertisements, together with remittance, should be sent to the Classified Advertisement Dept., Everyday Electronics, 6 Church Street, Wimborne, Dorset BH21 1JH. Tel: (0202) 881749.

AGE A & G ELECTRONICS LTD.
ELECTRONIC COMPONENTS MAIL ORDER COMPANY.
Electronic components, I.C.'s, diodes, LED's, capacitors, potentiometers, solar chargers, computer disks, video tapes, aerosols, etc.
Brand new quality components at unbeatable prices.
1990 catalogue is out now

Access (SEND £1 FOR YOUR COPY) refundable with first order

VISA

100 Park Avenue, London E6 2SR. Tel: 01-552 2386

WALTONS OF WOLVERHAMPTON
Established since 1947 - offering a complete range - I.C.s, transformers, switches, pots, capacitors, resistors, kits, speakers, test equipment, books and lots, lots more!
COME AND SEE US AT: MON-SAT 9-6.00 pm
55A WORCESTER STREET, WOLVERHAMPTON
TEL: 0902 22039

ELECTRONIC COMPONENTS
EVERYTHING FOR YOUR NEXT PROJECT
THE BIGGEST DISPLAY IN THE SOUTH IS AT
FRASER ELECTRONICS
42 ELM GROVE ★ SOUTHSEA ★ HANTS
Telephone 0705-815584

PLEASE MENTION
EVERYDAY ELECTRONICS
WHEN REPLYING TO
ADVERTISEMENTS

SERVICE MANUALS
Most available for Amateur Radio, Military Surplus, Test Equipment, Vintage Valve, Colour TV, Mono TV, Video Recorders etc. etc
Over 100,000 stocked. LSAE Enquiries with Make/Model wanted.
FREE catalogue unique repair and data guides for LSAE
MAURITRON (EE)
8 Cherry Tree Road, Chinnor, Oxon OX9 4QY
Tel: (0844) 51694



IF YOU WISH TO RESERVE A SPACE IN OUR CLASSIFIED SECTION. RING - 'DAVID LEAVER' ON (0202) 881749 AND HE WILL BE PLEASED TO ADVISE YOU ON YOUR REQUIREMENTS.

RCS VARIABLE VOLTAGE D.C. BENCH POWER SUPPLY
1 to 24 volts up to 1/2 amp. 1 to 20 volts up to 1 amp. 1 to 16 volts up to 1 1/2 amps A.C. Fully stabilised. Twin panel meters for instant voltage and current readings. Overload protection.
Fully variable. Operates from 240V AC. Compact Unit. size 9 x 5 1/2 x 3 in.

£39 inc. VAT + Post £2

RADIO COMPONENT SPECIALISTS
337 WHITEHORSE ROAD, CROYDON SURREY, U.K. Tel: 01-684 1665
List, Large SAE. Delivery 7 days. Callers welcome. Closed Wednesday

NEW VHF MICROTRANSMITTER KIT
Tunable 80-115 MHz, 500 metre range, sensitive electret microphone, high quality PCB, SPECIAL OFFER complete kit ONLY £5, assembled and ready to use £8.95 post free. Access/Visa orders telephone 021 411 1821 (24hrs).
Cheques/P.O.s payable to:
QUANTEK ELECTRONICS LTD
(Dept. EE), 45a Station Road Northfield, Birmingham B31 3TE

TECHNICAL INFO SERVICES (EE)
76 Church St., Larkhall, Lanarkshire ML9 1HE
Phone 0698 884585 Mon-Fri, 9-5.
any other time 0698 883334. FOR FAST QUOTES
WORLD'S LARGEST COLLECTION SERVICE MANUALS - Most unobtainable elsewhere. Prices range from only £1.50 - large s.a.e. any quotation, no obligation to buy.
WORLD'S SOLE Suppliers of TV & Video Repair manuals, etc. from TV TECHNIC, also such publishers as Heinemann, News, TV Technic, Thom etc. Every published service sheet in stock, supplied full size, not bits & pieces. CTV's or any combination £3.50 plus Lsae; any other single item £2.50 plus Lsae. Complete Circuit Sets for most Videorecorders only £7 set (no serv. shits made).
LSAE for QUOTATIONS plus GIANT CATALOGUE - NEWSLETTERS - BARGAINS - FREE S&SN as available.
Comprehensive TV Repair Manual £9.50. Complete Radio Service and Repair Course £9.50. Complete Repair & Service Manuals - Mono TV £12.50. CTV £17.00. Video £19.50. Complete Repair Data with circuit - Mono TV £9.50. CTV £12.50. Video £10.50.
£3.00 plus LSAE BRINGS THE ONLY COMPREHENSIVE SERVICE SHEETS & MANUALS, CATALOGUES plus FREE CHASSIS GUIDE and £4.00 OF VOUCHERS

USE THIS SPACE
SELL YOUR PRODUCTS
IT ONLY COSTS **£28** + VAT
(see above for details)

Kits

FM MICRO TRANSMITTER KITS 20mm x 28mm. £2.99 inc p&p. Cheques/PO to Minral, 39 Parkside, Orrell, Wigan, WN5 8LU.

KITS. Microtransmitter, VHF/FM, 14x25mm, including free microphone, £4.50. VHF/FM bleeper tracking transmitter, £7.99. Voice operated switch, £8.99. Telephone transmitter, VHF/FM, £4.99. Automatic telephone recording switch, £7.99. SAE list. ACE(EE). 99 Greenheath, Hednesford, Staffs. Access orders 05438 71902 (24 hrs).

1 1/2 AMP. 1.25V-37V VARIABLE REGULATED POWER SUPPLY KIT 40mm x 20mm. Input A.C. or D.C., to 40V. Includes heatsink and components. £6.99 inc P&P. Cheque/P.O. to Steve's Services, 40 Finmere, Bracknell, Berks. RG12 4WF.

PLANS. Electrify metal objects, un-pleasant shock, uses 9V battery, £3. Bug detector, £3. VHF bleeper transmitter, £3. All 3 £8. SAE List. ACE (EE). 99 Greenheath, Hednesford, Staffs.

RF PROJECTS AND KITS including transmitters. For catalogue send SAE (A4) to T.M. Electronics, 39 Mayeswood Road, Grove Park, London SE12.

G.C.S.E. ELECTRONICS KITS. Ten different £10.50 (+70p, p+p) or SAE for details. SIR-KIT ELECTRONICS, 70 Oxford Road, Clacton, CO15 3TE.

Miscellaneous

PROTOTYPE PRINTED CIRCUIT BOARDS, one offs and quantities, for details send s.a.e. to Mr B. M. Ansbro, 38 Poyning Drive, Sussex. BN3 8GR, or phone Brighton 720203.

ELECTRONIC COMPONENTS & TEST EQUIPMENT For bargain list send SAE. Dept EE, 76 Wensleydale Road, Great Barr, Birmingham. B42 1PL.

TRANSMITTER CIRCUIT DIAGRAMS PACK - Medium, Shortwave, C.B., some crystal controlled, minimum 17 circuits. Includes constructors' guide and price list for kits. Cheques/P.O.'s, £5.75 to 'D. Davies', 33 Gwaelodygarth, Merthyr Tydfil, CF47 8YU.

HUNDREDS OF UNUSUAL ITEMS CHEAP! Send 88p (coins/stamps) for interesting samples and list. Grimsby Electronics, Lambert Road, Grimsby.

COMPONENTS AND AUDIO EQUIPMENT. Send S.A.E. for free list to ACE Mailtronix Ltd. P.O. Box 41, Wakefield, W. Yorks. WF2 7YA. Large range of Components and Audio sub-assemblies at competitive prices.

SOUND ACCESSORIES AND PRODUCTS including microphones, mixers, amplifiers for all discos, groups, home studios & PA's - send 20p SAE for lists. Sound Services, 61 Clarence Road, Fleet, GU13 9RY.

KIA "HAPPY CHRISTMAS" FREEBIE!! Catalogue + 12 fun-packed projects and stereo demo-cassette; + transistors giftpack!!... Return-advert + £1 coin (p&p) to 8 Cunliffe Road, Ilkley, LS29 9EA.

NATIONAL COMPONENT CLUB

SPECIAL OFFERS * SPECIAL OFFERS

SCANNER KIT(T)

A complete, six channel LED chaser kit for less than a fiver! The kit comes complete with all components, including PCB and instructions simple enough for even a complete novice. Works from 6-15Vdc.

Only £4

MAINS POWER SUPPLY FOR ABOVE £1

* SPECIAL OFFER PACKS *

100	ASSORTED CAPACITORS	£1
30	ASSORTED TRANSISTORS	£1
25	ELECTROLYTIC CAPACITORS	£1
12	LED's (5mm red or green)	£1
5	555 TIMER IC's	£1
5	741 OP-AMPS	£1

FREE MYSTERY PACK WITH ALL ORDERS OVER £6

Please add £1 P&P, but do not add VAT.

P.O. or cheque to: NATIONAL COMPONENT CLUB, DEPT EE, BAILEY HILL, CASTLE CARY, SOMERSET BA7 7AD

We now accept Access - phone (0963) 51171

★ FREE CLUB MEMBERSHIP ★

Just phone above number or write for details

A Fair Deal For Our Advertisers

No guesses, no wishful thinking—the circulation of this magazine is audited to the strict professional standards administered by the Audit Bureau of Circulations

ABC

The Hallmark of Audited Circulation

MARAPET

★ SPECIAL CHRISTMAS & NEW YEAR OFFERS ★
A 'FREE' E180 VIDEO TAPE with every British Telecom 'ROBIN' Answering Machine SOLD

Smart 'low-profile' styling ● Low cost single tape design ● Remote interrogation (Voice activated) ● Easy to use ● Complete with tape, socket doubler & transformer. JUST £68.99 plus £3.75 P&P

SPECIAL SOLDERING PACKAGE Buy the Weller S125D 'General Duty' 25W 240Vac iron, complete with BH-S1 die-cast stand and we'll give you — absolutely 'free' — A length of both 22 & 26swg Solder and a 13A Plug-top. Available now at £16.47+ £2.30 P&P.

SAVE £2

WE STOCK A RANGE OF ELECTRONIC COMPONENTS ... Tools ... Electrical Accessories ... Telephone Equipment and MUCH MORE. WHY NOT SEND FOR OUR CATALOGUE!!! Including our list of SPECIAL OFFERS AND CLEARANCE BARGAINS. Simply send 2x20p stamps, towards postage for your copy NOW.

WE CAN NOW SUPPLY A RANGE OF 'MANUFACTURERS ORIGINAL SPARES' for many makes of TV & Video Recorder. Also SINCLAIR & AMSTRAD COMPUTERS ... So whether it's a Custom Chip, a Remote Control Handset or maybe a Service Manual you require ... GIVE US A TRY!!!

MAIL ORDER ONLY. NO VAT. Offers end 12/1/90.

Dept. EEA., 1 HORNBEAM MEWS, GLOUCESTER GL2 0UE

SPECIAL OFFERS

Varta Mopak nic. cad. rechargeable batteries 3.6V 100mA	1.85p
Miniature 3V DC Electric Motor with stabilising Capacitor. Approx. Dimensions, Length 42.5mm, Width 32mm, Shaft 10mm	70p each
4 Way 13amp Extension Block fitted with 2MTRS 13amp 3 core flex and a 13amp Plugtop	£6.50
2 Way 13amp 10MTR Extension Reel with Safety Cut Out	£12.95
2 Way Powerline Professional 25MTR 13amp Extension Reel with Cut Out	£24.95
QUALITY SCREWDRIVER SET Manufactured In West Germany to Din Standards. Rated at 1000V consisting of Four Parallel Blade Drivers, Blade sizes 75mmx2.5mm, 100mmx4mm, 125mmx5.5mm, 150mmx6.5mm. Two Cross Point, Blade Sizes 80mmx5mm, 100mmx6mm, One 70mm 240V Mains Screwdriver	£9.36 per set
LONG NOSE PLIERS 8"(200mm) 1000V	£4.90 each
SIDE CUTTERS 6 1/2"(160mm) 1000V	£4.67 each
WIRE STRIPPER 6 1/2"(160mm) 1000V	£5.50 each
ANTEX SKS SOLDERING KIT Consisting of a CS240 17 Watt 240V Soldering iron, an ST4 Solder Stand, Approx 1mtr of Solder and a booklet on How to Solder	£9.12 each
ARCOLETRIC ROCKER SWITCHES On/Off snap-in type rated 200/250A C. 6.3mm tab: PACK ONE Consisting of 10 assorted illuminated single-pole rocker switches. To fit panel hole approx. 28.2mmx11.5mm	£4.00 per pack
PACK TWO Consisting of 10 assorted illuminated and non-illuminated double-pole rocker switches. To fit panel hole approx. 30mmx22.1mm	£6.00 per pack

CHAFFORD VALLEY PRODUCTS

Chafford Lane, Fordcombe, Kent TN3 0SH.
Tel. 089 2740287 Fax. 089 2740216.

MAIL ORDER ONLY. ALL PRICES INCLUSIVE VAT. ADD £1.00p P&P UNLESS OTHERWISE STATED. TERMS CASH, CHEQUE OR POSTAL ORDER WITH ORDER. SCHOOL ACCOUNTS AVAILABLE

MAKE YOUR INTERESTS PAY!

More than 8 million students throughout the world have found it worth their while! An ICS home-study course can help you get a better job, make more money and have more fun out of life! ICS has over 90 years experience in home-study courses and is the largest correspondence school in the world. You learn at your own pace. When and where you want, under the guidance of expert 'personal' tutors. Find out how we can help YOU. Post or phone today for your FREE INFORMATION PACK on the course of your choice.

GCSE / GCE / SCE	CAR MECHANICS
ELECTRONICS	COMPUTER PROGRAMMING
BASIC ELECTRONIC ENGINEERING (City & Guilds)	TV, VIDEO & HI-FI SERVICING
ELECTRICAL ENGINEERING	RADIO AMATEUR LICENCE EXAM (City & Guilds)
ELECTRICAL CONTRACTING / INSTALLATION	

Course of interest _____
Name: _____ P.Code _____
Address: _____
International Correspondence School, Dept. ECS10, 312/314 High Street, Sutton, Surrey SM1 1PR. Tel: 01-643 9568 or 041-221 2926 (24 hrs)

Need an extra pair of hands?

It's often the case that conventional methods just won't do. Fortunately there is now an alternative with the

MULTI-PURPOSE JIG

It will hold a circuit board steady for assembly and wiring—
It can hold things while glue sets—
It can hold models for painting and repair—
All its interchangeable heads rotate through 360 degrees so you can position your workpiece to best advantage—no need to take it out to turn it over either—just rotate it to where you want it.
Precision spring loaded head for holding pressures of up to 5.5lbs.



Each jig is hand built for a lifetime of use.
Supplied with circuit board assembly head, 12.5mm rubber faced heads and static discharge-lead.
Other heads and accessories available.

Standard jig takes items up to 310 x 145mm **£19.50**
Mini jig takes items up to 148 x 85mm **£16.50**

inc. VAT and carriage

Local authority, school and college orders welcome
EVERETT WORKSHOP ACCESSORIES
5 Railway Terrace, Henllan, Llandyssul,
Dyfed SA44 5TH Tel: 0559 371226

MAIL ORDER AND RETAIL SHOP

Stockist of:

Large range of Semiconductors: Transistors, Diodes, Zeners, Thyristors Triacs, regulators, opto isolators LED. Integrated circuits: TTL, Cmos, CPU, support device, Roms-proms, controllers and generators etc.
Resistors: Pots, presets, Capacitors, including computer grade, trimmers, tuners etc,
Chokes, transformers, Relays, Buzzers, Speakers etc.
Switches: standard, miniature, slide, rockers, pushbuttons etc. Connectors: large range including ready made leads, IDC, URO, Din, plugs and sockets etc. Di sockets: low profile and wire wrap etc.
Panel meters, soldering irons, solder suckers, solder etc. Aerosol switch cleaners, lubricants, protectors and freezers etc. Motors, modulators, trimmers, oscillator modules: rechargeable batteries, solar panels etc.
Power supplies Linear and switch mode by Astec, Farnell, Siemens, Advance, Gould, Gresham etc.
Disc Drive Units: 5.25, 3.5 inches, hard disc, and cables etc.
Test Instruments: Analogue, Digital, Oscilloscopes, Generators etc. Large range of instrument cases.

WE BUY COMPONENTS AND INSTRUMENTS

Callers Welcome, Shop Hours: Mon., Tu., Thu., Fri. 9am to 5.30pm Wed. & Sat. 9am to 2pm

COMPACT SWITCH MODE

Supplies — 51 watts to 1 kilowatt. Various Voltages. Please Ring for further Details.



Fuselodge Ltd.



267 Acton Lane, Chiswick, London W4 5DD Telephone: 01-994 6275

OMNI ELECTRONICS

174 Dalkeith Road, Edinburgh EH16 5DX • 031 667 2611

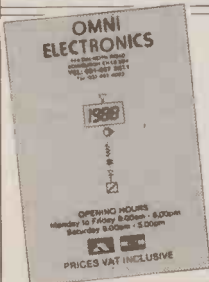

Have you sent for your copy of our catalogue yet?

If not, simply send 2x 1st class stamps for a copy by return.

A COMPREHENSIVE RANGE WITH SERVICE SECOND TO NONE

Open: Monday-Friday 9.00-6.00
Saturday 9.00-5.00



ADVERTISERS INDEX

AUDIO ELECTRONICS	33
BICC — VERO ELECTRONICS	23
B K ELECTRONICS	Cover (iii)
BLACKMORE ELECTRONICS	69
BULL J & N	Cover (ii)
CAMBRIDGE COMPUTER	
SCIENCE	30
CHAFFORD VALLEY PRODUCTS	75
CIRKIT DISTRIBUTION	33
CRICKLEWOOD ELECTRONICS	54
CR SUPPLY CO.	72
ELECTRONIZE DESIGN	69
ELV FRANCE	4.5
EVERETT WORKSHOP ACCESS	75
FRASER ELECTRONICS	72
FUSELIDGE	76
GREENWEL ELECTRONICS	7
HART ELECTRONIC KITS	25
HIGHGRADE COMPONENTS	6
HILLS COMPONENTS	37
HOBBYKIT	49
ICS	75
JAYTEE ELEC. SERVICES	69
JIDENCO CD	71
LONDON ELEC COLLEGE	76
MAGENTA ELECTRONICS	8.9
MAPLIN ELECTRONICS	Cover (iv)
MARAPET	75
MARCO TRADING	43
NATIONAL COLLEGE OF TECH.	76
NATIONAL COMPONENT CLUB	75
NUMBER ONE SYSTEMS	53
OMNI ELECTRONICS	76
RADIO & TV COMPONENTS	2, 65
RISCOMP	49
SATURN SYSTEMS	65
SERVICE TRADING CO.	72
SHERWOOD DATA SYSTEMS	25
SHERWOOD ELEC. COMP.	76
SPECIALIST SEMICONDUCTORS	73
SUMA DESIGN	54
TANDY	31
TASPA	49
TK ELECTRONICS	10
WEKA PUBLISHING	38.9
ZENITH ELECTRONICS	72

BTEC ELECTRONICS TECHNICIAN FULL-TIME TRAINING

2 YEAR

BTEC National Diploma (OND) ELECTRONIC & COMMUNICATIONS ENGINEERING
(Electronics, Computing, Television, Video, Testing & Fault Diagnosis)

1 YEAR

BTEC National Certificate (ONC) ELECTRONIC ENGINEERING
1—INFORMATION TECHNOLOGY
(Electronics, Satellite TV, Networks, Telecomms)

2—ELECTRONIC EQUIPMENT SERVICING

(Electronics, Television, Video Cassette Recorders, CCTV, Testing and Fault Diagnosis)

3—SOFTWARE ENGINEERING

(Electronics, Assembler, BASIC, Pascal, CAD/CAM)

4—COMPUTING TECHNOLOGY

(Electronics, Computing Software/Hardware, Microelectronics)

10 MONTHS

BTEC Higher National Certificate (HNC) COMPUTING TECHNOLOGY & ROBOTICS
(Microprocessor Based Systems, Control, Robotics)

These courses include a high percentage of college based practical work to enhance future employment prospects
No additional fees for overseas students

Shortened courses of from 3 to 6 months can be arranged for applicants with previous electronics knowledge

THOSE ELIGIBLE CAN APPLY FOR E.T. GRANT SUPPORT AN EQUAL OPPORTUNITIES PROGRAMME

O.N.C. and O.N.D.

Monday 8th January 1990

FULL PROSPECTUS FROM

LONDON ELECTRONICS COLLEGE
(Dept. EE), 20 PENYWERN ROAD
EARLS COURT, LONDON SW5 9SU
Tel: 01-373 8721

SHERWOOD ELECTRONIC COMPONENTS

45 Rutland Street, Mansfield, Notts NG18 4AP
SPECIAL PACKS — All at £1.00 each

SP1	12x5mm Red LEDs
SP2	12x5mm Green LEDs
SP3	12x5mm Yellow LEDs
SP4	10x5mm Amber LEDs
SP5	36x5mm 1 part LED clips
SP6	12x3mm Red LEDs
SP7	12x3mm Green LEDs
SP8	10x3mm Yellow LEDs
SP9	40x3mm 1 part LED clips
SP10	50x1N4148 signal diodes
SP11	25x1N4001 rectifier diodes
SP12	25x1N4002 rectifier diodes
SP13	25xRad.Elec.Caps. (1-1000µF)
SP18	15xBC182 Transistors
SP19	15xBC183 Transistors
SP20	15xBC184 Transistors
SP21	15xBC212 Transistors
SP22	15xBC214 Transistors
SP23	15xBC549 Transistors
SP24	5xCmos 4001
SP25	5x555 Timer
SP26	5x741 Op-Amp
SP27	5xCmos 4002
SP28	5xCmos 4011
SP29	3xCmos 4013
SP30	5xCmos 4025
SP31	4xCmos 4071

SP32	4xCmos 4077
SP33	4xCmos 4061
SP34	2xCmos 4510
SP35	2xCmos 4511
SP36	20x10µF/25V Rad.Elec.Caps.
SP37	15x100µF/35V Rad.Elec.Caps.
SP38	20x47µF/25V Rad.Elec.Caps.
SP39	12x470µF/16V Rad.Elec.Caps.
SP40	15xBC237 Transistors
SP41	25xmixed Transistors
SP43	2xLM1458
SP44	12x5mm Leds-4 each, Red, Green Yellow
SP45	25x1N4000 series rect. diodes
SP46	15x400mW zeners—assorted values
SP47	5xminiature push button switches
SP101	15 metres of 22SWG 60-40 solder
SP102	15x8 pin DIL sockets
SP103	12x14 pin DIL sockets
SP104	12x16 pin DIL sockets
SP105	5x74LS00 I.C.s
SP106	5x74LS02 I.C.s
SP107	20xmixed presets —Hor. +Vertical
SP108	15xBC382 Transistors
SP109	15xBC557 Transistors
SP110	4x74LS13 I.C.s

1 pack of your choice FREE when you buy any 10 of the above £1.00 packs.

ADDITIONAL PACKS

SP50	25x5mm Red LEDs	£2.00
SP51	25x5mm Green LEDs	£2.00
SP52	50xRad. Elec. Caps.	£1.95
SP53	30xDIL sockets 8, 14, 16	£2.00
SP54	1xTIL38+1xTIL100	£1.80
SP57	100x1N4148 diodes	£1.75
SP65	60x3mm+5mm Leds	£4.80

RESISTOR PACKS

0.25W Carbon Film resistors 10R-10M	
5 each value — total 365	£2.75
10 each value — total 730	£4.50
1000 popular values	£6.00
Individual resistors	2p ea.
10+ one value	1p ea.
100 one value	75p

CMOS

4000	25p	4070	27p
4001	25p	4071	27p
4002	25p	4072	27p
4011	25p	4073	27p
4012	27p	4075	27p
4013	36p	4077	32p
4017	55p	4081	27p
4023	30p	4093	27p
4025	25p	4510	65p
4027	50p	4511	65p
4040	70p	4514	£1.25
4047	65p	4515	£1.30
4049	40p	4516	65p
4066	40p	4528	70p

I.C.s

555	22p
556	75p
741	22p
747	70p
CA3140E	45p
CA3240E	£1.25
LM338	55p
LM390-14	£1.25
LM723	60p
LM1458	55p
TL071	60p
TL072	80p
TL081	40p
TL082	55p

V. REGS.

100mA	
78L05	25p
78L12	25p
78L15	26p
79L05	30p
79L12	30p
79L15	30p
1A	
7805	35p
7812	35p
7815	36p
7905	36p
7912	38p
7915	38p

Cheques or P.O. to:

SHERWOOD ELECTRONIC COMPONENTS

Please add £1 P&P to orders under £20.00

This only a small sample of components stocked, send 75p for new 1990 catalogue, contains vouchers redeemable against orders over £5.00. NO VAT



NATIONAL COLLEGE OF TECHNOLOGY

PACKAGED SHORT COURSES

The National College of Technology (NCT Ltd) offers a range of packaged short courses in analogue electronics, digital electronics and fibres & optoelectronics for study at home or at work. The advantages are that you may,

- commence at any time
- work at your own pace
- have a tutor (optional)

and there is no travelling involved. BTEC certificates are available subject to the conditions of the award. These highly popular packed courses contain workbooks, a cassette tape, circuit board and components necessary to provide both theoretical and practical training.

Whether you are a newcomer to electronics or have some experience and simply need updating, there is probably a packaged short course ready for you. Write or telephone for details, quoting Everyday Electronics, to:

**NCT Ltd, Bicester Hall,
5 London Road, Bicester
Oxon OX6 7BU**

or telephone (0296) 613067 Ext. 202



POWER AMPLIFIER MODULES-TURNABLES-DIMMERS-LOUDSPEAKERS-19 INCH STEREO RACK AMPLIFIERS

OMP POWER AMPLIFIER MODULES

Supplied ready built and tested.

OMP POWER AMPLIFIER MODULES Now enjoy a world-wide reputation for quality, reliability and performance at a realistic price. Four models available to suit the needs of the professional and hobby market, i.e., Industry, Leisure, Instrumental and Hi-Fi etc. When comparing prices, NOTE all models include Toroidal power supply, integral heat sink, Glass fibre P.C.B., and Drive circuits to power compatible Vu meter. Open and short circuit proof.

THOUSANDS OF MODULES PURCHASED BY PROFESSIONAL USERS



OMP100 Mk 11 Bi-Polar Output power 110 watts R.M.S. into 4 ohms, Frequency Response 15Hz - 30KHz - 3dB, T.H.D. 0.01%, S.N.R. -118dB, Sens. for Max. output 500mV at 10K, Size 355 x 115x65mm. **PRICE £33.99 + £3.00 P&P.**

NEW SERIES II MOS-FET MODULES



OMP/MF 100 Mos-Fet Output power 110 watts R.M.S. into 4 ohms, Frequency Response 1Hz - 100KHz - 3dB, Damping Factor >300, Slew Rate 45V/uS, T.H.D. Typical 0.002%, Input Sensitivity 500mV, S.N.R. -125dB. Size 300 x 123 x 60mm. **PRICE £39.99 + £3.00 P&P.**



OMP/MF200 Mos-Fet Output power 200 watts R.M.S. into 4 ohms, Frequency Response 1Hz - 100KHz - 3dB, Damping Factor >300, Slew Rate 50V/uS, T.H.D. Typical 0.001%, Input Sensitivity 500mV, S.N.R. -130dB. Size 300 x 155 x 100mm. **PRICE £62.99 + £3.50 P&P.**



OMP/MF300 Mos-Fet Output power 300 watts R.M.S. into 4 ohms, Frequency Response 1Hz - 100KHz - 3dB, Damping Factor >300, Slew Rate 60V/uS, T.H.D. Typical 0.0008%, Input Sensitivity 500mV, S.N.R. -130dB. Size 330 x 175 x 100mm. **PRICE £79.99 + £4.50 P&P.**

NOTE:— MOS-FET MODULES ARE AVAILABLE IN TWO VERSIONS, STANDARD — INPUT SENS. 500mV BAND WIDTH 100KHz, PEG (PROFESSIONAL EQUIPMENT COMPATIBLE) — INPUT SENS. 775mV, BAND WIDTH 50KHz, ORDER STANDARD OR PEG



Vu METER Compatible with our four amplifiers detailed above. A very accurate visual display employing 11 L.E.D. diodes (7 green, 4 red) plus an additional on/off indicator. Sophisticated logic control circuits for very fast rise and decay times. Tough moulded plastic case, with tinted acrylic front. Size 84 x 27 x 45mm. **PRICE £8.50 + 50p P&P.**

LOUDSPEAKERS



LARGE SELECTION OF SPECIALIST LOUDSPEAKERS AVAILABLE, INCLUDING CABINET FITTINGS, SPEAKER GRILLES, CROSS-OVERS AND HIGH POWER, HIGH FREQUENCY BULLETS AND HORNS, LARGE S.A.E. (30p STAMPED) FOR COMPLETE LIST.

McKENZIE:— INSTRUMENTS, P.A., DISCO, ETC.

- ALL MCKENZIE UNITS 8 OHMS IMPEDANCE**
- 8" 100 WATT C8100GPM GEN. PURPOSE, LEAD GUITAR, EXCELLENT MID. DISCO. RES, FREQ, 80Hz. FREQ. RESP. TO 14KHz. SENS. 99dB. **PRICE £29.30 + £2.00 P&P**
 - 10" 100 WATT C10100GP GUITAR, VOICE, ORGAN, KEYBOARD, DISCO, EXCELLENT MID. RES, FREQ, 70Hz. FREQ. RESP. TO 6KHz. SENS. 100dB. **PRICE £35.58 + £2.50 P&P**
 - 10" 200 WATT C10200GP GUITAR, KEYBOARD, DISCO, EXCELLENT HIGH POWER MID. RES, FREQ, 45Hz. FREQ. RESP. TO 7KHz. SENS. 103dB. **PRICE £48.67 + £2.50 P&P**
 - 12" 100 WATT C12100GP HIGH POWER GEN. PURPOSE, LEAD GUITAR, DISCO. RES, FREQ, 40Hz. FREQ. RESP. TO 7KHz. SENS. 98dB. **PRICE £37.59 + £3.50 P&P**
 - 12" 100 WATT C12100TC (TWIN CONE) HIGH POWER WIDE RESPONSE, P.A., VOICE, DISCO. RES, FREQ, 45Hz. FREQ. RESP. TO 14KHz. SENS. 100dB. **PRICE £38.58 + £3.50 P&P**
 - 12" 200 WATT C12200B HIGH POWER BASS, KEYBOARDS, DISCO, P.A. RES, FREQ, 40Hz. FREQ. RESP. TO 7KHz. SENS. 100dB. **PRICE £65.79 + £3.50 P&P**
 - 12" 300 WATT C12300GP HIGH POWER BASS LEAD GUITAR, KEYBOARDS, DISCO, ETC. RES, FREQ, 45Hz. FREQ. RESP. TO 5KHz. SENS. 100dB. **PRICE £87.51 + £3.50 P&P**
 - 15" 100 WATT C15100BS BASS GUITAR, LOW FREQUENCY, P.A., DISCO. RES, FREQ, 40Hz. FREQ. RESP. TO 5KHz. SENS. 99dB. **PRICE £55.05 + £4.00 P&P**
 - 15" 200 WATT C15200BS VERY HIGH POWER BASS. RES, FREQ, 40Hz. FREQ. RESP. TO 4KHz. SENS. 99dB. **PRICE £75.10 + £4.00 P&P**
 - 15" 250 WATT C15250BS VERY HIGH POWER BASS. RES, FREQ, 40Hz. FREQ. RESP. TO 4KHz. SENS. 99dB. **PRICE £82.54 + £4.50 P&P**
 - 15" 400 WATT C15400BS VERY HIGH POWER, LOW FREQUENCY BASS. RES, FREQ, 40Hz. FREQ. RESP. TO 4KHz. SENS. 102dB. **PRICE £96.47 + £4.50 P&P**
 - 18" 400 WATT C18400BS EXTREMELY HIGH POWER, LOW FREQUENCY BASS. RES, FREQ, 27Hz. FREQ. RESP. TO 3KHz. SENS. 99dB. **PRICE £172.06 + £5.00 P&P**

EARBENDERS:— HI-FI, STUDIO, IN-CAR, ETC.

- ALL EARBENDER UNITS 8 OHMS (Except EB8-50 & EB10-50 which are dual impedance tapped @ 4 & 8 ohm)**
- BASS, SINGLE CONE, HIGH COMPLIANCE, ROLLED FOAM SURROUND**
 - 8" 50 WATT EB8-50 DUAL IMPEDANCE, TAPPED 4/8 OHM BASS, HI-FI, IN-CAR. RES, FREQ, 40Hz. FREQ. RESP. TO 7KHz. SENS. 97dB. **PRICE £8.90 + £2.00 P&P**
 - 10" 50 WATT EB10-50 DUAL IMPEDANCE, TAPPED 4/8 OHM BASS, HI-FI, IN-CAR. RES, FREQ, 40Hz. FREQ. RESP. TO 5KHz. SENS. 99dB. **PRICE £12.00 + £2.50 P&P**
 - 10" 100 WATT EB10-100 BASS, HI-FI, STUDIO. RES, FREQ, 35Hz. FREQ. RESP. TO 7KHz. SENS. 96dB. **PRICE £27.76 + £3.50 P&P**
 - 12" 60 WATT EB12-60 BASS, HI-FI, STUDIO. RES, FREQ, 28Hz. FREQ. RESP. TO 3KHz. SENS. 92dB. **PRICE £21.00 + £3.00 P&P**
 - 12" 100 WATT EB12-100 BASS, STUDIO, HI-FI, EXCELLENT DISCO. RES, FREQ, 26Hz. FREQ. RESP. TO 3KHz. SENS. 93dB. **PRICE £38.75 + £3.50 P&P**
 - FULL RANGE TWIN CONE, HIGH COMPLIANCE, ROLLED SURROUND**
 - 5 1/2" 60 WATT EB5-60TC (TWIN CONE) HI-FI, MULTI-ARRAY DISCO ETC. RES, FREQ, 63Hz. FREQ. RESP. TO 20KHz. SENS. 92dB. **PRICE £9.99 + £1.50 P&P**
 - 6 1/2" 60 WATT EB6-60TC (TWIN CONE) HI-FI, MULTI-ARRAY DISCO ETC. RES, FREQ, 38Hz. FREQ. RESP. TO 20KHz. SENS. 94dB. **PRICE £10.99 + £1.50 P&P**
 - 8" 60 WATT EB8-60TC (TWIN CONE) HI-FI, MULTI-ARRAY DISCO ETC. RES, FREQ, 40Hz. FREQ. RESP. TO 18KHz. SENS. 89dB. **PRICE £12.99 + £1.50 P&P**
 - 10" 60 WATT EB10-60TC (TWIN CONE) HI-FI, MULTI-ARRAY DISCO ETC. RES, FREQ, 35Hz. FREQ. RESP. TO 12KHz. SENS. 86dB. **PRICE £16.49 + £2.00 P&P**

TRANSMITTER HOBBY KITS

PROVEN TRANSMITTER DESIGNS INCLUDING GLASS FIBRE PRINTED CIRCUIT BOARD AND HIGH QUALITY COMPONENTS COMPLETE WITH CIRCUIT AND INSTRUCTIONS

- 3W FM TRANSMITTER 80-108MHz, VARICAP CONTROLLED PROFESSIONAL PERFORMANCE, RANGE UP TO 3 MILES, SIZE 38 x 123mm, SUPPLY 12V @ 0.5AMP. **PRICE £14.49 + £1.00 P&P**
- FM MICRO TRANSMITTER (BUG) 100-108MHz VARICAP TUNED COMPLETE WITH VERY SENS FET MIC, RANGE 100-300m, SIZE 56 x 46mm, SUPPLY 9V BATT, PRICE **£8.62 + £1.00 P&P**



3 watt FM Transmitter



POSTAL CHARGES PER ORDER £1.00 MINIMUM. OFFICIAL ORDERS WELCOME FROM SCHOOLS, COLLEGES, GOVT. BODIES, ETC. PRICES INCLUSIVE OF V.A.T. SALES COUNTER, VISA ACCESS ACCEPTED BY POST, PHONE OR FAX.



* PRICES INCLUDE V.A.T. * PROMPT DELIVERIES * FRIENDLY SERVICE * LARGE S.A.E., 30p STAMPED FOR CURRENT LIST.

OMP VARISPEED TURNTABLE CHASSIS



★ MANUAL ARM ★ STEEL CHASSIS ★ ELECTRONIC SPEED CONTROL 33 & 45 ★ VARI PITCH CONTROL ★ HIGH TORQUE SERVO DRIVEN DC MOTOR ★ TRANSIST SCREWS ★ 12" DIE CAST PLATTER ★ NEON STROBE ★ CALIBRATED BAL. WGT ★ REMOVABLE HEAD SHELL ★ 1/2" CARTRIDGE FIXINGS ★ CUE LEVER ★ POWER 220/240V 50/60Hz ★ 390x305mm ★ SUPPLIED WITH MOUNTING CUT-OUT TEMPLATE. **PRICE £59.99 + £3.50 P&P.**

OPTIONAL MAGNETIC CARTRIDGES

STANTON AL500
PRICE £16.99 + 50p P&P

GOLDRING G850
PRICE £8.99 + 50p P&P

OMP MOS-FET POWER AMPLIFIERS, HIGH POWER, TWO CHANNEL 19 INCH RACK

THOUSANDS PURCHASED BY PROFESSIONAL USERS



NEW MXF SERIES OF POWER AMPLIFIERS
THREE MODELS:— MXF200 (100w + 100w)
MXF400 (200w + 200w) MXF600 (300w + 300w)

All power ratings R.M.S. into 4 ohms.

FEATURES: ★ Independent power supplies with two Toroidal Transformers ★ Twin L.E.D. Vu meters ★ Rotary indexed level controls ★ Illuminated on/off switch ★ XLR connectors ★ Standard 775mV inputs ★ Open and short circuit proof ★ Latest Mos-Fets for stress free power delivery into virtually any load ★ High slew rate ★ Very low distortion ★ Aluminium cases ★ MXF600 Fan Cooled with D.C. Loudspeaker and Thermal Protection.

USED THE WORLD OVER IN CLUBS, PUBS, CINEMAS, DISCOS ETC.

SIZES:— MXF 200 W19" x H3 1/2" (2U) x D11"
MXF 400 W19" x H5 1/4" (3U) x D12"
MXF 600 W19" x H5 1/4" (3U) x D13"

MXF200 £171.35
MXF400 £228.85
MXF600 £322.00
SECURICOR DELIVERY £12.00 EACH

OMP LINNET LOUDSPEAKERS

THE VERY BEST IN QUALITY AND VALUE



MADE ESPECIALLY TO SUIT TODAY'S NEED FOR COMPACTNESS WITH HIGH OUTPUT SOUND LEVELS, FINISHED IN HARDWEARING BLACK VYNNIDE WITH PROTECTIVE CORNERS, GRILLE AND CARRYING HANDLE INCORPORATES 12" DRIVER PLUS HIGH FREQ. HORN FOR FULL FREQ. RANGE. 45Hz-20KHz BOTH MODELS 8 OHM, SIZE H18" x W15" x D12".

CHOICE OF TWO MODELS

POWER RATINGS QUOTED IN WATTS RMS FOR EACH CABINET

OMP 12-100 (100W 100dB) PRICE £159.99 PER PAIR
OMP 12-200 (200W 102dB) PRICE £209.99 PER PAIR

SECURICOR DEL.:— £12.00 PER PAIR

IN CAR STEREO BOOSTER AMPLIFIER

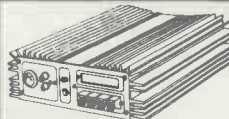

TWO SUPERB HIGH POWER CAR STEREO BOOSTER AMPLIFIERS

150 WATTS (75x75) INTO 4 OHMS
300 WATTS (150x150) INTO 4 OHMS
FEATURES:—
★ HIGH & LOW INPUT IMPEDANCES
★ HIGH & LOW INPUT SENSITIVITIES
★ VARIABLE INPUT GAIN CONTROL
★ SHORT CIRCUIT OUTPUT PROTECTION
★ POWER REQUIREMENT 12V. D.C.
PRICES: 150 WATT £43.00
300 WATT £95.00 + £3.00 P&P EACH

PIEZO ELECTRIC TWEETERS—MOTOROLA

PIEZO ELECTRIC TWEETERS — MOTOROLA

Join the Piezo revolution. The low dynamic mass (no voice coil) of a Piezo tweeter produces an improved transient response with a lower distortion level than ordinary dynamic tweeters. As a crossover is not required these units can be added to existing speaker systems of up to 100 watts (more if 2 put in series). FREE EXPLANATORY LEAFLETS SUPPLIED WITH EACH TWEETER.

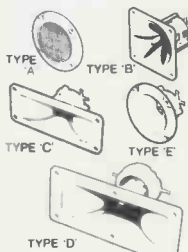

TYPE 'A' (KSN2036A) 3" round with protective wire mesh, ideal for bookshelf and medium sized Hi-fi speakers. Price £4.90 each + 50p P&P.
TYPE 'B' (KSN1005A) 3 1/2" super horn. For general purpose speakers, disco and P.A. systems etc. Price £5.99 each + 50p P&P.
TYPE 'C' (KSN016A) 2" x 5" wide dispersion horn. For quality Hi-fi systems and quality discos etc. Price £6.99 each + 50p P&P.
TYPE 'D' (KSN1025A) 2" x 6" wide dispersion horn. Upper frequency response retained extending down to mid range (2KHz). Suitable for high quality Hi-fi systems and quality discos. Price £9.99 each + 50p P&P.
TYPE 'E' (KSN1038A) 3 3/4" horn tweeter with attractive silver finish trim. Suitable for Hi-fi monitor systems etc. Price £5.99 each + 50p P&P.
LEVEL CONTROL Combines on a recessed mounting plate, level control and cabinet Input Jack socket. 85x85mm. Price £3.99 + 50p P&P.

STEREO DISCO MIXER

STEREO DISCO MIXER with 2 x 5 band L & R graphic equalisers and twin 10 segment L.E.D. Vu Meters. Many outstanding features 5 inputs with individual faders providing a useful combination of the following:—
3 Turntables (Mag). 3 Mics. 4 Line including CD plus Mic with talk over switch Headphone Monitor. Pan Pot L. & R. Master Output controls. Output 775mV. Size 360x280x90mm. Supply 220-240V.
Price £134.99 — £4.00 P&P



B. K. ELECTRONICS Dept EE
UNIT 5, COMET WAY, SOUTHEAST-ON-SEA, ESSEX. SS2 6TR
TEL: 0702-527572 FAX: 0702-420243

**ORDER
YOUR COPY
OF THE NEW
MAPLIN CATALOGUE
ON SALE NOW**

Pick up a copy from any W.H. Smith for just £2.25 or post this coupon now to receive your copy for just £2.25 + 50p p & p. If you live outside the U.K. send £4 or 17 International Reply Coupons. I enclose £2.75.

Name

Address

Send to Maplin Electronics, P.O. Box 3, Rayleigh, Essex SS6 8LR. Post Code

AVAILABLE FROM 10th NOVEMBER 1989 IN ALL W.H. SMITH STORES

EE 90



**OVER 580 PAGES WITH HUNDREDS OF NEW PRODUCTS AT SUPER LOW PRICES
THE NEW MAPLIN CATALOGUE - WORLDS APART!
1990 BUYER'S GUIDE TO ELECTRONIC COMPONENTS SEND FOR YOUR COPY TODAY**