

EVERYDAY

JANUARY 1999

PRACTICAL

ELECTRONICS

<http://www.epemag.wimborne.co.uk>

£2.65

VOLUME COMPRESSOR

Automatic control of loud TV adverts

COURTESY LIGHT

A headlight delay to light your way

FROM RUSSIA WITH LOVE?

Barry Fox visits a "closed" cosmodrome and a rocket factory in Moscow



EPE MIND PICKLER - 2

Construction of our mind entrainment project



THE No.1 MAGAZINE FOR
ELECTRONICS TECHNOLOGY
& COMPUTER PROJECTS



PLUS PhizzyB Computers - Understanding Computers
Circuit Surgery • Ingenuity Unlimited • Innovations

WIND GENERATORS 380 WATT 1.14 metre dia blades carbon matrix blades, 3 year warranty, 12vdc output, 24v version available, control electronics included, brushless neodymium cubic curve alternator, only two moving parts, maintenance free simple roof top installation start up speed 7mph, max output (30mph) 380w £499 ref AIR1

HYDROPONICS DO YOU GROW YOUR OWN? We have a full colour hydroponics catalogue available containing nutrients, pumps, fittings, environmental control, light fittings, plants, test **TELEKINETIC ENHANCER PLANS** Mystify and amaze your friends by creating motion with no known apparent means or cause. Uses no electrical or mechanical connections, no special gimmicks yet produces positive motion and effect. Excellent for science projects, magic shows, party demonstrations or serious research & development of this strange and amazing psychic phenomenon £4/set Ref F/TKE1

ELECTRONIC HYPNOSIS PLANS & DATA This data shows several ways to put subjects under your control. Included is a full volume reference text and several construction plans that when assembled can produce highly effective stimuli. This material must be used cautiously. It is for use as entertainment at parties etc only by those experienced in its use £15/set Ref F/IEH2

GRAVITY GENERATOR PLANS This unique plan demonstrates a simple electrical phenomena that produces an anti-gravity effect. You can actually build a small mock spaceship out of simple materials and without any visible means - cause it to levitate. £10/set Ref F/GRA1

WORLDS SMALLEST TESLA COIL/LIGHTNING DISPLAY GLOBE PLANS Produces up to 750 000 volts of discharge, experiment with extraordinary HV effects "Plasma in a jar", St Elmo's fire, Corona, excellent science project or conversation piece £5/set Ref F/BTC1/LG5

VOICE SCRAMBLER PLANS Miniature solid state system turns speech sound into indecipherable noise that cannot be understood without a second matching unit. Use on telephone to prevent third party listening and bugging £6/set Ref F/VSS

PULSED TV JOKER PLANS Little hand held device utilises pulse techniques that will completely disrupt TV picture and sound works on FM too! DISCRETION ADVISED £8/set Ref F/TJ5

BURNING, CUTTING CO2 LASER PLANS Projects an invisible beam of heat capable of burning and melting materials over a considerable distance. This laser is one of the most efficient, converting 10% input power into useful output. Not only is this device a workhorse in welding, cutting and heat processing materials but it is also a likely candidate as an effective directed energy beam weapon against missiles, aircraft, ground-to-ground, etc. Particle beams may very well utilize a laser of this type to blast a channel in the atmosphere for a high energy stream of neutrons or other particles. The device is easily applicable to burning and etching wood, cutting, plastics, textiles etc £12/set Ref F/LC7

ULTRASONIC BLASTER PLANS Laboratory source of sonic shock waves. Blow holes in metal, produce 'cold' steam, atomize liquids. Many cleaning uses for PC boards, jewelry, coins, small parts etc £6/set Ref F/ULB1

ANTI DOG FORCE FIELD PLANS Highly effective circuit produces time variable pulses of acoustical energy that dogs cannot tolerate £6/set Ref F/DOG2

LASER BOUNCE LISTENER SYSTEM PLANS Allows you to hear sounds from a premises without gaining access £12/set Ref F/LLIST1

PHASOR BLAST WAVE PISTOL SERIES PLANS Handheld, has large transducer and battery capacity with external controls. £6/set Ref F/PPSP4

INFINITY TRANSMITTER PLANS Telephone line grabber/room monitor. The ultimate in home/office security and safety! simple to use! Call your home or office phone, push a secret tone on your telephone to access either A) On premises sound and voices or B) Eavesdrop conversation with break-in capability for emergency messages £7 Ref F/TELEGRAB

ELECTROMAGNETIC GUN PLANS Projects a metal object a considerable distance - requires adult supervision £5 ref F/EML2

ELECTRIC MAN PLANS, SHOCK PEOPLE WITH THE TOUCH OF YOUR HAND! £5/set Ref F/EMA1

2 FOR 1 MULTIFUNCTIONAL HIGH FREQUENCY AND HIGH DC VOLTAGE, SOLID STATE TESLA COIL AND VARIABLE 100,000 VDC OUTPUT GENERATOR PLANS Operates on 9-12vdc, many possible experiments £10 Ref F/HVM7/TCL4

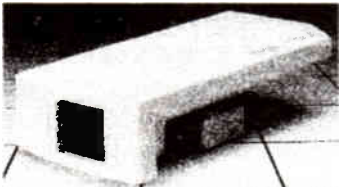

COLOUR CCTV VIDEO CAMERAS From £99

Works with most modern video's, TV's, Composite monitors, video grabber cards. Pal, 1v P-P, composite, 75ohm, 1/3" CCD, 4mm F2.8, 500x582, 12vdc, mounting bracket, auto shutter, 100x50x180mm, 3 months warranty, 1 off price £119 ref XEF150, 10 or more £99 ea 100+ £89

CIRCUIT PACKS Packs of 35 circuit diagrams covering lasers, SW radios, geigers, bugs, char etc Pack1, Pack2, Pack3 £4.99 each **SMOKE ALARMS** Mains powered, made by the famous Gent company, easy fit next to light fittings, power point. £4.99 ref SMKX **CONVERT YOUR TV INTO A VGA MONITOR FOR £25!** Converts a colour TV into a basic VGA screen. Complete with built in psu, lead and s/ware. Ideal for laptops or a cheap upgrade. Supplied in kit form for home assembly. SALE PRICE £25 REF SA34

***15 WATT FM TRANSMITTER** Already assembled but some RF knowledge will be useful for setting up. Preamp req'd, 4 stage 80-108mhz, 12-18vdc, can use ground plane, yagi or dipole £69 ref 1021 ***4 WATT FM TRANSMITTER KIT** Small but powerful FM

transmitter kit 3 RF stages mic & audio preamp inc £24 ref 1028 **PIR CAMERA** Built in CCTV camera (composite output) IR strobe light PIR detector and battery backup. Designed to 'squirr' pictures down the 'phone line but works well as a standalone unit. Bargain price £49.95 ref SS81 3 or more £44.95 ref SS80

4AH D SIZE NICADS pack of 4 £10 ref 4AHPK **ELECTRIC FENCE KIT** Everything you need to build a 12vdc electric fence complete with 200m of electric fence wire £49 ref AR2 **SENDER KIT** Contains all components to build a AVV transmitter complete with case £35 ref VSXX2

UV LIGHTS 4' fluorescent 340nm £38.99 ref UV23 **33 KILO LIFT MAGNET** Neodymium 32mm £15 ref MAG33

10 WATT SOLAR PANEL Amorphous silicon panel fitted in a anodized aluminium frame. Panel measures 3' by 1' with screw terminals for easy connection. 3' x 1' solar panel £55 ref MAG45 **Unframed 4 pack (3'x1') £58.99 ref SOLX**

12V SOLAR POWERED WATER PUMP Perfect for many 12v DC uses ranging from solar fountains to hydroponics! Small and compact yet powerful. Will work direct from our 10 watt solar panel in bright sunlight. Max head 17 ft Max flow = 8 Lpm 1.5A Ref AC8 £18.99 **SOLAR ENERGY BANK KIT 50x 6" x 12" 6v solar panels (amorphous) + 50 diodes £99 ref EF112** **PINHOLE CAMERA MODULE WITH AUDIO!** Superb board camera with on board sound! extra small just 28mm square (including microphone) ideal for covert surveillance. Can be hidden inside anything - even a matchbox! Complete with 15 metre cable, psu and tv/rv connectors. £73.95 ref CC6

SOLAR MOTORS Tiny motors which run quite happily on voltages from 3-12vdc. Works on our 6v amorphous 6" panels and you can run them from the sun! 32mm dia 20mm thick £1.50 each

WALKIE TALKIES 1 MILE RANGE £37/PAIR REF MAG30 **DRILL OPERATED PUMP** Fits to any drill in seconds, uses standard garden hose, pumps up to 40 gph! £8.99 ref DRL3

GIANT SCREEN VIEWER Turn your TV picture into a supersize screen! This high precision Fresnel lens converts even the smallest screen up to a massive 26" at a fraction of the cost of a big TV. Easily fitted in minutes. Also ideal for PC monitors etc £26.95 ref SVGA2

TELEPHONES Just in this week is a huge delivery of telephones, all brand new and boxed. Two piece construction with the following features - illuminated keypad, tone or pulse (switchable), recall, redial and pause, high/low and off ringer switch and quality construction finished in a smart off white colour and is supplied with a standard international lead (same as US or modems) if you wish to have a BT lead supplied to convert the phones these are also available at £1.55 each ref BTLX **Phones £4.99 each ref PH2**

LIQUID CRYSTAL DISPLAYS Bargain prices, 20 character 2 line, 83x19mm £3.99 ref SMC2024A

16 character 4 line, 62x25mm £5.99 ref SMC1640A

40 character 1 line 154x16mm £6.00 ref SMC4011A

LM255X HITACHI LAPTOP SCREENS 240x100mm, 640x200 dots. New with data £15 ref LM2

SEALED LEAD ACID BATTERIES 12V 6.5AH, NEW £12 REF BATT12

12V 6.5AH, S/HAND PACK OF 5 £20 REF EF99

12V 15AH AS NEW, £18 REF LOT8

THE ULTIMATE ENCLOSURE for your projects must be one of these! Well made ABS cover together beige case measuring 120 x 150 x 50mm. Fitted with rubber feet and front mounted LED. Inside is a pcb fitted with other bits and pieces you may find useful. Sold as a pack of five for £10 ref MD1, pack of 20 for £19.95 ref MD2

YOUR HOME COULD BE SELF SUFFICIENT IN ELECTRICITY Comprehensive plans with loads of info on designing systems, panels, control electronics etc £7 ref PV1

LOW COST CORELESS MIC 500 range 90 - 105mhz, 115g, 193 x 26 x 39mm, 9v PP3 battery required. £17 ref MAG15P1

AUTO SUNCHARGER 155x300mm solar panel with diode and 3 metre lead fitted with a cigar plug 12v 2watt £12.99 REF AUG10P3

SOLAR POWER LAB SPECIAL 2x 6"x6" 6v 130mA cells, 4 LED's, wire, buzzer switch + 1 relay or motor £7.99 REF SA27

SOLAR NICAD CHARGERS 4 x AA size £9.99 ref 6P476, 2 x C size £9.99 ref 6P477

AIR RIFLES .22As used by the Chinese army for training, so there is a lot about! £39.95 Ref EF78 500 pellets £4.50 ref EF80

Interactive websites
designed and hosted.
bullnet.co.uk

REGISTER FOR OUR
ELECTRONIC NEWSLETTERS
BULL-ELECTRICAL.COM

BULL ELECTRICAL

250 PORTLAND ROAD, HOVE, SUSSEX.
BN3 5QT. (ESTABLISHED 50 YEARS).

MAIL ORDER TERMS: CASH, PO OR CHEQUE
WITH ORDER PLUS £4.00 P&P PLUS VAT.

24 HOUR SERVICE £6.50 PLUS VAT.

OVERSEAS ORDERS AT COST PLUS £3.50
(ACCESS, VISA, SWITCH, AMERICAN EXPRESS)

'phone orders : 01273 203500

FAX 01273 323077

Sales@bull-electrical.com

200 WATT INVERTERS plugs straight into your car cigarette lighter socket and is fitted with a 13A socket so you can run your mains operated devices from your car battery £49.95 ref SS66 **THE TRUTH MACHINE** Tells if someone is lying by micro tremors in their voice. battery operated, works in general conversation and on the 'phone and TV as well! £42.49 ref TD3 **INFRA RED FILM 6"** square piece of flexible infra red film that will only allow IR light through. Perfect for converting ordinary torches lights, headlights etc to infra red output only using standard light bulbs. Easily cut to shape. 6" square £15 ref IRF2

HYDROGEN FUEL CELL PLANS Loads of information on hydrogen storage and production. Practical plans to build a Hydrogen fuel cell (good workshop facilities required) £8 set ref FCP1

STIRLING ENGINE PLANS Interesting information pack covering all aspects of Stirling engines. pictures of home made engines made from an aerosol can running on a candle! £12 ref STIR2 **ENERGY SAVER PLUGS** Saves up to 15% electricity when used with fridges motors up to 2A light bulbs, soldering irons etc £9 ea ref LOT71 10 pack £69 ref LOT72

12V OPERATED SMOKE BOMBS Type 3 is a 12v trigger and 3 smoke cannisters, each cannister will fill a room in a very short space of time! £14.99 ref SB3 Type 2 is 20 smaller cannisters (suitable for simulated equipment fires etc) and 1 trigger module for £29 ref SB2 Type 1 is a 12v trigger and 20 large cannisters £49 ref SB1

HI POWER ZENON VARIABLE STROBES Useful 12v PCB fitted with hi power strobe tube and control electronics and speed control potentiometer. Perfect for interesting projects etc. 70x55mm 12vdc operation. £5 ea ref FLS1 pack of 10 £49 ref FLS2

DRILL OPERATED PUMP Fits to any drill in seconds uses standard garden hose, pumps up to 40 gph! £8.99 ref DRL3

NEW LASER POINTERS 4 5mw 75 metre range, hand held unit runs on two AA batteries (supplied) 670nm £29 ref DEC49

HOW TO PRODUCE 35 BOTTLES OF WHISKY FROM A SACK OF POTATOES Comprehensive 270 page book covers all aspects of spirit production from everyday materials includes construction details of simple stills etc. £12 ref MS3

NEW HIGH POWER MINI BUG With a range of up to 800 metres and a 3 days use from a PP3 this is our top selling bug! less than 1" square and a 10m voice pickup range. £28 Ref LOT102

BUILD YOUR OWN WINDFARM FROM SCRAP New publication gives step by step guide to building wind generators and propellers. Armed with this publication and a good local scrap yard could make you self sufficient in electricity! £12 ref LOT81

CCTV CAMERA MODULES 46x70x29mm 30 grams, 12v 100mA auto electronic shutter 3.6mm F2 lens CCIR 512x492 pixels, video output is 1v p-p (75 ohm). Works directly into a scart or video input on a tv or video. IR sensitive. £49 ref EF137

IR LAMP KIT Suitable for the above camera, enables the camera to be used in total darkness! £6 ref EF138

UK SCANNING DIRECTORY As supplied to Police, MOD M15 and GCHQ! covers everything from secret government frequencies, eye in the sky, prisons, military aviation etc £18.50 ref SCANB **INFRA RED POWERBEAM** Handheld battery powered lamp, 4 inch reflector gives out powerful pure infrared light! perfect for CCTV use. nightsights etc £29 ref PB1

SUPER WIDEBAND RADAR DETECTOR Detects both radar and laser X K and KA bands, speed cameras, and all known speed detection systems. 360 degree coverage, front & rear w/avoidances, 1" x 2" 7" x 4" 6" fits on visor or dash £149

CHIEFTAN TANK DOUBLE LASERS 9 WATT+3 WATT+LASER OPTICS Could be adapted for laser listener, long range communications etc. Double beam units designed to fit in the gun barrel of a tank, each unit has two semi conductor lasers and motor drive units for alignment 7 mile range, no circuit diagrams due to MOD, new price £50 000? us? £199. Each unit has two gallium Arsenide injection lasers, 1 x 9 watt, 1 x 3 watt, 900nm wavelength, 28vdc 600hz pulse frequency. The units also contain an electronic receiver to detect reflected signals from targets. £199 Ref LOT4

MAGNETIC CREDIT CARD READERS AND ENCODING MANUAL £9.95 Cased with flyleads, designed to read standard credit cards! complete with control electronics PCB and manual covering everything you could want to know about whats hidden in that magnetic strip on your card! just £9.95 ref BAR31

EXTERNAL CAMERA Introducing the Bulldog model 4 vandal resistant camera in heavy steel case for interior or exterior use. Top quality case housing a 420 line camera module. Each camera is supplied with a 15m cable terminating in Scart and phono plugs. Multi angle bracket for easy installation in any situation. A 12vdc psu is also included. Easily installed in a few minutes, plugs straight into VCR or TV (phono or scart). Bargain price £89.95 ref CC1

3HP MAINS MOTORS Single phase 240v brand new, 2 pole 340x180mm, 2850 rpm, built in automatic reset overload protector keyed shaft (40x16mm) Made by Leeson £99 each ref LEE1

LOPTX Made by Samsung for colour TV £3 each ref SS52

LAPTOP LCD SCREENS 240x175mm £12 ref SS51

PIR WITH BUILT IN CCTV CAMERA Module also includes an infra red strobe light, battery backup etc. 320x240 pixels, 90x65 field of view. £49.95 ea ref SS81 3 or more £44.95 ref SS82

WANT TO MAKE SOME MONEY? STUCK FOR AN IDEA? We have collated 140 business manuals that give you information on setting up different businesses. you peruse these at your leisure using the text editor on your PC. Also included is the certificate enabling you to reproduce (and sell) the manuals as much as you like! £14 ref EP74

HIGH POWER DC MOTORS, PERMANENT MAGNET 12 - 24v operation. probably about 1/4 horse power, body measures 100mm x 75mm with a 60mm x 5mm output shaft with a machined flat on it. Fixing is simple using the two threaded bolts protruding from the front. £22 ref MOT4

ELECTRONIC SPEED CONTROLLER KIT For the above motor is £19 ref MAG17. Save £5 if you buy them both together, 1 motor plus speed controller rrp is £41. offer price £36 ref MOT5A

Online

web catalogue

bull-electrical.com

bull-electrical.com

bull-electrical.com

bull-electrical.com

bull-electrical.com

bull-electrical.com

bull-electrical.com

bull-electrical.com

bull-electrical.com

ISSN 0262 3617
PROJECTS ... THEORY ... NEWS ...
COMMENT ... POPULAR FEATURES ...

VOL. 28 No. 1 JANUARY 1999

EVERYDAY

PRACTICAL

ELECTRONICS

<http://www.epomag.wimborne.co.uk>

The No. 1 Magazine for Electronics Technology
and Computer Projects

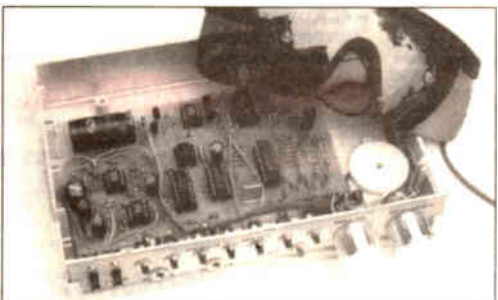
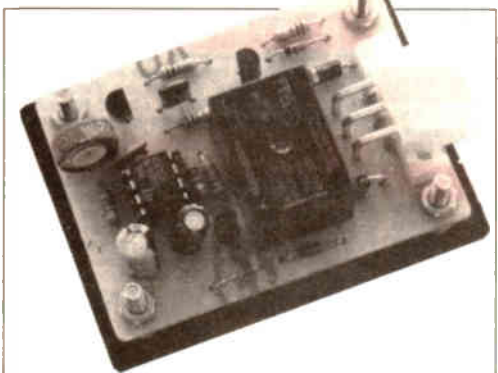
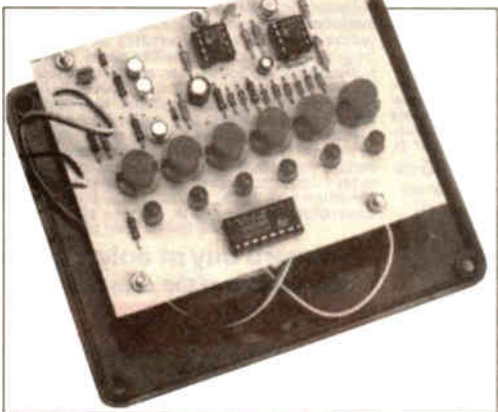
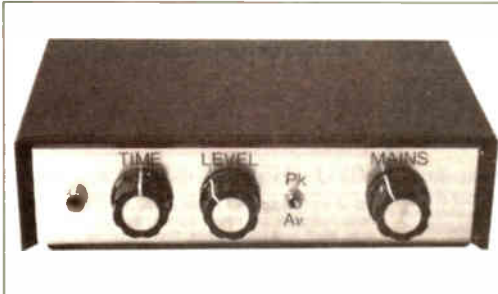

© Wimborne Publishing Ltd 1998. Copyright in all drawings, photographs and articles published in EVERYDAY PRACTICAL ELECTRONICS is fully protected, and reproduction or imitations in whole or in part are expressly forbidden.

Our February '99 Issue will be published on Friday, 31 December 1998. See page 3 for details.

Everyday Practical Electronics, January 1999

Projects and Circuits

- ALTERNATIVE COURTESY LIGHT CONTROLLER** by Paul Brigham 12
Motorists – lighten the depths of darkness in your garage or driveway
- TWINKLE TWINKLE REACTION GAME** by John Koushappas 20
Twinkle, twinkle little chip, you'll be tuneless if we're quick!
- VOLUME COMPRESSOR** by Robert Penfold 37
Taking a level approach to cracking the TV ads sound barrier
- INGENUITY UNLIMITED** hosted by Alan Winstanley 43
Using Solenoid Valves in Place of Motorized Valves; Mini Siren Alarm; Cooling Monitor for Outboard Engines
- PhizyB COMPUTERS – 3** by Clive 'Max' Maxfield, Alvin Brown and Alan Winstanley 54
Constructing and testing the Alphanumeric L.C.D. Interface board
- EPE MIND PICKLER – 2** by Andy Flind 58
Construction of our mind machine – and then you can relax!

Series and Features

- NEW TECHNOLOGY UPDATE** by Ian Poole 19
Engineering assemblies for future recycling disassembly
- FROM RUSSIA WITH LOVE?** by Barry Fox 24
After touring the Russian Cosmodrome, Barry relates how Russian rockets are launching American satellites
- CIRCUIT SURGERY** by Alan Winstanley 32
Solder Tips; Logic Circuitry "Internals"; Net those Chips; Voltage and Ground
- PhizyB COMPUTERS – 3** by Clive 'Max' Maxfield and Alvin Brown 48
Programming with shifts, rotates, stacks and alphanumeric l.c.d.s
- NET WORK – THE INTERNET PAGE** surfed by Alan Winstanley 69
Freemove – Not So Free; The Apple of Your iMac; Core Thought; Links

Regulars and Services

- EDITORIAL** 11
- INNOVATIONS** – Barry Fox highlights technology's leading edge 15
Plus everyday news from the world of electronics
- READOUT** John Becker addresses general points arising 29
- SHOPTALK** with David Barrington 34
The essential guide to component buying for EPE projects
- PLEASE TAKE NOTE** 34
Greenhouse Computer (July '98); PIC16c84 Toolkit (July '98); Foghorn Timing Switch (IU, Dec '98); Reliable IR Remote Control (Oct/Nov '98); Logic Gate Tester (IU, Nov '98)
- CD-ROMS FOR ELECTRONICS** 46
Parts Gallery + Electronic Circuits and Components; Digital Electronics; plus NEW PICtutor, plus NEW Modular Circuit Design
- BACK ISSUES** Did you miss these? 56
- DIRECT BOOK SERVICE** 64
A wide range of technical books available by mail order
- ELECTRONICS VIDEOS** Our range of educational videos 67
- PRINTED CIRCUIT BOARD SERVICE** 68
PCBs for EPE projects – some at "knockdown" prices! Plus EPE software
- ADVERTISERS INDEX** 72

Readers Services • Editorial and Advertisement Departments 11

Surplus always wanted for cash!

THE ORIGINAL SURPLUS WONDERLAND!

THIS MONTH'S SELECTION FROM OUR VAST EVER CHANGING STOCKS

Surplus always wanted for cash!

THE AMAZING TELEBOX

Converts your colour monitor into a QUALITY COLOUR TV!!



TV SOUND & VIDEO TUNER
CABLE COMPATIBLE

The TELEBOX is an attractive fully cased mains powered unit, containing all electronics ready to plug into a host of video monitors made by makers such as MICROVITEC, ATARI, SANYO, SONY, COMMODORE, PHILIPS, TATUNG, AMSTRAD etc. The composite video output will also plug directly into most video recorders, allowing reception of TV channels not normally receivable on most television receivers* (TELEBOX MB). Push button controls on the front panel allow reception of 8 fully tuneable 'off air' UHF colour television channels. TELEBOX MB covers virtually all television frequencies VHF and UHF including the HYPERBAND as used by most cable TV operators. A composite video output is located on the rear panel for direct connection to most makes of monitor or desktop computer video systems. For complete compatibility - even for monitors without sound - an integral 4 watt audio amplifier and low level Hi Fi audio output are provided as standard.

TELEBOX ST for composite video input type monitors £36.95
TELEBOX STL as ST but fitted with integral speaker £39.50
TELEBOX MB Multiband VHF/UHF/Cable/Hyperband tuner £69.95
For overseas PAL versions state 5.5 or 6 mHz sound specification. *For cable/hyperband signal reception Telebox MB should be connected to a cable type service. Shipping on all Teleboxes, code (B)

NEW State of the art PAL (UK spec) UHF TV tuner module with composite 1V pp video & NICAM hi fi stereo sound outputs. Micro electronics all on one small PCB only 73 x 160 x 52 mm enable full software control via a simple 2 wire link to any IBM type computer. Supplied complete with simple working program and documentation. Requires +12V & +5V DC to operate. **BRAND NEW - Order as MY00. Only £49.95 code (B)**

FLOPPY DISK DRIVES 2 1/2" - 14"

Massive purchases of standard 5 1/4" and 3 1/2" drives enables us to present prime product at industry beating low prices! All units (unless stated) are BRAND NEW or removed from often brand new equipment and are fully tested, aligned and shipped to you with a full 90 day guarantee. Call for over 2000 unlisted drives for spares or repair.

- 3 1/2" Panasonic JU363/4 720K RFE £24.95(B)
- 3 1/2" Mitsubishi MF355C-L 1.4 Meg. Laptops only £25.95(B)
- 3 1/2" Mitsubishi MF355C-D, 1.4 Meg. Non laptop £18.95(B)
- 5 1/4" Teac FD-55GFR 1.2 Meg (for IBM pc's) RFE £18.95(B)
- 5 1/4" Teac FD-55F-03-U 720K 40/80 (for BBC's etc) RFE £22.95(B)
- 5 1/4" BRAND NEW Mitsubishi MF501B 360K £29.95(B)
- Table top case with integral PSU for HH 5 1/4" Floppy or HD £29.95(B)
- 8" Shugart 800/801 8" SS refurbished & tested £210.00(E)
- 8" Shugart 810 8" SS HH Brand New £195.00(E)
- 8" Shugart 851 8" double sided refurbished & tested £260.00(E)
- 8" Mitsubishi M2894-63 double sided NEW £295.00(E)
- 8" Mitsubishi M2896-63-02U DS slimline NEW £295.00(E)
- Dual 8" cased drives with integral power supply 2 Mb £499.00(E)

HARD DISK DRIVES

- 2 1/2" TOSHIBA (19 mm H) MK2101MAN 2.16 Gb. New £199.00
 - 2 1/2" TOSH. (12.5 mm H) MK1002MAV 1.1 Gb laptop. New £115.00
 - 2 1/2" to 3 1/2" conversion kit for Pc's, complete with connectors £12.95
 - 3 1/2" FUJJI FC-309-26 20mb MFM I/F RFE £59.95
 - 3 1/2" CONNER CP3024 20 mb IDE I/F (or equiv.) RFE £59.95
 - 3 1/2" CONNER CP3044 40mb IDE I/F (or equiv.) RFE £69.00
 - 3 1/2" RODIME R03075 45mb SCSI I/F (Mac & Acorn) £69.00
 - 3 1/2" QUANTUM 40S Prodrive 42mb SCSI I/F, New RFE £49.00
 - 3 1/2" WESTERN DIGITAL 850mb IDE I/F New £185.00
 - 5 1/4" MINISCRIBE 3425 20mb MFM I/F (or equiv.) RFE £49.95
 - 5 1/4" SEAGATE ST-238R 30 mb RLL I/F Refurb £69.95
 - 5 1/4" CDC 94205-51 40mb HH MFM I/F RFE tested £69.95
 - 5 1/4" HP 97548 850 Mb SCSI RFE tested £99.00
 - 5 1/4" HP C3010 2 Gbyte SCSI differential RFE tested £195.00
 - 8" NEC D2246 85 Mb SMD interface. New £199.00
 - 8" FUJITSU M2322K 180Mb SMD I/F RFE tested £195.00
 - 8" FUJITSU M2392K 2 Gb SMD I/F RFE tested £345.00
- Many other drives in stock - Shipping on all drives is code (D)

TEST EQUIPMENT & SPECIAL INTEREST ITEMS

- MITS. FA3445ETKL 14" Industrial spec SVGA monitors £245
- 1KW to 400 kW - 400 Hz 3 phase power sources - ex stock EPOA
- IBM 8230 Type 1, Token ring base unit driver £760
- Wayne Kerr RA200 Audio frequency response analyser £2500
- IBM 53F5501 Token Ring ICS 20 port loba module £750
- IBM MAU Token ring distribution panel 8228-23-5050N £95
- AIM 501 Low distortion Oscillator 9Hz to 330KHz, IEEE £550
- ALLGON 6360, 11805-1880 MHz hybrid power combiners £250
- Trend DSA 274 Data Analyser with G703(2M) 64 I/O EPOA
- Marconi 6310 Programmable 2 to 22 GHz sweep generator £8500
- Marconi 2022 10KHz-1GHz RF signal generator £1550
- Marconi 2030 opt 03 10KHz-1.3 GHz signal generator, New £5150
- HP1650B Logic Analyser £3750
- HP3781A Pattern generator & HP3782A Error Detector £3500
- HP6821A Dual Programmable GPIB PSU 0-7 V 160 watts £1800
- HP6284 Rack module variable 0-20V @ 20A metered PSU £675
- HP54121A DC to 22 GHz four channel test set EPOA
- HP6130A opt 020 300 MHz pulse generator, GPIB etc £8500
- HP A1, A0 8 pen HPGL high speed drum plotters - from £950
- EG+G Brookdeal 96035C Precision lock in amp £650
- View Eng. Mod 1200 computerised inspection system EPOA
- Sony DXC-3000A High quality CCD colour TV camera £1100
- Kelthley 590 CV capacitor / voltage analyser £3750
- Racal ICR40 dual 40 channel voice recorder system EPOA
- Flokers 45KVA 3 ph On Line UPS - New batteries £9500
- ICI R5030UV3A Cleanline ultrasonic cleaning system EPOA
- Mann Tally MT845 High speed line printer £2200
- Intel SBC 486/133SE Multibus 486 system, 8Mb Ram £945
- Siemens K4400 64Kb to 140Mb demux analyser £2950

IC's - TRANSISTORS - DIODES

OBSOLETE - SHORT SUPPLY - BULK

6,000,000 Items EX STOCK

For MAJOR SAVINGS - CALL OR SEE OUR WEBSITE

VIDEO MONITOR SPECIALS

One of the highest specification monitors you will ever see - At this price - Don't miss it!!

Mitsubishi FA3415ETKL 14" SVGA Multisync colour monitor with fine 0.28 dot pitch tube and resolution of 1024 x 768. A variety of inputs allows connection to a host of computers including IBM PC's in CGA, EGA, VGA & SVGA modes, BBC, COMMODORE (including Amiga 1200), ARCHIMEDES and APPLE. Many features: Etched faceplate, test switching and LOW RADIATION MPR specification. Fully guaranteed, supplied in EXCELLENT

condition. **Only £119 (E)** Order as MITS-SVGA
TIR & Swivel Base £4.75
VGA cable for IBM PC types.
External cables for other types of computers CALL

As New - Ex Demo
17" 0.28 SVGA Mitsubishi Diamond Pro monitors
Full multisync etc. Full 90 day guarantee. £325.00 (E)

Just in - Microvitec 20" VGA (800 x 600 res.) colour monitors.
Good SH condition - from £299 - CALL for info

PHILIPS HCS35 (same style as CM8833) attractively styled 14" colour monitor with both RGB and standard composite 15.625 KHz video inputs via SCART socket and separate phono jacks. Integral audio power amp and speaker for all audio visual uses. Will connect direct to Amiga and Atari BBC computers. Ideal for all video monitoring / security applications with direct connection to most colour cameras. High quality with many features such as front concealed flap controls, VCR correction button etc. Good used condition - fully tested - guaranteed
Dimensions: W14" x H12 3/4" x 15 1/2" D.
Only £99 (E)

PHILIPS HCS31 Ultra compact 9" colour video monitor with standard composite 15.625 KHz video input via SCART socket. Ideal for all monitoring / security applications. High quality, ex-equipment fully tested & guaranteed (possible minor screen bums). In attractive square black plastic case measuring W10" x H10" x 1 3/8" D. 240 V AC mains powered.
Only £79.00 (D)

KME 10" 15M10009 high definition colour monitors with 0.28" dot pitch. Superb clarity and modern styling. Operates from any 15.625 khz sync RGB video source, with RGB analog and composite sync such as Atari, Commodore Amiga, Acorn Archimedes & BBC. Measures only 13 1/2" x 12" x 11". Good used condition.
Only £125 (E)

20" 22" and 26" AV SPECIALS

Superbly made UK manufacture. PIL all solid state colour monitors, complete with composite video & optional sound input. Attractive test style cases. Perfect for Schools, Shops, Disco, Clubs, etc. In EXCELLENT little used condition with full 90 day guarantee.

20"....£135 22"....£155 26"....£185 (F)

DC POWER SUPPLIES

Virtually every type of power supply you can imagine. Over 10,000 Power Supplies Ex Stock
Call or see our web site.

LOW COST PC'S

Always over 1000 PC's from stock. 1000's of spares and accessories. Call or see our web site for info.

19" RACK CABINETS

Superb quality 6 foot 40U
Virtually New, Ultra Smart
Less than Half Price!

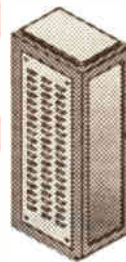

Top quality 19" rack cabinets made in UK by Optima Enclosures Ltd. Units feature designer, smoked acrylic lockable front door, full height lockable half louvered back door and louvered removable side panels. Fully adjustable internal fixing struts, ready punched for any configuration of equipment mounting plus ready mounted integral 12 way 13 amp socket switched mains distribution strip make these racks some of the most versatile we have ever sold. Racks may be stacked side by side and therefore require only two side panels to stand singly or in multiple bays. Overall dimensions are: 7 7/8" H x 32 1/2" D x 22" W. Order as:
OPT Rack 1 Complete with removable side panels. £345.00 (G)
OPT Rack 2 Rack, Less side panels £245.00 (G)

Over 1000 racks, shelves, accessories
19" 22" & 24" wide 3 to 46 U high.
Available from stock !!

32U - High Quality - All steel RakCab

Made by Eurocraft Enclosures Ltd to the highest possible spec, rack features all steel construction with removable side, front and back doors. Front and back doors are hinged for easy access and all are lockable with five secure 5 lever barrel locks. The front door is constructed of double walled steel with a 'designer style' smoked acrylic front panel to enable status indicators to be seen through the panel, yet remain unobtrusive. Internally the rack features fully slotted reinforced vertical fixing members to take the heaviest of 19" rack equipment. The two movable vertical fixing struts (extras available) are pre punched for standard 'cage nuts'. A mains distribution panel internally mounted to the bottom rear, provides 8 x IEC 3 pin Euro sockets and 1 x 13 amp 3 pin switched utility socket. Overall ventilation is provided by fully louvered back door and double skinned top section with top and side louvres. The top panel may be removed for fitting of integral fans to the sub plate etc. Other features include: fitted castors and floor levelers, prepunched utility panel at lower rear for cable / connector access etc. Supplied in excellent, slightly used condition with keys. Colour Royal blue. External dimensions mm=1625H x 635D x 603 W. (64" H x 25" D x 23 3/4" W)
Sold at LESS than a third of makers price !!



A superb buy at only £245.00 (G)
42U version of the above only £345 - CALL

BATTERY SCOOP - 50% off !!

A special bulk purchase from a cancelled export order brings you the most amazing savings on these ultra high spec 12v DC 14 Ah rechargeable batteries. Made by Hawker Energy Ltd, type SBS15 featuring pure lead plates which offer a far superior shelf & guaranteed 15 year service life. Fully BT & BS6290 approved. Supplied BRAND NEW and boxed. Dimensions 200 wide, 137 high, 77 deep. M6 bolt terminals. Fully guaranteed. Current makers price over £70 each! **Our Price £35 each (C) or 4 for £99 (D)**

RELAYS - 200,000 FROM STOCK

Save ££££'s by choosing your next relay from our massive stocks covering types such as Military, Octal, Cradle, Hermetically Sealed, Contactors, Time Delay, Reed, Mercury Wetted, Solid State, Printed Circuit Mounting. CALL US WITH YOUR NEEDS. Many obsolete types from stock. Save ££££'s

LOW COST RAM & CPU'S

INTEL 'ABOVE' Memory Expansion Board. Full length PC-XT and PC-AT compatible card with 2 Mbytes of memory on board. Card is fully selectable for Expanded or Extended (288 processor and above) memory. Full data and driver disks supplied. RFE. Fully tested and guaranteed. Windows compatible. £59.95
Half length 8 bit memory upgrade cards for PC AT XT expands memory either 256k or 512k in 64k steps. May also be used to fill in RAM above 640k DOS limit. Complete with data.
Order as: XT RAM 9U, 256k. £34.95 or 512k £39.95

SIMM SPECIALS

- 1 MB x 9 SIMM 9 chip 120ns Only £8.50
 - 1 MB x 9 SIMM 3 chip 80 ns £10.50 or 70ns £11.95
 - 1 MB x 9 SIMM 9 chip 80 ns £10.50 or 70ns £11.75
 - 4 MB 70 ns 72 pin SIMM - with parity - Only £35.00
 - INTEL 486-DX33 CPU £19.95 INTEL 486-DX66 CPU £59.00
- FULL RANGE OF CO-PROCESSOR EX STOCK - CALL FOR £££
MOTOROLA 25 Mhz 68040 (XC68040RC25M) CPU'S £59.00
shipping charges for RAM / CPU upgrades is code B

SOFTWARE SPECIALS

NT4 WorkStation, complete with service pack 3 and licence - OEM packaged.
Special Price ONLY £99.00
Microsoft - Windows for Workgroups 3.11 & DOS 6.22. Supplied on 3 1/2" disks with licence & concise documentation. £39.95
DOS 5.0 on 3 1/2" disks with concise books c/w QBasic. £14.95
Wordperfect 8 for DOS supplied on 3 1/2" disks with manual £24.95
shipping charges for software is code B

DISTEL on the web II - Over 16,000,000 Items from stock - www.distel.co.uk



ALL MAIL & OFFICES
Open Mon - Fri 9.00 - 5.30
Dept PE, 32 Biggin Way
Upper Norwood
LONDON SE19 3XF

LONDON SHOP
Open Mon - Sat 9.00 - 5.30
215 Whitehorse Lane
South Norwood
On 68A Bus Route
N. Thornton Heath &
Selhurst Park. BR Rail Stations

NEW DISTEL
Visit our web site
www.distel.co.uk
email admin@distel.co.uk

ALL ENQUIRIES
0181 679 4414
FAX 0181 679 1927

All prices for UK Mainland. UK customers add 17.5% VAT to TOTAL order amount. Minimum order £10. Bone Fide account orders accepted from Government, Schools, Universities and Local Authorities - minimum account order £50. Cheques over £100 are subject to 10 working days clearance. Carriage charges (A)=£3.00, (AT)=£4.00, (B)=£5.50, (C)=£6.50, (D)=£12.00, (E)=£15.00, (F)=£18.00, (G)=CALL. Allow approx 6 days for shipping - faster CALL. All goods supplied to our Standard Conditions of Sale and unless stated guaranteed for 90 days. All guarantees on a return to base basis. All rights reserved to change prices / specifications without prior notice. Orders subject to stock. Discounts for volume. Top CASH prices paid for surplus goods. All trademarks, tradenames etc acknowledged. © Display Electronics 1988. E & O.E. 09/88



NEXT MONTH

WIRELESS MONITORING SYSTEM

Until recently, the lack of availability of low-cost data transmitters meant that the use of telecommunications within the home for hobbyists or for educational purposes was either too expensive or complicated to be practical. Increases in the demand for such devices, along with improvements in the technology, means that various companies are now mass-producing telemetry equipment that is low cost and can legally be used in the domestic environment. This article describes a project that makes use of such modules in order to monitor conditions or environments without the need for wires.

The system can be used to monitor the activity of virtually any number of different conditions within a small area, i.e. around a house or space within a classroom or workshop.

The beauty of this design is its incredible flexibility! The PIC based transmitters have been designed to make any hardware very simple and place all of the strain on the software running them. This means that by re-programming the devices, many types of data logging can be achieved.

For example, the PIC could be programmed to collect and store information regarding a sensor signal for a long period before transmitting this information, useful to monitor, say, temperatures and speeds in a vehicle – downloading the data once back at base. Alternatively, it could be programmed to transmit a message only if a sensor output fell below or rose above a pre-determined level. It is due to this wide range of configurations that a specific system is described, but advice is given to readers who may wish to reprogram the PICs.

A further advantage of the PIC is that it consumes a very low quiescent current. Consequently the transmitter units can be battery powered and operate over very long periods without the need for any maintenance.



PIC MIDI SUSTAIN PEDAL

In the pre-MIDI era it was common for synthesisers, electronic pianos, etc. to have a socket for a pedal-operated switch. The footswitch normally functioned as a sustain pedal, with the last note or notes played being held on for as long as the pedal was operated.

In the post-MIDI era this type of input is virtually extinct, and functions such as sustain and swell pedals are handled via the MIDI input. This offers great versatility, and in many ways is a step forward, but it brings a major drawback in that simple switches are no longer sufficient.

A MIDI Sustain Pedal was described in the May 1995 issue of EPE, and this used a UART plus 10 other integrated circuits.

This new PIC based design can be switched to operate as either a Sustain Pedal or a Portamento type, and uses no integrated circuits other than the PIC microcontroller itself. Unlike its predecessor, this unit uses so few components that it is suitable for those having limited experience of electronic project construction, including complete beginners.

LIGHT ALARM

Quite often, situations arise where it is useful to have a simple alarm that can be placed with personal items to alert the owner if they are being tampered with. There are many ways of producing such a device, each with its inherent advantages and disadvantages.

In this article, we look at a circuit that is triggered by the presence of light. Although relatively simple in concept, the unit has a wide variety of uses ranging from indicating when a cupboard or drawer has been opened to operating as a simple luggage alarm.

PLUS • PHIZZYB-4 AND ALL THE REGULARS

NO ONE DOES IT BETTER

EVERYDAY

PRACTICAL

ELECTRONICS

DON'T MISS AN ISSUE -
PLACE YOUR ORDER NOW!

FEBRUARY ISSUE ON SALE
FRIDAY, DECEMBER 31

SHERWOOD ELECTRONICS

FREE COMPONENTS

Buy 10 x £1 Special Packs and choose another one FREE

SP1	15 x 5mm Red Leds	SP132	2 x TL082 Op.amps
SP2	12 x 5mm Green Leds	SP133	20 x 1N4004 diodes
SP3	12 x 5mm Yellow Leds	SP134	15 x 1N4007 diodes
SP6	15 x Red Leds	SP136	3 x BFY50 transistors
SP7	12 x Green Leds	SP137	4 x W005 1-5A bridge rectifiers
SP10	100 x 1N4148 diodes	SP136	20 x 2-2/63V radial elect. caps.
SP11	30 x 1N4001 diodes	SP140	3 x W04 1-5A bridge rectifiers
SP12	30 x 1N4002 diodes	SP142	2 x Cmos 4017
SP18	20 x BC182 transistors	SP143	5 Pairs min. crocodile clips (Red & Black)
SP20	20 x BC184 transistors	SP144	3 x TIP31A transistors
SP21	20 x BC212 transistors	SP145	6 x ZTX300 transistors
SP23	20 x BC549 transistors	SP146	10 x 2N3704 transistors
SP24	4 x Cmos 4001	SP147	5 x Stripboard 9 strips x 25 holes
SP25	4 x 555 timers	SP151	4 x 8mm Red Leds
SP26	4 x 741 Op.amps	SP152	4 x 8mm Green Leds
SP28	4 x Cmos 4011	SP153	4 x 8mm Yellow Leds
SP29	4 x Cmos 4013	SP154	15 x BC548 transistors
SP31	4 x Cmos 4071	SP156	3 x Stripboard, 14 strips x 27 holes
SP36	25 x 10/25V radial elect. caps.	SP160	10 x 2N3904 transistors
SP37	15 x 100/35V radial elect. caps.	SP161	10 x 2N3906 transistors
SP39	10 x 470/16V radial elect. caps.	SP165	2 x LF351 Op.amps
SP40	15 x BC237 transistors	SP167	6 x BC107 transistors
SP41	20 x Mixed transistors	SP168	6 x BC108 transistors
SP42	200 x Mixed 0-25W C.F. resistors	SP175	20 x 1/63V radial elect. caps.
SP47	5 x Min. PB switches	SP177	10 x 1A 20mm quick blow fuses
SP102	20 x 8-pin DIL sockets	SP182	20 x 4-7/63V radial elect. caps.
SP103	15 x 14-pin DIL sockets	SP183	20 x BC547 transistors
SP104	15 x 16-pin DIL sockets	SP187	15 x BC239 transistors
SP105	5 x 74LS00	SP191	3 x Cmos 4023
SP109	15 x BC557 transistors	SP192	3 x Cmos 4066
SP111	15 x Assorted polyester caps	SP193	20 x BC213 transistors
SP112	4 x Cmos 4053	SP194	10 x OA90 diodes
SP115	3 x 10mm Red Leds	SP195	3 x 10mm Yellow Leds
SP116	3 x 10mm Green Leds	SP197	6 x 20 pin DIL sockets
SP118	2 x Cmos 4047	SP198	5 x 24 pin DIL sockets
SP120	3 x 74LS93		
SP124	20 x Assorted ceramic disc caps		
SP130	100 x Mixed 0-5W C.F. resistors		
SP131	2 x TL071 Op.amps		

RESISTOR PACKS - C.Film

RP3	5 each value - total 365 0-25W	£2.80
RP7	10 each value - total 730 0-25W	£4.00
RP10	1000 popular values 0-25W	£5.80
RP4	5 each value-total 365 0-5W	£3.75
RP8	10 each value-total 730 0-5W	£6.35
RP11	1000 popular values 0-5W	£8.10

1999 Catalogue £1 inc. P&P or FREE with first order.
P&P £1.25 per order. NO VAT.
Orders to:
Sherwood Electronics,
7 Williamson St., Mansfield,
Notts. NG19 6TD.

Radio - Tech

Radio Modules at Lower Prices than any catalogue, Guaranteed!



RXM-173-225-4686-80 VHF Security Receiver

Part	Catalogue RRP**	Our Price
TXM-418-A (9V)	£ 14 50	£ 10.99
TXM-418-F (3V)		
SILRX-418-A or SILRX-418-F	£ 29 95	£ 22.48
BIM-418-F	£ 58.00	£ 49.92
BIM-433-F		
TXM-173-225 (1mW) or TXM-173-225- (10mW)	£ 42.00	£ 20.48
RXM-173-4666	£ 64 75	£ 24.85

**Typical Catalogue Company RRP effective Jan 1998 ex VAT

Prices Exclude VAT and Carriage. P & P add £1.50 for orders < £ 100.00 otherwise £6.00 of next day delivery.

Telephone Sales 01992 576107



Fax 01992 561994



<http://www.radio-tech.co.uk> e-mail: sales@radtec.demon.co.uk

SQUIRES

MODEL AND CRAFT TOOLS

A comprehensive range of Miniature Hand and Power Tools and now an extensive range of Electronic Components featured in a fully illustrated

336-page Mail Order Catalogue

1999 Issue

SAME DAY DESPATCH
FREE POST & PACKING

For your free copy of our catalogue write, telephone or fax to:

Squires, 100 London Road,
Bognor Regis, West Sussex
PO21 1DD

Tel: 01243 842424

Fax: 01243 842525



DISTANCE LEARNING COURSES in:

Analogue and Digital Electronics
 Circuits, Fibres & Opto-Electronics
 Electronic Testing & Fault Diagnosis
 Programmable Logic Controllers
 Mechanics and Mechanisms
GCSE and BTEC Mathematics

- Courses to suit **beginners** and those wishing to **update** their knowledge and practical skills
- Courses are delivered as self-contained kits
- No travelling or college attendance
- Learning is at your own pace
- Courses may have BTEC Certification and Tutoring

For information contact:
 NCT Ltd., P.O. Box 11
 Wendover, Bucks HP22 6XA
 Telephone 01296 624270; Fax 01296 625299
 Web: <http://www.nct.ltd.uk>

DATA-NET

The Encyclopaedia of Electronic Circuits

Whether you are an Amateur or an Engineer, this encyclopaedia is an incredible mine of information and will help you to save hundreds of hours of search.

The 10 CD-ROM set contains complete datasheets on over **180.000 circuits** from **61 manufacturers** which represents more than **300.000 pages** of technical information in PDF format.

The search engine helps you to find the datasheet of a specific circuit in seconds, compare several circuits at the same time and print or export the data.

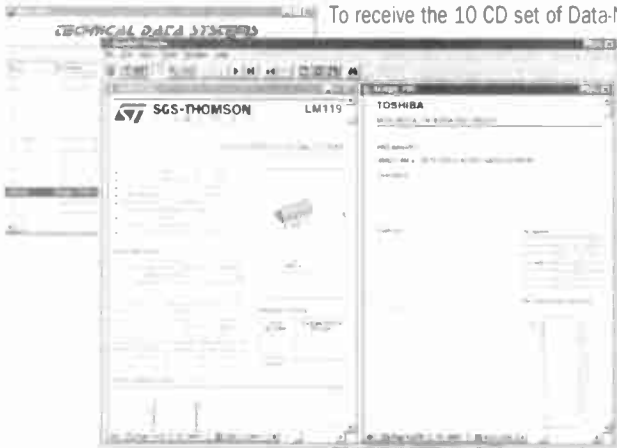

To receive the 10 CD set of Data-Net for only **£39 (inc. VAT and UK Postage)**, please send your order to :

Dannell Electronics Ltd
Unit 15, Enterprise Court
Lakes Road • Braintree • Essex CM7 3QS
Phone : 01376 550262 • Fax : 01376 550019
email : datanet@dannell.co.uk

Data-Net runs with Windows® 3.1/95/NT3.51 and NT 4.0

**10 CDs, 180.000 circuits, 300.000 pages of info.
for £39 only (inc. VAT and UK postage)**

Cheques & Postal Orders should be made payable to Dannell Electronics Ltd. Visa, Master/Eurocard orders are accepted. Please give card number and expiry date. For orders from within EU, please add £5.50 for airmail postage. For foreign orders, we use the VAT portion of the price for airmail postage and packing.

FREE!

OUR
LATEST
BARGAIN LIST
- 32 PAGES FULL OF
QUALITY SURPLUS
STOCK AND ALL AT
THE LOWEST PRICES!



GREENWELD

ELECTRONIC COMPONENTS

27D Park Road • Southampton • SO15 3UQ
TELEPHONE: 01703 236363 FAX: 01703 236307
E-Mail: greenweld@aol.com INTERNET: <http://www.greenweld.co.uk>

PHONE, FAX OR WRITE TODAY FOR YOUR FREE COPY!

TOROIDAL MAINS TRANSFORMERS

All with 220/240V primary winding

24V + 24V at 25VA would give 25V at 1A or 50V at 1/2A, price, £3. Order Ref: 3P245.

30V + 30V at 120VA would give 30V at 4A or 60V at 2A, price £8. Order Ref: 8PG2

110V + 110V at 120VA would give 110V at just over 8A or 220V at 1/2A, price £8. Order Ref: 8PG3.

35V + 35V at 150VA would give 35V at 6 1/2A or 70V at 2A, price £8. Order Ref: 8PG9.

35V + 35V at 220VA would give 35V at 6 1/2A or 70V at 3 1/4A, price £9. Order Ref: 9PG4.

110V + 110V at 220VA would give 110V at 2A or 220V at 1A, price £10. Order Ref: 10PG5.

45V + 45V at 500VA would give 45V at 11A or 90V at 5 1/2A, price £20. Order Ref: 20PG7.

110V + 110V at 500VA would give 110V at 5A or 220V at nearly 3A, price £25. Order Ref: 25PG8.



SUPER WOOFERS.

A 10in. 4ohm with power rating of 250W music and normal 150W. Normal selling price for this is £55 + VAT, you can buy at £29 including VAT and carriage. Order Ref: 29P7. The second one is an 8in. 4ohm, 200W music, 200W normal, again by Challenger, price £18. Order Ref: 18P9. Deduct 10% from these prices if you order in pairs or can collect. These are all brand new in maker's packing.



SMART HIGH QUALITY ELECTRONIC KITS

All kits are complete with p.c.b. and other components in a blister pack

CAT. NO.	DESCRIPTION	£
1003	5W electronic siren	2.53
1005	Touch switch	2.87
1008	SF function generator	6.90
1010	5-input stereo mixer with monitor output	19.31
1016	Loudspeaker protection unit	3.22
1017	30W linear CB	14.71
1020	0-50 minute timer	2.99
1023	Dynamic head preamp	2.50
1024	Microphone preamplifier	2.07
1025	7W hi-fi power amplifier	2.53
1026	Running lights	4.60
1027	NiCad battery charger	3.91
1030	Light dimmer	2.53
1032	Stereo tone control	4.14
1039	Stereo VU meter	4.60
1042	A.F. generator 350Hz-16kHz	1.70
1043	Loudness stereo unit	3.22
1047	Sound switch	5.29
1048	Electronic thermostat	3.68
1050	3-input hi-fi stereo preamplifier	12.42
1052	3-input mono mixer	6.21
1053	Electronic metronome	3.22
1054	4-input instrument mixer	2.76
1056	8V20V 8A stabilised power supply	12.42
1057	Cassette head preamplifier	3.22
1059	Telephone amplifier	4.60
1062	5V 0-5A stabilised supply for TTL	2.30
1063	12V 2A power supply	2.30
1064	+ 12V 0-5A stabilised supply	3.22
1067	Stereo VU meter with leads	9.20
1068	10V 0-5A stabilised power supply	2.53
1070	Hi-Fi preamplifier	7.47
1071	4-input selector	6.90
1082	Car voltmeter with I.e.d.s	7.36
1083	Video signal amplifier	2.76
1085	D.C. converter 12V to 6V or 7.5V to 9V	2.53
1086	Music to light for your car	4.60
1093	Windscreens wiper controller	3.68
1094	Home alarm system	12.42
1098	Digital thermometer, with I.c.d.	11.50
1100	2x18W interated amplifier	18.39
1101	Dollar tester	4.60
1106	Thermometer with I.e.d.s	6.90
1107	Electronics to help win the Pools	3.68
1112	Loudspeaker protection with delay	4.60
1113	2x18W power amplifier	5.98
1115	Courtesy light delay	2.07
1118	Time switch with triac 0-10 mins	4.14
1122	Telephone call relay	3.68
1123	Morse code generator	1.84
1126	Microphone preamplifier	4.60
1127	Microphone tone control	4.60
1128a	Power flasher 12V d.c.	2.53
1133	Stereo Sound-to-Light	5.26

BATTERY MOTOR WITH GEARBOX. Will operate on any DC voltage between 6V and 24V, price £3 Order Ref 3P108. A speed controller is available for this £12 in kit form or £20 made up, but if you intend to operate it from the mains, then our power supply 2P3 will give you 3 speeds and will also reverse. Price of power supply is £2

ANOTHER PROJECT CASE. Should be very suitable for a non-recognisable bug or similar hand-held device. It is 150mm long, 36mm wide and 15mm thick. Originally these were TV remote controls price 2 for £1 Order Ref 1068

A MUCH LARGER PROJECT BOX. Size 216mm x 130mm x 85mm with lid and 4 screws. This is an ABS box which normally retails at around £6. All brand new price £2.50 Order Ref 2 5P28

BT TELEPHONE EXTENSION WIRE. This is proper heavy duty cable for running around the skirting board when you want to make a permanent extension. Four cores properly colour coded 25m length only £1 Order Ref 1067

LARGE TYPE MICROSWITCH. With 2in lever changeover contacts rated at 15A at 250V 2 for £1 Order Ref 1 21R7

MINI MICROSWITCH. Only approximately 15mm long with a 20mm lever which could quite easily be removed, changeover contacts rated at 5A AC, 50p each Order Ref 1 21R8

FLEX PROTECTORS. Rubber 30mm long 8mm diameter with a 12mm shoulder. Ideal for protecting flex passing through a metal panel, 5 for £1 Order Ref 1 21R10

10K POT. With double-pole mains on off switch, good length of 1/4in. spindle and hex fixing nut, 50p each Order Ref 1 22R6

DITTO but 5K Order Ref 1 11R24

AMSTRAD POWER SUPPLY AMPLIFIER. This is quite a big unit, measures approximately 8in long and 3 1/2in wide and has a heatsink approximately 3in high. At one end is the mains transformer which looks to be about 40VA. Then there is an assortment of i.c.s power transistors and the lead coming out terminates on a panel with twin speaker sockets and miscellaneous input sockets. Price £5 Order Ref 1 1R2

BALANCE ASSEMBLY KITS. Japanese made when assembled ideal for chemical experiments, complete with tweezers and 6 weights 0.5 to 5 grams. Price £2 Order Ref 2P444

SUPER CROMPTON PARKINSON MAINS MOTOR. Really well made, totally enclosed by ventilated framework. Size approximately 4in diameter, 4in high and with 2in of 3/4in spindle. Speed is 750rpm/hp is not quoted but we estimate this to be around 1.6hp. Price £10 Order Ref 10P149

EQUIPMENT COOLING BLOWER. Near enough 5in square and 1 1/2in thick but a really good air mover. Mains operated price £4 Order Ref 715L

OVEN THERMOSTAT with knob calibrated so you can set it to cut out at any temperature up to 600 F £3 Order Ref 3P229

SPEAKER IN CABINET. Just right if you want music in the garden. Cabinet size approximately 8in x 5in x 4in thick, speaker is 6 1/2in 8 ohm. These are ex-equipment but in tip top condition, price £4 each or 2 for £7 Order Ref 812L

PURE SINE WAVE GENERATOR. All parts to make this £3 Order Ref 1 10R14

DOORBELL PSU. This has A.C. voltage output so is ideal for operating most doorbells. The unit is totally enclosed so perfectly safe and it plugs into a 13A socket. Price only £1 Order Ref 1 30R1

THIS MONTH'S TWO FOR ONE OFFER IS THE SWITCH MODE POWER SUPPLY

Made by Astec, outputs are 12V at 4A and 5V at 15A. This PSU can be modified with a few extra components and would then give 12V at 10A d.c. We give the details. The price is still £9.50 but you get two instead of one. Offer ends 31st December. Order Ref: 9.5P4.

GEAR WHEELS. Set of 5, quite small, should enable you to get a variety of speeds, mounted in a metal case but easy to remove and use separately. Price £1 the set Order Ref D409

ULTRASONIC MOVEMENT DETECTOR. Nicely cased, free standing, has internal alarm which can be silenced. Also has connections for external speaker or light. Price £10 Order Ref 10P154

CYCLE LAMP BARGAIN. You can have 100 6V MES bulbs for just £2.50 or 1,000 for £20. They are beautifully made, slightly larger than the standard 6.3V pilot bulbs so they would be ideal for making displays for night lights and similar applications. 50 joined in series can be connected to the mains and would make a very attractive window display. 100 for £2.50 Order Ref 2 5P29

12Vx12V RELAY. Miniature, clear plastic enclosed, has one set changeover contacts, one set that breaks contact and 3 sets that make contact. Price £1 each Order Ref GR30

COMPONENT MOUNTING PANEL. Heavy Paxolin, size approximately 10in x 2in with 32 pairs of brass pillars for soldering or binding on components. £1 Order Ref 1 7RC26

AIR-SPACED TUNING CAPACITOR. Twin 100pF with trimmers, extra small. Fixed from the front by 3 screws. £2 each Order Ref 1 7RC29

PEA LAMPS. Very tiny, only 4mm, but 14V at 0-04A, wire-ended, 25p each Order Ref 1 7RC28

HIGH AMP THYRISTOR. Normal two contacts from the top and heavy threaded fixing underneath. We don't know the ampereage of this but think it to be at least 25A. Price 50p each Order Ref 1 7RC43

THREE LEVEL PRESSURE SWITCH. All 3 are low pressures and the switch could be blow-operated. With a suitable tubing these switches could control the level of liquid, etc. price £1. Order Ref. 67

BREAKDOWN UNIT. Order Ref: BM41001. This is probably the most valuable breakdown unit that you have ever been offered. It contains the items specified below just 2 of which are currently selling at £3.50 each. Other contents are: Computer grade electrolytics, 330uF 250V DC, you get 4 of these, 4,700uF at 50V DC, you get 2 of these, 1,000uF at 16V DC, you get one of these, and 16A 250V double rocker switch, 115V to 250V selector switch. You also get a standard flat pin instrument socket, a 250V 5A bridge rectifier, 2 x 25A bridge rectifiers mounted on an aluminium heatsink but very easy to remove.

2 NPN powered transistors ref BUV47, currently listed by Maplins at £3.50 each, a power thyristor, Mullard ref BTW69 or equivalent, listed at £3

All the above parts are very easy to remove, 100s of other parts not so easy to remove, all this is yours for £5 Order Ref 1 11R8

GLISTENING JEWEL CHRISTMAS LIGHTS. This is a 40 light set which is twice the normal so you will have a tree to be really envied. If you put these around the door or window it will please everybody. They are all ready with 2 spare bulbs, price £4.50 Order Ref 4 5P2

35mm PANORAMIC CAMERA. Has super wide lens ideal for holiday viewing. Is focus free and has an extra bright and clear viewfinder. Brand new and guaranteed individually boxed. £6.50 Order Ref 6 5P2

FLASHING BEACON. Ideal for putting on a van, a tractor or any vehicle that should always be seen. Uses a Xenon tube and has an amber coloured dome. Separate fixing base is included so unit can be put away if desirable. Price £5 Order Ref 5P267

MEDICINE CUPBOARD ALARM. Or it could be used to warn when any cupboard door is opened. The light shining on the unit makes the bell ring. Completely built and neatly cased, requires only a battery. £3 Order Ref 3P155

WATER LEVEL ALARM. Be it bath, sink cellar, sump or any other thing that could flood. This device will tell you when the water has risen to the preset level. Adjustable over quite a useful range. Neatly cased for wall mounting ready to work when battery fitted. £3 Order Ref 3P156

BIKE RADIO. In fact, it is more than a radio, it is an alarm and a spotlight. The radio is battery operated of course and needs 3 AA cells. Only one band but this is the FM band so will receive Radio 1 and 2. Comes complete with handlebar fixing clips. Price £4 Order Ref 4P72

EMERGENCY LIGHTING UNIT with perspex cover. Contains internal rechargeable batteries and its own charger to operate an internal fluorescent tube. Stays on for 3 hours should mains fail. Price £15 Order Ref 15P32

BUMP 'N GO SPACESHIP. A wonderful present for a budding young electrician. It responds to claps and shouts and should it strike an object it will set off in another direction. Kit contains all the parts and a youngster should be able to assemble but you might have to help with the soldering of the components onto the p.c.b. The assembly instructions are very detailed and explicit and providing he follows the step by step illustrations then a successful spaceship will result. price £9 Order Ref 9P9

PHILIPS 9in. MONITOR. Not cased, but it is in a frame for rack mounting. It is high resolution and was made to work with the IBM One per disk computer. Price £15 Order Ref 15P1

METAL CASE FOR 9in. MONITOR. Supplied as a flat pack price £12 Order Ref 12P3

TELEPHONE EXTENSION LEAD. Nicely made and BT approved. Has the plug into BT socket one end and the telephone socket the other end. Total length 12m. £2 Order Ref 2P39

ORGAN MASTER KEYBOARD. Three octave keyboard, extremely well made and with piano size keys. New and unused, only £5 Order Ref 5P282

INSULATION TESTER WITH MULTIMETER. Internally generates voltages which enable you to read insulation directly in megohms. The multimeter has four ranges AC DC volts 3 ranges DC milliamperes 3 ranges resistance and 5 AC range. Ex-British Telecom but in very good condition. Tested and guaranteed, probably cost at least £50 each, yours for only £7.50 with leads, carrying case £2 extra. Order Ref 7 5P4

REPAIRABLE METERS. We have some of the above testers but faulty not working on all ranges, should be repairable, we supply diagram. £3 Order Ref 3P176

LCD MULTIRANGE VOLT/METER/AMMETER. A high quality 3 1/2 digit LCD panel meter incorporating an A/D converter chip (7106) to provide 5 voltage ranges and 5 current ranges within one unit. Ranges are selected by onboard connectors and expandable by resistors. Price £11.50 Order Ref 11 5P2

PIANO ON KEY CHAIN. Although it is quite small, only 20mm long it will play any tune. Instructions with it tell you which keys to press for 'Happy Birthday', 'Twinkle Twinkle Little Star', 'Jingle Bells' and 'London Bridge'. It is also a light, it has a little lamp which can be operated by the end switch. Battery operated (not included), price £1.50 Order Ref 1 5P39

12V RECHARGEABLE YUASA BATTERY. Sealed so usable in any position - suit golf trolley, lawn mower, portable lights, etc. etc. only £3.50 Order Ref 3 5P11

CHARGER FOR YUASA BATTERY. This battery charger plugs into a 13A socket, charges at approximately 1/2A so it would charge this battery overnight. Complete with croc clips, ready to go. £5 Order Ref 5P269

250M TWIN 5A EXTENSION LEAD. Rubber but treated so it can't perish through sunlight. etc. Ideal for most garden tools. Price £20 Order Ref 20P35

8mm PROJECTORS. With zoom lens, brand new and perfect, complete with one reel and hand-book. Regular price over £100, yours for £39 Order Ref 39P1

Ditto but with sound as well and a mike, £49 Order Ref 49P1. The zoom lens alone is worth more.

SOLDERING IRON. Super mains powered with long life ceramic element, heavy duty 40W for the extra special job. Complete with plated wire stand and 245mm lead. £3. Order Ref 3P221

WORKING TOYS THAT DON'T NEED BATTERIES. Three kits available - Helicopter, Order Ref. 7P17, Monoplane, Order Ref 7P18, or Oldy World gramophone, Order Ref 7P20. All £7 each.

DYNAMIC MICROPHONE. 500 ohm, plastic body with black mesh head, on/off switch, good length lead and terminated with audio plug. £2 Order Ref 2P220



1 10th HORSEPOWER 12V MOTOR. Made by Smiths, the body length of this is approximately 3in, the diameter 3in and the spindle 5/8in diameter. Quite a powerful little motor which revs at 2000rpm. Price £6 Order Ref 6P47

MINI BLOW HEATER. 1kW ideal for under desk or airing cupboard etc. Needs only a simple mounting frame, price £5 Order Ref 5P23

TERMS

Send cash, P.O. cheque or quote credit card number - orders under £25 add £3.50 service charge.

J & N FACTORS
Pilgrim Works (Dept. E.E.)
Stairbridge Lane, Bolney,
Sussex RH17 5PA
Telephone: 01444 881965

The Alternative Oscilloscope

Pico Technology provides an alternative to costly, bulky and complicated oscilloscopes. The ADC range of virtual instrumentation enables your PC to perform as an **oscilloscope, spectrum analyser and digital multimeter.**

- ▼ Upto 100 MS/s sampling and 50 MHz spectrum analysis
- ▼ A fraction of the price of comparable benchtop DSOs
- ▼ Simple Windows based user interface

The practical alternative
Connection to a PC gives virtual instruments the edge over traditional

"...the most powerful, flexible test equipment in my lab"

oscilloscopes: the ability to print and save waveforms is just one example. Advanced trigger modes, such as save to disk on trigger, make tracking down elusive intermittent faults easy. Combining several instruments into one small unit means it is lighter and more portable. When used with a notebook computer, field engineers can carry a complete electronics lab in their PC.



The simple alternative

Virtual instruments eradicate the need for bewildering arrays of switches and dials associated with traditional 'benchtop' scopes. The units are supplied with PicoScope for Windows software.

Controlled using the standard Windows interface, the software is easy to use with full on line help. Installation is easy and no configuration is required; simply plug into the parallel port and it is ready to go. We provide a two year guarantee and free technical support via phone, fax or E-mail.



The low cost alternative

The Pico range of PC based oscilloscopes work with your PC - anything from a dustbin-ready 8086 to the latest pentium. The PicoScope software utilises your monitor to display data. This gives you a larger, clearer display than any scope, at a fraction of the price.

The savings don't stop there: All those expensive upgrades needed for traditional oscilloscopes: such as FFT maths, disk drives and printers are already built into your computer. The PC has made computing affordable, now Pico has made test equipment affordable too.

Seeing is understanding

FROM £59



Call for a FREE demo disk or visit our web site.
Fax: (0)1954 211880 Tel: (0)1954 211716
E-mail: post@picotech.co.uk <http://www.picotech.com>
Broadway House 149-151 St Neots Road Hardwick Cambridge CB3 7QJ UK



The complete monitoring system

Temperature

The **EnviroMon** system, from Pico Technology is one of the most versatile and cost effective monitoring systems on the market today. It can measure temperatures from -55 to 300°C, check light and humidity levels or record the position of a switched system. Its applications are endless; from food storage & preparation to energy management.

Open Door

Humidity

Light



At the core of the system is the logger, which stores up to 15,000 readings and displays them from each sensor in turn. Reports can be printed on a stand-alone printer or data sent to a PC for long term storage and graphical

analysis using the powerful supplied software. EnviroMon for Windows.

The EnviroMon system records data 24 hours a day, 365 days a year, even if the mains power fails. Should a parameter goes out of range, it alerts you with various alarms or a telephone message.

EnviroMon Starter kit £395 + VAT

Call for full product range and FREE demo disk or visit our web site.

Pico Technology Limited, Broadway House, 149-151 St. Neots Rd, Hardwick, Cambridge, CB3 7QJ UK
Tel: 01954 -211716 Fax: 01954 -211880
E-mail: post@picotech.co.uk <http://www.picotech.com>

The best things come in small packages

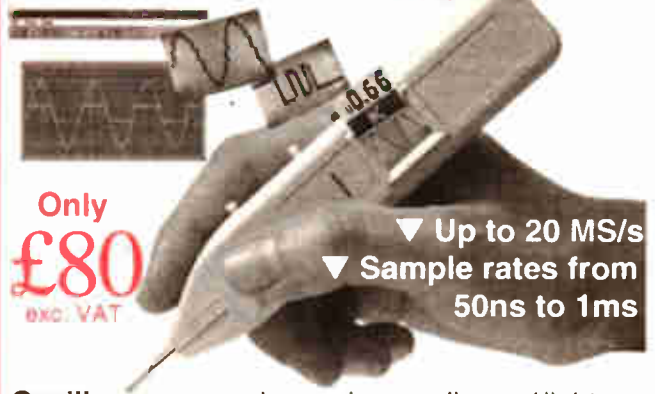

Only £80
exc. VAT

- ▼ Up to 20 MS/s
- ▼ Sample rates from 50ns to 1ms

Oscilloscopes are becoming smaller and lighter: Now Pico Technology brings you the latest development, the **osziFOX** hand held scope.

Despite its small size, its performance can match that of a service oscilloscope. With sampling rates of up to 20 MS/s, even signals in microprocessor circuits can be measured.

The osziFOX is ideal for taking measurements in digital circuits, telephone installations, hobby electronics, production line tests and on-the-spot measuring. It provides the ultimate in portability and flexibility.

As with the rest of the Pico Technology range, the PC link gives the osziFOX the edge: the ability to print and save waveforms is just one example.

Complete price £98.11 including VAT + P&P (UK), cables and software included.

Tel: 01954 -211716 Fax: 01954 -211880

E-mail: post@picotech.co.uk

Visit our web site: www.picotech.com

Pico Technology Limited, Broadway House, 149-151 St. Neots Rd, Hardwick, Cambridge, CB3 7QJ



MAIL ORDER ONLY ● CALLERS BY APPOINTMENT

EPE MICROCONTROLLER P.I. TREASURE HUNTER

The latest MAGENTA DESIGN - highly stable & sensitive - with MC control of all timing functions and advanced pulse separation techniques.

- New circuit design 1994
- High stability drift cancelling
- Easy to build & use
- No ground effect, works in seawater



- Detects gold, silver, ferrous & non-ferrous metals

- Efficient quartz controlled microcontroller pulse generation.
- Full kit with headphones & all hardware

KIT 847.....£63.95

PORTABLE ULTRASONIC PEsT SCARER

A powerful 23kHz ultrasound generator in a compact hand-held case. MOSFET output drives a special sealed transducer with intense pulses via a special tuned transformer. Sweeping frequency output is designed to give maximum output without any special setting up.

KIT 842.....£22.56

SUPER ACOUSTIC PROBE

Our very popular project - now with ready built probe assembly and diecast box. Picks up vibrations amplifies, and drives headphones. Sounds from engines, watches, and speech through walls can be heard clearly. Useful for mechanics, instrument engineers and nosey parkers! A very useful piece of kit.

KIT 865.....£29.95

DC Motor/Gearboxes

Our Popular and Versatile DC motor/Gearbox sets. Ideal for Models, Robots, Buggies etc. 1-5 to 4-5V Multi ratio gearbox gives wide range of speeds.

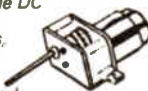

LARGE TYPE - MGL £6.95
SMALL - MGS - £4.77

Stepping Motors

MD38...Mini 48 step...£8.65
MD35...Std 48 step...£9.99
MD200...200 step...£12.99
MD24...Large 200 step...£22.95



PIC PIPE DESCALER

- SIMPLE TO BUILD
- HIGH POWER OUTPUT
- AUDIO & VISUAL MONITORING
- SWEEPED FREQUENCY

An affordable circuit which sweeps the incoming water supply with variable frequency electromagnetic signals. May reduce scale formation, dissolve existing scale and improve lathering ability by altering the way salts in the water behave. Kit includes case, P.C.B., coupling coil and all components. High coil current ensures maximum effect. L.E.D. monitor

KIT 868£22.95 POWER UNIT.....£3.99



MICRO PEsT SCARER

Our latest design - The ultimate scarer for the garden. Uses special microchip to give random delay and pulse time. Easy to build reliable circuit. Keeps pets/pests away from newly sown areas, play areas, etc. Uses power source from 9 to 24 volts.

- RANDOM PULSES
- HIGH POWER
- DUAL OPTION

KIT 867.....£19.99

KIT + SLAVE UNIT.....£32.50

Plug-in power supply £4.99



WINDICATOR

A novel wind speed indicator with LED readout. Kit comes complete with sensor cups, and weatherproof sensing head. Mains power unit £5.99 extra.

KIT 856.....£28.00

★ TENS UNIT ★

DUAL OUTPUT TENS UNIT

As featured in March '97 issue.

Magenta have prepared a FULL KIT for this excellent new project. All components, PCB, hardware and electrodes are included. Designed for simple assembly and testing and providing high level dual output drive.

KIT 866.... Full kit including four electrodes £32.90

Set of 4 spare electrodes £6.50

1000V & 500V INSULATION TESTER

Superb new design. Regulated output, efficient circuit. Dual-scale meter, compact case. Reads up to 200 Megohms. Kit includes wound coil, cut-out case, meter scale, PCB & ALL components.

KIT 848.....£32.95



SPACEWRITER

An innovative and exciting project. Wave the wand through the air and your message appears. Programmable to hold any message up to 16 digits long. Comes pre-loaded with "MERRY XMAS". Kit includes PCB, all components & tube plus instructions for message loading.

KIT 849.....£16.99

12V EPROM ERASER

A safe low cost eraser for up to 4 EPROMS at a time in less than 20 minutes. Operates from a 12V supply (400mA). Used extensively for mobile work - updating equipment in the field etc. Also in educational situations where mains supplies are not allowed. Safety interlock prevents contact with UV.

KIT 790.....£28.51

SUPER BAT DETECTOR

NEW!

1 WATT O/P, BUILT IN
SPEAKER, COMPACT CASE
20kHz-140kHz

NEW DESIGN WITH 40kHz MIC.

A new circuit using a 'full bridge' audio amplifier i.c., internal

speaker, and head-phone/tape socket. The latest sensitive transducer, and 'double balanced mixer' give a stable, high performance superheterodyne design.

KIT 861.....£24.99

ALSO AVAILABLE Built & Tested£39.99



E.E. TREASURE HUNTER P.I. METAL DETECTOR MK1

Magenta's highly developed & acclaimed design. Quartz crystal controlled circuit MOSFET coil drive. D.C. coupled amplification. Full kit includes PCB, handle, case & search coil.

- KIT INC. HEADPHONES
- EFFICIENT CMOS DESIGN
- POWERFUL COIL DRIVE

- DETECTS FERROUS AND NON-FERROUS METAL - GOLD, SILVER, COPPER ETC.

- 190mm SEARCH COIL
- NO 'GROUND EFFECT'

KIT 815.....£45.95



MOSFET MkII VARIABLE BENCH POWER SUPPLY 0-25V 2-5A.

Based on our Mk1 design and preserving all the features, but now with switching pre-regulator for much higher efficiency. Panel meters indicate Volts and Amps. Fully variable down to zero. Toroidal mains transformer. Kit includes punched and printed case and all parts. As featured in April 1994 EPE. An essential piece of equipment.



Kit No. 845.....£64.95

3-NOTE DOORCHIME

IDEAL BEGINNERS PROJECT

Uses SAB0600 chip to produce natural sounding 3-note chime. Adjustable pitch - so that two can be used for front and back doors.

Kit includes P.C.B., all parts and instructions. No case or battery

KIT 869.....£5.99

ULTRASONIC PEsT SCARER

Keep pets/pests away from newly sown areas, fruit, vegetable and flower beds, children's play areas, patios etc. This project produces intense pulses of ultrasound which deter visiting animals.

- KIT INCLUDES ALL COMPONENTS, PCB & CASE
- EFFICIENT 100V TRANSDUCER OUTPUT
- COMPLETELY INAUDIBLE TO HUMANS
- UP TO 4 METRES RANGE
- LOW CURRENT DRAIN

KIT 812.....£14.81



SIMPLE PIC PROGRAMMER

INCREDIBLE LOW
PRICE!

Kit 857 **£12.99**

INCLUDES 1-PIC16C84 CHIP
SOFTWARE DISK, LEAD
CONNECTOR, PROFESSIONAL
PC BOARD & INSTRUCTIONS

Power Supply £3.99

EXTRA CHIPS:
PIC 16C84 £4.84

Based on the design in February '96 *EPE* article, Magenta have made a proper PCB and kit for this project. PCB has 'reset' switch, Program switch, 5V regulator and test L.E.D.s. There are also extra connection points for access to all A and B port pins.

PIC16C84 LCD DISPLAY DRIVER

INCLUDES 1-PIC16C84
WITH DEMO PROGRAM
SOFTWARE DISK, PCB,
INSTRUCTIONS AND
24-CHARACTER 2-LINE
LCD DISPLAY

Kit 860 **£19.99**

Power Supply £3.99

FULL PROGRAM SOURCE
CODE SUPPLIED - DEVELOP
YOUR OWN APPLICATION!

Another super PIC project from Magenta. Supplied with PCB, industry standard 2-LINE x 24-character display, data, all components, and software to include in your own programs. Ideal development base for meters, terminals, calculators, counters, timers - Just waiting for your application!

★ Chip is pre-programmed with demo display ★

PIC16C84 MAINS POWER 4-CHANNEL CONTROLLER & LIGHT CHASER

- WITH PROGRAMMED 16C84 AND DISK WITH SOURCE CODE IN MPASM
- ZERO VOLT SWITCHING - 10 CHASE PATTERNS
- OPTO ISOLATED
- 4 X 3 KEYPAD CONTROL
- SPEED CONTROL POT.
- HARD FIRED TRIACS
- 4 CHANNELS @5 AMPS

Now features full
4-channel chaser software
on DISK and
pre-programmed
PIC16C84 chip. Easily
re-programmed for your
own applications.
Software source code is
fully 'commented' so that
it can be followed easily.

Kit 855 **£39.95** LOTS OF OTHER APPLICATIONS

68000 DEVELOPMENT AND TRAINING KIT

KIT 601
£69.95

- USED WORLDWIDE IN SCHOOLS & COLLEGES
- FULL FEATURED MONITOR, LINE ASSEMBLER & CROSS ASSEMBLER DISK
- NOW WITH EXPANDED RAM & ROM
- FULL 8MHz 68000 16-BIT DATA BUS
- FULL MANUAL, DATA COMMS & SOFTWARE DISK
- 2 SERIAL PORTS & EXPANDABLE I/O

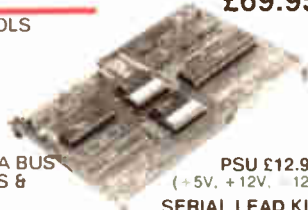

PSU £12.99
(+ 5V, +12V, -12V)
SERIAL LEAD KIT
9-way & 25-way £4.99

Mini-Lab & Micro Lab Electronics Teach-In 7

As featured in *EPE* and now published as Teach-In 7. All parts are supplied by Magenta. Teach-In 7 is £3.95 from us or *EPE*

Full Mini Lab Kit - £119.95 -
Power supply extra - £22.55
Full Micro Lab Kit - £155.95
Built Micro Lab - £189.95



EPE PIC Tutorial

NEW!

At Last! A Real, Practical, Hands-On Series
3-Part Series - Starting March '98

- Learn Programming from scratch
- Uses Re-Programmable PIC16C84 Chip
- Start by lighting an l.e.d. and work up through over 30 tutorials to Sound Generation, Data Display, and a Security System
- PIC TUTOR Board has Input Switches, Output l.e.d.s, and on board programmer

PIC TUTOR BOARD KIT

Includes: PIC16C84 Chip, TOP Quality PCB printed with Component Layout and all components* (*not ZIF Socket or Displays). Included with the Magenta Kit is a disk with Test and Demonstration routines.

KIT 870 **£27.95, Built & Tested £42.95**

Optional: Power Supply - £3.99, ZIF Socket - £9.99

LCD Display - With Software and Connection details **£7.99**

LED Display - Including Software..... **£6.99**

PIC TOOLKIT

- PROGRAMS PIC16C84 and 16F84
- ACCEPTS TASM AND MPASM CODE

Full kit includes PIC16C84 chip, top quality p.c.b. printed with component layout, turned pin PIC socket, all components and software*
*Needs QBASIC or QUICKBASIC

KIT 871 . . . **£13.99.** Built and tested **£21.99**

SUPER PIC PROGRAMMER

- READS, PROGRAMS, AND VERIFIES
- WINDOWS™ SOFTWARE
- PIC16C6X, 7X, AND 8X
- USES ANY PC PARALLEL PORT
- USES STANDARD MICROCHIP • HEX FILES
- OPTIONAL DISASSEMBLER SOFTWARE (EXTRA)
- PCB, LEAD, ALL COMPONENTS, TURNED PIN SOCKETS FOR 18, 28, AND 40 PIN ICs.

• SEND FOR DETAILED
INFORMATION - A
SUPERB PRODUCT AT AN
UNBEATABLE LOW PRICE.

Kit 862 **£29.99**

Power Supply £3.99

DISASSEMBLER
SOFTWARE **£11.75**

PIC STEPPING MOTOR DRIVER

INCLUDES: PCB,
PIC16C84 WITH
DEMO PROGRAM,
SOFTWARE DISK,
INSTRUCTIONS
AND MOTOR.

Kit 863 **£18.99**

FULL SOURCE CODE SUPPLIED.
ALSO USE FOR DRIVING OTHER
POWER DEVICES e.g. SOLENOIDS.

Another NEW Magenta PIC project. Drives any 4-phase unipolar motor - up to 24V and 1A. Kit includes all components and 48 step motor. Chip is pre-programmed with demo software, then write your own, and re-program the same chip! Circuit accepts inputs from switches etc and drives motor in response. Also runs standard demo sequence from memory.

MAGENTA

All prices include VAT. Add £3.00 p&P. Next Day £6.99

Tel: 01283 565435 Fax: 01283 546932 E-mail: Magenta_Electronics@compuserve.com



Station Road, Cullercoats, Tyne & Wear, NE30 4PQ

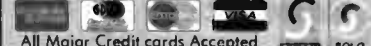

Prices Exclude Vat @17.5%. Add £1.25 carriage & Vat to all orders. Cheques / Postal orders payable to ESR Electronic Components.

See Next / Last Months Ad. for COMPONENT ACCESSORIES

Table of electronic components including 4000 Series, 74HC Series, and 74LS Series with part numbers and prices.

Table of electronic components including EPROMs, RAM, A/D Converters, Data Acquisition, Thyristors, Triacs, Diac, Si. Switch, Transistors, Voltage Regulators, and Diodes.

Table of electronic components including Bridge Rectifiers, Diodes, Transistors, Voltage Regulators, Diodes, and various other components.

Table of electronic components including various diodes, transistors, and other parts.

No Minimum Order Value

Table for Electrolytic Radial and Electrolytic Axial capacitors with specifications and prices.

We carry a large range of capacitors in stock, including: Ceramic Mini Disc, Dipped Ceramic Multilayer, Dipped & Boxed Polyester, Mylar Film, Polystyrene, MKT Polyester, Tanfume Bead, Sub-miniature Radial, 105 C Radial, Low Leakage Radial, Non Polarised Radial, PCB Can Electrolytics, Polypropylene & Ceramic Trimmers and Tuning, Dilecon & O Type Variable capacitors. Full technical details available.

Resistors - Please State Value Required per 100 of one value only. 1/2W Carbon Film 5%, E12 Series 100-1M0, £0.02 Each, £0.80 per 100.

Prot Resistors - Please State Value Required Enclosed, 10mm Square Harz / Vert. 1000-1M0 0.15W £0.15 Each.

Potentiometers - Please State Value Required Single Gang 1/2" Shaft, 25mm Dia. 4700-2M2 Linear £0.49 Each.

EVERYDAY

PRACTICAL

ELECTRONICS

VOL. 28 No. 1

JANUARY '99

Editorial Offices:
EVERYDAY PRACTICAL ELECTRONICS EDITORIAL
ALLEN HOUSE, EAST BOROUGH, WIMBORNE
DORSET BH21 1PF
Phone: Wimborne (01202) 881749
Fax: (01202) 841692. **Due to the cost we cannot reply to overseas orders or queries by Fax.**

E-mail: editorial@epemag.wimborne.co.uk
Web Site: <http://www.epemag.wimborne.co.uk>

See notes on **Readers' Enquiries** below – we regret lengthy technical enquiries cannot be answered over the telephone.

Advertisement Offices:
EVERYDAY PRACTICAL ELECTRONICS
ADVERTISEMENTS
MILL LODGE, MILL LANE
THORPE-LE-SOKEN, ESSEX CO16 0ED
Phone/Fax: (01255) 861161

INGENIOUS

Some simple projects this month to go alongside the more heavyweight *PhizzyB* and *Mind PICkler*. It's still interesting to see what ingenious devices can be built with relatively few components and rest assured we will not be forsaking the "lower end", so to speak, of designs. Whilst we have more very exciting projects in the pipeline – projects like next month's *Wireless Monitoring System* (see page 3), which simply would not have been possible a year or so ago – we still like to show what can be done with a little ingenuity and a few components.

This month's *Twinkle Twinkle Reaction Game* and the *Alternative Courtesy Light* are good examples of simple projects. The circuits used for them both could also be employed in other designs of your own making, and this is often what happens to our projects. Many readers tell us that, whilst they sometimes build projects to our design, more often than not they will modify the circuit to meet their own needs, or use part of our circuit in a totally different project to fulfil their particular requirements.

LATERAL THINKING

This, of course, is what our IU pages are all about and we are always pleased to see our younger readers participating as one has this month. Please don't be frightened to contribute to IU; we are not looking for professional designs, simply for your innovative ideas or methods of cracking little problems. There is a shining example of a simple solution in the *Cooling Monitor for Outboard Engines* in IU this month – what could be simpler than a battery and three components? It's the application of some lateral thinking that had made this a worthwhile IU submission – like all great ideas it's so simple once someone else has thought it up. A bit like that great invention, cats eyes – but even that has now been improved almost beyond recognition with the application of PICs – our *Innovations* pages pick up the story (sorry about the pun).

Once again, some lateral thinking has improved a simple idea and achieved a massive stride forward in road safety. Let's hope all our motorways can eventually be equipped with active cats eyes to tell us when we are too close to the vehicle in front (just think of that in thick fog), or when the road is freezing, or if traffic is coming to a halt, etc.

Electronics is a wonderful thing.



AVAILABILITY

Copies of *EPE* are available on subscription anywhere in the world (see right), from all UK newsagents (distributed by Seymour) and from the following UK electronic component retailers: Maplin – all stores throughout the UK (and in S. Africa); Greenweld Electronics; Omni Electronics. *EPE* can also be purchased from retail magazine outlets around the world. An on-line version can be purchased from www.epemag.com



SUBSCRIPTIONS

Annual subscriptions for delivery direct to any address in the UK: £26.50. Overseas: £32.50 standard air service, £50 express airmail. Cheques or bank drafts (in £ sterling only) payable to *Everyday Practical Electronics* and sent to EPE Subscriptions Dept., Allen House, East Borough, Wimborne, Dorset BH21 1PF. Tel: 01202 881749. Fax: 01202 841692. E-mail: subs@epemag.wimborne.co.uk. Subscriptions start with the next available issue. We accept MasterCard or Visa. (For past issues see the *Back Issues* page.)

BINDERS

Binders to hold one volume (12 issues) are available from the above address. These are finished in blue p.v.c., printed with the magazine logo in gold on the spine. Price £5.95 plus £3.50 post and packing (for overseas readers the postage is £6.00 to everywhere except Australia and Papua New Guinea which cost £10.50). *Normally sent within seven days but please allow 28 days for delivery – more for overseas orders.*

Payment in £ sterling only please. Visa and MasterCard accepted, minimum credit card order £5. Send, fax or phone your card number and card expiry date with your name, address etc. Or order on our secure server via our web site. Overseas customers – your credit card will be charged by the card provider in your local currency at the existing exchange rate.

Editor: MIKE KENWARD

Secretary: PAM BROWN

Deputy Editor: DAVID BARRINGTON

Technical Editor: JOHN BECKER

On-Line Editor: ALAN WINSTANLEY

Business Manager: DAVID J. LEAVER

Subscriptions: MARILYN GOLDBERG

Editorial: Wimborne (01202) 881749

Advertisement Manager:

PETER J. MEW, Frinton (01255) 861161

Advertisement Copy Controller:

PETER SHERIDAN, Wimborne (01202) 882299

READERS' ENQUIRIES

E-mail: techdept@epemag.wimborne.co.uk
We are unable to offer any advice on the use, purchase, repair or modification of commercial equipment or the incorporation or modification of designs published in the magazine. We regret that we cannot provide data or answer queries on articles or projects that are more than five years old. Letters requiring a personal reply *must* be accompanied by a **stamped self-addressed envelope or a self-addressed envelope and international reply coupons. Due to the cost we cannot reply to overseas queries by Fax.**

All reasonable precautions are taken to ensure that the advice and data given to readers is reliable. We cannot, however, guarantee it and we cannot accept legal responsibility for it.

COMPONENT SUPPLIES

We do not supply electronic components or kits for building the projects featured, these can be supplied by advertisers (see *Shoptalk*).

We advise readers to check that all parts are still available before commencing any project in a back-dated issue.

ADVERTISEMENTS

E-mail: adverts@epemag.wimborne.co.uk
Although the proprietors and staff of EVERYDAY PRACTICAL ELECTRONICS take reasonable precautions to protect the interests of readers by ensuring as far as practicable that advertisements are *bona fide*, the magazine and its Publishers cannot give any undertakings in respect of statements or claims made by advertisers, whether these advertisements are printed as part of the magazine, or in inserts.

The Publishers regret that under no circumstances will the magazine accept liability for non-receipt of goods ordered, or for late delivery, or for faults in manufacture. Legal remedies are available in respect of some of these circumstances, and readers who have complaints should first address them to the advertiser.

TRANSMITTERS/BUGS/TELEPHONE EQUIPMENT

We advise readers that certain items of radio transmitting and telephone equipment which may be advertised in our pages cannot be legally used in the UK. Readers should check the law before buying any transmitting or telephone equipment as a fine, confiscation of equipment and/or imprisonment can result from illegal use or ownership. The laws vary from country to country; overseas readers should check local laws.

ALTERNATIVE COURTESY LIGHT CONTROLLER

PAUL BRIGHAM



Let this neat little add-on light your way in the dark.

THE IDEA of an Alternative Courtesy Light Controller was borne from a situation which arose after moving house recently whereby, after parking the car in the garage and switching off the headlights it became difficult to find the way out without tripping over something or knocking into the car. It was found that when the car headlights were on, the reflective light they gave off was quite sufficient to see adequately and consequently find a safe route out. Of course, clearing out some of the prize "junk" would have solved the problem, but it was thought an electronic solution was a more challenging and rewarding option.

The unit described here simply provides a delayed switch-off action of the vehicles' headlights, providing an "Alternative Courtesy Light" to that to which we are accustomed, i.e. the interior courtesy light.

Both the author and friends, who have units fitted, have found it to be most useful in an array of situations which had not been envisaged before. Also, many readers will, no doubt, possibly dream up many more useful applications for this simple circuit.

USER FRIENDLY

The unit can be operated in one of two ways which are both controlled by the driver upon leaving the vehicle. First, the unit can be switched on by "flashing" the vehicles headlights prior to leaving the vehicle, usually done by pulling the indicator stalk mounted on the steering column towards you, or alternatively by switching the headlights off *after* the ignition has been switched off.

The two different modes of operation are incorporated primarily due to the different habits drivers have when switching off their vehicle. Most people probably switch the engine off immediately they have parked up, but leave the lights on whilst gathering things from their vehicle.

However, other people tend to switch off their lights first, followed by the engine, thus the two different operating modes are intended to make the unit some what "user friendly". It was also found that people

liked the controlling aspect of manually activating the

unit, hence the inclusion of the differing switching modes.

Once the unit is activated, whether intentionally or accidentally, it can be switched off immediately if required without having to wait for it to time out. This is simply done by switching on the ignition and then, obviously, off again.

However, if the unit was activated automatically, via the action of switching ignition off then headlights off, you must, of course, remember to switch the headlights off *first* otherwise the unit will re-activate. This in practice does not prove a problem.

A point worth mentioning here is: if the vehicle has a "lights on" audible indicator this will sound after the unit has been activated and the door is opened, even if you remembered to switch your lights off. It was not feasible to attempt to overcome this since there are so many different types fitted to vehicles and to cover all possible solutions in one circuit would be impractical. At worst, all that tends to happen is that you re-check that you have switched your lights off - which cannot be a bad thing!

CIRCUIT DESCRIPTION

The full circuit diagram for the Alternative Courtesy Light Controller is shown in Fig.1. The circuit is centred around IC1, a low power CMOS version of the popular 555 timer i.e., which is wired in monostable mode. In this mode it can provide a "high" output (almost equal to its supply voltage) at pin 3 for a duration set by the resistor/capacitor combination of R5, preset VR1 and capacitor C3.

The circuit works by monitoring the voltage on IC1 pins 6 and pin 7. As this voltage rises, i.e. as capacitor C3 begins to charge up via the resistor combination of R5 and VR1, a critical point is reached where the voltage across the capacitor reaches approximately two-thirds of the supply voltage.

At this point, the output at pin 3 will change its state from high to low (0V). Whilst in this low state, threshold pin 7 now acts as a current sink whereby

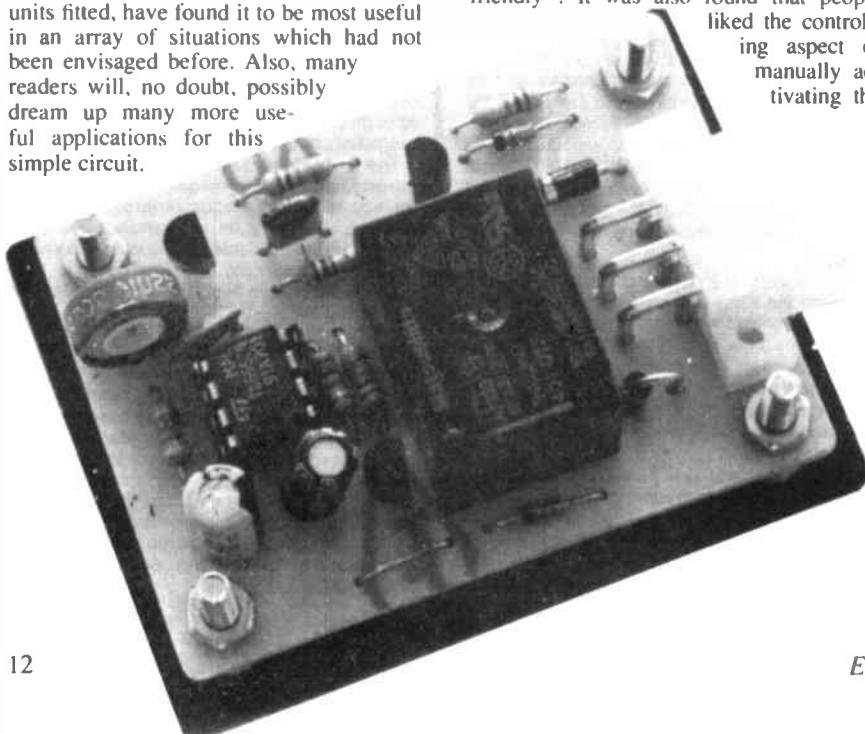

capacitor C3 discharges through it resulting in the voltage across it being virtually 0V.

When first powered up, the output at pin 3 remains low due to the high state of the trigger pin (2) and the fact that capacitor C3 is fully discharged, via pin 7. The i.c. will remain in this condition until a negative pulse is applied to pin 2 whereby pin 7 flips over and allows C3 to charge up via resistor R5 and preset VR1, to a point where the voltage reaches two-thirds of the supply as previously described, whereupon pin 7 becomes a current sink and discharges C3 again.

The time it takes the voltage across C3 to reach two-thirds of the supply is known as the timing period and corresponds directly to the time that pin 3 will remain high before returning to its low state. The formula to calculate this timing is:

$$t = \frac{1.1 RC}{1000} \text{ where}$$

t = time in seconds

R = total resistance in kilohms and

C = total capacitance in microfarads

$$\text{Thus } t = \frac{1.1 \times 47 \times 100}{1000} = 5 \text{ seconds}$$

$$\text{and } t = \frac{1.1 \times 267 \times 100}{1000} = 30 \text{ seconds}$$

at the two extreme settings of VR1.

TRIGGERING

An important aspect of the triggering stage is that pin 2 and pin 4 are required to return to a high state again before the expected timing period expires. In this circuit, pin 2 is normally clamped high by resistor R4 but can be briefly pulsed low via transistor TR2.

Basically, what happens is that when either the Main Beam or the Dipped Beam is briefly switched on, a positive-going pulse is developed across capacitor C2, so turning on TR2. Resistor R1 and diodes D1 and D2 limit the switched voltage direction and current flow.

When TR2 is turned on, pin 2 is taken low and the timing period commences with output pin 3 going high. At the end of the pulse across C2, TR2 switches off resulting in pin 2 being clamped high once again by resistor R4.

Resistor R3 biases the base (b) of TR2 to 0V after it has switched off to ensure no false triggering can occur.

IC1 pin 4 (Reset) is taken high by the switching on of relay RLA, which, as discussed in a moment, happens at the point of IC1 being triggered, and returns low upon completion of the timing period. Current flow to pin 4 from the relay contacts is via D4, D2 and R1.

As previously stated, if the unit is set accidentally by the user it can be reset by switching on the ignition and then turning it off again.

When the ignition is switched on, transistor TR1 is also switched on through current limiting resistor R2, resulting in the timing cycle terminating since Reset pin 4 is taken low. The internal circuitry of IC1 does the rest and all we need to ensure is that the Reset pin is taken high again before a new timing cycle can begin.

Thus, while the ignition is ON the Reset pin is kept low and the timing cannot begin - resulting in a fail-safe operation whilst driving. Transistor TR1 is also used to discharge C2 so that it is always ready to receive current and thus generate a pulse at the base of TR2.

OUTPUT DRIVE

Looking at the output stage, from pin 3 of IC1, relay RLA is switched on by transistor TR3 through the current limiting resistor R6. The normally open (n.o.) switch contacts of this relay are then closed and used to supply a feed to the vehicles' own headlight switching relay (see Fig.3), which in turn switches on the Dipped Beam headlights for a set period. Diode D5 is incorporated in the circuit to prevent any back e.m.f., created by the "collapsing" relay coil current, from damaging the other semiconductors in the circuit.

Capacitor C1 smooths the supply line. C4 is incorporated to ensure stability of IC1. Diode D3 prevents damage to the unit should it be accidentally wired up with reverse power supply polarities.

CONSTRUCTION

All the components for the Alternative Courtesy Light module are accom-

COMPONENTS

Resistors

R1, R2,	
R6	10k (3 off)
R3	1M
R4	1k
R5	47k
All 0.25W carbon film	

See
**SHOP
TALK**
Page

Potentiometer

VR1	220k enclosed carbon preset, vertical
-----	---------------------------------------

Capacitors

C1	47µ radial elect. 16V
C2	2n2 polyester
C3	100µ radial elect. 16V
C4	100n polyester (optional)

Semiconductors

D1, D2, D5	1N4148 signal diode (3 off)
D3, D4	1N4001 1A 50V rectifier diode (2 off)
TR1, TR2, TR3	BC337 npn silicon transistor (3 off)
IC1	ICM7555IPA low power CMOS timer

Miscellaneous

RLA	12V 400 ohm coil relay, with 5A s.p.s.t. contacts
SK1	p.c.b. mounting, right-angle header power connector (6-way), with matching free plug
FS1	1A fuse, with in-line fuseholder

Printed circuit board available from the *EPE PCB Service*, code 217; case, size and type to choice; 8-pin d.i.l. socket; crimp contacts (socket) for SK1; multistrand auto-type connecting wire; cable ties; insulating tape; solder etc.

Approx Cost
Guidance Only

£12
excluding case

modated on a small single-sided printed circuit board (p.c.b.). The topside component layout, underside full-size copper foil master and connecting plug wiring details are shown in Fig.2. This board is available from the *EPE PCB Service*, code 217.

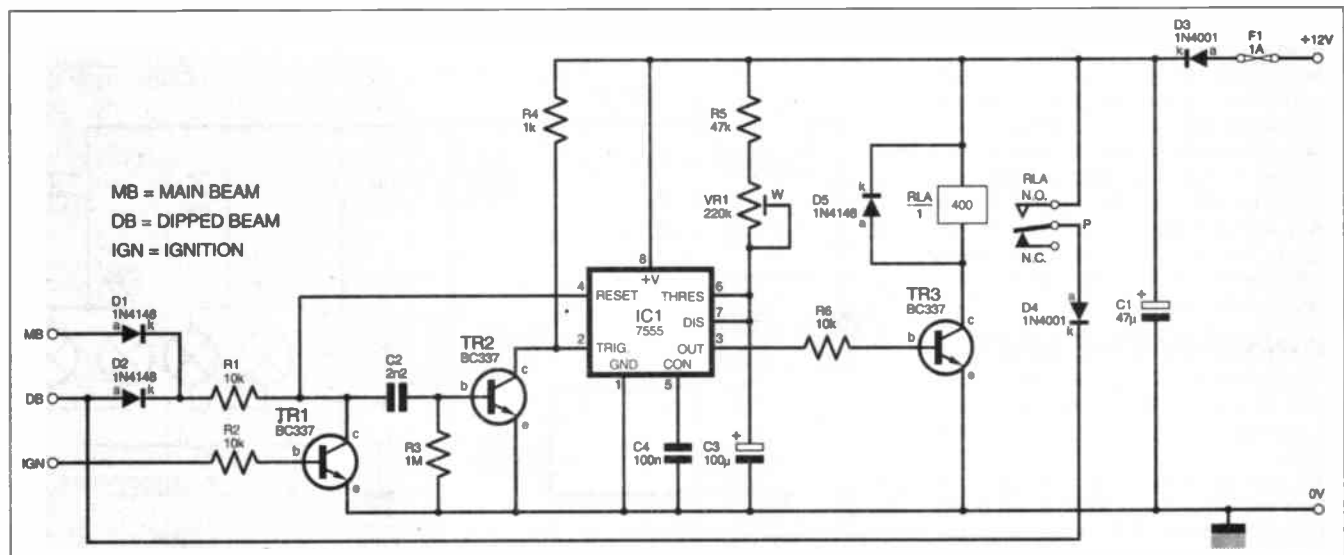
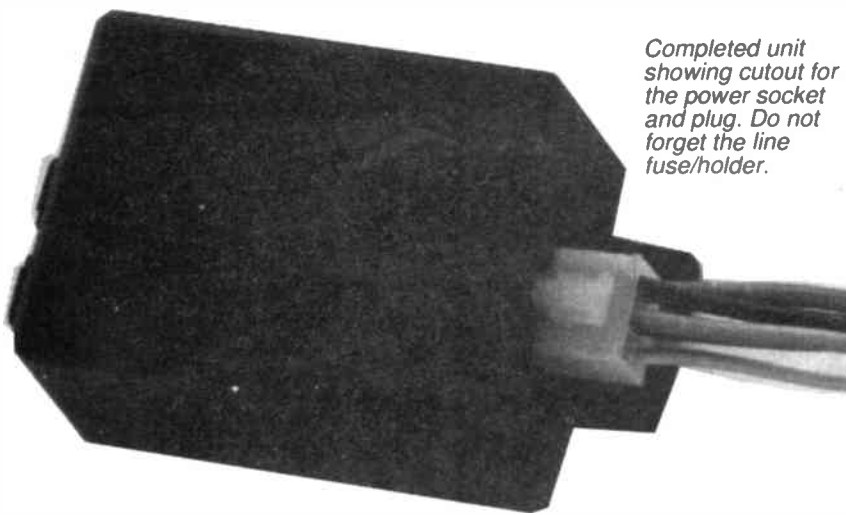

Fig.1. Complete circuit diagram for the Alternative Courtesy Light Controller.



Completed unit showing cutout for the power socket and plug. Do not forget the line fuse/holder.

Construction of the unit should provide no great problems providing you stick with the p.c.b. design shown and use an adequately sized box to house the p.c.b. Starting with the two link wires continue with the resistors and diodes, observing the polarity of the latter.

Next, fit the transistors, capacitors (again watch the polarity), i.c. socket, relay and connector block SK1. Do not insert the timer i.c. into its socket until you have completed the board construction and double-checked the p.c.b. for any errors.

Once you are satisfied everything checks out correctly, the unit can be bench tested.

TESTING

Begin testing by first adjusting preset VR1 to its mid position and then connect a +12V and 0V supply to the respective pins in the connecting block SK1, whereby the current consumption of the unit should be about 23mA. The unit should remain off, i.e. the relay contacts should not have switched over. Next, connect the ignition and check for a current consumption of 23mA approximately.

With the ignition still connected, apply +12V to both the MB and DB connecting points on SK1, thus simulating the switching of the lighting circuits within the vehicle. Nothing should have happened yet! Next remove the ignition supply and then re-apply +12V to either of the MB or DB connections observing the status of the relay contacts, which should switch over and latch on for about 15 seconds.

When both "beams" have been tested, re-apply the ignition connection with the relay latched and listen for it dropping out, in other the words the unit has been reset.

Testing is now complete, so finally adjust preset VR1 for the desired timing period and then apply a good coat or two of p.c.b. lacquer to the board in readiness for the harsh environment it will be exposed to in the vehicle.

WIRING IN THE UNIT

The schematic wiring diagram of Fig.3 shows a typical layout for an external lighting circuit in a negative earth vehicle.

As can be seen, relays are used to switch the Dipped and Main beam lights within the vehicle, due to the relatively high currents generated at switching on, which the vehicle's interior switch cannot

handle. Basically, the unit is wired in parallel with the vehicle's own Dipped beam switch and therefore does not interfere with its action.

Before beginning to fit the unit to the vehicle you MUST disconnect the battery to prevent any accidental damage during fitting to both the unit and the vehicle wiring.

As always, a good "chassis" earth point should be located and used. An existing earth point can be regarded as ideal, otherwise create your own and check it with a meter for continuity with the chassis. You should be able to make the other connections inside the vehicle behind the steering wheel cowling. For example, the Main beam and Dipped beam supplies can be found at the light switch and the permanent and ignition supplies taken off the actual ignition switch itself.

Whilst continuing to make a good sound job, it is best to solder all connections, and this may mean cutting cables but it is, nevertheless, the best way to connect up. Complete all connections with heat shrink sleeving or a good wrapping of insulation tape.

Upon completion and prior to re-fitting any interior panels, re-connect the vehicle battery, fit the in-line fuse into its holder and then go through the procedures for activating and deactivating the unit ensuring everything works OK. Once satisfied, secure both the unit and wiring in place

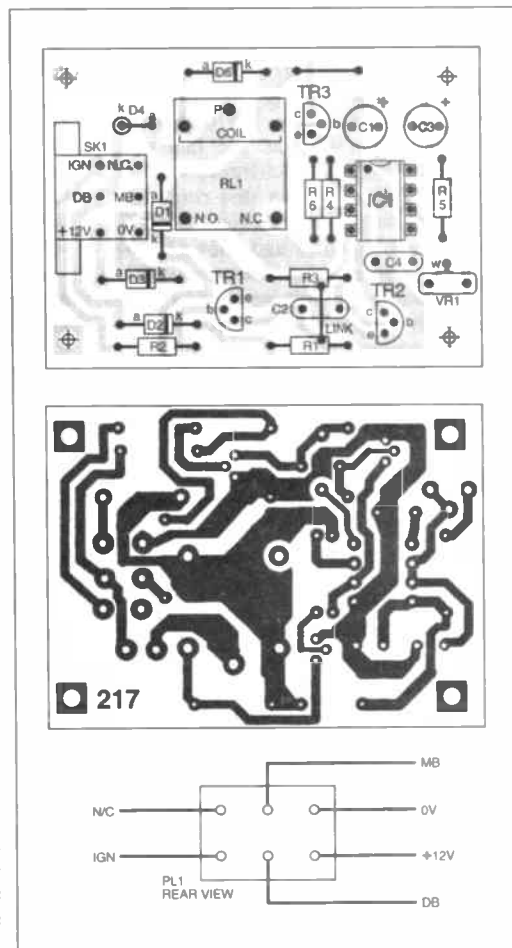

Fig.2. Printed circuit board component layout, copper foil master and wiring to rear of header plug.

behind the dashboard masking all the wiring with black insulation tape to give that professional finish, then re-fit any interior trims that have been removed.

CONCLUSION

Once fitted the Alternative Courtesy Light Controller should require no servicing and remain completely self-contained, giving you a very useful luxurious add-on for which even some top specification cars cannot boast to have fitted.

Finally, remember that it is illegal to leave headlights switched on when a vehicle is parked on a public highway.

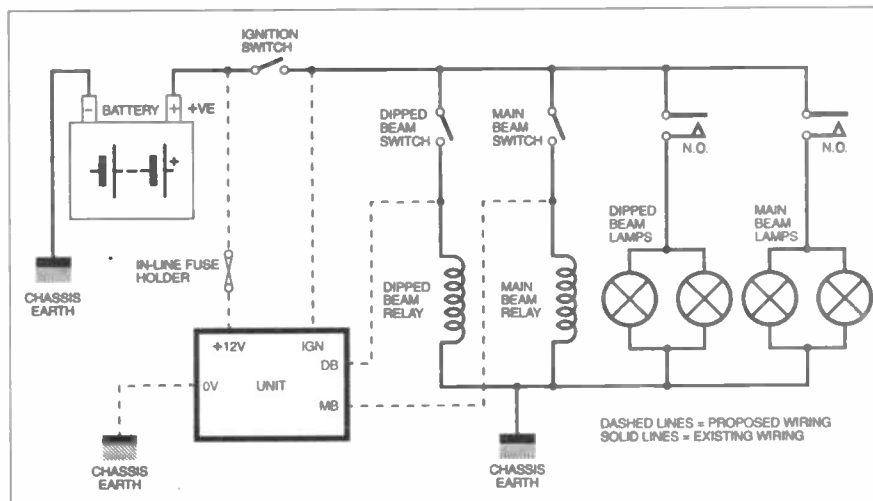

Fig.3. Schematic wiring diagram for wiring the unit into the vehicle.

IS IT iMACULATE?

Apple is bouncing back with iMac, the “revolutionary new Internet computer” – Barry Fox shares his reactions to it.

LIKE early Amstrad PCs, the iMac integrates the screen and electronics into a single casing, which connects by cable to a keyboard and mouse. The casing is made of translucent coloured plastics, which gives the unit a toy-like look. But the specification is no toy, a 4GB hard disk, with 32MB of RAM. The price makes it no toy either, £999 – which is on a par with a high spec Pentium PC, often now bundled with a free printer or scanner.

The iMac package is much more basic. There is no floppy disk drive, just a rather flimsy CD-ROM drive with very awkward disk click retainers. The mouse and keyboard, also of translucent plastic, have a budget feel. The iMac has no serial or parallel ports, only the latest USB (Universal Serial Bus). So most existing printers and other peripherals will not plug in.

Apple says that Epson and Hewlett-Packard will be making USB printers, and a smart cable that connects existing serial/parallel peripherals to a USB port. Imation (formerly 3M) will be making an add-on floppy disk drive. But Apple is very reluctant to quote prices or availability, saying only that the printers should sell for the European equivalent of around \$350 and the floppy drive for around \$150, with the smart cable costing between \$60 and \$70.

The clear message is that customers should insist on a full working package, not buy the iMac and then have to hunt for matching peripherals at whatever price the manufacturers ask.

There are no expansion slots but the RAM is upgradeable to 128MB. Nick Graves, Apple's European Marketing Manager, says he has “not a clue” how much additional RAM will cost. Graves says the 233MHz power PC matches the performance of a Pentium 400MHz.

Lack of a floppy drive makes it more awkward to transport data from home to office or school. The user must rely on the built-in modem to send files via the Internet. Nick Graves says the iMac is assembled in Cork, but the pre-production sample tested was labelled Korean. It was also very slow to start up, taking 90 seconds from switch-on. This, says Graves, may be because pre-release versions had some BIOS software on the hard disk, rather than in ROM. Once booted, however, the iMac can be put to sleep and re-awoken quickly at the touch of a single button on the keyboard.

L.C.D. JUBILEE, PLUS IrDA CONTROL

Wireless simultaneous command and control for PCs and peripherals

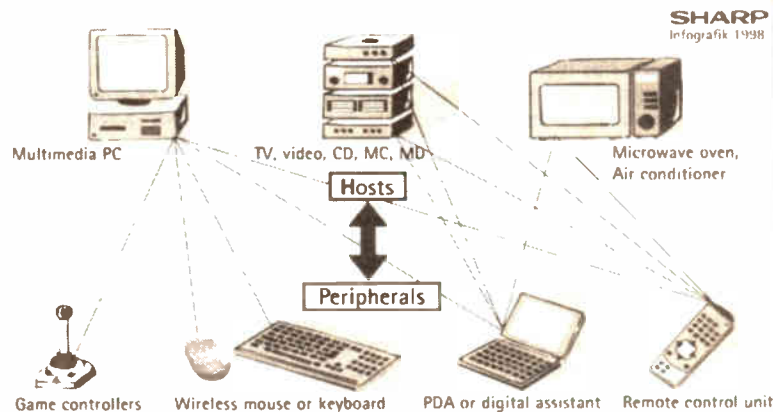

Wireless solution for PC peripherals and home appliances

AMAZING, the l.c.d. is celebrating its Silver Jubilee – it is 25 years since Sharp manufactured the world's first pocket calculator with a liquid crystal display, and triggered a wave of innovation, the end of which is not yet in sight.

As Sharp point out, l.c.d.s have become a key technology, without which many products would be unimaginable. “The l.c.d. has become a universal user interface”, says Martin Beckmann, press spokesman for Sharp Electronics (Europe). “For this reason we are focussing a large part of our worldwide research work on the further development of this technology.”

Sharp's researchers are already hard at work in a bid to realise their vision of a paper-thin computer. They have already presented the so-called SGS technology, which makes it possible to integrate switching circuits contained in a wafer thin layer on the glass of an l.c.d. They expect to expand the technique to make a fully functional display computer. The vision is then of a foldable computer, a type of electronic paper for the next century.

Recently (Munich Nov '98), the company also demonstrated new bi-directional infra-red command and control units that will allow the simultaneous wireless linking of several devices. Main applications for the IrDA Control Transceivers are PCs and their peripherals, audio, video and broadcasting products, home electronics and the vast area of mobile devices.

SYNTHESISER A-Z

THE A-Z of Analogue Synthesisers revised edition has just been published, Part One: A-M has been received in our office. Peter Forrest is the originator of the entire work, including text, photos (it's well illustrated), graphics and design.

Many of you may well be familiar with the earlier edition (1994) which came to be acclaimed as the “bible” of classic keyboards and synthesisers. The latest edition is greatly expanded and thoroughly revised. The aim of the work is to present a complete rundown of all the major analogue synthesisers and keyboards ever made. Judging by the 320 pages of the A-M volume it appears to have achieved its aim.

To our pleasure we see that even Doug Shaw's PE Minisonic is mentioned, a design which Practical Elec-

tronics published in 1974-75. All EPE editorial staff were associated with it, and remember it well! That was in the days when such things were well within the capabilities of hobbyists – before commercial manufacturers became deeply involved, offering ready-made synths that could do far more with their custom designed chips than any hobbyist could achieve from the common-place components on retail sale.

The book's ISBN is 0 9524377 2 4, it may be ordered through your local bookstore or direct from the publisher (£16 incl UK P&P): Susurreal, Dept EPE, Star House, Sandford, Crediton, Devon EX17 4LR. Tel: 01363 774627. Fax: 01363 777872. E-mail: pforrest@mail.eclipse.co.uk.

DIAMONDS ARE FOR LONGER

Barry Fox reveals that diamonds are being used to increase video tape recording times.

JAPANESE company Matsushita is using a new kind of magnetic tape, one tenth the thickness of a human hair, to let a pocket camcorder record broadcast quality video and sound for two hours without stopping. The tape, to be sold under the Panasonic brand name, is coated with pure cobalt metal, deposited by evaporation at high temperature in a vacuum, and strengthened by diamond-like material. The same tape can be used to increase the capacity of tapes used to backup data from a PC.

Matsushita, along with rivals Sony and TDK, have been developing ME tape for twenty years, but it has been an expensive technological curiosity. The main advantage is that the material is very thin, so that more tape can be stored in a small cassette. But this makes it inefficient at recording analogue signals which require a thick magnetic layer to capture low frequencies.

The latest consumer video format, called Digital Video Cassette, records both sound and vision as high frequency digital code. This code can be faithfully captured in a very thin magnetic coating. Eight of ten camcorders now sold in Japan use the DVC format, with cassettes smaller than a matchbox. Matsushita thinks that their owners will pay a premium to increase the maximum recording time from a DV cassette from 80 minutes to 120 minutes.

ME tape is made by leading a roll of clear polyethylene naphthalate plastics, around 60cm wide, through a chamber which contains a vacuum similar to

outer space. The film passes over a crucible in which cobalt metal is heated by an electron beam to 2000°C and vaporised. The vapour settles on the film as it clings to a moving drum which is cooled to 0°C. This lets the cobalt bond to the film as a smooth coating, like a mirror surface, without melting the plastics.

A layer of carbon is then deposited in a similar manner to create a reinforcing layer of diamond-like material over the cobalt. Finally a layer of fluorine-based lubricant is deposited on top of the diamond to help the tape move smoothly through a video recorder. The tape is then slit into 6.35mm strips and loaded into standard DV cassettes.

Previous ME tapes have needed a 7-micrometre base film to withstand the strain of travelling through a video recorder, without stretching or breaking. This has limited the maximum tape length in the cassette, and the recording time to 80 minutes. With the diamond backing Matsushita can make do with 4.8 micrometres, to create tape which is only 5.5 micrometres thick. This lets one tiny DV cassette store enough tape to run non-stop for 120 minutes.

Matsushita estimates that the new tape will cost around twice the price of conventional DV tape. The first cassettes will soon go on sale in Japan.

When used to store computer data, the same cassette has a capacity of 22 Gigabytes. More likely, however, ME tape will be loaded into standard computer industry cartridges to increase their storage capacity several times over.

PIC ROAD STUDS

ASTUCIA'S Intelligent Road Stud is reported in a recent issue of *Microchip World* as being the first serious alternative to reflective road markers (cat's eyes). Conceived in 1992, the basic idea was to provide a cost-effective light that would mark the road ahead regardless of weather conditions and did not rely on car's headlamps to illuminate it.

Variations on the basic idea could change colour, flash or provide warning of impending danger ahead, even creating a trail of lights behind a car as it passes the studs, giving real-time information to following vehicles about the distance they are behind the vehicle ahead. Another idea was for an ice-warning version, changing the lighting colour to blue when ice was detected.

Astucia now have a variety of intelligent road studs to suit the different needs of various countries. PIC microcontrollers were chosen as the controlling devices. Ultra high intensity l.e.d.s are used as the light source and solar panels recharge the nickel metal hydride cells that power them.

The studs are used at the Channel Tunnel terminals to control traffic flow. They are expected to be placed at various black spots around Britain as well as in other countries. Other applications include roundabout control, aircraft taxi way control, police use and road toll monitoring.

For more information contact Astucia (UK) Ltd, Unit 2 Canalside Works, Leverton Road, Retford, Notts DN22 6QF. Tel: 01777 702658. Fax: 01777 703127.

Web: www.astucia.co.uk.

Arizona Microchip Technology Ltd are at 505 Eskdale Road, Winnersh Triangle, Wokingham, Berks RG41 5TU. Tel: 0118 921 5800. Fax: 0118 921 5820. Web: www.microchip.com.

MAPLIN SA

WOW, Maplin are continuing to expand their range of shops – into Africa now, South Africa to be more precise. The new store (Maplin's 50th) is located at 7a Prime Park, Tienne Meyer, Bellville, near Cape Town (tel: 021 949 1999). It offers an impressive 37,000 strong product range to choose from, both at the store and in the Maplin catalogue.

The new store aims to provide local shoppers with an accessible range of electronic products, coupled with enthusiastic and highly trained staff who will be on hand to give advice.

For more (UK) information, contact Maplin Electronics, PO Box 777, Rayleigh, Essex SS6 8LU. Tel: 01702 554000. Fax: 01702 554001. Web: www.maplin.co.uk.

UK SUCCESS STORY



ARCAM, the renowned British manufacturer of audio equipment, has achieved two notable awards for one of its hi-fi products. The Arcam Alpha 10 Hi-Fi Amplifier has received the Millennium Award by the Design Council. The award is made to "outstanding Best of British products". Arcam's intention with the Alpha 10 was to design an amplifier

sited to the 21st Century and which can be upgraded as new technologies and user requirements emerge. It's good hear of such philosophies in this day of "built-in obsolescence".

The Alpha 10 has also won the EISA award and was voted by 40 European magazines as the European Amplifier of the Year 1998-99. The EISA (European Imaging & Sound Association) Award is intensely competitive and extremely prestigious (the electronics industry Car of the Year!). The award is a striking endorsement of Arcam's future-proof design.

For more information about Arcam's superb products, contact A&R Cambridge Ltd., Dept EPE, Pembroke Avenue, Denny Industrial Centre, Waterbeach, Cambs CB5 9PB. Tel: 01223 203200. Fax: 01223 863384.

E-mail: custserv@arcam.co.uk. Web: www.arcam.co.uk.



THE QUICKROUTE

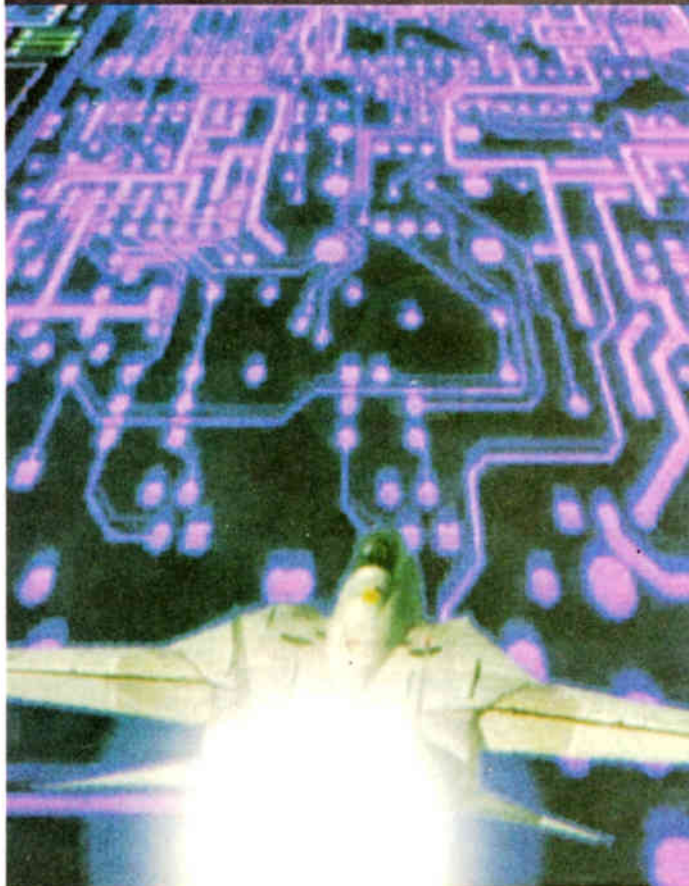

Simulation Circuit Capture PCB Autorouting CAD/CAM

Imagine an electronics design system that lets you draw schematics onto the screen and then simulate them at the touch of a button. Now imagine pressing another button and seeing the schematic replaced with a PCB rats-nest. Pressing another button starts the autorouter, and finally you can click on File then Save As to create a complete set of CAD/CAM files.

Too easy? We hope so. Quickroute has always been designed first and foremost to be easy to use. That's why simulation, circuit capture, PCB autorouting and CAD/CAM support are all integrated into **one** package. So that you only have to learn **one** package.

But it doesn't end there. We have included a wide range of features in Quickroute to help you work effectively. For example our Gerber import facility lets you check your CAD/CAM files before sending them to your manufacturer.

We have also introduced a major new **PLUGIN** module called the SymbolWizard that actually creates custom symbol designs for you. Simply select a template, specify pad and spacing properties and SymbolWizard creates the schematic and PCB symbols for you!

If you would like to find out more about Quickroute, why not call us on **FREEphone** 0800 731 28 24, or visit our web site on www.quickroute.co.uk. Prices start at under £100 including UK P&P and VAT for a complete system.

**"modern, powerful
and easy to use"**

Elektor Electronics 97



FREEphone

0800 731 28 24

Int +44 161 476 0202 Fax 0161 476 0505
Web www.quickroute.co.uk

30 DAY MONEY BACK GUARANTEE



Electronics Principles 5.0

If you are looking for an easy and enjoyable way of studying or improving your knowledge of electronics then this is the software for you.

By Clive W. Humphris.

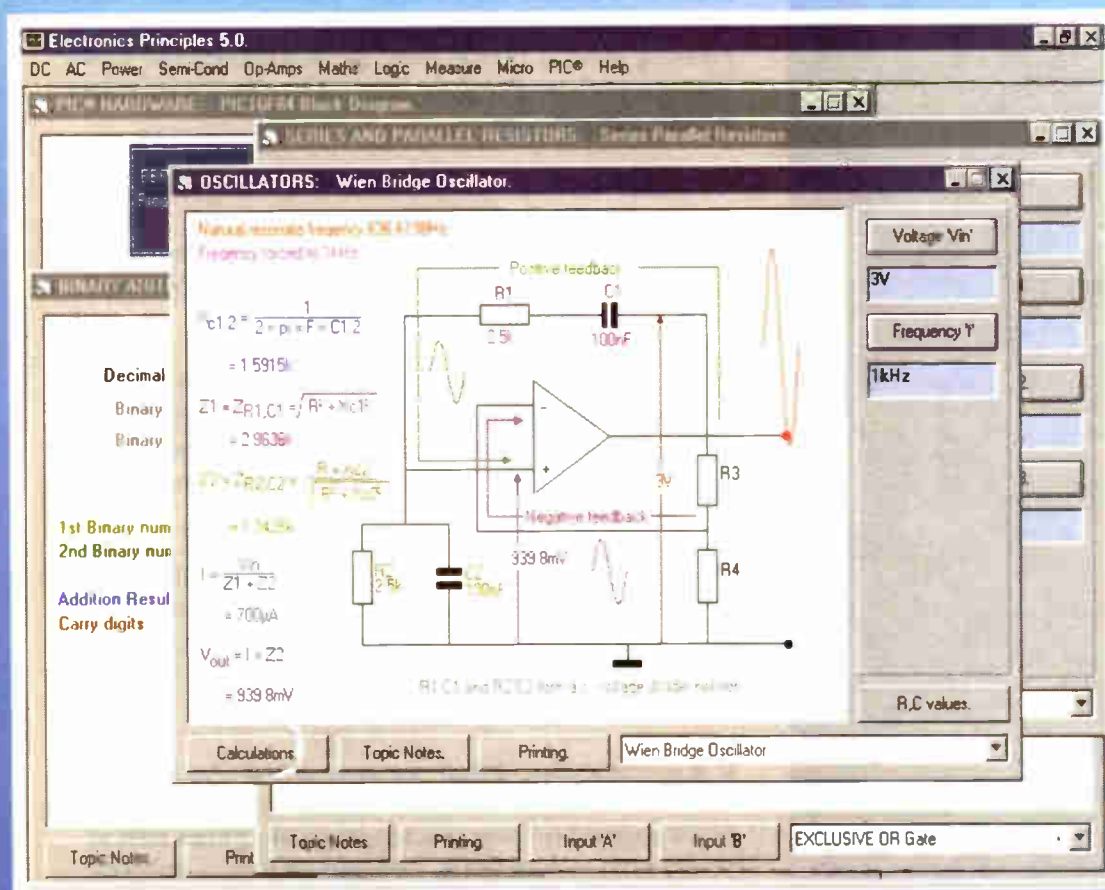

"One rather good program that I've found in Electronics Principles. The range of electronics covered is very wide, from simple atomic structure to the workings of the latest microcontrollers."

I was very impressed ... It ran smoothly and without problems on several IBM PCs."

Tex Swann, Technical Projects Sub Editor, Practical Wireless magazine June 1998.

"Electronics Principles is a well thought out and comprehensive program that is also easy to install and stable in operation. It can be wholeheartedly recommended."
Robert Penfold, Everyday Practical Electronics magazine, October 1998.

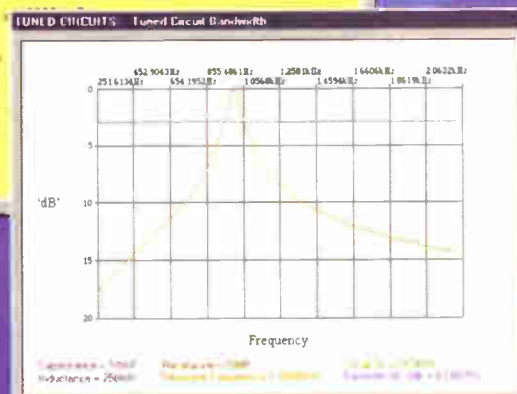
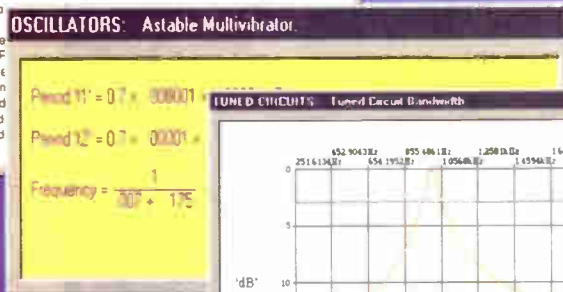
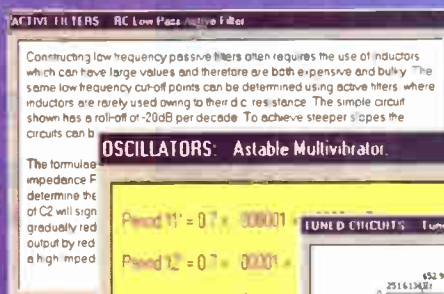

Electronics Principles 5.0 £99.95*
multi-user Site Licence £495.95*

Windows 3.1, 3.11, NT, '95 & '98
Please state CD-ROM or disks.

EPT Educational Software, Pump House, Lockram Lane, Witham, Essex, UK, CM8 2BJ.
Tel/Fax: 01376 514008. sales@eptsoft.demon.co.uk <http://www.eptsoft.demon.co.uk>

*UK and EC countries add £2 per order for post & packing. VAT should be added to the total.

Outside Europe £3.50 for air mail postage by return.

Switch, Delta, Visa and Mastercard orders accepted - please give card number and expiry date.
Cheques & Postal Orders should be made payable to EPT Educational software.

New Technology Update

Ingenious reverse engineering techniques could allow better reclamation of obsolete electronic assemblies. Ian Poole reports.

GREEN issues are becoming increasingly important. There are naturally the issues of reducing the amount of greenhouse and other toxic gasses into the atmosphere. One area that has been of particular importance to the electronics industry is that of cleaning fluids to remove the flux from printed circuit boards after soldering. Now many new methods of cleaning have been developed, thereby reducing the pollution to the atmosphere.

However, there are many other areas that need to be addressed to ensure that the overall level of the pollution of our planet is kept to a minimum. The amount of electronic equipment that is manufactured today is vast. Yet very little of it is recycled. One of the main reasons for this is the huge cost of disassembly and this has meant that many products containing valuable components have had to be used as landfill or crushed so that some of the more valuable raw materials can be reused.

In many countries now there are requirements to increase the amount of electronics equipment being recycled. In several countries legislation is about to hit the statute books that will require companies producing the equipment to take it back for recycling. In other countries other schemes are either in operation or are about to be launched.

Whatever approach is adopted in each country, though, the overall effect is that the amount of electronics equipment reaching landfill sites will be reduced, and the amount being recycled will have to increase. This will require new technologies to be developed that will enable the recycling process to be achieved far more easily and cost effectively.

Different materials

To help solve the problem, the Cleaner Electronics Group at Brunel University has exploited the properties of a group of metal alloys known as shape memory alloys (SMA). In a system called Active Disassembly using Smart Materials (ADSM), electronic equipment could be made of materials that would actively disassemble themselves once they were subjected to temperatures at a given level. In this way the cost of disassembly could be significantly cut, making recycling far more cost effective.

The idea revolves around the fact that certain metal alloys can be made into a particular shape by heating them, typically to a temperature around 400°C, and then rapidly cooling them. The part can then only resume its original shape if it is reheated. The temperature at which this occurs is somewhat less than the temperature required in the original manufacture of the

part, and may range between about 60°C and 120°C.

Two main SMAs were used in these investigations. The first was Nickel Titanium (NiTi), and the second was Copper-Zinc-Aluminium (CuZnAl). These operated in slightly different ways, but the end results were the same.

Whilst the metal alloys are the most widely used materials, a group of polymers also exhibits the same properties, and these may provide a cheaper and more convenient solution for the longer term.

If these materials are used in the manufacture of fasteners and clips, it is possible to pass the equipment through a heat treatment process, often using steam. Once this happens, the fasteners will let go and spring actuators can be used to push apart the components of the product. In this way the major part of disassembly is for the components to be picked out of the equipment and sorted and sent for re-use.

As different materials have different temperatures at which they return to their original shape, it is being proposed that fasteners could be made with different temperatures so that a unit could be successively disassembled.

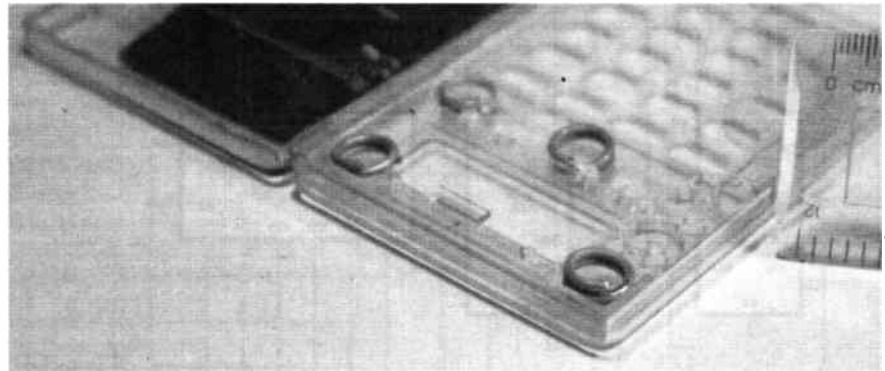

Temperature sensitive fasteners allow rapid equipment disassembly for reclamation of reusable parts.

Design

If a system of this nature were employed, then disassembly would become an integral part of the design process. During a typical disassembly process the case would separate from the main electronics assemblies early in the cycle. Then board-level assemblies would be freed. Connectors freeing themselves as well as individual components would follow this. At the end of the process the individual components would be left and they could be easily sorted for reclamation or re-use.

One problem might occur with components that can be damaged by heat. Liquid crystals are one example of this. These assemblies could be freed and reclaimed at an early stage in the process.

Trials

A number of trials have been undertaken, both on the components made out of the smart materials, and on equipment made using the smart fasteners and actuators. These trials proved to be enormously helpful. They highlighted the ways in which the fasteners and actuators should be used, along with suitable locations for them. Further tests proved that the sequential disassembly of products in this manner is feasible.

It was also shown that this approach is possible on a commercial basis. Until recently, the cost of disassembly was exceedingly high. The majority of this was taken up by the manual nature of disassembly. Owing to the fact that products were not designed to be disassembled, it was difficult and time consuming to salvage any components. In addition to this, many components were destroyed in the process. As a result, it was only viable to salvage a few high cost items or metals and leave any others, consigning them to landfill sites.

Using the new system, the labour content of disassembly is vastly reduced. In

turn, this reduces the cost of disassembly to a level where it is viable to reclaim a very large number of the components.

Naturally there would be a cost associated with the use of the system, but with some countries introducing penalties if products are not recyclable, this would almost certainly provide a cheaper option, apart from the advantages in being able to reduce pollution. In addition to this, much of the increased cost of using the new system could be recouped by the re-use of the components.

More information can be found via E-mail:

Joseph Chiodo at joseph.chiodo@brunel.ac.uk or (Web) <http://www.brunel.ac.uk:8080/~dtsrjdc/ADSM.html>, where Joseph Chiodo and Prof. E.H. Billett are carrying out the research.

TWINKLE TWINKLE REACTION GAME

JOHN KOUSSHAPPAS

Call the tune with this novel audio/visual reaction timer.

THIS SIMPLE game plays the Twinkle Twinkle Little Star tune, or another melody of your choice, for as long as the player can press the button corresponding to the currently lit l.e.d.s. The light emitting diodes (l.e.d.s) turn on one at a time in a random order and change at a frequency of just over 1Hz.

Alternatively, you can arrange the sequence so that the tune will play if the incorrect buttons are pressed.

CIRCUIT DESCRIPTION

The full circuit diagram for the Twinkle Twinkle Reaction Game is shown in Fig.1. IC1 is a 555 timer set up as a low frequency astable multivibrator. This controls

the speed at which the l.e.d.s change their "random" stationary position.

Another 555 timer, IC2, is set up as a high frequency astable. It is gated by the output of IC1, with IC1's output controlling the Reset line (pin 4) of IC2. However, in order to do this, IC1's output must be inverted first, hence transistor TR1 is used, set up as an inverter. This is because the Reset line on a 555 timer is active low.

The output from IC2 at pin 3 feeds the Clock input of IC3 (pin 14), a 4017 divider/decoder. This chip has ten outputs, one of which switches on for each successive clock pulse with only one output on at a time. However, in this circuit, only the first six outputs (Q0 to Q5) are used. Each

of the used outputs has an l.e.d. connected to it. These form the display.

Also connected to the six outputs are six pushbutton switches, S1 to S6. The outputs of these switches feed a resistor/capacitor circuit, R9, R10 and C4. The best way to describe how this works is to use the analogy of trying to fill a bucket with a small hole in it. If you turn the tap on, you will fill it. Turn the tap off and eventually the bucket will empty.

The quantity here is the voltage across capacitor, C4. When the correct button is pressed, the capacitor is quickly charged. If the wrong buttons are pressed continuously, or no buttons are pressed, the capacitor will eventually discharge. The voltage across this capacitor, when it is above a preset level, switches on the following circuit and thus allows the tune to be played.

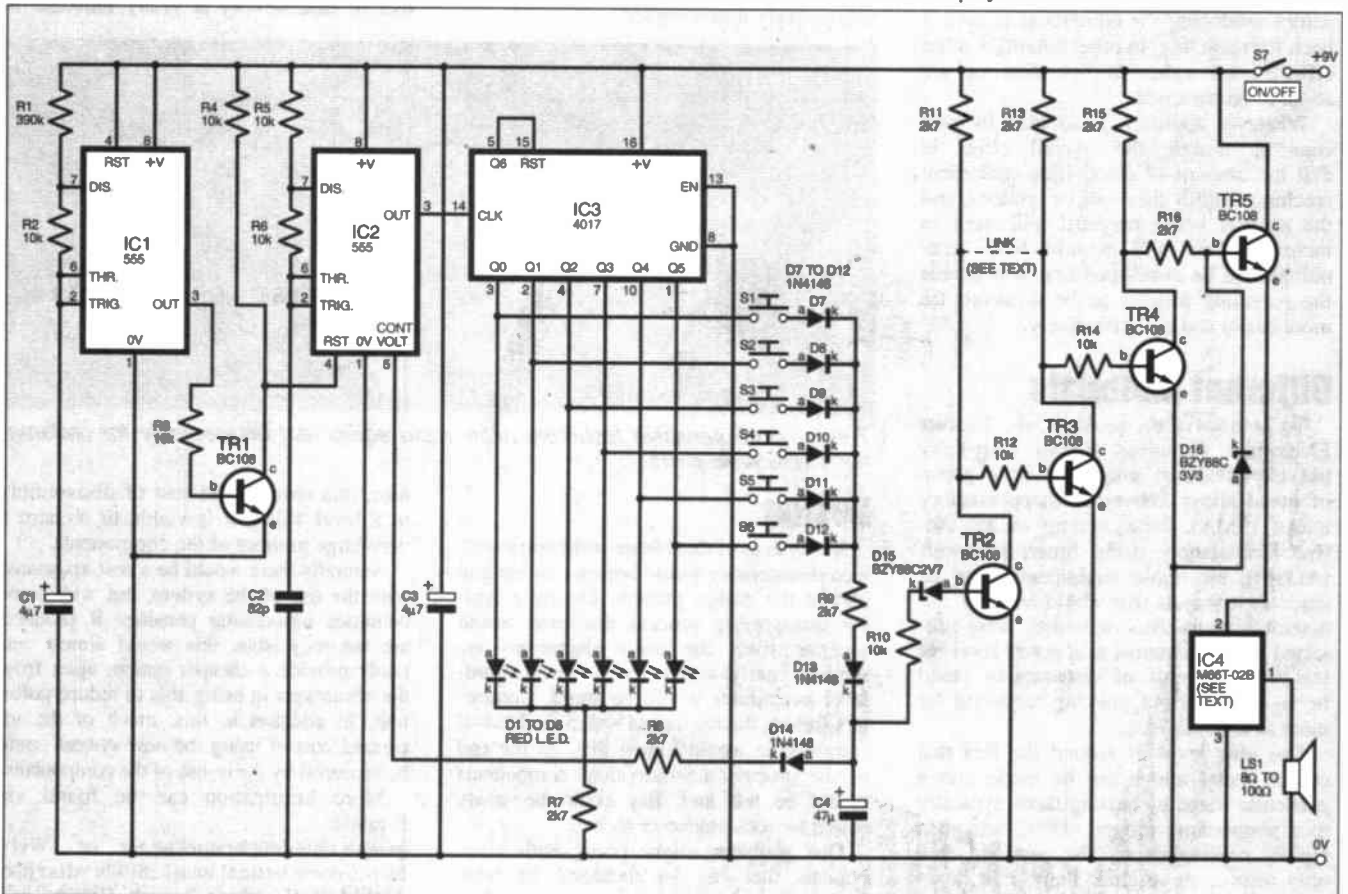

Fig.1. Complete circuit diagram for the Twinkle Twinkle Reaction Game. Transistor TR3 and resistors R12 and R13 are optional - see text.

This preset level is determined by the Zener diode D15 and the base-emitter voltage of transistor TR2. The Zener's voltage is 2.7V and the base-emitter's voltage is 0.6V. Thus, the preset voltage level across capacitor C4 must be greater than 3.3V in order to switch on TR2. This transistor acts as an inverter, as do transistors TR3 (when used) and TR4.

When TR4 is off, its collector (c) voltage is "high" and will actually be about 6V and the voltage across the second Zener diode, D16, will be 3.3 volts. When TR4 is on, this short-circuits the Zener, making its voltage 0V.

OUTPUT DRIVER

Transistor TR5 is used as a driver transistor, and powers the special tune generator IC4 with a controlled voltage of 2.7V. This is necessary as the tune generator chip only works at voltages between 2.5V and 3V.

The voltage across capacitor C4 also connects, via resistor R8 and steering diode D14, to the Control Voltage pin (5) of IC2 and provides a random voltage element which changes the frequency of that astable. This makes the light sequence of the l.e.d.s truly random.

Table 1: Choice of Melody

Tune	Type (IC4)
Twinkle Twinkle Little Star	M66T-02B
Old McDonald Had a Farm	M66T-36
I'd Like To Teach The World To Sing	M66T-205
White Christmas	M66T-214
Warning Tone	M66T-215

PLAY TIME

Transistor TR3, resistors R12 and R13 form an inverter which inverts the output function from playing the tune when the correct sequence of buttons is pressed to playing the tune when an incorrect sequence is pressed (or no buttons are pressed). These components are therefore optional for this purpose.

The dashed link in the circuit diagram is made as a fine copper track on the printed circuit board (p.c.b.), therefore, if the inverting function is required, this link must be removed, by cutting the track with a knife. Therefore, if the normal function is required, simply leave out TR3, R12 and R13. If the inverting function is required, break the track link, and fit TR3, R12 and R13.

POWER CONSUMPTION

Current drain from a PP3 battery is under 20mA. A cheap PP3 battery will thus give approximately 6 to 10 hours of continuous operation of the unit. In casual use, Twinkle Twinkle can be used for several weeks before a battery change is required.

CONSTRUCTION

The Twinkle Twinkle Game is built on a small single-sided printed circuit board (p.c.b.). The topside component layout and underside copper foil master pattern are shown in Fig.2.



COMPONENTS

Resistors

R1	390k
R2 to R6	
R10, *R12	
R14	10k (8 off)
R7 to R9,	
R11, *R13,	
R15, R16	2k7 (7 off)

All 0.25W 5% carbon film.

*Optional - see text

See
SHOP
TALK
Page

Capacitors

C1, C3	4µ7 sub-min. radial elect. 10V (2 off)
C2	82p ceramic
C4	47µ sub-min. radial elect. 10V

Semiconductors

D1 to D6	5mm red or green l.e.d. (6 off)
D7 to D14	1N4148 signal diode (8 off)
D15	BZY88C2V7 2.7V Zener diode
D16	BZY88C3V3 3.3V Zener diode
TR1 to TR5	BC108 npn transistor (5 off) (TR3 optional - see text)
IC1, IC2	LM555 timer (2 off)
IC3	4017B decade counter
IC4	M66T-02B CMOS melody generator (see text)

Miscellaneous

S1 to S6	s.p.s.t. p.c.b. mounting pushswitch (push-to-make) with round red tops (6 off)
S7	s.p.s.t. sub-min. slide switch
LS1	8 ohm to 100 ohm min. loudspeaker

Printed circuit board available from the EPE PCB Service, code 210; plastic ABS box (MB3), size 118mm x 98mm x 45mm; 9V battery (PP3), with clips; multistrand connecting wire; M3 40mm long bolts (4 off); M3 nuts (12 off); M3 washers (4 off); self-adhesive rubber feet (4 off); solder etc.

Approx Cost
Guidance Only

£25

This board is available from the *EPE PCB Service*, code 210.

Begin construction by fitting the resistors. Be careful with the diodes as the 1N4148 and the Zener types can be easily confused. Read the writing on the components with a magnifying glass if necessary.

One or two capacitors may need to be fitted on the underside of the p.c.b. if they are too big to fit on the top side. Sub-miniature capacitors will fit on the top-side but older, larger types, particularly for the 47 μ F capacitor may not fit on the topside. The key dimension to look out for is the height of the component, in fact, for any of the components, it must be less than the height of the outer rim of the push-button switches when mounted on the p.c.b.

The specified pushbutton switches are polarised, so make sure you put them into the p.c.b. with the flattened side as shown in Fig.2. The l.e.d.s should be mounted to the same height as the tops of the pushswitches so that they will all protrude from the case by the same amount, which will be about 2mm to 3mm.

Finally, solder the transistors and IC4 straight onto the board, as close as possible to being flush with the p.c.b. Construction is completed with the insertion of the three i.c.s in their sockets, observing correct orientation.

BOX PREPARATION

The prototype was built into an MB3 type ABS plastic box, size 79mm x 62mm x 39mm. It just so happens that if the bottom-right of the p.c.b. is located in the bottom-right corner of the case lid, with the bottom edge of the p.c.b. touching the bottom edge of the case lid, all the switches and l.e.d.s will be in the centre of the face of the box when drilled.

To make the drilling easy, simply make two faithful photocopies of the component side (this should be done on a *good* photocopier!) and cut them close to the board border outlines. Taking one of the copies mark through to the other side of the paper the four mounting holes, and tape this (*reverse side*) to the box lid with its bottom-right corner sitting in the bottom-right corner of the box lid, the intended final position of the p.c.b., see photographs. Drill these with a 3mm drill bit.

Having removed the tape and paper from the lid, mark out and drill a small matrix of holes to allow the sound from the loudspeaker to escape. Do this in the middle of the four p.c.b. mounting holes, to match the size of your loudspeaker.

With the other photocopy, before taping it in place, mark out six "X"s from the opposing diagonals of the four pads which show the pushbutton switches' positions. This will show where the centre of the large "button" holes need to be drilled. Similarly, mark the six l.e.d. positions. This copy does not need to be reversed but you should note that it will mount in the box in the *bottom-left* corner. Make absolutely sure of the positions and then tape it in place.

The switch holes were drilled with a 10mm (13/32in.) drill bit and the l.e.d.

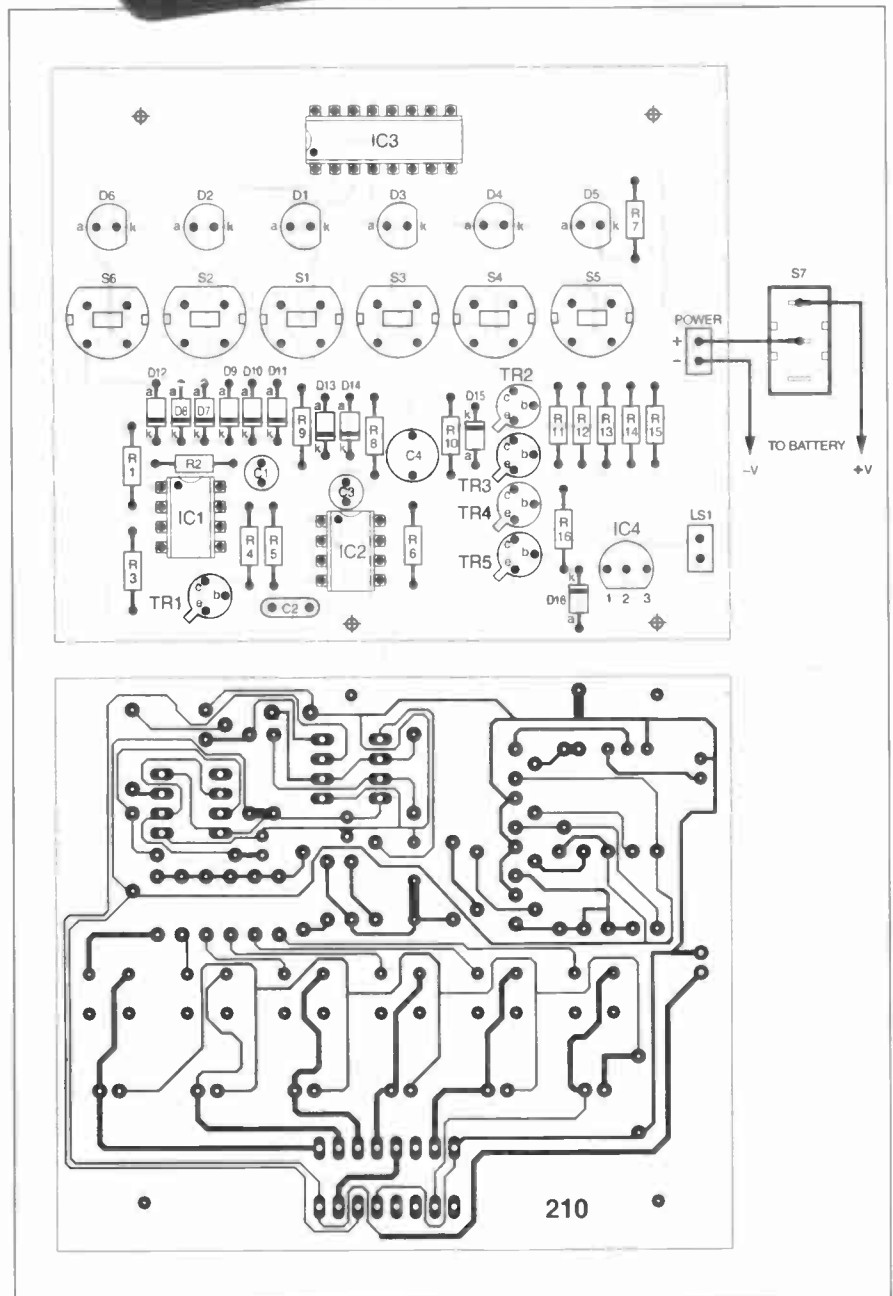
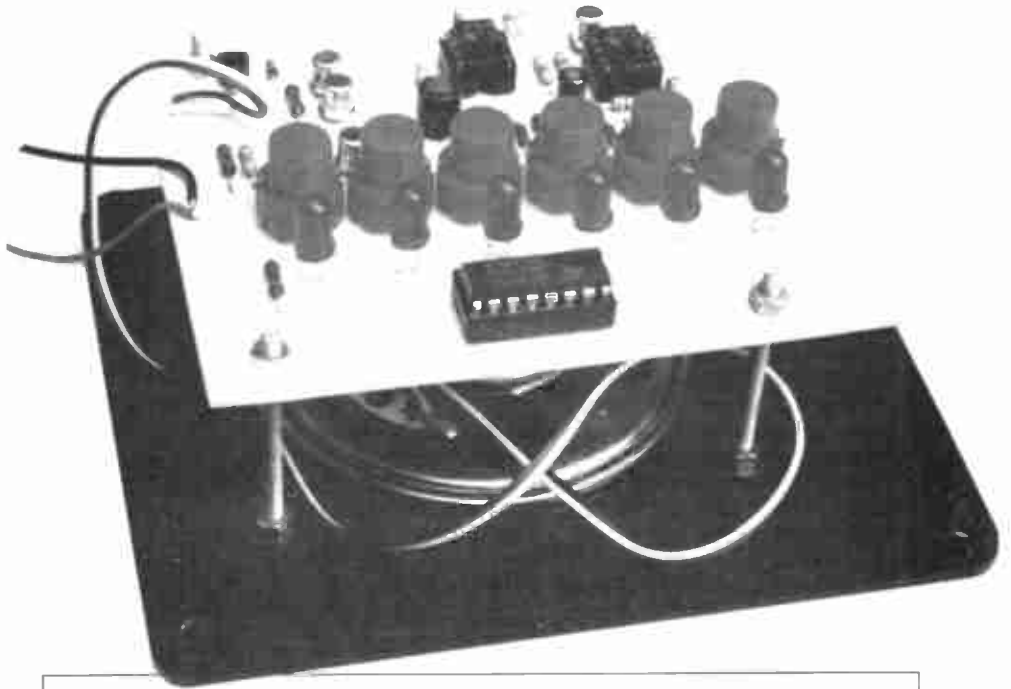

Fig.2. Printed circuit board component layout and full size underside copper foil master for the Twinkle Twinkle Reaction Game.

holes were drilled with a 5.5mm drill bit. A larger drill bit can be used to remove the rough edges which occur when drilling ABS plastic, and to provide a "concave" finish to each of the holes. This is best done by hand-twisting the drill bit.

This is a very effective way of finishing off all holes, both outside the box and inside, giving a neat, professional finish. In the case of l.e.d.s, it can even eliminate the need for grommets or l.e.d. clips.

PLASTIC WELDING

Many constructors will be all too aware of how easily a slip of the soldering iron can lead to a ruined plastic box. The tip of the soldering iron can thus be equally useful in effecting what the author calls *plastic welds*.

First, a few words of warning. The fumes from melting plastic can be quite nasty so, if you are going to carry out this procedure for a prolonged length of time, do it in a well ventilated room and try to avoid breathing in the fumes.

Using some of the plastic swarf which resulted from drilling the holes in the box, melt down three small balls of ABS plastic. Position the loudspeaker in its final mounting position. Take one ball of ABS and melt it onto the side frame of the loudspeaker. Caress it with the tip of the iron, towards, and into, the ABS box lid, gently melting the inside of the lid also, see Fig.3.

Be careful not to punch right through, as that would be the end of your box lid! Also, avoid excessive heat as this will result in a heat-damage warp showing up on the outer surface. A plastic weld takes a good few seconds longer than a solder "weld" to cool so a steady hand is needed.

Having completed one plastic weld, now perform two further welds in a roughly triangular configuration, Fig.3. Your loudspeaker will be held securely. You can, if you wish, mount the On/Off switch using the same plastic welding method.

The use of your soldering iron for welding plastic like this will leave the iron tip in a bit of a mess. Having wiped off as much as possible onto a soldering iron sponge (use the other side of the sponge for plastic!), switch off the iron. When it has cooled down, the tip of the iron can be made good as new by rubbing it down with an abrasive p.c.b. polishing block!

ASSEMBLY

The p.c.b. is secured to the case lid, above the small loudspeaker LS1, by using four 40mm long M3 bolts and 12 M3 nuts. The bolts are threaded through the lid mounting holes and secured by one set of four nuts.

Next, four more nuts (one for each bolt) are screwed onto the bolts, but this time a space of about 32mm should be left between the bottom nuts to allow the p.c.b. to clear the speaker. Now mount the p.c.b. on the mounting bolts and secure the board with the remaining four nuts.

Before tightening up the nuts, adjust the height of the p.c.b. so that the six pushbuttons of the switches protrude from the case by about 2mm. This may

need to be up to 3mm for the round type of switch tops.

The On-Off slide switch, S7, is mounted on the left-hand side of the case, for which a small square profile hole needs to be drilled and filed out with a needle file, to give a neat appearance. Assembly is completed by connecting and wrapping the PP3 battery in some tissue paper and wedging it inbetween the p.c.b. and the case lid. Screw the unit together, and stick four rubber feet to the base. The unit can be finished off with some simple rub-down lettering.

TESTING

The circuit should work reliably first time. If it doesn't, the following may help solve the problem. Test for a square wave output from pin 3 of IC1, which will have a very long mark:space ratio (e.g. 100:1).

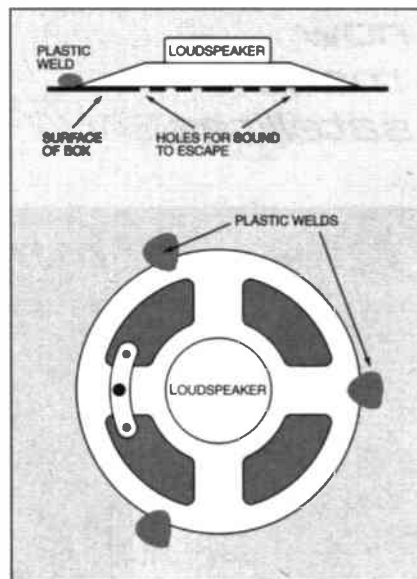

Fig.3. Suggested method of securing the speaker to the lid using "plastic welds".

If it is there, test pin 4 of IC2 which should have a very small mark:space ratio (e.g. 1:100). The frequency is just over 1Hz.

The output from pin 3 of IC2 is a high frequency square wave. If nothing is coming out of pin 3, pull IC2 out of its socket, bend outwards pins 4 and 5 and replace in the socket. If an output appears, re-bend pin 4 back into place and test again. If the output is still there, the fault lies around components D15, R10, R9, D13, D14, C4 or R8, i.e. the voltage feedback circuit to pin 5 of IC2.

If two or more l.e.d.s are on at the same time, one or more of D1 to D6 may have been placed on the p.c.b. the wrong way round.

If the tune fails to play, check that the voltage emerging from the emitter (e) of TR5 is 2.7V when the buttons are pressed correctly and switches to zero, after a small delay, when no buttons are pressed. If this is the case, the fault lies with either the chip having been blown or a faulty loudspeaker. If not, check for the simple inverting action of each of transistors TR2 and TR4.

IN USE

The sound level from the speaker is relatively quiet so you need to be in a

quiet room to hear the tune. Some people have commented that the sound needs to be amplified but if it was any louder it would soon become really annoying and a mute switch would need to be fitted! With such a simple circuit there is a cheat mode. Simply holding down all the switches simultaneously will play the tune continuously.

FURTHER DEVELOPMENTS

Green l.e.d.s or yellow l.e.d.s can be used equally well in this circuit. The brightness of the l.e.d.s is controlled by resistor R7. Reduce the value of R7 to increase the brightness, at the expense of the battery's life.



Bottom and side view of completed unit showing speaker "grille", rubber feet and on/off switch.

The Twinkle Twinkle tune generator chip IC4 is available in four other versions, see Table 1 (earlier). If one of the other tune generators are installed, simply reletter the unit with a new name, e.g. Old MacDonald!

The speed of the lights changing is governed by resistor R1. Reduce its value to increase the speed of the changes; increase in value to reduce the speed of changes.

A simple add-in to allow the use of personal headphones can be easily fitted into the case. Any 3.5mm chassis mounting headphone socket is suitable, wired in parallel with the loudspeaker it will provide an adequate output. If a stereo socket is used, you should connect the left and right channels (known as the tip and the ring) together in parallel.

APPLICATIONS

Although intended to be just a simple toy, Twinkle Twinkle can be a useful medical aid in the rehabilitation of patients who have lost hand-eye coordination and/or suffered muscle motive neurological defects or injuries. □

Acknowledgement

Due acknowledgement is given to Ken Bone, senior p.c.b. technician at Middlesex University, for the production of four excellent prototype p.c.b.s.

FROM RUSSIA WITH LOVE?

BARRY FOX

Russian rockets now launch American made communications satellites.

IT IS an eerie experience to fly by special charter, with military papers, into an area of the old Soviet Union that was never marked on a map, and when finally marked was deliberately shown in the wrong place. It is even eerier to land on a deserted airstrip, the largest in the world, and drive by old bus over bumpy roads, past decaying buildings and deep into the desert wasteland to look at a rocket launch site that was built, not just to put men in space, but to rain destruction on the Western world.

But the spookiest thing of all, is to walk through the rain into a giant, decaying brick building on the outskirts of Moscow and see at least a dozen giant Proton rockets being assembled – not now as Inter-Continental Ballistic Missiles, designed to carry nuclear war-heads, but to earn hard currency for the crippled Russian economy.

But first the background, and some hard facts.

ASTRA

Luxembourg now owns more territory in space than it does on the ground. Astra, the Societe Europeenne des Satellites, launched 1A in December 1988 and made Rupert Murdoch's Sky what it is today. SES has launched eight satellites in the ten years since then; seven at 19 degrees East, broadcasting a mix of analogue and digital signals, with Astra 2A now safely in place at the company's new all-digital slot at 28 East.

Currently Astra transmits direct to 27 million analogue dish households in Europe (four million of them in the UK) and four million digital homes. By 2004, Astra expects the ratio to be 24 million digital: 20 million analogue.

2A is the sixth satellite which SES has bought from Hughes Aerospace in California. It is the first launch into the new slot at 28 East. Hughes started to manufacture satellites for the US Government in the early 1960s. 2A is a high power version of the 601 design, with seven kilowatt power consumption and 15 years expected



Astra 2A launch using a Proton rocket.



lifetime. Each channel is powered by a 98.5 watt travelling wave tube amplifier.

DELAY

2A was originally scheduled for launch in August 1997, but was delayed by late delivery from maker Hughes Aerospace and problems with the Russian rocket programme after one failed when launching Asiasat 3 over Christmas 1997. So earlier this year Astra temporarily moved 1D from 19 East to 28 degrees East so that BSKyB could start a digital service even if Astra 2A could not be launched in time. Astra has also leased the Nordic satellite Sirius 3 for a year to provide backup for 2A until Astra 2B is launched in the third quarter of 1999.

After a successful launch from Russia's Baikonur Cosmodrome at the end of August, 2A was tested in orbit at the end of September, just ahead of Sky's official launch on October 1st. All worked well and in early October Astra started 1D's month-long space drift back to 19 East.

Astra 2A has 32 transponders, four for backup while 28 transmit. By launch time 24 had already been "sold" – 14 of them to BSKyB, the rest to the BBC and other broadcasters. Astra 1D has only 18 transponders with six spares, so 2A was essential for a full Sky Digital launch.

COSMODROME

The Russian Baikonur Cosmodrome was built in June 1955, in a 7,000 square kilometre area of desert leased from the Republic of Kazakhstan by the Russian Government. The sky is clear 300 days of the year. It's close to the Aral Sea, some thousand miles east of Moscow, and is still a closed area.

The nearest air strip is Yubileine ("Anniversary") which was built ten years ago as a landing runway for the Russian shuttle, called Buran. The runway is 87 metres wide, and 4,500 metres long, with a 500 metre emergency extension at each end. This makes it the largest in the world. The project was to have employed 30,000 Russians, with up to 30 launches a year. The shuttle was capable of putting equipment weighing up to 200 metric tonnes into orbit.

"It was like a truck, a military cargo vehicle," says Erik Laursen, Chief Engineer at ILS.

Buran could launch in winds of up to 60 miles per hour, whereas the US shuttle mis-

sions have to be postponed if the wind on the exposed Cape Kennedy site in Florida rise to 16 miles an hour.

Buran only made one flight in 1988. It was un-manned and landed after one orbit. Although the mission was successful, Russia's money for the shuttle project ran out. Russia still has two fully finished shuttles, and three shuttle launchers moth-balled in the hope that one day the shuttle programme can be re-born.

The first artificial earth satellite, Sputnik, was launched from the site on October 4 1957 by the Russian Ministry of Defence. Yuri Gagarin went up from the Cosmodrome in 1961. Baikonur is now run by the Russian Strategic Rocket Forces. In all over 1,100 rockets have been launched from the pads there, accounting for one-fifth of the world's satellites. The remote site houses the world's largest liquified oxygen plant.

ROCKET FACTORY

There are two rival rocket manufacturers in Russia, Khrunichev and RSC (Russian Space Complex) Energia. Both are based in Moscow and, until recently, were secret, closed plants. Both built Inter-Continental Ballistic Missiles (ICBMs) and both have modified their military technology to launch commercial rockets to earn hard currency from the West.

Khrunichev developed the Proton launch vehicle in the early 1960s and the first launch took place in July 1965. Originally a two stage rocket which carried a 150

megaton warhead, Proton was converted to a four stage launcher for satellites. There were also plans to modify it to carry a man to the moon like Apollo 8, but the Russians dropped out of the manned space race. Proton can now lift a satellite weighing over 2,000 kilograms into geostationary orbit. It has flown more than 200 space missions, including the launch of the Salyut and Mir space stations.

The Khrunichev factory can produce at least 15 rockets a year depending on demand. Most use four stages, the first three stages powered by nitrogen tetroxide and dimethyl-hydrazine fuel. The fourth stage, made by Energia, uses liquid oxygen and synthetic kerosene or synthin.

US JOINT VENTURE

In 1993, the Lockheed Corporation of the US, Khrunichev and RSC Energia signed a joint venture deal to use Russian-built Proton rockets to launch commercial satellites from Baikonur. In 1995 Lockheed merged with Martin Marietta, to form Lockheed Martin which now makes the Atlas rockets which launch from the Vandenberg Air Force Base in California and Cape Canaveral in Florida, near the Kennedy Space Centre. The same year the American and Russian companies tied the knot to form ILS, International Launch Services.

Proton was first used for a commercial launch on April 9th 1996, to launch Astra 1F into the 19 East slot. Since then Proton has been used to launch Inmarsat, Telstar,

Iridium, Panamsat and Echostar satellites. It failed when launching Asiasat 3, on December 25, 1997.

Will Trapton Executive Vice President of ILS refuses to break down the cost between satellite, rocket, services, software and insurance but confirms "All contracts are in dollars". Others are more forthcoming. Astra is paying between \$250 and \$300 million for Astra 2A, split between the price of the satellite, the launch and insurance. Significantly all payments are now made in US dollars. The rouble is so unsteady that hotels and businesses in Russia are now all billing in dollars, although sometimes they use the word "unit" instead of "dollar" to save face.

BUREAUCRACY

Russia may be trying to bury Communism, but the old bureaucracy persists. Queuing is a way of life. So is crime.

Compuserve has withdrawn its access numbers in Russia because of fraud. Money changers in the street offer a high rouble rate per dollar, and then off-load counterfeit notes. But the money changers only buy dollars if they were printed after 1993, which is when the US Government started watermarking because of counterfeiting.

Shop staff have no urgency. While three of us browsed goods in a souvenir shop, a saleswoman chatted on the phone until we left.

SES was so concerned about flying its executives, VIP guests and press to the Baikonur launch site, that it insisted on

ASTRA 2A

There is something very special about the Astra 2A satellite. New technology on board could mean it is still working in the year 2025 – outliving Sky's owner Rupert Murdoch.

All satellites need an on-board jet system which fires every day to compensate for the tugs of solar or lunar gravity which continually pull the craft out of its allocated 75km square box in space. Until now all satellites have used chemical jets, usually produced by burning a "bi-propellant" mix of monomethyl hydrazine and nitrogen tetroxide.

When the station-keeping fuel runs out, the satellite wanders out of control, making reception of its signals unreliable. There is also the risk that the craft will bump into another, damaging it.



Artist's impression of Astra 2A in orbit.

So the last few drops of fuel are used to dump the satellite into a graveyard orbit where it sits useless but safe before falling to earth and burning up. Early satellites lasted only a few years. More recent models have a life of seven to ten years.

Hughes Space and Communications of California started looking for an alternative thrust system in the early 1960s, and first tried putting an electrical charge on vapourised caesium or mercury so that it jetted from the craft at high speed. The gasses corroded the jets. In 1984 Hughes engineers found that they could ionise xenon to create as much thrust as a chemical jet. Xenon is inert so causes no corrosion.

The Xenon Ion Propulsion System (XIPS), known as "zips", feeds Xenon gas to a chamber where the gas is electrically charged and ionised. A series of grid electrodes, like those in an old-fashioned vacuum tube valve, are oppositely charged to accelerate the gas into 3000 parallel streams. These streams leave the chamber through a 13cm outlet, at a speed of 30km/second, driving the satellite in the opposite direction.

A neutraliser electrode, mounted outside the jet, produces oppositely charged ions which stop the thrust streams being attracted back to the thruster.

Two angled thrusters operate twice a day for up to 5 hours, drawing 500 watts. Until recently this drained power from the transmitters. However, recent developments in gallium arsenide technology now let the solar panels deliver up to 10 kilowatts, which is enough to drive the thrusters and power the transmitters.

The Xenon is 90 per cent lighter than the equivalent bi-prop fuel, so the satellite can carry more and work for up to 15 years. XIPS was first built into a PanAmsat communications satellite launched last year and is now used on board Astra 2A. Astra asked Hughes also to include a full bi-propellant system, with control software that lets engineers at Astra's control centre in Luxembourg switch at will between XIPS and bi-prop. This provides full redundancy if one system fails. If both systems work as intended, 2A's working life will be at least 25 years instead of the guaranteed 15.

"This has a mixed meaning for us," admits Hal McDonnell of Hughes. His job is to sell satellites to broadcasters and so far they have needed a new one every decade at least.

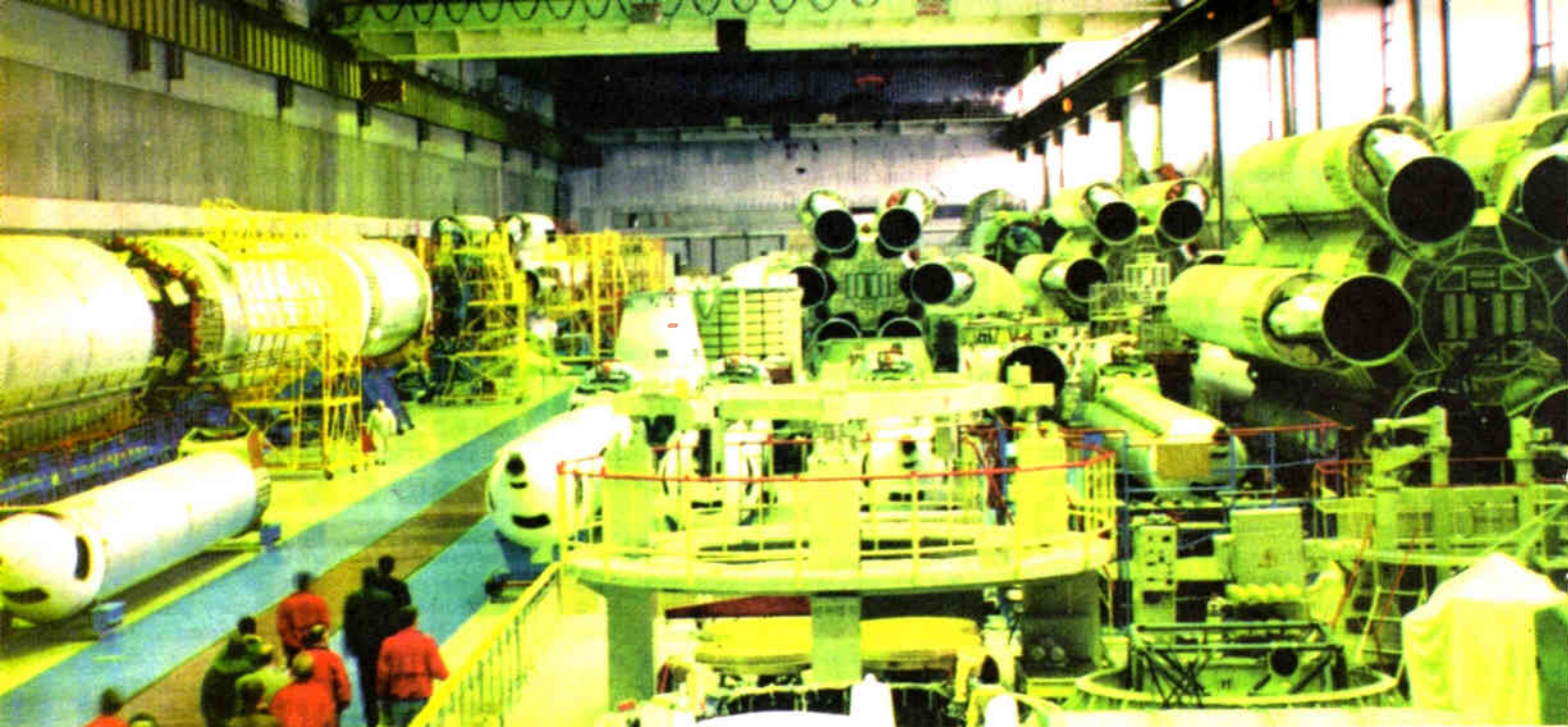

Inside the Khrunichev factory where a dozen or so Proton rockets are being built.

having the charter aircraft serviced in Germany, and checking the full service record.

The Russian military have a rigid requirement of 30 days notice for entering the Baikonur launch zone. No-one, not even ILS staff, can visit if they have missed the deadline by even a day.

When the charter plane landed on the desert airstrip, now surrounded by abandoned, decaying buildings, three Customs officials and guards weighed down with medals and epaulettes, took over an hour to check the papers of everyone on board. We needed our boarding passes to get off!

Visitors to the Kremlin grounds cannot carry knapsacks; but if they fold them, they can carry them as handbags.

Anyone who passes through an airport faces repeated passport and paper checks, by slow-motion officials who must stamp form after form. It can take three hours to get through Immigration, and then another hour or two through Customs. Little things tell a lot.

At the airport there is no attempt to warn a queue that a position is closing. The guard simply slams the door shut, leaving the queue to disperse and join the rear of other lines. All Russians returning from holiday are automatically sent through the Red Channel and searched. Aboard the flight, the air hostess prefaced the safety demonstration with a curt, "Pay attention".

Government VIPs have their own fast track lane through immigration and customs. They are also cocooned from traffic jams in Moscow's clogged streets. In the days of Communism, all Russian streets had a central lane, reserved for the Politburo, or political elite. The lanes are still there – used today for VIPs.

AMERICAN SATELLITES

The old shuttle airstrip is now used by the Americans to fly in their satellites. The rockets are shipped from Moscow by train.

Twelve carriages are used and the journey takes five days.

Because the Proton rocket was originally developed as an ICBM, it is transported and assembled in a horizontal position, unlike US rocket launchers which are assembled vertically. Only at the very last stage is the 60 metre column raised to a vertical position on metal centering posts.

The rockets are so powerful that they can be launched in even high winds. "The Proton is a beast. You could hit it with a sledgehammer", says one of the ILS team.

ILS staff spend at least a month at a time at Baikonur, with no entertainment other than a bar, and TV with VCR to show American movies they have brought in. The nearest town is an hour's drive away, and the only thing there is a market and bar with a few different beers. There is only one path allowed for walking. To avoid the tortuous use of unpronounceable names, the joint Russian-American team simply give each other numbers, most involving seven, with a nod at James Bond.

The land is flat, sandy scrub, that stretches as far as the eye can see, with wolves and eagles preying on rodents which come out at night. The desert round the old Shuttle airstrip is already reclaiming the decaying buildings, cracking structures, rusting pipes and crumbling runway. From the air Kazakhstan looks like Death Valley in North America.

2A LAUNCH

The VIP launch viewing site is a sandy mound built over a safety bunker, with a hut on top and a generator to provide some electric light, a bowl of water for washing, and a couple of portable camping toilets brought in by the Western visitors. A circular strip around the perimeter looks suspiciously like a mine field.

The stars are astonishingly bright. The 2A launch took place at 6.31am in the morning, just as dawn was breaking, and with no count-down, just a blaze of light followed a few seconds later by the roar and

vibration of the motors which lift the rocket up into the sky and over to the East into transfer orbit 200 miles above the Equator.

After two or three minutes the rocket is just a bright spot in the sky, with the discarded first stages falling in flames to the earth, on ground rented by Russia from Kazakhstan. After five minutes all visible trace has gone.

A crackly Tesla loudspeaker carries the voice of the interpreter intoning, "Stable, flight is nominal, pitch roll is nominal. Flight is normal".

After ten minutes the commentator switches off and it's all over, bar the bumpy drive back across the now sunny desert to the derelict airstrip and the two hour flight back to Moscow. While we are still showing our papers to the form stampers in Immigration and Customs, word comes through from California, by GSM cellphone, that the fourth and final stage has successfully fired and released the satellite. It has taken longer to negotiate Russian bureaucracy than it took the rocket to reach orbit.

CRIPPLING

The unspoken concern all round is that the state of the Russian economy will cripple the space launch venture. Khrunichev and ILS hope that billing in dollars will save the day. But once again, little things tell a lot.

ILS engineers find themselves frustrated by some of the old-fashioned designs at Baikonur. A crane, designed to lift heavy objects, takes literally four hours to crawl from floor to ceiling of a hanger. It was probably designed for nuclear war-heads, which had to be very carefully handled. There is no switch or gearing to speed up the movement for satellite parts.

The 2A launch had to be delayed by four days, due to the need for "longer processing time during the spacecraft preparation at Baikonur". This careful wording concealed the real reason. When

Hughes shipped the spacecraft they also had to ship all the necessary equipment, including a cable to hoist the satellite into position. The cable was the wrong length and the cash-starved Cosmodrome had absolutely nothing else to do the job.

"There is no back-up in Russia. So when they got the wrong cable, the new one had to be shipped in from the USA. It would have taken half a day to get it to Cape Canaveral. It took four days to Russia. But you just can't 'make do'" says Hal McDonnell, Vice President of Hughes.

The ILS engineers have admiration for the Russian Proton design. "They are masters of fluid engineering" says McDonnell. "Once a plan has been drawn up, engineers will follow it meticulously".

"We are proud to tell our children that we were part of the conversion to commercial use," said one Russian who works at Baikonur.

PAST THE SELL-BY DATE

But McDonnell worries about the lack of cash available to the engineers. When Asiasat 3 failed at Christmas 1997, it was not because the Proton rocket exploded. The fourth stage rocket motor made by Energia failed to fire as intended. It shut down after just one second. An enquiry established the cause. Russian engineers, strapped for cash, had used out-of-date sealing material for one of the fuel lines.

The firing procedure is controlled by a computer, which senses the chemistry of the jets. Because the material was wrong, the computer judged that the burn had finished too early, and automatically shut it down.

So the satellite was stranded in low orbit. After the insurance was paid, Hughes experimented with the craft, using remaining fuel on board to swing it twice round the moon and into geo-stationary orbit for tests. The exercise was successful, but the satellite is useless, because it has virtually no positioning fuel left on board.

Says McDonnell "The problem with the fourth stage of Asiasat is worrying. When we say, 'has this part been refurbished', and someone says 'yes', how do we know it has been done? Three years ago Hughes said we won't supply satellites until some of the local problems are fixed. Some have been fixed. They have invested in the most modern data processing system in the world for Baikonur. But if the crisis worsens, how much money will be sucked off from Khrunichev by the Russian Government?"

BACK-UP

There is already considerable rivalry between Khrunichev and Energia, because their success depends on continued support from the Russian Government.

"Khrunichev is held responsible for the failure of Asiastat," complains one of the rocket engineers, "But the upper stage that failed was made by Energia."

Alexander Lebedev, Deputy General Director of Khrunichev, tries to reassure his American partners: "We are backed by the Moscow International Bank. We have no reason to worry. We have reserves in roubles and dollars. We have contracts to launch rockets for five more Western clients this year. The Cosmodrome has its own power and water

supplies, independent of both the Russian or Kazakhstan governments. All contracts with ILS are in dollars. We pay the Russian Federation programme only paltry sums – it has no effect."

But Will Trapton reminds that ILS has a dual launch strategy, with dual rocket suppliers – launches can be switched to Atlas rocket in the USA.

KHRUNICHEV

The Khrunichev factory is on the outskirts of Moscow. The giant, decaying brick buildings are as large as a small town. Our Russian guide admitted that although he had lived in the area for thirty years he had not even known it was there or what it did. Russians have been brought up not to ask questions.

The factory was built in the 1920s, using German equipment to build cars. In the 1940s it switched to aircraft production and then in the 1960s started making ICBMs and space launchers. Khrunichev also built the original Mir spacecraft and still has a full-sized mock-up. Mir used an IBM 86 computer. One of the few luxuries on board is a steam bath chamber, complete with birch twigs.

ALPHA STATION

The Khrunichev factory is now helping to make the Alpha station, the first stage of which was due to be launched in November from Baikonur. A mock-up of the first stages has been built for zero gravity training. American and Russian crew will wear space suits, weighted with lead, to move round the chamber while submerged in water to simulate weightlessness.

Alpha manning should begin in July 1999 after the shuttle launch of another component from Kennedy Space Centre in December. Mir will then be pushed out of orbit, and left to burn up as it re-enters Earth on 8 June 1999.

The Proton rocket was completely secret until 1985, when a few details were disclosed in an obscure Russian language technical encyclopaedia. The Khrunichev factory is now extraordinarily open. Visitors are allowed to roam the immense hangers, touching the dozen or so Proton rockets now being built. The metal engineering is precise and clean, while very basic. Although it will be destroyed during the launch, even the smallest fault can destroy the mission.

"The trick is to make it cheaper but as reliable," says Hal MacDonnell.

In the 1980s, 25,000 people worked at Khrunichev, there are still 18,000, thanks largely to the dollar earning ILS project. Energia is now helping with the Sea Launch project promoted by Boeing; the plan is to launch satellites from a sea-based platform.

DISTRESSING

I left Moscow with a sense of relief; no more standing in queues while petty officials enjoy their moment of power and justify their jobs. I left too with a deeply distressing concern. If the space project, which is earning hard currency, is struggling to survive, what hope have the authorities of maintaining nuclear power stations, ships and submarines in a safe condition?

But I also brought away one nice memory of the indefatigable Russian sense of humour.

At the post-launch press conference in Moscow, Hal McDonnell sat next Alexander Lebedev. After the Russian finished speaking, the interpreter said he was handing over to "Mr Hughes".

"Mr Hughes is dead", said McDonnell, "but I'll take questions." As the room full of press laughed, a few heard the Russian translator say quietly into his microphone, "And people who make fun of interpreters do not live long either." □

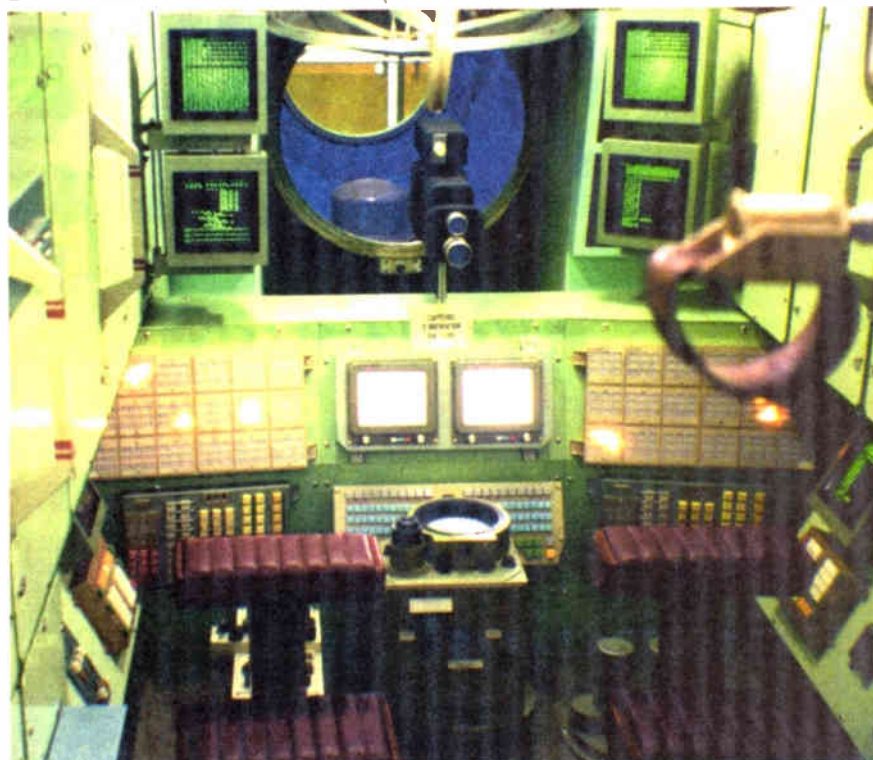

Full-size mock-up of the Mir spacecraft.

Find out what's coming soon: Visit the Web Site: <http://www.asamicros.com>.

Prices you can't afford to miss!

LCD's

non backlit:

1 X 16 - £ 7.29 2 X 16 - £ 7.99

backlit:

1 X 16 - £12.57 2 X 16 - £14.09

2 X 20 - £27.01 2 X 24 - £28.19

4 X 20 £32.89

Graphics:

128 X 64 £46.99

192 X 64 £50.51

Project PCB's

PIC18 PCB - 18 pin PIC's, proto area, PSU, RS232,



terminal block £ 5.86

Kit of parts £15.26

MICROCHIP

Dontronics

Full range of the DT series PCB's available from only: £ 3.48

Check out the web site!



Special Offer:

Basic Bundle: PIC BASIC Compiler, PIC18 PCB, Kit of parts, 2 X 16 LCD.

All for an amazing £77.24

That's a saving of over £10!

BASIC

From microEngineering Labs:

PIC BASIC

Compiler £ 58.74

Pro Version £176.25

ASA Micros Ltd.

21 Edmunds Fold, Littleborough, Lancs OL15 9LS

All prices INCLUDE VAT at 17.5%. Subject to £3 P&P

Tel: 01706 371695 Fax: 01706 375896 email: sales@asamicros.com



1



Technical productsyours for under £4

The Electromail CD-ROM Catalogue provides a virtual technical superstore, product encyclopaedia, and a help line with round-the-clock service - the moment you slip it into your computer!

It's quite amazing just how much you can get out of it. Products from batteries to bearings, fuses to fans, semi-conductors to computers, hand tools to power tools. On-line advice, and access to a full library of data sheets, providing detailed information on almost every product in our range. But the best thing about Electromail, is that it's open just when you want to go shopping. 24 hours a day. 365 days a year.

And in most cases your order will be despatched on the very



a more professional choice

same day you order (failing that, the next working day).

The Electromail CD-ROM Catalogue offers you more products and services than any of the alternatives. Send for your copy and get a head

start in your business, your home or hobby ... and at just £3.99 with free delivery, it's not worth struggling on without it!

HOW TO ORDER



Tel 01536 204555 or Fax 01536 405555

When ordering by fax or phone quote stock no. 313-6988 and have your credit card details handy. Alternatively, you can open your own Electromail account - please ask for details.

Electromail, P.O. Box 33, Corby, Northants, NN17 9EL. Tel: 01536 204555 Fax: 01536 405555

READOUT

John Becker addresses some of the general points readers have raised. Have you anything interesting to say? Drop us a line!

WIN A DIGITAL MULTIMETER

The DMT-1010 is a 3½ digit pocket-sized l.c.d. multimeter which measures a.c. and d.c. voltage, d.c. current and resistance. It can also test diodes and bipolar transistors.

Every month we will give a DMT-1010 Digital Multimeter to the author of the best *Readout* letter.



★ LETTER OF THE MONTH ★

SATISFACTION

Dear EPE,

Letters in *Readout* Sept '98 by Messrs Tate and Chamberlain regarding circuit information and component availability raised several points of interest – that is, for those who like to get at the nitty-gritty of their hobby rather than just assemble a project on a ready-made p.c.b. using the latest i.c.s. Such attitudes can lead to a lack of knowledge of basic electronics principles, failure to correct faults and a loss of interest.

However, it has to be accepted that if a large sophisticated project is being built, then this is the only method, but for a smaller project it is a challenging but interesting and pleasurable task to build a published p.c.b. project on stripboard, working out your own layout.

Surely one point of the hobby is the satisfaction and pleasure of doing the job yourself. After 60 years of construction and still doing so, I have built a wide range of receivers, TVs and test equipment, in spite of the fact that many of these were available cheaper at the time with the availability of WWII and commercial surplus.

As Mr Tate has discovered, back copies of *EPE* are available at some libraries (as well as the publishers) and this applies also to other hobbyist electronics magazines which all have included a wide range of circuits. A wide range of books is also available covering basic theory and practical circuits. Additionally, there are clubs such as the British Amateur Electronics Club and the British Amateur Television Club which issue their own magazines, and there are many local radio clubs.

**Norman Smith,
Stoke-on-Trent, Staffs**

*Yes, the satisfaction of successfully doing electronics as a hobby is greatly rewarding. We do, though, also have readers who are not only interested from a hobbyist point of view, but also want to become professionally involved after learning some of the basics through magazines such as *EPE* (we are the only one, though, which places a very high priority on education). We try to cater for a wide range of needs.*

And we do like to hear about people enjoying electronics.

ON BOARD PLOTTING

Dear EPE

I'd like to make a couple of points regarding the *Easy PCB Making* article in *EPE* Oct '98, about the production of home made p.c.b.s, and offer a couple of tips to other readers.

Whilst I'm sure direct plotting onto copper clad is a very effective way of producing p.c.b.s, I don't think it is really applicable to most amateur/hobbyist constructors. My p.c.b. output is of the order of half a dozen boards per year, with the rest of my projects being confined to stripboard. Even with a free plotter, free pens and ink I don't think I could justify the workshop space for something which would be seldom used.

The pen and tape method of construction is heavily criticised in the article. Whilst I agree a Saint's patience is required to produce an accurate board with this method, the results are invariably excellent. I have never had to repair over-etched tracks with bits of resistor leg on boards made in this way.

Even if this method is frowned upon for building circuits, it is a good way of producing unusual and extremely hard wearing front panels. By "Lettrasetting" legends onto copper clad and then etching I have produced numerous case fronts, which look as good today as they did when they were made. Tinning or a coat of spray lacquer keeps the copper appearance bright.

Finally, I would like to suggest a way of making Press 'n' Peel transfer paper go further. This method does indeed work well, though it has taken me many attempts to perfect the correct combination of printer, toner setting, track width and iron-on temperature. The Press 'n' Peel sheets are fairly expensive (making the extra expense of pre-sensitised photo boards more attractive).

When producing small boards it doesn't take many failed prints to put the project over budget. I have found that the sheets can be cut into four pieces, then stuck dull side up in the centre of a piece of copier paper using a thin border of Pritt Stick. The advantages are two-fold. Firstly, my laser printer handles paper much better than the slippery plastic film alone. Secondly, by ironing through the paper onto the copper, the plastic film tends to wrinkle less, resulting in fewer fractured tracks.

**Matt Waite,
Beeston,
Leeds**

Matt's comments were sent to us via the Net, and our On-line Editor, Alan, got to them first! Here's Alan's reply (I endorse what he says):

Personally I have nothing against using direct application of etch-resistant transfers onto copper foil, but only for one-offs, and there's no scope for modifying boards and prototyping again in light of further circuit developments. Error correction can also be difficult, but I agree it's a good way of originating one-off boards.

I do prefer UV developing, once a consistent supply of boards and chemicals have been established, I find that this is invariably the best way to produce a board at home.

Alan Winstanley

TOOLKIT PUZZLE

Dear EPE,

I built the *PIC Toolkit* (July '98) as described but when I try to program the PIC (using *TOOLKIT.BAS*) the final statement from the programming software is "XXX verifying errors" where XXX is the size in bytes of PIC code.

I have checked that the circuit is OK, replaced the PIC16C84 by a PIC16F84 and changed the configuration for a high speed crystal but no success. What could be the problem?

Kypros Vassiliou, via the Net

It seems that your computer may not be reading data from the PIC. Are you using a standard printer port cable? (See also the Acknowledging Toolkit letter on this page.)

Have you set the Toolkit software register code (&H378, &H278, &H3BC) to that required by the computer (see pages 529 and 530 of the July '98 issue, under Printer Port). It could also be that your computer is one of those machines which, like my Compaq as discussed in the article, does not seem to allow access to the handshake lines from BASIC, a problem for which I can offer no remedy.

In the latter instance, set the program to bypass error checking as discussed in the text. I have never genuinely experienced an incorrectly programmed PIC during normal operation of the hardware, even on the Compaq where error checking is inhibited.

Toolkit is designed to program both C and F versions of the '84 and at all speed configurations to 10MHz.

(Incidentally, the more projects we publish for use with PC-compatible computers, the more it becomes apparent that the term PC-compatible is open to wide interpretation by computer manufacturers – we are sometimes tempted to think that perhaps the description is simply an artist's impression of an intangible dream!)

ACKNOWLEDGING TOOLKIT

Dear EPE,

I can't get the PIC16x84 Toolkit (July '98) to verify a program in the PIC, it just returns a file full of NOPs. There also seems to be some confusion over the printer lead connector in Fig.5. The Busy line is shown going to pin 11 of the printer port, which according to my information is that for the Acknowledge line. Please could you clarify?

Gist of queries from several readers

It's what one might call "a printer's error", except that it's not the printer's fault – it's mine!

Although I actually programmed for the PC's Acknowledge line, I mistakenly wrote Busy on my draft drawings. Then, when writing up the words and formalising Fig.5 some weeks later, I referred to the drafts to remind me of which line I was using in software – and so the original error rippled on through. What an elementary mistake – it re-affirms the ideal of checking source material (the software in this instance) instead of derivatives! Hence the repeated use of Busy instead of Ack throughout the article.

Consequently, as stated under Please Take Note elsewhere in this issue, all references to Busy should be read as Acknowledge. Furthermore, in Fig.5 the connection marked Busy should go to printer port connector pin 10, not 11 as shown. The software, p.c.b. and standard printer cable connections are correct.

AIR THEM!

Whatever your views on electronics and allied subjects, air them in public, either through *Readout* or our *Chat Line* via www.epemag.wimborne.co.uk

PASS THE PORT!

Dear EPE,

I now have the full version of the PhizzyB Simulator on CD-ROM and find it thoroughly invigorating. In fact, I am so consumed with it that I am thinking of taking a whole week off work to revel in my new-found wealth of knowledge!

However, during assembly, I had a few problems trying to get my PC to recognise my newly-connected hardware PhizzyB. In the end I had to take the cover off my machine for the first time ever, and I noticed that the two serial ports have either been snipped off or the PC's been like that since it was born! In which case, how come the computer told me that they were both working properly, and even that COM1 was not available? I don't see how any of them can be used if they are not connected to anything!

So the next step was to fix some ribbon cables to them and seek out any sockets or plugs that looked like willing participants. I had to hard-wire in COM2 (what a task that was!) and then switched everything on – the hardware PhizzyB worked straight away on the test1.ram file.

I have successfully brought about the being of the physical version of the PhizzyB and all is well, due to Alan Winstanley and his unstinting help through the last week with numerous E-mails and support. I am looking forward to learning a lot more about computers in the forthcoming issues, especially as I finally got it to work before December's EPE! Yipppee!

Ian Gill, via the Net

Alan Winstanley told me over the phone about Ian's port COMplications! I was sure you would be interested too, so Alan forwarded the above to me (which is a precis of several communications), together with his reply to Ian, as follows:

In Windows 95/98, it's possible to add COM ports "on paper" by using the Add New Hardware wizard in Control Panel, but Windows will merely allocate the resources (IRQs and I/O range) needed to operate them. You could, therefore, have multiple COM ports allocated, with none of them physically existing in hardware.

You can check for resource conflicts by right clicking My Computer / Properties / Device Manager / Ports. However, Windows might not recognise whether anything is physically connected to the serial ports or, in your case, whether the serial port has been chopped off!

Device Manager merely reports whether the resources have been configured to allow you to run the COM port properly. PnP (Plug & Play) devices (e.g. PnP modems or ethernet cards) will be configured automatically and Windows will usually recognise such hardware on booting up.

Alan Winstanley

DARK AGE INTERPRETER

Dear EPE,

I think Mr Zammit is living in the dark ages! In his letter (EPE December '98), he calls BASIC an old-fashioned, inefficient interpreted language – he is clearly inaccurate. He should know that PASCAL is a dying language! Modern BASIC is nothing like the early '80's incarnation that Mr Zammit must be referring to. Even QBasic that came bundled with MS-DOS allows structured programming. Microsoft's QuickBASIC added even more language functionality, and the ability to compile fast standalone .EXEs too!

PASCAL may be quite popular with educational establishments, as it's a good language to start from, but it's only Borland's Delphi that gives it any life these days. I would have thought that the majority of your readers are most likely to be familiar with BASIC since it's more readily available without the need to purchase expensive compilers. Anyone competent enough to understand PASCAL shouldn't have difficulties converting BASIC code into PASCAL anyway!

As a professional programmer, I use Visual Basic exclusively these days and I could go on for hours about why I think it's the best overall Windows language. However, I believe what is of greater importance is not which language, but which environment your readers want their programs written for. DOS programs don't convert easily into Windows programs and vice-versa without some expertise, even if they are written in the same fundamental language.

I/O routines are particularly tricky to convert. Personally, I would suggest you stick to publishing sample DOS routines written in BASIC to at least get the reader started, and where possible offer alternatives on your web site. I'm sure your Chat Zone will allow your readers to help each other with the finer details of language conversions.

Stuart Johnson,
Southampton, via the Net

Thanks for the interesting comments. On this basis I continue to feel justified in not getting involved with PASCAL. I still wonder, though, if I am being old-fashioned about not yet using Visual Basic and offering readers programs written in it.

For example, I am currently working on Teach-In 2000 (starting publication in late '99) and am writing numerous interactive screens that are programmed in QuickBASIC/QBasic. I have the continuing niggle that I would find it all much easier if I were to use VB. The thought of a lengthy learning curve daunts me though, especially as I am not sure how many readers have VB – and I want readers to feel they can modify my programs internally as well as using their externally accessed screen options.

Will more readers please tell me their thoughts on this.

MAINS EARTH

Dear EPE,

Regarding the Mains Socket Tester (Sept '98), I cannot believe that anyone would make such a fundamental mistake as that shown in Fig.1 and described in the text at the bottom left of page 637!

In the UK, the Earth and Neutral are never connected together. To do so would render the system potentially lethal! Considering the domestic mains system at which this article is aimed, the Live and Neutral originate at a 3-phase sub-station transformer belonging to the electricity company.

The Earth conductor of each circuit in your house is connected *only* to the protective Earth conductor of the cable feeding your house from the electricity company mains supply system. The power cable of this system is continued back to the sub-station where it is earthed to a metal spike in the ground.

It is not uncommon to find voltages of up to 30V between Earth and Neutral in certain circumstances too technical for this note. This situation is even more common in multi-storey flats where 3-phase lifts etc. are fed from the local sub-station which also feeds the houses.

Bob McMillan,
Dundonald, Kilmarnock

We referred this letter to Bart Trepak, author of the article, who replied:

As regards the exact wiring arrangements at the substation, the point being made was that the Earth and Neutral lines in the domestic mains supply are effectively at the same potential and may therefore be regarded as being connected when considering the operation of the circuit.

This is also the case with supplies where although there may be a small difference of, as you say, up to 30 volts between the two lines (I for one would not like to have to choose between being connected between Live and Neutral or Live and Earth as the effect would be much the same!) this would still not affect the operation of the circuit.

As you say, the technical reasons for this are involved and this is of academic interest to any would-be constructor of the project as the substation wiring is not something they could change.

This is a subject that has come up before and which generates (excuse the pun) some debate. In order to make everyone aware of what is involved we are planning a feature on power generation for later this year.

HUGE BASIC

Dear EPE,

I was recently given a copy of EPE and it brought back a lot of memories from the 1970s when I was still at school, and you were still two separate magazines – *Everyday Electronics* and *Practical Electronics*. (I see J. Bull are still advertising – I've got a £5 credit note from them dated 1980 – do you think they would still honour it?)

My reason for E-mailing: in the letter *Toolkit Problem of Readout* November '98, John Becker (any relation to Data Becker?) refers to the QBasic limit on the amount of memory available for string handling. I wondered if he was aware of the effect of running QBasic with the "/AH" (Arrays Huge) command-line switch?

The command "QB /AH" starts QBasic in Arrays Huge mode (sic), which increases the largest array size from 64KB to a dizzying (?) 128KB! As a side effect, it also doubles the amount of string storage available.

Generally, you can get away with renaming QB.COM to QB2.COM and creating a batch file called QB.BAT containing just one line, QB2 /AH %1 %2 %3 which always runs QBasic in Arrays Huge mode.

(P.S. I would appreciate an E-mail if you decide to publish this suggestion).

Peet McKimmie, Aberdeen, via the Net

Extremely useful-sounding info – I was unaware of /AH and will try it.

On your other comments – it may be to your real credit if you grasp the Bull by the horns, but in sincerity I would not really expect any retailer to keep records going that far back and so feel they would be justified in refusing claims of such antiquity.

We can't advise you that you are in print – but hopefully you will see this letter next time you look at the EPE OnLine web site, where electronic versions of EPE can be downloaded.

All readers, if you want more details on this newly introduced service, drop in on www.epemag.com. You can also get to the site via www.epemag.wimborne.co.uk.

Having given a Sales Plug, back to the story – a number of readers were experiencing memory overload problems with Toolkit. I had not experienced them myself during program development. However, after exercising the other remaining brain cell, I could see why some situations might bring about the problem, and that it was not confined to just disassembly, but to TASMIMPASM conversion as well.

Consequently (and before receiving Peet's Huge comment) I spent a while rewriting some parts of Toolkit's program. In a nutshell, the disassembly now adds tabulating spaces on output to disk (instead of during disassembly). The TASMIMPASM conversion splits all "comments" out to a separate file while the full source code data is being brought in for conversion. Following conversion, the "comments" are recombined with the source code during output to disk (and in the correct positions).

Toolkit users should no longer suffer memory loss (if they do, tell a doctor, not me!).

As advised in Please Take Note elsewhere in this issue, the amended program is on the PIC disk and our ftp site.

And Data Becker? No, no relation that I know of. My brother Richard, though, is heavily into electronics. Long term readers will no doubt recall his forays into robotics with several designs published in EE/PE. Early 1999 we shall report on his latest robotic escapades through our news pages.

Crownhill Associates Limited

PIC12C508/509 DEVELOPMENT SYSTEM

This integrated development environment offers a unique software development tool for the PIC 12C508 / 509. The package consists of 508/509 In-Circuit Emulator, Programmer, EdICE a fully integrated Assembler with trace functions & ICE508 tracer/disassembler.

The development system is supplied with MPASM assembler/disassembler and 10 projects, including circuit diagrams and unprotected source code. Projects cover subjects from simple sound effect generator through to an accurate Digital Volt Meter, Smoke Alarm, Stop Watch, LCD display driver, Keypad encoder and more

Price £59.95 + 7.50 P&P + VAT

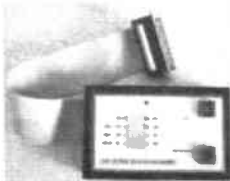

NEW! PIC PROGRAMMER KIT

Programs the Popular PIC 16C84, 16F84, 12C508/9 and 24xx series serial memory devices. Connects to the serial port of a PC and requires No EXTERNAL power supply. The kit includes instructions for assembly, circuit diagram and component layout.

This handy little programmer is easy to build, taking no more than 30 mins. to assemble and test. The Professional quality PCB is double-sided, through-plated with solder resist and screen printing to aid efficient assembly. It is supplied with driver software to run in DOS on a 286 PC upwards and under Windows 95 on 486 or Pentium and a Disk full of interesting projects, tips and data sheets for PIC devices, including FREE Assembler and Simulator (requires 9-pin D-type to 9-pin D-type cable to connect to serial port of PC)

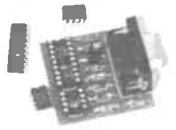

CABLE £5 INC. VAT AND DELIVERY. COMPLETE KIT just £15.00 including Delivery and VAT (UK Only). Or READY BUILT £20.00 INCLUDING Delivery and VAT (UK ONLY)

1998 Microchip CD ROM

- Packed with information
- All current data sheets
- Programs and Diagrams
- Application notes
- PDF Viewer

£10 Inc. VAT P&P (In UK)

PIC16C84 /04p
1-10 £2.00
11-100 £1.90
101-500 £1.80

PIC 12C508/509 DIL
ALL AT 0.65p
Low Cost programmer
for the above devices @
£35.00

24LC16 £1.00

PIC16C620 £1.95
PIC16C621 £2.25
PIC16C622 £2.50

PIC Prices + P&P VAT



AMAZING LOW PRICES
PIC 84 & MEMORY

PIC BASIC COMPILER

Write PIC Programs in BASIC

- Expanded BASIC Stamp I compatible instruction set
- True compiler provides faster program execution and longer programs than BASIC interpreters
- I2CIN and I2COUT instructions to access external serial EEPROMs and other I2C devices
- More user variables
- Peek and Poke instructions to access any PIC register from BASIC
- Serial speeds to 9600 baud
- In-line assembler and Call support
- Supports all most popular PICs, PIC16C55x, 6x, 7x, 8x, 92x and PIC14000 micros
- Use with any PIC programmer

Write your PIC programs in BASIC! The PicBasic Compiler converts BASIC programs into hex or binary files that can be programmed directly into a PIC microcontroller. The easy-to-use BASIC language makes PIC programming available to everyone with its English-like instruction set

Supplied with Universal PIC CHIP Programmer, connects to Parallel port of PC and programs all popular PIC micros. Complete with programming toolkit - Editor, Assembler & Programming software.



Universal PIC CHIP programmer supports the following Microchip devices
PIC16C52, PIC16C54, PIC16C55, PIC16C56, PIC16C57, PIC16C58A, PIC16C61, PIC16C62.



PIC16C63, PIC16C64, PIC16C65, PIC16C620, PIC16C621, PIC16C622, PIC16C71, PIC16C73, PIC16C74, PIC16C84, PIC16C82, PIC16F84, PIC16F83, PIC16C55A, PIC14000, PIC16C508, PIC12C509, & MEMORY CHIP24C01 TO 24LC65

Price
£49.95 + P&P + VAT

PIC BASIC PRO

The PicBasic Pro Compiler allows BASIC Stamp II commands, using pins on PORTA, C, D, E, as well as PORTB, and the capability of using more RAM and program space.

A list of the new features and commands appear below

- Real If... Then... Else... Endif
- Hierarchical expression handling
- Interrupts in Basic and assembler
- Built-in LCD support
- Oscillator support from 3-56Mhz to 20Mhz
- More variable space (processor dependent)
- MPASM/ICE compatibility
- All Assembly routine for all functions are supplied and can be modified to suit your needs

Supplied with sample programs including circuit diagrams

PIC BASIC without programmer or PIC84 £49.95 + 5.00 P&P + VAT
PACKAGE with programmer & PIC 16x84 £99.95 + 5.00 P&P + VAT
PIC BASIC PRO without programmer or PIC16F84 £150.00 + 5.00 P&P + VAT
PIC BASIC PRO with programmer and PIC16F84 £198.00 + 5.00 P&P + VAT

<http://www.crownhill.co.uk/picbasic>

The Old Bakery, New Barns Road, Ely, Cambs
Tel: 01353 666709 Fax: 01353 666710
email: sales@crownhill.co.uk <http://www.crownhill.co.uk>

NOW AVAILABLE RANGER 2

for Windows 95™

Demo Software - available from our Web Address

The Complete, Integrated Schematic & PCB Layout Package

Windows Ranger 2

For Windows 95 & NT

- New Hierarchical Circuit
- Split Devices • Gate & Pin Swap
- New Edit Devices in Circuit
- Copper Fill • Power Planes
- Autorouter • Back Annotation

£250

Ranger 2 Outputs:
Full Windows Outputs
Plus - HP-GL
Gerber
NC Drill
AutoCad DXF

Windows Ranger 2 with Specetra SP2

Ranger & Specetra Autorouter provide the most cost effective PCB Design system available. A powerful, intuitive system at an outstanding price!

£600

Windows Ranger 2 Upgrade

Upgrade your existing PCB Package to Windows Ranger 2.

£150

SPECIAL OFFER Ranger 2 Lite £35 (Prices exc VAT/P&P)

Demo Software -download from <http://biz.ukonline.co.uk/seetrax>



Call 01730 260062

Fax 01730 267273 Old Buriton Limeworks, Kiln Lane, Buriton, Petersfield, Hants. GU31 5SJ



Advanced Systems & Technology for PCB Manufacture

CIRCUIT SURGERY

ALAN WINSTANLEY

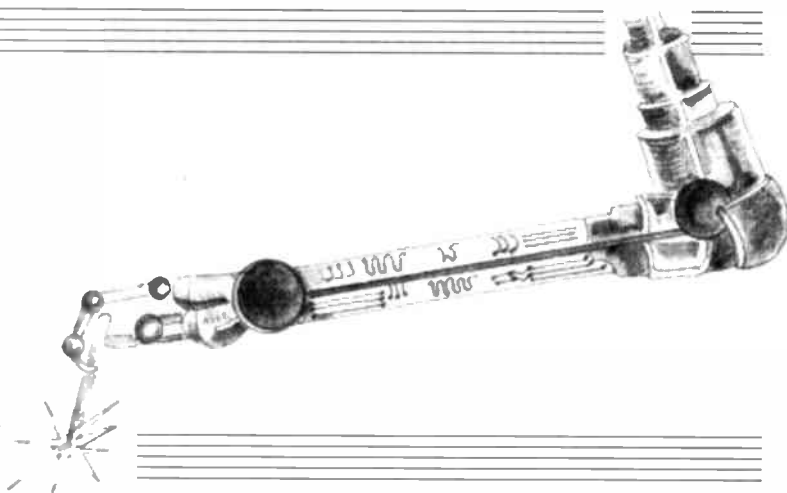

Our in-house "Surgeon" examines the inner workings of the 4017, takes a few soldering tips on board and we look at "negative" voltage supplies.

Solder Tips

My thanks to *Kenny Trussel* who writes in via E-mail with a soldering tip or two:

"I read your Basic Soldering Guide on the EPE web site and thought it was very good. I'm an electrical engineer and have done quite a bit of soldering. One thing I was taught as a student by an "expert solderer" was to coat the tip of the iron before you put it back in its holder. This keeps the tip nice and tinned.

Also I learned - and now practise - leaving the tip coated when I turn off the soldering iron. This lets the solder dry on the tip and protects it from oxidation. When the iron is heated up next time, the solder can be wiped away with a sponge leaving the tip nice and shiny."

The practice of dabbing fresh solder onto a hot soldering iron tip - called "tinning the bit" - has several benefits. It makes the hot tip receptive to more solder and it helps to keep oxides and contamination off the tip (which otherwise interfere with making a good joint). It also helps the tip to make a better thermal contact with the joint being made, because the molten solder on the tip fills the irregular gap between the tip and the joint.

After a few minutes, the tinning tends to oxidise so it's best to wipe it on a damp sponge and re-apply fresh solder. It is certainly a good idea to tin it at regular intervals and also before switching off, to help maintain good "tip hygiene".

Bits and Pieces

Incidentally, it is most important that you tin new bits *immediately* they are used for the first time or they can eventually become virtually unusable. Try using Tip Tinner & Cleaner, a special paste in small tins produced by Multicore Solders, which does two jobs in one. Simply dab the iron on this and wipe away the excess before making a joint. It's available from Maplin and others.

Back on the subject of the *Basic Soldering Guide*, I am in the process of adding extra close-up photos including some more specific desoldering advice. Be sure to check the *EPE* web site, see: <http://www.epemag.wimborne.co.uk/solderfaq.htm>.

Logic Circuitry "Internals"

From *Gilles Armand Rose* came this query concerning logic chips:

"Can you tell me the internal structure of logic gates (e.g. the CD4017), and tell me where I can find Internet sites which provide circuit diagrams?"

When we researched our series *Teach-In '98 - An Introduction to Digital Electronics* - we found that many modern data books no longer describe the internal circuitry of logic chips. It is as though they take it for granted that we already know, or we do not need to know to begin with! This makes it more difficult in learning or establishing fundamental electronic principles.

This is where older data books come in. I have the very first COS/MOS logic data book published by RCA Solid State, which lays bare popular CMOS gates and logic functions down to MOS transistor level. Older Texas Instruments data books from the 1980's show the "internals" for many devices, so you can gain some idea of their internal circuitry.

Design Route

As Philips Semiconductors say, the (HEF)4000 range is still useful even today, as it offers today's designers an "easy-in" design route, and CMOS logic still has many other important benefits including low power consumption and wide operating voltages. (A correspondent in the USA tells me that this is why old semiconductor technology still gets used amongst subcontractors at NASA: it is well documented and proven, and everyone understands it, no matter whom they work for.)

The "internals" of logic chips are still relevant today and would appeal directly to followers of *Teach-In '98* because they will be able to relate (we hope!) to how the gates are arranged inside a chip such as the venerable CD4017 or HEF4017. See Fig.1 for logic diagram.

Net Those Chips

If you have Internet access at home or at a library then you can soon grab technical data from manufacturers' web sites. Never before has such accessibility been possible, and I regret that many more traditional

readers who "don't have a computer or Internet and never will", are missing out.

You could see whether a local library has Internet access, or try an Internet café. If you are a "newbie" then ask for help - everyone will be only too delighted to get you started. (My monthly *Net Work* column includes advice and information for Internet users.)

Data sheets can often include internal circuits of common logic functions. Usually data sheets are presented in Adobe's Portable Document Format (.PDF) format, so you need the (free) Acrobat Reader from www.adobe.com to actually view and print them. I tend to save the .PDF file to disk by right mouse-clicking in my browser, then Save Target As . . . , then I view and laser-print them when I'm off-line.

Amongst the finest Internet sources of chip data available is the famous "*Chip Directory*" which originates in Holland. Go to <http://xs4all.nl/~ganswijk/chipdir> and you can find mirror sites in other countries (in the UK it's <http://www.shellnet.co.uk/chipdir>).

Another good site is the Taiwanese <http://www.semi.com.tw> which offers some 45,000 data sheets and has a very good search engine, although when tested there were some access problems. Undeterred I fetched the Data Sheet for the HEF4017 from Philips (www.philips.com) within five minutes.

To answer your specific question, Fig.1 is the internal circuit diagram of a typical 4017. It contains a five-stage Johnson counter (see *Teach-In '98* Part 10, August 98 for a more detailed description of logic counters) and since both the Q and \bar{Q} complementary outputs of each register are used, the Johnson counter provides 10 possible output states. The shift registers are clocked to produce a Johnson binary code (i.e. a *twisted-ring count*, see Table 1).

On each successive clock edge the Johnson counter feeds the final inverted bit (\bar{Q}_5) back to the data input of the first flip-flop. This results in a "ring" of bits rippling along their outputs. (Note that you will sometimes see the bits numbered Q0 to Q4 instead, which is technically more preferable.)

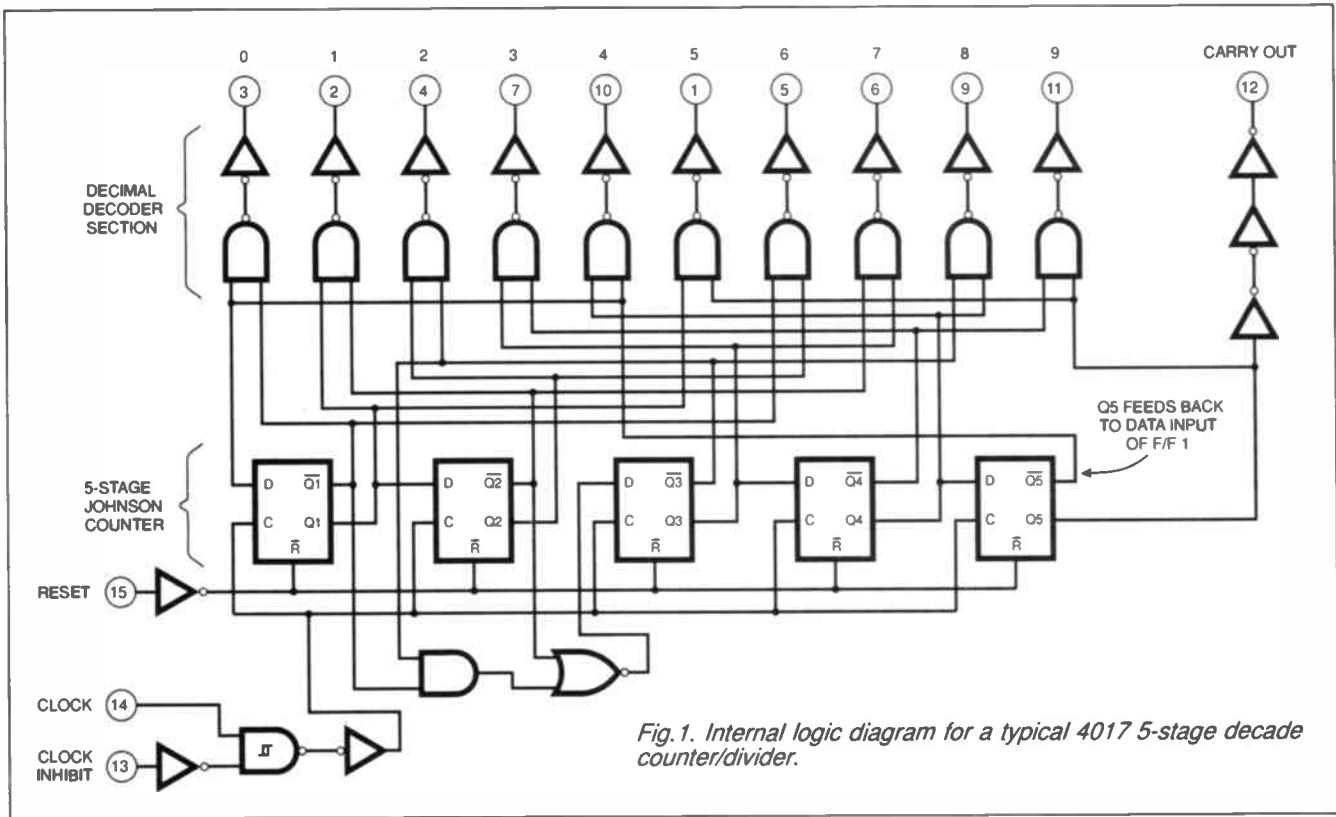

Fig. 1. Internal logic diagram for a typical 4017 5-stage decade counter/divider.

By using a two-input AND gate for each output, it's possible to decode the ten states of the Johnson binary code, and we described how this happens in *Teach-In '98 Part 10*. In the 4017 circuit diagram, an array of ten inverted NAND gates with buffers decodes the binary count to provide a "1 of 10" count. This means that only one of the 4017's output pins is high at any time.

Both the Q and \bar{Q} inputs of each register are used in this decoding scheme. In the case of the logic count 00000 for example, by ANDing $\bar{Q}1$ and $\bar{Q}5$ - which will both be logic 1 - a logic high is generated at pin 3 (decimal 0 output). A similar process occurs for the other nine counts which are decoded by the gate array. I'll let you work that one out! Incidentally, according to their data sheet, the Philips HEF4017 device uses NOR gates in the decoder section instead.

Voltage and Ground

"I'm reading a book called *Basic Electronics Theory* but I'm lost at the part

Table 1: A 5-bit Johnson counter produces a twisted-ring count of ten unique states before the sequence recommences.

Q1	Q2	Q3	Q4	Q5
0	0	0	0	0
1	0	0	0	0
1	1	0	0	0
1	1	1	0	0
1	1	1	1	0
1	1	1	1	1
0	1	1	1	1
0	0	1	1	1
0	0	0	1	1
0	0	0	0	1

which introduces transistor amplifiers. The base has to be connected more positive than the emitter, but less negative than the collector. What does this mean?

I don't understand this because I have no idea what is meant by "ground" (0 volts). If ground is usually negative, how is it 0V?

Also, what is meant by "dropping" a voltage across a resistor? I desperately need help, fast! Thanks from R. Taylor, via the Internet."

Both these questions are frequently asked by beginners. If, for example, you have a 12V car battery labelled "+12V" on one terminal, the other terminal *must* be at zero volts. There is a potential difference (another expression for voltage) of 12V between the two terminals.

Your confusion is understandable: unfortunately battery polarities are labelled as *plus* and *minus* mainly for the layman to understand, but a battery marked +12V and -12V would really provide a potential difference (p.d.) of 24 volts. A mathematician would agree! The electronics user would argue that labelling "+12V" and "0V" is correct instead. So you can indeed have zero volts.

In circuit diagrams it can get a bit messy if a 0V "rail" is drawn everywhere, so people often imply that anything connected to 0V is joined together via an "invisible" common wire. The "ground" or "earth" symbol is used to denote this.

A simple circuit with the negative (0V!) terminal of battery B1 wired to a "ground" symbol is shown in Fig.2a. It is seen a lot in data sheets and American books, though it is not the practice at EPE. The resistors R2 and R4 plus diode D1 cathode (k) also connect to the 0V terminal, therefore. This is implied by the ground symbols.

Note that sometimes if something is said to be grounded, this can mean it is connected to an electrical earth, e.g. the earth pin (UK) or ground pin (USA) of a mains plug. Check the context carefully. In EPE we use separate symbols for "chassis" and "earth" (Fig 2b). American readers will especially notice the difference.

The phrase "voltage dropping" across a resistor is electronics jargon used to describe how, when a current flows through a resistor, a voltage must appear "across"

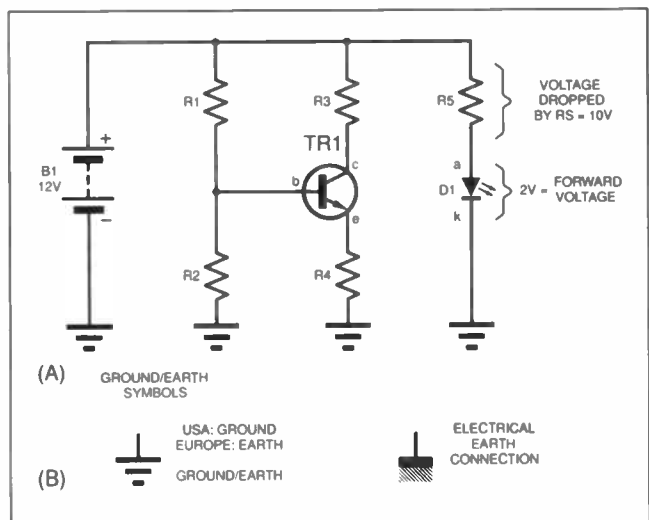

Fig.2. (a) The ground/earth symbol is used to denote components which are wired together, in this case to 0V. (b) Symbols used to distinguish electrical earth and "ground" or earth.

it. This is often called the *voltage drop*. As for measuring voltages in a circuit, all you need to know is that everything is *relative*. Twelve volts in relation to what? Less negative than where?

Back to the circuit of Fig. 2a, the cathode (k) of l.e.d. D1 connects to 0V. Like most l.e.d.s., a "forward voltage" of roughly 2V will appear across it when it is illuminated, meaning its anode (a) is at a voltage of +2V with respect to its cathode. Because its cathode also happens to be connected to 0V, we can also say that the anode is "+2V with respect to the 0V rail."

In electronics, we normally measure voltages *with respect to the 0V rail*. If we simply say that the anode is just "at 2V", everyone will assume that we mean "+2V relative to the 0V rail".

Finally, if 2V appears across the l.e.d., then we have to account for the remaining 10V of our original 12V: the voltage cannot just vanish. In fact, it is "dropped" by the series resistor R5.

We electronics buffs usually say that there is a "voltage drop across R5" or that "R5 has 10V across it." You'll soon be using this jargon routinely like the rest of us!

CIRCUIT THERAPY

Circuit Surgery is your column. If you have any queries or comments, please write to: Alan Winstanley, *Circuit Surgery*, Wimborne Publishing Ltd., Allen House, East Borough, Wimborne, Dorset, BH21 1PF, United Kingdom. E-mail alan@epemag.demon.co.uk. Please indicate if your query is not for publication. A personal reply cannot always be guaranteed but we will try to publish representative answers in this column.



SHOP TALK

with David Barrington

Alternative Courtesy Light

The main point to watch out for when building the *Alternative Courtesy Light* is to ensure you select a suitably rated relay for the task in hand. The author recommends one of the miniature power relays stocked by **Maplin**, code JM18U. This is the 12V single-pole changeover version having 5A contacts. An alternative would be the 10A version, code JM67X.

For a safe and professional finish, the power plug and socket have a simple latching arrangement and were also ordered from the same supplier. These should be ordered as: 6-way right-angled header, SD52G; free plug, SD34M; crimp contact sockets, SD57M.

The small plastic box came from **Farnell** (☎ 0113 263 631 or <http://www.farnell.com>), code 531-893 (5 off quantities only). The small printed circuit board is available from the *EPE PCB Service*, code 217.

Volume Compressor

Readers should not have any difficulty in sourcing components for the *Volume Compressor* project. You do not have to use a rotary mains switch here, any *mains rated* "double-pole double-throw" (d.p.d.t.) changeover toggle switch will do the same job. However, if you want to keep to the ergonomics of the model and use a rotary type, it can be purchased from **Maplin**, code FH57M. They also supplied the aluminium, vinyl-effect, box, code LH38R(WB3).

Although the main wiring diagram shows the mains transformer having two 6V secondary windings wired in series to produce the required 12V, this just happened to be to hand and almost any 100mA 12V miniature type, provided it sits comfortably in the case, will be OK. After all, the circuit only draws about 8mA; slightly more when the panel l.e.d. is switched on.

PhizzyB L.C.D. Interface Board

When putting together the parts needed to complete the *L.C.D. Interface Board*, this month's *PhizzyB* project, check that the 20-way IDC box header matches the "link cable" connector you made up last month. If you are using the **Maplin** (<http://www.maplin.co.uk>) part mentioned in the previous instalment, you will need to quote code FJ14Q.

Several different brands of 2-line 16-character l.c.d. modules are marketed, but the vast majority appear to use the same chipset line-up and interwiring arrangement. The one used in our model is the Hitachi LM016L version and should be widely available; certainly, **Magenta Electronics** (<http://www.magenta2000.co.uk>) carry stocks and you could also try **Greenweld** (<http://www.greenweld.co.uk>), who sometimes have offers on these. The components list includes several alternatives, so readers should have no difficulty in finding a supplier.

The printed circuit board (type A) is part of the 4-section board available from the *EPE PCB Service*, code 216 (see page 68).

EPE Mind PICKler - 2

No mind bending barriers should confront readers tackling the construction part of the *EPE Mind PICKler* project. However, when the **Maplin** base listing Index in their catalogue was checked for the 74HC132 quad Schmitt NAND gate we failed to recognise that the two identical code entries for this device are for a surface mount version. The Index does not list the 14-pin d.i.l. code which is: **UB29G**.

The ready-programmed PIC16F84 microcontroller is available from the author (mail order only) for the sum of £10 inclusive UK. Overseas readers must add an extra £1 for postage and packing (overseas orders must be paid in pounds sterling). Orders should be sent to the following and all payments made out to *Mr A. Flind* at **22 Holway Hill, Taunton, Somerset, TA1 2HB. No callers.**

If you wish to do your own programming, the software is supplied as TASM source and object files on a 3.5in. PC-compatible disk from the Editorial Offices, see *EPE PCB Service* page 68. There is an admin charge of £2.75 each (UK). For overseas readers, the charge is £3.35 (surface mail) and £4.35 (airmail). If you are an Internet user, it can be downloaded *Free* from our FTP site: <ftp://ftp.epemag.wimborne.co.uk/pubs/PICS/MindPICKler>. It was also on the *Free* CD-ROM, cover-mounted on the Nov '98 issue.

The printed circuit board is available from the *EPE PCB Service*, code 214. Finally, please heed the warning about PICKler's use!

Twinkle Twinkle Reaction Game

Looking down the list of parts needed for the *Twinkle Twinkle Reaction Game*, the only item likely to cause concern is the M66 melody generator chip. This was obtained from **Maplin**, the Twinkle Twinkle tune was chosen and carries the code M66T-02B. A selection of a further four devices from the same family is possible.

The red round-topped pushswitches used in the prototype model came from the **Rapid** (☎ 01206 751166 or <http://www.rapidelec.co.uk>) D6 range of keyboard switches, code 78-0160. They are also available in five other colours. Most of our advertisers should be able to offer good alternatives.

The printed circuit board is available from the *EPE PCB Service*, code 210.

PLEASE TAKE NOTE

Greenhouse Computer

(July '98)

Under certain circumstances, a small d.c. voltage can occur across the probes and may affect the readings. To avoid the problem amend the Controller p.c.b. as follows: change C14 to 10nF, C13 to 470nF, add a 100k resistor in parallel with the probes (across TB3), add a 470nF capacitor in series with TB3 pin 2 and its probe. The *EPE* software disk and ftp site have been updated with a slightly amended version of the program that reduces the default watering time.

PIC16x84 Toolkit

(July '98)

QuickBASIC/QBasic memory capacity can be exceeded in some situations of the conversion/disassembly routines. The program has been slightly rewritten to overcome these problems - the *EPE Software Disk* has been updated with the amended program, as has the ftp site.

Also, all references to the Busy line should read as Acknowledge line. In Fig.5 the connection marked Busy should go to printer port connector pin 10, not 11 as shown. The software, p.c.b. and standard printed cable connections are correct.

Foghorn Timing Switch

(Ingenuity Unlimited Dec '98)

Page 896, Fig.4. The author has notified us of the following amendments to the circuit diagram: VR3 wiper/track should connect to the junction of diode D12 and VR6, not to D12 anode (a). An *additional* diode is then needed in the wire between VR3 (anode) and D12/VR6 (cathode).

The warning signals have also been clarified as follows:

1. Power vessel under way - *Dash*
2. Power vessel stopped - *Dash, Dash*
3. Sailing, fishing, towing, etc. - *Dash, Dot, Dot*
4. Vessel being towed - *Dash, Dot, Dot, Dot*

Reliable IR Remote Control

(Oct/Nov '98)

We seem to have fallen foul of the supply bug concerning the Holtek HT12B chip used in the Transmitter. Within a few days of the final part being published, **Maplin** supplies dried up followed by "we shall not be re-stocking".

Contacting Holtek (<http://www.holtek.com.tw>) via the Net, showed three UK distributors who were not very helpful. However, speaking to one of our advertisers, **FML Electronics** informed us that they will have stocks of the HT12B by the time this issue appears on sale, and it will cost £1.49 plus £1 p&p. Mail order only to **FML Electronics**, Dept EPE, Freepost NEA3627, Bedale, North Yorkshire, DL8 2BR.

Logic Gate Tester

(Ingenuity Unlimited, Nov '98)

Page 818, Fig.2. On IC2 the pin marked CLK2 should be denoted as pin 6, and not as shown.

30% discount for EPE readers on two bench multimeters



APPA201 3½ digit £99 inc vat & del



APPA 203 3¾ digit inc vat & del

Vann Draper is offering 30% discount to readers of *Everyday Practical Electronics* on two of their professional quality, battery/mains powered, bench digital multimeters.

The APPA 201 normally sells for £139.83 but for readers of *EPE* the price is only £99 fully inclusive of vat & delivery.

The APPA 203 is normally priced at £175.08 and is available to readers of *EPE* for just £125 fully inclusive.

Both models are supplied ready to use complete with test leads, mains lead, carrying strap, operating manual, and a 12 month guarantee.

To order simply post the coupon to:

Vann Draper Electronics Ltd at Unit 5, Premier Works, Canal Street, South Wigston, Leicester LE18 2PL.

Alternatively tel 0116 2771400, fax 0116 2773945 or email sales@vanndraper.co.uk

APPA 201 specification

Display	: 2000 count, back lit lcd
Ranging	: Auto and manual
DC voltage	: 200mV, 2, 20, 200, 1000V Accy 0.5%
AC voltage	: 2, 20, 200, 750V Accy 1.5%
DC current	: 200µA, 2mA, 20, 200, 10A Accy 0.8%
AC current	: 200µA, 2mA, 20, 200, 10A Accy 1.5%
Resistance	: 200, 2k, 20, 200, 2M, 20M Accy 0.8%
Continuity test	: Threshold less than 50ohm
Diode test	: Test current 1.0mA
Additional functions	: Data hold
Power requirement	: 120/240Vac or 6 x AA batteries

APPA 203 specification

Display	: 4000 count, back lit lcd
Ranging	: Auto and manual
Bar graph	: 42 segment
DC voltage	: 400mV, 4, 40, 400, 1000V Accy 0.4%
AC voltage	: 4, 40, 400, 750V Accy 0.8%
DC current	: 4mA, 40, 400, 10A Accy 0.7%
AC current	: 4mA, 40, 400, 10A Accy 1.3%
Resistance	: 400, 4k, 40, 400, 4M, 40M Accy 0.6%
Capacitance	: 4nF, 40, 400, 4µF, 40µF
Frequency	: 100Hz, 1KHz, 10, 100, 1MHz
Continuity test	: Threshold less than 50ohm
Diode test	: Test current 0.6mA
Additional functions	: Min, Max, Hold, Relative, Delay hold
Power requirement	: 120/240Vac or 6 x AA batteries



Vann Draper Electronics Ltd

The test & measurement specialists

www.vanndraper.co.uk

Kenwood, Grundig, Hitachi, Fluke, Kathrein, Glassman

Use this coupon for your order

Please supply me:

..... APPA 201 meter(s) at £99 inc vat & del

..... APPA 203 meter(s) at £125 inc vat & del

Name:

Address:

Tel no:

Total £

Cheques payable to Vann Draper Electronics Ltd or debit my visa, mastercard or switch card:

Card type:

Card No:

Expiry date:

Switch iss No:

Signature:

Overseas readers can still obtain this discount but carriage charges vary according to country. Please telephone, fax, email or write to Vann Draper.

PROTEUS

The IVth Generation

Schematic Capture

NEW Version IV

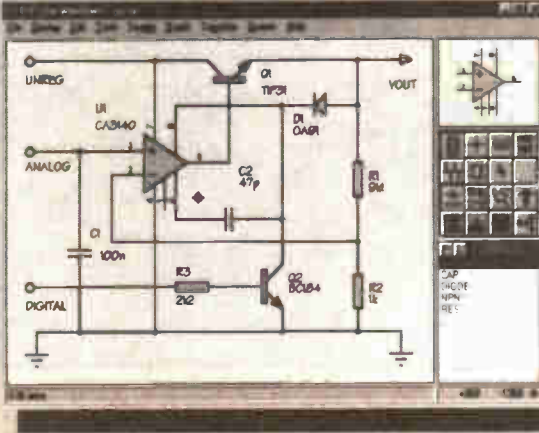

- Produces attractive schematics like you see in the magazines.
- Netlist, Parts List & ERC reports. ● Hierarchical Design. ● Full support for buses including bus pins. ● Extensive component/model libraries. ● Advanced Property Management.
- Seamless integration with simulation and PCB design.

New Features

- Component Auto-Placer
- Pinswap/Gateswap Optimizer
- Background Regeneration of Power Planes
- Enhanced Autorouting with Tidy Pass
- Full Control of Schematic Appearance
- Extensive New Component Libraries

Available in 5 levels - prices from £295 to £1625 + VAT.
Call now for further information & upgrade prices.

Simulation

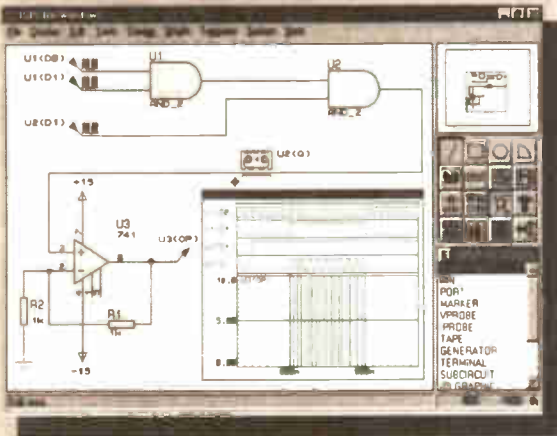

- Non-Linear & Linear Analogue Simulation. ● Event driven Digital Simulation with modeling language. ● Partitioned simulation of large designs with multiple analogue & digital sections. ● Graphs displayed directly on the schematic.

FREE
SOFTWARE
ISIS & ARES Lite
Schematic & PCB
Design

**SHAREWARE VERSIONS
AVAILABLE TO DOWNLOAD
FROM OUR WEBSITE**

<http://www.labcenter.co.uk>

labcenter
Electronics

PCB Design

NEW Version IV

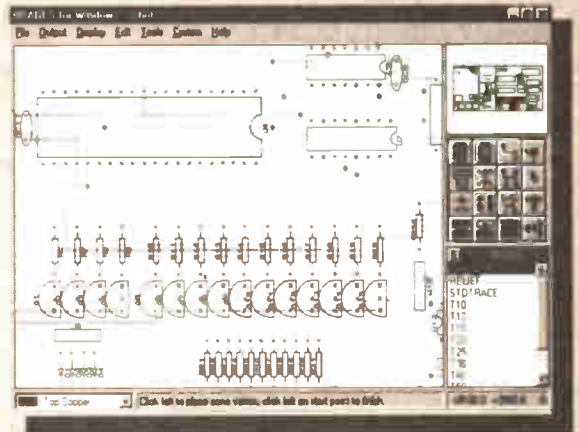

- Automatic Component Placement. ● Rip-Up & Retry Autorouter with tidy pass. ● Pinswap/Gateswap Optimizer & Backannotation. ● 32 bit high resolution database. ● Full DRC and Connectivity Checking. ● Shape based gridless power planes. ● Gerber and DXF Import capability.

"PROTEUS
is particularly good
with its rip-up-and-retry
autorouter"

EWV January 1997

Write, phone or fax for your free demo disk, or ask about our full evaluation kit.
Tel: 01756 753440. Fax: 01756 752857. EMAIL: info@labcenter.co.uk
53-55 Main St, Greenington. BD23 5AA. WWW: <http://www.labcenter.co.uk>

Fully interactive demo versions available for download from our WWW site.
Call for educational, multi-user and dealer pricing - new dealers always wanted.
Prices exclude VAT and delivery. All manufacturer's trademarks acknowledged.

VOLUME COMPRESSOR

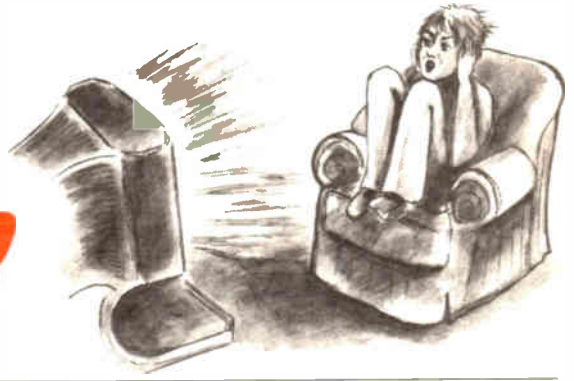

ROBERT PENFOLD

Taking a level approach to cracking the sound barrier!

YOU might think that the majority of complaints received by broadcasting companies concern things such as bad language, nudity, sex scenes and violence. However, the programmes that deal with these things consistently claim that the most common cause of complaint is in fact poor sound quality!

There seem to be two main courses of complaints, and one of these is that the volume of background music is excessive. The perceived loudness of background music and sound effects seems to be a subjective matter, and in general we find it harder to hear the dialogue above the music as we get older. There is no easy solution to this problem, and if the sound engineers set a high background level nothing short of some highly sophisticated digital processing will ease matters for the listener.

The other main complaint concerns inconsistencies in the sound levels. Obviously some variations in the sound level are inevitable, but they will presumably be introduced deliberately for dramatic effect as well. What many listeners find unacceptable are the sudden increases in volume that occur within programmes, or (more often) during the breaks for advertisements.

HIGHS AND LOWS

These high volume levels are almost certainly produced deliberately in order to grab our attention. The broadcasters have to operate within maximum audio modulation limits, and on the face of it this factor should prevent abnormally high volume levels from occurring.

In practice the sound engineers have some room for manoeuvre. The sound levels are normally kept comfortably within the maximum permitted modulation level, enabling higher than normal volume levels to be achieved by taking the modulation level to the absolute limit.

The peak signal level does not govern the perceived volume level anyway. If two signals have the same peak level but one has a higher average level than the other, the one having the higher average amplitude will sound louder. Also, the frequency content of the signal has a significant affect on its perceived loudness.

Human hearing operates less efficiently towards the extremes of the audio range, and operates at maximum efficiency at middle frequencies and the lower treble range. By concentrating on this range of frequencies where our hearing operates well, and minimising the signal content at other frequencies, the perceived loudness of the sound can be increased.

AUDIO COMPRESSOR

The obvious way of combating sudden jumps in volume is to use an audio compressor. This is a form of automatic volume control, and its basic action is to automatically reduce the gain when the input signal is above a certain threshold level. The higher the input signal goes above this threshold level, the lower the gain is set. This gives virtually constant volume from signals that are at or anywhere above the threshold level.

An ordinary audio compressor should be reasonably effective at combating sudden increases in volume during the advertisements, and should greatly reduce the need for manual adjustment of the volume control. However, an ordinary compressor can be "fooled" by signals having a high average level, because devices of this type normally respond to the peak signal level. Also, an ordinary compressor does not take into account the frequency content of the signal, and responds equally to signals at high, medium, and low frequencies.

The audio compressor described here is specifically designed to deal with loud advertisements and the like. It can operate as a conventional compressor that responds to the peak level of the input signal, but it also has an "average" mode. In this mode the gain is reduced more on strong signals that have a high average level than it is for signals of equal peak amplitude but a lower average level.

With this type of compression the perceived volume of the output signal should remain virtually constant while the input amplitude is above the threshold level. In order to achieve this the peak amplitude of the output signal will actually reduce slightly on signals that have a high average level.

The unit is also designed to be more sensitive to signals at frequencies where human hearing is most sensitive. Again, the amplitude of the output signal will actually be lower for signals that are predominantly at these frequencies, thus avoiding any perceived increase in volume.

The Volume Compressor is designed to fit between the headphone output or "line" output of the television set, and a spare input of a hi-fi amplifier. It should also work well when used with inexpensive amplifier/speakers of the type sold for use with computer sound cards.

Although described here as a monophonic device, for stereo operation it is basically just a matter of building two boards, one to process each stereo channel.

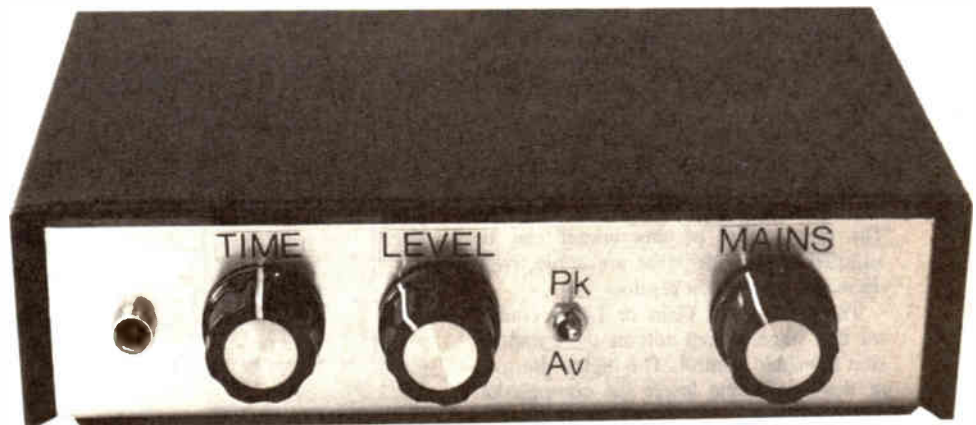

Front panel layout of the completed Volume Compressor.

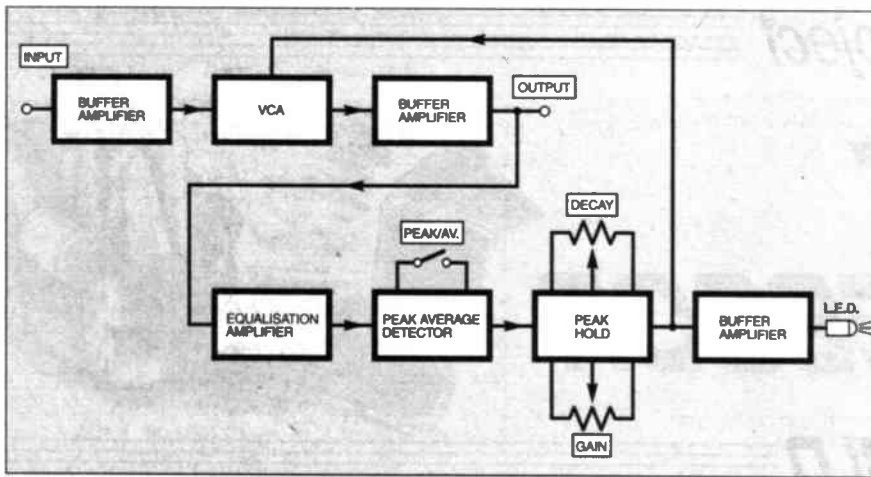

Fig. 1. System block diagram for the Volume Compressor.

SYSTEM OPERATION

The general arrangement used in this unit is a slightly modified version of a conventional audio compressor, as can be seen from the block diagram of Fig. 1. The main signal path is through an input buffer amplifier, a voltage controlled amplifier (v.c.a.), and another buffer stage at the output. The losses through the v.c.a. are normally very low, but they are increased at high volume levels by applying a strong control voltage to the v.c.a.

The control voltage is generated by a side-chain that is fed from the output of the circuit. The first stage in the side-chain is an equalisation amplifier. This equalisation stage boosts the signal to a more useful level, but it provides slightly more gain at middle and lower treble frequencies.

A graph of the relative frequency response of the equalisation amplifier is shown in Fig. 2. This equalisation characteristic was derived from practical tests, and there is scope for individual constructors to search for their ideal response curve.

The next stage is a rectifier and smoothing circuit that can be switched to operate as either a peak level detector or an average type. It provides a positive d.c. output signal that is proportional to either the peak or average level of the input signal.

There is a slight flaw when using the "average" mode in that the variations in gain from the v.c.a. are quite rapid. The time constant of the circuit is kept long enough to avoid problems with distortion, but there could still be audible effects on the output signal.

Simply using a longer time constant would cure this problem, but would make the unit slow to respond to increases in volume. Feeding the output of the detector circuit to a peak-hold stage offers a better solution.

This stage responds almost instantly to increases in the input voltage, but gives a more gradual reduction in the output potential when the input voltage has subsided. The decay time of this circuit can be adjusted to provide what are subjectively deemed to be the best results.

There is also a Gain or Level control for this stage, which acts as the compression threshold control. The higher the gain of the circuit, the lower the compression threshold.

The output of the peak-hold circuit drives the control input of the v.c.a., and also

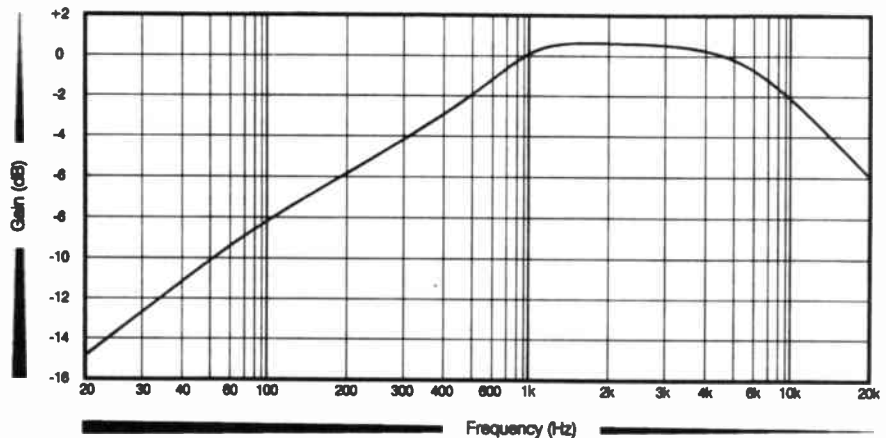

Fig. 2. The relative frequency response of the equalisation stage.

drives an l.e.d. indicator via a buffer stage. The l.e.d. lights up when the input signal exceeds the compression threshold level.

A typical compression characteristic for the unit appears in Fig. 3. The broken line represents the output level that would be obtained with no compression used. The compression is introduced quite abruptly at an input level of about 200 millivolts r.m.s., but it is not introduced so abruptly that the compression becomes too obvious.

CIRCUIT OPERATION

The main circuit diagram for the Volume Compressor is provided in Fig. 4, with the circuit for the mains Power Supply Unit shown separately in Fig. 6. Taking Fig. 4 first, the input buffer amplifier utilizes IC1 as a straightforward unity gain non-inverting amplifier. Resistors R1 and R2 set

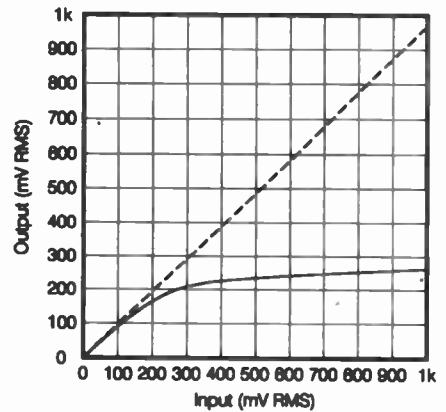

Fig. 3. Graph showing the compression characteristic for the Volume Compressor (1kHz sinewave test signal).

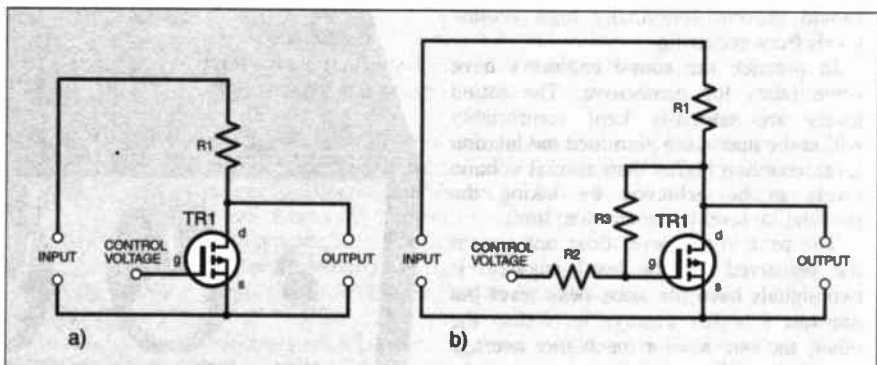

Fig. 5. (a) Circuit diagram for a basic MOSFET v.c.a. and (b) an improved version with feedback to reduce distortion.

the input impedance of the circuit at 50 kilohms.

The v.c.a. is based on a CMOS 4007UBE dual complementary pair and inverter, IC2. In this circuit only one *n*-channel MOSFET is used, and no connections are made to the other sections of the device. The gate, drain, and source connections are at pins 3, 4, and 5 respectively. The device's substrate (pin 7) is connected to the 0V supply rail.

MOSFET ATTENUATION

The *n*-channel enhancement mode MOSFET is used as a form of voltage controlled resistor, which is in turn used in a simple v.c.a. circuit. This is best explained by examining the two basic MOSFET circuits shown in Fig. 5. Fig. 5a shows the circuit for a basic MOSFET v.c.a., which is really just

a conventional potential divider having one section formed by resistor R1, and the other arm provided by the drain-to-source resistance of MOSFET TR1.

Transistor TR1 is switched off when its gate (g) terminal is at a potential of about one volt or less, and it then exhibits a drain(d)-to-source(s) resistance of many megohms. This produces minimal losses through resistor R1, and any losses through this component will be due to the load impedance at the output rather than the affect of TR1.

DISTORTION

If the input voltage to the gate of TR1 is steadily increased, at typically about 1.5V, TR1 will start to conduct, and its drain-to-source resistance then falls quite dramatically. With a gate potential of a few volts the drain-to-source resistance drops to just a few hundred ohms.

Provided resistor R1 is given a suitably high resistance value, this produces a large voltage drop through the circuit due to a simple potential divider action. The circuit therefore provides the required action, with losses through the circuit controlled by the input voltage to TR1.

Unfortunately, there is a major drawback when this type of circuit is applied to audio signals. The resistance provided by TR1 is not pure resistance, and actually varies somewhat with changes in the signal voltage. In an audio application this results in a fair amount of distortion being added to the processed signal.

The distortion is not significant when TR1 is switched off, because its resistance is always too high to have any significant effect on the circuit. The distortion is not very high when TR1 is fully switched on, since its resistance then alters little with changes in the signal voltage.

It is when TR1 starts to conduct that the distortion is worst. When viewed on an oscilloscope there is a very noticeable flattening of the negative half cycles.

FEEDBACK

The standard solution to this problem is to use feedback from the drain (d) to the gate (g) of the transistor, as can be seen in circuit Fig.5b. Resistors R2 and R3 provide feedback from the drain to the gate of TR1, and the amount of feedback is controlled by the ratio of their values.

With too little feedback the negative half cycles remain slightly compressed, but with excessive feedback the distortion is moved to the positive half cycles. Optimum results are usually obtained with these resistors roughly equal in value, but the ideal ratio depends on the type of f.e.t. in use, and probably varies slightly from one sample to another.

Returning to Fig. 4, resistors R4 to R6 are the equivalents of R1, R3, and R2 in Fig.5b. One slight problem in using feedback over the MOSFET is that it couples some of the control voltage into the audio signal path. This coupling can be minimised by including a fairly low value resistor across the input of the v.c.a. (R3), and giving the feedback resistors relatively high values.

Another unity gain non-inverting amplifier, IC3, is used in the output buffer stage. Resistors R7 and R8 set the input impedance at 235k, and this high value ensures that there are minimal losses through resistor R4 when the MOSFET is switched off.

EQUALISATION LEVEL

Capacitor C5 couples some of the output of IC3 to the equalisation amplifier. This is another non-inverting mode circuit, and it is based on IC4. Capacitor C9 shunts feedback resistor R12 at high frequencies, giving increased feedback and the high frequency roll-off.

Capacitor C8 shunts feedback resistor R11 at middle audio frequencies, giving reduced feedback and increased gain. Resistor R13 limits the effect of C8 though, so that the maximum boost is only about 6dB or so.

The output of IC4 is coupled to the level detector circuit by capacitor C10. With switch S1 in the closed (Peak) position this circuit is just a conventional half-wave rectifier and smoothing circuit.

The low source impedance of IC4 ensures that the circuit has a very fast attack time, but the relatively high value of resistor R17 produces a much slower decay time. This gives a charge voltage on smoothing capacitor C11 that reflects the peak level of the input signal.

When switch S1 is open (Average), resistor R15 increases the source impedance for C11, giving a slower attack time that is equal to the decay time. The charge on capacitor C11 then reflects the average input level.

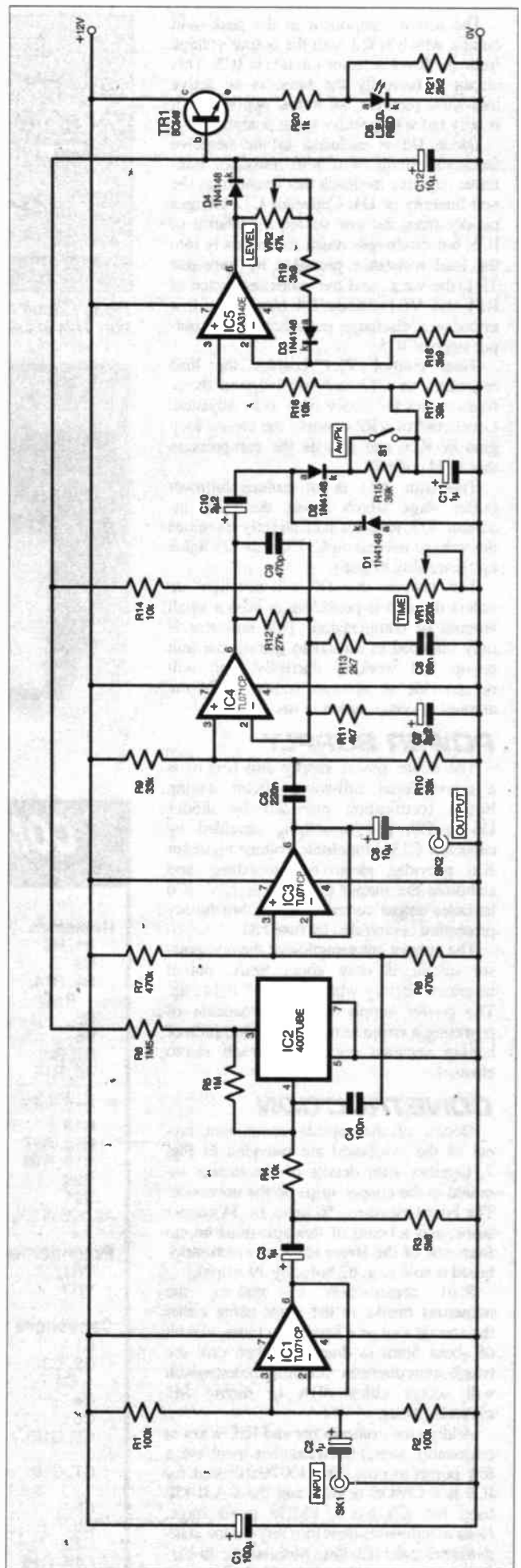

Fig.4. Circuit diagram for the Volume Compressor.

The active component in the peak-hold circuit, which is fed with the output voltage from the level detector circuit, is IC5. This circuit is basically the same as an active half-wave rectifier, but in this application it is only fed with positive input potentials.

Diode D3 is included in the negative feedback circuit of IC5 to introduce non-linear negative feedback that counteracts the non-linearity of D4. Capacitor C12 charges rapidly from the low source impedance of IC5, but discharges much more slowly into the load resistance provided by transistor TR1, the v.c.a., and the series resistance of R14 and VR1. Diode D4 blocks the low impedance discharge path through the output stage of IC5.

Time control VR1 enables the load resistance on C12 to be varied, and therefore enables the decay time to be adjusted. Level control VR2 controls the closed loop gain of IC5, and acts as the compression threshold control.

Transistor TR1 is an emitter follower buffer stage which drives the l.e.d. indicator, D5. Resistor R21 slightly increases the voltage needed on C12 before D5 lights up reasonably brightly.

This ensures that D5 will not light up unless the unit is providing at least a small amount of compression. This indicator is only intended as an aid to getting the unit set-up and working correctly, and will not provide an accurate indication of the amount of compression in use.

POWER SUPPLY

The mains power supply unit (Fig.6) is a conventional full-wave circuit having bridge rectification provided by diodes D6 to D9, and smoothing provided by capacitor C13. Monolithic voltage regulator IC6 provides electronic smoothing and stabilises the output potential at 12V. IC6 includes output current limiting, but further protection is provided by fuse FS1.

The current consumption of the compressor circuit is only about 8mA, but it increases slightly when l.e.d. D5 lights up. The power supply circuit is capable of powering a stereo version of the compressor having separate circuits for each stereo channel.

CONSTRUCTION

Details of the topside component layout of the stripboard are provided in Fig. 7, together with details of the breaks required in the copper strips on the underside. The board measures 56 holes by 34 copper strips, and a board of this size must be cut from one of the larger sizes in which stripboard is sold (e.g. 62 holes by 39 strips).

Start construction by making the numerous breaks in the strips using either the special tool or a hand-held twist-drill bit of about 5mm in diameter. Then drill the two 3.3mm diameter mounting holes, which will accept either 6BA or metric M3 mounting bolts.

Adding the components and link-wires is reasonably straightforward, but there are a few points to note. The 4007UBE used for IC2 is a CMOS device, and the CA3140E used for IC5 has a PMOS input stage. Both components therefore require the standard anti-static handling precautions. In particular, they *must* be mounted in sockets and *should not* be plugged into circuit until the unit is in all other respects finished.

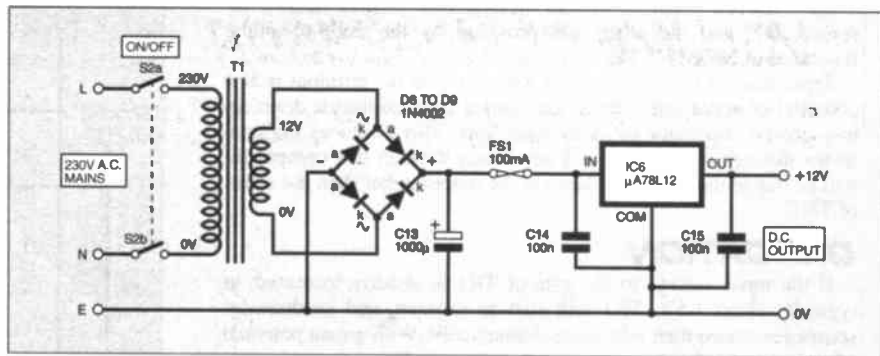
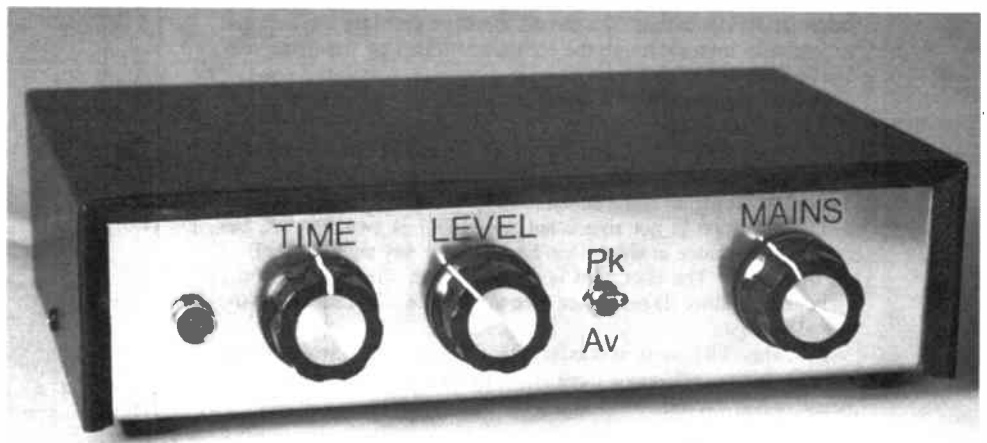

Fig.6. Circuit diagram for a suitable mains power supply for the Volume Compressor. This is capable of powering a stereo version.



COMPONENTS

Approx Cost
Guidance Only

£25

excluding case

Resistors

R1, R2	100k (2 off)
R3	5k6
R4, R14,	
R16	10k (3 off)
R5	1M
R6	1M5
R7, R8	470k (2 off)
R9, R10	33k (2 off)
R11	4k7
R12	27k
R13	2k7
R15, R17	39k (2 off)
R18, R19	3k9 (2 off)
R20	1k
R21	2k2

All 0.25W 5% carbon film

Potentiometers

VR1	220k rotary carbon, lin
VR2	47k rotary carbon, lin

Capacitors

C1	100µ radial elect. 16V
C2, C3,	
C11	1µ radial elect. 50V (2 off)
C4	100n polyester
C5	220n polyester
C6, C12	10µ radial elect. 25V (2 off)
C7, C10	2µ2 radial elect. 50V (2 off)
C8	68n polyester
C9	470p polystyrene
C13	1000µ radial elect. 25V
C14, C15	100n ceramic (2 off)

Semiconductors

D1, D2,	
D3, D4	1N4148 signal diode (4 off)
D5	5mm red panel l.e.d., with holder
D6, D7,	
D8, D9	1N4002 1A 100V rectifier diode (4 off)
TR1	BC549 silicon npn transistor
IC1, IC3,	
IC4	TL071CP bifet op.amp (or similar) (3 off)
IC2	4007UBE CMOS dual comp. pair and inverter
IC5	CA3140E PMOS op.amp
IC6	µA78L12 12V 100mA positive regulator

Miscellaneous

S1	s.p.s.t. min toggle switch
S2	rotary mains switch
SK1, SK2	phono socket (2 off)
T1	standard mains primary, 12V 100mA secondary transformer (see text)
FS1	100mA 20mm "quick-blow" fuse
Metal instrument case, size 200mm x 130mm x 52mm; 0.1 inch pitch stripboard having 56 holes by 34 strips; 8-pin d.i.l. holder (4 off); 14-pin d.i.l. holder; control knob (2 off); 20mm fuse-holder; mains lead and plug fitted with 2A fuse; multi-strand connecting wire; solder pins; solder, etc.	

See
SHOP
TALK
Page

VOLUME COMPRESSOR

Fig.7. Stripboard component layout, interwiring to off-board components and details of breaks required in the underside copper strips.

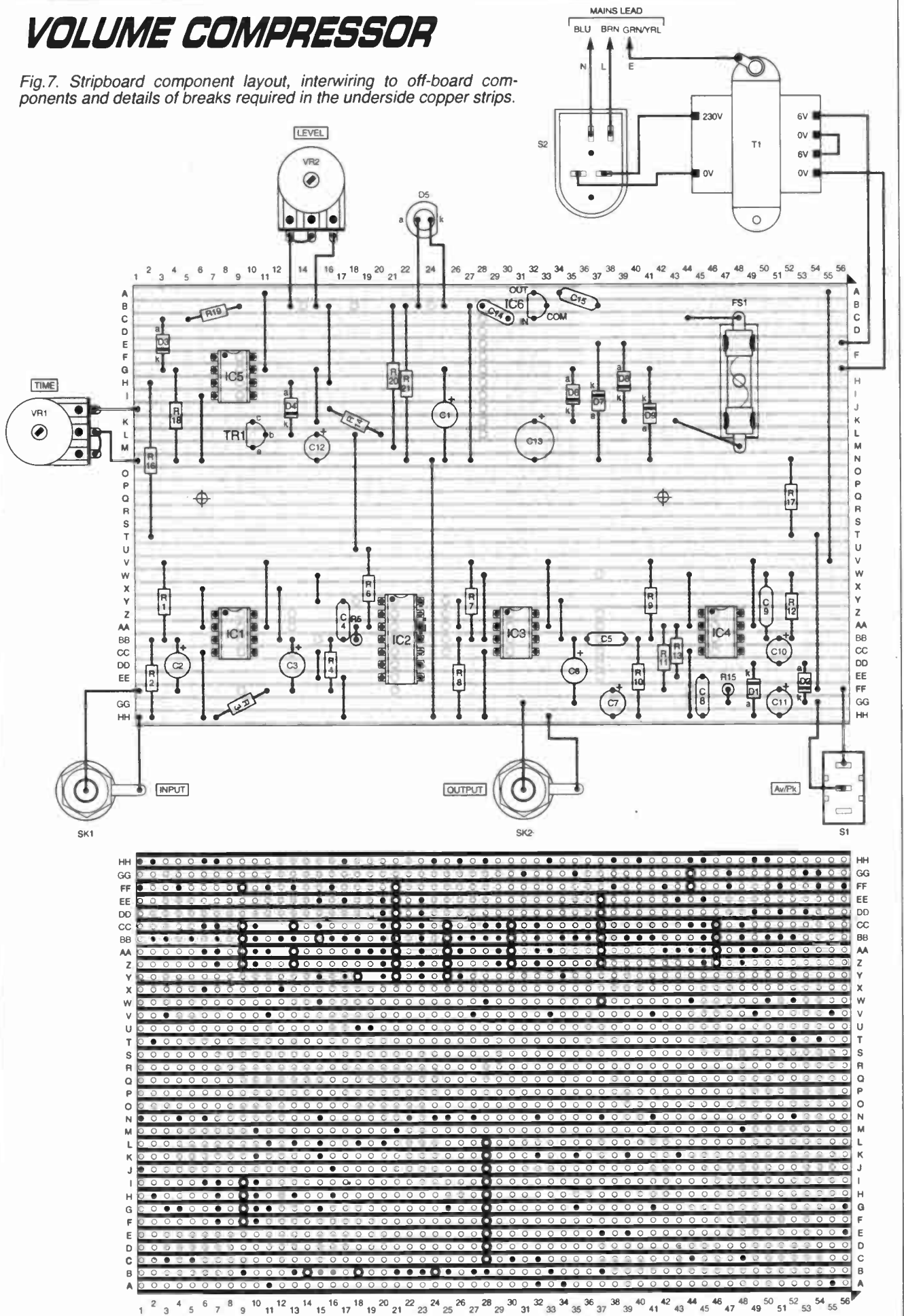

Fuse FS1 is mounted in a chassis mounting fuseholder, which is bolted to the component panel using a short M3 or 6BA bolt and fixing nut. These are not normally supplied with the fuseholder.

Some of the link-wires are quite long, and it is advisable to insulate these with p.v.c. sleeving to ensure that no accidental short circuits occur. The component layout is designed to accept polyester capacitors that have 7.5mm (0.3 inch) lead spacing, and it could be difficult to use types having a different spacing.

CASE DETAILS

As this project is mains powered it *must* be housed in a **METAL** case that has a screw fitting lid or cover and not some form of clip-on type that would provide easy access to the dangerous mains wiring. A medium size instrument case is probably the best type to use.

Also, the case must be reliably earthed to the mains Earth lead. A solder tag fitted on one of the mains transformer's mounting bolts makes a good connection point for the mains earth lead.

When designing the layout of the unit try to keep mains transformer T1 and the mains wiring well separated from the rest of the circuitry. It is best to mount phono sockets SK1 and SK2 on the rear panel so that the input and output leads are kept well out of the way where they will not hamper attempts to use the front panel controls.

The hard wiring between the circuit board and off-board components is also shown in Fig. 7. While this is all pretty simple, as the mains supply is involved it is *essential* to take great care with the wiring, and to thoroughly double-check it once it has been completed.

Projects that connect to the mains supply are potentially lethal, and should not be constructed by beginners unless an experienced constructor properly supervises them.

STEREO COMPRESSION

For a stereo version of the unit two circuit boards must be constructed, but only one set of power supply components is required since one supply unit is capable of powering two boards. Therefore, omit C13, C14, C15, IC6, and diodes D6 to D9 from the second board. Of course, the supply rails of the two boards must be linked so that one board is powered from the other.

Potentiometers VR1 and VR2 can be separate controls in the two stereo channels, but there is no obvious advantage in this. It would be better to use dual-gang pots so that the two channels can be adjusted in unison.

Either a much larger metal case will be required for a stereo unit, or the two circuit boards must be stacked one above the other. This approach will require much longer mounting bolts plus extra spacers to hold the boards well apart. The lower board must be wired to the controls, etc. before the upper board is added.

IN USE

If the unit is fed from the Headphone socket of the television set, the Volume control of the TV must be well advanced so

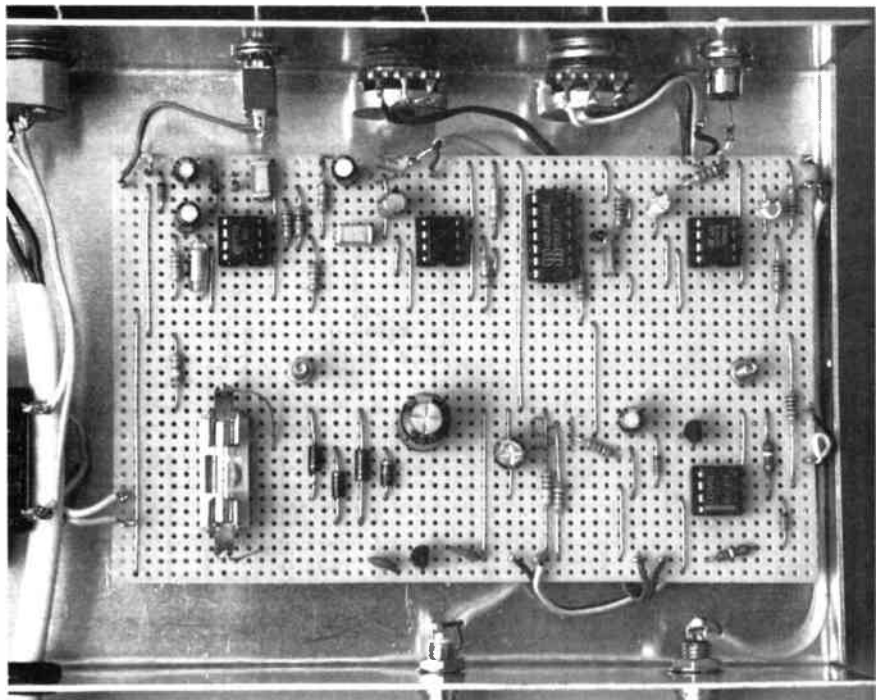

The completed circuit board and wiring to the front and rear panel mounted components.

that the compressor receives a reasonably high input level. The Volume Compressor is connected to the television and the amplifier by way of screened leads, and it may be necessary to make up these leads yourself, depending on the connectors fitted to the amp. and the TV set. Alternatively, it might be possible to use ready-made leads if phono sockets SK1 and SK2 are changed to a different type such as 3.5mm jack sockets.

The input signal should be coupled through the unit with no significant loss of quality if it is functioning correctly. If there is any sign of a malfunction, switch off at once and recheck the wiring, etc. Initially, have mode switch S1 set to the Average (open) position.

Assuming all is well, Level control VR2 should be advanced just far enough to make l.e.d. D5 light up on volume peaks.

This should give sufficient compression to "tame" excessively loud signals, but VR2 can be advanced further to provide more compression as desired. However, using a large amount of compression tends to make the processing fairly obvious, with a clear increase in the background noise level during quiet passages.

The best setting for Time (decay) control VR1 is largely a matter of personal preference. A short decay time enables the unit to rapidly follow variations in the input level and is in some ways preferable to a longer decay time, but the effect obtained is not to everyone's liking.

The unit is likely to work best with switch S1 at the Average setting, but it is worth trying it at the Peak setting. Note that there will be a drop in the output level when the "peak" mode is used, and that Level control VR2 will need readjustment. □

Layout of components inside the metal instrument case and wiring to the mains transformer and switch. Note a "strain relief" grommet must be used at the mains cable entry hole.

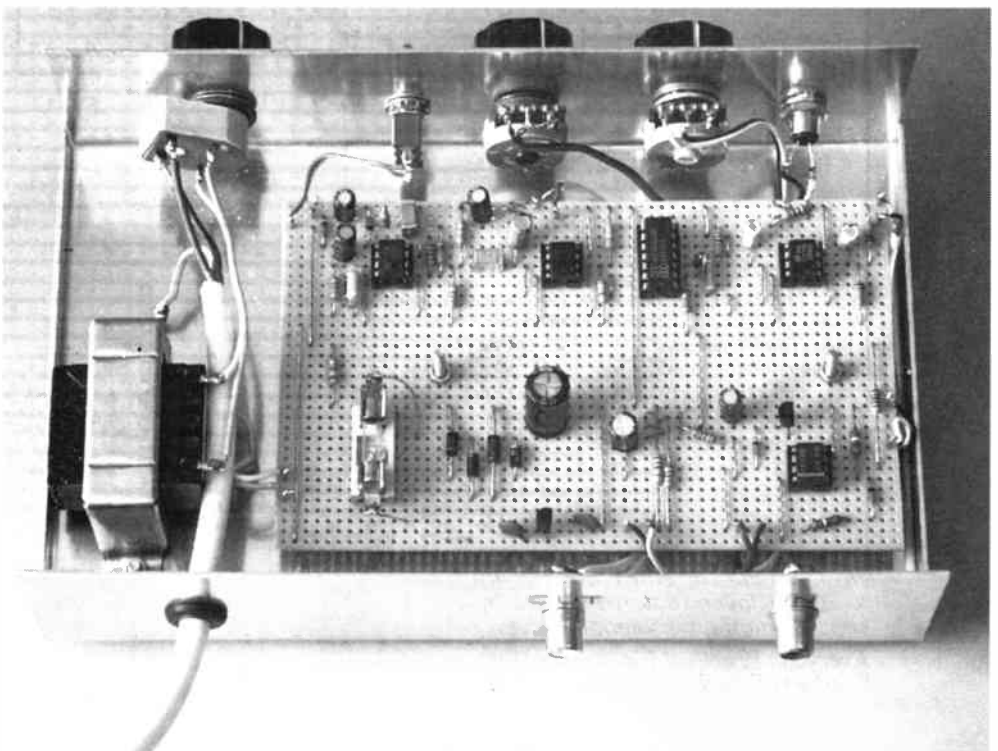

INGENUITY UNLIMITED

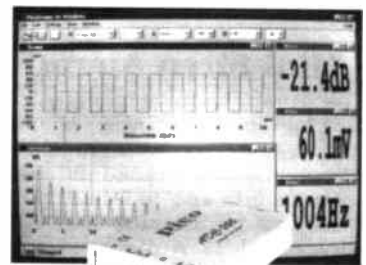

WIN A PICO PC BASED OSCILLOSCOPE

- 50MSPS Dual Channel Storage Oscilloscope
- 25MHz Spectrum Analyser
- Multimeter
- Frequency Meter
- Signal Generator

If you have a novel circuit idea which would be of use to other readers then a Pico Technology PC based oscilloscope could be yours.

Every six months, Pico Technology will be awarding an ADC200-50 digital storage oscilloscope for the best IU submission. In addition, two single channel ADC-40s will be presented to the runners up.

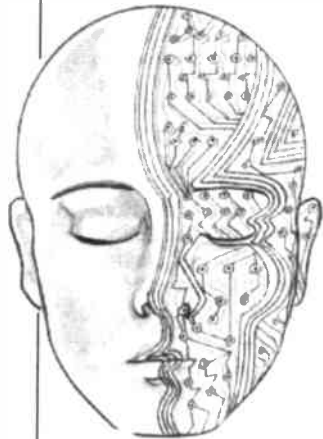

Our regular round-up of readers' own circuits. We pay between £10 and £50 for all material published, depending on length and technical merit. We're looking for novel applications and circuit tips, not simply mechanical or electrical ideas. Ideas *must be the reader's own work* and **not have been submitted for publication elsewhere**. The circuits shown have NOT been proven by us. *Ingenuity Unlimited* is open to ALL abilities, but items for consideration in this column should preferably be typed or word-processed, with a brief circuit description (between 100 and 500 words maximum) and full circuit diagram showing all relevant component values. **Please draw all circuit schematics as clearly as possible.**

Send your circuit ideas to: Alan Winstanley, *Ingenuity Unlimited*, Wimborne Publishing Ltd., Allen House, East Borough, Wimborne, Dorset BH21 1PF. They could earn you some real cash and a prize!

Using Solenoid Valves in Place of Motorized Valves

THE CIRCUIT diagram of Fig.1 originated when a complex motorized analogue steam-valve became defective in an industrial process. The valve required 4mA as a command for "fully close" and 20mA for "fully open". This had to be replaced by an on-off solenoid valve and a current-controlled interface circuit would therefore be needed to avoid altering the existing control system.

The heart of the circuit is IC1, a TL494 switch mode p.s.u. chip. The output pulse width at pin 11 varies in proportion to the analogue voltage at pin 3. Since a range of 500mV to 3.5V at pin 3 corresponds to 96% to 0% pulse-width respectively at pin 11, we need to "re-map" V_{in} such that when $V_{in} = 2V$ (4mA input), we get zero pulse width and for $V_{in} = 10V$ (20mA input) we obtain maximum pulse width (T seconds).

The re-mapping is handled by IC2a to IC2c. The values of resistor R8 and capacitor C2 determine T according to the approximate formula $T = (R8 \times C2) / 1.1$ - i.e. around 90 seconds.

Since only 96 per cent maximum pulse width is obtainable and not 100 per cent, a glitch operation of the valve will result in these maximum pulse-width cases. To counteract this problem, IC2d is an oscillator of period T_y ; this and latch IC3a ensure the valve will remain in any one state for at least T_y seconds, say 1 second.

The circuit was tested without resistor R7 (i.e. $R7 = 0\Omega$), but since the data sheet specifies $10\mu F$ for C2 minimum, the addition of 47Ω for R7 should improve reliability. Note that as V_{in} changes, the output pulse width at pin 11 changes simultaneously, and it does not need to wait until the next cycle from the TL494.

If your 12V supply has a soft-start then power should rise to 90% of 12V within 10ms of power-up. Fortunately, this is the case for most power supplies.

Naseer Ahmad,
London, NW6.

Fig.1. Circuit for substituting a 4mA to 20mA driven motorized valve by a simple on/off type solenoid valve.

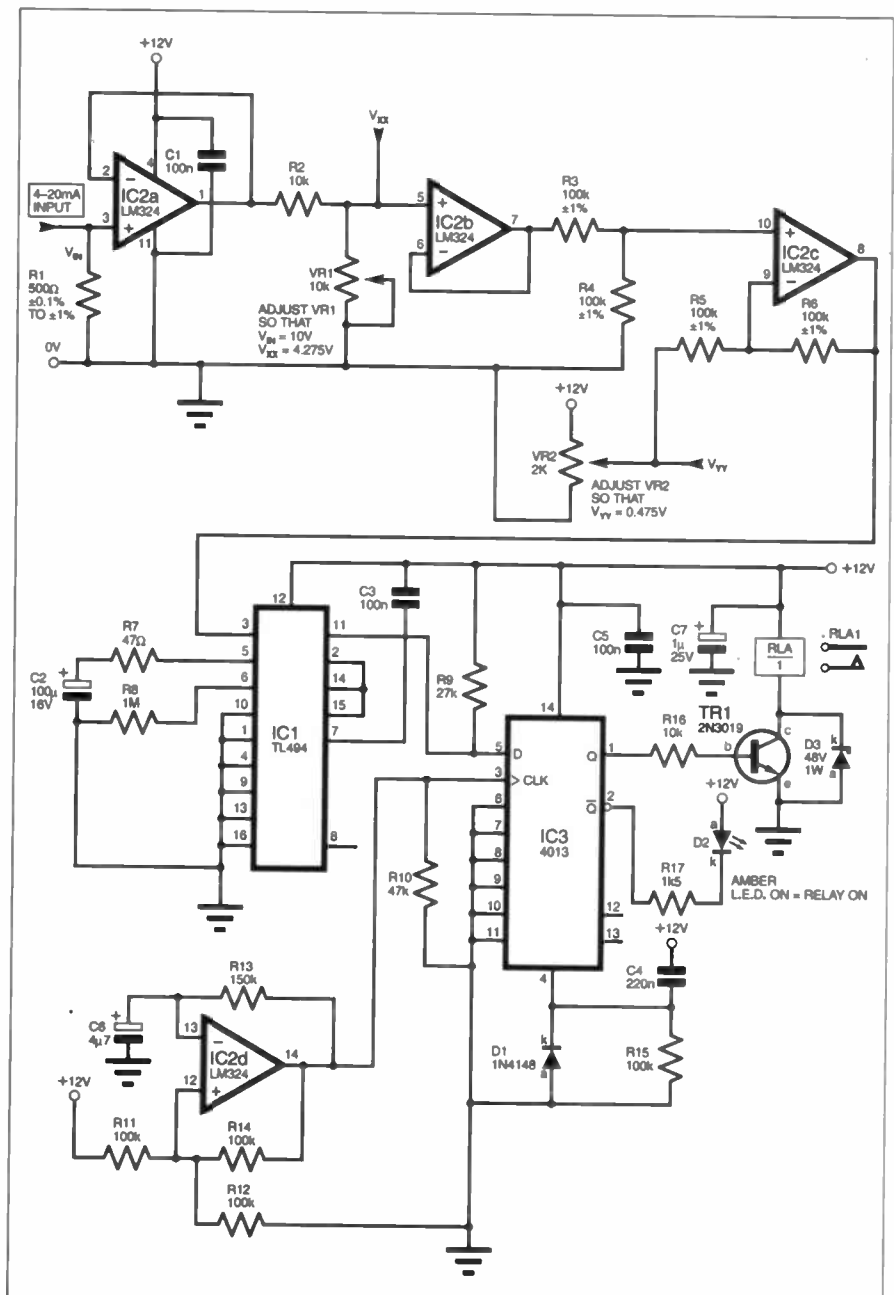

Mini Siren Alarm

- A Wail of a Time

THE CIRCUIT diagram of Fig.2 was designed in order to simulate the screeching of a standard car alarm. It can operate from a 5V to 9V d.c. power source and can be integrated into other alarm systems. IC1a is configured as a square wave oscillator the output of which is buffered by another NAND gate, IC1b. This drives D1, a light-emitting diode which flashes.

A standard 555 timer, IC2, is wired slightly differently from the usual method, in order to generate a 50% duty cycle. This directly drives the loudspeaker LS1, and a Mylar-cone type could perhaps be used for outdoor applications.

The control voltage terminal (pin 5) of IC2 is connected to the timing capacitor C1 where a continuously changing ramp voltage is present. This is used to modulate the frequency of the 555 timer and it gives the alarm its attention-grabbing sound.

During its normal "standby" state, the input pin of IC1a is pulled low by resistor R1, so the NAND oscillator and the 555 timer are disabled. When a positive voltage is applied to pin 1 of IC1a the alarm will sound. The output could be fed to an amplifier to generate a higher output if desired.

Lawrence Mercer (age 14),
Fife, Scotland.

Before submitting your idea:

Please be brief and to the point with written material, which should be typed or word-processed and limited to approximately 100-500 words. Drawings should be clear and conform as much as possible with the EPE house style. Please avoid a lengthy introduction as preamble would of necessity be edited down, but you should include relevant information and describe the operation of major relevant components in your own words. **Entries are not accepted on computer diskettes or by E-mail.**

Material should **NOT** be submitted simultaneously elsewhere for publication. Readers are advised that it is the practice of the Publishers to purchase All Rights to any articles used without exception, and successful entrants will be requested to sign a written disclaimer agreeing to this. Please note that it may be impossible to cancel articles from the publication schedule if that item is already in the process of going to press. - ARW.

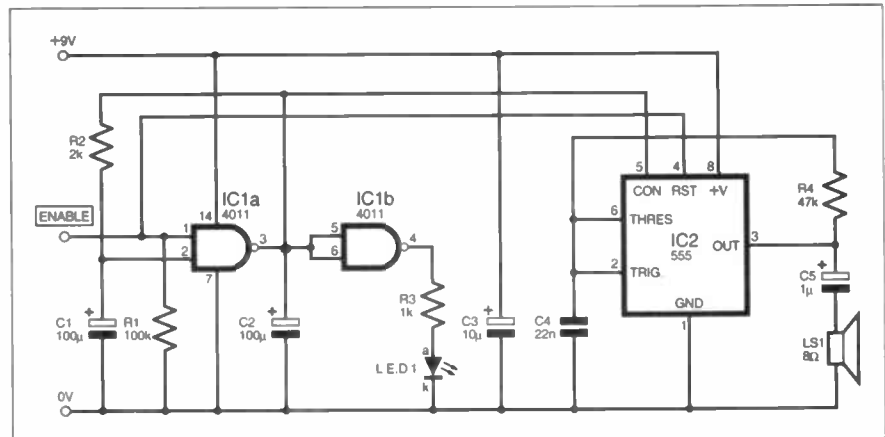

Fig.2. Circuit diagram for the Mini Siren Alarm.

Cooling Monitor for Outboard Engines

- Keeps You Motoring

MOST outboard motors discharge their cooling water through a small-diameter pipe placed high on the engine casing. It is

important to monitor this process to ensure that cooling water flow is constant at all times, in order to reduce the risk of engine damage. However, it has become common practice to build engines into cockpit lockers to reduce smell and noise emissions, which makes this monitoring process harder.

The simple circuit diagram for an Outboard Motor Cooling Monitor shown in Fig. 3 helps alleviate this. A plastic funnel is positioned on the water outlet and when cooling water flows through, it bridges two

contacts on the funnel's spout, which turns on a simple transistor switch TR1. The l.e.d. D1 illuminates to confirm that cooling water is flowing.

The circuit can be built into a small box and powered by two AA cells for many months without the need for an on-off switch or l.e.d. series resistor. The "probes" were a pair of brass screws and nuts fitted to the funnel.

Bernard Miers,
Pedwell, Somerset.

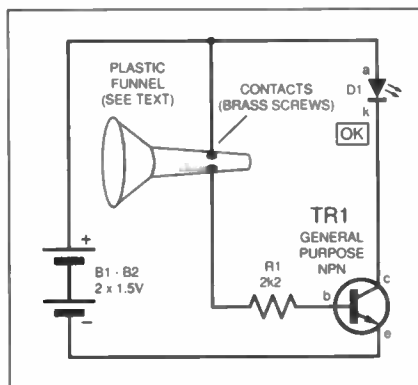

Fig.3 (left).
Circuit diagram
for a simple
outboard motor
coding monitor.

INGENUITY UNLIMITED

BE INTERACTIVE

IU is your forum where you can offer other readers the benefit of your Ingenuity. Share those ideas and earn some cash and possibly a prize!

Quad speed Toshiba 1/3rd height SCSI cd-rom drives	£20 each, 6 for £100	1-2MB 5 1/4" floppy drive	£10
1 meg. 30-pin parity simms...	£3.75 each, 4 for £12	12V d.c. 200 r.p.m. geared motor	£1.50 each, 10 for £12
4 meg. 30-pin parity simms...	£13 each, 4 for £50	SCSI 2 fast differential hard drives	
256k pipeline burst cache	£4.50 each	1 Gig	£58
512k pipeline burst cache	£9 each	2 Gig	£85
Trident 512k video cards	£12 each	4 Gig	£145
Trident 1mb VLB video cards	£20 each	1 Gigabyte laptop drives, 2 1/2" IDE	£78 each
Internal VGA leads	£2.50 each, 10 for £20		
3-device SCSI leads	£3 each		
IDE leads	£2 each		
Hard and floppy drive IDE controller cards	£5		
14,400 internal voice/fax/data modem	£15		
28,800 internal voice/fax/data modem	£28		
3lb mixed component pack	£4.95		
Jumbo component pack	£10		
250 off mixed capacitors	£4.95		
250 off i.c. sockets	£3.95		
1000 off mixed ceramic caps	£7.50*		
20 off mixed crystals/filters	£4.95		
25 off mixed relays	£3.50		
Brand new 360k 5 1/4" floppy drive	£4.50		
5 1/4" to 3 1/2" floppy drive converter leads	£1.50*		

QUANTITY DISCOUNTS AVAILABLE PLEASE RING.

We also buy all forms of electronic components, p.s.u.'s, disk drives etc. Lists to below address.

ALL PRICES INCLUDE V.A.T.
PLEASE ADD £2.00 p&p EXCEPT
ITEMS MARKED * WHICH ARE 50P.
SAE FOR BULK BUYING LIST
PAYMENT WITH ORDER TO:
Dept EE, COMPELEC,
14 Constable Road,
St. Ives, Huntingdon,
Cambs PE17 6EQ
Tel/Fax: 01480 300819

• OSCILLOSCOPE SALE •

HP 1740A, 100MHz, 2-channel + trig view, delay sweep, extensive trig facilities, £340
Schlumberger 5220, 100MHz, 3-channel, delay sweep, digital readout, built-in DVM, £340
Phillips PM3267P, 100MHz, 2-channel + trig view, delay sweep, mains or 20V-30V d.c., £350
Trio CS2110, 100MHz, 4-channel, delay sweep, £300
TEK 7603, 100MHz, 4-channel, delay sweep, on screen readout, 7A26 dual channel amps, £280
TEK 7603, 70MHz, 4-channel, delay sweep, on screen readout, 7A18 dual channel amps, £250
HP1707, 2-channel, delay sweep, and x10 magnifier, mains or 12V-36V d.c., can be fitted with internal battery pack for true portable use, £280
Tequipment D63, 50MHz, 2-channel, delay sweep, with x5 mag on Y and x10 mag on X, works well but delay/timebase knob is cracked/hard to read, so £180
Scopex 14D15, 15MHz, 2-channel, x10 magnifier, modem scope, GWO, £125
TEK 422, 20MHz, 2-channel, x10 magnifier, old but useful, £75
TEK 531A, valve scope, with several plug ins, inc Spect Anal, working but needs service, £25
Add storage to your scope - Datalab DL905 transient recorder, GWO £35
Lyons pulse generator, type PG-2E, 1Hz-10MHz, variable frequency, width, etc., £30
Advance A.P. sine/square generator, Type H, 10Hz-50KHz, £20
Racal Universal Counter, Model 835, max. freq. 15MHz, measures frequency, period, ratio of two frequencies, time interval etc., 6 Nixie tube display, £25
Farnell variable power supply, single meter, 30V/0-5A, £15

No VAT required. Carriage at cost. Call to arrange a demonstration

ARRAN TECHNOLOGY LTD - 0116 2717516

QUASAR
Electronics

Product data
FAX back
01279 832269

NEW!

PROJECT KITS

COMBINATION LOCK Versatile electronic lock comprising main circuit & separate keypad for remote opening of lock. Relay supplied. 3029-KT £8.95

LIGHT ALARM Protect your valuables. Alarm sounds if circuit detects smallest amount of light. Place in cash box etc. 3008-KT £4.50

ALARM SIREN 110db of ear piercing noise. PCB fits in box with has 2 x 35mm piezo elements built into their own resonant cavity. Use as an alarm siren or just for fun! 6-9VDC. 3015-KT £8.75

LED COUNTER 3 digit basic event counter circuit on main board. Count & Reset switches & debounce circuit on 2nd. Cascade 2 or 3 kits for more digits. Box provided. 3001-KT £12.95

FUNCTION GENERATOR Quad Op-Amp oscillator & wave shaper circuit generates audio range square waves (1kHz-8kHz), triangle & pseudo sine outputs. 9VDC. 3023-KT £4.25

LOGIC PROBE tests CMOS & TTL circuits & detects fast pulses. Visual & audio indication of logic state. Full instructions supplied. 3024-KT £7.75

ROULETTE LED 'Ball' spins round the wheel, slows down & drops into a slot. 10 LED's, CMOS decade counter & Op-Amp. Educational & fun! 3006-KT £9.75

PELLIER JUNCTION HEAT PUMP Boil & freeze water instantly. Use for regulated cooling of temperature sensitive components & much more. Heatsink required. 3006-KT £18.50

9V XENON TUBE FLASHER Transformer circuit steps up 9V battery supply to flash the 25mm long Xenon tube. Adjustable flash rate (0.25-2 Sec's). 3022-KT £16.95

LM383 AUDIO AMPLIFIER Popular module for any general (Class B) audio application. Typ. output 10W @ 16V & 2W speaker; 1W @ 9V & 8W. 3047-KT £9.25

LED FLASHER 5 ultra bright red LED's flash in sequence or randomly. Ideal for model railways. 3052-KT £4.50

MULTI SEQUENCE LED FLASHER same as 3052-KT above but you have 7 patterns to choose from. 3037-KT £4.50

LED DICE Classic intro to electronics & circuit analysis. 7 LED's simulate dice roll, slow down & land on a number at random. 555 IC circuit. 3003-KT £7.75

DUAL LED DICE PIC 16C54 circuit performs similar function to 3003-KT above but two dice. Good intro to micro-controllers. Software code supplied on disk. 3017-KT £16.25

16C84 PIC PROGRAMMER Reads, programs & verifies. Uses any PC parallel port. All hardware, software & documentation needed to learn & test this IC provided. 3081-KT £25.50

STAIRWAY TO HEAVEN Tests hand-eye co-ordination. Press switch when green segment of LED lights to climb the stairway - miss & start again! Good intro to several basic circuits. 3005-KT £7.75

SPEED CONTROLLER for any common DC motor up to 100V/5A. Pulse width modulation gives maximum torque at all speeds. 5-15VDC. 3087-KT £17.50

3V/1.5V TO 9V BATTERY CONVERTER Replace expensive 9V batteries with economic 1.5V batteries. IC based circuit steps up 1 or 2 'AA' batteries to give 9V/1.5V. 3035-KT £4.75

AM RADIO KIT Tuned Radio Frequency front-end, single chip AM radio IC & 2 stages of audio amplification. All components inc. speaker provided. PCB 32x102mm. 3063-KT £8.95

TRAIN SOUNDS 4 selectable sounds - whistle blowing, level crossing bell, chugging, & 'clackety-clack'. All components inc. speaker supplied. 5G1 £4.50

AUDIO TO LIGHT MODULATOR Controls intensity of one or more lights in response to an audio input. Safe, modern opto-coupler design. Means voltage experience required. 3012-KT £5.75

THREE TIMER CIRCUITS in one kit! 3 PCB's & all components to make timers for a few seconds or up to 21 years! Onboard relay outputs. 3085-KT £19.25

8 CHANNEL IR TX/RX Controls 8 relays using IR remote control unit. 3072-KT £54.95

TELEPHONE ACTIVATED SWITCH Control 4 relays from anywhere in world by phone. (Not BT approved). 3086-KT £58.95

10W STEREO AMPLIFIER MODULE Uses TDA2009 class AB audio power amp IC designed for quality stereo applications. 3088-KT £9.95

17W BRIDGE AMPLIFIER 40W of 'brute' power @ 12VDC, into 4W speakers. Ideal car booster amp. 3091-KT £7.95

STEREO VU METER shows peak music power using 2 rows of 10 LED's (green, yellow, red) moving bar display 0-30db. 3089-KT £10.95

IR REMOTE TOGGLE SWITCH Use any remote control unit to switch onboard relay on/off. 3058-KT £9.50

PC DATA ACQUISITION UNIT Enables your PC to monitor & control external events & devices through it's parallel port. 3093-KT £99.95

PIC 16C71 FOUR SERVO MOTOR DRIVER Independently control 4 servo motors (not supplied). 3102-KT £16.75

UNIPOLAR STEPPER MOTOR DRIVER for any 5, 6 or 8 lead motors. 3 run modes. 3109-KT £17.50

LASER POINTER KIT 5mW Hitachi 670nm red laser diode. Attractive plastic case supplied. 3070-KT £49.95

ULTRASONIC MOVEMENT DETECTOR Xtal controlled oscillator, detector circuit & edge mounted transducers on a 75x40mm PCB. 4-7m range. Adjustable sensitivity. Outputs to drive external relay/circuits. 9VDC. 3049-KT £12.95

plus AUDIO • EDUCATIONAL • LASER • SECURITY • TEST GEAR • BOOKS • more

Our high quality project kits are supplied with all components, fibre glass PCB's & comprehensive instructions. **FREE CATALOGUE** with order or send 2 x 1st Class stamps (refundable) for details of over 100 kits & publications. Mail order only. Please ADD £2.00 P. & P. to all orders (Europe £3, Rest of World £4) & make cheques/PO's payable to Quasar Electronics. Goods normally despatch within 5 working days but please allow 28 days for delivery. Prices include VAT at 17.5%.

Quasar Electronics Unit 14 Sunningdale BISHOP'S STORTFORD Herts CM23 2PA
Tel./Fax 01279 306504 E-mail: epeales@quasar-electronics.freeserve.co.uk
Web site: <http://www.quasar-electronics.freeserve.co.uk>

SURVEILLANCE

High performance surveillance kits Room transmitters supplied with sensitive electret microphones & battery holders/clips. All transmitters can be received on an ordinary VHF FM radio.

MTX - Miniature 3V Transmitter Easy to build & guaranteed to transmit 500 metres (over 1000m possible with high voltage & better aerial). 3-9V operation. Only 45x18mm. 3007-KT £4.95

MRTX - Miniature 9V Room Transmitter Our best selling 'bug'. Super sensitive, high power 1000m range (Up to 2 miles with 18V supply & better aerial). 9V operation. 45x19mm. 3018-KT £5.95

HPTX - High Power Room Transmitter High performance, 2 stage transmitter gives greater sensitivity & high quality reception. 1000m range with 9V battery, 6-12V operation. On/off switch. Size 70x15mm. 3032-KT £8.95

VTX - Voice Activated Transmitter Powerful 2 stage voice activated transmitter. Only operates when sounds are detected. 10m range. Low standby current - conserves battery power. Adjustable sensitivity & turn-off delay. Only 63x30mm. 3026-KT £7.95

TRI - Telephone Recording Interface Connect between phone line & cassette recorder. Automatic-ally switches on tape when phone is used. Records all conversations. Powered from line. 48x32mm. 3033-KT £5.95

TRVS - Tape Recorder Vox Switch Very sensitive, voice activated switch - automatically turns on cassette recorder when sounds are detected. Adjustable sensitivity & turn-off delay. 115x19mm inc. mic. 3013-KT £8.95

MTTX - Miniature Telephone Transmitter Attaches anywhere to phone line. Transmits only when phone is used! Uses phone line as aerial & power source. 500m range. 45x15mm. 3016-KT £4.95

Two Station Intercom/Hard Wired Bug Each unit has its own speaker, microphone & amplifier (LM386). Turn into a hard wired bug by using 4 stand ribbon cable supplied to send power from the receiving unit to the remote 'bug' unit. 9V. 3021-KT £11.75

Telephone Amplifier Kit Pick-up coil & sensitive amplifier let you hear conversations without even holding the phone! Can be used for surveillance purposes. 3055-KT £9.25

Two Station Intercom/Hard Wired Bug Each unit has its own speaker, microphone & amplifier (LM386). Turn into a hard wired bug by using 4 stand ribbon cable supplied to send power from the receiving unit to the remote 'bug' unit. 9V. 3021-KT £11.75

Telephone Amplifier Kit Pick-up coil & sensitive amplifier let you hear conversations without even holding the phone! Can be used for surveillance purposes. 3055-KT £9.25

Telephone Amplifier Kit Pick-up coil & sensitive amplifier let you hear conversations without even holding the phone! Can be used for surveillance purposes. 3055-KT £9.25

Telephone Amplifier Kit Pick-up coil & sensitive amplifier let you hear conversations without even holding the phone! Can be used for surveillance purposes. 3055-KT £9.25

Telephone Amplifier Kit Pick-up coil & sensitive amplifier let you hear conversations without even holding the phone! Can be used for surveillance purposes. 3055-KT £9.25

Telephone Amplifier Kit Pick-up coil & sensitive amplifier let you hear conversations without even holding the phone! Can be used for surveillance purposes. 3055-KT £9.25

Telephone Amplifier Kit Pick-up coil & sensitive amplifier let you hear conversations without even holding the phone! Can be used for surveillance purposes. 3055-KT £9.25

Telephone Amplifier Kit Pick-up coil & sensitive amplifier let you hear conversations without even holding the phone! Can be used for surveillance purposes. 3055-KT £9.25

Telephone Amplifier Kit Pick-up coil & sensitive amplifier let you hear conversations without even holding the phone! Can be used for surveillance purposes. 3055-KT £9.25

Telephone Amplifier Kit Pick-up coil & sensitive amplifier let you hear conversations without even holding the phone! Can be used for surveillance purposes. 3055-KT £9.25

Telephone Amplifier Kit Pick-up coil & sensitive amplifier let you hear conversations without even holding the phone! Can be used for surveillance purposes. 3055-KT £9.25

Telephone Amplifier Kit Pick-up coil & sensitive amplifier let you hear conversations without even holding the phone! Can be used for surveillance purposes. 3055-KT £9.25

Telephone Amplifier Kit Pick-up coil & sensitive amplifier let you hear conversations without even holding the phone! Can be used for surveillance purposes. 3055-KT £9.25

Telephone Amplifier Kit Pick-up coil & sensitive amplifier let you hear conversations without even holding the phone! Can be used for surveillance purposes. 3055-KT £9.25

Telephone Amplifier Kit Pick-up coil & sensitive amplifier let you hear conversations without even holding the phone! Can be used for surveillance purposes. 3055-KT £9.25

Telephone Amplifier Kit Pick-up coil & sensitive amplifier let you hear conversations without even holding the phone! Can be used for surveillance purposes. 3055-KT £9.25

Telephone Amplifier Kit Pick-up coil & sensitive amplifier let you hear conversations without even holding the phone! Can be used for surveillance purposes. 3055-KT £9.25

Telephone Amplifier Kit Pick-up coil & sensitive amplifier let you hear conversations without even holding the phone! Can be used for surveillance purposes. 3055-KT £9.25

Telephone Amplifier Kit Pick-up coil & sensitive amplifier let you hear conversations without even holding the phone! Can be used for surveillance purposes. 3055-KT £9.25

Telephone Amplifier Kit Pick-up coil & sensitive amplifier let you hear conversations without even holding the phone! Can be used for surveillance purposes. 3055-KT £9.25

Telephone Amplifier Kit Pick-up coil & sensitive amplifier let you hear conversations without even holding the phone! Can be used for surveillance purposes. 3055-KT £9.25

Telephone Amplifier Kit Pick-up coil & sensitive amplifier let you hear conversations without even holding the phone! Can be used for surveillance purposes. 3055-KT £9.25

Telephone Amplifier Kit Pick-up coil & sensitive amplifier let you hear conversations without even holding the phone! Can be used for surveillance purposes. 3055-KT £9.25

Telephone Amplifier Kit Pick-up coil & sensitive amplifier let you hear conversations without even holding the phone! Can be used for surveillance purposes. 3055-KT £9.25

Computer Controlled Robotics

Bring Electronics to Life



3 Axis Arm £115



Carpet Rover £89



5 Axis Arm £139



Mobile Arm £179



Hexapod Walker £110



Micro Mouse £79

Technology Education Index

Telephone for our catalogue or visit our web site for further details

40 Wellington Road, Orpington, Kent BR5 4AQ
Telephone - (01689) 876880
Web Site - <http://www.technologyindex.com>
Prices exclude VAT and £5.00 next day carriage





X-FACTOR

THE EXPERTS IN RARE & UNUSUAL INFORMATION!

Full details of all X-FACTOR PUBLICATIONS can be found in our catalogue. N.B. Minimum order charge for reports and plans is £5.00 PLUS normal P&P

SUPER-EAR LISTENING DEVICE Complete plans to build your own parabolic dish microphone. Listen to distant voices and sounds through open windows and even walls! Made from readily available parts. R002 £3.50

TELEPHONE BUG PLANS Build your own micro-beetle telephone bug. Suitable for any phone. Transmits over 250 metres - more with good receiver. Made from easy to obtain, cheap components. R008 £2.50

LOCKS - How they work and how to pick them. This fact filled report will teach you more about locks and the art of lock picking than many books we have seen at 4 times the price. Packed with information and illustrations. R008 £3.50

RADIO & TV JOKER PLANS We show you how to build three different circuits for disrupting TV picture and sound plus FM radio! May upset your neighbours & the authorities!!

DISCRETION REQUIRED. R017 £3.50
INFINITY TRANSMITTER PLANS Complete plans for building the famous Infinity Transmitter. Once installed on the target phone, device acts like a room bug. Just call the target phone & activate the unit to hear all room sounds. Great for home/office security! R019 £3.50

THE ETHER BOX CALL INTERCEPTOR PLANS Grabs telephone calls out of thin air! No need to wire-in a phone bug. Simply place this device near the phone lines to hear the conversations taking place! R025 £3.00

MINI CCTV CAMERA Latest high quality IR-sensitive monochrome camera module for Video Intercom CCTV, Surveillance etc. Simply plug into scart or video. Six on-board IR LED's. Less than half the size of a cigarette packet!

ASSEMBLED UNIT: 30A7-AS £69.95

FEATURES
* Compact & light camera PCB module 54Wx38L x30mmH, 33 grams
* Low power consumption 12V DC, 150mA
* Low light requirement 0.1Lux (IR LED on)
* High quality, high resolution CCD image 512x512 pixels
* Video output 1Vp-p/75Ω
* Lens 3.6mm, F1.8
* Field of view 74° x 56°
* Maintenance free
* Built-in electronically controlled auto-iris
* Internal synchronisation

Low cost

90 dB spectrum analyser

12 and 16 bit resolution

Up to 1250 kpsps

Large buffer memory

Audio testing and analysis

Mains harmonics testing

Power supply design

Analog telephony

Vibration and noise measurements

High precision scopes, without the high cost

NEW!



Most digital scopes today are capable of achieving only 8 bit resolution. Pico Technology's new PC-based oscilloscopes represent a quantum improvement in digital scope technology. The ADC-212 offers 12 bit resolution, while its big brother, the ADC-216, is capable of 16 bit resolution. The scopes offer all the advantages associated with PC based test & measurement, such as large colour displays and a familiar Windows interface. Also, being Pico Technology products, the high performance is not matched by a high price tag.

ADC-212 / 216 - dual channel high resolution

Features

- Low cost
- 90 dB spectrum analyser
- 12 and 16 bit resolution
- Up to 1250 kpsps
- Large buffer memory

Applications

- Audio testing and analysis
- Mains harmonics testing
- Power supply design
- Analog telephony
- Vibration and noise measurements

ADC-212.....£299 ADC-216.....£499

Products supplied with software, cables and power supply. Prices exclude VAT

Call for a free demo disk and price list with offer

Tel: 01954 -211716 Fax: 01954 -211880
post@picotech.co.uk, www.picotech.com

PICO

Everyday Practical Electronics are pleased to be able to offer all readers these **ELECTRONICS CD-ROMS**

TWO APPLICATIONS ON ONE CD-ROM

ELECTRONIC CIRCUITS & COMPONENTS + THE PARTS GALLERY by Mike Tooley

ELECTRONIC CIRCUITS & COMPONENTS

Electronic Circuits & Components provides an introduction to the principles and application of the most common types of electronic components and shows how they are used to form complete circuits. The virtual laboratories, worked examples and pre-designed circuits allow students to learn, experiment and check their understanding as they proceed through the sections on the CD-ROM. Sections on the disk include:

- Fundamentals:** units & multiples, electricity, electric circuits, alternating circuits.
- Passive Components:** resistors, capacitors, inductors, transformers.
- Semiconductors:** diodes, transistors, op.amps, logic gates.
- Passive Circuits**
- Active Circuits**

THE PARTS GALLERY

Many students have a good understanding of electronic theory but still have difficulty in recognising the vast number of different types of electronic components and symbols. *The Parts Gallery* helps overcome this problem; it will help students to recognise common electronic components and their corresponding symbols in circuit diagrams. Selections on the disk include:

- Components**
- Components Quiz**
- Symbols**
- Symbols Quiz**
- Circuit Technology**

Hobbyist/Student £34 inc VAT
Institutional (Schools/HE/FE/Industry)£89 plus VAT
Institutional 10 user (Network Licence) £169 plus VAT

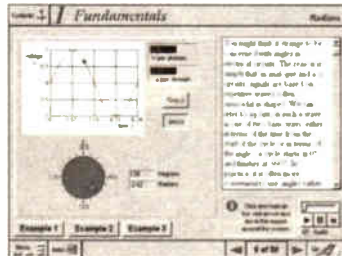

Virtual laboratory – sinusoids

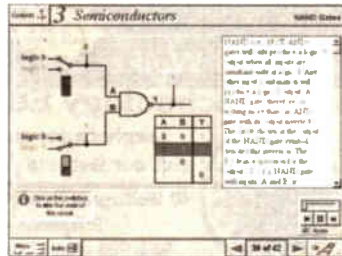

Logic laboratory

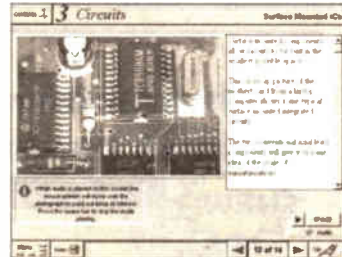

Circuit technology screen

DIGITAL ELECTRONICS by Mike Tooley

Digital Electronics builds on the knowledge of logic gates covered in *Electronic Circuits & Components*, and takes users through the subject of digital electronics up to the operation and architecture of microprocessors. The virtual laboratories allow users to operate many circuits on screen.

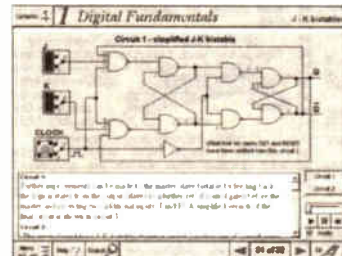

Virtual laboratory – flip-flops

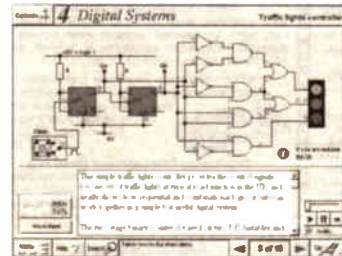

Virtual laboratory – traffic lights

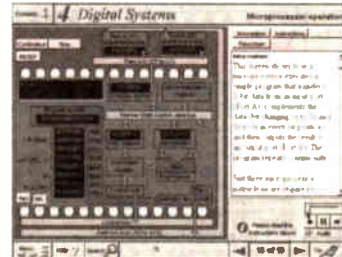

Microprocessor

Hobbyist/Student £45 inc VAT
Institutional (Schools/HE/FE Industry)£99 plus VAT
Institutional 10 user (Network Licence) £199 plus VAT

FUNDAMENTALS

Fundamentals introduces the basics of digital electronics including binary and hexadecimal numbering systems, ASCII, basic logic gates and their operation, monostable action and circuits, and bistables – including JK and D-type flip-flops

COMBINATIONAL LOGIC

Multiple gate circuits, equivalent logic functions and specialised logic functions such as majority vote, parity checker, scrambler, half and full adders. Includes fully interactive virtual laboratories for all circuits

SEQUENTIAL LOGIC

Introduces sequential logic including clocks and clock circuitry, counters, binary coded decimal and shift registers.

DIGITAL SYSTEMS

A/D and D/A converters and their parameters, traffic light controllers, memories and microprocessors – architecture, bus systems and their arithmetic logic unit.

GALLERY

A catalogue of commonly used IC schematics taken from the 74xx and 40xx series. Also includes photographs of common digital integrated circuits and circuit technology.

NEW MODULAR CIRCUIT DESIGN by Max Horsey and Philip Clayton

This CD-ROM has been developed from Max Horsey's *Teach-In* series *A Guide to Modular Circuit Design* (EPE Nov '95 to Aug '96). This highly acclaimed series presented a range of tried and tested analogue and digital circuit modules, together with the knowledge to use and interface them. Thus allowing anyone with a basic understanding of circuit symbols to design and build their own projects.

Essential information for anyone undertaking GCSE or "A" level electronics or technology and for hobbyists who want to get to grips with project design.

Over seventy different Input, Processor and Output modules are illustrated and fully described together with detailed information on construction, fault finding and components, including circuit symbols, pinouts, power supplies, decoupling etc. A full contents list and alphabetical index are provided and, at every stage, alternative modules are offered.

Written by a highly experienced author and teacher (Max is Head of Electronics at Radley College), this CD brings it all together for all students of electronics.

Single User Version £19.95 inc. VAT
Multiple User Version £34 plus VAT

designing your circuit

simply select your modules from the wide choice available, read how they work and join them up to make your circuit

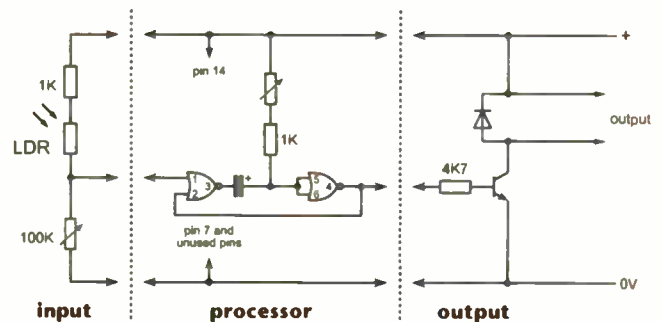

"I found that I could design a circuit without my teacher's help. And it worked! Everything was to hand - which chips to use - and which pins did what."

Andrew Preston (GCSE student)

Interested in programming PIC microcontrollers?

PICtutor by John Becker



The Virtual PIC

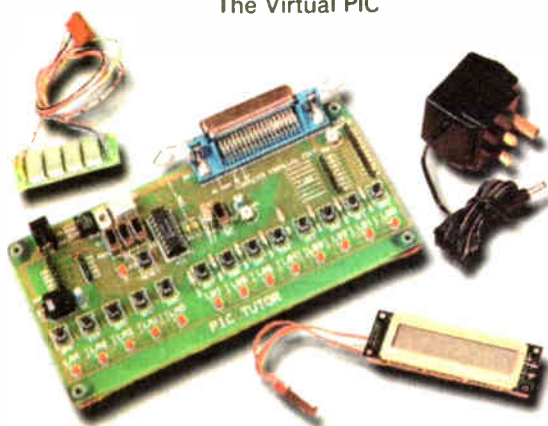

Deluxe PICtutor Hardware

Developed from our famous and incredibly popular *EPE PIC Tutorial* series by John Becker (*EPE* March to May '98) this CD-ROM, together with the PICtutor experimental and development board, will teach you how to use PIC microcontrollers with special emphasis on the PICx84 devices. The board will also act as a development test bed and programmer for future projects as your programming skills develop.

This interactive presentation uses the specially developed Virtual PIC simulator to show exactly what is happening as you run, or step through, a program. In this way the CD brings the *EPE PIC Tutorial* series to life and provides the easiest and best ever introduction to the subject.

Nearly 40 tutorials cover almost every aspect of PIC programming in an easy to follow logical sequence.

HARDWARE

Whilst the CD-ROM can be used on its own, the physical demonstration provided by the PICtutor Development Kit, plus the ability to program and test your own PIC16x84s, really reinforces the lessons learned. The hardware will also be an invaluable development and programming tool for future work once you have mastered PIC software writing.

Two levels of PICtutor hardware are available – Standard and Deluxe. The Standard unit comes with a battery holder, a reduced number of switches and no displays. This version will allow users to complete 25 of the 39 Tutorials – it can be upgraded to Deluxe at a later date, by adding components, if required.

The Deluxe Development Kit is supplied with a plug-top power supply (the Export Version has a battery holder), all switches for both PIC ports plus l.c.d. and 4-digit 7-segment l.e.d. displays. It allows users to program and control all functions and both ports of the PIC and to follow the 39 tutorials on the CD-ROM.

All hardware is supplied **fully built and tested** and includes a PIC16F84 electrically erasable programmable microcontroller.

CD-ROM

- Hobbyist/Student £45 inc. VAT
- Institutional (Schools/HE/FE Industry) £99 plus VAT
- Institutional 10 user (Network Licence) £199 plus VAT

HARDWARE

- Standard PICtutor Development Kit..... £47 inc. VAT
- Deluxe PICtutor Development Kit..... £99 plus VAT
- Deluxe Export Version £96 plus VAT

(UK and EU customers add VAT at 17.5% to "plus VAT" prices)

Minimum system requirements for these CD-ROMs: PC with 486/33MHz, VGA+256 colours, CD-ROM drive, 8MB RAM, 8MB hard disk space. Windows 3.1/95/98/NT, mouse, sound card (not required for PICtutor or Modular Circuit Design).

CD-ROM ORDER FORM

Please send me:

- Electronic Circuits & Components + The Parts Gallery
- Digital Electronics
- PICtutor

Version required:

- Hobbyist/Student
- Institutional
- Institutional 10 user

- PICtutor Development Kit – Standard
- PICtutor Development Kit – Deluxe Deluxe Export

- Modular Circuit Design – Single User
- Modular Circuit Design – Multiple User

Full name:.....

Address:.....

Post code:..... Tel. No:.....

Signature:.....

I enclose cheque/PO in £ sterling payable to WIMBORNE PUBLISHING LTD for £.....

Please charge my Visa/Mastercard: £ Card expiry date:.....

Card No:.....

Please supply name and address of card holder if different to the delivery address.

ORDERING

ALL PRICES INCLUDE UK POSTAGE

Student/Single User/Standard Version – price includes postage to most countries in the world
EU residents outside the UK add £5 for airmail postage per order

OVERSEAS ORDERS: Institutional, Multiple User and Deluxe Versions – overseas readers add £5 to the basic price of each order for airmail postage (do not add VAT unless you live in an EU country, then add 17½% VAT or provide your official VAT registration number).

Send your order to:
Direct Book Service
33 Gravel Hill, Merley Wimborne
Dorset BH21 1RW
(Mail Order Only)

Direct Book Service is a division of Wimborne Publishing Ltd. To order by phone ring
01202 881749. Fax: 01202 841692
We cannot reply to overseas orders by Fax
Goods are normally sent within seven days

Demos (not Modular Circuit Design) available on the *EPE CD-ROM No.1* (Free with the November '98 issue) – send £2 for this CD-ROM if you require the demos. For Modular Circuit Design demo send £6.95 for cut down version (£5 refunded if you buy full version). Minimum order for credit card payment is £5.

PhizzyB COMPUTERS

Part 3: Shifts, Stacks and L.C.D.s

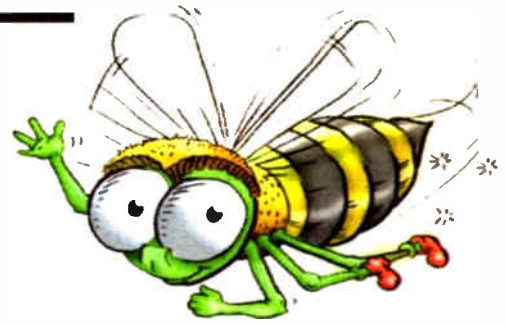

Clive "Max" Maxfield and Alvin Brown

WELCOME to the third instalment of a really unique and exciting electronics and computing project. This series of articles will be of interest to anyone who wants to know how computers perform their magic, because it uses a unique mix of hardware and software to explain how computers work in a fun and interesting way.

This series doesn't assume any great technical knowledge, although an understanding of fundamental electronic concepts would certainly be an advantage. You do need, though, to have had some experience at assembling components onto a printed circuit board. You should also be moderately familiar with using a PC-compatible computer.

... and so that's the way you balance your preambulating notched tattles. Oh, there you are! We got tired of waiting for you so we started without you. Well close the door, pull up a chair, and we'll go through the whole thing again one more time just for you ...

In last month's PhizzyB article (Part 2) we experimented with the PhizzyB's external input and output ports. We showed you how the PhizzyB can read real binary data from switches hooked up to its input ports, and we demonstrated a simple data output display in the form of an l.e.d. bargraph.

MASTER PLAN

Now, PhizzyB lovers, for your delectation and delight, we're about to unveil our PhizzyB Master Plan. Hang on to your hats!

This month we are going to use the PhizzyB to control a very simple liquid crystal display (l.c.d.) module, which is described in the accompanying constructional article.

Next month, in Part 4, we will be using a new simple input device to experiment with "interrupts" to explain some more versatile control and programming options.

Looking ahead to Part 5 and beyond, we will be adding a servo-motor output board, at which point we will start to use the PhizzyB as the "brain" of a very simple robot called the PhizzyBot!

In subsequent articles we will construct and experiment with a variety of simple sensor devices for our PhizzyBot. Remember, though, that we designed into your PhizzyB a whole gamut of programming instructions enabling it to be used at the heart of control, measurement, buggy and robotic applications and much more besides – in fact almost anything, limited only by your desire to program the little rascal and put the hardware PhizzyB to work in the real world.

Even if you decide not to construct the hardware PhizzyB, you can still follow much of this series by running the CD-ROM and following the on-screen tutorials.

BEE-ING HELPFUL

If you're new to this kind of thing, don't worry if it all takes a little time to get to

grasp with some the programming aspects. There's enough in the PhizzyB computer to keep you going for ages, and PhizzyB will be a great companion for many years!

Also remember that we offer BOTH on-line or written support upon request – so help is never far away.

Those with more experience of such things will be pretty eager to check the PhizzyB Addressing Modes and Instruction Set. This is contained on the full version CD-ROM and will be found under **Help -> Search on Help Contents -> Official Beboputer Microprocessor Databook**.

The instruction set is reproduced in Appendix A although it cannot be printed off. (It is actually a free excerpt from the full *Microprocessor Databook* which can be purchased on-line for a very modest price via the secure web site of www.maxmon.com.)

Before we can all get to the magical point where the hardware PhizzyB is doing really cool and useful work – such as the robotic application – it's necessary to delve more deeply into some of the programming techniques which we have cunningly incorporated into the PhizzyB.

So in this part we'll press on with more instructions and demonstrations.

You should by now have developed the habit of entering and assembling the demo listings on your PC, proving them on the PhizzyB Simulator and sending the entire machine code to the real PhizzyB sitting patiently on your serial port. From there, you can sit back and admire your handiwork operating in the real world.

ROTATE AND CARRY

Before we start to play with the l.c.d. there are a few instructions that you need to get to know. Last month we introduced

the concept of the Z (zero) and N (negative) status flags. In fact, the status register contains a number of other flags, including one that we call the C (carry) flag. This flag is used for a variety of purposes, and can adopt different roles depending on the instruction being performed.

For example, the carry flag is used in conjunction with the *rotate* instructions. The PhizzyB supports two rotate instructions called ROLC (rotate left through the carry) and RORC (rotate right through the carry).

The ROLC rotates the accumulator one bit to the left. The most-significant bit (MSB) of the accumulator is loaded into the carry flag, while the original value in the carry flag is loaded into the least-significant bit (LSB) of the accumulator (Fig.1a).

By comparison, the RORC rotates the accumulator one bit to the right. The LSB of the accumulator is loaded into the carry flag, while the original value in the carry flag is loaded into the MSB of the accumulator (Fig.1b).

EXPERIMENT 1

Rotate instructions

In order to view the effect of these rotate instructions, start up the PhizzyB Simulator, activate the assembler, and then enter the program shown in Listing 1.

As you will see, this is really a rather simple program. Following our constant label declarations, the first thing we do is to load the accumulator with whatever value is on the 8-bit switch on the interface board (see last month) that drives the input port at address \$F010.

Next we enter a loop, in which we store the value in the accumulator to the 8-bit l.c.d. display (see last month) connected to the output port at address \$F030. Then

Listing 1

```
INPORT0: .EQU $F010    #Assign a label to input port $F010
OUTPORT0: .EQU $F030    #Assign a label to output port $F030

.ORG $4000            #Set start address to $4000
LDA [INPORT0]        #Load accumulator from I/P port 0
STA [OUTPORT0]       #Store accumulator to O/P port 0
LOOP:               #Store accumulator to O/P port 0
    ROLC            #Rotate accumulator left one bit
    JMP [LOOP]     #Jump to LOOP and do it all again
. END
```

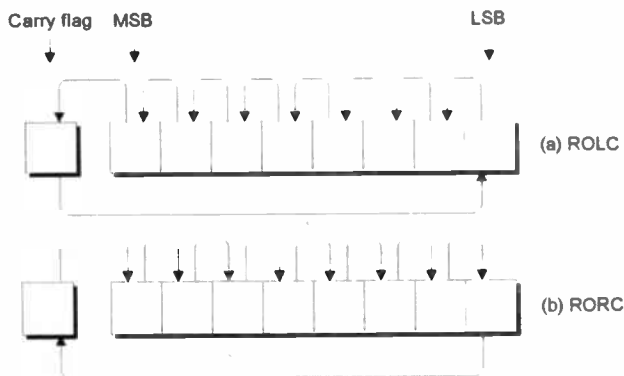

Fig.1. (a) The rotate left ROLC and (b) rotate right RORC instructions.

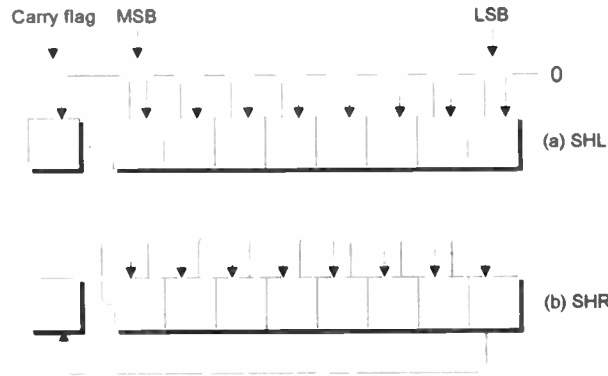

Fig.2 (a) Shift Left (SHL) and (b) Shift Right (SHR) instructions.

we rotate the value in the accumulator one bit to the left, and jump back to the label LOOP to store this new value to the 8-bit l.e.d.s.

Use the File -> Save As command to save this program as **bbexpla.asm**. Use the File -> Assemble command to assemble the program to generate the corresponding **bbexpla.ram** file and use the Memory -> Load RAM command to load this file into the simulator's memory.

This would also be a good time to use the assembler's Window -> View Listing File command to access the list file for this program and print it out. (Don't forget to use the corresponding Window -> View Source File command to return to the source file when you've finished.)

Now set the 8-bit switches to a pattern of 00000011 and start clicking the simulator's Step (St) button. You can use the printout of the listing file and the 7-segment program counter (PC) displays on the simulator to follow your progress as the original pattern on the switches is rotated through the accumulator.

Compare what happens with Fig.1a to make sure that all is as it should be. Observe that when you reach the pattern 11000000, the next rotate causes the 1 in the accumulator's MSB to "fall off the end" and be loaded into the carry flag (the C bit on the status register lights to indicate this).

If you wish to load another pattern to be rotated, you will first have to click the simulator's Reset (Rs) button, enter the

new pattern on the switches, and then start clicking the Step button again.

Now reset the simulator, return to the assembler, change the ROLC instruction to an RORC, and save this new program as **bbexplb.asm**. Assemble this new program to generate the corresponding **bbexplb.ram** file. Load this file into the simulator, set up a new pattern on the 8-bit switches, and start stepping through this new program to make sure that the actions of the RORC instruction match those shown in Fig.1b.

You should then use the PBLink utility (last month) to download both of these programs in turn to your real PhizzyB and verify that the real world agrees with its simulation counterpart.

EXPERIMENT 2

Shift instructions

The PhizzyB also supports two *shift* instructions called SHL (shift left) and SHR (shift right). First let's consider the SHL, which shifts the contents of the accumulator one bit to the left (Fig.2a). As we see, the SHL is very similar to the ROLC, except that a 0 is shifted into the LSB of the accumulator.

Use the assembler to reload the **bbexpla.asm** program you created earlier and save it out under the new name of **bbexp2a.asm**. Now change the ROLC instruction to SHL, assemble the program to generate the corresponding **bbexp2a.ram** file, and load this file into the simulator's memory (you may also

wish to print out this program's list file).

Set the 8-bit switches to a value of 00001111 (15 in decimal), and click the simulator's Step button twice. This loads the value into the accumulator and then outputs it to the 8-bit l.e.d.s. Now click the Step button once to execute the SHL instruction, once again to execute the JMP, and once more to execute the STA.

Observe that shifting the accumulator one bit to the left results in a pattern of 00011110 (30 in decimal) appearing on the 8-bit l.e.d. display. In other words, due to the fact that binary is a base-2 number system, shifting a value one bit to the left has the same effect as *multiplying* it by two!

Now reset the simulator, then use the assembler to reload the **bbexp1b.asm** program you created earlier and save it out under the new name of **bbexp2b.asm**. Change the RORC instruction to SHR (which shifts the contents of the accumulator one bit to the right as illustrated in Fig.2b). Assemble the program to generate the corresponding **bbexp2b.ram** file, and load this file into the simulator's memory.

Set the 8-bit switches to a value of 00111100 (60 in decimal), and step through the program until this value appears on the 8-bit l.e.d.s. Continue to step until the display shifts one bit to the right, resulting in a value of 00011110 (30 in decimal).

Thus, we see that shifting a binary value one bit to the right is the same as *dividing* it by two! In fact, there are a number of interesting points about the SHR instruction, not the least that, as opposed to shifting a 0 into the MSB, we actually shift a copy of the MSB back on itself.

The reason for this is a little convoluted, so we will side-step this issue for the moment (see the Bonus Article section later). In the meantime, download both of these programs in turn to your real PhizzyB and again verify that the real world agrees with its simulation counterpart.

PhizzyB CALCULATOR

As an added bonus, the PhizzyB comes equipped with a special calculator (Fig.3). Use the Tools -> Calculator command to activate this device, or click the calculator icon on the PhizzyB's toolbar. (Note that this calculator is only available with the full copy of the PhizzyB Simulator, not the demo version.)

At the top left of the calculator are three buttons: Bin (Binary), Dec (Decimal), and

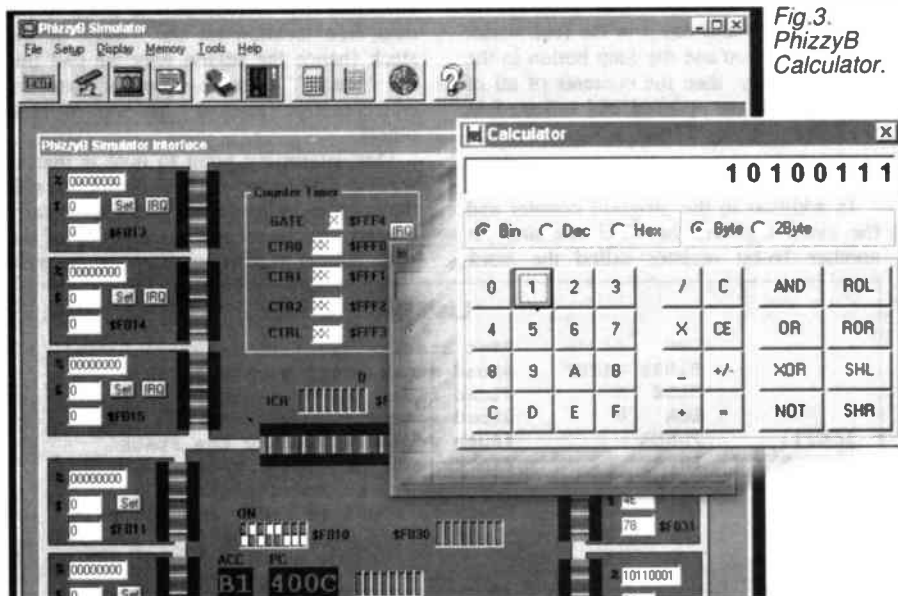

Fig.3. PhizzyB Calculator.

Hex (Hexadecimal). As we shall see, we can use these buttons to easily convert values from one number system into another.

At the top right of the calculator are two buttons called Byte and 2Byte, which are used to control the size of the value being displayed (these buttons are currently grayed out, because they only work in the Bin and Hex modes).

Click the Bin button to place the calculator into its binary mode, then click the Byte button so that the display only shows eight bits. Now enter the binary value 00011110, then click the Dec button to reveal this value's decimal equivalent, which is 30.

Return the calculator to its binary mode, and then click the SHL button to shift this value one bit to the left. Note that the SHL and SHR buttons act in the same way as do their PhizzyB counterparts, but the calculator's ROL and ROC buttons act slightly differently to the PhizzyB's ROLC and RORC instructions. Use the PhizzyB's **Help -> Search On Help Contents** command to learn what these differences are.

EXPERIMENT 3

Index register

In addition to the accumulator and the status register, the CPU contains a number of other registers, one of which is the 16-bit index register (called X for short). Amongst other things, the index register can be used as a counter. To illustrate this, use the assembler to enter the program shown in Listing 2 and save this as file `bbexp3.asm`.

As we see, this program introduces a couple of new instructions. First we use **BLDX** (big load index register) to load the index register with a decimal value of ten. The reason this instruction is called a "big load" is that the PhizzyB's index register is 16 bits wide, which is twice as wide as its 8-bit databus.

Next we enter a loop in which we store the accumulator to the 8-bit i.e.d. display, use an **INCA** (increment accumulator) instruction to add one to the current contents of the accumulator, and then a **DECX** (decrement index register) instruction to subtract one from the current contents of the index register.

Note that the PhizzyB also supports the related **DECA** (decrement accumulator) and **INCX** (increment index register) instructions.

Also note that the **INCA**, **DECA**, **INCX** and **DECX** instructions can all affect the contents of the zero flag. In the case of our program, the **DECX** instruction occurs after the **INCA**, which means that our **JNZ** (jump if not zero) instruction will only cause the program to jump back to the **LOOP1** label if the index register contains a value other than zero.

The end result is that this program will loop around incrementing the accumulator and decrementing the index register until the index register contains zero, at which point the program will become trapped in a second loop (continually jumping back to label **LOOP2**).

Now remembering that we loaded the index register with a value of ten, what value do you expect to see on the 8-bit i.e.d.s? Really? Well let's see shall we?

Listing 2

```

OUTPUT0: .EQU $F030      #Assign a label to output port $F030

          .ORG $4000     #Set start address to $4000
          BLDX 10        #Load X register with Dec 10
          LDA 0          #Load accumulator with 0
LOOP1:   STA [OUTPUT0]  #Store accumulator to O/P port 0
          INCA          #Increment the accumulator
          DECX          #Decrement the X register
          JNZ [LOOP1]   #Jump to LOOP1 if X register not zero
LOOP2:   JMP [LOOP2]   #Loop around doing nothing
          .END

```

Make sure you've reset the simulator, assemble this program to generate the corresponding `bbexp3.asm` file, then load this file into the simulator and click the Ru (Run) button (you may also wish to print out a copy of this program's list file).

As we see, the 8-bit i.e.d.s end up containing a value of `00001001` (9 in decimal). Hmmmm, wonder why this happened? Unfortunately, the program runs too quickly for us to observe all of the details. Another aspect is that the PhizzyB (and hence the simulator) doesn't display the value in the index register (because if we had added 7-segment displays for all of the CPU's registers, the PhizzyB would have been significantly bigger and much more expensive to build).

REGISTER DISPLAY

Fear not, though - we also have our faithful CPU register display, which was introduced in the *PhizzyB User Manual: Vol 1* (check your simulator's on-line help for more details). Reset the simulator and invoke this display using the **Display -> CPU Registers** command (drag the resulting window to the right-hand side of the simulator's PhizzyB board).

Now step through the program observing the values in the index register and the accumulator, and make sure you understand why the 8-bit i.e.d.s end up displaying a value of `00001001`. Note especially what happens to the Z (Zero) flag in the simulator and on the CPU register display when the index register is finally decremented to contain zero.

How could we change our program such that the i.e.d.s end up displaying a value of `00001010` (10 in decimal)? (The answer's given later.)

As usual, download this program to your PhizzyB and run it in the real world. Note that if you use the Step button in the PBLink utility, then the contents of all of the registers are updated and reflected in the PBLink utility's window.

WELL STACKED

In addition to the program counter and the index register, the CPU contains yet another 16-bit register called the *stack*

pointer (SP), which points to an area in the memory called ... you guessed it ... the *stack*.

When the PhizzyB is first powered up (or when it's been reset), the stack pointer doesn't contain any meaningful value, so it's up to us to use a **BLDSP** (big load stack pointer) instruction to load it with something useful.

Remember that our programs always start at address `$4000`, which is the first location in the PhizzyB's RAM. Now assume for the sake of argument that we use a **BLDSP** instruction to load the stack pointer with a value of `$4FFF` (Fig.4).

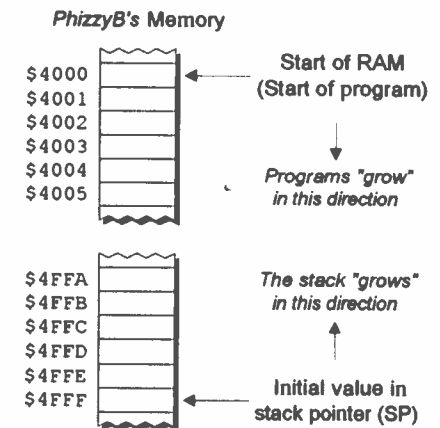

Fig.4. The PhizzyB Stack and Stack Pointer.

As you will come to see, the stack and the stack pointer are incredibly useful tools. One thing we can do is to "push" a byte of data onto the stack. In this case, the data will be copied into the current memory location pointed to by the stack pointer, and the stack pointer will then be automatically decremented to point to the next free location on the "top" of the stack (hence the reason why we call this the "stack," because bytes of data are conceptually "stacked" on top of each other).

One interesting point to note is that as we add data to the stack, it grows towards the program. This means that it's typically a good idea to set the initial value of the stack pointer as far away from the program

Listing 3

```

          .ORG $4000     #Set start address to $4000
          BLDSP $4FFF    #Load stack pointer with $4FFF
          BLDX 5         #Load index reg with Dec 5
          LDA 0          #Load accumulator with 0
LOOP1:   PUSHA          #Push accumulator into the stack
          INCA          #Increment the accumulator
          DECX          #Decrement the index register
          JNZ [LOOP1]   #Jump to LOOP1 if index reg not zero
LOOP2:   JMP [LOOP2]   #Loop around doing nothing
          .END

```

as we can, so as to give the stack as much room to grow as possible. (If the stack grows big enough to enter the program, the results are almost invariably catastrophic ... at least in programming terms.)

In this case, however, each of our test programs is only a few bytes long, so initializing the stack pointer to \$4FFF (which is 4,095 decimal memory locations away from address \$4000) gives us more than enough breathing room for comfort.

EXPERIMENT 4

The Stack

In order to illustrate how the stack works, use the assembler to enter the program shown in Listing 3 and save this as file **bbexp4.asm**.

In this program we first use **BLDSP** to load the stack pointer with address \$4FFF, then we use **BLDX** to load the index register with 5, followed by **LDA** to load the accumulator with 0.

Next we enter a loop, which commences with a **PUSHA** (push accumulator) instruction that copies the current value in the accumulator onto the top of the stack (as pointed to by the stack pointer, which subsequently automatically decrements itself to point to the next free location on the top of the stack).

Then we increment the accumulator, decrement the index register, and use a **JNZ** to test whether or not the index register now contains a zero (as we did in Experiment 3).

Just to ensure that we're all marching to the same drum beat, click the simulator's Power button to power it down, then click it once more to apply power again (this randomizes the contents of the simulator's memory). Now assemble your program, load the resulting **bbexp4.ram** file into the simulator's memory, and run it.

Wait until the stack pointer in the CPU register display shows a value of \$4FFA, then click the simulator's St (Step) button to drop down into the Step mode.

Now use the Display -> Memory Walker command to access the Memory Walker display (which is introduced in the *PhizzyB User Manual: Vol 1*). Click the right-hand Find What Address? icon in the Memory Walker's toolbar and enter an

address of \$4FFF, and then scroll (and size) the display until you can see locations \$4FF9 through \$5000.

The values of \$00 through \$04 in locations \$4FFF through \$4FFB came from the accumulator, whose contents we kept pushing onto the top of the stack. The stack pointer now points to address \$4FFA (the next free location on the top of the stack).

Note that the \$XX values shown in address \$4FFA (and elsewhere) are used to indicate that these locations currently contain random values (because we haven't written anything useful into them yet).

To complement the **PUSHA** instruction there is also a **POPA** (pop accumulator). This automatically increments the stack pointer to point to the last byte of data written onto the stack, and then copies this data into the accumulator.

Admittedly, what we've seen thus far may not make the stack seem tremendously exciting, but as we progress you will come to understand just how cunning and powerful it can be.

EXPERIMENT 5

A simple subroutine

One area in which the stack is extremely useful is in the case of *subroutines*. In order to illustrate this, first use the assembler to load the **bbexpla.asm** program we created

earlier, save this as **bbexp5a.asm**, and then assemble it to generate the corresponding **bbexp5a.ram** file.

As you will recall, this program loads a value from the 8-bit switches into the accumulator, and then enters a loop whereby the contents of the accumulator are first stored to the 8-bit l.e.d.s and then rotated one bit to the left.

In Experiment 1 we stepped through this program, but this time we're going to run it at full speed. If you've been playing with a real PhizzyB, reset it and ensure that the PBLink utility is closed down. (Note that while the PBLink utility is active, it continually "pings" signals to the PhizzyB, which ends up slowing the simulator.)

Now reset the simulator, load the **bbexp5a.ram** file, set the 8-bit switches to a pattern of 00000011, and click the simulator's Run button.

Unless you're working on a very old computer, it's likely that the resulting display on the 8-bit l.e.d.s is just a blur. What we need is some way to slow the program down, and one technique we can use to achieve this is a subroutine.

Reset the simulator, use the assembler to save your **bbexp5a.asm** file as **bbexp5b.asm**, and modify this file as shown in Listing 4 (the additions are shown in bold).

Listing 4

```

INPORT0: .EQU $F010      #Assign a label to input port $F010
OUTPORT0: .EQU $F030     #Assign a label to output port $F030
DELAYVAL: .EQU $0F       #Assign a delay value

                                #Set start address to $4000
                                BLDSP $4FFF      #Load stack pointer with $4FFF
                                LDA [INPORT0]      #Load accumulator from I/P port 0
LOOP:    STA [OUTPORT0]   #Store accumulator to O/P port 0
                                ROLC               #Rotate accumulator left one bit
                                JSR [WAIT]        #Jump to subroutine called WAIT
                                JMP [LOOP]         #Jump to LOOP and do it all again

## Start of WAIT subroutine
WAIT:    PUSHA          #Save existing ACC into the stack
                                LDA DELAYVAL      #Load ACC with delay value
                                DECA             #Decrement accumulator
                                JNZ [WAITLOOP]    #Jump if ACC not equal to 0
                                POPA             #Retrieve original ACC from stack
                                RTS              #Return from subroutine
                                .END

```

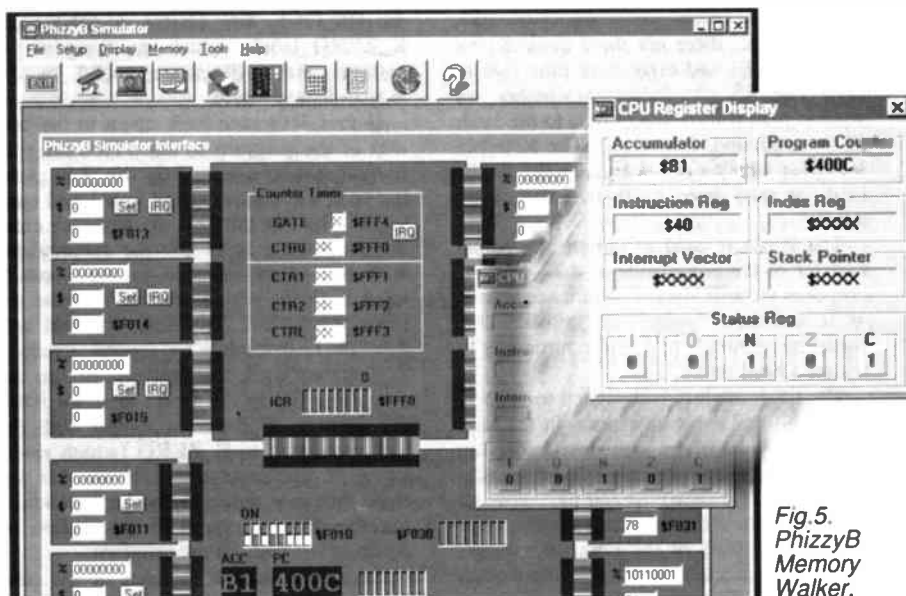

Fig.5. PhizzyB Memory Walker.

CONSTANTLY DELAYED

Our first modification is to declare a constant label called **DELAYVAL** and to assign it a value of \$0F. Our second is to add a **BLDSP** instruction that loads the stack pointer with a value of \$4FFF.

Now we load the accumulator from the 8-bit switch, store it to the 8-bit l.e.d.s, and rotate it as before. However, instead of immediately jumping back to the beginning of the main loop, we now use a **JSR** (jump to subroutine) instruction, which, in this case, directs the CPU to jump to the address associated with a subroutine we've called **WAIT**.

A key point to understand at this juncture is that before the CPU jumps to the **WAIT** subroutine, it first places the address of the next instruction to be executed after the **JSR** – the **JMP** in this case – onto the top of the stack.

As the PhizzyB's address bus is 16 bits wide, this requires two bytes on the stack. The convention used by the PhizzyB is to store the least-significant byte of the address first (into memory location \$4FFF in this case), followed by the most-significant byte (into location \$4FFE), leaving the stack pointer pointing to the first free location on the top of the stack at address \$4FFD.

Remember that all of this activity is automatically initiated by the JSR instruction and is (relatively) invisible to the user. As soon as this "return address" has been safely squirreled away on the top of the stack, the CPU jumps to the first instruction in our WAIT subroutine.

PUSH AND JUMP

Unfortunately, we now have another problem, because we will want to use the current value in the accumulator when we return to the main body of our program, but we also need to use the accumulator as part of this subroutine.

One solution is to use a PUSHA, which copies the current value in the accumulator onto the top of the stack at address \$4FFD, and automatically decrements the stack pointer to point to the next free location on the top of the stack at address \$4FFC.

Next we load the accumulator with the value associated with the constant label DELAYVAL (\$0F in this case), then we start to loop around decrementing the accumulator and jumping back to label WAITLOOP until the accumulator contains zero.

Next, we use a POPA to copy the last value we placed on the top of the stack into the accumulator (this is the original value we saved when we entered the subroutine), then we use an RTS (return from subroutine) instruction to return us to the main body of the program.

The RTS automatically retrieves the Return Address stored on the stack by the JSR instruction, which means that the CPU returns to the JMP instruction in the main body of the program.

The end result of all of this is that every time we pass through the loop in the body of the program, we call (jump to) our WAIT subroutine, whose sole purpose in life is to add some element of delay (the time it takes to execute its instructions).

SLOWER FLASHING

Assemble this program to generate the corresponding bbexp5b.ram file, load this file into your simulator, and set the program running again. This time the rate at which the l.c.d.s flash on the display should be noticeably slower.

Now reset the simulator, change the value assigned to DELAYVAL to say \$8F. Re-assemble, re-load, and re-run the program, and observe that the display is now much slower.

Feel free to experiment with other delay values, and also download this program to your real PhizzyB and replicate the experiment in the real world. When you've finished, remember to reset both the PhizzyB and the simulator.

CALLING ECONOMY

Before we proceed to the next (and final - hurrah!) experiment, we should note that subroutines can be used for a variety of purposes. For example, rather than creating a

program as one humongous chunk, it often makes things more manageable and easier to understand if we split the program into a collection of smaller, logically self-contained functions in the form of subroutines.

The body of the program can then call these subroutines in the required sequence. Quite apart from anything else, this technique makes it easy to modify individual subroutines without affecting the bulk of the program.

Another advantage of subroutines becomes apparent if we have a program that performs the same sequence of actions a number of times, in which case it is often a good idea to gather these actions together in the form of a subroutine. For example, we might write a program that called our WAIT subroutine from a number of different locations.

During future articles in this series we will also consider such topics as *nested subroutines* (subroutines that call other subroutines) and *recursive subroutines* (subroutines that call themselves), but there's no time for that now, because we have our last experiment to perform.

L.C.D. MODULE

In a moment you can enjoy what that staunch fellow Alan Winstanley has prepared for you to play with - the liquid crystal display (l.c.d.) described in his PhizzyB constructional article. (Note that this experiment requires you to have a real PhizzyB and l.c.d. module).

To briefly summarize some key points from the constructional article, the l.c.d. module in question supports two rows of sixteen characters each. This module has 14 pins, but only 11 are of interest to us here, as shown in Table 1.

Table 1. L.C.D. Pin Connections

Pin	Name	Function	Signal
4	RS	Register Select	OP3
5	R/W	Read/Write	OP2
6	E	Enable	OP1
7	D0	Data bit 0	-
8	D1	Data bit 1	-
9	D2	Data bit 2	-
10	D3	Data bit 3	-
11	D4	Data bit 4	OP4
12	D5	Data bit 5	OP5
13	D6	Data bit 6	OP6
14	D7	Data bit 7	OP7

As we see, there are three control pins (RS, R/W, E) and eight data pins (D0 to D7). The RS pin indicates whether we wish to pass commands or data to the l.c.d. (0 = command, 1 = data). The R/W pin indicates whether we wish to write to the l.c.d. or read from it (0 = write, 1 = read).

The E pin is used to initiate the actual transfer of the commands or data. For our purposes we will always commence with E = 0, and then "pulse" or "strobe" this signal by setting it to 1 and returning it to 0 after a brief delay.

The l.c.d. module is designed to support both 8-bit and 4-bit interfaces. In the case of an 8-bit interface, the device driving this module would be capable of passing data to all eight data pins and have enough signals free to drive the control pins.

However, each of the PhizzyB's external output ports only has eight output pins, OP0 to OP7. This means that we will have

to use the l.c.d.'s 4-bit interface mode, in which four of the PhizzyB's output bits are used to pass data to the l.c.d., and three are used to drive the l.c.d.'s control lines. The remaining output bit is unused.

EXPERIMENT 6

PhizzyB-ing the L.C.D. module

Connect the l.c.d. module to the external output port at address \$F031, access the PBLink utility, open the lcdtest.ram file supplied with the simulator, download this file to the PhizzyB, and run the program to see the messages "HELLO WORLD" and "IT WORKS!"

Pretty cool, eh? Now let's examine this program to discover how it works. Before we start, use your assembler to load the lcdtest.asm file and print it out, so that you can more easily follow our discussions.

At the very bottom of the program (just before the .END statement) you will see two labels, MESS1 and MESS2, each of which is followed by a series of hexadecimal values. Each of these values corresponds to a character that appears on the l.c.d. module. The values associated with MESS1 form the "HELLO WORLD" that appears on the upper row, while the values associated with MESS2 form the "IT WORKS!" that appears on the lower row.

But how do we know which values are associated with which letters? In fact much of the display module's character set is largely based on a very common code known as ASCII (the American Standard Code for Information Interchange) (see Table 2).

For example, the first code associated with MESS1 is \$48, which equates to the letter "H", while the \$20 codes that appear here and there correspond to space characters. Note that each string must be terminated with a \$00 (NUL) character.

Feel free to save our program under a new name, and then modify these codes to build your own messages (note that the program only allows each l.c.d. line to contain 16 characters).

Now bounce up to the top of the program to view the constant labels. Specifically, note that we're associating the label LCDOUT with the external output port at address \$F031. Also note the RS_ONE, RS_ZERO, E_ONE, and E_ZERO labels, which are assigned bit patterns that will prove useful in the not-so-distant future.

In fact, let's race back down to the bottom of the program to the STROBE subroutine, whose sole task in life is to pulse the l.c.d.'s E control signal to a 1 and back to a 0. The first thing we do when we enter this subroutine is to OR the accumulator with the value assigned to the constant label E_ONE, which sets bit 1 of the accumulator to a 1 (this is the bit that will drive the l.c.d. module's E control signal).

Next we write the contents of the accumulator out to the l.c.d., then we AND the contents of the accumulator with the value assigned to E_ZERO (which resets bit 1 of the accumulator to 0) and we store this new value to the l.c.d. module. Finally, we use an RTS instruction to return to the body of the program.

To a large extent the rest of the program is self-explanatory, at least insofar as

the "big brush strokes" are concerned. The first part of the program is solely concerned with initializing the display (to fully understand these actions you need to have a better understanding of the l.c.d. module than we have space for here – but see Table 3 and the Additional Notes section below).

The instructions associated with LOOP1 are in charge of displaying message MESS1 (similarly, the instructions associated with LOOP2 are in charge of displaying message MESS2). Note especially the LDA [MESS1.X] statement. This illustrates another use for the index register, for a form of addressing known as the *indexed addressing mode* (again see the Additional Notes).

DOUBLE NIBBLES

Last but not least, the WCOMND and WDATA labels provide two different entry points into the same subroutine. This subroutine is in charge of splitting a byte into two 4-bit nibbles and writing these nibbles out one after the other.

The way this works is as follows: If we were using the 8-bit interface approach, then in order to write a byte of data into the l.c.d., we would set up the RS and R/W signals, drive a full byte of data onto the data bits, and then pulse the E signal.

But, as we're using the 4-bit interface technique, we have to pass our data to the l.c.d. as two 4-bit nibbles. That is, we set up the RS and R/W signals, drive the most-significant nibble of data onto data bits D7 through D4, and use the STROBE subroutine to pulse the E signal. Then we drive the least-significant nibble of data onto data bits D7 through D4 and pulse the E signal again.

In the future we will be able to use this display for a whole smorgasbord of applications, such as an event timer and stop watch, or to display values captured from external sensors hooked to the PhizzyB.

ADDITIONAL NOTES

For your interest, an absolutely excellent two-part article on how to use l.c.d. modules appeared in the February and March '97 issues of *EPE*. For your further reading pleasure, Adobe Acrobat .PDF versions of these files are available on the *EPE Demo CD* under *EPE Files and Projects*.

Additionally, specially re-formatted versions of this article are available in the *EPE On-line* web site library at www.epemag.com.

Furthermore, if you haven't already done so, it would be well worth your time to peruse the contents of the *PhizzyB User Manuals*, and also the appendices on the PhizzyB's instruction set and assembly language from our book: *The Official Bebopter Microprocessor Databook*. Remember that all of these documents are delivered on your PhizzyB CD-ROM (just check the simulator's on-line help for more details).

BONUS ARTICLE

But wait, there's more, because we've written a special bonus article that probes the hidden mysteries of *signed* and *unsigned* binary numbers. This article is available as a .PDF file from the *EPE* web site at www.epemag.wimborne.co.uk.

Table 2. The portion of the ASCII code used by the PhizzyB's l.c.d. module.

\$20	SP	\$30	0	\$40	@	\$50	P	\$60	'	\$70	p
\$21	!	\$31	1	\$41	A	\$51	Q	\$61	a	\$71	q
\$22	"	\$32	2	\$42	B	\$52	R	\$62	b	\$72	r
\$23	#	\$33	3	\$43	C	\$53	S	\$63	c	\$73	s
\$24	\$	\$34	4	\$44	D	\$54	T	\$64	d	\$74	t
\$25	%	\$35	5	\$45	E	\$55	U	\$65	e	\$75	u
\$26	&	\$36	6	\$46	F	\$56	V	\$66	f	\$76	v
\$27	.	\$37	7	\$47	G	\$57	W	\$67	g	\$77	w
\$28	(\$38	8	\$48	H	\$58	X	\$68	h	\$78	x
\$29)	\$39	9	\$49	I	\$59	Y	\$69	i	\$79	y
\$2A	*	\$3A	:	\$4A	J	\$5A	Z	\$6A	j	\$7A	z
\$2B	+	\$3B	;	\$4B	K	\$5B	[\$6B	k	\$7B	{
\$2C	,	\$3C	<	\$4C	L	\$5C	\	\$6C	l	\$7C	
\$2D	-	\$3D	=	\$4D	M	\$5D]	\$6D	m	\$7D	}
\$2E	.	\$3E	>	\$4E	N	\$5E	^	\$6E	n	\$7E	->
\$2F	/	\$3F	?	\$4F	O	\$5F	_	\$6F	o	\$7F	<-

Furthermore, for those of you who aren't yet connected to the Internet and the Web, this article is also available FREE on 3.5-inch floppy disk from the *EPE PCB Service* (except for a small admin charge).

BUZZ THE COMPETITION

By now you're probably feeling quite frisky as to your ability to create programs. After all, you've understood everything that we've done so far, haven't you? However, it's a lot easier to understand something when someone else is walking you through it, so why don't we see just how much you've learned. Here's a little competition – the winner of which will receive a year's *free* subscription to *EPE*!

All you have to do to win this delectable prize is to write a little program that loops around reading a value from the 8-bit switches and writing it to the 8-bit l.e.d.s. The trick is that we want the order of the bits to be reversed. That is, if you enter a value of 00011110 on the switches, we want to see a corresponding value of 01111000 displayed on the l.e.d.s.

And that's all there is to it (he said with a cheery grin)! Note that there are numerous ways of achieving this, so the only criteria we are going to impose is that your program should use as few bytes as possible.

E-mail the assembly code for your program to us at editor@epemag.com. Please

include your name, address, and contact details – including your E-mail address – as comments in the source code. In the event of a tie, we shall draw a winner at random. The decision of the judges (us in this case) is final.

The winner will be announced as soon as we've waded through all of the entries, and the winning solution (plus any other interesting solutions that catch our eye) will be posted on the *EPE* web site at www.epemag.wimborne.co.uk.

THREE ANSWERS

Answer to the question posed in Experiment 3 – there are at least three ways:

(a) Use the LDA to load the accumulator with a value of 1

(b) Use the BLDX to load the index register with a value of 11 decimal

(c) Exchange the positions of the INCA and the STA such that the accumulator is incremented before its contents are displayed.

NEXT MONTH

In Part 4, we'll get you constructing an interesting little input device to illustrate the difference between polling and interrupt-driven input/output techniques. To complement this, we will be investigating *interrupts* and *interrupt subroutines*, and then combining this new device along with the l.c.d. module to implement an event timer. Until then . . .

Table 3. The l.c.d. command control codes

Command	Binary								Hex
	D7	D6	D5	D4	D3	D2	D1	D0	
Clear Display	0	0	0	0	0	0	0	1	01
Display & Cursor Home	0	0	0	0	0	0	1	x	02 or 03
Character Entry Mode	0	0	0	0	0	1	I/D	S	04 to 07
Display On/Off & Cursor	0	0	0	0	1	D	U	B	08 to 0F
Display/Cursor Shift	0	0	0	1	D/C	R/L	x	x	10 to 1F
Function Set	0	0	1	8/4	2/1	10/7	x	x	20 to 3F
Set CGRAM Address	0	1	A	A	A	A	A	A	40 to 7F
Set Display Address	1	A	A	A	A	A	A	A	80 to FF

PhizzyB COMPUTERS

Construction – L.C.D. Interface

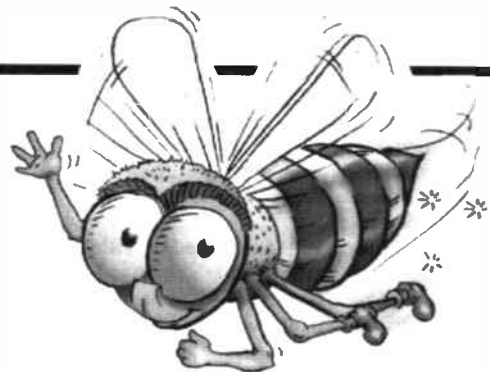

— Alan Winstanley

Let PhizzyB talk to you and the world via an easy-plug-in alphanumeric l.c.d. module.

LAST month in Part 2 we demonstrated a variety of programming routines which tested the input and output (I/O) ports of your hardware PhizzyB.

In this month's practical constructional feature, the addition of an alphanumeric liquid crystal display (l.c.d.) is described. It's very simple to assemble from standard parts and enables customised messages to be written and displayed using a programmable routine.

DISPLAY CIRCUIT

The circuit diagram for the L.C.D. Interface is shown in Fig.1. All of the decoding and display functions are performed by a standard 2-line 16-character alphanumeric l.c.d. display module.

Several different brands of l.c.d. are available but the vast majority use the same chipset and interwiring arrangements. The components list includes some alternatives. Although the display is an 8-bit device (so it can read 8-bit wide data), it is used in 4-bit mode so that it decodes and displays data only via its D4 to D7 inputs.

The other four bits (D0 to D3) are pulled down to 0V using resistors R1 to R4. Preset potentiometer VR1 adjusts the display contrast. Note that some makes of l.c.d. require a negative voltage connection to VR1 instead of a positive one, and that the use of R1 to R4 may not be necessary. None of the resistor values are critical and nearest-value sparesbox values will work.

If you would like to know more about the use of these types of liquid crystal displays, we reproduced an excellent two-part *EPE* practical article *How to use Intelligent L.C.D.s* by Julyan Ilett on the *EPE* CD-ROM No.1, given away free with the November '98 issue.

The two parts are located in the *epelcd* directory folder (file *lcd1.pdf*) and make excellent reading. Adobe Acrobat Reader is required to view them and this is also available on the CD, in the PLUS+ folder.

Printed copies of the articles (*EPE* Feb/Mar '97) are also available from the Editorial office – see *Back Issues* page.

CONSTRUCTION

A PhizzyB I/O board type "A" is used to carry the resistors and preset potentiometer. The layout of the components is illustrated in Fig.2 but is not at all critical: the wiring should be effective but does not need to be very neat or tidy.

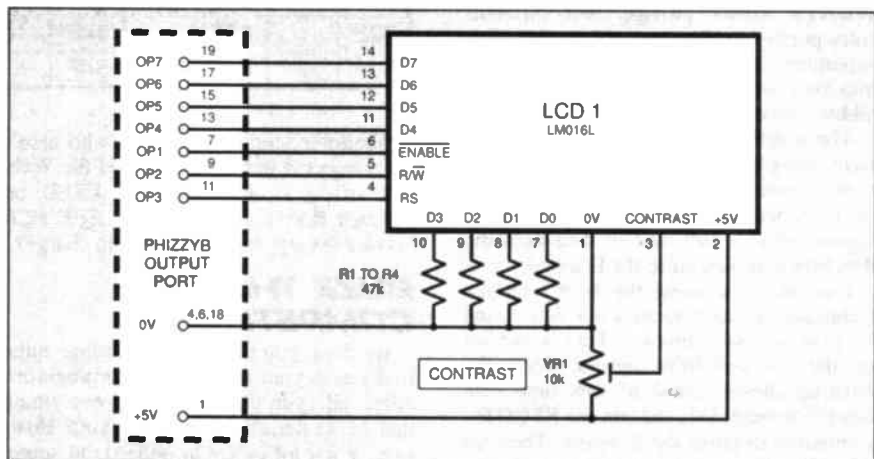

Fig.1. Circuit diagram for the PhizzyB's L.C.D. Interface.

You can change the positioning of the components as desired, provided that the circuit diagram is followed correctly. A seasoned electronics constructor will have no problems assembling the circuit and can safely skip through some of the details which are now presented for the benefit of inexperienced readers.

In the prototype, fourteen pieces (roughly six inches long – 15cms) of stranded hook-up wire were used to connect the l.c.d. to the board. A few millimetres of insulation should be stripped from each wire end and the bared end should be "tinned" using a little solder.

The wires can then be inserted into the solder pad holes along the edge of the l.c.d. and soldered into place. The copper pads on the display are through-hole-plated and it makes no difference whether you solder the wires on the top or underneath.

The I/O board should be prepared by soldering in the resistors (47 kilohms: yellow/violet/orange/gold) and preset VR1. You will almost certainly need to enlarge the three holes which carry VR1, by using a 1.3mm diameter twist drill on the board (ensure you do not drill away all the copper pad in the process!).

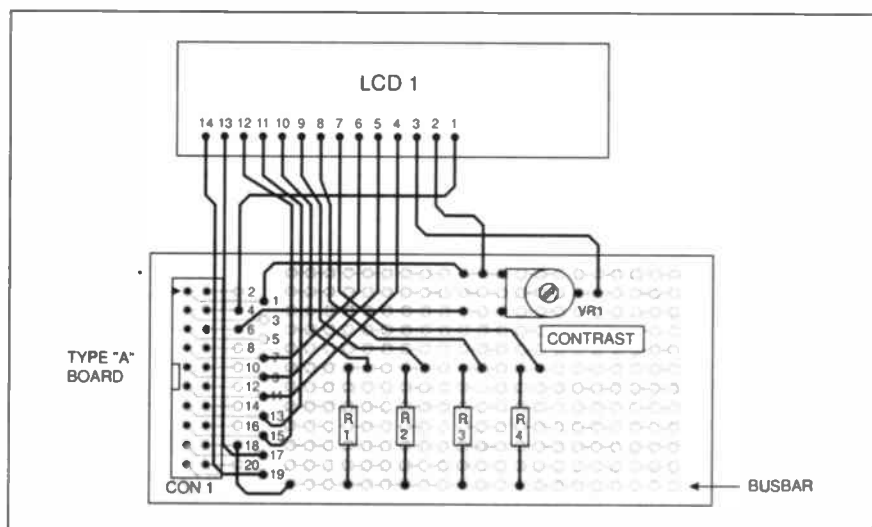
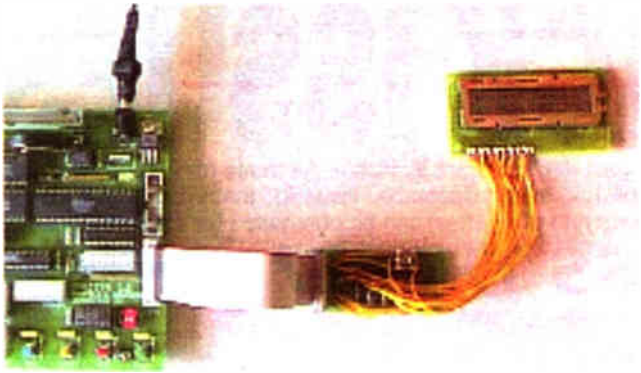
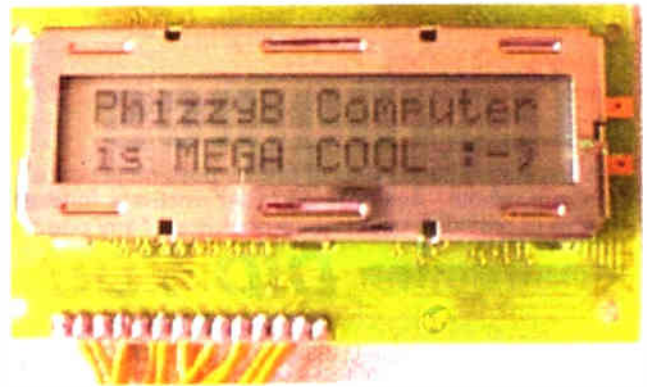

Fig.2. Component layout and connections for the L.C.D. Interface.



The L.C.D. Interface connected to PhizzyB.



The L.C.D. says it all!

Solder in the components as shown and then solder in the 20-way IDC header, noting again that the orientation of the notch is important. (Pin 1 of the header is also usually denoted by an arrowhead in the plastic moulding.)

The remaining part of construction involves merely soldering the l.c.d. leads into place. Starting with pin 14 of the l.c.d. (the left-most pad), solder the wire ends onto the I/O board in accordance with the Fig.1. Three small jumper wires are also used on the I/O board.

After completing the assembly, check it all carefully, looking for incomplete soldering or bridged joints. Then use a 20-way IDC lead (as fabricated last month) to connect the I/O board to port \$F031 on the main PhizzyB board.

DISPLAY CHECKING

Your PhizzyB can then be powered up from the mains adaptor and connected to your PC using a null modem lead. The full working version of the PhizzyB Simulator CD-ROM should then be loaded. (The demo version disallows communication with the hardware PhizzyB). On its 7-segment displays your PhizzyB will be displaying:

```
00 4000
00 0000
```

To launch the PhizzyB Simulator software on your computer, now go:

Start -> Programs -> PhizzyB -> PhizzyB

Open the PhizzyB PBLink Interface by clicking the icon, or go Tools ->

COMPONENTS

Resistors
R1 to R4 47k 5% carbon film

Potentiometer
VR1 10k min. preset, horiz.

Miscellaneous
LCD1 Hitachi LM016L 2-line
16-character l.c.d. module

CON1 20-way IDC header
PhizzyB I/O board type "A" (full 4-section board available from the *EPE PCB Service*, code 216 (I/O Board); 20-way IDC lead and connectors (see Part 2); connecting wire; solder.

Alternatives to the l.c.d. include the (USA) Optrex DMC-16207 (Digkey 73-1025-ND) and the IIIV TLCM-1621. They are all pin-compatible.

The 20-way header CON1 must match the connector used in the 20-way IDC lead (see Part 2), so it is best to check the brand before ordering.

Approx Cost
Guidance Only **£15**

PhizzyB Interface to do the same. Click **File Open** and a file called `lcdtest.ram` should be available (what a surprise!).

You can then download this to the hardware PhizzyB running on the serial port. Press the Run button on the PhizzyB or Run/F2 on the PB Link software to run the l.c.d. test program.

The 7-segment l.c.d. displays will blank out for approximately three or four seconds. However, the l.c.d. should now

load a message, though this may not yet be seen. If necessary, rotate VR1 until a welcome message becomes visible. Having now set the contrast, press Run once again to see the message spelled out in real time by your PhizzyB.

In fact the display's default on power-up is 1-line mode (you might just see a single row of boxes initially), so after running the program to place it in 2-line mode, some adjustment of the contrast might be needed as a one-off setup. It should then operate normally and pressing the Run button will initialise the message again.

MESSAGE CHANGING

You can open the file `lcdtest.asm` using the PhizzyB Assembler tool to view the routine. It contains notes to help explain the operation of the program. For more fun, try opening `lcdtest.asm`, save it as `lcdtest2.asm` to make a copy, and then edit the output port to \$F032.

Assemble into `lcdtest2.ram` and send that to the PhizzyB. Unplug and move the l.c.d. to the second PhizzyB port, \$F032. Run the program to prove the l.c.d. does indeed still operate as instructed, only this time on the second port.

As a further challenge, try editing the message data (`MESS1` and `MESS2`) contained within the file, to see if you can write alternative messages. Referring to Table 2 of this month's tutorial, experiment with different code numbers for the message and see what happens!

You should soon discover how the character data is derived very simply from two co-ordinates. For example, the "H" in "HELLO" is \$48, which is the first hexadecimal number shown in `MESS1` in the listing. You can have lots of fun writing other data to your newly-constructed l.c.d. interface, by changing the data, re-assembling it and sending it to your PhizzyB.

You would need to be quite unlucky for the display not to work first time, and if you follow the interwiring diagram closely we don't think you'll have a problem. There is little scope for error, but if you are not met with success, check that the interwiring is correct, the soldering is intact and that everything is correctly orientated.

You can contact the constructional author by E-mail at: alan@epemag.demon.co.uk or by writing to the Editorial address.

Next month we move on to an expandable switch-sensing system.

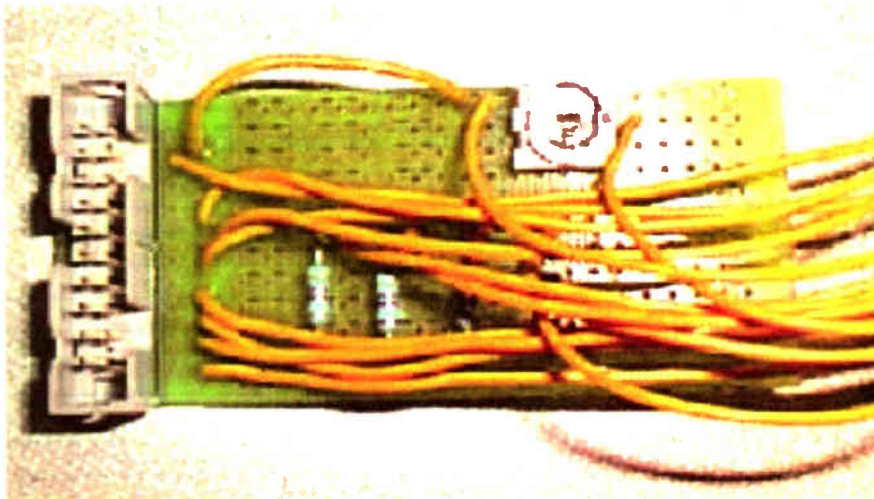

Close-up detail of the completed p.c.b. for the L.C.D. Interface.

We can supply back issues of *EPE* by post, most issues from the past five years are available. An index for the last five years is also available – see order form. Alternatively, indexes are published in the December issue for that year. Where we are unable to provide a back issue a photostat of any *one article* (or *one part* of a series) can be purchased for the same price.

DID YOU MISS THESE?

AUG. '97

PROJECTS ● Variable Bench Power Supply ● PIC-olo Music Maker ● Universal Input Amplifier ● Micropower PIR Detector – 2.
FEATURES ● Interface ● Ingenuity Unlimited ● Colossus Recreated ● Circuit Surgery ● Great Experimenters – 4 ● Net Work.



SEPT '97

PROJECTS ● PIC-Noughts & Crosses Game ● Ironing Safety Device ● Active Receiving Antenna ● Soldering Iron Controller ● Micropower PIR Detector – 3.
FEATURES ● Ingenuity Unlimited ● Raising the Pressure – RC4190 Switch-Mode I.C. ● Circuit Surgery ● Techniques – Actually Doing It ● Great Experimenters – 5 ● Net Work.

OCT '97

PROJECTS ● PIC Water Descaler ● Remote Control Finder ● Multi-Station Quiz Monitor ● Rechargeable Handlamp.
FEATURES ● Ingenuity Unlimited ● It's Probably Murphy's Law ● Interface ● Circuit Surgery ● Kanda PIC Explorer Review ● Network

NOV '97

PROJECTS ● Portable 12V PSU/Charger ● Case Alarm ● Auto-Dim Bedlight ● *EPE* Time Machine.
FEATURES ● Satellite Celebration ● Ingenuity Unlimited ● TEACH-IN '98 – An Introduction to Digital Electronics-1 ● Techniques – Actually Doing It ● Circuit Surgery ● Net Work ● Free Greenweld Catalogue.

DEC '97

PROJECTS ● Safe and Sound – Security Bleepers ● Active Microphone ● Car Immobiliser ● Mini Organ.
FEATURES ● TEACH-IN '98 – An Introduction to Digital Electronics-2 ● Circuit Surgery ● Interface ● B² Spice Review ● Ingenuity Unlimited ● Alternative and Future Technologies-1 ● Net Work – The Internet ● *Free* Giant Data Chart – Formulae.

JAN '98

PROJECTS ● Disco Lights Flasher ● Simple M.W. Radio ● *EPE* Virtual Scope-1 ● Surface Thermometer.
FEATURES ● TEACH-IN '98 – An Introduction to Digital Electronics-3 ● Circuit Surgery ● Ingenuity Unlimited ● Alternative and Future Technologies-2 ● Net Work – The Internet ● *Free* – Giant PIC Data Chart.

FEB '98

PROJECTS ● Water Wizard ● Kissometer ● Waa-Waa Effects Pedal ● *EPE* Virtual Scope – 2.
FEATURES ● TEACH-IN '98 – 4 ● Ingenuity Unlimited ● Techniques-Actually Doing It ● Circuit Surgery ● Net Work – The Internet ● Chip Special – HT7630 PIR Controller.

MAR '98 Photostats Only

PROJECTS ● Lighting-Up Reminder ● The Handy Thing ● Switch-Activated Burglar Alarm ● Audio System Remote Controller.
FEATURES ● TEACH-IN '98 – 5 ● Ingenuity Unlimited ● Interface ● Stripboard Magic Review ● Circuit Surgery ● Net Work ● *EPE* PIC Tutorial Supplement 1

APRIL '98

PROJECTS ● Simple Metal Detector ● Single or Dual Tracking Power Supply ● Experimental Piezo-Cable Projects – Distributed Microphone – Vibration Alarm ● RC-Meter.
FEATURES ● Ingenuity Unlimited ● Patent Your Invention ● TEACH-IN '98 – 6 ● Circuit Surgery ● Net Work ● Techniques – Actually Doing It ● *EPE* PIC Tutorial Supplement 2

MAY '98

PROJECTS ● Dice Lott ● Security Auto-Light ● Stereo Tone Control plus 20W Stereo Amplifier ● Improved Infra-Red Remote Repeater.
FEATURES ● TEACH-IN '98 – 7 ● Net Work ● *EPE* PIC Tutorial Supplement 3

JUNE '98

PROJECTS ● *EPE* Mood Changer ● Simple SW Receiver ● Atmel AT89C2051/1051 Programmer ● Reaction Timer.
FEATURES ● 8051-based EEPROM Microcontrollers ● TEACH-IN '98 – An Introduction to Digital Electronics – 8 ● Circuit Surgery ● Techniques – Actually Doing It ● Ingenuity Unlimited



JULY '98

PROJECTS ● PIC16x84 Toolkit ● Noise Cancelling Unit ● Low Battery Indicator ● Greenhouse Computer – 1.
FEATURES ● Using the L200CV Voltage Regulator ● TEACH-IN '98 – 9 ● Ingenuity Unlimited ● Circuit Surgery ● Net Work.

AUG '98

PROJECTS ● Lightbulb Saver ● Float Charger ● PC Transistor Tester ● Greenhouse Computer – 2 ● Time Machine Update.
FEATURES ● TEACH-IN '98 – 10 ● Circuit Surgery ● Techniques – Actually Doing It ● Ingenuity Unlimited ● New Technology Update ● Net Work ● IVEX PCB Cad Review.

SEPT '98

PROJECTS ● Mains Socket Tester ● Personal Stereo Amplifier ● Greenhouse Radio Link ● PIC Altimeter.
FEATURES ● TEACH-IN '98 – 11 ● Ingenuity Unlimited ● Circuit Surgery ● Interface ● Net Work ● Crocodile Clips Review.



OCT '98

PROJECTS ● Voice Processor ● Digiserv R/C Channel Expander ● Reliable Infra-Red Remote Control ● PC Capacitance Meter.
FEATURES ● Easy PCB Making ● Using LM335 and LM35 Temperature Sensors ● Circuit Surgery ● Ingenuity Unlimited ● Net Work ● Electronics Principles 5.0 Review.

NOV '98

PROJECTS ● PIC Tape Measure ● T-Stat Electronic Thermostat – 1 ● PhizzyB Computers – 1 ● 15-way Infra-Red Remote Control.
FEATURES ● Circuit Surgery ● Ingenuity Unlimited ● New Technology Update ● Net Work – The Internet ● Easy PC for Windows 95 Review ● *FREE* *EPE* CD-ROM No.1.

DEC '98

PROJECTS ● *EPE* Mind Pickler-1 ● Fading Christmas Lights ● Handheld Function Generator ● Damp Stat Electronic Thermostat ● PhizzyB Computers-2.
FEATURES ● PhizzyB Computers-2 Understanding Computers ● Circuit Surgery ● Ingenuity Unlimited ● Interface ● Net Work – The Internet ● 1998 Index ● *FREE* 48-page Understanding Passive Components booklet.

BACK ISSUES ONLY £2.75 each inc. UK p&p.

Overseas prices £3.35 each surface mail, £4.35 each airmail.

We can also supply issues from earlier years: 1990 (except Jan., March, April, Oct. and Dec.), 1991 (except May, June, Aug., Sept. and Nov.), 1992 (except April and Dec.), 1993 (except Jan. to May and Dec.), 1994 (except April, May, June and Nov.), 1995 (except Jan., March, May, June, July, Aug., Sept., Nov. and Dec.), 1996 (except Feb., April, May, July, Aug., Nov.), 1997.

Please note we are not able to supply copies (or 'stats of articles) of *Practical Electronics* prior to the merger of the two magazines in November 1992.

Where we do not have an issue a photostat of any *one article* or *one part* of a series can be provided at the same price.

ORDER FORM – BACK ISSUES – PHOTOSTATS – INDEXES

Send back issues dated

Send photostats of (article title and issue date)

Send copies of last five years indexes (£2.75 for five inc. p&p – Overseas £3.35 surface, £4.35 airmail)

Name

Address

I enclose cheque/P.O./bank draft to the value of £.....

Please charge my Visa/Mastercard £.....

Card No. Card Expiry Date

Note: Minimum order for credit cards £5. Please supply name and address of cardholder if different from that shown above.
SEND TO: **Everyday Practical Electronics, Allen House, East Borough, Wimborne, Dorset BH21 1PF**
Tel: 01202 881749. Fax: 01202 841692. (Due to the cost we cannot reply to overseas queries or orders by Fax.)
E-mail: orders@epemag.wimborne.co.uk

Payments must be in £ sterling – cheque or bank draft drawn on a UK bank. Normally supplied within seven days of receipt of order.
Send a copy of this form, or order by letter if you do not wish to cut your issue.

M1/99

SURVEILLANCE PROFESSIONAL QUALITY KITS

No. 1 for Kits

Whether your requirement for surveillance equipment is amateur, professional or you are just fascinated by this unique area of electronics SUMA DESIGNS has a kit to fit the bill. We have been designing electronic surveillance equipment for over 12 years and you can be sure that all our kits are very well tried, tested and proven and come complete with full instructions, circuit diagrams, assembly details and all high quality components including fibreglass PCB. Unless otherwise stated all transmitters are tuneable and can be received on an ordinary VHF FM radio.

Genuine SUMA kits available only direct from Suma Designs. Beware inferior imitations!

UTX Ultra-miniature Room Transmitter

Smallest room transmitter kit in the world! Incredible 10mm x 20mm including mic. 3V-12V operation. 500m range..... £16.45

MTX Micro-miniature Room Transmitter

Best-selling micro-miniature Room Transmitter. Just 17mm x 17mm including mic. 3V-12V operation. 1000m range..... £13.45

STX High-performance Room Transmitter

High performance transmitter with a buffered output stage for greater stability and range. Measures 22mm x 22mm, including mic. 6V-12V operation. 1500m range. £15.45

VT500 High-power Room Transmitter

Powerful 250mW output providing excellent range and performance. Size 20mm x 40mm. 9V-12V operation. 3000m range..... £16.45

VXT Voice-Activated Transmitter

Triggers only when sounds are detected. Very low standby current. Variable sensitivity and delay with LED indicator. Size 20mm x 67mm. 9V operation. 1000m range. £19.45

HVX400 Mains Powered Room Transmitter

Connects directly to 240V A.C. supply for long-term monitoring. Size 30mm x 35mm. 500m range..... £19.45

SCRX Subcarrier Scrambled Room Transmitter

Scrambled output from this transmitter cannot be monitored without the SCDM decoder connected to the receiver. Size 20mm x 67mm. 9V operation. 1000m range..... £22.95

SCLX Subcarrier Telephone Transmitter

Connects to telephone line anywhere. requires no batteries. Output scrambled so requires SCDM connected to receiver. Size 32mm x 37mm. 1000m range..... £23.95

SCDM Subcarrier Decoder Unit for SCRX

Connects to receiver earphone socket and provides decoded audio output to headphones. Size 32mm x 70mm. 9V-12V operation..... £22.95

ATR2 Micro-Size Telephone Recording Interface

Connects between telephone line (anywhere) and cassette recorder. Switches tape automatically as phone is used. All conversations recorded. Size 16mm x 32mm. Powered from line..... £13.45

UTLX Ultra-miniature Telephone Transmitter

Smallest telephone transmitter kit available. Incredible size of 10mm x 20mm! Connects to line (anywhere) and switches on and off with phone use. All conversation transmitted. Powered from line. 500m range..... £15.95

TLX 700 Micro-miniature Telephone Transmitter

Best-selling telephone transmitter. Being 20mm x 20mm it is easier to assemble than UTLX. Connects to line (anywhere) and switches on and off with phone use. All conversations transmitted. Powered from line. 1000m range..... £13.45

STLX High-performance Telephone Transmitter

High performance transmitter with buffered output stage providing excellent stability and performance. Connects to line (anywhere) and switches on and off with phone use. All conversations transmitted. Powered from line. Size 22mm x 22mm. 1500m range..... £16.45

TKX900 Signalling/Tracking Transmitter

Transmits a continuous stream of audio pulses with variable tone and rate. Ideal for signalling or tracking purposes. High power output giving range up to 3000m. Size 25mm x 63mm. 9V operation..... £22.95

CD400 Pocket Bug Detector/Locator

LED and piezo bleeper pulse slowly. rate of pulse and pitch of tone increase as you approach signal. Gain control allows pinpointing of source. Size 45mm x 54mm. 9V operation..... £30.95

CD600 Professional Bug Detector/Locator

Multicolour readout of signal strength with variable rate bleeper and variable sensitivity used to detect and locate hidden transmitters. Switch to AUDIO CONFORM mode to distinguish between localised bug transmission and normal legitimate signals such as pagers, cellular, taxis etc. Size 70mm x 100mm. 9V operation..... £50.95

QTX180 Crystal Controlled Room Transmitter

Narrow band FM transmitter for the ultimate in privacy. Operates on 180MHz and requires the use of a scanner receiver or our QRX180 kit (see catalogue). Size 20mm x 67mm. 9V operation. 1000m range..... £40.95

QLX180 Crystal Controlled Telephone Transmitter

As per QTX180 but connects to telephone line to monitor both sides of conversations. 20mm x 67mm. 9V operation. 1000m range..... £40.95

QSX180 Line Powered Crystal Controlled Phone Transmitter

As per QLX180 but draws power requirements from line. No batteries required. Size 32mm x 37mm. Range 500m..... £35.95

QRX 180 Crystal Controlled FM Receiver

For monitoring any of the Q range transmitters. High sensitivity unit. All RF section supplied as pre-built and aligned module ready to connect on board so no difficulty setting up. Output to headphones. 60mm x 75mm. 9V operation..... £60.95

A build-up service is available on all our kits if required.

UK customers please send cheques, POs or registered cash. Please add £2.00 per order for P&P. Goods despatched ASAP allowing for cheque clearance. Overseas customers send Sterling Bank Draft and add £5.00 per order for shipment. Credit card orders welcomed on 01827 714476.

OUR LATEST CATALOGUE CONTAINING MANY MORE NEW SURVEILLANCE KITS NOW AVAILABLE. SEND TWO FIRST CLASS STAMPS OR OVERSEAS SEND TWO IRCS.

★★★ Specials ★★★

DLTX/DLRX Radio Control Switch

Remote control anything around your home or garden, outside lights, alarms, paging system etc. System consists of a small VHF transmitter with digital encoder and receiver unit with decoder and relay output, momentary or alternate, 8-way d.i.l. switches on both boards set your own unique security code. TX size 45mm x 45mm. RX size 35mm x 90mm. Both 9V operation. Range up to 200m.

Complete System (2 kits)..... £50.95

Individual Transmitter DLTX..... £19.95

Individual Receiver DLRX..... £37.95

MBX-1 Hi-Fi Micro Broadcaster

Not technically a surveillance device but a great idea! Connects to the headphone output of your Hi-Fi, tape or CD and transmits Hi-Fi quality to a nearby radio. Listen to your favourite music anywhere around the house, garden, in the bath or in the garage and you don't have to put up with the DJ's choice and boring waffle.

Size 27mm x 60mm. 9V operation. 250m range..... £20.95

**SUMA
DESIGNS**

DEPT. EE
THE WORKSHOPS, 95 MAIN ROAD,
BAXTERLEY, NEAR ATHERSTONE,
WARWICKSHIRE CV9 2LE

VISITORS STRICTLY BY APPOINTMENT ONLY



**Tel/Fax:
01827 714476**

EPE MIND PICKLER

ANDY FLIND Part Two

Relax with the power of a PIC.



LAST month the operating principles, circuit and the program flow for a PIC driven Mind Machine were described. This month the project will be completed with details of construction and testing and some notes on its use.

CONSTRUCTION

In contrast with previous Mind Machines the construction of the *EPE Mind PICKler* project is very straightforward. Nearly all the components are mounted on a single printed circuit board (p.c.b.), the layout of which is shown in Fig.6. This board is available from the *EPE PCB Service*, code 214.

Solder pins are recommended for all external connections to the board as they make these much more accessible and robust. These pins are usually quite a tight fit so it is best to fit them first. The author's usual method is to insert them with the aid of a small hammer, ensuring the board is very well supported on the other side whilst doing so! There are thirty pins in all.

Following this the three link wires should be fitted, followed by all the remaining components except the i.c.s and the 4700 μ F capacitor C18. D.I.L. sockets should be used for all the i.c.s except, of course, voltage regulator IC5, which should also be fitted at this stage.

Two leads should be connected to the pins for the pushswitches, one to the common positive (right-hand one) and one to the connection for S1. Touching these leads together will convince the PIC it is

being given an input. A lead should also be attached to the 0V (lower) Reset switch S8 connection, touching this to the other pin will reset the PIC. The circuit board is now ready for an initial test.

BOARD TESTS

The p.c.b. should now be powered up with a 9V supply. Following a small switch-on surge, the current drawn should be about 1mA. The presence of the 5V regulated supply should be checked at all the i.c. sockets (minus, of course, the i.c.s), save those for IC9 and IC7 where the supply will be 9V.

With the exception of IC1 and IC3, the supply pins in every case are 0V at bottom left and positive supply at top right. For IC3 they are 0V at bottom left and positive at pin 7, and for IC1 they are the two middle pins, pin 5 (0V) and pin 14 (+5V).

If these checks are satisfactory it should be safe to proceed with further functional testing. With the supply disconnected, piezo sounder LS1 should be connected and IC1 inserted into its socket.

At switch-on, there should be a single brief bleep. Pin 13 of IC1 should be at +5V, this is RB7 of the PIC, and is used to block the clock signal to the variable frequency oscillator stage. Pin 17 (RA0) should be at 0V, this is the 400Hz fixed frequency output which should not yet be running.

Touching the two wires to simulate operation of switch S1 three times should produce a bleep each time, after which pin 13 of IC1 should go to 0V and pin 17 to 2.5V if measured with a meter. Pin 17 should actually be generating a 400Hz squarewave which can be checked if an oscilloscope or amplifier is to hand. The control voltage may also be inspected at the right-hand end of resistor R20 or pin 3 of IC3's socket, where it should be seen changing very slowly as IC1 steps through a program.

If the Reset connection is now briefly connected to 0V there should be another bleep and pins 13 and 17 should return to +5V and 0V respectively. This completes checking of the operation of IC1.

With the supply disconnected again, IC2, IC3 and IC4 should be inserted in their sockets. The board should then be powered and the program set running by

Completed p.c.b. mounted in the low-profile case.

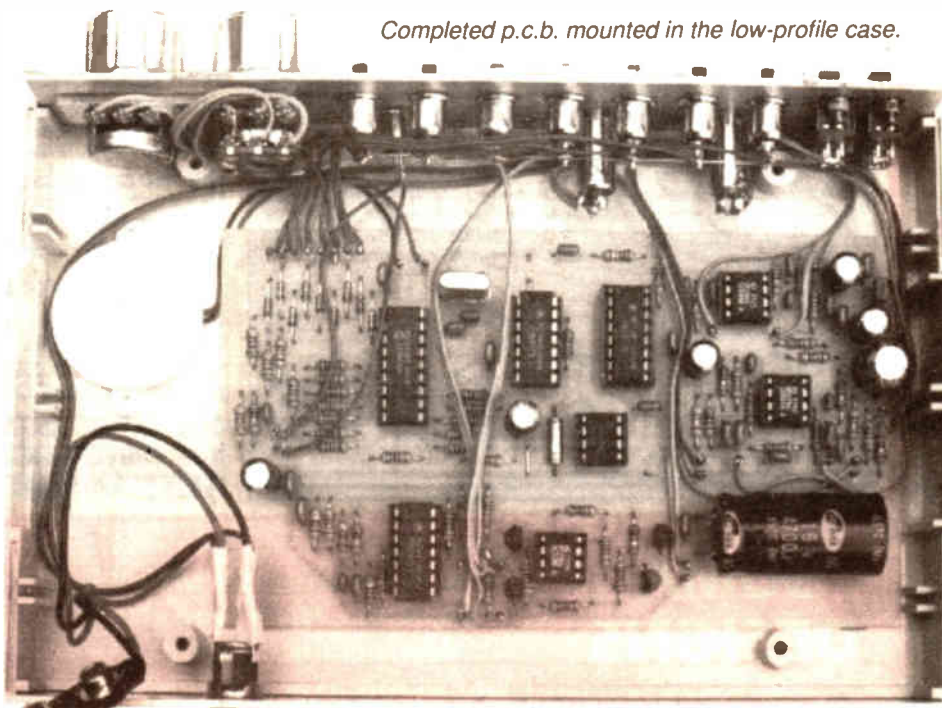

WARNING NOTICE

Photic stimulation at Alpha frequencies can cause seizures in persons suffering from Epilepsy. For this reason such people MUST NOT try this project.

A user who is not a known epileptic, but when using the *EPE Mind PICKler* begins to experience an odd smell, sound or other unexplained effects, should TURN IT OFF IMMEDIATELY and seek professional medical advice.

Because of the above possibility, the *EPE Mind PICKler* should not be used while on your own.

**YOU MUST TREAT THIS UNIT
WITH DUE RESPECT**

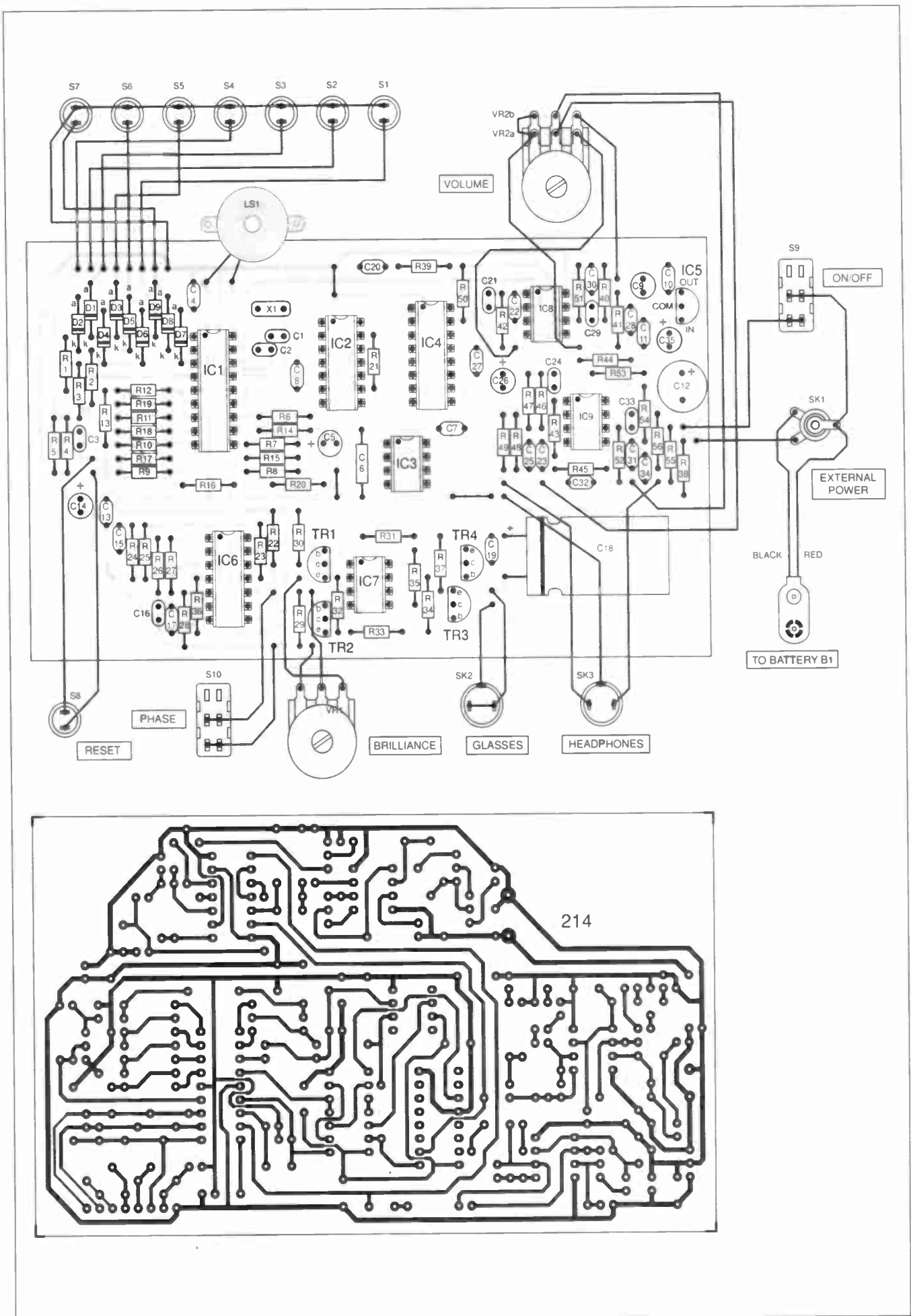

Fig.6. Printed circuit board component layout, wiring to off-board components and full size underside copper foil master pattern.

touching the connections for S1 three times as before. A squarewave of just under 400Hz should be present on pin 2 of IC2, this can be checked in the same way as pin 17 of IC1, either by looking for 2.5V with a meter, or by inspection with a 'scope or amplifier. This is the variable frequency output.

Next, IC8 should be inserted and the voltage at pins 1 and 7 (outputs) checked, both should be at about 2.5V. They should be checked again with the program running, when they should still be at about 2.5V. A check with a 'scope should reveal triangular waveforms on both at around 400Hz with a peak-to-peak amplitude of about 3V. Played through an amplifier this will sound "softer" than the squarewaves encountered so far.

To complete testing of the audio stages, the headphones and Volume control VR2 should be temporarily connected and IC9 inserted. When the program is set running the tones should be audible in the headphones and it should be possible to control their volume with VR2. The overall supply current will obviously depend on volume setting, but it should be somewhere between 12mA and 25mA.

SIGHT TEST

All that is necessary now to complete the board is to get the glasses i.e.d. driver operating. IC6 should be inserted, and the program set running. Pin 11 should measure about 2.5V (400Hz squarewave) as should pin 10, but at low frequencies the latter may show a slight flicker.

All the supplied programs start with fairly high frequencies and work gradually downwards, so if it has just been set running the reading here should be 2.5V. On a 'scope the signal will consist of pulses of varying width at 800Hz.

Pin 3 should be at about 1.25V and pin 4 at about 3.75V, but again flicker may be noticeable at low frequencies. These two pins operate at the actual "brainwave" frequencies of between 2Hz and 20Hz, controlled by the program.

The final step commences with the fitting of electrolytic capacitor C18. This has been left until now as the charge stored in it would keep the circuit powered for some time following supply disconnection, which is undesirable when i.c.s are being inserted and removed. A blob of glue or "Blu-Tack" will help to secure this component, which is mounted horizontally to obtain a low physical profile.

Next, the Brilliance control VR1 and the glasses (or a couple of i.e.d.s in series for testing) should be temporarily connected and IC7 inserted. If the circuit is now set running the i.e.d.s should operate with VR1 controlling their brightness.

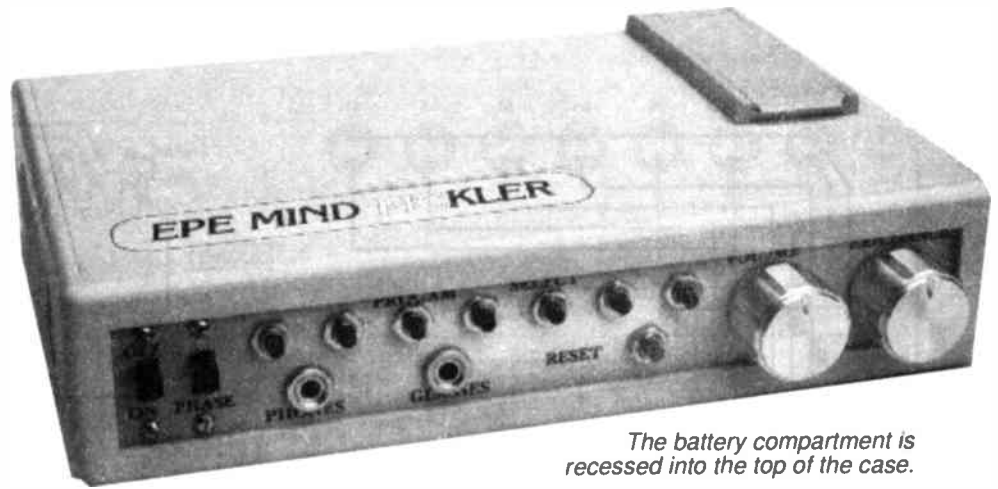

The battery compartment is recessed into the top of the case.

The overall supply current for the complete circuit should vary from a minimum of about 12mA to a maximum, with Volume and Brilliance controls at their highest settings, of about 50mA. Normal settings, such as would be used in most sessions, should result in a current of about 20mA to 30mA which is well within the capabilities of an alkaline PP3 battery. The circuit works with supplies down to about 6V which is the voltage at which such a battery is normally considered to be exhausted.

CASE DETAILS

The unit may be housed in any case of the constructor's choice but a particularly neat unit can be built using one of Vero's new "Patina" range, size 180mm x 120mm x 40mm. (See *Shoptalk* page.)

A full-size drilling template for the front panel is shown in Fig.7. If this is used, it will be found necessary to trim a small piece from one of the internal pillars to obtain clearance for switch S1, but this is minimal and can easily be done with a sharp knife.

The p.c.b. in the prototype is held in place with blobs of "Blu-Tack", which keep it perfectly secure. This adhesive seems to increase in strength and rigidity with time and allows simple mounting of such components without unsightly external screw heads on the case.

Positioning of the battery holder is less critical than that of components on the front panel, its position can be seen in the photographs. It would be possible to site the battery internally in the case for an even neater appearance, but this would require the case to be prised open each time replacement became necessary.

Another option would be to fit a bunch of seven or eight "AA" or "AAA" NiCad cells inside the case with an external charging socket on the rear panel, but

after several large and heavy rechargeable "Mind Machines" the author preferred to construct a small, lightweight one with a simple battery supply. As a compromise, the prototype has an external power socket.

The metal panels in this type of case tend to rattle, but a good way to prevent this and give a nice "solid" feel to the project is to put some tiny blobs of "Blu-Tack" in the slots before final assembly. This won't stop the case coming apart again easily, but it will prevent rattles.

FINAL ASSEMBLY

All the external interwiring connections to the board are also shown in Fig.6. Most of these are straightforward, but note that the wire connections to the board for switches S1 to S7 are not in direct order. Take care with these or the programs and times obtained from the unit will not be those expected!

The two front panel sockets SK2 and SK3 are of the compact screened 3.5mm chassis-mounting type, stereo for the headphones and mono for the glasses. It is necessary to remember which is which when plugging these items into the unit!

A minor problem with these was experienced when a faint "popping" noise was heard at low volume. This was traced to a poor socket contact connection to the 0V side of the plug for the glasses, leading to some of the return current going via the metal panel and the audio 0V lead. The cure is to solder the earth tags of both sockets to their cases, and it is suggested that this should be done anyway during construction as a preventative measure.

GLASSES

The i.e.d. glasses are the same as those used by the Mind Machine MkIII so readers who built one of these can skip this bit! Otherwise, they are constructed from glasses with plastic lenses which can be

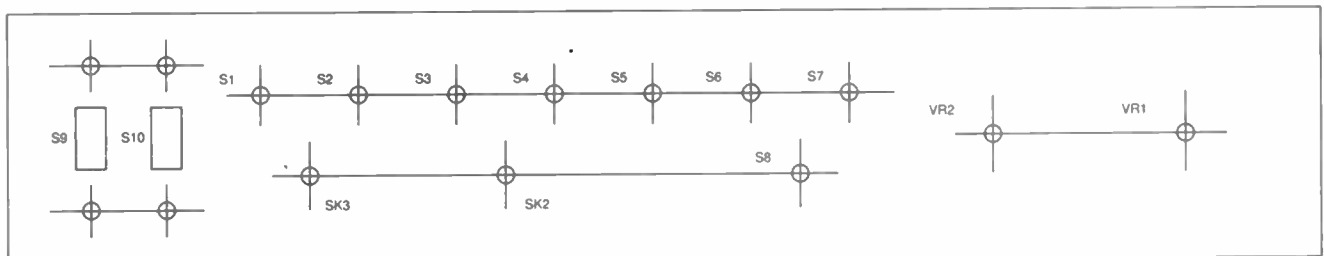

Fig.7. Full-size front panel drilling template. This diagram can be photocopied and glued to the aluminium panel and used as a drilling guide. A second copy can be coloured and have small rub-down lettering put on it to finish off the front panel.

drilled so that the l.e.d.s can be pushed into the holes.

Various types of glasses have been tried over the years, but cheap ski goggles, available from most sports shops, seem preferable as they are light and comfortable to wear, have darkened lenses and they look good. Oddly enough this pattern seems to be favoured by most commercial producers of this type of unit.

The l.e.d.s used in the model are 5mm "hyperbright" red types, with a quoted output of 3.5cd at a viewing angle of 30°. Because of this narrow viewing angle it is necessary to place them fairly accurately over the eyeballs.

A way of doing this is to place small blobs of "Blu-Tack" (the author is very fond of this stuff!) on the lenses, put the glasses on, relax the eyes as far as possible and move the blobs around until they appear to be dead centre in the field of view. They will then serve as markers for drilling.

The l.e.d.s are connected as shown in Fig.8. Any thin, flexible twin-core cable can be used to connect them to the plug and it can be secured to the glasses frame with a couple of small cable ties.

If possible, the headphones should be of the completely separate type, not those using a headband, as they could clash with the glasses. Cheap headphones generally sound better as they do not reproduce hiss and distortion so readily, but the sound quality from this design is such that it can be used with expensive 'phones without such noises causing distraction.

SOFTWARE

The seven programs supplied in the PIC are shown in graphical form in Fig.9, with notes on the effect each is intended to achieve. They will probably have different potencies for individual users, number two is particularly effective.

For those wishing to do their own programming, the software is supplied as TASM source and object files, as with this language it is simple to include all the equates, etc in a single file. It can be programmed into both PIC16C84 and PIC16F84 devices using any of the TASM programming systems, including those of the *PIC Tutorial* (Mar '98-May '98) and the *PIC Toolkit* (July '98).

The software on disk (see *Shoptalk*) or downloaded from the Internet consists of two files: *mmprog.obj* is the original object file; whilst *mmprog.asm* is the associated text source file, which can be modified by the user and re-assembled

Life-size model showing lettering on front panel.

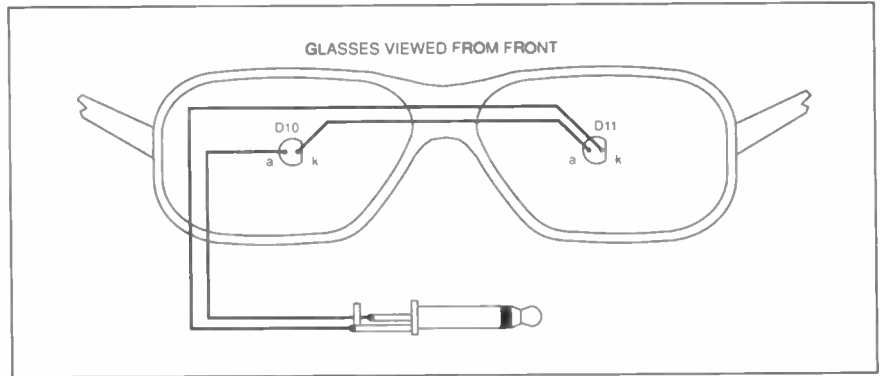
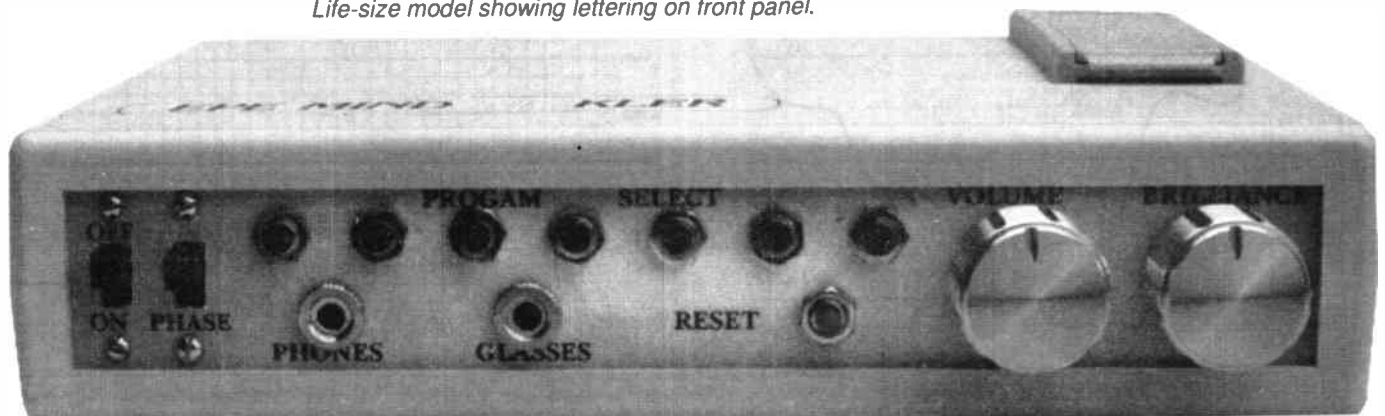
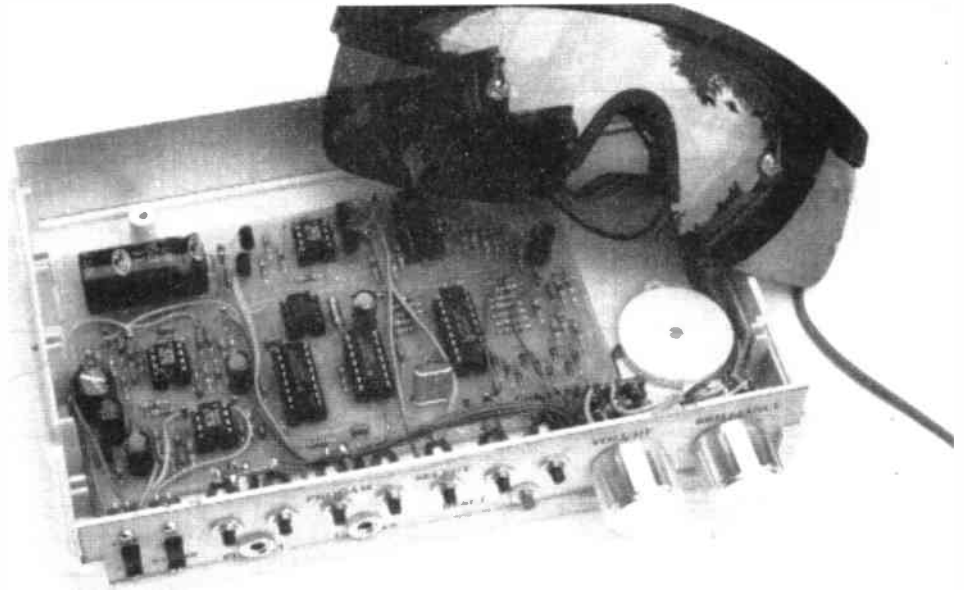

Fig.8. Suggested glasses arrangement with wiring details between the l.e.d.s and jack plug. The leads can be taped together along one of the side frames to give a neat finish.



Top removed from the completed EPE Mind PICkler showing general arrangement of components inside the case. The auxiliary power inlet socket is mounted on the rear panel. Here it is obscured by the l.e.d. ski goggles.

for use in altering the operation of the project.

The main purpose in doing this will normally be to change the supplied programs to ones devised by the user. This can be done without extensive knowledge of PIC assembly language since the seven programs consist of strings of 31 numerical values near the beginning of the PIC program.

The *mmprog.asm* file is in plain text format and can be opened in any text editor including DOS "EDIT". At the top will be found some general notes about the pro-

gram, followed by two "defines", then the "equates" and the interrupt and start vectors.

Following this is the label "table" with the command "addwf pcl,f". Immediately following this is the first of the numbers comprising the first program. Note that all the numbers used must be preceded with "retlw".

There are seven groups of 31 numbers and changing any of them will alter the associated program. It is merely necessary to determine the new values required and insert them.

NEW PROGRAM

To devise a new program, it is best to start with a blank chart similar to the last one shown in Fig.9, but enlarged and with extra divisions on the frequency axis clearly marked. A curve for the shape of the new program can be pencilled onto this and the corresponding frequencies for each step read from it.

These must be converted into the corresponding numerical values for the PIC program using the formula:

$$256 \times \left(1 - e^{-\left(\frac{0.5}{400 - f} - 0.00125 \right)} \right) - 1$$

SPREADSHEET

This could be done with a calculator, but the process would be tedious. A better way is to use a spreadsheet, as constructors following this will obviously have a computer on hand for PIC programming. The author uses an early version of Microsoft "Works" for the job.

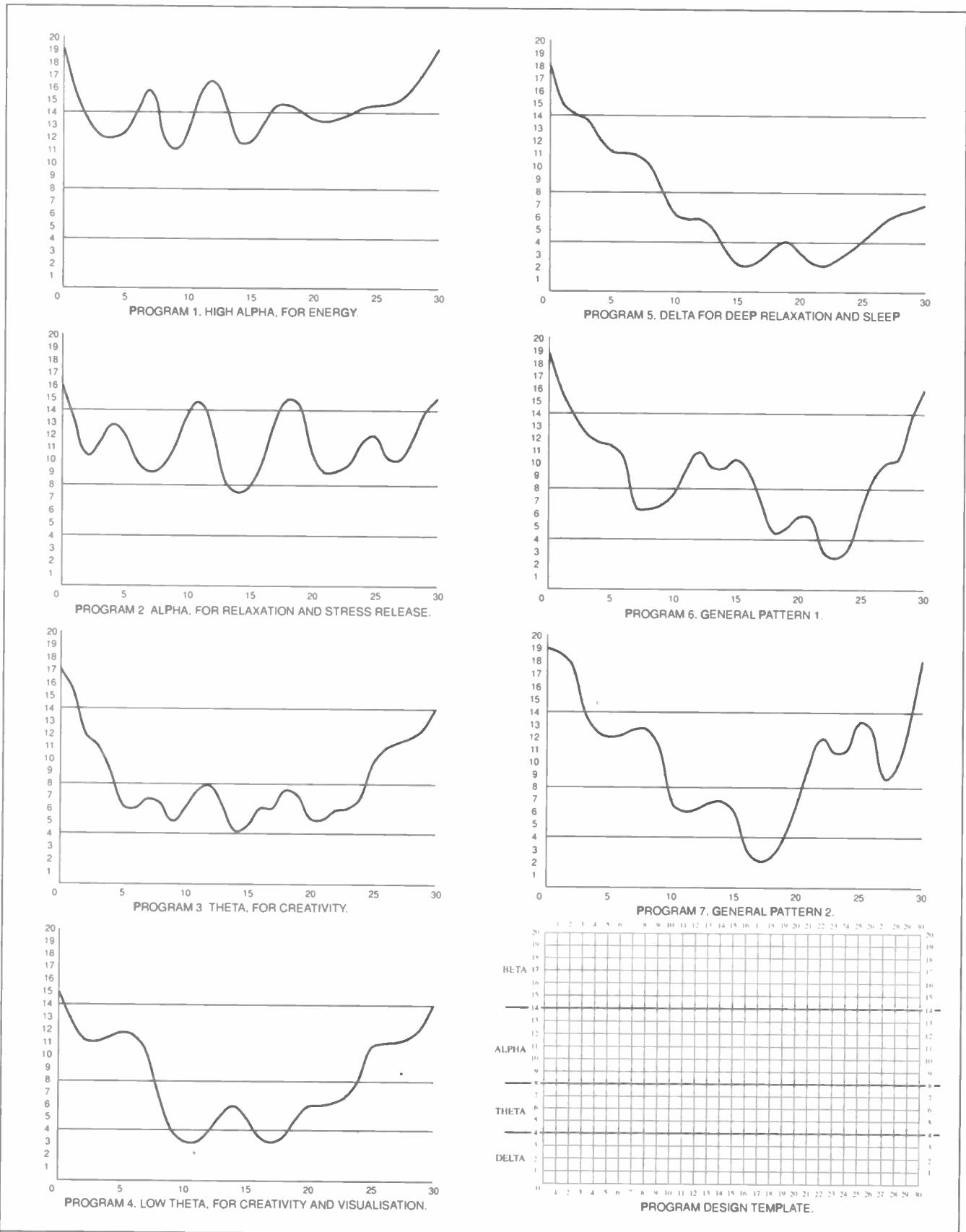

Fig.9. Graphical representations of the seven programs "stored" in the ready-programmed PIC16F84 microcontroller. The last blank chart will help readers undertaking their own programming to produce their own "relaxation rhythms".

If the desired frequency is placed in cell A1, entering the formula:

$(256 \times (1 - \text{EXP}(-(0.5/(400 - A1) - 0.00125)/0.000123))) - 1$

into cell B1 automatically generates the value required for the PIC program. This can be "replicated" to allow simple generation of the remaining thirty values required for a program. The output format should be set to "fixed" with no decimal places since the PIC doesn't understand decimal points!

Note that this formula generates decimal values for the TASM assembler which uses decimal by default. If another assembler is used which defaults to HEX, the user will have to make an adjustment for this, probably by specifying that numbers entered are in decimal.

The exponential part of the formula compensates for the exponential charging rate of capacitor C6, whilst the "1" subtracted at the end was determined by empirical means (*trial and error!*) to compensate for a small but constant error probably due to a propagation delay. The overall result with the prototype was astonishing accuracy, far better than that of previous designs, within 0.1Hz over most of the range.

RELAXATION

In use, the unit normally produces a sensation of extreme relaxation, which may continue for an extended period. It seems to do this as much by slowing down conscious intellectual thought as by "entraining" brainwave frequencies, so it is worth trying to reduce the number of one's thoughts whilst using it.



"Stilling" the intellect seems to be the primary purpose of most forms of meditation. Mantras, koans and many other systems used by meditators seem to have the common purpose of distracting the intellect to "shut it down" to some extent, so that the intuitive "right brain" can be perceived.

"Mind machines" perform this function more readily than many of the traditional methods, so perhaps they are best regarded as modern hi-tech meditation aids. For best results it is still necessary to work at it though, users will not get nearly so much benefit if they simply sit and contemplate all their usual worries and discontents throughout the session.

One writer on meditation tells his readers to "let thoughts go" with each outgoing breath. "Breathe thoughts out" he says, and the author has found this technique to be particularly helpful in conjunction with the EPE Mind Pickler.

FURTHER THOUGHTS

For readers who would like to explore

this subject in greater depth, the author can particularly recommend the works of authors Barry Long and Stuart Wilde, which can be found in larger bookstores or "New Age" specialist booksellers.

From the practical point of view, for a really fascinating hypothesis on the operation of the human brain, it's hard to beat the opening chapters of "The Origin of Consciousness In The Breakdown Of The Bicameral Mind" by Julian Jaynes. This was originally published in 1982 as a Pelican paperback, though an updated version is now apparently available from Penguin.

This book gives detailed descriptions of the fascinating experiments of Roger Sperry which proved that we each have two entirely separate "minds" within our brains, and continues by presenting a theory that intellectual consciousness as we know it only evolved around four thousand years ago, before which we humans may have "thought" in an entirely different manner. It's gripping reading for those into this kind of stuff.



Buy your magazine online. **EPE**, the first magazine in the world to be available to buy from the web. \$3.95 per issue, \$23.95 for a year's subscription.

**TAKE A LOOK,
A FREE ISSUE IS AVAILABLE**

Save money on printed copies – take out a subscription

Everyday Practical Electronics Books



TEACH-IN No. 7 plus FREE Software ANALOGUE AND DIGITAL ELECTRONIC COURSE
(Published by *Everyday Practical Electronics*)
Alan Winstanley and Keith Dye
B.Eng(Tech)AMIEE

FREE SOFTWARE

The highly acclaimed *Teach-In* series, which included the construction and use of the *Mini Lab* and *Micro Lab* test and development units, has been put together in book form. Additionally EPT Educational Software have developed a GCSE Electronics software program to complement the course and a FREE DISC covering the first two parts of the course is included with the book.

An interesting and thorough tutorial series aimed specifically at the novice or complete beginner in electronics. The series is designed to support those undertaking either GCSE Electronics or GCE Advanced Levels, and starts with fundamental principles.

If you are taking electronics or technology at school or college, this book is for you. If you just want to learn the basics of electronics then this is for you. If you are teaching electronics or technology you must make sure you see it. *Teach-In No. 7* will be invaluable if you are considering a career in electronics or



even if you are already training in one. The *Mini Lab* and software enable the construction and testing of both demonstration and development circuits. These learning aids bring electronics to life in an enjoyable and interesting way; you will both see and hear the electron in action! The *Micro Lab* microprocessor add-on system will appeal to higher level students and those developing microprocessor projects.

Order code T17 £3.95

ELECTRONICS TEACH-IN 88/89 - INTRODUCING MICROPROCESSORS
Mike Tooley BA (published by *Everyday Practical Electronics*)

A complete course that can lead successful readers to the award of a City and Guilds Certificate in Introductory Microprocessors (726/303). The book contains everything you need to know including full details on registering for assessment, etc. Starting with basic terminology, integrated circuits, logic families and numbering systems the text builds in stages, with revision and assessments built in, up to programming, languages, flow charts, etc. The course is ideal for the newcomer to the subject.

80 pages (A4) £2.45

Order code T1-88/89

DIRECT BOOK SERVICE

The books listed have been selected by *Everyday Practical Electronics* editorial staff as being of special interest to everyone involved in electronics and computing. Books are supplied by mail order direct to your door. Full ordering details are given on the last book page.

For another selection of books see the next two issues of EPE.

Testing and Test Gear

HOW TO USE OSCILLOSCOPES AND OTHER TEST EQUIPMENT

R. A. Penfold

This book explains the basic function of an oscilloscope, gives a detailed explanation of all the standard controls, and provides advice on buying. A separate chapter deals with using an oscilloscope for fault finding on linear and logic circuits, plenty of example waveforms help to illustrate the control functions and the effects of various fault conditions. The function and use of various other pieces of test equipment are also covered, including signal generators, logic probes, logic pulsers, and crystal calibrators.

104 pages £1.50

Order code BP267

SERVICING PERSONAL COMPUTERS - 4th EDITION

Mike Tooley BA

The revised and enlarged fourth edition has been completely re-written to cover the latest technology, such as 32-bit microprocessors and serial communications servicing. It includes a diagnostic disk offer. Essential for anyone concerned with the maintenance of personal computer equipment or peripherals, whether professional service technician, student or enthusiast.

387 pages Hardback £3.00

Order code NE15

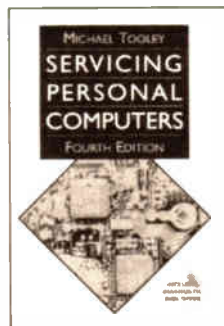

Radio, TV, Satellite

BASIC RADIO PRINCIPLES AND TECHNOLOGY

NEW

Ian Poole

Radio technology is becoming increasingly important in today's high technology society. There are the traditional uses of radio which include broadcasting and point to point radio as well as the new technologies of satellites and cellular phones. All of these developments mean there is a growing need for radio engineers at all levels.

Assuming a basic knowledge of electronics, this book provides an easy to understand grounding in the topic. Chapters in the book: Radio Today, Yesterday, and Tomorrow; Radio Waves and Propagation; Capacitors, Inductors, and Filters; Modulation; Receivers; Transmitters; Antenna Systems; Broadcasting; Satellites; Personal Communications; Appendix - Basic Calculations.

263 pages £14.99

Order code NE30

PROJECTS FOR RADIO AMATEURS AND S.W.L.S.

R. A. Penfold

This book describes a number of electronic circuits, most of which are quite simple, which can be used to enhance the performance of most short wave radio systems.

The circuits covered include: An aerial tuning unit; A simple active aerial; An add-on b.f.o. for portable sets; A wavetrapp to combat signals on spurious responses; An audio notch filter; A parametric equaliser; C.W. and S.S.B. audio filters; Simple noise limiters; A speech processor; A volume expander.

Other useful circuits include a crystal oscillator, and RTTY/C.W. tone decoder, and a RTTY serial to parallel converter. A full range of interesting and useful circuits for short wave enthusiasts.

92 pages £3.95

Order code BP304

AN INTRODUCTION TO AMATEUR RADIO

I. D. Poole

Amateur radio is a unique and fascinating hobby which has attracted thousands of people since it began at the turn of the century.

This book gives the newcomer a comprehensive and easy to understand guide through the subject so that the reader can gain the most from the hobby. It then remains an essential reference volume to be used time and again. Topics covered include the basic aspects of the hobby, such as operating procedures, jargon and setting up a station. Technical topics covered include propagation, receivers, transmitters and aerials etc.

150 pages £4.99

Order code BP257

SIMPLE SHORT WAVE RECEIVER CONSTRUCTION

R. A. Penfold

Short wave radio is a fascinating hobby, but one that seems to be regarded by many as an expensive

pastime these days. In fact it is possible to pursue this hobby for a minimal monetary outlay if you are prepared to undertake a bit of d.i.y., and the receivers described in this book can all be built at low cost. All the sets are easy to construct, full wiring diagrams etc. are provided, and they are suitable for complete beginners. The receivers only require simple aerials, and do not need any complex alignment or other difficult setting up procedures.

The topics covered in this book include: The broadcast bands and their characteristics; The amateur bands and their characteristics; The propagation of radio signals; Simple aerials; Making an earth connection; Short wave crystal set; Simple t.r.f. receivers; Single sideband reception; Direct conversion receiver.

Contains everything you need to know in order to get started in this absorbing hobby.

88 pages £3.95

Order code BP275

Computers and Computing

MULTIMEDIA ON THE PC

Ian R. Sinclair

In this book, you'll find out what a CD ROM is, how it works, and why it is such a perfect add-on for a PC, allowing you to buy programmes, text, graphics and sound on a CD. It also describes the installation of a CD ROM drive and a sound card, pointing out the common problems that arise, and then shows how to use them to create a complete multimedia presentation that contains text, photos, a soundtrack with your own voice recorded as a commentary, even animation and edited video footage.

184 pages £11.95

Order code PC112

UNDERSTANDING PC SPECIFICATIONS

R. A. Penfold (Revised Edition)

If you require a microcomputer for business applications, or a high quality home computer, an IBM PC or compatible is often the obvious choice. They are competitively priced, and are backed up by an enormous range of applications programs, hardware add-ons, etc. The main difficulty for the uninitiated is deciding on the specification that will best suit his or her needs. PCs range from simple systems of limited capabilities up to complex systems that can happily run applications that would have been considered beyond the abilities of a microcomputer not so long ago. It would be very easy to choose a PC system that is inadequate to run your applications efficiently, or one which goes beyond your needs and consequently represents poor value for money.

This book explains PC specifications in detail, and the subjects covered include the following: Differences

between types of PC (XT, AT, 80386, etc); Maths co-processors; Input devices (keyboards, mice, and digitisers); Memory, including both expanded (EMS) and extended RAM; RAM disks and disk caches; Floppy disk drive formats and compatibility; Hard disk drives (including interleave factors and access times); Display adapters, including all standard PC types (CGA, Hercules, Super VGA, etc); Contains everything you need to know if you can't tell your EMS from your EGA!

128 pages £4.95

Order code BP282

Our postage is the same no matter how many books you buy - just £1.50 in the UK.

Theory and Reference

Bebop To The Boolean Boogie

By Clive (call me Max)
Maxfield
ORDER CODE BEB1
£24.95

470 pages. Large format
Specially imported by EPE – Excellent value
An Unconventional Guide to Electronics Fundamentals, Components and Processes

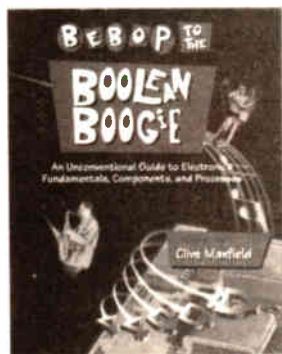

This book gives the "big picture" of digital electronics. This in-depth, highly readable, up-to-the-minute guide shows you how electronic devices work and how they're made. You'll discover how transistors operate, how printed circuit boards are fabricated, and what the innards of memory ICs look like. You'll also gain a working knowledge of Boolean algebra and Karnaugh maps, and understand what Reed-Muller logic is and how it's used. And there's much, MUCH more (including a recipe for a truly great seafood gumbo!). Hundreds of carefully drawn illustrations clearly show the important points of each topic. The author's tongue-in-cheek British humor makes it a delight to read, but this is a REAL technical book, extremely detailed and accurate. A great reference for your own shelf, and also an ideal gift for a friend or family member who wants to understand what it is you do all day....

DIGITAL ELECTRONICS – A PRACTICAL APPROACH
With **FREE Software: Number One Systems – EASY-PC Professional XM and Pulsar (Limited Functionality)**
Richard Monk

FREE SOFTWARE

Covers binary arithmetic, Boolean algebra and logic gates, combination logic, sequential logic including the design and construction of asynchronous and synchronous circuits and register circuits. Together with a considerable practical content plus the additional attraction of its close association with computer aided design including the FREE software.

There is a 'blow-by-blow' guide to the use of EASY-PC Professional XM (a schematic drawing and printed circuit board design computer package). The guide also conducts the reader through logic circuit simulation using Pulsar software. Chapters on p.c.b. physics and p.c.b. production techniques make the book unique, and with its host of project ideas make it an ideal companion for the integrative assignment and common skills components required by BTEC and the key skills demanded by GNVQ. The principal aim of the book is to provide a straightforward approach to the understanding of digital electronics.

Those who prefer the 'Teach-In' approach or would rather experiment with some simple circuits should find the book's final chapters on printed circuit board production and project ideas especially useful.

250 pages

Order code NE28

£16.99

Bebop Bytes Back

FREE CD-ROM

By Clive "Max" Maxfield
and Alvin Brown
ORDER CODE BEB2
£29.95

Over 500 pages. Large format
Specially imported by EPE – Excellent value
An Unconventional Guide To Computers

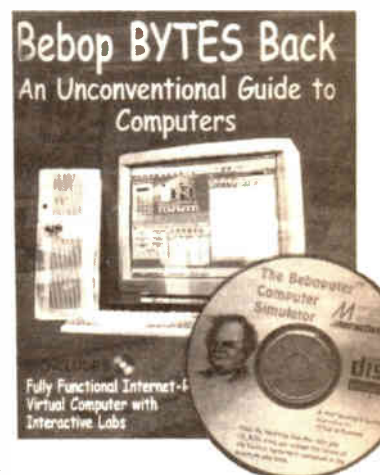

Plus **FREE CD-ROM** which includes:
Fully Functional Internet-Ready Virtual Computer with Interactive Labs

This follow-on to *Bebop to the Boolean Boogie* is a multimedia extravaganza of information about how computers work. It picks up where "Bebop I" left off, guiding you through the fascinating world of computer design . . . and you'll have a few chuckles, if not belly laughs, along the way. In addition to over 200 megabytes of mega-cool multimedia, the accompanying CD-ROM (for Windows 95 machines only) contains a virtual microcomputer, simulating the motherboard and standard computer peripherals in an extremely realistic manner. In addition to a wealth of technical information, myriad nuggets of trivia, and hundreds of carefully drawn illustrations, the book contains a set of lab experiments for the virtual microcomputer that let you recreate the experiences of early computer pioneers. If you're the slightest bit interested in the inner workings of computers, then don't dare to miss this one!

DIGITAL GATES AND FLIP-FLOPS
Ian R. Sinclair

This book, intended for enthusiasts, students and technicians, seeks to establish a firm foundation in digital electronics by treating the topics of gates and flip-flops thoroughly and from the beginning.

Topics such as Boolean algebra and Karnaugh mapping are explained, demonstrated and used extensively, and more attention is paid to the subject of synchronous counters than to the simple but less important ripple counters.

No background other than a basic knowledge of electronics is assumed, and the more theoretical topics are explained from the beginning, as also are many working practices. The book concludes with an explanation of microprocessor techniques as applied to digital logic.

200 pages

Order code PC106

£8.95

Audio and Music

AN INTRODUCTION TO LOUDSPEAKERS AND ENCLOSURE DESIGN

V. Capel

This book explores the various features, good points and snags of speaker designs. It examines the whys and wherefores so that the reader can understand the principles involved and so make an informed choice of design, or even design loudspeaker enclosures for him – or herself. Crossover units are also explained, the various types, how they work, the distortions they produce and how to avoid them. Finally there is a step-by-step description of the construction of the Kapellmeister loudspeaker enclosure.

148 pages

Order code BP256

£3.99

ACOUSTIC FEEDBACK – HOW TO AVOID IT

V. Capel

Feedback is the bane of all public address systems. While feedback cannot be completely eliminated, many things can be done to reduce it to a level at which it is no longer a problem.

Much of the trouble is often the hall itself, not the equipment, but there is a simple and practical way of greatly improving acoustics. Some microphones are prone to feedback while others are not. Certain loudspeaker systems are much better than others, and the way the units are positioned can produce a reduced feedback. All these matters are fully explored as well as electronic aids such as equalizers, frequency-shifters and notch filters.

The special requirements of live group concerts are considered, and also the related problem of instability that is sometimes encountered with large set-ups. We even take a look at some unsuccessful attempts to cure feedback so as to save readers wasted time and effort duplicating them.

Also included is the circuit and layout of an

inexpensive but highly successful twin-notch filter, and how to operate it.

92 pages

Temporarily out of print

PREAMPLIFIER AND FILTER CIRCUITS

R. A. Penfold

This book provides circuits and background information for a range of preamplifiers, plus tone controls, filters, mixers, etc. The use of modern low noise operational amplifiers and a specialist high performance audio preamplifier i.c. results in circuits that have excellent performance, but which are still quite simple. All the circuits featured can be built at quite low cost (just a few pounds in most cases). The preamplifier circuits featured include: Microphone preamplifiers (low impedance, high impedance, and crystal). Magnetic cartridge pick-up preamplifiers with R.I.A.A. equalisation. Crystal/ceramic pick-up preamplifier. Guitar pick-up preamplifier. Tape head preamplifier (for use with compact cassette systems).

Other circuits include: Audio limiter to prevent overloading of power amplifiers. Passive tone controls. Active tone controls. PA filters (highpass and lowpass). Scratch and rumble filters. Loudness filter. Audio mixers. Volume and balance controls.

92 pages

Order code BP309

£4.99

COMPUTERS AND MUSIC – AN INTRODUCTION

R. A. Penfold

Computers are playing an increasingly important part in the world of music, and the days when computerised music was strictly for the fanatical few are long gone.

If you are more used to the black and white keys of a synth keyboard than the QWERTY keyboard of a computer, you may be understandably confused by the jargon and terminology bandied about by computer buffs.

But fear not, setting up and using a computer-based music making system is not as difficult as you might think.

This book will help you learn the basics of computing, running applications programs, wiring up a MIDI system and using the system to good effect, in fact just about everything you need to know about hardware and the programs, with no previous knowledge of computing needed or assumed. This book will help you to choose the right components for a system to suit your personal needs, and equip you to exploit that system fully.

174 pages

Order code PC107

£8.95

ELECTRONIC PROJECTS FOR GUITAR

R. A. Penfold

This book contains a collection of guitar effects and some general purpose effects units, many of which are suitable for beginners to project building. An introductory chapter gives guidance on construction.

Each project has an introduction, an explanation of how it works, a circuit diagram, complete instructions on stripboard layout and assembly, as well as notes on setting up and using the units. Contents include: Guitar tuner; Guitar preamplifier; Guitar headphone amplifier; Soft distortion unit; Compressor; Envelope waa waa; Phaser; Dual tracking effects unit; Noise gate/expander; Treble booster; Dynamic treble booster; Envelope modifier; Tremelo unit; DI box.

110 pages

Temporarily out of print

HIGH POWER AUDIO AMPLIFIER CONSTRUCTION

R. A. Penfold

Practical construction details of how to build a number of audio power amplifiers ranging from about 50 to 300/400 watts r.m.s. includes MOSFET and bipolar transistor designs.

96 pages

Order code BP277

£3.99

Circuits, Data and Design

Practical Electronic Filters

Owen Bishop

This book deals with the subject in a non-mathematical way. It reviews the main types of filter, explaining in simple terms how each type works and how it is used.

The book also presents a dozen filter-based projects with applications in and around the home or in the constructor's workshop. These include a number of audio projects such as a rhythm sequencer and a multi-voiced electronic organ.

Concluding the book is a practical step-by-step guide to designing simple filters for a wide range of purposes, with circuit diagrams and worked examples.

88 pages **Order code BP299** £4.99

Electronic Hobbyists Data Book

R. A. Penfold

This book should tell you everything you are ever likely to want to know about hobby electronics, but did not know where to ask or refer. Comprehensive contents pages makes it easy to quickly locate the data you require.

The subjects covered include: Common circuits, and related data (including helpful graphs and tables of values); Colour codes for resistors, capacitors and inductors; Pinout details for a wide range of CMOS and TTL devices, plus basic data on the various logic families; Pinout details and basic data for a wide range of operational amplifiers; Data and leadout information for a wide range of transistors, FETs, power FETs, triacs, thyristors, diodes, etc; General data including MIDI message coding, radio data, ASCII/Baudot coding, decibel ratios, etc.

242 pages **Order code BP396** £5.95

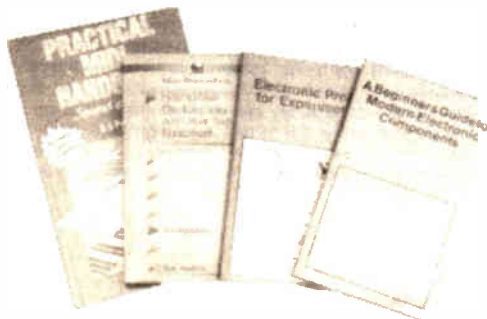

50 Simple LED Circuits

R. N. Soar

Contains 50 interesting and useful circuits and applications, covering many different branches of electronics, using one of the most inexpensive and freely available components - the light-emitting diode (LED). Also includes circuits for the 707 common anode display.

64 pages **Order code BP42** £2.99

Book 2 50 more I.e.d. circuits.

50 pages

Order code BP87 £2.99

Circuit Source Book 1

A. Penfold

Written to help you create and experiment with your own electronic designs by combining and using the various standard "building block" circuits provided. Where applicable, advice on how to alter the circuit parameters is given.

The circuits covered in this book are mainly concerned with analogue signal processing and include: Audio amplifiers (op.amp and bipolar transistors); audio power amplifiers; d.c. amplifiers; highpass, lowpass, bandpass and notch filters; tone controls; voltage controlled amplifiers and filters; triggers and voltage comparators; gates and electronic switching; bargraphs; mixers; phase shifters, current mirrors, hold circuits, etc.

Over 150 circuits are provided, which it is hoped will be useful to all those involved in circuit design and application, be they professionals, students or hobbyists.

182 pages **Order code BP321** £4.99

A Beginner's Guide to TTL Digital ICs

R. A. Penfold

This book first covers the basics of simple logic circuits in general, and then progresses to specific TTL logic integrated circuits. The devices covered include gates, oscillators, timers, flip/flops, dividers, and decoder circuits. Some practical circuits are used to illustrate the use of TTL devices in the "real world"

142 pages **Order code BP332** £4.95

How to Use Opamps

E. A. Parr

This book has been written as a designer's guide covering many operational amplifiers, serving both as a source book of circuits and a reference book for design calculations. The approach has been made as non-mathematical as possible.

160 pages **Order code BP88** £3.99

Circuit Source Book 2

R. A. Penfold

This book will help you to create and experiment with your own electronic designs by combining and using the various standard "building blocks" circuits provided. Where applicable, advice on how to alter the circuit parameters is provided.

The circuits covered are mainly concerned with signal generation, power supplies, and digital electronics.

The topics covered in this book include: 555 oscillators; sine-wave oscillators; function generators; CMOS oscil-

lators; voltage controlled oscillators; radio frequency oscillators; 555 monostables; CMOS monostables; TTL monostables; precision long timers; power supply and regulator circuits; negative supply generators and voltage boosters; digital dividers; decoders, etc; counters and display drivers; D/A and A/D converters; opto-

isolators, flip/flops, noise generators, tone decoders, etc.

Over 170 circuits are provided, which it is hoped will be useful to all those involved in circuit design and application, be they professionals, students or hobbyists.

192 pages **Order code BP322** £4.99

Project Building

ANDROIDS, ROBOTS AND ANIMATRONS

John Lovine

Build your own working robot or android using both off-the-shelf and workshop constructed materials and devices. Computer control gives these robots and androids two types of artificial intelligence (an expert system and a neural network). A lifelike android hand can be built and programmed to function doing repetitive tasks. A fully animated robot or android can also be built and programmed to perform a wide variety of functions.

The contents include an Overview of State-of-the-Art Robots; Robotic Locomotion; Motors and Power Controllers; All Types of Sensors; Tilt; Bump; Road and Wall Detection; Light; Speech and Sound Recognition; Robotic Intelligence (Expert Type) Using a Single-Board Computer Programmed in BASIC; Robotic Intelligence (Neural Type) Using Simple Neural Networks (Insect Intelligence); Making a Lifelike Android Hand; A Computer-Controlled Robotic Insect Programmed in BASIC; Telepresence Robots With Actual Arcade and Virtual Reality Applications; A Computer-Controlled Robotic Arm; Animated Robots and Androids; Real-World Robotic Applications.

224 pages **Order code MGHT** £19.99

Electronic Projects for Experimenters

R. A. Penfold

Many electronic hobbyists who have been pursuing their hobby for a number of years seem to suffer from the dreaded "seen it all before" syndrome. This book is fairly and squarely aimed at sufferers of this complaint, plus any other electronics enthusiasts who yearn to try something a bit different. No doubt many of the projects featured here have practical applications, but they are all worth a try for their interest value alone.

The subjects covered include:- Magnetic field detector, Basic Hall effect compass, Hall effect audio isolator, Voice scrambler/descrambler, Bat detector, Bat style echo location, Noise cancelling, LED stroboscope, Infra-red "torch", Electronic breeze detector, Class D power amplifier, Strain gauge amplifier, Super hearing aid.

138 pages **Order code BP371** £4.95

Practical Fibre-Optic Projects

R. A. Penfold

While fibre-optic cables may have potential advantages over ordinary electric cables, for the electronics enthusiast it is probably their novelty value that makes them worthy of exploration. Fibre-optic cables provide

an innovative interesting alternative to electric cables, but in most cases they also represent a practical approach to the problem. This book provides a number of tried and tested circuits for projects that utilize fibre-optic cables.

The projects include:- Simple audio links, F.M. audio link, P.W.M. audio links, Simple d.c. links, P.W.M. d.c. link, P.W.M. motor speed control, RS232C data links, MIDI link, Loop alarms, R.P.M. meter.

All the components used in these designs are readily available, none of them require the constructor to take out a second mortgage.

132 pages **Order code BP374** £4.95

Electronic Project Building for Beginners

R. A. Penfold

This book is for complete beginners to electronic project building. It provides a complete introduction to the practical side of this fascinating hobby, including the following topics:

Component identification, and buying the right parts; resistor colour codes, capacitor value markings, etc; advice on buying the right tools for the job; soldering; making easy work of the hard wiring; construction methods, including stripboard, custom printed circuit boards, plain matrix boards, surface mount boards and wire-wrapping; finishing off, and adding panel labels; getting "problem" projects to work, including simple methods of fault-finding.

In fact everything you need to know in order to get started in this absorbing and creative hobby.

135 pages **Order code BP392** £4.95

A Beginner's Guide to Modern Electronic Components

R. A. Penfold

The purpose of this book is to provide practical information to help the reader sort out the bewildering array of components currently on offer. An advanced knowledge of the theory of electronics is not needed, and this book is not intended to be a course in electronic theory. The main aim is to explain the differences between components of the same basic type (e.g. carbon, carbon film, metal film, and wire-wound resistors) so that the right component for a given application can be selected. A wide range of components are included, with the emphasis firmly on those components that are used a great deal in projects for the home constructor.

166 pages **Order code BP285** £4.99

BOOK ORDERING DETAILS

Our postage price is the same no matter how many books you order, just add £1.50 to your total order for postage and packing (overseas readers add £3 for countries in the EEC, or add £6 for all countries outside the EEC, surface mail postage) and send a PO, cheque, international money order (£ sterling only) made payable to Direct Book Service or credit card details, Visa or Mastercard - minimum credit card order is £5 - to: DIRECT BOOK SERVICE, 33 GRAVEL HILL, MERLEY, WIMBORNE, DORSET BH21 1RW (mail order only).

Books are normally sent within seven days of receipt of order, but please allow 28 days for delivery (more for overseas orders). Please check price and availability (see latest issue of Everyday Practical Electronics) before ordering from old lists.

For a further selection of books see the next two issues of EPE.

DIRECT BOOK SERVICE IS A DIVISION OF WIMBORNE PUBLISHING LTD. Tel 01202 881749

Fax 01202 841692. Due to the cost we cannot reply to overseas orders or queries by Fax.

E-mail: dbs@epemag.wimborne.co.uk

BOOK ORDER FORM

Full name:

Address:

..... Post code: Telephone No:

Signature:

I enclose cheque/PO payable to WIMBORNE PUBLISHING LTD for £

Please charge my Visa/Mastercard £ Card expiry date

Card Number

Please send book order codes:

Please continue on separate sheet of paper if necessary

2a

VIDEOS ON ELECTRONICS

A range of videos (selected by EPE editorial staff) designed to provide instruction on electronics theory. Each video gives a sound introduction and grounding in a specialised area of the subject. The tapes make learning both easier and more enjoyable than pure textbook or magazine study. Each video uses a mixture of animated current flow in circuits plus text, plus cartoon instruction etc., and a very full commentary to get the points across. The tapes originate from VCR Educational Products Co, an American supplier. (All videos are to the UK PAL standard on VHS tapes.)

BASICS

VT201 to VT206 is a basic electronics course and is designed to be used as a complete series, if required.

VT201 54 minutes. Part One; D.C. Circuits. This video is an absolute must for the beginner. Series circuits, parallel circuits, Ohms law, how to use the digital multimeter and much more.

Order Code VT201

VT202 62 minutes. Part Two; A.C. Circuits. This is your next step in understanding the basics of electronics. You will learn about how coils, transformers, capacitors, etc are used in common circuits.

Order Code VT202

VT203 57 minutes. Part Three; Semiconductors. Gives you an exciting look into the world of semiconductors. With basic semiconductor theory. Plus 15 different semiconductor devices explained.

Order Code VT203

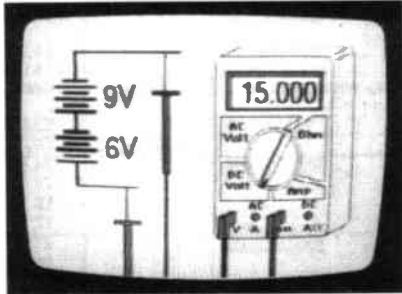

VT204 56 minutes. Part Four; Power Supplies. Guides you step-by-step through different sections of a power supply.

Order Code VT204

VT205 57 minutes. Part Five; Amplifiers. Shows you how amplifiers work as you have never seen them before. Class A, class B, class C, op.amps. etc.

Order Code VT205

VT206 54 minutes. Part Six; Oscillators. Oscillators are found in both linear and digital circuits. Gives a good basic background in oscillator circuits.

Order Code VT206

£34.95 each
Inc. VAT & postage

Order 8 or more get one extra FREE
Order 16 get two extra FREE

VCR MAINTENANCE

VT102 84 minutes: Introduction to VCR Repair. Warning, not for the beginner. Through the use of block diagrams this video will take you through the various circuits found in the NTSC VHS system. You will follow the signal from the input to the audio/video heads then from the heads back to the output.

Order Code VT102

VT103 35 minutes: A step-by-step easy to follow procedure for professionally cleaning the tape path and replacing many of the belts in most VHS VCR's. The viewer will also become familiar with the various parts found in the tape path.

Order Code VT103

DIGITAL

Now for the digital series of six videos. This series is designed to provide a good grounding in digital and computer technology.

VT301 54 minutes. Digital One; Gates begins with the basics as you learn about seven of the most common gates which are used in almost every digital circuit, plus Binary notation.

Order Code VT301

VT302 55 minutes. Digital Two; Flip Flops will further enhance your knowledge of digital basics. You will learn about Octal and Hexadecimal notation groups, flip-flops, counters, etc.

Order Code VT302

VT303 54 minutes. Digital Three; Registers and Displays is your next step in obtaining a solid understanding of the basic circuits found in today's digital designs. Gets into multiplexers, registers, display devices, etc.

Order Code VT303

VT304 59 minutes. Digital Four; DAC and ADC shows you how the computer is able to communicate with the real world. You will learn about digital-to-analogue and analogue-to-digital converter circuits.

Order Code VT304

VT305 56 minutes. Digital Five; Memory Devices introduces you to the technology used in many of today's memory devices. You will learn all about ROM devices and then proceed into PROM, EPROM, EEPROM, SRAM, DRAM, and MBM devices.

Order Code VT305

VT306 56 minutes. Digital Six; The CPU gives you a thorough understanding in the basics of the central processing unit and the input/output circuits used to make the system work.

Order Code VT306



RADIO

VT401 61 minutes. A.M. Radio Theory. The most complete video ever produced on a.m. radio. Begins with the basics of a.m. transmission and proceeds to the five major stages of a.m. reception. Learn how the signal is detected, converted and reproduced. Also covers the Motorola C-QUAM a.m. stereo system.

Order Code VT401

VT402 58 minutes. F.M. Radio Part 1. F.M. basics including the functional blocks of a receiver. Plus r.f. amplifier, mixer oscillator, i.f. amplifier, limiter and f.m. decoder stages of a typical f.m. receiver.

Order Code VT402

VT403 58 minutes. F.M. Radio Part 2. A continuation of f.m. technology from Part 1. Begins with the detector stage output, proceeds to the 19kHz amplifier, frequency doubler, stereo demultiplexer and audio amplifier stages. Also covers RDS digital data encoding and decoding.

Order Code VT403

MISCELLANEOUS

VT501 58 minutes. Fibre Optics. From the fundamentals of fibre optic technology through cable manufacture to connectors, transmitters and receivers.

Order Code VT501

VT502 57 minutes. Laser Technology A basic introduction covering some of the common uses of laser devices, plus the operation of the Ruby Rod laser, HeNe laser, CO₂ gas laser and semiconductor laser devices. Also covers the basics of CD and bar code scanning.

Order Code VT502

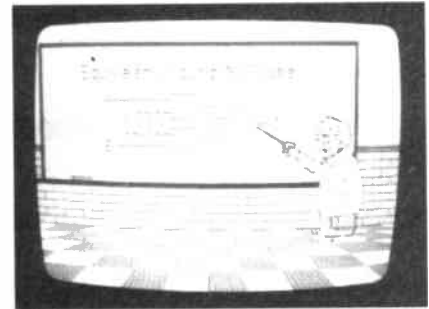

VIDEO ORDER FORM

Full name:

Address:

Post code: Telephone No.

Signature:

I enclose cheque/PO payable to WIMBORNE PUBLISHING LTD

Please charge my Visa/Mastercard: Card expiry date

Card No:

Please send video order codes:

Please continue on a separate sheet of paper if necessary.

ORDERING: Price includes postage to anywhere in the world.

OVERSEAS ORDERS: We use the VAT portion of the price to pay for airmail postage and packing, wherever you live in the world. Just send £34.95 per tape. All payments in £ sterling only (send cheque or money order drawn on a UK bank).

Send your order to:
Direct Book Service, 33 Gravel Hill,
Merley, Wimborne, Dorset BH21
1RW (Mail Order Only)

Direct Book Service is a division of Wimborne Publishing Ltd.

Tel: 01202 881749 Fax: 01202 841692

Videos are normally sent within seven days of receipt of order.

PCB SERVICE

Printed circuit boards for certain EPE constructional projects are available from the PCB Service, see list. These are fabricated in glass fibre, and are fully drilled and roller tinned. All prices include VAT and postage and packing. Add £1 per board for airmail outside of Europe. Remittances should be sent to The PCB Service, *Everyday Practical Electronics*, Allen House, East Borough, Wimborne, Dorset BH21 1PF. Tel: 01202 881749; Fax 01202 841692 (NOTE, we cannot reply to orders or queries by Fax); E-mail: orders@epemag.wimborne.co.uk. Cheques should be crossed and made payable to *Everyday Practical Electronics* (Payment in £ sterling only).

NOTE: While 95% of our boards are held in stock and are dispatched within seven days of receipt of order, please allow a maximum of 28 days for delivery – overseas readers allow extra if ordered by surface mail.

Back numbers or photostats of articles are available if required – see the *Back Issues* page for details.

Please check price and availability in the latest issue.

Boards can only be supplied on a payment with order basis.

PROJECT TITLE	Order Code	Cost
Mono "Cordless" Headphones – Transmitter/Receiver	990/991 (pr)	£10.16
Component Analyser (double-sided p.t.h.)	105	£12.18
Garden Mole-Ester	106	£6.07
Mobile Miser	107	£6.36
Bike Speedo	108	£6.61
*PIC-Tock Pendulum Clock	109	£6.31
Power Check	110	£6.42
Analogue Delay/Flanger	111	£7.95
Draught Detector	112	£6.22
Simple Exposure Timer	113	£6.63
Video Fade-to-White	114	£6.98
Direct Conversion 80m Receiver	116	£7.52
Vehicle Alert	117	£6.55
10MHz Function Generator– Main Board	118	£7.33
– PSU	119	£5.39
Tuneable Scratch Filter	115	£7.83
*Central Heating Controller	120	£7.85
D.C. to D.C. Converters – Negative Supply Generator	122	£5.96
– Step-Down Regulator	123	£6.01
– Step-Up Regulator	124	£6.12
*PIC Digital/Analogue Tachometer	127	£7.23
Stereo Cassette Recorder Playback/PSU	128	£7.94
Record/Erase	129	£9.04
*Earth Resistivity Meter	131/132 (pr)	£12.70
Current Gen. – Amp/Rect.	130 (set)	£40.00
Theremin MIDI/CV Interface (double-sided p.t.h.)	126	£6.77
Mains Failure Warning	126	£6.77
Pacific Waves	136	£9.00
PsiCom Experimental Controller	137	£6.78
Oil Check Reminder	125	£7.16
Video Negative Viewer	135	£6.75
Tri-Colour NiCad Checker	138	£6.45
Dual-Output TENS Unit (plus Free TENS info.)	139	£7.20
*PIC-Agoras – Wheelie Meter	141	£6.90
418MHz Remote Control – Transmitter	142	£5.36
– Receiver	143	£6.04
Puppy Puddle Probe	145	£6.10
MIDI Matrix – PSU	147	£5.42
– Interface	148	£5.91
Quasi-Bell Door Alert	133	£6.59
2M F.M. Receiver	144	£7.69
*PIC-A-Tuner	149	£7.83
Window Closer – Trigger	150	£4.91
– Closer	151	£4.47
Child Minder Protection Zone – Transmitter	153	£6.58
– Receiver	154	£6.42
Pyrotechnic Controller	155	£6.93
*PIC Digilogue Clock	156	£7.39
Narrow Range Thermometer	158	£6.37
Micropower PIR Detector – 1	152	£6.69
Infra-Red Remote Control Repeater (Multi-project P.C.B.)	932	£3.00
Karaoke Echo Unit – Echo Board	159	£6.40
– Mixer Board	160	£6.75
Computer Dual User Interface	161	£6.70
*PEsT Scarer	162	£6.60
Variable Bench Power Supply	932	£3.00
Universal Input Amplifier	146	£6.55
Micropower PIR Detector – 2 Controller	163	£6.72
*PIC-OLO	164	£7.02
Active Receiving Antenna	140	£6.59
Soldering Iron Controller	157	£6.63
*PIC Noughts & Crosses Game	165	£7.82
Micropower PIR Detector – 3	166	£5.72
Alarm Disarm/Reset Switch	167	£5.12
Ironing Safety Device	167	£5.12
Remote Control Finder	168	£6.32
Rechargeable Handlamp	169	£6.23
*PIC Water Descaler	170	£6.90
*EPE Time Machine	171	£8.34
Auto-Dim Bedlight	172	£6.63
Portable 12V PSU/Charger	173	£6.61
Car Immobiliser	175	£7.00
Safe and Sound (Security Bleeper)	179	£7.32
Surface Thermometer	174	£7.64
Disco Lights Flasher	178	£8.30
Waa-Waa Pedal (Multi-project PCB)	932	£3.00
*Virtual Scope – Digital Board	176	£14.49
Analogue Board (per board)	177	£7.34
*Water Wizard	180	£7.69
Kissometer	181	£7.67

PROJECT TITLE	Order Code	Cost
*EPE PIC Tutorial	MAR 98	182 £7.99
The Handy Thing (Double-Sided)	183	£6.58
Lighting-Up Reminder	184	£5.90
*Audio System Remote Controller – PSU	185	£7.05
Main Board	186	£8.29
Simple Metal Detector (Multi-project PCB)	APH 98	932 £3.00
Single or Dual-Tracking Power Supply	187	£7.90
*RC-Meter	188	£7.66
Security Auto-Light	MAY 98	189 £8.10
Stereo Tone Control plus 20W Stereo Amplifier		
Tone Control	190	£7.78
20W Amplifier	191	£8.58
*Dice Lott	192	£8.05
EPE Mood Changer	JUNE 98	193 £7.75
*AT89C2051/1051 Programmer		
Main Board	194	£8.50
Test Board	195	£8.69
*Reaction Timer Software only	–	–
*PIC16x84 Toolkit	JULY 98	196 £6.96
*Greenhouse Computer		
Control Board	197	£9.08
PSU Board	198	£8.10
Float Charger	AUG 98	199 £6.59
Lightbulb Saver	202	£3.00
Personal Stereo Amplifier (Multi-project PCB)	SEPT 98	932 £3.00
*Greenhouse Radio Link	200	£8.32
*PIC Altimeter	201	£8.15
Voice Processor	OCT 98	203 £7.18
*Digiserv R/C Expander	204	£7.69
IR Remote Control		
Transmitter	205	£3.00
Receiver	206	£3.50
*PIC Tape Measure	NOV 98	207 £6.82
Electronic Thermostat		
T-Stat	208	£4.00
PhizzyB		£14.95
A-PCB B-CD-ROM C-Prog. Microcontroller	Bee (A)(B)(C)	each
15-Way IR Remote Control		
Switch Matrix	211	£3.00
15-Way Rec/Decoder	212	£4.00
Damp Stat	DEC 98	209 £4.50
Handheld Function Generator	213	£4.00
*Fading Christmas Lights	215	£5.16
PhizzyB I/O Board (4-section)	216	£3.95
Twinkle Twinkle Reaction Game	JAN 99	210 £7.55
*EPE Mind PICKler	214	£6.30
PhizzyB I/O Board (4-section)	216	£3.95
Alternative Courtesy Light Controller	217	£6.72

EPE SOFTWARE

Software programs for EPE projects marked with an asterisk * are available on 3.5 inch PC-compatible disks or free from our Internet site. Three disks are available: **PIC Tutorial** (Mar-May '98 issues); **PIC Disk 1** (all other software Apr '95–Dec '98 issues); **EPE Disk 2** (Jan '99 issue to current cover date). The disks are obtainable from the *EPE PCB Service* at £2.75 each (UK) to cover our admin costs (the software itself is free). Overseas (each): £3.35 surface mail, £4.35 each airmail. All files can be downloaded free from our Internet FTP site: <ftp://ftp.epemag.wimborne.co.uk>.

EPE PRINTED CIRCUIT BOARD SERVICE

Order Code Project Quantity Price

Name.....

Address.....

I enclose payment of £..... (cheque/PO in £ sterling only) to:

Everyday Practical Electronics
Access (MasterCard) or Visa No.
Minimum order for credit cards £5



Signature..... Card Exp. Date.....

Please supply name and address of cardholder if different from the address shown

NOTE: You can order p.c.b.s via our Internet site on a secure server:
<http://www.epemag.wimborne.co.uk>

SURFING THE INTERNET NET WORK

ALAN WINSTANLEY

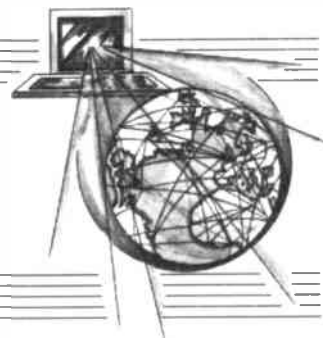

NET WORK is our monthly column for *EPE* Internet users. Try our web site at <http://www.epemag.wimborne.co.uk> for details of current and previous issues, subscriptions (new and renewals via our secure server), the *EPE Chat Zone* message board and more besides!

The source codes for this/last month's *EPE Mind PICKler* constructional project are available by anonymous FTP from <ftp://ftp.epemag.wimborne.co.uk/pub/PICS/MindPICKler>. Note the case-sensitivity of the address when you enter it.

Freerserve - Not So Free

Viewers of the TV soap *Coronation Street* will be interested to know that Des Barnes' fatal blow proved a ratings winner for the Granada TV network, as 17.1 million UK viewers tuned in. So says the new UK portal web site run by Freerserve (www.freerserve.net).

Freerserve is a new Internet service in the UK that sounds too good to be true. It provides you with a completely free Internet connection, and all you pay for are the phone calls. So what's the catch? It's pretty transparent really: by buying your loyalty and getting you to identify with their portal, Freerserve can channel advertising material from Dixons, the group behind Freerserve, directly to someone who's in the market for technology products.

Dixons hopes that other advertisers will climb aboard too, and Freerserve users can expect to be subjected to adverts from sister companies (which include The Link, Currys and PC World) and manufacturers of technology products as well. For many Internet users, the adverts may be a price well worth paying.

Think carefully before committing yourself. Freerserve's telephone support can only help, says their web site, in respect of sorting out your dialling software or (re-)configuring your Outlook Express or Internet Explorer, and (in small print) telephone support will cost you a pound a minute. Freerserve also offers support by E-mail, which won't be any use if you can't configure your Internet setup to begin with.

One Freerserve user alleged in a newsgroup that he spent £70 on phone support trying to unravel the mess he claimed his Freerserve installation made of his Internet Explorer. Another more experienced source tried it without noting any real problems, but interestingly he still decided to de-install it, as he "didn't need it": he continued with his (paid-for) Cable & Wireless Internet connection.

Other users are migrating over to Freerserve from their regular ISP without so much as a second thought. I'd welcome any honest experiences (good and bad) from Freerserve users, by E-mail. I'll summarise them in a future column.

The Apple of your iMac

The fortunes of Apple seem to be undergoing some transformation in the shape (literally) of their new home computer – the Apple iMac, a stylish new personal computer aimed squarely at those for whom lifestyle and simplicity of use rank above all else.

It relies heavily on Internet accessibility, which is why the iMac has no floppy disk. If you want to exchange files with others, then you can E-mail them. If you want to backup anything on to removable media, you must buy an external USB drive, or you could try uploading files to a remote site instead. There are several companies such as Atrieva (www.atrivea.com) and Net Realm (www.net-realm.com) which offer on-line storage services.

The reliance which the iMac has on the Internet is a double-edged sword. With immaculate timing, when I tried to confirm the two preceding links, my main Internet connection failed, which caused my PC to lock up. More recently I have been blocked by an unusually high number of engaged tones on my dial-in connection. Access to dot-com sites had also been disrupted due to

routing problems in the United States, and corrupt DNS data had been propagated amongst the world's name servers. Users don't need such hassle, and so for backing up my data, my Zip drive is probably more reliable than an Internet connection, so I'll stick to that.

For many people the Internet is now indispensable as an information resource, and with higher bandwidths, V.90 modems, free E-mail addresses (e.g. hotmail.com or bigfoot.com), free web sites (www.xoom.com) and now a free Internet connection (Freerserve), there has never been a better time to get Internet connectivity.

Apple can't make the iMac quickly enough. It is a neat-looking job full of modern design cues, using translucent blue-green radiused mouldings to encase its integrated 15-inch monitor and base unit. Its "Fisher-Price" styling is also winning it friends in primary schools, which can justify the cute styling as a benefit which is free when compared with an equivalent-priced PC. The iMac's looks alone will tip the balance for many impulse buyers. If only they could get the marketing and distribution right for a change, Apple's iMac could be poised to take over the home computer market where the Amstrad PCW left off.

Core Thoughts

Before you rush out and buy one, however, think of this: the iMac is marketed with the home Internet user in mind. Quite apart from the question marks over Internet reliability (100%, it is not), I have to try hard to find any Macintosh computers on sale anywhere. I am surrounded by countless examples of PC clones on sale, and every market town usually has one or two independent PC shops which are piled high with software and spares. I have repaired PC power supplies, mice and floppy drives easily and cheaply thanks to this universal availability.

You will have to dig more deeply for Macintosh software and hardware, and in fact mail order may be the only alternative. This will go against the grain of an iMac owner who is inexperienced in buying complex technical products at arm's length. Furthermore it is inevitable that many of your friends will own IBM-compatibles, and they will therefore play the latest games, and have access to the latest printers, CD writers or removable drives. Should you wish to E-mail files (images or wordprocessor documents) to your PC-owning friends then it is worth checking web sites devoted to the problems of incompatibilities between the two platforms. Help is available on www.macdisk.com, www.media4.com or www.mactimes.com for more pointers.

The savvy home buyer should take a longer term view about expanding and upgrading their system, and in my view should stick with the IBM-compatible PC, regardless of what people say about Microsoft or Windows 98 (which runs fine on a new PC, but no sane person would recommend it for older systems running quite happily on Windows 95). We know the PC parallel port and the serial port and ISA bus are old hat, but everything is fully documented and it works, and we can connect home-made hardware to them. PC users can also already enjoy an increasing range of USB hardware, and Windows software galore.

By opting for the iMac, you will buy an undeniably seductive and beautiful machine which will get you onto the Internet in no time at all. You will love using it, but you'll undoubtedly handicap your practical options for software, future upgrades, peripherals and repairs. The choice is yours.

Links

This month's choice of web site addresses appears as ready-made links for you to try on the *Net Work* page of the *EPE* web site. My E-mail address is alan@epemag.demon.co.uk.

Also, why not drop in to our *Chat Zone* and join the general conflag of chit-chat? It's accessible via our main web site.

ELECTRONICS

Everyday Practical Electronics reaches twice as many UK readers as any other independent monthly hobby electronics magazine, our audited sales figures prove it. We have been the leading independent monthly magazine in this market for the last fourteen years.

If you want your advertisements to be seen by the largest readership at the most economical price our classified and semi-display pages offer the best value. The prepaid rate for semi-display space is £8 (+VAT) per single column centimetre (minimum 2.5cm). The prepaid rate for classified adverts is 30p (+VAT) per word (minimum 12 words).

All cheques, postal orders, etc., to be made payable to Everyday Practical Electronics. VAT must be added. Advertisements, together with remittance, should be sent to Everyday Practical Electronics Advertisements, Mill Lodge, Mill Lane, Thorpe-le-Soken, Essex CO16 0ED. Phone/Fax (01255) 861161.

For rates and information on display and classified advertising please contact our Advertisement Manager, Peter Mew as above.

RCS VARIABLE VOLTAGE D.C. BENCH POWER SUPPLY
Up to 20 volts d.c. at 1 amp continuous, 1.5 amps peak, fully variable from 1 to 20 volts. Twin Voltage and Current meters for easy read-out. 240 volt a.c. input. Fully smoothed, size 23cmx14cmx8cm



£45 inc. VAT
Post £4

RADIO COMPONENT SPECIALISTS
337 WHITEHORSE ROAD, CROYDON SURREY, CR0 2HS. Tel: 0181-684 1665

Lots of transformers, high volt caps, valves, output transformers, speakers, in stock. Phone or send your wants list for quote.

ELECTRONIC KITS

- ◆ 88-108MHz FM transmitters from under £5
- ◆ Many educational and hobby electronic kits covering all technical abilities, from beginners' circuits to MCU/MPU designs
- ◆ Low cost PCB services and equipment
- ◆ Send 4x1st class stamps for catalogue

DTE MICROSYSTEMS, 112 SHOBNALL ROAD, BURTON -ON-TRENT, STAFFS DE14 2BB
PHONE or FAX: 01283 542229
<http://www.btinternet.com/~dtemicrosystems>

BRAND NEW SINCLAIR SPECTRUM & QL PARTS
ZX MICRODRIVES £15, INTERFACE ONE £20, CARTRIDGES 10 FOR £15, 50 FOR £50.
QL BOARDS 5, 6 & 7, POPULATED WITH JS ROMS, £30; UNPOPULATED, £12; MICRODRIVES £10 EACH. TOP & BOTTOM CASES £15, MEMBRANES £15.

THE P.C., MAC and QL's "Little Friend" MAC LINK £10 - P.C. LINK £25 - QL LINK £12
CAMBRIDGE Z88 A4 NOTEBOOK COMPUTER AVAILABLE AGAIN £99, RECONDITIONED £80
ONLY 1" THICK, 4xAA BATTIS, 20 HOURS WORK, LCD SCREEN, 72 Cks, 6 LINES, 32K RAM, EXTRA RAMS & EPROMS, 9 pin D SERIAL PORT, ROM HAS BBC BASIC, W/PROCESSOR, SPREADSHEET, DATA BASE, IMP/EXPORT TO PC etc, V52 TERMINAL.

W.N. RICHARDSON & CO.
PHONE/FAX 01494 871319
6 RAVENSMEAD, CHALFONT ST PETER, BUCKS, SL9 0NB.

BTEC ELECTRONICS TECHNICIAN TRAINING

GNVQ ADVANCED ENGINEERING (ELECTRONIC) - PART-TIME
HND ELECTRONICS - FULL-TIME
B.Eng FOUNDATION - FULL-TIME

Next course commences Monday 1st February 1999
FULL PROSPECTUS FROM

LONDON ELECTRONICS COLLEGE
(Dept EPE) 20 PENYVERN ROAD EARLS COURT, LONDON SW5 9SU
TEL: 0171-373 8721

THE BRITISH AMATEUR ELECTRONICS CLUB

exists to help electronics enthusiasts by personal contact and through a quarterly Newsletter.
For membership details, write to the Secretary:
Mr. J. F. Davies, 70 Ash Road, Cuddington, Northwich, Cheshire CW8 2PB.
Space donated by Everyday Practical Electronics

Miscellaneous

STEREO FM TRANSMITTER
Crystal controlled transmit frequency and pilot tone. Excellent quality sound, low power transmitter which is ideal for 'around the house' use. Send your favourite music to any FM radio. No frequency drift! High quality professionally made p.c.b. 3x2in. Kit £25 inc. p&p.
Send s.a.e. for details or see web site:
<http://homepages.entrprise.net/ngough/tx.htm>
N. J. Gough, 20 Earlsfield, Branston, Lincoln, LN4 1NP

PRINTED CIRCUIT BOARDS - QUICK SERVICE. Prototype and Production. Artwork raised from magazines or draft designs at low cost. PCBs also designed from schematics. Production assembly also undertaken. For details send to P. Agar, Unit 5, East Belfast Enterprise Park, 308 Albertrbridge Road, Belfast, BT5 4GX, or phone/fax 01232 738897.

PROTOTYPE PRINTED CIRCUIT BOARDS one offs and quantities, for details send s.a.e. to B. M. Ansbro, 38 Poyning Drive, Hove, Sussex BN3 8GR, or phone Brighton 883871, fax 01273 706670.

NEW AND USED COMPUTERS, spares, etc. at keenest prices. e.g.: 386 min 2MB RAM, 20MB HDD, desktop case, keyboard and cables, 12in. VGA mono monitor, £55. 486 DX33 min. 8MB RAM, 120MB HDD, desk top case, keyboard and cables, 14in. VGA colour monitor, £165. Many other systems available. Whatever you need, Phone/Fax 0181 853 3374 for prices.

FLUKE SCOPEMETER model 99, 50MHz handheld scope, multimeter and signal generator, battery/mains, l.c.d. display, cursor measurement, complete with softcase, hardly used, cost £2,000 new, will accept £900 ono. Phone 0181 723 2022.

VALVE ENTHUSIASTS: Capacitors and other parts in stock. For free advice/lists please ring Geoff Davies (Radio). Tel. 01788 574774.

SULLIVAN A.C. TEST SET, 500V 25A max. polished mahogany case, unused since recalibration 1993. £75. Tel. Brecon 01874 730735.

AMATEUR SCIENCE! Electronic plans and kits for amateur scientists - physics, astronomy, rocketry, meteorology, alternative energy and much more. Send £2.50 (payable to Space-Quest) for current edition of "Amateur Science!", our quarterly magazine containing projects, plans and articles. You also receive a FREE copy of our catalogue. Space-Quest, Byker Business Development Centre, Albion Row, Newcastle-upon-Tyne NE6 1LQ (www.users.globalnet.co.uk/~sqf).

G.C.S.E. ELECTRONIC KITS, at pocket money prices. S.A.E. for FREE catalogue. SIR-KIT Electronics, 52 Severn Road, Clacton, CO15 3RB.

NICOLET DIGITAL STORAGE OSCILLOSCOPE with integral disk drive, £350. Tel. Brecon 01874 730735.

GRAPHTEC (WATANABE) LINEARCORDER MARK VII. 8-channel high speed pen recorder, spare pens and manual, £150. Tel. Brecon 01874 730735.

DAWE STROBOSCOPE with accessory hand lamp and photoelectric pick-up, £125. Tel. Brecon 01874 730735.

THURLBY 1503 bench digital multimeter; Farnell PG5222 double pulse generator; Levell TG200DMP RC sine/square oscillator, 1Hz-1MHz; bargains at £60 each. Godfrey, 01235 762669.

EPE NET ADDRESSES

EPE FTP site: <ftp://ftp.epemag.wimborne.co.uk>
Access the FTP site by typing the above into your web browser, or by setting up an FTP session using appropriate FTP software, then go into quoted sub-directories:
PIC-project source code files: /pub/PICS
PIC projects each have their own folder; navigate to the correct folder and open it, then fetch all the files contained within. *Do not try to download the folder itself!*
EPE text files: /pub/docs
Basic Soldering Guide: [solder.txt](#)
EPE TENS Unit user advice: [tens.doc](#) and [tens.txt](#)
Ingenuity Unlimited submission guidance: [ing_unlt.txt](#)
New readers and subscribers info: [epe_info.txt](#)
Newsgroups or Usenet users advice: [usenet.txt](#)
Ni-Cad discussion: [nicadfaq.zip](#) and [nicad2.zip](#)
UK Sources FAQ: [uksource.zip](#)
Writing for EPE advice: [write4us.txt](#)

Ensure you set your FTP software to ASCII transfer when fetching text files, or they may be unreadable.
Note that any file which ends in .zip needs unzipping before use. Unzip utilities can be downloaded from: <http://www.winzip.com> or <http://www.pkware.com>

On-line readers! Try the new EPE Chat Zone - a virtually real-time Internet "discussion board" in a simple to use web-based forum!
<http://www.epemag.wimborne.co.uk/wwwboard>
Or buy **EPE Online: www.epemag.com**

TRAIN TODAY FOR A BETTER FUTURE

Now you can get the skills and qualifications you need for career success with an ICS Home Study Course. Learn in the comfort of your own home at the pace and times that suit you. ICS is the world's largest, most experienced home study school. Over the past 100 years ICS have helped nearly 10 million people to improve their job prospects. Find out how we can help YOU. Post or phone today for FREE INFORMATION on the course of your

Electrical Contracting & Installation
Electrical Engineering
C&G Basic Electronic Engineering
C&G Basic Mechanical Engineering
TV and Video Servicing
Radio and Hi-Fi Servicing
Refrigeration Heating & Air Conditioning
Motorcycle Maintenance

FREEPHONE 0500 581 557

Or write to: International Correspondence Schools, FREEPOST 882, 8 Elliot Place, Clydeside Skypark, Glasgow, G3 8BR. Tel. 0500 581 557 or Tel/Fax: Ireland 01 285 2533

Please send me my Free Information on your Electronics Courses.

Mr/Mrs/Ms/Miss (BLOCK CAPITALS PLEASE) _____ Date of Birth _____

Address _____

Postcode _____

Occupation _____ Tel. No. _____

From time to time, we permit other carefully screened organisations to write to you about products and services. If you would prefer not to hear from such organisations please tick box Dept. ZEEEO41298

Service Manuals

Available for most equipment, from the earliest Valve Wireless to the latest Video Recorder, Television, Computer Monitor, Test Equipment, Satellite, all Audio, Amateur Radio, etc., etc. If you need a Service Manual give us a call or check out the full stock list now on our web site. Originals or Photostats supplied as available.

For your FREE catalogue of Technical Books and repair guides PLUS full Floppy Disc Index of manuals available send 4 x first class stamps.

MAURITRON TECHNICAL SERVICES

8 Cherry Tree Road, Chinnor, Oxon, OX9 4QY

Tel: 01844-351694. Fax: 01844-352554.

E-mail: enquiries@mauriton.co.uk

Web site at: <http://www.mauriton.co.uk/mauriton/>

SUPPLIER OF QUALITY USED TEST INSTRUMENTS



CONTACT
Cooke International
Unit Four, Fordebridge Site, Barnham,
Bognor Regis, West Sussex, PO22 0HD, U.K.
Tel (+44)01243 545111/2 Fax: (+44)01243 542457
Web: <http://www.cooke-int.com>
E-mail: info@cooke-int.com

OPERATING & SERVICE MANUALS



CONTACT
Cooke International
Unit Four, Fordebridge Site, Barnham,
Bognor Regis, West Sussex, PO22 0HD, U.K.
Tel (+44)01243 545111/2 Fax: (+44)01243 542457
Web: <http://www.cooke-int.com>
E-mail: info@cooke-int.com

C.C.T.V. BOARD CAMERAS FROM £19.95

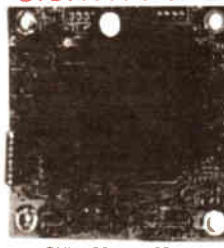

inc. VAT
MINIATURE C.C.T.V. CAMERAS FROM TOP USA MAKER. IDEAL FOR COVERT SURVEILLANCE OR SECURITY USE IN SHOPS, OFFICES AND PRIVATE HOMES. CONNECTS TO ANY TV OR VIDEO IN SECONDS - OPTIONAL CABLE ETC. AVAILABLE. OUR 1993 PRICE FOR THIS CAMERA WAS £385!! HUGE RECESSION IN ELECTRONIC INDUSTRY HAS SLASHED THESE PRICES TO RIDICULOUS LEVELS! THESE ARE USA MADE - NOT CHEAP CHINESE MODELS. READY BUILT WITH LENS ETC. BRAND NEW 1999 STOCK - FULL 12 MONTH GUARANTEE. WORKS FROM 9V-FP3 BATTERY!

ONLY 29mm x 29mm

Our Usual Trade Price £59.87
LOTS OF 10 £19.95
LOTS OF 5 £21.50
LOTS OF 2 £23.95
SAMPLE £25.95
WHILE STOCKS LAST!!
Add P&P £3 ANY ORDER

Audio Model add £5.00 Pinhole Model add £4.00 Cable, p.s.u., scarts, etc. available. Wide angle lens included FREE! VAT included	Applications: Security, Surveillance, Nanny Watching, Machine Monitoring, etc. Works alone or in any casing	1/3in. image sensor. Auto iris. Supply voltage 6V-13V. 90° wide angle lens. Size 1in x 1in approx.
---	---	--

A.S.A. (Est. 1979)
51 Cambridge Road
Middlesbrough
TS5 5NL
Order Hotline
01642 850173
Fax: 01642 823173

Professional 88-108MHz FM Broadcasting Kits

- All Our Kits include:
Detailed instructions with Schematics
High Quality Screen Printed PCBs
High Quality Components
- Our Product Range includes:
Transmitters from 0.05W to 35W
FM Stereo Coders
Audio Compressor Limiters
Antennas
RF Power Amps
- Our Kits Are Also Available Fully Assembled And Tested

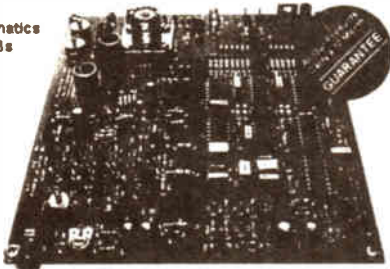

Our Kits Are Also Available Fully Assembled And Tested

WE DELIVER WORLD WIDE AND ACCEPT MAJOR CREDIT CARDS

Visit our Website at <http://www.veronica.co.uk>

Contact Us Now For A Free Brochure
Tel 01274 883434 Fax 01274 428665
email info@veronica.co.uk
Unit 56 1A Sandbeds/ Albert Rd Queensbury BRADFORD BD13 1AA



Cheat on toner

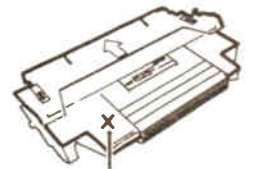

X marks the spot!
Cut or melt.

Refill your empty toner with the "Cut & Pour" method. Doesn't disturb the inner workings of your cartridge.
HP LaserJet 4/4M/4M Plus/5/5M/5N Refill bottle... £12.99 ex VAT
HP LaserJet 5L/6L/3100 Refill Bottle... £8.95 (ex VAT)
HP LaserJet 4L/4P Series Refill Bottle... £9.95 (ex VAT)
HP LaserJet 5P/6P Refill Bottle... £11.49 (ex VAT)
HP LaserJet 4000 Series Refill Bottle... £19.49 (ex VAT)
Many more lasers and copiers covered. FREE catalogue, FREE PHONE

0800 376 9922 (24 hrs)
Free FAX 0800 376 9955 (24 hrs) - <http://www.refilltoner.com>

TECHNICAL INFORMATION SERVICES

Midlinbank Farm, Ryelands, Nr. Strathaven, ML10 6RD
Tel: 01698 883334/884585 Fax: 01698 884825

PHONE NOW FOR YOUR FREE QUOTE
We have the World's Largest Collection of

SERVICE MANUALS

Why not join Europe's fastest growing "Information Library Service"
Buy ANY Service Manual for £10.00 and return any manual no longer needed for a £5.00 credit
CALL/WRITE NOW FOR FURTHER DETAILS
Initial joining fee of £65 : Thereafter £20 Yearly
Join Now: Get your first Manual FREE!

FML ELECTRONICS

- ★ NEW YEAR'S SALE ★
★ 10% OFF ALL OUR LIST PRICES DURING JANUARY 1999 ★
- NEW PRODUCTS NOW IN STOCK:**
- | | | | |
|--|------|---|-------------|
| ICL 7811DCPA CMOS OP AMP INUT/COMP 15mV | 98p | 10 4011B CMOS QUAD 2-INPUT NAND | NOW ONLY £1 |
| ICL 8088CC2R 1-2V VOLTAGE REFERENCE IC | 198p | 5 4012UB UNBUFFERED CMOS | NOW ONLY £1 |
| NE5534AN LOW NOISE OP AMP | 98p | 4 4088CN UNBUFFERED CMOS | NOW ONLY £1 |
| 40838 CMOS QUAD 2-INPUT NAND SCHMITT TRIG. | 27p | 10 7412 TRIPLE 3-INPUT NAND | NOW ONLY £1 |
| 74LS08N QUAD 2-INPUT NAND | 27p | 15 2N2827B TRANSISTORS | £1 |
| 74LS04N HEX INVERTER | 24p | 4 C108B1 2SA 108V THYRISTORS TO202 | £1 |
| 74LS05N HEX INVERTER O/C | 17p | 4 7905 -5V 1A VOLTAGE REGULATORS | £1 |
| 74LS24AN DUAL D-TYPE FLIP-FLOP | 37p | 2 FM INDOOR T AERIALS, SPADE CONNS | £1 |
| 74LS244N OCTAL BUFFER | 38p | 2 MAINS NEON PANEL INDICATORS, RED | £1 |
| MPS485 DARLINGTON PNP SI TRANSISTOR | 25p | 20 16-PIN D.I.L. SOCKETS | £1 |
| ZTX502 LOW POWER PNP SI TRANSISTOR | 23p | 30 0.022µF 250V POLYESTER CAPACITORS | £1 |
| | | 20 0.33µF 250V POLYESTER CAPACITORS | £1 |
| | | 8 MINIATURE CROC CLIPS, RED, BLACK OR MIXED | £1 |
| | | 4 20MM PANEL FUSEHOLDERS, FINGER RELEASE | £1 |
| | | 2 ROTARY SWITCHES 1P 12W, MADE BY ALPHA | £1 |
| | | 1 ARROW TOGGLE SWITCH SPST 250V 3A | £1 |
| | | 2 MINIATURE ROCKER SWITCHES SPST 2A, WHITE | £1 |
| | | 2 STANDARD ROCKER SWITCHES SPST 10A, BLACK | £1 |
| | | 2 LATCHING PUSH BUTTONS SPOT 1A 125V, RED | £1 |
| | | 10% SALE DOES NOT APPLY TO ADVERTS/BARGAIN PACKS AND ALL ITEMS SUBJECT TO REMAINING AVAILABLE PLEASE SEND LARGE SAE FOR FREE COMPONENT LISTS RETAIL, TRADE, GOVT AND EDUCATIONAL ORDERS WELCOME | |
| | | INLAND UK P&P STILL ONLY £1 PER ORDER, NO VAT CHECKES OR P.O.S WITH ORDER PLEASE TO: | |
| | | FML ELECTRONICS, FREEPOST MEA3827, BEDALE, NORTH YORKSHIRE, DL8 2BR. | |
- TELESCOPIIC RADIO AERIALS:**
- | | |
|--|------|
| 5 SECTION 183MM CLOSED, 570MM EXTENDED | 150p |
| 5 SECTION 220MM CLOSED, 745MM EXTENDED | 150p |
| 8 SECTION 160MM CLOSED, 955MM EXTENDED | 150p |
- PLASTIC CONTROL KNOBS TO FIT 6.25MM SHAFTS:**
- BLACK PUSH-ON KNOB 19MM DIA. x 18MM HIGH, HAVING A COLOURED CAP WITH A LINE, SPECIFY COLOURS.
- | | |
|--|----------|
| BLACK, BLUE, GREEN, GREY, RED OR YELLOW | 15p |
| MATCHING PAIRS OF CALIBRATED OR POINTER KNOBS: | |
| 37MM DIA. x 15MM HIGH & AL. SHORT | EACH 55p |
| 30MM DIA. x 18MM HIGH & AL. SHORT | EACH 85p |
| POINTER KNOB WITH WHITE LINE 32MM LONG | 30p |
| HEAVY DUTY KNOB BLK WITH ALJ TOP 45MM D | 50p |
| SMALL RIDGED KNOB WITH LINE 20MM D x 17MM H | 40p |
| SOLID BLACK ALJ 18MM DIA x 18MM H x LINE | 9p |

COVERT VIDEO CAMERAS

Black and White Pin Hole Board Cameras with Audio. Cameras in P.I.R., Radios, Clocks, Briefcases etc. Transmitting Cameras with Receivers (Wireless). Cameras as above with colour. Audio Surveillance Kits and Ready Built Units, Bug Detector etc.

A.L. ELECTRONICS

Please phone 0181 203 0161 for free catalogue.
Fax 0181 201 5359

New DTI approved Video Transmitters and Receivers (Wireless)

N. R. BARDWELL LTD (EPE)

100	Signal diodes 1N4148	£1.00	200	Assto disc ceramic capacitors	£1.00
75	Rectifier Diodes 1N4001	£1.00	50	Assto Sidel Presets (stand, cermet)	£1.00
50	Rectifier Diodes 1N4007	£1.00	50	Assto RF chokes (inductors)	£1.00
10	W01 Bridge Rectifiers	£1.00	50	Assto grommets	£1.00
10	555 Timer I.C.s	£1.00	80	Assto solder tags, p.conns, terminals	£1.00
4	741 Op Amps	£1.00	10	Assto crystals - plug in	£1.00
50	Assorted Zener Diodes 400mW	£1.00	24	Assto coil formers	£1.00
12	Assorted 7-segment Displays	£1.00	30	Assto di switches	£1.00
25	5mm l e d s . red, green or yellow	£1.00	20	Miniature slide switches sp/co	£1.00
25	3mm l e d s . red, green or yellow	£1.00	10	Standard slide switches dp/dt	£1.00
50	Axial l e d s 2mod red Diode Package	£1.00	30	Assto if transformers	£1.00
25	Assto High Brightness l e d s . var cols	£1.00	100	Assto beads (ceramic, teflon, fish spine)	£1.00
30	BC182L Transistors	£1.00	80	Assto small stand offs, 17throughs etc	£1.00
25	BC212L Transistors	£1.00	30	Assto di sockets up to 40 way	£1.00
30	BC237 Transistors	£1.00	10	TV coax plugs, plastic	£1.00
20	BC237 Transistors	£1.00	20	Small spring loaded terminals	£1.00
30	BC328 Transistors	£1.00	40	metres very thin connecting wire, red	£1.00
30	BC547 Transistors	£1.00	20	Tin glass reed switches	£1.00
30	BC548 Transistors	£1.00	20	Magnetic ear pips with lead and plug	£1.00
30	BC549 Transistors	£1.00	100	Any one value 1-w 5% cf resistors range 1R to 10M	£0.45
25	BC557 Transistors	£1.00			
30	BC558 Transistors	£1.00			
30	BC559 Transistors	£1.00			
25	2N3904 Transistors	£1.00			
100	50v wkg Axial Capacitors 1nf	£1.00			
100	50v wkg Axial Capacitors 4N7	£1.00			
100	50v wkg sub-miniature Capacitors 33nf	£1.00			
12	luf 250v encapsulated radial plastic cased capacitors	£1.00			
80	Assto capacitors electrolytic	£1.00			
80	Assto capacitors 1nf to 1µF	£1.00			

Prices include VAT, postage £1.25, 31p stamp for lists
288 Abbeydale Road, Sheffield S7 1FL
Phone (0114) 2552886 Fax (0114) 2500689
E-mail Bardwell@compuserve.com
Web site: <http://ourworld.compuserve.com/homepages/BARDWELLS>

NEW SPECIAL OFFERS

Amiga genlock pcb (uncased) for fitting videos it has a 23pin D lead to plug into the computer and pcb pins for composite video in and out. When no video input is connected the normal computer display is shown on the composite video out while the video input is added the white areas on the screen are replaced by the video image. The pcb is powered from the computer. £19.98

WATCH SLIDES ON TV "Liesgang diatv" automatic slide viewer with built in high quality colour tv camera, composite video output with a BNC plug in very good condition with few signs of use. £108.00

Board cameras all with 512x582 pixels 4x3.3mm sensor with composite video out. All need to be housed in your own enclosure and have fragile exposed surface mount parts and require 10 to 12vdc power supply.

47MMIR size 60x36x27mm with 6 infra red leds (gives the same illumination as a small torch would). £50.00+vat = £58.75

MP size 39x38x23mm spy camera with a fixed focus pin hole lens for hiding behind a very small hole. £26.43+vat = £31.06

Waterproof camera with stylish tilt & swivel case £92.76 + vat = £109.00 or 10 + £89.32 + vat = £104.95

DTA30 Hand held transistor analyser it tells you which lead is the base, the collector and emitter and if it is NPN or PNP or faulty. HMA20 hand held MOSFET analyser identifies gate drain and source and if P or N channel. DTA30 & HMA20. £38.34 each

DCA50 component analyser with lcd readout identifies transistors mosfets diodes & LEDs lead connections. £69.95

Speaker cabinets 2 way speaker systems with motorola tweeters

speaker dia	15"	12"	8"
power rating	250WRMS	175WRMS	100WRMS
impedance	8ohm	8ohm	8ohm
freq range	40Hz-20kHz	40Hz-20kHz	60Hz-20kHz
sensitivity(1W/1M)	97dB	94dB	90dB
size in mm	500x720x340	450x640x345	315x460x230
weight	21.1kg	16.8kg	7.4kg

price each for black vinyl coating £139.95 £99.99 £54.94
grey felt coating £159.97 £119.97 £64.99

(** = not normally in stock allow 1 week for delivery)

Power amplifiers 19" rack mount with gain controls

STA150	2x160WRms (40hm load)	14kg	£202.11
STA300	2x190WRms (40hm load)	11kg	£339.00
STA900	2x490WRms (40hm load)	15kg	£585.00

LEDs 3mm or 5mm red or green 7p each yellow 11p each cable ties 1p each. £5.95 per 1000 £49.50 per 10,000

Rechargeable Batteries

AA(HP7) 500mAh	£0.99	AA 500mAh with solder tags	£1.55
AA 950mAh	£1.75	CP(HP1) 1.2Ah	£2.20
C 2AH with solder tags	£3.80	DHP2 1.2Ah	£2.20
D 4AH with solder tags	£4.95	PP3 8.4V 110mAh	£4.95
12AA with solder tags	£1.55	Sub C with solder tags	£2.50
AAA (HP16) 180mAh	£1.75	1.3 AA with tags (pripactV)	£1.95

Nickel Metal Hydride AA cells high capacity with no memory. If charged at 100ma and discharged at 250ma or less 1300mAh capacity (lower capacity for high discharge rates) £2.95

Special offers please check for availability stick of 4 42x16mm nicad batteries 171mm16mm dia with red & black leads 4.8v £5.95

5 button cell 6V 280mAh battery with wres (Varia 5x2500K) £12.45

Orbital 866 battery pack 12v 160AH contains 10 sub C cells with solder tags (the size most commonly used in cordless screwdrivers and drills 22 diax42mm tall) it is easy to crack open and was manufactured in 1994. £8.77 each or 110.50 per box of 14

BCI box 190x106x50mm with slots to house a pcb the lid contains an edge connector (12 way 8mm pitch) and screw terminals to connect in wires and 5 slide in cable blanks. £2.95

7segment common anode led display 12mm £0.45

GAAs FET low leakage current S8873 £12.95 each

H9.95 10x7.95 100 - BC547A transistor 20 for £1.00

SL952 UHF Limiting amplifier LC 16 surface mounting package with data sheet. £1.95

DC DC converter Reliability model V12P5 12v in 5v 200ma out 300v input to output isolation with data. £4.95 each or pack of 10 £39.50

Arpaan 482903-C large stepping motor 14v 7.5 step 270hm 68mm dia body 6.3mm shaft. £8.95 or £200.00 for a box of 30

Polyester capacitors box type 22.5mm lead pitch 0.9uf 250vdc 18p each 14p 100 + 9p 1000 + 1uf 250vdc 20p each 15p 100 + 10p 1000 -

Polypropylene 1uf 400vdc (Wms MKP10) 27.5mm pitch 32x29x17mm case 75p each 60p 100 -

Philips 123 series solid aluminium axial leads 33uf 10v & 2.2uf 40v 40p each 25p 100 -

Solid carbon resistors very low inductance ideal for RF circuits 270hm 2W 680hm 2W 25p each 15p each 100 - we have a range of 0.25w 0.5w 1w and 2w solid carbon resistors, please send SAE for list

MX180 Digital multimeter 17 ranges 1000vdc 750vac 2Mohm 200mA transistor Hfe 9v and 1.5v battery test. £9.95

Hand held ultrasonic remote control. £3.95

CV2486 gas relay 30x10mm dia with 3 wire terminals will also work as a neon light. £3.49 each (100 - 2.25)

20p each or £8.50 per 100

Varbatim R300NH Streamer tape commonly used on nc machines and printing presses etc. it looks like a normal cassette with a slot out of the top. £4.95 each (£3.75 100 -)

Heatsink compound tube. £0.95

HV3-2405-E5 5.24v 50mA regulator ic 18-264vac input 8 pin DIL package. £3.49 each (100 - 2.25)

All products advertised are new and unused unless other wise stated. Wide range of CMOS TTL 74HC 74F Linear Transistors kits, rechargeable batteries, capacitors, tools etc always in stock.

Please add £1.95 towards P&P (orders from the Scottish Highlands, Northern Ireland Isle of Man, Isle of Wight and overseas may be subject to higher P&P for heavy items) VAT included in all prices.

JPG ELECTRONICS

276-278 Chatsworth Road
Cheslerfield S40 2BH
Access Visa Orders:
Tel: (01246) 211202 Fax: (01246) 550959
Callers welcome 9.30am to 6.30pm
Monday to Saturday

Millions of quality components at lowest ever prices!

Plus anything from bankruptcy - theft recovery - frustrated orders - over production etc. Send 45p stamped self addressed label or envelope for clearance lists.

Brian J Reed

**6 Queensmead Avenue, East Ewell
Epsom, Surrey KT17 3EQ**

Tel: 0181-393 9055 or 07775 945386

Mail order UK only.

Lists are updated and only 40 are sent out every 2 weeks. This normally ensures that orders can be fulfilled where only a few thousand of an item is available. (Payment is returned if sold out. I do not deal in credit notes). This will sometimes entail a delay of up to eight weeks - but the prices will be worth the wait!

ADVERTISERS INDEX

A.L. ELECTRONICS.....	72
ARRAN TECHNOLOGY.....	44
ASA MICROS.....	28
A.S.A.....	71
N. R. BARDWELL.....	72
B.K. ELECTRONICS.....	Cover (iii)
BRIAN J. REED.....	72
BULL ELECTRICAL.....	Cover (ii)
COMPELEC.....	44
COOKE INTERNATIONAL.....	71
CROWNHILL ASSOCIATES.....	31
DANNELL ELECTRONICS.....	5
DISPLAY ELECTRONICS.....	2
ELECTROMAIL.....	28
EPT EDUCATIONAL SOFTWARE.....	18
ESR ELECTRONIC COMPONENTS.....	10
FML ELECTRONICS.....	71
GREENWELD.....	5
ICS.....	71
J&N FACTORS.....	6
JPG ELECTRONICS.....	72
LABCENTER ELECTRONICS.....	36
MAGENTA ELECTRONICS.....	8/9
MAPLIN ELECTRONICS.....	Cover (iv)
MAURITRON.....	71
NATIONAL COLLEGE OF TECH.....	4
PICO TECHNOLOGY.....	7/45
QUASAR ELECTRONICS.....	45
QUICKROUTE SYSTEMS.....	17
RADIO-TECH.....	4
SEETRAX CAE.....	31
SHERWOOD ELECTRONICS.....	4
SQUIRES.....	4
SUMA DESIGNS.....	57
TECHNICAL INFORMATION SERVICES.....	71
TECHNOLOGY EDUCATION INDEX.....	45
THE TONER WAREHOUSE UK.....	71
VANN DRAPER ELECTRONICS.....	35
VERONICA KITS.....	71

ADVERTISEMENT MANAGER: PETER J. MEW

ADVERTISEMENT OFFICES:

**EVERYDAY PRACTICAL ELECTRONICS, ADVERTISEMENTS,
MILL LODGE, MILL LANE, THORPE-LE-SOKEN,
ESSEX CO16 0ED.**

Phone/Fax: (01255) 861161

For Editorial address and phone numbers see page 11.

**OMP MOS-FET POWER AMPLIFIERS
HIGH POWER, TWO CHANNEL 19 INCH RACK**



1000's
SOLD
TO PRO
USERS

THE RENOWNED MXF SERIES OF POWER AMPLIFIERS

FOUR MODELS:- MXF200 (100W + 100W) MXF400 (200W + 200W)
MXF600 (300W + 300W) MXF900 (450W + 450W)

ALL POWER RATINGS ARE R.M.S. INTO 4 OHMS, WITH BOTH CHANNELS DRIVEN
FEATURES: * Independent power supplies with two toroidal transformers * Twin LED Vu Meters
* Level controls * Illuminated on/off switch * Jack/XLR inputs * Speaker outputs * Standard 775mV
inputs * Open and short circuit proof * Latest Mos-Fets for stress free power delivery into virtually any
load * High slew rate * Very low distortion * Aluminium cases * MXF600 & MXF900 fan cooled with D.C
loudspeaker and thermal protection

USED THE WORLD OVER IN CLUBS, PUBS, CINEMAS, DISCOS ETC

SIZES:-
MXF200 W19" D11" H3 1/2" (2U)
MXF400 W19" D12" H5 1/2" (3U)
MXF600 W19" D13" H5 1/2" (3U)
MXF900 W19" D14 1/2" H5 1/2" (3U)

PRICES:- MXF200 £175.00 MXF400 £233.85
MXF600 £329.00 MXF900 £449.15

SPECIALIST CARRIER DEL. £12.50 EACH

OMP XO3-S STEREO 3-WAY ACTIVE CROSS-OVER SWITCHABLE 2-WAY



BASS MID TOP
CONFIGURED 3 WAY
BASS/MID TOP
2 WAY BASS/MID COMBINED
BASS MID TOP
2 WAY MID/TOP COMBINED

FEATURES:

Advanced 3-Way Stereo Active Cross-Over (switchable two way), housed in a 19" x 1U case. Each channel has three level controls Bass, Mid & Top. The removable front fascia allows access to the programmable DIL switches to adjust the cross-over frequency: Bass-Mid 125/250/500Hz, Mid Top 18/3/5Hz all at 24dB per octave. The 2/3 way selector switches are also accessed by removing the front fascia. Each stereo channel can be configured separately. Bass Invert Switches are incorporated on each channel. Nominal 775mV input/output. Fully compatible with OMP Rack Amplifier and Modules

PRICE:- £117.44 + £5.00 P&P

SOUNDLAB CDJ1700 CD PLAYER

VARIABLE SPEED



The new CDJ1700 now offers a tough build quality boasting an all new shockproof transport mechanism, frame accurate cueing and wide range pitch control. The CDJ1700 looks after the CD's while the operator looks after the sound.

FEATURES:

*19"X2U RACK MOUNTING *FULLY VARIABLE PITCH CONTROL PLUS/MINUS 16% *PITCH BLEND *3 BEAM LASER PICKUP *1 BIT 8 X OVERSAMPLING DAC *CUE AND LOOP FACILITY *TRACK SKIP WITH FF/REV *DIGITAL AND ANALOGUE OUTPUTS *CONTINUOUS/SINGLE TRACK PLAY *CLEAR BACKLIT MULTIFUNCTION DISPLAY *10 TRACK PROGRAM PLAY *TRACK ELAPSED TRACK REMAINING AND DISC REMAINING TIME DISPLAYS

SPECIFICATION:- Freq response 20Hz 20KHz S/N ratio >80dB THD <0.09%(1KHz) Channel separation >80dB(1KHz) Max output voltage 2Vrms Power 220 240Vac 50 60Hz Size W 482 H 88 D 250mm Weight 4.18Kg PRICE:- £225.00 + £5.00 P&P

STEREO DISCO MIXER MPX-7700

ECHO & SOUND EFFECTS



- * 4 STEREO INPUT CHANNELS
- * 2 DJ MIC INPUT CHANNELS
- * 2X7 BAND GRAPHIC EQUALISERS
- * HEADPHONE MONITOR WITH PFL
- * ASSIGNABLE CROSSFADE
- * DIGITAL ECHO

STEREO DISCO MIXER WITH:- *2X7 GRAPHIC EQUALISERS *2 MONO MIC INPUTS *DJ MIC WITH FADER, TALKOVER AND VOICE CHANGER *4 STEREO CHANNELS WITH INDIVIDUAL FADERS AND ASSIGNABLE CROSSFADE *CHANNELS SWITCHABLE, TURNTABLE (MAG CARTRIDGE), CD, LINE, TAPE, ETC. *ECHO WITH BALANCE, REPEAT AND DELAY *HEADPHONE MONITOR WITH PREFADE LISTEN *CHOICE OF 6 SOUND EFFECTS *STEREO MONO SWITCH *2 X LED VUMETERS *MASTER FADER *OUTPUT 775mV

*SIZE: 482X240X115mm *POWER: 230V AC 50/60Hz PRICE:- £169.00 + £5.00 P&P

SOUNDLAB MINI STROBE

- * IDEAL FOR USE IN DISCO'S / RAVES.
- * EDUCATIONAL EXPERIMENTS ETC.

A top quality mini strobe with high light intensity for its size and variable flash rate adjustment. Housed in a silver/black steel case with adjustable mounting bracket. * Flash Rate: Adjustable from zero to ten flashes per second * Mains Powered complete with plugged lead * 230V AC 50/60Hz

* Size: 125 X 84 X 52mm PRICE:- £19.99 + £2.20 P&P



**FLIGHTCASED
LOUDSPEAKERS**

A new range of quality loudspeakers, designed to take advantage of the latest loudspeaker technology and enclosure designs. All models utilize high quality studio cast aluminium loudspeakers with factory fitted grilles, wide dispersion constant directivity horns, extruded aluminium corner protection and steel ball corners, complimented with heavy duty black covering. The enclosures are fitted as standard with top hats for optional loudspeaker stands. The FC15-300 incorporates a large 16 X 6 inch horn. All cabinets are fitted with the latest Speakon connectors for your convenience and safety. Five models to choose from.

WEDGE MONITOR



PLEASE NOTE:- POWER RATINGS QUOTED ARE IN WATTS R.M.S. FOR EACH INDIVIDUAL CABINET. ALL ENCLOSURES ARE 8 OHM.

15=15 inch speaker
12=12 inch speaker

ibl FC15 300 WATTS Freq Range 35Hz-20KHz, Sens 101dB, Size H695 W502 D415mm

PRICE:- £299.00 per pair

ibl FC12-300 WATTS Freq Range 45Hz-20KHz, Sens 96dB, Size H600 W405 D300mm

PRICE:- £249.00 per pair

ibl FC12-200 WATTS Freq Range 40Hz-20KHz, Sens 97dB, Size H600 W405 D300mm

PRICE:- £199.00 per pair

ibl FC12-100 WATTS Freq Range 45Hz-20KHz, Sens 100dB, Size H546 W380 D300mm

PRICE:- £179.00 per pair

ibl WM12 200 WATTS Freq Range 40Hz-20KHz, Sens 97dB, Size H418 W600 D385mm

PRICE:- £125.00 EACH

SPECIALIST CARRIER DEL:- £12.50 per pair, Wedge Monitor £7.00 each

Optional Metal Stands PRICE:- £49.00 per pair Delivery:- £6.00

ibl IN-CAR AUDIO BASS BOX 10/100

INCREDIBLE VALUE



The new ibl In-Car Audio Bass Box has been designed with a sloping front to reduce internal standing waves. The bass box incorporates a 10 inch 4 ohm loudspeaker with a genuine 100 watts R.M.S. output resulting in powerful and accurate bass reproduction.

FEATURES:- * Cabinet manufactured from MDF and sprayed in a durable black shiny HAMMERITE finish. * Fitted with a 10 inch loudspeaker with rolled rubber edge and coated cone assembly * The top of the cabinet incorporates gold plated connection terminals. SPECIFICATION:- 100Watts R.M.S. 200 Watts Peak (Music). Ported reflex, critically tuned. Size:- H405 W455 D305mm.

PRICE:- £79.00 + £6.00P&P

OMP MOS-FET POWER AMPLIFIER MODULES

SUPPLIED READY BUILT AND TESTED

These modules now enjoy a world wide reputation for quality, reliability and performance at a realistic price. Four models are available to suit the needs of the professional and hobby market i.e. Industry, Leisure, Instrumental and Hi Fi etc. When comparing prices, NOTE that all models include toroidal power supply, integral heat sink, glass fibre PCB and drive circuits to power a compatible Yu meter. All models are open and short circuit proof.

THOUSANDS OF MODULES PURCHASED BY PROFESSIONAL USERS



OMP/MF 100 Mos-Fet Output power 100 watts R.M.S into 4 ohms, frequency response 1Hz - 100KHz -3dB, Damping Factor >300, Slew Rate 45V/uS, T.H.D. typical 0.002%, Input Sensitivity 500mV, S.N.R. -110dB. Size 300 x 123 x 60mm.

PRICE:- £42.85 + £4.00 P&P



OMP/MF 200 Mos-Fet Output power 200 watts R.M.S into 4 ohms, frequency response 1Hz - 100KHz -3dB, Damping Factor >300, Slew Rate 50V/uS, T.H.D. typical 0.001%, Input Sensitivity 500mV, S.N.R. -110dB. Size 300 x 155 x 100mm.

PRICE:- £66.35 + £4.00 P&P



OMP/MF 300 Mos-Fet Output power 300 watts R.M.S into 4 ohms, frequency response 1Hz - 100KHz -3dB, Damping Factor >300, Slew Rate 60V/uS, T.H.D. typical 0.001%, Input Sensitivity 500mV, S.N.R. -110dB. Size 330 x 175 x 100mm.

PRICE:- £83.75 + £5.00 P&P



OMP/MF 450 Mos-Fet Output power 450 watts R.M.S into 4 ohms, frequency response 1Hz - 100KHz -3dB, Damping Factor >300, Slew Rate 75V/uS, T.H.D. typical 0.001%, Input Sensitivity 500mV, S.N.R. -110dB, Fan Cooled, D.C. Loudspeaker Protection, 2 Second Anti-Thump Delay. Size 385 x 210 x 105mm.

PRICE:- £135.85 + £6.00 P&P



OMP/MF 1000 Mos-Fet Output power 1000 watts R.M.S into 2 ohms, 725 watts R.M.S into 4 ohms, frequency response 1Hz - 100KHz -3dB, Damping Factor >300, Slew Rate 75V/uS, T.H.D. typical 0.002%, Input Sensitivity 500mV, S.N.R. -110dB, Fan Cooled, D.C. Loudspeaker Protection, 2 Second Anti-Thump Delay. Size 422 x 300 x 125mm.

PRICE:- £261.00 + £12.00 P&P

NOTE: MOS-FET MODULES ARE AVAILABLE IN TWO VERSIONS: STANDARD INPUT SENS 500mV, BAND WIDTH 100KHz OR PEC (PROFESSIONAL EQUIPMENT COMPATIBLE). INPUT SENS 775mV, BAND WIDTH 50KHz ORDER STANDARD OR PEC



DELIVERY CHARGES PLEASE INCLUDE AS ABOVE TO A MAXIMUM AMOUNT £30.00. OFFICIAL ORDERS FROM SCHOOLS, COLLEGES, GOVT. BODIES, PLCs ETC. PRICES INCLUSIVE OF V.A.T. S.A.E. COUNTER CREDIT CARD ORDERS ACCEPTED BY POST PHONE OR FAX



B.K. ELECTRONICS

UNIT 1 COMET WAY, SOUTHEND-ON-SEA, ESSEX, SS2 6TR.

TEL.: 01702 527572 FAX.: 01702-420243

Web:- <http://www.bkelec.com> E-mail:- Sales@bkelec.com

MAPLIN
ELECTRONICS

Order your catalogue now
on **01702 554000**
or visit and collect from one
of our 48 stores nationwide.
You can also purchase your
catalogue from your local
Maplin store, WH Smith and
John Menzies.

CATALOGUE

- Over 1,000 new products
- Includes over £50 worth of discount vouchers
- Order code CA18

DOUBLE CD

- Includes **FREE** datasheet CD-Rom
- **FREE** McAfee anti-virus software
- **FREE** 30 day Demon Internet trial
- Order code CQ02

**THE NEW
CATALOGUE
OUT NOW**

£3.99

**electronics
& beyond**

98-99

17,000
NEW
products

£1.95

**electronics
& beyond**
98-99



the
key to
better selection and service

Telephone 01702 554000 with your enquiry

The catalogue costs just £3.99 plus p+p* and the CD Rom is available at just £1.95 plus p+p* including free datasheet CD Rom.

*(Add 50p for P&P). Orders outside the UK please send £8.99 or 21 IRCs for Airmail in Europe or surface mail outside Europe. Send £16.04 or 37 IRCs for Airmail outside Europe to:
Maplin Electronics, PO Box 777, Rayleigh, Essex, England, SS6 8LU. Prices include VAT and are subject to change. All items subject to availability. E+OE. **WHEN ORDERING PLEASE QUOTE PRIORITY CODE MA095**