

EVERYDAY

JANUARY 1992

ELECTRONICS

INCORPORATING ELECTRONICS MONTHLY

£1.60



**STEPPING MOTOR
DRIVER/INTERFACE**



**MICRO SENSE ALARM
TRANSISTOR CHECKER**

**ELECTRONICS CROSSWORD
& WORDSEARCH**

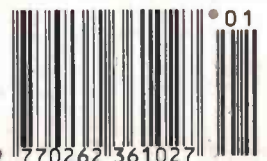

THE No. 1 INDEPENDENT MAGAZINE for ELECTRONICS, TECHNOLOGY and COMPUTER PROJECTS

EVERYDAY ELECTRONICS

INCORPORATING ELECTRONICS MONTHLY

ABC

VOL. 21 No. 1 JANUARY 1992

The No 1 Magazine for Electronic & Computer Projects

ISSN 0262 3617

PROJECTS... THEORY... NEWS...
COMMENT... POPULAR FEATURES...

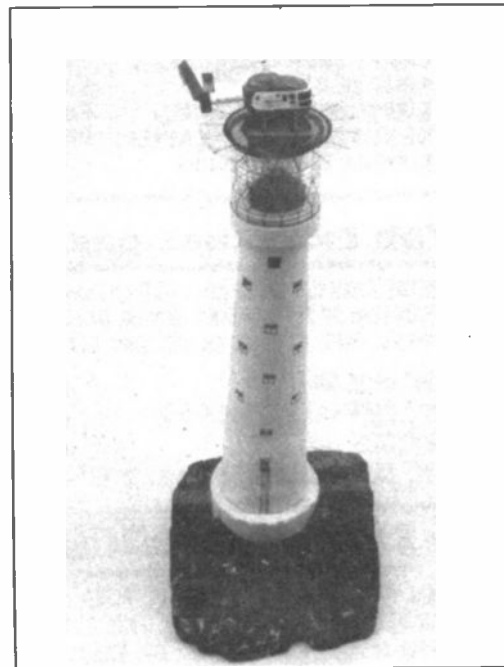
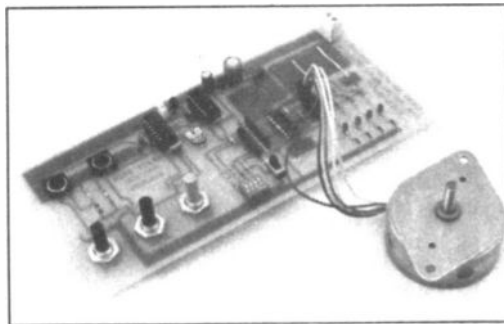
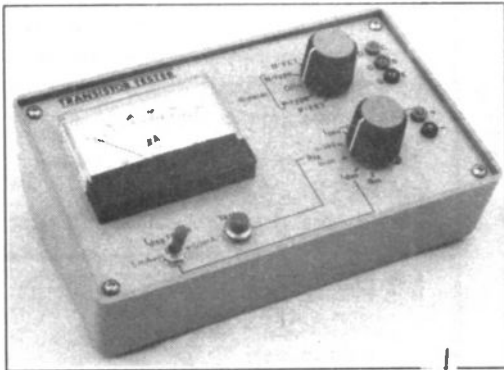

© Wimborne Publishing Ltd 1991. Copyright in all drawings, photographs and articles published in EVERYDAY ELECTRONICS is fully protected, and reproduction or imitations in whole or in part are expressly forbidden.

Our February '92 issue will be published on Friday, 3 January 1992. See page 3 for details.

Projects

- TRANSISTOR CHECKER** by Steve Knight 12
Check out unmarked or suspect semiconductors
- MICRO-SENSE ALARM** by Jason Sharpe 18
Protect your test gear and valuables with this novel alarm
- STEPPER MOTOR DRIVER/INTERFACE** by Mark Stuart 34
Stand-alone demonstration board, with computer interface facility
- MIND MACHINE PROGRAMMER** by Andy Flind 42
Part Two: Capture your best mood, and take the strain out of your brain!
- SIMPLE MODEL SERIES**
- 7 - BISHOP ROCK LIGHTHOUSE** by Owen Bishop 55
Simulated model of this famous shipping landmark

Series

- INFORMATION TECHNOLOGY AND THE NATIONAL CURRICULUM** by T. R. de Vaux-Balbirnie 22
Part Three: Information Storage
- INTERFACE** by Robert Penfold 50
The spot for all computer enthusiasts - Improved Temperature Sensor
- MAGNETIC RECORDING** by Vivian Capel 52
Part Four: Head Driver Circuits
- AMATEUR RADIO** by Tony Smith G4FAI 61
Albania's Back; USA Bombshell; RA Annual Report

Features

- EDITORIAL** 11
- EUROPEAN SHOW REPORT** by Barry Fox 28
Barry unearths some of the latest trends and thinking at Europe's largest home entertainment show in Berlin
- CROSSWORD/WORDSEARCH** by Malcolm Argent 32
A "simple" puzzle with an electronic theme for Christmas amusement
- EVERYDAY NEWS** 40
What's happening in the world of electronics
- SHOPTALK** with David Barrington 40
Product news and component buying
- SIMPLE MODELS SERIES SPECIAL**
- EASIWIRE OFFER** 54
- DIRECT BOOK SERVICE** 62
Selected technical books and all the EE books by mail order
- PRINTED CIRCUIT BOARD SERVICE** 66
P.C.B.s for EE projects

FREE WITH THIS ISSUE

CRICKLEWOOD ELECTRONICS COMPONENTS
1992 CATALOGUE

Banded to all copies

ADVERTISER'S INDEX

72

Readers Services • Editorial and Advertisement Departments 11

HARD DISC DRIVES

20 Mb (IDE - CONNER)	£ 79
20 Mb (MFM)	£ 79
40 Mb (IDE)	£ 140
100 Mb (IDE - CONNER)	£ 235
MOUNTING KIT	£ 9
MOUNTING KIT (RAILS ONLY)	£ 5

HARDCARDS

20 Mb AT	£105
20 Mb XT	£125
40 Mb AT	£170
40 Mb XT	£185
100 Mb AT	£265
100 Mb XT	£285

■ IDEAL FOR 1512 / 1640 COMPUTERS

FLOPPY DISC DRIVES

3½" 1.44M INTERNAL	£ 40
3½" 720K INTERNAL	£ 33
5¼" 1.2M INTERNAL	£ 45

MONITORS

TILT & SWIVEL BASES ON ALL MONITORS

14" SVGA+ / XVGA COLOUR £ 235
0.28 DOT PITCH - 1024 x 768

12" VGA PAPER WHITE £ 75

COMPUTER CASES

WITH 200W P.S.U AND L.E.D.DISPLAY

FLIP-TOP	WITH 3 BAYS	£ 60
DESKTOP	WITH 4 BAYS	£ 80
MINI TOWER	WITH 5 BAYS	£ 70
MIDI TOWER	WITH 5 BAYS	£ 95
FULL TOWER	WITH 6 BAYS	£ 107

**LET HOBBYKIT QUOTE FOR
YOUR COMPUTER SYSTEM**

KEYBOARD / MICE

AT 102 KEY - UK - IBM CLICK	£24
MOUSE - 3 BUTTON / MAT / ADAPTOR	£15

ADD ON CARDS

2 x FDD CONTROLLER - XT/AT - ALL FORMATS	£27
4 x FDD CONTROLLER - XT/AT - ALL FORMATS	£39
VGA CARD - 8 OR 16 BIT - 256K	£43
SUPER VGA - 16BIT - 512K	£60
2 SERIAL / 1 PARALLEL / 1 GAMES PORT	£16

CONTROLLER CARDS

IDE - AT 16BIT-2HDD/2FDD	£ 17
IDE - AT 16BIT-2HDD/2FDD/2S/1P/1G	£ 26
IDE - 8 BIT-XT	£ 29
IDE - 8 BIT-SLAVE / 1ST OR 2ND HDD	£ 39
IDE - AS ABOVE-16 BIT-WORKS WITH MFM	£ 45
XT - MFM - 8 BIT - 2 HDD ONLY	£ 38
AT RLL - 2 x HDD	£ 25
AT MFM - 2 x HDD / 2 x FDD	£ 44
AT RLL - 2 x HDD / 2 x FDD	£ 40

■ IDEAL FOR 1512 / 1640 COMPUTERS

MOTHERBOARDS

★ COMPLETE WITH 1 Mb MEMORY ★

286 - 16	L/S 21 MHz	£ 105
286 - 20	L/S 25 MHz	£ 125
386SX - 25	L/S 31 MHz	£ 225
386SX - 25	WITH 64K CACHE	£ 298
386DX - 33	WITH 64K CACHE	£ 407
486DX - 33	WITH 64K CACHE	£ 786

OTHER 386 / 486 MOTHERBOARDS - PLEASE CALL

SPECIAL OFFER 286 - 16 SYSTEM

● FEATURES INCLUDE ●

- 286-16 (L/S 21MHZ)
- 1 Mb ON BOARD MEMORY
- 20 Mb HARD DISC IDE
- 3½" 1.44M FLOPPY
- HDD / FDD CONTROLLER
- 2S / 1P / 1G
- VGA CARD (256K)
- KEYBOARD (102 KEYS)
- MINI TOWER CASE
- CHOICE OF MONITOR

12" VGA PAPER WHITE	£ 460
14" VGA COLOUR	£ 545
14" SVGA+ / XVGA COLOUR	£ 640

DOS SYSTEMS

MS DOS 5.0	£ 65
DR DOS 6.0	£ 65

HOBBYKIT

CREDIT CARD HOTLINE

☎ 081 - 205 7485

UNIT 19 CAPITOL INDUSTRIAL PARK
CAPITOL WAY, LONDON, NW9 0EQ
FAX NUMBER : 081 - 205 0603

END OF LINES

MODEMS - V22 BIS - 2400 BPS

AUTO DIAL / REDIAL / ANSWER - FULL DUPLEX
TONE & PULSE DIAL - BT & BABT APPROVED
SUPPLIED WITH EAZILINK COMMS PACKAGE
MC2400 - INTERNAL £ 65

3½" - 720K EXTERNAL FLOPPY
DISC DRIVE - NEW - GREY CASE £ 26

3½" - 1.44 M INTERNAL FLOPPY
DISC DRIVE - NEW - BLACK ONLY £ 35

5¼" - 360K INTERNAL FLOPPY DISC
DRIVE - NEW - GREY OR BLACK £ 24

CGA CARD - FULL LENGTH
COMPOSITE & TTL £ 12

60 MEG TAPE STREAMER
DC600 - 5¼" TRAY
PRICE : £ 190

●● ALL PRICES
INCLUDE V A T ●●

ACCESSORIES

5¼" ADAPTOR KIT FOR 3½" FDD	£ 8.00
5¼" TRAY FOR 3½" FDD	£ 5.50
POWER LEAD FOR 3½" FDD	£ 3.00
IDC PIN TO EDGE CONNECTOR PCB	£ 4.00
SHORT F D D CONTROLLER CABLE 2'	£ 4.00
LONG F D D CONTROLLER CABLE 4'	£ 7.00
POWER SPLITTER	£ 4.50
HARD DRIVE CABLES (MFM/RLL)	£ 6.00
IDE HARD DRIVE CABLE (2 DRIVES)	£ 6.00
KEYBOARD EXTENSION CABLE	£ 3.00

FDD EXTERNAL CASES

METAL GREY CASE SUITABLE FOR EXTERNAL
MOUNTING OF FLOPPY DISC DRIVES, HARD DISC
DRIVES, TAPE STREAMERS, CD ROMS ETC

5¼" CASE ONLY	£ 8
5¼" CASE + LEADS FOR F D D	£ 17
3½" CASE ONLY	£ 8
3½" CASE + LEADS FOR F D D	£ 20

3 STATION NETWORK SYSTEM

ALL PARTS FOR 3 STATIONS SUPPLIED -
DRIVER SOFTWARE AND DATA. USES TWISTED
PAIR CABLE - EXPANDABLE - 1Mb TRANSFER
RATE - EASY INSTALLATION. £ 57

**PLEASE ADD £ 3.00 TO ALL
ORDERS TO COVER POSTAGE**

FREE INSIDE BULL ELECTRICAL 40 PAGE CATALOGUE

SPINNING HEART

A novelty circuit to impress your loved one on St. Valentines day. Novelties to tell your sweetheart how you feel are often expensive. Here is a clever little circuit that is bound to get the message over and impress the one you love. The spinning heart consists of 24 red l.e.d.s arranged in the shape of a love heart. The lights appear to move around the heart giving a spinning effect which looks very effective.

TELESOUND

If you find your personal hi-fi is a little too personal at times – in a hotel for instance. Then this little gadget is for you. The Telesound plugs into your personal stereo and into the aerial socket of a TV set and hey presto! your tapes can be played through the TV set

PROGRAMMABLE TIMER

A simple, easy to construct unit that will give time periods from microseconds to hours. The timer has unlimited uses such as; TV sleep timer; alarm bell duration timer; lamp flasher; process or cooking timer etc.

EVERYDAY ELECTRONICS

FEBRUARY ISSUE ON SALE FRIDAY 3rd JANUARY 1992.



NEXT MONTH



VIEWCOM

TEL 801 471 9338 TLX 929709 VICOM G. FAX 081 552 0946
DIGITAL INTEGRATED CIRCUIT SPECIALISTS

4000 SERIES		4519B		74LS20		74LS347		74HC180		74HC7006		74HC4066		BC547B		1N4728A		30 00000		LINE AR	
4000B	0.10	4520B	0.28	74LS21	0.12	74LS348	1.18	74HC181	0.43	74HC7008	1.88	74HC4067	3.32	BC547C	0.07	1N4735A	0.24	32 00000	1.21	MISC	
4000B	0.11	4522B	0.72	74LS22	0.12	74LS349	0.79	74HC182	0.43	74HC7010	0.28	74HC4075	0.36	BC548	0.07	1N4736A	0.24	48 00000	1.88	3630BM	3.40
4001A	0.11	4526B	0.48	74LS24	0.33	74LS353	0.88	74HC183	0.43	74HC7014	1.34	74HC4094	0.84	BC548B	0.07	1N4740A	0.24	8.888200	1.60	3989C	3.70
4001B	0.10	4527B	0.48	74LS26	0.12	74LS364	1.38	74HC185	0.55	74HC7016	2.04	74HC4316	0.88	BC549	0.07	1N4743A	0.24			4N3	0.80
4001UB	0.12	4528B	0.48	74LS27	0.12	74LS365A	0.26	74HC186	0.59	74HC7026	0.56	74HC4351	1.04	BC549B	0.07	1N4744A	0.24			55418UG	2.80
4002B	0.11	4529B	0.82	74LS30	0.12	74LS366A	0.32	74HC187	0.51	74HC7292	0.77	74HC4511	0.84	BC550	0.07	1N5226B	0.09	0.204800	8.23	555	0.20
4006B	0.30	4530B	0.48	74LS32	0.13	74LS367	0.28	74HC188	0.37	74HC7294	0.77	74HC4514	1.84	BC550C	0.08	1N5232B	0.09	0.307200	6.99	58174AN	11.80
4007UB	0.11	4531B	0.88	74LS33	0.13	74LS367A	0.28	74HC189	1.32	74HC7402	0.84	74HC4515	1.88	BC556	0.05	1N5234B	0.09	1.000000	3.95	6N136	1.80
4008B	0.31	4532B	0.78	74LS33	0.14	74LS367A	0.30	74HC189	1.32	74HC7403	0.84	74HC4516	1.08	BC556A	0.05	1N5337B	0.48	1.843200	3.71	6N139	1.75
4009AE	0.18	4534B	0.98	74LS38	0.13	74LS368A	1.32	74HC192	0.40	74HC7404	1.48	74HC4520	0.98	BC556B	0.05	1N5339B	0.48	2.000000	4.85	93L34DC	8.40
4009UB	0.18	4536B	1.98	74LS40	0.13	74LS373	0.42	74HC190	0.80	74HC7405	1.40	74HC4521	1.04	BC557	0.07	1N5352B	0.48	2.091500	3.71	96L02PC	3.60
4010B	0.10	4538B	0.57	74LS42	0.23	74LS374	0.42	74HC191	0.54	74HC7406	1.40	74HC4522	1.04	BC557B	0.07	1N5355B	0.48	2.457800	1.82	AD202JY	42.80
4011B	0.11	4539B	0.82	74LS47	0.50	74LS375	0.44	74HC192	0.52	74HC7407	2.04	74HC4523	1.04	BC558	0.07	1N5365B	0.48	2.500000	1.82	AD204JY	33.45
4011UB	0.12	4541B	0.84	74LS48	0.48	74LS377	0.70	74HC193	0.40	74HC7408	2.04	74HC4524	1.04	BC558A	0.07	1N5366B	0.48	3.000000	2.25	AD232JY	4.55
4012B	0.15	4543B	2.52	74LS49	0.82	74LS380	0.82	74HC194	0.45	74HC7409	2.04	74HC4525	1.04	BC559	0.07	1N5370B	0.48			AD233JY	6.43
4013B	0.17	4544B	1.48	74LS51	0.11	74LS379	0.88	74HC195	0.45	74HC7410	2.04	74HC4526	1.04	BC559A	0.07	1N5380B	0.48			AD235JY	8.16
4014B	0.28	4547B	1.78	74LS54	0.11	74LS381A	3.05	74HC221	0.82	74HC7411	2.04	74HC4527	1.04	BC559B	0.07	1N5401	0.11	3.275800	1.66	AD238JY	4.72
4015B	0.31	4549B	1.24	74LS55	0.13	74LS385	2.22	74HC237	0.49	74HC7412	2.04	74HC4528	1.04	BC560	0.07	1N5402	0.11	8.068800	2.25	AD242JY	15.74
4016B	0.18	4551B	4.08	74LS73	0.20	74LS386	0.46	74HC238	0.50	74HC7413	2.04	74HC4529	1.04	BC560A	0.07	1N5428A	0.55	7.984320	1.49	AD254AD	18.30
4017B	0.25	4553B	1.82	74LS73A	0.28	74LS390	0.39	74HC240	0.47	74HC7414	2.04	74HC4530	1.04	BC560B	0.07	1N5429	1.40	7.984320	1.49	AD258AJD	25.75
4018B	0.26	4554B	4.82	74LS74	0.18	74LS393	0.34	74HC241	0.48	74HC7415	2.04	74HC4531	1.04	BC561	0.07	1N5482	1.40	8.000000	1.14	AD584JY	1.53
4019B	0.15	4556B	2.52	74LS75	0.18	74LS395	0.34	74HC242	0.48	74HC7416	2.04	74HC4532	1.04	BC562	0.07	1N5485	1.40	10.000000	2.25	AD585JY	2.81
4020B	0.29	4558B	0.64	74LS75	0.21	74LS395A	0.68	74HC243	0.59	74HC7417	2.04	74HC4533	1.04	BC563	0.07	1N5487	1.40	10.000000	2.25	AD586JY	2.81
4021B	0.32	4557B	1.88	74LS76	0.22	74LS398	1.22	74HC244	0.43	74HC7418	2.04	74HC4534	1.04	BC564	0.07	1N5489	1.40	10.000000	2.25	AD587JY	2.81
4022B	0.32	4558B	1.88	74LS76A	0.24	74LS399	0.66	74HC245	0.47	74HC7419	2.04	74HC4535	1.04	BC565	0.07	1N5491	1.40	10.000000	2.25	AD588JY	2.81
4023B	0.11	4560B	1.52	74LS77	0.42	74LS399A	4.97	74HC251	0.24	74HC7420	2.04	74HC4536	1.04	BC566	0.07	1N5492	1.40	10.000000	2.25	AD589JY	2.81
4023UB	0.17	4561B	1.80	74LS78	0.40	74LS469	4.88	74HC253	0.39	74HC7421	2.04	74HC4537	1.04	BC567	0.07	1N5493	1.40	10.000000	2.25	AD590JY	2.81
4024B	0.21	4562B	3.96	74LS78A	0.37	74LS490	4.88	74HC257	0.35	74HC7422	2.04	74HC4538	1.04	BC568	0.07	1N5494	1.40	10.000000	2.25	AD591JY	2.81
4025B	0.15	4563B	2.52	74LS79	0.22	74LS491	4.88	74HC258	0.35	74HC7423	2.04	74HC4539	1.04	BC569	0.07	1N5495	1.40	10.000000	2.25	AD592JY	2.81
4026B	0.57	4568B	3.96	74LS85	0.34	74LS540	0.93	74HC259	0.51	74HC7424	2.04	74HC4540	1.04	BC570	0.07	1N5496	1.40	10.000000	2.25	AD593JY	2.81
4027B	0.18	4569B	2.34	74LS86	0.22	74LS541	0.76	74HC266	0.44	74HC7425	2.04	74HC4541	1.04	BC571	0.07	1N5497	1.40	10.000000	2.25	AD594JY	2.81
4028B	0.25	4572B	0.80	74LS90	0.24	74LS546	4.43	74HC273	0.41	74HC7426	2.04	74HC4542	1.04	BC572	0.07	1N5498	1.40	10.000000	2.25	AD595JY	2.81
4029B	0.30	4572UB	0.84	74LS91	0.74	74LS568	1.82	74HC279	0.34	74HC7427	2.04	74HC4543	1.04	BC573	0.07	1N5499	1.40	10.000000	2.25	AD596JY	2.81
4030B	0.15	4980B	1.88	74LS92	0.28	74LS569	1.14	74HC280	0.80	74HC7428	2.04	74HC4544	1.04	BC574	0.07	1N5500	1.40	10.000000	2.25	AD597JY	2.81
4031B	0.15	4981B	2.96	74LS93	0.24	74LS590	4.88	74HC283	0.35	74HC7429	2.04	74HC4545	1.04	BC575	0.07	1N5501	1.40	10.000000	2.25	AD598JY	2.81
4032B	0.48	4982B	8.88	74LS93	0.39	74LS593	4.92	74HC298	0.49	74HC7430	2.04	74HC4546	1.04	BC576	0.07	1N5502	1.40	10.000000	2.25	AD599JY	2.81
4033B	0.58	4983B	0.57	74LS96	0.48	74LS595	3.30	74HC299	1.04	74HC7431	2.04	74HC4547	1.04	BC577	0.07	1N5503	1.40	10.000000	2.25	AD600JY	2.81
4034B	0.72	4984B	4.64	74LS107	0.25	74LS597	3.30	74HC323	1.07	74HC7432	2.04	74HC4548	1.04	BC578	0.07	1N5504	1.40	10.000000	2.25	AD601JY	2.81
4035B	0.38	4985B	0.88	74LS107A	0.28	74LS621	1.76	74HC354	0.37	74HC7433	2.04	74HC4549	1.04	BC579	0.07	1N5505	1.40	10.000000	2.25	AD602JY	2.81
4036B	1.76	4987B	4.60	74LS109	0.25	74LS622	1.66	74HC356	0.44	74HC7434	2.04	74HC4550	1.04	BC580	0.07	1N5506	1.40	10.000000	2.25	AD603JY	2.81
4038B	0.42	4988B	4.80	74LS109A	0.27	74LS623	1.28	74HC365	0.33	74HC7435	2.04	74HC4551	1.04	BC581	0.07	1N5507	1.40	10.000000	2.25	AD604JY	2.81
4039B	1.76	4989B	3.42	74LS112	0.25	74LS624	2.10	74HC366	0.35	74HC7436	2.04	74HC4552	1.04	BC582	0.07	1N5508	1.40	10.000000	2.25	AD605JY	2.81
4040B	0.29	4720B	8.80	74LS112A	0.27	74LS625	2.28	74HC367	0.35	74HC7437	2.04	74HC4553	1.04	BC583	0.07	1N5509	1.40	10.000000	2.25	AD606JY	2.81
4041B	0.32	4720V	8.87	74LS113	0.44	74LS626	2.18	74HC368	0.35	74HC7438	2.04	74HC4554	1.04	BC584	0.07	1N5510	1.40	10.000000	2.25	AD607JY	2.81
4042B	0.28	4723B	2.86	74LS113A	0.44	74LS627	2.33	74HC373	0.45	74HC7439	2.04	74HC4555	1.04	BC585	0.07	1N5511	1.40	10.000000	2.25	AD608JY	2.81
4043B	0.32	4724B	1.30	74LS114	0.44	74LS628	2.18	74HC374	0.47	74HC7440	2.04	74HC4556	1.04	BC586	0.07	1N5512	1.40	10.000000	2.25	AD609JY	2.81
4044B	0.32	4731VP	8.95	74LS114A	0.46	74LS629	0.93	74HC375	0.51	74HC7441	2.04	74HC4557	1.04	BC587	0.07	1N5513	1.40	10.000000	2.25	AD610JY	2.81
4045B	0.68	4737VP	23.20	74LS122	0.33	74LS640	0.94	74HC377	0.88	74HC7442	2.04	74HC4558	1.04	BC588	0.07	1N5514	1.40	10.000000	2.25	AD611JY	2.81
4046B	0.58	4738VP	24.80	74LS123	0.33	74LS641	1.12	74HC386	0.18	74HC7443	2.04	74HC4559	1.04	BC589	0.07	1N5515	1.40	10.000000	2.25	AD612JY	2.81
4047B	0.41	4752VP	35.95	74LS125	0.28	74LS641-1	1.28	74HC390	0.48	74HC7444	2.04	74HC4560	1.04	BC590	0.07	1N5516	1.40	10.000000	2.25	AD613JY	2.81
4048B	0.23	4753VP	11.05	74LS125A	0.30	74LS642	0.62	74HC393	0.48	74HC7445	2.04	74HC4561	1.04	BC591	0.07	1N5517	1.40	10.000000	2.25	AD614JY	2.81
4049B	0.18	4754VP	18.12	74LS126	0.28	74LS642-1	2.48	74HC423	0.84	74HC7446	2.04	74HC4562	1.04	BC592	0.07	1N5518	1.40	10.000000	2.25	AD615JY	2.81
4049UB	0.17	4007B	0.85	74LS126A	0.28	74LS643	0.94	74HC452	0.84	74HC7447	2.04	74HC4563	1.04	BC593	0.07	1N5519	1.40	10.000000	2.25	AD616JY	2.81
4050B	0.18	4097	0.82	74LS132	0																

CA3140E	0.87	ICL8211CPA	2.20	LM112H	0.74	LM350H	5.83	M708B1	1.42	SL952DP	7.28	63B03XP	11.95	SCN2674BC3N40	10.24	63256L-P-12	4.95
CA3141E	1.42	ICL8212CPA	1.26	LM112H	2.10	LM350D	4.34	MAX232CPE	3.90	SN75107AN	1.27	6502	3.40	SCN2674BC4N40	8.42	63256L-P-16	4.95
CA3146E	1.15	ICM7207AIPD	7.86	LM118H	20.06	LM360H	7.72	MAX232VE/SM	6.86	SN75107BN	1.87	6502A	3.90	SCN268AC1N24	6.32	CM6118AE3	5.30
CA3181E	1.28	ICM7207AIP	8.00	LM119H	17.05	LM360N	9.63	MAX232VFA	6.80	SN75108BN	2.08	6502C	3.90	SCN268AC1N26	6.52	CM6117AE3	5.35
CA3162E	1.49	ICM7211AMP	5.78	LM119J	22.83	LM361N	10.35	MC14550A	5.34	SN75110AN	1.67	6522	3.89	SCN2691AC1A24	6.82	HM1-6118-5	3.15
CA3183E	1.32	ICM7211AMP/L	4.86	LM124J	3.83	LM3676N	1.35	MC10305P	3.10	SN75112AN	1.57	6522A	3.89	SCN2691AC1A28	6.95	HM16116L-P-3	2.80
CA3199E	1.30	ICM7212AMP/L	4.70	LM121K	29.25	LM3677N	3.53	MC13377P	4.93	SN75114AN	4.57	6551	3.10	SCN2691AC1A28	6.82	HM16116L-P-3	2.80
CA3240E	1.38	ICM7216AJL	27.82	LM123CL	20.14	LM380N	1.00	MC1413P	0.74	SN75114AN	4.57	6551A	3.10	SCN2691AC1A28	6.82	HM16116L-P-3	2.80
CA3246E	0.44	ICM7217AIP	9.85	LM134H	10.81	LM380N-14	2.12	MC14490P	3.40	SN75115AN	1.20	65C02P2	6.90	SCN2691AC1A28	6.82	HM16116L-P-3	2.80
CA3280E	1.88	ICM7217AIP	10.42	LM135H	12.03	LM380N-8	2.10	MC14505OP	2.83	SN75115AN	1.20	65C02P2	6.90	SCN2691AC1A28	6.82	HM16116L-P-3	2.80
CA3290E	0.91	ICM7217AIP	10.42	LM1360N	2.4	LM380N-8	5.45	MC14505OP	2.83	SN75115AN	1.20	65C02P2	6.90	SCN2691AC1A28	6.82	HM16116L-P-3	2.80
CA3306CE	9.23	ICM7218CJL	0.41	LM13700N	2.32	LM381N	4.53	MC14588P	0.32	SN75138AN	3.10	65C22P2	5.67	SCN2691AC1A28	6.82	HM16116L-P-3	2.80
CA3396E	2.59	ICM7218CJL	0.41	LM139AJ	18.30	LM383T	4.34	MC1468L	1.46	SN75138AN	3.10	65C51E1	5.67	SCN2691AC1A28	6.82	HM16116L-P-3	2.80
CA3420E	1.57	ICM7218CJL	0.41	LM139J	3.31	LM384N	4.17	MC1488P	0.58	SN75150P	1.11	65C51E2	4.48	SCN2691AC1A28	6.82	HM16116L-P-3	2.80
CA358E	0.33	ICM7218EJL	16.08	LM1458H	2.88	LM385PL-2	2.08	MC1489A	0.80	SN75150P	1.32	68000CP10	4.02	SCN2691AC1A28	6.82	HM16116L-P-3	2.80
CA555CE	0.20	ICM7224IPL	25.04	LM1458M	1.05	LM385PL-2.5	2.08	MC1489P	0.80	SN75151N	5.02	68000CP12	7.72	SCN2691AC1A28	6.82	HM16116L-P-3	2.80
CA741E	0.18	ICM7226BIP/L	9.24	LM1458N	0.45	LM385M-1.2	2.40	MC1558L	2.80	SN75151N	5.02	68000CP18	7.72	SCN2691AC1A28	6.82	HM16116L-P-3	2.80
CD82C55A	8.85	ICM7227AIP	12.80	LM1469N	10.18	LM386N-1	1.82	MC3302P	0.80	SN75155P	1.36	68000CP8	5.86	SCN2691AC1A28	6.82	HM16116L-P-3	2.80
CN836	0.98	ICM7242IPA	2.40	LM1458J	5.75	LM386N-1	1.73	MC3479P	7.82	SN75155P	1.36	6802P	2.87	SCN2691AC1A28	6.82	HM16116L-P-3	2.80
CD82C55B	2.78	ICM7249IDP	14.62	LM1555J	5.75	LM386N-4	2.18	MC3495J	2.45	SN75159P	4.94	6803P	4.98	SCN2691AC1A28	6.82	HM16116L-P-3	2.80
CD82C55C	2.80	ICM7555CBA	1.67	LM1557H	20.43	LM387AN	3.27	MC3523J	2.94	SN75159P	5.77	6805E2P	9.18	SCN2691AC1A28	6.82	HM16116L-P-3	2.80
CD82C55D	3.80	ICM7555IPA	0.84	LM158AH	14.99	LM387N	3.15	MC4024AP	0.84	SN75160BN	7.35	6805E3P	9.18	SCN2691AC1A28	6.82	HM16116L-P-3	2.80
CD82C55E	3.10	ICM7558IPD	1.30	LM158H	6.88	LM388T-1	9.29	MC4044P	0.84	SN75160BN	7.35	6805E4P	9.18	SCN2691AC1A28	6.82	HM16116L-P-3	2.80
CD82C55F	12.28	ICL7104-16CPL	29.08	LM159H	14.32	LM3909N	3.24	MC7	0.84	SN75162BN	11.78	6806P	1.52	SCN2691AC1A28	6.82	HM16116L-P-3	2.80
DA3083ALCN	12.38	ICL7104-16CPL	29.08	LM1801N	1.12	LM3909N	2.18	MC761	1.18	SN75172N	4.58	6844P	17.20	SCN2691AC1A28	6.82	HM16116L-P-3	2.80
DA3083BLCN	12.38	ICL7104-16CPL	29.08	LM1801N	1.12	LM3909N	2.18	MC761	1.18	SN75172N	4.58	6844P	17.20	SCN2691AC1A28	6.82	HM16116L-P-3	2.80
DA3083CLCN	12.38	ICL7104-16CPL	29.08	LM1801N	1.12	LM3909N	2.18	MC761	1.18	SN75172N	4.58	6844P	17.20	SCN2691AC1A28	6.82	HM16116L-P-3	2.80
DA3083DLCN	12.38	ICL7104-16CPL	29.08	LM1801N	1.12	LM3909N	2.18	MC761	1.18	SN75172N	4.58	6844P	17.20	SCN2691AC1A28	6.82	HM16116L-P-3	2.80
DA3083ELCN	12.38	ICL7104-16CPL	29.08	LM1801N	1.12	LM3909N	2.18	MC761	1.18	SN75172N	4.58	6844P	17.20	SCN2691AC1A28	6.82	HM16116L-P-3	2.80
DA3083FLCN	12.38	ICL7104-16CPL	29.08	LM1801N	1.12	LM3909N	2.18	MC761	1.18	SN75172N	4.58	6844P	17.20	SCN2691AC1A28	6.82	HM16116L-P-3	2.80
DA3083GLCN	12.38	ICL7104-16CPL	29.08	LM1801N	1.12	LM3909N	2.18	MC761	1.18	SN75172N	4.58	6844P	17.20	SCN2691AC1A28	6.82	HM16116L-P-3	2.80
DA3083HLCN	12.38	ICL7104-16CPL	29.08	LM1801N	1.12	LM3909N	2.18	MC761	1.18	SN75172N	4.58	6844P	17.20	SCN2691AC1A28	6.82	HM16116L-P-3	2.80
DA3083ILCN	12.38	ICL7104-16CPL	29.08	LM1801N	1.12	LM3909N	2.18	MC761	1.18	SN75172N	4.58	6844P	17.20	SCN2691AC1A28	6.82	HM16116L-P-3	2.80
DA3083JLCN	12.38	ICL7104-16CPL	29.08	LM1801N	1.12	LM3909N	2.18	MC761	1.18	SN75172N	4.58	6844P	17.20	SCN2691AC1A28	6.82	HM16116L-P-3	2.80
DA3083KLCN	12.38	ICL7104-16CPL	29.08	LM1801N	1.12	LM3909N	2.18	MC761	1.18	SN75172N	4.58	6844P	17.20	SCN2691AC1A28	6.82	HM16116L-P-3	2.80
DA3083LLCN	12.38	ICL7104-16CPL	29.08	LM1801N	1.12	LM3909N	2.18	MC761	1.18	SN75172N	4.58	6844P	17.20	SCN2691AC1A28	6.82	HM16116L-P-3	2.80
DA3083MLCN	12.38	ICL7104-16CPL	29.08	LM1801N	1.12	LM3909N	2.18	MC761	1.18	SN75172N	4.58	6844P	17.20	SCN2691AC1A28	6.82	HM16116L-P-3	2.80
DA3083NLCN	12.38	ICL7104-16CPL	29.08	LM1801N	1.12	LM3909N	2.18	MC761	1.18	SN75172N	4.58	6844P	17.20	SCN2691AC1A28	6.82	HM16116L-P-3	2.80
DA3083OLCN	12.38	ICL7104-16CPL	29.08	LM1801N	1.12	LM3909N	2.18	MC761	1.18	SN75172N	4.58	6844P	17.20	SCN2691AC1A28	6.82	HM16116L-P-3	2.80
DA3083PLCN	12.38	ICL7104-16CPL	29.08	LM1801N	1.12	LM3909N	2.18	MC761	1.18	SN75172N	4.58	6844P	17.20	SCN2691AC1A28	6.82	HM16116L-P-3	2.80
DA3083QLCN	12.38	ICL7104-16CPL	29.08	LM1801N	1.12	LM3909N	2.18	MC761	1.18	SN75172N	4.58	6844P	17.20	SCN2691AC1A28	6.82	HM16116L-P-3	2.80
DA3083RLCN	12.38	ICL7104-16CPL	29.08	LM1801N	1.12	LM3909N	2.18	MC761	1.18	SN75172N	4.58	6844P	17.20	SCN2691AC1A28	6.82	HM16116L-P-3	2.80
DA3083SLCN	12.38	ICL7104-16CPL	29.08	LM1801N	1.12	LM3909N	2.18	MC761	1.18	SN75172N	4.58	6844P	17.20	SCN2691AC1A28	6.82	HM16116L-P-3	2.80
DA3083TLCN	12.38	ICL7104-16CPL	29.08	LM1801N	1.12	LM3909N	2.18	MC761	1.18	SN75172N	4.58	6844P	17.20	SCN2691AC1A28	6.82	HM16116L-P-3	2.80
DA3083ULCN	12.38	ICL7104-16CPL	29.08	LM1801N	1.12	LM3909N	2.18	MC761	1.18	SN75172N	4.58	6844P	17.20	SCN2691AC1A28	6.82	HM16116L-P-3	2.80
DA3083VLCN	12.38	ICL7104-16CPL	29.08	LM1801N	1.12	LM3909N	2.18	MC761	1.18	SN75172N	4.58	6844P	17.20	SCN2691AC1A28	6.82	HM16116L-P-3	2.80
DA3083WLCN	12.38	ICL7104-16CPL	29.08	LM1801N	1.12	LM3909N	2.18	MC761	1.18	SN75172N	4.58	6844P	17.20	SCN2691AC1A28	6.82	HM16116L-P-3	2.80
DA3083XLCN	12.38	ICL7104-16CPL	29.08	LM1801N	1.12	LM3909N	2.18	MC761	1.18	SN75172N	4.58	6844P	17.20	SCN2691AC1A28	6.82	HM16116L-P-3	2.80
DA3083YLCN	12.38	ICL7104-16CPL	29.08	LM1801N	1.12	LM3909N	2.18	MC761	1.18	SN75172N	4.58	6844P	17.20	SCN2691AC1A28	6.82	HM16116L-P-3	2.80
DA3083ZLCN	12.38	ICL7104-16CPL	29.08	LM1801N	1.12	LM3909N	2.18	MC761	1.18	SN75172N	4.58	6844P	17.20	SCN2691AC1A28	6.82	HM16116L-P-3	2.80
DA3083ALCN	12.38	ICL7104-16CPL	29.08	LM1801N	1.12	LM3909N	2.18	MC761	1.18	SN75172N	4.58	6844P	17.20	SCN2691AC1A28	6.82	HM16116L-P-3	2.80
DA3083BLCN	12.38	ICL7104-16CPL	29.08	LM1801N	1.12	LM3909N	2.18	MC761	1.18	SN75172N	4.58	6844P	17.20	SCN2691AC1A28	6.82	HM16116L-P-3	2.80
DA3083CLCN	12.38	ICL7104-16CPL	29.08	LM1801N	1.12	LM3909N	2.18	MC761	1.18	SN75172N	4.58	6844P	17.20	SCN2691AC1A28	6.82	HM16116L-P-3	2.80
DA3083DLCN	12.38	ICL7104-16CPL	29.08	LM1801N	1.12	LM3909N	2.18	MC761	1.18	SN75172N	4.58	6844P	17.20	SCN2691AC1A28	6.82	HM16116L-P-3	2.80
DA3083ELCN	12.38	ICL7104-16CPL	29.08	LM1801N	1.12	LM3909N	2.18	MC761	1.18	SN75172N	4.58	6844P	17.20	SCN2691AC1A28	6.82	HM16116L-P-3	2.80
DA3083FLCN	12.38	ICL7104-16CPL	29.08	LM1801N	1.12	LM3909N	2.18	MC761	1.18	SN75172N	4.58	6844P	17.20	SCN2691AC1A28	6.82	HM16116L-P-3	2.80
DA3083GLCN	12.38	ICL7104-16CPL															

SURVEILLANCE PROFESSIONAL QUALITY KITS

No. 1 for Kits

Whether your requirement for surveillance equipment is amateur, professional or you are just fascinated by this unique area of electronics SUMA DESIGNS has a kit to fit the bill. We have been designing electronic surveillance equipment for over 12 years and you can be sure that all of our kits are very well tried, tested and proven and come complete with full instructions, circuit diagrams, assembly details and all high quality components including fibreglass PCB. Unless otherwise stated all transmitters are tuneable and can be received on an ordinary VHF FM radio.

UTX Ultra-miniature Room Transmitter

Smallest room transmitter kit in the world! Incredible 10mm x 20mm including mic. 3-12V operation. 500m range£16.45

MTX Micro-miniature Room Transmitter

Best-selling micro-miniature Room Transmitter
Just 17mm x 17mm including mic. 3-12V operation. 1000m range.....£13.45

STX High-performance Room Transmitter

Hi performance transmitter with a buffered output stage for greater stability and range. Measures 22mm x 22mm including mic. 6-12V operation, 1500m range£15.45

VT500 High-power Room Transmitter

Powerful 250mW output providing excellent range and performance. Size 20mm x 40mm. 9-12V operation. 3000m range.....£16.45

VXT Voice Activated Transmitter

Triggers only when sounds are detected. Very low standby current. Variable sensitivity and delay with LED indicator. Size 20mm x 67mm. 9V operation. 1000m range...£19.45

HVX400 Mains Powered Room Transmitter

Connects directly to 240V AC supply for long-term monitoring. Size 30mm x 35mm. 500m range£19.45

SCRX Subcarrier Scrambled Room Transmitter

Scrambled output from this transmitter cannot be monitored without the SCDM decoder connected to the receiver. Size 20mm x 67mm. 9V operation. 1000m range.....£22.95

SCLX Subcarrier Telephone Transmitter

Connects to telephone line anywhere, requires no batteries. Output scrambled so requires SCDM decoder connected to receiver. Size 32mm x 37mm. 1000m range.....£23.95

SCDM Subcarrier Decoder Unit for SCRX

Connects to receiver earphone socket and provides decoded audio output to headphones. Size 32mm x 70mm. 9-12V operation£22.95

ATR2 Micro Size Telephone Recording Interface

Connects between telephone line (anywhere) and cassette recorder. Switches tape automatically as phone is used. All conversations recorded. Size 16mm x 32mm. Powered from line£13.45

UTLX Ultra-miniature Telephone Transmitter

Smallest telephone transmitter kit available. Incredible size of 1mm x 20mm! Connects to line (anywhere) and switches on and off with phone use. All conversation transmitted. Powered from line. 500m range£15.95

TLX700 Micro-miniature Telephone Transmitter

Best-selling telephone transmitter. Being 20mm x 20mm it is easier to assemble than UTLX. Connects to line (anywhere) and switches on and off with phone use. All conversations transmitted. Powered from line. 1000m range£13.45

STLX High-performance Telephone Transmitter

High performance transmitter with buffered output stage providing excellent stability and performance. Connects to line (anywhere) and switches on and off with phone use. All conversations transmitted. Powered from line. Size 22mm x 22mm. 1500m range£16.45

TKX900 Signalling/Tracking Transmitter

Transmits a continuous stream of audio pulses with variable tone and rate. Ideal for signalling or tracking purposes. High power output giving range up to 3000m. Size 25mm x 63mm. 9V operation£22.95

CD400 Pocket Bug Detector/Locator

LED and piezo bleeper pulse slowly, rate of pulse and pitch of tone increase as you approach signal. Gain control allows pinpointing of source. Size 45mm x 54mm. 9V operation£30.95

CD600 Professional Bug Detector/Locator

Multicolour readout of signal strength with variable rate bleeper and variable sensitivity used to detect and locate hidden transmitters. Switch to AUDIO CONFORM mode to distinguish between localised bug transmission and normal legitimate signals such as pagers, cellular, taxis etc. Size 70mm x 100mm. 9V operation£50.95

QTX180 Crystal Controlled Room Transmitter

Narrow band FM transmitter for the ultimate in privacy. Operates on 180 MHz and requires the use of a scanner receiver or our QRX180 kit (see catalogue). Size 20mm x 67mm. 9V operation. 1000m range£40.95

QLX180 Crystal Controlled Telephone Transmitter

As per QTX180 but connects to telephone line to monitor both sides of conversations. 20mm x 67mm. 9V operation. 1000m range£40.95

QSL180 Line Powered Crystal Controlled Phone Transmitter

As per QLX180 but draws power requirements from line. No batteries required. Size 32mm x 37mm. Range 500m£35.95

QRX180 Crystal Controlled FM Receiver

For monitoring any of the 'Q' range transmitters. High sensitivity unit. All RF section supplied as a pre-built and aligned module ready to connect on board so no difficulty setting up. Outpt to headphones. 60mm x 75mm. 9V operation£60.95

A build-up service is available on all our kits if required.

UK customers please send cheques, POs or registered cash. Please add £1.50 per order for P&P. Goods despatched ASAP allowing for cheque clearance. Overseas customers send sterling bank draft and add £5.00 per order for shipment. Credit card orders welcomed on 0827 714476.

OUR LATEST CATALOGUE CONTAINING MANY MORE NEW SURVEILLANCE KITS NOW AVAILABLE. SEND TWO FIRST CLASS STAMPS OR OVERSEAS SEND TWO IRCS.

★★★ Specials ★★★

DLTX/DLRX Radio Control Switch

Remote control anything around your home or garden, outside lights, alarms, paging system etc. System consists of a small VHF transmitter with digital encoder and receiver unit with decoder and relay output, momentary or alternate, 8-way dip switches on both boards set your own unique security code. TX size 45mm x 45mm. RX size 35mm x 90mm. Both 9V operation. Range up to 200m.

Complete System (2 kits)£50.95
Individual Transmitter DLTX£19.95
Individual Receiver DLRX£37.95

MBX-1 Hi-Fi Micro Broadcaster

Not technically a surveillance device but a great ideal! Connects to the headphone output of your Hi-Fi, tape or CD and transmits Hi-Fi quality to a nearby radio. Listen to your favourite music anywhere around the house, garden, in the bath or in the garage and you don't have to put up with the DJ's choice and boring waffle. Size 27mm x 60mm. 9V operation. 250m range£20.95

**SUMA
DESIGNS**

DEPT. EE
THE WORKSHOPS, 95 MAIN ROAD,
BAXTERLEY, NEAR AATHERSTONE,
WARWICKSHIRE CV9 2LE



0827 714476

VISITORS STRICTLY BY APPOINTMENT ONLY

1992 CATALOGUE + 48 PAGE BARGAIN LIST - OUT NOW!

TIMER SWITCH

Z5174 Superb geared mains motor 1 rev per 12hrs with cam operated switches - 2 c/o rated 16A 250V. Size 60x54x43mm. **Only £3.00** 100 + 1.50

LOW COST SOUND CHIPS

UM34811A Melody generator.
Price £1.20 100 + 0.75
UM3562 3 gun sound generator.
Price 75p 100 + 0.38
UM66 3 christmas carols 75p 100 + 0.38
All supplied with a typical circuit.

BRIDGE RECT CLEARANCE

Z2347 4A 200V in line.
Prices 6/£1 100 + 0.09 1k + 0.06

PC KEYBOARDS

Z8946 Standard 102 key keyboard made by Cherry with 5pin Din connector to plug straight into your PC! (switchable between MF/AT/XT) - Oh yes, nearly forgot - the keys have a Russian character set (in addition to English) so you can practice a bit of peristroika!

Price **Only £25.00**
Z8954 AT/XT switchable, French character set. **£20.00**
Z8955 AT/XT switchable, German character set. **£20.00**

NICAD BATTERIES

Z2349 Nicad Battery Pack. Brand new, intended for use in Zonephones, comprising 4 x 1/2A size cells each rated 1.2V 0.45Ah, size 16.1mm dia x 28mm. DP £9.92.
Our price **£2.00** 100 + 1.00 1k + 0.70

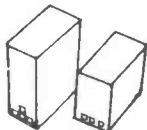

Z4150 Ex mobile radio battery. 56 x 63 x 33mm case (sometimes damaged) contains 8 x AA size rechargeable Nicads. These can be removed by breaking the case open. Each cell rated 1.25V 600mA. **£3.00**

Z4149 As above but 84 x 66 x 33mm. There are again 8 cells but they are longer than AA size, being 73mm long. Each cell rated 1.25V 900mA. **£4.50**

HIGH VALUE CAPACITORS

Code	Value	Volts	Size	Price
Z4343	2200	40	45 x 26	60p
Z4419	3300	25	50 x 26	40p
Z5147	4700	100	105 x 51	£3.00
Z4345	10,000	40	56 x 41	£2.50
Z5146	10,000	100	105 x 64	£4.00
Z4346	15,000	25	56 x 41	£2.50

MODEMS

Z8936 Buzzbox DSL 21 CCITT V21 modem (300 baud) made by DaCom Systems. Complete, new and boxed. External PSU. 5 pin DIN plug, and instructions. Very simple to use, only 4 wires employed. Originate and answer mode selectable. **£24.95**

Z8937 One to One 21/23 IAD CCITT V21/23 auto answer modem 300, 1200/75, 75/1200 baud full duplex 1200 baud half duplex Tx, or Rx. Made by Master Systems Ltd. Complete, new and boxed modem suitable for use with micro computers with RS232C interfaces. Comprehensive 76 page manual, external power supply and 25 pin 'D' standard DCE connector. **£75.00**

Z5123 Modem. Fully functional brand new and boxed. Standard 160 x 100mm Eurocard with DIN41612 connector. Only 300 baud, but at the price we're asking represents superb value for money!! Supplied complete with wiring details - needs ±12V. **Only £14.95**

VARIABLE PSU KIT

K642 Simple kit utilising our Z660 power supply to give a 10 watt variable output from 4-20V, fully stabilised. Only needs 2 components added! Input must be at least 3V above max required output. Circuit features overload/short circuit protection and thermal cut-out. Input 7-25V DC, 1.5A; Output 4-20V DC variable 10 watts max; Size 50 x 50 x 21mm.
Price **£5.95**



132 Pages of Electronic, Hobby and Craft materials + Tools, Audio, Video and Test Equipment!! + 48 pages of Surplus Bargains!
Only £2.00 inc post. Why not subscribe to the next 6 bargain lists at approx monthly intervals? Only £2 inc post.

ZONEPHONE TERMINAL

Tx/Rx in plastic case with logic control all inside steel case with I/P and O/P sockets, 8V 3.8Ah sealed lead acid battery. All this inside another steel case 480 x 300 x 150 with 2 whip aerials on top.
Price **£29.95**

OPTO BARGAINS

Z2171 24 character x 2 lines LCD by Optrex. High quality display with 192 character ROM, easily interfaced with either 4 or 8 bit uP's. Supplied with data. Characters are 5 x 7 dot arrays with separate cursor. Module size 118 x 35mm. DP around £30.00.
Our price **£10.00**

Z2172 40 character x 1 line LCD by Optrex (Japan). Double height display with 192 character ROM; other characters can be displayed by generation in RAM, easily interfaced with either 4 or 8 bit uP's. Supplied with data. Characters are 5 x 12 dot arrays measuring 3.2 x 10mm. Module size 220 x 40mm. DP over £50.00.
Our price **£15.00**

Z5096 16 character x 1 line. Very similar to our Z1814 but slightly larger character 6.3 x 3.15 (8 x 5 dots). Type LCDM16166 by Refac. Supplied with data. Uses Hitachi HD44780A00 chip (supplied). **£8.00**

Z4148 LCD as Z4115 but 6 digit, 50 pins. Trade price £10.86.
Price **£3.00**

Z5119 Communications LCD. This large (140 x 40mm) display (made for Marconi) has 110 pins and shows a variety of symbols and power levels used in radio communication, includes a bargraph display. No further info and only limited appeal, hence the very low price.
Price **Just £2.00**

Z4115 8 digit 12.7mm high LCD and holder. These are 14 segment devices allowing alphanumeric display. Normally costing over £15.00 we are offering these for just **£4.50**
Z1637 LCD Display - direct drive 3 1/2 digit with Lo-Batt. 12.7mm high digits. Op voltage 4-12 RMS @ 32Hz type. Consumes only 25µA with all segments on. Trade price £7.97 each. Supplied with data, but no edge connector.
Prices **£1.00** 25 + 0.65 100 + 0.50

Z2163 4 Digit multiplexed LCD. 50 x 30mm probably for an electronic balance-symbols include balance pens, 5 stage bar graph, lbs and kg's etc. Digit height 12mm. Self adhesive pad on back. 13 pin PCB connector.
Price **£2.00**

SWITCH MODE POWER SUPPLIES

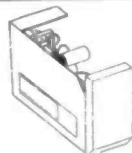

Z8921 Apricot PSU - beautiful unit 160 x 110 x 55mm with IEC switched mode inlet. Made by Astec. Model BM43024. 120/240V input. Outputs: +5V @ 2.5A; +12V @ 2A. **£12.95**

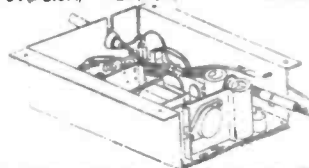

AA12351 Partially cased, overall size 160 x 104 x 45mm. Input and outputs are on flying leads, all colour coded. There is also an additional IEC socket to extend mains to another unit.
Input 115/230V, 50/60Hz
Outputs +5V 5A, +12V 0.15A
Total Wattage 50W
Price **£6.95** 25 + 5.43 100 + 4.53

Conversion Kit

K725 This kit converts the AA12531 PSU into a much more versatile supply, giving +5V @ 2.5A; +12V @ 2A; -12V @ 0.1A; -5V @ 0.55A. Complete kit of parts and full instructions.
Price **£3.50**

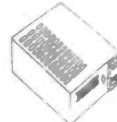

BM41012 Astec, totally enclosed steel cased unit 175 x 136 x 65mm, with switched and fused IEC mains inlet. PCB 160 x 80mm with output pins and connector.
Input 115/230V, 50/60Hz
Outputs +5V 3.75A, +12V 1.5A, 12V 0.4A
Total Wattage 65W
Price **£14.95** 25 + 11.70 100 + 9.75
Z8923 Intelligence SM060 80 watt unit 180 x 110 x 57mm. 120/240V input, and unusually 4 outputs: (Max rating per output quoted - total load must not exceed 80W): +5V @ 6A; +12V @ 2A; +25V @ 3A; -12V @ 500mA.
Price **£22.95**

All 1 off prices include VAT; quantity prices do not. P&P £2.50 per order. Min Credit Card £12. Official orders from Education welcome, min invoice charge £15.00. Payment is accepted by cheque, postal order, cash (including foreign currency bank notes) book tokens, Access, Visa, Connect.

Our stores have enormous stocks of components and our trade counter is open from 9-5.30 Mon-Sat. Come and see us!
Tel: (0703) 236363 Fax: (0703) 236307



27D PARK ROAD, SOUTHAMPTON, SO1 3TB

SURFACE MOUNT

K5101 Presets - cermet in wide range from 10R to 1M. Pack of 50 **£3.00**
K5102 Transistors - a dozen different types including BCF29/30 BCW 29/71/72/81 etc. Pack of 100 **£3.00**

CABLE TV UNIT



Z8939 Two tone brown case contains PCB 192 x 195mm with easily removed UHF modulator made by Labgear (Sound and Vision); video pre-amp; stabilised power supply and all the decoding circuitry (9 transistors and TBA673 chip). On the front of the case is a cable/off air switch and 5 push buttons (5 channels and on/off mains switch). There are 4 cables coming from the rear. The case can easily be utilised for other purposes - the dark brown inserts on the front are both easily removable, if required. Please note the low price we are asking in no way reflects their true worth - they're taking up a lot of space, so we need to shift them quickly!! Supplied with circuit diagram.
Price **£6.95** 100 + 3.50 1k + 2.50

COMPUTER INTERFACE

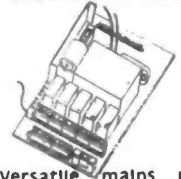

Z8957 Versatile mains powered switching unit and power supply, ideal for controlling up to 5 separate circuits via BBC user port. Supplied with 6 program listings and full instructions. Can also be used with PC - details included. Relay contacts are SPCO rated 10A. There's also 2 auxiliary DC outputs, 12V @ 1.5A and 5V @ 1A. **£14.95**

HIGH QUALITY NICAD CHARGER

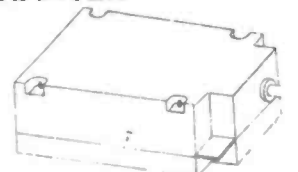

Z5136 Nicad switched mode battery charger for charging 6 x AA, C or D cells. 70mA 16 hour rate, 700mA 1.5 hour rate, 25mA float charge automatically switched in when battery reaches correct charge level. Outputs for fast and slow charging simultaneously if necessary, both on timers to prevent over charging. **£12.95**

STEPPER MOTOR

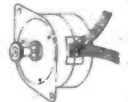

Z5054 Superb little 12V motor by Airpax. 35mm dia x 21mm deep with a 16 tooth 9.5mm dia gear wheel mounted on the 2mm dia spindle. Fixing centres 42mm 7/8", 48 step. 100 + price is £9.04. Supplied with data sheet.
Prices **£3 each** 100 + 2.00

EASIWIRE

The easy to use no-soldering wiring tool which makes construction of small electronic projects so simple! All included in the kit are: Wiring pen; Utility tool; Punched wiring board; Self adhesive sheet; Spring loaded terminals and jacks; Spare spool of wire; Excellent instruction book. Catalogue price £15.00.
Price **£5.00**

MAGENTA ELECTRONICS LTD



MAIL ORDER AND SHOP
EE116
135 Hunter St
Burton-on-Trent
Staffs, DE14 2ST
Tel: 0283 65435
Fax: 0283 46932

All prices include VAT at 17½%

Shop open 9-5 Mon-Fri;
9-2 Saturday
Official orders welcome

Add £2
p&p to
all orders

STEPPING MOTOR DRIVER/INTERFACE

EE Jan '92

A single board, stand alone, stepping motor driver with built-in oscillator for variable low speed, high speed, and acceleration control. Suitable for all Magenta's four-phase unipolar motors and most others - up to 35V and 1.5A per phase. Half step, Full step and Wave-drive modes - switch selectable. L.E.D. mimic display, and connector for computer port.

Kit includes MD35 motor

KIT REF 843

OR BUILT

£29.95

£44.95

D.C. MOTOR GEARBOXES

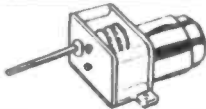

Ideal for Robots and Buggies. A miniature plastic reduction gearbox coupled with a 1.5-4.5 Volt mini motor. Variable gearbox reduction ratios are obtained by fitting from 1 to 6 gearwheels (supplied). Two types available:

SMALL UNIT TYPE MGS £4.08

Speed range 3-2200 rpm. Size 37x43x25mm

LARGE UNIT TYPE MGL £4.65

Speed range 2-1150 rpm. Size 57x43x29mm

**Supplying Electronics
for Education,
Robotics, Music,
Computing and much,
much more!**

CATALOGUE
AVAILABLE PRICE
£1.00 INC. P&P

STEPPING MOTORS

A range of top quality stepping motors suitable for driving a wide range of mechanisms under computer control using simple interfacing techniques.

ID36 PERMANENT MAGNET MOTOR -
48 steps per rev £16.86

MD200 HYBRID MOTOR -
200 steps per rev £17.10

MD35 ¼ PERMANENT MAGNET MOTOR -
48 steps per rev £12.98

MD38 PERMANENT MAGNET MOTOR -
48 steps per rev £9.15

HAMEG HM 203-7 OSCILLOSCOPE

New model just arrived. High quality reliable instrument made in W. Germany. Outstanding performance. Full two year parts and labour warranty. £338
20MHz-2 channels 1mV sensitivity + £59.15 VAT
Easy to operate and high performance Next Day Delivery £10.00
(cheques must be cleared)

EDUCATIONAL BOOKS & BOOK PROJECTS

ADVENTURES WITH ELECTRONICS

The classic Easy to Follow book suitable for all ages. Ideal for beginners. No soldering, uses an S-DEC breadboard. Gives clear instructions with lots of pictures. 16 projects - including three radios, siren, metronome, organ, intercom, timer, etc. Helps you learn about electronic components and how circuits work. Component pack includes an S-DEC breadboard and all the components for the series.

ADVENTURES WITH ELECTRONICS £5.75
COMPONENT PACK (less book) £22.83

FUN WITH ELECTRONICS

From the USBORNE Pocket Scientist series - An enjoyable introduction to electronics. Full of very clear full colour pictures accompanied by easy to follow text. Ideal for all beginners - children and adults. Only basic tools are needed. 64 full colour pages cover all aspects - soldering - fault finding - components (identification & how they work). Also full details of how to build 6 projects - burglar alarm, radio, game, etc. Requires soldering - 4 pages clearly show you how.

The components supplied in our pack allows all the projects to be built and kept. The book is available separately.

FUN WITH ELECTRONICS Book £2.95
COMPONENT PACK (less book) £17.93

30 SOLDERLESS BREADBOARD PROJECTS

A book of projects by R. A. Penfold covering a wide range of interests. All projects are built on a Verobloc breadboard. Full layout drawings and component identification diagrams enable the projects to be built by beginners. Each circuit can be dismantled and rebuilt several times using the same components. The component pack allows all projects in the book to be built one at a time.

Projects covered include amplifiers, light actuated switches, timers, metronome, touch switch, sound activated switch, moisture detector, M.W. Radio, Fuzz unit, etc.

30 SOLDERLESS BREADBOARD
PROJECTS Book 1 £2.95
COMPONENT PACK £27.74

ENJOYING ELECTRONICS

A more advanced book which introduces some arithmetic and calculations to electronic circuits. 48 chapters covering elements of electronics such as current, transistor switches, flip-flops, oscillators, charge, pulses, etc. An excellent follow-up to Teach-in or any other of our series. Extremely well explained by Owen Bishop who has written many excellent beginners' articles in numerous electronics magazines.

ENJOYING ELECTRONICS Book £3.60
COMPONENT PACK £14.62

Note - A simple multimeter is needed to fully follow this book. The M102 BZ is ideal. £13.98

A FIRST ELECTRONICS COURSE

A copiously illustrated book that explains the principles of electronics by relating them to everyday objects. At the end of each chapter a set of questions and word puzzles allow progress to be checked in an entertaining way. An S-DEC breadboard is used for this series - soldering is not required.

A FIRST ELECTRONIC COURSE BOOK £4.99
PACK £22.83

EVERYDAY ELECTRONICS KIT PROJECTS

ALL KITS HERE HAVE BEEN FEATURED IN EE AND ARE SUPPLIED WITH MAGAZINE ARTICLE REPRINTS. SEPARATE REPRINTS ALSO AVAILABLE PRICE 80p EACH INCLUSIVE P&P KITS INCLUDE CASES, PCB'S HARDWARE AND ALL COMPONENTS (UNLESS STATED OTHERWISE) CASES ARE NOT DRILLED OR LABELS SUPPLIED UNLESS STATED.

Ref	Price	Ref	Price
843 STEPPING MOTOR DRIVER/INTERFACE Jan 92 or built	£29.95 £44.95	584 SPECTRUM SPEECH SYNTH (no case) Feb 87	£23.90
842 PORTABLE ULTRASONIC PEST SCARER, Aug '91	£22.56	581 VIDEO GUARD Feb 87	£9.59
841 DIGITAL LCD THERMOSTAT May 91 with punched and printed case	£29.95	569 CAR ALARM Dec 86	£14.24
840 DIGITAL COMBINATION LOCK Mar 91 with drilled case	£19.86	561 LIGHT RIDER LAPEL BADGE Oct 86	£11.65
839 ANALOGIC TEST PROBE Jan 91	£13.23	560 LIGHT RIDER DISCO VERSION Oct 86	£22.41
838 MICROCONTROLLER LIGHT SEQUENCER Dec 90. With drilled and labelled case	£57.17	559 LIGHT RIDER 16 LED VERSION Oct 86	£15.58
835 SUPERHET BROADCAST RECEIVER Mar 90 With drilled panels and dial	£17.16	556 INFRA-RED BEAM ALARM Sep 86	£32.39
834 QUICK CAP TESTER Feb 90	£10.39	544 TILT ALARM July 86	£8.94
833 EE 4 CHANNEL LIGHT CHASER Jan 90	£32.13	542 PERSONAL RADIO June 86	£13.17
815 EE TREASURE HUNTER Aug 89 Full Kit	£46.95	528 PA AMPLIFIER May 86	£30.60
814 BAT DETECTOR June 89	£21.44	523 STEREO REVERB Apr 86	£30.21
812 ULTRASONIC PET SCARER May 89	£14.81	513 BBC MIDI INTERFACE Mar 86	£31.93
800 SPECTRUM EPROM PROGRAMMER Dec 88	£30.60	512 MAINS TESTER & FUSE FINDER Mar 86	£10.07
796 SEASHELL SYNTHESISER Nov 88	£28.65	497 MUSICAL DOOR BELL Jan 86	£21.41
790 EPROM ERASER Oct 88	£28.51	493 DIGITAL CAPACITANCE METER Dec 85	£49.96
769 VARIABLE 25V-2A BENCH POWER SUPPLY Feb 88	£56.82	481 SOLDERING IRON CONTROLLER Oct 85	£6.25
744 VIDEO CONTROLLER Oct 87	£33.29	464 STEPPER MOTOR INTERFACE FOR THE BBC COMPUTER less case Aug 85	£9.60
740 ACOUSTIC PROBE Nov 87	£20.01	1035 STEPPER MOTOR EXTRA OPTIONAL POWER SUPPLY PARTS	£9.15 £5.86
739 ACCENTED BEAT METRONOME Nov 87	£23.94	461 CONTINUITY TESTER July 85	£7.08
734 AUTOMATIC PORCH LIGHT Oct 87	£19.62	456 ELECTRONIC DOORBELL June 85	£8.63
730 BURST-FIRE MAINS CONTROLLER Sep 87	£15.50	444 INSULATION TESTER Apr 85	£22.37
728 PERSONAL STEREO AMP Sep 87	£16.34	392 BBC MICRO AUDIO STORAGE SCOPE INTERFACE Nov 84	£40.82
724 SUPER SOUND ADAPTOR Aug 87	£43.86	387 MAINS CABLE DETECTOR Oct 84	£6.31
722 FERMOSTAT July 87	£13.88	386 DRILL SPEED CONTROLLER Oct 84	£9.91
719 BUCCANEER I.B. METAL DETECTOR July 87	£30.22	362 VARICAP AM RADIO May 84	£15.02
718 3-BAND 1.6-30MHz RADIO Aug 87	£30.30	337 BIOLOGICAL AMPLIFIER Jan 84	£27.59
715 MINI DISCO LIGHTS June 87	£14.39	263 BUZZ OFF Mar 83	£6.49
707 EQUALIZER (IONISER) May 87	£17.75	242 INTERCOM no case July 82	£6.50
700 ACTIVE I/R BURGLAR ALARM Mar 87	£40.74	240 EGG TIMER June 82	£7.85
		108 IN SITU TRANSISTOR TESTER June 78	£10.76
		106 WIERD SOUND EFFECTS GEN Mar 78	£8.94
		101 ELECTRONIC DICE Mar 77	£7.15

INSULATION TESTER

EE APRIL 85



A reliable electronic tester which checks insulation resistance of wiring appliances etc., at 500 volts. The unit is battery powered simple and safe to operate. Leakage resistance of up to 100 Megohms can be read easily. One of our own designs and extremely popular.

KIT REF 444

£22.37

PET SCARER

EE MAY 89

Produces high power ultrasound pulses. L.E.D. flashes to indicate power output and level. Battery powered (9V-12V or via Mains Adaptor).

KIT REF 812

Mains Adaptor £2.02

£14.81

DIGITAL COMBINATION LOCK

EE MAR '91

Digital combination lock with a 12 key keypad. 4 digit code operates 250V-16A SPCO relay. A special anti-tamper circuit allows the relay to be mounted remotely from the keypad without any loss of security. Can be operated in many modes (latching/unlatching, manual/automatic setting, continuous/momentary output, etc.). Article describes operation as Vehicle Immobilising security system. Low current drain. *Kit includes drilled case.*

KIT REF 840

£19.86

DIGITAL LCD THERMOSTAT

EE MAY '91

A versatile thermostat with LCD read out. MIN/MAX temperature recording, clock and individually settable upper and lower switching points. Covers -10 to 110 degrees Celsius, accurate to within 0.1 degrees. Submersible probe on 3 meter lead. Kit includes punched and printed case. Save on energy bills by improved control of your hot water system. Also ideal for greenhouse soil temperature and aquarium control. Complete kit includes thermostat and probe, mains power supply and relay output. PCB's and punched and printed case.

KIT REF 841

£29.95

3 BAND SHORT WAVE RADIO

EE AUG 87

Covers 1.6-30 MHz in 3 bands using modern miniature coils. Audio output is via a built-in loudspeaker. Advanced design gives excellent stability, sensitivity and selectivity. Simple to build.

KIT REF 718

£30.30

PORTABLE ULTRASONIC PEST SCARER

EE AUG '91

A powerful 23kHz Ultrasonic generator in a compact hand-held case. A MOSFET output drives a weatherproof transducer at up to 300V peak to peak via a special tuned transformer. Sweeping frequency output requires no setting up or alignment. Kit includes all components, PCB, transducer and case.

KIT REF 842

£22.56

ACOUSTIC PROBE

EE NOV '87

A very popular project which picks up vibrations by means of a contact probe and passes them on to a pair of headphones or an amplifier. Sounds from engines, watches and speech travelling through walls can be amplified and heard clearly. Useful for mechanics, instrument engineers and nosey parkers!

KIT REF 740

£20.01

4 CHANNEL LIGHT CHASER

EE Jan '90

A 1000W per channel chaser with zero volt switching, hard drive, inductive load capability, mic sound sensor and sophisticated 'beat' detector. Chase steps to music or auto when quiet. Variable speed and mic. sens. LED mimic on front panel. Switchable for 3 or 4 channels. P552 output. Ideal for rope lights, pin spots, disco and display lighting.

KIT REF 833

£32.13

EE EQUALISER

EE MAY '87

A mains powered Ioniser with an output of negative ions that give a refreshing feeling to the surrounding atmosphere. Negligible current consumption and all-insulated construction ensure that the unit is safe and economical in use. Easy to build on a simple PCB.

KIT REF 707

£17.75

LIGHT RIDERS

EE OCT '86

Three projects under one title - all simulations of the Knight Rider lights from the TV series. The three are a lapel badge using six LEDs, a larger LED unit with 16 LEDs and a mains version capable of driving six main lamps totalling over 500 watts.

KIT REF 559 CHASER LIGHT £15.58

KIT REF 560 DISCO LIGHTS £22.41

KIT REF 561 LAPEL BADGE £11.65

MICROCONTROLLER LIGHT SEQUENCER

EE DEC '90

A superb kit with pre-drilled painted and silk screen printed case for a really professional finish. This kit uses a microcontroller I.C. to generate 8-channel light sequences. Sequences are selected by keypad from over 100 stored in memory. Space for 10 user programmed sequences up to 16 steps long also available. 1000 watts per channel, zero volt switching, inductive load capability. Opto-isolated for total safety. Many other features. Complete kit includes case, PCBs, all components and hardware.

KIT REF 838

£57.17

EPROM ERASER

EE OCT '88

Safe low-cost unit capable of erasing up to four EPROM's simultaneously in less than twenty minutes. Operates from a 12V supply. Safety interlock. Convenient and simple to build and use.

KIT REF 790

£28.51

EE TREASURE HUNTER

EE AUG '89

A sensitive pulse induction Metal Detector. Picks up coins and rings etc., up to 20cms deep. Low "ground effect". Can be used with search-head underwater. Easy to use and build, kit includes search-head, handle, case, PCB and all parts as shown.

KIT REF 815

Including headphones

£45.95

SUPERHET BROADCAST RECEIVER

EE MAR '90

At last, an easy to build SUPERHET A.M. radio kit. Covers Long and medium Wave bands, built in loudspeaker with 1 watt output. Excellent sensitivity and selectivity provided by ceramic I.F. filter. Simple alignment and tuning without special equipment. Kit available less case, or with pre-cut and drilled transparent plastic panels and dial for a striking see-through effect.

KIT REF 835

£17.16

**IMPORTS EASY PC FILES
UPGRADE DISCOUNT AVAILABLE**

Finally...an exceptional PCB and Schematic CAD system for every electronics engineer!

BoardMaker 1 is a powerful software tool which provides a convenient and professional method of drawing your schematics and designing your printed circuit boards, in one remarkably easy to use package. Engineers worldwide have discovered that it provides an unparalleled price performance advantage over other PC-based systems.

BoardMaker 1 is exceptionally easy to use - its sensible user interface allows you to use the cursor keys, mouse or direct keyboard commands to start designing a PCB or schematic within about half an hour of opening the box.

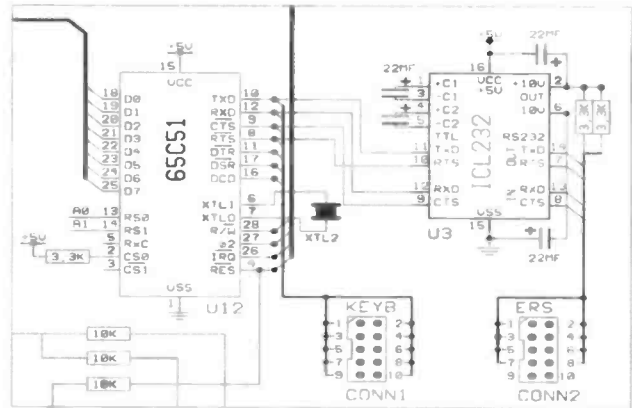

Produce clear, professional schematics for inclusion in your technical documentation.

HIGHLIGHTS

Hardware:

- IBM PC, XT, AT or 100% compatible.
- MSDOS 3.x.
- 640K bytes system memory.
- HGA, CGA, MCGA, EGA or VGA display.
- Microsoft or compatible mouse recommended.

Capabilities :

- Integrated PCB and schematic editor.
- 8 tracking layers, 2 silk screen layers.
- Maximum board or schematic size - 17 x 17 inches.
- 2000 components per layout. Symbols can be moved, rotated, repeated and mirrored.
- User definable symbol and macro library facilities including a symbol library editor.
- Graphical library browse facility.
- Design rule checking (DRC)- checks the clearances between items on the board.
- Real-time DRC display - when placing tracks you can see a continuous graphical display of the design rules set.
- Placement grid - Separate visible and snap grid - 7 placement grids in the range 2 thou to 0.1 inch.
- Auto via - vias are automatically placed when you switch layers - layer pairs can be assigned by the user.
- Blocks - groups of tracks, pads, symbols and text can be block manipulated using repeat, move, rotate and mirroring commands. Connectivity can be maintained if required.
- SMD - full surface mount components and facilities are catered for, including the use of the same SMD library symbols on both sides of the board.
- Circles - Arcs and circles up to the maximum board size can be drawn. These can be used to generate rounded track corners.
- Ground plane support - areas of copper can be filled to provide a ground plane or large copper area. This will automatically flow around any existing tracks and pads respecting design rules.

Output drivers :

- Dot matrix printer
- Compensated HP laser printer
- PostScript output.
- Penplotter driver (HPGL or DMPL).
- Photoplot (Gerber) output.
- NC (ASCII Excellon) drill output.

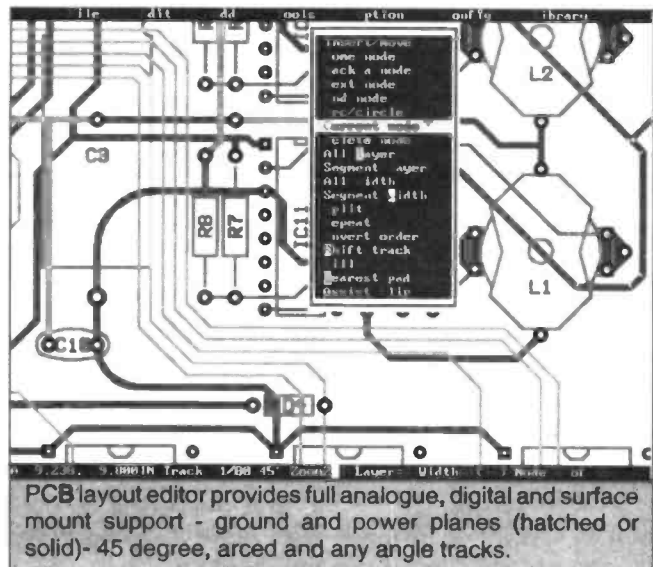

PCB layout editor provides full analogue, digital and surface mount support - ground and power planes (hatched or solid)- 45 degree, arced and any angle tracks.

£95

Despite its quality and performance, BoardMaker 1 only costs £95.00. Combine this with the 100% buy back discount if you upgrade to BoardMaker 2 or BoardRouter and your investment in Tsien products is assured. Price excludes carriage and VAT.

Don't take our word for it. Call us today for a FREE demonstration disk and judge for yourself.



tsien

Tsien (UK) Limited
Cambridge Research Laboratories
181A Huntingdon Road
Cambridge CB3 0DJ
Tel 0223 277777
Fax 0223 277747

All trade marks acknowledged

EVERYDAY ELECTRONICS

INCORPORATING ELECTRONICS MONTHLY

The No.1 Magazine for Electronic & Computer Projects
VOL. 21 No. 1 JANUARY '92

Editorial Offices:
EVERYDAY ELECTRONICS EDITORIAL,
6 CHURCH STREET, WIMBORNE,
DORSET BH21 1JH
Phone: Wimborne (0202) 881749
Fax: (0202) 841692. DX: Wimborne 45314.
See notes on Readers' Enquiries below - we regret that lengthy technical enquiries cannot be answered over the telephone.

Advertisement Offices:
EVERYDAY ELECTRONICS ADVERTISEMENTS,
HOLLAND WOOD HOUSE, CHURCH LANE,
GREAT HOLLAND, ESSEX CO13 0JS.
Phone (0255) 850596

COMMITMENT

A recent visit to Philips at Southampton (see our news pages) made me realise just what level of financial commitment is now necessary for the development of "consumer electronics" chips. What is perhaps even more interesting is the level of development that takes place in the UK, and the importance of Philips in the world market for i.c.s and consumer electronics in general.

We all know the brand name but what is perhaps less obvious is the vast number of Philips chips that appear in equipment made by a wide range of other manufacturers from all over the world. Worldwide semiconductor sales are dominated by American and Japanese companies with Intel and Philips keeping the European flag flying. If you just look at dedicated consumer i.c.s Philips are the third largest supplier behind Toshiba and Sanyo and during 1990 (1991 figures are not yet available) they gained ground on both of them.

MADE IN JAPAN

We tend to think of consumer electronics products as coming mainly from the Far East, it is good to know that much of that product contains chips that were designed, developed and made (but often not packaged) in Europe.

With the gradual overlapping of consumer, electronic data processing and communications markets the development of "consumer" electronics has a greater impact on the overall electronic product market. Home computers are now virtually the same machines as those used in industry and communications systems are no longer obviously for just home or office use. So while IBM (the largest electronics company in the world - based on sales in financial terms) are very much an electronic data processing market manufacturer many of the smaller companies are finding their consumer electronics base is spreading more and more into traditional "business" equipment areas.

DEVELOPED IN THE UK

Many of the innovative products that we will be buying in the future marked "Made in Taiwan" will be based on the technology and chips that were "invented", designed and developed - in association with their manufacturers - by UK engineers working in Southampton. This is thanks to an investment of £6.8 million and one of the largest single concentrations of electronic engineering expertise in the UK.



SUBSCRIPTIONS

Annual subscriptions for delivery direct to any address in the UK: £18.50. Overseas: £23 (£40.50 airmail). Cheques or bank drafts (in £ sterling only) payable to Everyday Electronics and sent to EE Subscriptions Dept., 6 Church Street, Wimborne, Dorset BH21 1JH. Tel: 0202 881749. Subscriptions start with the next

available issue. We accept Access (MasterCard) or Visa payments, minimum credit card order £5.

BACK ISSUES

Certain back issues of EVERYDAY ELECTRONICS are available price £1.80 (£2.30 overseas surface mail) inclusive of postage and packing per copy - £ sterling only please, Visa and Access (MasterCard) accepted, minimum credit card order £5. Enquiries with remittance, made payable to Everyday Electronics, should be sent to Post Sales Department, Everyday Electronics, 6 Church Street, Wimborne, Dorset BH21 1JH Tel: 0202 881749. In the event of non-availability one article can be photostatted for the same price. Normally sent within seven days but please allow 28 days for delivery. We have sold out of Jan, Feb, Mar, Apr, June, Oct, & Dec. 88, Mar & May 89 & Mar 90.

BINDERS

Binders to hold one volume (12 issues) are available from the above address for £5.95 (£6.95 to European countries and £9.00 to other countries, surface mail) inclusive of post and packing. Normally sent within seven days but please allow 28 days for delivery.

Payment in £ sterling only please. Visa and Access (MasterCard) accepted, minimum credit card order £5. Tel: 0202 881749

Editor: MIKE KENWARD

Secretary: PAMELA BROWN

Deputy Editor: DAVID BARRINGTON

Business Manager: DAVID J. LEAVER

Editorial: WIMBORNE (0202) 881749

Advertisement Manager:
PETER J. MEW, Frinton (0255) 850596

Classified Advertisements:
Wimborne (0202) 881749

READERS' ENQUIRIES

We are unable to offer any advice on the use, purchase, repair or modification of commercial equipment or the incorporation or modification of designs published in the magazine. We regret that we cannot provide data or answer queries on articles or projects that are more than five years old. Letters requiring a personal reply must be accompanied by a stamped self-addressed envelope or a self addressed envelope and international reply coupons.

All reasonable precautions are taken to ensure that the advice and data given to readers is reliable. We cannot however guarantee it and we cannot accept legal responsibility for it.

COMPONENT SUPPLIES

We do not supply electronic components or kits for building the projects featured, these can be supplied by advertisers.

We advise readers to check that all parts are still available before commencing any project in a back-dated issue.

We regret that we cannot provide data or answer queries on projects that are more than five years old.

ADVERTISEMENTS

Although the proprietors and staff of EVERYDAY ELECTRONICS take reasonable precautions to protect the interests of readers by ensuring as far as practicable that advertisements are *bona fide*, the magazine and its Publishers cannot give any undertakings in respect of statements or claims made by advertisers, whether these advertisements are printed as part of the magazine, or are in the form of inserts.

The Publishers regret that under no circumstances will the magazine accept liability for non-receipt of goods ordered, or for late delivery, or for faults in manufacture. Legal remedies are available in respect of some of these circumstances, and readers who have complaints should first address them to the advertiser.

TRANSMITTERS/BUGS/TELEPHONE EQUIPMENT

We would like to advise readers that certain items of radio transmitting and telephone equipment which may be advertised in our pages cannot be legally used in the U.K. Readers should check the law before using any transmitting or telephone equipment as a fine, confiscation of equipment and/or imprisonment can result from illegal use. The laws vary from country to country; overseas readers should check local laws.



TRANSISTOR CHECKER

STEVE KNIGHT

Check out your collection of "suspect" and unmarked transistors, including f.e.t.s, with this tester.

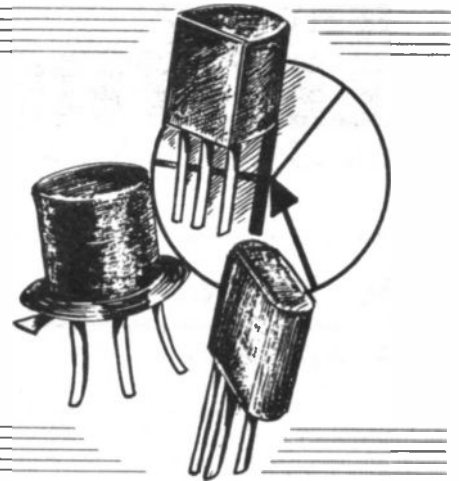

TRANSISTORS, both of the bipolar and field-effect varieties, particularly when they have been used over and over again in experimental set-ups, (and schools and colleges are in the forefront of such situations) are apt to find themselves in circuit systems where the operating conditions are not always to their liking. Reversed and excessive applied voltages are old established favourites on the road to ruin, and eventually there arrives the day when a box or a drawer full of assorted devices of dubious antecedence are left for the pupil or the student to take his or her pick, and (when the experiment doesn't do what it should) ruminate on whether the trouble is due to their incompetence, the circuit design or the bits they are using.

Some transistors pack up completely and it doesn't take too long to spot the cause of the trouble. However the main problem usually arises from those transistors that give the appearance of working but have in fact poor gain or excessive leakage, so that things half function and the circuit designer (if he is being followed) gets a lot of unwarranted stick.

But dubious devices apart, it is frequently necessary to select transistors from perfectly good collections for, perhaps, high gain, or to pick out pairs having close gain and current figures for matching purposes, and so on. A transistor checker is then a useful piece of test equipment.

REQUIREMENTS

What is needed is not a complicated box of tricks which will provide us with every parameter a transistor possesses, most of which the amateur experimenter would have no use for, anyway, but a simple checker that will provide, in a few seconds flat, those reassuring functional checks on diodes and transistors before they are incorporated into equipment.

There have been a number of simple testers published in magazines over the years since the transistor put in an appearance, but I have not seen any which cater for field-effect devices (f.e.t.s) as well as the "ordinary" bipolar types. The circuit to be described will cater for all diodes and both sorts of small-signal transistors as well as, of course, differentiating between *npn* and *npn* bipolars and *n*- and *p*-channel f.e.t.s.

BASIC PRINCIPLES

The bipolar transistor can usually be summed up for acceptance or rejection by the basic measurements of its leakage (saturation) current and its current gain. In the case of the f.e.t. the parameters of importance are the pinch-off voltage (V_p), the value of the drain current (I_{DSS}) with the gate voltage (V_g) set to zero, and the mutual transconductance (g_m). Diodes, of course, can be checked simply by noting the effectual forward and reverse resistance.

COMMON EMITTER

Starting with bipolar transistors, the effect of leakage becomes most important when the transistor is used in the common-emitter configuration. Suppose in Fig. 1 that an *npn* transistor is connected to collector and base

supplies but has its emitter (e) left open-circuited.

A meter included in the collector circuit might be expected to record zero collector current, but actually a small leakage current will flow across the collector-base junction even though it is reverse biased. This leakage is composed of minority carriers (holes in this case) which move across the junction in the direction collector-to-base. But such a movement of holes from collector to base *inside* the device is equivalent to a movement of electrons (as recorded, *outside* the device) in the direction base-to-collector.

This current therefore shows itself in the external circuit as an *addition* to the collector current I_c which will flow normally when the emitter is reconnected. This unwanted part of I_c is designated I_{CBO} , and is temperature dependent. In a silicon transistor it amounts to only a few nanoamps under normal conditions, but can be considerably higher in a germanium device.

If a transistor is now connected as shown in Fig. 2, this time with the base (b) left open, the leakage current I_{CBO} which still

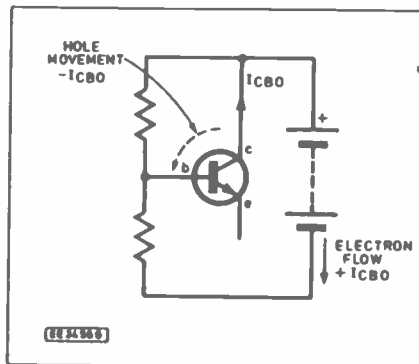

Fig. 1. The effect of leakage current.

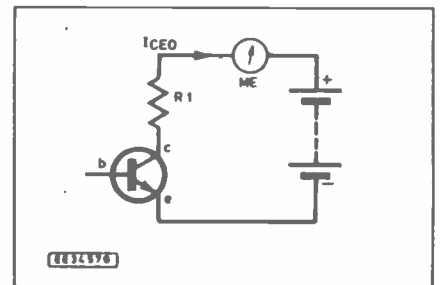

Fig. 2. How leakage is amplified by transistor action.

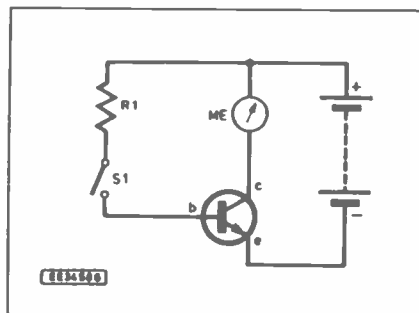

Fig. 3. Method of measuring static current gain.

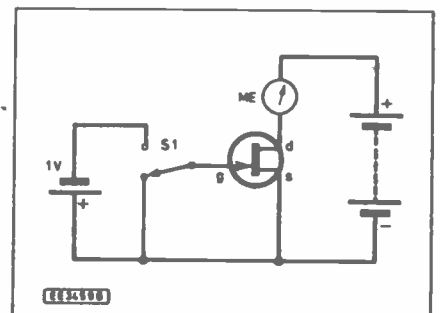

Fig. 4. Method of measuring transconductance.

flows, will be treated as a base input signal and will be amplified by the transistor to give a collector current expressed as I_{CEO} . This current may well be several hundred times the value of I_{CBO} and hence may be significant in determining the thermal stability of an amplifier when it becomes an unwanted part of the main collector current.

The checker will measure I_{CBO} and the effect of its amplification in the common-emitter configuration, that is, the value of I_{CEO} . The I_{CEO} is simply measured by using the basic circuit of Fig. 2.

The transistor under test has its base connection left "open circuit" and the amplified leakage is shown on a microammeter ME1 (protected to full scale deflection (f.s.d.) by resistor R1) wired into the collector circuit. In a good silicon device the current, even though amplified, will normally be negligible but in a poor example it may run to several microamps.

Germanium transistors have relatively high I_{CBO} 's even when perfectly good, and I_{CEO} 's up to $100\mu A$ are not uncommon, particularly in some of the older types. Anything over this figure should certainly be rejected.

CURRENT GAIN

Turning now to the measurement of current gain, the d.c. gain of a transistor (or its static common-emitter amplification factor h_{FE}) is a figure indicating how many times the base current is effectually contained in the collector current. In other words, how well is it amplifying?

This is determined by measuring the change in collector current resulting from a known change in base current. Fig. 3 shows a common method (there are others); here resistor R1 is selected so that when switch S1 is operated, the current flowing through R1 into the base is some precise figure, say, $10\mu A$.

By suitable scaling, the collector current as measured on the meter ME1 will indicate a direct value for the current gain. This gain figure is for purely d.c. conditions: the a.c. gain or dynamic gain figure (h_{FE}) when a load resistor is used in the collector circuit, is always less than the static gain, in general about 10 per cent smaller.

CHECKING F.E.T.s

For the f.e.t., the diagram of Fig. 4 shows the basic circuit arrangement for the measurement of I_{DSS} and g_m . With switch S1 in the position shown, the gate (g) of the f.e.t. is "earthed" and the milliammeter ME1 gives a direct reading of I_{DSS} . When the switch is changed over, the gate (g) is biased by $-1V$ and the drain current falls.

The mutual transconductance g_m is a measure of the change in drain current divided by the change in gate voltage. Since the gate change is one volt, the change in the meter current gives a direct indication of g_m , that is, so many milliamps-per-volt or, as it is usually expressed, so many milli-siemens.

A close approximation to the pinch-off voltage is obtained from a simple relationship between I_{DSS} and g_m which will be given later.

The above descriptions have been made assuming npn transistors and n-channel f.e.t.s. For pnp transistors and p-channel f.e.t.s, all supply voltage polarities are simply reversed. We are now ready to combine these basic systems into the complete checker.

CIRCUIT DETAILS

The complete circuit diagram of the Transistor Checker is shown in Fig. 5, and this

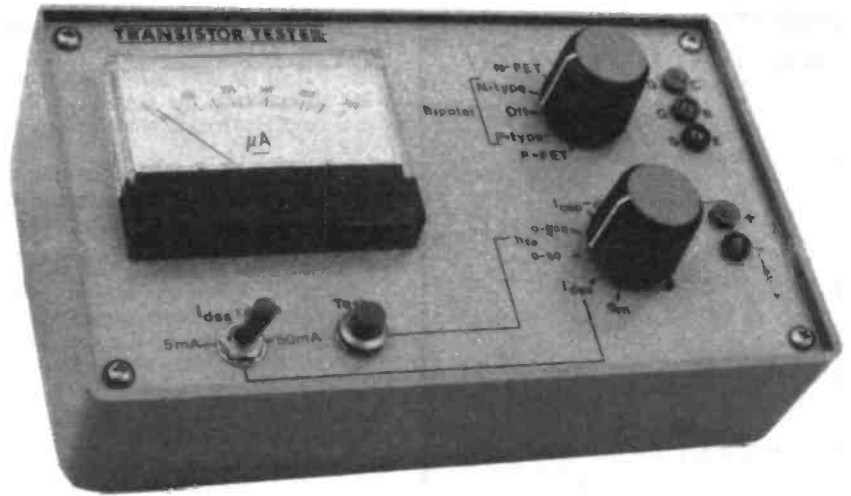

contains all the forms of the basic systems discussed earlier under Fig. 2, Fig. 3 and Fig. 4.

The amount of switching might seem off-putting at first sight, but provided the work is approached in a logical way, things are not so fraught as they might appear. There are two main switch assemblies involved; S1 having three wafers each of 2-pole, 5-way; and S2 made up of two wafers, each also 2-pole, 5-way.

One of the poles on S2 is not used. For both these switches, 2-pole, 6-way wafers are used but the mechanism is stopped off at the 5-way position.

The only other components are seven resistors, a preset potentiometer, a capacitor, a $500\mu A$ moving coil meter ME1, diode D1, a biased toggle switch and a push-to-make push button switch S3, plus

coloured terminals and knobs. Most of the resistors go on to a simple circuit board for convenience and this is fitted directly to the terminals of the meter.

The whole assembly is consequently built on to a single aluminium panel which fits into a small "console" type ABS plastic case measuring 159mm by 91mm by 61mm. Any alternative style of case may of course be used provided it has adequate space.

POLARITY SWITCHING

The first wafer of switch S1, that is, S1a and S1b, are simply reversing switches for the meter ME1. The meter terminals are changed over to suit the polarity when either npn or pnp (or n- or p-channel f.e.t.s) are being tested.

Fig. 5. Complete circuit diagram for the Transistor Checker. Switch S1 is shown in the N-FET position and S2 in the I_{CEO} - Diode position. Components enclosed in dotted lines are mounted on the p.c.b. Circled letters refer to connections on the circuit board.

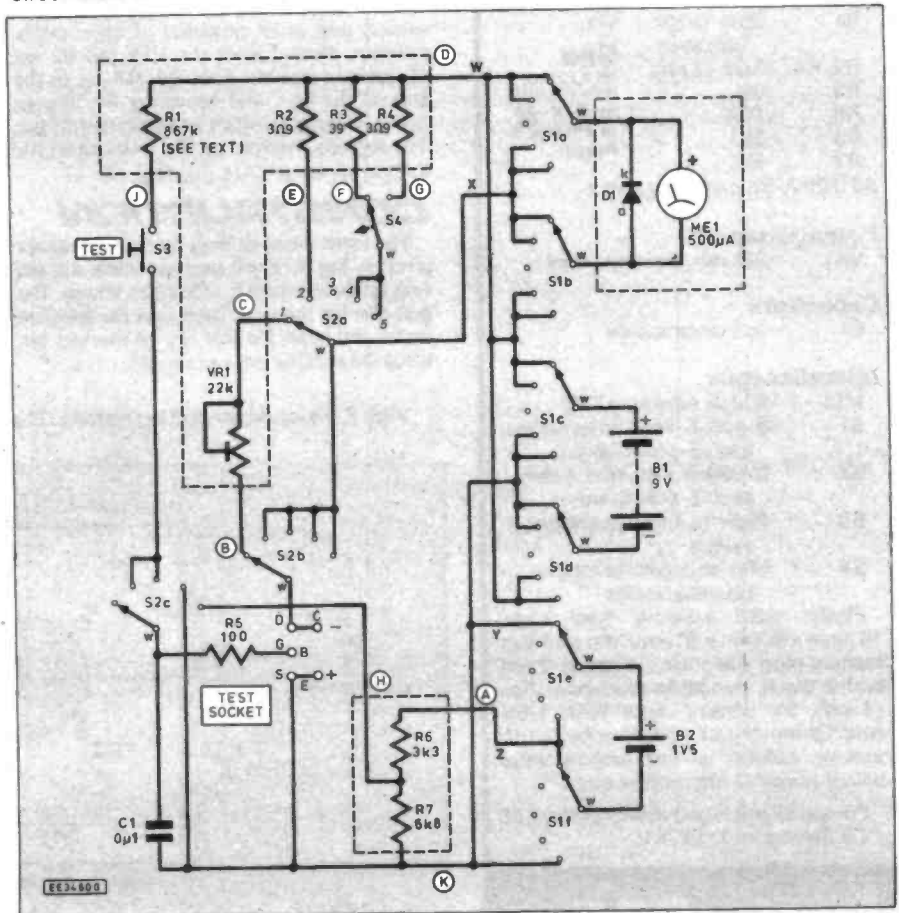

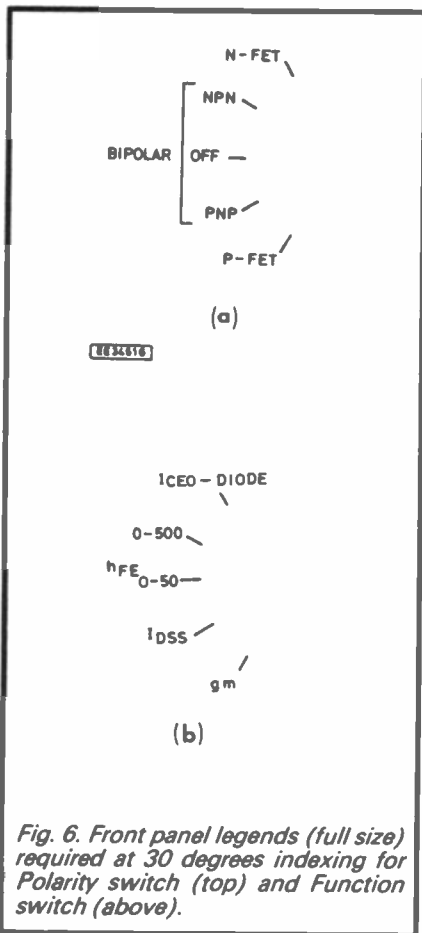

COMPONENTS

Resistors

R1	867k (820k + 47k, (see text)
R2, R4	3Ω9 (2 off)
R3	39
R5	100
R6	3k3
R7	6k8

See
**SHOP
TALK**
Page

All 0.25W 5% carbon or better

Potentiometer

VR1	22k min. skeleton preset
-----	--------------------------

Capacitors

C1	0μ1 ceramic disc
----	------------------

Miscellaneous

ME1	500μA Altai type T23
S1	6-pole 5-way, three wafers each 2-pole 5-way
S2	3-pole 5-way, two wafers each 2-pole 5-way
S3	Push-to-make pushbutton switch
S4	Min. changeover toggle, biased one side

Plastic ABS console type case, 161mm x 96mm x 61mm/39mm; 1mm wander plug and socket, 1 green, 2 red and 2 black; miniature crocodile clips (3 off); 9V battery, type PP3; 1.5V cell; 19mm (¾in.) collet knobs, 2 off; various colours of connecting wire; solder pins (12 off); solder etc.

Printed circuit board available from **EE PCB Service**, code EE781.

Approx cost guidance only **£35** excl. batts.

Similarly, the second wafer, S1c and S1d, reverses the polarity of the 9V supply (battery B1) for the same reason. Wafer S1e and S1f also reverses the polarity of the f.e.t. gate supply battery B2 when f.e.t.s are being checked.

The relevant functions of the switch positions are indicated in Fig. 6(a). Use this as your lettering guide on the front panel.

FUNCTION SWITCH

Switch S2 selects the various measuring modes after S1 has been set to suit the type of device being tested. Looking at the circuit diagram, in the position shown (I_{CEO}-Diode), the meter is connected in series with preset potentiometer VR1 (wired as variable resistor) and the transistor (or diode) under test.

For a transistor, the base connection is an open-circuit and hence the meter will read the leakage current I_{CEO}. For a diode, the forward conduction will be indicated.

The second and third positions of S2 give an indication of current gain, h_{FE}, after the manner shown earlier in Fig. 3. On the second position resistor R2 shunts the meter and converts it to read 5000μA (5mA) f.s.d.; in the third position the meter is left unshunted.

When the pushbutton switch S3 is pressed, 10μA flows through resistor R1 into the base of the test transistor, hence the meter indicates either a maximum h_{FE} of 500 (position 2) or 50 (position 3). This last sensitive position should only be used for cases of h_{FE} which fall below 50 on the 500 range.

The fourth and fifth positions of the switch are reserved for f.e.t. testing; on the fourth position I_{DSS} is shown on the meter (now shunted by resistor R3 to read 50mA f.s.d.). If the reading is very small, an auxiliary switch S4 converts the f.s.d. to 5mA; this switch is normally biased to the least sensitive position.

The fifth switch position (as per Fig. 4. earlier) puts a 1V potential of appropriate polarity, derived from the 1.5V cell B2 via the resistor divider chain R6, R7, on to the gate of the f.e.t. and hence, by the change noted in I_{DSS}, provides an indication of g_m. The legends required on the front panel for this switch are given in Fig. 6(b)

CONSTRUCTION

The front panel drilling measurements are given in Fig. 7. These measurements suit the original panel which is 155mm by 90mm. The hole size for the meter also suits the specified meter; the holes for this can be marked out using the packing piece as a guide.

Fig. 7. Front panel drilling details. The meter hole drilling depends on unit used.

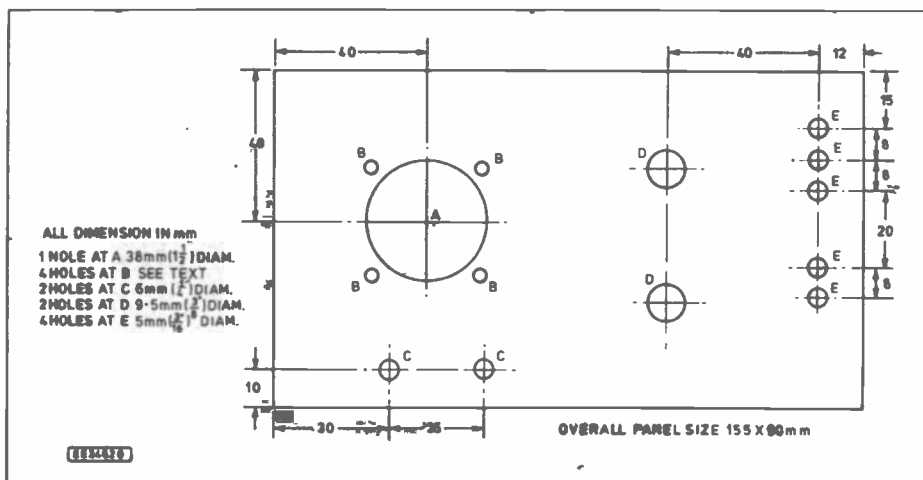

All the front panel lettering should be added after drilling but *before* any of the components are mounted. The switch positions are indexed out at 30 degrees intervals on a radius from the fixing hole which suits the knobs you are going to use. Collet, 19mm (¾in.), type knobs were found to be best as there is then no problem with the alignment of the pointer-mark when they are fitted and no precise orientation of the switches on the panel is necessary.

SWITCH WIRING

It is best to wire up the wafers of switches S1 and S2 before fixing them to the front panel. If each wafer is wired up systematically and interconnections made where necessary between the wafers, there is no real problem about the job; all that is needed is a logical progression from each wafer to the next.

If you look again at the main circuit diagram Fig. 5, there are connections from the wipers (w) of each of the three wafers of S1 which go to: (i) the meter, (ii) the 9V battery, (iii) the 1.5V cell. Solder distinctive coloured wires on the switch wipers for easy identification.

Again looking at the diagram, notice that there are only *four* leads which actually come from these wafers to connect with the remainder of the circuit; these are indicated by the letters W, X, Y, Z. Once the interconnections between wafers have been made, the switch can be mounted on the front panel.

The same procedure applies to switch S2; most of the outgoing wires (in this case shown as circled letters on the circuit diagram) go off to a small printed circuit board (p.c.b.) which will be described in a moment. Again, the use of coloured leads will avoid confusion.

The pushbutton switch S3 and the biased changeover switch S4 are mounted immediately below the meter, while the input test sockets are fitted on the right of the panel as the photographs show. The group of three sockets are for bipolar and field-effect transistors and are marked D-C, G-B and S-E, representing either drain, gate, source or collector, base, emitter inputs respectively. The two lower sockets are for diode testing and are marked + and - (plus and minus) respectively.

The terminals used are 1mm type coloured sockets which are bought together with matching 1mm plugs. You can use spring

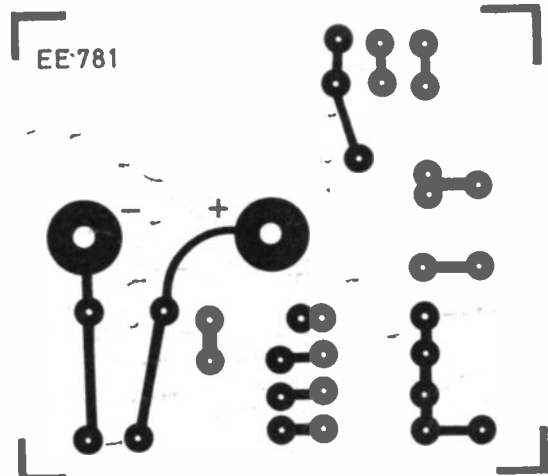
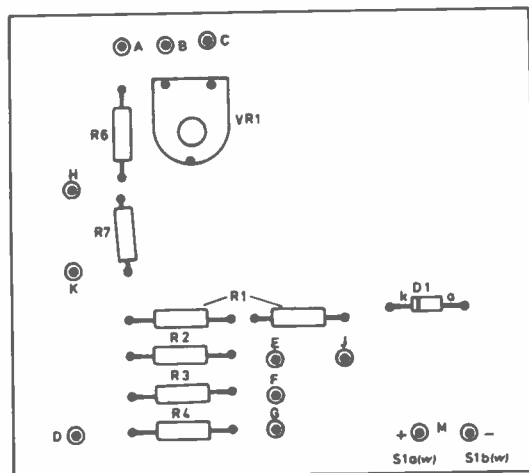

Fig. 8. Printed circuit component layout and full size copper foil master pattern. Resistor R5 and capacitor C1 are wired directly between switch wafer and output sockets.

type terminals as an alternative but watch the available space.

The method of connecting transistors adopted by the author utilises three miniature crocodile clips connected by short flexible leads to the 1mm plugs which then go into the appropriate sockets. Some of the older transistors had leads sufficiently long to plug directly into the sockets but these are now few and far between; using 'croc' clips will accommodate practically every style of transistor output configuration.

CIRCUIT BOARD

Apart from the switches and sockets, most of the remaining discrete components are mounted on a small printed circuit board; the exception being resistor R5 and capacitor C1. This board is available from the *EE PCB Service*, code EE781.

The p.c.b. is screwed directly on to the meter's rear terminals and carries all the resistors except R5 which, along with capacitor C1, is hard wired directly between switch wafer S2c wiper or pole contact and the appropriate sockets. The full size copper track layout and component dispositions are given in Fig. 8 where the lettering refers to that shown on the circuit diagram; this makes the interwiring from the switch leads

and the connections to switches S3 and S4 relatively easy.

Preset potentiometer VR1 should at this point be set to its maximum resistance position, fully anticlockwise. It is important to note in passing that the values of the shunt resistors R2, R3 and R4 apply *only* to the specified meter and will have to be modified if you use an alternative meter.

Resistor R1 is actually made up from an 820k in series with a 47k; we need 10 μ A to flow into a transistor base when switch S3 is pressed but the base-emitter voltage drop is different for silicon and germanium devices. Assuming the battery p.d. is 9V, then about 8.4V is available for a silicon device and about 8.75V for a germanium one.

Hence, to get 10 μ A to flow a compromise is necessary in the value of resistor R1. So 867 kilohms seems reasonable, though there is not much point in being pedantic about this, bearing in mind the tolerance of the resistors, and the variation in the potential barrier voltage of different transistors.

The two batteries are located beneath and to either side of the circuit board. They are fixed to the front panel with double-sided sticky pads. The 9V supply battery is positioned nearest the wafer switches, see photographs.

With the simple p.c.b. used here, it is no problem to use either etch-resistant transfers or a Dalo pen to map out the tracks. The only critical spacing is that for the meter fixing holes which must be exactly 25.4mm (1in.) apart. Use solder pins as the connecting points for the incoming wires.

SETTING UP

With the project assembled and with the batteries in place, a quick preliminary check can be made. This is quite simple as only preset VR1 needs adjustment to give the meter a full-scale reading on the available battery voltage.

With S1 set to OFF and S2 set to I_{CEO} Diode, short out the input sockets C and E. Then switch S1 to either the *npn* or *pnp* position and adjust VR1 to provide a full-scale reading on the meter.

This completes all that is strictly necessary for the operation of the tester but you can if you wish check on the accuracy of the meter shunting for the *h_{FE}* ranges. To do this, connect a 47 kilohms (or thereabouts) variable potentiometer, resistance fully in, across the C-E terminals.

Switch S1 to either *npn* or *pnp* and switch S2 to the *h_{FE}* 0-50 range. Adjust the pot carefully to give f.s.d., then turn switch S2 to

Components mounted on the rear of the front panel. The switch wafers are pre-wired before mounting on the switch mechanism.

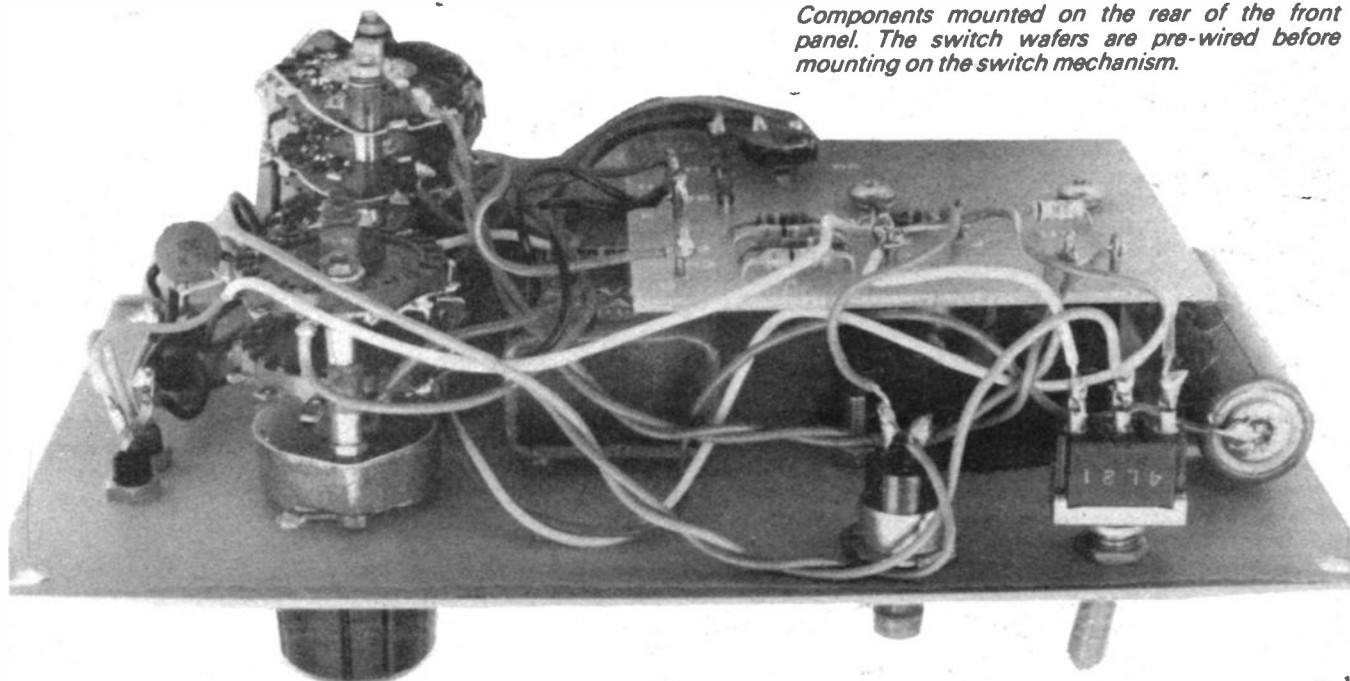

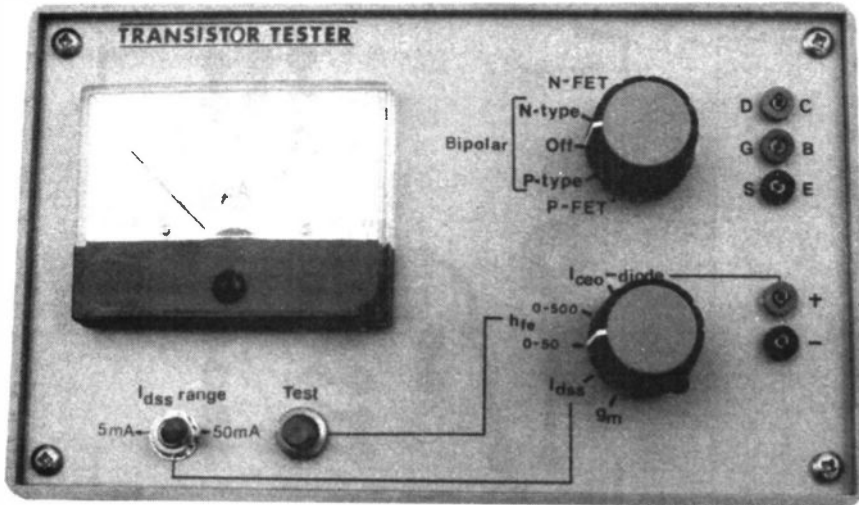

Front panel layout and lettering.

the 0-500 range. Check that the meter now reads 50 on this 0-500 range. For any serious error, say, a reading outside 45-55, resistor R2 will need adjusting.

OPERATION

Here is a brief summary of the procedures for testing diodes, bipolar and field-effect transistors. Always start with the instrument switched OFF and with the Function switch set to I_{CEO} -Diode.

Diodes

To check a Diode: Connect the marked end of the diode (the cathode (k)) to the negative terminal and the anode (a) to the positive terminal. With S2 on I_{CEO} -Diode, switch S1 to the PNP position; the meter should then indicate the forward conduction of the diode, generally close to a full scale reading.

Switch now to the NPN position on S1. The meter will now indicate the diode reverse leakage which for a good diode should be undetectable.

Transistors

To check a bipolar transistor: Assuming an npn device, connect the collector (c), base (b) and emitter (e) leads to the appropriate terminals. Set the function switch to I_{CEO} -Diode and the polarity switch to NPN.

The meter will now indicate the open-base leakage current I_{CEO} on a 500 μ A full-scale deflection. For a good silicon transistor this reading should be negligible but for a germanium transistor a current of 100 μ A might not be unusual, particularly for some of the older types.

To check the gain, switch to the h_{FE} 0-500 position and press the Test button S3. The meter will indicate the static current gain directly; if the reading is less than 50, switch to the 0-50 position.

In cases where the leakage is appreciable, make a note of the meter reading before pressing Test switch S3; deduct this reading from that obtained when S3 is pressed to get a true value for h_{FE} . It is the change in the current which matters.

To determine whether a transistor is npn

or pnp use can be made of the diode terminals. Put the collector lead into the + socket (plus) and the combined emitter and base leads, shorted together, into the - socket (minus). Switch the function switch alternately to PNP and NPN; then the position which produces the full-scale reading (or very close to it) is that which suits the type of transistor under test.

Field Effect Transistors

To check a f.e.t.: Assuming an n-channel f.e.t. connect the drain (d), gate (g) and sources (s) leads to the appropriate terminals. Set the Function switch to I_{DSS} and the polarity switch to N-FET.

The meter will now indicate (on a 50mA f.s.d. range) the drain current for zero gate volts. If the reading is below 5mA, operate the biased switch S4 to give a 5mA f.s.d. range. Note this reading.

Switch now to g_m ; the previous I_{DSS} reading will decrease, a bias of 1V now being applied to the gate. The change in the current will give an indication of g_m either in mA/V or millisiemen.

To evaluate V_p (the pinch-off point) use the simple relationship:

$$V_p = \frac{-2I_{DSS}}{g_m}$$

Thus, for example, if $I_{DSS} = 4\text{mA}$ and $g_m = 1.5\text{mA/V}$ (or 1.5 millisiemen) then:

$$V_p = \frac{-2 \times 4}{1.5} = -5.3\text{V}$$

PRECAUTIONS

At all times, when carrying out tests, make sure that the clips to the "transistor under test" do not short together before switching the unit on; failure to do this could lead to the meter "cracking" over and the result could be a bent pointer. Always return switch S1 to OFF before connecting or removing a transistor.

Most small-signal type transistors and f.e.t.s can be checked on this instrument, as can most small power silicon types: high power types cannot be tested accurately because of the low collector currents used. □

The completed tester showing the two batteries secured (with double-sided sticky pads) beneath the circuit board. The resistor R5 and capacitor C1 can just be seen on the left.

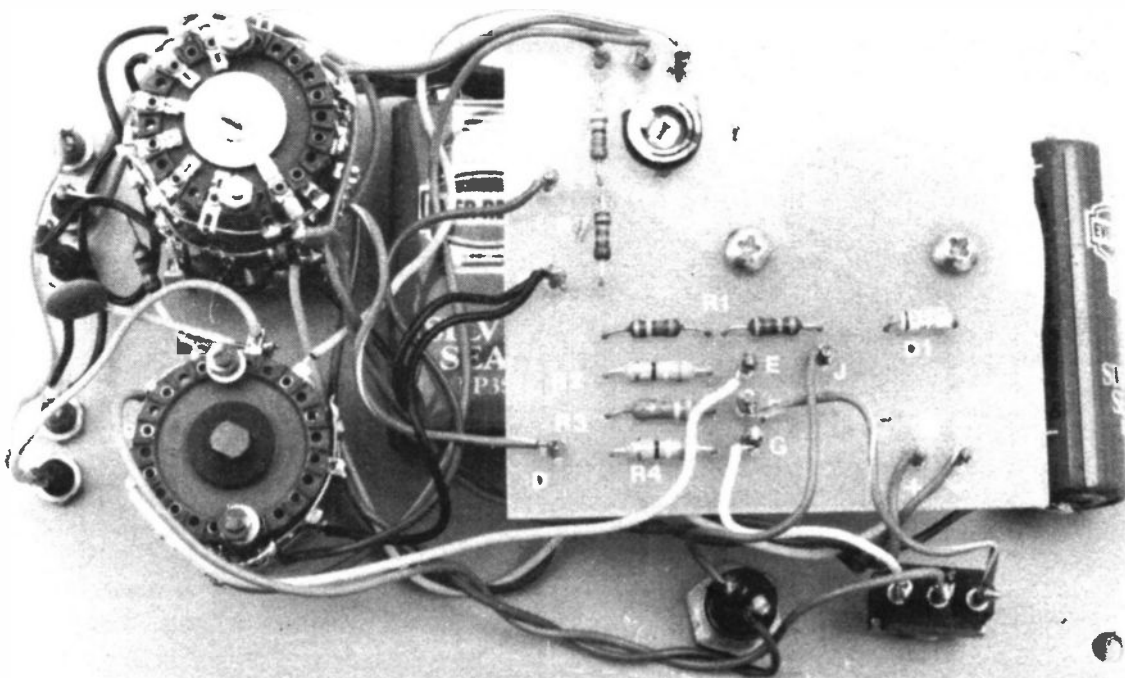

OMP MOS-FET POWER AMPLIFIERS
HIGH POWER, TWO CHANNEL 19 INCH RACK

THOUSANDS PURCHASED BY PROFESSIONAL USERS



THE RENOWNED MXF SERIES OF POWER AMPLIFIERS
FOUR MODELS:- MXF200 (100W + 100W) MXF400 (200W + 200W)

MXF600 (300W + 300W) MXF900 (450W + 450W)
ALL POWER RATINGS R.M.S. INTO 4 OHMS, BOTH CHANNELS DRIVEN

FEATURES: ★ Independent power supplies with two toroidal transformers ★ Twin L.E.D. Vu meters ★ Level controls ★ Illuminated on/off switch ★ XLR connectors ★ Standard 775mV inputs ★ Open and short circuit proof ★ Latest Mos-Fets for stress free power delivery into virtually any load ★ High slew rate ★ Very low distortion ★ Aluminium cases ★ MXF600 & MXF900 fan cooled with D.C. loudspeaker and thermal protection.

USED THE WORLD OVER IN CLUBS, PUBS, CINEMAS, DISCOS ETC.

SIZES:- MXF200 W19" xH3 1/2" (2U)xD11"
MXF400 W19" xH5 1/2" (3U)xD12"
MXF600 W19" xH5 1/2" (3U)xD13"
MXF900 W19" xH5 1/2" (3U)xD14 1/2"

PRICES:- MXF200 £175.00 MXF400 £233.85
MXF600 £329.00 MXF900 £449.15
SPECIALIST CARRIER DEL. £12.50 EACH



OMP VARISPEED TURNTABLE CHASSIS

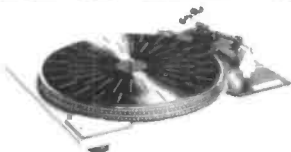

★ Manual arm ★ Steel chassis ★ Electronic speed control 33 & 45 R.P.M. ★ Vari pitch control ★ High torque servo driven DC motor ★ Transit screws ★ 12" die cast platter ★ Neon strobe ★ Calibrated balance weight ★ Removable head shell ★ 1/2 cartridge fixings ★ Cue lever ★ 220/240V 50/60Hz ★ 390x305mm ★ Supplied with mounting cut-out template.

PRICE £61.30 + £3.70 P&P

OPTIONAL MAGNETIC CARTRIDGES STANTON AL500mkII GOLDRING G950
PRICE £16.95 - 50P P&P PRICE £7.15 - 50P P&P

STEREO DISCO MIXER DJ6500

★ WITH ECHO ★

STEREO DISCO MIXER with 2 x 7 band L & R graphic equalisers with bar graph LED Vu meters. **MANY OUTSTANDING FEATURES:-** Including Echo with repeat & speed control, DJ Mic with tone control & talk-over switch, 7 Channels with individual faders plus cross fade, Cue Headphone Monitor. Useful combination of the following inputs:- 3 turntables (mag), 3 mics, 5 Line for CD, Tape, Video etc.



Price £134.99 + £5.00 P&P

SIZE: 482 x 240 x 120mm

PIEZO ELECTRIC TWEETERS - MOTOROLA

Join the Piezo revolution! The low dynamic mass (no voice coil) of a Piezo tweeter produces an improved transient response with a lower distortion level than ordinary dynamic tweeters. As a crossover is not required these units can be added to existing speaker systems of up to 100 Watts (more if two are put in series). **FREE EXPLANATORY LEAFLETS ARE SUPPLIED WITH EACH TWEETER.**

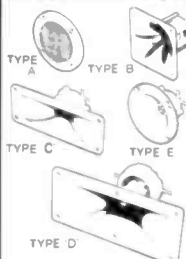

TYPE 'A' (KSN1036A) 3" round with protective wire mesh. Ideal for bookshelf and medium sized Hi-Fi speakers. Price £4.90 - 50p P&P.
TYPE 'B' (KSN1005A) 3 1/4" super horn for general purpose speakers, disco and P.A. systems etc. Price £5.99 - 50p P&P.
TYPE 'C' (KSN1016A) 2" x5" wide dispersion horn for quality Hi-Fi systems and quality discos etc. Price £6.99 - 50p P&P.
TYPE 'D' (KSN1025A) 2" x5" wide dispersion horn. Upper frequency response retained extending down to mid-range (2KHz). Suitable for high quality Hi-Fi systems and quality discos. Price £9.99 - 50p P&P.
TYPE 'E' (KSN1038A) 3 1/2" horn tweeter with attractive silver finish trim. Suitable for Hi-Fi monitor systems etc. Price £5.99 - 50p P&P.
LEVEL CONTROL Combines, on a recessed mounting plate, level control and cabinet input jack socket. 85x85mm. Price £4.10 - 50p P&P.

OMP LINNET LOUDSPEAKERS

THE VERY BEST IN QUALITY AND VALUE

Made especially to suit today's need for compactness with high output sound levels, finished in hard wearing black vinylite with protective corners, grille and carrying handle. Each unit incorporates a 12" driver plus high frequency horn for a full frequency range of 45Hz-20KHz. Both models are 8 Ohm impedance. Size: H20" x W15" x D12".

CHOICE OF TWO MODELS

POWER RATINGS QUOTED IN WATTS RMS FOR EACH CABINET

OMP 12-100WATTS (100dB) PRICE £163.50 PER PAIR
OMP 12-200WATTS (200dB) PRICE £214.55 PER PAIR

SPECIALIST CARRIER DEL. £12.50 PER PAIR



IN-CAR STEREO BOOSTER AMPS

THREE SUPERB HIGH POWER CAR STEREO BOOSTER AMPLIFIERS
150 WATTS (75 + 75) Stereo, 150W Bridged Mono
250 WATTS (125 + 125) Stereo, 250W Bridged Mono
400 WATTS (200 + 200) Stereo, 400W Bridged Mono
ALL POWERS INTO 4 OHMS

Features:
★ Stereo, bridgable mono ★ Choice of high & low level inputs ★ L & R level controls ★ Remote on-off ★ Speaker & thermal protection.



PRICES: 150W £49.99 250W £99.99
400W £109.95 P&P £2.00 EACH

POSTAL CHARGES PER ORDER £1.00 MINIMUM. OFFICIAL ORDERS FROM SCHOOLS, COLLEGES, GOVT. BODIES, P.L.C. ETC. PRICES INCLUSIVE OF V.A.T. SALES COUNTER. VISA AND ACCESS ACCEPTED BY POST, PHONE OR FAX.

OMP MOS-FET POWER AMPLIFIER MODULES SUPPLIED READY BUILT AND TESTED.

These modules now enjoy a world-wide reputation for quality, reliability and performance at a realistic price. Four models are available to suit the needs of the professional and hobby market i.e. Industry, Leisure, Instrumental and Hi-Fi etc. When comparing prices, NOTE that all models include toroidal power supply, integral heat sink, glass fibre P.C.B. and drive circuits to a compatible Vu meter. All models are open and short circuit proof.

THOUSANDS OF MODULES PURCHASED BY PROFESSIONAL USERS

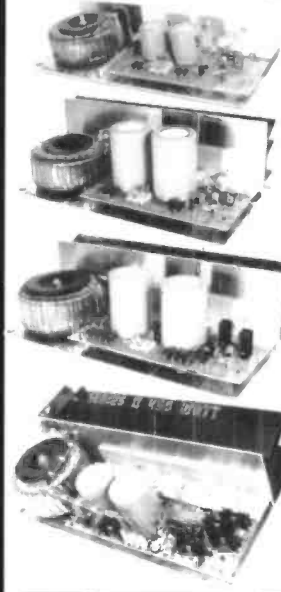

OMP/MF 100 Mos-Fet Output power 110 watts
R.M.S. into 4 ohms, frequency response 1Hz - 100KHz
-3dB, Damping Factor >300, Slew Rate 45V/uS,
T.H.D. typical 0.002%, Input Sensitivity 500mV, S.N.R.
-110 dB. Size 300 x 123 x 60mm.
PRICE £40.85 + £3.50 P&P

OMP/MF 200 Mos-Fet Output power 200 watts
R.M.S. into 4 ohms, frequency response 1Hz - 100KHz
-3dB, Damping Factor >300, Slew Rate 50V/uS,
T.H.D. typical 0.001%, Input Sensitivity 500mV, S.N.R.
-110 dB. Size 300 x 155 x 100mm.
PRICE £64.35 + £4.00 P&P

OMP/MF 300 Mos-Fet Output power 300 watts
R.M.S. into 4 ohms, frequency response 1Hz - 100KHz
-3dB, Damping Factor >300, Slew Rate 60V/uS,
T.H.D. typical 0.001%, Input Sensitivity 500mV, S.N.R.
-110 dB. Size 330 x 175 x 100mm.
PRICE £81.75 + £5.00 P&P

OMP/MF 450 Mos-Fet Output power 450 watts
R.M.S. into 4 ohms, frequency response 1Hz - 100KHz
-3dB, Damping Factor >300, Slew Rate 75V/uS,
T.H.D. typical 0.001%, Input Sensitivity 500mV, S.N.R.
-110 dB, Fan Cooled, D.C. Loudspeaker Protection, 2
Second Anti-Thump Delay, Size 385 x 210 x 105mm.
PRICE £132.85 + £5.00 P&P

NOTE: MOS-FET MODULES ARE AVAILABLE IN TWO VERSIONS:
STANDARD - INPUT SENS 500mV, BAND WIDTH 100KHz.
PEC (PROFESSIONAL EQUIPMENT COMPATIBLE) - INPUT SENS
775mV, BAND WIDTH 50KHz. ORDER STANDARD OR PEC.



Vu METER Compatible with our four amplifiers detailed above. A very accurate visual display employing 11 L.E.D.s (7 green, 4 red) plus an additional on/off Indicator. Sophisticated logic control for very fast rise and decay times. Tough moulded plastic case, with acrylic tinted front. Size 84 x 27 x 45mm.
PRICE £8.70 + 50p P&P

LOUDSPEAKERS

LARGE SELECTION OF SPECIALIST LOUDSPEAKERS AVAILABLE, INCLUDING CABINET FITTINGS, SPEAKER GRILLES, CROSS-OVERS AND HIGH POWER, HIGH FREQUENCY BULLETS AND HORNS, LARGE (A4) S.A.E. (50p STAMPED) FOR COMPLETE LIST.

P - From McKenzie Professional Series
S - From McKenzie Studio Series

McKENZIE - INSTRUMENTS, P.A., DISCO, ETC

ALL MCKENZIE UNITS 8 OHMS IMPEDANCE

- 8" 100 WATT C8-100GP GEN. PURPOSE, LEAD GUITAR, EXCELLENT MID, DISCO. RES. FREQ. 80Hz, FREQ. RESP. TO 7KHz, SENS 96dB. PRICE £31.45 + £2.00 P&P
- 10" 100WATT C10-100GP GUITAR, VOICE, KEYBOARD, DISCO, EXCELLENT MID. RES. FREQ. 72Hz, FREQ. RESP. TO 6KHz, SENS 97dB. PRICE £38.89 + £2.50 P&P
- 10" 200WATT C10-200GP GUITAR, KEYB'D, DISCO, EXCELLENT HIGH POWER MID. RES. FREQ. 69Hz, FREQ. RESP. TO 5KHz, SENS 97dB. PRICE £53.21 + £2.50 P&P
- 12" 100WATT C12-100GP HIGH POWER GEN. PURPOSE, LEAD GUITAR, DISCO. RES. FREQ. 49Hz, FREQ. RESP. TO 7KHz, SENS 98dB. PRICE £40.35 + £3.50 P&P
- 12" 100WATT C12-100TC (TWIN CONE) HIGH POWER, WIDE RESPONSE, P.A., VOICE, DISCO. RES. FREQ. 45Hz, FREQ. RESP. TO 12KHz, SENS 97dB. PRICE £41.39 + £3.50 P&P
- 12" 200WATT C12-200B HIGH POWER BASS, KEYBOARDS, DISCO, P.A. RES. FREQ. 45Hz, FREQ. RESP. TO 5KHz, SENS 99dB. PRICE £71.91 + £3.50 P&P
- 12" 300WATT C12-300GP HIGH POWER BASS, LEAD GUITAR, KEYBOARDS, DISCO ETC. RES. FREQ. 49Hz, FREQ. RESP. TO 7KHz, SENS 100dB. PRICE £95.66 + £3.50 P&P
- 15" 100WATT P C15-100BS BASS GUITAR, LOW FREQUENCY, P.A., DISCO. RES. FREQ. 40Hz, FREQ. RESP. TO 5KHz, SENS 98dB. PRICE £59.05 + £4.00 P&P
- 15" 200WATT P C15-200BS VERY HIGH POWER BASS. RES. FREQ. 40Hz, FREQ. RESP. TO 3KHz, SENS 98dB. PRICE £80.57 + £4.00 P&P
- 15" 250WATT P C15-250BS VERY HIGH POWER BASS. RES. FREQ. 39Hz, FREQ. RESP. TO 4KHz, SENS 99dB. PRICE £90.23 + £4.50 P&P
- 15" 400WATT P C15-400BS VERY HIGH POWER, LOW FREQUENCY BASS. RES. FREQ. 40Hz, FREQ. RESP. TO 4KHz, SENS 100dB. PRICE £105.46 + £4.50 P&P
- 18" 500WATT P C18-500BS EXTREMELY HIGH POWER, LOW FREQUENCY BASS. RES. FREQ. 27Hz, FREQ. RESP. TO 2KHz, SENS. 98dB. PRICE £174.97 + £5.00 P&P

EARBENDERS:- HI-FI, STUDIO, IN-CAR, ETC

- ALL EARBENDER UNITS 8 OHMS (Except EB8-50 & EB10-50 which are dual impedance tapped @ 4 & 8 ohm) BASS, SINGLE CONE, HIGH COMPLIANCE, ROLLED SURROUND
- 8" 50WATT EB8-50 DUAL IMPEDANCE, TAPPED 4/8 OHM BASS, HI-FI, IN-CAR. RES. FREQ. 40Hz, FREQ. RESP. TO 7KHz, SENS 97dB. PRICE £8.90 + £2.00 P&P
- 10" 50WATT EB10-50 DUAL IMPEDANCE, TAPPED 4/8 OHM BASS, HI-FI, IN-CAR. RES. FREQ. 40Hz, FREQ. RESP. TO 5KHz, SENS. 99dB. PRICE £13.65 + £2.50 P&P
- 10" 100WATT EB10-100 BASS, HI-FI, STUDIO. RES. FREQ. 35Hz, FREQ. RESP. TO 3KHz, SENS 96dB. PRICE £30.39 + £3.50 P&P
- 12" 100WATT EB12-100 BASS, STUDIO, HI-FI, EXCELLENT DISCO. RES. FREQ. 26Hz, FREQ. RESP. TO 3KHz, SENS 93dB. PRICE £42.12 + £3.50 P&P
- FULL RANGE TWIN CONE, HIGH COMPLIANCE, ROLLED SURROUND
- 5 1/2" 60WATT EB5-60TC (TWIN CONE) HI-FI, MULTI-ARRAY DISCO ETC. RES. FREQ. 63Hz, FREQ. RESP. TO 20KHz, SENS 92dB. PRICE £9.99 + £1.50 P&P
- 6 1/2" 60WATT EB6-60TC (TWIN CONE) HI-FI, MULTI-ARRAY DISCO ETC. RES. FREQ. 38Hz, FREQ. RESP. TO 20KHz, SENS 94dB. PRICE £10.99 + 1.50 P&P
- 8" 60WATT EB8-60TC (TWIN CONE) HI-FI, MULTI-ARRAY DISCO ETC. RES. FREQ. 40Hz, FREQ. RESP. TO 18KHz, SENS 89dB. PRICE £12.99 + £1.50 P&P
- 10" 60WATT EB10-60TC (TWIN CONE) HI-FI, MULTI ARRAY DISCO ETC. RES. FREQ. 35Hz, FREQ. RESP. TO 12KHz, SENS 98dB. PRICE £16.49 + £2.00 P&P

TRANSMITTER HOBBY KITS

PROVEN TRANSMITTER DESIGNS INCLUDING GLASS FIBRE PRINTED CIRCUIT BOARD AND HIGH QUALITY COMPONENTS COMPLETE WITH CIRCUIT AND INSTRUCTIONS

3W TRANSMITTER 80-108MHz. VARICAP CONTROLLED PERFORMANCE. RANGE UP TO 3 MILES. SIZE 38 x 123mm. SUPPLY 12V @ 0.5AMP. PRICE £14.85 + £1.00 P&P

FM MICRO TRANSMITTER 100-108MHz. VARICAP TUNED, COMPLETE WITH VERY SENS FET MIC. RANGE 100-300m. SIZE 56 x 46mm. SUPPLY 9V BATTERY. PRICE £8.80 + £1.00 P&P

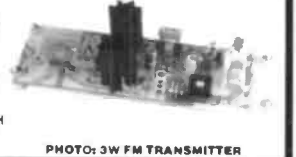

PHOTO: 3W FM TRANSMITTER

MICRO SENSE ALARM

JASON SHARPE



A comprehensive alarm that can protect any object, particularly electronic equipment, uses piezo sensors combined with tilt switches, if required, stuck onto the equipment.

useful in the case of false alarms to detect what caused the error, also when the alarm is first switched on it will show if the loop is open or short circuited. Features of the alarm are:

- ★ Uses sensitive piezo transducers
- ★ Three state security loop
- ★ Trigger source indicators
- ★ Status indicator
- ★ Auto turn off sounder

THANKS to modern technology electronic goods keep becoming smaller and more portable, unfortunately this also makes life easier for the thief. This alarm was designed to protect computers and their peripherals from being removed while unattended.

Items are protected by fixing piezo transducers to them, with self adhesive foam pads. When an attempt is made to remove the sensor a voltage is produced by the piezo crystal as it is distorted, which will set off the alarm. If the security loop is cut or short circuited the alarm will also be set off, tilt switches (and other types of switches) may be connected in series and parallel with the loop and fixed to the back of the sensors for even more security.

The source of the last trigger pulse is shown by three l.e.d.'s, this feature is

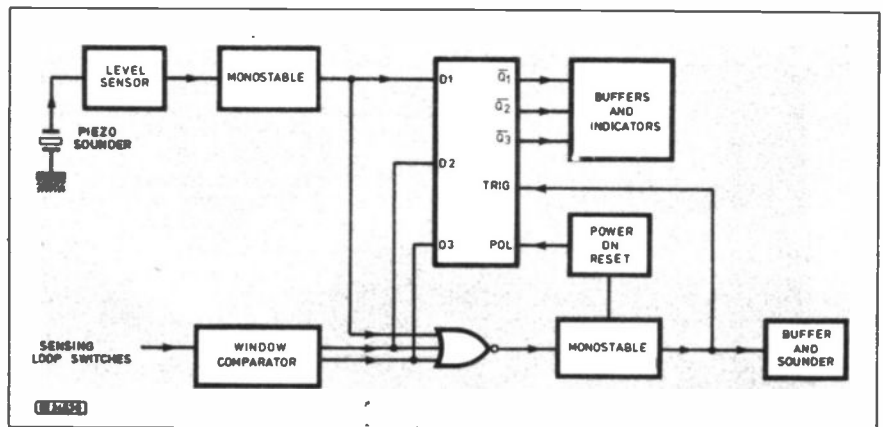

Fig. 1. Block diagram of the Micro Sense Alarm.

A block diagram of the Micro Sense Alarm is shown in Fig. 1 and Fig. 2 shows the full circuit diagram without the power supply unit.

The output from the piezo transducers is fed into an inverter arranged as an amplifier, the input sensitivity is set by VR1 and R1, the higher their combined resistance the higher the input sensitivity. The output of the amplifier is fed into another inverter which translates the analogue signal into a digital high or low.

Components R3, TR1, R4, C1 and a further inverter form a monostable which has the affect of "stretching" the short pulse received from the piezo transducer. If the input becomes high (i.e. a trigger pulse has been sensed) C1 is discharged via TR1, when the input goes low again C1 starts to charge via R4, the inverter squares the output to produce a high pulse which is longer than the input pulse.

Most security loops are just wire loops, which means they can be shorted out and disabled, the security loop on this alarm has an 18k resistor from the loop input to ground, which is fixed to the last sensor in the chain. Inside the alarm the input has an 18k resistor connected to positive, this

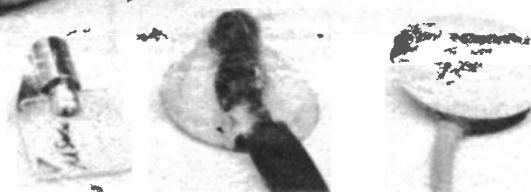
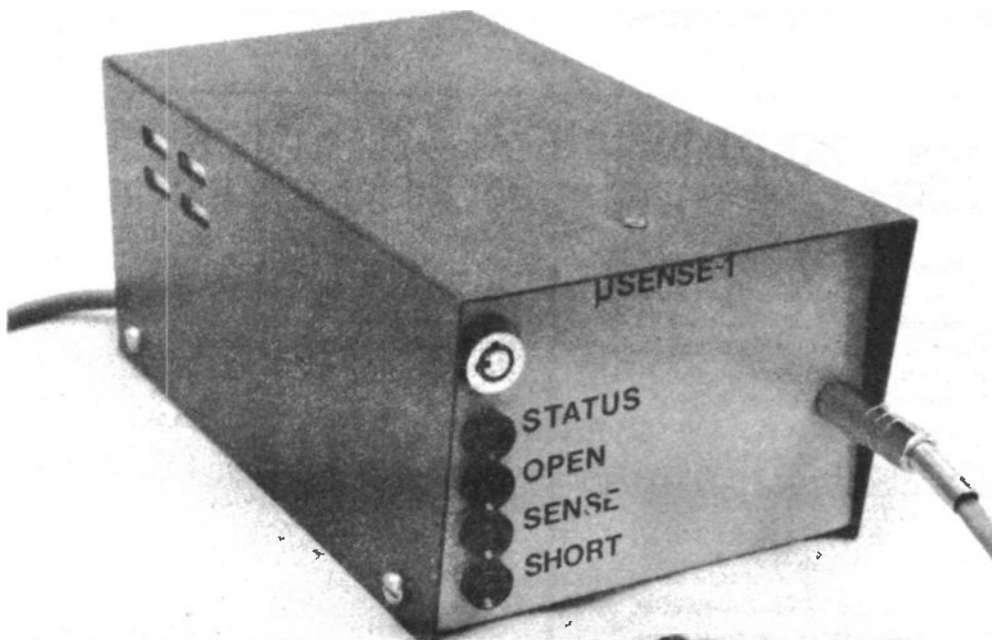



AMSTRAD PORTABLE PC'S FROM £149 (PPC1512SD), £179 (PPC1512DD), £179 (PPC1640SD), £209 (PPC1640DD). MODEMS £30 EXTRA-NO MANUALS OR PSU.

HIGH POWER CAR SPEAKERS. Stereo pair output 100w each 4ohm impedance and consisting of 6 1/2" woofer 2" mid range and 1" tweeter ideal to work with the amplifier described above. Price per pair £30.00 Order ref 30P7R

2KV 500 WATT TRANSFORMERS Suitable for high voltage experiments or as a spare for a microwave oven etc 250v AC input. £10.00 ref 10P93R

MICROWAVE CONTROL PANEL. Mains operated, with touch switches. Complete with 4 digit display, digital clock, and 2 relay outputs one for power and one for pulsed power (programmable) ideal for all sorts of precision timer applications etc. £6.00 ref 6P18R

FIBRE OPTIC CABLE. Stranded optical fibres sheathed in black PVC. Five metre length £7.00 ref 7P29R

12V SOLAR CELL. 200mA output ideal for trickle charging etc. 300 mm square. Our price £15.00 ref 15P42R

PASSIVE INFRA-RED MOTION SENSOR. Complete with daylight sensor, adjustable lights on timer (8 secs -15 mins), 50' range with a 90 deg coverage. Manual override facility. Complete with wall brackets, bulb holders etc. Brand new and guaranteed. £25.00 ref 25P24R

VIDEO SENDER UNIT Transmit both audio and video signals from either a video camera, video recorder or computer to any standard TV set within a 100' range! (tune TV to a spare channel) 12V DC op. £15.00 ref 15P39R Suitable mains adaptor £5.00 ref 5P191R

FM TRANSMITTER housed in a standard working 13A adaptor (bug is mains driven) £26.00 ref 26P2R

MINIATURE RADIO TRANSCEIVERS A pair of walkie talkies with a range of up to 2 kilometres. Units measure 22x52x155mm. Complete with cases. £30.00 ref 30P12R

FM CORDLESS MICROPHONE. Small hand held unit with a 500' range! 2 transmit power levels reqs PP3 battery. Tuneable to any FM receiver. Our price £15.00 ref 15P42AR

12 BAND COMMUNICATIONS RECEIVER. 9 short bands, FM, AM and LW DX local switch, tuning eye, mains or battery. Complete with shoulder strap and mains lead. NOW ONLY £19.00!! ref 19P14R

WHISPER 2000 LISTENING AID. Enables you to hear sounds that would otherwise be inaudible! Complete with headphones. Cased £5.00 ref 5P179R

CAR STEREO AND FM RADIO. Low cost stereo system giving 5 watts per channel. Signal to noise ratio better than 45db, wow and flutter less than .35%. Neg earth. £25.00 ref 25P21R

LOW COST WALKIE TALKIES. Pair of battery operated units with a range of about 200'. Our price £8.00 a pair ref 8P50R

7 CHANNEL GRAPHIC EQUALIZER. plus a 60 watt power amp! 20-21KHZ 4-8R 12-14V DC negative earth. Cased £25.00 ref 25P14R

NICAD BATTERIES. Brand new top quality. 4 x AA's £4.00 ref 4P44R, 2 x C's £4.00 ref 4P73R, 4 x D's £9.00 ref 9P12R, 1 x PP3 £6.00 ref 6P35R

TOWERS INTERNATIONAL TRANSISTOR SELECTOR GUIDE. The ultimate equivalents book. Latest edition £20.00 ref 20P32R

CABLE TIES. 142mm x 3.2mm white nylon pack of 100 £3.00 ref 3P104R. Bumper pack of 1,000 ties £14.00 ref 14P6R

1992 CATALOGUE AVAILABLE NOW

IF YOU DO NOT HAVE A COPY PLEASE REQUEST ONE WHEN ORDERING OR SEND US A 6"x9" SAE FOR A FREE COPY.

GEIGER COUNTER KIT. Complete with tube, PCB and all components to build a battery operated geiger counter. £39.00 ref 39P1R

FM BUG KIT. New design with PCB embedded coil. Transmits to any FM radio. 9v battery req'd. £5.00 ref 5P158R

FM BUG Built and tested superior 9v operation. £14.00 ref 14P3R

COMPOSITE VIDEO KITS. These convert composite video into separate H sync, V sync and video. 12V DC. £8.00 ref 8P39R

SINCLAIR CS MOTORS 12v 29A (full load) 3300 rpm 6" x 4" 1/4" O/P shaft. New. £20.00 ref 20P22R

As above but with fitted 4 to 1 infine reduction box (800rpm) and toothed nylon belt drive cog £40.00 ref 40P8R

SINCLAIR CS WHEELS 13" or 16" dia including treaded tyre and inner tube. Wheels are black. Spoked one piece poly carbonate. 13" wheel £6.00 ref 6P20R. 16" wheel £6.00 ref 6P21R

ELECTRONIC SPEED CONTROL KIT for CS motor. PCB and all components to build a speed controller (0-95% of speed). Uses pulse width modulation. £17.00 ref 17P3R

SOLAR POWERED NICAD CHARGER. Charges 4 AA nicads in 8 hours. Brand new and cased. £6.00 ref 6P3R.

12 VOLT BRUSHLESS FAN: 1 1/2" square brand new ideal for boat, car, caravan etc. £5.00 ref 5P206

ACORN DATA RECORDER ALF503 Made for BBC computer but suitable for others. Includes mains adapter, leads and book. £15.00 ref 15P43R

VIDEO TAPES. Three hour superior quality tapes made under licence from the famous JVC company. Pack of 10 tapes £20.00 ref 20P20R

PHILIPS LASER. 2MW HELIUM NEON LASER TUBE. BRAND NEW FULL SPEC £40.00 REF 40P10R. MAINS POWER SUPPLY KIT £20.00 REF 20P33R. READY BUILT AND TESTED LASER IN ONE CASE £75.00 REF 75P4R. 6V 10AH LEAD ACID sealed battery by Yuasa ex equipment but in excellent condition now only 2 for £10.00 ref 10P95R

12 TO 220V INVERTER KITs supplied it will handle up to about 15w at 220v but with a larger transformer it will handle 80 watts. Basic kit £12.00 ref 12P17R. Larger transformer £12.00 ref 12P41R

VERO EASI WIRE PROTOTYPING SYSTEM Ideal for designing projects on etc. Complete with tools, wire and reusable board. Our price £6.00 ref 6P33R

MICROWAVE TURNABLE MOTORS. Ideal for window displays etc. £5.00 ref 5P165R

STC SWITCHED MODE POWER SUPPLY 220v or 110v input giving 5v at 2A, +24v at 0.25A, +12v at 0.15A and +90v at 0.4A. £6.00 ref 6P59R

HIGH RESOLUTION 12" AMBER MONITOR. 2v 1.5A Hercules compatible (TTL input) new and cased £22.00 ref 22P2R

VGA PAPER WHITE MONO monitors new and cased 240v AC. £59.00 ref 59P4R

25 WATT STEREO AMPLIFIER. STK043. With the addition of a handful of components you can build a 25 watt amplifier £4.00 ref 4P69R (Circuit dia included)

LINEAR POWER SUPPLY Brand new 220v input +5 at 3A, +12 at 1A, -12 at 1A. Short circuit protected. £12.00 ref 12P21R

MINI RADIO MODULE Only 2" square with ferrite aerial and tuner. Superb! Req's PP3 battery. £1.00 ref BD716R

BARGAIN NICADS AAA SIZE 200MAH 1.2V PACK OF 10 £4.00 REF 4P92R, PACK OF 100 £30.00 REF 30P16R

FRESNEL MAGNIFYING LENS 83 x 52mm £1.00 ref BD827R

ALARM TRANSMITTERS. No data available but nicely made complex transmitters 9v operation. £4.00 each ref 4P81R

UNIVERSAL BATTERY CHARGER. Takes AA's, C's, D's and PP3 nicads. Holds up to 5 batteries at once. New and cased, mains operated. £6.00 ref 6P36R

ASTEC SWITCHED MODE POWER SUPPLY 80mm x 165mm (PCB size) gives +5 at 3.75A, +12 at 1.5A, -12 at 0.4A. Brand new £12.00 ref 12P39R

VENTILATED CASE FOR ABOVE PSU with IEC filtered socket and power switch. £5.00 ref 5P190R

IN CAR POWER SUPPLY. Plugs into cigar socket and gives 3.4, 5.6, 7.5, 9, and 12v outputs at 800mA. Complete with universal spider plug. £5.00 ref 5P167R

RESISTOR PACK. 10 x 50 values (500 resistors) all 1/4 watt 2% metal film. £5.00 ref 5P170R

CAPACITOR PACK 1,100 assorted non electrolytic capacitors £2.00 ref 2P288R

CAPACITOR PACK 2. 40 assorted electrolytic capacitors £2.00 ref 2P287R

QUICK CUPPA? 12v immersion heater with lead and cigar lighter plug. £3.00 ref 3P92R

LED PACK. 50 red leds, 50 green leds and 50 yellow leds all 5mm. £8.00 ref 8P52R

FERRARI TESTAROSSA. A true 2 channel radio controlled car with forward, reverse 2 gears plus turbo. Working headlights. £22.00 ref 22P6R

WASHING MACHINE PUMP. Mains operated new pump. Not self priming. £5.00 ref 5P18R

IBM PRINTER LEAD. (D25 to centronics plug) 2 metre parallel. £5.00 ref 5P186R

COPPER CLAD STRIP BOARD 17" x 4" of 1" pitch 'vero' board. £4.00 a sheet ref 4P62R or 2 sheets for £7.00 ref 7P22R

STRIP BOARD CUTTING TOOL. £2.00 ref 2P352R

50 METRES OF MAINS CABLE £3.00 2 core black precut in convenient 2 m lengths. Ideal for repairs and projects. ref 3P91R

4 CORE SCREENED AUDIO CABLE 24 METRES £2.00. Precut into convenient 1.2 m lengths. Ref 2P365R

TWEETERS 2 1/4" DIA. 8 ohm mounted on a smart metal plate for easy fitting. £2.00 ref 2P366R

COMPUTER MICE Originally made for Future PC's but can be adapted for other machines. Swiss made £8.00 ref 8P57R. Atan ST conversion kit £2.00 ref 2P362R

6 1/2" 20 WATT SPEAKER Built in tweeter 4 ohm £5.00 ref 5P205R

ADJUSTABLE SPEAKER BRACKETS Ideal for mounting speakers on internal or external corners, uneven surfaces etc. 2 for £5.00 ref 5P207R

PIR LIGHT SWITCH Replaces a standard light switch in seconds. Light operates when anybody comes within detection range (4m) and stays on for an adjustable time (15 secs to 15 mins). Complete with daylight sensor. Unit also functions as a dimmer switch! 200 watt max. Not suitable for fluorescents. £14.00 ref 14P10R

CUSTOMER RETURNED 2 channel full function radio controlled cars only £8.00 ref 8P200R

WINDUP SOLAR POWERED RADIO! FM/AM radio takes rechargeable batteries complete with hand charger and solar panel. 14P200R

240 WATT RMS AMP KIT Stereo 30-0-30 psu required £40.00 ref 40P200R

300 WATT RMS MONO AMP KIT £55.00. Psu required ref 5P200

ALARM PIR SENSORS Standard 12v alarm type sensor will interface to most alarm panels. £16.00 ref 16P200

ALARM PANELS 2 zone cased keypad entry, entry exit time delay etc. £18.00 ref 18P200

MODEMS FOR THREE POUNDS!! Fully cased UK modems designed for dialup system (PSTN) no data or info but only £3.00 ref 3P145R

TELEPHONE HANDSETS Bargain pack of 10 brand new handsets with mic and speaker only. £3.00 ref 3P146R

BARGAIN STRIPPERS Computer keyboards. Loads of switches and components excellent value at £1.00 ref CD40R

PC POWER SUPPLIES These units are new but need attention complete with case, fan IEC

input plug disc drive and mother board fly leads. Our price is £5.00 (less than the fan alone would cost!) ref 5P208R

HIGH VOLTAGE CAPACITORS A pack of 20 500PF 10KV capacitors ideal for ionizers TV repairs and high voltage experiments etc. Price is £2.00 ref 2P378R

DATA RECORDERS Customer returned mains battery units built in mic ideal for Computer or general purpose audio use. Price is £4.00 ref 4P100R

SPECTRUM JOYSTICK INTERFACE Plugs into 48K Spectrum to provide a standard Atan type joystick port. Our price £4.00 ref 4P101R

ATARI JOYSTICKS Ok for use with the above interface, our price £4.00 ref 4P102R

BENCH POWER SUPPLIES Superbly made fully cased (metal) giving 12v at 2A plus a 6V supply. Fused and short circuit protected. For sale at less than the cost of the case! Our price is £4.00 ref 4P103R

SPEAKER WIRE Brown twin core insulated cable 100 feet for £2.00 REF 2P79R

MAINS FANS Brand new 5" x 3" complete with mounting plate quite powerful and quite. Our price £1.00 ref CD41R

DISC DRIVES Customer returned units mixed capacities (up to 1.44M) We have not sorted these so you just get the next one on the shelf. Price is only £7.00 ref 7P1R (worth it even as a stripper)

HEX KEYBOARDS Brand new units approx 5" x 3" only £1.00 each ref CD42R

PROJECT BOX 5 1/2" x 3 1/2" x 1 1/2" black ABS with screw on lid. £1.00 ref CD43R

SCART TO SCART LEADS Bargain price leads at 2 for £3.00 ref 3P147R

SCART TO D TYPE LEADS Standard Scart on one end, Hi density D type on the other. Pack of ten leads only £7.00 ref 7P2R

OZONE FRIENDLY LATEX 250ml bottle of liquid rubber sets in 2 hours. Ideal for mounting PCB's. fixing wires etc. £2.00 each ref 2P379R

QUICK SHOTS Standard Atan compatible hand controller (same as joysticks) our price is 2 for £2.00 ref 2P380R

VIEWDATA SYSTEMS Brand new units made by TANDATA complete with 1200/75 built in modem infra red remote controlled qwerty keyboard BT approved. Prestel compatible. Centronics printer port RGB colour and composite output (works with ordinary television) complete with power supply and fully cased. Our price is only £20.00 ref 20P1R

3 INCH DISCS Ideal for Amstrad PCW and Spectrum +3 machines pack of 10 discs is £12.00 ref 12P1R

AC STEPDOWN CONVERTOR Cased units that convert 240v to 110v 3" x 2" with mains input lead and 2 pin American output socket (suitable for resistive loads only) our price £2.00 ref 2P381R

SPECTRUM +3 LIGHT GUN PACK complete with software and instructions £8.00 ref 8P58R

CURLY CABLE Extends from 8' to 6 feet! D connector on one end, spade connectors on the other ideal for joysticks etc (6 core) £1.00 each ref CD44R

COMPUTER JOYSTICK BARGAIN Pack of 2 joysticks only £2.00 ref 2P382R

MINI MONO AMPLIFIER PACK 4 amplifiers for £2.00! 3 watt units 9-12v operation ideal for experiments etc £2.00 ref 2P383R

BUGGING TAPE RECORDER Small hand held cassette recorder that only operate when there is sound then turn off 6 seconds after so you could leave it in a room all day and just record any thing that was said. Price is £20.00 ref 20P3R

IEC MAINS LEADS Complete with 13A plug our price is only £3.00 for TWO! ref 3P148R

COMPUTER SOFTWARE BARGAIN 10 cassettes with games for Commodore 64, Spectrum etc. Our bargain price one pound! ref CD44R

NEW SOLAR ENERGY KIT Contains 8 solar cells, motor, tools, fan etc plus educational booklet. Ideal for the budding enthusiast! Price is £12.00 ref 12P2R

FUSE PACK NO 1 Fifty fuses 1 1/4" long (glass) quick blow 10 popular values £2.00 ref 2P384R

FUSE PACK NO 2 Fifty fuses 20mm long (glass) quick blow 10 popular values £2.00 ref 2P385R

POTENTIOMETER PACK NO 1 30 pots for £3.00! ideal for projects etc. Ref CD45R

286 AT PC 286 MOTHER BOARD WITH 640K RAM FULL SIZE METAL CASE, TECHNICAL MANUAL, KEYBOARD AND POWER SUPPLY £139 REF 139P1 (no floppy cards or drives included)

35MM CAMERAS Customer returned units with built in flash and 28mm lens 2 for £8.00 ref 8P200

STEAM ENGINE Standard Mamod 1332 engine complete with boiler piston etc £30.00 ref 30P200

TALKING CLOCK LCD display, alarm, battery operated. Clock will announce the time at the push of a button and when the alarm is due. The alarm is switchable.

from voice to a cock crowing £14.00 ref 14P200R

HANDHELD TONE DIALERS Small units that are designed to hold over the mouth piece of a telephone to send MF dialing tones. Ideal for the remote control of answer machines. £5.00 ref 5P209R

COMMODORE 64 MICRODRIVE SYSTEM Complete cased brand new drives with disc and software 10 times faster than tape machines works with any Commodore 64 setup. The original price for these was £49.00 but we can offer them to you at only £25.00! Ref 25P1R

USED SCART PLUGS Pack of 10 plugs suitable for making up leads only £5.00 ref 5P209R

C CELL SOLAR CHARGER Same style as our 4 x AA charger but holds 2 C cells. Fully cased with flip top lid. Our price £6.00 Ref 6P79R



BULL ELECTRICAL
250 PORTLAND ROAD HOVE SUSSEX
BN3 5QT TELEPHONE 0273 203500
MAIL ORDER TERMS: CASH PO OR CHEQUE
WITH ORDER PLUS £2.50 POST PLUS VAT.
PLEASE ALLOW 7 - 10 DAYS FOR DELIVERY
NEXT DAY DELIVERY £8.00
FAX 0273 23077

SOME OF OUR PRODUCTS MAY BE UNLICENSABLE IN THE UK

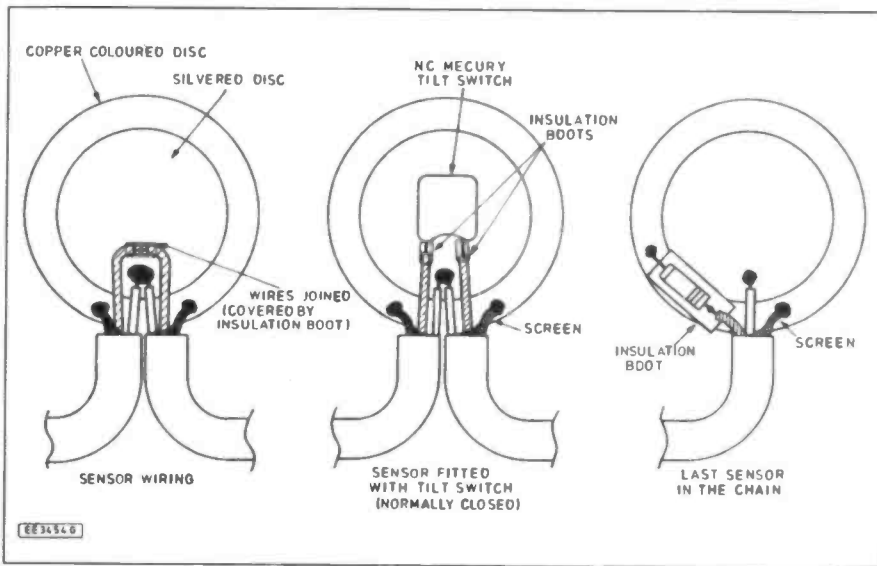
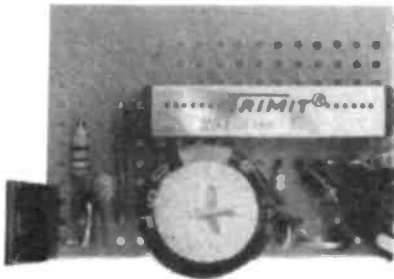
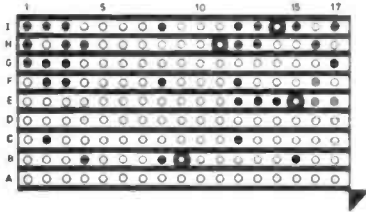
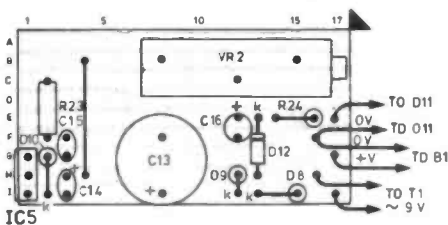

Fig. 4. Construction and wiring of the sensors.

Fig. 5. Wiring of the p.s.u. stripboard.



cable of required length, and a chain of piezo transducers to the other, solder the copper outside part of the transducer to the cable screen and connect other wires as shown in Fig. 4. Be careful not to get the sensor to hot, especially the silvered disc as this will begin to desilver if it gets too hot.

The last sensor in the chain should have an 18k resistor soldered between the security loop wire and ground (outer disc). When the unit has been tested (see Testing section) the sensors can be given extra protection by applying silicon rubber on the solder side of the sensors.

CONSTRUCTION

The Veroboard layout for the power supply is shown in Fig. 5, construction is quite simple, but check the polarities of the capacitors and diodes. In the prototype IC5 (7805) was used to fix the board into the box, and was mounted on a heatsink insulator.

When the case has been drilled the transformer can be fixed in place, and the mains lead connected (the Earth of the mains cable should be connected to the case), the output leads can then be connected to the power supply board which is fixed in place by means of a screw through the regulator tag.

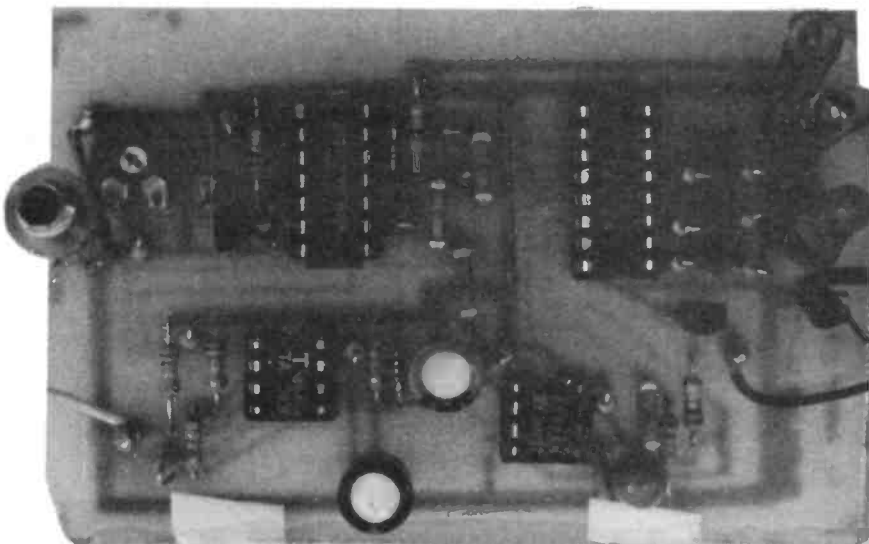

Resistors

R1	100k	See SHOP TALK Page
R2	1M	
R3	6k8	
R4	27k	
R5, R6, R8	18k (3 off)	
R7, R13	2k2 (2 off)	
R9, R10	4k7 (2 off)	
R11	47k	
R12, R15 to R19	10k (6 off)	
R14	2M2	
R20 to R22	390 (3 off)	
R23	100	
R24	680	
R25	220	

All $\frac{1}{4}W \pm 10\%$ carbon film.

Potentiometers

VR1	2M2 skeleton preset
VR2	500 multiturn preset

Capacitors

C1	2 μ 2 tantalum 35V
C2, C3	3n3 poly. layer (2 off)
C4, C8	1n poly. layer (2 off)
C5	47 μ radial elect. 16V
C6, C9,	
C11, C12,	
C14	0 μ 1 ceramic (5 off)
C7	47 μ tantalum 10V
C10	100 μ radial elect. 16V
C13	2,200 μ radial elect. 16V
C15	1 μ tantalum 35V
C16	22 μ radial elect. 16V

Semiconductors

IC1	4069UBE Hex inverter
IC2	LM393 voltage comparator
IC3	555 timer
IC4	4042 quad clocked D-latch
IC5	7805 +5V 1A voltage regulator
TR1 to TR5	BC548 npn silicon (5 off)
D1 to D4,	
D12	1N4148 (5 off)
D5 to D7	high brightness red l.e.d. (3 off)
D8 to D10	1N4001 1A 50V rec. (3 off)
D11	tri-colour l.e.d.

Miscellaneous

S1	s.p.s.t. microswitch
S2	s.p.s.t. key operated switch
X1 to Xn	piezo transducers number as required
T1	9V-0-9V 20VA mains transformer
B1	6V 1AH sealed lead acid battery

Stereo jack plug and socket as required to connect sensors; l.e.d. mounting clips; 14 pin d.i.l., 16 pin d.i.l. and 8 pin d.i.l. (2 off) i.c. sockets; metal case approx 102mm x 102mm x 180mm; p.c.b. available from the *EE PCB Service*, order code EE783; stripboard, 9 strips by 17 holes; sticky pads as required for sensors; tilt switches as required - see text.

Approx cost
guidance only

£28

Excluding battery

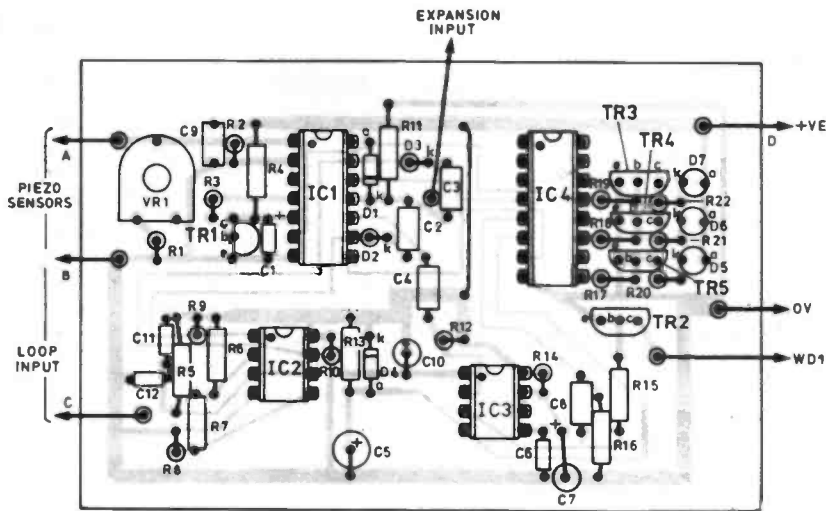
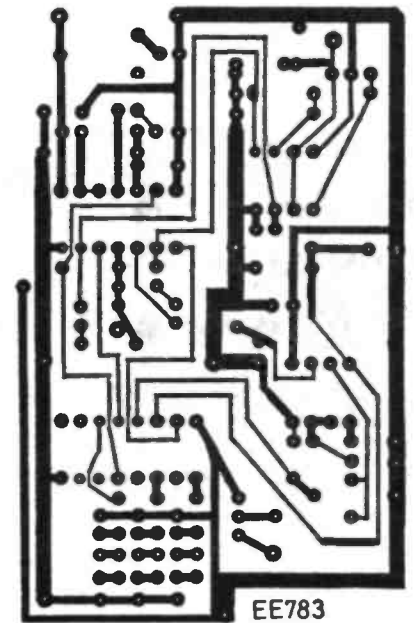

Fig. 6. P.C.B. layout and wiring for the Micro Sense Alarm.



ALARM BOARD

Assembly of the p.c.b. is quite straightforward (Fig. 6), insert the i.c. sockets and link first, then the diodes and resistors, and then the transistors, capacitors and Veropins. Before inserting the l.e.d.'s place insulation boots (or insulation stripped from some wire) $\approx 2.5\text{cm}$ long onto their leads and insert them into the p.c.b., also solder the large tag (screen) of the stereo socket firmly to the 0V pin (between the loop and sense inputs), connect the other leads and the buzzer.

After testing the board may be fixed into the case (see Fig. 7 for wiring information). The case used for the prototype was made of steel and is not recommended as it is quite hard to work with, cases of similar style made of aluminium are generally available.

POWER SUPPLY TESTING

When the power supply has been assembled in the box, you should check that the case is connected to earth, using an ohmmeter. When the mains is connected to the unit the output from the board should be set to 6.8 volts, by adjusting VR2.

Connect the sensors to the alarm board, and also a power supply ($\approx 5\text{V}$). Try connecting the security loop input to ground, and also disconnecting the wire from the input, both of these actions should cause the alarm to sound and the appropriate l.e.d.s to light, to reset the alarm remove and reconnect the power (NOTE: when testing the alarm it might be a good idea to cover the hole in the sounder with tape to lower the sound level slightly).

Tapping the piezo sensors with a small metal object should also set the alarm off. Adjust the sensors to the required sensitivity using VR1. When the unit has been tested it can then be installed in the drilled case as shown.

Switch S1 is a microswitch arranged so that it is held closed when the case is fixed together. Thus anyone opening the case will trigger the alarm. The unit is now ready for use. \square

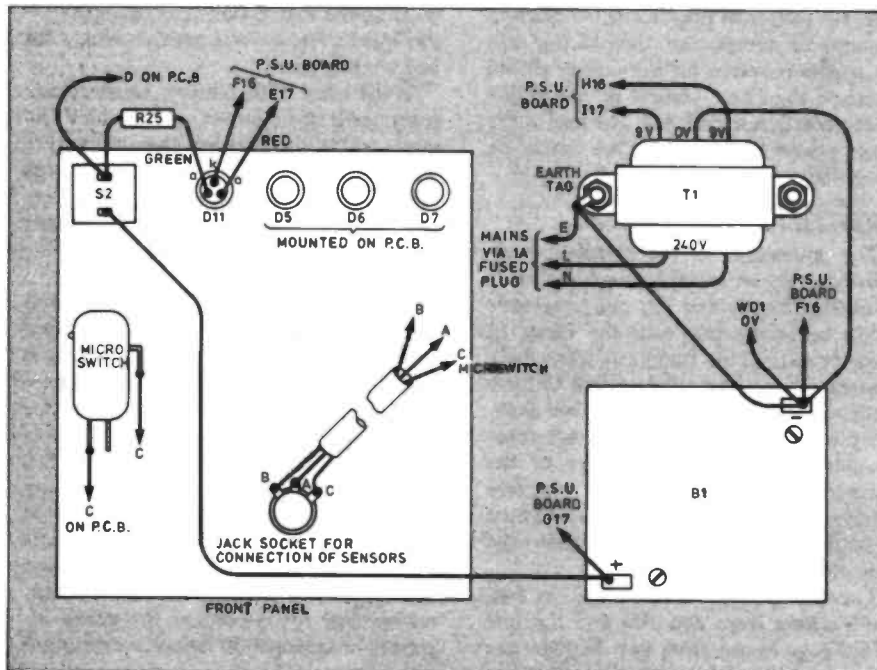
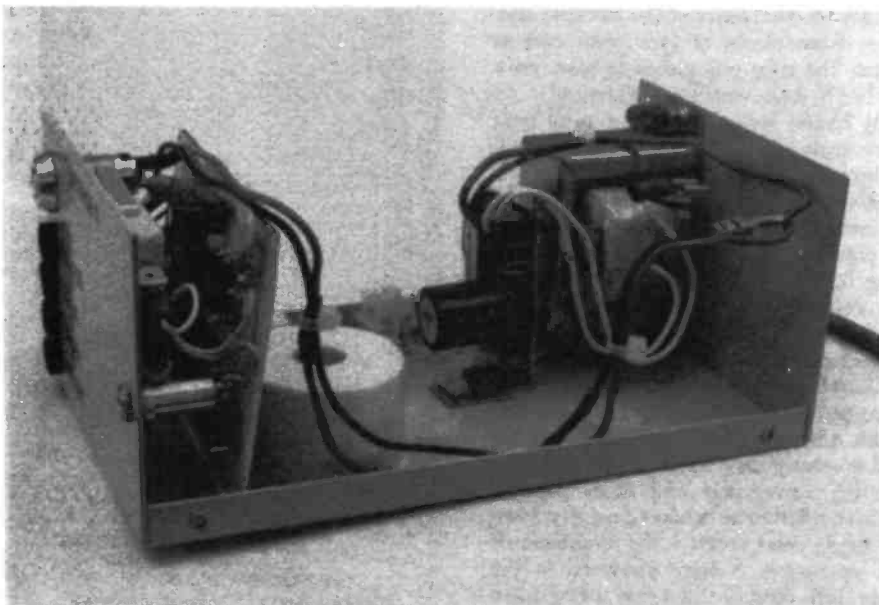

Fig. 7. Interwiring of the off-board components in the alarm.

Internal layout of the prototype alarm. The lead acid battery B1 has been removed to show the p.s.u. board and transformer.



INFORMATION TECHNOLOGY AND THE NATIONAL CURRICULUM

T. R. de VAUX BALBIRNIE

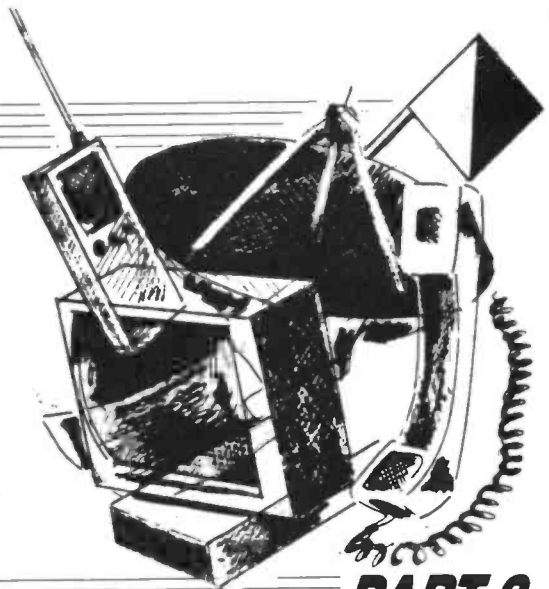

PART 3

THIS is the third article in a 12-part series concerning Communication, Information Storage and related matters in the Science National Curriculum. Readers who have not been following the series are advised to read the first article (in November's issue) – this gives some background information which will be found useful. This month we will look at the topic of *Information Storage*.

Children should know that information in the form of number, text, pictures (graphics) and sound may be stored electronically using various everyday devices such as tape recorders and computers.

STORAGE OF INFORMATION

It often happens that information is only useful for a short while. For example, an invitation to a party the following day is unlikely to be of much value in a month's time. However, there are times when information needs to be *preserved* so that it may be *retrieved* at a later date. If you have money in the bank, the amount you have needs to be stored and the information updated whenever some is taken out or more is put in.

In ancient times, people stored information in the only way they knew how – by making drawings on the cave walls where they lived. Animals and everyday objects of the time were depicted painstakingly and in great detail. Man always seems to have had an urge to preserve the things in his daily life for others to see. Perhaps he saw this as a type of diary.

When man learnt to read and write, a far more versatile means of storing (by writing) and retrieving (by reading) information became possible. Some of the earliest writing has been found on clay tablets and dates from around 4000 BC. Later, large amounts of information were stored in the form of books.

The earliest books had to be written by hand using quill pens, usually by monks or scribes, and were only seen and used by the educated few. The work in producing them was so slow that only a few copies of a book could ever be made. Books could be collected together in libraries, much as

they are today, to give access to massive amounts of information. One of the sadder stories concerns the burning of all the books in the Great Library of Alexandria by the Muslims in 642 AD. The loss to the world caused by this single act cannot be calculated.

PRINTING

The invention of the printing press allowed many copies of books to be made relatively cheaply and this put large-scale access to information into the hands of more people. There had been some early attempts at printing – the ancient Chinese made wood-cuts of characters, inked them, and pressed them on to paper. It was then possible to make several copies of the same small piece of information relatively quickly and easily. However, for something as large as a book this would have been very difficult.

The first printed books were, in fact, *scrolls* dating from 896 AD and the first folded page books, from 949 AD. No one knows exactly who invented "real" printing – and there certainly were some very early printed books. However, Johannes Gutenberg in the 15th century is accredited with producing the first practical printing press using moveable type. He made moulds for each letter of the alphabet and, from these, pieces of type were cast in metal. The type was placed in rows on a flat bed to make words and sentences.

By careful design, all the pieces of type were made the same height so they could be inked, gently pressed on to paper and a high-quality copy of a whole page made in one operation. His greatest task was to print the Bible in Latin – the "Gutenberg Bible" – this consisted of over 1200 two-column pages of 42 lines each (see photograph). Two hundred copies of the Gutenberg Bible were printed in 1456.

Gutenberg's basic printing method remained more or less unchanged for 400 years. Although of great importance, it was still relatively slow and not well suited to printing newspapers and other material which needed to be produced quickly. Even so, single news sheets – the forerunner of the newspaper – were produced in the early 16th century using this method and

in 1622 the first commercial newspaper – *The Weekly News* – was printed using a flat bed printing press.

In the early 19th century, an automatic press using steam power was invented and this greatly speeded up the printing of sheets of newsprint – *The Times* was produced in this way. However, it was still slow by today's standards because the paper had to be manipulated in the machine sheet by sheet.

In the mid-19th century, the *rotary printing press* was invented and this, in modified form, is still used today – here the type is not set out on a flat bed as in the Gutenberg press but formed on the surface of a cylinder instead. The paper is in the form of a large roll. As the cylinder rotates, the paper rolls over it producing one copy after another very rapidly. The paper is then cut into sheets and folded. This is basically how newspapers (and magazines like *EE*) are printed today but modern technology has revolutionised the actual assembly of information before presenting it for printing.



The Gutenberg Bible
(Photo courtesy of The British Museum)

BOOKS

Books, of course, remain a vital form of information storage and modern technology has not reduced the importance of the printed word. The advantage of a book is that it is convenient, does not need a power supply and the information may be retrieved (by reading it) more or less anywhere. Moreover, once a person has learned to read, the whole world of books is available. No further specialized knowledge is needed.

This may be compared with information stored on a computer. A person must first learn to be *computer literate* but, unlike reading, this literacy needs to be constantly updated as new equipment becomes available. On the other hand, books are large compared with the amount of information stored. A complete set of telephone directories – about 100 books – for the United Kingdom is extremely bulky. This same information may be stored using a computer database in a very much smaller space. Moreover, the use of a database would enable you to find the telephone number you wanted far more quickly.

With books, it may be difficult carrying a large amount of information from one place to another. Also, the weight of a book may mean that the information would be costly and time-consuming to send long distances – by post.

Books are versatile in that they can store text, images (pictures and diagrams), numbers and music (in the form of a score). Until fairly recently banking was carried out manually by writing down all the details of deposits and credits in the various accounts in a ledger. This job is now done electronically using computers. Computers do the job faster, far more accurately and with the support of fewer people.

Most important of all, the information can be turned into electrical signals and sent along telephone wires from one computer to another. Money (in the form of electrical signals) may then be deposited or withdrawn automatically. Since a complete telephone network already exists, the signals may be sent from one bank to another – even in another country – conveniently and in practically no time at all.

STORING PICTURES

Photography enables man to store accurate visual information – a scene, person, etc. Previously, these had to be drawn or painted by hand. Painting was not always accurate – the painter often flattered the client because he or she was paying the fee. Like printing, no one actually invented photography – there had been several early experiments using chemicals which darken when light shines on them.

Joseph Niepce produced a successful photograph in 1826 but Henry Fox Talbot (1800-77), a British botanist and physicist, invented a photographic process using a *negative* which would be recognized by photographers today.

This experiment shows that chemicals containing silver darken when light shines on them and this can be used to produce

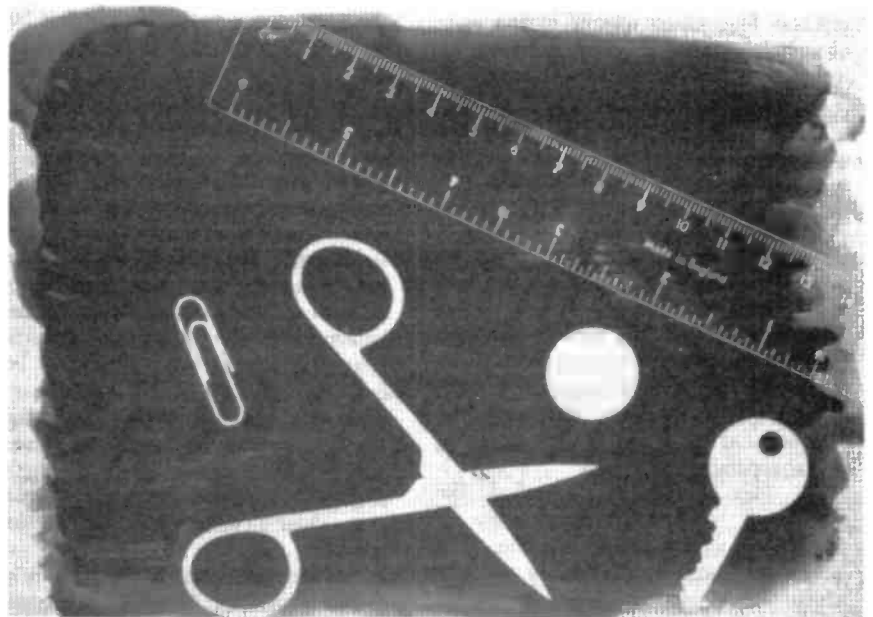
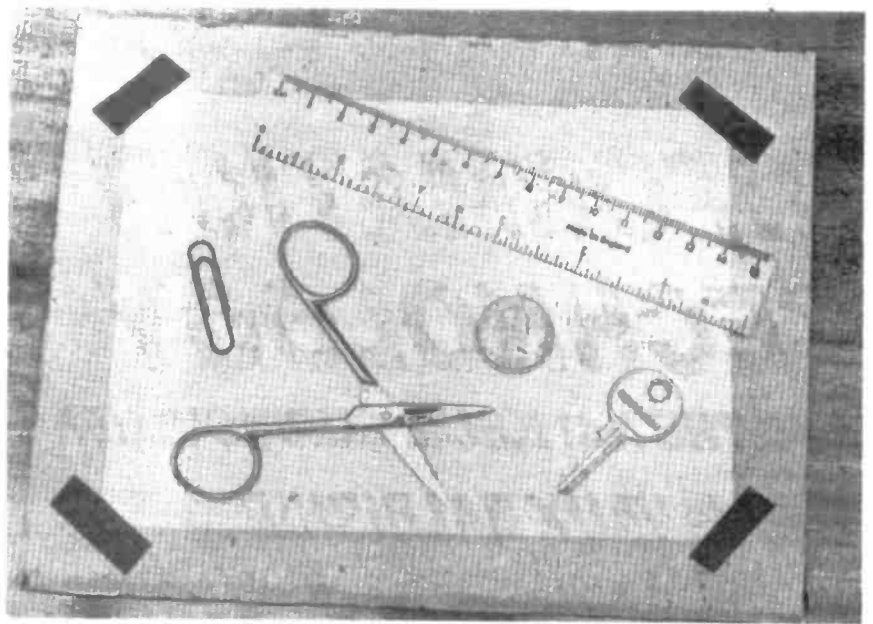

Making a shadow photograph (top) and the finished result (bottom).

a simple form of photograph called a "shadow photograph". *Note that this experiment should not be performed by young children and should be demonstrated. Since silver nitrate is poisonous and causes staining of the skin, rubber gloves should be worn throughout.*

You will need a small amount (about 10ml) of freshly made 2 per cent silver nitrate solution, a small artist's paintbrush and some writing paper. You will also need some scrap paper to work on. Keeping away from bright light, "paint" the silver nitrate solution on to the writing paper to make a 10cm square. Place the paper in a warm, dark place to dry. When it is dry, arrange some flat objects such as paper clips, scissors and a plastic ruler on it.

Carefully carry the paper with the objects on it to a place where bright light – preferably sunlight – can shine on it. Do not allow the objects to move during the exposure. The paper will darken to a deep brown colour but the paper beneath the objects will remain white. This will hap-

pen in a few seconds in bright sunlight but may take several hours in weak daylight. If the objects are removed in a dim part of the room, their outlines will be clearly seen (see photograph). Unfortunately, the paper will darken all over and the images will fade in time.

MOVING PICTURES

To make *moving pictures* was an early dream of man. Some simple inventions appeared to show birds flying and other similar things by flashing drawings rapidly before the eye. The Zoetrope (see photograph) had a paper cylinder with a series of pictures painted on the inner surface. When the cylinder was rotated, and the pictures viewed through slits in the body of the device, the subject seemed to be moving naturally. However, this was nothing more than a toy.

Movie film (cinematography) remained a problem. Again, there was no one inventor but the French Lumiere developed a camera and projector

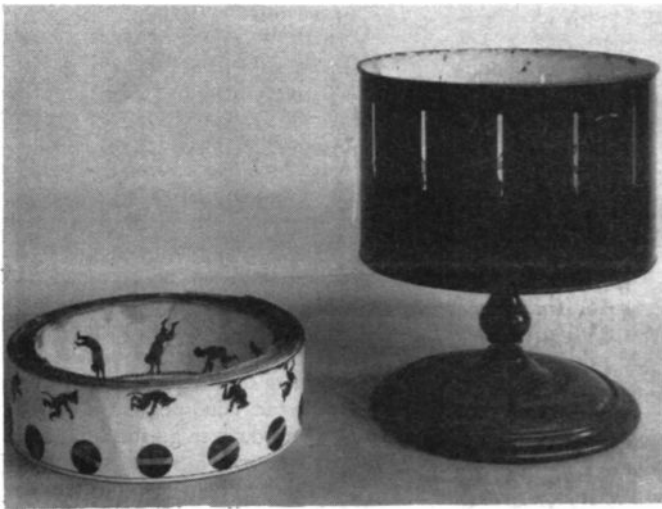

The Zoetrope a simple form of "moving pictures".
(Reproduced by permission of the Trustees of the Science Museum)



Thomas Alva Edison and his phonogram (1888) some cylinder recordings are shown.
(Reproduced by permission of the Trustees of the Science Museum)

celluloid film which worked in the style of modern equipment. They demonstrated their process in 1895. Here, information is stored as a succession of still pictures on transparent film. By projecting these in quick succession on to a screen, the impression of smooth movement is obtained.

STORING SOUND

Another of man's dreams was to preserve sounds – the spoken word and music. It was through Thomas Alva Edison's work with the electric telegraph (see last month's article) – recording the dots and dashes of the Morse code – which convinced him that speech itself could be recorded and subsequently replayed using similar apparatus.

His idea – which he called the *phonograph* – was to speak near a diaphragm which would vibrate. The diaphragm would be attached to a needle which would also vibrate. The needle would rest in a piece of tin foil wrapped around a revolving cylinder. The vibrating needle would produce a spiral groove in the tin foil and the modulations of this groove would carry all the information of the sound. To reproduce the sound, the needle would be placed at the beginning of the groove and the cylinder turned again. The needle would be made to vibrate by

the undulations in the groove and hence the diaphragm would vibrate in sympathy. The original sound would then be reproduced.

Edison successfully tested his phonograph in 1877 by speaking the words, "Mary had a little lamb". The oldest surviving cylinder recording in the BBC record library dates from 1884.

Although this method worked after a fashion, tin foil was found to be a poor material for the job and Edison made an improved version of the phonograph in 1888 using wax instead. Very soon, Emile Berliner replaced the cylinder with a flat disc rather like a present day record. Wax-covered cardboard was used and different needles were used for cutting and playing. The device was now known as a *gramophone* – a name which survives to this today.

The original records were "one-offs" and made for curiosity. To make more than one copy, it was necessary for the performer to speak or sing into a funnel from which several rubber tubes would radiate to a number of phonographs, each making its own record! To be an effective storage medium, records needed to be copied in bulk and pressing techniques for this were soon developed using a plastic material. These copies did not wear out as quickly as

the wax master from which they were made.

With the triode valve having been invented by Lee de Forest (see last month's article), it became possible in the 1920's to use electronic techniques to make recordings. For this, a microphone turned the sounds into electrical signals which held all the information. These signals were magnified using a valve amplifier and the resulting output made to vibrate the needle of an electric cutter. Non-electric methods, however, were still used for playing the records back. The sound was made loud enough for household listening by playing the vibrations of the diaphragm into a large horn.

Early records had a very short playing time because they rotated at high speed – 78 r.p.m. (revolutions per minute). The playing time was increased by the invention of the long-playing record in the 1940's. This rotated at a far slower speed – 33 r.p.m. or 45 r.p.m. – and the grooves – *microgrooves* – were much closer together. In the meanwhile, inexpensive valve-operated record players became common in the home. These gave a better quality of reproduction as well as much louder sound compared with an *acoustic* gramophone. It is interesting to look at the groove of an old record using a low-power microscope.



Berliner disc gramophone (1890)
(Reproduced by permission of the Trustees of the Science Museum)

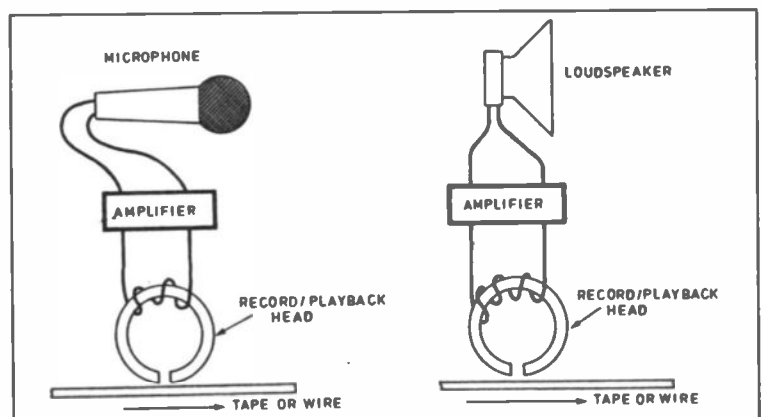

Fig. 1. Basic method of magnetic recording and replay.

RECORD EXPERIMENT

This experiment needs an old "useless" record and a sewing needle or pin. The needle is threaded through a small piece of paper to act as a diaphragm and held gently between the fingers of one child. Using a pencil or pen in the centre hole, another child turns the record steadily. The needle is now rested in the groove. The sound will be heard and the paper felt to be vibrating. This non-electric method clearly shows how the record groove produces vibrations which reproduce the original sound.

MAGNETIC RECORDING

A more recent advance is making sound recordings on *tape*. This method is widely used today – almost every home has a cassette recorder often combined with a radio. This method developed from early experimental recorders using steel wire which were tried at the turn of the century. In these, sound was picked up by a microphone and the electrical signals passed through a coil of wire wound on an iron core with a narrow gap (see Fig. 1).

The iron core was magnetized and the strength of its magnetization followed the pattern of the original sound. Steel wire was passed across the iron core and this picked up the magnetization. Steel – unlike iron, retains its magnetism so along the length of the wire was a magnetic imprint whose strength followed the sound pattern.

To replay the recording, the wire was rewound to the beginning and passed over the iron core again. Now the coil produced an electrical signal which reproduced the original sound in an earphone. This invention was ahead of its time and was waiting for Lee de Forest to invent the triode valve. This enabled the weak electrical signals to be amplified and fed to a loudspeaker.

Steel wire was found to be a poor material for the job and specially made tape was later used. Early magnetic tape used a paper base but this was easily damaged and later tape used a plastic material. In an improved form this is still used today. The base material is coated with a very thin layer of iron oxide (or similar magnetic material) which behaves like the steel wire described earlier.

Tape recorders began to appear in the 1940's in the home, for entertainment, and in offices as dictation machines. The original machines used *spools* of tape (open reel recorders) and similar open reel machines are still used by professional operators. Cassette recorders are more convenient and have largely replaced open reel recorders for household and semi-professional use but the principle of operation and type of recording tape used is the same.

One advantage of tape recording is the ease with which the recording may be erased and the tape used again (unlike disc recordings). Also, with open reel equipment, editing may be carried out – the tape cut in places, parts spliced in or removed, re-arranged, etc. Thus, a radio interview can have all the hesitations and mistakes removed before broadcasting it.

SOUND MOVIES

It is interesting to see how the two techniques – film making and sound recording came together to make sound movies. In some early films, the sound was recorded on a large diameter disc. However, it was difficult to keep accurate synchronization between the sound and picture (the lip movement and words fell out of step). Also, if the needle jumped or was knocked, synchronization was lost. This often happened and caused great amusement in the audience. Sometimes the only way to proceed was to start the reel of film again from the beginning!

Warner Brothers kept to this system even after optical sound recording had been perfected. Good quality optical sound recording was the invention of Lee de Forest (the inventor of the triode valve)



Fig. 2. An optical sound track running down the side of a film.

and he demonstrated his system in 1923 although there had been some unsuccessful attempts using similar methods previously.

In his system, the sound track ran along the edge of the film itself. This meant that there were no synchronization problems and the quality of the sound was much better. Fig. 2 shows the appearance of an optical sound track.

When the film was projected, light from a separate small lamp – the *exciter lamp* – shone through the sound track. The light passing through would then flicker in sympathy with the original sound. This light was picked up using a light-sensitive cell which produced varying electrical sig-

nals. The result was fed into the input of a valve amplifier and hence to a loudspeaker. In this way, the original sound was reproduced. Using this method *The Jazz Singer* was shown in 1928 and was an instant success.

Today, sound is stored using magnetic stripes on the film itself (see under Magnetic Recording). This has several advantages. Firstly, the quality is much better. Also, by using more than one track, *stereophonic* sound can be recorded and played back through more than one loudspeaker. With modern wide-screen films the sound will then appear to come from the actors themselves as they move across the screen. Loudspeakers all around the auditorium add even greater realism.

With the development of television, film-makers found themselves in competition with it and many improvements – some of them merely gimmicks – were used in an attempt to lure the audiences back to the cinema. Colour films succeeded because these could be shown in the cinema before colour television was available at home. Also the quality and breadth of the sound coupled with the large screen made the experience more realistic.

There were even attempts at 3D (three-dimensional) films. These involved the audience wearing special pairs of glasses without which the picture was simply a jumble; these were not popular.

VIDEO RECORDING

In the late 1950's special tape recorders succeeded in recording not only sound information but *television pictures* too. For technical reasons this is a difficult job and was waiting for more advanced technology to be developed. Before then, television programmes had to be made "live" and any recording made on film.

With video recording the programme could be recorded several times as necessary to produce a perfect result. Also, the tape could be edited like audio tape. This made programme production much simpler because all the scenes at one particular location could be made in one recording session, videotape editors could then assemble the whole programme in the right order and this is the technique used today. Now, videocassette recorders are familiar pieces of equipment.

A recent storage medium is the *Compact Disc*. This is usually thought of as being a sound storage medium. However, it may be used to store *text* and *pictures* too. In the future it will be used for much bulk storage of information – for example, maps and telephone directories. Unfortunately, the information stored on it cannot be updated – it is a *read only* medium at the moment. The Compact Disc is an important advance because it uses *digital technology*. The meaning of this will be explained in a future article.

CLOCKS AND WATCHES

A further modern device using digital technology is the electronic watch or clock. This is set with the correct information – the day, date, time and so on and this is updated automatically. The information

may be retrieved by looking at the display (for the time) and by pressing various buttons (to recall the day, date, etc).

It would be useful for children to use a digital stop clock or watch for simple timing operations. You will probably find that they are better at setting these devices than you are!

STORING INSTRUCTIONS

Sometimes the information we wish to store is a *set of instructions* for a machine to follow. The most powerful way of doing this is by using a computer as we shall see later. However, it is worth mentioning "punched card" systems which are still in use today. Anyone who has looked around the back of an old fairground "steam" organ will have noticed that the music is stored in the form of holes punched in card. This rolls through the machine.

Today, we would call the information on the card a *program* since it tells the playing mechanism what to do and when to do it. Some Victorian table-top organs stored similar information on discs where raised protrusions on the surface pressed keys and allowed air to blow the pipes inside. Punched cards were used by Joseph Jacquard in the early 1800's to control the pattern of weave in his loom.

Today, car-wash machines often use a form of punched card which is fed into the machine and provides the instructions for exactly what kind of wash has been paid for. Early cash dispensers outside banks used punched cards. Today, these have been replaced by cards with magnetic striping. Here, information about the account is read from the card using a device similar to a tape recorder.

Today, a computer (the *hardware*) needs instructions (the *software*) to tell it what to do. We often store these instructions as a *program* on a *magnetic disc*. We shall be looking at some simple examples of this next month.

CALCULATOR

As well as text (writing), pictures and sound, we often need to store and work with *numbers*. We can enter a number in an electronic calculator and that number will remain in the calculator's memory. However, to use a calculator simply to store a number is a waste of a calculator's power. The same job could be done by writing it down on a piece of paper.

The advantage of a calculator is that as well as *storing* numbers, it can perform *calculations* on them too. Calculations which would be too time consuming for a human to do can now be done easily by an electronic calculator and with much less likelihood of error.

The first calculator was an *abacus* and although this has been around for some 5000 years it is still commonly used in China, the Middle East and Japan. It is likely that the abacus developed from the idea of making marks in a tray of sand with the finger. In use, beads are slid up and down rods.

In the most common type of abacus, the Chinese *suan pan*, there are several columns of beads with a cross piece to

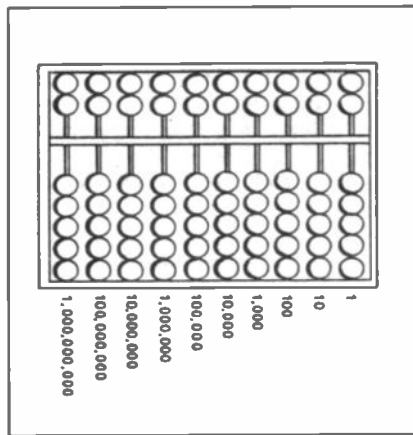

A Chinese abacus – these are still used in China.

divide them into columns of two beads above and five below (see Fig. 3). In the right-hand column, the lower five beads represent *units* and those above the division *fifties*. The next column represents *tens* and *fifties* and so on. By sliding the beads on the rods, a skilled operator can add and subtract numbers more quickly than by using an electronic calculator.

In 1642, Pascal invented a calculating machine where numbers could be added together by entering them on dials at the front of the machine. In 1617 Leibnitz produced a calculator which could perform multiplication using toothed wheels. This type of technology was used until relatively recently. William Oughtred invented the *slide rule* which is still sometimes used today. This has a *cursor* which can move along the various scales on the ruler to perform multiplication and division. Someone is certain to have one of these at home.

These devices have the advantage of needing no power supply. However, there are many types of calculation which are not well suited to them, especially where very large or very small numbers are involved and the inexpensive electronic calculator is much faster and a great deal more versatile.

Calculators can only deal with numbers but computers can deal with text, images (graphics) and sound. In reality, a computer can only store *numbers*. Even when you think it is storing text or pictures it is really storing numbers. Every letter of the alphabet, upper and lower case,

also punctuation marks and so, on, are turned into a code of numbers and it is really these which the computer is storing. When we recall the words we are recalling the numbers and the computer turns them back into letters of the alphabet. When storing a picture, it breaks the image into thousands of small squares (pixels) and stores these as numbers.

COMPUTERS

The first designs for machines which could be called true computers were made by the English mathematician Charles Babbage (1791-1871). In 1833 he designed his "Difference Engine No. 1" and in 1847 his "Difference Engine No. 2". He went on to design other machines – notably the "Analytical Engine". Unfortunately, none of his machines were ever completed because of the limitations of machine tool technology at that time.

Although the machines would today be classed as computers, they were designed long before the electronics age and were to be purely mechanical devices. The Second Difference Engine has recently been constructed using the original plans at the Science Museum in London. This uses 4,000 (excluding the printing mechanism which has not been built) parts and weighs approximately 3 tonnes. The total cost of building the machine and mounting a six month exhibition is £500,000. This exhibit demonstrates that these machines would have worked had it been possible to build them in Babbage's day.

Similar but simpler mechanical devices were used until fairly recently for such calculations as insurance premiums and betting odds for dog races. By today's standards, mechanical computers are complicated, relatively slow, expensive, heavy and bulky. Also, because they were mechanical, parts would wear out so constant maintenance was required.

Next month we shall complete this topic by looking in more detail at the computer as a storage medium and also explore the range of microelectronic devices which are now found in everyday life.

Babbages Second Difference Engine being demonstrated at the Science Museum.

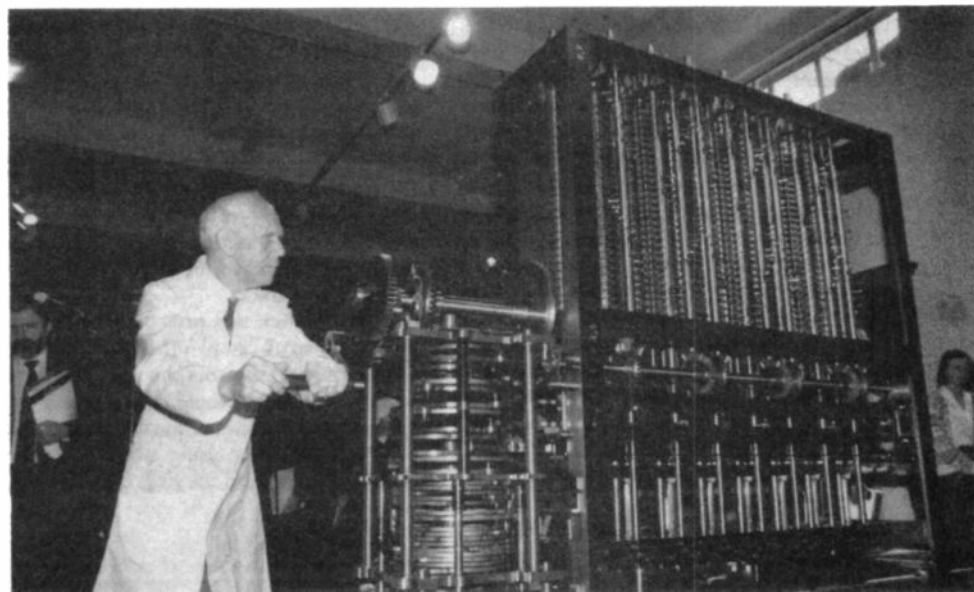



ESR ELECTRONIC COMPONENTS

Station Road, Cullercoats,
Tyne & Wear NE30 4PQ
Tel. 091 251 4363 Fax. 091 252 2296

PCB EQUIPMENT

UV EXPOSURE UNIT - 229 x 159mm working area, built in timer, 2 x 8w tubes £62.57
 PHOTO RESIST BOARD - single sided pre-sensitized FR4 glass fibre board. 3 x 4 in. £0.86 4 x 6 in. £1.62 6 x 6 in. £2.41
 PLASTIC DEVELOPING TRAY £1.35
 FERRIC CHLORIDE (0.5kg) £2.45
 TIN PLATING POWDER (90g) £8.33
 STRIPBOARD 0.1 pitch 64 x 127mm £1.30 64 x 431mm £4.03 95 x 127mm £1.62 95 x 95mm £1.33 95 x 431mm £8.27
 BREADBOARD 81 x 60mm 390TP £2.98 175 x 42mm 640TP £3.40 175 x 87mm 840TP £5.34 *203 x 75mm 840TP £7.00
 * inc plate & 4mm posts

KITS

Complete with screen printed & solder mask board, components and full instructions.
 CAR ALARM voltage drop £12.99
 200W CAR BOOSTER 12/24V CD/line/speaker input. inc housing. £91.88
 ELECTRONIC DICE (dual) £9.15
 SOUND GENERATOR 10 tones, line & speaker output £19.11
 2.5W UNIVERSAL AMPLIFIER £6.86
 AF SIGNAL INJECTOR/TRACER adjustable o/p & i/p £8.39
 DIGITAL CODE LOCK 4 digit code flip/flop or latch o/p £19.11
 AC MOTOR/DRILL CONTROLLER carbon brush 24-240Vac 5A £15.28

D CONNECTORS

9 pin	Plug	Socket
15 Pin	£0.29	£0.30
15 Pin H.D.	£0.39	£0.39
25 Pin	£0.81	£0.90
9 Way plastic cover	£0.48	£0.50
15 Way plastic cover	£0.30	£0.33
25 Way plastic cover	£0.30	£0.36

SOLDERING IRONS

Antex Soldering irons
 M12 Watt £7.11
 C15 Watt £7.11
 G18 Watt £7.30
 CS17 Watt £7.21
 XS25 Watt £7.30
 ST4 STAND £2.75
 New PORTASOL HOBBY
 35Watt gas iron £11.17
 DESOLDER PUMP £3.00
 ANTISTATIC PUMP £4.30
 22SWG 0.5Kg Solder £7.40
 18SWG 0.5Kg Solder £6.60
 1mm 3 yds Solder £0.50

AUDIO CONNECTORS

PHONO PLUG inc strain relief, Red or Black £0.17
 PHONO PLUG right angle, Red or Black £0.23
 PHONO Chassis Socket £0.16
 6.35mm Plastic Mono Plug with strain relief £0.25
 As above but Stereo £0.45
 6.35mm Chassis Socket, switched Mono £0.36, switched Stereo £0.49
 3.5mm Mono Plug £0.17
 3.5mm Stereo Plug £0.29
 3.5mm Mono line skt £0.24
 3.5mm Stereo line skt £0.29
 PLASTIC DIN PLUGS
 2 pin £0.15, 5/360 £0.27, 3 pin £0.24, 6 pin £0.30, 4 pin £0.29, 7 pin £0.33, 5/180 £0.26, 8 pin £0.45, 5/240 £0.30
 XLR Chassis Socket £1.65
 XLR Chassis Plug £1.32
 XLR Line Socket £1.45
 XLR Line Plug £1.36

ELECTROLYTIC RADIAL CAPACITORS

uF	16V	25V	63V	100V
0.47	-	-	£0.05	£0.07
1.0	-	-	£0.05	£0.06
2.2	-	-	£0.05	£0.06
4.7	-	-	£0.05	£0.08
10	£0.05	£0.05	£0.06	£0.08
22	£0.05	£0.05	£0.09	-
47	£0.06	£0.06	£0.11	-
100	£0.06	£0.09	£0.11	-
220	£0.09	£0.12	£0.31	-
470	£0.15	£0.19	£0.57	-
1000	£0.22	£0.29	-	-
2200	£0.37	£0.57	-	-
4700	-	£1.11	-	-

HARDWARE

PCB Nylon Stand-offs clip into board, screw from base.
 5mm spacing £0.24/10 £1.68/100
 10mm spacing £0.26/10 £1.82/100
 13mm spacing £0.30/10 £2.10/100
 SELF TAPPING SCREWS Pan head
 No 6 x 6.4mm £0.14/10 £0.88/100
 No 6 x 9.5mm £0.12/10 £0.78/100
 No 6 x 13mm £0.13/10 £0.85/100
 No 6 x 19mm £0.16/10 £1.04/100
 T2 Box 75 x 56 x 25mm £0.76
 T3 Box 75 x 51 x 25mm £0.72
 T4 Box 111 x 57 x 22mm £0.92
 M81 Box 79 x 61 x 40mm £1.36
 M82 Box 100 x 76 x 41mm £1.48
 M83 Box 118 x 98 x 45mm £1.72
 M85 Box 150 x 100 x 60mm £2.36

REGULATORS

78L05, 78L12, 78L15 £0.24
 79L05, 79L12, 79L15 £0.28
 7805, 7812, 7815 £0.28
 7905, 7912, 7915 £0.38
 LM317T 1.5A 1.2-37V £0.44
 LM723 150mA 2-37V £0.29

DIODES

Zener Diodes 2V7-33V
 BZY88 400mW £0.08
 BZX85 1.3W £0.14
 1N4001-1N4005 £0.07
 1N4006-1N4007 £0.08
 1N5400-1N5402 £0.09
 1N5404-1N5406 £0.11
 1N5407-1N5408 £0.15
 1N4148 Signal £0.05
 OA90 Signal £0.07
 OA91 Signal £0.10

THYRISTORS & TRIACS

PO102AA 0.8A 100V SCR £0.22
 TIC106D 5A 400V SCR £0.40
 TIC206D 4A 400V Triac £0.65
 BTA08-400B 8A iso £1.74

VELLEMAN KITS

Stockists of the full range of Velleman kits. Catalogue available upon request.

RESISTORS

0.25W 5% CF E12 Series £0.60/100
 0.5W 5% CF E12 Series £0.95/100
 0.25W 1% MF E24 Series £1.72/100
 POTS Log or Lin 470R - 1MO 25mm dia 0.25in shaft £0.40
 PRESETS Enclosed Horz or Vert 100R - 1MO 0.15W £0.15
 PRESETS Skeleton Horz or Vert 100R - 1MO 0.1W £0.11

CAPACITORS

Ceramic Disc 100V 10pF to 100nF £0.07
 Ceramic Plate 100 & 63V 1.0pF to 12nF
 1pF-1nF £0.06, 1n2-2n7 £0.09, 3n3-4n7 £ 0.12, 10n & 12n £0.06
 Polystyrene 160V 5% 47pF to 10nF
 47p-2n2 £0.09, 2n7-10n £0.12

RELAYS

6V SPDT 6A £0.70
 12V SPDT 6A £0.70
 6V DTPD 6A £1.96

DIL SOCKETS

8 Pin	£0.07
14 Pin	£0.11
16 Pin	£0.15
18 Pin	£0.16
20 Pin	£0.16
24 Pin	£0.19
28 Pin	£0.22
40 Pin	£0.25

TEST & MEASUREMENT

HM103S ANALOGUE METER
 19 ranges (Inc 10Acd), fuse & diode protection, battery test, shock resistant tilted case, mirrored scale, supplied with battery, leads & instructions. Dim. 154 x 77 x 43mm £11.47
 HC2020S ANALOGUE METER
 20 Ranges (inc 10Acd), fuse & diode protection, transistor & diode tester, polarity reverse switch, high impact shock resistant case. Supplied with battery, leads, stand & instructions. Dim. 150 x 102 x 45mm £18.45

DY107 LOGIC PROBE
 TTL & CMOS, displayed in light & sound, pulse enlargement, pulse detection down to 25nsec, max freq. 20MHz. Supplied with full instructions. £7.72

MX190 DIGITAL METER
 19 ranges, 3.5 digit 12mm LCD, signal injector, diode test, fuse protection, auto polarity & zero, supplied with battery, leads & instruction manual. Dim. 126 x 70 x 24mm £14.73

M2315B DIGITAL METER
 17 Ranges (inc 10Acd), 3.5 digit 12mm LCD, diode test, buzzer, auto polarity & zero, over-range & low bat indication, supplied with battery, leads & instructions. Dim. 130 x 72 x 33mm £23.40

RF CONNECTORS

BNC Solder Plug £0.85
 BNC Crimp Plug £0.68
 BNC Solder Skt £1.08
 BNC Chassis Skt £0.78
 PL259 5.2mm £0.58
 PL259 11mm £0.58
 RND UHF socket £0.48
 SQR UHF socket £0.40
 F Plug RG58 £0.27
 F Plug RG6 £0.27
 N Plug RG8 £1.64

LINEAR ICs

TLO71CP £0.32
 TLO72CP £0.34
 TLO74CN £0.48
 TLO81 £0.29
 TLO82CP £0.34
 TLO84CN £0.46
 TBA120S £0.60
 LM301A £0.25
 CA311E £0.28
 CA324 £0.23
 LM348N £0.31
 LF351N £0.36
 LM358N £0.27
 LM377 £2.57
 LM380N £1.12
 LM381 £2.70
 LM386 £0.48
 LM387 £1.60
 LM392N £0.79
 LM393N £0.28
 CA555 £0.22
 NE556N £0.36
 NE567N £0.36
 UA733 £0.64
 CA741CE £0.18
 LM748CN £0.31
 TB810S £0.68
 TB820M £0.39
 LM1458 £0.26
 ULN2004 £0.48
 TDA2030 £1.35
 CA3046 £0.37
 CA3080 £0.72
 CA3130 £0.98
 CA3140 £0.44
 CA3240 £1.22
 LM3900 £0.72
 LM3914 £2.70
 LM3915 £2.70
 MC4558 £0.36
 NE5532 £0.80
 ICL7621 £1.70

ADAPTORS

BNC Plug - PHONO Skt £0.78
 BNC Plug - BNC Plug £1.96
 BNC Skt - BNC Skt £1.00
 BNC Plug - UHF Skt £1.38
 BNC Plug - 2 x BNC Skt £1.89
 BNC Skt - 2 x BNC Skt £1.89
 UHF Plug - BNC Skt £1.59
 F Socket - F Socket £0.33
 3.5mm Plug - 2 x Skt £1.20
 3.5mm Plug - 25in Skt £0.57
 0.25in Plug - 3.5mm £0.57

AUDIBLE WARNING

400Hz 75dB 9-20V £0.72
 450Hz 80dB 9-12V £1.14
 4KHz 90dB 3-15V £0.92
 2.8KHz 100dB pulsed £1.60
 3.5KHz 75dB 240Vac £1.22
 4KHz 80dB 30V pk-pk £0.58

BRIDGE RECTIFIERS

W005 1.5A 50V £0.19
 W02 1.5A 200V £0.20
 BR32 3A 200V £0.36
 BR62 6A 200V £0.64
 1004 10A 400V £1.39

4000 Series

4000	£0.20	BC107	£0.14
4001	£0.17	BC108A	£0.12
4002	£0.19	BC109C	£0.15
4006	£0.32	BC177	£0.16
4007	£0.20	BC178	£0.16
4008	£0.31	BC179	£0.18
4010	£0.19	BC182LB	£0.09
4011	£0.16	BC183LB	£0.09
4013	£0.17	BC184L	£0.11
4014	£0.30	BC212L	£0.09
4015	£0.31	BC212LB	£0.09
4016	£0.18	BC213LC	£0.09
4017	£0.25	BC214	£0.11
4018	£0.27	BC327	£0.12
4022	£0.32	BC328	£0.10
4024	£0.21	BC337	£0.12
4025	£0.15	BC338	£0.08
4026	£0.40	BC527	£0.24
4027	£0.18	BC528	£0.24
4029	£0.27	BC537	£0.24
4030	£0.17	BC538	£0.24
4033	£0.56	BC547C	£0.09
4035	£0.31	BC548C	£0.08
4040	£0.29	BC549C	£0.10
4042	£0.22	BC557C	£0.09
4046	£0.31	BC558C	£0.09
4047	£0.25	BC559C	£0.09
4049	£0.20	BDX33C	£0.46
4051	£0.25	BDX34C	£0.54
4052	£0.40	BFY50	£0.24
4053	£0.24	BFY51	£0.24
4055	£0.30	BFY52	£0.24
4060	£0.31	TIP29C	£0.33
4063	£0.29	TIP30C	£0.33
4066	£0.18	TIP31C	£0.33
4069	£0.20	TIP32C	£0.34
4072	£0.17	TIP33C	£1.02
4075	£0.17	TIP41A	£0.36
4076	£0.30	TIP42C	£0.28
4077	£0.15	2N2222	£0.16
4082	£0.17	2N2905A	£0.28
4089	£0.55	2N3704	£0.09
4093	£0.15	2N3705	£0.09
4094	£0.31	2N3706	£0.09
4095	£0.56	2N3771	£1.22
4510	£0.26	2N3772	£1.28
4511	£0.29	2N3773	£1.88
4515	£0.78	2N3904	£0.10
4520	£0.26	2N3905	£0.10
4521	£0.84	2N3906	£0.09
4534	£2.48		
4538	£0.37		
4541	£0.31		
4572	£0.25		
4584	£0.24		
4585	£0.48		
40106	£0.24		
40174	£0.34		

74LS Series

74LS00	£0.14
74LS01	£0.17
74LS02	£0.18
74LS03	£0.17
74LS04	£0.14
74LS05	£0.17
74LS08	£0.17
74LS09	£0.17
74LS10	£0.17
74LS11	£0.17
74LS12	£0.16
74LS20	£0.16
74LS21	£0.16
74LS26	£0.16
74LS32	£0.17
74LS37	£0.16
74LS42	£0.25
74LS51	£0.19
74LS52	£0.19
74LS56	£0.20
74LS92	£0.40
74LS93	£0.25
74LS107	£0.30
74LS109	£0.21
74LS123	£0.40
74LS125	£0.21
74LS133	£0.22
74LS138	£0.24
74LS153	£0.25
74LS154	£0.90
74LS157	£0.25
74LS159	£0.25
74LS164	£0.26
74LS165	£0.53
74LS175	£0.24
74LS191	£0.24
74LS193	£0.24
74LS367	£0.21
74LS374	£0.32

CONNECTORS

CROC CLIPS 33mm Red or Black £0.12
 CROC CLIPS 45mm Red or Black £0.20
 PP3 Battery Snap £0.10
 PP9 Battery Snap £0.14
 4mm BANANA PLUG Red or Black £0.09
 4mm BUNCH PIN PLUG Red or Black £0.30
 4mm BINDING POST Red or Black £0.54
 SCART PLUG £0.80
 SCART PCB Skt £0.78
 SCART LINE Skt £1.35
 IEC LINE SOCKET £0.78
 IEC CHASSIS PLUG £0.72
 IEC CHASSIS SKT £0.66
 CAR AERIAL PLUG £0.19
 CIGAR LIGHTER PLUG £0.30

ORDERING INFORMATION

All prices exclude VAT.
 Please add 85p carriage to all orders and VAT (17.5%).
 No minimum order charge.

Please send payment with your order
 PO/Cheques made payable to
ESR Electronic Components

Access & Visa cards accepted
 Official orders from schools & colleges welcome.

CALL IN - OPEN: MON 8.30-5.00 SAT 10.00-5.00



EUROPEAN INTERNATIONAL AUDIO and VIDEO FAIR

**Barry Fox reports from Berlin
on the latest trends in home
entertainment on show at the
Funkausstellung '91 exhibition.**

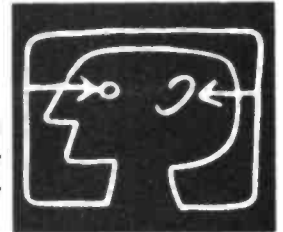

EVERY two years since 1924, with only the war years missing, the city of Berlin has staged a radio show or Funkausstellung. The radio show has now become an international "world of consumer electronics" exhibition taking in TV, video, satellite, telecommunications, computers, games, hi fi and electronic gadgetry.

Manufacturers from all round the world now see the *Internationale Funkausstellung*, or IFA, as the prime pad for launching new products into Europe. This year IFA was bigger than ever, with 571 exhibitors from 29 countries spread through 25 enormous exhibition halls. Despite an entry fee to the public of 15 German marks (around £5 pounds) the organisers expected nearly a million visitors during the ten day show.

For the first time since 1961, visitors came over from the East. Where the Berlin wall once stood, there is now just a strip of land with not a trace of the concrete obscenity which for thirty years split the city in two. In fact the only trace of the wall are the pieces of rubble which street merchants now sell off as souvenirs.

Significantly, satellite aerials are now sprouting over the drab concrete apartment blocks and old housing (some still bomb-damaged and shell-pocked) in the Eastern sector.

IFA saw the usual crop of electronic novelties, and the emergence of several distinct trends in the consumer electronics industry.

Whats Up Mac

In the run-up to opening-day all eyes had been on Philips and Sony who were due to try and build confidence in their new home digital recording systems, Digital Compact Cassette and Mini Disc. There was also clearly a row brewing between the satellite broadcasters, such as BSkyB, who want to continue transmitting in PAL, and European electronics companies who have invested heavily in the development of MAC and high definition MAC technology. As the show opened a temporary truce between Philips and Sony collapsed and the simmering bitterness between the PAL and MAC factions flared into open warfare.

By 1992 the Eureka 95 team of 1000 engineers will have spent over £500 million pounds on an HDTV system to broadcast the Olympics to 1000 HDTV sets across Europe. The HDTV system is a 1250 line version of the 625 line MAC system developed for satellite. If MAC fails, so does HD-MAC. Most

satellite broadcasters, like Rupert Murdoch's BSkyB, are scorn-ing MAC and using the terrestrial PAL system.

In Berlin Peter Bogels, President of the EU-95 HDTV directorate, blamed the European Commission for leaving PAL loopholes in its 1986 MAC Directive.

"There was a flaw, a hole in the law, that let people start PAL transmissions", said Bogels. Despite the magnitude of the EC's mistake no one in the HDTV directorate can say who in the EC was responsible.

EC Telecommunications Commissioner, Filippo Maria Pandolfi recently met Rupert Murdoch in Brussels and joined German Telecommunications Minister, Christian Schwarz-Schilling in Berlin to announce the EC's latest plan. This doubles, to 1Bn ECUs, the European tax payers' money available for simultaneously broadcasting PAL programmes in MAC until January 1994. Any new broadcaster now starting in PAL must switch to MAC in 1994 and will not be paid the sweetener to simulcast.

Pandolfi has now asked a Working Group to report by 15 September on whether there will be enough satellite transmitters in orbit to cope with simulcasting.

Eight German broadcasters (ARD, ZDF, RTL Plus, Sat 1, Pro 7, Tele 5, Premiere and VPRT) issued a statement saying "No" to the proposal because "it is not fair for the EC to make this law and not friendly for the consumer or for owners of satellites or receivers in Europe".

Although demonstrations of the 1250 line HD MAC system at Berlin were impressive, parallel demonstrations intended to show how HDTV signals can also be received on 625 line MAC sets were disappointing.

Although this was due to technical defects in the cable relay system used on the enormous exhibition site, no one told the million visitors expected. Whereas the digital circuits in a full-blown HDTV set can compensate for spurious echo signals, other sets cannot.

The first demonstration of a wide screen PAL system, PAL Plus, which Grundig, Nokia, Philips, Thomson and European broadcasters have been developing in parallel with HDTV, gave better pictures than the MAC demonstrations. To avoid undermining MAC's credibility, the PAL Plus designers stress that their system is intended only for terrestrial use. But they admit it could equally well be used by satellites.

To transmit PAL Plus, the broadcaster feeds a 625 or 1250 line wide screen picture signal through a digi-

The HK33 LD multi-media laser-disc system from Sharp brings all the fun of "Koraoke" into the home. The system is claimed to allow anyone to "sing-along" with the video clips of their favourite stars.

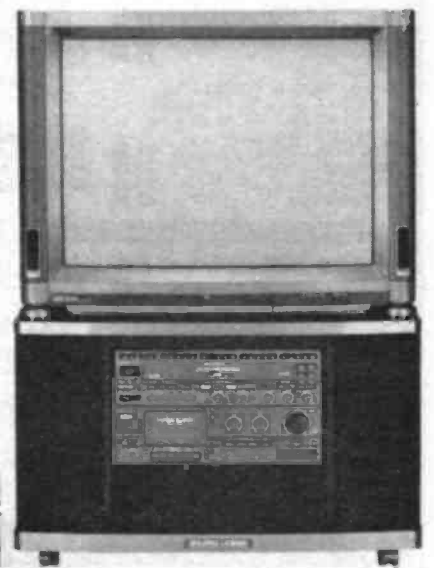

Widescreen TV set from Nokia/ITT

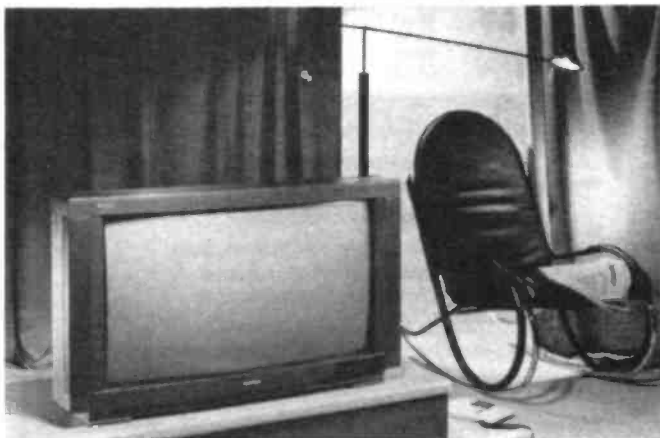

tal filter. This reduces the number of picture scanning lines by a quarter. The remaining three quarters appear on a conventional 4:3 aspect ratio PAL TV set as a letterbox picture, with black borders at the top and bottom.

The filtered information is converted into a digital "helper" signal like teletext. This helper is buried in the black borders of the letterbox picture as a signal which conventional TV sets treat as pure black. So the helper code is invisible on conventional sets. A PAL Plus receiver decodes the helper to rebuild a 625 line picture which fills the full area of a 16:9 wide aspect screen. Demonstrations given at Berlin prove that the "helped" signal is clearer than the original.

Behind Closed Doors

Pre-show leaks had Philips and Sony doing a cross-licencing deal on their new, rival, home digital recording systems, Digital Compact Cassette (Philips) and Mini Disc (Sony). There were no such deals. And both companies badly fumbled their pitch. It is a measure of the strength of DCC that the format still looks likely to prevail over MD.

The show opened with no sign of MD or DCC on Sony's public stand. Upstairs, in a closed room behind a wall of bureaucratic security the trade and press could see MD, with descriptive placards and literature round the room. A DCC player (one of the many hand-built models made by Philips) sat on a shelf, without any descriptive material, like an unwelcome corpse.

The was no sign of DCC or Mini Disc on the Philips stand either. This in itself was a surprise bearing in mind the considerable amount of advance publicity which DCC has generated. Upstairs, and behind similarly bureaucratic security, Philips demonstrated DCC in a studio room and had four units in a glass case. The top end DCC-900 will be launched in the spring, the mid-range DCC-300 in the late summer along with the DCC-180 "portable personal", and a car player due towards the end of 1992.

At Sony's press conference Kozo Ohson, Senior Managing Director of Sony and Jack Schmuckli, Chairman of Sony's European operations, claimed that Mini Disc was being "endorsed by major players in the software industry such as EMI, Warner and Sony's own CBS group". Sony also distributed a document which clearly promised that Sony, EMI, Warner, Virgin and BMG "will support Mini Disc". A question and answer session proved this to be pure wishful fantasy.

Said Christian Jorg, BMG's Manager of New Technologies (representing RCA, Ariola and Arista), "We are interested in Mini Disc. We would like to evaluate it. But we are quite a way from introducing it. It does not have our full support at this point. No decision has yet been made about it and when we will release material on Mini Disc".

BMG's Chairman Michael Dornemann had already written to Michael Schulhof, President of Sony Software, CBS. "Clearly BMG needs more information on Mini Disc before we can begin to consider marketing and manufacturing preparations".

A spokesman for EMI was equally vague. "We have an open mind to every carrier". Geoff Holmes, Senior Vice President of Time Warner, (Warner, Elektra and Atlantic) was equally reserved. "It is too early to talk. We are evaluating MD". The man from Virgin never showed up.

Back in London Virgin confirmed there had been no deal with either Philips or Sony.

"If the public wants it we will sell it" said Virgin.

No Endorsement

Prior to the show there had been agreement between Philips and Sony that each would exhibit each other's format. "I don't know what they've done with ours", admitted Schmuckli. In fact Philips had sent it straight to Eindhoven for technical evaluation.

Around 500 people attended the Philips' press conference and many left bitterly disappointed. Completely misreading the predominantly technical environment at Berlin, Philips sailed in with a patronizing presentation that centred round a clumsy audio-visual show anchored by Peter McCann, described by Philips Audio MD Wim Wielans as from the BBC's Tomorrow's World. As a matter of record, McCann left TW in June.

Both McCann and Wielans repeatedly used the slogan "everybody is supporting DCC". Even with the qualification which McCann later added, "by which we mean everyone in the whole chain of the music industry who is of importance", this claim is patently and blatantly untrue.

BASF are committed to tape production. For hardware, Grundig, B&O, Thomson, Sanyo, Sharp and Yamaha are on board with Matsushita (Panasonic/Technics) and Tandy.

Philips has much stronger software support than Mini Disc, but missed the trick of bringing this out at the press conference; there was no Question and Answer session.

Whole strings of Japanese electronics companies, including Sony, Pioneer, JVC, Denon, Mitsubishi, Akai, Trio-Kenwood and Toshiba have not yet signed to support DCC. Neither have tape companies TDK or Maxell.

The rest of the industry may very well back DCC in the future, but at present for Philips to say that "everybody is supporting DCC" is as inaccurate and foolhardy as the original slogan Philips coined for CD, "perfect sound for ever". As proved by the poor quality of early CD players and the scare over discs which failed because the air got to the aluminium reflective layer, nothing is perfect and nothing lasts for ever.

Mobile Library

Although Philips looks likely to win the battle for a new *de-facto* home digital audio standard with DCC, Sony is surely onto a winner with Data Discman, launched last July in Japan. Tagged "Tomorrow's Mobile Library", this is a portable CD player with an LCD screen and small Qwerty keyboard. It plays 8cm CD-ROM discs which contain reference works, text books, foreign language dictionaries and encyclopaedias. The 8cm disc has a storage capacity of 200 megabytes. Although this is only one-third the storage capacity of a full size, 12cm CD-ROM, it is more than enough to hold several volumes of an encyclopaedia.

Data Discman has been a success in Japan with over 130,000 units sold and 35 disc titles now available. The Discman ROM discs are incompatible with existing CD-ROM computer systems and with the CD-Interactive system to be launched next year. Also, although the portable unit can be connected by video lead to a TV screen for clearer display there is no socket for connection to a computer. This is deliberate policy. It prevents users downloading text or data from an electronic book. This restriction has encouraged publishers to support the format.

Data Discman will go on sale in Germany this November, for around 1000 DM (around £350) with 14 electronic books including Langenscheidt's English/German dictionary and the Bertelsmann Universal Lexicon. Sony plans a launch in the UK early next year with English language titles.

Data Discman could finally make electronic publishing a reality. Although many electronic books and databases are already available on 12cm CD-ROM, a mish-mash of standards requires that the set-up for a Personal Computer with CD-ROM drive must be fine-tuned to run each CD-ROM in turn, with the set-up for one disc not working for another. By creating a new standard for Data Discman Sony guarantees the user buy-and-play simplicity, while protecting the publisher from piracy.

Travelling Light

Every year it seems that manufacturers cannot possibly make video camcorders any lighter or any smaller. Virtually all now use a tiny solid state image sensor (CCD chip, less than 1cm in size) behind the lens instead of the bulky tube sensors used in early video cameras. But every year the rival manufacturers manage to shave off a few more grams and centimetres. This brings its own penalties. Panasonic now builds an electronic image stabilizer into its Palmcorder, a VHS-C camcorder with 12:1 zoom lens weighing 700 grams. The image stabilizer compensates for the unsteadiness in pictures shot with a light camcorder that fits in the palm of a hand.

Sony now claims the record for the smallest and lightest camcorder in the world. The new Traveller TR-705 weighs just 590 grams and will sell for under £1000. The remarkable feature of the Traveller is that it is a Hi-8 recorder, the 8mm video equivalent of Super VHS.

The VHS-C NV-35 Palmcorder from Panasonic weighs in at only 700grams.



Pictures are better than broadcast quality. The Traveller also records sound in stereo.

Hitachi is now introducing new technology which will let camcorders get even smaller and lighter in the future. Its new 8mm models VM-23 and VM-25 convert the analogue signal which comes from the image sensor into digital code. All the processing work which must be done on the picture signal before it is recorded can now be in the digital domain. This reduces the amount of circuitry needed because it is much easier to integrate digital systems into a single chip than analogue systems. Witness the way watches and calculators have got smaller and cheaper, with more and more facilities.

TV Mouse

Nokia/ITT is already selling table-top VCRs with a system called ASO (Active Sideband Optimum) which gives clearer pictures from poor recordings, e.g. old tapes. ASO works by cleaning up the f.m. video signal which comes off the tape before it is demodulated and processed by all the conventional circuitry in a VHS recorder. Now Nokia has developed ASO Plus, which goes one stage further.

ASO Plus continually monitors the condition of the f.m. signal coming off tape and applies only the amount of clean-up processing that the signal needs. So the recorder gets the best possible picture from any tape, whether old and worn or brand new.

Japanese company Sanyo uses ASO, but probably only because Sanyo makes Nokia's VCRs under subcontract in Japan. So far no other Japanese company has taken up Nokia's system. Nokia's new slogan is, "The sharpest image VHS video ever had to offer". But JVC, inventor of the VHS video system is not impressed and has no plans to use ASO.

Nokia may have more success with a clever new remote control for a TV set or VCR. It works like a computer mouse. The viewer just presses a couple of buttons to display a cursor on screen and then tilts the control from left to right or up and down to move the cursor and select options from a menu. The control has a tiny roller ball, like a ball bearing, hidden inside. The ball rolls between infra-red diode light sources and light sensors to generate an electrical signal which indicates the physical position of the controller. This signal is then translated into a control signal which moves the cursor on screen.

CD Photos

Over the last ten years portable video recorders and camcorders have completely killed the small gauge, home movie film industry. Kodak no longer even makes Standard 8 movie film and Super 8 cartridges are increasingly hard to find in the shops. Now there is a trend towards electronic still imaging. Kodak argues that electronic still cameras can never match the resolution of 35mm camera slide film and is committed to the hybrid system called Photo CD. At Berlin Kodak confirmed plans to launch this new system in the UK next June.

Photographers will shoot pictures with conventional cameras and conventional film and have it processed in the usual way. Then they will pay a Photo CD centre to convert the pictures into digital code and transfer up to 100 onto a 12cm CD. This Photo CD will play on a Photo CD player, looking like a CD player, which displays the pictures on the screen of any TV set.

The images stored on the disc are of a far higher quality than any TV screen can display (four times the resolution of a high definition TV picture and fifteen times the resolution of a con-

ventional TV picture) so photographers can use their Photo CDs as a storage and quick display medium. They will then pay the Photo CD centre to make high quality paper prints of selected images.

Philips will make Photo CD players for Kodak to sell under the Kodak brand name. Other manufacturers will be able to buy a circuit board which performs all the vital functions. Kodak hopes that this will encourage other firms to start selling their own-brand Photo CD players.

Unlike all other new formats Photo CD has the advantage that it is not dependent on pre-recorded software. Photographers are in effect creating their own Photo CD software.

The big question mark is over price. Kodak may well be able to meet the promised price tag of around £300 for a player (which also plays audio discs) but the predicted prices for transferring snapshots to Photo CD look very over-optimistic. At Berlin Kodak reiterated its pledge that the Photo CD Centre will charge less than £10 to transfer 24 pictures from film to disc. Having in mind the heavy capital investment in transfer equipment (up to £100,000) the cost of blank record-capable CDs (currently around £30 each) and the cost of labour to control the transfer process, it is hard to swallow the £10 price promise.

Kodak says that volume production of discs will drastically reduce their price. But I now have a bet (one pint of beer) with Kodak's head of public relations and legal affairs in Europe, Dr. Karl Steinorth. At Berlin I bet him that the cost of transferring 24 pictures will be higher than the 25-30 DM (well under £10) he pledged at Berlin.

In Japan both Sony and Canon sell electronic still picture cameras which record 50 images on a 5cm (2in.) magnetic floppy computer disc. Both companies launched in the USA but sales were slow. Sony never launched its Mavica system in Europe but Canon went ahead with the Ion. Sales of the Ion have been slow too, for one very simple reason. People like to carry snapshot prints around in their wallets to show to friends. An electronic still camera must be connected to a TV set to display images.

New Trends

At Berlin Panasonic announced a video printer which can connect to a video recorder, or electronic still camera, and make a paper print from the video image. But the Panasonic Movie Printer, which goes on sale this winter, will cost at least £1000, with blank paper as costly as photographic paper.

To solve the cost problem Canon unveiled its "Ion print service" at Berlin. Canon says that by the end of 1992 over 1000 hi fi, video and camera shops throughout Europe will have installed a video printer. Photographers will take electronic snapshots on an Ion camera and then take the floppy disc to their nearest Ion service centre. There they will tell a sales assistant which of the 50 images on the disc they want printed. Each colour print will take around two minutes to make, and cost around 75p. The printer is controlled by a Commodore Amiga computer, which allows some manipulation of the image before printing. Although the system works well print quality is frankly poor - generally inferior to a Polaroid instant picture print.

BASF has a neat idea for a new range of VHS cassettes. It is borrowed from the 8mm video format. On audio cassettes users prevent accidental erasure or over-recording by breaking off a safety tag on the rear edge of the cassette. The same system is used for VHS. The only way then to record on a protected cassette is to stick Sellotape over the gap left by the broken tag, which is inelegant.

Video 8 cassettes have a sliding tag, similar to the sliding tag on 3.5in. computer floppy discs. Now BASF has made a VHS cassette with a sliding tab instead of the usual breakable tag. First prototypes use a red tag but BASF will change it to green, reasoning that it makes more sense to have a "green for go" signal.

Now that wide screen 16:9 aspect ratio TV sets are coming on the market (from Thomson/Ferguson, Nokia/ITT and Philips), manufacturers are looking at ways of using home video as a source of wide screen material. JVC in Japan already sells an anamorphic lens adaptor for its camcorders. This optically squeezes a wide screen image into the conventional 4:3 picture area, just like a Cinemascope cinema film camera. The tape is played back on a conventional VCR, and for viewing is projected onto a screen with an anamorphic lens over it.

The more elegant approach is to squeeze and unsqueeze the image electronically, without the use of extra lenses. This is done by altering the speed at which the picture lines are scanned. A standard already exists for doing this.

At Berlin JVC announced that it will soon start selling a

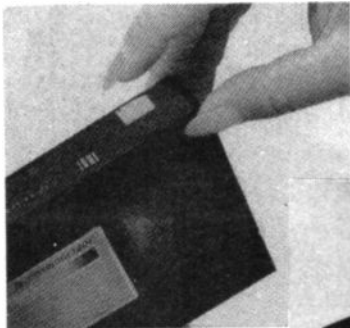

Breakdown of the Nokia TV Mouse controller showing the roller ball between the I.e.d. sensors.

The new VHS cassette from BASF has a sliding record/save tab.



Super VHS recorder which will electronically compress a wide screen image for replay on wide screen TV sets. The HR-S 4700 also has circuitry which automatically detects whether the image recorded on tape is of conventional 4:3 size or compressed 16:9 wide screen format. It then decodes the picture, depending on aspect ratio.

Initially the HR-S4700 will be of most use for playing back pre-recorded tapes of wide screen films made in compressed format. Thomson/Ferguson already has plans to subsidise the duplications of widescreen movie tapes. But the logical next step is a camcorder with the ability to record electronically compressed wide screen images. Although there is so far no VHS camcorder which plays this trick, Hitachi showed the pre-production prototype of an 8mm camcorder which can shoot in either wide screen or conventional 4:3 format.

This Hitachi camcorder has a CCD image sensor which has wide screen, 16:9 aspect ratio. For wide screen filming, the full area of the CCD is used, with the picture electronically compressed into 4:3 format for recording onto tape. For 4:3 shooting, the camera uses only part of the CCD image sensor area. Electronic compression is made easier because the camcorder uses Hitachi's digital signal processing circuitry.

The widescreen pictures shown at Berlin on a wide format back projection screen were very impressive. This must surely be the way amateur video movie making goes in the future.

Cinevision

Berlin was seen by the European TV manufacturers as the launch pad for widescreen TV sets, with an aspect ratio of 16:9. The manufacturers have now coined the neat name tag "Cinevision".

There is mounting confusion over just what the various new widescreen sets offer, and what compromises they adopt. To try and clear the air I put together a short summary in the simplest words I could find and then got all three manufacturers, Philips, Nokia/ITT and Thomson/Ferguson to check it for accuracy.

Conventional 625 line TV in Europe displays 50 images a second, each made up from 312.5 lines, vertically staggered so that they interlace to create the illusion of twenty five 625 line pictures a second.

Philips and Grundig are already building 100Hz circuitry into their large screen 4:3 TV sets. Some people, especially if used to



The new Photo CD discs and player from Kodak. The latest Philips widescreen TV can be seen in the background.

North American NTSC TV which has a picture rate of 60Hz, find wide area flicker very noticeable on European 50Hz TV sets. At 100Hz flicker disappears completely.

The Ferguson Space System 16:9 wide screen set, and also Nokia's, doubles the line structure from 625 to 1250 but retains an interlaced structure and retains the 50Hz field rate. So there are 50 images a second, each made up from 625 lines staggered to interlace on screen as a 50Hz, 1250 line picture.

The Philips widescreen set retains the 625 line interlaced structure, but doubles the field rate from 50Hz to 100Hz. So there are 100 images a second, each made up from 312.5 lines, staggered to create the illusion of fifty, 625 line pictures.

Philips will move next to 625 line "progressive" scan at 100 Hz, with 100 images a second each made up from a full 625 lines.

WINTER 1991/1992 CATALOGUE

OUT NOW!

- 100's of price reductions throughout the catalogue
- 200 pages
- Latest new products
- £££'s worth of discount vouchers
- On sale from 14th November at most large newsagents or directly from **Cirkit**



£1.70
plus 30p postage

Cirkit

CIRKIT DISTRIBUTION LTD

Park Lane · Broxbourne · Hertfordshire · EN10 7NQ

Telephone (0992) 444111 · Fax (0992) 464457



EE CROSSWORD

Across

- 2 Some call a servant, a shining light,
It's straight and narrow, all right?
- 6 Very tiny, but just the same,
A thousand micro's this contains.
- 7 A useful amp, that 741,
So Pam Perkins now has one.
- 9 Electric pressures rule the game,
I x R equals the same.
- 10 The initial start I want to see,
Of a rival to EE.
- 11 Likewise of 10 across,
This time the BEST - the Boss!
- 12 Current is limited, there's no chance,
But Oh Mum! She has resistance.
- 14 Transistor's are all the same, some moan,
But this one's in a field of its own.
- 15 Some words reversed have a value of none,
This little gem is worth a million.
- 18 Such a variable device, my dear,
To measure one's potency, we hear.
- 19 Let there be light, and resistance low.
What is it, initially, I want to know.
- 20 Although not manual, this feedback is able,
It's in my bag contents and keeps me stable.
- 21 A large source of energy, it can't be seen,
The MP holds it, if you see what I mean.
- 23 Not NOT, nor NOR, this gate can be,
But any high input, a high output you'll see.
- 25 No connection, but there should be,
It is a fault? It could be.
- 27 "Hear this!" he said "The answer's within."
It will provide a thorough grounding.
- 29 On the end of a 'scope lead, to prod so willing,
But first stop Robert, he holds it within.
- 30 Electric, water or gas, it could be,
Most likely 240 volts a.c.
- 31 Is this a golf course, we hear?
Just short connections from there to here.

Down

- 1 Digital electronics is the order of the day,
Initially, it's an uncommitted logical array.
- 2 Far from dead, this brown wire be,
Potentially dangerous, go carefully!
- 3 A burning need that won't melt your heart,
A bit too hot to handle this part.
- 4 One by any other name, but so appealing,
This holds wires in the ceiling.
- 5 A memory so lecherous, we hear,
It's random and without Visa. Oh dear!
- 6 A sound where left and right compare,
Fine if you only have one ear.
- 8 A male connection and that's a fact,
Just gulp backwards to make contact.

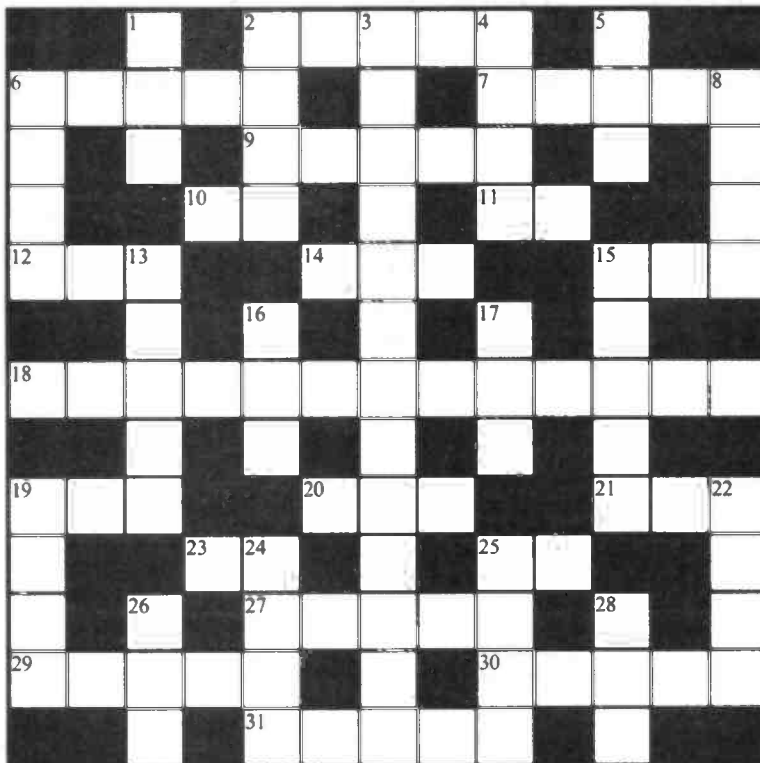

- 13 Swinging needle or LCD,
It'll measure the same with accuracy.
- 15 It's a good yardstick for some,
And sounds just like 13 down.
- 16 All inputs up switch and output too,
This clever gate hides in sand for you.
- 17 This is motivation initially,
Applied to electronic circuitry.
- 19 Freed from darkness but still in clamps,
This shining example might draw amps.
- 22 Some good contacts must be found,
They'll be a snip, the other way round.
- 24 For wire or solder this can be,
It sounds genuine enough to me.
- 25 As 12 Across, but plural you see,
A James Bond Movie, initially.
- 26 It's not paper, you can't write to this,
But you can read, only memory it is.
- 28 Noah led his animals with this direction,
This i.c. socket will make the connection.

Seasons
greetings to
all our
readers

These puzzles are for fun
only. See page 51
for solution.

EE WORD SEARCH

E L B A T S A E O P A M P
G V I N F R A R E D E O R
A U Y N D A A G C Y W S E
T W L L E D E E D E W F C
L T I P A A R O R I M E N
O A I R C S R S T E O T S
V M M I E I U C K R P D P
S N I P E P H A S E A M E
L K E P P O N L E D W C A
O H M L K R E E L L T A K
Q R Y E R A W T F O S D E
T I M E R O T S I S E R R
R E T E M O I T N E T O P

All the words in this Word Search are to do with electronics. When all the words are found, the remaining letters, starting from the top left hand corner, will spell out a familiar title and a name associated with it. Every letter is used.

The words to find are:

ADC
AGC
AMPERE
ASTABLE
CHOKE
DIODE
EMF
INFRA RED
LAMP
LED
LINEAR
MOSFET
OHM
OP AMP
PHASE
PINS
PLUG
POTENTIOMETER
POWER SUPPLY
RADAR
REEL
RESISTOR
RIPPLE
SCALE
SOFTWARE
SOLDER
SPEAKER
SWITCH
TEST
TRACK
TIMER
TOOLS
VOLTAGE
WIRE

MARCO TRADING

INCORPORATING EAST CORNWALL COMPONENTS
ELECTRONIC COMPONENTS



& EQUIPMENT

MAIL ORDERS • WHOLESALE
RETAIL



VISIT

SEND ORDERS TO - DEPT 1

MARCO TRADING
THE MALTINGS, HIGH STREET, WEM
SHROPSHIRE SY4 5EN

Tel: (0939) 32763 Telex: 35565
Fax: (0939) 33800

ELECTRICAL & ELECTRONIC
COMPONENT SUPPLIERS

24HR ANSAPHONE

LATEST 1992 CATALOGUE

- ★ Velleman Kit Catalogue
- ★ Free pre-paid envelope
- ★ Many new lines
- ★ Pages of special offers
- ★ Free gifts

132 PAGES



POST & PACKING IS NOW

£2.25

ALL PRICES INCLUDE

17½% VAT

TWIN FLUORESCENT LAMP - 12V



A very attractive twin tube lampholder with two 12V BW fluorescent tubes. White plastic case with clear plastic ribbed diffuser and ON/OFF switch. Supplied with 90cms of twin flex for connection to 12V battery (Red stripe to positive). Ideal for caravans, boats, vans, etc.
Overall dimensions: 370 x 65 x 41mm
ORDER CODE: Opto TFL12

Price 1+ 10+ 50+
£6.50 5.00 £5.25

SINGLE FLUORESCENT LAMP - 12V

Identical to above unit but single tube 12V dc, 8 Watts Dims 360 x 62 x 37mm.
ORDER CODE: Opto SL **£5.50**

SPARE TUBES

Replacement tube for above Twin and Single fluorescent lamps. Fits most 12V fluorescent lamps, Philips, etc. Tube length approx 300mm (inc pins).
ORDER CODE: Opto Tube

£1.50 ea, 10 for £12

PORTABLE FLUORESCENT LAMP - 12V



Free-standing or hanging with 15ft cable terminating in cigar lighter plug. For use in car, boat, van or home emergency. 12V dc. EVEN FLOODS IN WATER!
Overall dimensions: 430 x 30mm
ORDER CODE: 1+ 10+ 50+
Price **£6.50 6.00 £5.25**

FULL RANGE OF BABANI BOOKS IN OUR 1992 CATALOGUE

RESISTOR KITS - each value Individually packed

¼W pack 10 each value E12 - 10R to 1M 610 pieces.....	£5.30
¼W pack 5 each value E12 - 10R to 1M 305 pieces.....	£3.75
¼W pack Popular - 10R to 10M 1000 pieces.....	£6.99
¼W pack 10 each value E12 - 2R2 to 2M2 730 pieces.....	£8.75
¼W pack 5 each value E12 - 2R2 to 2M2 365 pieces.....	£5.40
¼W pack Popular - 2R2 to 10M 1000 pieces.....	£10.75
1W pack 5 each value E12 - 2R2 to 1M 365 pieces.....	£18.25
2W pack 5 each value E12 - 10R to 2M2 317 pieces.....	£25.00

ADDITIONAL KITS

Disc ceramic 50V...125 pieces	£3.99
Zener Diodes 5ea ... 55 pieces	£3.99
Electrolytics caps. radial.....	100 pieces £8.50
Fuses Q blow 20mm, 80 pieces	£4.75
Fuses T delay 20mm 80 pieces	£8.50
Pre-set pots. Hor.....	120 pieces £7.75
Pre-set pots. Vert.....	120 pieces £7.75
Polyester 100V.....	110 pieces £5.00
Nuts & Bolts.....	800 pieces £5.99

YUASA SEALED LEAD ACID BATTERY



1+ SUPER PRICE! £10.50
Two for £19.00

£38.00
Two for £60.00



YUASA CODE	H	W	D	Max Initial Charge Current	2.5V/Cell	2.3V/Cell
NP10-6	101	151	50mm	2.5A	7.5	6.9
NP24-12B	125	166	175mm	6.0A	15	13.8

Weights: NP10-6 2.2Kg NP24-12B 22.7Kg NP24-12B has bolt style terminals NP10-6 is spade style

JANUARY SPECIAL OFFER VIDEO LIGHT KIT ONLY NEW £69.99

TO81B VIDEO LIGHT KIT
A semi professional video light kit comprising 100W halogen lamp, remote 12V dc 7Ah sealed lead acid battery in carrying case with shoulder strap. 220/240V ac operated battery charger and camcorder power supply adaptor.

TO80B CAMCORDER BATTERY CHARGER KIT

A universal camcorder battery charger/power supply kit consisting of the charger, cigar lighter socket connecting lead, camcorder power lead, 4 adaptor plugs and a pouch. Compatible with the majority of 6, 7.2 and 9V camcorder batteries. **£22.00**

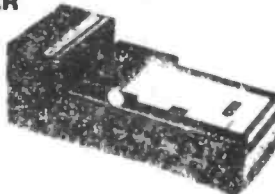

VIDEO LIGHT 30W

30W video camera light with hot shoe fitting and power on/off switch. Accepts 6V 1700mAh battery pack (Sony NP55 and NP77 typically)



£15.99

VHS VIDEO TAPES

VHS - JVC
3 HOUR
£1.99 each
10+
£1.75 each

MAXELL TAPES

UDI-90
90 MINS
£7.50
for 10

COMPUTER GRADE CAPACITORS

4700µf 100V Max Ripple 8+ at 100Hz - 85°C
DIMS: 115 x 50mm. List price is over £14 each!
Relax. Not from us 1- 10-
ORDER CODE: SO/COMG **£3.50 £3.00**

QUARTZ-HALOGEN SPOTLIGHT

THIS UNIT SUBJECT TO DESIGN CHANGE. Hand held or hanging. Heat resistant polycarbonate housing, highly polished reflector. Protective lens cover doubles as base stand. With On/Off switch and 12ft curly cable terminating in cigar lighter plug. Produces 250,000 candle power - 5 times the intensity of average car headlamps.
Power 12V dc, 4.5A, 55W
Dims 160 x 88 x 110mm
Price **£5.75**



CAMCORDER BAG

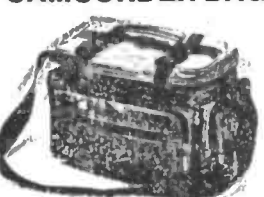

TO89A CAMCORDER BAG £16.99

Soft padded camcorder bag with shoulder strap. One internal pocket and four zippered external pockets. Black weatherproof material.

CD PLAYER G060 (CDP 10)



★ 3-beam semi-conductor laser
★ 6-track programmable memory
★ Repeat one - repeat all facility
★ Built-in 3" disc adaptor
★ Track search and Index
£99

System Compact disc digital audio system
Optical pick-up 3-beam semi-conductor laser
Error correction CIRC
Sampling frequency 41.1kHz
D/A conversion 16-bit linear
Filter Digital filter - active filter
Frequency response 20-20000Hz
S/N ratio < 0.9%
Harmonic distortion < 80dB
Channel separation > 70dB
Max output voltage 2Vrms
Power 240V ac 10W
Dims. 350 x 90 x 290mm

BSR TURNTABLES...

We have just taken delivery of another large quantity of BSR Turntables, which this time are mounted on a plinth, finished in black. They really look good. Plinth is ¼" chip-board for easy drilling, etc. Supplied complete with cartridge and stylus, and drive belt.
Motor rating: 12V 0.06A. Complete with arm 'lift' lever
Plastic arm, speed selector, 33/45rpm 1+
ORDER CODE: SO/BSR/P **£12.50 £11.00**

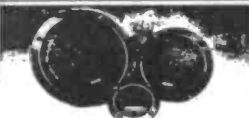

COMPONENT SPEAKER SYSTEM B020 (TC6500) PRICE £25.75

2 x 3 way component speaker system comprising two 8.5 woofers, two 4-mid-range, two 2.25 tweeters and all leads, filters and fixing screws. Finished in black with black mesh grills.
FULL RANGE OF EMINENCE CAR SPEAKERS AND LOUD SPEAKERS IN STOCK

SOLDER 18 & 22 SWG - 500gm REEL

18swg	1+	10+
22 swg	£4.95	£4.70
	£4.99	£4.75

Remember: Our prices INCLUDE VAT!

CLOSED CIRCUIT TELEVISION SYSTEM

1 X CAMERA **£120** 1 X CAMERA BRACKET **£7.75**



Complete price **£185**
Plus £10 carr

USED **£70** 1X MONITOR

FM TRANSMITTER

Made in U.K.
Very high quality 'Mini-Bug' - ideal for baby alarm, etc! A very good range is obtainable - we have obtained over 1/2 mile, but it does depend on conditions. Simply remove cover - insert battery - and you're ready to go. Reception can be obtained on any FM radio.
Frequency 105-109MHz FM
ORDER CODE SEC/FMB1
PRICE: **£9.99**

FM KIT

For those of you who enjoy building kits - we now offer the above transmitter in kit form. Ideal for the beginner - supplied complete with full, easy to follow instructions. Box NOT INCLUDED - See our BOXES Section for suitable housing.
ORDER CODE SEC/FMKIT
PRICE: **£7.50**

HOME ALARM PACKAGE

Includes:
★ Optima Alarm Control Panel
★ External Red Bell Box
★ 2 x 1 Internal Passive I.R.
★ 2 x Door Contacts
★ Siren for bell box
★ 100 mtrs. cable and clips
★ Full fitting instructions
ONLY £130

BACK-UP LEAD ACID BATTERY

12V 1.9Ah
£15.27
LEAD ACID CHARGER
£19.99

STEPPING MOTOR DRIVER/INTERFACE

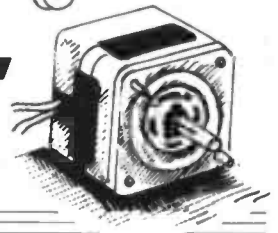
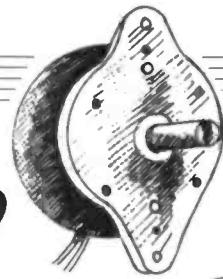

MARK STUART

An explanation of stepping motor operation plus a stand-alone demonstration/driver board which also allows computer drive.

STEPPING motors have always provided one of the simplest ways of producing controlled movement in a wide range of hobby, commercial, and industrial applications. Although mechanically very simple, their electrical drive requirements are more complicated, requiring special driver i.c.s which are in turn driven from a computer.

For many applications the computer programming is simple, providing no more than a measured pulse train to the driver i.c. In these circumstances an excessive amount of computer time can be wasted just running the motor to evaluate its mechanical performance. Where computer access is limited, as in a teaching environment, any means of saving computer time is valuable.

This project allows stepping motors to be operated and demonstrated without tying up a computer, but also includes a computer interface which allows full computer control when required. It is an ideal means of testing and evaluating stepping motor applications and projects, and allows excellent classroom demonstrations. The design is the result of many requests from teachers, and others, over the past few years and it is hoped that it meets most of their requirements.

FEATURES

The circuit can drive almost any standard four phase unipolar stepping motor in Full Step, Half Step, or One Phase mode, with variable speed and acceleration, and with continuous i.e.d. monitoring of the winding energisation sequences. Two preset speed controls allow instantaneous Start/Stop operation for low speeds and low inertia loads, and Ramp Up/Ramp Down operation for high speeds and high inertia loads.

A third control allows the ramp time to be adjusted to match the load. The low and high speed controls can be used together to give instant starting to low speed followed by ramped acceleration and deceleration to and from a higher speed.

A separate power supply is required; 12V at 1A is sufficient for most small motors but up to 35 volts and 1.5A can be handled by the output driver i.c. which has built in thermal protection. An on-board voltage

regulator provides a 5 volt supply from the main motor supply for the low power section of the circuit.

The main driver i.c.'s inputs are all accessible via a single-in-line eight way plug on the board which allows direct computer control without having to change any links or switches.

STEPPING MOTOR PRINCIPLES

The operation of stepping motors is best explained by means of Fig. 1 which shows a diagram of an elementary motor with a single permanent magnet for a rotor and two pairs of electromagnetic poles for the stator. This motor would have only four steps per revolution, but operates on exactly the same principle as one with 48 or 200 steps. The main difference is that both the rotor and stator have several pairs of magnetic poles instead of the few shown so

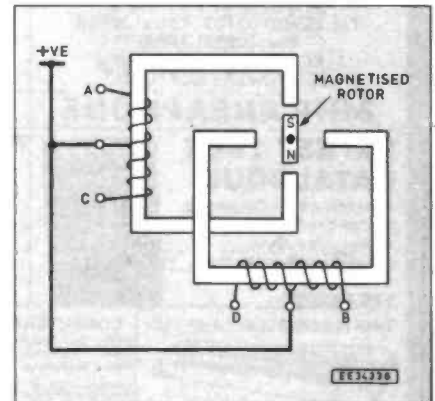
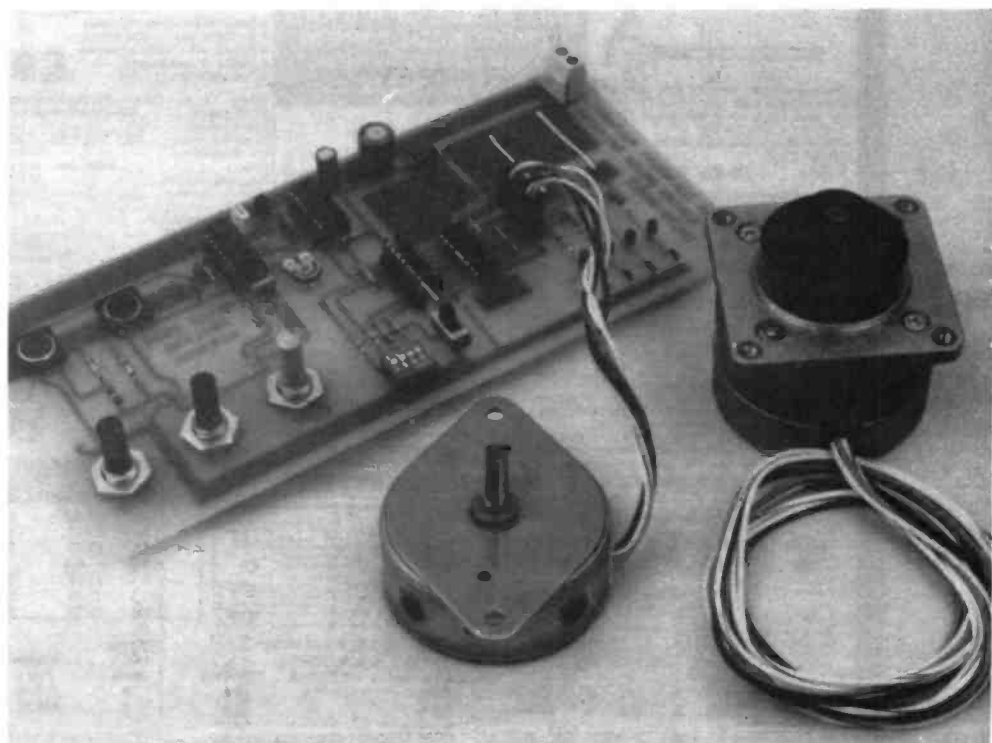

Fig. 1. Principle of operation of a stepping motor.

that they can align in 48 or 200 different positions.

If the rotor of the simple motor were rotated by hand, it would tend to "notch" into one of four preferred positions with the magnet aligned either way round with each pair of poles. This effect is shown by ordinary stepping motors which have a very "notchy" feel when rotated. Counting the notches gives the number of steps per revolution in Full Step mode.



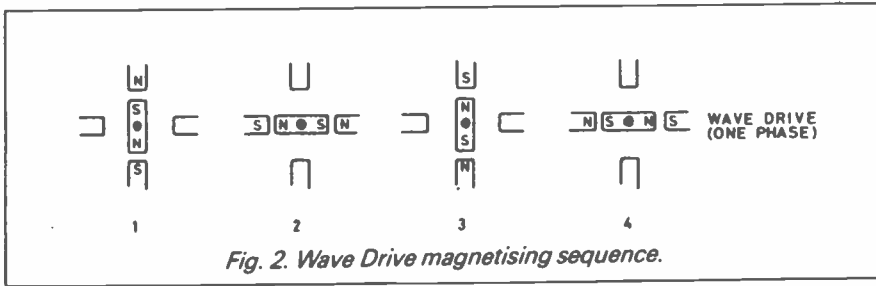

Fig. 2. Wave Drive magnetising sequence.

Table 1: Wave-Drive Sequence

Half Step = L, One Phase = H				
Step	A	B	C	D
PRO	ON	OFF	OFF	OFF
1	ON	OFF	OFF	OFF
2	OFF	ON	OFF	OFF
3	OFF	OFF	ON	OFF
4	OFF	OFF	OFF	ON

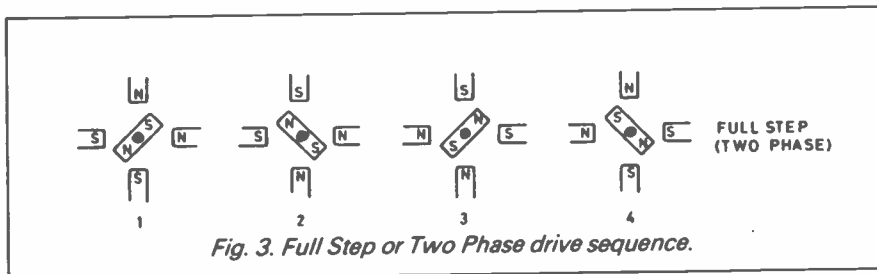

Fig. 3. Full Step or Two Phase drive sequence.

Table 2: Two-Phase Drive Sequence

Half Step = L, One Phase = L				
Step	A	B	C	D
PRO	ON	OFF	OFF	ON
1	ON	OFF	OFF	ON
2	ON	ON	OFF	OFF
3	OFF	ON	ON	OFF
4	OFF	OFF	ON	ON

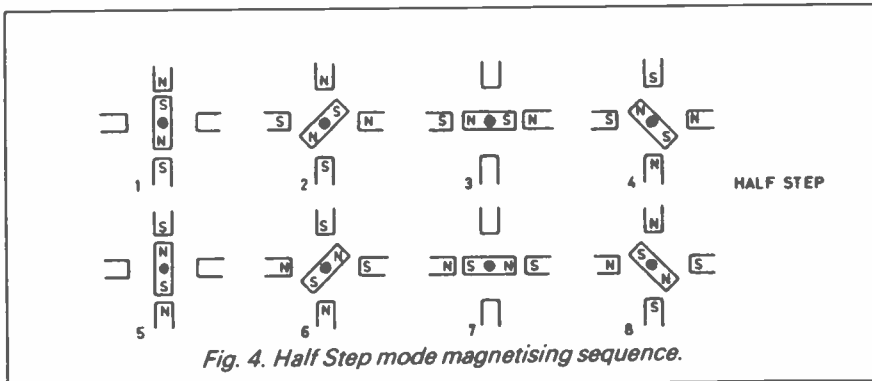

Fig. 4. Half Step mode magnetising sequence.

Table 3: Half Step Drive Sequence

Half Step = H, One Phase = L				
Step	A	B	C	D
PRO	ON	OFF	OFF	OFF
1	ON	OFF	OFF	OFF
2	ON	ON	OFF	OFF
3	OFF	ON	OFF	OFF
4	OFF	ON	ON	OFF
5	OFF	OFF	ON	OFF
6	OFF	OFF	ON	ON
7	OFF	OFF	OFF	ON
8	ON	OFF	OFF	ON

To energise the simple motor, terminals A, C, D, and B are connected individually or in combinations to the negative terminal of the motor power supply. If terminal A is connected, then current flowing from the motor supply through the winding magnetises the associated iron core in one direction. Connecting terminal C instead of A magnetises the core in the opposite direction.

If terminals A and C are connected to negative together, then the two currents' magnetising effects oppose one another and the core is not magnetised at all. The same effects apply when connecting points B and/or D to negative, the magnetisation of the associated core follows a similar pattern. Note that the two cores, with their windings, operate entirely separately from one another.

WAVE DRIVE

The simplest way to drive the motor is called Wave Drive. Fig. 2 shows the stator magnetising sequence and the corresponding rotor positions, and Table 1 shows which terminals are connected to negative for each step. Ignore for now the other information in the tables which refer to other connections of the driver i.e. The relevant information is in the columns marked A to D and rows 1 to 4.

In Wave Drive, as each winding is energised, the magnetic rotor moves to align with the electromagnetised poles. By switching in the correct sequence the magnetic rotor moves to each position in turn, rotating fully after four steps. By energising the windings in the reverse sequence, the rotor can be made to revolve in the opposite direction.

Wave Drive is the simplest method to describe but is not a very efficient way to run a stepping motor. This is because only one winding is used at a time and so only half of the winding wire and space, and the stator core material is utilised. To improve upon this Two Phase or Full Step drive is used.

FULL STEP

Full Step (or Two Phase) drive involves a similar four step sequence to Wave Drive but two windings are energised at each step. Fig. 3 and Table 2 show the rotor positions and the winding energisation patterns.

Note that the rotor aligns with the stronger magnetic field between the two sets of poles. The torque is increased substantially over Wave Drive as two windings now provide the magnetic field instead of one.

HALF STEP

A third method of operation is Half Step mode. This is a combination of the two previous ones and takes advantage of the rotor's ability to align alternately with the stator poles and between them, to double the number of steps available from the motor. Fig. 4 and Table 3 show the rotor positions and winding energisation patterns.

In this mode the torque varies up and down with each half step as the motor moves alternately between Wave Drive and Full Step modes. This would seem to be a disadvantage, but it is not a serious one. As the motor does not have to move so far with each step the varying torque does not reduce performance significantly, and the increased smoothness of running due to twice the number of steps being used gives big reductions in noise and vibration levels.

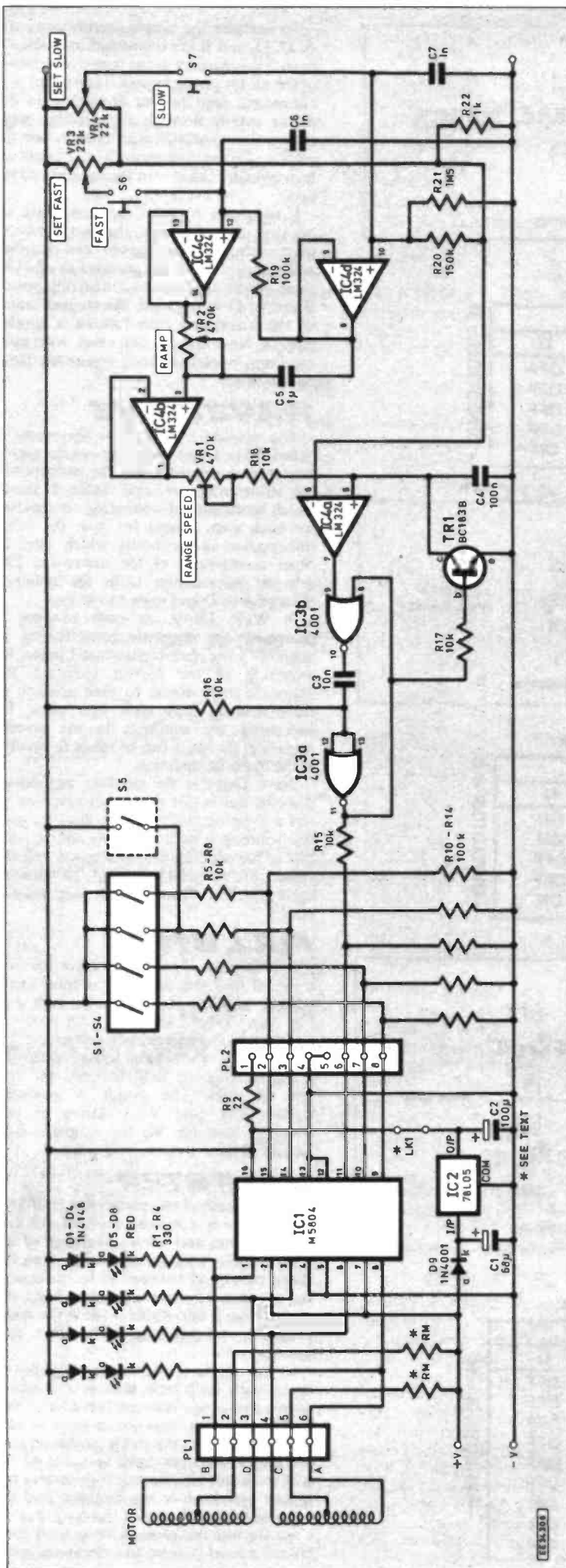

Fig. 5. Complete circuit diagram of the Stepping Motor Driver/Interface. LK1 is referred to under "Motor Connections".

In most practical stepping motor applications Full Step or Half Step operation are used. Wave Drive is inefficient and often a smaller (and cheaper) motor can be used driven in Full Step mode than would be possible with Wave Drive. Other more sophisticated methods of drive are used in industry.

One such method is Microstepping, where the current in each winding is not just switched on and off, but increased and decreased in a series of steps so that the rotor can take up many intermediate positions between the poles. With the necessarily complicated circuits this method gives very high accuracy smooth movement.

SPEED

There is no lower speed limit to stepping motor operation. One step every week is quite acceptable. At the opposite end of the spectrum however the maximum speed is limited by many things.

The main limit is determined by the inductance of the windings which reduces the rate at which the winding current can rise. Above a certain speed the winding current reduces until the torque becomes too small to be any use. This limit can be pushed up effectively by increasing the motor drive voltage at high speeds, but there is still a limit, and stepping motors can only be considered as low speed drives.

Switching of the windings is normally carried out electronically by power transistors. To use mechanical switches such as relays is impractical because of the operating speed required. In this design a special i.c. is used which contains four Darlington power transistors and all of the logic to switch them in the correct sequence to give all three modes of operation described.

The i.c. is driven by various logic inputs which select the stepping mode, direction etc. In addition a variable frequency pulse train is provided to drive the "Step" input of the i.c. For each pulse received the i.c. outputs advance one step in the selected sequence. The faster the pulse rate, the faster the motor rotates.

CIRCUIT

The full circuit diagram of the controller is shown in Fig. 5. The motor driver and interface i.c. (IC1) is the M5804. The inputs to IC1 are pins 9, 10, 11, 14, and 15. These are driven with logic levels provided by S1 to S4 and the output of IC3a which provides a pulse train for the Step input.

The four i.c. outputs are Darlington transistors connected to pins 1, 3, 6, and 8. The internal block schematic of IC1 is shown in Fig. 6 and the output Darlington transistors are shown individually in more detail in Fig. 7. Each output device is fitted with a parallel reverse protection (ground clamping) diode and a flyback (supply clamping) diode. These prevent any high voltages from appearing across the transistors as the inductive motor windings are switched on and off.

Though the transistors are each rated at 35 volts and 1.5 amps, the total output that can be provided by the i.c. is limited in practice by the package temperature rise. To allow the maximum dissipation the i.c. has a thick copper lead frame which allows heat to pass down the pins to the circuit board tracks. The printed circuit board layout has been designed to allow plenty of track area around the ground pins (4, 5, 12, and 13) to act as a heatsink.

The flyback diodes are connected to pins 2 and 7 of the i.c. These are normally connected to the highest (positive) voltage point in the circuit. In this application these connections have been made via wire links to the motor supply positive rail. Alternative connections are possible (for example via Zener diodes) but for most applications direct links to the motor positive supply are preferred.

Plenty of space has been allowed on the board for current limiting resistors. These (marked RM) are used when the application demands especially quick response time and improved torque at high speeds. How this works is explained later. For most applications these resistors can be omitted and replaced with short circuiting links.

On the input side the i.c. is almost a standard CMOS device. The only difference being that the logic supply must not exceed 7 volts. There are five input pins which function as follows:

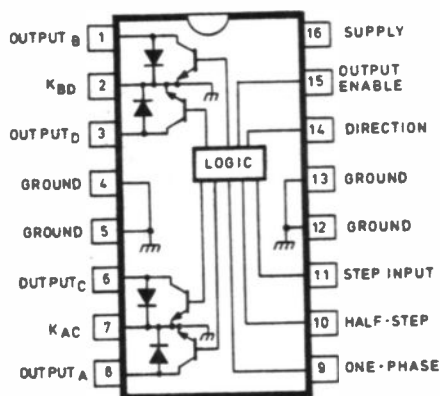

EE782

Fig. 6. Internal schematic of IC1.

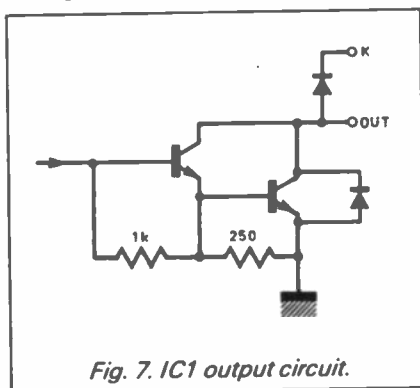

Fig. 7. IC1 output circuit.

IC1 PINS 9 & 10 TRUTH TABLE

	PIN 9	PIN 10
TWO-PHASE	L	L
ONE-PHASE	H	L
HALF-STEP	L	H
STEP-INHIBIT	H	H

Pin 9 – One Phase

This pin sets the i.c. in One Phase stepping mode when it is set to logic 1.

Pin 10 – Half Step

This pin sets the i.c. in Half Step mode when it is set to logic 1.

Note that when pins 9 and 10 are both at logic 0 the i.c. is in Full Step mode, and when they are both set to logic 1 the i.c. ignores incoming Step pulses (Step Inhibit mode). This latter function can be useful under computer control as it allows the motor to be stopped without interfering with the Step pulse input. Table 1 shows this more clearly.

Pin 11 – Step Input

When this pin changes from logic 1 to 0 (negative transition) the motor executes one step. The actual winding energisation sequence depends on which step mode is selected.

Pin 14 – Direction Input

This sets the direction of rotation of the motor by reversing the stepping sequence. The selected sequence progresses down the table when the pin is set to logic 0, and up the table when set to logic 1. To ensure correct sequences are followed, this pin, and pins 9 and 10, should only be switched when Pin 11 (Step Input) is at logic 0.

Pin 15 – Output Enable

All outputs are turned off when this pin is held at logic 1. This is useful for power saving in advanced applications by allowing the outputs to be pulsed on and off (Chopped). For most applications it is tied to logic 0. This pin does not affect the stepping sequences in any way.

The rest of the circuit is concerned with providing IC1 with input pulses and logic levels to determine the mode of operation, and indicators to monitor the output. Four input control pins to IC1 (pins 2, 3, 7, and 8 on PL2) are normally held at 0V by means of 100k resistors R10 to R14. To set these pins to 5V (logic 1) they are pulled up through resistors R5 to R8 via the four-way s.p.s.t. switch S1 to S4. As the direction control switch is likely to get a great deal more use than the others an additional switch (S5) is also fitted, this is a more robust p.c.b. mounted switch that will save wear and tear on S3.

The main input to IC1 is the STEP input which is at pin 6. This is driven with positive pulses from a voltage controlled oscillator made up from IC3a, and b, and IC4a. The frequency of this oscillator is controlled by d.c. voltages supplied via IC4b from IC4c and d. These in turn are fed from the two speed control potentiometers VR3 and VR4 via push to make switches S6 and S7.

OSCILLATOR

The oscillator is best explained if it is first assumed that C4 is fully discharged and therefore has no voltage across it. If a slow speed has been set by VR4, and S7 is being pressed, a d.c. voltage will be present at the output of IC4, C4 begins to charge from this voltage via R18 and VR1. IC4 compares the voltage across C4 with a reference voltage (approximately 0.5V) which is generated by a potential divider consisting of VR3 and VR4 in parallel in its upper section, and R22 in its lower section.

At first the voltage on C4 is small and well below the 0.5 volts across R22 and so the output of IC4a stays close to 0V. As soon as the voltage on C4 rises above the reference voltage, the output of IC4 rises swiftly to nearly 5V, and triggers the monostable formed by IC3a, and b. The output from IC3a is a positive pulse which drives the STEP input of IC1 via R15 and turns on TR1 via R17. As TR1 turns on it immediately discharges C4 which begins to charge again via R18 and VR1 at the end of the monostable pulse, and so the cycle continues.

The higher the voltage on the output of IC4b, the higher the charge current and so the quicker the voltage across C4 rises. In this way the frequency of the output pulses is proportional to the applied voltage.

The use of a voltage controlled oscillator is necessary because stepping motors cannot be driven at full speed from a standing start. The two push switches allow this to be demonstrated because the SLOW speed switch (S7) applies the control voltage instantaneously whilst the FAST speed switch (S6) allows the control voltage to ramp gently up to the set speed at a rate determined by C5 and VR2.

FAST SETTING

The Fast speed setting voltage is buffered by IC4c which has a voltage gain of 1. It has a very high input resistance and so does not load VR3 which provides it with a d.c. voltage input corresponding to the required speed. The voltage from IC4c is applied to the input of another buffer amplifier (IC4b) via the ramp control VR2 and shunt capacitor C5. The other end of C5 is held at constant voltage by IC4d which is set to the reference voltage via R20 when S7 is open, or to the Slow speed level voltage from VR4 when S7 is closed.

As S6 is closed the voltage from VR3

slider immediately appears on the output of IC4c. C5 then charges via VR2 so that the voltage at the input to IC4b slowly changes to match that at the output of IC4c. In this way the voltage controlling the pulse frequency ramps slowly up (and down) to the required level. The setting of VR2 and the value of C5 set the ramp rate which can be adjusted so that the final speed is reached in a time between a few milliseconds and several seconds.

The Slow speed setting control does not have a ramp facility and the pulse frequency changes immediately to the required setting. This is achieved by applying the voltage from VR4 to the lower end of C5 via IC4d and to the upper end via IC4c. This means that C5 does not have to charge or discharge as the voltage ACROSS it does not change, and so the pulse frequency changes instantly.

This method is known as bootstrapping, and is used in many other types of circuit, especially to reduce the effect of undesired capacitances. Its application here is less common but it does an admirable job as it allows both fast and slow controls to work independently and together without any unwanted interaction.

The power supply for the logic section of IC1 and the pulse generating circuits is derived from the motor supply via D9 and IC2 with decoupling capacitors C1 and C2.

INDICATORS

Four l.e.d.s (D5 to D8) are provided to monitor the states of the output drivers, these are protected from reverse voltages by D1 to D4 and have their supply current limited by R1 to R4. These are useful for demonstrating the various operating modes, and light with or without a motor being connected.

Spaces are allowed on the board for series limiting resistors "RM" which are used with lower voltage motors or higher supply voltages. For most applications these should be replaced with wire links and the motor supply voltage should match the motor rating.

It is advantageous to use series resistors and to increase the supply voltage above the motor rating when very high performance is required. The resistor values are chosen to limit the motor current to the maximum allowed for the motor. This has the effect of increasing the rate of rise of motor current and allows faster stepping rates and higher acceleration to be achieved without overheating.

CONSTRUCTION

Construction is relatively simple as the entire circuit is built on a single printed circuit board (available from the EE PCB Service code EE782), and there isn't any wiring to off-board components. Fig. 8 shows the component layout and the copper track pattern.

Before fitting any components check that the three potentiometers fit correctly into the large holes in the board and that all of the other holes are clear of solder.

Fit the resistors and diodes first and solder them in. Resistors R10 to R14 are in a single-in-line network which has its common pin at one end marked with a dot. The board has been drilled to accept 8 or 9 pin networks. Some of the pins are unused but do not need to be cut off as they only connect harmlessly to the negative supply. Preset VR1 should be fitted with care as it is an open type and prone to damage.

COMPONENTS

Resistors

- R1 to R4 330 (4 off)
- R5 to R8 10k (4 off)
- R9 22
- R10 to R14 100k 8 or 9 pin single in-line network
- R15 10k
- R16 to R18 10k (3 off)
- R19 100k
- R20 150k
- R21 1M5
- R22 1k
- RM To suit motor and supply (see text)

All 0.25W 5% carbon film except R10 to R14

Potentiometers

- VR1 470k preset, lin.
- VR2 470k rotary carbon, lin.
- VR3, VR4 22k rotary carbon, lin. (2 off)

Capacitors

- C1 68µ radial elect., 35V
- C2 100µ radial elect., 10V
- C3 10n ceramic, 50V (5mm)
- C4 100n polyester, 100V (5mm)
- C5 1µ multilayer ceramic, 50V (5mm)
- C6, C7 1n ceramic plate 50V (2 off)

Semiconductors

- D1 to D4 1N4148 signal diode (4 off)
- D5 to D8 Red 3mm i.e.d. (4 off)
- D9 1N4001 1A 50V rec. diode
- IC1 M5804 stepping motor driver
- IC2 78L05 +5V 100mA voltage reg.
- IC3 4001 quad CMOS NOR gate
- IC4 LM324 quad op.amp.
- TR1 BC183B npn transistor

Miscellaneous

- S1 to S4 4-way s.p.s.t d.i.l. switch
- S5 p.c.b. slide switch (optional)
- S6, S7 p.c.b. mounting s.p.s.t. push-to-make switch (2 off)

Printed circuit board available from **EE PCB Service**, code EE782; PL1 6-pin 0.1in matrix p.c.b. header; PL2 8-pin 0.1in matrix p.c.b. header; motor to suit, see text; 2-way p.c.b. terminal block; connecting wire; solder, etc.

£30

Approx cost guidance only

See **SHOP TALK** Page

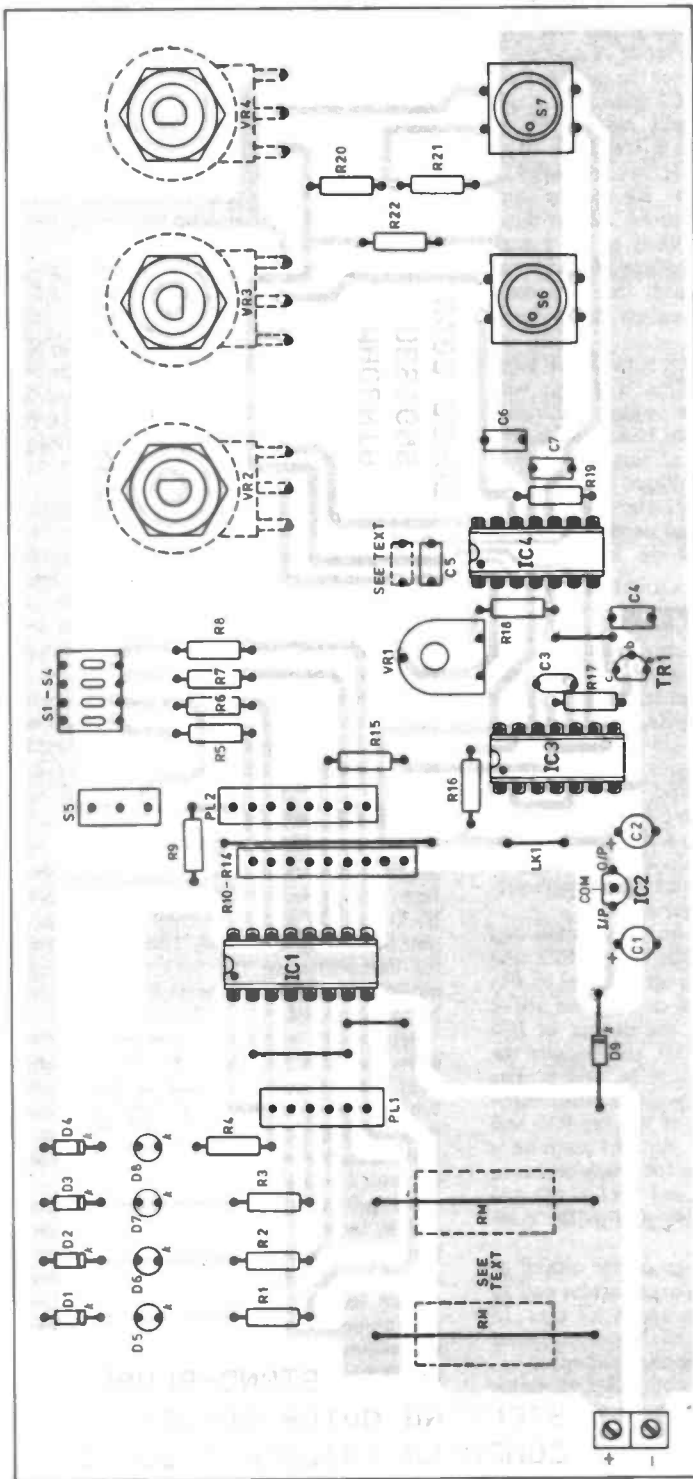
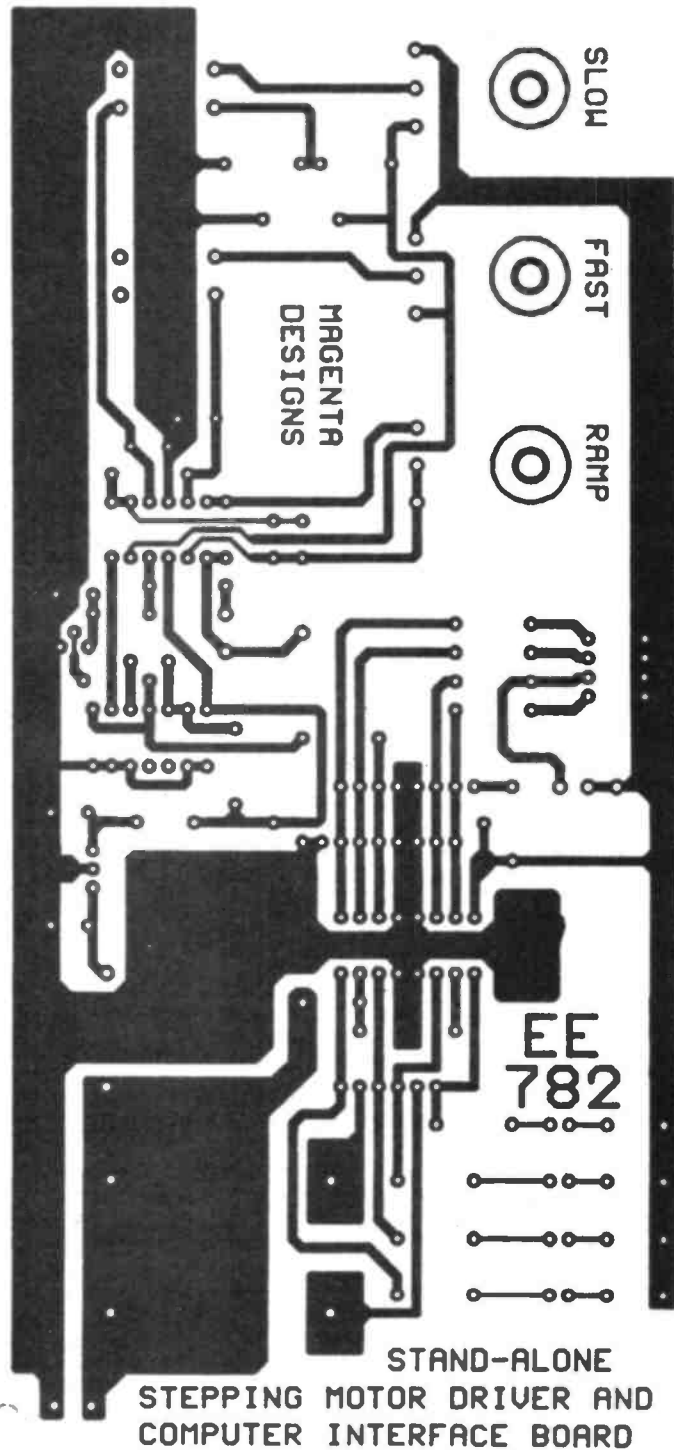

Fig. 8. P.C.B. layout and wiring, the text refers to LK1.



STAND-ALONE STEPPING MOTOR DRIVER AND COMPUTER INTERFACE BOARD

Next fit IC1 directly into the board. As explained earlier this i.c. uses its pins to conduct heat away to the printed circuit board tracks, a socket is not recommended as it seriously reduces the flow of heat to the board and would reduce the i.c. current rating. The M5804 has proved to be very reliable and so it is unlikely ever to need unsoldering. IC3 and IC4 can be fitted in sockets as this will help with fault-finding should any be required. IC2 should be soldered directly into the board.

Apart from C1 and C2 the capacitors can be fitted either way round. Two spaces have been provided for C5 so that its value can be doubled by adding another capacitor in parallel to give a prolonged ramp time.

Switches S1 to S4 are in an 8-pin d.i.l. package and could be fitted into a socket if preferred. If heavy use is expected it is better not to use a socket, as the constant movement could cause intermittent contact. S5 must be soldered straight into the board. In order to keep the switch upright it is helpful first to solder just one pin. The switch position can then be adjusted by melting the solder, and the other pins can be soldered when the correct position has been obtained. This process is also useful when fitting PL1 and PL2 and the l.e.d.s all of which need to be fitted upright on the board.

A number of wire links are required. These can be made from insulated or bare tinned copper wire and should be bent neatly before insertion into the board. Fit two more wire links in the positions marked RM unless resistors are to be used.

The two push-to-make switches have small plastic pips on their undersides which must be removed so that the switches fit flat on the board.

When everything else has been done the potentiometers should be fitted. Bend the tags forward so that they fit into the holes from the track side of the board with their spindles passing through to the component side. Fit the nuts first and tighten them before soldering the tags.

Once assembly is complete, carefully check the soldering for dry joints and bridges, and ensure that all components are correctly placed and the right way round where necessary. Time spent at this stage can save a great deal of time later finding simple faults.

TESTING

The entire circuit should be tested before connecting a motor. D5 to D8 indicate the state of the outputs from IC1.

Apply a current limited supply of between 8 and 15 volts to the Motor Supply terminals. A convenient type of current limit is a small bulb, such as a 12V 2.2 Watt type wired in series with the positive supply. Alternatively a resistor of 10 ohms or so could be used. A bulb is preferable, as it lights to indicate excessive current drain.

As S6 and S7 are open circuit there should not be any drive pulses to IC1 and a static pattern of one or two l.e.d.s should be present provided S1 is set to the OFF state. Set S2, S3, and S4 to OFF as well so that IC1 is set into the Full Step or Two Phase mode.

Now set VR1 to mid position, and VR2, VR3, and VR4 fully anticlockwise, and press S7. Whilst holding S7 rotate VR4 clockwise and check that the pattern of l.e.d.s begins to change and speeds up as VR4 is rotated further. Release S7 and

check that the l.e.d.s stop. Repeat the process this time using S6 and VR3 and note the effect of VR2 on the speeding up and slowing down of the pattern. If all is well so far adjust VR1 and check that this has an overall effect on the speed range of both controls. Note also that the speed range is the same for VR3 and VR4, the only difference being that the ramp affects only S6 and VR3.

If any of the l.e.d.s will not light check the polarity and the associated resistor and diode.

If the oscillator section is not operating properly check that the voltage from IC2 is 5V and that the voltage across R22 is approximately 0.5V. Measure the voltage on the sliders of VR3 and VR4 and check that it can be adjusted from 0.5V to 5V. IC3c, and d are buffer amplifiers and so their outputs should follow their inputs over most of the range between 0.5V to 4V. Similarly the output of IC4b should also follow its input.

The output of IC4a should be low most of the time, pulsing positive only very briefly. Without an oscilloscope this will be impossible to see and so a multimeter will simply read 0V. It should be possible to get this section of the circuit working by simple checks and careful inspection as there are not many components involved.

The correct operation of switches S1 to S5 can be checked by a multimeter on the pins of IC1 or PL2. Setting a switch to ON will raise the voltage from zero to 4.5V. Note that as S3 and S5 are in parallel closing either of them will have the same effect, and both must be open to get 0V.

The various operating modes of IC1 can be inspected by operating the switches and setting the lowest possible speed with VR3 or VR4. With the correct setting it is possible to single-step the circuit so that the motor drive sequences can be followed. The truth table and motor drive sequence tables should be referred to and each combination checked.

MOTOR CONNECTIONS

Once it is established that the circuit is working correctly, a motor can be connected to PL1. The Magenta MD35 has a connector attached already that matches these connections and can be plugged in either way round. All Four phase unipolar motors have two separate centre-tapped windings which are interchangeable. As long as the two centre taps are correctly identified, and the corresponding winding ends are connected either side, the motor will run. Reversing either of the windings

will change the direction of rotation, but will not have any other effect.

Whichever motor is used it is essential to have a power supply that can deliver enough current to supply two windings together without dropping below 8V. If the supply falls further the voltage regulator IC2 will run out of headroom and its output will drop, causing no damage, but with unpredictable results to the rest of the circuit.

It is possible to operate lower voltage motors by having a separate 5 volt supply for the logic circuits and removing link LK1. Motors can then be driven from as low as 3 volts, but the l.e.d. indicators will not function properly. PL2 allows a separate 5V supply to be connected for this purpose, and it can be conveniently derived from a computer supply as only 30mA or so is required. Resistor R9 protects the computer in case of short circuits.

COMPUTER OPERATION

All inputs to IC1 are available at PL2 for connection to a computer output port. For many applications it will only be required to connect the Negative, Step, and Direction pins. The rest can be pre-set by the switches. Most computer ports will easily override the switch settings which are fed to IC1 via Resistors R5 to R8. These resistors should prevent any conflict and give the computer automatic priority.

Programming is simply a matter of setting the output port line connected to the Step input High and Low alternately each time a step is required. More advanced programming will allow the motor to be accelerated and run at different speeds. Up to four boards and motors can be operated from a single port if sufficient programming skill is available, and only Step and Direction commands are required to be under program control.

IN USE

As a demonstration tool this board is excellent. The three modes of motor drive can be run and their characteristics observed. The effect of inertial loads on the acceleration and motor stability can also be investigated. For practical applications the motor can be run from the board and any mechanical problems sorted out before embarking on computer control. Two boards and motors provide the basis of a computer controlled X - Y positioning system which could be operated from just four lines of a computer port. All in all the board is an effective and inexpensive way to put stepping motors to work. □

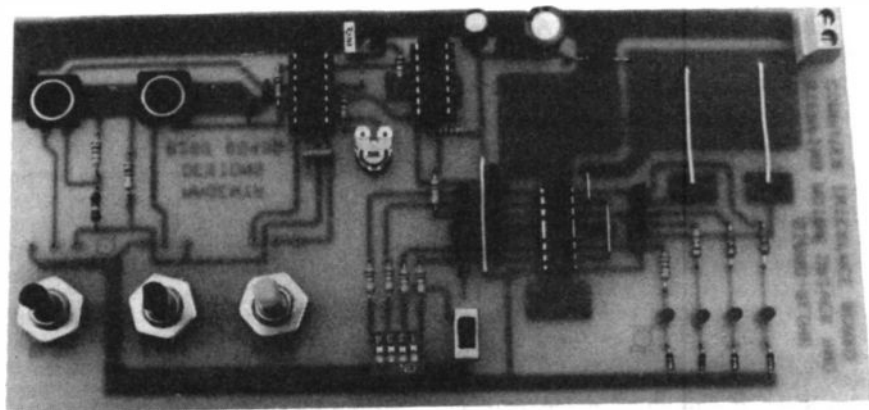

The prototype p.c.b., the final version has been modified slightly.

SHOP TALK

with David Barrington

TRANSISTOR CHECKER

Running through the list of components required to build the *Transistor Checker*, we were not expecting any supply problems to be encountered when ordering parts. We were surprised to find that the two major components, namely the rotary switch mechanism/wafers and the meter, are not so widely stocked as first anticipated.

The 0-500 μ A moving coil meter used in the model is an Altai T23 type and has an internal resistance of 360 ohm. This meter is currently listed by Greenweld (code Y200, some with mirrored scale), Henry's Audio Electronics (code Y200) and Electrovalue (code T23).

Other meters can be used of course provided they have identical electrical characteristics. The size of case may need to be changed to accommodate the meter used. One such meter is available from Greenweld (Code Y183) at about half the price.

The miniature rotary wafer switch assembly is usually listed in catalogues under such sub-headings, within switch sections, as "Maka-Switch" types and consists of the mechanical mechanism and various combinations of wafers. The spindle rotation limit stop of the mechanical assembly is adjusted to stop at position five. A number of 2-pole 5-way (Electrovalue - RA series) or the more common 2-pole 6-way wafers (Maplin FH46A-mech, FH48C-wafer), (Cricklewood Electronics WSM1-mech, WS26-wafer) are mounted on the mechanical assembly to form suitable switches for this application.

The single-sided printed circuit board is available from the *EE PCB Service*, code EE781 (see page 66).

STEPPING MOTOR DRIVER/INTERFACE

The M5804 stepping motor driver i.c. specified in the "comp list" for the *Stepping Motor Driver/Interface* is only available from Magenta Electronics. They also list a range of suitable stepping motors for use with this stand-alone or computer linked circuit.

A complete kit of parts (£29.95), in-

cluding p.c.b. and their MD35- $\frac{1}{4}$ motor, is available from Magenta Electronics, Dept EE, 135 Hunter Street, Burton-on-Trent, Staffs, DE14 2ST (☎ 0283 65436). Add £2 for post and packing.

The printed circuit board is available from the *EE PCB Service*, code EE782.

MIND MACHINE PROGRAMMER

Some of the semiconductor devices called up for the *Mind Machine Programmer*, an add-on board for last month's project, will certainly cause local sourcing problems and take some finding.

The only source we have been able to locate for the LP2951 CN micropower voltage regulator is from Electromail (☎ 0536 204555), code 648-578.

Double checking current catalogues and advertisement listings for the DAC0832LCN D/A converter chip, the only source of supply appears to be from Viewcom Electronics (☎ 081 471 9338). They are also able to supply the Analogue to Digital i.c. ADC0804LCN and the static RAM.

The rest of the semiconductors seem to be generally available and should not cause concern. Most of them are listed in the latest components catalogue from Cricklewood.

However when placing your order for parts, make sure your supplier understands that you want the BC184 transistor and NOT one with the letter L (BC184L). Although it is the same transistor, it has differing leadout arrangements according to letter code. If you are stuck with a BC184L, the leads can be carefully bent to fit on the circuit board.

The printed circuit board for the Programmer is available from the *EE PCB Service*, code EE780. Finally, it is very important that ALL constructors and possible users of the unit pay special attention to the warning at the start of the article.

BISHOP ROCK LIGHTHOUSE - SIMPLE MODEL SERIES

The miniature solder terminals shown in use on the "circuit boards" for the *Bishop Rock Lighthouse*, this month's *Simple Model Series* project, are the p.c.b. eyelet type. These consist of a looped wire with

the resulting two end leads separated by a coloured ceramic bead and are usually used to establish test points on circuit boards.

The eyelet terminals should be readily available from advertisers and are normally sold in packs of ten, each of different colour, for about £1 per pack. The rest of the components are standard items, but the lighthouse "rocks" or base must be able to accommodate the loudspeaker.

The speaker must be rated at 64 ohms but physical size will depend on the final model. The one used in our "cut out" lighthouse is a miniature 38mm diameter type.

The model and electronic circuit is built on printed white card which can be obtained from the EE Editorial Offices for the sum of £1.50 (including postage). The wiring up of the circuit card is accomplished by the use of the Vero Easiwire "no soldering" wire-wrapping system.

To help with assembly special arrangements have been made with Greenweld Electronic Components (☎ 0703 236363) and Bull Electrical (☎ 0273 203500) to supply a complete kit, including cards, for the sum of £5.95 plus £1 postage. They are also making a special offer on Easiwire wirewrap kits - see "Special Offer" page 54.

MICRO-SENSE ALARM

We do not expect any component purchasing problems to be encountered when buying parts for the *Micro Sense Alarm*. The piezoelectric sounders used in the model are, in fact, the elements only.

Because of the dangers of possible damage during soldering, it might be wise to purchase elements which have leads already attached to them. These leads can be cut short and the specified two-core screened cable soldered to the shortened leads.

If you are going to use tilt switches for additional security, the miniature metal encapsulated mercury types should be purchased. These are fairly widely stocked and should not be a problem.

You could use the miniature, mercury loaded, metal cased vibration switch or the miniature glass encapsulated tilt switch. The glass type are fairly fragile and would certainly need to be well protected as mercury is a poisonous substance.

The 6V battery used in the unit should be a rechargeable sealed lead-acid type. These appear to be available from the larger components stockist. On special offer at the moment is a 6V 10AH version from Marco Trading which, although slightly more expensive, will give a much longer "standby life". This will mean a larger case. The printed circuit board is obtainable from the *EE PCB Service*, code EE783 (see page 66).

EVERYDAY NEWS

UK IC DESIGN

The Integrated Circuit & Application Centre at Southampton, the first of its kind to be established within Philips Semiconductors, was formally opened by Kevin Kennedy, Chairman and Managing Director, Philips Electronics (UK), on Tuesday 22 October 1991.

Employing some 360 staff, the majority of whom are graduate engineers or equivalent, it represents an investment by Philips of some £6.8m and is one of the largest single concentrations of electronic engineering expertise in the UK.

The centre combines on one site the design, marketing and logistics operations for microchips used in all types of consumer electronics equipment - television sets, VCRs, compact disc players etc. It also looks at how new developments in chip technology will improve the performance of such equipment.

Startext

At Southampton engineers are developing the chips for the products of the future. Just reaching the retail shops are VCR's with Startext or PDC (Programme Delivery Control), this is the best system of programming a VCR we have so far seen.

The user simply calls up the Teletext programme schedule page, selects the required programme with a cursor and the rest is automatic. If the programme is delayed (or broken with a news bulletin) the VCR will still record it and not the interruptions. It will record every episode

of a series or mini series but it will not record films designated 18 without a security code. In addition to this it puts a title and time on the start of the recording so your tape is easily identified. The system is not "local time" dependent thus eliminating the problem associated with a 24 hour clock, summertime changes, different time zones (on satellite broadcasts) etc.

Channel 4 are already transmitting the necessary Startext codes and others are likely to follow soon. Philips say that the systems is so simple even an adult can program the video.

Other developments at Southampton include Teletext for Far Eastern countries where ideographic systems of writing are used i.e. in Chinese; closed captioning for hearing impaired on US television, as required to be fitted to most TVs sold in the USA by 1993; Digital Compact Cassette chip sets; continuing development of chips for NICAM stereo and compact disc, plus HDTV developments with D2-MAC chips etc.

2 x 220 watt MOSFET AMPLIFIER

A top-of-the-range performer that will satisfy the most demanding audio enthusiast. If you're looking for an amplifier to power your subwoofer, the **SPARKOMATIC** is all you'll need! Highly sophisticated MOS-FET technology dramatically extends frequency response, separate input sensitivity controls, built-in protection circuitry for overheat and short circuit with I.e.d. indication, output power: 2 x 220 watt maximum and 2 x 110 watt at 0.1% THD, Bridged 440 watt mono maximum and 220 watt mono at 0.5% THD.



£164.50 plus £3.50 P&P

100 watt x 4 CLASS A AMPLIFIER FOR CARS

Delivers 4 x 100 watt into 4 woofers or with the aid of its built in active cross over delivers 200 watt of Bass via sub-woofer output and 2 x 100 watt, full range into 2 speakers; thus giving you all the power you require to make even traffic jams a positive pleasure. SPECIFICATION 4 x 100W (4Ω), 2 X 200W Bridged, THD .08%, S/N RATIO: 7 90db, RESPONSE 10Hz-50KHz, LOW PASS FILTER SWITCHED 75Hz 150Hz, INPUT 4 x PHONO 100-3 Volts, INPUT x 4 HIGH LEVEL 20KΩ, SIZE 240mm x 50mm x 400mm.

£118.50 postage £4.50

75 watt x 2 CLASS A AMPLIFIER FOR CARS

Small but powerful, high efficiency amplifier, suitable for a number of hidden mounting locations. Easy connection through phono and high level input capability. SPECIFICATION 2 x 75 watts 4Ω, 1 x 150 watt Bridged, THD 0.190, S/N RATIO: 7 85 dB, RESPONSE 20Hz-30KHz, INPUTS: 2 X PHONO 100mV-3 VOLT 2 X HIGH LEVEL 2 X 20KΩ, SIZE 240mm X 50mm X 140mm.

£48.50 postage £3.50

11 BAND COMPONENT GRAPHIC EQUALIZER FOR CARS



This neat unit connects between the line output of your car stereo and your power amplifiers so you are able to adjust the sound as in a studio compensating for soft furnishing and sound reflections from glass, also it has a sub-woofer output to drive a separate amplifier for that extra deep bass sound. FEATURES: 2 channel inputs 4 channel outputs via phono sockets, CD input via 3.5mm jack 11 band graphic. SPECIFICATION RANGE 20Hz-60KHz THD 0.05%, S/N RATIO 85dB, EQ FREQUENCIES 60Hz, 120Hz, 250Hz, 380 Hz, 500 Hz, 750 Hz, 1 KHz, 2KHz, 4KHz, 8KHz, 16KHz (Boost cut of ±12 dB) SIZE 178mm x 25mm x 140mm.

£32.70 postage £1.80.

EMINENCE 4Ω PROFESSIONAL USA MADE IN CAR CHASSIS SPEAKERS

All units are fitted with big magnets "Nomex" Voice coils NOT ALUMINIUM, "Nomex" is very light and can stand extremely high temperatures, this mixture makes for high efficiency and long lasting quality of sound.

V6 6 1/2" 200W Max	Range 50Hz-3KHz	£34.40
V8 8" 300W Max	Range 45Hz-3KHz	£39.35
V10 10" 400W Max	Range 33Hz-4KHz	£44.45
V12 12" 400W Max	Range 35Hz-3KHz	£45.95
BOSS 15" 800W Max	Range 35Hz-4KHz	£79.90
KING 18" 1200W Max	Range 20Hz-1KHz P.O.A.	

Postage £3.85 per speaker.

AUDAX JBL 40-100 watt CAR TWEETERS

These state of the art advanced technology, high performance 10 mm dome tweeters are Ferrofluid coded and are active horn-loaded for high dispersion of sound with very low distortions. Ideal for tuning up your dull sounding in-car system. SPECIFICATION IMP4Ω 40 watts at 5KHz, 100 watt at 10KHz, MAGNET, SIZE 5mm x 30mm, VOICE COIL SIZE 10.5mm EFFICIENCY 92.8 dB, SIZE 51mm x 51mm x 16.5mm. RECOMMENDED 5k. 1st ORDER CROSSOVER, VALUE 1.5uf-2.2uf supplied. **£7.50 pair plus 90p post.**

MAIL ORDER £1 BARGAIN PACKS BUY 20 GET 1 FREE Please state pack(s) required

No.	Qty.	per pack
BP015B	1	30W dome tweeter. Size 90x66mil JAPAN made
BP017	3	33000µF 16V d.c. electrolytic high quality computer grade UK made
BP019	20	20 ceramic trimmers
BP020	4	Tuning capacitors, 2 gang dielectric a.m. type
BP021	10	3 position, 8 tag slide switch 3 amp rated 125V a.c. made in USA
BP022	5	Push-button switches, push on push off, 2 pole changeover. PC mount JAPAN made
BP023	6	2 pole 2 way rotary switch
BP024	2	2 Right angle, PCB mounting rotary switch, 4 pole, 3 way rotary switch UK made by LOR-LIN
BP025	4	3 pole, 3 way miniature rotary switch with one extra position off (open frame YAXLEY type)
BP026	4	4 pole, 2 way rotary switch UK made by LORLIN
BP027	30	Mixed control knobs
BP029	6	Stereo rotary potentiometers
BP030	2	10k wire wound double precision potentiometers UK made
BP032	4	UHF varicap tuner heads, unboxed and untested UK made by PHILIPS
BP033	2	FM stereo decoder modules with diagram UK made by PHILIPS
BP033A	4	6" x 4" High grade Ferit rod. UK made
BP034	3	AM IF modules with diagram PHILIPS UK MADE
BP034A	2	AM-IF tuner head modules. UK made by Mullard
BP034B	1	Hi-Fi stereo pre-amp module inputs for CD, tuner, tape, magnetic cartridge with diagram. UK made by MULLARD
BP035	6	All metal co-axial aerial plugs
BP036	6	Fuse holders, panel mounting 20mm type
BP038	20	5 pin din, 180° chassis socket
BP039	6	Double phono sockets, Paxolin mounted
BP041	3	2.8m lengths of 3 core 5 amp mains flex
BP042	2	Large VU meters JAPAN made
BP043	30	4V miniature bulbs, wire ended, new untested
BP044	2	Sonotone stereo crystal cartridge with 78 and LP stylus JAPAN made
BP045A	2	Mono Cassette Record and play heads
BP046A	2	606 Mains transformers, PCB mounting. Size 42x33x35
BP047A	1	25V DC 150mA mains adaptor in black plastic case with flying input and output leads new units made for famous sound mixer manufacturer. Size 80x55x47
BP049	10	OC44 transistors. Remove paint from top and it becomes a photo-electric cell (ORP 12). UK made by MULLARD
BP050	30	Low signal transistors n.p.n., p.n.p. types
BP051	6	14 watt output transistors, 3 complimentary pairs in T066 case (Ideal replacement for AD161 and 162s)
BP052A	1	Tape deck pre-amp IC with record/replay switching No LM1818 with diagram
BP053	5	5 watt audio ICs No TBA800 (ATEZ)
BP054	10	Motor speed control ICs, as used with most cassette and record player motors
BP055	1	Digital DVM meter I.C. made by PLESSEY as used by THANDAR with diagram
BP056	4	7 segment 0.3 LED display (red)
BP057	8	Bridge rectifiers, 1 amp, 24V
BP058	200	Assorted carbon resistors
BP059	1	Power supply PCB with 30V 4VA transformer, MC7B18CT IC & bridge rectifier. Size 4" x 2 1/2"
BP061	5	6.35mm Mono jack plugs
BP063	5	6.35mm stereo switched jack sockets
BP064	12	Coax chassis mount sockets
BP065	1	3mtr Euro-mains lead with chassis socket

Postage £3 per order

ROADSTAR OF SWITZERLAND. QUALITY 13cm 40 watt CAR SPEAKERS. Fitted with dual polypropylene cone and foam rubber surround. Large 70mm magnet for good bass and treble response. Supplied complete with grills, fixing screws and cable.

OFFER PRICE £11.70 pair

They weigh nearly 1.5kg. Postage £3.15 each
2 pairs for £22 POST PAID UK ONLY UNDER 1/2 PRICE OFFER

AUSTIN ROVER MINI MAYFAIR. 15 watt POD SPEAKERS. Moulded in a black housing for vertical or horizontal use. Fitted with a good mains 10cm speaker.

£4.95 pair plus £3 pp or

2 pairs for £10.50 post paid UK only

BSR STEREO RECORD PLAYER DECK

Manual auto operation, 3 speed (78, 45, 33 1/3), 240V operation, unused but store soiled.
£10.50 ea P&P £3.75 2 for £18.00 P&P £3.75

RADIO AND TV COMPONENTS ACTON LTD

323 EDGWARE ROAD LONDON W2 1BN

MAIL ORDER TERMS: POSTAL ORDERS AND CHEQUES. All orders will be sent by air to arrive 5 working days. Cash orders by ACCESS VISA. Phone orders delivered 9.30-12pm, 2pm-6pm. Orders received by 6pm will be despatched the next day.

Phone 071 723 8432 or 081 992 8430

323 Edgware Road, London W2 1BN, Closed Sun

FILOFAX.

PERSONAL ORGANISER
RADIO/CALCULATOR

Solar Powered
Calculator



Eight Digit
Display

Imperial,
Metric
Conversion
Tables

Battery
Powered
AM Radio
High/Low
Volume Control

Earphone provided

Punched with 6 holes to fit into all personal organisers
Listed price £19.95 **OUR PRICE £8.95 plus 75p p&p**

30 + 30 WATT AMPLIFIER KIT



An easy to build amplifier with a good specification. All the components are mounted on the single PCB which is already punched and back-printed.

- 30W x 2 (DIN 4 ohm)
 - CD/Aux, tape I, tape II, tuner and phono inputs.
 - Separate treble and bass.
 - Headphone jack.
- Size (H.W.D.) 74 x 400 x 195mm.
Kit enclosed: case, PCB, all components, scale and knobs **£40.00 + £3.50 pp.**
(Featured project in *Everyday Electronics*, April 1989 issue). Reprint Free with kit.

MULTIBAND RADIO

VHF 54-176MHz + AM CB BANDS 1-80
Listen to: AIR TRAFFIC CONTROL, AIRCRAFT, RADAR, PUBLIC UTILITIES, RADIO AMATEURS and MANY MANY MORE SQUELCH CONTROL AERIAL



£17.95
POSTAGE
£2.85

ROSS PUSH BUTTON RADIO

Mains and battery operated. High quality VHF/FM, Medium and Long Wave reception, 6 push button selected preset stations. Fully retractable telescopic aerial. Headphone/earphone jack socket. Size 230H x 150W x 65D. Ref. RE-5500. Brand new. Listed price over £30.00
OFFER £15.00
+ £2.80 pp

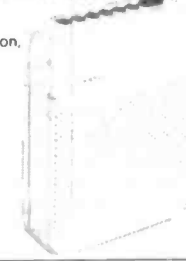

VIDEO SENDER

With this handy unit you can transmit the output of your home video, video camera or satellite equipment over-the-air to a receiving television within a range of 100ft. Simply connect the video and audio output of your equipment into this unit and a 10-13.8V dc power supply extra
£3.75 size 122 x 70 x 21mm

£11.50 + £2 pp

VHF RADIO TRANSMITTERS

100mW mini bug. Built on a neat little fibre glass pcb with condenser mic. Fully tuneable over the FM band. 9V DC **£5.75 + £0.90 pp**
2 Watt transmitter kit, supplied with fibre glass pcb, all components, diagrams, ready for you to build. 12-24V DC. **£7.50 + £0.70 pp**
25 Watt Transmitter kit. Fully tuneable over the FM band. Kit comprises double sided pcb diagrams and all components, including heat sink. Supply voltage 12-18V DC. **£67 + £1 pp**
Transmitters listed on this page are not licensable in the UK.

SPECIAL OFFER

DTMF TONE DIALLER

Suitable for remote control of telephone answering machines, videos, appliances etc. requiring DTMF signals over telephone lines.

£8.95

Please add 75p p&p when ordering



Please add 2.2% to all our prices due to the increase of the VAT rate to 17.5%

Constructional Project

MIND

MACHINE

Part 2: PROGRAMMER BOARD

ANDY FLIND

Learn to relax with this sophisticated programmable Entrainment unit.



CONSTRUCTORS of last month's *Mind Machine* will probably have found that the best way to use it is to start at a fairly high frequency, reduce it gradually, then, when the session is drawing to a close, slowly bring it back up. The snag with doing this manually is that it requires concentration which, however small, prevents the user really "letting go" and enjoying the deep relaxation the instrument can induce.

A fixed frequency could be used, but the brain appears to adapt to steady stimulation, reducing the effect. A programmable controller for the Mind Machine is therefore a highly desirable addition to this project.

PROGRAMMING

When the programming part of the design was first tackled it seemed simple, which just proves how wrong one can be! The idea at least is uncomplicated. The existing "Frequency" control is used to program the desired frequency pattern over about thirty seconds, then this is replayed over fifteen, thirty or forty-five minutes. The circuit has only to store the control sequence and reproduce it at the slower speed.

It soon became clear that the best method would be conversion of the control voltage to

a stream of 8-bit digital words for storage in a RAM. These would then be read back at the slower rate and restored to the voltage.

The block diagram of Fig. 1. shows that the system consists of an analogue-to-digital (A/D) converter, the RAM, and a digital-to-analogue (D/A) converter for the output. A "clock" oscillator motivates it, an "address generator" tells the RAM where to store the bits, some switching and timing controls it all and a counter halts it when the sequence is complete. For anyone who hasn't actually designed this sort of circuit however, life is full of exciting surprises!

STORAGE

The 6264 CMOS RAM was chosen for storage. With a capacity of just over eight thousand 8-bit words and a micropower standby mode, it seemed ideal. The first pitfall was that when "enabled" for data transfer, it proved quite thirsty.

It must be given a valid address, "selected" briefly and written to or read from, then returned to the standby state to conserve power. The current eight bits of data must therefore be copied into an eight-bit latch before conversion to analogue.

The A/D and D/A converters, chosen for their low operating current, are both intended for use with microprocessors and have connections that must be tied high or low to achieve the desired operation. Like the RAM they must be told when to perform their functions, and their inputs must be valid before this happens, leading to some fairly complex timing circuitry.

Finally, the analogue output from the D/A chip is a current, not a voltage, which should flow into negative supply potential. To convert this to the original voltage requires an op-amp able to operate below negative supply, so an extra, lower voltage negative supply rail is needed.

CIRCUIT DESCRIPTION

The full circuit of the Mind Machine Programmer appears in Fig. 2. Starting with the "clock", this is constructed from internal oscillator gates in IC4, a CMOS 4060B. Switches S1a and S1b determine the final output frequency by selecting the appropriate oscillator speed and division ratio.

This is further divided by four in the 4024B divider IC6, the final "clock" appearing at pin 11 of this chip. The frequencies here are approximately 270Hz for the 30-second programming sequence; 9.1Hz for a fifteen minute session; 4.6Hz for thirty minutes, and 3Hz for forty-five minutes.

Moving to the address generator, the RAM address bus has thirteen bits, the first of these being taken from the next stage of IC6 at pin 9. This is also applied to the input of the twelve-stage divider IC7, a 4040B, which generates the remaining twelve address bits.

Fig. 1. Block diagram of the programming system for the Mind Machine.

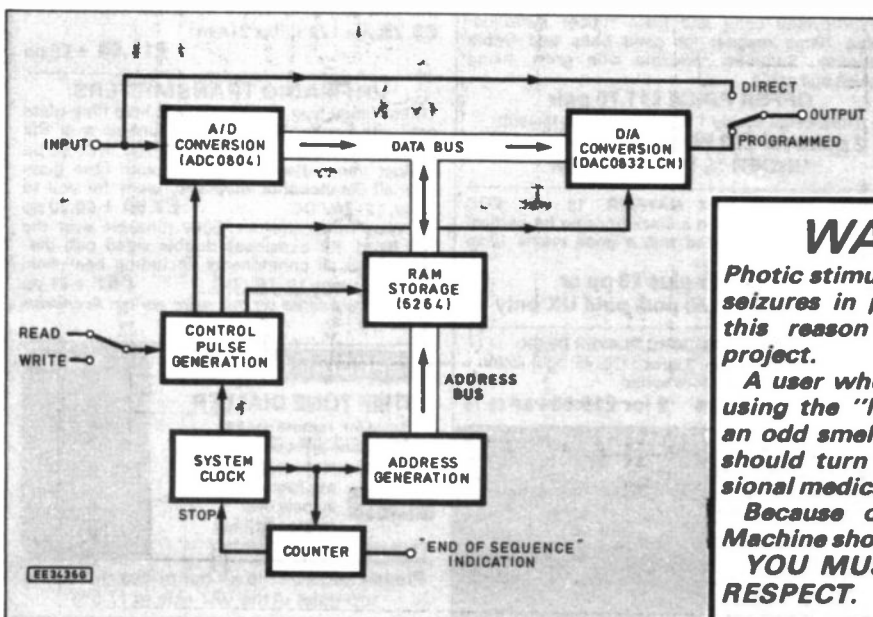

WARNING NOTICE

Photic stimulation at Alpha frequencies can cause seizures in persons suffering from Epilepsy. For this reason such people MUST NOT try this project.

A user who is not a known epileptic, but when using the "Mind Machine" begins to experience an odd smell, sound or other unexplained effect, should turn it off immediately and seek professional medical advice.

Because of the above possibility the Mind Machine should not be used while on your own.

YOU MUST TREAT THIS UNIT WITH DUE RESPECT.

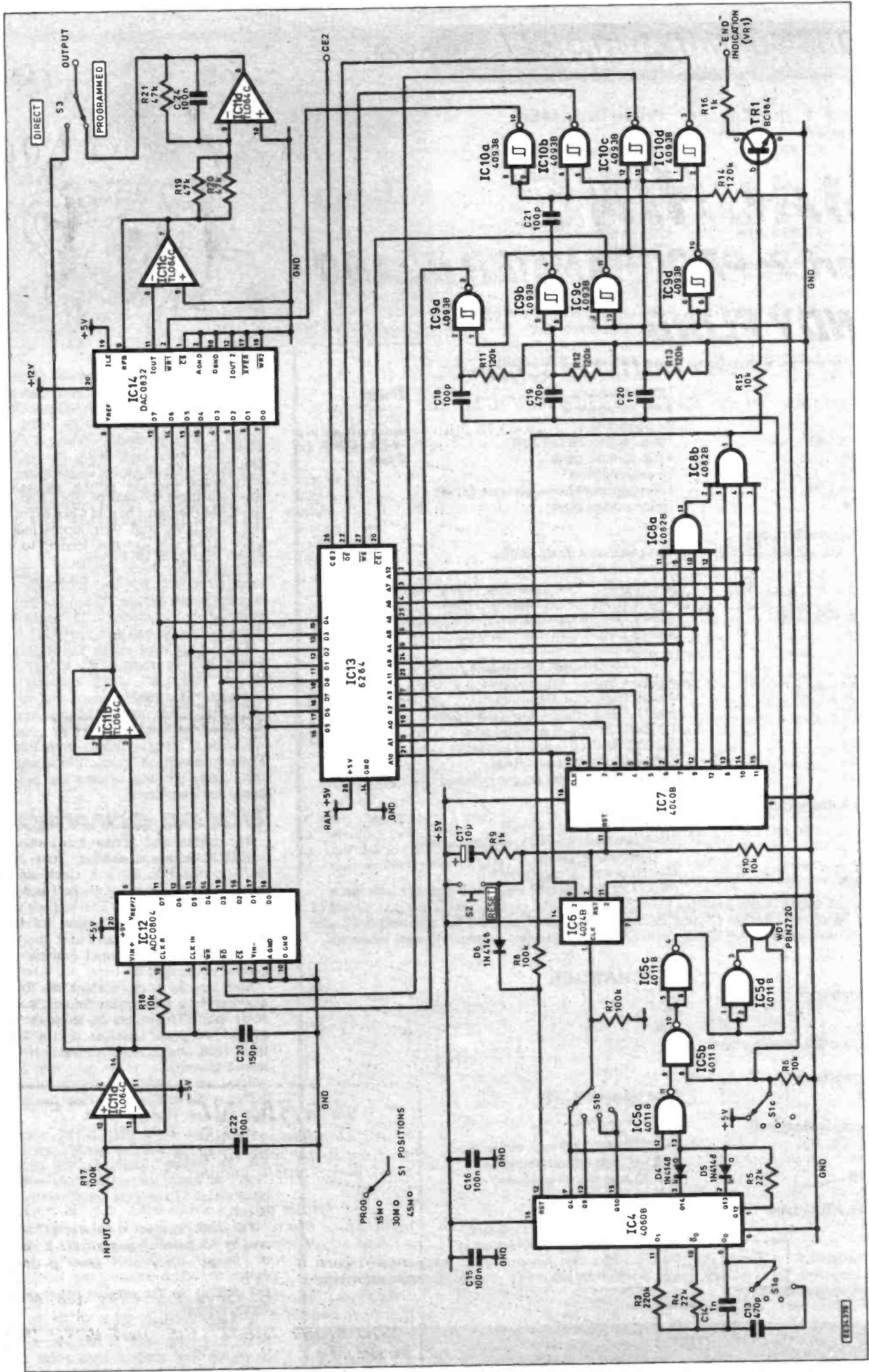

Fig. 2. Complete circuit diagram for the Mind Machine Programmer section. The power supply voltage regulation circuit is shown in Fig. 4.

COMPONENTS

PROGRAMMER

Resistors

R, R2, R7, R8, R17	100k (5 off)
R3	220k
R4, R5	22k (2 off)
R6, R10, R15, R18	10k (4 off)
R9, R16	1k (2 off)
R11, R12, R13, R14	120k (4 off)
R19, R20, R21	47k (3 off)
All 0.6W 1% metal film	

Capacitors

C1, C4, C7, C9, C15, C16	100n ceramic disc, 50V (6 off)
C2	100µ radial elect., 25V
C3	10n miniature polyester layer
C5, C11, C12, C17	10µ radial elect. 50V (4 off)
C6, C8,	100µ radial elect., 10V (2 off)
C10	2µ2 radial elect., 50V
C13	470p polystyrene
C14	1n polystyrene
C18, C21	100p ceramic plate (2 off)
C19	470p ceramic plate
C20	1n ceramic plate
C22, C24	100n miniature polyester layer (2 off)
C23	150p ceramic plate

Semiconductors

D1, D2, D3, D4, D5, D6	1N4148 signal diode (6 off)
TR1	BC184 npn silicon transistor
IC1	LP2951CN +5V micropower voltage regulator
IC2	ICL7660 negative voltage converter
IC3, IC9, IC10	4093B, CMOS quad Schmitt NAND gate (3 off)
IC4	4060B CMOS 14-stage counter, with internal oscillator
IC5	4011B CMOS quad NAND gate
IC6	4024B CMOS 7-stage counter
IC7	4040B CMOS 12-stage counter
IC8	4082B CMOS dual 4-input AND gate
IC11	TL064C low power quad op-amp
IC12	ADC0804LCN 8-bit A/D converter
IC13	6264 64K CMOS static RAM
IC14	DAC0832LCN 8-bit double buffered D/A converter

Miscellaneous

S1	3-pole 4-way rotary switch
S2	Miniature push-to-make, release-to-break, pushbutton switch
S3	Miniature s.p.d.t. toggle switch
WD1	PBN2720 piezoelectric transducer element, with leads
Printed circuit board, available from <i>EE PCB Service</i> , code EE780; 8-pin d.i.l. socket (2 off); 14-pin d.i.l. socket (7 off); 16-pin d.i.l. socket (2 off); 20-pin d.i.l. socket (2 off); 28-pin d.i.l. socket; AAA alkaline cells (3 off); ribbon cable, connecting wire; solder etc.	

CHARGER

Resistors

R1	12
R2	10k
Both 0.6W 1% metal film	

Capacitors

C1	470µ radial elect., 25V
----	-------------------------

Semiconductors

D1, D2, D3	1N4007 1A 1000V rect. diode (3 off)
TR1	BC214L npn silicon transistor
TR2	BFX30 npn silicon transistor

Miscellaneous

T1	Mains transformer, 240V primary; 15V-0V-15V 100mA secondary
Stripboard 0.1in. matrix, size 10 strips x 20 holes; miniature 240V mains chassis mounting plug and "free" socket; plastic bracket for mounting stripboard; mains rated wire; connecting wire etc.	

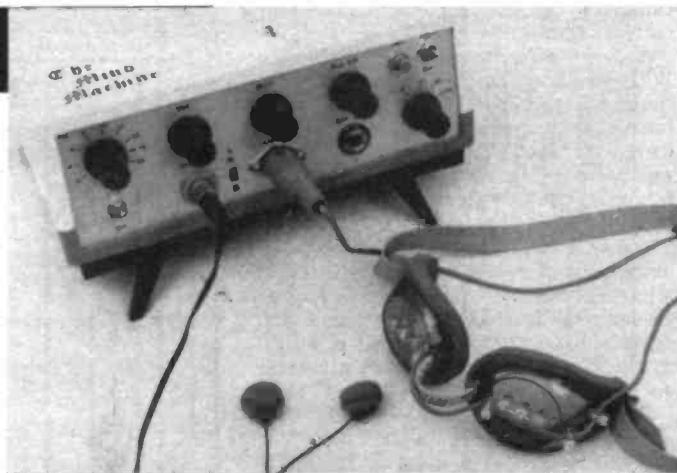

See
SHOP
TALK
Page

These thirteen bits are applied directly to the RAM, IC13. The last seven also go to IC8, a 4082B dual 4-input AND gate. When the output of this goes high, after 8128 cycles, it stops the clock by taking IC4's (pin 12) "reset" input high. When the output of IC8 goes high it also turns on transistor TR1 to indicate the end of the sequence to the user. Resistor R16 is connected to the top of the Brilliance control, VR1 of the "sound/light board", so that when TR1 is biased on, it dims the glasses.

Pressing the Reset switch S2 takes the "resets" of IC4, IC6 and IC7 high, resetting the whole counter. When the circuit is switched on, capacitor C17 resets it as though switch S2 had been operated.

The output from switch S1c is normally pulled low by resistor R6 except when set to "Program", which connects it to +5 volts. This enables the circuit to read a sequence into the RAM and activate the circuit around IC5, which generates one-second "bleeps" during programming. There are exactly thirty-one bleeps, counting them helps the user to time the program pattern as it is entered.

PULSE CONTROL

The timers and gating built with IC9 and IC10 determine whether data is "written" or "read" to IC13, by providing the appropriate sequence of control pulses to IC12, IC13 and IC14. The address increments each time IC6 pin 11 goes low, whilst control pulses are produced as it goes high, so there is always a valid address when control pulses appear.

Each time the clock goes high, the RAM is activated by a 100µs pulse from IC9c to its "chip enable" input, pin 20. If switch S1c is in the "Program" position, a 10µs pulse from IC9a causes A/D converter IC12 to start a conversion. At the same time IC12's outputs are enabled by a 100µs pulse from IC10c, so the data resulting from the conversion appears at them.

Note that IC9a and IC10c are both enabled by the positive signal from switch S1c. In "replay" positions this signal is "low" so input conversion does not take place and IC12's outputs are effectively open circuit.

The analogue input at resistor R17 is buffered by IC11a before going to IC12. Manual or "Direct" operation is possible through switch S3, which transfers this buffered input directly to the output, bypassing the digital process.

A delay of about 45µs is produced by IC9b, following which IC10b, also enabled by switch S1c, sends a 10µs pulse to the "write enable" (pin 27) of RAM IC13. This

Approx cost
guidance only

£44.50

causes it to read the data from IC12 into the current address.

A similar pulse from IC10a is sent to the WR1 pin (2) of the D/A converter IC14, causing it to copy data at its input to internal latches, where it is converted to a current at "Iout", pin 11. IC9d inverts the signal from S1c and so inhibits IC10d, preventing an "output enable" signal going to the RAM.

The D/A converter IC14 contains an internal chain of switchable resistors, fed from a reference voltage, with a feedback resistor for use in an inverting op-amp circuit. The designer has to supply the op-amp, in this case IC11c, and the output of this is inverted and restored to the original value by IC11d.

The reference for the resistor chain is 2.5V in this design. Conveniently, this appears at pin 9 of IC12, derived from the 5volt supply rail. Not so conveniently, the input to IC14 has a low impedance, so it is buffered by IC11b.

During "replay", the signal from S1c is low, disabling IC9a and IC10c, so IC12 does nothing. IC10d is now enabled, however. As the clock goes positive and the RAM is activated, IC10d tells it to output data from the current address.

As before, a delayed 10µs pulse from IC10a initiates copying of data to the internal latches of IC14 for analogue conversion. When the RAM enabling pulses end and its outputs go open-circuit, the data remains in IC14's latches and the analogue output remains valid. The timing for all this is shown in the diagram of Fig. 3.

VOLTAGE REGULATION

Voltage regulation for the circuit, shown in Fig. 4, is on the same board. Raw battery +12V is decoupled by capacitors C1 and C2, and supplied to IC11 and IC14. IC1 provides regulated +5V through diode D1 for everything else except the RAM, which is powered through diode D2.

Placing diode D1 between the output pin 1 and sense pin 2 of IC1 causes automatic compensation for the drop across this diode and D2. When the power is off, the +4.5V backup battery supplies the RAM through diode D3 to retain the program, with diode D2 isolating it from the rest of the circuit.

The error output, at IC1 pin 5, is normally

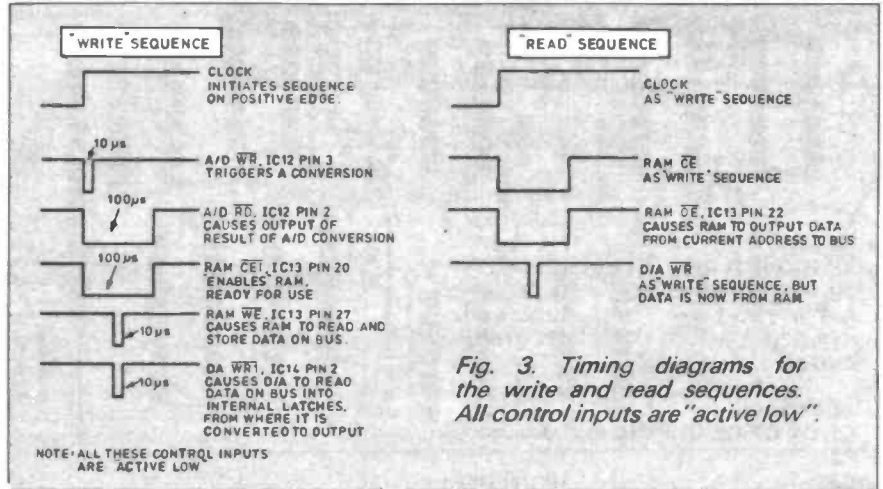

Fig. 3. Timing diagrams for the write and read sequences. All control inputs are "active low".

high but goes low if the output falls by five per cent. It needs a pull-up resistor, in this case R1.

When the circuit is switched on and this output indicates a healthy supply, resistor R2 and capacitor C10 introduce a brief delay before the RAM can be activated. When it is switched off, the RAM is disabled immediately.

This arrangement prevents it being enabled and connected to other parts of the circuit whilst they are in "non-valid" states.

Finally, as IC11c's output must be able to swing below negative rail, an auxiliary -5V supply for IC11 is generated by the converter IC2.

CONSTRUCTION

The Programmer and Supply Regulator circuits are both built up on the same printed circuit board (p.c.b.). This board is available from the EE PCB Service, code EE780.

The printed circuit board component lay-

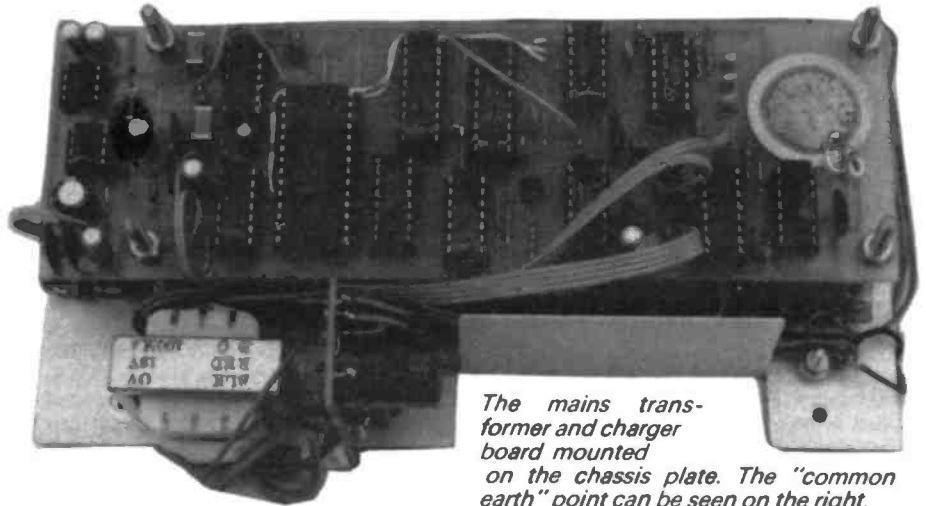

The mains transformer and charger board mounted on the chassis plate. The "common earth" point can be seen on the right.

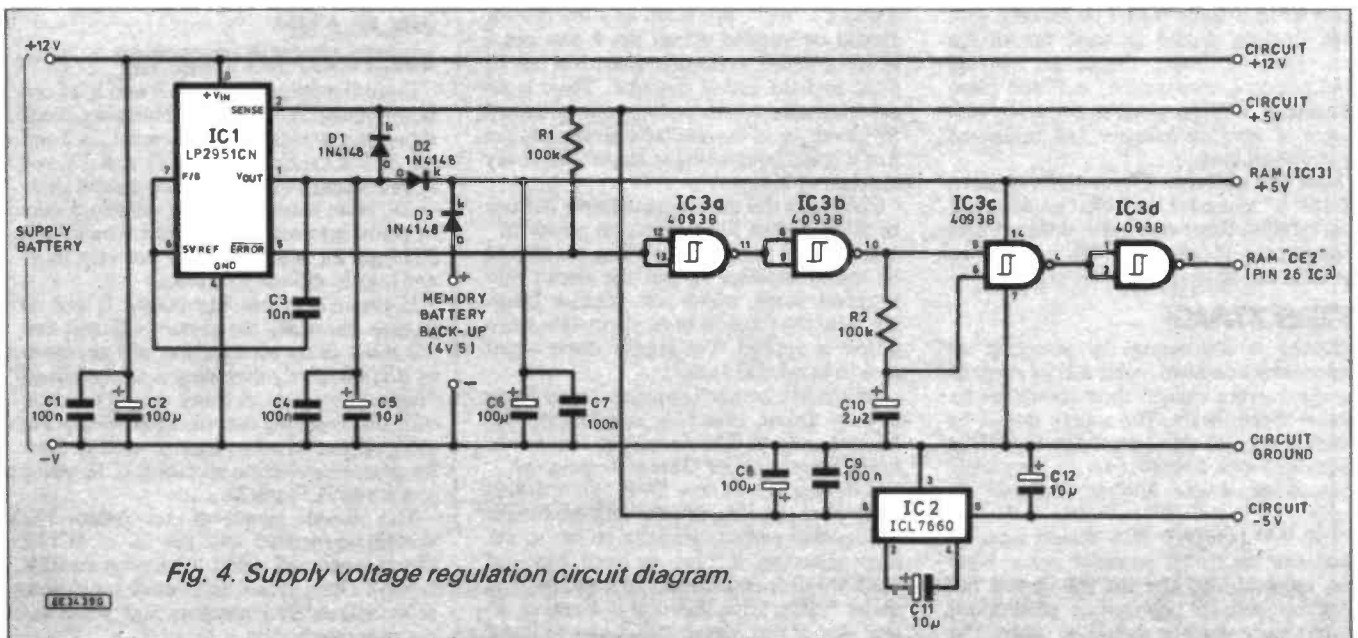
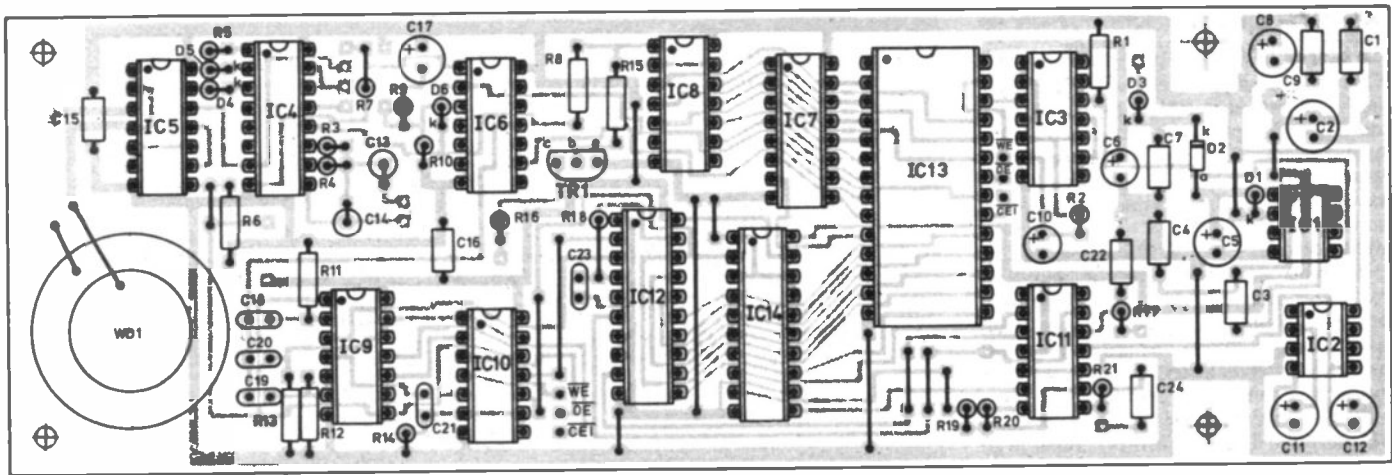

Fig. 4. Supply voltage regulation circuit diagram.



EE34400

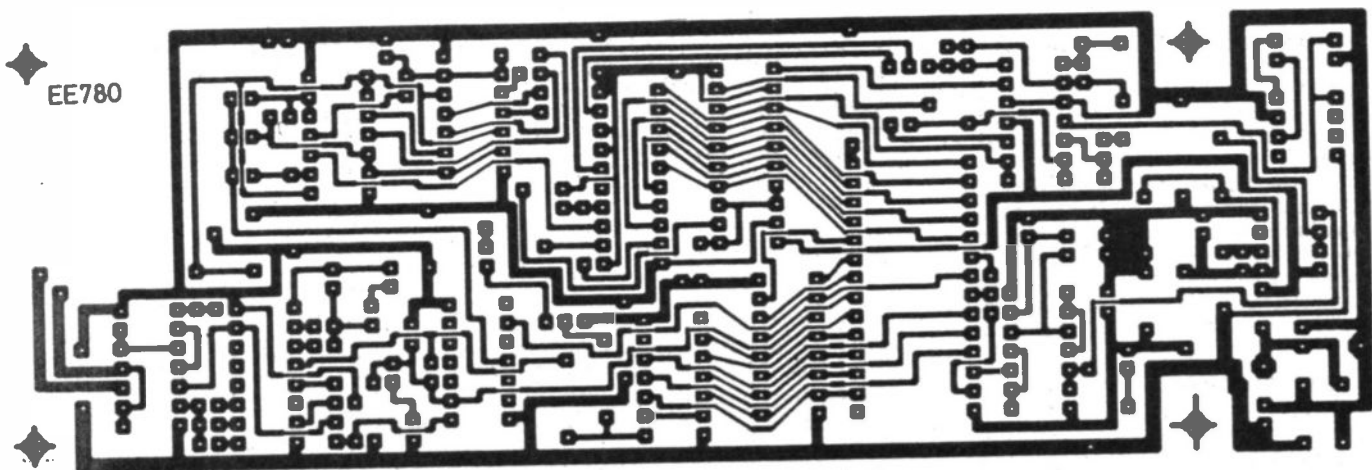

Fig. 5. Printed circuit board component layout and full size copper foil master pattern.

out and full-size copper foil master pattern is shown in Fig. 5. Construction of the board should follow the usual procedure of fitting components in height order, the lowest first for greatest ease.

To reduce cost a single-sided p.c.b. is used, a drawback to this being that thirteen links are necessary. Additionally the six points marked in pairs as WE, OE and CE1 must be linked together with insulated wire. The route of these three wires can be seen from the photographs.

The small ceramic capacitors tend to crack easily so their leads should be handled with care. Sockets should be used for all the i.c.s, none of which should be inserted until testing is commenced. A 27mm piezo transducer, WD1, is glued to the p.c.b. with a spot of Araldite adhesive and connected by two short leads.

Note that transistor TR1 is a BC184, not a BC184 "L" as used in the Light/Sound board (last month). Same transistor, different lead arrangement. If only a BC184L is available, the leads can be bent to allow it's use.

TESTING

Testing is commenced by powering up without any i.c.s fitted. After a brief surge as the electrolytics charge, there should be no further supply drain. The supply should be switched off and the electrolytics should be discharged with a resistor across the supply connections, a one kilohm (1k) will do nicely.

The +V regulator IC1 should now be fitted and the circuit powered again. Note that most of the i.c.s on this board are CMOS types, so appropriate precautions against static damage should be taken. The

supply current should now be about 140µA, and the regulated +5V should be present across decoupling capacitors C8 and C6.

Next, the -5V converter IC2 can be fitted, and when powered the presence of -5V across capacitor C12 checked. The drain current should now be around 200µA. If this is OK, the regulation is operational and testing of the rest of the circuit can proceed.

CLOCK

Starting with the clock IC4, this won't run unless it's "reset" line is low so a 10k resistor should be inserted across pin 1 and pin 7 of IC8's socket to do this. Then IC4 can be fitted and the circuit powered. There is no need to make connections to any of switch S1 points yet. If the oscillator is running, pin 3 of IC4 will be clocking at about 1Hz, easily checked with a meter.

Following this the bleep generator IC5 can be fitted. Switch S1c connection points "C" and "D" on the p.c.b. (see Fig. 6.) should be linked together to put the circuit into Program mode, which will produce bleeping from the transducer at about 1Hz when power is applied. The supply drain ought now to be around 1mA.

Switch S1b connection points E and G can now be linked, effectively selecting the 30-Minute position. The circuit will continue to bleep, because C and D are still connected.

If divider IC6 is now fitted, pin 6 should clock at about 1Hz, in time with the bleeps. This proves correct operation so far, so address generator IC7 can be fitted. Pin 9 of this should clock at about 1Hz, and pin 7 at about 0.5Hz. If so, this too is working, so the "end of run" detector IC8 can be fitted,

following removal of the 10k resistor from it's socket.

At the connections for S1b, points E and F should now be linked to select a Thirty-Second run time. On power-up, an automatic "reset" should be effected by capacitor C17, so the circuit should bleep thirty-one times and then stop.

Momentarily shorting S2 connection points I and J should cause the sequence to repeat. If so, the clock and address generator sections are working correctly.

PULSE GENERATORS

Control pulse generators IC9 and IC10 can now be fitted. With the circuit bleeping, check the apparent voltage at IC12 socket pin 2 and pin 3, IC13 socket pins 20, 22 and 27, and IC14 socket pin 2. All of these should show +5V. If an oscilloscope is available it may be possible to see negative pulses on all but IC13 pin 22, although these are very short and may be difficult to resolve.

If the link across S1c points C and D is now removed, the circuit will still run for about thirty seconds, but will not bleep as it is effectively executing a thirty-second "replay" sequence. A check should be made whilst it is running that the above points are still positive. A scope may be used to look for negative pulses on all except IC12 pins 2 and 3, and IC13 pin 27.

The RAM power-up controller IC3 should be inserted and pin 26 of IC13's socket monitored whilst turning on the 12V supply. There should be a small but visible delay before this point goes high when the circuit is switched on.

A/D-D/A CONVERTERS

With power supplies, clock, address generator and control pulses all running, at last the interesting part has been reached! The A/D converter IC12 can be inserted. Pin 19 is an internal "clock" output and should have an average d.c. level of about 2.5V. It may be checked with a 'scope, it runs at about 350kHz.

Reference output pin 9 should be at 2.5V d.c. The supply current should by now be 2.5mA to 3.0mA.

Next, IC11, the TL064 quad op. amp, should be fitted. The circuit input, point Q, should be connected to "ground" (negative rail). This ought to result in 0V at IC11 pin 14, the input buffer. Pin one should be at 2.5V, and the total supply current should be about 4.1mA.

The D/A converter IC14 can be inserted next, and S1c points C and D shorted again to put the circuit into Program mode. Whilst the circuit is running (and beeping), the output, from point R, should equal the input, since data conversion and transfer between the A/D and D/A chips should be taking place.

If a ten kilohm linear potentiometer is connected across the 5V supply (across capacitor C8) and the wiper (centre tag) taken to the input, a meter will show the output tracking the input during the programming period. When the sequence ends, the output should remain at its final value.

RAM CHECK

Finally, the RAM chip IC13 can be fitted. A programming sequence should be executed with a varying voltage applied to the input, then the short across S1c connections removed, and the sequence triggered again by linking S2's connections briefly.

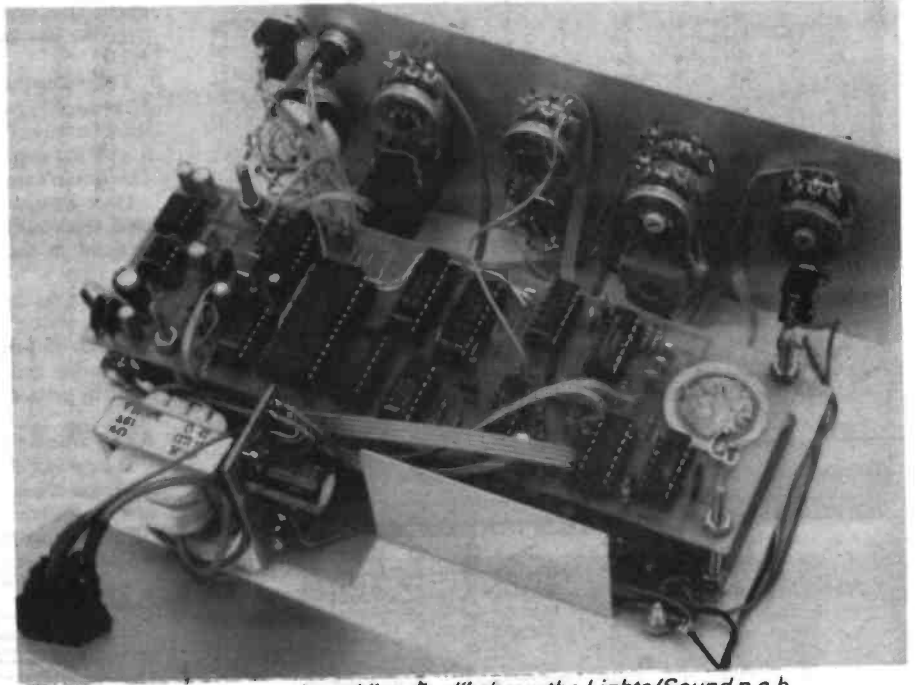

The programmer board "stacked" above the Lights/Sound p.c.b.

This should result in a replay of the voltage pattern just entered, this time obtained from the RAM. It will run for only thirty seconds of course, since for testing this period is still selected at S1b's connections.

This completes the board checks, so it can now be fitted to the Mind Machine project for fully automated operation. The total supply current taken by this board when running should be about 5.0mA.

ASSEMBLY

The Programmer board fits above the existing Mind Machine Lights/Sound board,

on the four screws projecting from the chassis plate. It faces the opposite way to the Sound/Lights board, all the i.c.s pointing away from the front panel.

The board is longer than the first board, one end projecting beyond the mounting. The back-up battery "pack" fits beneath this projection.

Connection into the Mind Machine project is straightforward. The trickiest part is the bunch of wires connecting switch S1, but with some ribbon cable to keep things neat this shouldn't cause any real difficulties. All connections are shown in Fig. 6.

The lead from the wiper of Frequency control VR4 is disconnected from the original p.c.b. and taken instead to the input, point Q, of the Programmer board. A s.p.d.t. S3 switch selects Programmed (point R) or Direct (point M) output from the programmer and feeds it to the original board's input. S2 is a miniature press-to-make switch for program restarting.

The +12V supply is taken from the existing on-off switch to point S on the board, whilst negative, point T, is connected to the common "Earth" on the chassis. The backup battery consists of three alkaline AAA cells, taped and soldered together to make a 4.5V pack and fastened to the chassis with cable ties. This semipermanent installation is fine since they should last virtually for their shelf life, a couple of years at least.

The "end of run" output, point M, is soldered to the existing lead on the top end of Brilliance control VR1. When transistor TR1 turns on it reduces the voltage across this potentiometer to about a tenth of its normal value, causing marked dimming of the lights.

RELAX

In normal use, switch S1 is set to Program, S3 to Programmed, and the Reset button S2 pressed. Programming begins as soon as it is released, and the desired pattern is entered with the frequency control, the beeps being counted so that the point in the program is known. The author normally starts at about 14Hz, falling to 7Hz to 8Hz over the first two or three beeps, holding this briefly, then dropping slowly to 4Hz, then back up to

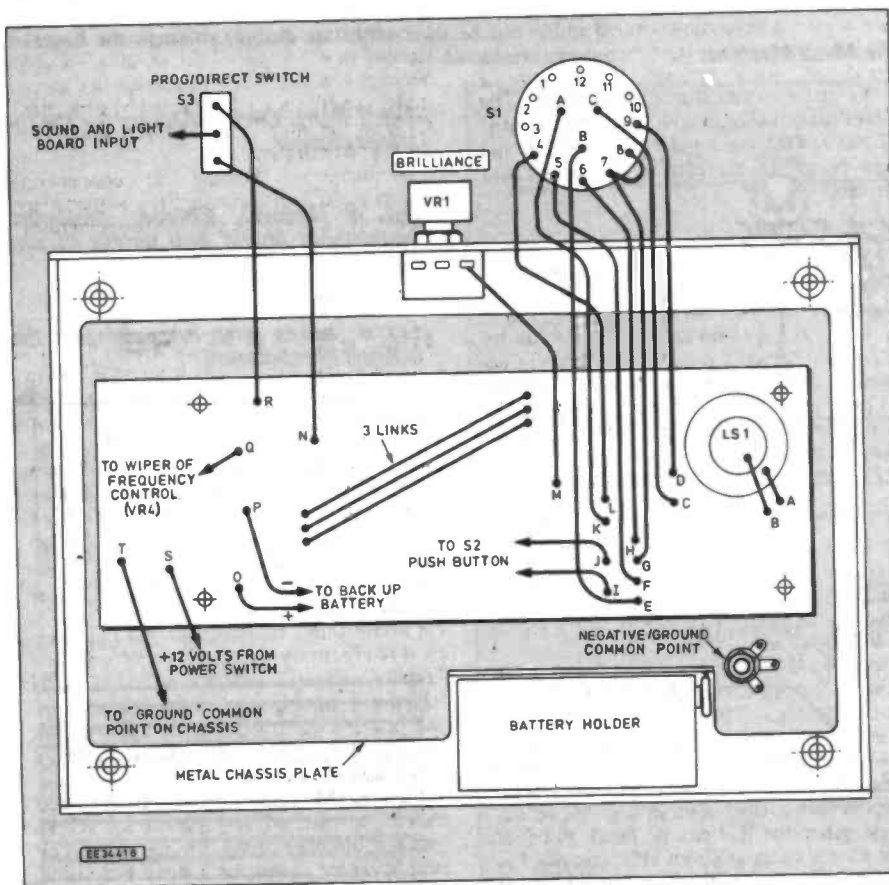
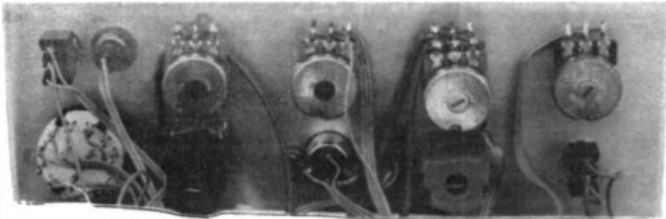
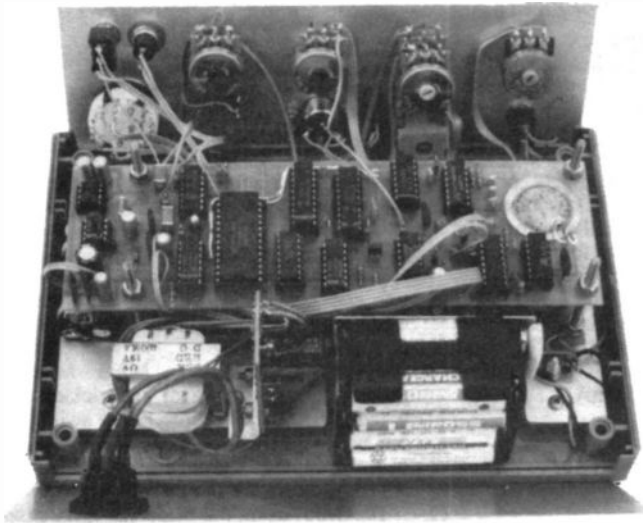
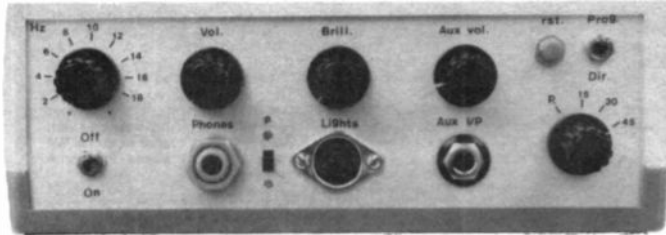

Fig. 6. Interwiring from the circuit board to off-board components.



Rear view (above) of components mounted on the front panel and (below) front panel lettering on the completed unit.



General layout of components inside the Mind Machine.

about 7Hz, with some brief (one-bleep) excursions to 12Hz, then over the last two or three bleeps returning smoothly to 14Hz-16Hz.

Following program entry, S1 is set to 15, 30 or 45 minutes and S2 pressed to repeat the sequence over this period. It is possible to relax far more deeply with the automatic control sequence, in fact it is all too easy to fall asleep as *delta* frequencies are approached! This doesn't seem to detract from the beneficial effects, though.

Once a satisfactory program pattern has been found, it can be used repeatedly. There is no need to reprogram as it will be retained in the RAM when the machine is switched off. On power-up a "reset" is performed automatically, so it is only necessary to don glasses and phones and switch on to enjoy a session.

Switch S3 permits manual frequency control, though if the sequence has ended the lights will be dimmed. This is easily overcome by pressing Reset.

BUILT-IN CHARGER

The project can be powered by ordinary batteries. However, to save case dismantling for battery changes, the prototype is fitted with Ni-Cads and a built-in charger.

This is a simple transformer, rectifier and constant-current arrangement connected *permanently* to the battery pack. A miniature three-pin chassis plug mounted on the case rear panel accepts mains input to the charger.

The charger circuit diagram is shown in Fig. 7. The mains transformer T1 has a 15V-0V-15V secondary winding, with the output rectified by diodes D1 and D2 and smoothed by capacitor C1. Transistors TR1 and TR2 form a simple constant-current circuit, the output from this going to the battery pack through diode D3 to prevent any "back-feeding" when it is not operating.

This little circuit was assembled on a scrap of 0.1in. stripboard. The breaks in the underside copper strips and the topside component layout appear in Fig. 8.

Transistor TR2 may warm up a little in use so a clip-on heat-sink should be fitted. Testing is simple, just check that a voltage appears across capacitor C1 when the transformer is powered and that the output into the batteries is around 50mA-60mA.

There is just room inside the case for the transformer and board behind the p.c.b.s, alongside the battery pack, as can be seen in the photographs. The board is mounted vertically on a bracket cut from a piece of plastic.

The mains Earth is connected to the chassis plate, and all connections to the rear of the plug are sleeved for safety. The wiring for this part of the project is shown in Fig. 9. The Mind Machine can be used whilst on charge, although the batteries must be connected. □

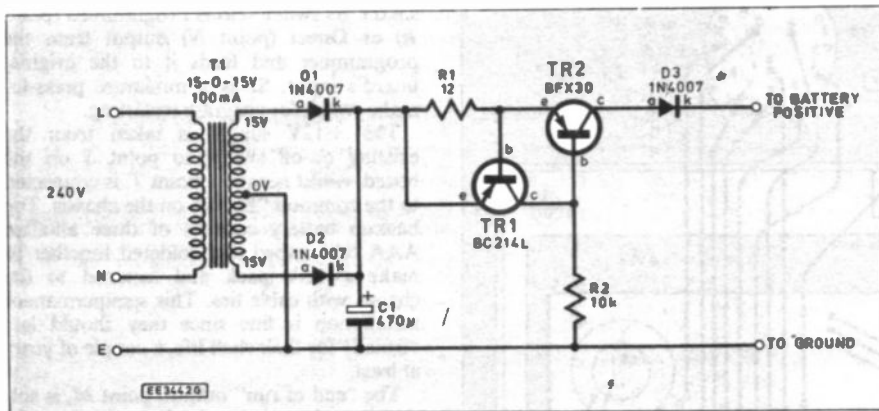
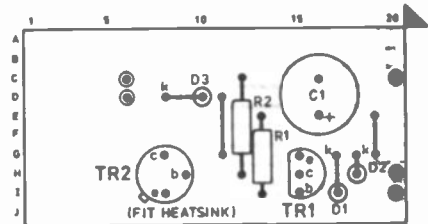

Fig. 7 (left). Circuit diagram for the internal charger.

Fig. 8 (below). Charger stripboard component layout and details of underside breaks in copper strips.

Fig. 9 (below left). Interwiring of the charger components.



EE34430

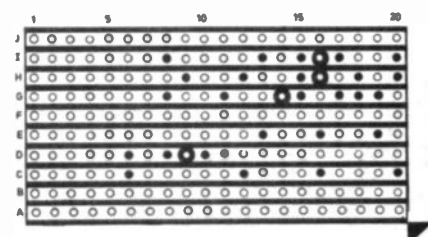

EE34440

HART

HART AUDIO KITS – YOUR VALUE FOR MONEY ROUTE TO ULTIMATE HI-FI

HART AUDIO KITS give you the opportunity to build the very best engineered hi-fi equipment there is, designed by the leaders in their field, using the best components that are available.

Every HART KIT is not just a new equipment acquisition but a valuable investment in knowledge, giving you guided hands-on experience of modern electronic techniques.

In short HART is your 'friend in the trade' giving you, as a knowledgeable constructor, access to better equipment at lower prices than the man in the street.

You can buy the reprints and construction manual for any kit to see how easy it is to build your own equipment the HART way. The FULL cost can be credited against your subsequent kit purchase.

Our list will give you fuller details of all our Audio Kits, components and special offers.

AUDIO DESIGN 80 WATT POWER AMPLIFIER.



This fantastic John Linsley Hood designed amplifier is the flagship of our range, and the ideal powerhouse for your ultimate hi-fi system. This kit is your way to get UK performance for a few tenths of the cost! Featured on the front cover of 'Electronics Today International' this complete stereo power amplifier offers World Class performance allied to the famous HART quality and ease of construction. John Linsley Hood's comments on seeing a complete unit were enthusiastic: "The external view is that of a thoroughly professional piece of audio gear, neat elegant and functional. This impression is greatly reinforced by the internal appearance, which is redolent of quality, both in components and in layout. Options include a stereo LED power meter and a versatile passive front end giving switched inputs using ALPS precision, low-noise volume and balance controls. A new relay switched front end option also gives a tape input and output facility so that for use with tuners, tape and CD players, or indeed any other 'flat' inputs the power amplifier may be used on its own, without the need for any external signal handling stages. 'Slave' and 'monobloc' versions without the passive input stage and power meter are also available. All versions fit within our standard 420 x 260 x 75mm case to match our 400 Series Tuner range. All six power supply rails are fully stabilised, and the complete power supply, using a toroidal transformer, is contained within a heavy gauge aluminium chassis/heat-sink fitted with IEC mains input and output sockets. All the circuitry is on professional grade printed circuit boards with roller tinned finish and green solder resist on the component ident side, the power amplifiers feature an advanced double sided layout for maximum performance. All wiring in this kit is pre-terminated, ready for instant use."

RLH11 Reprints of latest articles..... £1.80
K1100CM HART Construction Manual..... £4.50

LINSLEY HOOD 'SHUNT FEEDBACK' R.I.A.A. MOVING COIL & MOVING MAGNET PICKUP PREAMPLIFIER



Modern, ultimate sound systems are evolving towards a built-in RIAA preamplifier within the turntable unit, keeping noise pickup to a minimum. This new circuit by John Linsley Hood uses latest generation integrated circuits in the sonically preferred shunt feedback configuration to give an accurate and musical sound, with the ability to use both moving magnet and moving coil cartridges. Power comes from two 9v PP3 size batteries or a mains power supply. This HART kit is exceptionally easy to build with detailed instructions and all the specially selected components fitting directly on to the roller tinned fibreglass printed circuit board. Even the gold plated phono sockets mount directly on the board.

This Kit now comes with latest generation low-noise front end IC and onboard power stabilisers for any DC input voltage between 9v and 30v.

K1500 Special Discount Price for complete Kit..... £87.99

ALPS PRECISION LOW-NOISE STEREO POTS.



To fulfil the need for higher quality controls we are now importing an exciting new range of precision audio pots in values to cover most quality amplifier applications. All in 2-gang stereo format, with 20mm long 6mm dia. steel shafts. Now you can throw out those noisy ill-matched carbon pots and replace with the real hi-fi components only used selectively in the very top flight of World class amplifiers. The improvement in track accuracy and matching really is incredible giving better tonal balance between channels and rock solid image stability. Motorised versions have 5v DC Drive motor.

2-Gang 100K Lin..... £8.86
2-Gang 10K, 50K & 100K Log..... £9.60
2-Gang 10K Special Balance..... £10.71
2-Gang 20K Log MOTORISED..... £19.20
2-Gang 10K Special Balance, MOTORISED, zero crosstalk and < 10% centre loss with near Log/Antilog Tracks..... £19.98

HIGH QUALITY REPLACEMENT CASSETTE HEADS



Do your tapes lack treble? A worn head could be the problem. For top performance cassette recorder heads should be replaced every 1,500 hours. Fitting one of our high quality replacement heads could restore performance to better than new! Standard inductances and mountings make fitting easy on nearly all machines (Sony are special, see below) and our TC1 Test Cassette helps you set the azimuth spot on. As we are the actual importers you get prime parts at lower prices, compare our prices with other suppliers and see! All our heads are suitable for use with any Dolby system and are normally available ex stock. We also stock a wide range of special heads for home construction and industrial users.

HM120 Standard Mono R/P Head..... £3.51
HC15 Standard Quality Stereo R/P Head..... £2.49
HC66 High Quality Stereo R/P Head, Permalloy..... £7.98
HS16 Sendust Alloy Stereo Head..... £16.85
HC80 NEW RANGE High Beta Permalloy Stereo head. Modern space saver design for easy fitting and lower cost. Suitable for chrome metal and ferric tapes, truly a universal replacement head for everything from hi-fi decks to car players and at an incredible price too!..... £8.30
H0551 4-Track RECORD & Play Permalloy Head for auto-reverse car players or quadraphonic recording £14.90
H524 Standard Erase Head..... £1.90
H561 Hi Field Erase Head for METAL Tapes..... £3.49
HRP373 Downstream Monitor Stereo Combination Head..... £47.90

Many other SPECIAL cassette Heads in stock, see our LIST.

REEL TO REEL HEADS

999R 2/4 Record/Play 110mH. Suits Stuart Tape Circuits..... £13.64
998E 2/4 Erase Head 1mH. Universal Mount, Suits Stuart..... £11.98

TAPE RECORDER CARE PRODUCTS

HART TC1 TEST CASSETTE Our famous triple purpose test cassette. Sets tape azimuth, VU level and tape speed..... £5.36
DEM1 Mains Powered Tape Head Demagnetizer, prevents noise on playback due to residual head magnetisation..... £4.48
DEM115 Electronic, Cassette Type, demagnetizer..... £8.91

COMPUTER CORNER

The following are a selection of our new range of VERY competitively priced, High Quality, computer systems. Due to our long experience of importing we have the necessary contacts in the Far East to buy at very advantageous prices and can pass the savings on to you. All hard disc machines ordered with DOS are fully formatted and ready to use.

HART MODEL AT-286/16WP COMPUTER

Fully fledged AT286 machine, cheap enough to use as the fastest wordprocessor in the west! Only a few years ago the AT-286 machine was the fastest standard office computer known. Now we can offer the superfast 16MHz version (earlier ones were only 10 or 12MHz) at such an incredibly low price that it can be used in any office or home. Not only that but ours comes with ultrafast memory so that the machine can run in 'zero wait state'.



Advanced features are:- Full 1MB of memory (Expandable to 4MB), 102 key UK keyboard, compact desktop case, 1.2MB 5 1/4" High Density Disk Drive and Interface card for extra drive, Graphics/Printer Card, built in Hard Disk Interface.

HART AT-286/16WP..... ONLY £277.25
14" FST Hercules monitor, Amber..... £83

14" Paper White Hercules Monitor, (Both have T/S Base)..... £86
Trust Writer W/P Software uses Wordstar commands. £19.50

40MB AT-386/16UG Hard Disk Computer. Specification as AT-286 but with 45MB 25ms hard disk, VGA Colour Graphics Card with 512K RAM, parallel printer port, 2 serial ports, 1 game port..... £523.50
40MB AT-386/20SX UG..... ONLY £853.10

HART 40MB AT-386/16SX EL



Entry level 386 machine for demanding applications at moderate cost. Spec as our AT286/16WP with 1MB Dram memory, Mini Tower case, 45MB 25ms hard disk drive, VGA Colour Graphics Card with 256K RAM

40MB AT-386/16SX EL is..... ONLY £834.30 (Ex Vat)

HART 52MB AT-386/20SX UG



Luxury version of the above with higher processor speed and amazing 9 millisecond access time hard disk, 2MB SIMM RAM, Compact Tower Case, VGA 1024 x 768 card with 512K RAM, upgradeable to 1MB of Video memory.

OPTIONAL EXTRAS

HART Computers can be 'custom made' to fit your personal

requirements, at NO extra cost! Simply select the options you require. If replacing any item in the standard specification for that model then deduct the cost of the part not needed.

SOFTWARE

MS-DOS 5 Latest Release, Full version, 3.5" or 5.25"..... £59
DR DOS 6..... £77
Microsoft Windows 3.3.5" or 5.25" Disks..... £65

MONITORS

SM1421 AM TU Hercules Mono with FST Tube and Stand, Amber..... £83
SM1421 PW TU As Above but Paper White Screen..... £86
SM1416A VGA Mono Monitor c/w tilt and swivel stand, Amber..... £86.70
SM1416W As Above, Paper white..... £89
SM1485-00 Super VGA Multisync Colour Monitor, 28" dot pitch, 50MHz Bandwidth, up to 1024 x 768, c/w stand..... £235

KEYBOARDS

K261 102 Key Enhanced UK Layout, Tactile Click, AT/XT Switchable with dual slope feet, (Standard Keyboard supplied with systems)..... £31
K108 Similar to above, single slope feet, Alps switches..... £26
KB6153A As above but with heavy metal base..... £44

I/O and GRAPHIC CARDS

AT Super I/O Card 2 x FDD, 1xIDE, 2 Serial, 1 Parallel, 1 Game Ports..... £21.20
Hercules Mono Graphic & Printer card..... £11.70
16-Bit VGA Card, 256K..... £46.50
Trident 8900 VGA Card, 512K..... £67.30
Trident 8900 VGA Card with 1Mb..... £86.90

DISK DRIVES

5.25" 1.2Mb Floppy Disk Drive..... £49
3.5" 1.44Mb Floppy Disk Drive..... £45
Adapter to fit 3.5" drive in 5.25" slot, c/w power adapter..... £19
45MB 25ms Hard Disk Drive..... £165
52MB Quantum Hard Disk, Lightning Fast 9ms Access time..... £261

CASES

WE 611P Desktop Case, Flip Top, 200W PSU..... £56.40
WE727P Mini Tower Case, 200W PSU..... £84.70
108MP Mini Tower Case, Compact Style..... £89
CT107 Midi Tower Case..... £108

MOTHERBOARDS

AT-286/16 OK.RAM..... £89
AT-386-16SX OK.RAM..... £195
AT-386-20SX OK.RAM..... £245

PLEASE NOTE THAT ALL ITEMS IN THIS SECTION ARE PRICED EX VAT.



MANUFACTURERS OF QUALITY AUDIO KITS AND COMPUTERS

24 hr. SALES LINE (0691) 652894 Fax: (0691) 662864

AUDIO KIT PRICES are VAT INCLUSIVE. COMPUTER PRICES EXCLUDE VAT

HART

HART ELECTRONIC KITS LTD
8 PLYN MILL
OSWESTRY, SHROPSHIRE
SY10 9AF

INTERFACE



Robert Penfold

IN LAST month's *Interface* article a simple eight bit Analogue to Digital Converter was described, together with a simple temperature sensor. This month we continue on the same theme, with an improved temperature sensor circuit. This provides greater resolution and a wider temperature range.

SIGNAL PROCESSING

The main problem with the basic design described last month is that it provides a resolution of only one degree Centigrade. Over a temperature range of 0 to 100 or 110 degrees, it is actually possible to obtain a much more useful resolution of 0.5 degrees using an 8-bit converter.

A second problem with the original design is that it lacks accuracy at low temperatures. This is partially due to limitations of the temperature sensor, and partially due to problems in removing the slight zero offset of the converter.

The circuit diagram for the Improved Temperature Sensor is shown in Fig. 1. Like the original circuit, this is based on the LM35DZ temperature sensor (IC1), which is usable over a 0 to 100 degree Centigrade temperature range. If the more expensive LM35CZ is used, the upper end of the range is extended to 110 degrees Centigrade.

The LM35 provides an output voltage that is equal to 10 millivolts per degree Centigrade, with no d.c. offset. This matches the 10 millivolt resolution of the Analogue to Digital Converter (last month), giving the one degree resolu-

tion. Simply amplifying the output from the LM35 by a factor of two boosts the output voltage to 20 millivolts per degree, and gives 0.5 degree resolution. With a maximum temperature of 100 or 110 degrees Centigrade, this gives a maximum output potential of 2.0 or 2.2 volts, which is still within the 2.56 volt maximum of the converter.

CIRCUIT

Component IC2 is a simple non-inverting amplifier which is d.c. coupled and has a voltage gain of two times. Its gain must be set very precisely at this figure in order to obtain accurate results. The gain has therefore been made adjustable, and VR2 is used to trim it to precisely the correct figure.

Potentiometer VR1 is an offset null control. Conventionally an offset null control is used to compensate for offset voltages in the operational amplifier's biasing. It will do so in this case, but it can also be used to compensate for any slight offsets in the analogue to digital converter, or in the temperature sensor.

Note that the output of this circuit must connect directly to the analogue input terminal of the ZN448E in the converter circuit. The input attenuator and zero adjustment circuits of the converter should be omitted.

SOFTWARE

Taking readings from the interface is achieved in much the same way as for the original temperature interface. First out-

put a dummy value to in/out address 768 in order to initiate a reading. After a delay of at least nine microseconds, the converter is read at input/output address 768. Simply divide the returned values by two in order to convert them into readings in degrees Centigrade.

I have assumed here that the converter is at the base address of the thirty two address "prototype card" block. If the unit is placed elsewhere in the input/output map, then obviously the appropriate address must be used instead of address 768.

The accompanying Listing.1 is for a program that takes readings at one second intervals. It displays the current temperature on the screen, together with maximum and minimum readings.

This program is useful for testing and calibration purposes, as well as for use when utilizing the system for temperature monitoring. It is suitable for the Quick BASIC compiler, or the QBASIC interpreter supplied with MS/DOS 5.0. It might work with other PC BASICs, but if not it should certainly be quite easy to convert it to work with other PC BASICs.

CALIBRATION

The original temperature interface circuit does not require any calibration, but it does not exactly offer the ultimate in accuracy. This version can provide much better accuracy, but only if it is calibrated accurately.

Calibration requires two accurate temperatures, and one of these can be iced water at 0 degrees Centigrade. The other

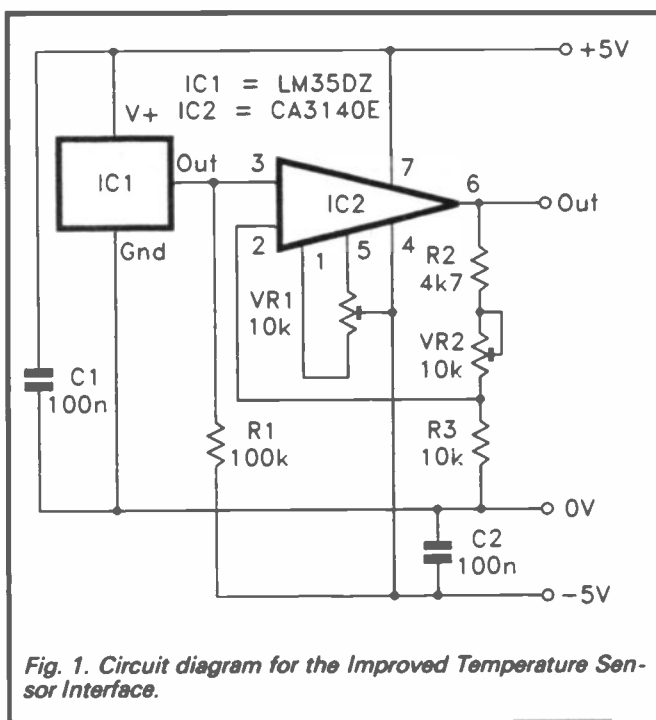

Fig. 1. Circuit diagram for the Improved Temperature Sensor Interface.

```
SCREEN 0
WIDTH 40, 25
CLS 2
```

```
Tmax = 0
Tmin = 127
f% = "£££.££"
```

```
LOCATE 8, 6
PRINT "Temp."
LOCATE 8, 18
PRINT "Max"
LOCATE 8, 31
PRINT "Min"
LOCATE 15, 1
PRINT "Press SPACE BAR to exit"
```

```
WHILE INKEY$ <> " "
  OUT 768, 0
  SLEEP 1
  Tnow = INP(768) / 2
  IF Tnow > Tmax THEN Tmax = Tnow
  IF Tnow < Tmin THEN Tmin = Tnow
  LOCATE 10, 5
  PRINT USING f%; Tnow
  LOCATE 10, 17
  PRINT USING f%; Tmax
  LOCATE 10, 30
  PRINT USING f%; Tmin
WEND
```

Listing One:
Temperature
Reading

temperature must be much higher, and this could be water at about 50 degrees Centigrade or so. A good quality thermometer should be used to accurately monitor the precise temperature of the water.

The calibration process is very straightforward. Start with both VR1 and VR2 set at roughly the centres of their adjustment ranges. Place IC1 in the iced water and adjust VR1 for a reading of zero. Next place IC1 in the hot water, and adjust VR2 for the correct reading. Repeat this procedure a few times until no further adjustment is necessary. The unit should then work with good accuracy over the full temperature range.

When calibrating and using the unit, bear in mind that IC1 should not be directly immersed in liquids. It must be mounted inside a container of some kind, such as a small test-tube, so that no liquid comes into contact with its leadout wires.

It is a good idea to use some silicon grease to give a good thermal contact between the container and IC1. Even so, the response time will not be particularly fast. It will take the sensor several seconds to respond to large and rapid changes in temperature. Be careful to allow sufficient adjustment time when calibrating the unit.

NEGATIVE TEMPERATURES

The LM35CZ can handle negative temperatures down to -40 degrees Centigrade. Unfortunately, these negative temperatures provide negative output voltages which the converter can not handle. One way around this difficulty is to use VR1 to provide an offset, so that the output voltage from IC2 is always positive.

For example, suppose that the unit must measure temperatures down to -10 degrees Centigrade. With IC1 at this temperature, VR1 would be adjusted for a reading of zero. With IC1 then set at the higher calibration temperature, VR2 would be adjusted for a reading ten degrees higher than the actual calibration temperature.

In order to obtain readings in degrees Centigrade, the software would first

have to divide readings by two, and then deduct ten to compensate for the deliberate offset. This would give a usable temperature range of -10 to -110 degrees Centigrade.

Some initial experiments would suggest that a 10 degree offset can be handled with no significant degradation in accuracy. This might not be the case with the full 40 degree offset needed to read down to the -40 degree minimum of the LM35CZ.

However, if you need to read down to such low temperatures it might be worthwhile experimenting along these lines. VR1 certainly seems to be able to handle a 40 millivolt input offset. Of course, if the unit is made to read right down to -40 degrees, you have to accept some loss of coverage at the other end of the range. The maximum input voltage of the converter would be reached at a temperature of 87.5 degrees.

There is plenty of scope for experimentation with a unit of this type. With suitable software you can do such things as monitoring heating systems, the outside temperature, etc. Most PCs have good graphics capability these days, and it should not be too difficult to produce software to log readings and then display them as graphs.

PC INCOMPATIBILITIES

There are hundreds of different PC expansion cards, monitors, etc. currently available, and with a few provisos, they should all work perfectly well together. In reality there seems to be the occasional problem, which I suppose is inevitable with so many products being produced by so many different companies around the world. This means that you need to be a little careful when buying PC hardware.

Possibly I have been unlucky, but I have encountered numerous PC compatibility problems over the last few years. The worst case was a 12MHz AT motherboard which only seemed to work with about one-in-two expansion cards! With some swapping around of cards between various computers I did eventually managed to produce a complete

computer based on this motherboard, but why did some cards refuse to work with it while others were fine?

More recently I have had problems with non-Intel maths co-processors which worked in some computers but not in others, and a monitor which worked with some VGA cards in all modes, but refused to respond to others when used in the 800 x 600 super VGA mode.

In the case of the monitor the problem seemed to be due to differences in the scan rates of VGA cards. The super VGA modes are not properly standardised, and this clearly leaves room for incompatibility problems. Many VGA cards now have a configuration switch which enables you to select between two sets of scanning frequencies. A lower set than any super VGA monitor should be able to handle, and a higher one for "flicker-free" viewing on suitable monitors.

The expansion card problem and (possibly) the co-processor one seems to be something more fundamental. Modern motherboards and expansion cards are largely devoid of TTL chips, and instead use a variety of LSI chip technologies. This seems to result in occasional conflicts where two sets of chips do not agree about what constitutes valid logic 0 and logic 1 voltages. This usually results in the computer completely hanging up, or crashing soon after switch-on.

There also seems to be problems with drive currents, with some chips simply not having sufficiently powerful outputs. This factor seems to be responsible for some computers being unable to drive some printers via their parallel ports.

It would seem to be a good idea, where possible, to check that PC hardware will work properly with your system before handing over any money. Alternatively, make sure that you can return the equipment for a refund if there are any incompatibility problems.

Next month: We will continue with PC interfacing, and the subject of digital to analogue converters will be covered.

Crossword Solution



WORD SEARCH

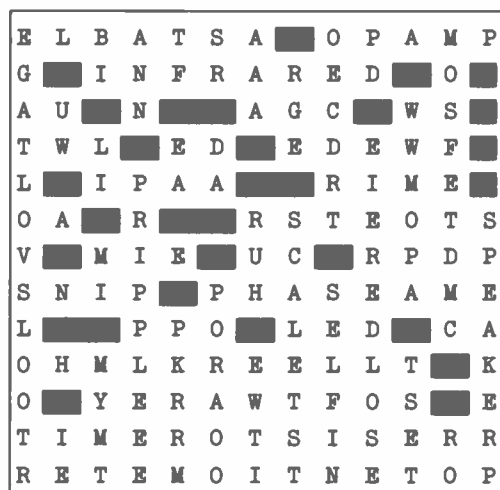

★ SOLUTION ★

The familiar title is - EVERYDAY ELECTRONICS The associated name is - MIKE KENWARD

Special Series

MAGNETIC RECORDING

Part 4: HEAD DRIVE CIRCUITS

VIVIAN CAPEL



IT MAY seem that all we need to do to make a magnetic recording on tape is to connect a recording head to an amplifier and a biasing system, and pass the tape at uniform speed across it. As may be expected, there is rather more to it than that.

Our first consideration is that of head impedance, it should be of the optimum for the required function. Just as with the magnetic characteristics we discussed last month, the electrical requirements for the recording and playback heads are quite different.

The strength of a magnetic field produced by a coil is proportional to the current flowing through it rather than the voltage across it. So we must be able to drive adequate signal and bias currents through the head in order to make a good recording. As high impedances limit the amount of current that could pass, it follows that the head winding should be of low impedance.

In the case of the playback head, it is necessary to generate as high a voltage as possible from the flux on the tape, in order that a large signal voltage is presented to the first stage and a high signal/noise ratio thus be obtained. This requires a large number of turns on the coil, which gives it a high impedance.

So, a low impedance is best for the recording head whereas a high impedance is desirable for playback. No problem here as long as separate heads are used, but with a single record/playback head, impedance must be a compromise.

SWITCHING

When a single head is used it must be switched from the record to the playback amplifier and back again, which can be done with a single-pole two-way switch. An obvious way of connecting it is having one side of the winding connected to the chassis, and the other switched either to the input of the playback amplifier or the output of the recording amplifier.

Such an arrangement though, would be prone to trouble. Remember that very high gain must follow the playback head to translate the minute signals from the tape into the high volume needed for realistic sound reproduction. So, any trace of oxide on the switch contacts would produce audible noise. Furthermore, the switch and its terminals would be liable to pick up hum and would need careful screening which could pose practical difficulties.

The alternative switching system commonly used, is both simple and ingenious.

One side of the head winding is permanently connected to the recording amplifier output circuit, while the other side is permanently taken to the playback amplifier input. Connections from both are taken to a switch, while the switch common is connected to the chassis (Fig. 1).

In the play position, the switch "earths" the A side of the windings, but in the record position, the B side of the winding is earthed. As the switch is connected to chassis in both positions it cannot pick up hum, and there is no switching of "live" connections.

There is no need to switch the erase head during playback with a.c. systems, as the oscillator is switched off. With d.c. erasure, switching the head is necessary.

H.F. LOSS

Taking a further look at the impedance of the head, this results from a combination of inductance and the d.c. resistance of the coils. The formula is:

$$Z = \sqrt{R^2 + X_L^2}$$

where Z is the impedance; R is the resistance of the coils; and X_L is the reactance resulting from the coil inductance.

When recording low frequencies, the reactance X_L is low compared to the resistance, but at high frequencies the opposite is true, and the reactance becomes large in proportion to the resistance. What this means in practice is that the recording current encounters a low impedance at bass frequencies, but a continually rising one

as the frequency increases. It decreases proportionally, producing a falling treble response.

PHASE ANGLES

There is another ill effect. Phase angles change as the relationship between reactance and resistance alters. So, high frequencies become displaced in phase relative to lower ones. As the stereo effect depends strongly on phase differences between channels it can be seen that phase errors can result in impaired stereo.

The most common solution to these problems is to increase the value of R by including a high value resistor in series with the head coil. This has a swamping effect by maintaining a more constant ratio between reactance and resistance over the frequency range. It ensures that the circuit is mainly resistive and so behaves in a more linear manner in its frequency as well as its phase response.

A further improvement can be achieved by connecting a capacitor across the resistor. This increases the high frequencies applied to the head and also improves the phase correlation between high and low frequencies. The values of the resistor and capacitor depend on the resistance and inductance of the head, all being chosen to give the flattest overall response with minimum phase displacement for the particular head.

This gives rise to an important practical point. Replacing a worn head on a tape recorder is quite a straightforward task. If the maker's replacement is used there is no problem, but it may not be available, or it may be decided to upgrade from a permalloy to an HPF (hot-pressed ferrite).

Whatever the replacement, it should have approximately the same resistance and inductance as the original, otherwise the series components will not produce the required compensation. Having said that, minor differences, particularly of coil resistance, have little effect and can be ignored.

RECORDING AMPLIFIER

The output stage feeding the head circuit must produce a high voltage to overcome the high series resistance, and also a high current to drive the coils. So it must provide a high power compared to what actually is needed to generate the recording flux. The output stage must therefore be of a power output type, and many recorders use the loudspeaker output stage to drive the head in the record mode.

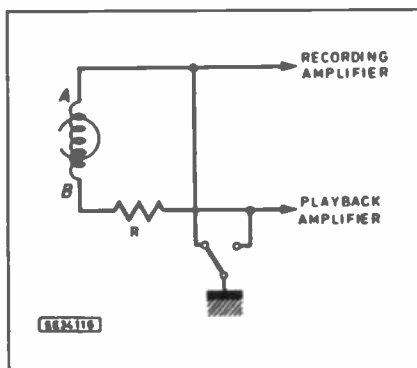

Fig. 1. Switching to a combined record/playback head. One end of the head winding goes to the recording amplifier and the other to the playback circuit. Alternate ends of the winding are earthed for each function thereby avoiding signal switching and possible hum problems.

Another factor which comes into play is the *slew rate* of the output stage. All power amplifiers have a limit to the rate of change that the output voltage can follow. It is obvious that the rate of change of a large signal is greater than that of a smaller one.

It is also evident that a high frequency cycle is completed much quicker than a cycle of a low frequency, so the rate of change is correspondingly greater. The rate of change is thus proportional to frequency and signal magnitude.

In a recording amplifier where high output voltages are required, the output stage slew rate may be inadequate at high frequencies. This can be another cause of falling h.f. response, and also generate the intermodulation distortion which occurs when the slew rate is exceeded. The effect is reduced by selecting output transistors having high slew ratings at the voltages and frequencies required.

There is another type of output stage which overcomes these problems by eliminating the need for the high-value series resistor. As we have seen, the recording flux is obtained as a result of current through the head windings rather than voltage. The output stage therefore is designed as a *constant-current source*,

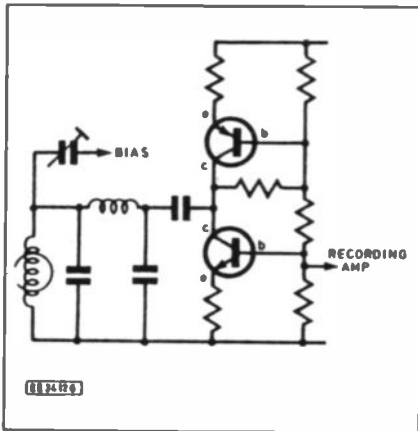

Fig. 2. Transconductance recording output stage supplies signal current that is not dependent on the impedance of the load thereby eliminating the need for a high-value series resistor (Tanberg Acitilinear).

that is the current it supplies remains constant irrespective of the impedance of the load. So, when the impedance rises at higher frequencies, the current is not reduced.

An example of this type of circuit is the Acitilinear circuit devised by Tanberg, (Fig. 2). It consists of a complementary push-pull output circuit similar to that used for many audio amplifiers, but with *negative feedback* from the transistor collectors (c) to the base circuit. An LC filter circuit couples the output to the head.

This type of circuit provides more than sufficient current to drive the head and because high signal voltages are not required to overcome a high series resistance there are no slew rate problems. A bonus is that the stage serves as a buffer between the bias oscillator and the recording amplifier so that feedback of the oscillator voltage to earlier stages is greatly reduced.

HEAD DRIVE ADJUSTMENT

Recording signals that are too large cause the operating point on the hysteresis

loop to encroach onto the curved portions and so generate distortion. Yet those that are too small degrade the signal/noise ratio and require the playback amplifier to be turned well up, further increasing noise. So there is an optimum point beyond which peak recording levels should not rise, nor should they fall too far below.

This is the 0dB point on the recording level meter. However, due to the tolerances of components in the recording amplifier this has to be set for each particular instrument during manufacture, and a pre-set control will be found inside the machine for the purpose.

To reset it a millivoltmeter and an audio oscillator with variable output is required, also the service manual, or at least the appropriate information from it. A 10 or 100 ohm resistor is included in the "earthy" end of the record head by the makers and the meter is connected across it, see Fig. 3. To avoid false readings the bias oscillator must now be disabled, and then the fixed tone from the external audio oscillator is injected into the Auxiliary or MIC socket.

The output level of the oscillator is next adjusted to obtain 0dB on the VU meter, then the pre-set drive control is set to give the millivolt reading specified in the manual. Readings vary from model to model, but a typical one is 0.35mV over 10 ohm for Ferric tape, and 0.7mV for Chrome tape.

It can be said that this adjustment rarely needs to be done unless major components have been changed in the recording amplifier.

BIAS LEVEL ADJUSTMENT

The bias level may need resetting if a different type of tape from that recommended is used. In most cases the differences are too small to make much difference for average domestic use. Professionals set the bias for each tape recorded, as these are masters from which copies will be made and top performance is essential. Hi-fi enthusiasts may also wish to optimise the setting for a particular brand of tape.

Adjustment is usually by means of a small variable capacitor in series with the bias oscillator feed to the record head, but variable resistors or tunable coils are also used. The measurement is made in the same way as that for recording level, that is across the 10 or 100 ohm resistor in series with the recording head.

When the recorder is switched to record with no signal input, a reading is obtained. If the maker's setting is being checked, the reading should be compared with that given in the manual and any necessary adjustment made. As with the recording drive, values vary between models, but roughly, the reading should be about ten times that of the recording level at zero VU. Across 10 ohm it usually ranges from 3.0-7.5mV, while across 100 ohm, 30-75mV.

To set the level for a different make of tape, an audio oscillator that can generate a 400Hz and a 10kHz tone is required. These are recorded on the tape at -12dB on the VU meter. The tape is played back and the output levels of the two tones compared. If that of the 10kHz tone is lower, there is too much bias and the amount should be decreased, but if it is higher, bias is insufficient and it should be increased.

Adjust accordingly, then erase the tape and record the two tones again at the

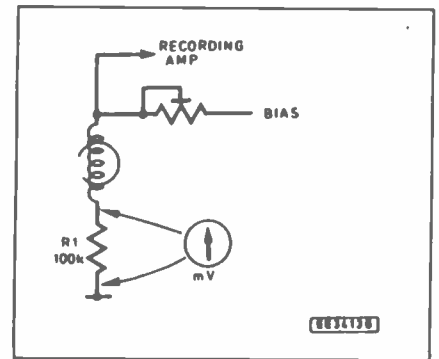

Fig. 3. Adjusting recording bias, commonly by preset resistor in series with the bias feed. Reading is taken by a millivoltmeter across 100 ohms (10 ohms in some models) in the earthy end of the head.

same level. Playback once more and check the comparative levels as before, then make further bias adjustment as required.

The process is repeated until the 10kHz tone is just 1dB down if optimum distortion level is desired. It may be remembered from a previous article, that the two do not coincide, one must adjust for either one or the other, or a compromise can be made.

AUTOMATIC LEVEL CONTROL

Automatic level control (ALC) is found in most portable recorders. Part of the output of the recording amplifier is rectified then used to control the gain of an earlier stage. This ensures that the recording level is not too high or too low without the necessity of manually adjusting the level. It also takes care of increases and decreases of signal level during recording.

The time constants of the circuit are chosen to give a rapid attack, but slow decay. Thus sudden loud signals produce an almost immediate reduction in gain to prevent overload, but afterwards the circuit fades up the gain gradually to avoid too obvious gain changes.

The system is useful for speech and "on location" recordings where it would be difficult to set and maintain levels manually, but it does have serious drawbacks for other work. Level changes are noticeable, as background noise drops then fades up as the signal varies.

For recording music it is hopeless, as the dynamic range is telescoped, musical climaxes are emaciated, and quiet passages that are reduced to almost inaudibility after loud fortissimos, gradually get unnaturally louder.

Early recorders had a manual/automatic switch, whereby the user could select the mode according to the use, but although gimmicks abound on modern machines, this very useful facility has disappeared. Some serious users have had their machines converted to manual operation. This involves removing the feed to the controlled stage and either fitting a manual control or in some cases it is possible to arrange for the playback volume control to serve as a level control during recording. Modification details differ considerably between models.

Having explored the heads and their drive circuits, we will return to the tape itself in our next article and see how this apparently simple commodity is far more complex than it appears, and what is involved in its manufacture.

SIMPLE MODEL SERIES SPECIAL EASIWIRES OFFER

FREE EASIWIRES IF YOU BUY ANY FOUR MODEL KITS OR EASIWIRES FOR £5 WHEN YOU PURCHASE A PROJECT KIT.

The two companies mentioned below have large stocks of Easiwire solderless wire wrapping systems, as used to build all our *Simple Model Series* projects. They have agreed to make these available to EE readers who purchase complete kits of components for the projects, **INCLUDING** printed cards to cut out and assemble for each model. If you are prepared to buy *any four* of the seven model kits then you can get your Easiwire **FREE**.

If you buy *any one* model kit you can purchase an Easiwire kit for just **£5**. (These kits were previously advertised by BICC-Vero at £15, including p&p). To get your kit and Easiwire simply fill in the appropriate coupon and send it with your cheque (or credit card details) to *either of the companies*.

The seven projects are: Police Car (July 91); Musical Roundabout (Aug 91); Micro Micro - a dolls house microcomputer (Sept 91); Centurion Tank (Oct 91); Mini Microwave - dolls house microwave oven (Nov 91); Christmas Novelty Decoration (Dec 91); Bishop Rock Lighthouse (Jan 92). These models all play tunes or make noises or flash lights etc.



All prices include VAT

Please fill in the appropriate coupon below, tick the relevant boxes and send your cheque/PO/credit card number with *one* of the coupons to:

GREENWELD ELECTRONIC COMPONENTS
27 PARK ROAD,
SOUTHAMPTON SO1 3TB
Tel: 0703 236363
Fax: 0703 236307

OR

BULL ELECTRICAL
250 PORTLAND ROAD,
HOVE, SUSSEX
BN3 5QT
Tel: 0273 203500
Fax: 0273 23077

SEND EITHER COUPON TO EITHER COMPANY - YOU CHOOSE YOUR SUPPLIER
Overseas readers please add £3 to cover the extra postage charge.

FREE EASIWIRES

Please send me my **FREE** Easiwire kit. I understand that I must buy four model kits at the price given by EE -

I enclose a cheque/PO for £..... for the kits ticked below

Please debit my credit card

Card No.

Ex. Date.....Signature.....

The kits I require are:

Tick four or more boxes.	{	Police Car (July '91).....	£5.95 plus £1 p&p	<input type="checkbox"/>
		Musical Roundabout (Aug '91).....	£7.95 plus £1 p&p	<input type="checkbox"/>
		Micro Micro (Sept '91).....	£2.50 plus £1 p&p	<input type="checkbox"/>
		Centurion Tank (Oct '91).....	£4.95 plus £1 p&p	<input type="checkbox"/>
		Mini Microwave (Nov '91).....	£5.50 plus £1 p&p	<input type="checkbox"/>
		Christmas Novelty (Dec '91).....	£4.95 plus £1 p&p	<input type="checkbox"/>
		Bishop Rock Lighthouse (Jan '92)	£5.95 plus £1 p&p	<input type="checkbox"/>

Name.....

Address.....

£5 EASIWIRES

Please supply the Lighthouse on its own at £5.95 plus £1 p&p

Please supply an Easiwire at £5 with the above kit

Overseas readers please add £3 to cover the extra postage charge.

I enclose a cheque/PO for £..... (£6.95 or £11.95)

Please charge my credit card -

Card No.

Ex Date

Signature

Name

Address

Simple Model Series

FLASH!

BLEEP!!

WHIRR!!!

BISHOP ROCK LIGHTHOUSE

OWEN BISHOP

PROJECT 7

The last model in a series which combines two hobbies in one - electronics and model-making. Simple electronic circuits combined with easy-to-assemble models that cover a wide range of interests.

STANDING on a pinnacle of rock rising sheer out of the ocean floor in the westernmost Scilly Isles, the Bishop Rock lighthouse is said to be the most exposed in Britain. The rocks are submerged at spring tides and, given that there are an average of 30 gales in this area each year, it is small wonder that this region is a potential danger to shipping. The rock is said to be named after a sailor called Bishop who was one of only two survivors cast up on it after the wrecking of a whole merchant fleet in the Scillies in the 17th Century.

The present lighthouse is Bishop Rock III. The original Bishop Rock I was started in 1847 but was destroyed by a storm in 1850 before it ever became operational. Bishop Rock II was a sturdier and taller structure which was first lit in 1858, but suffered greatly from the storms. Eventually it was encased in further granite masonry and increased in height to its present size. Its design was by James Douglass, and it was built by his son William Tregarthen Douglass. It first came into service on 25 October 1887.

Even in these days of remote operation, Bishop Rock III continues to be a watched lighthouse, operated by Trinity House. The addition of a "helideck", well above the surges of the Atlantic breakers, makes relief operations considerably easier than they used to be, though still hazardous enough.

Bishop Rock III was originally lit by oil lamps, but now uses an electric lamp of 2,600,000 candle-power, with a range of 29 sea miles. It is white and its characteristic signal is two flashes every 15 seconds. The original fog warning was an explosive charge set off every five minutes but nowadays there is a fog-horn, giving two blasts every 90 seconds.

The model is based on the dimensions of the light-house at a scale of approximately 1/200. It reproduces the light character and fog warning of Bishop Rock III, except

that we have simplified the logic circuit by sounding the fog-horn every 60 seconds.

In the real lighthouse, the flash is produced by a set of lenses rotating around the lamp; for simplicity we flash the lamp on and off electronically. However, to simulate the effect of the rotating lenses, the lamp takes an appreciable time to acquire full brightness and to turn off.

The circuit can be adapted to produce other light characters should you prefer to base your model on a lighthouse near your home. Similarly, the fog horn has variable pitch and a programmable sounding sequence.

BUILDING THE TOWER

The lower part of the tower is a cylindrical base. Use a plastic or metal cap taken from a domestic spray-can (furniture polish, oven-cleaner etc). The cap should have an external diameter of about 54mm, and an internal diameter of at least 50mm. The exact height does not matter except that, to accommodate the circuit boards and speaker, it needs to be at least 47mm high. Fig. 1 shows the details. Paint the cap a "rocky" granite colour and draw a vertical ladder down from top to bottom, about 2mm wide with rungs 2mm apart.

If you cannot find a suitable cap, cut the base from thin cardboard as shown. Form this into a cylinder and secure the flap with glue. Bend the tags inward. Cut out the base top and glue this to the tags. We used buff-coloured card for the base and main

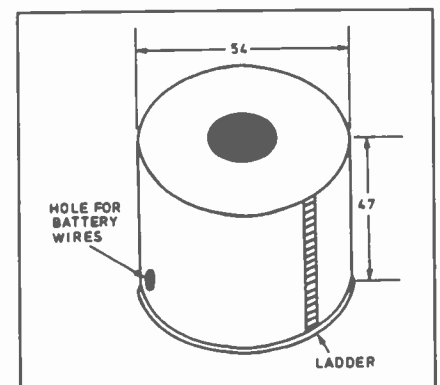
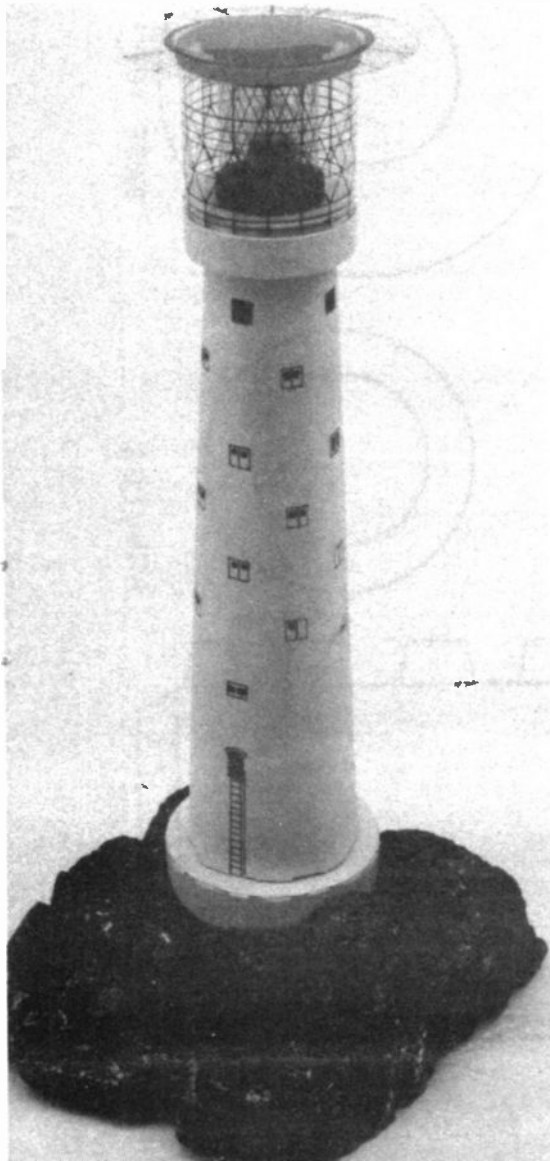
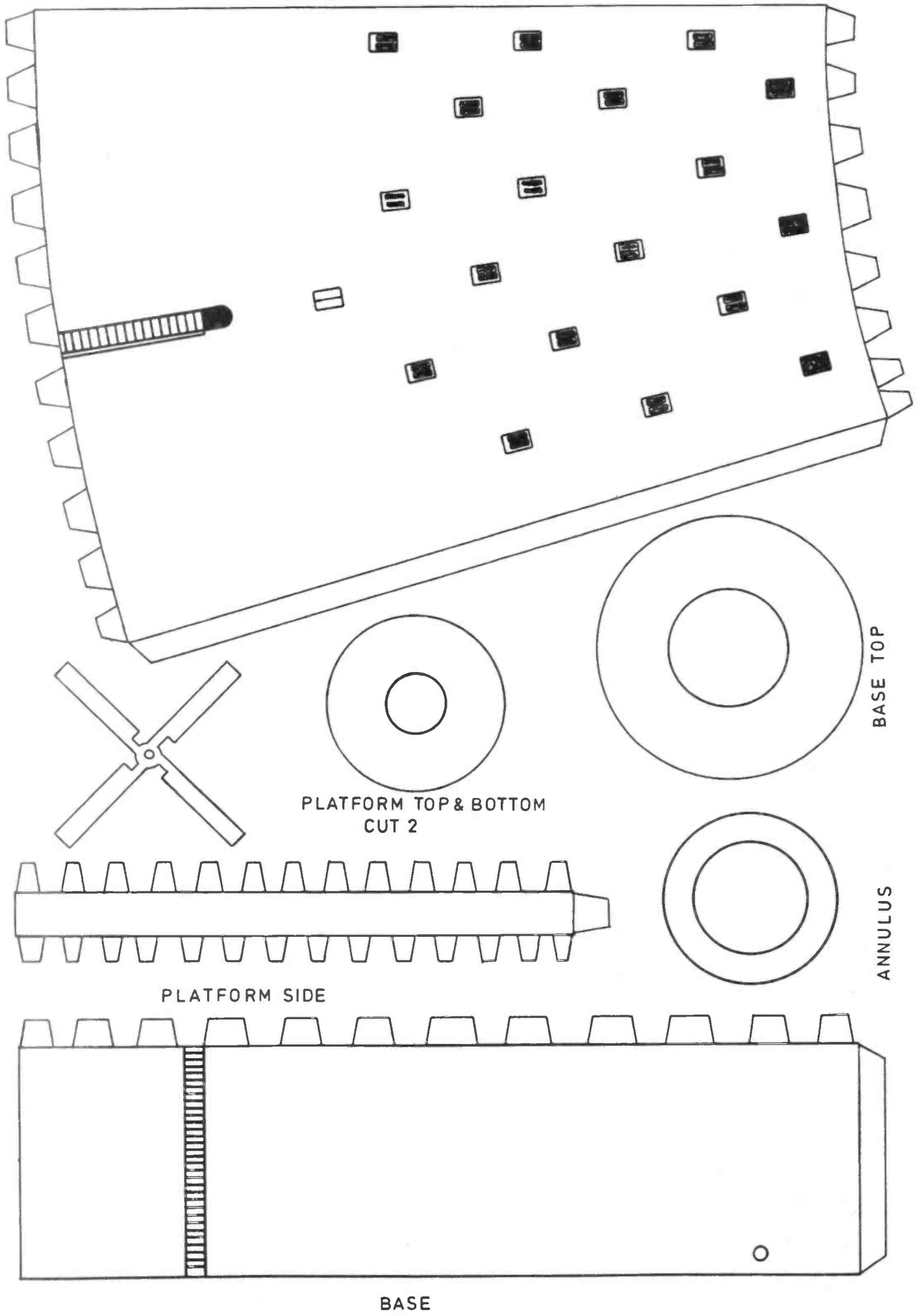
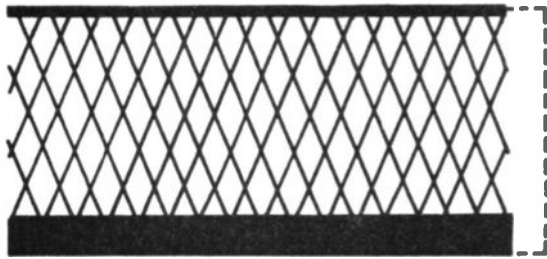

Fig. 1. The base of the Lighthouse.







LANTERN

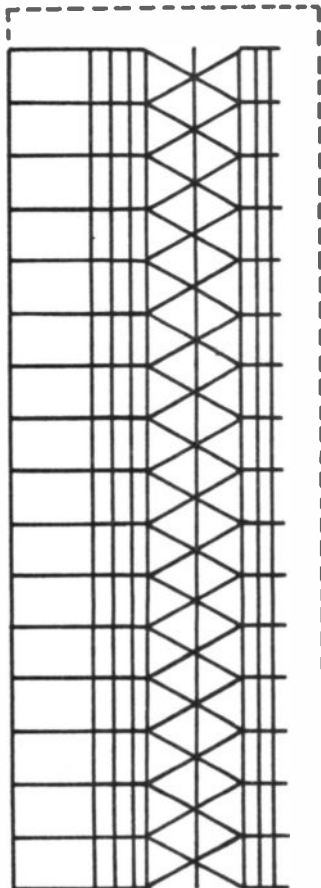

HELIDECK CAGE

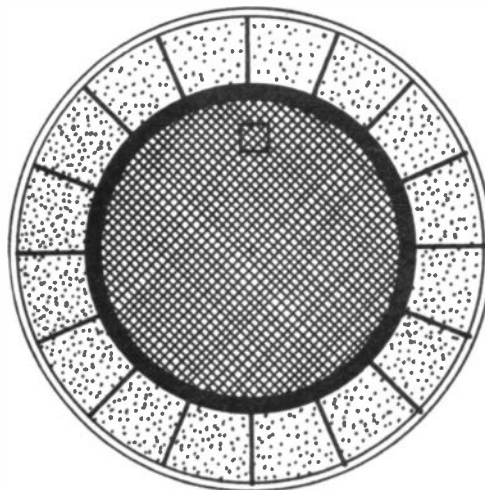

HELIDECK

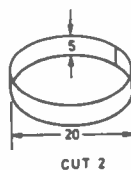

Fig. 2 (left). Card rings for the lantern

tower, so no painting was needed. If you are using white card, paint the base and draw the ladder on it where shown.

Readers with the equipment and skill could model the main tower by turning it in wood on a lathe. It is 162mm long and tapers from 42mm diameter at the bottom end to 27mm at the top. The tapering is more pronounced toward the bottom of the tower, and it hardly tapers at all near the top. Bore a hole centrally up the tower to take the wires from the base to the lamp.

The tower is topped by a circular platform which can be cut from 9mm plywood, with a hole bored centrally in it. Paint the tower, and draw the door and windows. A ladder leads from the door down to the bottom of the main tower.

The main tower can also be made from thin cardboard, though this inevitably lacks the graceful lines of the real thing, and of the wood-turned model. Form the cardboard into a narrow cone and secure the flap with glue. Make the platform from two card circles glued to two discs which form the top and bottom of the platform. Finally glue the tags at the top

and bottom of the main tower to the platform and base respectively.

THE LANTERN

Make a photocopy of the designs for the lantern, helideck and helideck cage on transparent film, in black. Cut out the lantern design. Cut two strips of thin card 5mm wide and about 200mm long. Apply glue to one side of one strip, for half its length. Wind the strip around a cylindrical object 20mm in diameter, to form a ring of about three turns (Fig. 2). The cylinder should preferably taper slightly to make it easier to remove the ring from it when the glue has dried. A small cap from a domestic spray-can was found to be exactly the right size and shape for this. Use a large black spirit-marker pen to blacken the edges and outside surface of the ring. Prepare a second ring using the other strip and blacken this too.

Cut out a card disc 27mm diameter, for the top of the lantern; blacken the upper surface of this, its edge and the outer region of the lower surface (Fig. 3). Cut another disc 20mm in diameter. Roll the lantern transparency into a cylinder and use one

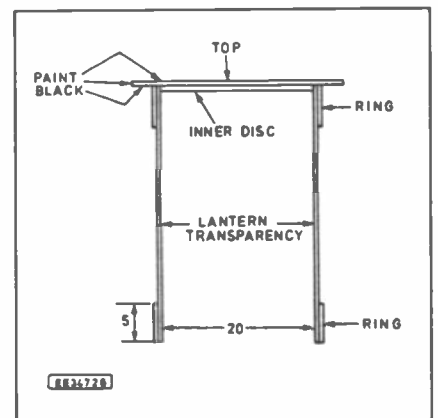
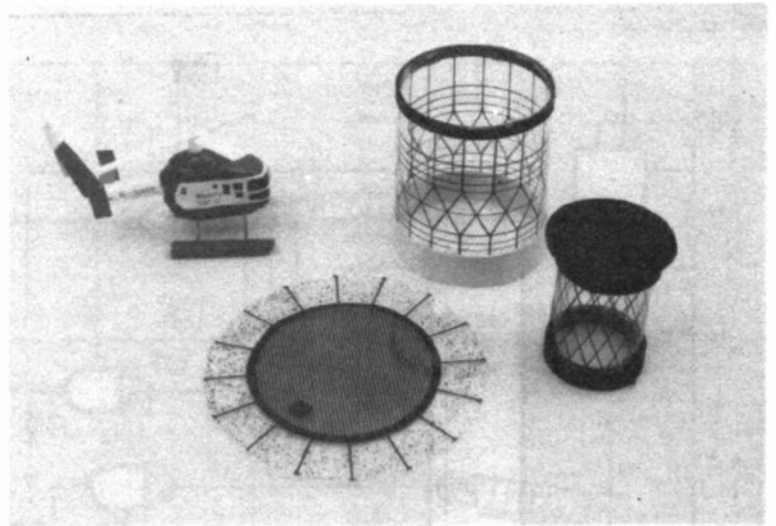

Fig. 3. Formation of the lantern housing

ring to hold it rolled, the ring being nearer to what will eventually be the bottom of the lantern. Apply glue to the inside of the other ring and insert the eventual top of the rolled transparency into this. Press the transparency firmly against the inside of this ring to form it into a perfect cylinder.

While the glue is still wet, invert the rolled transparency on the under-side of the lantern top. Then apply glue to the inner card disc and push this down inside the lantern, gluing it to the underside of the lantern top. This helps push the transparency firmly against the inside of the ring. When the glue has dried, remove the first ring, apply glue to its inner surface and push in back on to what will eventually be the lower end of the lantern.

Cut out an annulus of medium-thick card and glue this to the top of the platform. The lantern is a push-fit into this so that it can easily be removed for changing the bulb.

Cut out the photocopied designs for the helideck and the helideck cage. The construction of the helideck cage is similar to that of the lantern, except that the rings are made from strips 2.5mm and 9mm wide. They are wound around a cylindrical object 36mm in diameter. Paint the narrow ring black inside and out. The wide ring is to be the same colour as the tower. Form the cage design into a cylinder and slip the narrow ring around it near the top. Apply glue to the inside of the wide ring and push the lower end of the cage into this so that the lower edge of the cage pattern itself

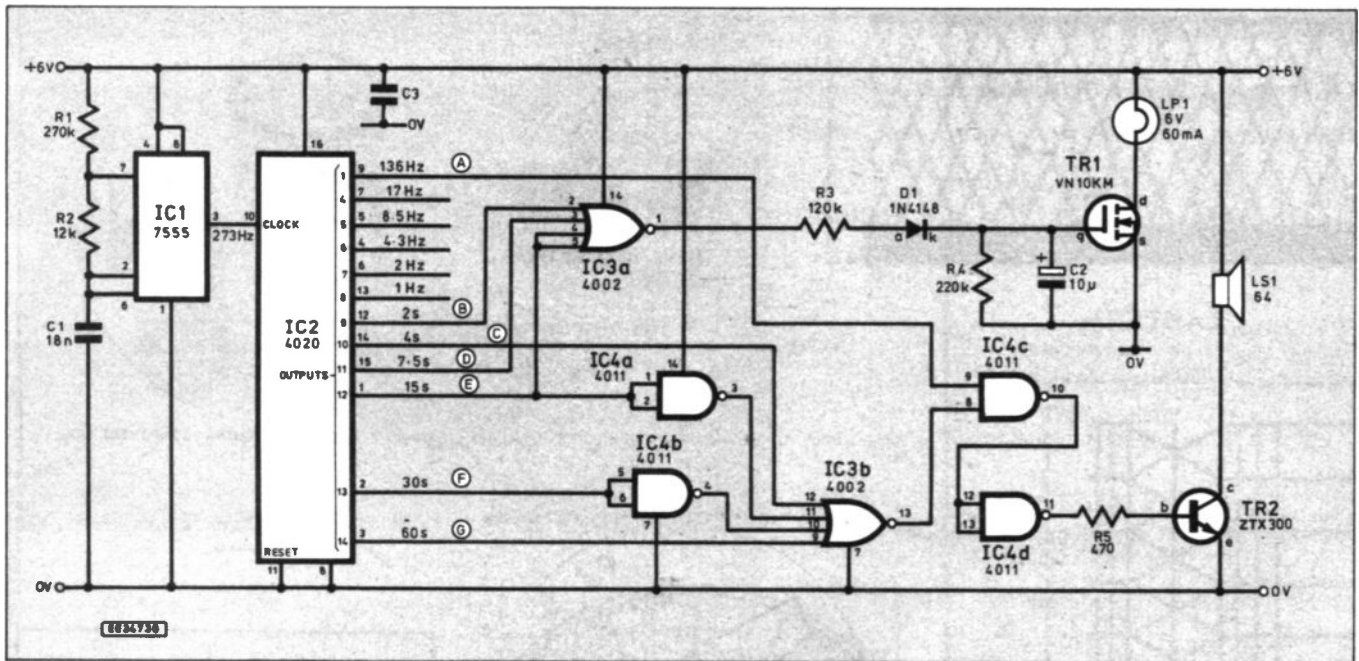

Fig. 4. Circuit diagram for the light and fog horn.

(the triple railings) are just visible above the ring. This ring is to be a push-fit over the platform, so that the cage may be removed for changing the bulb.

When the glue is dry, apply glue to the inside and top edge of the narrow ring and slide this into place at the top of the cage. At the same time invert the cage on to the helideck transparency (also inverted), so fixing the helideck to the top of the cage.

HOW IT WORKS

The clock (IC1 in Fig. 4) oscillates at 273Hz. This signal is repeatedly halved in frequency by the 14 stages of the counter in IC2. The outputs from stages 2 and 3 are not available. The available outputs with their frequencies or periods are shown. Any of these outputs can be used to produce the desired character. The logic is explained below in some detail so that readers will understand how to adapt the circuit for producing other characters.

The logic for flashing the lamp depends on the binary sequence of outputs from stages B, D and E, where "0" = low voltage and "1" = high voltage (Table 1). Each count in the table represents slightly less than one second, so the sequence repeats with the period of output E, which is approximately 15 seconds, as required. During this time the lamp flashes twice, each flash lasting one second.

Table 1:
Truth table for lamp flashing

Count	Output				State of lamp
	E	D	C	B	
0	0	0	0	0	FLASH
1	0	0	0	1	
2	0	0	1	0	FLASH
3	0	0	1	1	
4	0	1	0	0	
5	0	1	0	1	
6	0	1	1	0	
7	0	1	1	1	
8	1	0	0	0	
9	1	0	0	1	
10	1	0	1	0	
11	1	0	1	1	
12	1	1	0	0	
13	1	1	0	1	
14	1	1	1	0	
15	1	1	1	1	

The table shows that the flash occurs if and only if B, D and E are all low. The state of C is immaterial. The state of B, D and E is detected by feeding the three outputs to a NOR gate. A four-input gate is used, so signal E is fed to two of the inputs.

The output of the NOR gate is normally low, but goes high when all three inputs are low. A high output from the NOR gate raises the voltage of the gate of TR1, turning the transistor on. The switching action is modified by R4 and C2, which delays the time at which the lamp reaches full brightness. When the NOR gate goes low, the diode prevents the capacitor from discharging. The charge leaks away through R4 and the lamp dims out.

The logic for sounding the fog-horn depends on the binary sequence of outputs from stages C to G (Table 2). Each count in this table represents about four seconds, and the sequence repeats with the period of output G, which is approximately 60 seconds. During this time the fog-horn sounds twice, each blast lasting two seconds. The table shows that the flash occurs if and only if C and G are low and E and F are high. The fact that E has to be high means that there is always an appreciable gap between the horn sounding and the lamps flashing, giving a more realistic effect. The state of D is immaterial.

The state of C, E, F and G is detected by feeding the four outputs to a NOR gate, as before. However, because we are looking for high states of E and F, these signals must be inverted. The signals first go to NAND gates (IC4a/b) with their inputs wired together so that they act as INVERT gates, then to the NOR gate.

When C, E, F and G are in the correct state the output of the NOR gates goes high, and this output goes to a NAND gate (IC4c). This gate also receives the 136Hz audio signal A, but this passes through the gate only when the NOR gate output is high. When the NOR gate is low the output from IC4c is continuously high. The signal is inverted once again, by IC4d, so that it is low between blasts, thus leaving TR2 and the loudspeaker switched off during the inactive state.

CIRCUIT BOARD A

Circuit board "A" (Fig. 5) holds the timer and counter i.c.s. Like (almost) everything to do with lighthouses, the circuit boards are circular and stack inside the lighthouse base. Drill the holes in the board, then insert the two i.c. sockets and capacitor C1; glue them to the board to make the wiring more secure. Insert C2 and bend its leads and glue the body of the capacitor to the board. Next insert the p.c.b. terminals.

There are more terminals than usual in this project as this makes it easier to customise the circuit design to produce a range of light and fog-horn characters. The beads on the recommended p.c.b pins are in a

Table 2:
Truth table for the fog-horn

Count	Output					State of horn
	G	F	E	D	C	
0	0	0	0	0	0	
1	0	0	0	0	1	
2	0	0	0	1	0	
3	0	0	0	1	1	
4	0	0	1	0	0	
5	0	0	1	0	1	
6	0	0	1	1	0	
7	0	0	1	1	1	
8	0	1	0	0	0	
9	0	1	0	0	1	
10	0	1	0	1	0	
11	0	1	0	1	1	
12	0	1	1	0	0	SOUND
13	0	1	1	0	1	
14	0	1	1	1	0	SOUND
15	0	1	1	1	1	
16	1	0	0	0	0	
17	1	0	0	0	1	
18	1	0	0	1	0	
19	1	0	0	1	1	
20	1	0	1	0	0	
21	1	0	1	0	1	
22	1	0	1	1	0	
23	1	0	1	1	1	
24	1	1	0	0	0	
25	1	1	0	0	1	
26	1	1	0	1	0	
27	1	1	0	1	1	
28	1	1	1	0	0	
29	1	1	1	0	1	
30	1	1	1	1	0	
31	1	1	1	1	1	

COMPONENTS

Resistors

R1	270k
R2	12k
R3	120k
R4	220k
R5	470

Carbon film 0.25W, 5%, or metal film 0.6W 1%.

Capacitors

C1	18n polyester miniature dipped case, or metallised ceramic plate
C2	10µ tantalum, 15V
C3	220n polyester miniature layer

Semiconductors

D1	1N4148 silicon signal diode
TR1	VN10KM V MOS <i>n</i> -channel power f.e.t.
TR2	ZTX300 <i>nnp</i> transistor
IC1	7555 CMOS timer
IC2	4020 CMOS 14-stage counter/divider
IC3	4002 CMOS dual 4-input NOR gate
IC4	4011 CMOS quadruple 2-input NAND gate

Miscellaneous

LP1	6V, 60mA MES filament lamp (or similar)
LS1	64Ω speaker, 38mm diam. 16-pin d.i.l. i.c. socket; 14-pin d.i.l. i.c. sockets (2 off); 8-pin d.i.l. i.c. socket; p.c.b. eyelet terminals (21 off); battery connector; insulating tape; p.c.b. lacquer; Easywire pen and tool; insulated connecting wire.

Materials

Thin card, buff or printed white card – see Shop Talk and Special Offer page, (or wood) for tower. Block of expanded polystyrene, approx. 140 x 100 x 50. Red and white enamel paint (e.g. Humbrol); black acrylic paint (e.g. Tamiya Color).

Approx cost guidance only

£6

(components only)

range of different colours: it is advisable to adopt a colour code for each of the lines A to G, and to use the same code on board B. For certain variations in the light and sound characters, you may need to wire the p.c.b. terminals to a different set of output pins (see later).

Test the circuit by connecting the battery. The output from IC1 pin 3 is a signal of 273Hz. You can hear this if you connect a crystal earphone to pin 3, by way of a 100nF capacitor. Connect the other terminal of the earphone to the 0V rail.

On an oscilloscope, the signal can be seen to have a very high mark-space ratio. Monitor the signals from the terminals of IC2; the important ones are those labelled A to G in Fig. 4. Signal A can be heard with an earphone; a voltmeter is used to check signals B to G.

CIRCUIT BOARD B

Circuit board "B" holds the logic circuits and the transistor switches which control the lamp and loudspeaker. It may be necessary to revise the logic connections if other light and sound characters are required.

See
SHOP
TALK
Page

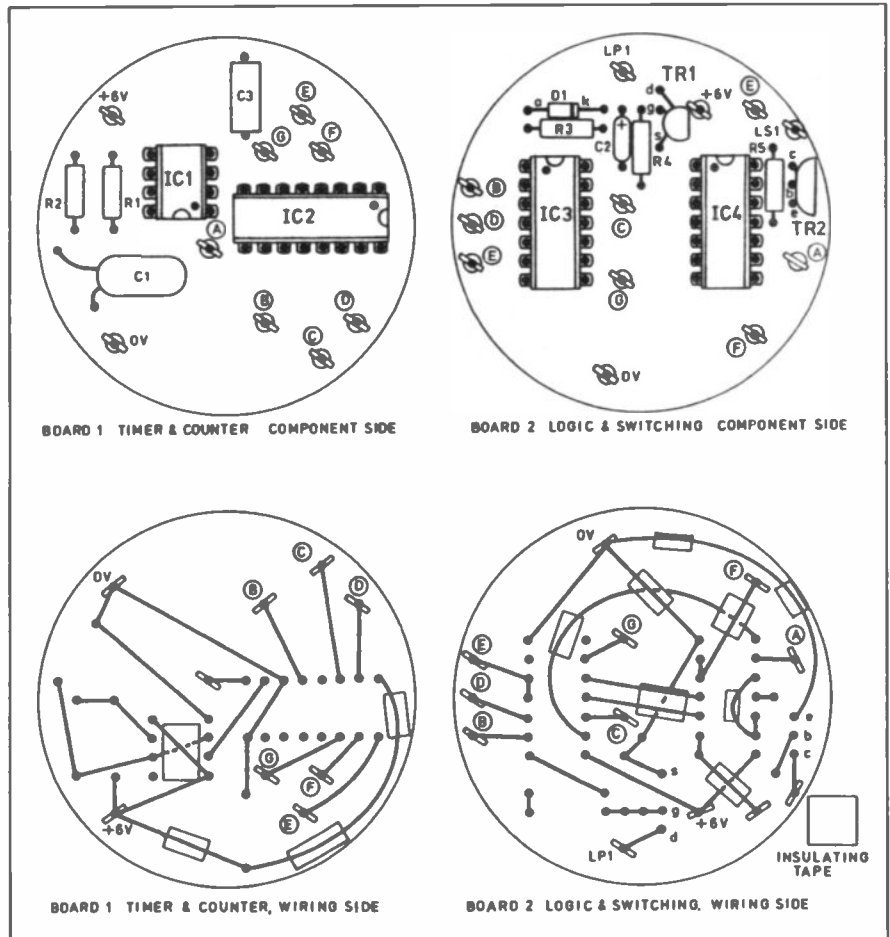

Fig. 5. The construction of the two circuit cards using the Easiwire wiring system.

Wiring up the board is straightforward. The board is tested after wiring the inter-board connections (Fig. 6). Note that there are *two* E terminals on Board B.

Use thin flexible insulated wires, each about 10cm long, except for the lamp and battery is connections. For the battery, you can use a press-stud battery connector, but you may need to extend the wires if the battery to be hidden from sight. The wires to the lamp need to be about 30cm long. If a bulb holder is used, connect the wires to the screw terminals. Otherwise, solder the wires directly to the bulb, or hold them in place with insulating tape. When the battery is connected, the lamp begins to flash and the loudspeaker sounds as described earlier.

ASSEMBLY

The final assembly is shown in Fig. 7, with the circuit boards and loudspeaker stacked inside the base with card separators (discs 50cm diameter) to prevent short circuits. The speaker rests face-down on the table.

If the lamp is in a holder, glue this to the platform. If the wires are soldered to the lamp, wrap black insulating tape around the threaded part of the bulb. Nip the tube of tape below the bulb and wedge it firmly into the hole in the top of the platform. Place the lantern over the bulb; it is held in place by the annulus. Lower the cage over the lantern and push it gently down over the platform. All that is needed now is a helicopter to bring supplies to the keeper.

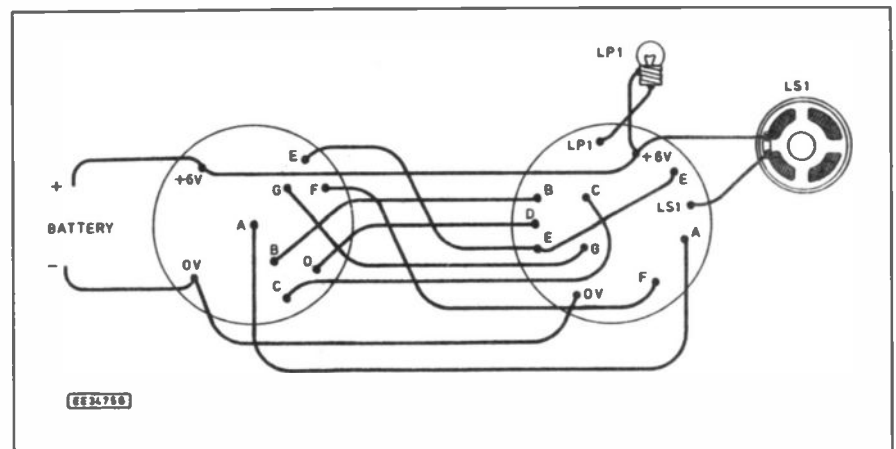

Fig. 6. Interwiring between the board, battery, lamp and loudspeaker.

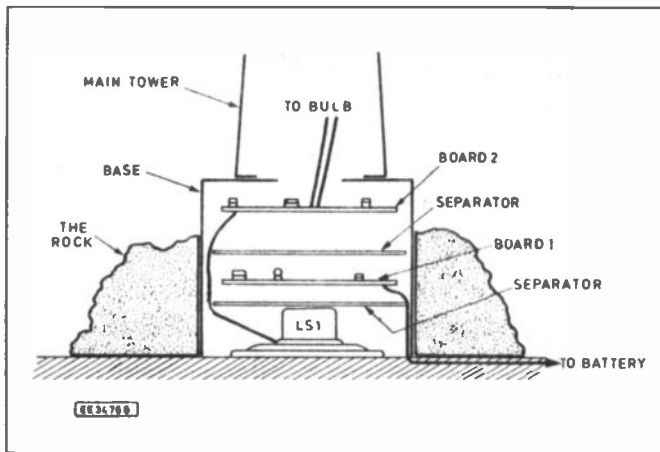
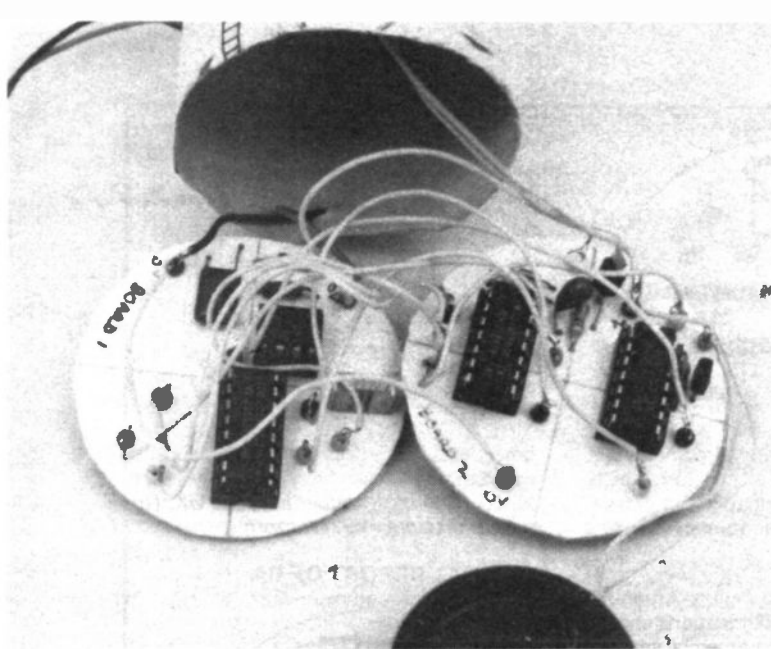

Fig. 7. Fitting the electronics in the base.

HELICOPTER

The supply helicopter used by Trinity House is the popular West German light utility helicopter, the MBB BO105. We made a simple model of this, moulding the main fuselage from Fimo, a modelling material which is fairly soft when purchased but which hardens when placed in an oven at 130°C for about half an hour. To save a certain amount of painting use either red or white Fimo.

Make the rear fuselage from 3mm diameter white plastic rod. Before hardening the main fuselage make a socket in this to accept the rear fuselage. Also push a pin in at four places to make holes ready for the undercarriage struts.

Cut the tail and rudder from thin red card and glue into slots cut in the rear fuselage (Fig. 8). Cut a propeller from thin white card and mount this on the tail-plane as shown; fill the collar with glue before inserting the pin into it. Cut the four-bladed rotor from the same white card.

Carve the floats from plastic strip; bore two holes half-way into each to take the struts. Make the struts from dressmaker's pins; you may have to experiment here, as some types of pins snap in two when you try to bend them. The pins will not be a really firm fit in the holes but, when the model is painted, the paint secures them well enough.

Paint the main fuselage white, with red top and bottom. Also paint windows in black and, if possible the logo "Trinity House" and the registration number of

one of its helicopters G-BATC. Finally mount the rotor.

BISHOP ROCK

The rock itself can be carved from a block of expanded polystyrene or timber. It needs a flat bottom, sheer sides and a very rugged top. A circular opening 54mm in diameter runs from top to bottom so that the rock surrounds the base of the light-house, making it less likely to topple over. Cut a groove in the bottom of the rock for the battery wires.

Paint the rock matt black, possibly adding a touch of dark brown here and there. Before painting, test the paint on a spare scrap of expanded polystyrene; the solvents of some paints cause the polystyrene to shrink away almost to nothing! A water-soluble acrylic model paint (Tamiya Color, matt black XF-1) gave a very realistic effect on white polystyrene.

OTHER CHARACTERS

Both the light and fog horn can be changed to different characteristics. The first thing to decide is the length of the longest sequence, usually the fog-horn sequence. The length of the shorter sequence (usually the light) must be a binary submultiple (half, quarter, eighth . . .) of this. The actual length of the Bishop Rock fog-horn sequence is 90s but, since the light sequence lasts 15s, it was decided to make the horn sequence 60s, i.e. four times the light sequence, instead of six times, which is difficult to arrange.

If the longest sequence is t seconds, and this is to be taken from output G, the frequency of the clock must be $f = 16384/t$. The frequency is determined by the values of R1, R2 and C1:

$$f = \frac{1.44}{(R1 + 2.R2) C1}$$

If this frequency proves to be suitable for the fog-horn, it can be used direct from the clock; otherwise, use A which runs at $f/2$. If a lower frequency is needed, use output F for the longest sequence, length t , and calculate $f = 8192/t$.

Next set out truth tables similar to Tables 1 and 2 and mark when the lamp is to flash or the horn to sound. Try to mark these events so that they occur when there is a majority of '0's on the line. Then decide the logic requirements. Table 1 gives a double flash, as required for Bishop Rock, but a single flash can be obtained (at count 0) by NORing together all four outputs. A single flash of double the length (counts 1 and 2) is obtained by NORing outputs C, D and E only.

The circuit has two NAND gates (IC4a/b) for inverting outputs that are to be active when they are "1". If either of these gates are not used, their inputs *must* be wired either to 0V or +6V.

This model concludes the series, we hope you have enjoyed making at least one of the models. □

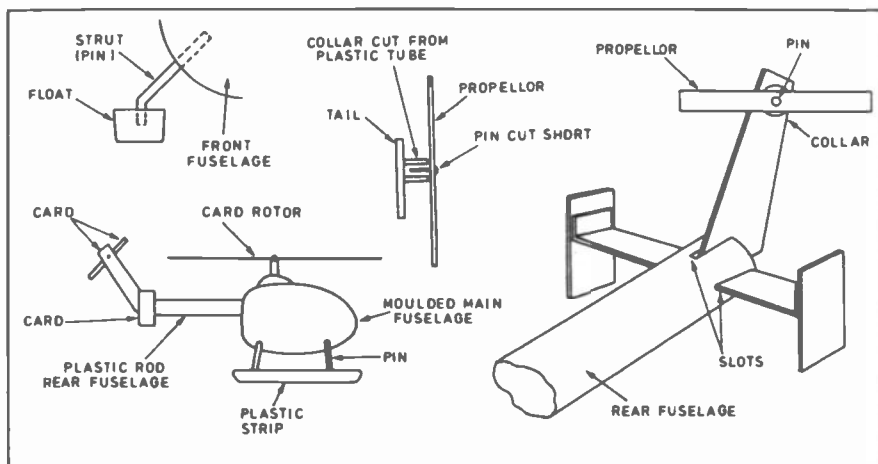

Fig. 8. Construction of the helicopter.



REPORTING

AMATEUR RADIO

Tony Smith G4FAI

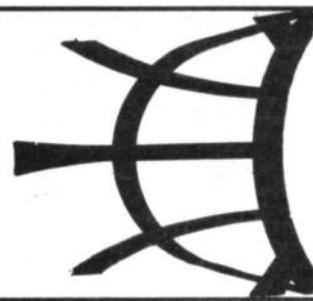

ALBANIA BACK

The first Albanian amateur radio station for 45 years came on-the-air on 16th September. At a grand opening ceremony at Albania's PTT headquarters, attended by high government officials, and broadcast on Tirana TV, amateur station ZA1A made a special transmission to ITU headquarters in Geneva where the ITU Secretary-General was present.

In the days that followed, the bands went wild as DXers, award hunters, and others just wanting to welcome the Albanians back, tried to contact ZA1A. Because of the numbers involved, each contact could only be a brief exchange of reception reports, but that was enough to get a QSL card confirming contact with a new country. More stations are appearing as time goes on and just a few days before writing this, in early October, I listened with awe as a "pileup" of what must have been hundreds of stations from many countries tried to make contact with two more ZAs on 28MHz.

No one new to amateur radio could cope with such a situation unaided however, and teams of experienced operators from several countries, under the auspices of the International Amateur Radio Union and other amateur organisations, have been in Albania training a number of enthusiastic students ready to take the lead in reviving amateur radio throughout their country.

Trying to get through pileups is not my favourite type of operating, but I do have a go sometimes and get the same satisfaction as everyone else when I manage to beat the pack. In this case though, I shall probably wait till there are a few more ZAs on the air and there's time to actually have a chat with some of them!

USA BOMBSHELL

A sensational proposal by the FCC (the USA licensing authority) could change the entire concept of "amateur" radio; a change which in the long term could well affect the status of the hobby in many countries, including the UK.

Continually bombarded with letters and phone calls from amateurs who want changes in the "absolutely-no-business" rules; and subject from time to time to political lobbying and Congressional inquiries along the same lines, the FCC has suggested to the American Radio Relay League, America's national radio society, that it makes formal proposals for change. It has even suggested what those changes might be, so there seems little doubt about the eventual outcome.

It all hinges around "third party" communications, that is, the passing of messages on behalf of other persons. In the USA, and in many other countries, all amateurs can already pass simple greetings messages on behalf of others and they can also provide communications on behalf of the emergency and other

services in certain defined circumstances. In the UK there are lesser third party facilities plus long-established emergency services as mentioned in this column from time to time.

The essential basis of third party communications is that no regular organisational or business communications should be provided for which commercial services are available, and that no payment should be received by amateur operators whatsoever. It has often been suggested to the FCC that the rules are too restrictive and that amateur radio could be used for non-commercial activities without affecting its amateur status.

RELAXATION OF RULES

The FCC now proposes that non-amateur communications handled by amateurs in the future, without the present limitations, could include communications for non-profit or charitable organisations, government agencies, and public safety agencies; classroom instruction in schools; selling or trading electronic apparatus amongst amateurs; providing information to the news media; club business; personal business, including placing orders on local suppliers via auto-patch into the public telephone system; and rebroadcasting transmissions from other stations such as weather stations, the Voice of America, or WWV (time signals, etc.)

The order or precedence would be *Priority* - emergency communications; *Primary* - normal amateur communications; and *Secondary* - non-amateur communications. Only when the first two traditional usages are insufficient to completely occupy the bands would the unused frequencies be available to carry non-amateur traffic.

To preserve the non-business status of amateur radio no operator would be able to sell a communication service using amateur frequencies. An exception to this would be permitted payment to control operators transmitting Morse practice and information bulletins from W1AW, ARRL's headquarters station (already permitted); and those providing classroom instruction over the air.

These proposals will inevitably provoke a mixed reception. Those who believe the amateur spectrum should be opened up to non-amateur communications will be delighted, but many will feel that the unique character of amateur radio is under threat and that the bands are full enough already without congesting them further with non-amateur traffic.

The communications industry, which stands to lose business if the proposals are implemented, may have something to say also! It will be interesting to follow this debate over the months ahead and to see the final outcome. With the DTI's current policy of liberalisation and

deregulation it will also be interesting to see if similar proposals eventually reach, and receive consideration, in the UK. (Information from *W5YI Report*).

ANNUAL REPORT OF RA

The Radiocommunications Agency (previously the Radiocommunications Division) of the DTI recently published its annual report for the year 1990-1991. This covers the entire field of non-government activity in the radio spectrum, but I refer here only to that part of the report covering amateur radio.

Apart from describing the introduction of the Amateur Radio Novice licence on 1st April 1991, previously covered at length in this column, the report refers to the concern of the RA about abuse on amateur radio, in particular associated with repeater stations.

Action, the report says, has been taken to deal with this by improving the management and monitoring of the 300 or so repeaters in the UK. Each repeater is managed by a local group, while the Radio Society of Great Britain provides a number of central services and support through its Repeater Management Group.

Additionally, amateurs are encouraged to submit reports of abuse to the RSGB's Amateur Radio Observation Service (AROS). If AROS is unable to solve the problem a report may be sent to the Radio Investigation Service for further investigation, and this has resulted in a number of successful prosecutions.

During the year, some changes have been made to the amateur radio licence. The most significant involved providing clubs with special event privileges, allocating extra frequencies for unattended operation and allowing vertical polarisation and mobile operation at 50MHz.

As at 31st March 1991, the number of amateur licences class A, was 32,954 and Class B, 27,930. There were also 257 voice repeaters, 236 packet radio repeaters, and 55 beacons. During the year there were five convictions for offences under the Wireless Telegraphy Acts and two formal warnings were issued for breaches of the Act.

SANGHEAN SERVICING - 2

I mentioned last month the problem a reader was having in getting his Sangean ATS 803A world band receiver repaired by Comet. I have now received a letter from Charlie Avery, PR Executive of Comet PLC, who says that his company decided to discontinue this model early in 1991, and that the manufacturer has since gone out of business.

Prior to this, Comet were able to secure a limited supply of spare parts so they can still repair some sets, depending on the problem. If they do not have the appropriate spares, however, it is unlikely that they will be able to help.

SPECIAL EVERYDAY ELECTRONICS BOOKS



ELECTRONICS TEACH-IN 88/89 - INTRODUCING MICROPROCESSORS

Mike Tooley BA (published by *Everyday Electronics*)
A complete course that can lead successful readers to the award of a City and Guilds Certificate in Introductory Microprocessors (726/303). The book contains everything you need to know including full details on registering for assessment, etc.

Sections cover Microcomputer Systems, Micro-processors, Memories, Input/Output, Interfacing and Programming. There are various practical assignments and eight Data Pages covering the most popular microprocessor chips.

An excellent introduction to the subject even for those who do not wish to take the City and Guilds assessment.
80 pages (A4 size) **Order code TI-88-89** £2.45

ELECTRONIC PROJECTS BOOK 1

Published by *Everyday Electronics* in association with Magenta Electronics.

Contains twenty of the best projects from previous issues of *EE* each backed with a kit of components. The projects are: Seashell Sea Synthesiser, EE Treasure Hunter, Mim Strobe, Digital Capacitance Meter, Three Channel Sound to Light, BBC 16K sideways Ram, Simple Short Wave Radio, Insulation Tester, Stepper Motor interface, Eprom Eraser, 200MHz Digital Frequency Meter, Infra Red Alarm EE Equaliser

Ioniser, Bat Detector, Acoustic Probe, Mainstester and Fuse Finder, Light Rider - (Lapel Badge, Disco Lights, Chaser Light), Musical Doorbell, Function Generator, Tilt Alarm, 10W Audio Amplifier, EE Buccaneer Induction Balance Metal Detector, BBC Midi Interface, Variable Bench Power Supply, Pet Scanner, Audio Signal Generator.
128 pages (A4 size) **Order code EPT1** £2.45

ELECTRONICS TEACH-IN No. 3 - EXPLORING ELECTRONICS

(published by *Everyday Electronics*)
Owen Bishop
Another *EE* value for money publication aimed at students of electronics. The course is designed to explain the workings of electronic components and circuits by involving the reader in experimenting with them. The book does not contain masses of theory or formulae but straightforward explanations and circuits to build and experiment with.

Exploring Electronics contains more than 25 useful projects, assumes no previous knowledge of electronics and is split into 28 easily digestible sections.
88 pages (A4 size) **Order code TI3** £2.45

ELECTRONICS TEACH-IN No. 4 INTRODUCING DIGITAL ELECTRONICS

(published by *Everyday Electronics*)
Michael J. Cockcroft
Although this book is primarily a City & Guilds Introductory level course (726/301), approximately 80% of the information

forms a very basic introduction to electronics in general, it therefore provides an excellent introductory text for beginners and a course and reference book for GCSE students.

Full details on registering for C&G assessment, details of assessment centres, components required and information on the course in general are given.

The City & Guilds introduction to module 726/301 reads: "A candidate who satisfactorily completes this module will have a competence to identify basic components and digital integrated circuits and connect them together to form simple working circuits and logic units". This provides an excellent introduction to the book.

112 pages (A4 size) **Order code TI4** £2.95

ELECTRONICS TEACH-IN No. 5 GUIDE TO BUILDING ELECTRONIC PROJECTS

Published by *EVERYDAY ELECTRONICS*
Due to the demand from students, teachers and hobbyists we have put together a range of articles from past issues of *Everyday Electronics* that will assist those involved with the construction of electronic projects.

The book contains the complete *Project Development* for GCSE series.

Contents: Features - First Steps in Project Building; Building with Vero; Project Development for GCSE; Getting your Projects Working, Guide to Printed Circuit Boards; Choosing and Using Test Equipment - The Multimeter, The Oscilloscope, P.S.U.s, Logic Probes, Digital Frequency Meters, Signal Generators, etc; Data - Circuit Symbols; Component Codes; Resistors; Identifying Components; Capacitors; Actually Doing It - Understanding the Circuit Diagram, Component Codes, Mounting circuit boards and controls, Understanding Capacitors; Projects - Lie Detector; Personal Stereo Amplifier; Digital Experimenters' Unit, Quizmaster; Siren Effects Unit; UV Exposure Unit; Low-cost Capacitance Meter; Personal Radio.

88 pages (A4 size) **Order code TI5** £2.95

EVERDAY ELECTRONICS DATA BOOK

Mike Tooley BA (published by *EE* in association with *PC Publishing*)
This book is an invaluable source of information of everyday relevance in the world of electronics. It contains not only sections which deal with the essential theory of electronic circuits, but it also deals with a wide range of practical electronic applications.

It is ideal for the hobbyist, student, technician and engineer. The information is presented in the form of a basic electronic recipe book with numerous examples showing how theory can be put into practice using a range of commonly available "industry standard" components and devices.

A must for everyone involved in electronics!
256 pages **Order code DATA** £8.95

DIRECT BOOK SERVICE

The books listed have been selected by *Everyday Electronics* editorial staff as being of special interest to everyone involved in electronics and computing. They are supplied by mail order direct to your door. Full ordering details are given on the last book page. For another selection of books see next month's issue

ELECTRONIC TEST EQUIPMENT HANDBOOK

Steve Money
The principles of operation of the various types of test instrument are explained in simple terms with a minimum of mathematical analysis. The book covers analogue and digital meters, bridges, oscilloscopes, signal generators, counters, timers and frequency measurement. The practical uses of the instruments are also examined.

Everything from Audio oscillators, through R, C & L measurements (and a whole lot more) to Waveform Generators and testing Zeners. A truly comprehensive book for the hobbyist, student, technician and engineer.
206 pages **Order code PC109** £8.95

HOW TO TEST ALMOST EVERYTHING

ELECTRONIC - 2nd EDITION
Jack Derr and Dalton T. Horn
Describes electronic tests and measurements - how to make them with all kinds of test equipment, and how to interpret the results. New sections in this edition include logic probes, frequency counters, capacitance meters, and more (An American book).
190 pages **Order code T12925** £9.05

GETTING THE MOST FROM YOUR MULTIMETER

R. A. Penfold
This book is primarily aimed at beginners and those of limited experience of electronics. Chapter 1 covers the basics of analogue and digital multimeters, discussing the relative merits and the limitations of the two types. In Chapter 2 various methods of component checking are described, including tests for transistors, thyristors, resistors, capacitors and diodes. Circuit testing is covered in Chapter 3, with subjects such as voltage, current and continuity checks being discussed.

In the main little or no previous knowledge or experience is assumed. Using these simple component and circuit testing techniques the reader should be able to confidently tackle servicing of most electronic projects.
96 pages **Order code BP239** £2.95

MORE ADVANCED USES OF THE MULTIMETER

R. A. Penfold
This book is primarily intended as a follow-up to BP239, (see above), and should also be of value to anyone who already understands the basics of voltage testing and simple component testing. By using the techniques described in chapter 1 you can test and analyse the performance of a range of components with just a multimeter

TESTING, THEORY AND REFERENCE

(plus a very few inexpensive components in some cases). Some useful quick check methods are also covered.

While a multimeter is supremely versatile, it does have its limitations. The simple add-ons described in chapter 2 extended the capabilities of a multimeter to make it even more useful. The add-ons described include an active r.f. probe, a high resistance probe, an a.c. sensitivity booster, and a current tracer unit.
84 pages **Order code BP265** £2.95

THE ILLUSTRATED DICTIONARY OF ELECTRONICS - 4th EDITION

Rufus P. Turner and Sten Gibilisco
With more than 27,000 terms used in electronics today, this collection is THE most comprehensive dictionary available. Including all practical electronics and computer terms, it is as up-to-date as the latest advances in the field itself! Tables and data on subjects most often consulted for projects and experiments are included. Other conversion tables include English/metric and metric/English conversions for units of energy, power and volume, and Fahrenheit/Celsius temperature conversion charts.

Setting this edition apart from other electronic dictionaries is its emphasis on illustration. Featuring more than complete definitions, this fourth edition includes over 450 detailed drawings and diagrams.

All entries are listed in alphabetical order. Abbreviations and initials are listed in sequence with whole words. All terms of more than one word are treated as one word. (An American book).
648 pages **Temporarily out of print**

ELECTRONICS - A "MADE SIMPLE" BOOK

G. H. Olsen
This book provides excellent background reading for our *Introducing Digital Electronics* series and will be of interest to everyone studying electronics. The subject is simply explained and well illustrated and the book assumes only a very basic knowledge of electricity.
330 pages **Order code NE10** £4.95

PRACTICAL ELECTRONICS CALCULATIONS AND FORMULAE

F. A. Wilson, C.G.I.A., C.Eng., F.I.E.E., F.I.E.R.E., F.B.I.M.
Bridges the gap between complicated technical theory, and "cut-and-try" methods which may bring success in design but leave the experimenter unfulfilled. A strong

practical bias - tedious and higher mathematics have been avoided where possible and many tables have been included.

The book is divided into six basic sections: Units and Constants, Direct-current Circuits, Passive Components, Alternating-current Circuits, Networks and Theorems, Measurements.
256 pages **Order code BP53** £3.95

PRACTICAL DIGITAL ELECTRONICS HANDBOOK

Mike Tooley (Published in association with *Everyday Electronics*)
The vast majority of modern electronic systems rely heavily on the application of digital electronics, and the *Practical Digital Electronics Handbook* aims to provide readers with a practically based introduction to this subject. The book will prove invaluable to anyone involved with the design, manufacture or servicing of digital circuitry, as well as to those wishing to update their knowledge of modern digital devices and techniques. Contents: Introduction to integrated circuits; basic logic gates; monostable and bistable devices; timers; microprocessors, memories; input and output devices; interfaces; microprocessor buses. Appendix 1: Data. Appendix 2: Digital test gear projects; tools and test equipment; regulated bench power supply; logic probe; logic pulser; versatile pulse generator; digital IC tester; current tracer; audio logic tracer; RS-232C breakout box; versatile digital counter/frequency meter. Appendix 3: The oscilloscope. Appendix 4: Suggested reading. Appendix 5: Further study.
208 pages **Order code PC100** £8.95

ELECTRONICS-BUILD AND LEARN

R. A. Penfold
The first chapter gives full constructional details of a circuit demonstrator unit that is used in subsequent chapters to introduce common electronic components - resistors, capacitors, transformers, diodes, transistors, thyristors, fets and op amps. Later chapters go on to describe how these components are built up into useful circuits, oscillators, multivibrators, bistables and logic circuits.

At every stage in the book there are practical tests and experiments that you can carry out on the demonstrator unit to investigate the points described and to help you understand the principles involved. You will soon be able to go on to more complex circuits and tackle fault finding logically in other circuits you build.
120 pages **Order code PC103** £8.95

AUDIO AND MUSIC

LOUDSPEAKERS FOR MUSICIANS

Vivian Capel
This book contains all that a working musician needs to know about loudspeakers; the different types, how they work, the most suitable for different instruments, for cabaret work, and for vocals. It gives tips on constructing cabinets, wiring up, when and where to use wadding, and when not to, what fittings are available, finishing, how to ensure they travel well, how to connect multi-speaker arrays and much more.
Ten practical enclosure designs with plans and comments are given in the last chapter, but by the time you've read that far you should be able to design your own!
164 pages **Order code BP297** £3.95

MAKE MONEY FROM HOME RECORDING

Clive Brooks
Now that you've spent a fortune on all that recording gear, MIDI and all, wouldn't it be nice to get some of it back? Well here's the book to show you how.
It's packed with money making ideas, any one of which will recoup the price of the book many times over. Whether you have a fully fledged recording studio at home, or just a couple of stereo cassette recorders and a microphone, you'll be able to put the ideas in this book into practice and make money.
105 pages **Order code PC104** £5.95

INTRODUCTION TO DIGITAL AUDIO

(Second Edition)
Ian Sinclair
Digital recording methods have existed for many years and have become familiar to the professional recording engineer, but the compact disc (CD) was the first device to bring digital audio methods into the home. The next step is the appearance of digital audio tape (DAT) equipment.
All this development has involved methods and circuits that are totally alien to the technician or keen amateur who has previously worked with audio circuits. The principles and practices of digital audio owe little or nothing to the traditional linear circuits of the past, and are much more comprehensible to today's computer engineer than the older generation of audio engineers.
This book is intended to bridge the gap of understanding for the technician and enthusiast. The principles and methods are explained, but the mathematical background and theory is avoided, other than to state the end product.
128 pages **Order code PC102** £6.95

SYNTHESIZERS FOR MUSICIANS

R. A. Penfold
Modern synthesizers are extremely complex, but they mostly work on principles that are not too difficult to

understand. If you want to go beyond using the factory presets or the random poking of buttons, this is the book for you.
It covers the principles of modern synthesis - linear arithmetic as used by Roland, phase distortion (Casio), Yamaha's frequency modulation, and sampling - and then describes how the instruments are adjusted to produce various types of sound - strings, brass, percussion, etc. The theoretical side of synthesis is treated in an easy to understand way - the technical information being restricted to what you need to know to use your instrument effectively.
168 pages **Order code PC105** £6.95

AUDIO

F. A. Wilson, C. G. I. A., C. Eng., F.I.E.E., F.I.E.R.E., F.B.I.M.
Analysis of the sound wave and an explanation of acoustic quantities prepare the way. These are followed by a study of the mechanism of hearing and examination of the various sounds we hear. A look at room acoustics with a subsequent chapter on microphones and loudspeakers then sets the scene for the main chapter on audio systems - amplifiers, oscillators, disc and magnetic recording and electronic music.
320 pages **Order code BP111** £3.95

CIRCUITS AND DESIGN

REMOTE CONTROL HANDBOOK

Owen Bishop
Remote control systems lend themselves to a modular approach. This makes it possible for a wide range of systems, from the simplest to the most complex, to be built up from a number of relatively simple modules. The author has tried to ensure that, as far as possible, the circuit modules in this book are compatible with one another. They can be linked together in many different configurations to produce remote control systems tailored to switch a table lamp on and off, or to operate an industrial robot, this book should provide the circuit you require.
226 pages **Order code BP240** £3.95

COIL DESIGN AND CONSTRUCTION MANUAL

B. B. Babani
A complete book for the home constructor on "how to make" RF, IF, audio and power coils, chokes and transformers. Practically every possible type is discussed and calculations necessary are given and explained in detail. Although this book is now rather old, with the exception of torroids and pulse transformers little has changed in coil design since it was written.
96 pages **Order code 160** £2.50

30 SOLDERLESS BREADBOARD PROJECTS - BOOK 1

R. A. Penfold
Each project, which is designed to be built on a "Verobloc" breadboard, is presented in a similar fashion with a brief circuit description, circuit diagram, component layout diagram, components list and notes on construction and use where necessary. Whenever possible, the components used are common to several projects, hence with only a modest number of reasonably inexpensive components, it is possible to build in turn, every project shown. Recommended by BICC-Verobloc.
160 pages **Order code BP107** £2.95

BOOK 2 - All projects use CMOS i.c.s. but the items on component identification etc., are not repeated from Book 1.
160 pages **Order code BP113** £2.25

ELECTRONIC CIRCUITS HANDBOOK

Michael Tooley BA
This book aims to explode two popular misconceptions concerning the design of electronic circuits: that only those with many years of experience should undertake circuit design and that the process relies on an understanding of advanced mathematics. Provided one is not too ambitious, neither of these popularly held beliefs is true.
Specifically, this book aims to provide the reader with a unique collection of practical working circuits together with supporting information so that circuits can be produced in the shortest possible time and without recourse to theoretical texts.
Furthermore, information has been included so that the circuits can readily be modified and extended by readers to meet their own individual needs. Related circuits have been grouped together and cross-referenced within the text (and also in the index) so that readers are aware of which circuits can be readily connected together to form more complex systems. As far as possible, a common range of supply voltages, signal levels and impedances has been adopted.
As a bonus, ten test gear projects have been included. These not only serve to illustrate the techniques described but also provide a range of test equipment which is useful in its own right.
277 pages **Order code NE05** £16.95

AUDIO IC CIRCUITS MANUAL
R. M. Marston
A vast range of audio and audio-associated i.c.s. are readily available for use by amateur and professional design engineers and technicians. This manual is a guide to the most popular and useful of these devices, with over 240 diagrams. It deals with i.c.s. such as low frequency linear amplifiers, dual pre-amplifiers, audio power amplifiers, charge coupled device delay lines, bar-graph display drivers, and power supply regulators, and shows how to use these devices in circuits ranging

AUDIO IC CIRCUITS MANUAL

R. M. Marston
A vast range of audio and audio-associated i.c.s. are readily available for use by amateur and professional design engineers and technicians. This manual is a guide to the most popular and useful of these devices, with over 240 diagrams. It deals with i.c.s. such as low frequency linear amplifiers, dual pre-amplifiers, audio power amplifiers, charge coupled device delay lines, bar-graph display drivers, and power supply regulators, and shows how to use these devices in circuits ranging

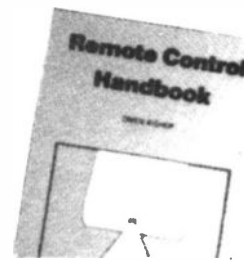
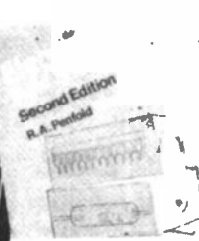

from simple signal conditioners and filters to complex graphic equalizers, stereo amplifier systems, and echo/reverb delay line systems etc.
168 pages **Order code NE13** £12.95

HOW TO DESIGN ELECTRONIC PROJECTS

R. A. Penfold
The aim of this book is to help the reader to put together projects from standard circuit blocks with a minimum of trial and error, but without resorting to any advanced mathematics. Hints on designing circuit blocks to meet your special requirements are also provided.
128 pages **Order code BPT27** £2.25

50 CIRCUITS USING GERMANIUM SILICON AND ZENER DIODES

R. N. Soar
Contains 50 interesting and useful circuits and applications, covering many different branches of electronics, using one of the most simple and inexpensive of components - the diode. Includes the use of germanium and silicon signal diodes, silicon rectifier diodes and Zener diodes, etc.
64 pages **Order code BP36** £1.95

DESIGNING WITH LINEAR ICs

G. C. Loveday
A book that deals with the design of the vital area of analog circuitry covering design with modern linear integrated circuit devices. The first chapter introduces the reader to important design techniques, test strategies, layout, and protection and also includes a section on the use of a typical CAD tool. There are separate chapters that cover in depth the use of op-amps, comparators and timers each with detailed design examples and reader exercises. A final chapter brings all the previous work together in a number of complete design problems with fully worked solutions. The text is essentially non-mathematical and is supported by many diagrams.
64 pages **Order code BP38** Special Price £6.95

TIMER/GENERATOR CIRCUITS MANUAL

R. M. Marston
This manual is concerned mainly with waveform generator techniques and circuits. Waveform generators are used somewhere or other in most types of electronic equipment, and thus form one of the most widely used classes of circuit. They may be designed to produce outputs with sine, square, triangle, ramp, pulse, staircase, or a variety of other forms. The generators may produce modulated or unmodulated outputs, and the outputs may be of single or multiple form.
Waveform generator circuits may be built using transistors, op-amps, standard digital ICs, or dedicated waveform or "function" generator ICs.
The manual is divided into eleven chapters, and presents over 300 practical circuits, diagrams and tables. The subjects covered include: Basic principles; Sine wave generators; Square wave generators; Pulse generator circuits; "Timer IC" generator circuits; Triangle and sawtooth generators, Multi-waveform generation; Waveform synthesizer ICs; Special waveform generators; Phaselocked loop circuits; Miscellaneous "555" circuits.
267 pages **Order code NE18** £12.95

OPTOELECTRONICS CIRCUITS MANUAL

R. M. Marston
A useful single-volume guide to the optoelectronics device user, specifically aimed at the practical design engineer, technician, and the experimenter, as well as the electronics student and amateur. It deals with the subject in an easy-to-read, down-to-earth, and non-mathematical yet comprehensive manner, explaining the basic principles and characteristics of the best known devices, and presenting the reader with many practical applications and over 200 circuits. Most of the i.c.s. and other devices used are inexpensive and readily available types, with universally recognised type numbers.
182 pages **Order code NE14** £12.95

POPULAR ELECTRONIC CIRCUITS - BOOK 1

POPULAR ELECTRONIC CIRCUITS - BOOK 2
R. A. Penfold
Each book provides a wide range of designs for electronic enthusiasts who are capable of producing working projects from just a circuit diagram without the aid of detailed construction information. Any special setting-up procedures are described.
BOOK 1 160 pages **Order code BP80** £2.95
BOOK 2 160 pages **Order code BP98** £2.95

CMOS CIRCUITS MANUAL

R. M. Marston
Written for the professional engineer, student or enthusiast. It describes the basic principles and characteristics of these devices and includes over 200 circuits.
All the circuits have been designed, built and fully evaluated by the author; all use inexpensive and internationally available devices.
187 pages **Order code NE12** £12.95

Note - our postage charge is the same for one book or one hundred books!

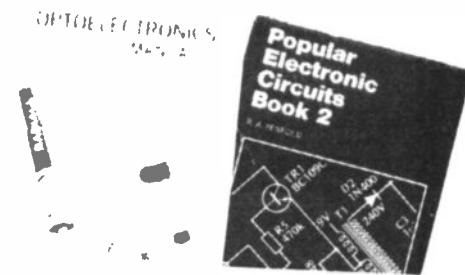

PROJECT CONSTRUCTION

HOW TO DESIGN AND MAKE YOUR OWN P.C.B.s

R. A. Penfold
Deals with the simple methods of copying printed circuit board designs from magazines and books and covers all aspects of simple p.c.b. construction including photographic methods and designing your own p.c.b.s.
80 pages **Order code BP121** £2.50

HOW TO GET YOUR ELECTRONIC PROJECTS WORKING

R. A. Penfold
We have all built projects only to find that they did not work correctly, or at all, when first switched on. The aim of this book is to help the reader overcome just these problems by indicating how and where to start looking for many of the common faults that can occur when building up projects
96 pages **Order code BP110** £2.50

ELECTRONIC SCIENCE PROJECTS

O. Bishop
These projects range in complexity from a simple colour temperature meter to an infra-red laser. There are novelties such as an electronic clock regulated by a resonating spring, and an oscilloscope with solid-state display. There are scientific measuring instruments such as a pH meter and an electro-cardiometer. All projects have a strong scientific flavour. The way they work, and how to build and use them are fully explained.
144 pages **Order code BP104** £2.95

BEGINNER'S GUIDE TO BUILDING ELECTRONICS PROJECTS

R. A. Penfold
Shows the complete beginner how to tackle the practical side of electronics, so that he or she can confidently build the electronic projects that are regularly featured in

magazines and books. Also includes examples in the form of simple projects.
112 pages **Order code 227** £1.95

TEST EQUIPMENT CONSTRUCTION

R. A. Penfold
This book describes in detail how to construct some simple and inexpensive but extremely useful, pieces of test equipment. Stripboard layouts are provided for all designs, together with wiring diagrams where appropriate, plus notes on construction and use.

The following designs are included:- AF Generator, Capacitance Meter, Test Bench Amplifier, AF Frequency Meter, Audio Millivoltmeter, Analogue Probe, High Resistance Voltmeter, CMOS Probe, Transistor Tester, TTL Probe. The designs are suitable for both newcomers and more experienced hobbyists.
104 pages **Order code BP248** £2.95

DATA AND COMPONENT IDENTIFICATION



CHART OF RADIO, ELECTRONIC, SEMICONDUCTOR AND LOGIC SYMBOLS

M. H. Banani B.Sc.(Eng.)
Illustrates the common, and many of the not-so-common, radio, electronic, semiconductor and logic symbols that are used in books, magazines and instruction manuals, etc., in most countries throughout the world.
Chart **Order code BP27** £0.95

INTERNATIONAL TRANSISTOR EQUIVALENTS GUIDE

A. Michaels
Helps the reader to find possible substitutes for a popular selection of European, American and Japanese transistors. Also shows material type, polarity, manufacturer and use.
320 pages **Order code BP85** £3.95

RADIO, TV, SATELLITE

SETTING UP AN AMATEUR RADIO STATION

I. D. Poole
The aim of this book is to give guidance on the decisions which have to be made when setting up any amateur radio or short wave listening station. Often the experience which is needed is learned by one's mistakes, however, this can be expensive. To help overcome this, guidance is given on many aspects of setting up and running an efficient station. It then proceeds to the steps that need to be taken in gaining a full transmitting licence.

Topics covered include: The equipment that is needed; Setting up the shack; Which serials to use; Methods of construction; Preparing for the licence.

An essential addition to the library of all those taking their first steps in amateur radio
86 pages **Order code BP300** £3.95

BEGINNER'S GUIDE TO RADIO - 9th EDITION

Gordon J. King
Radio signals, transmitters, receivers, antennas, components, valves and semiconductors, CB and amateur radio
286 pages **Order code NE08** £8.95

AN INTRODUCTION TO RADIO DXING

R. A. Penfold
Anyone can switch on a short wave receiver and play with the controls until they pick up something, but to find a particular station, country or type of broadcast and to receive it as clearly as possible requires a little more skill and knowledge. The object of this book is to help the reader to do just that, which in essence is the fascinating hobby of radio DXing.
112 pages **Order code BP91** £1.95

EXPERIMENTAL ANTENNA TOPICS

H. C. Wright
Although nearly a century has passed since Marconi's first demonstration of radio communication, there is still research and experiment to be carried out in the field of antenna design and behaviour.

The aim of the experimenter will be to make a measurement or confirm a principle, and this can be done with relatively fragile, short-life apparatus. Because of this, devices described in this book make liberal use of cardboard, cooking foil, plastic bottles, cat food tins, etc. These materials are, in general, cheap to obtain and easily

worked with simple tools, encouraging the trial-and-error philosophy which leads to innovation and discovery.

Although primarily a practical book with text closely supported by diagrams, some formulae which can be used by straightforward substitution and some simple graphs have also been included.
72 pages **Order code BP278** £3.50

NEWNES SHORTWAVE LISTENING HANDBOOK

Joe Pritchard G1UQW
Part One covers the "science" side of the subject, going from a few simple electrical "first principles", through a brief treatment of radio transmission methods to simple receivers. The emphasis is on practical receiver designs and how to build and modify them, with several circuits in the book.

Part Two covers the use of sets, what can be heard, the various bands, propagation, identification of stations, sources of information, QSLing of stations and listening to amateurs. Some computer techniques, such as computer Morse decoding and radio teletype decoding are also covered
224 pages **Order code NE16** £14.95

COMPUTING

SERVICING PERSONAL COMPUTERS - 2nd EDITION

Mike Toolley BA
The revised and enlarged second edition contains a new chapter on the IBM PC, AT, TX and compatibles. It is essential for anyone concerned with the maintenance of personal computer equipment or peripherals, whether professional service technician, student or enthusiast.
240 pages (Hard cover) **Order code NE15** £25

HOW TO EXPAND, MODERNISE AND REPAIR PCs AND COMPATIBLES

R. A. Penfold
Not only are PC and compatible computers very expandable, but before long most users actually wish to take advantage of that expandability and start upgrading their PC systems. Some aspects of PC upgrading can be a bit confusing, but this book provides advice and guidance on the popular forms of internal PC expansion, and should help to make things reasonably straightforward and painless. Little knowledge of computing is assumed. The only assumption is that you can operate a standard PC of some kind (PC, PC XT, PC AT, or a 80386 based PC).

The subjects covered include: PC overview, Memory upgrades; Adding a hard disk drive; Adding a floppy disk drive; Display adaptors and monitors; Fitting a maths co-processor; Keyboards; Ports; Mice and digitisers, Maintenance (including preventative maintenance) and Repairs, and the increasingly popular subject of d.i.y. PCs.
156 pages **Order code BP271** £4.95

AN INTRODUCTION TO PROGRAMMING THE BBC MODEL B MICRO

R. A. & J. W. Penfold
Written for readers wanting to learn more about programming and how to make best use of the incredibly powerful model B's versatile features. Most aspects of the BBC Micro are covered, the omissions being where little could usefully be added to the information provided by the manufacturer's own manual.
144 pages **Order code BP139** £1.95

AN INTRODUCTION TO 8502 MACHINE CODE

R. A. & J. W. Penfold
No previous knowledge of microprocessors or

machine code is assumed. Topics covered are: assembly language and assemblers, the register set and memory, binary and hexadecimal numbering systems, addressing modes and the instruction set, and also mixing machine code with BASIC. Some simple programming examples are given for 8502-based home computers like the VIC-20, ORIC-1/Atmos, Electron, BBC and also the Commodore 64.
112 pages **Order code BP147** £2.95

The PRE-BASIC BOOK

F. A. Wilson, C.G.I.A., C.ENG., F.I.E.E., F.I.E.R.E., F.B.I.M.
Another book on BASIC but with a difference. This one does not skip through the whole of the subject and thereby leave many would-be programmers floundering but instead concentrates on introducing the technique by looking in depth at the most frequently used and more easily understood computer instructions. For all new and potential micro users.
192 pages **Order code BP146** £2.95

DIRECT BOOK SERVICE

ORDERING DETAILS

Please state the title and order code clearly, print your name and address and add the required postage to the total order.

Add 75p to your total order for postage and packing (overseas readers add £1.50 for countries in Europe, or add £2.50 for all countries outside Europe, surface mail postage) and send a PO, cheque, international money order (£ sterling only) made payable to Direct Book Service or credit card details (including card expiry date), Visa or Mastercard (Access) - minimum credit card order is £5 - quoting your name and address, the order code and quantities required to DI-

RECT BOOK SERVICE, 33 GRAVEL HILL, WIMBORNE, DORSET BH21 1RW (mail order only).

Although books are normally sent within seven days of receipt of your order, please allow a maximum of 28 days for delivery. Overseas readers allow extra time for surface mail post.

Please check price and availability (see latest issue of *Everyday Electronics*) before ordering from old lists.

Note - our postage charge is the same for one book or one hundred books!

MORE BOOKS NEXT MONTH

DIRECT BOOK SERVICE IS A DIVISION OF WIMBORNE PUBLISHING LTD.



**The UK Distributor for
Standard Toroidal Transformers**
* 106 types available from stock
* Sizes from 15VA to 625VA

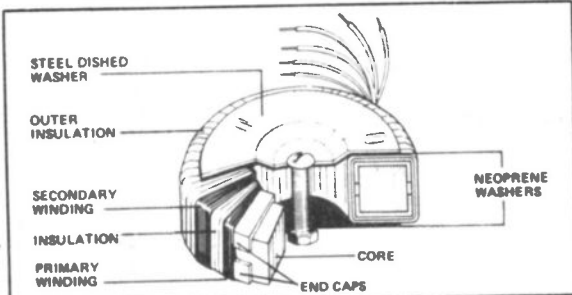

Write or phone for free Data Pack

Jaytee Electronic Services

143 Reculver Road, Beltinge, Herne Bay, Kent CT6 6PL
Telephone: (0227) 375254



Happy Memories

4116	150ns pulls	1.00	256x9 SIMM 80ns	11.50
4164	100ns	1.45	256x9 SIPP 80ns	12.00
41256	120ns	1.40	6264 100ns LP	1.95
41256	100ns	1.55	62256 100ns LP	2.95
41256	80ns	1.65	2764 250ns	1.85
41464	100ns	2.20	27128 250ns	2.25
414256	80ns	3.95	27256 250ns	2.45
411000	80ns	3.95	27C256 250ns	2.45
1Megx9 SIMM 80ns		33.50	27512 250ns	3.45
1Megx9 SIPP 80ns		35.50	27C512 250ns	3.75

Motherboards

80286 Upto 4Mb RAM EMS on board	
12MHz £86 16MHz £83 20MHz £99	
80386SX 16MHz £155 20MHz £175	
80386DX 25MHz £295	
80386DX 33MHz Cache £399	

Odds

120Mb Internal Tape Streamer	£215
102 Key Tactile Keyboard	£29.50
3 Button opto-mech mouse	£16.95

Video

16bit VGA 256K 800x600	£49.50
16bit VGA 1Mb 1024x768x256	£79.50
Hercules / printer card	£12.95
Paper White TTL 14" Monitor	£79.50
VGA Paper White	£110
VGA Colour 1024x768 with 2yrs on-site warranty	£275

Diskdrives

5¼" 1.2Mb Floppy	£47
3½" 1.44Mb Floppy	£44
5¼" Frame for floppy	£5
40Mb 28Ms 3½" IDE	£149
90Mb 19Ms 3½" IDE	£259
106Mb 19Ms 3½" IDE	£299
211Mb 15Ms 3½" IDE	£499

Cards

16bit controller 2xFDD and 2 x IDE HDD	£18.00
With Serial, Parallel & Games port on board	£29.00
8bit Ser, Par & games	£12.95

Cases

Fliptop 200W	£75.00
Smart Desktop 200W	£87.50
Tower Case 220W	£169

Carriage on Motherboards, Floppy drives & Keyboards £5, Video & Controller cards £3, Hard disks, Cases & Monitors £10, IC's free if over £15 nett, otherwise add 50p. VAT to be added to total. Full list of IC's, computers and computer parts on request.

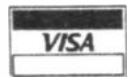

Happy Memories, FREEPOST,
Kington, Herefordshire HR5 3BR
Tel (054 422) 618 Fax (054 422) 628



HILLS COMPONENTS

established since 1973

can offer the trade a selection of nearly 4,000 product lines covering the following ranges

Aerials & Accessories
Batteries & Accessories
Cables & Accessories
Computer Accessories
Connectors (all types)
Electronic kits/Modules
Filters/Fuses
Hardware/Fixings
Headphones/Intercoms
Connecting leads (all types)
Microphones
Multimeters
Passive Components
P.C. Boards
Relays
Speakers
Switches
Service Aids
Soldering Equipment
Telephones & Accessories
Transformers

TRADE ENQUIRIES ONLY

Please phone or write quoting your company name & address for a copy of our 1991 catalogue

TRADE ONLY

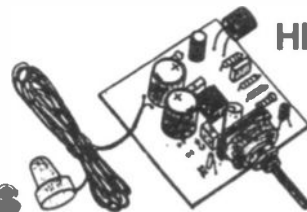
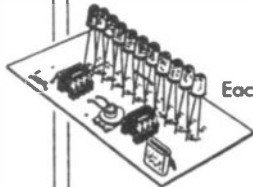
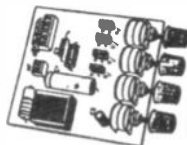

ELECTRONIC KITS & MODULES

FOR HOBBYISTS ELECTRONICS ENTHUSIASTS
EDUCATIONAL ESTABLISHMENTS ETC.

Build your own:

Geiger-Mueller Indicator, Metal Detector,
Stereo Amplifier, Digital Combination Lock, or
any of the many other kits available for numerous applications

Each kit comes in component form with easy to follow instructions for assembly

OVER 100 KITS TO CHOOSE FROM

Some of the popular kits include

- * Antenna Amplifiers
 - * Lie Detectors
 - * Alarm Systems & Monitors
 - * Infra-Red Light Barriers
 - * Sirens - Kojak-Warship-FBI-Ships-Space
 - * Micro-Wave Indicators
 - * Radios & Receivers
 - * Electronic Barking Dog
 - * Lighting Consoles
 - * Amplifiers (up to 200w)
 - * Car Aerial Amplifiers
- PLUS MANY MANY MORE

Call us now for details of your local Stockist

HILLS COMPONENTS LTD

Units 5 & 6
Melinite Industrial Estate
Brixton Road, Watford
Herts WD2 5SL
0923 52000

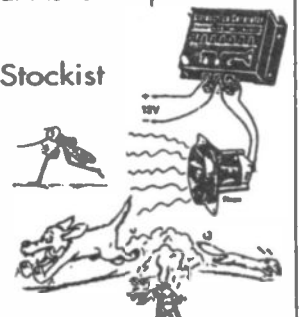
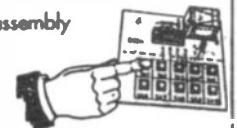
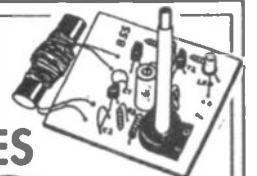

PCB SERVICE

Printed circuit boards for certain constructional projects are available from the PCB Service, see list. These are fabricated in glass fibre, and are fully drilled and roller tinned. All prices include VAT and postage and packing. Add £1 per board for airmail outside of Europe. Remittances should be sent to **The PCB Service, Everyday Electronics, 6 Church Street, Wimborne, Dorset BH21 1JH.** Cheques should be crossed and made payable to *Everyday Electronics* (Payment in £ sterling only).

NOTE: While 95% of our boards are now held in stock and are dispatched within seven days of receipt of order, please allow a maximum of 28 days for delivery - overseas readers allow extra if ordered by surface mail. Please check price in the latest issue.

Boards can only be supplied on a payment with order basis.
We do have older boards in stock - please enquire.

PROJECT TITLE	Order Code	Cost
Spectrum EPROM Programmer	628	£7.87
Bat Detector	647	£4.95
Electronic Spirit Level	649	£3.85
Distance Recorder	651	£5.23
Power Supplies - Fixed Voltage	654	£4.08
Variable Voltage	655	£4.48
Music on Hold	646	£3.85
Power Supplies - 25V 700mA	656	£4.35
30V 1A	657	£4.55
EE Seismograph - Control	658	£4.08
Detector	659	£4.22
Lego/Logo & Spectrum	660	£6.49
Wash Pro	643	£3.83
Biofeedback Monitor - Front End	661	£4.52
Processor	662	£4.56
Logo/Lego & Spectrum Interface	664	£5.60
EEG Electrode Impedance Meter	665	£3.98
Biofeedback Signal Generator	666	£4.08
Quick Cap Tester	668	£3.92
Weather Station		
Anemometer - Freq./Volt Board	670	£3.94
Optional Display	669	£3.73
Wind Direction	673/674	£4.22
System Power Supply	675	£3.59
Prophet In-Car Ioniser	676	£3.18
EE Weather Station		
Display Driver	672 & 678	£4.22
Display and Sensor	671	£4.47
Fermostat Mk2	677	£4.28
Superhet Broadcast Receiver-Tuner/Amp	679/680	£4.22
Stereo Noise Generator	681	£4.24
Digital Experimenter's Unit - Pulse Generator	682	£4.46
Power Supply	683	£3.66
Enlarger Timer	684	£4.28
EE Weather Station		
Rainfall/Sunlight Display	685	£4.27
Rainfall Sen and Sunlight Sen	686/687	£4.16
Amstrad Speech Synthesiser	689	£4.68
80 Metre Direct Conversion Radio	691	£4.95
Mains Appliance Remote Control		
Infra-Red Transmitter	692/693	£4.75
Mains Appliance Remote Control		
Encoder Board A	694	£6.61
Encoder Board B	695	£4.78
The Tester	696	£4.15
Mains Appliance Remote Control		
Mains ON/OFF Decoder	697	£4.55
(5 or more 697's ordered together £3.25 each)		
Simple Metronome	698	£3.94
Hand Tally		
Main Board (double-sided) and Display Board	699, 700	£10.95
Alarm Bell Time-Out	701	£4.10
Mains Appliance Remote Control		
Temperature Controller (p.c.b. only)	702	£5.20
Ghost Waker		
Frequency Meter	703	£4.32
	704	£5.25
Freq. Meter/Tachometer	705	£3.98
EE Musketeer (TV/Video/Audio)	706	£5.78
Colour Changing Christmas Lights	707	£4.39
Microcontroller Light Sequencer	708/709	£10.90
Versatile Bench Power Supply Unit	710	£4.24
Teach-In '91, Part 1 - L200 Module	711	£3.93
Dual Output Module	712	£4.13
LM723 Module	713	£4.21
Spatial Power Display	714	£5.33
Amstrad PCW Sound Generator	715	£5.03
Teach-In '91, Part 2 - G.P. Transistor Amp	717	£3.77
Dual Op.Amp Module	718	£3.83

PROJECT TITLE	Order Code	Cost
Intercom (Teach-In '91 Project 2)	719	£4.41
Analogic Test Probe	720	£3.24
MARC Phone-In	721	£6.87
Teach-In '91 Part 3 - TBA820M Amplifier	723	£4.05
High Quality Power Amp	724	£4.93
Bench Amplifier (Teach-In '91 Project 3)	725	£4.45
Gingernut 80m Receiver		
R.F. section (726), Voltage Regulator (727)	726/7/8	£3.06
Audio Amplifier (728)	all 3 together	per board £8.16
Pocket Tone Dialler	729	£4.36
Battery To Mains Inverter	730	£4.97
Simple Basic Alarm	731	£4.50
Car Code Lock (pair)	732a/b	£4.69
Teach-In '91 Part 4 - Sinusoidal Oscillator	733	£4.39
8038 Oscillator	734	£4.15
Waveform Generator (Teach-In '91 Project 4)	735	£4.72
Humidity Tester	716	£4.97
Model Train Controller (double-sided)	736	£9.75
Electronic Die (Teach-In '91 Project 5)	737	£4.93
Teach-In '91 Part 5 - Digital Counter Module	738	£4.35
Modular Disco Lighting System		
Switched Power Output Module	739	£5.91
Digital LCD Thermostat-Control Board	740	£4.05
-Power/Relay Board	741	£3.76
Pulse Generator (Teach-In '91 Project 6)	742	£4.97
Teach-In '91 Part 6 - Timer Module	743	£4.62
Digilogue Car Tachometer	744	£5.63
Modular Disco Lights - Simple Chaser	745	£5.00
Sweeper Module	746	£5.17
Automatic Light Control - PSU Board	747	£4.88
Logic Board	748	£5.17
Radio Receiver (Teach-In '91 Project 7)	749	£4.57
Teach-In '91 Part 7 - R.F. Amplifier Module	750	£4.23
Modular Disco Lights - Masterlink	752	£6.36
Ultrasonic Proximity Meter		
Display Unit (753) & Sensor Unit (754)	753/754	£7.06
Disco Lights (Teach-In '91 Project 8)		
PSU and Pre-amplifier	755	£4.54
Low, Mid, High Filter/Triac (set of 3 boards)	756	£11.00
Teach-In '91 Part 8 - Solid State Switch Module	757	£4.29
Mod. Disco Lights - Pattern Gen	760	£6.79
Teach-In '91 Part 8 - Light Sensitive Switch	761	£4.74
Opto-Link (Teach-In '91 Project 9) - Transmitter	762	£4.85
Receiver	763	£4.88
Receiver	764	£3.77
Portable PeST Scarer		
Capacitance Meter	751	£5.17
Modular Disco Lights - Dimmer Interface	765	£8.17
Mod. Disco Lights		
VU Sound Module (Double-sided)	767	£8.68
UV Exposure Unit	768	£4.63
PC-Scope Interface - Main Board	769	£6.95
Expansion Plug (Double-sided)	770	£5.96
Mod. Disco Lights		
Superchaser (Double-sided)	771	£6.91
Supersweep (Double-sided)	772	£8.26
Bicycle Alarm	773	£5.01
Darts Scorer	774	£7.90
Knockerbox	775	£5.35
Signal Generator - Main Board	776	£7.46
PSU	777	£4.73
Mind Machine - Main Board	778	£7.00
Auto Nightlight	779	£5.03
Mind Machine - Programmer Board	780	£7.39
Transistor Checker	781	£4.63
Stepping Motor Driver/Interface	782	£10.39
Micro-Sense Alarm	783	£5.42

EE PRINTED CIRCUIT BOARD SERVICE

Order Code Project Quantity Price

Name.....

Address.....

I enclose payment of £..... (cheque/PO in £ sterling only payable to Everyday Electronics) Access (MasterCard) or Visa No.

Minimum order for credit cards £5

Signature..... Card Ex. Date.....

Please supply name and address of card-holder if different from the address shown

BLOCK CAPITALS PLEASE

NEW FROM HIGH-Q 30 VELLEMAN KITS

Added To Our Range

NOW "130" KITS AVAILABLE
For all Electronic Enthusiasts

Sole UK Importers • Trade Enquiries contact below

NEW KITS INCLUDE:

- CODELOCK**
- CAR ACCESSORIES**
- COUNTERS**
- CAR ALARM**
- DIMMERS**
- POWER SUPPLIES**
- HOUSEHOLD APPLICATIONS**
- AUDIO**
- SENSORS**
- TIMERS**
- DIGITAL CONTROLLED PRE-AMPLIFIER**
- 1-CHANNEL INFRA-RED RECEIVER**
- COMMUNICATIONS**
- ALARMS**
- LIGHT-EFFECTS**
- COMPUTER INTERFACE**
- GADGETS**
- MEASURING DEVICES**
- 15-CHANNEL INFRA-RED TRANSMITTER**

For 1991 Catalogue & Price List, please sent 75p (UK) or £2.00 (Overseas) to:

HIGH-Q-ELECTRONICS



P.O. BOX 142, Hatfield, Herts AL9 7JH
Tel: 0707 263562 Fax: 0707 276746

NEW DISCO KITS

SWITCHABLE 3-4 CHANNEL LIGHTING CONTROLLER.

With beatchase and speed controls.

PCB + Components Kit...£21.00

Hardware + punched

case kit with label etc.....£12.00



MULTICHASE 4 CHANNEL LIGHTING CONTROLLER.

With chase select, beatchase and speed controls.

PCB + Components kit...£26.00

Hardware + punched

case kit with label etc.....£13.00

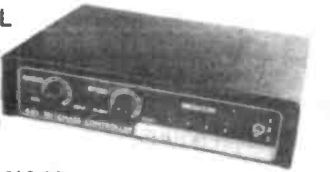

COMPUTER CHASE 4 CHANNEL LIGHTING CONTROLLER.

With sound chase/sound to light automatic audio level. 3 superb programs including over 20 different chases.

PCB + Components Kit.....£35.00

Hardware + punched

case kit with label etc.....£15.00



All Hardware Kits include Bulgin 8 way socket, mains lead, mains switch, 1/4" audio jack socket, cable restraint, feet and all fixings.

All Prices include VAT. P&P only £1.50 per order.

WORTTECH electronics

98 School Street, Wolverhampton, West Midlands WV3 0NR.
Tel: (0902) 23275

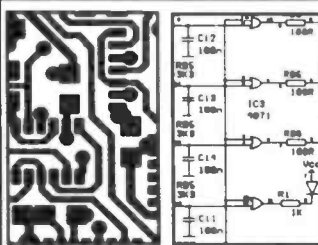
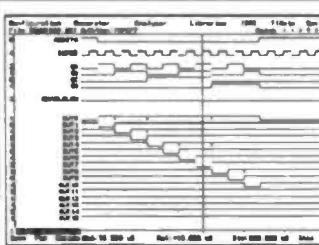
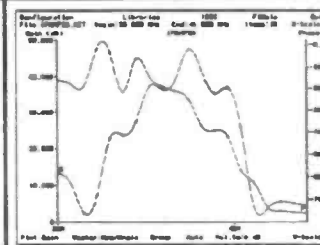
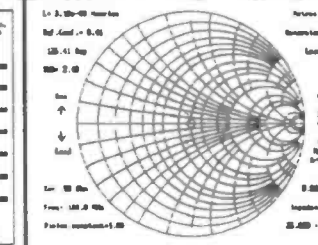
PCB & SCHEMATIC CAD	DIGITAL SIMULATION	ANALOGUE SIMULATION	SMITH CHART CAD
EASY-PC £98	PULSAR £195	ANALYSER III £195	Z-MATCH II £195
			
<ul style="list-style-type: none"> ● Design Single sided, Double sided and Multilayer boards. ● Provides Surface Mount support. ● Standard output includes Dot Matrix / Laser / Inkjet printers, Pen Plotters, Photo-plotters and NC Drill. ● Award Winning EASY-PC is in use in over 9000 installations in 50 Countries World-Wide. ● Runs on PC/XT/AT/286/386 with Herc, CGA, EGA, VGA. ● Superbly Easy to use. ● Not Copy Protected. 	<ul style="list-style-type: none"> ● At last! A full featured Digital Circuit Simulator for less than £1000! ● Pulsar allows you to test your logic designs without the need for expensive test equipment. ● Catch glitches down to a pico second per week! ● Includes 4000 Series CMOS and 74LS Libraries. ● Runs on PC/XT/AT/286/386/486 with EGA or VGA. Hard disk recommended. ● Not Copy protected. 	<ul style="list-style-type: none"> ● NEW powerful ANALYSER III has full graphical output. ● Handles R's, L's, C's, BJT's, FET's, OP-amp's, Tapped and untapped Transformers, and Microstrip and Co-axial Transmission Lines. ● Calculates Input and Output Impedances, Gain and Group Delay. ● Covers 0.001 Hz to >10GHz ● Runs on PC/XT/AT/286/386/486 with EGA or VGA. ● Not Copy protected. 	<ul style="list-style-type: none"> ● Z-MATCH II takes the drudgery out of RF matching problems and includes many more features than the standard Smith Chart. ● Provides quick accurate solutions to many matching problems using transmission line transformers, stubs, discrete components etc.. ● Supplied with comprehensive user instructions including many worked examples. ● Runs on PC/XT/AT/386/486, CGA, EGA, VGA ● Not Copy Protected
<p>For full info' Phone, Fax or Write to:</p> <h3 style="margin: 0;">Number One Systems Ltd.</h3> <p style="margin: 0;">The Electronics CAD Specialists</p> <p style="margin: 0;">REF: EVD, HARDING WAY, SOMERSHAM ROAD, ST. IVES, HUNTINGDON, CAMBS, PE17 4WR, ENGLAND. Telephone: 0480 61778 (7 lines) Fax: 0480 494042 International: +44-480-61778 Fax: +44-480-494042</p> <p style="margin: 0;">ACCESS, AMEX, MASTERCARD, VISA Welcome.</p>			
			<p>Technical support free for life!</p>

EVERYDAY CLASSIFIED ELECTRONICS

The prepaid rate for semi-display space is £8 (+ VAT) per single column centimetre (minimum 2.5cm). The prepaid rate for classified adverts is 30p (+ VAT) per word (minimum 12 words).

All cheques, postal orders, etc., to be made payable to Everyday Electronics. VAT must be added. Advertisements, together with remittance, should be sent to the Classified Advertisement Dept., Everyday Electronics, 6 Church Street, Wimborne, Dorset BH21 1JH. Tel: (0202) 881749.

SERVICE MANUALS

Available for most equipment. TV, Video, Audio, Test, Amateur Radio, Military Surplus, Kitchen, etc. Any Video Recorder, Video Camera or Oscilloscope Manual £15.00 (subject to stock). All other Manuals £10.00 (subject to stock).

State Make and Model required with order. Over 100,000 manuals available for equipment from 1930's to the present. Circuit sections supplied on full size sheets up to A1 size (33" x 24") if applicable. Originals or photostats supplied as available.

FREE Repair and Data Guide Catalogue with all orders or send SAE for your copy today

MAURITRON (EE)

8 Cherry Tree Road, Chinnor, Oxfordshire OX9 4QY
Tel: (0844) 51694
Fax: (0844) 52554

BTEC ELECTRONICS TECHNICIAN FULL-TIME TRAINING

THOSE ELIGIBLE CAN APPLY FOR E.T. GRANT SUPPORT AN EQUAL OPPORTUNITIES PROGRAMME

O.N.C., O.N.D. and H.N.C.

Next course commences Monday 6th January 1992 FULL PROSPECTUS FROM

LONDON ELECTRONICS COLLEGE (Dept EE) 20 PENYWERN ROAD EARLS COURT, LONDON SW5 9SU
TEL: 071-373 8721

NEW VHF MICROTRANSMITTER KIT

Tunable 80-135MHz, 500 metre range, sensitive electret microphone, high quality PCB. SPECIAL OFFER complete kit ONLY £5.95 Assembled and ready to use £9.95 post free.

Access/Visa orders telephone 021 411 1821 Send 2x1st class stamps for Catalogue. Cheques/P.O. payable to QUANTEK ELECTRONICS LTD
Kits Dept. (EE), 45a Station Road Northfield, Birmingham B31 3TE



Cooke International

We stock used test equipment, scopes, sig. gens., DVM's, oscillators, etc in large quantities. We can now offer a copy service for workshop manuals for many instruments. Please ask for details. Send SAE for lists

Contact: Cooke International, Unit 4, Fordingbridge Site, Main Road, Barnham, Bognor Regis, West Sussex PO22 0EB
Open: Mon-Fri 9am-5pm or phone 0243 545111 - Fax: 0243 542457

ON-LINE VIDEO

ELECTRONICS FOR THE HOBBYIST is a 90 minute video-cassette using computer-graphic simulations to enable the hobbyist or student to understand the way in which common electronic components work and is available directly from us at only £19.95 inc. P&P. Other titles available. S.A.E. for list. Allow 14 days for delivery. Send Cheques/P.O. payable to: On-Line Video Marketing (Dept EV-2) The Cottage, Tredown Farm, Bradstone, Milton Abbot, Tavistock, Devon PL19 0QT

RCS VARIABLE VOLTAGE D.C. BENCH POWER SUPPLY

1 to 24 volts up to 1/2 amp 1 to 20 volts up to 1 amp 1 to 18 volts up to 1 1/2 amps d.c. Fully stabilised. Twin panel meters for instant voltage and current readings. Overload protection. Fully variable. £45 + Post and insurance £4

Operates from 240V a.c. Compact Unit. Size 9 x 5 1/2 x 3in. NEW MODEL Up to 30volts d.c. at 6 amps 10 amps peak. Fully variable. Twin panel meters. Size 14 1/2 x 11 x 4 1/2in. £98 inc VAT. Carr £6

RADIO COMPONENT SPECIALISTS

337 WHITEHORSE ROAD, CROYDON SURREY, U.K. Tel: 081-684 1665

List, Large SAE Delivery 7 days. Callers welcome. Closed Wednesday

RESISTORS & CAPACITORS

Top quality components at VERY SPECIAL PRICES!!!
SAE for lists and Order Form
M. Collier, Grantham House Grantham Bank, Barcombe East Sussex BN8 5DJ

PCB CAD USERS

Artwork transparencies produced from your printouts or files
Superb quality
SAE for details and FREE sample

SB Electronics Services

10 Peacock Crescent Clifton Estate, Nottingham NG11 8EP
Tel 0602 841831

N. R. BARDWELL LTD (EE)

200	Signal diodes 1N4148	£1.00
75	Rectifier Diodes 1N4001	£1.00
75	Rectifier Diodes 1N4003	£1.00
50	Rectifier Diodes 1N4007	£1.00
55	Rectifier Diodes 1N5401	£1.00
10	NE555 Timer i.c.s.	£1.00
5	741 Op Amp i.c.s.	£1.00
8	C106D1 400V 5 amp thyristors	£1.00
8	BFY51 Transistors	£1.00
30	BC478 Transistors	£1.00
30	MPSA92 Transistors	£1.00
25	Asstd. high brightness i.e.d.s.	£1.00
50	axial i.e.d.s (Diode package) wide angle red	£1.00
50	Rectangular red i.e.d.s.	£1.00
20	Miniature axial i.e.d.s super bright red	£1.00
24	Miniature red i.e.d.s 3mm dia.	£1.00
12	Asstd. seven segment displays	£1.00
4	43" Corn. anode seven segment displays	£1.00
100	22NF 100V radial film capacitors	£1.00
100	33NF 50V radial film capacitors	£1.00
200	Asstd. disc ceramic capacitors	£1.00
80	4U7 16V Radial electrolytics	£1.00
75	4U7 63V Radial electrolytics	£1.00
80	10UF 16V Radial electrolytics	£1.00
50	10UF 50V Radial electrolytics	£1.00
80	22UF 25V Radial electrolytics	£1.00
80	33UF 16V Radial electrolytics	£1.00
80	47UF 16V Radial electrolytics	£1.00
50	47UF 50V Radial electrolytics	£1.00
80	100UF 10V Radial electrolytics	£1.00
50	220UF 16V Radial electrolytics	£1.00
60	470UF 10V Radial electrolytics	£1.00
40	1000UF 10V Radial electrolytics	£1.00
30	Asstd. IF transformers	£1.00
48	Asstd. coil formers	£1.00
100	Asstd. RF chokes	£1.00
30	Asstd. di socket up to 40 pin	£1.00
30	Assorted socket/conn/edge-dil-etc	£1.00
20	1 inch Glass reed switches	£1.00
10	4P 3W MBB min. rotary switches	£1.00
20	Min. SPST slide switches	£1.00
20	Magnetic ear pipe plus lead & plug	£1.00
1	Peltier effect heat pump	£1.95
1	10 watt Stereo amplifier, 4 controls plus data	£2.95
1	10mm Flashing i.e.d. red	£0.75
1	10mm Ultra bright i.e.d. red 300 MCD	£0.80

Prices include VAT, postage £1.00. Stamp for Lists
288 Abbedale Road, Sheffield S7 1FL
Phone (0742) 552886. Fax (0742) 500689

Miscellaneous

KITS, PLANS, ETC for surveillance, protection (sonic, HV), "007" gear. Send 2 x 22p stamps for list. ACE(EE), 53 Woodland Way, Burntwood, Staffs.

G.C.S.E. ELECTRONICS KITS at pocket money prices. S.A.E. for FREE catalogue. SIR-KIT ELECTRONICS, 70 Oxford Road, Clacton CO15 3TE.

PROTOTYPE PRINTED CIRCUIT BOARDS one offs and quantities, for details send s.a.e. to B.M.A. Circuits, 38 Poyning Drive, Sussex BN3 8GR, or phone Brighton 720203.

OSCILLOSCOPE SC110 10MHz Sinclair battery or PSU, single trace, £60. Thandar PFM-200-A frequency counter £60. Phone 0267 290363.

HUNDREDS of unusual items cheap! Send 90p (coins/stamps) for interesting samples and list. Grimsby Electronics, Lambert Road, Grimsby.

UNUSUAL KITS, bat detectors, brain wave stimulators, microtransmitters, etc. For list send SAE to P. Cartwright, 10 Charlotte Rd, Edgbaston, Birmingham B15 2NQ.

WANTED. Circuit diagram for soundlab car amplifier model KB 907. Will pay good money as urgently required. Tel 0933 665128.

RS232 Serial comms, professional software, COMIO VI.1, for IBM PC com ports. Very easy to use. C. 8086, source code functions for byte, string, block, buffered, interrupt driven I/O. Manual, Demos, utilities. £25 per package.

Richard, Micro SciTech Ltd 0252 625439. OSCILLOSCOPE, Hameg HM1005, 100MHz, still with 1 year warranty, £700. RS UV exposure box £45. Weller solder station £35. 0993 705877.

TURN your hobby into a business using the Home Enterprise Package. For details send SAE to H.E.P., 53 Greystoke Avenue, Sandyford, Newcastle-upon-Tyne NE2 1PN.

TRANSMITTER circuit diagrams - FM, Medium, Shortwave, CB - Full instructions, minimum seventeen circuits. Cheques/PO's £4.25 to: D. Davies, 33 Gwaclodygarth, Merthyr Tydfil, CF47 8YU, UK.

CHEMILUMINESCENT lightsticks - fascinating chemical lightsource. Nine 4" sticks sent for £9.99 (red, blue or green). Lilco Ltd, 23 Middlewood Park, Livingston, EH54 8AZ

THE BRITISH AMATEUR ELECTRONICS CLUB

exists to help electronics enthusiasts by personal contact and through a quarterly Newsletter. For details, write to the Chairman:
Mr H. F. Howard, 41 Thingwall Park Fishpond, Bristol BS16 2AJ
Space donated by Everyday Electronics

Rechargeable Batteries

	Quantity	1-99	100-499
AA (HP7) 500mAh		£0.99	£0.77 + VAT
AA 500mAh solder tags		£1.55	£0.95 + VAT
AA 700mAh high capacity		£1.95	£1.20 + VAT
C (HP11), 1.2AH		£2.20	£1.69 + VAT
C 2AH with solder tags		£3.80	£2.25 + VAT
D (HP2) 1.2AH		£2.80	£1.96 + VAT
D 4AH with solder tags		£4.95	£3.59 + VAT
PP3 8.4V 110mAh		£4.95	£3.85 + VAT
Sub C with solder tags 1.2AH		£2.50	£1.70 + VAT
1/2 AA with solder tags		£1.55	£1.17 + VAT
AAA (HP18) 180mAh		£1.75	£1.15 + VAT

Special offers for unusual sizes only while stocks last. Please check availability before ordering.

	Quantity	1-99	100-499
F cell 7AH 32 x 87mm with flat top		£3.95	£2.80 + VAT
F cell with solder tags		£4.30	£3.00 + VAT
Cellular telephone battery 42mm long x 16mm dia		£1.45	£0.95 + VAT
Stick of 4 171 x 16 dia with 150mm red & black leads		£5.95	£4.00 + VAT
4 cell battery 94 x 25mm 4.8V		£3.50	£2.30 + VAT

All 1 to 99 prices include VAT
Please add 95p postage & packing per order

JPG Electronics

276-278 Chatsworth Road, Chesterfield S40 2BH
Access & Visa orders tel: (0246) 211202

Technical Information Services

76 CHURCH STREET, LARKHALL, LANARKSHIRE, ML9 1HE
Tel. (0698) 884585 Mon-Fri 8.30am - 5.00pm
Tel. (0698) 883334 Outwith business hours
FAX facility available all day on both lines
Write now with an SAE for your



FREE QUOTE FREE VOUCHERS & FREE CATALOGUE

Remember, not only do we have EVERY service sheet ever produced, but we also have

THE WORLDS LARGEST COLLECTION OF SERVICE MANUALS

• WE ARE SOLE SUPPLIERS OF VARIOUS FAULT-FINDING GUIDES REPAIR MANUALS & TECHNICAL MANUALS

CTV, Video, CD, Hi-Fi, Camcorder, Satellites, Computers, Domestic Equip, etc

DATA REFERENCE MANUAL "...essential for the serious electrician"
FREE updating and a 10% discount voucher only £8.95
Incorporates Unique Model Identification and Chassis Data

WE BUY MANUFACTURER'S SURPLUS STOCK HENCE THESE LOW PRICES FOR PRIME COMPONENTS

	PRICE
PAPST FAN - 12V DC 1W 80mm x 32mm deep	£8.50
ETRI FAN - 240V 14W - 120mm x 38mm deep	£8.50
RELAY - SIEMENS - 12V 2 pole c/o Low Profile. Gold contact, high quality	£1.00
MAINS FILTER - Bulgin or similar quality make// E.C./3A 250V	£1.50
THERMAL PAPER - Rolls 80mm wide 25m long	£1.00
Box of 40 rolls	£23.00
BARGAIN PACKS - Approx 3 lbs. of quality NEW mixed components. No rubbish! We deal mainly in bulk to the trade. All smaller qty. parts go in the packs regardless of value	£7.00
HEAT SHRINK TUBING - Pack approx 15 x 16 inch lengths. Different diameters & colours	£3.00
HARDWARE PACKS - Same quality & quantity as the packs we do at all the major radio rallies - small nuts & bolts £3.50, small self tapping screws, £3.50, ring & spade crimp terminals - insulated	£3.50
3M STICKY PROTECTIVE FEET - gray rubber - sheet of 56	£3.00
COPPER CLAD P.C. BOARD - double sided 18" x 10.5" sheet, easy to cut - on thin and flexible fibre glass	£2.00
REPEATABLE COUNTERS - 6 digit panel mount inc. catalogue data, 12V DC	£8.00; 240V AC
TA-33 CMOS SAFE CONTINUITY PROBE - detects & locates short circuits with variable audio tone, easy to use. S.T.C. price £22.00	£8.00
Needs PP3 battery (state if required)	£0.50
EPROMS (Ex Equipment) 2764 £1.00, 27128 £1.00, 27256 £1.50, 27512 £2.00	
'D' TYPE CONNECTOR, 9 way P O R S, 80p, 25 way pig of skt £1.00, 37 way pig or skt	£1.30
BULGIN PANEL MOUNT LAMP HOLDERS (6.5V or 12V bulb) set of 3, red, amber and green	£3.00
FERRITE/R.F. PACK, Small cores etc. approx 200 pieces	only £3.00
IEC MAINS LEAD (Similar to kettle lead but for computers etc)	£2.00
POSTAL CHARGES: Orders £1 to £10 - £2.00; £10 to £20 - £4.00; LARGER ORDERS RING FOR CARRIAGE COST	
PLEASE ADD 17% VAT TO TOTAL COST INCLUSIVE OF POSTAL CHARGES	

PHONE 0222 831647

RICH ELECTRONICS

Dept. E.E. The Warehouse, Windsor Place, Senghenydd, Mid-Glam.S. Wales CF8 2GD

FAX 0222 830022



IF AN ADVERT IS WRONG, WHO PUTS IT RIGHT?

We do. The Advertising Standards Authority ensures advertisements meet with the strict Code of Advertising Practice. So if you question an advertiser, they have to answer to us.

To find out more about the ASA, please write to Advertising Standards Authority, Department X, Brook House, Torrington Place, London WC1E 7HN.



This space is donated in the interests of high standards in advertisements.

SHERWOOD ELECTRONICS

45 Rutland Street, Mansfield, Notts NG18 4AP

£1 Special Packs - Now even better value. Select 1 pack FREE for every 10 purchased

SP1 15 x 5mm Red Leds	SP38 25 x 47u/25V radial caps.
SP2 15 x 5mm Green Leds	SP39 12 x 470 u/16V radial caps
SP3 12 x 5mm Yellow Leds	SP42 200 x Mixed 0.25W C.Film resistors
SP6 15 x 3mm Red Leds	SP44 12 x 5mm Leds-4 ea. Red, Grn., Yel.
SP10 100 x 1N4148 diodes	SP46 20 x 400mW zener diodes
SP11 30 x 1N4001 diodes	SP48 15 x Axial caps
SP12 30 x 1N4002 diodes	SP102 20 x 6 pin DIL sockets
SP18 20 x BC182 transistors	SP103 15 x 14 pin DIL sockets
SP19 20 x BC183 transistors	SP104 15 x 16 pin DIL sockets
SP20 20 x BC184 transistors	SP106 6 x 74LS00
SP24 6 x Cmos 4001	SP108 6 x 74LS02
SP25 5 x 555 timers	SP110 5 x 74LS13
SP26 5 x 741 Op-amps	SP112 6 x Cmos 4063
SP28 6 x Cmos 4011	SP113 12 x 1N5400 diodes
SP29 4 x Cmos 4013	SP119 6 x Cmos 4072
SP31 5 x Cmos 4071	SP121 6 x Rect. Red Leds 5 x 2mm
SP33 5 x Cmos 4081	SP122 6 x Rect. Green Leds 5 x 2mm
SP36 25 x 10u/25V radial caps.	SP123 5 x Rect. Yellow Leds 5 x 2mm
SP37 20 x 100u/35V radial caps	SP124 20 x Assorted ceramic disc caps
	SP126 10 x 100u/16V radial caps

All new and full spec. components

1992 Catalogue now available £1 Contains vouchers redeemable against orders

Cheques or P.O. to

NO VAT

Please add £1 P&P to all orders

SHERWOOD ELECTRONICS

MAKE YOUR INTERESTS PAY!

Over the past 100 years more than 9 million students throughout the world have found it worth their while! An ICS home-study course can help you get a better job, make more money and have more fun out of life! ICS has over 90 years experience in home-study courses and is the largest correspondence school in the world. You learn at your own pace, when and where you want under the guidance of expert personal tutors. Find out how we can help YOU. Post or phone today for your FREE INFORMATION PACK on the course of your choice. (Tick one box only)

Electronics	<input type="checkbox"/>	TV, Video & Hi-Fi Servicing	<input type="checkbox"/>
Basic Electronic Engineering (City & Guilds)	<input type="checkbox"/>	Refrigeration & Air Conditioning	<input type="checkbox"/>
Electrical Engineering	<input type="checkbox"/>	Car Mechanics	<input type="checkbox"/>
Electrical Contracting/Installation	<input type="checkbox"/>	Computer Programming	<input type="checkbox"/>
OCSE / OCE / SCE over 40 examination subjects to choose from	<input type="checkbox"/>		

Name _____ Address _____

ICS

International Correspondence Schools Dept ECS 12 312/314 High Street, Sutton, Surrey SM1 1R
Telephone 051-843 9588 or 041-221 2828 (24 hours)

MENDASCOPE LTD

REPAIR & RECALIBRATE
OSCILLOSCOPES
ALL MAKES AND MODELS
NATIONWIDE COLLECTION
& DELIVERY

FREE ESTIMATES

Llangollen, Clwyd, N. Wales LL20 7PB

PHONE: 069 172 597

MISCELLANEOUS ITEMS

Camera returns; 35mm Auto	
Flash/ Wind-on, minor faults	£6.00 ea
or 2 for	£10.00
Dictaphone cassette, mech/record erase	
playback heads, 6V solenoid, motor, hall effect switch	£2.00 ea*
T.V./Printer stands	£3.95 ea
Bicc-Vero Easewire construction kit	£4.95 ea*
TTL/CMOS short circuit snoper	£4.95*
Dot matrix LCD 10x2 lines	£3.75 ea*
Dot matrix LCD 16 x 1 lines with Data	£4.95*
2 digit 16 segment VF display with data	£2.95 ea*
4 digit intelligent dot matrix display	£6.00*
17 segment V.F. display with driver board and data	£2.99 ea*
8 digit liquid crystal display	£1.75 ea*
4 digit LCD with 7211 driver chip	£3.50 ea*
Digital clock display	£2.50*
11 key membrane keypad	£1.50 ea*
Keyboard 392mm x 180mm/100 keys on board + LCD + 74HC05/74C09 easily removable	£4.95
19" 3U sub rack enclosures	£8.95
12V stepper motor, 48 steps per rev, 7.3° step angle	£3.95 ea*
Stepper motor board with 2 slotted opto + 2 mercury tilt switches	£3.95 ea*
1000 mixed 1/2 watt 1% resistors	£4.95 ea
250 electrolytic axial + radial caps	£4.95 ea
100 Mixed trimmer caps popular values	£4.95*
50 off MC 78M12CT Volt Regs	£2.95*
20 off W02M Volt Regs	£1.50*
Cable box UHF modulator/video preamp/transformer/R's + C's/leads	£6.95
1000 off mixed Multilayer Ceramic Caps	£7.95
Solar cell modules 0.45V 700mA	£2.95 ea*
B.B.C. Micro to disc drive lead	£1.50*
Car Burglar alarm vibration auto entry/exit delay	£5.95 ea*
Single zone alarm panel auto entry/exit delay housed in domestic light socket	£9.95 ea*

P.S.U.'s, TRANSFORMERS, COMPONENTS

P.C. P.S.U. 50 watt 115-230V input + 5V 4A + 12V 2.5A output with built in fan, IEC inlet + on/off	£9.95 ea
STC P.S.U. 240V input 5V 6A output (converts to 12V 3A details available)	£5.95 ea
240V input 5V 10A output (converts to 12V 5A no details)	£5.95 ea
600Q line output transformers	£1.25 ea
240V in 0-12V 0.75A out transformer	£1.75*
240V in 0-28V 62VA out transformer	£2.75
Transformer + PCB gives 2x7.5V 32VA with skt for 5 or 12V regulator, will power floppy drive	£3.75 ea
Ultrasonic transducers (transmit + receive)	£1.50 pair
3 to 18V Piezoelectric sounders	50p
9VDC electromechanical sounder	50p
24V DC electromechanical sounder	50p
2A 250V keyswitch 3 position key removable in two positions	£1.50*
DIL switches PCB MT 3/4/6 way	35p
5V SPCO SIL reed relay	40p
5V 2PCO DIL miniature relay	60p
12V 2PCO or 4PCO continental relay	60p
12V 10A PCB MT (to make contact) relay	95p*
3 to 12V electro magnetic acoustic transducer with data	75p*
2.4576/8.8329/21.10 MHz crystals	50p ea*
Bridges 25A 200V	£1.00*
2A 100V	50p*
3B Mixed components pack	£4.95
50 Mixed terminal blocks	£2.95
250off 16/22/24/40 way IC Sks	£4.95
100 off Phono plugs (red/black/grey)	£3.50*

QUANTITY DISCOUNTS AVAILABLE PLEASE RING

ALL PRICES INCLUDE A 1% PLEASE ADD 1.2% (VAT) EXCEPT ITEMS MARKED * WHICH ARE 50P SALE FOR BULK BUYING LIST PAYMENT WITH ORDER TO

Dept EE, COMPELEC,
14 Constable Road
St. Ives, Huntingdon,
Cambs PE17 6EQ
Tel/Fax: 0480 300819

CAMBRIDGE COMPUTER SCIENCE LIMITED

3.5" 720K Diskette Drives.....	£29.00 each
10MByte Winchester, used, 3 months Wty.....	£35.00 each
5.25" Disk Drives, 80 Tk, DSD.....	£25.00 each
5.25" Disk Drives, 80 Tk, DSD, Used, No Wty (£15.00 drives sold on strictly "as is" basis).....	£15.00 each
5.25" Disks, DSD, 48tp, boxes of 10 (free disk cleaner with 5 boxes).....	£16.00 each
Lockable diskette boxes for 80" 3.5" or 100" 5.25" (state which).....	£5.99 each
Small sized diskette boxes (lockable).....	40" 3.5" £4.78, 50" 5.25" £4.99
Printer stands (suit 80/152 cols).....	Basic £2.99, or with paper catcher £10.99
Digital multimeter, 14 ranges, inc leads & manual.....	£16.00 each
Apicort Disk drive PSU.....	£10.00 each
5V at 6A PSU.....	£4.80 each
5V at 10A PSU.....	£8.40 each
Ni-Cads AA £0.99, C £1.99, D £2.09, PP3 £4.99.....	Universal charger £3.99 each
Disk Drive Data lead BBC Micro to Disk Drives!.....	Single £2.00 Dual £4.00 each
Disk Drive Power lead BBC Micro to Disk Drives!.....	Single £2.00 Dual £4.00 each
74LS TTL pick and mix, buy 10 or more for.....	£8.12 each
Types available: 00 02 04 08 10 11 12 13 14 15 20 21 26 27 30 32 33 37 38 42 74 83 85	
74 174 191 193 240 253 257 260 298 353 365 366 373 385 390 399 670 682	
27128 EPROMS (Ex equipment).....	£1.20 each or £3.00/5
256K Byte DRAM Modules, removed from equipment.....	£8.00 each
6254-12 8K Byte SRAM.....	£3.00 each
62256-10 32K Byte SRAM.....	£3.00 each
65256 32K Byte RAMs.....	£4.00 each
8K Byte NV ram chips.....	£3.00 each
£10.00 four	
Range of Aluminium & plastic project boxes (ask for list)	
Prices include postage. Add 50p (plus VAT) to orders below £5.00. All items new unless stated.	
Add 17.5% VAT to all prices. Send an SAE for our latest list or for more info.	
Dept EE, 374 Milton Road, Cambridge CB4 1SU	
Tel: 0223 434802, 0831 430496 or 0831 430552 (Please note mail order only)	

C_SIM Electronic Circuit Simulation & Analysis Software

C_SIM is a circuit analysis & simulation environment for small computers. You can check for loop stability, frequency response or distortions in circuits before actually building anything, leading to 'right first time' designs, and lower development costs. It features:

- ★ Easy to use graphical user interface.
- ★ Editor for creation and viewing of circuit descriptions and simulation results.
- ★ Graph plotting program to plot simulation results, up to 4 traces per graph, with full cursor measurement system.
- ★ Analogue circuit simulator utilising a subset of the industry standard SPICE 2 simulator language, handling all passive components, BJTs, diodes, dependent and independent sources, and performing DC, AC and transient analysis.
- ★ A preprocessor which handles subcircuit hierarchies and library files of subcircuits.

C_SIM is constantly undergoing development. Forthcoming updates include an expression evaluator for passing parameters to subcircuits, and defining component values by formulae. C_SIM is available for the ATARI ST, COMMODORE AMIGA, and IBM PCs and compatibles, and comes complete with a ring bound manual. The PC version requires 512Kb RAM minimum, the ATARI ST/AMIGA versions require 1Mb RAM and 1Mb disk minimum. All versions run with hard disk if present, and are not copy protected. The price is £59.95 incl. p&p for all platforms. The IBM version comes on both 3.5 and 5.25 inch floppies.

Order now by post direct from

Akula Systems, 49 Lisson Grove, Mutton, Plymouth PL4 7DL

using cheque or postal order. Allow up to 28 days for delivery. Inquiries welcome. Alternatively, order your demonstration for only £14.95 incl. part-refundable when purchasing full system. This features a fully functional, but cut down system (limited number of nodes & parameters), with manual on disk and printed command summary.

Carbon Film resistors 1/4W 5% E24 series 0.51 R to 10M0.....	1p
100 off per value - 75p, even hundreds per value totalling 1000.....	£6.00p
Metal Film resistors 1/4W 10R to 1 M0 5% E12 series - 2p, 1% E24 series.....	3p
Mixed metal/carbon film resistors 1/4W E24 series 1R0 to 10M0.....	1 1/2p
1 watt mixed metal/Carbon Film 5% E12 series 4R7 to 10 Megohms.....	5p
Linear Carbon pre-sets 100mW and 1/4W 100R to 4M7 E6 series.....	7p
Miniature polyester capacitors 250V working for vertical mounting	
.015, .022, .033, .047, .068 - 4p, 0.1 - 5p, 0.12, 0.15, 0.22 - 6p, 0.47 - 8p, 1.0 - 12p	
Mylar (polyester) capacitors 100V working E12 series vertical mounting	
1000p to 8200p - 3p, .01 to .068 - 4p, 0.1 - 5p, 0.12, 0.15, 0.22 - 6p, 0.47/50V - 8p	
Submin ceramic plate capacitors 100V wkg vertical mountings, E12 series	
2% 1.8pf to 47pf - 3p, 2% 56pf to 330pf - 4p, 10% 390p-4700p.....	4p
Disc/plate ceramics 50V E12 series 1P0 to 1000P, E6 Series 1500P to 47000P.....	2p
Polystyrene capacitors 63V working E12 series long axial wires	
10pf to 820pf - 4p, 1000pf to 10,000pf - 5p, 12,000pf.....	6p
741 Op Amp - 20p, 555 Timer.....	22p
cmos 4001 - 20p, 4011 - 22p, 4017.....	40p
ALUMINIUM ELECTROLYTICS (Mfds/Volts)	
1/50, 2.2/50, 4.7/50, 10/25, 10/50.....	5p
22/16, 22/25, 22/50, 47/16, 47/25, 47/50.....	6p
100/16, 100/25 7p, 100/50 12p, 100/100.....	14p
220/16 8p, 220/25, 220/50 10p, 470/16, 470/25.....	11p
1000/25 25p, 1000/35, 2200/25 35p, 4700/25.....	70p
Submin, tantalum bead electrolytics (Mfds/Volts)	
0.1/35, 0.22/35, 0.47/35, 1.0/35, 3.3/16, 4.7/16.....	14p
2.2/35, 4.7/25, 4.7/35, 6.8/16 15p, 10/16, 22/8.....	20p
33/10, 47/6, 22/16 30p, 47/10 35p, 47/16 60p, 47/35.....	80p
VOLTAGE REGULATORS	
1A + or - 5V, 8V, 12V, 15V, 18V & 24V - 55p, 100mA 5.8, 12, 15, V +.....	30p
DIODES (piv/amps)	
75/25mA 1N4148 2p, 800/1A 1N4008 4p, 400/3A 1N5404 14p, 115/15mA OA91.....	8p
100/1A 1N4002 3p, 1000/1A 1N4007 5p, 60/1.5A S1M1 5p, 100/1A bridge.....	25p
400/1A 1N4004 4p, 1250/1A BY 127 10p, 30/15A OA47.....	10p
Zener diodes E24 series 3V3 to 33V 400mW - 8p, 1 watt.....	12p
Battery snaps for PP3 - 6p for PP9.....	12p
L.E.D.'s 3mm, & 5mm, Red, Green, Yellow - 10p, Grommets 3mm - 2p, 5mm.....	2p
Red flashing L.E.D.'s require 9-12V supply only.....	50p
Mains indicator neon with 220k resistor.....	10p
20mm fuses 100mA to 5A, 0.5p, 5p, 10p, 20p, 30p, 40p, 50p, 60p, 75p, 100p.....	6p
High speed pc drill 0.8, 1.0, 1.3, 1.5, 2.0mm - 30p, Machines 12V dc.....	£7.00
HELPING HANDS 6 ball joints and 2 croc clips to hold awkward jobs.....	£3.50p
AA/HP7 Nicad rechargeable cells 90p each, Universal charger unit.....	£8.50p
Glass reed switches with single pole make contacts - 8p, Magnets.....	12p
0.1" Stripboard 2 1/2" x 1" 9 rows 25 holes - 25p, 3" x 2 1/2" 24 rows 37 holes.....	70p
Jack plugs 2.5 & 3.5m.....	14p
Sockets Panel Mtg, 2.5 & 3.5m.....	10p
TRANSISTORS	
BC107/8/9 - 12p, BC547/8/9 - 8p, BC557/8/9 - 8p, BC182, 182L, BC183, 183L, BC184, 184L, BC212, 212L - 10p, BC327, 337, 337L - 12p, BC727, 737 - 12p, BD135/6/7/8/9 - 25p, BCY70 - 15p, BFY50/51/52 - 20p, BFY88 - 15p, 2N3055 - 50p, TIP31, 32 - 30p, TIP41, 42 - 40p, 8U208A - £1.20, 8F196, 197 - 12p, Ionisers with seven year guarantee, list price £16.95.....	£12.00

All prices are inclusive of VAT. Postage 30p (free over £5). Lists Free.

THE CR SUPPLY CO

127 Chesterfield Rd., Sheffield S8 0RN
Tel: 0742 557771 Return posting

AF WAVEFORM GENERATOR

KIT ONLY

£29.95

(£39.95 BUILT & TESTED)

The major drawback for the electronics enthusiast is the high cost of test gear. This is the first in a series of low cost instruments designed to make test gear more affordable to the enthusiast.



- ★ SINE, SQUARE/TRIANGLE
- ★ FREQUENCY RANGE 20Hz-18kHz
- ★ OUTPUT SIGNAL VOLTAGE 0-10V p-p
- ★ POWERED BY TWO PP3 BATTERIES (Not supplied)

Just add £1.50 P&P and send cash, cheque or P.O. to:-

KM ELECTRONICS

54 Moorside Road, Kirkheaton, Huddersfield HD5 0LP. Tel: (0484) 545914

LOW COST UHF RADIO SWITCHING

AS USED BY THE PROFESSIONAL SECURITY MARKET

Incorporating the latest Surface Acoustic Wave technology, the system consists of a small "zero-power", UHF transmitter with digital encoder and a UHF receiver unit with digital decoder and 3 relay outputs, 2 alternate and 1 momentary.

8-way DIL switches on both boards set the unique security code. Many applications including lighting, alarms, the "automatic home", etc.

Size:	Tx 45 x 30mm	Rx 55 x 65mm
Supply:	Tx 3-12V	Rx 5-12V
Range:	Up to 200m	

Complete System (2 kits).....	£29.99
Individual Transmitter.....	£15.99
Individual Receiver.....	£19.99

Please allow 28 days for delivery
Cheques/POs to:

BLB Electronics

341 Darwen Road, Bromley Cross, Bolton BL7 9BY



DISTANCE LEARNING COURSES

The National College of Technology offer a range of packaged learning short courses for study at home or in an industrial training environment which carry national BTEC awards. Study can commence at any time and at any level enabling you to create a study routine to fit around existing commitments. Courses on offer include:

- Analogue Electronics
- Digital Electronics
- Fibre/Optoelectronics
- Programmable Logic Controllers

Tutor support and BTEC certification are available as options with no travelling or college attendance required. These very popular courses which are ideal for vocational training contain workbooks, audio cassette lecturers, PCB's, instruments, tools, components and leads as necessary to support the theoretical and practical training. Whether you are a newcomer to electronics or have some experience and simply need an update or certification, there is probably a distance learning course ready for you. Write or telephone for details to:

National College of Technology
NCT Ltd., PO Box 11
Wendover, Bucks
Tel: (0296) 624270

WE HAVE THE WIDEST CHOICE OF USED OSCILLOSCOPES IN THE COUNTRY

TEKTRONIX 2236 Dual Trace 100MHz Delay Sweep Counter Timer (DMM)	£1000
TEKTRONIX 485 Dual Trace 550MHz Delay Sweep	£300
TEKTRONIX 475 Dual Trace 200MHz Delay Sweep	£350
SCHLUMBERGER 5218 Dual Trace 200MHz Delay Sweep with Trigger view	£350
HITACHI V650F Dual Trace 60MHz Delay Sweep	£450
TEKTRONIX 2215 Dual Trace 60MHz Delay Sweep	£450
TEKTRONIX 2225 Dual Trace 50MHz Delay Sweep	£350
TEKTRONIX 455 Dual Trace 50MHz Delay Sweep	£450
PHILIPS PM5217 Dual Trace 50MHz Delay Sweep	£400
TELEQUIPMENT 085 Dual Trace 50MHz Delay Sweep with V4 & S2A	£250
TELEQUIPMENT V3 Differential Amplifier for above	£40
GOLDD 05300 Dual Trace 20MHz Unhoused with 2 probes	£250
GOLDD 05300 Dual Trace 20MHz	£200
HITACHI Y212 Dual Trace 20MHz	£250
TROD CS1022 Dual Trace 20MHz	£225
HAMEIC 605 Dual Trace 60MHz Delay Sweep	£325
HAMEIC 705 Dual Trace 70MHz Delay Sweep	£250

THIS IS JUST A SAMPLE - MANY OTHERS AVAILABLE

RACAL/DANA Wideband Level Meter 502	£1000
RACAL/DANA Ultra LCR Capacitor 9341	£350
WAYNE KEER LCR Meter 4210	£600
WAYNE KEER Automatic Component Bridge B605	£450
WAYNE KEER Universal Bridge B602	£150
WAYNE KEER Component Tester B424	£125
FARNELL Synthesised Oscillator 05C1 - 0.0001Hz - 99.99kHz	£275
FARNELL Automatic Mod Meter MM	£300
MARCONI TF2008 AM/FM 100Hz-510kHz Sig Gen	£300
MARCONI TF2015 AM/FM 10.5-20MHz Sig Gen with TF2171	£400
MARCONI TF2015 without Synchroniser TF2171	£250
MARCONI TF2016 AM/FM 10kHz-120kHz Sig Gen with TF2173	£350
MARCONI TF2016 without Synchroniser TF2173	£175
MARCONI TF2356/2357 Level Osc/Meter 20MHz (the pair)	£950
H.P. 8620C Sweeper Main Frame 10-1300MHz	£800
RACAL 9009 Mod Meyer 10MHz-1.5GHz	£350
DEBBITRON T4120 with VPS vibrator	£1300
Uninterruptible PSU unused from:	£250
TEKTRONIX Navemeter Monitor type 528	£300
RACAL INSTRUMENTATION RECORDERS Store 40 and Store 7D	from £500

MARCONI SANDPERS Signal Sources:	from £300
6070A 400-1200 MHz	6056-2.4GHz
6055/6055B 850-2150MHz	6057-4.5-8.5 GHz

HP 141T Spectrum Analyser System with 8555A & IF Plug-in 10MHz-180kHz	£3250
HP 140 Spectrum Analyser System with 8554 & IF Plug-in 500kHz-1.75GHz	£1750
HP 142 Spectrum Analyser System with 8553 & IF Plug-in 1kHz-110MHz	£1400
HP Spectrum Analyser 162 with 8558B D-1-1500MHz	from £2250

Used Equipment - With 30 days guarantee. Manuals supplied if possible. This is a VERY SMALL SAMPLE OF STOCK. SAE or telephone for lists. Please check availability before ordering. CARRIAGE all units £10. VAT to be added to total of goods and carriage.

STEWART OF READING
110 WYKHAM ROAD, READING, BERKS RG6 1PL
Tel: 0734 268041 Fax: 0734 381998

DIGITAL MULTIMETERS - 3 1/2 DIGIT

DM105 14 ranges DC 2 amps etc ONLY £18
M2355 32 ranges AC/DC 10 Amps Diode & Transistor Tester Frequency Control etc ONLY £32.90

BRUEL & KJAE

Sound Level Meter 2206 1 Mic with Carrying Case £160
1 Mic type 4117 & 4132 Mics 4133
Pre-Amps 2613, 2615 & 2630
OTHER B & K EQUIPMENT AVAILABLE

AVO MULTIMETERS

TEST SET No1: Box 95X	£65 each
8 Mils with Carrying Case	£90
8 Mils with Carrying Case	£120

ALL METERS SUPPLIED WITH BATTERIES AND LEADS

LEADER LM196a Two Chn Multimeter 500-500Hz 1mV-300V	£100
REXBUS AV4275 AC Voltmeter Dual Ch 10Hz-500kHz 300uV-100V	£75
SOLARTRON 7045 Multimeter 4.5 Digit 50 Ranges Auto/Alan	£95
Large Range of BENCH POWER SUPPLIES available	from £80
X-Y PLOTTERS various models	from £25-£400

NEW EQUIPMENT

HAMEIC OSCILLOSCOPE HM1005 Triple Trace 100MHz Delay Timebase	£792
HAMEIC OSCILLOSCOPE HM604 Dual Trace 60MHz Delay Sweep	£610
HAMEIC OSCILLOSCOPE HM205-7 Dual Trace 20MHz Component Tester	£330
HAMEIC OSCILLOSCOPE HM205-3 Dual Trace 20MHz Digital Storage	£610

BLACK STAR EQUIPMENT (P&P all units £5)

APOLLO 10-100MHz Counter Timer Ratio/Period/Time interval etc	£222
APOLLO 100-100MHz (as above with more functions)	£295
METRO 100 FREQUENCY COUNTER 100MHz	£109
METRO 800 FREQUENCY COUNTER 800kHz	£135
METRO 1000 FREQUENCY COUNTER 10kHz	£178
JUPITOR 500 FUNCTION GEN 0.1Hz-500kHz Sine/Sqr/Tri	£110
ORION COLOUR BAR GENERATOR Pal/TV Video	£230

OSCILLOSCOPE PROBES Switched X1 X10 (P&P £5) £11

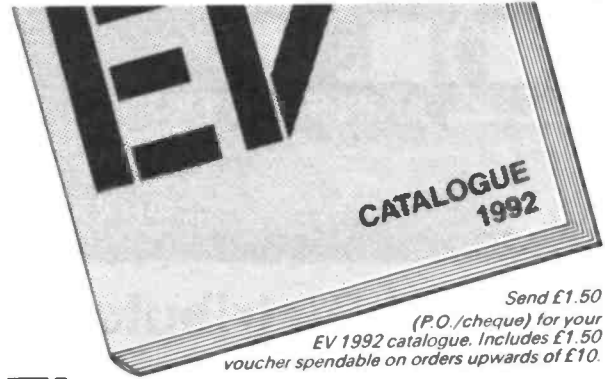

Send £1.50 (P.O./cheque) for your EV 1992 catalogue. Includes £1.50 voucher spendable on orders upwards of £10.

The CATALOGUE

120 pages, A4. Expertly presented and illustrated. Easily referred to. Packed with valuable information.

The COMPONENTS

As wide a choice as you could wish - semiconductors, surface mounting, opto-electronics, Rs & Cs, etc. Top quality, fairly priced.

The SUPPLIERS

Siemens, Boss, Cliff, Omeg, Lorin, R.S., Uniross, etc. - to our top quality standards.

The SERVICE

Prompt, personal, with customer satisfaction guaranteed. Access/Visa facilities.

ElectroValue

28(A) St. Jude's Road, Englefield Green, Egham, Surrey TW20 0HB.
Phone - 0784 433603 Fax - 0784 435216

TK FOR KITS

DISCO SEQUENCER

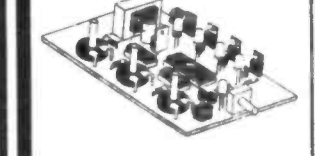

Four channels (up to 1kW each) to drive Rope lights, Pin-spots etc. (Resistive/Inductive loads) with 30 different eye-catching sequences. Variable speed and sequence change frequency AND built in audio input. Ideal for mobile or permanent displays. Complete KIT (less box).

XK141 26.95

Don't forget our other value for money DISCO KITS

DL8000 8-channel 80 programme sequencer	46.95
DL3000 3-channel sound to light	21.95
XK124 High power strobe with audio input	17.95
XK139 4-channel sequencer	14.50

PROGRAMMABLE ELECTRONIC LOCK

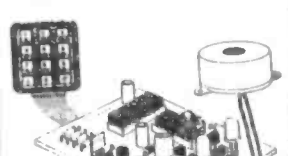

This kit should make keys obsolete. One 4-digit code entered on the keyboard could open the door to your shed, garage or home, or prevent unauthorised use of your computer, burglar alarm or car, while more than a preset number of incorrect entries will sound an alarm and disable the lock for a few minutes. If discovered, you can change the number easily from the keyboard. Supply: 5-15V d.c. Will drive our Latch Mechanism (701 150 13.95) or relay directly.

XK131 22.50

SEND 50p & 9x6 SAE for our latest CATALOGUE which includes details on more exciting kits such as Remote Control, Touch Dimmers, Temperature Controller and COMPONENTS.

SUPERSENSITIVE MICROBUG

Only 45x25x15mm, including built-in mic. 88-100MHz (standard FM radio). Range approx. 300m depending on terrain

Powered by 9V PP3 (7mA). Ideal for surveillance, baby alarm etc. **XK128 7.25**

ORDERING INFORMATION: Prices INCLUDE VAT but please add £1.25 P&P (UK). Overseas Customers: divide total order by 1.175 then add P&P. Europe £3.50, elsewhere £10. Send P.O. cheque/VISA/MASTERCARD No. with order. GIRO NO. 529314002. Local Authority and education orders welcome. Office Hours: Mon-Fri. 9.30 am - 5 pm. Shop Hours: Tues - Thurs. 10 am - 5 pm Sat. 10 am - 1 pm.

ORDERS: 081 - 567 8910 24 HOURS

TK ELECTRONICS 13 BOSTON ROAD, LONDON, W7 3JS.

COMPONENTS
For TV ★ Video
Audio ★ Computer

WE CAN SUPPLY A VAST RANGE OF SPARES for many makes of TV, Video, Computer & Audio Equipment. WRITE (Enclose a p.p.s.) or PHONE FOR A 'PRICE & AVAILABILITY' on your requirements. **0452 526883**

VIDEO BELT KITS

AMSTRAD VCR4600/4700/5200	£3.19
FISHER FV49P05/906/908	£2.93
JVC HR3300/3330/3660	£2.79
SANYO VTC5000/5150/5500	£1.49
SANYO VTC6500	£2.49
THORN 9900 to 9922	£2.79

VIDEO PINCH ROLLERS

AMSTRAD VCR4500/4600 Mod Kit	£6.17
HITACHI VT11/VT33	£5.17
JVC Above models	£5.17
SHARP VC381/386/388/390	£5.87
THORN 3V02/06/16/22/29/24	£5.17

SERVICE MANUALS

BINATONE 01/9771	£8.99
PHILIPS 22DC570/670-00	£3.25
PHILIPS RT4K400 Chassis	£10.00

OTHER SPARES

FERGUSON 3V23/29/30/32 Reel Idler	£5.55
HITACHI VT11/14/33/34/61/62/63 Video Head	£26.10
SHARP RGF28114 Main belt	£1.40
TOSHIBA STU2 Mains transformer	£9.90

COMPUTER SPARES

AMSTRAD/SINCLAIR		EPSON	
IC 40007 G Array	£19.96	C78010B/D031 CPU	£30.24
IC 40010 G Array	£18.96	HA13007 T Array	£4.66
IC AY38912A	£6.32	IC AY38912A	SINCLAIR
IC HA13408	£7.87	40054 ROM (+2)	£16.99
IC HD68455P	£15.18	40056 (128K/+2)	£17.99
IC LA4140	£1.70	ROM (48K/+)	£7.99
IC PEGA1A	£30.85	Z8302 (OL)	£10.48
IC UPC13784	£2.45	Z8401 (Spec)	£7.94
IC Protector N75	£1.55	ZTX213 Transistor	£0.28
Transistor 2SD1397	£4.99	ZTX650 Transistor	£0.49
Jack SKI (CPC I/O)	£2.07	UM1233 Modulator	£8.56
Joystick (CPC)	£8.71	Membrane (OL)	£7.95
Service Manual	£8.49	Membrane (Spec 48K)	£4.50
CPC 464 (early)	£8.49	Membrane (+128K)	£7.99
Service Manual	£13.89	Bubble Mat (+128K)	£1.18
PCW8256/8512	£13.89	Speaker (+48K)	£1.49
User Manual CPC464	£10.95	Power Slt (Spec)	£0.65
User Manual CPC8128	£14.25	28 way Edge Conn.	£3.49

LEADS & CONNECTORS

'Universal' Video Lead Kit	£7.40
3-piece 'Smart' Video Lead Kit	£8.59
AC Mains lead - 2 pin lig & 3 pin	£0.61

INTEGRATED CIRCUITS

LM733CN	£2.27
TBA830	£1.14
TBA810P	£1.40
TDA1001B	£2.66

ATARI

IC CO14806 (XE/L)	£11.40
IC CO20947 (XE/L)	£4.49
IC YM2149F (ST)	£10.02
SWITCH 'Reset' (ST)	£1.25
IC 5851 SID	£1.25
THERMISTOR (ST-PSU)	£1.34
TL431 (ST-PSU)	£1.20
IC 8520 CIA	£4.42
IC 8525 CIA	£4.42
PC101 (ST-PSU)	£4.73
PCT13V (STE-PSU)	£2.84

COMMODORE

IC 8510 CPU	£10.03
IC 8526 CIA	£11.11
IC 6569 VIC	£25.63
IC 6581 SID	£16.35
IC 8501 CPU	£10.80
IC 8520 CIA	£11.22
IC 251841-02 PLA	£3.98
IC 908114-01 PLA	£3.24
IC 901226-01 ROM	£6.55
IC 901227-01 ROM	£9.24
IC 901227-03 ROM	£12.33
Modulator 251818-02	£16.78
Serv. Manual BM7513	£2.99
Serv. Manual CM8833	£3.80
User Manual (C64)	£4.25
TV Lead (Also Spec.)	£1.49

All above are manufacturers original spares. We can also supply a range of manuals and parts for some other makes - including Acorn, Olivetti & Panasonic.

OTHER COMPUTER CHIPS

6502 CPU	£5.05	AM26L S31PC	£1.63
6522 VIA	£4.49	75154PC axline driver	£1.85
6818 RT Clock	£7.24	64Kx1 DRAM (120ns)	£1.99
8255A PPI	£2.82	64Kx1 DRAM (150ns)	£1.99
8272A FDC	£14.09	64Kx4 DRAM (100ns)	£2.69

TOOLS & EQUIPMENT

UNIROSS Plug-in 'Fast Charger' for AAA/AA Ni-CAD's	£5.49
UNIROSS C Ni-Cad. Battery	£2.09
WELLER WM12D Micropoint Soldering Iron 12W/240Vac	£8.25
'Universal' Crimping Tool	£2.45
Junior Hack Saw	£0.80
Craft Knife & Spare Blade	£0.58

SPECIAL OFFERS

SONY High Speed CPU (BMHz) - Same as NEC V30	74L500 TTL IC	18p ea (1+)
Direct replacement for 8006 CPU (Approx. 25% faster)	TEXAS DRAM (TMS4532-15N1.4) - For Spectrum 48K	1.59 ea (5+)
£8.88 White stocks last	£1.72 ea. (1+)	
SED 9420CAC	£14.83	£1.22 ea. (5+)

MAIL ORDER ONLY. Please add 95p (UK) P&P but not VAT. All items subject to availability - Prices can change without notice.

MARAPET (EEA)
1 HORNBEAM MEWS
GLOUCESTER GL2 0UE



The UK Distributor for the complete ILP Audio Range

- * Bipolar Modules – 15 watts to 180 watts
- * Mosfet Modules – 60 watts to 180 watts
- * Power Supplies
- * Pre-amplifier Modules
- * 100 volt Line Transformers
- * Power Slave Amplifiers

Write or phone for free Data Pack

Jaytee Electronic Services

143 Reculver Road, Beltinge, Herne Bay, Kent CT6 6PL
Telephone: (0227) 375254

OMNI ELECTRONICS

174 Dalkeith Road, Edinburgh EH16 5DX 031 667 2611

A COMPREHENSIVE RANGE WITH SERVICE SECOND TO NONE

OUR MUCH EXPANDED, BETTER
ILLUSTRATED CATALOGUE
COSTS £1.50 – INCLUDES
VOUCHERS TO USE
AGAINST FUTURE
PURCHASES. TO RECEIVE
A COPY PLEASE SEND
YOUR REMITTANCE
WITH THE VOUCHER BELOW.

Do
you have
your
copy
yet?

Please send me a copy of the 1990/91 OMNI catalogue.
Payment of £1.50 enclosed

NAME.....

ADDRESS.....

TELEPHONE.....

Open: Mon.-Thurs. 9.15 - 6.00
Friday 9.15 - 5.00
Saturday 9.30 - 5.00



ADVERTISERS INDEX

AKULA SYSTEMS.....	70
N. R. BARDWELL.....	68
BK ELECTRONICS.....	Cover (iii)
BLB ELECTRONICS.....	70
BULL ELECTRICAL.....	Cover (ii)
CAMBRIDGE COMP. SCIENCE.....	70
CIRKIT DISTRIBUTION.....	30
COMPELEC.....	69
CR SUPPLY COMPANY.....	70
ELECTRONIZE DESIGN.....	72
ESR ELECTRONIC COMP.....	27
ELECTROVALUE.....	71
GREENWELD ELECTRONICS.....	7
HAPPY MEMORIES.....	65
HART ELECTRONIC KITS.....	49
HIGH-Q ELECTRONICS.....	67
HILLS COMPONENTS.....	65
HOBBYKIT.....	2
ICS.....	69
JAYTEE ELECTRONIC SERVICES.....	65/72
JPG ELECTRONICS.....	68
K M ELECTRONICS.....	70
MAGENTA ELECTRONICS.....	8/9
MAPLIN ELECTRONICS.....	Cover (iv)
MARAPET.....	71
MARCO TRADING.....	33
MAURITRON TECH. SERV'S.....	68
MENDASCOPE.....	69
NATIONAL COLLEGE OF TECHNOLOGY.....	70
NORTECH ELECTRONIC.....	67
NUMBER ONE SYSTEMS.....	67
OMNI ELECTRONICS.....	72
RADIO & TV COMPONENTS.....	41
RICH ELECTRONICS.....	69
SHERWOOD ELEC. COMP.....	69
STEWART OF READING.....	71
SUMA DESIGNS.....	6
TANDY.....	17
TECHNICAL INFO. SERVICES.....	69
TK ELECTRONICS.....	71
TSIEN.....	10
VIEWCOM ELECTRONICS.....	4/5

electronize CAR ALARM KITS

MICRO-PRESSURE CAR ALARM

This new type of alarm is triggered by a unique pressure sensing system. As any vehicle door is opened air is drawn out, causing a minute drop in air pressure. A sensor detects this sudden pressure change and sets off the alarm. An electronic filter, tuned to only 3Hz., and adjustable sensitivity avoid false alarms whilst an arrangement of timers provide automatic operation.

- ★ Operates on all doors and tailgate - no switches needed.
- ★ Automatically armed 40 seconds after leaving vehicle.
- ★ 10 second entry delay with audible warning. (0.5 second available.)
- ★ Sounds horn or siren intermittently for 30 seconds - then re-arms.
- ★ Easy fitting - only 3 wires to connect - no holes to drill.
- ★ Controlled by ignition switch, hidden switch or coded remote control. (The optional siren and coded remote control are supplied separately.)

MICRO-PRESSURE ALARM Parts kit £15.95 Assembled £22.35

NEW CODED IR REMOTE CONTROL

Our latest addition allows control of our alarms from outside the vehicle. Both transmitter and receiver use a chip designed specially for car security systems with 59,046 code combinations. You can even set your own code, with several vehicles on the same code or several transmitters for one vehicle if required.

- ★ High security, customer selected, 24 bit code.
- ★ Key-ring transmitter with long life miniature alkaline battery.
- ★ High power infra-red emitter with range up to 5 metres.
- ★ Low profile dash top receiver/decoder.
- ★ Flashing high intensity red L.E.D. warns off intruders.
- ★ Green L.E.D. shows alarm is off.

Use the coded transmitter and receiver with our Micro-Pressure or Volt Drop alarm to form a coded remote controlled system.

CODE TRANSMITTER Parts kit £13.95 Assembled £17.95

CODE RECEIVER Parts kit £21.35 Assembled £26.55

Also available :-

VOLT DROP CAR ALARM Parts kit £14.90 Assembled £20.95

120dB PIEZO SIREN Assembled £11.95

MICRO-PRESSURE TRIGGER Parts kit £10.95 Assembled £14.95

EXTENDED CDI IGNITION Parts kit £22.75 Assembled £28.45

All the above include cable, connectors and clear easy to follow instructions.

All kits include case, PCB, everything down to the last washer, even solder.

All prices now include post, packing and VAT on U.K. orders. Same prices apply to all European countries. For delivery outside Europe please add £3.

Telephone orders accepted with VISA or ACCESS payment.

Order direct (please quote ref. EE1) or send for more details from :-

ELECTRONIZE DESIGN

Tel. 021 308 5877

2 Hillside Road, Four Oaks, Sutton Coldfield, B74 4DQ

1992 BUYER'S GUIDE TO ELECTRONIC COMPONENTS

Maplin

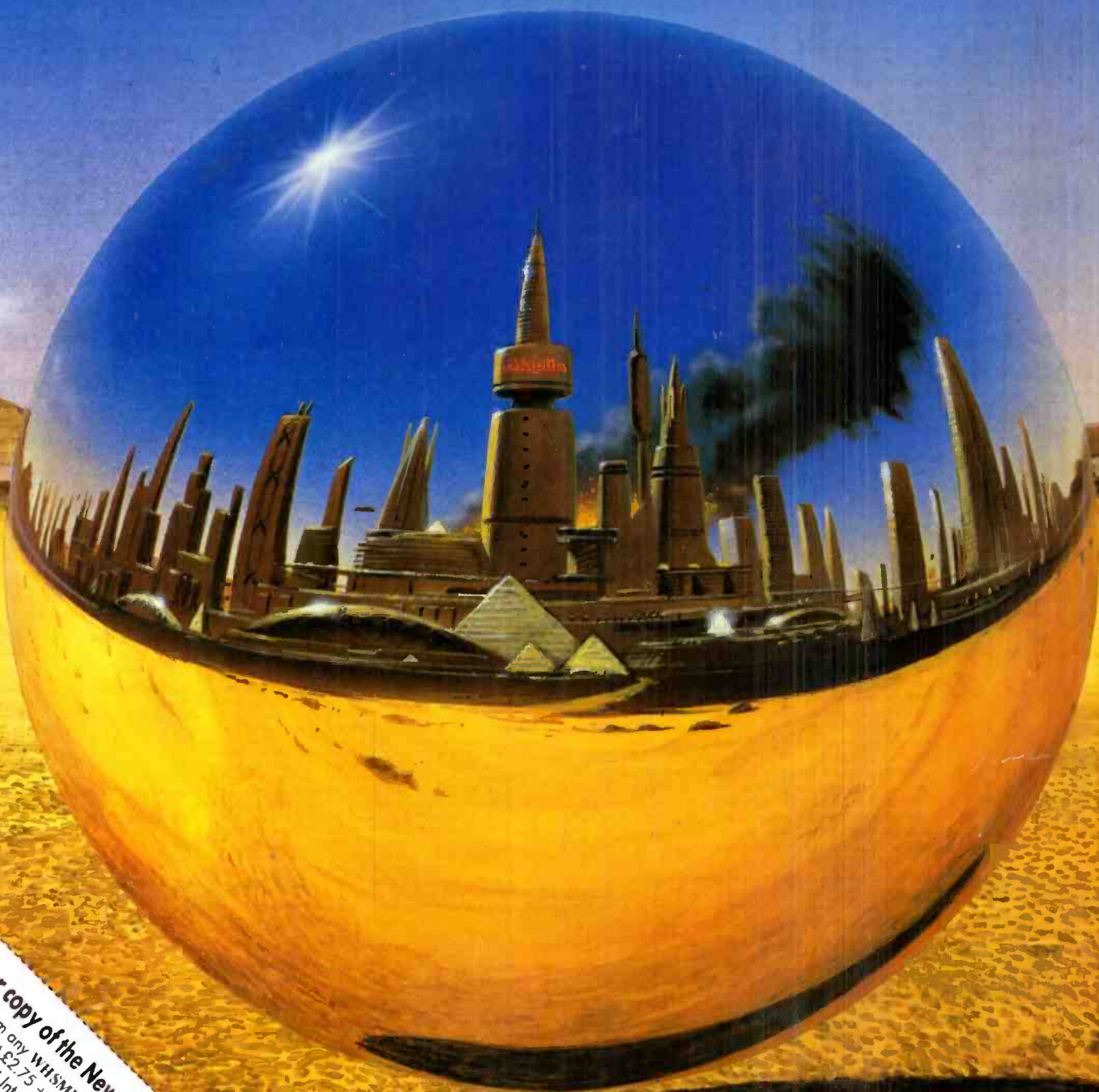

Order your copy of the New MAPLIN Catalogue on sale NOW!
Pick up a copy from any WHSMITH for just £2.75 or post this coupon now to receive your copy for just £2.75 + 20p p&p. If you live outside the U.K. send £4.85 or £14 International Reply Coupons. I enclose £2.95.

Name

Address

Post Code

Send to Maplin Electronics,
P.O. Box 3, Rayleigh,
Essex SS6 8LR.
EE92

Over 600 product packed pages with more than 600 brand new products.
On sale now, only £2.75

Available from all branches of WHSMITH and Maplin shops nationwide. Hundreds of new products at super low prices!