

**EVERYDAY**

**MARCH 1989**

# **ELECTRONICS**

**INCORPORATING ELECTRONICS MONTHLY**

**£1.40**

## **SPECIAL MIDI SUPPLEMENT**

**AUDIO  
LEAD  
TESTER**

**SUPER  
FILTER**

**PLUS**

**ROBOTICS, AMATEUR RADIO, BOOKS, NEWS,  
COMPONENT BUYING, THEORY, ETC.,**

**The Magazine for Electronic & Computer Projects**



## No. 1 LIST BAKERS DOZEN PACKS

All packs are £1 each, if you order 12 then you are entitled to another free. Please state which one you want. Note the figure on the extreme left of the pack ref number and the next figure is the quantity of items in the pack, finally a short description.

- BD2 5 13A spurs provide a fused outlet to a ring main where devices such as a clock must not be switched off.
- BD7 4 In flex switches with neon on/off lights, saves leaving things switched on.
- BD9 2 6V 1A mains transformers upright mounting with fixed clamps.
- BD11 1 6 1/2in speaker cabinet ideal for extensions, takes our speaker. Ref BD137.
- BD13 12 30 watt reed switches, it's surprising what you can make with these—burglar alarms, secret switches, relay, etc., etc.
- BD22 2 25 watt loudspeaker two unit crossovers.
- BD29 1 B.O.A.C. stereo unit is wonderful value.
- BD30 2 Nicad constant current chargers adapt to charge almost any nicad battery.
- BD32 2 Humidity switches, as the air becomes damper the membrane stretches and operates a microswitch.
- BD34 48 2 meter length of connecting wire all colour coded.
- BD42 5 13A rocker switch three tags so on/off, or change over with centre off.
- BD45 1 24hr time switch, ex-Electricity Board, automatically adjust for lengthening and shortening day, original cost £40 each.
- BD49 10 Neon valves, with series resistor, these make good night lights.
- BD56 1 Mini uniselector, one use is for an electric jigsaw puzzle, we give circuit diagram for this. One pulse into motor, moves switch through one pole.
- BD59 2 Flat solenoids—you could make your multi-tester read AC amps with this.
- BD67 1 Suck or blow operated pressure switch, or it can be operated by any low pressure variation such as water level in water tanks.
- BD91 1 Mains operated motors with gearbox. Final speed 16rpm, 2 watt rated.
- BD103A 1 6V 750mA power supply, nicely cased with mains input and 6V output leads.
- BD120 2 Stripper boards, each contains a 400V 2A bridge rectifier and 14 other diodes and rectifiers as well as dozens of condensers, etc.
- BD122 10m Twin screened flex with white pvc cover.
- BD128 10 Very fine drills for pcb boards etc. Normal cost about 80p each.
- BD132 2 Plastic boxes approx 3in cube with square hole through top so ideal for interrupted beam switch.
- BD134 10 Motors for model aeroplanes, spin to start so needs no switch.
- BD139 6 Microphone inserts—magnetic 400 ohm also act as speakers.
- BD148 4 Reed relay kits, you get 16 reed switches and 4 coil sets with notes on making c/o relays and other gadgets.
- BD149 6 Safety cover for 13A sockets—prevent those inquisitive little fingers getting nasty shocks.
- BD180 6 Neon indicators in panel mounting holders with lens.
- BD193 6 5 amp 3 pin flush mounting sockets make a low cost disco panel.
- BD196 1 In flex simmerstat—keeps your soldering iron etc. always at the ready.
- BD199 1 Mains solenoid, very powerful, has 1in pull or could push if modified.
- BD201 8 Keyboard switches—made for computers but have many other applications.
- BD210 4 Transistors type 2N3055, probably the most useful power transistor.
- BD211 1 Electric clock, mains operated, put this in a box and you need never be late.
- BD221 5 12V alarms, make a noise about as loud as a car horn. Slightly soiled but OK.
- BD242 2 6in x 4in speakers, 4 ohm made from Radiomobile so very good quality.
- BD252 1 Panostat, controls output of boiling ring from simmer up boil.
- BD259 50 Leads with push-on 1/4in tags—a must for hook-ups—mains connections etc.
- BD263 2 Oblong push switches for bell or chimes, these can mains up to 5 amps so could be foot switch if fitted into patress.
- BD268 1 Mini 1 watt amp for record player. Will also change speed of record player motor.
- BD283 3 Mild steel boxes approx 3in x 3in x 1in deep—standard electrical.
- BD293 50 Mixed silicon diodes.
- BD305 1 Tubular dynamic mic with optional table rest.
- VERY POWERFUL 12 VOLT MOTORS—1/3rd HORSEPOWER.** Made to drive the Sinclair C5 electric car but adaptable to power a go-kart, a mower, a rail car, model railway, etc. Brand new. Price £15.00 plus £2.00 postage. Our ref. 158.
- WHITE CEILING SWITCH 5 amp** 2 way surface mounting with cord and tassle. Made by the famous Crabtree Company. Price £1 each. Our ref. BD528.
- 13A SWITCH SOCKETS** Top quality made by Crabtree, fitted in metal box with cutouts so ideal for garage, workshop, cellar, etc. Price £2 each. Our ref. 2P37.

**AN ALLADIN'S CAVE** We have opened another shop in Hove, the address is number 12 Boundary Road which is between Hove and Portside fairly close to the seaford. When you want to see before you buy and when you want to browse around the special bargains available, this is where you should make for as the Portland Road shop in future will be just mail order. You can of course collect from Portland Road but you should bring in an order complete with reference numbers so that the stores can attend to it easily.

**THREE CAMERAS** All by famous makers, Kodak, etc. One disc and two different instant cameras. All in first class condition, believed to be in perfect working order but sold as untested. You can have them for £10 the three, including VAT, which must be a bargain—if only for the lenses, flash gear, etc. Our ref 10P58.



**ATARI 65XE COMPUTER** At 64K this is most powerful and suitable for home and business. Brand new, complete with PSU, TV lead, owner's manual and six games. Can be yours for only £45 plus £3 insured delivery.

**DATA RECORDERS ACORN** for Acorn Electron, etc., reference number ALF03, with TV lead, manual and PSU. Brand new. Price £10 plus £1.50 post. Order ref 10P44.

**ATARI XC12** for all their home computers. With leads and handbook. Brand new. Price £15 plus £2 post. Order ref 5P18.

**JOYSTICK FOR ATARI OR COMMODORE** for all Atari and Commodore 64 and Vic20. New. Price £5. Order ref 5P126.

**EXTRA SPECIAL OFFER** We will supply the Atari 65XE, data recorder XC12, joystick and six games for £57.50 plus £4 insured delivery.

**SUB-MIN TOGGLE SWITCH** Body size 8mm x 4mm x 7mm SBDT with chrome dolly fixing nuts. 4 for £1. Order Ref. BD049.

**VENNER TIME SWITCH.** Mains operated with 20 amp switch, one on and off per 24 hrs. repeats daily automatically correcting for the lengthening or shortening day. An expensive time switch but you can have it for only £2.95 without case, metal case—£2.95, adaptor kit to convert this into a normal 24hr. time switch but with the added advantage of up to 12 on/off per 24hrs. This makes an ideal controller for the immersion heater. Price of the adaptor kit is £2.30.

**SOUND TO LIGHT UNIT.** Complete kit of parts for a three channel sound to light unit controlling over 2000 watts of lighting. Use this at home if you wish but it is plenty rugged enough for disco work. The unit is housed in an attractive two-tone metal case and has controls for each channel, and a master on/off. The audio input and output are 1/4in. sockets and three panel mounting fuse holders provide thyristor protection. A four pin plug and socket facilitate ease of connecting lamps. Special price is £14.95 in kit form.

**MINI MONO AMP** on pcb, size 4in x 2in approximately. Fitted with volume control and place for a tone control should you require it. The amplifier has three transistors and we estimate output to be 3w. More technical data will be included with the amp. Brand new, perfect condition, offered at the very low price of £1. Our ref BD495.

**RE-CHARGEABLE NICADS 'D' SIZE** These are tagged for easy joining together but tags, being spot welded, are easy to remove. Virtually unused, tested and guaranteed. £2.00 ref 2P141 or 6 wired together for £10.00 ref 10P47.

**2.5kw TANGENTIAL BLOW HEATER** has an approximate width of 3in. (plus motor), elements made up of two 1.2kw sections so with switch available you can have 2.5kw, 1.2kw or cold blow. Over-heat cutout eliminates fire risk should fan stop or air flow be impeded. Fan blades are metal. Price £5 plus £2.50 post. Our ref SP62. Switch 50p.

**ALBA TWIN CASSETTE RECORDER AND PLAYER WITH STEREO RADIO** This is a mains/battery portable made to sell, we understand, at about £50 but the ones we have are line rejects. They are brand new still in the manufacturers' boxes but have a slight defect associated with the cassette section. The radio and amplifier section, both mono and stereo, is perfectly OK. If you are handy at mending things then this should be for you. Price £20 or two for £38 plus £3 insured post, either package. Our ref 20P7 or 2 x 20P7.

## LASER TUBE

Made by Philips Electrical. New and unused. This is helium-neon and has a typical power rating of 1.6mW. It emits random polarised light and is completely safe provided you do not look directly into the beam when eye damage could result. **DON'T MISS THIS SPECIAL BARGAIN!** Price £29.95 plus £3 insured delivery.

**POWER SUPPLY FOR PHILIPS LASER** available in kit form, Price £15 plus £2 postage.

## PAPST AXIAL FAN—MANUFACTURERS REF NO. TYP4580N.

This is mains operated, 15 watt rating and in a metal frame with metal blades so OK in high temperatures. Body size approx. 4 3/4" square x 1 1/8" thick. £6.00 each, plus £1.00 postage. Our ref 6P6.

**VERY POWERFUL MAGNETS** Although only less than 1" long and not much thicker than a pencil these are very difficult to pull apart. Could be used to operate embedded reed switches, etc. Price 50p each, 2 for £1.00. Ref BD642.



**ORGAN MASTER** is a three octave musical keyboard. It is beautifully made, has gold plated contacts and is complete with ribbon cable and edge connector. Brand new, only £12 plus £3 postage. Order ref. 12P5.

**MUSIC FROM YOUR SPECTRUM 128** We offer the Organ Master three octave keyboard, complete with leads and the interface which plugs into your 128. You can then compose, play, record, store, etc., your own music. Price £19 plus £3 special packing and postage. Order ref. 19P1.

**20A DOUBLE POLE RELAY WITH 12V COIL** complete with mounting brackets. Made by the Japanese Omron Company. Price £2 each. Our Ref. 2P173A.

**QUICK FIX MAINS CONNECTOR** A must for your workshop. Saves putting on plugs as you just push the wires under the spring clips. Automatically off when lid is up. Price £7.50. Our Ref. 7P5/1.

**BT HANDSET** With curly lead terminating with flat BT plug. Colour cream. Price £5. Our Ref. 5P123.

**RUBBER FEET** Stick on. Ideal for small instruments and cabinets. Pack of 56 for £1. Our ref BD603.

## J & N BULL ELECTRICAL

Dept. E.E., 250 PORTLAND ROAD, HOVE, BRIGHTON, SUSSEX BN3 5QT

**MAIL ORDER TERMS:** Cash, PO or cheque with order. Orders under £20 add £1.50 service charge. Monthly account orders accepted from schools and public companies. Access and B/card orders accepted. Brighton (0273) 734648 or 283588

## POPULAR ITEMS

Some of the many items described in our current list which you will receive if you request it

**3 1/2in FDD CHINON 80** track 500K. Shugart compatible interface. Standard connections, interchangeable with most other 3 1/2in and 5 1/4in drives. Brand new. £28.50 plus £3 insured post.

**CASE NOW AVAILABLE FOR THE CHINON F353** This is the 80 track, single sided one which we have been selling at £28.50. The case is sheet metal, finished in hammer-beige with ample ventilation and rubber feet. Overall size 4 1/4in x 7in x 1 1/2in approx. Designed to take the ribbon cable and 3 core power lead. Price £8. Our ref 8P21.

**3in FDD HITACHI HFD3055XA** Shugart compatible interface. 500K on 3in disc. Recommended for many Amstrads but interchangeable with most drives. £29.50 plus £3 insured post.

**FDD CASE AND POWER SUPPLY KIT** for the 3in or 3 1/2in. £11.00. Ref 11P2 for the Chinon, 11P3 for the Hitachi.

**5in MONITOR** made for ICL, uses Philips black and white tube. Brand new and complete but uncased. £16.00 plus £5.00 post.

**ACORN COMPUTER DATA RECORDER REF ALF03** Made for the Electron or BBC computers but suitable for most others. Complete with mains adaptor, leads and handbook. £10.00. Ref 10P44.

**POWERFUL IONISER** Uses mains transformer. Generates approx. 10 times more ions than the normal diode/cap ladder circuits. Complete kit £11.50 plus £3.00 post.

**FREE POWER!** Can be yours if you use our solar cells—sturdily made modules with new system bubble magnifiers to concentrate the light and so eliminate the need for actual sunshine—they work just as well in bright light. Voltage input is .45—you join in series to get desired voltage—and in parallel for more amps. **Module A** gives 100mA, Price £1. Our ref. BD631. **Module C** gives 400mA, Price £2. Our ref. 2P199. **Module D** gives 700mA, Price £3. Our ref. 3P42.

**SOLAR POWERED NI-CAD CHARGER** 4 Ni-Cad batteries AA (HP7) charged in eight hours or two in only 4 hours. It is a complete, boxed ready to use unit. Price £6. Our ref. 6P3.

**50V 20A TRANSFORMER 'C'** Core construction so quite easy to adapt for other outputs—tapped mains input. Only £25 but very heavy so please add £5 if not collecting. Order Ref. 2P54.

**SWITCH AC LOADS WITH YOUR COMPUTER** This is easy and reliable if you use our solid state relay. This has no moving parts, has high input resistance and acts as a noise barrier and provides 4kV isolation between logic terminals. The turn-on voltage is not critical, anything between 3 and 30V, internal resistance is about 1k ohm. AC loads up to 10A can be switched. Price is £2 each. Ref. 2P183.

**METAL PROJECT BOX** Ideal size for battery charger, power supply, etc.; sprayed grey, size 8in x 4 1/4in x 4in high, ends are louvred for ventilation other sides are flat and undrilled. Price £2. Our ref. 2P191.

**BIG SMOOTHING CAPACITOR.** Sprague powerwytic 39,000uF at 50V. £3. Our ref. 3P41.

**4-CORE FLEX CABLE.** Cores separately insulated and grey PVC covered overall. Each copper core size 7/0.2mm. Ideal for long telephone runs or similar applications even at mains voltage. 20 metres £2. Our ref. 2P196 or 100 metres coil £8. Order ref. 8P19.

**6-CORE FLEX CABLE.** Description same as the 4-core above. Price 15 metres for £2. Our ref. 2P197 or 100 metres £9. Our ref. 8P1.

**TWIN GANG TUNING CAPACITOR.** Each section is 0005uF with trimmers and good length 1/4in spindle. £1 each. Our ref. BD630.

**13A PLUGS** Pins sleeved for extra safety, parcel of 5 for £2. Order ref. 2P185.

**13A ADAPTERS** Takes 2 13A plugs, packet of 3 for £2. Order ref. 2P187.

**20V-0-20V** Mains transformers 2 1/2 amp (100 watt) loading, tapped primary. 200-245 upright mountings £4. Order ref. 4P24.

**BURGLAR ALARM BELL—6" gong** OK for outside use if protected from rain. 12V battery operated. Price £8. Ref. 8P2.

**VERY RELIABLE CAPACITOR** 4.7uF 400V not electrolytic so not polarised, potted in all can, size 1 3/4 x 3/4 x 1 1/2in high, with axial leads. A top grade capacitor made for high class instrument work. Ideal for PCB mounting. 2 for £1. Our ref. BD667.

**USEFUL MAINS TRANSFORMER** Upright mounting, normal tapped primary, has two secondaries. One gives 20v at 1.5 amps if used alone, or the other gives 10v at 3 amps if used alone. Join the two in series for 30v at 1 amp. Price £2. Our ref 2P214.

**CAPACITOR BARGAIN—axial ended, 470uF at 25V.** Jap made, normally 50p each, you get 4 for £1. Our ref. 613.

**SINGLE SCREENED FLEX** 7.02 copper conductors, pvc insulated then with copper screen, finally outer insulation. In fact quite normal screened flex. 10m for £1. Our ref BD668. Ditto, but solid conductor. 10m for £1. Our ref BD668a.

**M.E.S. BULB HOLDERS** Circular base batten type fitting. 4 for £1. Our ref. BD127a.

**SPRING LOADED TEST PRODS—Heavy duty,** made by the famous Bulgin company. Very good quality. Price 4 for £1. Ref. BD597.

**ASTEK P.S.U.—Switch mode** type. Input set for +230V. Output 3.5 amps at +5V, 1.5 amps at +12V, and 3 amps at +5V. Should be OK for floppy disc drives. Regular price £30. Our price only £10. Ref. 10T34. Brand new and unused.

**APPLIANCE THERMOSTATS—Spindle adjust** type suitable for convector heaters or similar. Price 2 for £1. Ref. BD582.

**3-CORE FLEX BARGAIN No. 1—Core size 5mm** so ideal for long extension leads carrying up to 5 amps or short leads up to 10 amps. 15mm for £2. Ref. 2P189.

**3-CORE FLEX BARGAIN No. 2—Core size 1.25mm** so suitable for long extension leads carrying up to 13 amps, or short leads up to 25A. 10m or £2. Ref. 2P190.

**ALPHA-NUMERIC KEYBOARD—**This keyboard has 73 keys giving trouble free life and no contact bounce. The keys are arranged in two groups, the main area is a QWERTY array and on the right is a 15 key number pad, board size is approx. 13" x 4"—brand new but offered at only a fraction of its cost, namely £3, plus £1 post. Ref. 3P27.

**WIRE BARGAIN—500 metres** 0.7mm solid copper tinned—and p.v.c. covered. Only £3 plus £1 post. Ref. 3P31—that's well under 1p per metre, and this wire is ideal for push on connections.

**INTERRUPTED BEAM KIT—**This kit enables you to make a switch that will trigger when a steady beam of infra-red or ordinary light is broken. Main components—relay, photo transistor, resistors and caps, etc. Circuit diagram but no case. Price £2. Ref. 2P15.

**1/8th HORSEPOWER 12 VOLT MOTOR** Made by Smiths, the body length of this is approximately 3in, the diameter 3in and the spindle 5/16th of an inch diameter. It has a centre flange for fixing or can be fixed from the end by means of 2 nuts. A very powerful little motor which revs at 3,000rpm. We have a large quantity of them so if you have any projects in mind then you could rely on supplies for at least two years. Price £6. Our ref 6p1, discount for quantities of 10 or more.

## POWERFUL IONISER

Generates approx. 10 times more IONS than the ETI and similar circuits. Will refresh your home, office, workshop etc. Makes you feel better and work harder—a complete mains operated kit, case included. £11.50+£3 P&P.

# EVERYDAY ELECTRONICS

INCORPORATING ELECTRONICS MONTHLY

ABC

VOL 18 No 3 MARCH 1989

The Magazine for Electronic & Computer Projects

ISSN 0262-3617

PROJECTS ... THEORY ... NEWS ...  
COMMENT ... POPULAR FEATURES ...

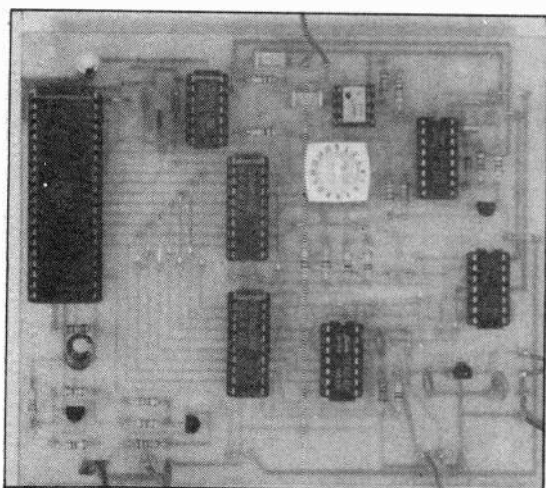
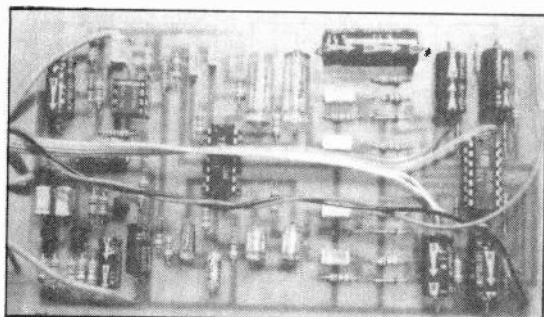
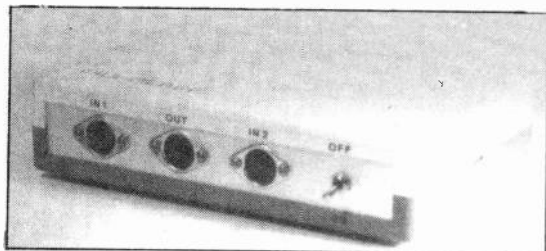
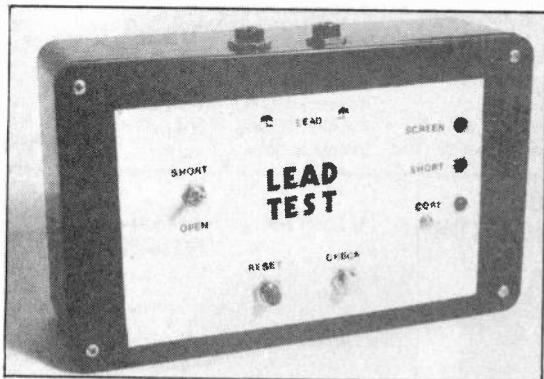

© Wimborne Publishing Ltd 1989. Copyright in all drawings, photographs and articles published in EVERYDAY ELECTRONICS is fully protected, and reproduction or imitations in whole or in part are expressly forbidden.

## Projects

- CALL ALERT** by T. R. de Vaux-Balbirnie **154**  
Doorbell warning for the hard of hearing
- SUPER FILTER** by Mark Stuart **158**  
Cut out those unwanted "bugs" on your C.B., hi-fi, or radio rig
- AUDIO LEAD TESTER** by Paul Bailey B.Sc **172**  
Take the frustration out of locating intermittent faults in audio leads
- MIDI INTERFACE** by Mike Hughes **175**  
Simple link for BBC micros
- MIDI MERGE** by Robert Penfold **179**  
A low-cost unit for combining two Midi signals into one
- MIDI PEDAL** by Robert Penfold **181**  
A "no hands" approach to driving an effects unit or any instrument that responds to programme change messages
- SOUND-TO-LIGHT** by Andy Flind **194**  
Produces the classic sound-to-light effect, but with an extra channel. Can be linked to the 4-Channel Light Dimmer described last month

## Series

- INTRODUCING DIGITAL ELECTRONICS**  
by Michael Cockcroft **160**  
Part Six: Switches and Relays
- AMATEUR RADIO** by Tony Smith G4FA1 **170**  
Bureaucracy Rules; Change of Name; Robot Beacon
- ON SPEC** by Mike Tooley BA **192**  
Readers Sinclair Spectrum page
- ROBOT ROUNDUP** by Nigel Clark **202**  
Investigating the world of robotics
- BBC MICRO** by R. A. & J. W. Penfold **210**  
Regular spot for BEEB fanatics

## Features

- EDITORIAL** **153**
- SPECIAL OFFER** **187**  
ILP Amplifier Modules
- MAGNETIC MAGIC** by Ian Graham **188**  
Taking the mystery out of the new family of video tapes
- FOR YOUR ENTERTAINMENT** by Barry Fox **190**  
Not So Super; Aspiring Event; Stop Press
- SHOPTALK** by David Barrington **193**  
Product news and component buying
- DOWN TO EARTH** by George Hylton **200**  
Synchronising Oscillators; Circadian Rhythms
- MARKET PLACE** **201**  
Free reader's buy and sell spot
- DIRECT BOOK SERVICE** **204**  
Special service to EE readers
- PRINTED CIRCUIT BOARD SERVICE** **208**
- ADVERTISERS INDEX** **216**
- SPECIAL MIDI SUPPLEMENT**  
**between pages 175 and 185**

Our April '89 issue will be published on Friday, 3 March 1989. See page 147 for details

Everyday Electronics, March 1989

Readers' Services • Editorial and Advertisement Departments **153**

# MAGENTA ELECTRONICS Ltd.

## A SELECTION OF OUR BEST PROJECT KITS

As usual these kits come complete with printed circuit boards, cases, all components, nuts, screws, wire etc. All have been tested by our engineers (many of them are our own designs) to ensure that you get excellent results.

### INSULATION TESTER

An electronic High Voltage tester for mains appliances and wiring. An inverter circuit produces 500 volts from a PP3 battery and applies it to the circuit under test. Reads insulation up to 100 Megohms. Completely safe in use.

**OUR KIT REF 444 £19.58**



### 'EQUALISER' IONISER



**KIT REF 707 £15.53**

A mains powered Ioniser that produces a breeze of negative ions in the air. A compact, safe, simple unit that uses a negligible amount of electricity.

### 3 BAND SHORTWAVE RADIO

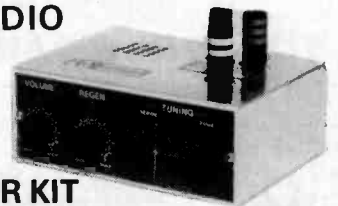

**OUR KIT REF 718 £26.53**

Covers 1.6-30 MHz in 3 bands using modern miniature coils. Audio output is via a built-in loudspeaker. Advanced design gives excellent stability, sensitivity and selectivity. Simple to build.

### DIGITAL CAPACITANCE METER

Simple and accurate (1%) measurements of capacitors from a few pF up to 1,000 uF. Clear 5 digit LED display indicates exact value. Three ranges - pF, nF, and uF. Just connect the capacitor, press the button and read the value.

**£41.55  
OUR KIT  
REF 493**

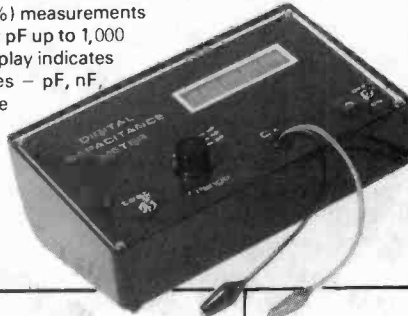

### SUPER SOUND-EFFECTS GENERATOR

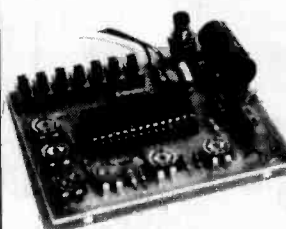

A wide range SN76477 sound effects board giving: Bird Chirps, Sirens, Helicopters, Explosions, Phaser Guns, Steam Train sounds, and more. Supplied without a case.

**KIT REF 781 £12.99**

### VISUAL GUITAR TUNER



Crystal controlled, with a super rotating LED display. Indicates high, low, and exact degree of mistuning. Use with pick-up or mic. Also has audible output.

**KIT REF E711 £21.99**

### MOSFET VARIABLE BENCH 25V 2.5A POWER SUPPLY



**OUR KIT REF. 769 £49.73**

A superb design giving 0-25V and 0-2.5A. Twin panel meters indicate Voltage and Current. Voltage is variable from zero to 25V. Current-Limit control allows Constant Current charging of NICAD batteries, and protects circuits from overload. A Toroidal transformer MOSFET power output device, and Quad op-amp IC design give excellent performance.

## TOP KITS

**COMPONENTS, KITS, BOOKS, TOOLS, MOTORS, GEARS, PULLEYS, OPTICAL FIBRES, ROBOTICS, AND MUCH MUCH MORE-IN OUR NEW CATALOGUE £1.00**

## PROJECT KITS FOR E.E. (Just a selection more in our catalogue)

Magenta supply Full Kits: Including PCB's (or Stripboard), Hardware, Components, and Cases (unless stated). Please state Kit Reference Number, Kit Title, and Price, when ordering. REPRINTS: If you do not have the issue of E.E. which includes the project, you will need to order the instruction reprint as an extra: 80p each. Reprints are also available separately—Send £1 in stamps.

REF NO.	KIT-TITLE	PRICE	REF NO.	KIT-TITLE	PRICE
807	MINI PSU Feb 89	£22.71	578	SPECTRUM I/O PORT less case Feb 87	£9.44
806	CONTINUITY TESTER Feb 89	£10.28	569	CAR ALARM Dec 86	£12.47
505	4 CHANNEL LIGHT DIMMER Feb 89	£37.99	563	200MHz DIG. FREQUENCY METER Nov 86	£82.98
803	REACTION TIMER Dec 89	£29.98	561	LIGHT RIDER LAPEL BADGE Oct 86	£10.20
802	PHASOR (Light Controller) Dec 88	£25.61	560	LIGHT RIDER DISCO VERSION	£19.62
801	DOWNBEAT METRONOME Dec 88	£17.57	559	LIGHT RIDER 16 LED VERSION	£13.64
800	SPECTRUM EPROM PROGRAMMER Dec 88	£26.97	556	INFRA-RED BEAM ALARM Sept 86	£28.35
796	SEASHELL SYNTHESISER Nov 88	£24.99	544	TILT ALARM July 86	£7.82
795	I.R. OBJECT COUNTER Nov 88	£29.63	542	PERSONAL RADIO June 86	£11.53
790	EPROM ERASER Oct 88	£24.95	528	PA AMPLIFIER May 86	£28.95
786	UNIVERSAL SOUND CHARGER July 88	£6.99	523	STEREO REVERB Apr 86	£26.44
781	SUPER SOUND EFFECTS GENERATOR May 88	£12.99	513	BBC MIDI INTERFACE Mar 86	£27.94
780	CABLE & PIPE LOCATOR April 88	£15.35	512	MAINS TESTER & FUSE FINDER Mar 86	£8.82
775	ENVELOPE SHAPER Mar 88	£14.99	497	MUSICAL DOOR BELL Jan 86	£18.72
769	VARIABLE 25V-2A BENCH POWER SUPPLY Feb 88	£49.73	493	DIGITAL CAPACITANCE METER Dec 85	£41.55
763	AUDIO SIGNAL GENERATOR Dec 87	£7.10	481	SOLDERING IRON CONTROLLER Oct 85	£5.47
740	ACCENTED BEAT METRONOME Nov 87	£13.54	464	STEPPER MOTOR INTERFACE FOR THE BBC. COMPUTER less case Aug 85	£11.68
744	ACOUSTIC PROBE Nov 87 (less bolt & probe)	£16.26		1D35STEPPER MOTOR EXTRA	£14.50
745	TRANSTEST Oct 87	£9.70		OPTIONAL POWER SUPPLY PARTS	£5.14
734	AUTOMATIC PORCH LIGHT Oct 87	£17.17	461	CONTINUITY TESTER July 85	£8.20
736	STATIC MONITOR Oct 87	£8.66	455	ELECTRONIC DOORBELL June 85	£7.56
723	ELECTRONIC MULTIMETER Sept 87	£46.96	453	GRAPHIC EQUALISER June 85	£26.94
728	PERSONAL STEREO AMP Sept 87	£14.31	444	INSULATION TESTER Apr 85	£19.58
730	BURST-FIRE MAINS CONTROLLER Sept 87	£13.57	430	SPECTRUM AMPLIFIER Jan 85	£6.91
724	SUPER SOUND ADAPTOR Aug 87	£38.39	392	BBC MICRO AUDIO STORAGE SCOPE INTERFACE Nov 84	£36.25
718	3 BAND 1.6-300MHz RADIO Aug 87	£26.53	387	MAINS CABLE DETECTOR Oct 84	£5.53
719	BUCCANEER I.B. METAL DETECTOR inc. coils and case, less handle and hardware July 87	£26.45	386	DRILL SPEED CONTROLLER Oct 84	£8.68
720	DIGITAL COUNTER/FREQ METER (10MHz) inc. case July 87	£67.07	362	VARICAP AM RADIO May 84	£13.15
722	FERMOSTAT July 87	£12.14	337	BIOLOGICAL AMPLIFIER Jan 84	£24.14
711	VISUAL GUITAR TUNER Jun 87	£22.99	263	BUZZ OFF Mar 83	£5.68
715	MINI DISCO LIGHT Jun 87	£12.59	242	2-WAY INTERCOM no case July 82	£5.89
707	EQUALISER (IONISER) May 87	£15.53	240	EGG TIMER June 82	£6.86
700	ACTIVE I/R BURGLAR ALARM Mar 87	£35.65	205	SUSTAIN UNIT Oct 81	£17.63
581	VIDEO GUARD Feb 87	£8.39	108	IN SITU TRANSISTOR TESTER Jun 78	£9.42
584	SPECTRUM SPEECH SYNTH. (no case) Feb 87	£20.92	106	WEIRD SOUND EFFECTS GEN Mar 78	£7.82
			101	ELECTRONIC DICE Mar 77	£8.26

### DIGITAL FREQUENCY 200 MHz METER

**KIT REF 563 £62.98**

An 8 digit meter reading from A.F. up to 200 MHz in two ranges. Large 0.5" Red LED display. Ideal for AF and RF measurements. Amateur and C.B. frequencies.



EE74 135 HUNTER STREET  
BURTON-ON-TRENT, STAFFS DE14 2ST  
ADD £1.00 P&P TO ALL ORDERS

PRICES INCLUDE VAT  
SHOP OPEN 9-5 MON-FRI  
OFFICIAL ORDERS WELCOME

**0283 65435**



# INTEGRATED AMPLIFIER

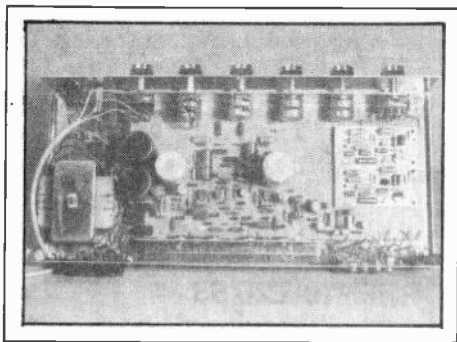

*A high quality amplifier providing 30W per channel for less than £35! It is possible and next month we publish full constructional details.*

# FREE!

## 32 page

# GREENWELD

# Spring catalogue supplement

Greenweld's 1989 Catalogue—given away free with our November '88 issue—was so popular they have come back with their Spring Supplement. 32 pages packed with bargains, plus a special design competition. Don't miss it, issues with catalogues usually sell out, place an order with your newsagent NOW!

## ROOM THERMOSTAT

*Those who have bought houses which already have central heating will know all too well how the main thermostat tends to be installed in the wrong place, i.e. in a cool hall or at the top of the stairs, and to be unnecessarily insensitive, or obtrusive in its "click-on, click-off" operations. This project enables the amateur constructor to make his own electronic thermostat and, if need be, to install it in a better site.*

## ELECTRON USER PORT

The Acorn Electron is essentially a cut down version of the popular BBC model B computer, and it has many features in common with the BBC machines; this includes BBC BASIC and the built-in assembler, but it lacks most of the ports.

This project provides a user port that has the same lines available as those on the BBC model B and master 128 computers. It enables the Electron to be used with many projects designed for the BBC machines.

# EVERYDAY ELECTRONICS

APRIL ISSUE ON SALE MARCH 3

# EXTENSION

# HIGH GRADE COMPONENT PARCELS

Unless otherwise stated, all the clearance parcels we offer contain brand new, top grade components. If some of the offers look too good to be true, all I can say is that the optimists will get some stunning bargains, the cynics will never know what they've missed, so everybody will be happy! All offers apply only while current stocks last – watch out for next month's parcels or, better still, be the first to hear about any new offers by putting your name on our mailing list. (Please write in, or 'phone Pete Leah on 0272 522703 after 6.30 pm).

**EVERYTHING  
MUST  
GO!**

## UNIVERSAL EVERYTHING PARCEL

This one contains some of just about any component you care to name! There are passives (resistors, capacitors, tants, presets), opto devices (couplers, LEDs of all shapes and sizes, infra-red components, 7-segment displays), semiconductors (transistors, diodes, ICs, rectifiers), and all kinds of other odds and ends (relays, VDRs, neons, battery connectors, mixed components packs). A stunning range of components – enough to get a workshop or lab. started – at a ridiculously low price.

The components are of excellent quality, in packs originally intended to sell at £1 each. To make sure you get a good variety, the 20-pack parcel will have no more than two of any one pack, the 100 pack parcel will have at most five of any one pack. Packs supplied as they come – our choice.

**PARCEL 1A: 20 PACKS for £10**  
**PARCEL 1B: 100 PACKS for £39!**

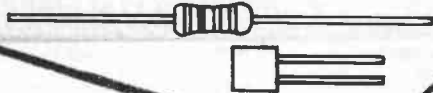

## INTEGRATED CIRCUITS

This parcel contains nothing but ICs. The mixture offers TTL and CMOS logic, interface ICs, linear, data converters, op-amps, special functions, and so on. Some of the ICs are pre-packed with data sheets, some (TTL, CMOS, op-amps) we expect you to identify for yourself, others will be covered by the free *data pack* provided, and the rest you'll have to identify under your own steam. If you know your ICs you'll be in for a few nice surprises.

**PARCEL 3A: 200 ICs for £12!**

**PARCEL 3B:  
500 ICs for £49!**

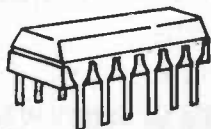

## ELECTROLYTICS

A first class selection of good, modern electrolytics. The mixture ranges from small coupling caps up to huge power supply electrolytics – you'll be hard pressed to find any value between 1µF and 2200µF that isn't represented. A wide range of very useful components. Go for it!

**PARCEL 5A:  
1000 ELECTROLYTICS for £8**

**PARCEL 5B:  
2500 ELECTROLYTICS for £16**

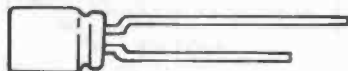

## TANTALUM CAPACITORS

A nice range of tants in values up to 47µF. Lots of useful caps, and we're not mean with the most expensive ones. A fine selection.

**PARCEL 4A: 100 TANTS for £6.80**

**PARCEL 4B: 500 TANTS for £29!**



## TRANSISTORS

A mix of general purpose silicon transistors, mostly bipolar NPN and PNP, with a few FETs and unijunctions thrown in (when available) to spice the mixture. The contents vary from month to month – at the moment there are BC212s, BC213s, BC548s, BC238Bs, MTJ210s, and so on. Next month – who knows? All top quality components.

**PARCEL 6A:  
200 TRANSISTORS for £6!**



## MASSIVE CLEARANCE SALE

Once again, a general purpose parcel containing a huge variety of components: resistors, capacitors, ICs, transistors, electrolytics, tants, triacs, LEDs, diodes, thermistors, trimmers, VDRs, all sorts. All new, top quality components. This is mostly remainders from our own stock – stuff we forgot to advertise, or have in too small a quantity to sell individually. Guaranteed to be worth at least eight times the price if valued from any standard component catalogue! What more can I say?

**PARCEL 2A: 1000+ top grade components for £12!**

(Value £100+)

**PARCEL 2B: 5000+ top grade components for £49!**

(Value £500+)



## LEDs

All shapes, sizes and colours of LEDs. Round ones in various sizes, rectangular ones, red, green, amber and yellow ones, clear and tinted lenses, all sorts.

**PARCEL 7A: 100 LEDs for £5.90**

**PARCEL 7B: 500 LEDs for £24.90**

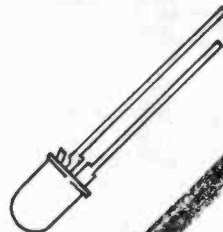

## CAPACITORS

An exciting selection of capacitors. There are ceramics for decoupling and general use, Polystyrenes for high performance circuits, dipped and moulded polyesters in values from a few nF up to 2.2µF (very expensive!), tants and aluminium electrolytics – just about any capacitor you'll ever need. Don't miss this one!

**PARCEL 8A:  
1000 CAPACITORS for £6.50**

**PARCEL 8B:  
2500 CAPACITORS  
for £14.90**



# HIGHGRADE COMPONENTS LTD

Unit 11, 8 Woburn Road, Eastville, Bristol BS5 6TT

### UK Orders:

Please add £2.50 towards postage and packing

### Europe and Eire:

Please add £6.00 carriage and insurance

### Outside Europe:

Please add £12.00 carriage and insurance

# AMPLIFIERS FROM JAYTEE

The UK Distributor for the complete ILP Audio Range



## BIPOLAR AND MOSFET MODULES

The unique range of encapsulated amplifier modules with integral heatsink.

HY30 15W Bipolar amp. £11.30	HY248 120W Bipolar amp (8ohm) £24.15
HY60 30W Bipolar amp £11.30	HY364 180W Bipolar amp (4ohm) £37.55
HY6060 30W Stereo Bipolar amp £23.65	HY368 180W Bipolar amp (8ohm) £37.55
HY124 60W Bipolar amp (4ohm) £18.50	MOS128 60W Mosfet amp £34.95
HY128 60W Bipolar amp (8ohm) £18.50	MOS248 120W Mosfet amp £42.40
HY244 120W Bipolar amp (4ohm) £24.15	MOS364 180W Mosfet amp £66.25

## PLATE AMPLIFIERS

Bipolar and Mosfet modules with the same electronics as above amplifiers housed in a different extrusion without heatsink.

HY6060P 30W Stereo Bipolar amp. £19.15	HY364P 180W Bipolar amp (4 ohm) £24.85
HY124P 60W Bipolar amp (4 ohm) £14.20	HY368P 180W Bipolar amp (8 ohm) £24.85
HY128P 60W Bipolar amp (8 ohm) £14.20	MOS128P 60W Mosfet amp. £29.95
HY244P 120W Bipolar amp (4 ohm) £19.25	MOS248P 120W Mosfet amp. £33.05
HY248P 120W Bipolar amp (8 ohm) £19.25	MOS364P 180W Mosfet amp. £55.20

Note: These modules require additional heatsinks

## POWER SUPPLIES

Comprising toroidal transformer and DC board to power the ILP amplifier modules.

PSU30 Pre-amplifier £10.35	PSU542 HY248 £26.15
PSU212 1 or 2 HY30 £18.30	PSU552 MOS248 £28.20
PSU412 HY6060, HY124, 1or2 HY60 £20.45	PSU712 HY244 (2) £30.25
PSU422 HY128 £22.60	PSU722 HY248 (2) £31.25
PSU432 MOS128 £23.55	PSU732 HY364 £31.25
PSU512 HY244, HY128 (2) £25.15	PSU742 HY368 £33.30
PSU522 HY124 (2) £25.15	PSU752 MOS364, MOS248 (2) £33.30
PSU532 MOS128 (2) £26.15	

## PRE-AMP and MIXER MODULES

These encapsulated modules are supplied with in-line connectors but require potentiometers, switches etc.

HY6 Mono pre-amp with bass and treble £ 9.25
HY66 Stereo pre-amp with bass and treble £15.00
HY83 Guitar pre-amp with special effects £18.95
B6 Mounting board for HY6 £ 1.15
B66 Mounting board for HY66 or HY83 £ 1.75

## POWER SLAVES

These cased amplifiers are supplied assembled and tested in 60 and 120 watt Bipolar or Mosfet versions.

US12 60 watt Bipolar (4ohm) £75.00	US32 60 watt Mosfet £99.95
US22 120 watt Bipolar (4ohm) £83.75	US42 120 watt Mosfet £108.35

Prices include VAT and carriage



Quantity prices available on request  
Write or phone for free Data Pack

Jaytee Electronic Services

143 Reculver Road, Beltinge, Herne Bay, Kent CT6 6PL  
Telephone: (0227) 375254 Fax: 0227 365104

## NEW THIS MONTH

Range of 'OK' Kits at half price! 5 diff. top quality kits containing all parts, inc. PCB, plastic case and comprehensive instructions!

EK1 Quick Reaction	£2.90
EK2 Electronic Organ	£3.34
EK3 Digital Roulette	£4.29
EK4 Electronic Dice	£3.98
EK5 Morse Code Oscillator	£1.99

**COMPUTER KEYBOARD** £4.0011  
Yes, only £4 for this Cherry keyboard—67 full travel keys inc. function keys. Size 340x130mm. Pale/dark brown £4.00

**EPSON SERIAL INTERFACES**  
Model 8143 £15  
Model 8148 with 2k buffer £25  
Just arrived—full details on next list together with other items in this parcel — ribbons, discs, other hardware add-ons



## Introducing DIGITAL ELECTRONICS

This exciting new series can lead to a worthwhile qualification—and we can supply all the components you need! The first six parts: Everything as listed in the booklet given free with EE. Just £12.95!

Low cost tool kit:  
15 Watt mains soldering iron, screw-driver, cutters, snipe nose pliers, wire strippers. All for £9.95

## ★STAR BUY★

## FREE!!!

**GREEN SCREEN HI-RES 12in. MONITOR CHASSIS**  
Brand new and complete except for case, the super high definition (100 lines at centre) makes this monitor ideal for computer applications. Operates from 12V d.c. at 1.1A. Supplied complete with circuit diagram and 2 pots for brilliance/contrast, plus connecting instructions. Standard input from IBM machines, slight mod (details included) for other computers. Only £24.95+£3 carr.

**MONITOR INTERFACE KIT**  
Enables our hi-res monitor (above) and most others to be used with virtually any computer. PCB £3.00  
Complete set of on-board components plus regulator and heatsink £9.95  
Suitable transformer for interface and above monitor £5.31

With every Vero Easiwire kit purchased for £15, we're giving away, absolutely FREE, a complete set of components for either of January's projects. Tilt Alarm or Siren! Limited supplies, so order NOW!

**PARTS FOR PROJECTS SO FAR**  
IR Receiver (inc. case) £6.00  
IR Transmitter (inc. case) £2.00  
SIREN (inc. case) £3.00  
TILT ALARM (inc. case) £5.30  
MINIDRILL for circuit cards (better than punching holes) £1.69

**AM/FM STEREO TUNER**  
Z497 Complete radio chassis with push-button selection for LW/MW/FM and ON/OFF. Ferrite rod for LW and MW selection, co-ax socket for FM aerial. Supplied with mains transformer and rectifier/smoothing cap, and wiring details. PCB is 333 x 90mm. Only £7.95

## 1989 CATALOGUE

- ★ 100 BIG pages of components and equipment
- ★ Low, low prices
- ★ Fast "by return" service
- ★ 28 pages of Surplus Bargains
- ★ Only £1—send for yours now!

### CURRAH MICRO SPEECH

We've bought up remaining stocks of this popular add-on to re-sell at a fraction of the original cost!  
Z4136 New complete and boxed set for the ZX Spectrum £8.95  
Z4140 As above, but unboxed—these were bulk packed £7.95  
Z4138 Microslot. 'T' connector allowing peripherals to be connected to the Spectrum. New and boxed £2.00  
Also a quantity of 'returns' available. See Bargain List 43 for details

### SPECIAL OFFER ON DIL SOCKETS

Must clear excess stocks—1/4 million low profile top quality IC sockets to dispose of!

Pins	10	100	1000
8	40p	£3.00	£20
14	68p	£5.10	£34
16	72p	£5.40	£36
18	76p	£5.70	£38
20	80p	£6.00	£40
22	84p	£6.30	£42
24	88p	£6.60	£44
28	92p	£6.90	£46
40	96p	£7.20	£48

### HEADPHONES AND SPEAKERS

Combination pack of Walkman type player units, consisting of stereo headphones and a pair of micro speakers in yellow, blue or green. Packed on a clear display card. £2.50

### POWER SUPPLIES

Z4117 Special low price switch mode PSU. 50W unit on PCB 160 x 100mm. Mains input, outputs 5V at 5A; +12V at 1A; -12V at 1A.  
List £40+ Our price £9.50  
Z4113 BBC Computer PSU (early models). Steel case 158 x 72 x 55mm, 2m long mains lead, rocker switch, fused. Outputs: +5V at 2.5A; -5V at 100mA. £3.95  
Z4112 Another switch mode PSU. Same size as Z4117. Outputs 24V at 1.7A; 12V at 0.8A. £9.95

### KEYBOARDS

Z8848 Alphanumeric plus separate numeric keyboard. 104 keys plus 11 chips. 442 x 175mm. £12.00  
Z4116 24 way (8 x 3) membrane keypad. Large (200 x 90mm) area—they were used in a teaching aid. Overlay template and pinout supplied £3.00

### NOTICE

#### TO RETAILERS

Greenweld Electronics Ltd. have been appointed Official Wholesalers of Verobloc, Veroboard, Easiwire and Accessories by Vero. We will be only too happy to supply all your Veroboard requirements at Trade Price. Ring, write or fax us for full information and prices.



All prices include VAT; just add £1.00 P&P; Min Credit Card £5. No CWO min. Official orders from schools welcome—Min invoice charge £10.00. Our shop has enormous stocks of components and is open 9-5.30 Mon-Sat. Come and see us!

### HOW TO CONTACT US

By post using the address below; by phone (0703) 772501 or 783740 (ansaphone out of business hours); by FAX (0703) 787555; by EMail Telecom Gold 72:MAG36026; by Telex 265871 MONREF G quoting 72:MAG36026.

443D MILLBROOK ROAD, SOUTHAMPTON SO1 0HX



**MARCOS TRADING**  
**THE MATTINGS, HIGH STREET, WEM,  
 SHROPSHIRE SY4 5EN DEPT EE3**  
 Tel: 0939 32763 Telex 35565 Fax 0939 33800

Electronic Component Mail Order Company—Established 1972  
 100+ PAGE CATALOGUE AVAILABLE—SEND £1 FOR YOUR COPY  
 Including Discount Tickets—50p off £5+ order; £1 off £10+ order; £5 off £50+ order.

Tel: (0939) 32763. Telex: 35565. Fax: 0939 33800  
 Please add 85p P&P & 15% VAT

**VISIT OUR RETAIL SHOPS**

**WEM (MARCOS)**, The Mattings, High Street (0939) 32763  
**WOLVERHAMPTON (WALTONS)**, 55A Worcester Street (0902) 22039  
**BIRMINGHAM (SUPERTRONICS)**, 65 Hurst Street (021) 666 6504

**MARCH SPECIAL OFFER  
 DRILL PRESS**

5-speed, single phase bench top drill press for general purpose workshop use.  
 HP motor drives the 13mm chuck via a Vee belt and pulley wheels. Table  
 adjustable for height and angle. Fitted with depth gauge and depth stop. Complete  
 with instruction manual and chuck key.

Chuck capacity ..... 0-13mm  
 Spindle speeds ..... 600 900 1250 1750 2600 rpm  
 Spindle travel ..... 50mm  
 Chuck to table clearance ..... 150mm  
 Chuck to base clearance ..... 250mm  
 Dia. .... 575 x 420 x 200mm  
 Power 240V ac 130W @ 1420 rpm

**£75 PLUS 15% VAT  
 & £1.65 P&P**

WE RESERVE THE RIGHT TO  
 CHANGE THE PRICES WITHOUT  
 PRIOR NOTICE

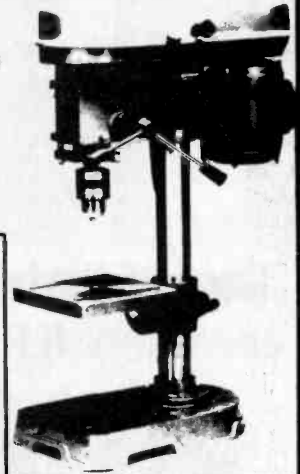

EVERYONE IS TALKING  
 ABOUT IT SO WHY  
 NOT READ ABOUT IT  
 AN INTRODUCTION  
 TO SATELLITE TV

As a definitive introduction  
 to the subject this book is  
 presented on two levels.  
 For the absolute beginner  
 with no previous knowl-  
 edge, the story is told as  
 simply as it can be in the  
 main text.  
 For the professional  
 engineer, amateur enthu-  
 siast, student or others  
 with technical back-  
 grounds, there are nu-  
 merous appendices backing  
 up the main text with  
 additional technical and  
 scientific details. Formulae,  
 calculations and tables etc.  
 There is also much for  
 the DIY enthusiast with  
 practical advice on choosing and installing the most  
 problematic part of the system - the dish antenna.  
 95pp/14 169 p 1980 -104 x 195 mm 112 pages

An Introduction to  
 Satellite Television

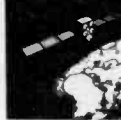

**ONLY £5.95**

<b>ANTEX SOLDERING</b>	
C IRON 15W £5.40	SK2 kit £8.30
CS Iron 17W £5.60	SK5 kit £7.99
XS Iron 25W £5.80	SK6 kit £8.20
ST4 stand	£2.20
TCSU-D soldering station	£72.50
Spare elements from	£3.20
Spare tips for above irons	£1.20

**UNIVERSAL P.C.B. ASSEMBLY JIG**  
 TO ACCOMMODATE P.C.B. SIZE UP TO MAXIMUM:-  
 265 x 238mm



**OUR PRICE  
 £15.00**

(NORMAL PRICE OVER £60.00)

FULL RANGE OF  
 TRANSISTORS/  
 IC's-CMOS  
 VALVES ETC  
 Boxes transformers  
 Audioover 7,000 lines

Also we  
 do the  
 full range  
 of Babani  
 Books  
 NO  
 VAT  
 TO BE  
 ADDED

**SOLDER AT A RIDICULOUSLY LOW PRICE!!!**  
 500gms reel of 22 SWG  
 Multi-Core Solder 60%  
 (in 40% alloy non-corrosive.  
**ONLY £4.99**  
 Also 18 SWG



10+ £3.75

**NI-CAD RECHARGEABLE BATTERIES**  
 AAA - £1.25 (10+£1.20ea.)  
 AA - 90p (10+ 85p ea.)  
 C - £2.10 (10+£1.90ea.)  
 D - £2.50 (10+£2.20ea.)  
 PP3 - £4.10 (10+£3.90ea.)



**HELPING  
 HANDS  
 with  
 magnifier**

**12V RECHARGEABLE UNIT**  
 10 x D size Ni-Cads (4Ah) encapsulated in a black plastic case. Inse-  
 holder. gives 12V output when fully charged. Ex-equipment—fully  
 tested and guaranteed. 245 x 75 x 75mm.



**£7.99**

**plus £1.85 P&P plus 15% VAT**

**CHARGER FOR NI-CAD BATTERIES**  
 Charges AAA,  
 AA, C, D &  
 PP3 NI-CADS



**£4.50**

**ONLY £5.99**  
**QUARTZ-  
 HALOGEN  
 SPOTLIGHT**  
**PLUS**  
**85p 15% VAT**



**FM  
 TRANSMITTER**

Very High  
 Quality  
**"MINI-BUG"**  
 -Ideal for  
 Baby Alarm,  
 etc!!  
 A very good range is  
 obtainable - We have  
 obtained over 1/2  
 mile, but it does  
 depend on  
 conditions. Simply  
 remove cover -  
 insert battery - and  
 you're ready to go.  
 Reception can be  
 obtained on any FM  
 radio.  
 Frequency:  
 06-109  
 MHz-Fm **£8.50**  
 Power: PP3 9V.

**12V Twin Fluorescent lamp**  
**12" Double Tubes**  
 IDEAL FOR BOATS,  
 CARAVANS, VANS, ETC.



**£5.99 EACH  
 10 OFF £4.99**

ATTRACTIVE WHITE  
 FITTING, RIBBED  
 PERSPEX DIFFUSER.  
 ON/OFF SWITCH.  
 3PL CABLE TRANSISTORISED  
 CIRCUITRY, KEYHOLE FIXING.  
 12V D.C. 8W TUBES.  
 368 x 67 x 43mm

**JUST ARRIVED**  
 High quality  
 Desolder Pump  
**£2.99**  
 Normally £8.99  
 European Made  
 Spare Tip 60p

**ORXY PORTASOL GAS SOLDERING IRON**  
 1+ Price £16.00  
 5+ Price £15.30  
**SPARE TIPS: 1, 2, 4, 3.2, 4.0mm £4**



**BT APPROVED EQUIPMENT**

Master Socket (flush)	£2.90
Master Socket (surface)	£2.75
Secondary Socket (flush)	£1.90
Secondary Socket (surface)	£1.85
BT Cable (per metre)	15p
BT Cable 100 metres	£12.00 reel
Line Jack Cord with plug	£1.25
Extension lead, 5 mtr	£2.90
Wiring Tool	36p
Plug - 431A	25p
Stimel Phone	£17.35
Viscount Phone	£26.04
Conversion kit & wiring diag.	£6.90

**CONQUERING NEW HEIGHTS**



**CROTECH 3133**

- ★ Component Comparator
- ★ Variable Hold Off
- ★ Triple DC Source
- ★ DC - 25 MHz
- ★ 40ns/div
- ★ 2mV/div
- ★ Low Cost

**Full 2 Year Warranty**

**£319\***

To scale the heights, just call  
 us for your **FREE** copy of our  
 catalogue



\*(Ex VAT & Delivery)

*Yes its 25MHz for £319*

**Crotech Instruments Limited**

2 Stephenson Road, St. Ives, Huntingdon, Cambs. PE17 4WJ  
 Telephone: (0480) 301818



# SOLDERLESS WIRING

## EASIWIRE

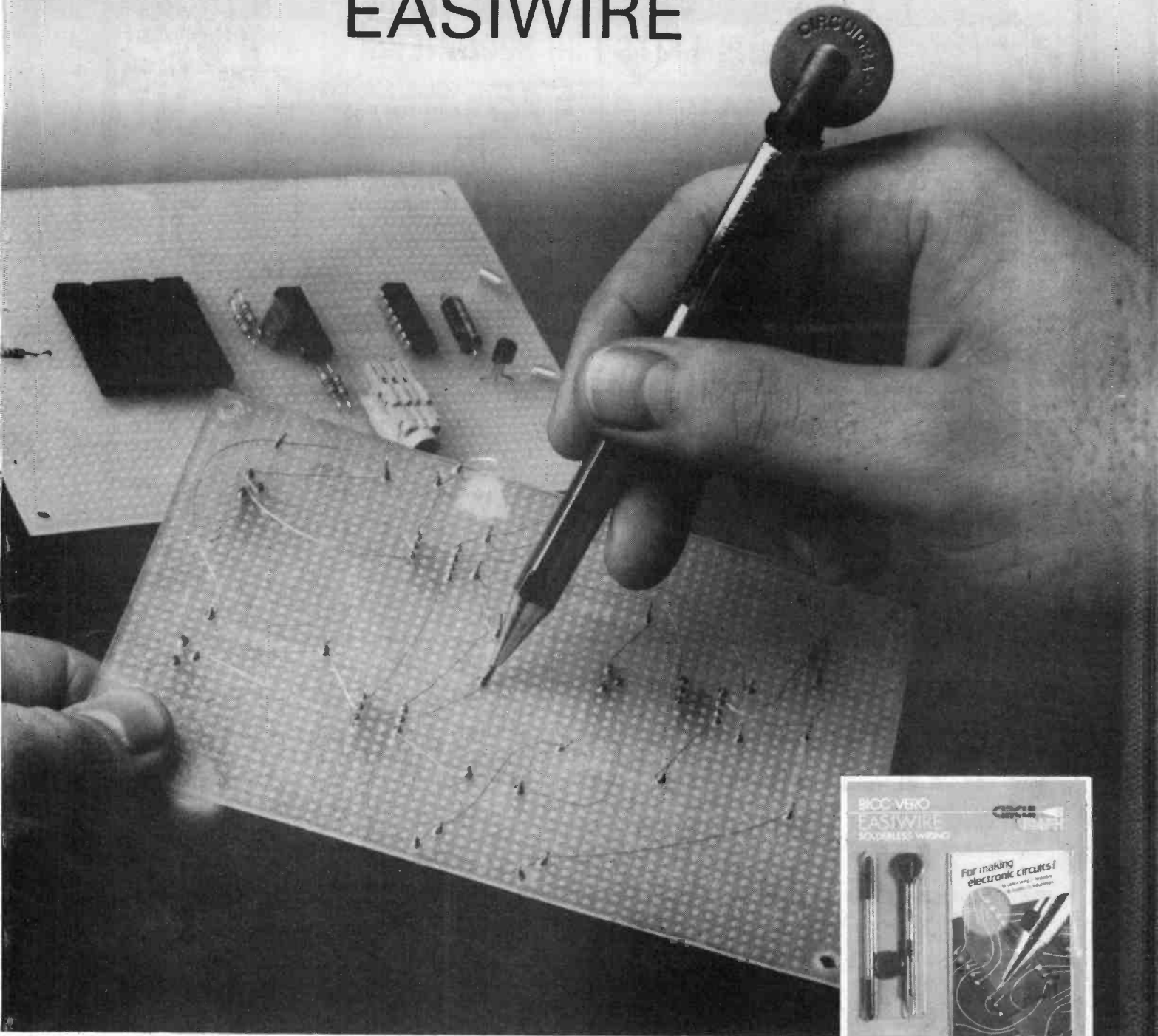

Construct your electronic circuits the new, quick and easy-to-learn way, **WITHOUT** solder: with Circuigraph Easiwire from BICC-VERO

With Easiwire all you do is wind the circuit wire tightly around the component pins. No soldering, no chemicals, no extras, simplicity itself. Circuits can be changed easily, and components re-used.

Easiwire comes in kit form. It contains all you need to construct circuits: a high-quality wiring pen with integral wire cutter, 2 reels of wire, a tool for component positioning and removal, a flexible injection moulded wiring board, double-sided adhesive sheets, spring-loaded terminals and jacks for power connections and an instruction book. Of course, all these components are available separately too.

To take advantage of the special introductory offer, complete the coupon on the right and send it to:

**BICC-VERO ELECTRONICS LIMITED,**  
Flanders Road,  
Hedge End,  
Southampton, SO3 3LG



Please rush me.....Easiwire kits, retail price £18.-;  
**special introductory offer £15.-.** (includes p & p and VAT).

I enclose cheque/postal order for....., made payable to  
BICC-VERO Electronics Limited

Please debit my credit card as follows:



Card Number .....

Expiry Date .....

Name .....

Address .....

Signature .....

or phone 04892 88774 now with your credit card number  
(24-hour answering service).

# KITS & COMPONENTS

## ELECTRONIC GUARD DOG



One of the best burglar deterrents is a guard dog and this kit provides the barking. Can be connected to a doorbell, pressure mat or any other intruder detector and produces random threatening barks. All you need is a mains supply, intruder detector and a little time.  
**XK125** ..... **£24.00**

## DISCO LIGHTING KITS

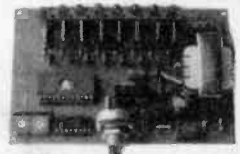

**DL8000K** 8-way sequencer kit with built-in opto-isolated sound to light input. Only requires a box and control knob to complete ..... **£31.50**  
**DL1000K** 4-way chaser features bi-directional sequence and dimming 1kW per channel ..... **£19.25**  
**DLZ1000K** Uni-directional version of the above. Zero switching to reduce interference ..... **£10.80**  
**DLA/1** (for DL & DLZ1000K) Optional opto input allowing audio 'beat'/light response ..... **77p**  
**DL3000K** 3-channel sound to light kit, zero voltage switching, automatic level control and built-in mic. 1kW per channel ..... **£15.60**

## POWER STROBE KIT

Produces an intense light pulse at a variable frequency of 1 to 15Hz. Includes high quality PCB, components, connectors, 5Ws strobe tube and assembly instructions. Supply: 240V ac. Size: 80x50x45.  
**XK124 STROBOSCOPE KIT** ..... **£13.75**

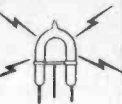

## SIMPLE KITS FOR BEGINNERS

Especially aimed at the beginner. Have fun with your project even after you have built it and also learn a little from building it. These kits include high quality solder reslst printed circuit boards, all electronic components (including speaker where used) and full construction instructions with circuit description.



### SPECIAL OFFERS ON SK KITS FOR SCHOOLS AND TRAINING CENTRES

- contact Sales Office for discounts and samples

**SK1 DOOR CHIME** plays a tune when activated by a pushbutton ..... **£3.90**  
**SK2 WHISTLE SWITCH** switches a relay on and off in response to whistle command ..... **£3.90**  
**SK3 SOUND GENERATOR** produces FOUR different sounds, including police/ambulance/fire-engine siren and machine gun ..... **£3.90**  
**XK113 MW RADIO KIT** based on ZN414 IC, kit includes PCB, wound aerial and crystal earpiece and all components to make a sensitive miniature radio. Size: 5.5x2.7x2 cms. Requires PP3 9V battery ..... **£6.60**  
**XK118 TEN EXCITING PROJECTS FOR BEGINNERS** this kit contains a solderless breadboard, components, and a booklet with instructions to enable the absolute novice to build ten fascinating projects including a light operated switch, intercom, burglar alarm, and electronic lock. Each project includes a circuit diagram, description of operation and an easy to follow layout diagram. A section on component identification and function is included, enabling the beginner to build the circuits with confidence ..... **£15.00**

## SUPER-SENSITIVE MICROBUG

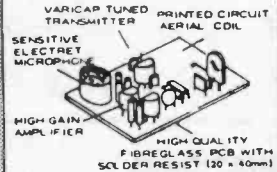

Only 45x25x15mm, including built-in mic. 88-100MHz (standard FM radio). Range approx. 300m depending on terrain. Powered by 9V PP3 (7mA). Ideal for surveillance, baby alarm etc. .... **£5.50**

## VERSATILE REMOTE CONTROL KIT

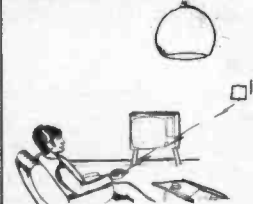

Includes all components (+transformer) for a sensitive IR receiver with 16 logic outputs (0-15V) which with suitable interface circuitry (relays, triacs, etc - details supplied) can switch up to 16 items of equipment on or off remotely. Outputs may be latched to the last received code or momentary (on during transmission) by specifying the decoder IC and a 15V stabilised supply is available to power external circuits. Supply: 240V AC or 15-24V DC at 10mA. Size (exc. transformer) 9x4x2 cms. Companion transmitter is the MK18 which operates from a 9V PP3 battery and gives a range of up to 60ft. Two keyboards are available - MK9 (4-way) and MK10 (16-way).  
**MK12 IR Receiver** (inc transformer) ..... **£16.30**  
**MK18 Transmitter** ..... **£7.50**  
**MK9 4-way Keyboard** ..... **£2.20**  
**MK10 16-way Keyboard** ..... **£6.55**  
**601133 Box for Transmitter** ..... **£2.60**

## SOLID STATE RELAY BARGAIN

Zero voltage switching - no radio interference. 2.5KV input to output isolation. 4 KV terminals to heatsink isolation. 3V to 32V input voltage easily interfaced to TTL or CMOS logic. 24V to 240V rms load voltage. Inductive load switching. Built-in snubber network. 10A max. 4A with no heatsink at 40°C.  
**CD240/10** ..... **£2.25**



## ELECTRONIC WEIGHING SCALES

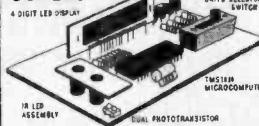

Kit contains a single chip micro-processor, PCB, displays and all electronics to produce a digital LED readout of weight in Kgs or Sts/lbs. A PCB link selects the scale - bathroom/ two types of kitchen scales. A low cost digital ruler could also be made.  
**EST** ..... **£6.50**

## PROPORTIONAL TEMPERATURE CONTROL KIT



Uses 'burst fire' technique to maintain temperature to within 0.5°C. Ideal for photography, incubators, wine-making, etc. Max. load 3kW (240V ac) Temp range up to 90°C. Size: 7x4x2.5cms.  
**MK4** ..... **£7.80**

## ★ ★ ★ BARGAIN COMPONENT PACKS ★ ★ ★

Refill those empty component drawers at a fraction of the normal price and don't be caught out. All components supplied are to full spec, and are not seconds or surplus stock. Prices exclude VAT (15%).

Pack A: 650x25 watt resistor 47R-10M	£4.25
Pack B: 60xRadial electrolytes 1uf-1000uf	£3.25
Pack C: 30x Polyester capacitors a or 0.01uf-1uf	£4.50
Pack D: 35x horizontal presets 1k-1M	£3.00
Pack E: 30x IC sockets 8, 14, 16 pin	£2.00
Pack F: 25x Red 5mm LEDs	£1.75
Pack G: 25x Green LEDs	£2.00
Pack H: 30x 5mm LEDs 10 Red, 10 Green, 10 Yellow	£2.50
Pack J: 50x 1N4148 silicon diodes	£1.00
Pack K: 40x npn/pnp transistors BC/548/558 General Purpose	£2.25

**FREE** Solderless Breadboard (verobloc type) when you buy all ten packs.



## MICROPROCESSOR TIMER

Kit controls 4 outputs independently switching on/off at 18 preset times over a 7-day cycle. LED display of time/day easily programmed. Includes box.  
**CT6000K** ..... **£47.20**  
**XK114** Relay kit for CT6000 includes PCB, connectors and one relay. Will accept up to 4 relays. 3A/240V c/o contacts ..... **£4.30**  
**701115** Additional relays ..... **£1.80**



# TK ELECTRONICS

**TK ELECTRONICS**  
**13 Boston Road**  
**London W7 3SJ**  
**Tel: 01-567 8910**  
**Fax: 01-566 1916**

**ORDERING INFORMATION** All prices exclude VAT. Free p&p on orders over £50 (UK only), otherwise add £1+VAT. Overseas p&p: Europe £3.50, elsewhere £10. Send cheque/PO/Barclaycard/Access No. with order. Giro No. 529314002. Local authority and export orders welcome. Goods by return subject to availability.



## ORDERS: 01-5678910 24 HOURS

# EVERYDAY ELECTRONICS

INCORPORATING ELECTRONICS MONTHLY

The Magazine for Electronic & Computer Projects  
**VOL. 18 No. 3** **March '89**

## Editorial Offices

EVERYDAY ELECTRONICS EDITORIAL,  
6 CHURCH STREET, WIMBORNE,  
DORSET BH21 1JH

Phone: Wimborne (0202) 881749

FAX: (0202) 841692

See notes on **Readers' Enquiries** below—we regret that lengthy technical enquiries cannot be answered over the telephone

## Advertisement Offices

EVERYDAY ELECTRONICS ADVERTISEMENTS  
HOLLAND WOOD HOUSE, CHURCH LANE,  
GREAT HOLLAND, ESSEX CO13 0JS. Clacton  
(0255) 850596

## INTERNATIONAL

One of the fascinations of editing EE lies in reading your letters. They come in from literally all over the world, very often simply to order a subscription, a p.c.b. or a book, or sometimes to ask for help with an EE project. The interesting thing is that while many readers can speak very little English they can all understand basic electricity and electronics.

Our hobby is truly international—the circuits are drawn and read in the same way in Bulgaria, Botswana, Bermuda and Brazil and virtually all of the components are available to anyone anywhere. Many U.K. component suppliers sell parts by mail order to readers in hundreds of different countries.

## HOT MAIL

Letters come into the office almost every day from countries at war with each other—there they are side by side in the mail from all the “hot spots” around the world. Of course in many places electronics is being used as part of modern warfare and terrorism, to spy, to identify and of course to aim, time, target and destroy.

What a pity that what starts as a hobby finishes up being used for evil.

## FRIENDS

With this in mind we have thrown open our *Market Place* section to anyone who would like to advertise for pen friends who have an interest in electronics. In this way we hope that we can help readers to understand each other a little more, to generate respect among fellow enthusiasts and hopefully reduce the tension in our world just a little. It is not going to produce any dramatic results—it may not produce any results at all!—but the more “friends” everyone has around the world the more we might consider our actions before blasting the other guy.

In the future an EE reader may be in a position of power, as technically qualified personnel increasingly are in the modern world; it is just possible that through the mutual hobby of electronics a greater respect for others may help world peace.

Let us use electronics to keep the peace and improve our lifestyles rather than to destroy. If you would like a pen friend interested in electronics just drop us a line and we will try to publish the details as soon as possible.

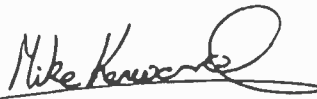

## SUBSCRIPTIONS

Annual subscriptions for delivery direct to any address in the UK: £15.70. Overseas: £19.00 (£36 airmail). Cheques or bank drafts (in £ sterling only) payable to Everyday Electronics and sent to EE Subscriptions Dept., 6 Church Street, Wimborne, Dorset BH21 1JH.

Subscriptions can only start with the next available issue. For back numbers see below.

## BACK ISSUES

Certain back issues of EVERYDAY ELECTRONICS are available price £1.50 (£2.00 overseas surface mail—£ sterling only please) inclusive of postage and packing per copy. Enquiries with remittance, made payable to Everyday Electronics, should be sent to Post Sales Department, Everyday Electronics, 6 Church Street, Wimborne, Dorset BH21 1JH. In the event of non-availability remittance will be returned. *Please allow 28 days for delivery. We have sold out of Sept., Oct. & Nov. 85, April, May & Dec. 86, Jan., Feb., April, May & Nov. 87, Jan., March, April, May, June & Oct. 88.*

## BINDERS

Binders to hold one volume (12 issues) are available from the above address for £4.95 (£6.95 to European countries and £9.00 to other countries, surface mail) inclusive of postage and packing. *Please allow 28 days for delivery. Payment in £ sterling only please.*

Editor MIKE KENWARD

Secretary PAMELA BROWN

Deputy Editor

DAVID BARRINGTON

Editorial Assistant

COLETTE MCKENZIE

Editorial: WIMBORNE (0202) 881749

Advertisement Manager

PETER J. MEW Clacton (0255) 850596

Classified Advertisements

Wimborne (0202) 881749

## READERS' ENQUIRIES

We are unable to offer any advice on the use, purchase, repair or modification of commercial equipment or the incorporation or modification of designs published in the magazine. We regret that we cannot provide data or answer queries on articles or projects that are more than five years old. Letters requiring a personal reply must be accompanied by a **stamped self-addressed envelope** or a **self-addressed envelope and international reply coupons**.

All reasonable precautions are taken to ensure that the advice and data given to readers is reliable. We cannot, however, guarantee it and we cannot accept legal responsibility for it.

## COMPONENT SUPPLIES

We do not supply electronic components or kits for building the projects featured, these can be supplied by advertisers.

## OLD PROJECTS

We advise readers to check that all parts are still available before commencing any project in a back-dated issue.

We regret that we cannot provide data or answer queries on projects that are more than five years old.

## ADVERTISEMENTS

Although the proprietors and staff of EVERYDAY ELECTRONICS take reasonable precautions to protect the interests of readers by ensuring as far as practicable that advertisements are *bona fide*, the magazine and its Publishers cannot give any undertakings in respect of statements or claims made by advertisers, whether these advertisements are printed as part of the magazine, or are in the form of inserts.

The Publishers regret that under no circumstances will the magazine accept liability for non-receipt of goods ordered, or for late delivery, or for faults in manufacture. Legal remedies are available in respect of some of these circumstances, and readers who have complaints should address them to the advertiser or should consult a local trading standards office, or a Citizen's Advice Bureau, or a solicitor.

## TRANSMITTERS/BUGS

We would like to advise readers that certain items of radio transmitting equipment which may be advertised in our pages cannot be legally used in the U.K. Readers should check the law before using any transmitting equipment as a fine, confiscation of equipment and/or imprisonment can result from illegal use.

The law relating to this subject varies from country to country; overseas readers should check local laws.

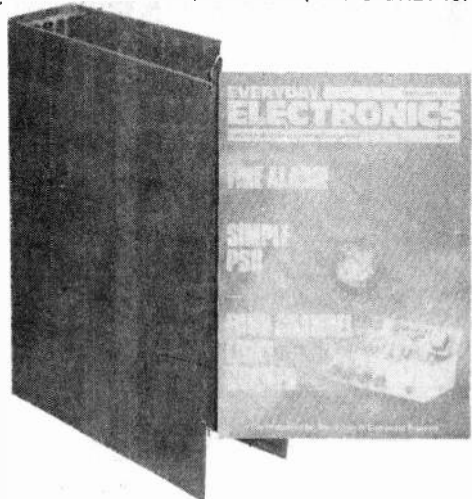

# CALL ALERT

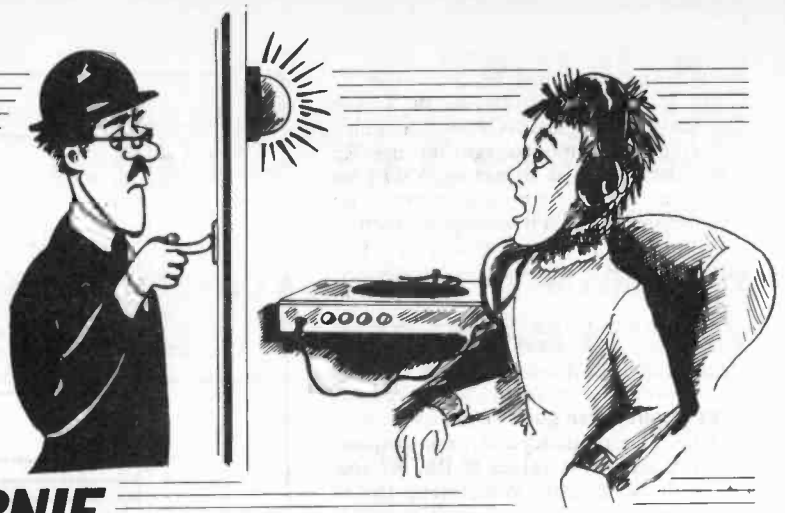

**T. R. de VAUX-BALBIRNIE**

*Doorbell warning for the hard-of-hearing or for those working out of earshot of the bell.*

**T**HIS doorbell warning device was designed as an aid for the deaf. However, it will also be of interest to those working out of earshot of the doorbell—when gardening, for example. In use a flashing mains lamp, or lamps, come on when the bell push is operated. Flashes continue at two second intervals for some preset time between three and 30 seconds approximately—these timings are easily increased if required. Lamps to a maximum total load of 300W may be connected so five separate 60W lamps, for example, may be used to cover different areas of the house and garden.

The Call Alert is an add-on circuit with self-contained battery. It may be used in

conjunction with any type of battery or transformer-operated bell, buzzer or door chimes. This is referred to simply as a “bell” in the text. The additional circuit does not interfere with normal working of the bell and may be switched off at any time. A push-button switch may be used to cancel operation once the lamps have attracted attention. Alternatively, it may be left to end its timing cycle naturally.

The continuous standby current requirement is very small, 200 $\mu$ A approximately in the prototype circuit so the battery will have a long life. The unit may be situated any reasonable distance from the bell and is connected to it using cheap light-duty two-core wire.

## WARNING

Since constructing this project involves mains installation work, some readers will wish to leave this part of the job to a qualified electrician who will also be able to advise on the type of fittings required for outdoor use. In particular, the unit needs to be connected to the mains through a switched and fused outlet. It would also be possible to plug it into an adjacent wall socket. A separate fuse would be needed if a non-fused plug was to be used.

## CIRCUIT DESCRIPTION

The circuit for the Call Alert is shown in Fig. 1 with the existing part to the left of the dotted line and the add-on circuit to the right. The principle component is IC2—a dual CMOS timer integrated circuit. This contains two identical sections, IC2a and IC2b. IC2a is connected as a monostable. Thus, once triggered at pin six by a “low” (supply negative) pulse derived from the existing doorbell circuit, it will switch on

Fig. 1. The complete circuit diagram for the Call Alert. The existing doorbell wiring is shown to the left of the dotted line.

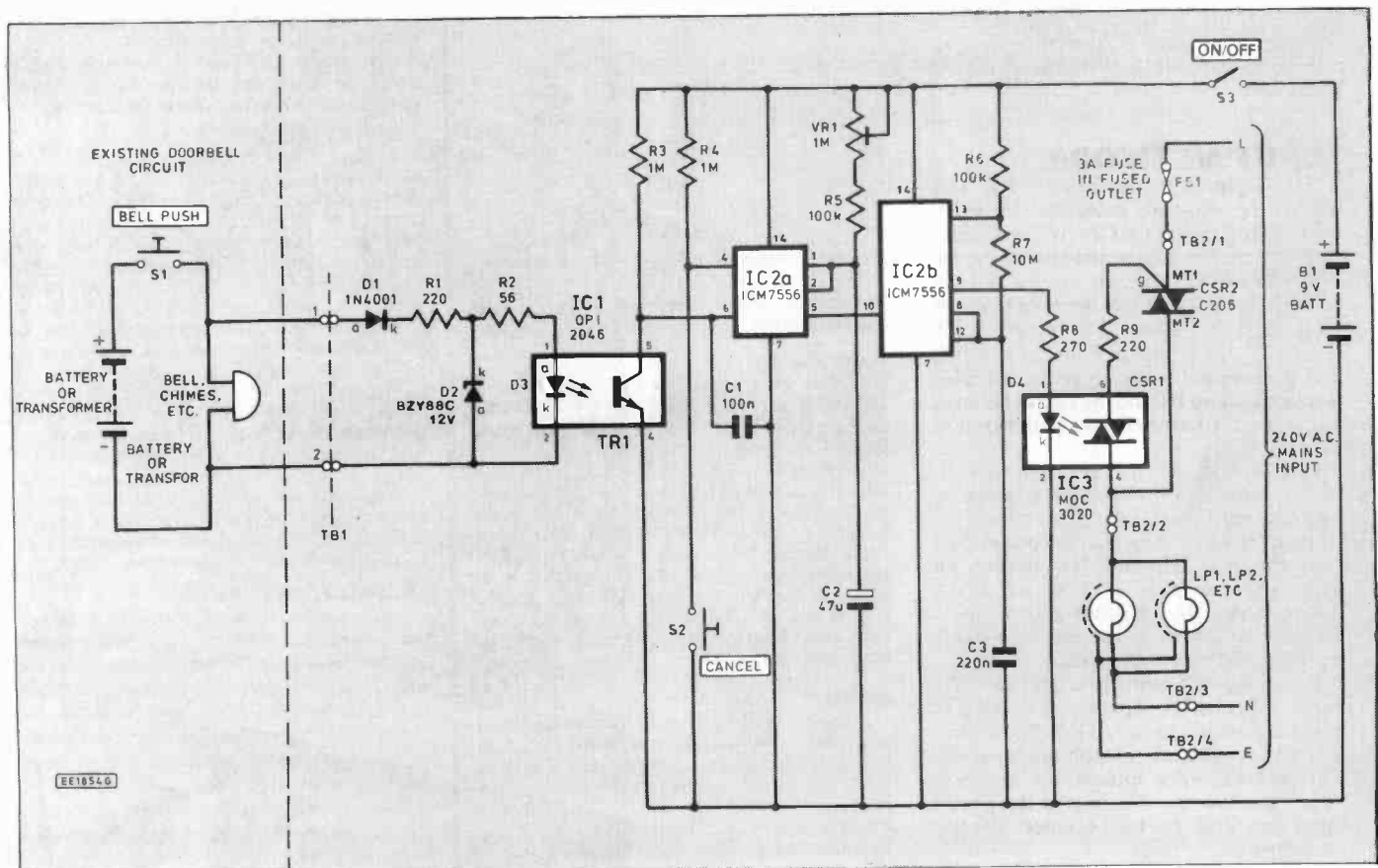

for a time determined by the values of VR1, R5 and C2 then switch off. In the absence of such a pulse, IC2 pin six remains high (positive supply voltage) through R3 which prevents false triggering. VR1 provides the time period adjustment. The input pulse is delivered through the section consisting of IC1 in conjunction with D1, D2, R1 and R2—this will be described in detail later.

When IC2a is triggered, its output, pin 5, goes high thus making IC2b reset input, pin ten, high also. IC2b is connected as an astable and with pin ten high, the device produces square-wave pulses from its output, pin nine. The frequency and mark-to-space ratio are set by the values of R6, R7 and C3. With the specified components this is two seconds approximately with equal on and off states. Since the frequency is not thought to be particularly important, no adjustment is provided. With IC2a off, pin five is low and this, when applied to pin ten, inhibits IC2b. No pulses are then produced and pin nine remains low.

### OPTO LINK

Component IC3 is an optically-coupled triac—it contains two sections, an infra-red l.e.d., D4, and a triac, CSR1. A conducting path is established between the triac main terminals (pins four and six) when D4 is on. There is no electrical coupling between the two parts so mains and battery sections are completely isolated. With IC2b on (pin nine high), current flows through D4 which operates CSR1. This, in turn, triggers external triac, CSR2 with gate current entering through R9 so establishing a conducting path between main terminals MT1 and MT2. Mains current then flows through the lamp(s) LP1, LP2, etc.

Although CSR1 can handle mains voltage, the maximum operating current is too small for the present purpose, hence the need for the more substantial external triac, CSR2. S3 and S2 are the ON-OFF and CANCEL switches respectively. S2 operates by making IC2 reset input, pin four, low any time before the timing period has ended.

### INPUT NETWORK

The input network centred on IC1 applies the triggering pulse from the existing doorbell circuit to IC2a. IC1 is an optically-coupled transistor and provides isolation between the existing circuit and the new add-on unit. D1 is biased to allow only positive pulses to pass. If the supply is a.c. (derived from a mains transformer), the first positive half-cycle to arrive will pass through D1 and R1 and the circuit behaves just as if d.c. (derived from a battery) were used.

In many types of bell, operation depends on the rapid make-and-break action of a pair of contact points. This generates high-voltage "spikes". Any positive pulses passing through D1 and R1 having an amplitude greater than 12V will cause Zener diode, D2, to conduct and bypass them. This protects the semiconductor devices in the rest of the circuit.

When the bell-push S1 is pressed, IC1 internal l.e.d., D3, operates and triggers internal phototransistor, TR1. The collector, pin five, goes low (supply negative voltage) and this, when applied to IC2a pin six makes this low too. The rest of the circuit then functions in the manner already described.

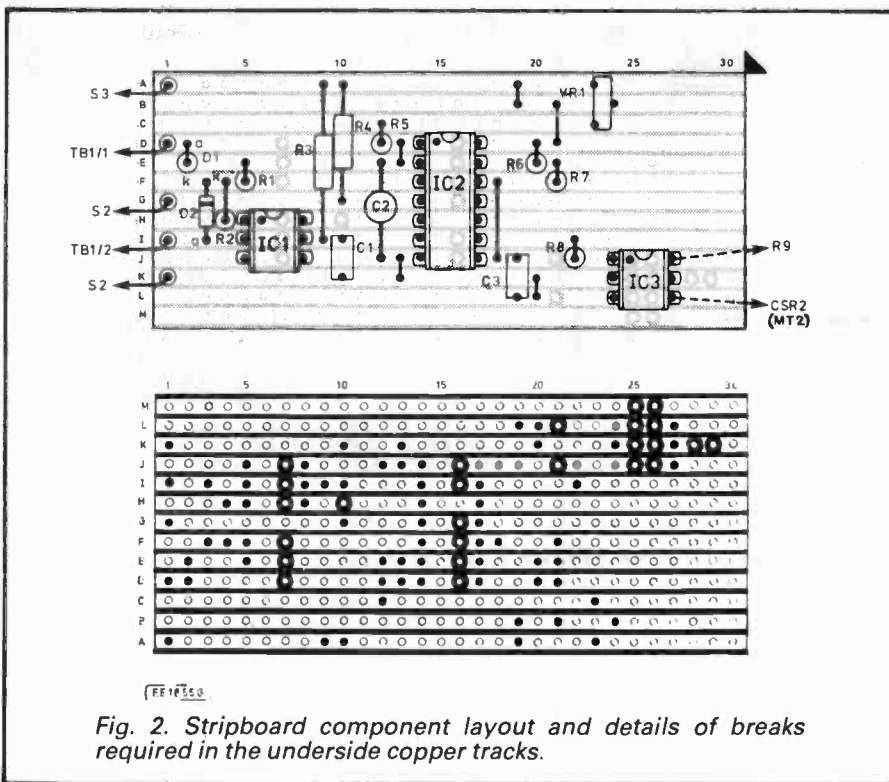

Fig. 2. Stripboard component layout and details of breaks required in the underside copper tracks.

Where long wiring exists between the main unit and the bell, stray a.c. pick-up along the leads is of no consequence since this is insufficient to operate D3. There is a chance that such pick-up could occur direct to IC2 pin 6 and decoupling capacitor, C1, is included to prevent this.

### CONSTRUCTION

Refer to Fig. 2 which shows the circuit panel layout used in the prototype unit. This is based on a piece of 0.1 inch matrix

stripboard size 13 strips x 30 holes. Cut this slightly large then file it to fit the slots of the plastic box. Make all track breaks and inter-strip links as indicated. Note that the copper track between IC2 pins five and ten must be left intact. The double row of breaks at IC3 position isolate the mains and battery sections of the circuit. It is essential, for safety reasons, that these breaks are complete and carefully checked.

Solder the on-board components including the i.c. sockets into position taking care

Close-up view of the circuit board and wiring to CSR2 triac.

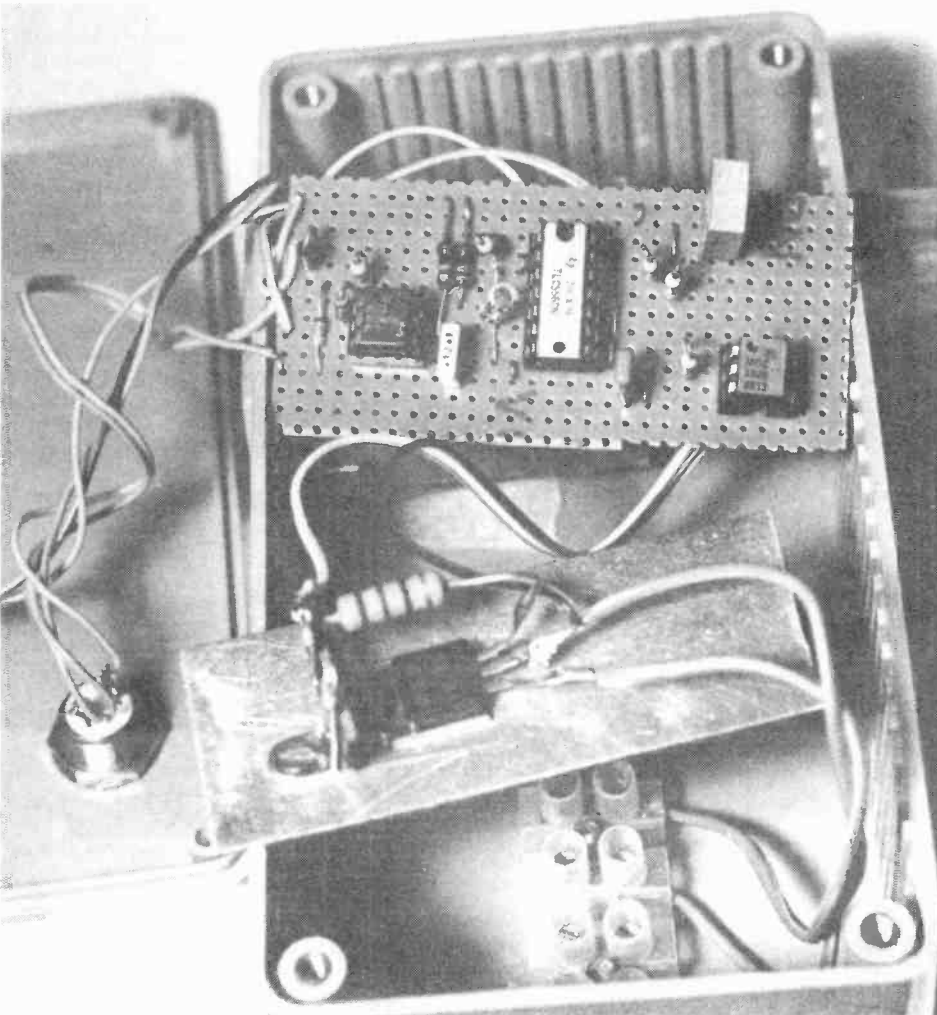

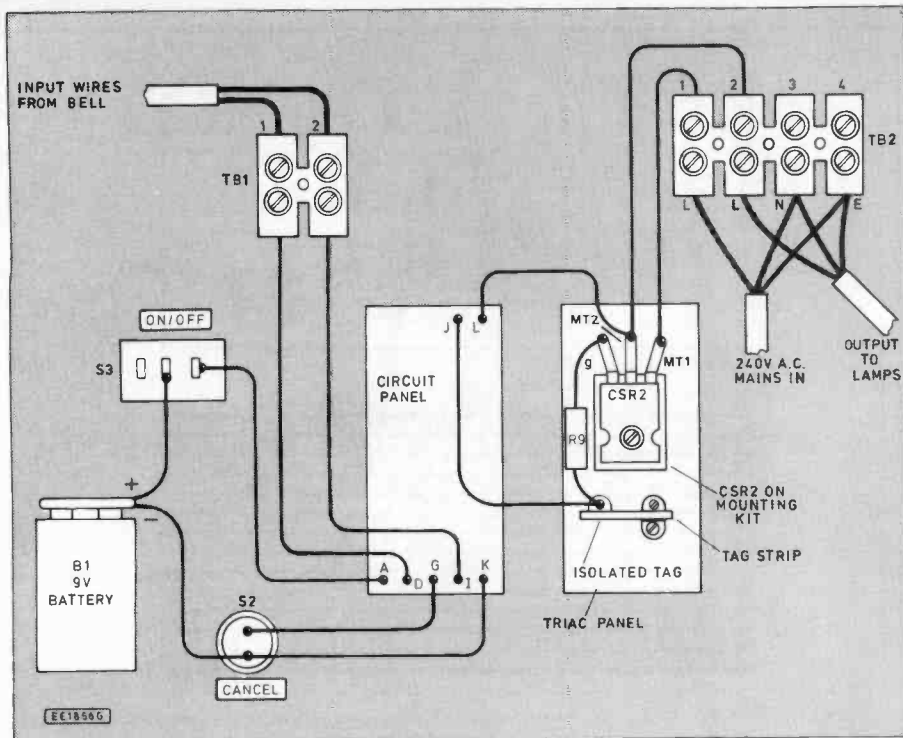

Fig. 3. Interwiring from the board and power triac to the switches, battery and terminal blocks.

over the polarities of D1, D2 and C2. Do not insert the i.c.'s themselves until the end of construction. Note that R9 is mounted on the separate triac panel later. Six-pin d.i.l. sockets are needed for IC1 and IC3. These are not available from all suppliers but 8-pin sockets may be filed down if necessary.

After a careful check for errors, solder 15cm pieces of light-duty stranded connecting wire to strips A, D, G, I and K along the left-hand side of the circuit panel as indicated. Connect 15cm light-duty mains type wires to IC3 pins four and six—these must be made **direct** to the i.c. pins on the underside of the circuit panel **not through copper strips**. The soldering here must be secure and carefully checked. **On no account may either wire contact pin five.**

Adjust VR1 sliding contact to approximately mid-track position and insert the i.c.'s into their holders with the correct orientation. Since IC2 is a CMOS device, it could be damaged by static charge on the body—to avoid this, insert it without touching the pins.

### CASE

A plastic case of the specified type must be used for safety reasons. Prepare the case by drilling holes for S3 (ON-OFF), S2

(CANCEL) and for terminal blocks TB1 and TB2. Note that although TB1 may be mounted inside the box since it is connected to the mains. Drill a small hole for the wires passing through the box to TB1. Drill two holes for the mains input and output wires, make the hole for the drawer-type battery holder (see photograph); mount these components.

Cut a piece of 18 s.w.g. sheet aluminium size 76×30mm. This is used as a heat sink for the triac so no other material should be used. Refer to Figs. 3 and 4 and mount the triac and two-way tag strip on it making sure that these do not touch. Note that a mounting kit must be used for CSR2 to isolate the metalwork from the mains. Bend the triac pins away from the panel and mount R9 between CSR2 gate and the **isolated tag** of the tag strip. Connect the wires leading from IC3 pins four and six to CSR2 main terminal, MT2, and the isolated tag respectively. Use similar wire to connect the triac main terminals, MT1 and MT2 to TB2/1 and TB2/2. Refer to Fig. 3 and complete all wiring.

Note that with some types of battery holder, a separate battery connector is needed—with others, placing the battery in the drawer makes the connection automat-

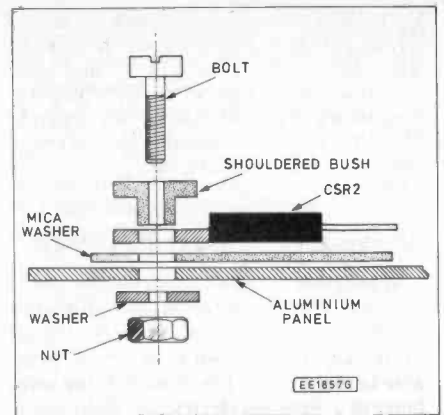

Fig. 4. Method of mounting the power triac on the heatsink using a mica insulating kit.

## COMPONENTS

**Shop  
Talk**

See page 193

### Resistors

R1	220
R2	56
R3, R4	1M (2 off)
R5, R6	100k (2 off)
R7	10M
R8	270
R9	220 1W

All, apart from R9, 0.25W±0.5%

### Potentiometer

VR1	1M sub-miniature vertical preset
-----	----------------------------------

### Capacitors

C1	100n monolithic ceramic
C2	47µ radial elec 16V
C3	220n monolithic ceramic

### Semiconductors

D1	1N4001
D2	BZY88C 12V Zener diode
CSR2	C206 3A triac
IC1	OPI 2046 single transistor opto-coupler
IC2	ICM 7556 CMOS dual timer
IC3	MOC 3020 optically-coupled triac

### Miscellaneous

B1	PP3 battery and drawer-type holder
S2	Miniature push-to-make switch
S3	Miniature SPST rocker switch

Plastic box size 146×76×46mm internal; 0.1 in. matrix stripboard size 13 strips×30 holes; 6-pin i.c. holders (2 off); 14-pin i.c. holder; TO220 mounting kit; 18 s.w.g. sheet aluminium; two-way tag strip; 3A terminal block—6 sections required; strain relief holders; lamps and mains wire as required.



Finished Call Alert showing the sliding battery drawer.

Approx. cost  
Guidance only

**£16**

ically. Make certain that, with the triac and circuit panels in position everything is secure, there is no possibility of any wires touching any other wires, touching the metalwork or breaking free. Check that S2 and S3 connections remain clear of everything else when the lid is on.

## CONNECTING TO THE MAINS

Begin by making the mains installation—it is essential to follow relevant regulations. Any reader who is unsure of being able to make a safe job must seek the assistance of a qualified electrician. Before connecting mains wiring, switch off at the fusebox. Connect the mains input wires to TB2 as shown—Live to TB2/1, Neutral to TB2/3 and Earth to TB2/4. Connect the output (to the lamps) Live to TB2/2, Neutral to TB2/3 and Earth to TB2/4. Strain relief for these wires must be provided inside the case.

A mains fuse of 3A rating must be placed in the fused outlet or mains plug. Fit the battery and replace the lid. Note that whenever the mains supply is connected, the lid of the case must be on. A drawer-type battery holder is specified so that the battery may be replaced without removing the lid.

Make the connections between TB1 and the bell. This may be carried out using any light-duty twin wire (e.g. "bell wire"). Note that these wires are connected across the low voltage bell itself *not* the bell-push or supply. Trial and error methods may be needed to locate the correct terminals inside the bell unit. If the bell is transformer-operated, the polarity does not

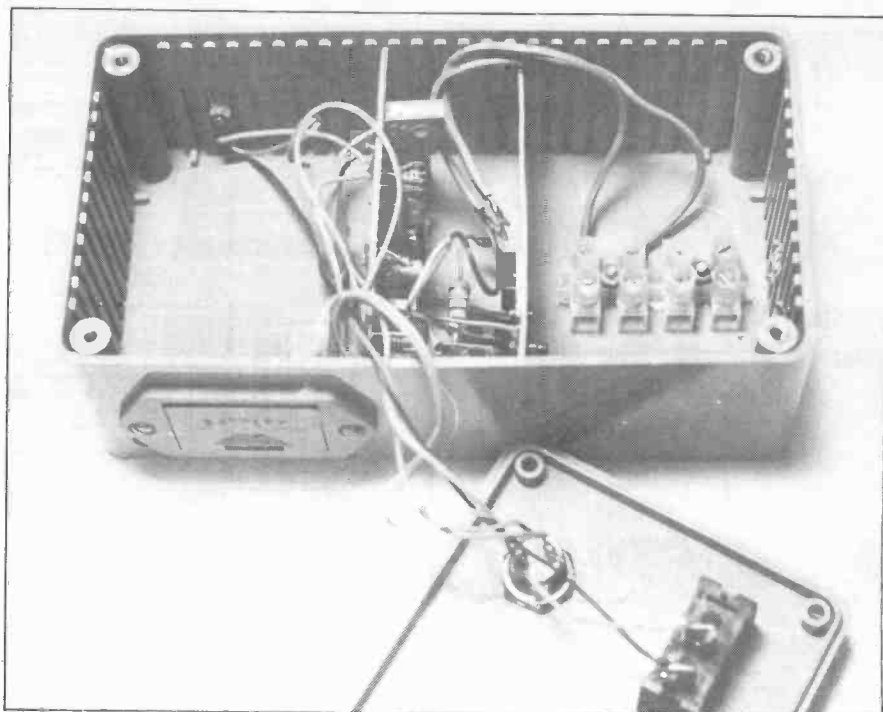

The completed alert, with lid removed, showing the circuit board and triac heatsink slotted in position.

matter. If it uses a battery, connect one way and test. If it fails to work, connect TB1 wires the other way round.

Switch on the mains then S3. This usually triggers the circuit—if so, press S2 (CANCEL). Operate the bell-push for an instant. The circuit should trigger and the light(s) come on and flash at two second intervals for 15 seconds approximately. If time adjustment is needed, isolate the circuit from the mains, remove the lid and

adjust VR1. Anticlockwise adjustment increases the operating time. If a longer time is required despite having adjusted VR1 sliding contact to maximum travel, increase the value of C2. The unit may then be put into permanent service. With certain types of traditional "make-and-break" bells and buzzers (not chimes) tested with the prototype some erratic flashing occurs while the bell push is actually being pressed—this effect may be ignored. □

**MINIATURE PASSIVE INFRARED SENSOR RP33**

Detects intrusion up to 12 Metres Away

Size: only 80x60x40mm. Wide 85° coverage. Switchable detection indicator.

This advanced intrusion detector operates by detecting the body heat of an intruder moving within the detection field whilst ignoring ambient changes. Easily installed in a room or hallway, the unit provides reliable detection of any intrusion. Operating from a 12V supply and requiring only 15mA, it is ideal for use with the CA 1382 or any equivalent high quality control unit. Supplied with full instructions its performance compares with detectors costing more than twice the price.

**ONLY £23.95 + VAT**  
Quantity discounts start at 3 units

# SECURITY

SYSTEMS, MODULES, COMPONENTS

## SAVE ££££'s

BY INSTALLING YOURSELF OR SEND FOR FREE LITERATURE TODAY

**CA 1382 ADVANCED CONTROL UNIT that's simple to install and operate.**

- Fully automatic siren re-set.
- Audible entry/exit warning.
- Alarm sounded memory.
- 2 separate loop inputs + 24hr circuits.
- Built-in electronic siren driver.
- Easily installed, full instructions supplied.

The latest control panel provides effective and reliable control for all types of security installations. Its advanced circuitry checks the loop circuits every time it is switched on, preventing incorrect members of the family. In addition it provides 24hr. personal attack protection. Housed in a steel case, it is supplied with full operating instructions.

Available in kit form with fully-built electronics, £39.95 + VAT.

Only **£44.95 + VAT**

**INFRARED SYSTEM IR 1470**

Consists of a separate transmitter & receiver, the system provides an invisible modulated beam which when broken operates the built-in relay. For use with security systems, but also ideal for photographic purposes and industrial applications.

Size: 80x50x35mm.

Only **£25.61 + VAT**

**CPU 9000 SELF-CONTAINED ALARM SYSTEM**

Immediate Security Without Installation For Homes, Storerooms, Clubhouses, Caravans, etc.

- Detects intruders up to 30ft.
- Penetrating 103db Siren with auto reset
- Compact size only 203x180x78mm
- Easily extended for coverage of additional rooms or large areas.

This exciting new System which contains a Passive Infra-Red Sensor, Control Unit and Power Supply, together with a high output Siren all housed in the one compact steel case, provides immediate protection of a chosen area without the need for costly wiring and expensive installation costs. Operating from a standard 240V supply, provision has been made to incorporate a re-chargable 12V battery which is capable of operating the System for up to 10 days before re-charging becomes necessary, and which is carried out by the built-in charger. Where protection of more than one room is required, additional sensors may be wired to the main unit. An external siren unit may also be fitted to warn neighbours. Supplied with 2 keys and full operating instructions, the unit is fully guaranteed for 12 months. Immediate protection for only:

**Priced £67.72 + VAT**

**CA 1250 LOW COST ALARM CONTROL MODULE**

This tried and tested control unit represents the finest value for money in control systems, providing the following features:

- Built-in electronic siren drives 2 loudspeakers
- Provides exit and entrance delays together with fixed alarm time
- Battery back-up with trickle charge facility
- Operates with magnetic switches, pressure pads, ultrasonic or I.R. units
- Anti-tamper and panic facility
- Stabilised output voltage
- 2 operating modes full alarm anti tamper and panic facility
- Screw connections for ease of installation
- Separate relay contracts for external loads
- Test loop facility.

Price **£19.95 + VAT**

**DIGITAL ULTRASONIC DETECTOR US 5063**

This advanced module uses crystal control transmitter and digital signal processing to detect movement at distances of up to 20ft or more. With built-in timing and 12V operation, it is ideal for a wide range of security applications.

Only **£13.95 + VAT**. Suitable steel enclosure complete with necessary mounting pillars and fittings.

Only **£2.95 + VAT**

**Lighting Controller DP 3570**

This versatile module provides timed switching of loads up to 3A for pre-set times between 10 secs and 5 mins, the timed period being triggered by the opening or closing of an external loop or switch. The built-in 12V 250mA power supply is available for operating external sensors. Suitable plastic enclosure £2.85 + VAT

Only **£13.95 + VAT**

**HW 1250—ATTRACTIVE HOUSING PLUS HARDWARE FOR CA 1250**

An attractive steel case designed to house the Control Unit CA 1250 together with the appropriate LED indicators and key switch (available separately). Supplied with the necessary pillars, fixings, and punched front panel, the unit is given a professional appearance by the adhesive silk screened label. Size 200x180x700mm.

Only **£9.50 + VAT**

**POWER SUPPLY & MAINS SWITCHING UNIT PS 1265**

In addition to providing 12V stabilised output of 700mA, this module may be used to provide a switched 240V output for operating security lighting etc. when used in conjunction with the CA 1382, CA 1250, CPU 9000 etc. Suitable plastic enclosure £2.85 + VAT.

Priced at **£12.95 + VAT**.

**RISCOMP LIMITED** Callers by Appointment Office hours Mon-Fri 9am-5pm

Dept EE3, 51 Poppy Road Princes Risborough, Bucks HP17 9DB

## The Security Specialist

F&P U.K. Orders 75p per order Export add 10% Tel: (084 44) 6326 Fax: 08444 7102

ORDER BY MAIL OR TELEPHONE

# SUPER FILTER

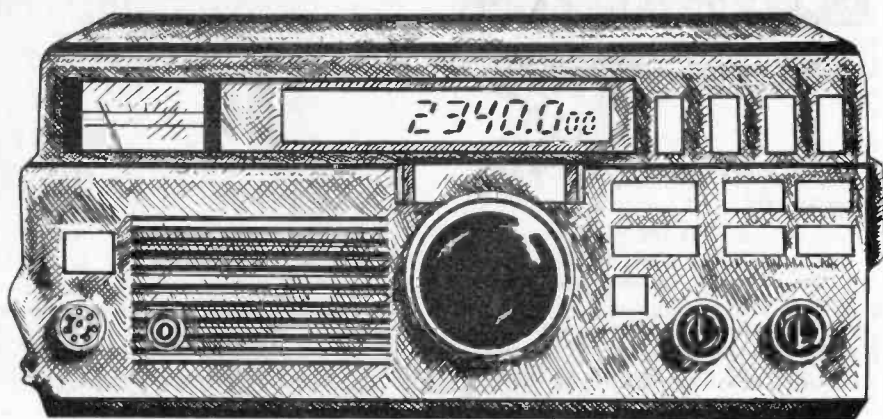

**MARK STUART**

*A universal filter suitable for use with audio equipment, radios, CBs, amateur transceivers etc.*

**T**HIS project has many applications where h.f. and v.h.f. radios are in use. It consists of a block containing twelve separate low pass filters which remove interference from leads passing through them. Its main application is in removing power line interference, and interference picked up by speaker leads, from motor vehicle and domestic CBs, amateur transceivers (especially 144MHz) and v.h.f. stereo receivers and hi-fi systems.

## CIRCUIT

The circuit diagram of the unit which is very simple is shown in Fig. 1. The block filter contains twelve identical "pi" sections

each consisting of two shunt capacitors and a series inductor. The term "pi" is used for this type of filter because the components form the shape of the Greek letter "pi" ( $\pi$ ). Fig. 1a shows the circuit of each section of the filter. The two capacitors are identical and are each 2,500p. The operation of the filter is easily explained if it is first understood that at high frequencies a capacitor approximates a short circuit and an inductor and open circuit.

Interference approaching one end of the filter is first short circuited to earth by C1. Any that remains cannot pass through to the other side because of L1, which acts like an open circuit. Finally C2 short circuits any remaining high frequency inter-

ference to earth. In practice the capacitors are not perfect short circuits, and the inductor is not a perfect open circuit. The interference cannot be reduced completely to zero but is reduced by a substantial amount.

This particular filter reduces interference at CB and v.h.f. frequencies by at least 50dB which corresponds to a voltage reduction of greater than 300 to 1.

At d.c. and audio frequencies C1 and C2 have an impedance of several thousand ohms and L1 an impedance of 0.01 ohm. Their effect is thus negligible and so power and audio signals pass without any difficulty. The rejection of the filter begins to act at 2MHz and is fully effective from 20MHz right up to 1GHz.

## CONSTRUCTION

The aim of the prototype was to make installation and construction as simple as

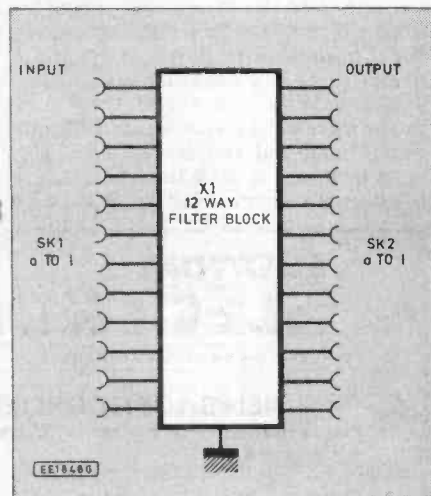
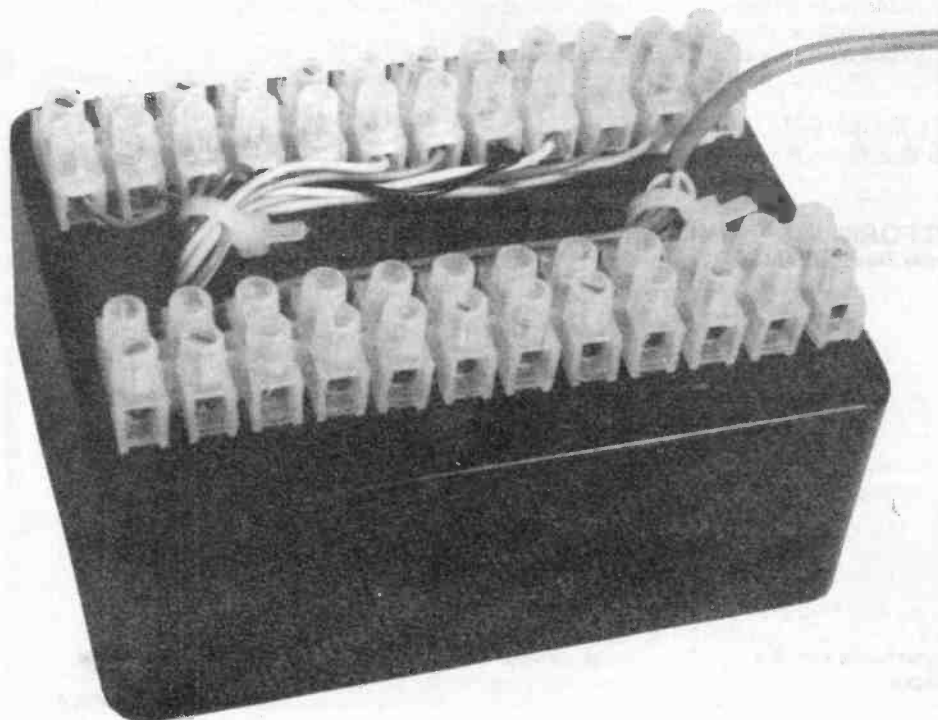
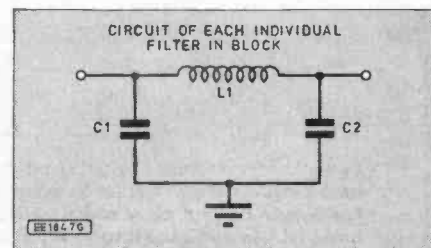

Fig. 1a (above). The circuit of the Super Filter. 1b (below) one  $\pi$  filter section.





# COMPONENTS

## Shop Talk

See page 193

- X1 Filter block type 1206-502
- SK1, Sk2 12 Way terminal blocks (2 off)

Grommets 2; aluminium panel 33x72mm—18 s.w.g.; M3 screws (2 off); M3 nuts (2 off); self tapping screws No 6x8mm (8 off); M4 nut; M4 screw; M4 solder tag; 7/0.2 wire 300mm each of 12 colours; 16/0.2 wire 200mm green; plastic case size 100x76x40 with p.c.b. guides; sleeving 500mm of 3mm dia.

Approx. cost  
Guidance only

# £6

possible. The filter block was secured to a small aluminium plate that could be slid into the guide slots of a small plastic case. Fig. 2 shows the dimensions and drilling details for the plate to fit the box specified. Other cases, including metal ones, may be used and the mounting plate varied to suit.

The two ends of the filter block are marked with letters and numbers that enable each individual filter to be identified. Twelve lengths of approximately 150mm of 7/0.2 wire are soldered to the tags on each end of the filter block and brought out of the case at opposite ends via small grommets—see photo.

If possible, twelve different colours of wire should be used to help with identification. If this is not possible, and only one colour is used the ends can be sorted out using a battery and bulb, or a multimeter. Wires from the filter block are connected to two twelve way terminal blocks, one for input and the other for output. On the prototype these blocks were separated by just over 25mm, and two sets of wires kept apart by means of cable ties. If the filter is to be used in more exacting situations it

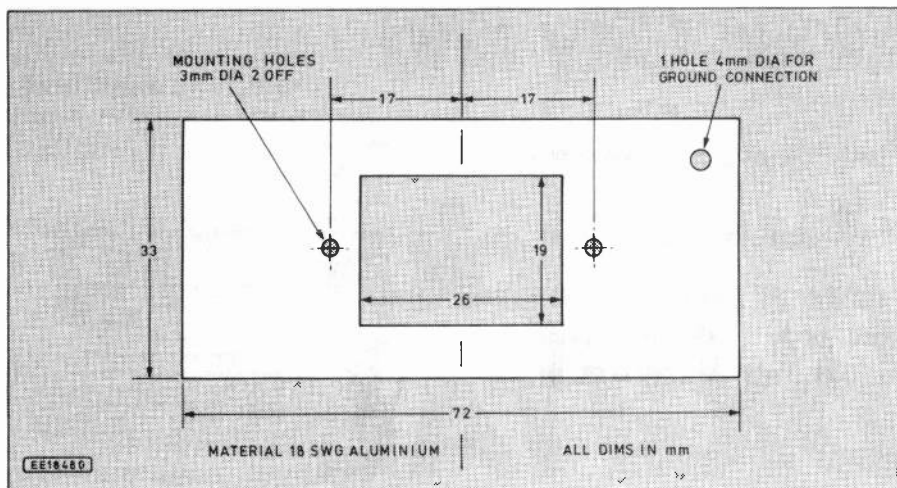

Fig. 2. Details of the mounting plate.

would be wise to use a metal screen between the input and output wires.

The most important connection to the filter is the ground connection made to the body of the block. In the prototype a short length of thicker wire was used with a spade connector attached. At high frequencies the performance of the filter is very dependent upon a good connection. The best way to ensure this is to use a metal case and bolt it firmly to the car body or to the back of the radio or amplifier in the case of a domestic installation.

### IN USE

The ideal way to reduce interference is to ensure that all leads entering or leaving the equipment are filtered. This is quite straightforward with this unit, and up to 12 separate leads can be attached. It is very important to filter speaker leads, as a great deal of interference can be picked up by these and passed into the system via the output circuits. In vehicle use it is most important to filter the power leads and speaker leads.

The availability of twelve channels allows one filter to be used by several pieces of equipment. The filter specified has a current rating of 10 amps and a voltage rating of 350V d.c. This should be adequate for most applications, including its possible use on the h.t. lines of valve

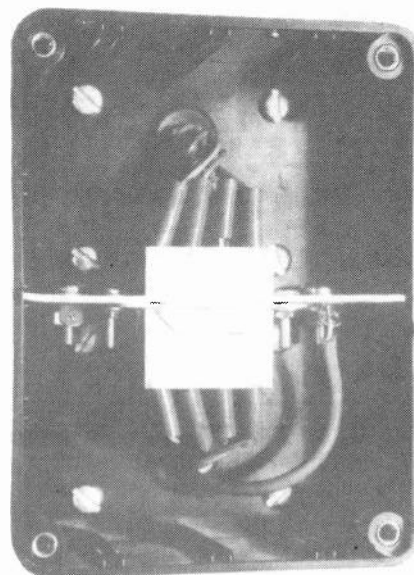

receivers. Note though that the unit must not be used for mains filtering.

Finally, there are some types of interference that are extremely difficult to remove. In particular, interference which enters via the aerial. This type of filter will have no benefit whatsoever in this case. If this is happening the only way to cure the problem is to suppress the interference source. □

## EVERYDAY ELECTRONICS

INCORPORATING ELECTRONICS MONTHLY

### NEWSAGENT ORDER FORM

Please reserve/deliver a copy of **Everyday Electronics** for me each month.

Signed .....

Name and Address .....  
(BLOCK CAPITALS PLEASE)

.....

.....

Everyday Electronics is published on the first Friday of each month and distributed by Seymour.  
Make sure of your copy of EE each month—cut out this form, fill it in and hand it to your newsagent.

## EVERYDAY ELECTRONICS

### SUBSCRIPTION ORDER FORM

Annual subscription rates (1989): UK £15.70. Overseas £19 (surface mail) £36 (air mail)  
To: Everyday Electronics, Subs. Dept., 6 Church Street, Wimborne, Dorset BH21 1JH.

Name .....

Address .....

.....

I enclose payment of £ ..... (cheque/PO in £ sterling

only payable to Everyday Electronics)

Access or Barclaycard No.

.....

Signature ..... Card Expiry Date .....

Please supply name and address of card-holder if different from the subscription address shown above.

Subscriptions can only start with the next available issue. For back numbers see the Editorial page.



# Introducing DIGITAL ELECTRONICS

## Part 6: Circuit Assembly plus Switches and Relays

By **Michael J. Cockcroft**  
Training Manager, Peterborough ITeC

**W**E now finish off the section on Circuit Assembly before moving to the meat of part 6: Switches and Relays.

### A Case Study

In this "case study" we will build and test the light sensor circuit from Appendix D of the City and Guilds Resource Document. The circuit diagram for this is in Fig. 5.15b (last month) and the components are from the list in the booklet given free with the October '88 issue (you don't need to buy a 6V bulb, it works with the 12V one). *Note: The October issue has now sold out but we can supply photostats of the article and booklet for £1.50 including P&P (£2 to overseas addresses).*

The stripboard layout for the circuit is given in Fig. 6.1. Use this layout and the steps of Fig. 6.2 to build the circuit (do not connect power to it yet). When the circuit is assembled inspect all the joints for shorts and poor soldered joints. Remove any shorts and solder any poor joints again. Using a multimeter on the x1 Ohms range or a continuity tester, check that the following connections are made:

- 2N3053 (base) to ORP 12 (a)
- 2N3053 (emitter) to Batt (-)
- 2N3053 (collector) to Bulb (a)
- ORP 12 (a) to 10k Resistor (a)
- ORP 12 (b) to Batt (-)
- 10k Resistor (b) to Batt (+)
- Bulb (b) to Batt (+)

Once all connections are correct, connect 6 volts to the +ve and -ve wires. The bulb should illuminate but not very brightly. The light dependent resistor (ORP 12) reacts to light; if you block the light to it with your hand it will cause the bulb to shine a little brighter. Put your thumb directly over the face of the

l.d.r. and then remove it while you watch the bulb.

### Exercises

1. Devise a component layout for the breadboard construction of any one of the remaining circuits of Fig. 5.15.

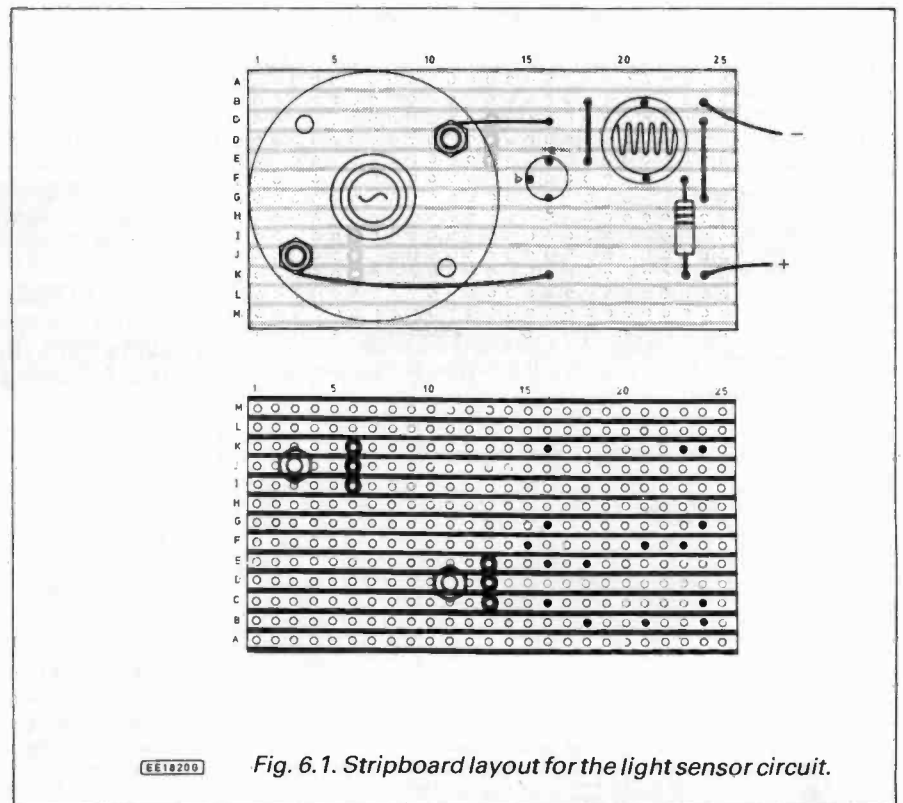

Fig. 6.1. Stripboard layout for the light sensor circuit.

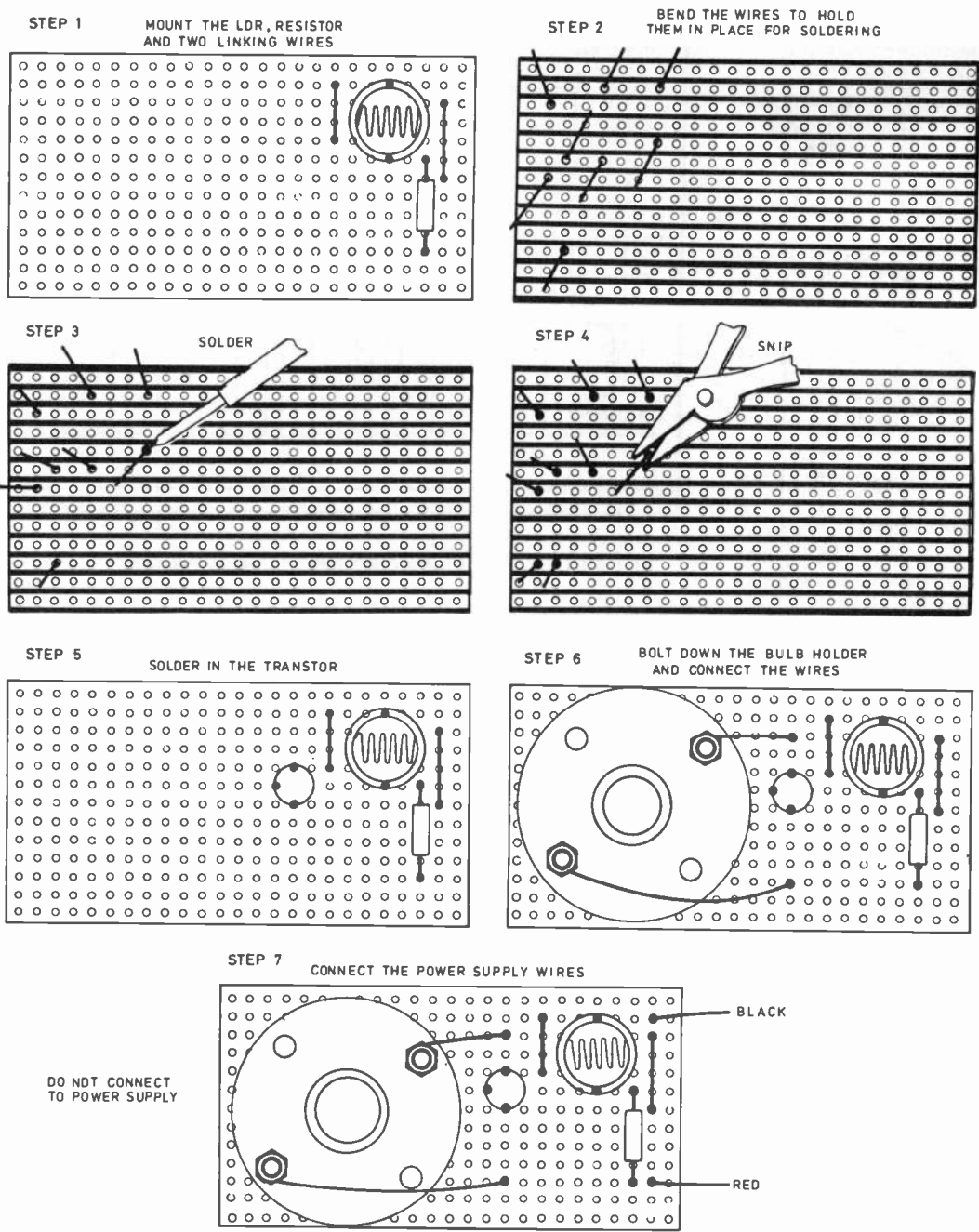
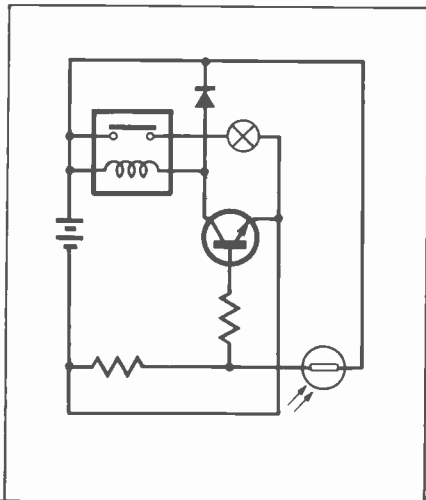

Fig. 6.2. Construction steps to build the light sensor.

2. Use standard conventions to re-draw the following circuit diagram.



3. **Logic Testing:** Using the "Pencilbox", and the Pencilbox block diagram, (or a similar logic tutor) follow the instructions set out over the page. Each time you are asked to take a measurement, do so using *all* of the following instruments:

- (a) Analogue meter
- (b) Digital meter
- (c) Oscilloscope
- (d) TTL Logic probe
- (e) CMOS Logic probe

Please write down your results and observations after carrying out each instruction and conclude with a summary of the whole exercise.

**Note** that integrated circuit pin numbers are included in the diagram.

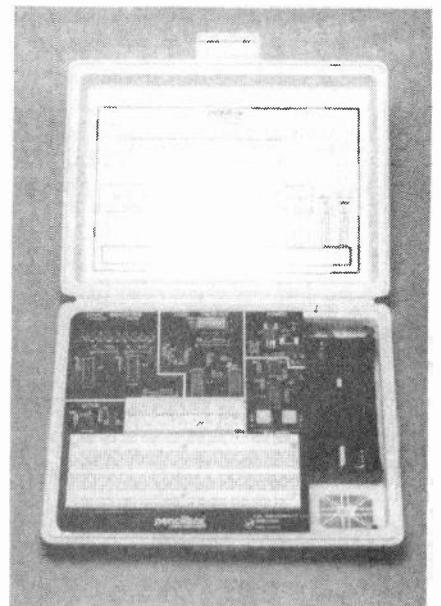

**INSTRUCTIONS**

Measure the supply rail voltage from the interconnect socket.

Set up a pattern of logic switches and measure the signal voltages at the outputs (pins 3, 5, 7 and 9) of the 74LS367 buffers.

These are TTL outputs.

Set up a pattern of signals at the inputs of the 4042 latches and measure the signal voltages at the outputs (pins 3, 9, 12 and 15).

These are CMOS outputs.

Measure the signal at "clock out" from the interconnect socket.

What is its frequency, amplitude and duty cycle?

Insert a 100n (disk ceramic) capacitor between EXT CAP- and EXT CAP+ and measure the clock out signal again.

What is the difference?

4. Follow the instructions below for a "latch exercise".

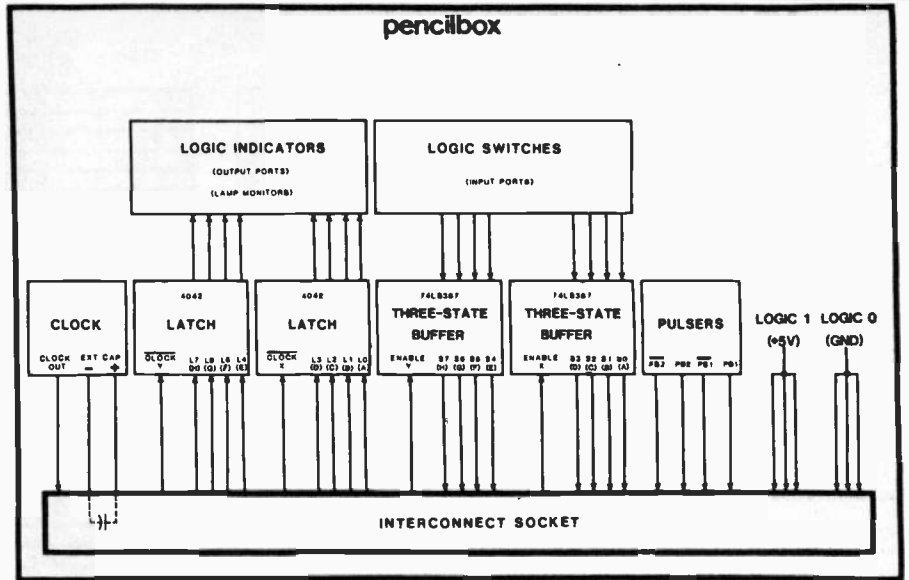

Block diagram of the Pencilbox—this appears in the lid of the box.

**INSTRUCTIONS**

Switch the unit on at the slide switch on the top right hand side of the printed circuit board.

**COMMENTS**

All eight l.e.d. indicators should be off.

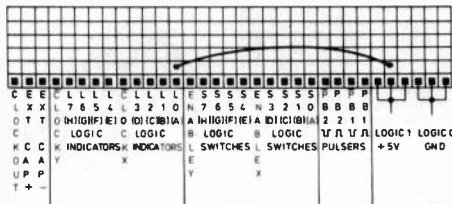

Link "LO" to "LOGIC1" on the interconnect socket.

This means make a wire connection between the two stated points. The l.e.d. "D0" should light up, all others should be off.

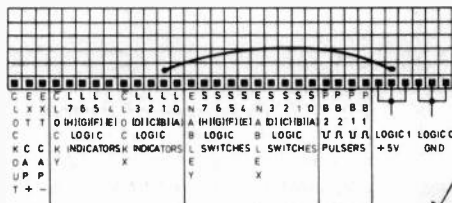

Move the linking wire to "L1".

L.E.D. "D1" should light up. All others should be off.

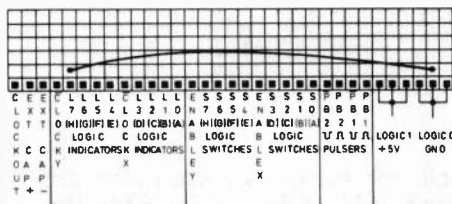

Test all other signals "L2" to "L7" in a similar fashion.

What happens if you move the other end of the linking wire to LOGIC0?

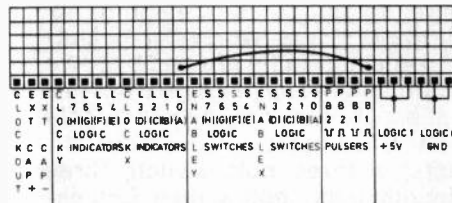

Move the linking wire to make a connection between "LO" and "PB1".

Depress "PB1"—what happens?

Move the linking wire to PB1.

Now what happens when you press PB1.

Repeat the above exercise using PB2 and PB2.

Remove the linking wire.

Link "LO" to "SO" and set all the logic switches to the up position.

Set "Switch 1" down—what happens?

Link all the remaining switches (S1 to S7) to corresponding l.e.d.s (L1 to L7).

Move the remaining switch down. (DO NOT USE A PEN OR PENCIL TO CHANGE THE SWITCH SETTINGS). Leave the wires connected.

Link "CLOCK X" to PB1" and "CLOCK Y" to "PB2".

You are setting up for a "latch" exercise.

Set four switches in the up position and four switches down. Press PB1 first and then PB2.

What happens?

Set these four switches in the down position now and the remaining four switches up (i.e. reverse all the switches). Press PB1 first and then PB2.

What is the function of the latches? What is the purpose of the two push buttons in this exercise.

Continued

Move the two linking wires connected to the push button switches from "CLOCK X" and "CLOCK Y" to "ENABLE X" and "ENABLE Y" respectively. Set all 8 logic switches up.

Press and hold PB1.

Release PB1. What happens?

Press and hold PB2.

Release PB2. What happens?

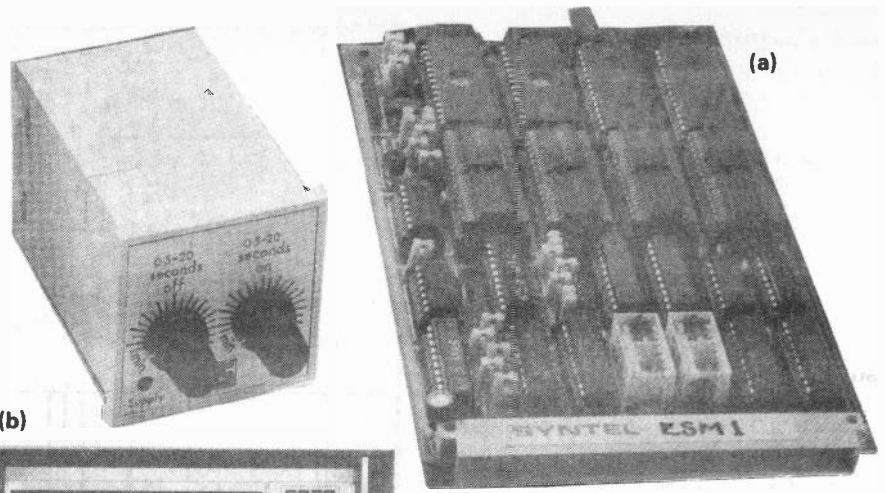

## Switches and Relays

This section of the course, which covers the following City and Guilds objectives, brings us half-way through the series and approximately halfway through the teaching material leading to the 726/301 certificate:

### 4.1 Switches and Relays

4.1.1 Describe the action of each of the following types of switch:

Single-pole single-throw toggle (s.p.s.t.)

Single-pole double throw toggle (s.p.d.t.)

Double-pole double throw toggle (d.p.d.t.)

Double-pole single throw toggle (d.p.s.t.)

Slide (as above)

Multi-way single and multi-pole rotary

Thumbwheel rotary

Dual-in-line (d.i.l.)

4.1.2 Describe the action of each of the following types of relay:

D.I.L. reed relays (s.p.s.t. and s.p.c.o.)

Miniature p.c.b. mounting (single and multi-pole types)

4.1.3 Describe at least THREE common applications of switches and relays.

There are hundreds of varieties of switches and relays. This month we will take a broad look at some of the most common types and configurations. We will also investigate the internal workings of relays and look into their application.

## Switches

In the broadest sense, switches may be selected for the way in which they will be attached to the intended product, Fig. 6.3 gives some examples: mounted on printed circuit boards (a), mounted on the panels of instrument housings (b), built into keyboards and keypads (c) remote from the equipment (d).

For all these applications there are many types of switch; some of the most common, are "rocker",

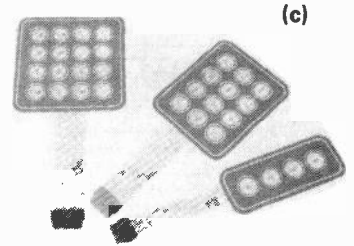
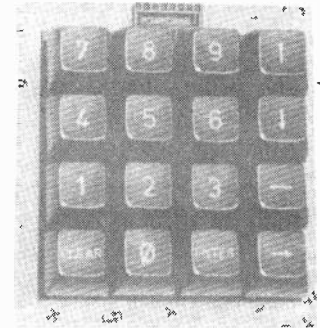
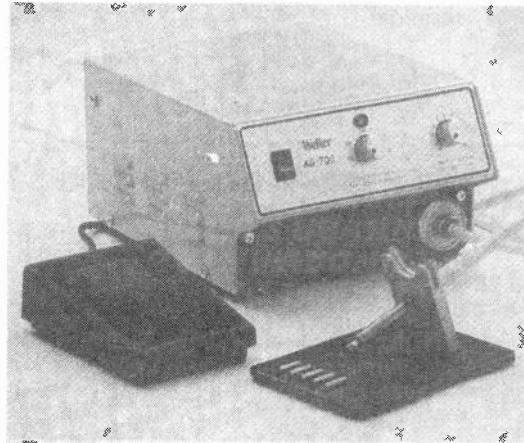
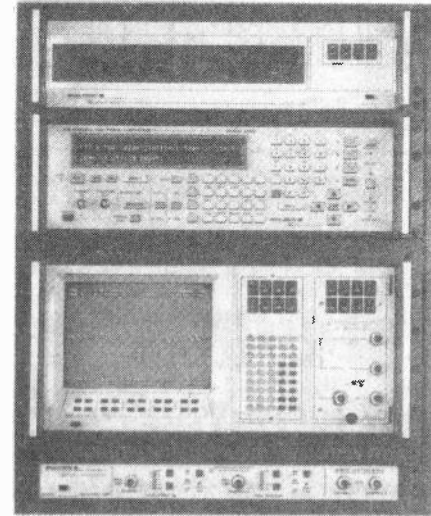

Fig. 6.3. Examples of switch mounting: (a) printed circuit board (b) panel mounted (c) keyboards (d) remote—e.g. footswitch.

"toggle", "slide", "push-button", and "rotary"—a range of which are depicted in Fig. 6.4. Apart from a variety of physical sizes for all types of switch (miniature, sub-miniature, ultra-miniature etc.) many have special features: heavy or light duty, low profile, waterproof, environmentally sealed [to protect the contacts from moisture, vapour, dirt etc.], illuminated [to indicate when activated].

The purpose of the switch is to make (close) or break (open) a circuit. If a switch is activated to "make" a circuit, the switch is said to have "normally open" contacts. If, on the other hand, the switch is activated to "break" a circuit, the switch has "normally closed" contacts. The push button switch sym-

bols for these two examples are given in Fig. 6.5a and Fig. 6.5b. The third symbol in the diagram (c) shows how the two switches (sets of contacts, really) of a and b can be combined in one package to form a double pole switch. A double pole switch can make or break two circuits; a three pole switch, three circuits; a four pole switch, four circuits . . . and so on.

As illustrated in Fig. 6.6, by using only two of the four double pole push button switch terminals, it may be used as either a push to make or as a push to break switch, depending on which pair of contacts (top or bottom pair of the symbol in Fig. 6.5c) are used. It can also, as shown in Fig. 6.6c, be used to make one circuit and break another.

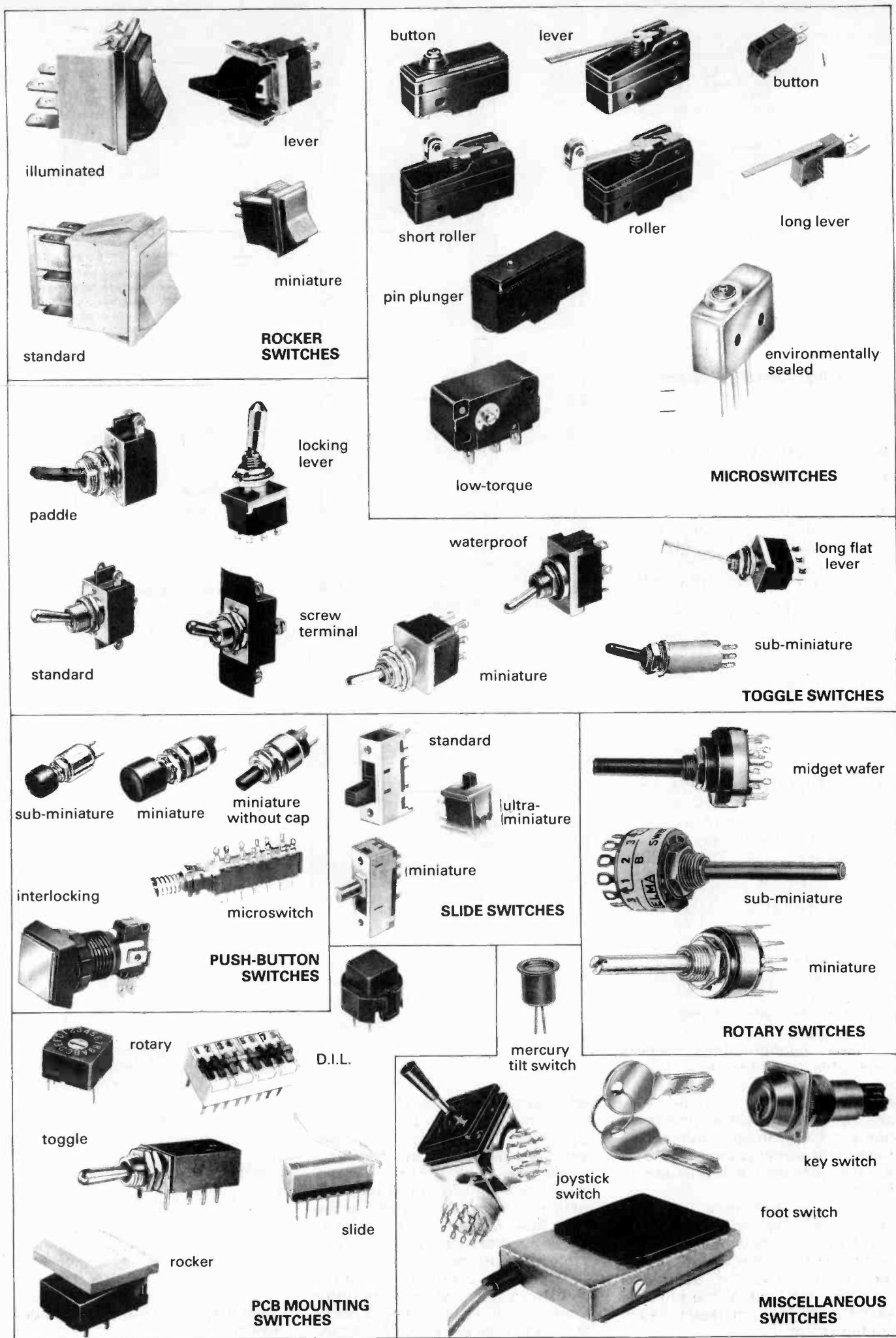

Fig. 6.4. Examples of switches.

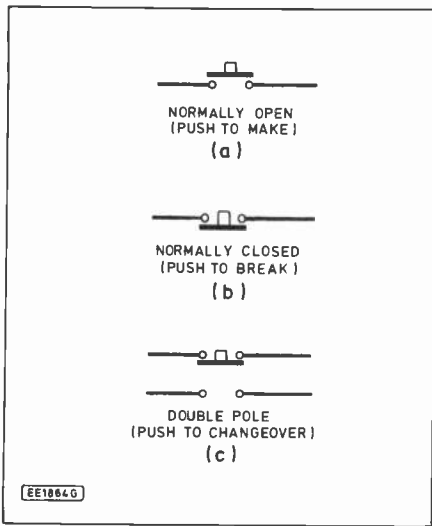

Fig. 6.5. Pushbutton switches.

### Push-Button Switch Action

When push-button switches are depressed they operate in one of two modes: they are either "momentary action" or "latching action" (sometimes called "alternate action"). Momentary action switches only remain activated for as long as the operating force is applied. Latching action switches toggle to the opposite state (either from off to on or from on to off) each time the operating force is applied.

### Switch Configurations

We used a particular type of rocker switch as part of an experiment in Part 1, the symbol for which is given in Fig. 6.7a. This is one of four basic switch configurations, namely:

- (a) Single pole single throw (s.p.s.t.)
- (b) Single pole double throw (s.p.d.t.)
- (c) Double pole single throw (d.p.s.t.)
- (d) Double pole double throw (d.p.d.t.)

These configurations, where applicable, are the same for all types of switch (rocker, push-button etc.) but the symbols vary accordingly. The symbols in Fig. 6.7 apply to the toggle and rocker types, and some example symbols for the slide switch are shown in Fig. 6.8.

These symbols may be interpreted with the aid of Table 6.1 which indicates how many "poles" and how many "throws" a particular switch allows. Fig. 6.9 shows how the terminals of the physical switches might be marked for each configuration.

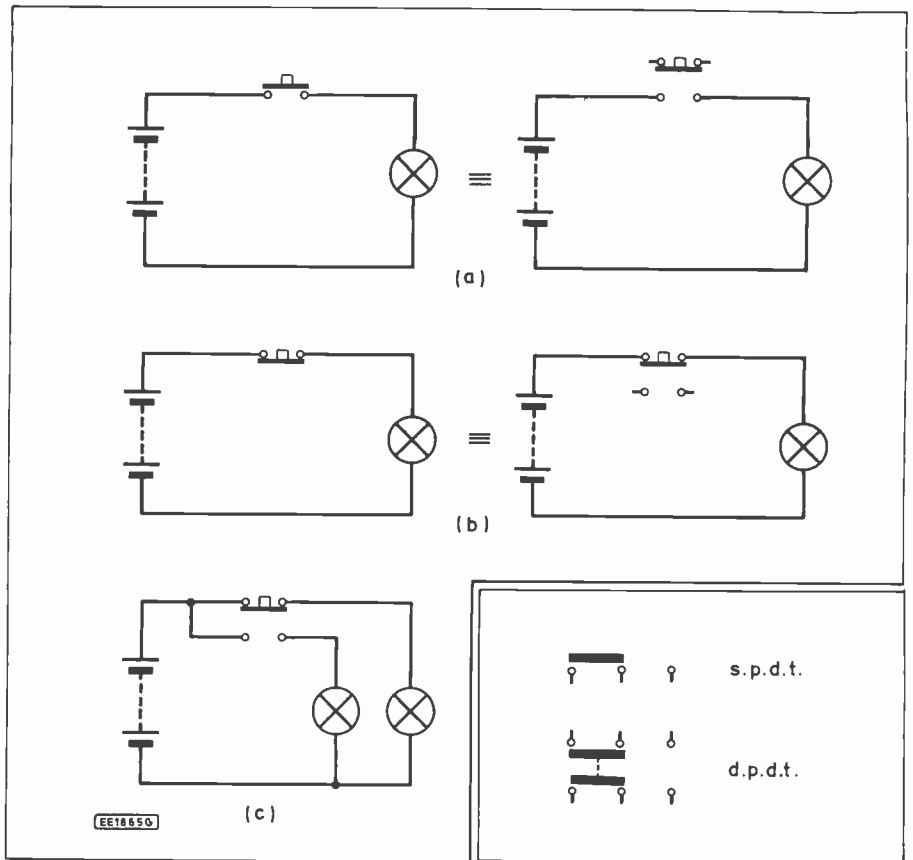

Fig. 6.6 Examples of the use of pushbutton switches.

Fig. 6.8. Slide switch examples.

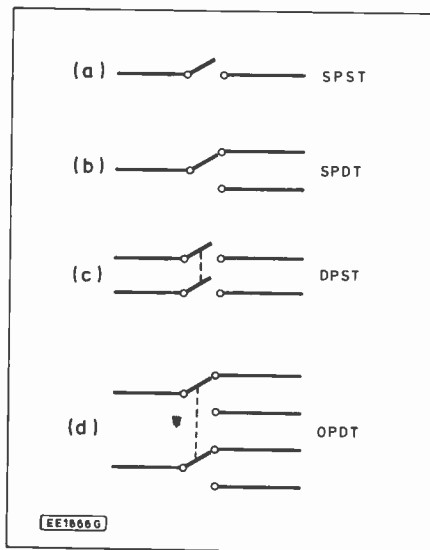

Fig. 6.7. Various rocker switches.

### Rotary Switches

Rotary switches are used for applications requiring more than two "throws". The symbol for a single pole 12 position rotary switch is given in Fig. 6.10a. This switch is capable of switching current from one circuit to any of 12 other circuits by rotating the knob from one position to another.

The most common configurations for rotary switches are single pole 12 way, 2 pole 6 way, 3 pole 4 way, and 4 pole 3 way. The reason

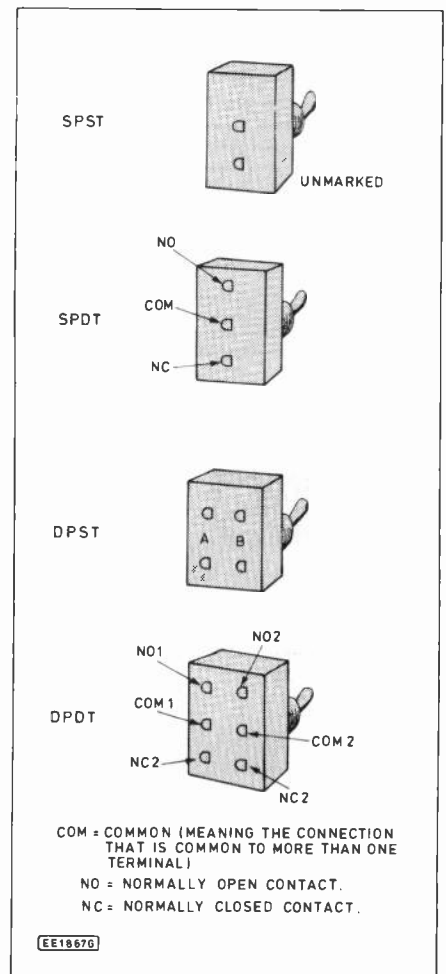

Fig. 6.9. Terminal markings on toggle switches.

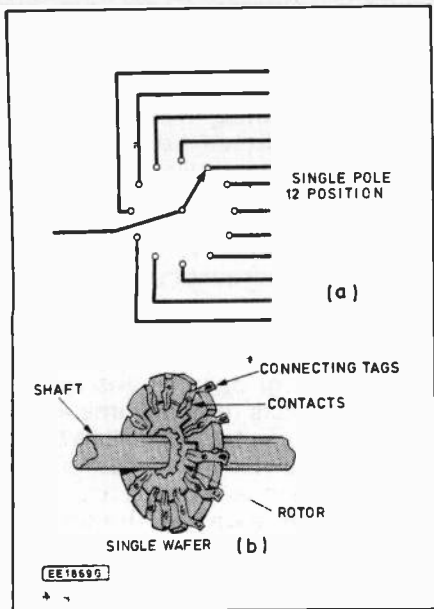

Fig. 6.10. A 12 way single pole rotary switch.

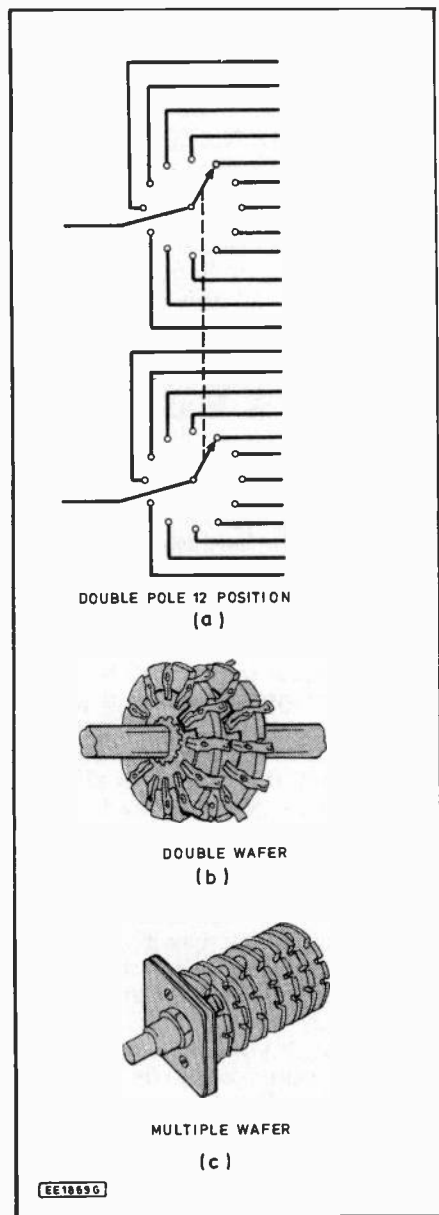

Fig. 6.11. A double pole 12 way rotary switch and (c) a multiple wafer rotary switch.

TABLE 6.1

Switch type	How many poles?	How many throws?	How many physical connections?	Comments
S.P.S.T.	1	1	2	Can only make or break one circuit
S.P.D.T.	1	2	3	Can switch the current flowing in one circuit between two circuits
D.P.S.T.	2	1	4	Can make or break two circuits at one time
S.P.D.T.	2	2	6	Can switch the current flowing in two circuits to two different circuits

for this is that it is possible for them all to have the same basic construction with different rotor plates (see Fig. 6.10b).

If more "poles" or more "throws" are required, wafers can be "ganged" to achieve it; for example, a 2 pole 12 way switch, the symbol for which is in Fig. 6.11a, can be made by ganging two single pole 12 way wafers, as shown in Fig. 6.11b. In practice, the shaft assembly and wafers can be bought separately so that complex structures can be produced (Fig. 6.11c).

### Relays

The relay is another kind of switch, a switch that is operated electrically. A variety of relays are shown in Fig. 6.12 and an example of the use of a relay is given in Fig. 6.13. This shows how a relay can be used in a low d.c. voltage electronic circuit to operate a high voltage a.c. (mains) appliance.

Since relays are switches the same configuration that we have already discussed for manual switches apply but note the following differences in terminology:

- single pole single throw contacts are referred to as single pole make or single pole on-off contacts (Fig. 6.14a).
- single pole double throw contacts are referred to as single pole change-over (s.p.c.o.) contacts (Fig. 6.14b).
- double pole single throw contacts are referred to as double pole make or double pole on-off contacts (Fig. 6.14c).
- double pole double throw contacts are referred to as double pole change-over (d.p.c.o.) contacts (Fig. 6.14d).

Note also, from Fig. 6.15, the different way in which the relay switch contacts are represented in circuit diagrams.

The main difference between relays and switches is in the applied operating force: relays are operated, directly or indirectly, by magnetically opening and closing

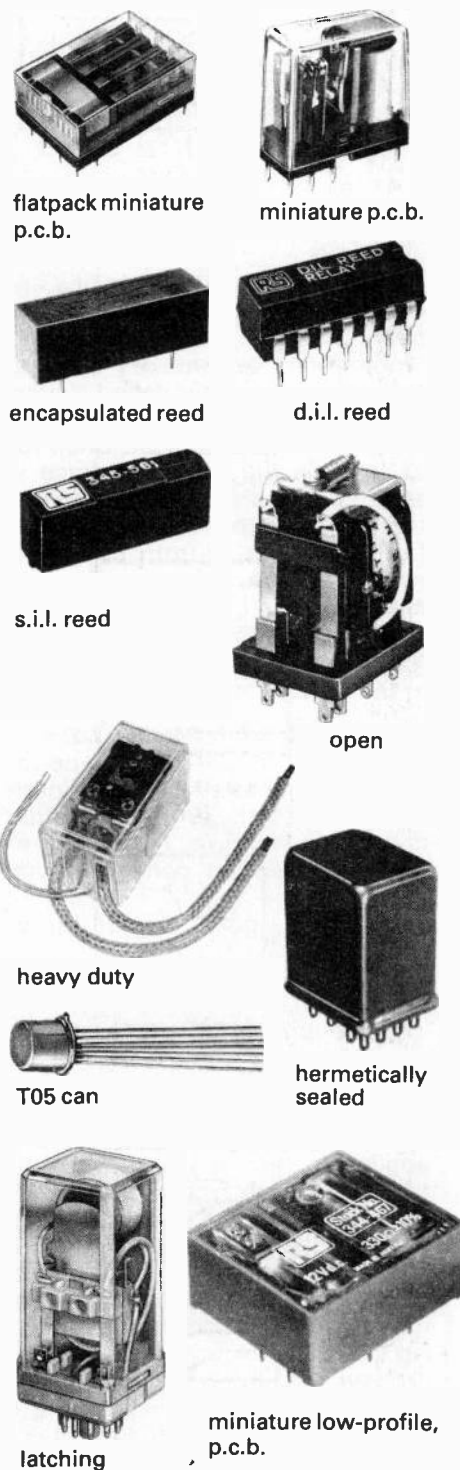
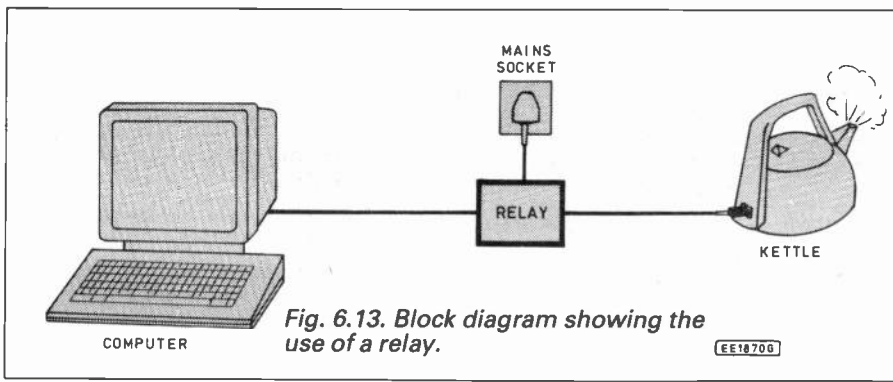

Fig. 6.12. Various relays.





switch contacts. There are two types of magnet—the ordinary (permanent) magnet and the electromagnet; the reed relay serves us well in illustrating the operation of a relay since it can be operated by both types. Fig. 6.16 shows how the reed relay contacts are closed by physically bringing them into the magnetic field surrounding an operating magnet or operating coil (electromagnet).

Permanent magnets are familiar to us all; however, the electromagnets used for opening and closing relay contacts require some explanation. An electromagnet is a bar or rod of soft iron with a coil of wire wrapped around it; when an electric current is passed through the coil the soft iron becomes a magnet.

To understand this consider, first, what happens when a current is passed through the straight conductor of Fig. 6.17a: a magnetic field is created around the conductor. The conductor becomes a magnet, not a very strong magnet but one which has exactly the same properties (for as long as current flows through the wire) as an ordinary magnet. Notice how the lines of force are spread a fixed distance apart.

We can increase the strength of the magnetic field around this same conductor by coiling it, as shown, in Fig. 6.17b, all the lines of force assist each other in creating a magnetic field in the space between them. A horseshoe magnet is stronger than a bar magnet for exactly the same reason (Fig. 6.18). In fact, the more coils there are in the conductor and the closer they are wound together, the stronger the magnetic field becomes. Such a coil is called a **solenoid**.

The strength of the magnetic field can be increased further still by wrapping this conductor around a soft iron bar (Fig. 6.17d) to form an electromagnet. Just as a point of interest, not only does passing a current through a coil of wire create a magnet, the reverse is also true: passing a magnet through a coil of wire creates a current (Fig. 6.17e).

If you have purchased the parts for this course, wire up the PP3 battery to the coil contacts of the relay via a push button switch (as in Fig. 6.19). Depress the switch a number of times and listen for the "click" of the relay contacts as they close together. If your relay has a transparent outer case (it may look something like the one in Fig. 6.20) you will be able to see the contacts opening and closing. When current passes through the coil the soft iron core magnetically attracts the metal bar, the bar rocks on the pivot and pushes the relay contacts together.

The contacts of this relay may

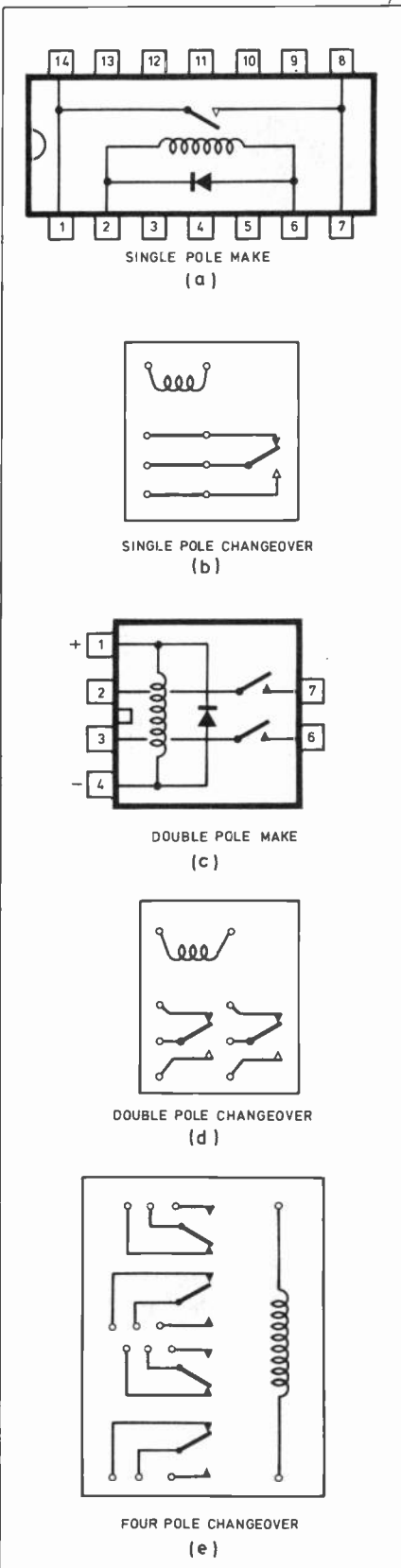

Fig. 6.14 (left). Various relay contact arrangements.

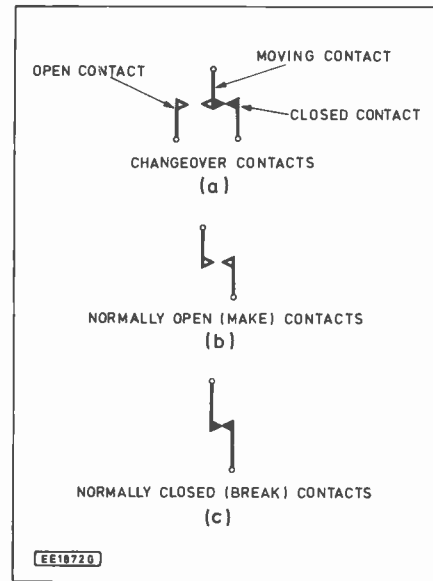

Fig. 6.15. Symbols used for relay contacts.

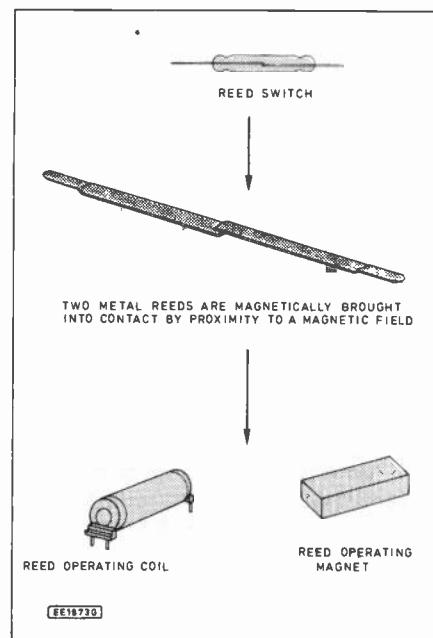
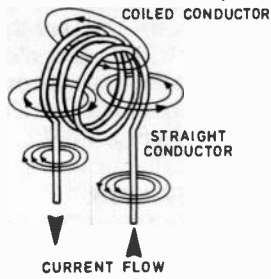
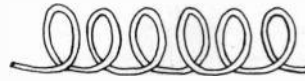

Fig. 6.16. Operation of a reed relay.



(a)



(b)

THE SOLENOID  
THE STRENGTH OF THE MAGNETIC  
FIELD IS DIRECTLY PROPORTIONAL  
TO THE NUMBER OF TURNS IN THE  
COIL AND THE AMOUNT OF CURRENT  
FLOWING THROUGH IT.



(c)

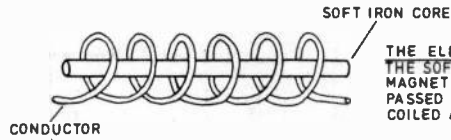

(d)

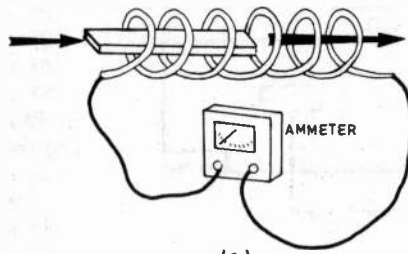

(e)

Fig. 6.17. The solenoid and electromagnetic induction.

EE18749

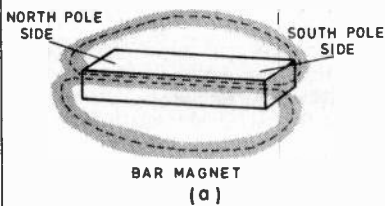

BAR MAGNET  
(a)

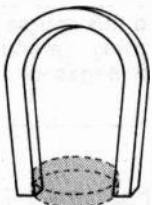

HORSESHOE MAGNET  
(b)

A STRONGER MAGNET IS CREATED BY BRINGING THE TWO POLES CLOSE TOGETHER (THE MAGNETIC LINES OF FORCE ARE CONCENTRATED TO PROVIDE STRONGER MAGNETIC FIELD.)

EE18770

Fig. 6.18. Creating a stronger magnet.

now be used as the controlling switch to another circuit; for example, to switch a mains appliance (Fig. 6.21—do not try this) or

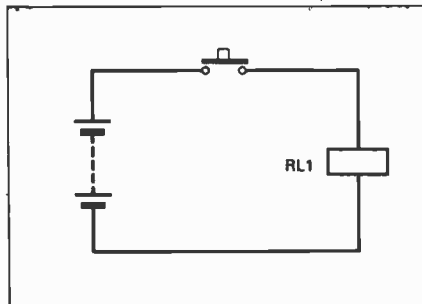
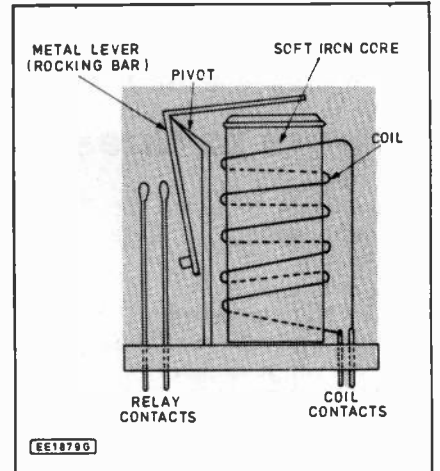

Fig. 6.19. Simple circuit for operating the relay.

Fig. 6.20 (right). Basic layout of a relay.



EE18790

Fig. 6.21. Using a relay to control a mains bulb (DO NOT TRY THIS).

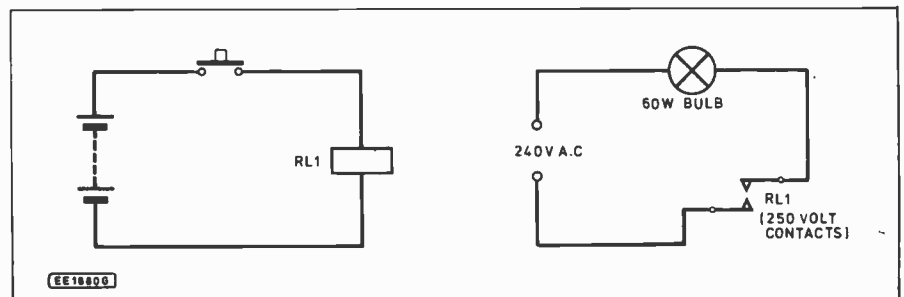

EE18800

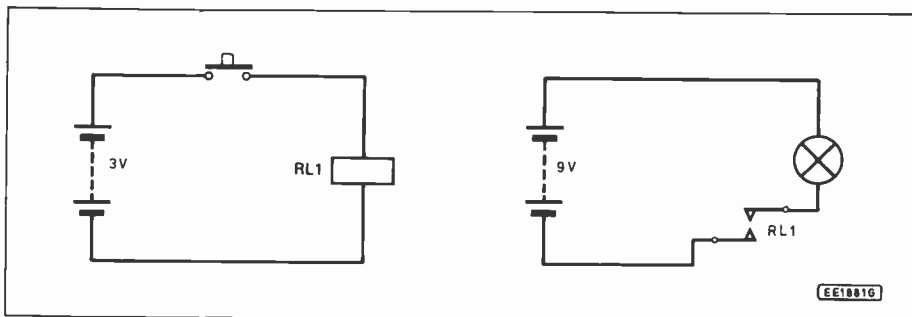

Fig. 6.22. Using a relay to control a low voltage bulb.

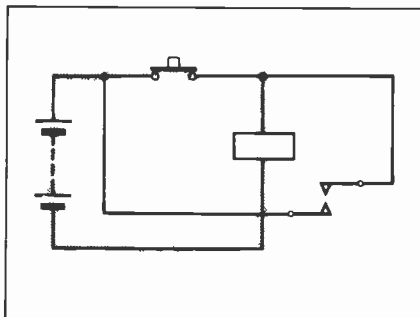

Fig. 6.23. Using the relay to switch its own coil.

another low voltage device (Fig. 6.22). Or even as a controlling switch for its own coil as shown in Fig. 6.23: the relay contacts in this circuit act as a "latch" to override the push-button switch after it has been pressed once—try it (listen carefully for the single "click" of the contacts because they will not open again no matter how many times you press the button, you will have to disconnect the battery to open

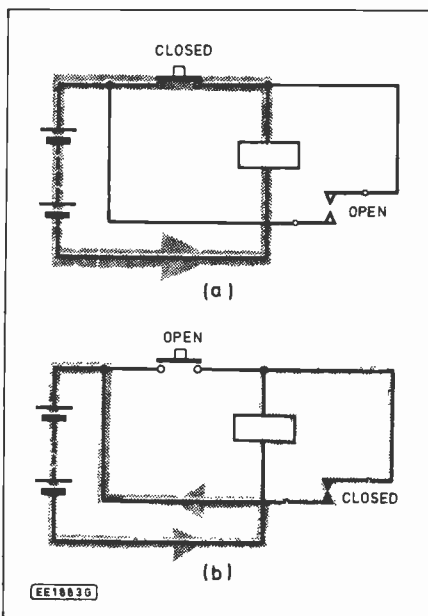

Fig. 6.24. Operation of Fig. 6.23 showing current flow when the switch is closed and when it is released.

them). Can you see how this works? When the switch is first depressed the current follows the path shown in Fig. 6.24a, this closes the relay contacts so that when the switch is released current follows the path shown in Fig. 6.24b.

### Questions

1. Draw the i.c. pin numbers onto the circuit diagram of Fig. 5.21a (last month) from the breadboard layout in Fig. 5.21b. The pin-out of the 4001 is given in Fig. 5.21c.
2. A continuity tester is connected to the "normally open" and "common" terminals of a s.p.d.t. switch, would there be continuity?
3. A specification states that both the "live" and "neutral" wires of a mains appliance must be switched in order to turn the unit off. Would you use a s.p.s.t., s.p.d.t., d.p.s.t., or a d.p.d.t. switch for the job?
4. Draw the symbols for the following switches:
  - 1) s.p.s.t.
  - 2) s.p.d.t.
  - 3) d.p.s.t.
  - 4) d.p.d.t.
  - 5) rotary 3 pole 4 way.
5. Draw the symbols for the following relays:
  - 1) double pole change-over
  - 2) single pole break
  - 3) s.p.c.o.
6. Complete the circuit drawing of the "touch switch" (Fig. 5.15c last month) to operate a mains appliance.
7. Explain the operation of the circuit in Fig. 6.6c.

## Answers to Questions in Part 5

1. The current is 7.5mA d.c. The most appropriate range is DC25mA.
2. Red lead to point B  
Black lead to point A
3. The voltage is 9V d.c. The most appropriate range is DC10V
4. Red lead to point C  
Black lead to point B
5. (a) 0.3V d.c.  
(c) 8V d.c.  
(e) 120V d.c.  
(b) 1.5V d.c.  
(d) 34V d.c.
6. (a) 0.1mA a.c.  
(b) 2mA a.c.  
(c) 30mA a.c.  
(d) 400mA a.c.  
(e) 5A a.c.
7. TIMEBASE, INTENS, XSHIFT, YSHIFT, FOCUS
8. Period to 30ms, width to 10ms
9. It would move across the screen
10. 0.5s
11. 20%, 1/4
12. 100kHz

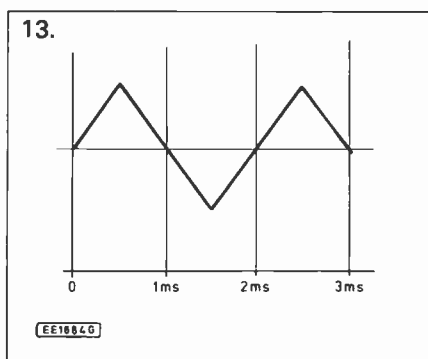

14. 20kHz
15. Regulated
16. A and C
17. 33.33%
18. 60ms
19. 20μs/cm
20. 50Hz

You should have been able to get all of the above correct from the information provided in the series.

Next month: We are now back on schedule with the course and next month we will cover Resistors.

**Recommended reading:** The book *Electronics* from the *Made Simple* books series will provide students with information relevant to this course and will also be an ongoing reference—see Direct Book Service pages for details.

### PENCILBOX

The Pencilbox Logic Tutor shown in Fig. 5.22 is available to all teaching establishments, companies or private individuals direct from E & L Instruments, Dept.EE, Whitegate Industrial Estate, Whitegate Road, Wrexham, Clwyd, LL13 8UG. Tel. 0978 291030. The unit costs £79.80 plus £1.50 p&p plus VAT. It is available to overseas customers; please write for a quote.

E & L issue a free catalogue showing their range of products.

# REPORTING AMATEUR RADIO

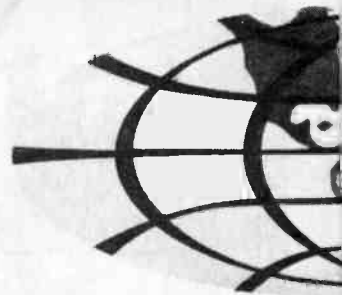

TONY SMITH G4FAI

## BUREAUCRACY RULES?

Last month I reported the concern of many amateurs at a restriction on the home-construction of transmitters for the 10 metre band which is contained in the new amateur radio licence, effective from 1st January 1989. They could not understand why such a thing should be in the licence when at the same time there was apparently an understanding by the Radio Society of Great Britain that the DTI did not intend the restriction to actually apply to amateurs, who were free to apply for exemption from it on an individual basis.

I duly applied to the DTI for my exemption, and have now received a formal Authority document which permits me "to manufacture radio transmitters for personal use, designed or adapted to operate within the frequency band 28.0-29.7MHz only".

It took two letters from me; an acknowledgment card and two letters from them, plus the formal document, just to say, in effect, "ignore what the new licence says and carry on doing what you did before."! It seems like bureaucracy for the sake of bureaucracy, but I'm still not convinced there's no ulterior motive in all this! The ban on home-construction is still contained in the licence while my personal Authority can be "withdrawn by the Secretary of State for whatever reason he shall deem necessary".

## CHANGE OF NAME

The British Amateur Teleprinter Group, at its Annual General Meeting on 5 November, decided to change its name to the British Amateur Teledata Group to reflect the fact that nowadays it caters for *all* amateur radio data operation, not just mechanical RTTY (radio teletype) as the old name suggests.

Despite the change of emphasis in its title, BARTG is not abandoning teleprinters which will continue to be a popular form of amateur communication. According to a booklet\* published by the group, the teleprinter dates back to Emile Baudot who, in 1874, devised his five-unit selecting code which enabled a receiving instrument to reproduce messages in normal print.

Over the years various commercial teleprinters evolved, including the famous Creed machines, and in 1959 BARTG was formed to encourage the then increasing use of teleprinters in amateur radio. It ran contests, it obtained and marketed scarce components and helped develop a special terminal unit to go between a teleprinter and amateur radio equipment.

Today, it still does these things, and more. It provides telephone advice to members, helping them get their stations on the air, and publishes a quarterly journal, DATACOM, with articles relating to all forms of amateur data

communications. It holds an annual rally for data enthusiasts, and runs a regular news broadcast, GB2ATG, on both the h.f. and v.h.f. amateur bands.

## COMPUTER COMPATIBLE

A typical RTTY station consists of a transceiver, a terminal unit, and a mechanical teleprinter—or a computer with RTTY software. It is necessary to learn to use the keyboard in the same way for both conventional and computer equipped stations which can then communicate with each other without difficulty. RTTY transmissions can of course be monitored by Short Wave Listeners having the necessary equipment and this can be an interesting extension of their hobby.

The RTTY code (alphabet) used by amateurs is known as ITA 2. The audio tones used to send the signals by radio are 170Hz apart, namely 1275Hz and 1445Hz, and the speeds used are 45.45, 50, or 75 bauds. The speed in bauds is the number of pulses per second.

Another, and faster, amateur teleprinter mode is known as AMTOR (Amateur Microprocessor Teleprinter Over Radio) which incorporates an error detecting system. More on this, and other modes next month.

## ROBOT BEACON

Linking modern computer technology with the earliest form of radio communication—Morse signalling—there is a fully automated Italian robot beacon on the ten metre amateur band, on 28.195MHz. Located at Bologna as a memorial to Marconi, this beacon, call-sign IY4M, responds to well-spaced Morse sent from amateur stations.

It automatically adjusts its sending and receiving speed to match that of the calling station; it exchanges signal reports and sends a greeting in English or one of several other languages. Various code signals prompt the provision of information about the robot, reports on keying speeds and other matters. With a knowledge of all the commands available it is possible to have quite a good QSO (contact) with the machine.

This is a useful facility if an amateur needs information about conditions on ten metres or about his own station's performance on that band. When installing a new rig (or after repairing the old one!), or trying a new antenna, it is helpful to have confirmation from a distant station that you are putting out a reasonable signal.

It is not always possible to find such a station just when you want it, but providing the band is open to Italy the robot is available and ready to help with a series of tests. It also indicates if one's Morse sending is satisfactory since it will only respond to well-sent code, and its reports on keying speeds help with adjustments to automatic or semi-automatic keyers.

## UNCANNY EXPERIENCE

Computers are frequently used today by amateurs learning Morse. Some programs teach the code from scratch and others help learners prepare to go on the air for the first time using the correct code abbreviations and procedures.

In an article in *Morsum Magnificat*, the journal for Morse enthusiasts, an American amateur reported recently an uncanny experience when using a program called "Dr QSO" which generates Morse contacts with imaginary stations throughout the USA.

For a few days before taking the big step and actually going on the air with his newly acquired skills Alan Plotnick, KC1CJ, had been troubled by the fact that when he switched on the program he frequently got a synthetic operator from Massillon, Ohio. When he finally sent out his first CQ call he was amazed to receive a reply from a real amateur station also located in Massillon!

He says, "I didn't know whether I was communicating with a live human being or whether my computer had taken over".

## MORE HAM GLASNOST

I reported in the October issue that USSR amateurs can now exchange QSL cards direct with amateurs in other countries, a marked contrast to the previous situation when all incoming and outgoing cards were compulsorily routed via Box 88, Moscow.

A recent report in *Amateur Radio*, journal of the Wireless Institute of Australia, suggests that glasnost has benefited the country's half a million radio amateurs even further. It says that the QSL concessions were announced at the first ever national conference of radio amateurs which was held in Moscow. Another relaxation announced at that time now allows Russian contacts with Israeli stations, which had been banned since the six-day war between the Soviet's ally, Egypt, and Israel, in 1967.

Additionally, all Soviet radio amateurs, says the report, can now contact stations in the capitalist countries—something only a relative few were allowed to do previously. I must admit I didn't know about this last restriction. There always seem to be lots of Russians on the bands, although, when I think back, I sometimes got no reply when I responded to their calls. I just put it down to poor band conditions.

\* *Amateur Radio Data Comms and BARTG*, published to help newcomers to RTTY, AMTOR, Fax and Packet Radio, and to introduce them to BARTG. Free of charge, on receipt of a C5 stamped addressed envelope, from Mrs P. Beedie GW6MOJ, Ffynnonlas, Salem, Llandeilo, Dyfed SA19 7NP.

# New REALISTIC® PORTABLE SCANNING RECEIVER

- Frequency Synthesized - No Crystals To Buy
- 68-88 MHz VHF-Lo
- 108-136 MHz (AM) Aircraft
- 136.005-174 MHz VHF-Hi
- 380-512 MHz UHF
- 806-960 MHz

**Realistic Pro-34.** Catch all the action on this hand-held programmable scanner. Features extended frequency coverage, including the new 800 MHz band! Scan up to 200 channels in 10 bands or search for new bands. Store frequencies in a special monitor band for one-key transfer to permanent memory. Lock-out key temporarily bypasses unwanted channels.

## The Key To Better Listening

Also features large LCD display showing channels and frequencies being scanned, monitored or programmed and has a switchable backlight for night viewing. Squelch control, built-in speaker, 1/8" earphone socket, flexible aerial and belt-clip. Includes BNC jack for adding external aerial.

# Tandy®

*Tune in to Tandy TODAY!*

Over 400 Stores  
And Dealers Nationwide  
Prices may vary at Dealers. Offers subject to availability.  
Tandy, Tandy Centre, Leamore Lane,  
Walsall, West Midlands. WS2 7PS

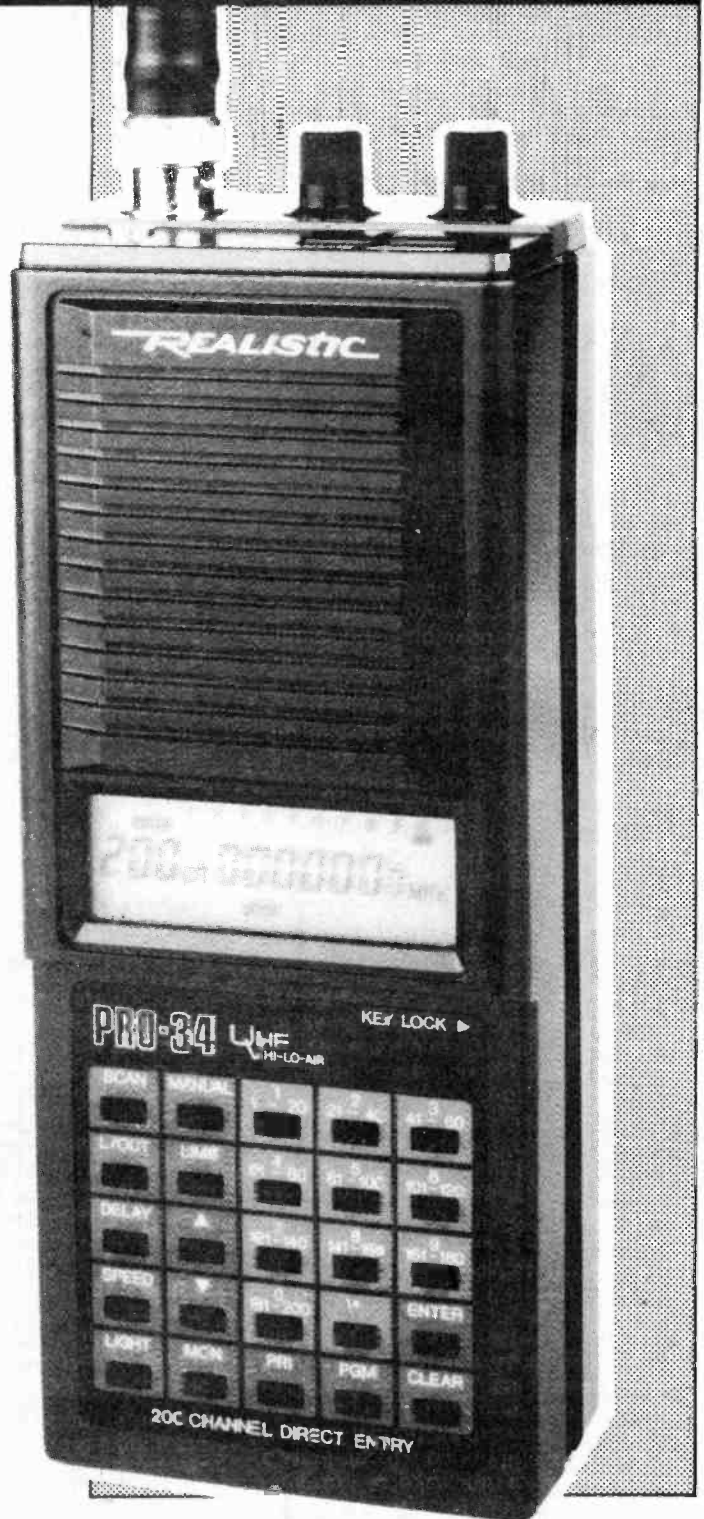

Realistic PRO-34 £249.95.  
Cat. No. 20-9135



# AUDIO LEAD TESTER

PAUL BAILEY

Simple piece of test equipment that allows quick diagnosis of faulty mono audio leads.

**A**NYONE who plays an electric guitar, keyboard, or other electronic musical instrument, or who uses hi-fi or recording equipment, will have had the frustrating experience of having a jack lead with an intermittent fault of some kind. Typical is the lead which buzzes and crackles, but works fine if it is held in a particular position.

The normal approach to this problem would be to open up the jack plugs at either end for a visual inspection. If this fails to show up the fault, the lead would be plugged in, the instrument played, and the cable "wiggled about" until the fault reappears. A multimeter on Ohms range is better, but often requires more than two hands to get results.

The simple piece of test equipment presented here allows quick diagnosis of faulty mono audio leads. The lead is simply plugged in, and the tester reset. A permanent fault is immediately indicated, an intermittent fault being latched as soon as it occurs.

Three types of fault are indicated:

- 1 Core to screen short circuit
- 2 Open circuit core
- 3 Open circuit screen

## CIRCUIT DESCRIPTION

The complete circuit diagram for the Audio Lead Tester shown in Fig. 1. As can be seen, most of the signal routing is accomplished by the four-pole double-throw switch S2.

To understand the circuit's operation let us consider what happens when a lead is plugged in to jack sockets SK1 and SK2 for test. Plugging in the lead operates S1 (this is an integral part of SK1) which connects +9V from the battery to the circuit.

After switch on, the two flip-flops IC1a and IC1b are reset by the operation of S3. This takes the RESET inputs (pins 4 and 10) high ("1").

Assume that S2 is set for testing for open circuits (shown as position one on all poles). The common ends of resistors R1,

R2, and R4, are connected to +9V via S2a. This turns transistors TR1 and TR2 hard on, thus holding the SK1 ends of the core and screen at virtually 0V.

Looking now at the SK2 ends of the lead, it can be seen that resistors R3 and R4 are attempting to pull the core and screen (respectively) to +9V. However, for a good lead, the contacts of SK2 stay at a low voltage near 0V because the lead conductors provide a low resistance path to TR1 and TR2 collectors.

Now consider a cable with, say, an open circuit core conductor. Resistor R3 succeeds in pulling the core contact of SK2 to +9V. Current thus flows through R3, diode D1, and R7 and hence into the base of TR3. Transistor TR3 is turned on and i.e.d. (D5)—"CORE OPEN"—lights up to indicate a fault. The same can be said for an open circuit screen conductor, the components this time being R4, D4, R8, TR4, and i.e.d. (D6)—"SCREEN OPEN".

This is fine provided the open circuit conductor remains open circuit. Often, though, faults of this type are intermittent, occurring perhaps only when the lead is flexed. This is where the need for IC1 arises.

If a high (+9V) level appears at the lower end of resistor R3 for any time at all, flip-flop IC1a will be clocked, the high on the D input (pin 5) being clocked through to the Q output (pin 1). This will again turn on D5 via D2, R7, and TR3. The fault is thus latched until being cleared by operation of switch S3.

Again the same applies for an intermittent open circuit screen. IC1b CLOCK input (pin 11) will go high, clocking data from pin 9 through to pin 13, turning on D6 via D3, R8 and TR4.

## SHORT CIRCUITS

Assume now that S2 is set for testing for a short circuit between screen and core conductors (shown as position 2 on all poles).

Fig. 1. Complete circuit diagram for the Audio Lead Tester.

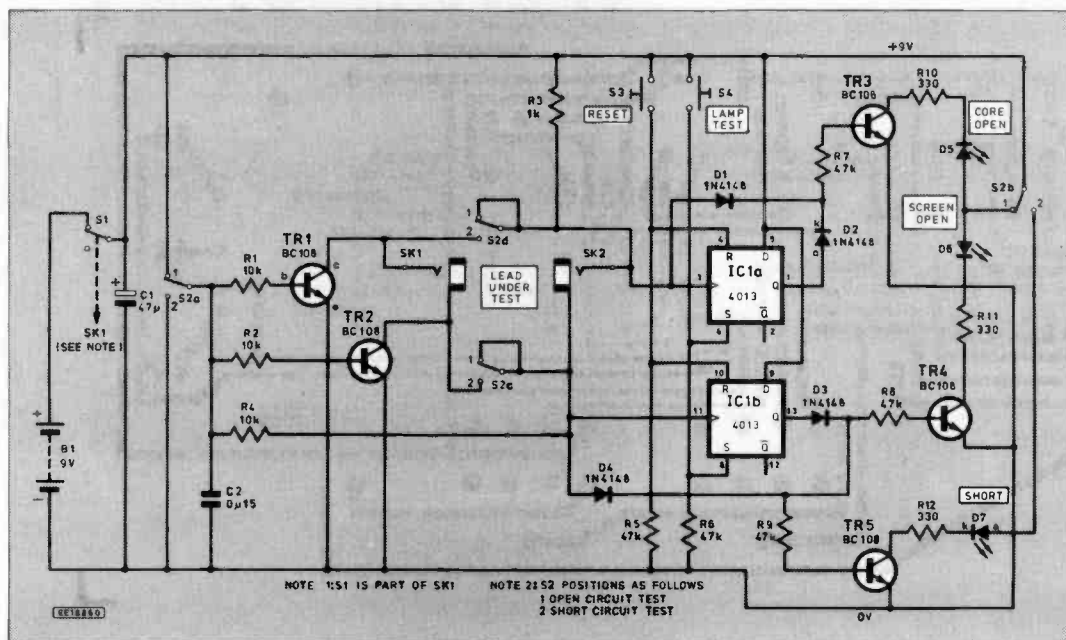

The common ends of resistors R1, R2, and R4 are now connected to 0V via S2a. Hence TR1 and TR2 are turned off and do not conduct at all.

It may be observed that now the two ends of the core conductor are connected together via S2d. The same is true for the screen conductor, via S2c. The core conductor is pulled up to +9V via resistor R3. However, the screen conductor is held at 0V via resistor R4.

Now consider a cable where core and screen are shorted together. The screen is pulled up towards +9V by resistor R3. Thus current flows through R3, the short circuit, diode D4, and resistor R9 and hence into the base of TR5. Transistor TR5 is turned on and l.e.d. (D7)—SHORT—lights to indicate a fault.

As before, often this type of fault is intermittent. IC1b thus comes into play once more. A momentary high on pin 11 (CLOCK input) clocks a high onto pin 13 and thus lights D7 (via D3, R9, and TR5).

Finally, S4 has been included to provide a check facility for the flip-flops, transistors, and light emitting diodes (l.e.d.s). Closing S4 takes IC1 pins 6 and 8 (SET inputs) high, thus setting pins 1 and 13 (Q outputs) high. If S2 is in the open circuit test position l.e.d.s D5 and D6 will light, or if S2 is in the short circuit test position D7 will light. This test also acts as a check on the battery condition.

## CONSTRUCTION

Construction is reasonably straightforward with all components (excluding switches S3, S4, and battery B1) being mounted on a single 12mm×76mm printed circuit board. This board is available from the *EE PCB Service*, code EE641.

The component layout and full size master foil pattern is shown in Fig. 2. If you are making your own p.c.b. all holes are drilled to 1.0mm diameter, with the exception of jack sockets SK1 and SK2 (2.5mm) and the mounting pillar screw (3.0mm).

Begin construction by forming and inserting the wire links. It is probably best to use insulated solid core wire for these, especially in the case of the two long links near SK2. Next insert the diodes, paying particular attention to the orientation of these, followed by the resistors, these requiring no particular orientation.

A 14-pin DIL socket should be fitted for carrying IC1. Fit the transistors next, keeping them close to the board to prevent shorting of adjacent leads. The capacitors may now be fitted, taking care to mount C1 with the correct polarity.

The jack sockets SK1 and SK2 can be set in place. Bend over and solder all the pins, as the p.c.b. is partly supported by these two sockets.

## SWITCH WIRING

Some preparation is required for switch S2 prior to mounting, as this switch is designed for wire, not p.c.b. connections. Cut twelve pieces of 22swg tinned copper wire (1/0.6mm solid wire with the insulation stripped off will do just as well) about 20mm long. They do not all have to be exactly the same length.

Tin each of the solder lugs on S2, and one end of each piece of wire. Now solder each piece of wire onto one of the S2 lugs, keeping the wire as straight as possible. This

done, S2 should drop onto the p.c.b., its twelve wires locating in each of the p.c.b. solder holes.

Having pulled S2 as tight as possible onto the face of the board, solder each wire to the relevant p.c.b. pad. Be careful not to hold the iron onto each wire for too long, otherwise the wire may become detached from the switch.

Mount the three l.e.d.s as follows: Cut the legs to a length of about 20mm. Next cut six lengths of 1mm sleeving, each 17mm long. Fit the lengths of sleeving onto the legs of the l.e.d.s.

Now solder the l.e.d.s into place observing their polarity. It is important that all three l.e.d.s sit at the same level off the board, the sleeving being used as a guide to achieve this.

Different manufacturers use different conventions to identify l.e.d. leads, but in case of doubt hold the l.e.d. up to the light so as to be able to see through it. The leg connected to the largest internal contact is always the cathode (denoted k in Fig. 2).

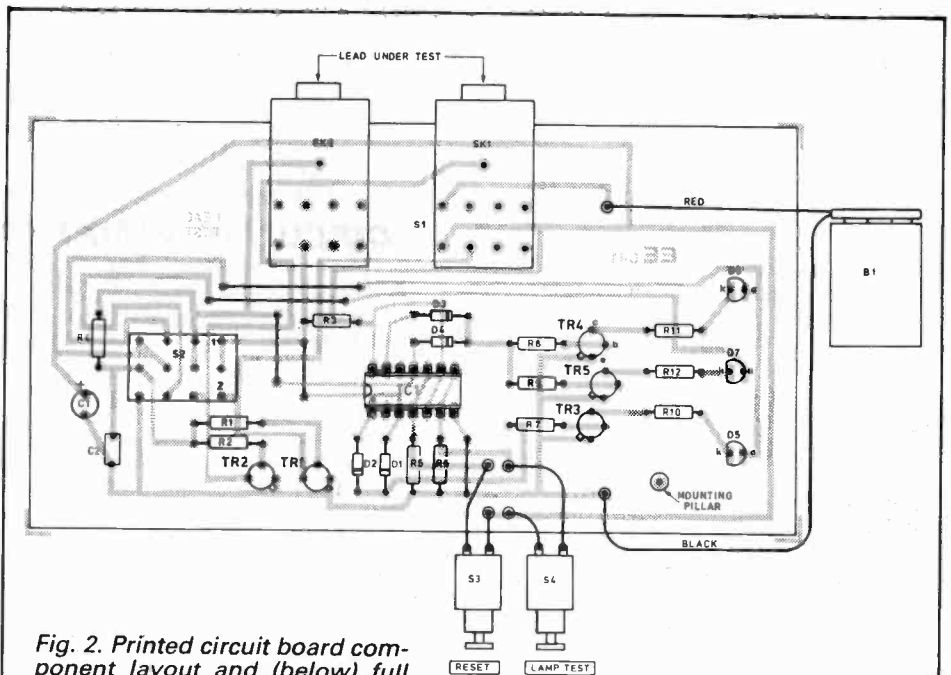
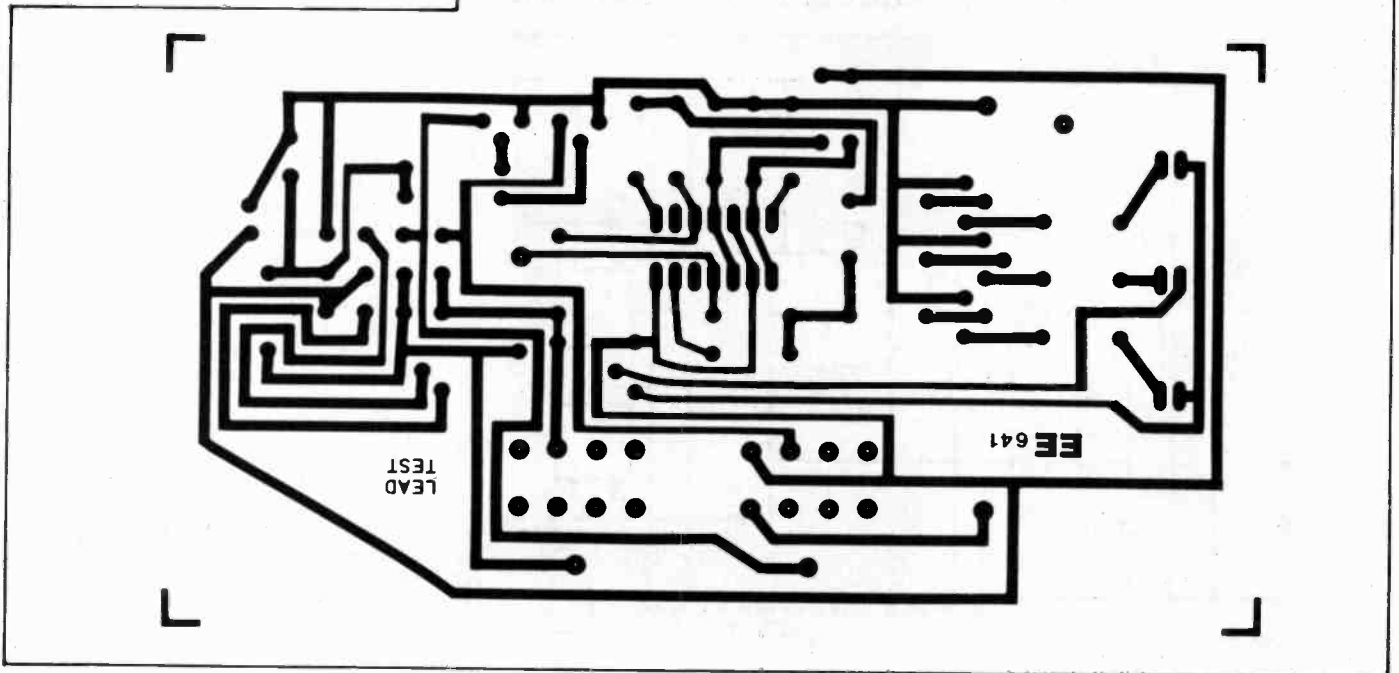

Fig. 2. Printed circuit board component layout and (below) full size copper foil master pattern.



This leaves the connection of the battery clip leads and the switches S3 and S4. Flexible insulated wire should be used to connect the latter to the p.c.b. It is a matter of preference whether to connect these flying leads to the board directly or to use terminal pins.

Lastly, IC1 may be fitted. Avoid unnecessary handling of this device as it can be damaged by static discharge.

## TESTING

The printed circuit board is now complete and may be bench tested. Before powering up, check over the board to ensure all components are fitted in the correct places and that polarity sensitive components are correctly oriented. Particularly check that IC1 has been installed the correct way around into its socket.

Connect a fresh PP3 battery or a d.c. supply set to 9V to the battery clip. In the case of the latter, the +9V goes to the cup-like terminal, and the 0V goes to the smaller stud terminal on the battery clips. No l.e.d.s should come on at this point since the power switch S1 (within SK1) has not been closed.

The easiest way to test the various functions is to use a test lead made out of two mono 1/4in. jack plugs connected together by two pieces of insulated wire. Failing this, two jack to jack leads could be used.

Plug a jack plug into socket SK1, this will power up the circuit. L.e.d.s may come on depending on the setting of S2. Plug the other end of the test lead (core and screen connected) into socket SK2.

Now check that the LAMP TEST switch turns on l.e.d.s D5 and D6 (S2 in the OPEN test position) and l.e.d. D7 (S2 in the SHORT test position). Check that the RESET switch S3 turns these l.e.d.s off.

By disconnecting and shorting the wires on the test lead, check that the correct faults are displayed for each setting of S2. Remember that operating RESET S3 will only clear the l.e.d.s if the fault condition is removed.

Since all components are p.c.b. mounted, few problems should be

encountered. However, if one or more of the tests described above fail to produce the correct result, the following may be checked.

Look carefully at the underside of the board in case there are any shorts between pins and tracks due to solder splashes. Also look for pins on IC1, S2 and SK1 and SK2 that have not been soldered.

Check on the board topside that no connections to S2 have become detached from the switch. Look carefully at the pins of IC1 in case a pin has been bent under the i.c. instead of going into the socket. If problems persist, the operation of the circuit may be checked through with a voltmeter (0V to battery 0V) with reference to Fig. 1, and the "Circuit Description".

## CASE

Once the p.c.b. has been tested and found to perform correctly it may be boxed up. The prototype was housed in a black ABS plastic box size 180mm x 110mm x 55mm deep. Exact positioning of holes will depend on the case used.

The p.c.b. is supported by sockets SK1 and SK2, switch S2, and a spacing pillar mounted using the hole near l.e.d. D5. This pillar should be 20mm long and tappable to allow fixing to the front panel using a 1/4in. 6BA screw at each end. Both fixing nuts on S2 should be used.

Remember when choosing a box, that room should be allowed not only for the p.c.b., but for switches S3 and S4, and the battery B1. The battery may simply be held in place using double-sided tape, or alternatively a retaining bracket may be made from some steel strip. The battery was mounted in the prototype using a panel mounting PP3 holder thus eliminating the need for the battery clips.

When drilling the front panel on the chosen box, just drill holes large enough to allow the l.e.d.s to protrude through slightly. Do not attempt to fit the l.e.d.s into mounting clips. Once drilled, the panel may be labelled with dry transfer lettering. This should be given a protective coat of clear lacquer.

# COMPONENTS

## Resistors

R1, R2, R4	10k (3 off)
R3	1k
R5, R6, R7,	
R8, R9	47k (5 off)
R10, R11,	
R12	330 (3 off)

All 1/4W 5% carbon.

**Shop  
Talk**

## Capacitors

C1	47µ elec. 25V	See page 193
C2	0µ15 polyester	

## Semiconductors

D1, D2, D3, D4	1N4148 (4 off)
D5, D6, D7	5mm red l.e.d. (3 off)
TR1, TR2, TR3,	
TR4, TR5	BC108 (5 off)
IC1	4013 Dual D-type flip-flop

## Switches

S1	(see SK1)
S2	4-pole 2-way toggle
S3, S4	Miniature push-to-make (2 off)

## Miscellaneous

SK1, SK2	PCB mounting 1/4in. switched stereo jack socket (2 off)
----------	---

Printed circuit board, available from *EE PCB Service* code EE641 (see page 208); PP3 holder or PP3 battery clip; plastic box, size approx. 180mm x 110mm x 55mm; PP3 9V battery; flexible insulated wire; solid wire; 20mm pillar; 6BA x 1/4in. screws (2 off); 1mm sleeving.

Approx. cost  
Guidance only

**£14**

## IN USE

The Audio Lead Tester is straightforward to use. A suspect lead is plugged into the two jack sockets, thus turning the unit on. Set the test switch first to the SHORT position, and hit RESET. If the SHORT l.e.d. stays lit continually, there is a permanent short between screen and core, most likely at one of the jack plugs.

If the SHORT l.e.d. does not come on, try flexing the lead, particularly where it enters the jack plugs, to see if a temporary short occurs. If it does, the SHORT l.e.d. will come on and stay on, although it may be reset using the RESET switch.

If no shorts are found, set the switch to OPEN, and again hit RESET. If the CORE or SCREEN l.e.d.s stay on, this indicates an open circuit lead. Again flexing the lead may show up an intermittent fault. Obviously, leads should be unplugged after testing to conserve battery power.

Although the tester is fitted with 1/4in. jack sockets, other mono leads may be tested. A phono-phono jack lead may be tested, for example, using readily available phono 1/4in. jack adapters on either end. The project could easily be modified, with the addition of extra switching, to test stereo or multiway leads, two conductors at a time. □

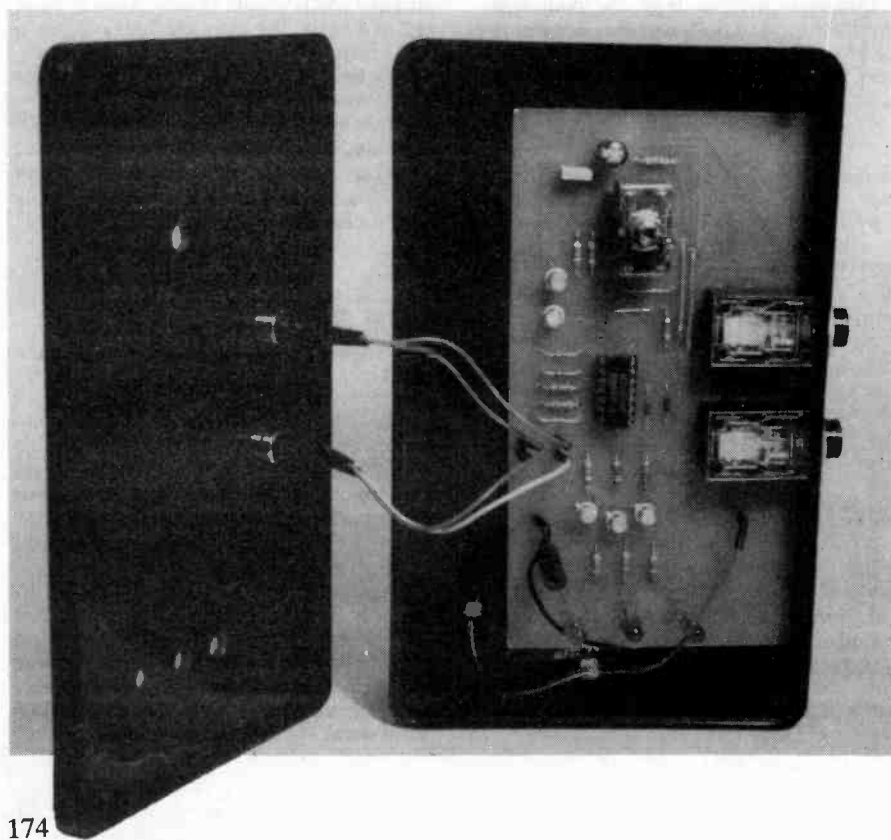



# SPECIAL MIDI SUPPLEMENT

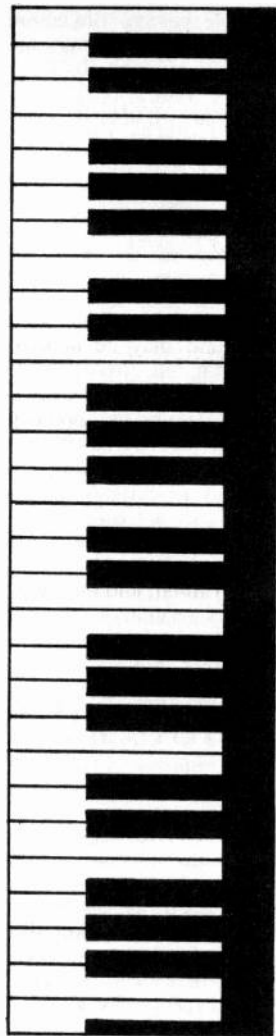

**T**HE adoption of MIDI by all the major electronic musical instrument manufacturers, and the inclusion of MIDI sockets on an increasingly wide range of equipment, has certainly revolutionised electronic music making. MIDI stands for "Musical Instruments Digital Interface", and it is a means of exchanging information between electronic musical instruments, or any equipment related to electronic music production.

Although MIDI is regarded by many as nothing more than a modern alternative to the old gate/CV method of interfacing synthesisers, or a means of synchronising drum machines, it actually has capabilities which go well beyond this. This supplement is designed to help you exploit some of the many MIDI facilities, or to simply start to use the MIDI facilities in conjunction with a BBC Micro.

The first article describes a **BBC/MIDI Interface** by Mike Hughes.

**Q**UITE a number of medium priced electronic musical keyboards are now provided with MIDI (Musical Instruments Digital Interface) circuitry but, unless you are into music in a big way or are prepared to spend a lot of money on special hardware interfaces, it is possible that you have never experimented with that very sophisticated piece of hardware lying dormant in your instrument (If you already have experience of MIDI the following projects—MIDI MERGE and MIDI PEDAL—will no doubt interest you).

If you have a BBC Model B computer you can, for the outlay of a few pence and a bit of software, turn it into a controller for your keyboard. With a suitable supporting program (which can be written in BASIC or better still in Assembler) you can get your computer to play polyphonic tunes, sequence rhythm patterns or provide a vamping bass whilst you practice with the melody.

This article describes the hardware interface required and gives a short program listing to provide the fundamentals on to which you can build your own more specialised software

## **MIDI MIGHT BE THERE**

You can tell if your keyboard is equipped for MIDI interfacing by looking for a couple of innocent five pin DIN sockets labelled MIDI IN and MIDI OUT. Because of the simplicity of our interface you will only be able to drive the keyboard from the computer so we shall be mainly interested with the MIDI IN socket.

If your keyboard is equipped with MIDI you may not be aware that whenever you press a key (or a set of keys) the instrument sends out three serial 10 bit digital codes to the MIDI OUT socket describing each key that is pressed or released. These codes would be used to control another keyboard or a synthesiser etc.

Likewise the keyboard is constantly checking the MIDI IN socket to see if similar sets of codes are being transmitted to it from another instrument or, as we shall be doing, from a computer.

The code numbers describe such things as:

- a) Is a key being pressed and, if so, which one.
- b) Has a key just been released and, if so, which one.
- c) Which instrument should respond to the signal (if several instruments are connected together).
- d) For touch sensitive keyboards—how hard the key was hit.

This list is by no means fully comprehensive of the whole set of MIDI instructions but these are the relevant ones as far as this article is concerned.

## **HIGH SPEED IS VITAL**

If you imagine that for every key pressed or released three lots of ten bits of data (30 bits in all) have to be transmitted then you will appreciate that the data has to be transmitted at a very high speed to cope with fast moving musical chords. The alternative would be for parts of the music to be left out which would, of course, be totally unacceptable.

To cater with this situation MIDI serial data has to be transmitted at the unusually high rate of 31.25 kilobaud which means 31,250 bits per second. This rate was chosen as a reasonable compromise between the fastest speed of playing, practical communications technology, and also because the 31.25 kilobaud clock rate can be obtained by a simple binary division from 1, 2 or 4 MHz. For example 2 MHz divided by 64 provides a frequency of 31.25 kHz.

This baud rate ensures that a 10 bit serial word will be transmitted in 320 microseconds and the group of three codes (to define a "key down" or a "key up" movement) in less than a thousandth of a second—fast enough for most styles of playing even if chords are involved!

## **THE SERIAL FORMAT**

The basic equipment of MIDI transmission is the 10 bit word made up of a start bit at logic level "0" followed by 8 bits of data (which is the code number in question) and terminated with a single stop bit at logic level "1". The start bit and bits of the data each take 32 microseconds to transmit and the connecting wire goes to logic level "1" for the stop bit and stays at that level until the beginning of the next word.

Conceptually it is a simple matter to make a computer output a sequence of "ones" and "zeros" at an output port and provided that the computer is fast enough and the program runs at a controlled speed it is fairly easy to generate this basic MIDI serial word.

## THE BBC COMPUTER IS FAST ENOUGH

Fortunately the BBC Model B has a fast enough clock to provide the 31.25 kilobaud rate required (provided certain precautions are taken) but the program has to run extremely fast. For this reason the transmission software has to be assembled into machine code. Unfortunately, for this application, the BBC computer makes extensive use of interrupts which break into any other operation taking place. If this was allowed to happen during the transmission of a word the baud rate timing would be disrupted. It is, therefore, necessary to disable the computer's interrupts whenever transmission takes place.

The BBC machine has a convenient User Port which can be used to output the data but the signal levels at this port are normal TTL voltages and this does not exactly meet the input characteristics of a MIDI IN socket. To appreciate the difference it is useful to understand the standard MIDI input hardware specification which is based on a 5mA "Current Loop".

## CURRENT LOOP AND OPTO ISOLATION

To minimise earth loop problems (which give rise to mains hum in complex interconnected audio systems)—and also to avoid expensive damage by wrong connections—the keyboard's MIDI IN socket is protected by an optical isolator consisting of an l.e.d. optically coupled to a photodiode. The transmitted data activates the l.e.d. inside the keyboard and the photodiode detects the changes and passes the digital signals to the rest of the keyboard's circuitry. The l.e.d. requires a current of 5mA to illuminate and this current is derived from the source of transmission which, after flowing through the l.e.d., returns to the transmission source—hence the term "Current Loop".

The input specification requires the l.e.d. to be illuminated for a transmitted logic level "0". This means that during a stop bit (and whilst waiting for the next word) the l.e.d. is extinguished.

## CIRCUIT

The BBC's User Port is not directly capable of providing this 5mA current drive. It is, however, a very simple matter to convert the TTL voltages into a current of

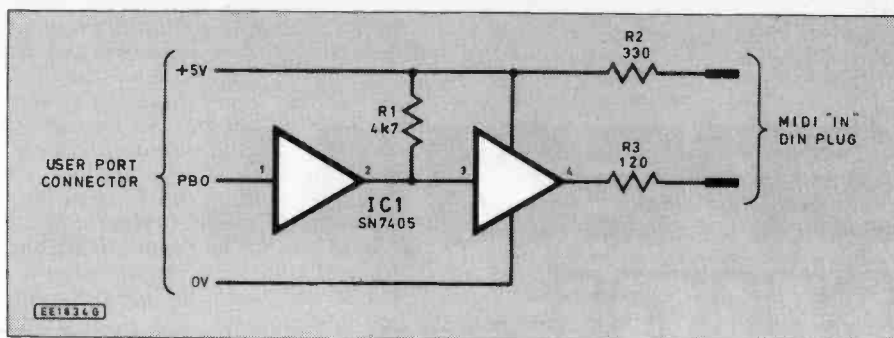

Fig. 1. Circuit of the BBC/MIDI Interface.

5mA which has the right polarity and logic sense to match the MIDI input requirement. This converter is the only piece of hardware required and it can be made out of two inverters from an SN7405 (standard TTL hex. open collector inverter) and three resistors as shown in the schematic drawing (Fig. 1). The prototype was made up on a small piece of matrix board glued to the back of a 20 pin User Port plug. Power is taken from the User Port socket itself.

The converter's output is fed down a screened lead (not to exceed 50 feet in length) to a standard 5 pin (180 degree) DIN plug. It is vitally important that the +5V rail, through R2, goes to pin 4 of the DIN plug. This is the pin identified by the figure 4 moulded into the base of the DIN plug. The inverter's output, through R3, goes to pin 5 of the DIN plug. If you get these connections the wrong way round current will try to flow the wrong way through the keyboard's l.e.d. and no signals will be received!

## MACHINE CODE TRANSMISSION ROUTINES

The Assembler Language listing contains four machine code sub-routines which are designed to reside in memory well out of harms way below PAGE. These, once loaded, can be called from any BASIC program as required.

When SETPORT is called (use the statements CALL SETPORT or CALL &COO depending on whether SETPORT has been defined as a variable) it simply defines the least significant bit of the User Port (PB0) to be an "Output Bit". This should

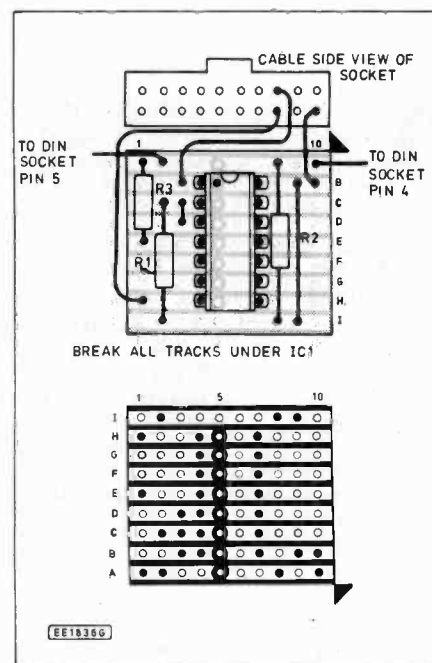

Fig. 2. Construction of the MIDI Interface

be one of the first things you do in your control program.

SEND is the main transmission sub routine and before calling it from BASIC you must first of all set the variable A% to the code number that is to be transmitted. When SEND is called the contents of A% are automatically transferred to the micro-processor's Accumulator. The statement to use is CALL SEND or CALL &COB.

The first thing SEND does is temporarily store the contents of the accumulator on to the stack and sets the User Port output to zero (Lines 170-190). This creates the beginning of the serial start bit which has to be held for 32 microseconds. This precise time delay is produced by the call to DELAY in Line 200 followed by a NOP which is a small timing correction factor.

Lines 220 and 230 recover the original data off the stack and get ready to transmit the eight bits in serial fashion. Sequential transmission of the eight bits is done by Lines 270-310 by rotating the accumulator right and sending the result to the User Port eight times. Each time this is done a delay of 32 microseconds is generated. In this fashion each bit from the accumulator (starting at the least significant bit) is output from User Port PB0 and, from the outside world this looks like a serial stream of data.

FINISH completes the sub routine by outputting logic level "1" (the stop bit) at



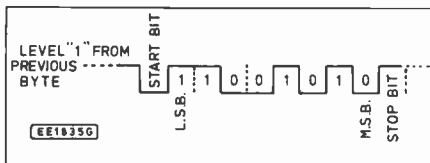

Fig. 3. Format of a MIDI serial byte of data.

the User Port. This is, once more, held for at least 32 microseconds before the sub routine returns to BASIC.

The remaining two sub routines are IOFF and ION which respectively switch off the internal interrupts of the BBC computer (to ensure precise timing of the SEND routine) and restore them. In practice these could be incorporated directly into the beginning and end of the SEND routine but have been left as separate callable routines for versatility. It is essential that IOFF is called by BASIC (use CALL IOFF OR CALL &C31) before SEND is called and, for convenience, ION should be called immediately after the return from SEND (use CALL ION OR CALL &C33).

## CODES YOU HAVE TO SEND

There are a large number of MIDI control codes (all of which have very useful purposes) but the sheer quantity of them, and complexity of some of them, can be a bit awe inspiring. Furthermore some codes are not supported by some keyboards and this can often give rise to confusion. For this reason we shall limit ourselves to considering just two codes which, by their very definition, have to be universal to all MIDI keyboards. These are the codes which tell a note to start sounding and stop sounding—how fundamental can you get!

Do not scoff at such a simple approach because you can do an awful lot and produce spectacular music with just these two code sequences.

Each of these two codes is made up of three separate 8 bit bytes of data. The first byte defines the operation together with the channel numbers (i.e. the identification which is to receive the data); the second byte defines the number of the note (Middle "C" is always note number 60 in MIDI parlance and other note numbers can be worked out by adding or subtracting 1 for each semi-tone up or down from Middle "C" so Top "C" is note 72 and Bottom "C" in note 48. Likewise Middle "G" is note 67 and so on).

The third byte defines the rate at which the key was hit or released—this is specifically for touch sensitive keyboards but we shall use the default values which will apply to non touch sensitive instruments.

## THE "NOTE ON" SEQUENCE

To make a specific note start sounding you have to send the three byte code described above. The first byte is made up of the following binary pattern:

1001xxxx

where xxxx, the least significant "nibble", defines the Channel Number that the receiving instrument is set to. Here is the first bit of potential confusion; the binary nibble 0000 is zero but it is used to define Channel 1 on the receiving instrument and although 1111 in binary means 15 in denary

it defines Channel 16. Fortunately we don't have to worry about this because, to make our system fairly foolproof, we shall operate in MIDI's "Omni" mode which means that ANY instrument will respond to Channel 1 unless it has been specifically set to something different.

In more simple terms the first byte is set to the decimal number 144 plus the binary version of the Channel Number. In the case of Channel 1 we simply have to add zero.

The second byte is the number of the note—as already described. It can be any value between 1 and 127 with 60 describing Middle "C". In practice five octave organ keyboards range from about 36 to 96 whereas full size piano keyboards range from about 21 to 108.

The third byte describes the rate of pressing a key but for non touch sensitive keyboards you should use the value of 64.

Therefore, to make Middle "C" start sounding you have to send the following decimal numbers to the keyboard:

144,60,64

## THE "NOTE OFF" SEQUENCE

The sequence which stops a note sounding follows the same sort of pattern that is used to start a note except that the first byte is constructed as follows:

1000xxxx

i.e. 128 plus the binary equivalent of the Channel Number.

The second byte defines the note which is to stop—exactly as before—and the third byte is the key release velocity which, for non touch sensitive keyboards, should always be zero.

The code sequence to stop Middle "C" sounding should, therefore, be:

128,60,0

## PLAYING A CHORD

To play a chord of "C Major" requires the Middle notes C, E, G and Top C to be played simultaneously and held down for the duration of the chord. In long hand the MIDI sequence to be transmitted in words and numbers would be:

```
Start Middle C    144,60,64
Start Middle E    144,64,64
Start Middle G    144,67,64
Start Top C       144,72,64
Wait for the duration of the chord
Stop Middle C     128,60,0
Stop Middle E     128,64,0
Stop Middle G     128,67,0
Stop Top C        128,72,0
```

Note that it is very important to keep a record of notes which have started so that you can stop them at the required point in time. They will not stop unless you tell them to and that can lead to terrible dischords!

## HOW TO USE THE DRIVER ROUTINE

The simplest way to get used to MIDI interfacing and developing programs is to start in an elementary way. First of all type in the Assembly Language program for the driver and save it to disc or tape before running it. Run it and the machine code will be set up in memory from location &C00. Clear the memory by typing NEW and then, after connecting the current loop

driver between the computer and your keyboard, try making Middle "C" sound for a short while by entering and running the following short BASIC program (NOTE Don't type in the comments):

```
10 CALL &C00      | Setup the output port
20 CALL &C31      | Switch off interrupts
30 A%=144         | Set start note byte & Channel
40 CALL &C0B      | Transmit it
50 A%=60          | Define Middle C
60 CALL &C0B      | Transmit it
70 A%=64          | Define key on velocity
80 CALL &C0B      | Transmit it
90 FOR X=1 TO 500: NEXT X | Note duration
100 A%=128        | Set note off byte & Channel
110 CALL &C0B     | Transmit it
120 A%=60         | Define Middle C
130 CALL &C0B     | Transmit it
140 A%=0          | Define key off velocity
150 CALL &C0B     | Transmit it
160 CALL &C33     | Enable interrupts
```

Take particular note of Line 10 which sets up the configuration of the output port and Lines 20 and 160 which, respectively, disable and enable the computer's interrupts.

There are obviously shorter cut methods of writing such a fundamental program which has such a large number of repeated operations but we have written it in sequential form to emphasise the order in which the codes have to be transmitted.

A shorter, and more versatile program could be written around DATA statements using an unused code, like 255, to define the pause. For example the following program plays the chord of C Major:

```
10 CALL &C00
20 CALL &C31
30 FOR X=1 TO 25
40 READ A%
50 IF A%=255 THEN FOR Y=1 TO 500: NEXT Y:
GOTO 70
60 CALL &C0B
70 NEXT X
80 CALL &C33
90 END
100 DATA 144,60,64,144,64,64,144,67,64
110 DATA 144,72,64,255,128,60,0,128,64,0
120 DATA 128,67,0,128,72,0
```

We chose a program to play a static chord to show that the system is polyphonic and there is, in theory, no limit to the number of notes which can be played simultaneously.

## CHROMATIC SCALE

The following example shows how you can play a single note chromatic scale between Middle C and an octave above Top C:

```

10 CALL &C00: REM Set up output port
20 CALL &C31: REM Disable interrupts
30 FOR X%=60 TO 84
40 PRODCtransmit
50 NEXT X%
60 CALL &C33: REM Enable interrupts
70 END
80 DEFPRODCtransmit
90 A%=144: CALL &C0B
100 A%=X% : CALL &C0B
110 A%=64 : CALL &C0B
120 FOR Z=1 TO 100: NEXT Z
130 A%=128: Call &C0B
140 A%=X% : CALL &C0B
150 A%=0 : CALL &C0B
160 ENDPROC

```

## TAKING IT FURTHER

Use of the other MIDI codes is beyond the scope of this particular article but we hope we have wetted your appetite. Clearly a lot of enjoyment can be gained from controlling your keyboard from software and the largest part of such a project is developing software that can make the most of the interface.

For those who would like to go further (but do not have programming skills) a complete compiler program is available on 40 track DFS disc or tape which allows you, in a very simple and speedy way, to write your own polyphonic music or backing, save it back to disc or tape and play it through your keyboard.

The software has been specially written to support this article but is too lengthy for printed publication. Your tune, which can have 12 note polyphony, is speedily written directly on to the screen and is held as machine code which allows long compositions and also permits repetitive sections to be looped or played at varying tempos. The program also permits keyboard voices to be changed while the music is playing. Included with the programme are a couple of sample tunes.

Copies of the program and instructions can be obtained direct from Mike Hughes at 2 Oaklands Lane, Biggin Hill, Westerham, Kent, TN16 3DN. Please state clearly whether you want Disc or Tape when you order with your remittance of £10 for disc or £7 for tape (including post and packing).

## LISTING OF FUNDAMENTAL DRIVER ROUTINES

The following program produces the machine code sub routines which, as described in the main article, output a MIDI 10 bit word (one start bit, eight data bits and one stop bit).

The program should be typed in and saved to disc or tape before running it. When you run it the code is assembled from location &C00.

You can, if you wish, use this listing to precede any BASIC program which you generate yourself. In this case your basic program should begin at Line 630 and you will have the advantage that you will not need to call the sub routines at their numeric addresses; you would simply have to use CALL SETPORT, CALL SEND, CALL IOFF or CALL ION as all the address variables will have previously been defined by the previous part of the program.

Remember that this program is only of use if you use the current loop interface between your BBC Model B and your keyboard.

```

10 FOR opt%=0 TO 3 STEP 3
20 P%=&C00
30 [
40 OPT opt%
50 :
60 \ Call SETPORT to define port config
70 :
80 .SETPORT LDA #1
90 STA &FE62
100 LDA #1
110 STA &FE60
120 RTS
130 :
140 \ Put transmit data in A% and Call SEND.
150 \ SEND transmits single start bit
160 :
170 .SEND PHA
180 LDA #0
190 STA &FE60
200 JSR DELAY
210 NOP
220 LDX #B
230 PLA
240 :
250 \ BYTE runs on to transmit data in A%
260 :
270 .BYTE STA &FE60
280 JSR DELAY
290 ROR A
300 DEX
310 BNE BYTE
320 :
330 \ FINISH transmits single stop bit
340 \ and returns you to BASIC
350 :
360 .FINISH LDA #1
370 STA &FE60
380 JSR DELAY
390 RTS
400 :
410 \ DELAY loop of 8 gives precise baud rate
420 :
430 .DELAY LDY #B
440 .LOOP DEY
450 BNE LOOP
460 RTS
470 :
480 \ Call IOFF before calling SEND
490 \ Interrupts have to be disabled to
500 \ ensure correct baud rate
510 :
520 .IOFF SEI
530 RTS
540 :
550 \ You must call ION to restore
560 \ interrupts after return from SEND
570 \ otherwise keyboard will be locked out
580 :
590 .ION CLI
600 RTS
610 J
620 NEXT

```

## COMPONENTS

### Resistors

R1 4k7  
R2 330  
R3 120

All ¼W carbon

**Shop  
Talk**

See page 193

### Semiconductors

IC1 SN7405 Hex inverter

### Miscellaneous

Plug to suit the BBC Micro User Port (20 pin); five way 180° DIN plug; Veroboard, 9 strips by 10 holes, 0.1 inch matrix; connecting cable.

Approx. cost  
Guidance only **£4** plus software

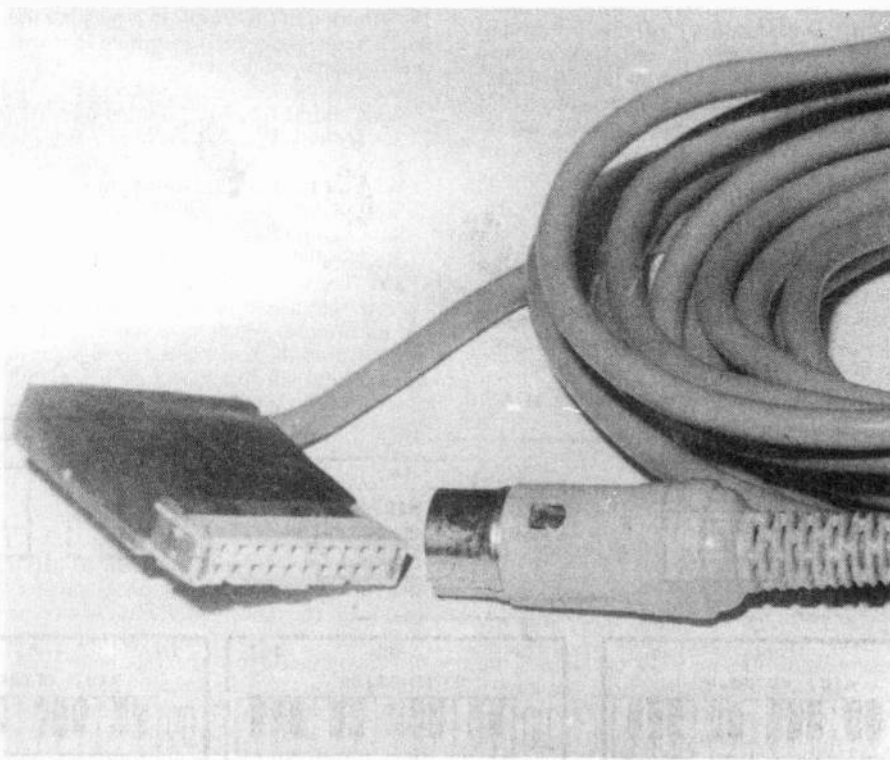

# SIMPLE MIDI MERGE UNIT

## Robert Penfold

**I**N THE pre-MIDI era sophisticated electronic music systems were something of a rarity. These days sophisticated computer controllers and polyphonic multi-timbral instruments have much more modest price-tags, and are generally vastly superior to the top-flight instruments of a few years ago. With a few pieces of MIDI equipment there are almost limitless musical possibilities.

There are also a large number of ways in which a given set of MIDI units can be organised into a system. In some cases what might be quite desirable might also be impossible due to a lack of MIDI ports to permit everything to be fitted together in the desired fashion. Usually a very simple add-on is all that is needed in order to facilitate the required method of connection. The two standard add-ons for these situations are MIDI THRU boxes and merge units. A THRU box (as described in the July 1987 issue of *Everyday Electronics*) simply takes a MIDI input signal and splits it to provide two or more buffered outputs. A MIDI merge unit provides the opposite function, and combines two MIDI signals into one.

A sophisticated MIDI merge unit will operate with signals on both inputs simultaneously. It takes signals on one input and

passes them through to the output, while signals on the other input are stored in a buffer until the output is free and they can be transmitted. Provided the two sources do not provide so much data that the unit becomes overloaded, this gives good results with no significant time-shifting of any MIDI messages.

While advantageous in some circumstances, a merge unit of this type is quite complex and expensive as it needs to be microprocessor based. For most purposes something that simply couples two inputs through to a single output will suffice, but simultaneous operation on both inputs must be avoided. This would give a scrambled output that would result in a malfunction of the system. A unit of this type should really be regarded as an alternative to a MIDI switch, but it has the advantage of effectively being automatic in operation.

### USES

A simple application for a MIDI Merge Unit would be in a setup of the type depicted in Fig. 1. Here a synthesiser (which could be a rack mounted type rather than a keyboard instrument) is played from a MIDI keyboard. The latter could be a synthesiser with the second instrument act-

ing as a "slave" to it, or it could be just a MIDI keyboard.

Suppose that the synthesiser will sometimes be used with a step-time sequencer such as a computer running a notation program. Either a lot of plugging and unplugging will be needed, or some form of switch or merge unit is required to feed signals from the desired controller to the MIDI "IN" socket of the synthesiser. As explained previously, a merge unit has the advantage of effectively giving automatic switching. It can be connected up and then largely forgotten!

Although it might seem to be possible to obtain much the same effect by feeding the output of the sequencer to the input of the keyboard, this will not work. The input signal appears on the "THRU" output and not at the "OUT" socket (apart from a few instruments which can be switched to this non-standard mode of operation). Driving the synthesiser from the "THRU" output of the keyboard will not work either. The keyboard's output signal does not appear at this socket.

Another arrangement is shown in Fig. 2 in which a simple merge unit can be used to good effect. Here two synthesisers have been "chained" together and are being played from a separate keyboard. A MIDI pedal unit is used to provide program change messages to switch to different sounds from the synthesisers at the appropriate times. A merge unit enables both the keyboard and the MIDI pedal to drive the synthesisers, but with a simple merge unit of the type described here it is necessary to take care not to operate the pedal and the keyboard simultaneously. Once again, with most keyboards it is not possible to obtain the desired effect by feeding the output of the MIDI pedal to the keyboard's "IN" socket.

As a point of interest, most MIDI keyboards have a "local off" mode, where the keyboard is disconnected from the sound generator circuits. The keyboard still functions and drives the MIDI "OUT"

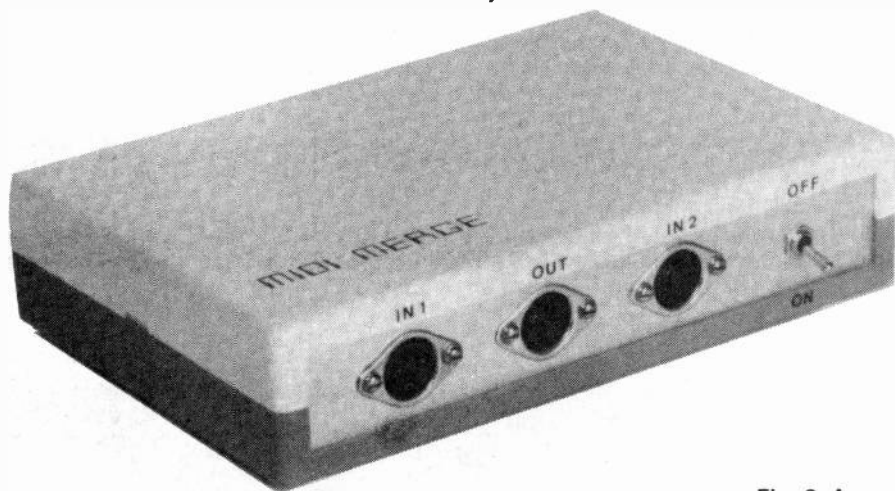

Fig. 1. A simple MIDI system using a merge unit.

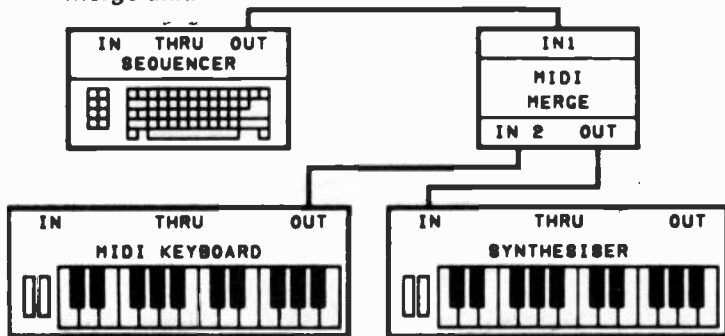
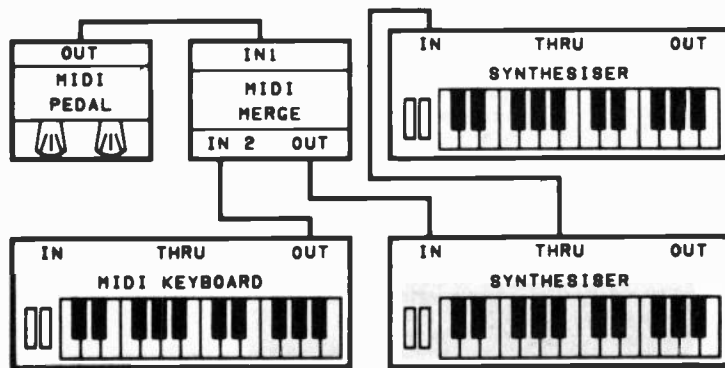

Fig. 2. A more complex setup using a merge unit.



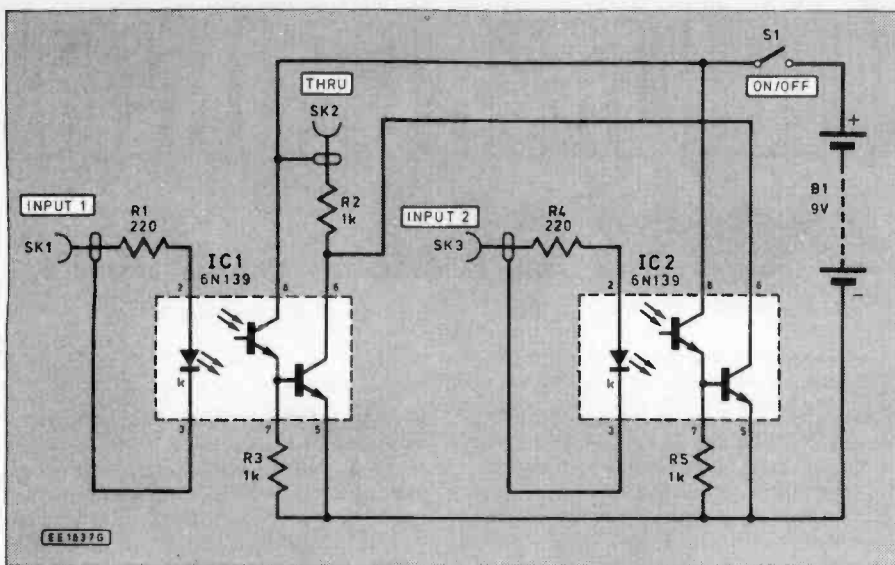

Fig. 3. The simple MIDI Merge Unit circuit diagram,

socket, and the sound generator circuits still respond to information received via MIDI. The instrument is effectively turned into a separate keyboard and MIDI sound module. The setup of Fig. 2 could therefore be implemented using a synthesiser switched to the "local off" mode to act as the separate keyboard and one of the synthesisers.

### THE CIRCUIT

A unit of this type can be very simple indeed, as will be apparent from the circuit diagram of Fig. 3. MIDI outputs are generally open collector types, and a simple merge function could conceivably be obtained simply by connecting two outputs in parallel. As the exact forms of output stages used are unknown quantities, and it is quite likely that none of the MIDI output terminals will be at earth potential, this

would be more than a little risky, and is certainly not to be recommended. It is better to have a simple combiner circuit, such as the one described here, which has an optoisolator at each input. This ensures complete isolation between the two sources.

The MIDI baud rate of 31.25 kilobaud is high enough to make it difficult to feed the signal through a relatively slow component like an optoisolator and obtain a reasonably accurate reconstruction of the signal at the output. Ordinary optoisolators of the type which use an infra-red l.e.d. and a photo-transistor seem to be totally inadequate, and even the high efficiency/high speed types seem to be barely adequate for this application.

In this circuit a slightly different type of optoisolator is used, and this is a component which has one transistor in the emitter follower mode, driving another which acts as a common emitter switch. This configuration might look rather like the familiar Darlington Pair arrangement, but it is not, as the collector of the two transistors are not connected together. Darlington devices offer good sensitivity but are very slow, and totally unsuitable for this application.

In fact the configuration used here is too slow without the inclusion of the emitter load resistor for the first transistor in each optoisolator (R3 and R5). This ensures

that the emitter follower stage operates at a reasonably high current, and that it operates suitably fast. Using a 16kHz squarewave test signal (which is comparable to a MIDI signal) there is no significant degradation of the waveform through the unit. In theory this circuit should operate at something like ten times the MIDI baud rate, and it should give excellent reliability with MIDI signals.

### OUTPUT

On the output side of the circuit, the two open collector outputs are simply wired together, and connected to the output socket via a common current limiting resistor (R2). Note that current limiting resistors are included at each input, as called for by the MIDI standard. This is presumably to protect the l.e.d.s in the event of equipment being connected incorrectly.

Power is obtained from a nine volt battery. This should have a long operating life as the maximum current consumption (with a continuous stream of data) is only about 2.5 milliamps, and the current consumption under stand-by conditions is likely to be no more than a few microamps. If the unit should happen to be accidentally left switched on for long periods it is unlikely that the battery will discharge to any significant extent.

### CONSTRUCTION

Details of the printed circuit board are shown in Fig. 4. Construction of the board is very straightforward, but do not overlook the single link-wire. The optoisolators are not static sensitive devices, but as they are not particularly cheap I would recommend that they are fitted into sockets. At this stage only fit pins to the board at the points where the connections to off-board components will eventually be made.

I used a case having approximate dimensions of 180 by 120 by 40 millimetres, but the unit could be fitted into a much smaller case if desired. The three sockets and the on/off switch are mounted in a row along the front panel of the unit. The input and output sockets are five way (180 degree) DIN types, which are the standard MIDI connectors. Each socket requires two short round-head 6BA fixing screws plus matching nuts. The printed circuit board is mounted on the base panel of the case using M3 or 6BA mounting screws plus spacers, or plastic stand-offs.

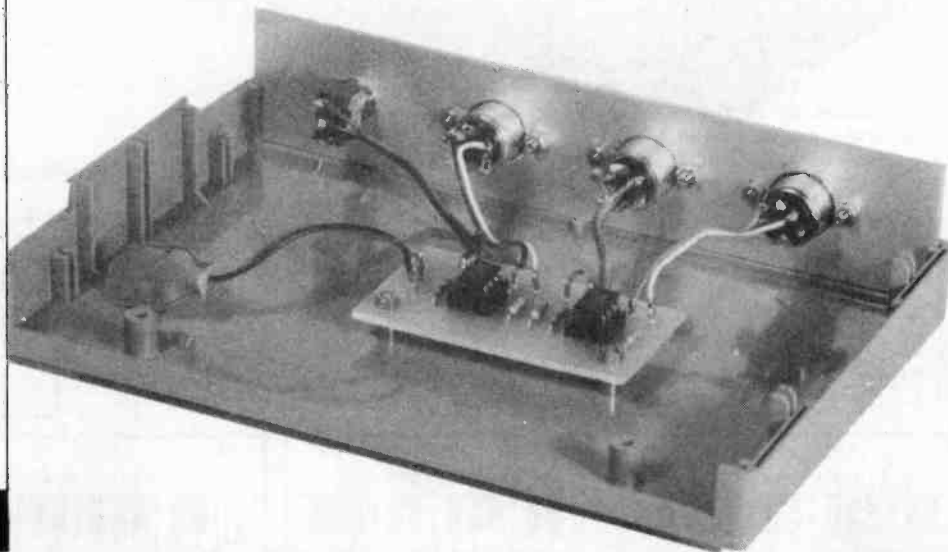

## COMPONENTS

Shop  
Talk

### Resistors

R1, R4 220 (2 off) See  
R2, R3, R5 1k (3 off) page 193

All 0.25 watt 5% carbon.

### Semiconductors

IC1, IC2 6N139 Darlington  
optoisolator  
(2 off)

### Miscellaneous

SK1 to SK3 5 way 180 degree  
SK3 DIN sockets (3 off)  
S1 S.P.S.T. sub-  
miniature toggle  
switch  
B1 9 volt battery  
(PP3 size)

Printed circuit board available  
from EE PCB Service order code  
EE640; case about 180mm x  
120mm x 40mm; battery connec-  
tor; pins; wire; solder; etc.

Approx. cost  
Guidance only

£14

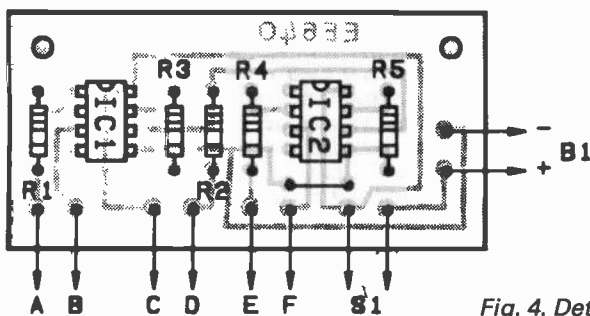

Fig. 4. Details of the printed circuit board.

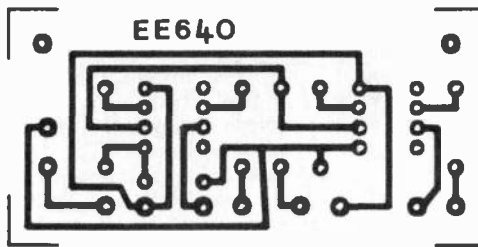

Fig. 5. The wiring of the sockets.

The small amount of hard-wiring is then added, using ordinary insulated multi-strand connection wire. Fig. 5 shows the wiring to the three sockets. This method of connection enables the unit to be wired into a system using standard MIDI cables. If you wish to make your own cables, twin screened lead is required.

The inner conductors are used to connect pins 4 and 5 on one plug to the same pins on the other plug. Cross-over connection (i.e. connect pin 4 on one plug to pin 5 on the other) must not be used. Apparently some ready-made audio DIN leads do use

cross-over connection, and are consequently unsuitable for MIDI use. The cable's screen is used to connect pin 2 on one plug to pin 2 on the other plug.

### TESTING

In order to test the unit it is merely necessary to connect a MIDI controller of some kind to each input, and to couple the output to a MIDI instrument. With the merge unit switched on, operating either controller should then produce the appropriate result from the instrument. If not, switch off the merge unit and recheck all the wir-

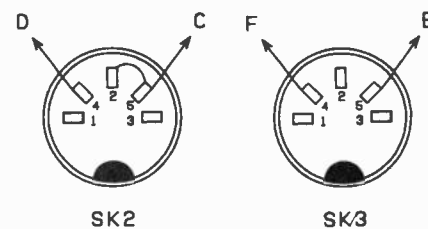

ing. Also, make sure that the MIDI equipment is all operating on suitable modes, channels, etc. □

# MIDI PEDAL

## Robert Penfold

**T**HIS MIDI Pedal project exploits one of the extra MIDI facilities; the program change messages. These messages are one of the more versatile aspects of the MIDI system, and this unit can be used to good effect with a wide range of MIDI equipment.

### QUICK CHANGE

There are two basic types of MIDI message, which are the channel and system types. The note on/off messages are the most common channel types, and these carry a channel identification number so that they can be directed to one particular instrument, or even to one voice of one particular instrument in the system. The system messages, which include the so-

called MIDI clock timing signals, are directed to everything in the system, and cannot be targeted at one particular item of equipment or voice of an item of equipment.

One of the most useful of the MIDI channel messages is the program change type. MIDI messages always start with a header byte which contains the code for the message involved, plus the channel number where appropriate. This header byte is then followed, where necessary, by one or more data bytes. The program change message has just one data byte, which is the new program number in the range 0 to 127.

Note that MIDI distinguishes between instruction and data bytes by having the most significant bit of instruction bytes always set to 1, and those of data bytes

always set to 0. This leaves only seven bits left for data, and gives a range of 0 to 127 rather than 0 to 255.

Some parts of the MIDI specification are rigidly defined, while other parts are left extremely vague. While I suppose that the vagueness can be a drawback, it does permit great versatility. The program change message is a good example of this. Each program is really a collection of control settings rather than a program in the normal computer sense. The MIDI specification does not lay down any rules as to what controls can be included under the command of program change messages, and this is entirely at the discretion of the equipment designers.

This has the drawback that just what each program number represents varies from one piece of equipment to another. It could even be different for two items of gear of the same type, because one might have been set up differently to the other. It gives great versatility though, since virtually anything can be controlled via MIDI program change messages.

In most cases these messages are used with instruments where each program is a different group of settings for the envelope shapers, filters, etc. In other words, each program produces a different sound from the instrument, and changing from program 1 to program 2 could switch from a piano to an organ sound for instance. It is important to realise that each program is a series of preset control settings, and that

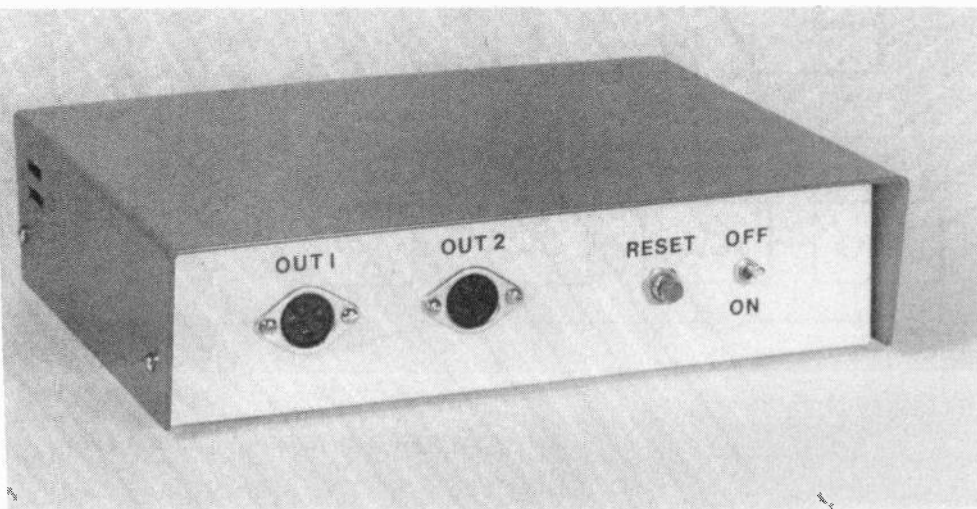

program change messages do not permit adjustment of individual controls (which is possible via the control change messages). However, for many purposes switching from one range of settings to another is all that is required.

## MIDI UNITS

There are now a wide variety of MIDI controlled units available, including effects units and audio mixers. These are mostly controlled via MIDI program change messages. Taking an effects unit as an example, this could be fed from the MIDI OUT socket of a synthesiser, and the latter could be set up to transmit program change messages each time its program was changed by way of the front panel controls. The effects unit would then change programs in sympathy with the synthesiser, and it could be set up to provide a suitable effect to enhance each sound produced by the synthesiser.

A MIDI pedal generates a program change message each time the foot-switch is operated. The most basic way of using a MIDI pedal (but a very effective one) is to have it driving the MIDI IN socket of a synthesiser or other MIDI equipped instrument. This permits the "no hands" approach to changing sounds. There are numerous other ways in which a MIDI pedal can be utilized though. It could be used to drive an effects unit, or both an instrument or an effects unit, or any equipment that responds to program change messages for that matter.

This MIDI pedal simply increments the program number by one each time the unit is activated. The program would presumably be set at 0 initially, but whatever the initial setting, the first operation of the pedal switches it to program 1, the next switches it to program 2, and so on. This method enables the electronics of the pedal unit to be kept reasonably uninvolved, but it is compatible with most MIDI equipment where any desired control settings can usually be assigned to each program. It is not of much use with any items of equipment that have factory preset programs which are not user redefinable.

In order to obtain worthwhile results it must be possible to set up the programs of the instrument so that the required sounds are obtained as the pedal is used to take the instrument through a sequence of programs. However, I have not encountered any units of the purely preset type, and most MIDI equipment seems to be designed to make it reasonably easy to set up each program in the desired manner.

In many cases the pedal will be used with equipment set to the "omni" mode, where messages on all the MIDI channels are accepted and responded to. The pedal unit can be preset via an "on-board" hex switch to transmit on any one of the sixteen MIDI channels, and is therefore usable in a setup where operation on a specific channel is essential. The unit has two MIDI OUT sockets, and it is self contained with power being provided by an internal nine volt battery.

## SYSTEM OPERATION

MIDI is a serial system which is very much like the standard RS232C type. It differs from the RS232C system in that it operates at the relatively high baud rate of 31250 baud, which is not a standard RS232C rate. Also, it does not use ordinary RS232C signal levels. In fact it is a current

loop system which has an opto-isolator at each input. It operates at a nominal current of five milliamps.

The arrangement used in this unit is shown in Fig. 1, albeit in somewhat simplified form. The UART (universal asynchronous transmitter/receiver) is at the heart of the unit, and it is this that generates the basic serial output signal. UARTs are better suited to this type of unit than most other serial devices, as other types are almost invariably only suitable for microprocessor based circuits. A crucial feature of UARTs for a relatively simple unit of this type is that they can be programmed via link-wires connected to control inputs, and they do not have to be set up under software control.

## UART

The "raw" output of a UART is not MIDI compatible, but a couple of simple inverter/driver stages are all that is needed in order to provide two outputs having the required five milliamps of drive. A clock oscillator sets the baud rate at the correct figure.

A UART provides a parallel to serial conversion, and will provide any standard word format. For MIDI operation a word format of one start bit, eight data bits, no parity, and one stop bit is required. This format is programmed into the device simply by taking five control inputs to the correct logic states.

In order to transmit the program change messages it is merely necessary to feed the first byte onto the data bus, and then supply a brief pulse to a control input of the UART to initiate transmission of this byte. The second byte (the new program number) is then fed to the data bus, and the control input of the UART is then pulsed again. The data byte is provided by a binary counter which must be incremented each time the unit is activated, so that the program number is automatically advanced each time the unit is operated.

The UART's parallel input bus is fed from two octal tristate buffers. A tristate output is one that can have the usual high or low output levels, but can additionally

take up a third state where it is deactivated and provides a high output impedance. In this case the two buffers are controlled by the Q and not Q ( $\bar{Q}$ ) outputs of a divide-by-two flip/flop, and only one or the other will be activated and drive the input data bus of the UART.

## CHANGE CODE

Initially it is the upper of the two buffers that is activated, and this feeds the output from a simple code generator circuit through to the UART. The code generator simply produces 1100 (in binary) as the most significant nibble, and this is the program change code. The least significant nibble can be varied from 0000 to 1111 (again in binary) by means of a switch circuit, and this sets the MIDI channel number.

When operated, the foot switch sets a bistable circuit. This in turn activates a gated oscillator which drives a control logic circuit, and via this, the flip/flop. The pulses from the oscillator and control logic blocks first activate the UART so that the header byte is transmitted. A subsequent pulse clocks the flip/flop to its alternative output states so that the output from the second buffer is fed through to the UART. This buffer is fed from a binary counter, and as explained previously, the most significant bit for data bytes are always set to logic 0. This counter is consequently a seven bit type, and not an eight bit counter.

The output of the counter is set to zero at switch-on, and it can be manually reset to zero at any time using the reset switch. However, the counter is incremented as the second buffer is activated, and it is therefore at 1 when the first data byte is fed through to the UART. This is correct in that the controlled equipment would normally be started at program number 0, and the pedal should generate a change to program 1 when it is first operated.

The next pulse from the control logic circuit causes the data byte to be transmitted by the UART, and the next one resets the bistable. This switches off the oscillator, and returns the unit to the stand-by mode. It remains in this state until the foot switch is operated again. The two bytes are then

Fig. 1. The MIDI Pedal block diagram

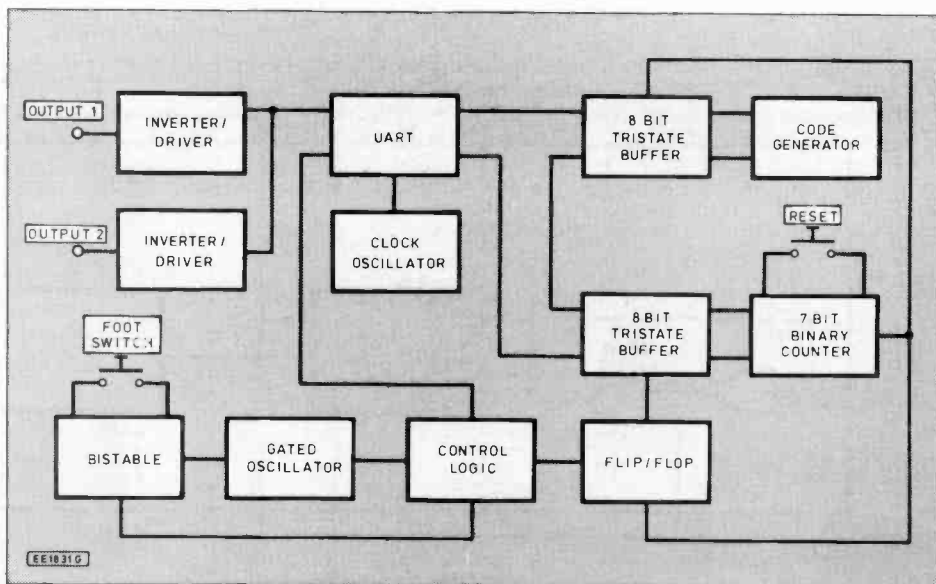



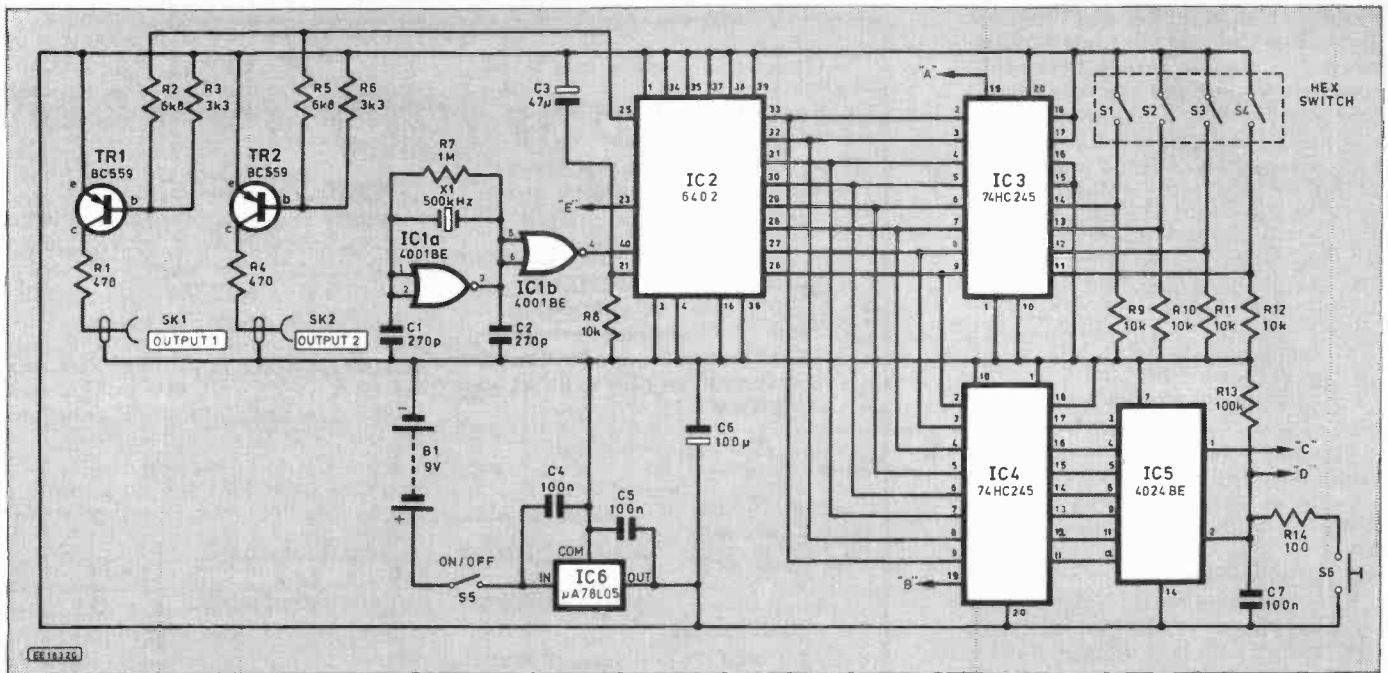

Fig. 2. The circuit for the transmitter section of the unit

transmitted once more, but with the counter being advanced by one prior to the data byte being sent. The unit thus provides the desired action, with a series of automatically incremented program change messages being transmitted.

### TRANSMITTER CIRCUIT

Fig. 2 shows the circuit diagram for the section of the unit that generates and transmits the header and data bytes. IC2 is the UART, and this is the industry standard 6402 type. This is supplied with a positive reset pulse at switch-on by C3 and R8. IC1 is a quad 2 input NOR gate, but IC1a and IC1b are wired as inverters. They are used as the clock oscillator and a buffer stage respectively. The clock frequency is set at 500kHz by ceramic resonator X1. IC2 requires a clock signal at sixteen times the transmission baud rate, and this gives the desired 31.25 kilobaud output.

The serial output signal from IC2 drives two common emitter switches (TR1 and

TR2) having open collector outputs. The i.e.d.s in the opto-isolators at the inputs of the controlled equipment act as the collector loads for TR1 and TR2, with R1 and R4 limiting the drive current to a suitable figure.

IC3 and IC4 are the octal tristate buffers, and are in fact octal transceivers. However, in this application they are permanently wired in the "receive" mode and are only used as buffers. The four most significant bits of IC3 are tied to the appropriate logic levels to generate the program change code, while the least significant bits are controlled by a hex switch (S1 to S4). Note that if the unit is only required to transmit on MIDI channel number 1, the hex switch can be omitted (but R9 to R12 should still be included, or replaced by link wires).

Hex switches are designed for "on-board" mounting, and this is not a panel mounted control. In the unlikely event that frequent channel changes will be required, probably the best option would be to use miniature toggle switches for S1 and S4,

but the channel numbers would then have to be entered in binary form.

IC5 is the seven bit binary counter, and it is reset at switch-on by C7 and R13. It can be manually reset using S6. These signals are also used to reset the flip/flop incidentally.

### SUPPLY

The circuit requires a reasonably stable five volt supply, and this is obtained from a nine volt battery via monolithic voltage regulator IC6. Battery operation is made feasible by the use of CMOS integrated circuits throughout the design, including the 6402 which has a remarkably low current consumption for such a complex device. The total current consumption of the circuit is only about six milliamps or so.

### CONTROL CIRCUIT

The circuit diagram for the control circuitry is shown in Fig. 3. The bistable is formed from the two remaining gates of

Fig. 3. The control logic circuits

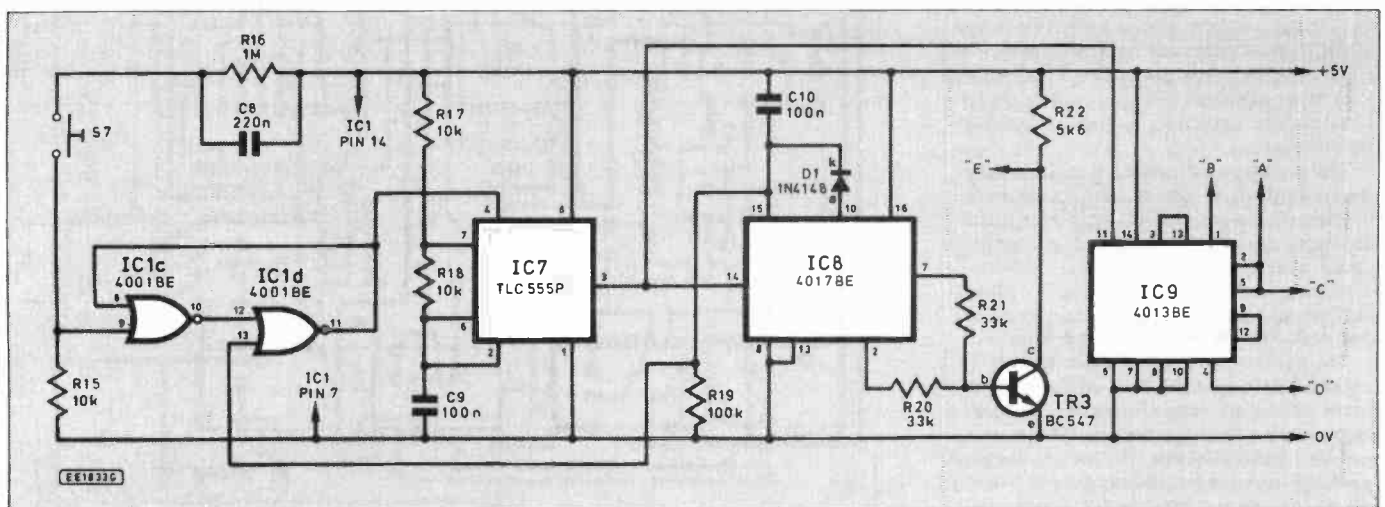

IC1. S7 is the foot switch, and it is "debounced" by R16 and C8. This "debouncing" is essential if multiple triggering of the unit is to be avoided. A simple 555 astable circuit based on IC7 provides the gate oscillator stage.

IC8 forms the basis of the control logic stage, and this is a CMOS 4017BE one of ten decoder. It is reset at switch-on by C10 and R19, and it is reset each time output "4" (pin 10) goes high, due to the coupling from this pin to the reset terminal via D1. This effectively relegates IC8 to a one of four decoder. Actually only outputs "1" and "3" are used, and these provide the pulses that initiate the transmission of data from the UART.

Transistor TR3 acts as a simple gate and inverter stage that mixes the two output signals and converts the positive output pulses from IC8 into the negative types required to drive the UART properly. When IC8 resets itself after four oscillator cycles, it also resets the bistable and switches off the oscillator.

IC9 is the divide by two flip/flop circuit, and this is actually a CMOS 4013BE dual D type flip/flop with both sections wired as divide by two stages and connected in series. The additional divider stage is needed because the control logic circuit operates on cycles of four oscillator pulses rather than on two pulse cycles. The extra divider stage keeps the control logic and flip/flop circuits properly synchronised.

## CONSTRUCTION

Details of the printed circuit board are provided in Fig. 4. The first point to note here is that all the d.i.l. integrated circuits are CMOS types, and therefore require the normal anti-static handling precautions to be observed. In particular, they should all be mounted in integrated circuit holders. Take special care with the 6402 UART which does not rank as a particularly cheap component. Do not fit the integrated circuits into their holders until the unit is in all other respects finished, and handle them as little as possible.

The board is a single-sided type but a number of link wires are required. These can be made from 22 s.w.g. tinned copper wire. Provided they are kept reasonably taut it should not be necessary to insulate any of them with sleeving. At this stage only pins are fitted to the board at the point where it will eventually be connected to the off-board components.

Provided the specified hex switch is used it should fit onto the board without too much difficulty. Other types may have a different pin arrangement though. Also, the circuit assumes that a switch is closed when it must generate a logic 1 level, but some hex switches go open circuit when they must generate a logic 1 output signal. Use of the specified switch is strongly recommended.

The prototype is housed in an aluminium instrument case which has approximate outside dimensions of 200 by 150 by 50 millimetres, and this comfortably accommodates everything including the batteries. The latter are six HP7 cells fitted in a plastic holder, and these couple to the unit via an ordinary PP3 style battery connector.

The prototype is built to operate with an external foot switch which connects to the main unit by way of a miniature jack socket mounted on the rear panel. Obviously it can be built with a heavy duty non-locking push button switch fitted on the top panel if preferred, and a sloping-front style case

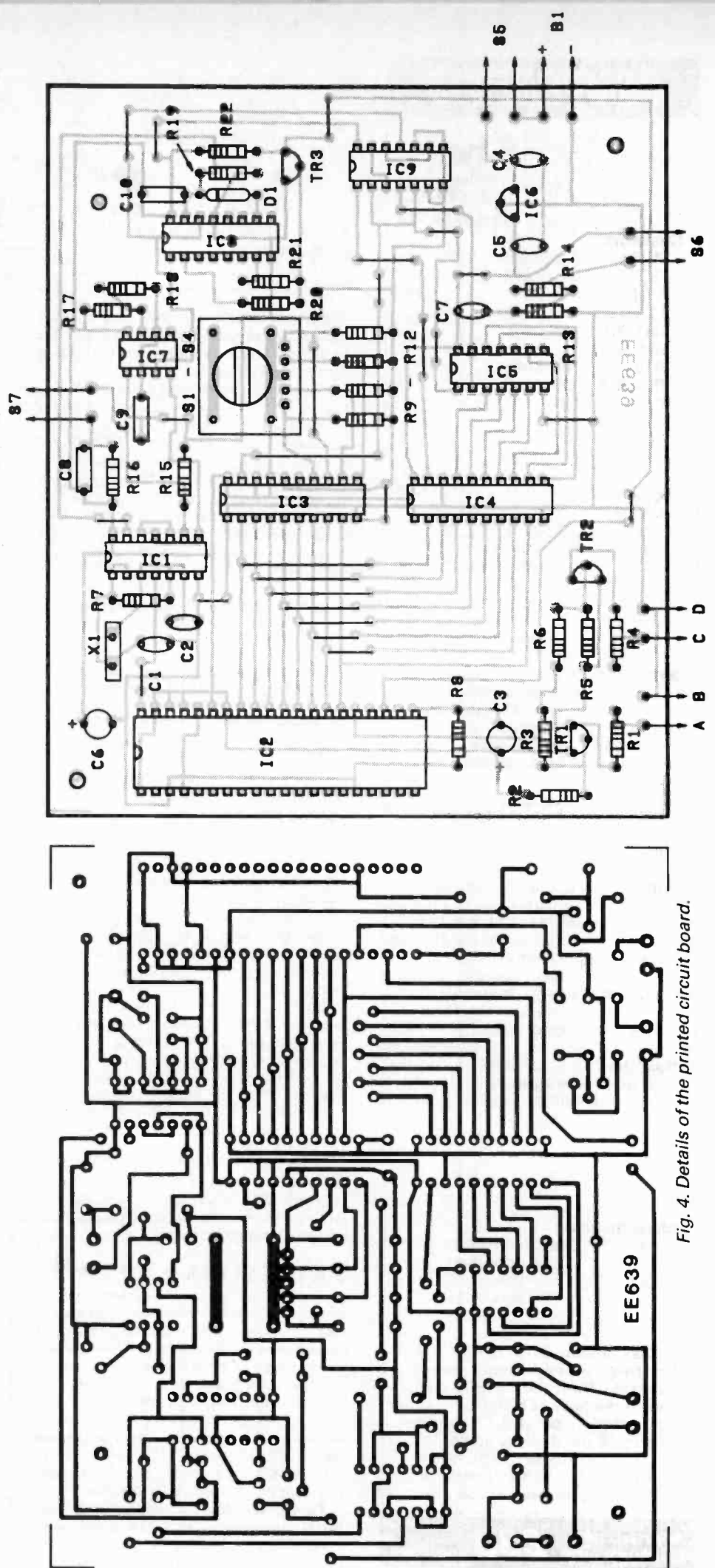

Fig. 4. Details of the printed circuit board.

# COMPONENTS

## Shop Talk

See page 193

### Resistors

R1, R4	470 (2 off)
R2, R5	6k8 (2 off)
R3, R6	3k3 (2 off)
R7, R16	1M (2 off)
R8 to R12, R15, R17, R18	10k (8 off)
R13, R19	100k (2 off)
R14	100
R20, R21	33k (2 off)
R22	5k6

All 0.25W 5% tolerance

### Capacitors

C1, C2	270p ceramic plate (2 off)
C3	47µ radial elect 16V
C4, C5, C7	100n ceramic (3 off)
C6	100µ radial elect 10V
C8	220n polyester
C9, C10	100n polyester (2 off)

### Semiconductors

IC1	4001BE CMOS quad 2 input NOR
IC2	6402 UART
IC3, IC4	74HC245 octal transceiver (2 off)
IC5	4024BE 7 bit ripple counter
IC6	µA78L05 100mA 5V regulator
IC7	TLC555P low power timer
IC8	4017BE CMOS 1 of 10 decoder
IC9	4013BE CMOS dual D type flip/flop
D1	1N4148 silicon signal diode
TR1, TR2	BC559 silicon pnp (2 off)
TR3	BC547 silicon npn

### Switches

S1 to S4	Hex switch
S5	S.P.S.T. sub-min. toggle
S6	Push to make, non-locking type
S7	Push button (see text)

### Miscellaneous

B1	9 volt (six HP7s in plastic holder)
SK1, SK2	5 way 180 degree DIN socket (2 off)
X1	500kHz ceramic resonator

Case about 200×150×50 millimetres; printed circuit board available from the *EE PCB Service*, order code EE639; 8 pin d.i.l. i.c. holder; 14 pin d.i.l. i.c. holder (3 off); 16 pin d.i.l. i.c. holder; 20 pin d.i.l. i.c. holder (2 off); 40 pin d.i.l. i.c. holder; battery connector (PP3 style), pins, wire, solder, etc.

Approx. cost **£30** inc. case  
Guidance only

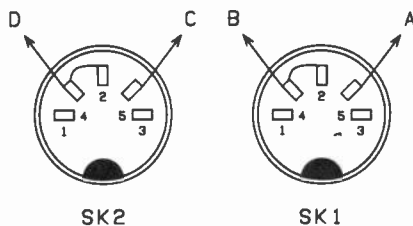

Fig. 5. The connections to SK1 and SK2.

might then represent the best form of housing for this project. Both the case and the switch must be heavy duty types if a built-in foot switch is used.

Whichever form of construction is selected, the printed circuit board is mounted on the base panel of the case on stand-offs, and the on/off switch, reset switch, and output sockets are mounted on the front panel. Five way 180 degree DIN sockets were not a random choice for SK1 and SK2 – these are the standard MIDI connectors. Fig. 5 shows the correct method of wiring these to the printed circuit board. The unit is completed by wiring the battery clip, reset switch, and on/off switch to the board, and then finally connecting either the foot switch or its socket on the rear panel.

## TESTING AND USE

To test the pedal, simply connect one of the output sockets to the MIDI IN socket of any item of equipment that responds to MIDI program change messages. Ideally you should use something like a synthesiser that shows the current programme number on its display, or you may have a computer plus MIDI interface and a utility program that displays received data.

Repeatedly activating S7 should result in the program switching the 1 first, then 2, and so on. If you make your own connecting cable, pins 4 and 5 on one plug connect to the same pins on the other plug. They are not cross connected (as in some DIN audio leads). Pin 2 connects to the cable's screen.

There are a few points that need to be borne in mind when testing and using the unit. First of all, bear in mind that if the controlled equipment is set to an "omni off" mode, it will almost certainly not respond to MIDI program change messages unless the MIDI pedal and the controlled equipment are set to the same MIDI channel.

Many pieces of MIDI equipment can be set to ignore program change instructions, and obviously, where appropriate, the controlled equipment must be set to respond to program change messages.

## ANOMALIES

Confusion often arises with MIDI due to anomalies in the numbering of programs and channels. The hex switch will almost certainly be numbered from 0 to 15, which is the range of binary values it produces. On the other hand, the convention is for MIDI channels to be numbered from 1 to 16. Accordingly, if you wish to set the panel to (say) MIDI channel number 9, the hex switch should be set to position "8". In other words you must set the switch to one less than the desired MIDI channel.

Things are less straightforward with MIDI program numbers. The actual range of numbers used in the messages is from 0 to 127, and this is the program numbering

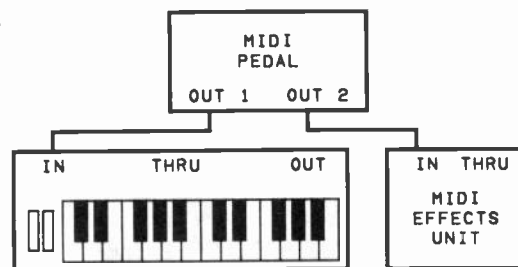

Fig. 6. Suggested MIDI wiring for a system having one instrument plus a MIDI effects unit

range used by some manufacturers. However, others use 1 to 128, and some use a totally different system. For instance, I have a Casio synthesiser which provides manual program selection via two sets of push button switches marked A to H, and 1 to 8. The programs are therefore numbered from A1 to H8!

The equipment manuals should make it clear what method of numbering is used, and provide a conversion table where an unusual method of numbering is in use. Bear in mind that most pieces of equipment do not use the full range of 128 programs. Sending an out-of-range program number will normally just result in it being ignored by the equipment, rather than causing anything catastrophic.

## CONNECTING

The normal method of connecting two or more items of MIDI equipment together is to connect the THRU socket of one unit to the IN socket of the next, and so on, building up a chain of connections as long as required. In practice things do not necessarily work out quite as easy as this.

Many MIDI instruments, especially the keyboard types, lack a THRU socket. Also, the chain system can produce poor reliability due to the signal being slightly degraded as it passes through each unit. The extra output on the pedal unit can therefore be very useful, and it is probably worthwhile using it, even where the chain system of connection could be used. For example, with a synthesiser and effects unit that are both to be controlled from the pedal the method of connection shown in Fig. 6 would be the best one to use. □

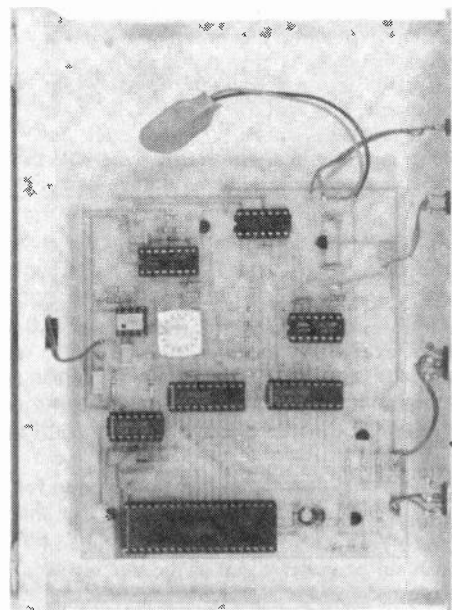

TEACH-IN SERIES

# TWO SPECIAL PUBLICATIONS

FROM EVERYDAY ELECTRONICS

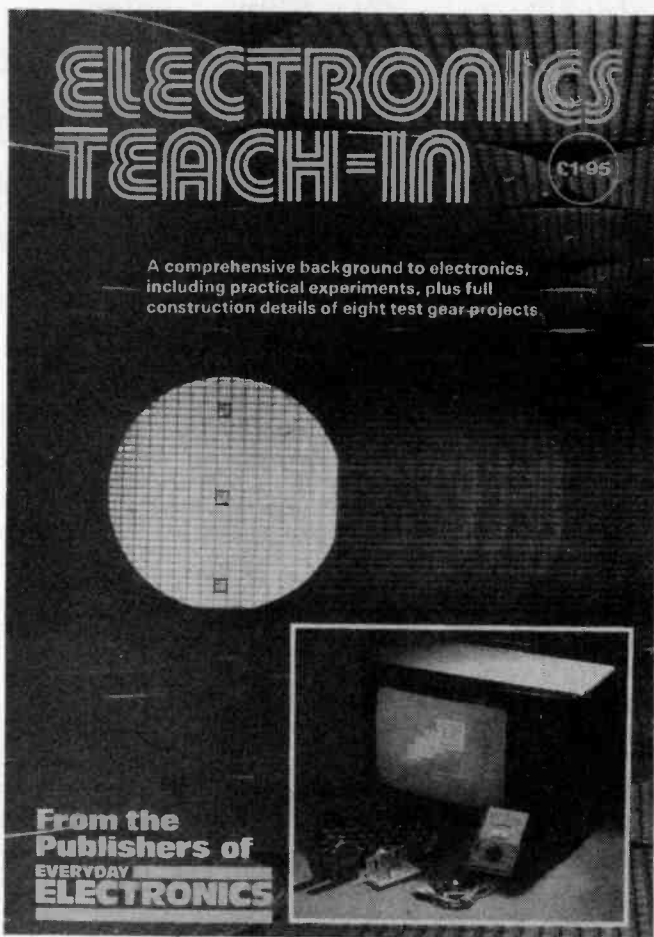

## THE FIRST "TEACH-IN" BOOK

**ONLY £1.95**

By Michael Tooley BA and David Whitfield MA MSc CEng MIEE

A comprehensive background to modern electronics including test gear projects. This 104 page, A4 size book forms a complete course in basic electronics; designed for the complete newcomer it will, however, also be of value to those with some previous experience of electronics. Wherever possible the course is related to "real life" working circuits and each part includes a set of detailed practical assignments.

This book is an excellent companion for anyone interested in electronics and will be invaluable for those taking G.C.S.E. or B.T.E.C. electronics courses. **ORDER CODE: EE/T-1**

**SEE DIRECT BOOK SERVICE pages—for full ordering details**

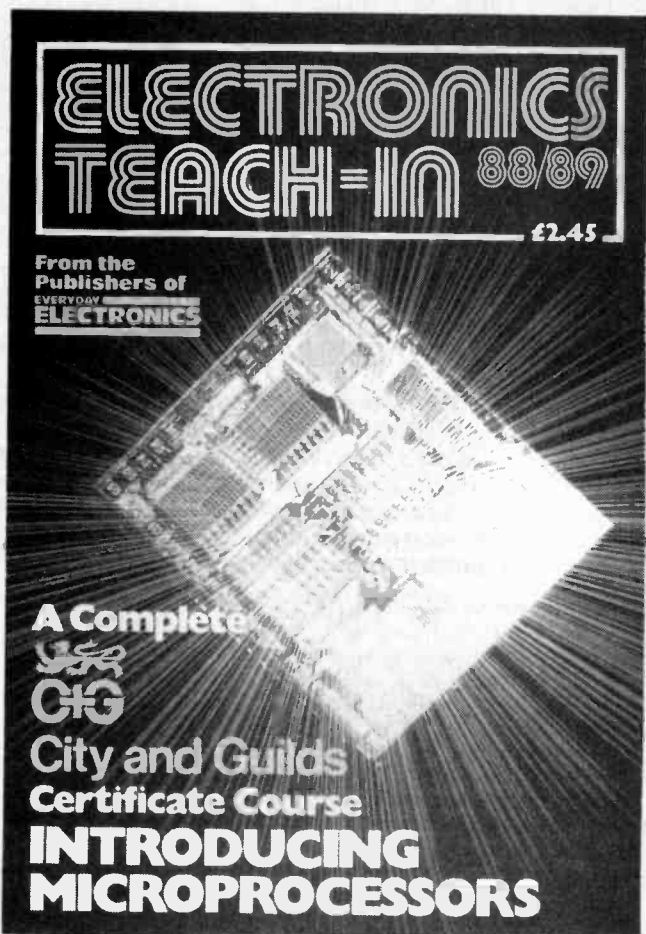

## TEACH-IN 88/89 BOOK

**£2.45**

**A complete City and Guilds Certificate Course for 726/303 Introductory Microprocessors**

Written by Mike Tooley BA this course can lead successful readers to a City and Guilds Certificate. Everything you need to know is included—even pre-test papers, etc.

From Terminology, Integrated Circuits and Logic Families in Part One, the course progresses in easy stages up to High- and Low-level Languages, Flow Charts and Assembly Language. Also featured is a range of eight Data Pages giving information on popular microprocessor chips. A comprehensive index is included, making this a valuable reference manual. **ORDER CODE: TI 88/89**

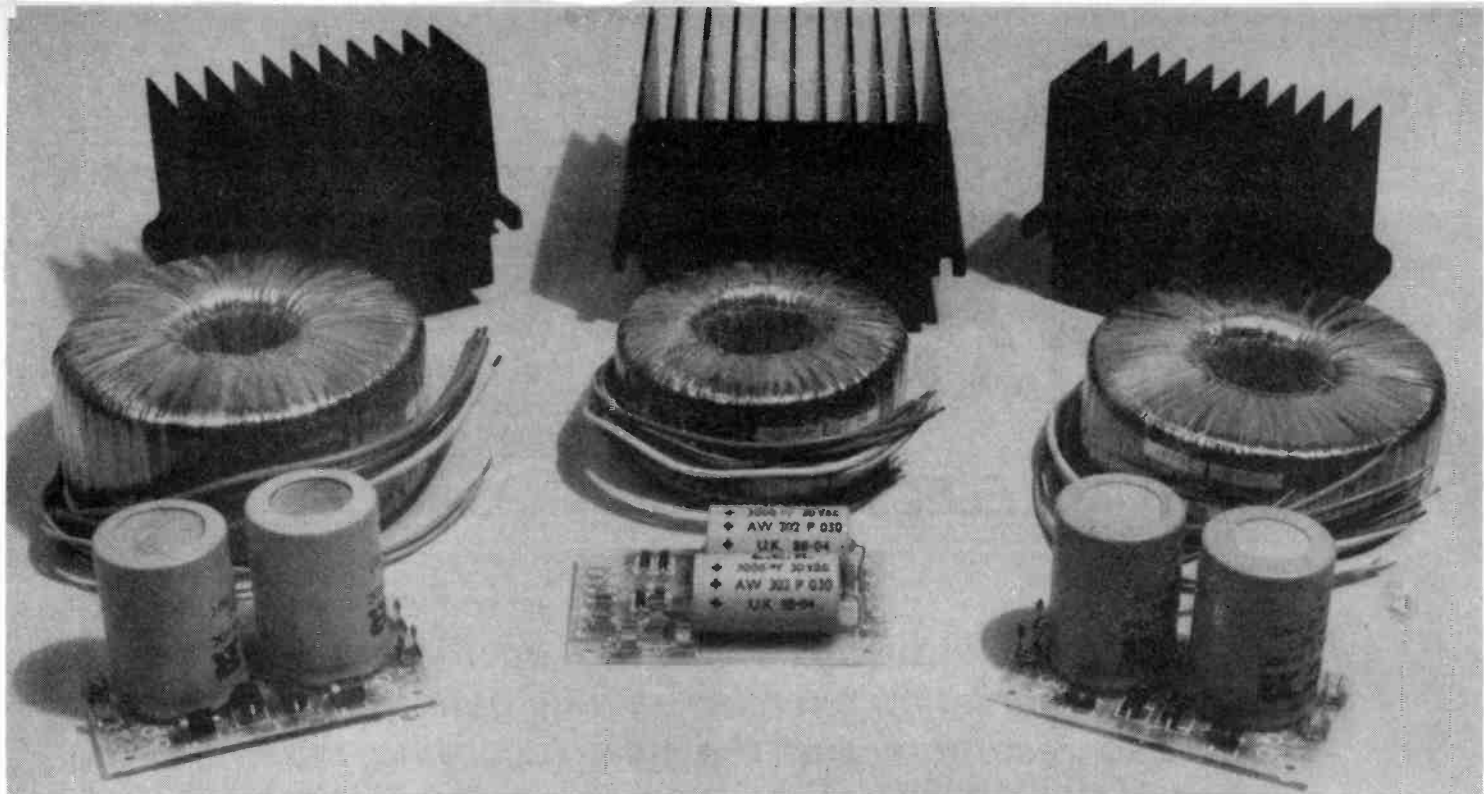

# SPECIAL OFFER

We are pleased to be able to arrange this EE Special Offer with Jaytee – probably the most comprehensive audio offer we have ever published! Jaytee Electronic Services are the sole UK distributors for the range of audio products manufactured by ILP Electronics Ltd.

A range of modular kits is offered at substantial discounts to build mono or stereo power amplifiers of 60, 120 or 180 watts with the option of 4 or 8 ohm output impedance.

THE unique encapsulated ILP modules require a maximum of 500mV audio input to give maximum output power. The power supplies consist of a toroidal transformer and a d.c. supply board (for rectification and smoothing). Construction is straightforward as the amplifier modules are supplied fully assembled and tested. All that is required is to provide case and connectors and wire-up the necessary input/outputs and interconnections.

Also on offer, when an amplifier kit is ordered, are the HY6 (mono) or HY66 (stereo) pre-amplifiers. These are suitable for a variety of inputs to drive the power amplifier stage and can be run from the same p.s.u.

Full data and information is provided with each kit.

Payment should be by cheque (made payable to Jaytee Electronic Services) or credit card (Access or Visa).

Send payment together with the coupon to EE Audio Offer, Jaytee Electronic Services, 143 Reculver Rd., Herne Bay, Kent CT6 6PL. Tel 0227 375254.

Offer closes Friday March 31, 1989

ORDER CODE	DESCRIPTION	PRICE	
		STANDARD	OFFER
KIT124	60 watt mono (4 ohm) (HY124 & PSU412)	£38.95	£33.75
KIT124S	60 watt stereo (4 ohm) (2 off HY124 & PSU522)	£62.15	£54.00
KIT128	60 watt mono (8 ohm) (HY128 & PSU422)	£41.10	£35.75
KIT128S	60 watt stereo (8 ohm) (2 off HY128 & PSU512)	£62.15	£54.00
KIT244	120 watt mono (4 ohm) (HY244 & PSU512)	£49.30	£42.75
KIT244S	120 watt stereo (4 ohm) (2 off HY244 & PSU712)	£78.55	£68.25
KIT248	120 watt mono (8 ohm) (HY248 & PSU542)	£50.30	£43.75
KIT248S	120 watt stereo (8 ohm) (2 off HY248 & PSU722)	£79.55	£69.25
KIT364	180 watt mono (4 ohm) (HY364 & PSU732)	£68.80	£59.75
KIT368	180 watt mono (8 ohm) (HY368 & PSU742)	£70.85	£61.50

P-AMP	Mono pre-amplifier (HY6 & B6)	£10.40	£8.45
P-AMP/S	stereo pre-amplifier (HY66 & B66)	£16.75	£13.95

Please note that the pre-amplifiers are only available at offer price if ordered with an amplifier kit.

ALL PRICES INCLUDE VAT, POST & PACKING (UK ONLY)  
Sorry this offer is not available to overseas readers.

Quantity	Please Supply Order Code	Value (£'s)

### TOTAL VALUE £

Please make cheques payable to Jaytee Electronic Services.  
Please charge by Access/Visa card (Ex. date) .....

No. ....

Signature .....

Name .....

Address .....

OFFER CLOSING FRIDAY MARCH 31, 1989  
UK READERS ONLY

# MAGNETIC MAGIC

IAN GRAHAM

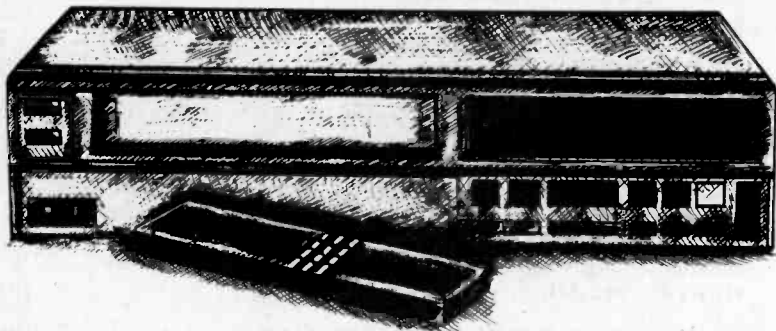

*The video industry is gearing up for its next major marketing exercise—a new generation of video recorders and the new recording tapes made to get the most from them. Ian Graham reports.*

**D**o you know your particle fineness factor from your picture purity index? And does a video tape's BET value mean anything to you? As video cassette recorders have improved over recent years and video users have become more discerning, recording tape technology has had to advance too to keep pace. Most video cassette manufacturers now offer at least two different grades of blank video tape, with a bewildering array of new terms to describe their properties and performance.

Improved video recording quality has been made possible mainly by the development of recording tape composed of smaller and smaller magnetic particles. The result is a range of different grades of video tape where before there was only one. Manufacturers have adopted a confusing variety of names for their tapes—Premium High Quality, XL-HIFI, Extra High Grade, High Definition Grade, Super XG, etc. Some of these grades are of equivalent quality, but it's almost impossible to tell from the name alone.

Manufacturers have developed ways of measuring the capabilities of their various grades of tape. As is usual in the video industry, different manufacturers tend to use different standards which are difficult to compare.

TDK's BET value indicates the size and packing density of the particles on the tape, but in a rather roundabout way. As the tape's magnetic particles are made smaller, the total number required to make up a certain weight increases and their surface area also increases.

The BET value is the surface area of one gram of the magnetic particles, measured in square metres per gram. So, a tape with a BET value of 35 means that one gram of its magnetic particles has a surface area of 35 square metres. A tape with a higher BET value indicates that its magnetic particles are smaller and packed together more closely, and so the tape *should* be capable of improved recording quality.

## PARTICLES PER LINE

Maxell uses a different measurement—the Particle Fineness Factor. This is the total number of particles in the magnetic layer of a tape required to record a single line of a television picture. Higher quality tapes have smaller particles packed more closely together, and so use more of them to record a line of a picture. A larger Particle Fineness Factor therefore indicates that the tape should be capable of better recording quality.

As a rough guide, a basic grade blank video tape might have a PFF of 50-100 million. By comparison, a hi-fi quality tape such as Maxell's XL-HIFI has a PFF of 330 million and a top grade tape such as Maxell's RX (PRO) has a PFF of 510 million.

The quality of a television picture or video recording is judged by signal-to-noise ratios (S/N). In this context, noise doesn't mean crackles or hisses coming from the loudspeaker. A "noisy" television picture looks grainy or it may be covered in white speckles or streaks, or any combination of these. Luminance S/N determines

the picture's sharpness and clarity. Chrominance S/N affects picture quality two ways—AM (Amplitude Modulation) is concerned with colour intensity and PM (Phase Modulation) affects the picture's colour tones.

TDK has developed a picture quality rating that takes all three of these parameters into account. Called the Picture Purity Index, it is calculated by:

$$\text{Luminance S/N} \times \text{Chrominance S/N (AM)} \times \text{Chrominance S/N (PM)} \times 100.$$

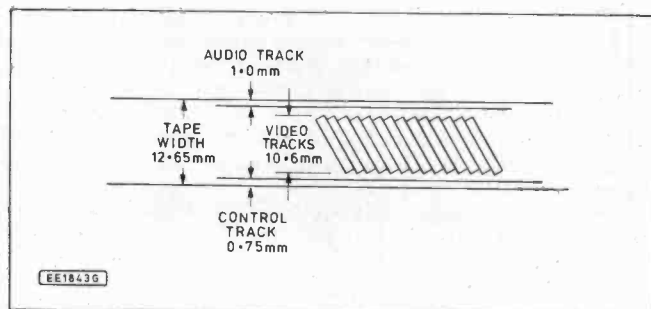

*Fig. 1 A VHS video recorder stores a television picture as a series of tracks across the width of the tape. Sound is recorded along one edge of the tape and a track containing control pulses is recorded along the other edge. The sound track is only 1mm wide. For stereo, this is split into two tracks, each only 0.35mm wide, with a 0.3mm gap between them.*

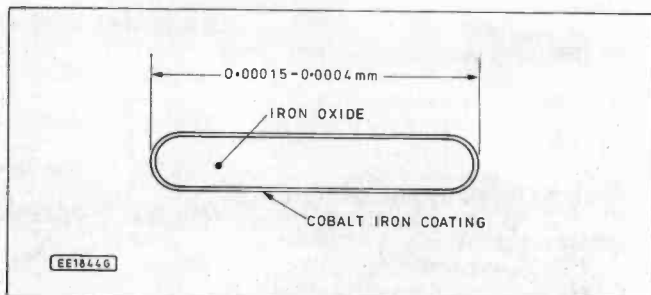

*Fig. 2 The magnetic particles in the tape which actually store a recording are needle-shaped ferric oxide crystals with a cobalt iron coating. Their length ranges from about half a micrometre for basic grade tapes down to less than a fifth of a micrometre for the highest grade tapes. (1 micrometre = 1 millionth of a metre, or a thousandth of a millimetre).*

A basic grade blank video tape might have a Picture Purity Index of just over 100. A high grade tape with a BET value of 35, such as TDK's E-HG, has a PPI of 188. The highest quality TDK tape (HD-X PRO) with a BET value of 50 has a PPI of 266.

No matter how good the tape's magnetic layer is, picture quality will suffer if the tape does not run smoothly through the recorder. If the friction between the tape and the capstans and rollers that guide it varies abruptly, the tape jitters and hiccups its way through them. These sharp changes in tape speed and position at the video heads show themselves as sound distortion and flickering or worse in the recorded picture. To minimise this, tapes now have a fine coating of carbon in their back surface. The carbon both lubricates the tape to enable it to move smoothly and dissipates any static electricity charges that might otherwise build up on the tape and attract dust and dirt.

## HARDWARE DEVELOPMENTS

Four video recorder developments in particular have spurred these advances in tape technology—HQ, hi-fi video, the camcorder and Super VHS (S-VHS).

HQ (High Quality) is an improved recording system that processes the picture electronically to make it clearer and sharper. Recorders with the system usually have an "HQ" emblem printed prominently on the control panel. HQ places greater demands on tape performance.

## HI-FI VIDEO

Before the hi-fi video recorder, sound was recorded in a strip along one edge of the tape. For stereo sound, the strip was divided into two tracks. Video information was and still is recorded across the width of the tape. Because of the slow tape speed, the sound quality was well below hi-fi standards.

A VHS tape plays at 2.339 centimetres per second compared to an audio tape cassette's 4.75cm/sec. The introduction of long play video recorders, capable of doubling the record/playback time of a tape by running it at half the speed, worsened the problem. Noise reduction systems helped to reduce the high level of tape hiss.

To improve stereo sound quality to hi-fi standards, a new way of recording the sound had to be developed. Sound quality could be improved by recording the sound in the same way as the pictures—that is, by tape heads mounted in a spinning drum laying

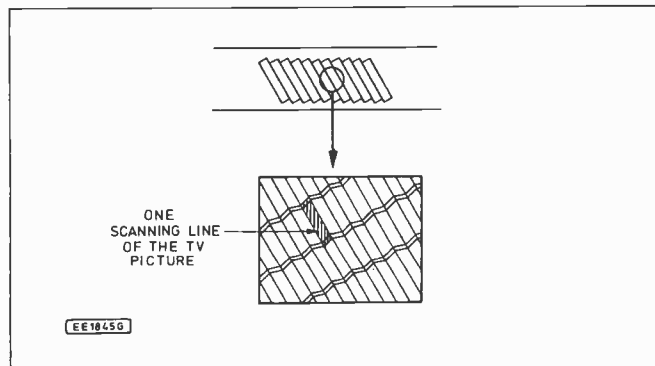
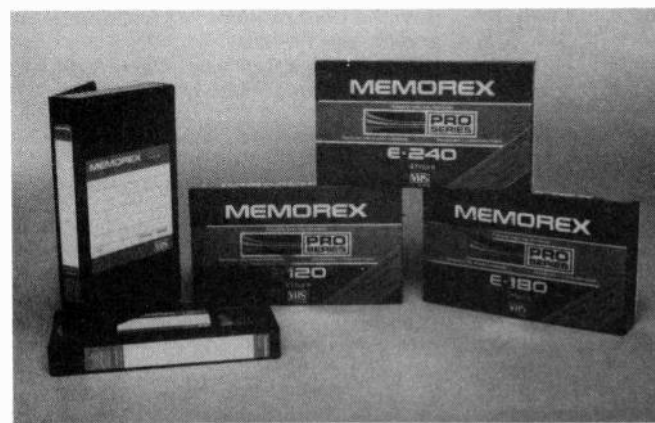

Fig. 3 Maxell's Particle Fineness Factor measures the number of magnetic particles needed to record a single scanning line of a television picture.



Most manufacturers now offer several different grades of video tape. Memorex's cassette range includes basic and high grade tapes, tapes aimed specifically at hi-fi video recorder users and the highest quality tapes available (their PRO Series).

down audio tracks across the width of the tape. Of course the major problem in trying to develop this sort of system is that the area of the tape where one would like to record sound is already occupied by video tracks.

It would be relatively easy to develop a system which recorded audio and video tracks alternately across the tape, but it would be incompatible with all the existing VHS recorders and tapes. As VHS is so dominant throughout the world, manufacturers wanted any new system to be compatible with these older recorders and tapes.

The answer was to provide two ways of recording sound on the tape. The older "linear" tracks along the edge of the tape were preserved. But additionally, sound tracks were recorded in the same place on the tape as video information but at a different depth in the tape. Like HQ, this required more of the video tape. It had to be of a certain high quality not only at the surface, but also deep down in the tape to accommodate this new "depth multiplex" recording system.

## CAMCORDER

Until the camcorder was introduced, video recording on the move could be rather awkward. A large heavy video recorder had to be slung over a shoulder, with an equally heavy video camera connected to it by a cable.

Not only was the system heavy (perhaps a total of up to nine kilograms) but it was impossible to concentrate on the camera viewfinder while recording on the move *and* at the same time ensuring that the recorder didn't bash into things. Fortunately, manufacturers successfully miniaturised the system to an astonishing extent, so that the camera and recorder could be built into the same package weighing less than two kilograms.

Basic grade blank video tapes are adequate for making recordings using a camcorder and playing them back on a television set. However, camcorder users frequently want to edit their recordings together to make a rather more professional-looking programme, or "videogram". Video editing is done entirely electronically. Because of the tiny dimensions of the video tracks (less than a twentieth of a millimetre wide), tapes cannot be edited like movie film—by physically cutting the required sections of film and sticking them back together again in the appropriate order.

Video tapes are edited by transferring sections of recordings from the original "master tapes" onto the programme tape. The required contents of one tape are recorded onto another. Any shortcoming in recording quality is compounded every time a recording is copied from one tape to another. Camcorder users, therefore, demand the highest quality master tapes. These are usually called "pro" quality or camera quality.

## BEYOND VHS

Super VHS (or S-VHS) represents the biggest improvement in video recording in recent years. Television picture sharpness is often expressed as a number of lines. The higher the number of lines quoted, the sharper the picture is. A typical VHS recorder specification might reveal a resolution figure of around 250 lines. A typical television set can resolve about 400 lines.

Video recorder manufacturers have been trying to close the gap. Super VHS recorders improve picture quality by keeping the picture's colour and black-and-white information further apart than normal. This reduces the amount of interference between them and eliminates one common picture fault called cross-colour.

The colour and black-and-white information from which the picture is constructed are stored on the tape at two different frequencies. The two frequencies are quite close together. A high frequency black-and-white signal produced by a very fine pattern comes very close in frequency to a low frequency colour signal. Sometimes the television set gets it wrong and actually decodes the signal as colour. This causes the shimmering false colour effects sometimes seen in a television presenter's finely patterned clothes. By keeping the signals further apart this is eliminated.

Super VHS recorders can deliver a resolution of over 400 lines when viewed on a television specially made to accept separate colour and black-and-white signals. Even a normal television set can resolve around 300 lines—still an improvement. A rival system from Sony, called ED-Beta, improves recording quality in a similar way. Sony is also developing a "Super" version of its Video 8 format. Super VHS video recorders are now beginning to appear in British shops.

So, just when you thought that the turbulent video market was settling down, the manufacturers have set off on another technology war, bringing us Super VHS, ED-Beta, an improved Video 8 and a range of different grades of video tapes. Here we go again! □

# FOR YOUR ENTERTAINMENT

BY BARRY FOX

## Not So Super

With DAT now yesterday's idea, Philips CDV (LaserVision video disc re-born with a digital soundtrack) selling only to enthusiasts and the public due soon to find out that receiving satellite signals is nowhere near as easy as buying a video recorder, what price Super VHS?

The major names in VHS (JVC, Panasonic, Mitsubishi) are now offering S-VHS recorders. But the price is around £1,000 and the new format could well turn out to be as much of a buff's speciality as LaserVision.

The great British public has never in the past shown any real interest in TV or video picture quality, being quite happy to watch rotten pictures on a maladjusted TV set with a misaligned aerial. Despite the best efforts of the tape industry, most people still buy the best-bargain cassettes and consistently ignore the promise of better picture quality from expensive high grade tape. Recorders with HQ circuitry, to improve picture quality, sell only because HQ is now a standard feature.

Real success for Super VHS depends on persuading the public that it is worth spending several hundred pounds extra for further improvements in quality which they will see only if they spend many more hundreds on a new TV set. Packaging S-VHS with Nicam digital stereo will help. Already S-VHS recorders have Nicam chips.

So far the only Nicam signals available come from the BBC's transmitters at Crystal Palace and they are still, officially, only tests. But later this autumn ITV starts broadcasting in stereo from London and Yorkshire. The BBC will then have to follow suit, regardless of whines about not having any money. Many films, music videos, and imported programmes are in stereo anyway.

The snag is that the public isn't too interested in hifi sound from TV either. . . .

## Too Good

Much has been written about the improved picture quality available from S-VHS, with resolution of over 400 lines. Note well that this has nothing to do with horizontal picture lines, it is a measure of the number of vertical lines, like pickets in a fence, which the system can display on screen without blurring one into the other. By comparison the resolution of even the best standard VHS recorder is around 240 lines and the best broadcast signal 330 lines.

So far only the original LaserVision video disc (around 400 lines) matches S-VHS for quality. The picture quality from CDV discs is not yet up to LV standard. And the selection of programmes

available on CDV is so poor that I doubt anyone would bother to copy them.

So, S-VHS is too good for all available programme material.

The new format comes into its own when replaying pre-recorded tapes or when it is used to shoot high quality home movies on a S-VHS camcorder. But the cost is high, over £1500. Main problem is the need for a CCD image chip of high enough quality (420,000 pixels) to do justice to the new tape format.

Most people will look no further than the Amstrad point-and-shoot camcorder at around a quarter the price.

## Not Compatible

Don't hold your breath for pre-recorded videos in S-VHS format, either. The key factor here, about which you will only get the right answer if you ask the right questions, is that there is incomplete compatibility between S-VHS and VHS. Although blank S-VHS tapes, costing an arm and a leg, can be used on a standard VHS recorder (if anyone is extravagant enough to want to do so) an S-VHS recording will not play back on a standard VHS machine.

This means that if the film companies want to support the S-VHS format, they will have to make two copies of each release, one in standard VHS and one in S-VHS. Libraries and retail outlets will have to stock two versions, too.

This isn't even happening in Japan. The chances of it happening in Britain where the software industry could not wait to get rid of V2000, Beta and Video 8, are minimal verging on cuckoo land. The film companies have not even made material available on S-VHS for demonstration purposes because they fear it will upset their existing market for standard VHS tapes.

S-VHS gets clear pictures by keeping the black and white signal, (Y, or luminance) separate from the colour signal (C, or chroma). So far there are only a few TV sets on the market with the "S" inputs needed to handle a Y/C signal.

The TV set must also have wider

bandwidth circuitry and a higher resolution tube than normal. If an S-VHS recorder is connected to the ordinary composite input of a standard TV set, then much of the benefit of the new format is thrown away.

The scart/peritel sockets now found on most sets do not cater for Y/C connection. So the scart standard is being modified (making it no longer a standard) to cope with Y/C signals.

There will also be add-on boxes which convert an S signal into a signal which conforms with the scart R,G,B signal. But as different sets have slightly different R,G,B signal standards (varying time delays between the different colour signals) the whole situation starts to look very messy.

In the future MAC satellite TV will offer better picture quality but an S-VHS recorder will not record a raw MAC signal—it will need conversion to Y/C, or RGB or PAL, first.

## Aspiring Event

Nothing to do with electronics, but I have to pass this on. . . .

There was a lot of publicity when professional cockney broadcaster Derek Jameson married Ellen Petrie at Arundel Cathedral in Sussex.

I wonder if the happy couple knew what happened twenty years ago when the spire of the Cathedral was deemed beyond repair. Because the building is in a bottleneck of very congested streets, erecting scaffolding and rebuilding in the usual way would have caused traffic chaos for many months, if not years. So the church fathers hit on a clever wheeze.

They had a replica spire moulded from fibreglass reinforced plastics. One morning at 6am, before the traffic started, a helicopter flew over the Cathedral and lowered the spire into position.

At first the colours did not match. But now the phoney spire has weathered in and no-one notices.

As people often say, it's wonderful what they can do with plastics now. . . .

## Stop Press

Recently a small business was visited by a high ranking VAT inspector. He looked through the company's accounts and found them all in order. "I can't think why the computer said I had to come, and allocated a full day" he mused.

Finding nothing suspicious, the inspector was left with several spare hours. So he and the company boss went for a pie and a pint. Over a drink the VAT inspector explained how the "Big Brother" VAT computer is programmed to send a high ranking inspector in for a full day if it suspects someone is fiddling their returns.

The computer had once suspected that a small printing company was crooked. One inspector went through the books with a tooth comb, but found nothing. Then another inspector called, but he too found nothing. The firm's payments on paper and ink and the money earned on printing receipt and invoice books all tied up.

It was only on a third visit that an even smarter inspector finally twigged. The firm was making its money out of printing phoney invoices which other firms were using to fiddle their VAT.



# MINIMUM COST • MAXIMUM CONTROL

The **NEW EIM O6x 8052** range of Single Board Controllers introduces a control device to match your requirements at low cost.

Also available:

- ★ IEEE and other expansion cards
- ★ CMOS versions
- ★ BARCODE facilities

**MONIFIETH BUSINESS CENTRE,  
SOUTH STREET, MONIFIETH  
DUNDEE DD5 4PJ  
Telephone: 0382 534944**

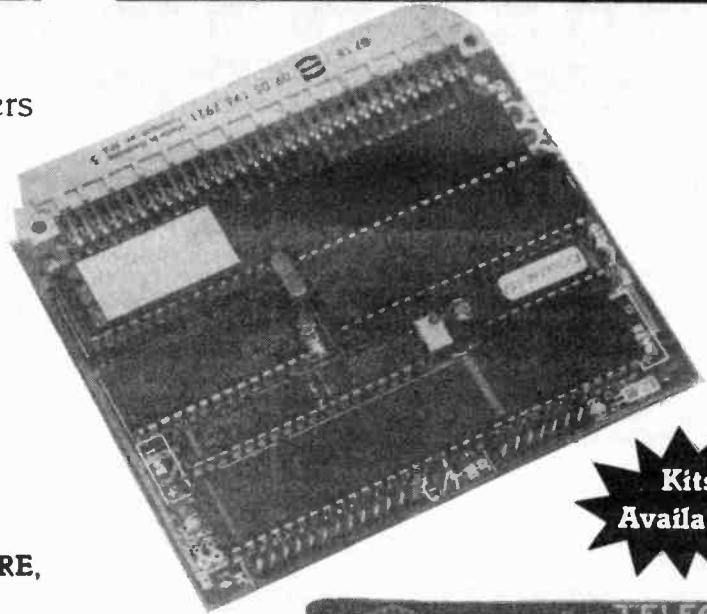

**Kits Available**



**E|TRAK electronics Ltd**

**OUT NOW!**

**CRICKLEWOOD**

**ELECTRONICS**

**1989 100 PAGE COMPONENT CATALOGUE PRICE £1**

SEND OFF FOR YOUR COPY TODAY...

- WE STOCK AN UNRIVALLED RANGE
- ALL OUR COMPONENTS ARE FIRST CLASS BRANDED ITEMS
- WE OFFER A SAME DAY SERVICE ON ALL STOCK ITEMS
- NO MINIMUM ORDER—IF YOU NEED ONE COMPONENT WE CAN SUPPLY ONE COMPONENT
- WE HAVE ADOPTED A NEW LOWER PRICING POLICY + QUANTITY DISCOUNTS
- FREE VOUCHERS WITH YOUR CATALOGUE—ORDER ONE NOW!...

JUST FILL IN THE COUPON OPPOSITE AND POST IT WITH YOUR £1 PAYMENT TO THE ADDRESS BELOW. YOU WILL RECEIVE NOT ONLY OUR SUPERB 100 PAGE CATALOGUE, BUT ALSO FREE VOUCHERS WHICH YOU CAN USE ON YOUR NEXT COMPONENTS ORDER.

CRICKLEWOOD ELECTRONICS LTD 40 CRICKLEWOOD BROADWAY LONDON NW2 3ET TEL: 01-450 0965/452 0161 FAX: 01-208 1441 TELEX: 914977

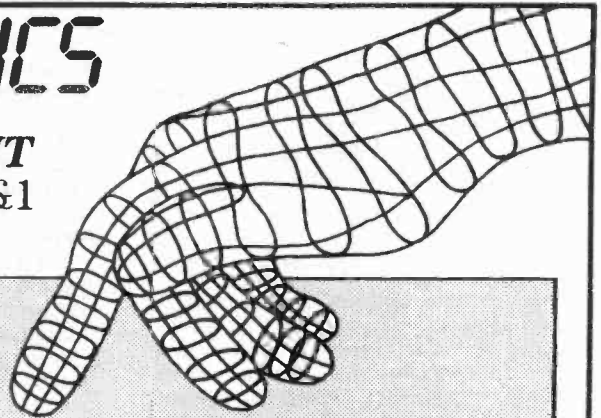

## FREE VOUCHERS!

SEND OFF FOR YOUR CATALOGUE AND VOUCHERS TODAY.

I WOULD LIKE TO RECEIVE..... COPY(COPIES) OF THE 1989 CRICKLEWOOD ELECTRONICS COMPONENT CATALOGUE. I ENCLOSE £..... PLEASE ENCLOSE MY FREE VOUCHERS.

Tape your £1 coin here, or send a cheque or postal order for £1.00 for every catalogue you require.

NAME.....

ADDRESS.....





*a regular feature for the Spectrum Owner...*

by Mike Tooley BA

**T**HIS month, as promised, we shall show how a budget-priced monitor can be easily interfaced to a Spectrum. We begin, however, with a topic which may concern users of Plus-Two (and later) machines.

### RS-232 Routines

Neil Roberts, a regular *On Spec* reader and self-confessed "Spectrum fanatic" asks whether anyone can shed any light on the RS-232 routines present in the Spectrum Plus-Two ROM. Unlike the original Spectrum ROM (which has been published in disassembled and commented form) there appears to be a complete lack of information concerning the newer sections of code.

Neil wishes to produce a simple communications software package to allow him to transfer files between a Plus-Two and several other popular microcomputers and needs information on the machine code which relates to decimal addresses 23343 ("input pre-routine"), 23348 ("token output pre-routine"), and 23370 ("character output pre-routine"). If you can help Neil, or have made use of the Plus-Two RS-232 facility, please drop me a line!

### Budget Monitors

There is nothing worse than the constant glare of a white screen monitor. Some years ago, with this problem very much in mind, I invested in a green-screen monitor. As I suspected, this proved to be a tonic for my tired eyes and made lengthy sessions with the Spectrum very much more pleasant. More recently, I have noticed that several suppliers are now offering second-hand green-screen monitors at rock-bottom prices.

As an example, one such company, J. and N. Bull Electrical of Hove, Sussex, can supply an 8in. green-screen monitor for a mere £17.50 (plus £4 carriage)\*. These units are ex-Reuter but are supplied "cased and ready to work" and are offered with a six month guarantee. They can be very easily connected to a Spectrum and cost a mere fraction of the price associated with a brand-new monitor.

\*At the time of going to press we understand that J. Bull have sold out of these monitors, however both J. Bull and Greenweld Electronics do have other cheap monitors for sale.

### Power Supplies

In common with several similar units, the ex-Reuter 8in. monitors require a stable 12V d.c. supply of around 2A. A suitable power supply circuit which will satisfy this requirement is shown in Fig. 1.

The mains transformer should be rated at 15V 2A (a Maplin 30VA toroidal unit with its two 15V 1A secondary windings wired in parallel is ideal). The LM338K regulator IC1 should be mounted on a heatsink rated at 2.1°C/W (or better). It is important to note that the case of the regulator is at the output voltage potential and thus an insulating kit should be fitted so that the heatsink can remain safely at 0V.

The power supply connections to the ex-Reuter monitor are shown in Fig. 2. The connector is rather unusual but may be easily replaced with something a little more conventional!

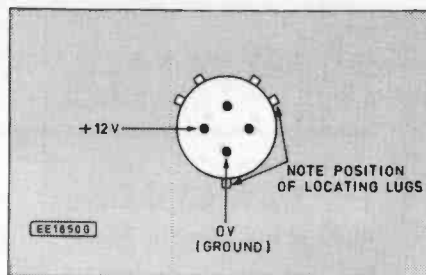

Fig. 2. Power connections for the 8in. ex-Reuter monitors.

play (normally this will occur at about mid-setting).

Later versions (e.g. Spectrum Plus-Two) have a DIN connector which provides composite and RGB video signals (see Fig. 4) and will interface directly to a 75ohm

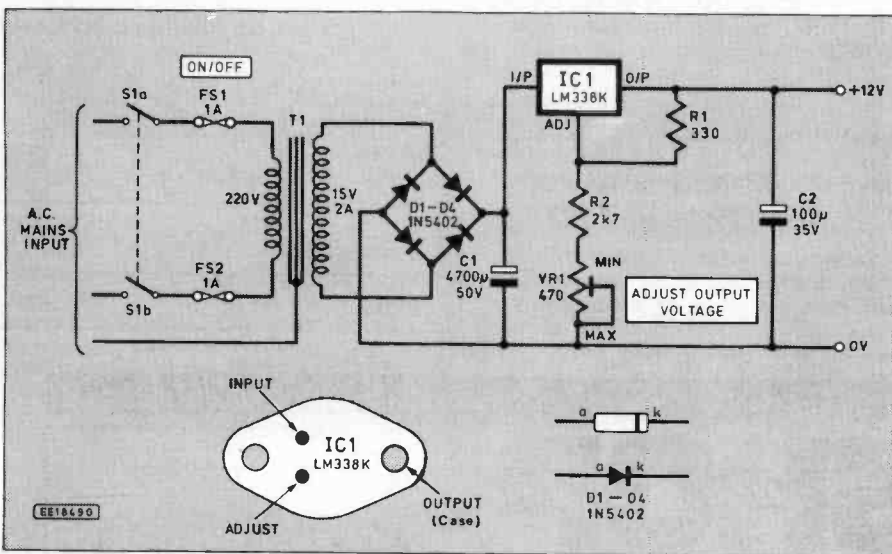

Fig. 1. Suggested circuit diagram for the Monitor power supply.

### Video Interface

Early versions of the Spectrum have a variety of video signals available at the edge connector and all that is required is a suitable buffer stage which will cope with a monitor input impedance of 75ohm. A suitable circuit based on a single npn transistor is shown in Fig. 3.

This circuit derives its signals and power from the expansion connector at the rear of the Spectrum and can be fitted externally or internally, as desired. The pre-set resistor is simply adjusted for a satisfactory dis-

monitor input without the need for an additional buffer stage. Fig. 5 shows the wiring configuration of the video cable.

### Spring Cleaning

Before putting a second-hand monitor into service, it is well worth removing the chassis from the case and giving the entire unit a complete external and internal "Spring clean". The c.r.t. (cathode ray tube) face, in particular, will benefit from a wash with warm water and liquid detergent

Fig. 3. Spectrum (issue two and later) monochrome video interface.

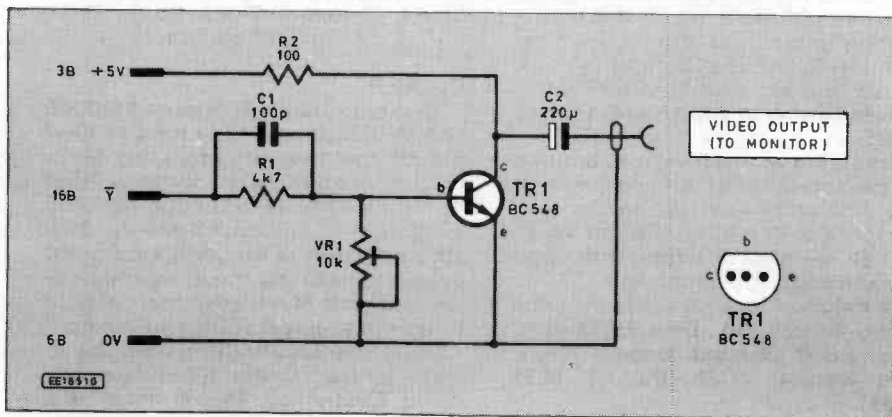

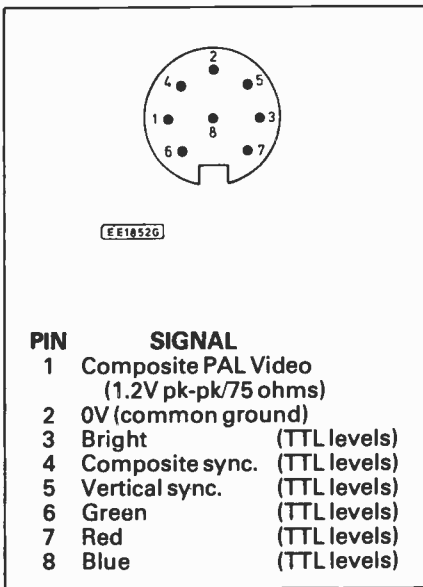

Fig. 4. Pinout for the Spectrum Plus-Two RGB connector.

to remove the grime which will almost certainly have become attached to the screen.

However, take care not to splash any water onto the circuitry or the printed circuit board. The best treatment for this is with the aid of a miniature vacuum cleaner and an appropriate nozzle which will search into some of the more inaccessible crevices!

## Adjustments

Monitor adjustments are quite straightforward provided one has the requisite trimming/adjusting tools. The 8in. ex-Reuter units have clearly labelled adjustment points, several of which are located on the "video processor board" on the left hand side of the unit.

Note that a plastic hexagonal trimming tool will be required for the horizontal width and linearity adjustments. A miniature insulated flat-bladed adjusting tool should be used in conjunction with the preset resistors for height, synchronisation, black level control, etc. adjustments.

Finally, it is often preferable to reverse the video display such that text appears bright against a dark background. This has the advantage of reducing traces of vertical flyback as well as the more obvious one of reducing the glare generated by a bright screen.

This reversal can easily be achieved with just two simple lines of BASIC:

```
10 REM select reverse video
11 BORDER 0: PAPER 0: INK 7:
CLS
```

To reset the video to the normal (default) values the following lines of codes are required:

```
910 REM select reverse video
911 BORDER 7: PAPER 7: INK 0:
CLS
```

**Next Month:** Again with a limited budget in mind, we shall be providing details for those who wish to add a disk drive to a Spectrum, Spectrum-Plus, Spectrum 128, or Spectrum Plus-Two machine.

In the meantime, if you would like a copy of our "On Spec Update", please drop me a line enclosing a large (250x300mm) adequately (i.e. 42p for UK postage) stamped addressed envelope. Mike Tooley, Department of Technology, Brooklands Technical College, Heath Road, Weybridge, Surrey, KT13 8TT.

Fig. 5. Wiring configuration for the Spectrum Plus-Two video cable.

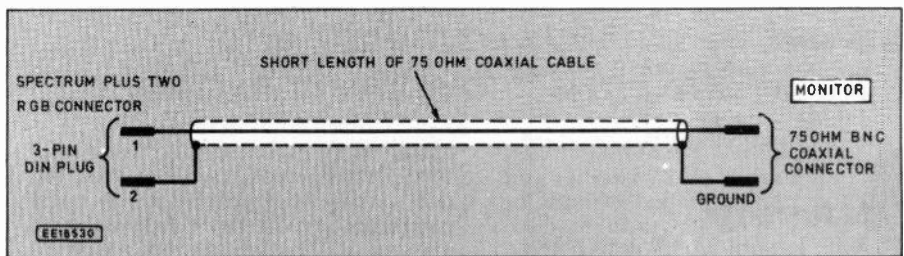

# SHOP TALK

BY DAVID BARRINGTON

### Security Plug

A product which nearly slipped through our net, but on further inspection has great potential for the experimenter, is the multi-pole jack plug and socket set from Rendar.

Consisting of a 12-way socket and a "keyed" plug with 12 contact pins along its barrel, the combination of plug and socket would make an ideal low-cost security "guard" for equipment. With the multiple choice of contact options, its use as a car security alarm would allow the owner to select his own "entry code".

Make or break switching may be fitted and electrical contact is made, between plug and socket, by turning the plug through 90 degrees after insertion. When inserted the plug is screened through the earth (metal tip) terminal.

For details of local stockists and price contact Rendar Ltd., Dept EE, Durban Road, South Bersted, Bognor Regis, West Sussex, PO22 9RL. ☎ 0234 825811.

### Super Filter

The 12-way low-pass filter block (type 1206-502) called for in the *Super Filter* may prove difficult to locate from a local source. The one used in the prototype was purchased from Magenta Electronics for the sum of £2.80.

A complete kit of parts (£5.98), including case and filter, may be purchased from Magenta Electronics, 135 Hunter Street, Burton-on-Trent, Staffs, DE14 2ST. Add £1 for P&P per order.

### Call Alert

The opto-coupled devices OPI2046 and MOC3020 needed in the *Call Alert* project could cause purchasing problems. These devices are currently listed in the *Electromail* catalogue (☎ 0536 204555), order codes 307-979 and 308-196. However, these devices do not appear to have any special characteristics and most of our advertisers should be able to supply suitable equivalents.

The only source we have been able to locate for the "drawer" type battery holder is *Electromail*. This is listed as a

chassis mounting type, code 508-116, and cost £1.32 plus a post and packing charge and VAT. No doubt, readers will have their own ideas about a suitable battery housing but please make ample allowance for the presence of mains voltage within the case.

### Audio Lead Tester

If any readers have difficulty in purchasing a 4-pole 2-way toggle switch for the *Audio Lead Tester*, this was obtained from Maplin code FH08J (4-pole SM toggle) £2.95. It might be possible to use the more standard "slider" type switch here, but it may require hard-wiring to the p.c.b.

The printed circuit board for the tester is available from the *EE PCB Service*, code EE641 (see page 208).

### MIDI Projects

Most of our advertisers keep ample stocks of computer connectors and cables, including BBC Micro leads, and should be able to supply those required for the *Midi Interface* project.

Darlington opto isolators are quite common devices and should not cause any purchasing problems. The *MIDI Merge* printed circuit board is available from the *EE PCB Service*, code EE640.

The only items that could cause concern when building the *MIDI Pedal* are the 500kHz ceramic resonator and the horizontal Hex switch. These were purchased from *Circuit* (☎ 0992 444111).

### Sound-To-Light

We do not expect any component buying problems for the *Sound-to-Light Interface* unit. Remember to specify the suffix L when ordering the BC184L.

The printed circuit board is available from *EE PCB Services*, code EE637.

# SOUND TO LIGHT INTERFACE

ANDY FLIND



Create your own "4-colour light show"  
Will interface with the 4-Channel Dimmer, described last month, and an Auto Fade project to appear next month.

**A**LTHOUGH the *Four-Channel Voltage-Controlled Dimmer* project (see last month) was intended for experimenters to use with their own creations, there will be occasions when it would be convenient if it could be rapidly set up for use as a "light-show", perhaps for a children's party, or a teenagers' home disco. A second unit containing the necessary interfacing, that would just plug straight into the first with a single lead, could be most useful.

This project is the first of two that, together, will provide this facility. It produces the classic "Sound-to-Light" effect. An improvement over most similar circuits is the provision of four channels instead of the usual three, allowing an extra colour to be added to the display.

## WORKING PRINCIPLE

The block diagram, Fig. 1, shows the working principle of the unit. Leaving aside the preamplifier for the moment, the audio signal enters through a sensitivity or level control, allowing adjustment to match various inputs, and is then buffered to provide a low-impedance drive to the filters.

The four filters each respond to particular frequency bands as they occur in the input, in this design these are centred about

70Hz, 350Hz, 2kHz and 5kHz. The output of each filter is demodulated, or converted into a d.c. voltage proportional to signal amplitude, and the four signals obtained are then used to drive the inputs of the dimmer.

The preamplifier section of the circuit is optional. During design it was desired to test the circuit from a signal source producing only about a millivolt and a low-noise amplifier was designed for this. This worked well, took little extra space and was sensitive enough to allow direct use from any microphones, so it was retained in the final circuit. A switch may be fitted to bring it into operation when required.

## CIRCUIT DESCRIPTION

The main circuit appears in Fig. 2. After the sensitivity control VR1, the signal is amplified and buffered by IC1 which is set by resistors R12 and R13 for a voltage gain of about five. The input impedance of this stage is the value of VR1 (10k), whilst the output impedance is effectively only a few ohms, a low value suitable for driving the filters.

Only one of the four filter-demodulators is shown as the others are identical, save for the values of the frequency determining components. The filters are based on the

standard second-order active bandpass circuit, using a single op-amp each. A fairly "soft" response is needed for this circuit.

After a lot of experiment, the optimum "Q" value for each filter, set by the ratio of input to feedback resistance, was set just above four, and the centre frequencies, set by the ratio of the capacitors to the resistors, were selected as 70Hz, 350Hz, 2000Hz and 5000Hz. Table 1 shows the component values for each filter (the two capacitors in each are the same) and the theoretical centre frequencies they give, which are as close to the selected values as standard component values allow.

Table 1: Component values for filters

Channel	Component Values	Centre Freq
a	R17	8k2
	R18	560k
	C8, C9	33n
b	R17	12k
	R18	820k
	C8, C9	4.7n
c	R17	10k
	R18	680k
	C8, C9	1n
d	R17	8k2
	R18	560k
	C8, C9	470p

Fig. 1. Block diagram showing the working principle of the unit.

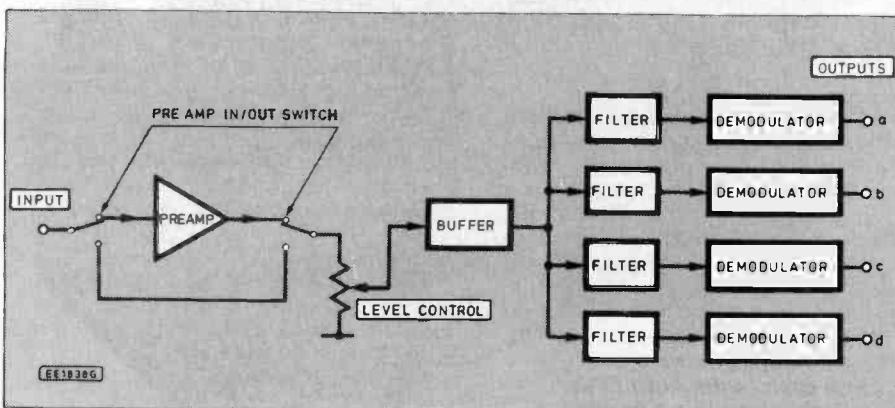

## DEMOMULATOR

Each filter is followed by a demodulator which converts the signal to a d.c. voltage. The demodulators are actually "peak value detectors". During positive half-cycles of the signal, if the input to the op-amp exceeds the value stored in capacitor C11, this capacitor will be charged via diode D3 to the signal value.

When the input falls the stored voltage decays by discharge through resistor R21. The rate of this discharge has quite a bearing upon the effect obtained from the unit, again the value was selected with careful trial and error.

The value chosen for capacitor C11 may seem a little high for this application, but there is a reason for it. It is necessary to have some control over the individual channels to set up the final effect, and the low value of the discharge resistors used means that level controls down to 10k in value can be connected directly to the outputs without altering the discharge rates significantly.

A small problem encountered during design was that when the circuit was operated from the auxiliary power supply of last month's Light Dimmer, hum on the supply rail tended to result in unwanted output from the lowest-frequency filter. The inclusion of decoupling components resistor R16 and capacitor C7 effectively cured this.

## SENSITIVITY

By itself this circuit is quite sensitive. Since the basic sensitivity of each dimmer channel is one volt, it was decided that "full output" for each channel of this interface should be about two volts so that the individual channel controls would be about half-scale.

For a two volt output, each demodulator needs an input of about 1.2V r.m.s. input. At their centre frequencies, the filters contribute reasonable gain, so the input to them needs to be only about 40mV r.m.s.

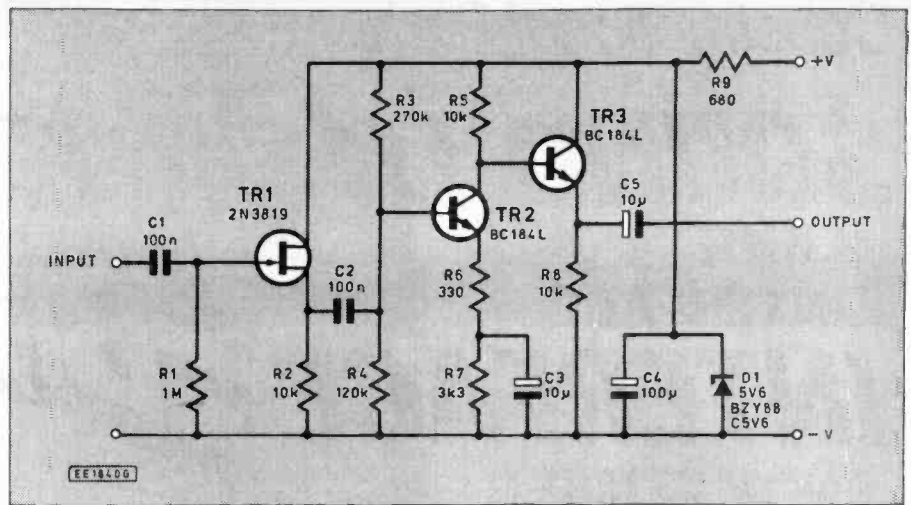

Fig. 3. Circuit diagram for the preamplifier stage.

high sensitivity of this part of the circuit, the supply to it is separately regulated and decoupled by capacitor C4, resistor R9 and Zener diode D1.

## CONSTRUCTION

The component layout and full size printed circuit board copper foil master pattern is shown in Fig. 4. This board is

available from the *EE PCB Service*, code EE637.

Construction of this project should be fairly straightforward. The preamplifier is optional, so the components of this part of the circuit may be omitted if it is felt that it would not be of any use.

The components for the four filter/demodulator channels are referred to by number followed by the letters "a", "b",

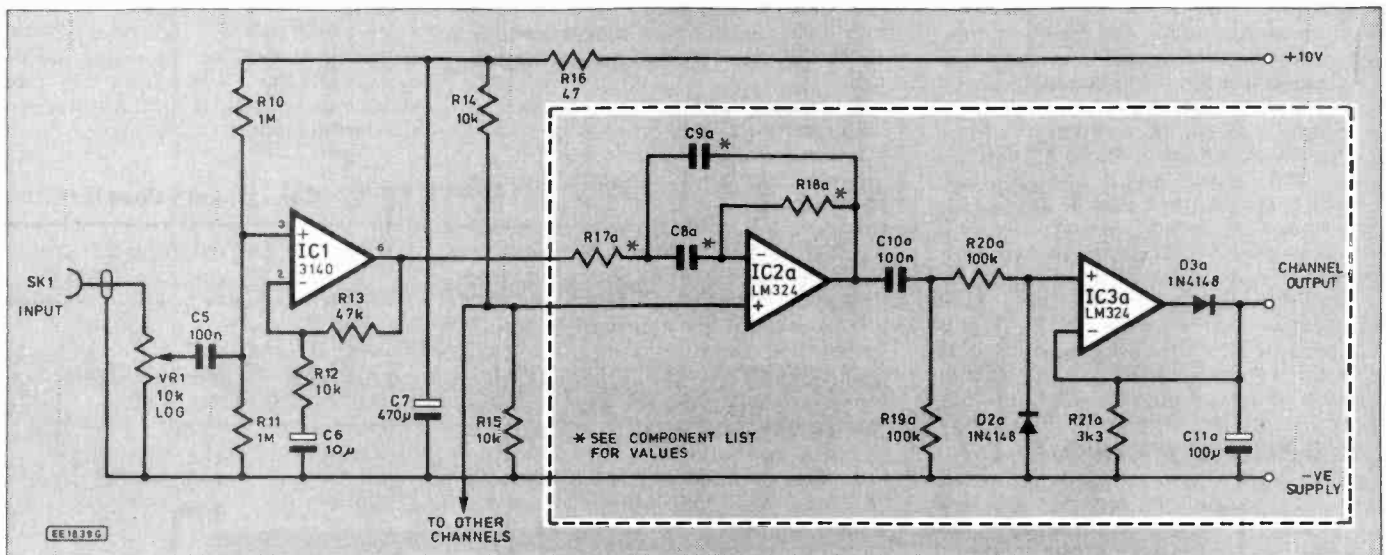

Fig. 2. Main circuit diagram for the Sound-to-Light Interface. The components within the dotted area are repeated for each of the four channels, see table and components list for values.

The input buffer amplifier contributes a voltage gain of just over five, so the circuit will deliver full output from an input of less than 10mV r.m.s. This sensitivity should be sufficient for most signal sources, but to allow operation from very low signals including microphones, the preamplifier stage may be used.

## PREAMPLIFIER

The preamplifier, Fig. 3 is a straightforward design using discrete devices for minimum internal circuit noise. The field effect transistor (f.e.t.) TR1 buffers the incoming signal, providing an input impedance of about one megohm, enough to match even crystal microphones.

Transistor TR2 provides the voltage gain, about twenty with the component values given. Transistor TR3 buffers the output so that it can drive the 10k Level Control potentiometer VR1. In view of the

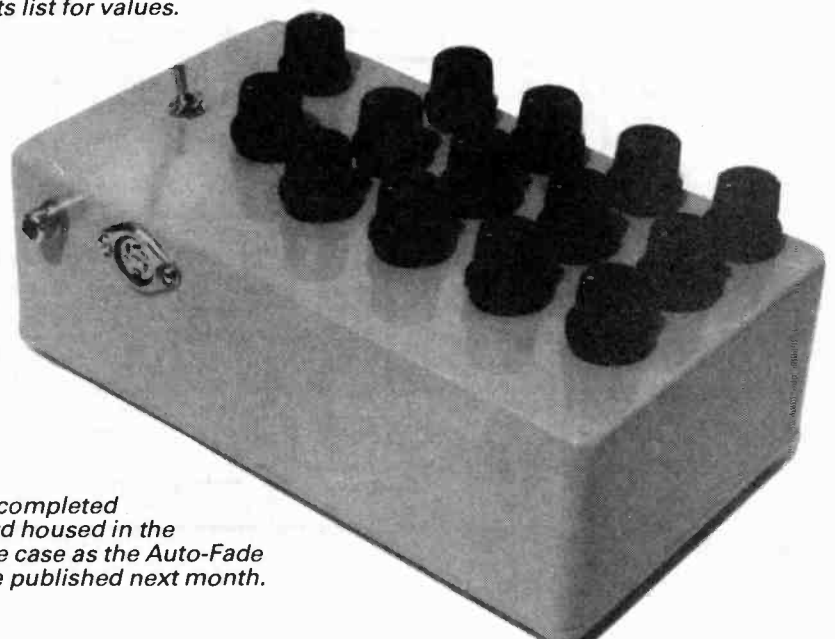

The completed board housed in the same case as the Auto-Fade to be published next month.

# SOUND TO LIGHT INTERFACE

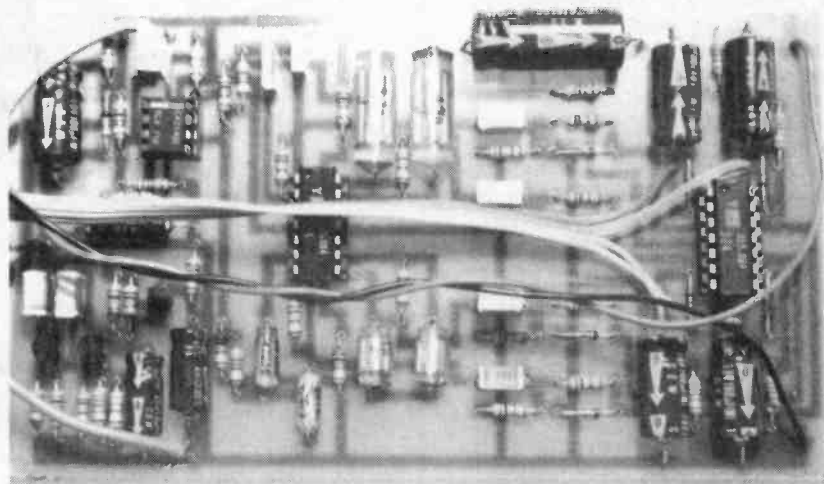
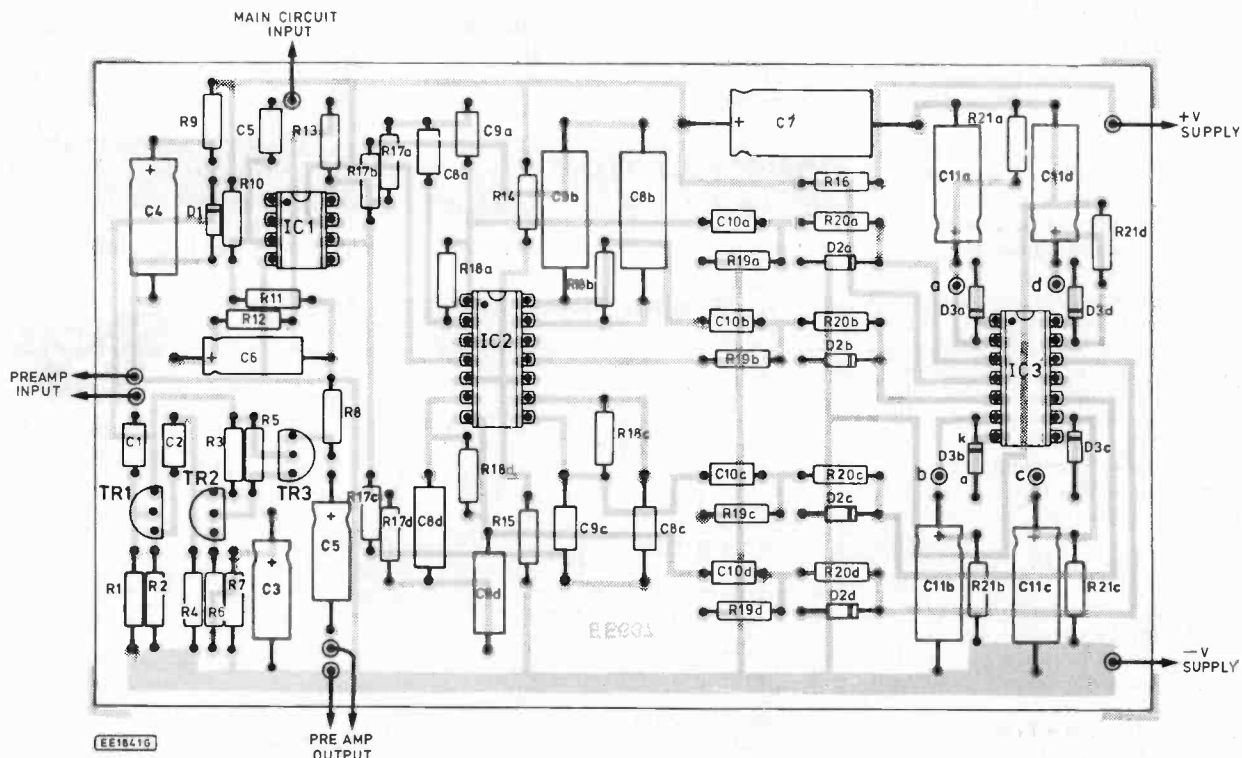
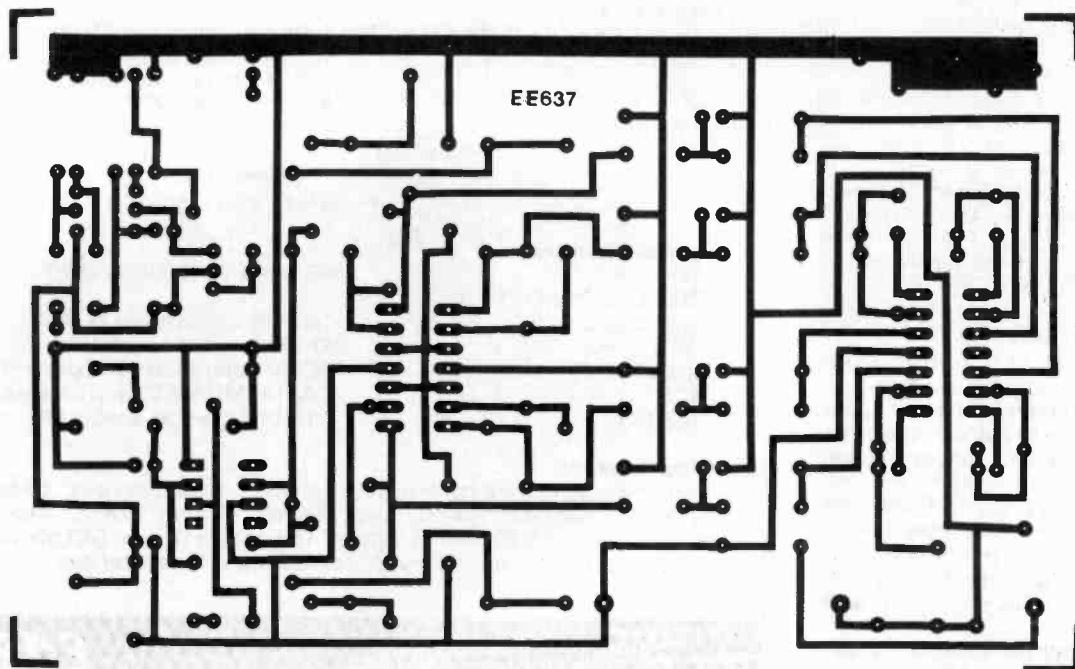

Fig. 4. Printed circuit board component layout and full size copper foil master pattern.



EE1841G



“c” or “d” as appropriate. They all have the same values with the exception of the frequency determining components resistors R17, R18, and capacitors C8 and C9. These should be as close to their stated values as possible to ensure the correct filter centre frequencies.

The resistors pose no problems as one percent types are now cheap and readily available. For the capacitors, polystyrene types, which normally have tolerances of about 2.5 percent, are recommended for all but the lowest range.

The larger value required of the 70Hz filter is not so easy to obtain in polystyrene, so here 33n polyester components are used. These have tolerances of 10 percent, but in practice this has not caused any problems.

Construction in the usual “height order” of the components is suggested to make things easy. DIL sockets are recommended for the i.c.s, which should not be fitted at this stage. Note that the upper two of the four C11 capacitors are placed positive end downwards.

## TESTING

Testing should begin, as mentioned above, without the three i.c.s in circuit. A supply of 10 volts should be connected, from a *separate*, current limited supply if this is available as this is always safer when first trying out a new project.

Check the supply current drawn, after the initial capacitor charging surge it should fall to about six or seven milliamps. Most of this will be taken by the preamplifier, so if this is not fitted the drain should be only half a milliamp.

If the preamplifier is present it can be checked first. The supply to this stage, as measured across capacitor C4, should be about 5.6V.

With respect to the negative supply, the d.c. volts at TR1 source (lead nearest the bottom of the board) should be measured. A precise value for this cannot be given as it will vary quite a bit between individual f.e.t.s, but a reasonable range should be from 0.5V to 3V.

Transistor TR2's emitter (a check at the top of capacitor C3 will suffice) should be about 1V, TR2 collector (bottom of resistor R5) 2.5V to 3V, and TR3 emitter (top of C5) 2V to 2.5V. This should verify that the preamp is OK, though if the equipment is available a small audio signal can be injected and the output measured to confirm that the voltage gain is about twenty.

Following on from the above checks, fit IC1, the 3140, which should add about 3mA to the overall drain. Measure the voltage at the output of IC1 pin six, which should be about half the supply voltage from capacitor C7. Note that this will be slightly less than the power source due to the drop across resistor R16.

If all seems well, fit IC2, which should add another milliamp to the drain, and check the d.c. voltages at all four outputs, which should again be half the supply. The outputs are easy to find; they are the four corner pins!

Finally, the last i.c. can be fitted. Short the input to ground (negative) first, to ensure absence of hum or similar stray signals, following which the four outputs, again all the corner pins, should be at negative rail.

This is about all the useful d.c. testing that can be done. If a suitable generator is available a signal of about 15mV r.m.s. can

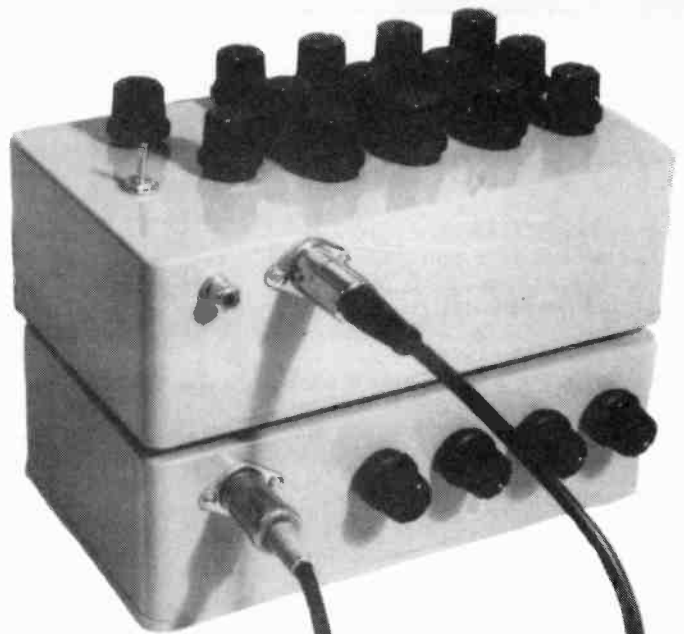

The Interface linked to the 4-Channel Light Dimmer.

## COMPONENTS

### Resistors

R1, R10, R11	1M (3 off)
R2, R5, R8, R12, R14, R15, R17c	10k (7 off)
R3	270k
R4	120k
R6	330
R7, R21a, R21b, R21c, R21d	3k3 (5 off)
R9	680
R13	47k
R16	47
R17a, R17d	8k2 (2 off)
R17b	12k
R18a, R18d	560k (2 off)
R18b	820k
R18c	680k
R19a, R19b, R19c, R19d, R20a, R20b, R20c, R20d	100k (8 off)

All 0.6W 1% metal film type.

### Potentiometer

VR1	10k log carbon
-----	----------------

### Capacitors:

C1, C2, C5, C10a, C10b, C10c, C10d	100n polyester layer (7 off)
C3, C6	10μ axial elec. 25V (2 off)
C4, C11a, C11b, C11c, C11d	100μ axial elec. 10V (5 off)
C7	470μ axial elec. 25V
C8a, C9a	33n polyester layer (2 off)
C8b, C9b	4n7 polystyrene (2 off)
C8c, C9c	1n polystyrene
C8d, C9d	470p polystyrene

### Semiconductors

D1	BZY88C5V6 5.6V 400mW Zener
D2a, D2b, D2c, D2d, D3a, D3b, D3c, D3d	1N4148 silicon diode (8 off)
TR1	2N3819 n-channel f.e.t.
TR2, TR3	BC184L npn silicon transistor (2 off)
IC1	CA3140 MOSFET input op-amp
IC2, IC3	LM324N quad op-amp (2 off)

### Miscellaneous

Printed circuit board, available from EE PCB Services, code EE637; 8-pin d.i.l. socket; 14-pin d.i.l. socket (2 off); case, ABS plastic, 190mm×110mm×60mm; S1 2-pole 2-way toggle switch; SK1 phono socket; screened cable; Vero solder pins; connecting wire; solder etc.

**Shop  
Talk**  
See page 193

Approx. cost  
Guidance Only

**£19**

be injected and swept through the frequency range of the circuit, the four outputs (hopefully!) peaking as their centre frequencies are reached.

Failing this, a suitable music signal can be connected through the control and the outputs checked for activity. The top output may be fairly inactive on some poor quality signals, though.

If fault-finding is required on a particular channel, the following notes will assist navigation around the board. The four channels are labelled "a", "b", "c" and "d" for identification, "a" being the lowest frequency and "d" the highest.

The outputs of IC2 and IC3 are in each case the four corner pins. Both have channel "a" at the top left-hand corner, the others follow in clockwise order for IC2, anti-clockwise for IC3.

The four filter input resistors R17 are in order from top to bottom of the board, as are the inputs to the demodulators, these being the four C10 capacitors and associated components. Other components in these areas of the circuit are all nearest their own corners of the associated i.c. A sketch "map" may help before starting.

### IN USE

Having completed and tested the p.c.b. for this project, its use is up to the individual constructor. It could be cased on its own, a suitable arrangement of wiring to the Level Control and a switch for selecting the preamplifier are shown in Fig. 5.

Bear in mind that the preamplifier is very sensitive, so all wiring to it must be carefully *screened* to avoid hum pickup. If the low-frequency channel suffers from continuous output this is the most likely cause. For many signal sources, the preamplifier will not be needed, indeed the sensitivity may be too great.

If the control is near the bottom of its range and difficult to adjust, some attenuation is called for; this need be nothing more than a resistor in series with the input. As control VR1 is 10k, a 100k resistor in series

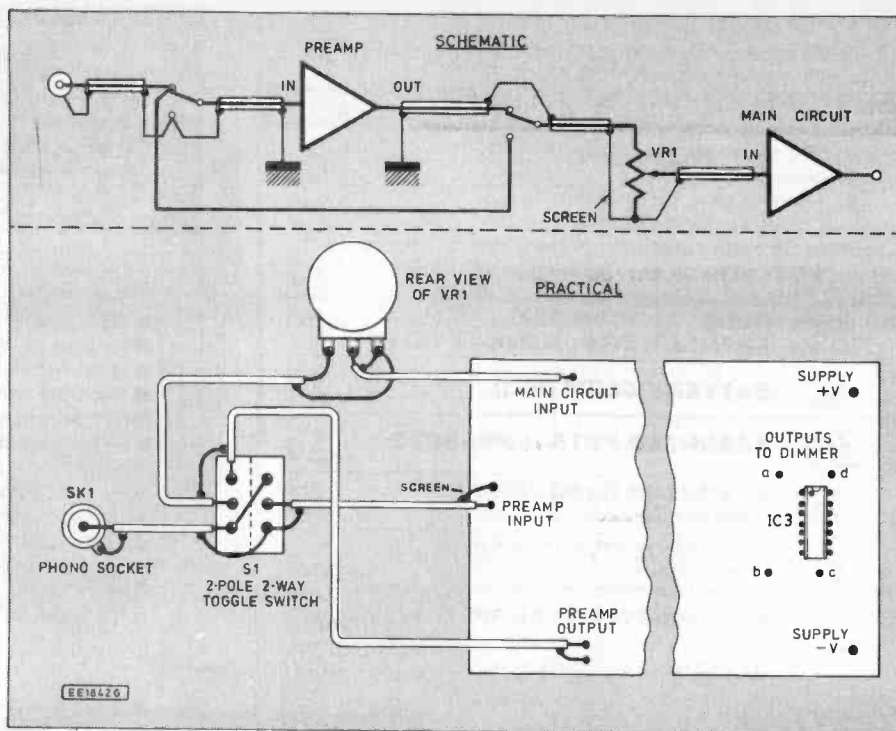

Fig. 5. Wiring details for selecting the preamplifier circuit via switch S1 and wiring to the Level Control VR1.

with the input will provide an attenuation factor of approximately ten, and so on. This could be built in, with a selector switch.

Some individual control is needed over each channel. The prototype Four-Channel Light Dimmer described last month, was built with four 100k input controls which provide this, but if these are not present they might be fitted at the outputs of this project instead. They should be set to about half scale, the input sensitivity adjusted for a reasonable display after which individual adjustments can be made.

Lamps driven with the unit are up to the individual, the prototype has been tried

with red for the lowest frequencies, then yellow, green and finally blue for the highest. This gives a pleasant display, though other combinations may be preferred.

The prototype model was fitted into a case the same size as that used for the original *Four-Channel Light Dimmer* project. This also contains a *Four-Channel Auto-Fader* circuit board, with switch selection between the effects. The two boxes connect together with a single lead, so that a wide variety of lighting effects can be rapidly set up with little trouble.

Details of a *Four-Channel Auto-Fader* and fitting of both units into the same case will appear in next month's issue. □

**Next Month: A Four-Channel Auto-Fader, wired into the same case as the Sound-to-Light.**

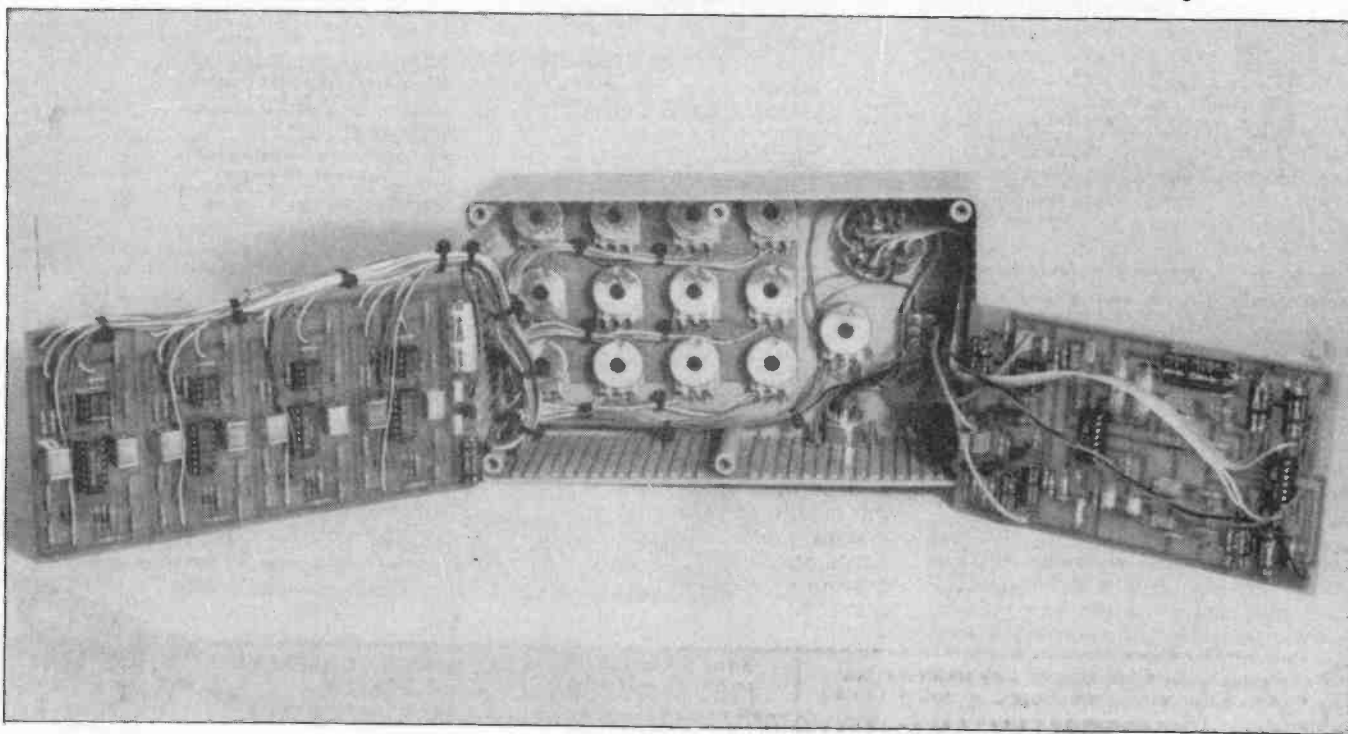



## NATIONAL COMPONENT CLUB

### SPECIAL OFFERS \* SPECIAL OFFERS

5	555 TIMER (IC's)	£1
5	741 OP-AMPS	£1
12	LED's (5mm red or green)	£1
25	GENERAL PURPOSE TRANSISTORS (BC548, BC182 etc)	£1
15	BATTERY CLIPS (PP3)	£1
25	ASSORTED POTS & PRESETS	£1
70	ASSORTED CAPACITORS (Picofarads-2200uf)	£1
25	ELECTROLYTIC CAPACITORS (1uf-2200uf)	£1
1	6V 1.8VA POWER SUPPLY	£1
?	MYSTERY PACK	£1
10	CROCODILE CLIPS (5 red and 5 black)	£1
1	90db PIEZO SOUNDER	£1

**ANY SIX PACKS FOR A FIVER !  
ALL TWELVE FOR A TENNER !**

P.O. or Cheque to: NATIONAL COMPONENT CLUB, DEPT.EE,  
HIGHER ANSFORD, CASTLE CARY, SOMERSET BA7 7JG.  
Please add £1 P & P but do not add VAT.

**\* FREE CLUB MEMBERSHIP \***

## ZENITH KITS - FOR THE ELECTRONICS ENTHUSIAST



The following is a selection from our catalogue:

■ Black Ice Alarm (for Winter Motorists).....	Kit £17.53
■ Negative Ion Machine, complete with case.....	Kit £24.11
■ Miniature F.M. 'BUG' transmitter 60-145MHz.....	Kit £6.95
■ 3-Watt F.M. transmitter 80-108MHz 12-Volt.....	Kit £13.99
■ Running light sequencer 10-channel, varispeed.....	Kit £15.89
■ Audio Power Meter 10-LED indication.....	Kit £12.94
■ VU-Meter 10-LED indication P.P.M. display.....	Kit £13.63
■ Electronic Door chime 3-note - variable freq.....	Kit £9.85
■ Infrared transmitter/receiver system.....	Kit £33.09
■ Light Activated Relay, 9-12Volt opp.....	Kit £8.91
■ Metal and Voltage Detector.....	R/Built £11.00
■ Tone Generator - Pulse or Warble tones.....	Kit £5.50
■ Loudspeaker Protector 5-100Watts.....	Kit £11.40

■ All Kits are available READY BUILT please see latest Catalogue.

■ All Kits contain full instructions PCBs and components ■ All prices include VAT and postage and packing ■ Overseas orders add 10% to above prices ■ Please send Cheque or Postal Order with Order.



ZENITH ELECTRONICS Dept. 2  
Cortlandt Business Centre  
Hailsham, East Sussex, UK BN27 1AE  
Telephone (0323) 847973  
Telex 878334 Fax 647204



Access & Barclaycard Orders  
Telephone (0323) 847973

S.A.E.  
(A4 + 26p)  
for  
FREE  
Catalogue

# HART

HART ELECTRONICS are specialist producers of kits for designs by JOHN LINSLEY-HOOD. All kits are APPROVED by the designer.

### LINSLEY-HOOD CASSETTE RECORDER CIRCUITS



Complete record and replay circuits for very high quality low noise stereo cassette recorder. Circuits are optimised for our HS16 Super Quality Sendust Alloy Head. Switched bias and equalisation to cater for chrome and ferric tapes. Very easy to assemble on plug-in PCBs. Complete with full instructions.

Complete Stereo Record/Play Kit .....	£33.70
VU Meters to suit .....	£2.30 each
Reprints of original Articles .....	75p no VAT
860X Stereo Mic Amplifier .....	£8.70

### LINSLEY HOOD 300 SERIES AMPLIFIER KITS

Superb integrated amplifier kits derived from John Linsley-Hood's articles in 'Hi-Fi News'. Ultra easy assembly and set-up with sound quality to please the most discerning listener. Ideal basis for any domestic sound system if quality matters to you. Buy the kit complete and save pounds off the individual component price.

K300-35 35 Watt. Discount price for Complete Kit ..	£98.79
K300-45 45 Watt. Discount price for Complete Kit ..	£102.36
RLH4&5. Reprints of Original Articles from 'Hi-Fi News'	£1.05 no VAT

### LINSLEY-HOOD SUPER HIGH QUALITY AM/FM TUNER SYSTEM.

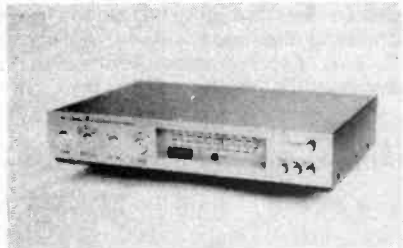

Our very latest kit for the discerning enthusiast of quality sound and an exotic feast for lovers of designs by John Linsley-Hood. A combination of his ultra high quality FM tuner and stereo decoder described in "ELECTRONICS TODAY INTERNATIONAL" and the Synchrodyne AM receiver described in "Wireless World". The complete unit is cased to match our 300 Series amplifiers. Novel circuit features in the FM section to include ready built pre-aligned front-end, phase locked loop demodulator with a response down to DC and advanced sample and hold stereo decoder together make a tuner which sounds better than the best of the high-priced exotica but, thanks to HART engineering, remains easy to build. The Synchrodyne section with its selectable bandwidth provides the best possible results from Long and Medium wave channels, so necessary in these days of split programming. If you want the very best in real HiFi listening then this is the tuner for you. Since all components are selected by the designer to give the very best sound this tuner is not cheap, but in terms of it's sound it is incredible value for money. To cater for all needs four versions are available with variations up to the top of the range full AM/FM model, with any unit being upgradeable at any time. Send for our fully illustrated details.

**DIGITAL ELECTRONICS COURSE**  
Send for your FREE list of the tools and components you will need for this exciting new series.

With every set of course components purchased we give a free £5 discount voucher, valid for six months.

### HIGH QUALITY REPLACEMENT CASSETTE HEADS



Do your tapes lack treble? A worn head could be the problem. Fitting one of our replacement heads could restore performance to better than new! Standard mountings make fitting easy and our TC1 Test Cassette helps you set the azimuth spot-on. We are the actual importers which means you get the benefit of lower prices for prime parts. Compare us with other suppliers and see! The following is a list of our most popular heads, all are suitable for use on Dolby machines and are ex-stock.

HC20 Permalloy Stereo Head. This is the standard head fitted as original equipment on most decks .....	£7.66
HS16 Sendust Alloy Super Head. The best head we can find. Longer life than Permalloy, higher output than Ferrite, fantastic frequency response .....	£14.86
HQ551 4-Track Head for auto-reverse or quadrophonic use. Full specification record and playback head .....	£14.50
HX100 Stereo Permalloy R/P head. Special Offer .....	£2.49
MA481 2/2 Language Lab R/P head .....	£13.35
SM166 2/2 Erase Head. Standard mounting, AC type .....	£8.85
SM150 2/2 Erase Head. DC Type .....	£3.60
HQ751E 4/4 Erase Head for Portastudio etc. ....	£46.80

Full specifications of these and other special purpose heads in our lists.

### HART TRIPLE-PURPOSE TEST CASSETTE TC1

One inexpensive test cassette enables you to set up VU level, head azimuth and tape speed. Invaluable when fitting new heads. Only £4.66 plus VAT and 50p postage.

Tape Head Oe-magnettiser. Handy size mains operated unit prevents build up of residual head magnetisation causing noise on playback .....

Send for your free copy of our *LISTS*. Overseas please send 2 IRCs to cover surface Post of 3 IRCs for Airmail.

Please add part cost of post, packing and insurance as follows:

<b>INLAND</b> Orders up to £10 - 50p Orders £10 to £49 - £1 Orders over £50 - £1.50	<b>OVERSEAS</b> Please send sufficient to cover Surface or Air Post as required.
--	---

Personal callers are always very welcome but please note that we are closed all day Saturday

24hr SALES LINE  
(0691) 652894

ALL PRICES EXCLUDE VAT  
UNLESS STATED



**HART**  
HART ELECTRONIC KITS LTD.  
6 PENYLAN MILL  
OSWESTRY, SHROPSHIRE  
SY10 9AF

# DOWN TO EARTH

BY GEORGE HYLTON



## SYNCHRONISING OSCILLATORS

WHEN I was on holiday, I noticed that the clock was fast. It was an old battery operated wall clock. I'd never had occasion to look at the "works". Now that I did so, I could see that it wasn't a quartz crystal clock but a mechanical one, with a balance wheel to do the timing. Evidently all the battery did was to provide the motive power, in other words to act as a substitute for a mainspring. How?

The balance wheel had an arm which swung to and fro close to a coil of wire. Clearly, the coil, when energised by current from the battery, became an electromagnet which gave a little tug to the balance wheel, keeping it swinging.

## SYNCHRONIZATION

The need, then, was some means of ensuring that the pulses of current which energise the coil came at just the right time. One way of doing this would be to energise the coil with pulses timed by a very stable oscillator. Easy enough, nowadays, with cheap quartz clock crystals and integrated frequency dividers.

But this clock was pre-quartz. Its circuitry, as far as I could see without dismembering it, comprised one ancient transistor (germanium, no doubt), one capacitor and one resistor — plus the coil, of course. Not the sort of components that make a precision oscillator.

Clearly, the balance wheel must be controlling the frequency, not the electronics. All that the electronics could be expected to do was to energise the coil at times controlled by the balance wheel. The balance wheel must be synchronising the operation of the circuitry, not the other way around.

## SELF STARTING

One way of arranging this might be to provide the balance wheel with a contact which connected the battery to the coil once per cycle. But in that case, once the clock had stopped, and the balance wheel was at rest, could you be sure that it would start up again when a new battery was put in?

You might be able to manage it, but a better arrangement would be to

engineer the electronics so as to form a self-starting oscillator. This would get the balance wheel going. Once going, it should then take over the task of timing. That way there'd be no danger of the mechanism stopping in some "dead" position where it couldn't re-start.

## BLOCKING OSCILLATOR

There's a well-known circuit which has the right behaviour. The blocking oscillator (Fig. 1) is an amplifier with its output coupled to its input via a phase-inverting transformer (L1, L2). When the circuit is turned on by closing S1, at first no current flows in TR1 because it takes time for C1 to charge through R1 to provide enough voltage across the base-emitter junction. In time, TR1 does begin to conduct, but initially at such a low collector current that there is insufficient gain to set going the positive feedback mechanism which provokes oscillation.

Soon, however, the current in TR1 does reach the critical value. Any noise in the circuit is then amplified and fed back to the base of TR1 in the right polarity to increase the currents. If the turns on L1 and L2 and the coupling between them are right, the effect is to turn TR1 on very rapidly. A big collector current flows. But not for long. The transistor saturates, its gain then falls abruptly and the build-up mechanism cannot go on.

After a large pulse of current the oscillation mechanism is exhausted. During that pulse, however, C1 has been charged by the corresponding pulse of base-emitter current. The direction of the current leaves the polarity of the charge on C1 such that the base-emitter junction is reverse biased and TR1 is cut off. The charge on C1 blocks further conduction by TR1, hence the name, blocking oscillator.

This is a temporary condition, because C1 slowly charges through R1 from the battery, and this charge is in

the reverse direction. In time, the whole cycle repeats itself. The circuit thus goes through intense periods of activity followed by intervals of passivity. The length of these inactive periods is determined largely by R1 and C1 — the larger these are the longer the inactive period.

## SENSITIVE TIMES

In the clock situation, the active moments provide the required current pulses in the electromagnet (whose coils are in this case L1, L2 or both). But it's still necessary to ensure that the brief active times come when the balance wheel is in the right position. To do this, a small magnet is fixed to the wheel. As it swings past the coils its field cuts their turns and a small voltage is induced.

If this voltage is to have any effect it must come near the end of the passive period, when TR1 is just beginning to conduct but not enough to burst into action. At this sensitive time, a very small nudge will push the circuit into violent activity. It's no use applying a synchronising voltage at other times, because the circuit will either be too firmly blocked off to take notice, or, if in action, already generating such large voltages and currents by itself that a tiny nudge from outside won't make any difference to speak of.

Fortunately, the sensitive times are quite long, because the voltage on C1 changes relatively slowly. If it stays within, say, 10mV of the critical value for 100msec then a 10mV sync. pulse applied any time during that 100msec will do the trick.

The upshot of this circuit behaviour is that the oscillation can be synchronised by the external signal (from the magnet) so long as the blocking oscillator runs naturally a little slower than the sync. In this case there's no chance that the circuit will get into a condition where it can't be nudged. If it tries to take longer over a cycle the sync. signals will speed up the action.

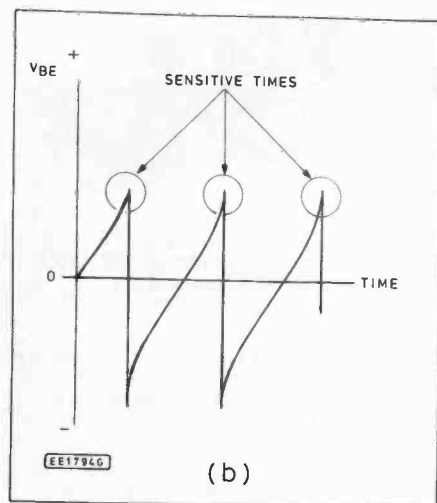
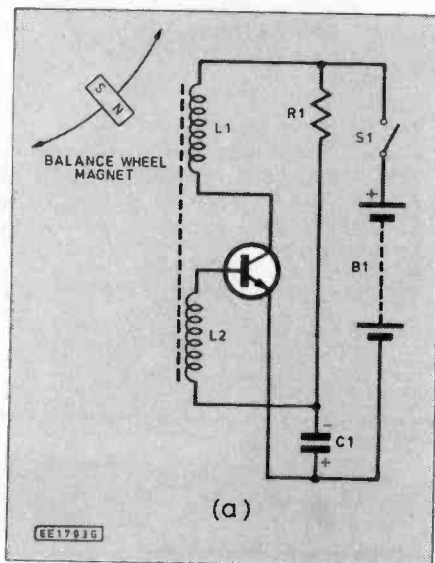

Fig. 1(a) Blocking oscillator circuit. (b) Base-emitter waveform. On switch-on, C1 charges through R1, raising the base voltage until TR1 conducts. A large pulse of collector current flows, and a corresponding pulse of base current which charges C1 as shown. This charge blocks further conduction until C1 recharges via R1 to the opposite polarity. The action then repeats. At moments just before TR1 conducts the circuit is easily nudged into action by a synchronising signal.

## CIRCADIAN RHYTHMS

This oscillator is just one example from the class known as relaxation oscillators. Many of the oscillators which are controlled by sync. signals (e.g. TV and oscilloscope time base oscillators) are of this type, though often so elaborated that their essential simplicity is not obvious. Indeed, the same type of action can be seen in non-electronic synchronised systems.

The human body undergoes regular changes whose period is about one day. They are called circadian rhythms. The triggering signals are things in the world around us with one-day periods — notably the alternation of day and night. If by travelling quickly by air in the direction that makes the day seem longer the natural, free-running rate takes over we are apt to feel a bit peculiar; "jet-lagged".

To find someone's natural circadian frequency it's necessary to screen him (or her, of course) from the normal sync. signals. One way which has been used is to get someone to live in a deep cave where there is no 24 hour variation of light, temperature, activity around you, and so on. When their circadian rhythm is measured (by recording the daily variations in body temperature etc. which reveal it) it turns out usually to have a period of about 25 hours — just what might be expected if the rhythm is to be synchronised by external 24 hour signals.

## PENDULUM OSCILLATORS

There is another class of oscillators, which includes the familiar electronic ones with LC tuned circuits. These run smoothly at a frequency determined by the LC circuit or its equivalent. They differ sharply from relaxation oscillators in that they can be synchronised by signals which run faster or slower than their natural frequency. On the other hand, they are much more resistant to synchronisation and try very hard to keep to their natural frequency.

The balance wheel in a clock or watch is such an oscillator. So is a pendulum. These mechanical oscillators have long been used for time measurement for the very reason that they like to run at their own rate. The vibrating crystal in a quartz clock is another example of a stable mechanical oscillator.

You can see why this type of oscillator can be made to run either slower or quicker by thinking about one form of pendulum, a swing. If somebody else is on the swing and you are standing behind them and doing the pushing, there are three possibilities. You can push at exactly the right moments, making the swing oscillate to and fro at its natural frequency. You can push a little too early, so that it starts each cycle too soon. This speeds it up. Or you can push a little too late, which increases the

swing away from you and slows it down.

To keep the swing going as high as in the natural case you have to work harder. And however hard you work you can't make very big changes to the frequency.

Synchronising electronic oscillators is much the same. First, the timing has to be right, or very nearly so. Secondly, the effort needed to maintain synchronism increases as the sync. frequency becomes increasingly different from the natural frequency. That is, the amplitude of sync. signal needed increases as the error increases.

## SUPPLY VOLTAGE

Pendulum-type oscillators, if correctly designed, have frequencies which are not much affected by variations in power-supply voltage. In contrast, a simple relaxation oscillator like the blocking oscillator is very much influenced. The Fig. 1 type tends to run fast as the battery voltage declines — which may explain why my clock ran fast. More sophisticated designs of relaxation oscillator (e.g. the 555 timer when used in astable mode) do not suffer much from moderate voltage changes. In a perfect design, the only changes in frequency would be those arising from temperature drift of the RC timing components.

# MARKET PLACE

**HP 141A STORAGE SCOPE.** Faulty but repairable. Manual, circuits. Scrap price £50. Buyer collects. Tel. 0734 421119.

**WANTED** instructions for Midland Ross Cambion units as used with BBC Micro. Good price paid. Mrs. Doris, 212 Stubley Lane, Dronfield, Sheffield S18 5YP.

**STORAGE CONTAINERS** 15cm<sup>3</sup> plastic snap shut cap. 10 for £1. P. Fowler, 26 Olton Road, Mickleover, Derby DE3 5PL.

**WANTED** any literature about plasma spheres, arcing horns, arc discharges, the works of Dr. Nikola Tesla. M. Fitz-Gibbon, 23 Grange Park, Steeple Aston, Oxford OX5 3SR.

**BUSH SRP51** record player 33/45/78. Din skts for stereo/tape/amp. Very good condition £15. Tel. Woking 64274.

**WANTED** output amplifier circuit board for a Bush audio system 1500 music centre. Mr. R. Stewart, 19 Mansion Ave.,

Port Glasgow, Strathclyde, Scotland PA14 6QF.

**WANTED** to buy or borrow circuit diagram National digital counter and marker type RD-9600. Sean Millar, Greygrove, Kilmihil, Co. Clare, Eire.

**MOVING HOUSE** thousands components for bulk sale. £20 the lot if collected. £25 if I post. J. De-Almeida, 18 Langton Pk., Wroughton, Swindon, Wilts SN4 0QN (0793) 812566.

**WANTED** Electronique 1.6MHz i.f. transformers. Valve receiver coil packs. Ex. U.S.A. T.C.S. receiver with p.s.u. Fowle 0202 698142.

**WANTED** second hand oscilloscope, any type. Must be cheap. 01 670 0794.

**EVERYTHING MUST GO.** 1000s of ICs, TR2, Rs, Cs +computers, monitors, boxes, p.c.b.s, etc. Offers the lot. Corwen 2902.

### FREE READERS ADS.

**RULES** Maximum of 16 words plus address and/or phone no. Private advertisers only (trade or business ads. can be placed in our classified columns). Pen pals or items related to electronics only. No computer software. EE cannot accept responsibility for the accuracy of ads, or for any transaction arising between readers as a result of a free ad. We reserve the right to refuse advertisements. Each ad. must be accompanied by a cut-out valid "date corner". Ads. will not appear (or be returned) if these rules are broken.

**HOUSE MOVING SALE** — everything must go. Chips, resistors, capacitors, Dragon computers. Full p.c.b.s. S.a.e. for list. Nic. Spiers, 114 Green Way, Tunbridge Wells, Kent TN2 3JN.

**1960s** model record player. Working. Good condition. Two tone grey. Offers invited plus post and packing. Mr. M. Dimelow, 42 East Ave., Rudheath, Northwich, Cheshire CW9 7JE.

**FOR SALE** components, resistors, capacitors, switches. A real assortment £2.50 inc. p&p. C. R. Brown, 7 Mayfield Dr., Buckley, Clwyd CH7 2PL.

Name & Address:			

BLOCK CAPITALS PLEASE

Please read the **RULES** then write your advertisement here— one word to each box. Add your name, address and/or phone no. Please publish the following small ad. **FREE** in the next available issue. I am not a dealer in electronics or associated equipment. I have read the rules. I enclose a **cut-out valid** date corner.

Signature ..... Date .....

**COUPON VALID FOR POSTING BEFORE 3 MARCH '89**  
(One month later for overseas readers)

**SEND TO: EE MARKET PLACE, EVERYDAY ELECTRONICS, 6 CHURCH STREET, WIMBORNE, DORSET BH21 1JH.**

For readers who don't want to damage the issue send a photostat or a copy of the coupon (filled in of course) with a **cut-out valid** "date corner"

EE MARKET PLACE  
MARCH '89

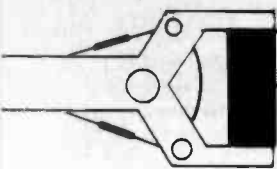

# Robot Roundup

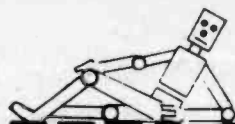

**NIGEL CLARK**

## PING-PONG CONTEST

THE SCOTS are mounting a challenge to regain the initiative for the British in the Robot Ping-Pong contest. The first *Edinburgh International Festival of Science and Technology* is being held in the city in April and the organisers are determined that there will be a Scottish entry in the ping-pong event.

To encourage interest they placed an advertisement in the Situations Vacant column of the *Scotsman*:

*"A vacancy has arisen for a Scottish Robot Table Tennis player.*

*"In April 1989 International Robot Table Tennis will take place in Edinburgh as part of the first ever Edinburgh International Festival of Science and Technology.*

*"Contestants will come from England, Finland, Switzerland, Sweden and West Germany.*

*"The successful competitor must be of Scottish origin, have good visual alertness and be capable of responding rapidly to changing circumstances. Experience preferable but not essential."*

The advertisement finished on an authentic note by claiming the festival to be an equal opportunities employer.

Howard Firth, director of the festival, said the advertisement attracted a varied response from people who thought that they would be playing robots and others tried to persuade the organisers that they would be better than the robots. There are now three possibilities which are showing signs of promise and Firth is keeping in close contact to see if it will be possible to have the first Scottish entry ready in time for the festival.

The competition may be eased somewhat by the likely non-appearance of last year's world champion, *Toughy*. It took the title on its home ground in Zurich and although Firth said it had been invited the team seemed unwilling to travel out of Switzerland with the high-powered machine.

However, with the Finns expected it still will not be easy. Their *Byrokrat* came second last year losing the final

21-18 and took part in some of the first rallies seen since the competition began.

Firth said that the idea for the festival, running from 3 April to 12 April, came from Edinburgh District Council which wanted to show the developments in new technology in the city and its surroundings. When the organisers heard about the Ping-Pong contest they decided it should be invited. Since then it has attracted a great deal of interest locally. Firth added that a state-of-the-art robotics exhibition was being planned to run alongside the competition.

The ping-pong players can be seen at the Meadowbank Centre for four days April 9 to 12.

## UPDATE

The update to the Robotech kit and the reaction to it have set off so much enthusiasm in its creator, George Walker, that he has set up a new company and has plans for putting it on the retail market. Stevenage Adventure Workpacks will be selling the full kit from its base in Knebworth, Hertfordshire at about £500.

For that price customers will receive all they need to make the arm featured in the Robotech 1, plus an interface. Walker said that software for the BBC series of machines could be made available at no extra cost. Software for IBM-compatibles is being worked on.

Whereas the original Robotech only had templates for the wooden components for the 3-axis arm plus gripper, giving the final product a Heath Robinson look, the latest offering will have the wooden parts included. Walker said there were about 100 wooden and electronic components with the wooden parts much smarter than on previous models. "It now looks a lot better than the prototype," he said.

He is also offering a starter pack at £150 from which the gripper can be made, controlled by a simple on-off switch. He said that for someone who wanted to learn about the ideas

involved in making the full arm the gripper kit was a useful starting point.

Walker decided to test the retail market following the good reaction he got from people in education, from whom he has been getting an increasing number of orders. While he has been offering them the same complete kit, he has also been willing to customise kits depending on how much they had to spend and what equipment was already available.

## UP THE WALL

Portsmouth Polytechnic's mechanical cockroach has driven Arthur Collie up the wall.

Last time we featured the progress of the six-legged walking insect (EE Sept 1987) the team had completed the mechanical work and phase one of the software was finished. However, since then the money financing the project has run out and the team disbanded.

Collie returned to his old job for a while before returning to the polytechnic to work on a new idea, a wall-climbing robot. This time he thinks he has something which could prove commercially successful. There has already been interest from a number of sources including boat owners who need to be able to inspect ships' hulls.

Building on the experience of the cockroach his concept is of a six-legged insect using suckers to attach itself to walls and powered by pneumatic cylinders. The improvements on the cockroach include a front section, including the front pair of legs, which is hinged to the rear section to make turning easier than the solid frame of the earlier version. There are also fewer valves in the cylinders, reducing the weight, which is of critical importance when it has to cling onto the sides of structures.

The insect is controlled by an IBM PC via an umbilical cord which is carried inside the hose for the compressed air. A completion date is not being given but Collie is very happy with the progress so far.

General view of the prototype Robotech kit showing the arm and "sensors."

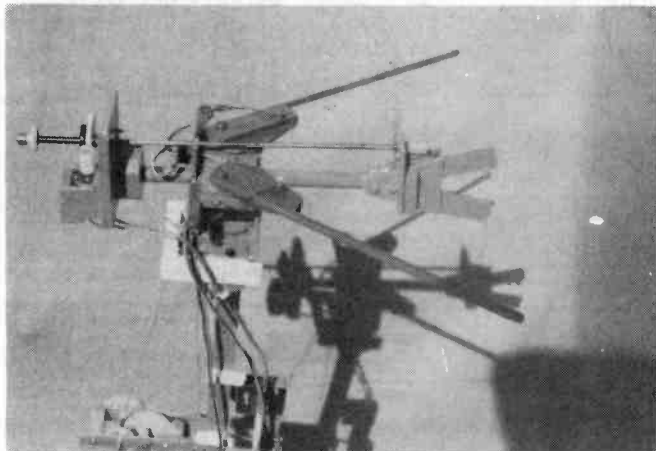

Gearbox operating "lift" mechanism for arm. Twin d.c. motors supply the lead screw power drive.

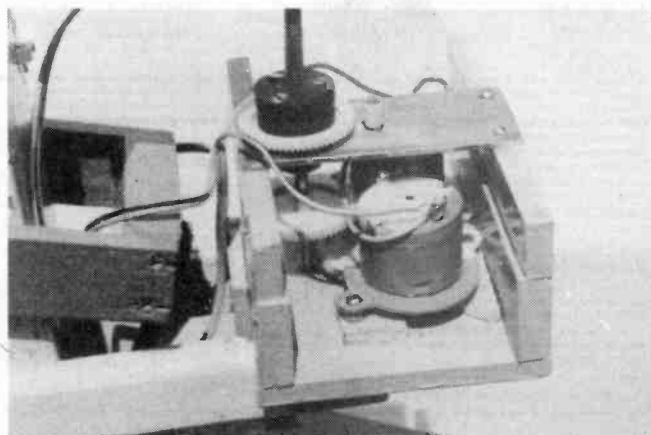

## POWER CONDITIONER

FEATURED IN ETI  
JANUARY 1988

The ultimate mains purifier. Intended mainly for lowering the noise floor and improving the analytical qualities of top-flight audio equipment.

The massive filter section contains thirteen capacitors and two current balanced inductors, together with a bank of six VDRs, to remove every last trace of impulsive and RF interference. A ten LED logarithmic display gives a second by second indication of the amount of interference removed.

Our approved parts set consists of case, PCB, all components (including high permeability toroidal cores, ICs, transistors, class X and Y suppression capacitors, VDRs, etc.) and full instructions.

PARTS SET £28.50 + VAT

A low cost (but high performance) mains conditioner is also available.  
MAINS CONDITIONER PARTS SET £5.40 + VAT  
RUGGED PLASTIC CASE £1.80 + VAT

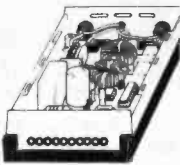

## KNIGHT RAIDER

FEATURED IN ETI JULY 1987

The ultimate in lighting effects for your Lamborghini, Maserati, BMW (or any other car, for that matter). Picture this: eight powerful lights in line along the front and eight along the rear. You flick a switch on the dashboard control box and a point of light moves lazily from left to right leaving a comet's tail behind it. Flip the switch again and the point of light becomes a bar, bouncing backwards and forwards along the row. Press again and try one of the other six patterns. An LED display on the control box let's you see what the main lights are doing.

The Knight Raider can be fitted to any car (it makes an excellent fog light) or with low powered bulbs it can turn any child's pedal car or bicycle into a spectacular 'TV-age toy'!

The parts set consists of box, PCB and components for control, PCB and components for sequence board, and full instructions.

Lamps not included.  
PARTS SET £19.90 + VAT

## RAINY DAY PROJECTS



All can be built in an afternoon!

- JUMPIN' JACK FLASH** (ETI March 1986)  
Spectacular rock, stage and disco lighting effect £6.90 + VAT
- CREDIT CARD CASINO** (ETI March 1987)  
The wicked pocket gambling machine £5.90 + VAT
- MAINS CONTROLLER** (ETI January 1987)  
Isolated logic to mains interface £6.20 + VAT
- MATCHBOX AMPLIFIERS** (ETI April 1986)  
Listen, 50W of Hi-Fi power from an amp small enough to fit in a matchbox!
- Matchbox Amplifier (20W) £6.50 + VAT
- Matchbox Bridge Amplifier (50W) £8.90 + VAT
- L165V Power Amplifier IC, with data and circuits £3.90 + VAT
- TACHO/DWELL METER** (ETI January 1987)  
Turn your Metro into a Porsche! £16.40 + VAT
- HI-FI POWER METER** (ETI May 1987)  
Measures Hi-Fi output power up to 100W - includes PCB, components, meters £3.90 + VAT
- Mono power meter £3.90 + VAT
- Stereo power meter £7.20 + VAT



FEATURED  
IN ETI  
AUGUST 1988

There's nothing quite so encouraging as having a quantifiable result to show for your training efforts. If you are not particularly fit, your resting heart rate will be around 80 beats per minute. As your jogging, aerobics or sport strengthens your heart, the rate will drop dramatically - possibly to 60bpm or less. With the S101, you can watch your progress day by day.

Breathing is important too. How efficiently do you take up oxygen? How quickly do you recover from 'oxygen debt' after strenuous activity? The S101 will let you know.

The approved parts set consists of case, 3 printed circuit boards, all components (including 17 ICs, quartz crystal, 75 transistors, resistors, diodes and capacitors), LCD, switches, plugs, sockets, electrodes, and full instructions for construction and use.

PARTS SET £33.80 + VAT

Some parts are available separately. Please send SAE for lists, or SAE + £2 for lists, circuit, construction details and training plan (free with parts set).



## THE DREAM MACHINE

FEATURED IN ETI  
DECEMBER 1987



Adjust the controls to suit your mood and let the gentle, relaxing sound drift over you. At first you might hear soft rain, sea surf, or the wind through distant trees. Almost hypnotic, the sound draws you irresistibly into a peaceful, refreshing sleep.

For many, the thought of waking refreshed and alert from perhaps the first truly restful sleep in years is exciting enough in itself. For more adventurous souls there are strange and mysterious dream experiences waiting. Take lucid dreams, for instance. Imagine being in control of your dreams and able to change them at will to act out your wishes and fantasies. With the Dream Machine it's easy!

The approved parts set consists of PCB, all components, controls, loudspeaker, knobs, lamp, fuseholders, fuse, mains power supply, prestige case and full instructions.

PARTS SET £16.50 + VAT

Ben Sweetland's best seller **GROW RICH WHILE YOU SLEEP** is now in stock. £2.95 (NO VAT)

## THE MISTRAL AIR IONISER

The best ioniser design yet - this one has variable ion drive, built-in ion counter and enough power to drive five multi-point emitters. For the technically minded, it has nine main drive stages, five secondary drives, and a four section booster to give an output capability of almost fifteen billion (1.47 x 10<sup>11</sup>) ions every minute, or 2.45 x 10<sup>11</sup> ions per second. With extra emitters this can be increased still further!

PARTS SET £24.80 + VAT

The parts set includes case, printed circuit boards, 126 top grade components, all controls, lamps, hardware, a multi-point phosphor-bronze emitter and full instructions.

Some parts are available separately - please send SAE for lists, or SAE + £1 for lists, circuit and construction details and further information (free with parts set).



## READY-BUILT MISTRAL

The Mistral ioniser (and most of our other projects) can now be supplied built, tested and ready to go. For details, please contact Peter Leah at P.L. Electronics, 8 Woburn Road, Eastville, Bristol BS5 6TT. Tel: 0272 522703. Evenings Only

**INTERNAL EMITTER** £2.69 + VAT

Can be used in place of the P-B external emitter, or both can be used together for the highest ion output. Parts set includes PCB, ion emitters, components and instructions.

## IPA BOARD CLEANER

£0.98 + VAT

Essential for removing grease and flux residues from the Mistral PCB to achieve peak performance. Applicator brush supplied.

## ION FAN

£9.80 + VAT

An almost silent piezo-electric fan, mains operated, to pump ions away from the emitter and into the room. Increases the effectiveness of any ioniser by five times!

## TV BOOSTER

Good TV pictures from poor aerials is what the project is all about. Keith Brindley's Aerial Booster gives a massive 22dB gain to ensure good viewing for campers and caravaners, from indoor aerials, or wherever a properly positioned high-gain antenna is not practical.

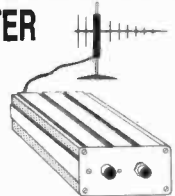

Based on the OM335 hybrid amplifier, the booster has specifications to rival the best weekend operation from 10MHz to 1.4 GHz, mid-band gain of up to 26dB and a wide supply range of 9V to 26V (it will run from car batteries for caravaners, dry batteries for campers, or a mains 'battery eliminator' in the home). No special UHF construction skills are needed - the project could be made by a careful beginner.

There are two parts sets for the project. AA1 contains the printed circuit board, OM335 hybrid amplifier, components and instructions. AA2 is the optional case set, rugged screened box, front and rear panels, waterproofing gaskets, feet, sockets and hardware.

AA1 PARTS SET £12.80 + VAT

AA2 PARTS SET £4.80 + VAT

## POWERFUL AIR IONISER

FEATURED IN ETI  
JULY 1986

Ions have been described as 'vitamins of the air' by the health magazines, and have been credited with everything from curing hay fever and asthma to improving concentration and putting an end to insomnia. Although some of the claims may be exaggerated, there is no doubt that ionised air is much cleaner and purer, and seems much more invigorating than 'dead air'.

The DIRECT ION ioniser caused a great deal of excitement when it appeared as a constructional project in ETI. At last, an ioniser that was comparable with (better than?) commercial products, was reliable, good to build and fun! Apart from the serious applications, some of the suggested experiments were outrageous!

We can supply a matched set of parts, fully approved by the designer, to build this unique project. The set includes a roller topped printed circuit board, 66 components, case, mains lead, and even the parts for the tester. According to one customer, the set costs 'about a third of the price of the individual components. What more can we say?'

PARTS SET WITH BLACK CASE £11.50 + VAT

PARTS SET WITH WHITE CASE £11.80 + VAT



Instructions are included

## BURGLAR BUSTER

Be safe from intruders with our Burglar Buster alarm system! It has all the features you'd expect from a high-tech alarm: entry and exit delay, anti-tamper loop, delay warning and control-box protection.

The parts set includes all four PCBs and all components to go on them. Other parts (case, switches, etc.) are available separately, if you haven't got anything suitable in your spares box. Set contains 4 PCBs, ICs, transistors, relays, capacitors, resistors, diodes, regulator, piezo sounder and full instructions.

BB1 PARTS SET £12.80 + VAT

## LEDs

Green rectangular LEDs for bar-graph displays.  
50 for £3.50 500 for £25  
100 for £6 1000 for £45

DIGITAL AND AUDIO EQUIPMENT LEDs  
Assorted 3mm LEDs: red, green, yellow and orange.  
25 of each (100 LEDs) for £6.80

U.K. orders: please add 80p post and packing and 15% VAT to total.  
Euro and overseas: no VAT. Carriage and insurance £4.50. Please allow up to 14 days for delivery.

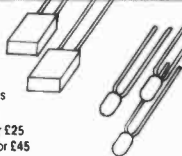

## BRAINWAVE MONITOR



FEATURED IN ETI  
AUGUST 1987

The most astonishing project ever to have appeared in an electronics magazine. Similar in principle to a medical EEG machine, this project allows you to hear the characteristic rhythms of your own mind! The alpha, beta and theta forms can be selected for study and the three articles give masses of information on their interpretation and powers.

In conjunction with Dr. Lewis's Alpha Plan, the monitor can be used to overcome shyness, to help you feel confident in stressful situations, and to train yourself to excel at things you're not good at.

Our approved parts set contains case, two PCBs, screening can for bio-amplifier, all components (including three PIM precision amplifiers), leads, brass electrodes and full instructions.

PARTS SET £36.90 + VAT ALPHA PLAN BOOK £2.50

SILVER SOLUTION for pairing electrodes: £3.60 + VAT  
Parts set available separately. We also have a range of accessories, professional electrode books, etc. Please send SAE for lists, or SAE + £2 for lists, construction details and further information (free with parts set).

*Specialist*  
**SEMICONDUCTORS**  
LIMITED

Tel: (0600) 3715

SALES DEPT., ROOM 111, FOUNDERS HOUSE, REDBROOK, MONMOUTH, GWENT.

# DIRECT BOOK SERVICE

## PROJECT CONSTRUCTION

### HOW TO GET YOUR ELECTRONIC PROJECTS WORKING

R. A. Penfold

We have all built projects only to find that they did not work correctly, or at all, when first switched on. The aim of this book is to help the reader overcome just these problems by indicating how and where to start looking for many of the common faults that can occur when building up projects.

96 pages Order code BP110 £2.50

### HOW TO DESIGN AND MAKE YOUR OWN P.C.B.s

R. A. Penfold

Deals with the simple methods of copying printed circuit

The books listed have been selected as being of special interest to everyone involved in electronics and computing. They are supplied by mail order direct to your door. Full ordering details are given on the last book page.

board designs from magazines and books and covers all aspects of simple p.c.b. construction including photographic methods and designing your own p.c.b.s.  
80 pages Order code BP121 £2.50

### BEGINNER'S GUIDE TO BUILDING ELECTRONIC PROJECTS

R. A. Penfold

Shows the complete beginner how to tackle the practical side of electronics, so that he or she can confidently build the electronic projects that are regularly featured in magazines and books. Also includes examples in the form of simple projects.

112 pages Order code No. 227 £2.25

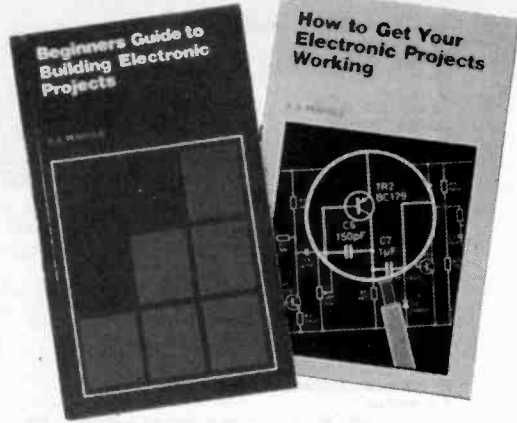

### PRACTICAL ELECTRONIC BUILDING BLOCKS—BOOK 1 PRACTICAL ELECTRONIC BUILDING BLOCKS—BOOK 2

R. A. Penfold

These books are designed to aid electronic enthusiasts who like to experiment with circuits and produce their own projects, rather than simply following published project designs.

**BOOK 1** contains: Oscillators—sinewave, triangular, squarewave, sawtooth, and pulse waveform generators operating at audio frequencies. Timers—simple monostable circuits using i.c.s, the 555 and 7555 devices, etc. Miscellaneous—noise generators, rectifiers, comparators and triggers, etc.

**BOOK 2** contains: Amplifiers—low level discrete and op-amp circuits, voltage and buffer amplifiers including d.c. types. Also low-noise audio and voltage controlled amplifiers. Filters—high-pass, low-pass, 6, 12, and 24dB per octave types. Miscellaneous—c. power amplifiers, mixers, voltage and current regulators, etc.

**BOOK 1** 128 pages Order code BP117 £1.95  
**BOOK 2** 112 pages Order code BP118 £1.95

## CIRCUITS AND DESIGN

### ELECTRONICS SIMPLIFIED—CRYSTAL SET CONSTRUCTION

F. A. Wilson, C.G.I.A., C.Eng., F.I.E.E., F.I.E.R.E., F.B.I.M.

Especially written for those who wish to participate in the intricacies of electronics more through practical construction than by theoretical study. It is designed for all ages upwards from the day one can read intelligently and handle simple tools.

80 pages Order Code BP92 £1.75

### MICRO INTERFACING CIRCUITS—BOOK 1 MICRO INTERFACING CIRCUITS—BOOK 2

R. A. Penfold

Both books include practical circuits together with details of the circuit operation and useful background information. Any special constructional points are covered but p.c.b. layouts and other detailed constructional information are not included.

Book 1 is mainly concerned with getting signals in and out of the computer; Book 2 deals primarily with circuits for practical applications.

**Book 1** 112 pages Order code BP130 £2.25  
**Book 2** 112 pages Order code BP131 £2.75

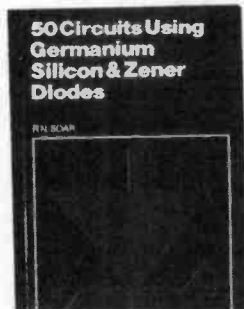

### 50 CIRCUITS USING GERMANIUM SILICON AND ZENER DIODES

R. N. Soar

Contains 50 interesting and useful circuits and applications, covering many different branches of electronics, using one of the most simple and inexpensive of components—the diode. Includes the use of germanium and silicon signal diodes, silicon rectifier diodes and Zener diodes, etc.

64 pages Order Code BP36 £1.50

### 50 SIMPLE LED CIRCUITS

R. N. Soar

Contains 50 interesting and useful circuits and applications, covering many different branches of electronics, using one of the most inexpensive and freely available components—the light-emitting diode (LED). Also includes circuits for the 707 common anode display.

64 pages Order Code BP42 £1.95  
**BOOK 2** 50 more l.e.d. circuits Order code BP87 £1.35

### A MICROPROCESSOR PRIMER

E. A. Parr, B.Sc., C.Eng., M.I.E.E.

Starts by designing a small computer which, because of its simplicity and logical structure, enables the language to be easily learnt and understood. The shortcomings are then discussed and the reader is shown how these can be overcome by changes and additions to the instruction set. In this way, such ideas as relative addressing, index registers, etc., are developed.

96 pages Order code BP72 £1.75

### COIL DESIGN AND CONSTRUCTION MANUAL

B. B. Babani

A complete book for the home constructor on "how to make" RF, IF, audio and power coils, chokes and transformers. Practically every possible type is discussed and calculations necessary are given and explained in detail. Although this book is now rather old, with the exception of torroids and pulse transformers little has changed in coil design since it was written.

96 pages Order Code 160 £2.50

### ELECTRONIC CIRCUITS HANDBOOK

Michael Tooley BA

This book aims to explode two popular misconceptions concerning the design of electronic circuits: that only those with many years of experience should undertake circuit design and that the process relies on an understanding of advanced mathematics. Provided one is not too ambitious, neither of these popularly held beliefs is true.

Specifically, this book aims to provide the reader with a unique collection of practical working circuits together with supporting information so that circuits can be produced in the shortest possible time and without recourse to theoretical texts.

Furthermore, information has been included so that the circuits can readily be modified and extended by readers to meet their own individual needs. Related circuits have been grouped together and cross-referenced within the text (and also in the index) so that readers are aware of which circuits can be readily connected together to form more complex systems. As far as possible, a common range of supply voltages, signal levels and impedances has been adopted.

As a bonus, ten test gear projects have been included. These not only serve to illustrate the techniques described but also provide a range of test equipment which is useful in its own right.

277 pages Order code NE05 £14.95

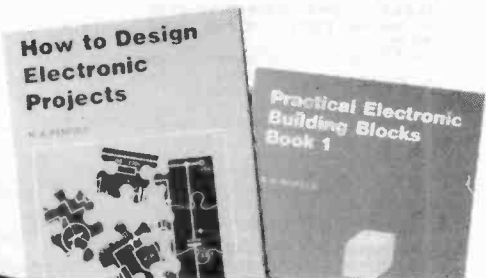

### HOW TO DESIGN ELECTRONIC PROJECTS

R. A. Penfold

The aim of this book is to help the reader to put together projects from standard circuit blocks with a minimum of trial and error, but without resorting to any advanced mathematics. Hints on designing circuit blocks to meet your special requirements are also provided.

128 pages Order code BP127 £2.25

### POPULAR ELECTRONIC CIRCUITS

—BOOK 1

POPULAR ELECTRONIC CIRCUITS

—BOOK 2

R. A. Penfold

Each book provides a wide range of designs for electronic enthusiasts who are capable of producing working projects from just a circuit diagram without the aid of detailed construction information. Any special setting-up procedures are described.

**BOOK 1** 160 pages Order code BP80 £2.95  
**BOOK 2** 160 pages Temporarily out of print

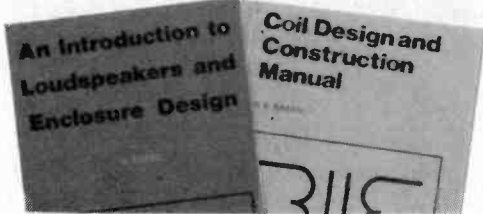

### AN INTRODUCTION TO LOUDSPEAKERS AND ENCLOSURE DESIGN

V. Capel

This book explores the various features, good points and snags of speaker designs. It examines the whys and wherefores so that the reader can understand the principles involved and so make an informed choice of design, or even design loudspeaker enclosures for him or herself. Crossover units are also explained, the various types, how they work, the distortions they produce and how to avoid them. Finally, there is a step-by-step description of the construction of the Kapellmeister loudspeaker enclosure.

148 pages Order Code BP256 £2.95

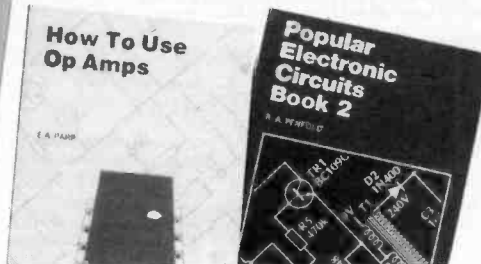

### HOW TO USE OP-AMPS

E. A. Parr

This book has been written as a designer's guide covering many operational amplifiers, serving both as a source book of circuits and a reference book for design calculations. The approach has been made as non-mathematical as possible.

160 pages Order code BP88 £2.95

### ELECTRONIC CIRCUITS FOR THE COMPUTER CONTROL OF MODEL RAILWAYS

R.A. Penfold

Home computers may easily be applied to the control of model railways and really quite sophisticated control, which needs only simple programming, is not too difficult to achieve. The main problem lies in interfacing the computer to the layout, but fortunately it is not too difficult or expensive to build suitable interfaces, and this book shows you how.

The projects consist of various types of controller, including a high quality pulse type, as well as circuits for train position sensing, signal and electric points control etc. The use of computers does not have to be restricted to massive layouts. Something as simple as an oval of track with a single siding can be given a new dimension by adding computer control and much fun can be had from these relatively simple set-ups.

88 pages Order code BP180 £2.95

### MODERN OPTO DEVICE PROJECTS

R.A. Penfold

In recent years, the range of opto devices available to the home constructor has expanded and changed radically. These devices now represent one of the more interesting areas of modern electronics for the hobbyist to experiment in, and many of these devices have useful practical applications as well. This book provides a number of practical

designs which utilize a range of modern opto-electric devices, including such things as fibre optics, ultra bright I.e.d.s and passive IR detectors etc.

While many of these designs are not in the "dead simple" category, they should be within the capabilities of anyone with a reasonable amount of experience in electronics construction and some of the more simple designs are suitable for beginners.

104 pages Order code BP194 £2.95

### ELECTRONIC CIRCUITS FOR THE COMPUTER CONTROL OF ROBOTS

Robert Penfold

Robots and robotics offer one of the most interesting areas for the electronics hobbyist to experiment in. Today the mechanical side of robots is not too difficult, as there are robotics kits and a wide range of mechanical components available. The micro controller is not too much of a problem either, since the software need not be terribly complex and many inexpensive home computers are well suited to the task.

The main stumbling block for most would-be robot builders is the electronics to interface the computer to the motors, and the sensors which provide feedback from the robot to the computer. The purpose of this book is to explain and provide some relatively simple electronic circuits which bridge this gap.

92 pages Order code BP179 £2.95

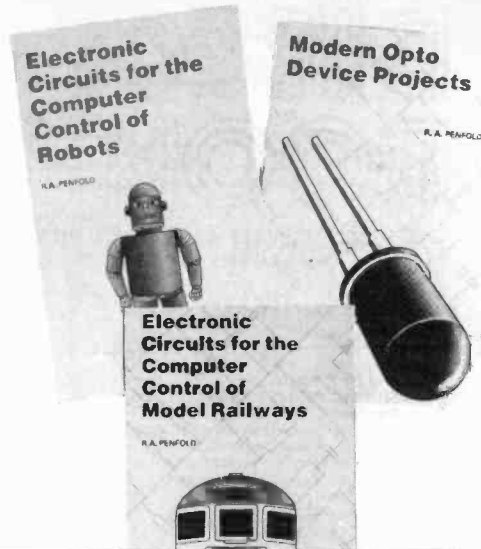

## DATA AND REFERENCE



## RECOMMENDED READING

### FOR INTRODUCING DIGITAL ELECTRONICS

ELECTRONICS—A "MADE SIMPLE" BOOK

G. H. Olsen

This book provides excellent background reading for our *Introducing Digital Electronics* series and will be of interest to everyone studying electronics. The subject is simply explained and well illustrated and the book assumes only a very basic knowledge of electricity.

330 pages Order code NE10 £4.95

**PRACTICAL DIGITAL ELECTRONICS HANDBOOK**  
Mike Tooley (Published in association with *Everyday Electronics*)

The vast majority of modern electronic systems rely heavily on the application of digital electronics, and the *Practical Digital Electronics Handbook* aims to provide readers with a practically based introduction to this subject. The book will prove invaluable to anyone involved with the design, manufacture or servicing of digital circuitry, as well as to those wishing to update their knowledge of modern digital devices and techniques. Contents: Introduction to integrated circuits; basic logic gates; monostable and bistable devices; timers; microprocessors; memories; input and output devices; interfaces; microprocessor buses. Appendix 1: Data. Appendix 2: Digital test gear projects; tools and test equipment; regulated bench power supply; logic probe; logic pulser; versatile pulse generator; digital IC tester; current tracer; audio logic tracer; RS-232C breakout box; versatile digital counter/frequency meter. Appendix 3: The oscilloscope. Appendix 4: Suggested reading. Appendix 5: Further study.

208 pages Order code PC100 £6.95

### ELECTRONICS TEACH-IN

Michael Tooley BA and David Whitfield MA MSc  
CEng MIEE (published by *Everyday Electronics*)

This value for money *EE* book provides a comprehensive background to modern electronics including test gear projects. A complete course in basic electronics; designed for the complete newcomer it will however also be of value to those with some previous experience of electronics. Wherever possible the course is related to "real life" working circuits and each part includes a set of detailed practical assignments. Includes details of eight items of related test gear giving full constructional information and diagrams for each one. They are: Safe Power Supply; Universal LCR Bridge; Diode/Transistor Tester; Audio Signal Tracer; Audio Signal Generator; RF Signal Generator; FET Voltmeter; Pulse Generator. An excellent companion for anyone interested in electronics and invaluable for those taking G.C.S.E. and BTEC electronics courses.

104 pages (A4 size) Order code EE/T-I £1.95

### PRACTICAL ELECTRONICS CALCULATIONS AND FORMULAE

F. A. Wilson, C.G.I.A., C.Eng., F.I.E.E., F.I.E.R.E., F.B.I.M.

Bridges the gap between complicated technical theory, and "cut-and-try" methods which may bring success in design but leave the experimenter unfulfilled. A strong practical bias—tedious and higher mathematics have been avoided where possible and many tables have been included.

The book is divided into six basic sections: Units and Constants, Direct-current Circuits, Passive Components, Alternating-current Circuits, Networks and Theorems, Measurements.

256 pages Order code BP53 £3.95

### ESSENTIAL THEORY FOR THE ELECTRONICS HOBBYIST

G. T. Rubaroe, T.Eng (C.E.I.), Assoc.I.E.R.E.

The object of this book is to supply the hobbyist with a background knowledge tailored to meet his or her specific requirements and the author has brought together the relevant material and presented it in a readable manner with minimum recourse to mathematics.

128 pages Order Code 228 £2.50

### MICROPROCESSING SYSTEMS AND CIRCUITS

F. A. Wilson, C.G.I.A., C.Eng., F.I.E.E., F.I.E.R.E., F.B.I.M.

A truly comprehensive guide to the elements of micro-processing systems which really starts at the beginning. Teaches the reader the essential fundamentals that are so important for a sound understanding of the subject.

256 pages Order Code BP77 £2.95

### CHART OF RADIO, ELECTRONIC, SEMICONDUCTOR AND LOGIC SYMBOLS

M. H. Banani, B.Sc.(Eng.)

Illustrates the common, and many of the not-so-common, radio, electronic, semiconductor and logic symbols that are used in books, magazines and instruction manuals, etc., in most countries throughout the world.

Chart Order Code BP27 £0.95

### ELECTRONICS TEACH-IN 88/89—INTRODUCING MICROPROCESSORS

Mike Tooley BA (published by *Everyday Electronics*)

A complete course that can lead successful readers to the award of a City and Guilds Certificate in Introductory Microprocessors (726/303). The book contains everything you need to know including full details on registering for assessment, etc.

80 pages (A4 size) Order code TI-88/89 £2.45

### ELECTRONIC HOBBYISTS HANDBOOK

R.A. Penfold

Provides an inexpensive single source of easily located information that the amateur electronics enthusiast is likely to need for the day-to-day pursuance of this fascinating hobby. Covers common component colour codes. Details the characteristics and pinouts of many popular semiconductor devices, including various types of logic ICs, operational amplifiers, transistors, FETs, unijunctions, diodes, rectifiers, SCRs, diacs, triacs, regulators and SMDs, etc. Illustrates many useful types of circuits, such as timers and oscillators, audio amplifiers and filters, as well as including a separate section on power supplies. Also contains a multitude of other useful data.

88 pages Order code BP233 £4.95

### AUDIO

F. A. Wilson, C.G.I.A., C.Eng., F.I.E.E., F.I.E.R.E., F.B.I.M.

Analysis of the sound wave and an explanation of acoustical quantities prepare the way. These are followed by a study of the mechanism of hearing and examination of the various sounds we hear. A look at room acoustics with a subsequent chapter on microphones and loudspeakers then sets the scene for the main chapter on audio systems—amplifiers, oscillators, disc and magnetic recording and electronic music.

320 pages Order Code BP111 £3.50

### HOW TO IDENTIFY UNMARKED ICs

K. H. Recorr

Shows the reader how, with just a test-meter, to go about recording the particular signature of an unmarked i.c. which should enable the i.c. to then be identified with reference to manufacturers' or other data. An i.c. signature is a specially plotted chart produced by measuring the resistances between all terminal pairs of an i.c.

Chart Order code BP101 £0.95

### RADIO AND ELECTRONIC COLOUR CODES AND DATA CHART

B. B. Babani

Although this chart was first published in 1971 it provides basic information on many colour codes in use throughout the world, for most radio and electronic components. Includes resistors, capacitors, transformers, field coils, fuses, battery leads, speakers, etc. It is particularly useful for finding the values of old components.

Chart Order code BP7 £0.95

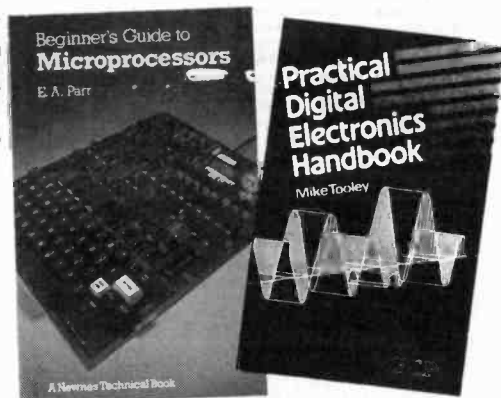

### BEGINNERS GUIDE TO MICROPROCESSORS

E.A. Parr

An excellent grounding in microprocessors, this book is broadly relevant to the whole of our *Introducing Microprocessors* course. It is easy to read and well illustrated.

224 pages Order code NE03 £5.95

### MICROELECTRONIC SYSTEMS 2 CHECKBOOK

R. Vears

The aim of this book is to provide a foundation in microcomputer hardware, software and interfacing techniques. Each topic is presented in a way that assumes only an elementary knowledge of microelectronic systems and logic functions. The book concentrates on 6502, 280 and 6800 microprocessors and contains 60 tested programs, 160 worked problems and 250 further problems.

Now replaced by *Microelectronic Systems N2 Checkbook*  
Order code NE04N £6.95

## OSCILLOSCOPES: HOW TO USE THEM—HOW THEY WORK

**Ian Hickman**  
Oscilloscopes are essential tools for checking circuit operation and diagnosing faults, and an enormous range of models is available. But which is the right 'scope for a particular application? Which features are essential, which not so important? What techniques will get the best out of the instrument?  
Ian Hickman, experienced in both professional and hobbyist electronics, has revised this well-established book to help all oscilloscope users—and potential users.

133 pages Order code NE09 £6.95



## PRACTICAL ELECTRONICS HANDBOOK

**Ian Sinclair**  
Ian Sinclair has now revised this useful and carefully selected collection of standard circuits, rules-of-thumb, and design data for professional engineers, students and enthusiasts involved in radio and electronics. Covering passive and active components, discrete component circuits (such as amplifiers, filters and oscillators) and linear and digital i.c.s, the book includes many items which are not elsewhere available in a single handy volume. The operation and functions of typical circuits are described, while mathematics is limited to that necessary for deciding component values for any application.

This revised edition contains more details on computers and microprocessors and has been brought up to date throughout.

199 pages Order Code NE06 £7.95

## BEGINNER'S GUIDE TO HI-FI

**Ian Sinclair**  
The *Beginner's Guide to Hi-Fi* will appeal to the audio enthusiast, whether newly won over by advances in technology or well established and wondering whether to update equipment. The book deals with the sound from its sources in the studio to its ultimate end in your ears, and shows what sound is, how it is recorded and how it is reproduced.

Every aspect of Hi-Fi, from pickup cartridges to loudspeakers, has been covered, and the emphasis has been on explaining design aims. Cassette systems have been given considerable prominence, including the more modern Dolby C and dbx noise reduction systems. The CD record has been covered in detail so that you can find out just why this system of sound reproduction is so superior.

194 pages Order Code NE07 £5.95

## ELECTRONICS-BUILD AND LEARN

**R. A. Penfold**  
The first chapter gives full constructional details of a circuit demonstrator unit that is used in subsequent chapters to introduce common electronic components—resistors, capacitors, transformers, diodes, transistors, thyristors, fets and op amps. Later chapters go on to describe how these components are built up into useful circuits, oscillators, multivibrators, bistables and logic circuits.

At every stage in the book there are practical tests and experiments that you can carry out on the demonstrator unit to investigate the points described and to help you understand the principles involved. You will soon be able to go on to more complex circuits and tackle fault finding logically in other circuits you build.

120 pages Order Code PC103 £5.95

## COMMUNICATION

**F. A. Wilson, C.G.I.A., C.Eng., F.I.E.E., F.I.E.R.E., F.B.I.M.**

A look at the electronic fundamentals over the whole of the communication scene. This book aims to teach the important elements of each branch of the subject in a style as interesting and practical as possible. While not getting involved in the more complicated theory and mathematics, most of the modern transmission system techniques are examined including line, microwave, submarine, satellite and digital multiplex systems, radio and telegraphy. To assist in understanding these more thoroughly, chapters on signal processing, the electromagnetic wave, networks and transmissions assessment are included, finally a short chapter on optical transmission.

256 pages Order Code BP89 £2.95

## GETTING THE MOST FROM YOUR MULTIMETER

**R.A. Penfold**  
This book is primarily aimed at beginners and those of limited experience of electronics. Chapter 1 covers the basics of analogue and digital multimeters, discussing the relative merits and the limitations of the two types. In Chapter 2 various methods of component checking are described, including tests for transistors, thyristors, resistors, capacitors and diodes. Circuit testing is covered in Chapter 3, with subjects such as voltage, current and continuity checks being discussed.

In the main little or no previous knowledge or experience is assumed. Using these simple component and circuit testing techniques the reader should be able to confidently tackle servicing of most electronic projects.

96 pages Order code BP239 £2.95

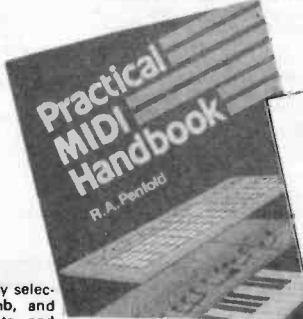

## PRACTICAL MIDI HANDBOOK

**R.A. Penfold**  
The Musical Instrument Digital Interface (MIDI) is surrounded by a great deal of misunderstanding, and many of the user manuals that accompany MIDI equipment are quite incomprehensible to the reader.

The *Practical MIDI Handbook* is aimed primarily at musicians, enthusiasts and technicians who want to exploit the vast capabilities of MIDI, but who have no previous knowledge of electronics or computing. The majority of the book is devoted to an explanation of what MIDI can do and how to exploit it to the full, with practical advice on connecting up a MIDI system and getting it to work, as well as deciphering the technical information in those equipment manuals.

128 pages Order code PC101 £5.95

## INTRODUCTION TO DIGITAL AUDIO

**Ian Sinclair**  
Digital recording methods have existed for many years and have become familiar to the professional recording engineer, but the compact disc (CD) was the first device to bring digital audio methods into the home. The next step is the appearance of digital audio tape (DAT) equipment. All this development has involved methods and circuits that are totally alien to the technician or keen amateur who has previously worked with audio circuits. The principles and practices of digital audio owe little or nothing to the traditional linear circuits of the past, and are much more comprehensible to today's computer engineer than the older generation of audio engineers.

This book is intended to bridge the gap of understanding for the technician and enthusiast. The principles and methods are explained, but the mathematical background and theory is avoided, other than to state the end product.

128 pages Order Code PC102 £5.95

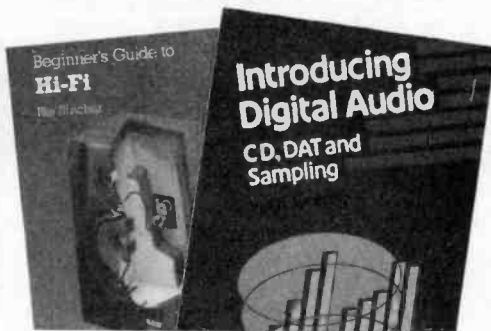

## INTERNATIONAL TRANSISTOR EQUIVALENTS GUIDE

**A. Michaels**  
Helps the reader to find possible substitutes for a popular selection of European, American and Japanese transistors. Also shows material type, polarity, manufacturer and use.

320 pages Order code BP85 £3.50

## TRANSISTOR RADIO FAULT-FINDING CHART

**C. E. Miller**  
Used properly, should enable the reader to trace most common faults reasonably quickly. Across the top of the chart will be found four rectangles containing brief description of these faults, viz—sound weak but undistorted, set dead, sound low or distorted and background noises. One then selects the most appropriate of these and following the arrows, carries out the suggested checks in sequence until the fault is cleared.

Chart Order code BP70 £0.95

## DIGITAL IC EQUIVALENTS AND PIN CONNECTIONS

**A. Michaels**  
Shows equivalents and pin connections of a popular selection of European, American and Japanese digital i.c.s. Also includes details of packaging, families, functions, manufacturer and country of origin.

256 pages Order code BP140 £5.95

## LINEAR IC EQUIVALENTS AND PIN CONNECTIONS

**A. Michaels**  
Shows equivalents and pin connections of a popular selection of European, American and Japanese linear i.c.s. Also includes details of functions, manufacturer and country of origin.

320 pages Temporarily out of print

## INTERNATIONAL DIODE EQUIVALENTS GUIDE

**A. Michaels**  
Designed to help the user in finding possible substitutes for a large selection of the many different types of diodes that are available. Besides simple rectifier diodes, also included are Zener diodes, i.e.d.s, diacs, triacs, thyristors, OCIs, photo and display diodes.

144 pages Order code BP108 £2.25

## NEWNES ELECTRONICS POCKET BOOK

**E. A. Parr**  
Newnes Electronics Pocket Book has been in print for over twenty years and has covered the development of electronics from valve to semiconductor technology and from transistors to LSI integrated circuits and microprocessors. To keep up to date with the rapidly changing world of electronics, continuous revision has been necessary. This new Fifth Edition takes account of recent changes and includes material suggested by readers of previous editions. New descriptions of op.amp. applications and the design of digital circuits have been added, along with a totally new chapter on computing, plus other revisions throughout.

315 pages (hard cover) Order Code NE02 £9.95

## TRANSISTOR SELECTOR GUIDE

This unique guide offers a range of selection tables compiled so as to be of maximum use to all electronics engineers, designers and hobbyists.  
Section 1: Covers component markings, codings and standards, as well as explaining the symbols used.  
Section 2: Tabulates in alpha-numeric sequence the comprehensive specifications of over 1400 devices.  
Section 3: Tabulates the devices by case type.  
Section 4: Considers particular limits to the electrical parameters when compiling the tables.  
Section 5: Illustrates package outlines and leadouts.  
Section 6: Consists of a surface mounting device markings conversion list.

192 pages Temporarily out of print

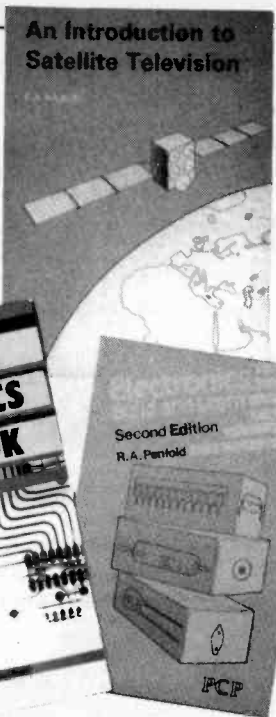

## RADIO & ELECTRONIC COLOUR CODES & DATA CHART

MILITARY COLOUR CODES FOR RESISTORS AND CAPACITORS		BRITISH AND AMERICAN RESISTOR AND CAPACITOR COLOUR CODES		USA COLOUR CODES FOR LOGIC AND OTHER IC'S	
0	Black	0	Black	0	Black
1	Brown	1	Brown	1	Brown
2	Red	2	Red	2	Red
3	Orange	3	Orange	3	Orange
4	Yellow	4	Yellow	4	Yellow
5	Green	5	Green	5	Green
6	Blue	6	Blue	6	Blue
7	Violet	7	Violet	7	Violet
8	Grey	8	Grey	8	Grey
9	White	9	White	9	White





## RADIO/TELEVISION

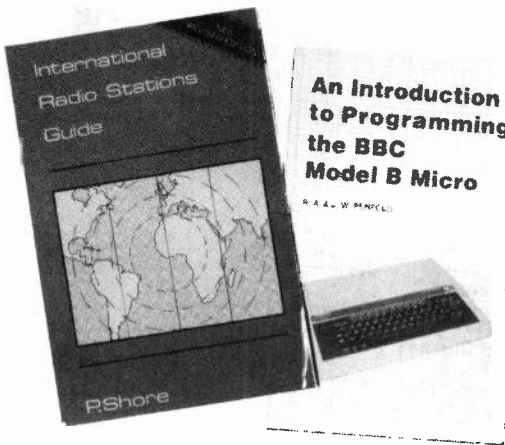

### AN INTRODUCTION TO RADIO DXING

**R. A. Penfold**  
Anyone can switch on a short wave receiver and play with the controls until they pick up something, but to find a particular station, country or type of broadcast and to receive it as clearly as possible requires a little more skill and knowledge. The object of this book is to help the reader to do just that, which in essence is the fascinating hobby of radio DXing.  
112 pages

Order code BP91 £1.95

### INTERNATIONAL RADIO STATIONS GUIDE

**P. Shore**  
Provides the casual listener, amateur radio DXer and the professional radio monitor with an essential reference work designed to guide him or her around the ever more complex radio bands. This new edition has been completely revised and rewritten and incorporates much more information which is divided into the following sections: Listening to Short Wave Radio; ITU Country Codes; World-wide Short Wave Radio Stations; European, Middle East and North African Long Wave Radio Stations; European, Near East and North African Medium Wave Radio Stations; Canadian Medium Wave Radio Stations; USA Medium Wave Radio Stations; Broadcasts in English; Programmes for DXers and Short Wave Listeners; UK FM Radio Stations; Time differences from GMT; Abbreviations; Wavelength/Frequency Conversion.  
320 pages

Order code BP255 £4.95

### A TV-DXERS HANDBOOK

**R. Bunney**  
Roger Bunney is probably one of the leading authorities in this country on the subject. Includes many units and devices which have been designed and used by active enthusiasts, and often, considerable ingenuity and thought have gone into the development of such units to overcome individual problems. A practical and authoritative reference to this unusual aspect of electronics.  
128 pages

Order code BP176 £5.95

### AN INTRODUCTION TO SATELLITE TELEVISION

**F.A. Wilson**  
As a definitive introduction to the subject this book is presented on two levels. For the absolute beginner or anyone thinking about purchasing or hiring a satellite TV system, the story is told as simply as such a complex one can be in the main text.

For the professional engineer, electronics enthusiast, student or others with technical backgrounds, there are numerous appendices backing up the main text with additional technical and scientific detail formulae, calculations, tables etc.

There is also plenty for the DIY enthusiast with practical advice on choosing and installing the most problematic part of the system—the dish antenna.

104 pages Order Code BP195 £5.95

## COMPUTING

### NEWNES COMPUTER ENGINEER'S POCKETBOOK

**Michael Tooley**  
An invaluable compendium of facts, figures, circuits and data, indispensable to the designer, student, service engineer and all those interested in computer and microcomputer systems. It will appeal equally to the hardware or software specialist and to the new band of "software engineers". This first edition covers a vast range of subjects at a practical level, with the necessary explanatory text. The data is presented in a succinct and rapidly accessible form so that the book can become part of an everyday toolkit.  
205 pages (hard cover)

Order code NE01 £8.95

### GETTING THE MOST FROM YOUR PRINTER

**J. W. Penfold**  
Details how to use all the features provided on most dot-matrix printers from programs and popular word processor packages like Wordwise, Visawrite and Quill, etc. Shows exactly what must be typed in to achieve a given effect.  
96 pages

Order Code BP181 £2.95

### A Z80 WORKSHOP MANUAL

**E. A. Parr, B.Sc., C.Eng., M.I.E.E.**  
This book is intended for people who wish to progress beyond the stage of BASIC programming to topics such as machine code and assembly language programming, or need hardware details of a Z80 based computer.  
192 pages

Order Code BP112 £3.50

### AN INTRODUCTION TO 68000 ASSEMBLY LANGUAGE

**R. A. & J. W. Penfold**  
Obtain a vast increase in running speed by writing programs for 68000 based micros such as the Commodore Amiga, Atari ST range or Apple Macintosh range etc., in assembly language. It is not as difficult as one might think and this book covers the fundamentals.  
112 pages

Order code BP184 £2.95

### THE ART OF PROGRAMMING THE ZX SPECTRUM

**M. James, B.Sc., M.B.C.S.**  
It is one thing to have learnt how to use all the Spectrum's commands and functions, but a very different one to be able to combine them into programs that do exactly what you want them to. This is just what this book is all about—teaching you the art of effective programming with your Spectrum.  
144 pages

Order code BP119 £2.50

### AN INTRODUCTION TO PROGRAMMING THE BBC MODEL B MICRO

**R. A. & J. W. Penfold**  
Written for readers wanting to learn more about programming and how to make best use of the incredibly powerful model B's versatile features. Most aspects of the BBC micro are covered, the omissions being where little could usefully be added to the information provided by the manufacturer's own manual.  
144 pages

Order code BP139 £1.95

### THE PRE-BASIC BOOK

**F. A. Wilson, C.G.I.A., C.ENG., F.I.E.E., F.I.E.R.E., F.B.I.M.**  
Another book on BASIC but with a difference. This one does not skip through the whole of the subject and thereby leave many would-be programmers floundering but instead concentrates on introducing the technique by looking in depth at the most frequently used and more easily understood computer instructions. For all new and potential micro users.  
192 pages

Order code BP146 £2.95

### AN INTRODUCTION TO COMPUTER PERIPHERALS

**J. W. Penfold**  
Covers such items as monitors, printers, disc drives, cassette recorders, modems, etc., explaining what they are, how to use them and the various types and standards. Helps you to make sure that the peripherals you buy will work with your computer.  
80 pages

Order Code BP170 £2.50

### AN INTRODUCTION TO PROGRAMMING THE ACORN ELECTRON

**R. A. & J. W. Penfold**  
Designed to help the reader learn more about programming and to make best use of the Electron's many features. Adds considerably to the information already supplied in the manufacturer's own instruction manual.  
144 pages

Order code BP142 £1.95

### AN INTRODUCTION TO PROGRAMMING THE ATARI 600/800 XL

**R. A. & J. W. Penfold**  
Especially written to supplement the manufacturer's own handbook. The information supplied will help the reader to master BASIC programming and to make best use of the Atari's many powerful features.  
128 pages

Order code BP143 £1.95

### AN INTRODUCTION TO PROGRAMMING THE SINCLAIR QL

**R. A. & J. W. Penfold**  
Helps the reader to make best use of the fantastic Sinclair QL's almost unlimited range of features. Designed to complement the manufacturer's handbook.  
112 pages

Order code BP150 £1.95

### AN INTRODUCTION TO Z80 MACHINE CODE

**R. A. & J. W. Penfold**  
Takes the reader through the basics of microprocessors and machine code programming with no previous knowledge of these being assumed. The Z80 is used in many popular home computers and simple programming examples are given for Z80-based machines including the Sinclair ZX-81 and Spectrum, Memotech and the Amstrad CPC 464. Also applicable to the Amstrad CPC 664 and 6128.  
144 pages

Order code BP152 £2.75

### AN INTRODUCTION TO 6502 MACHINE CODE

**R. A. & J. W. Penfold**  
No previous knowledge of microprocessors or machine code is assumed. Topics covered are: assembly language and assemblers, the register set and memory, binary and hexadecimal numbering systems, addressing modes and the instruction set, and also mixing machine code with BASIC. Some simple programming examples are given for 6502-based home computers like the VIC-20, ORIC-1/Atmos, Electron, BCC and also the Commodore 64.  
112 pages

Order code BP147 £2.50

### HOW TO GET YOUR COMPUTER PROGRAMS RUNNING

**J. W. Penfold**  
Have you ever written your own programs only to find that they did not work! Help is now at hand with this book which shows you how to go about looking for your errors, and helps you to avoid the common bugs and pitfalls of program writing. Applicable to all dialects of the BASIC language.  
144 pages

Order code BP169 £2.50

### AN INTRODUCTION TO COMPUTER COMMUNICATIONS

**R. A. Penfold**  
Provides details of the various types of modem and their suitability for specific applications, plus details of connecting various computers to modems, and modems to the telephone system. Also information on common networking systems and RTTY.  
96 pages

Order code BP177 £2.95

### COMPUTER TERMINOLOGY EXPLAINED

**I. D. Poole**  
Explains a wide range of terms that form the computer jargon used by enthusiasts. Includes a reference guide to the more commonly used BASIC commands.  
96 pages

Order code BP148 £1.95

# DIRECT BOOK SERVICE

(A Division of Wimborne Publishing Ltd.)

## TO ORDER

Please state the order code clearly, print your name and address and add the required postage to the total order.

Add 75p to your total order for postage and packing (overseas readers add £1.50 for countries in Europe, or add £2.00 for all countries outside Europe, surface mail postage) and send a PO, cheque or international money order (£ sterling only) made payable to **Direct Book Service** quoting your name and address, the order code and quantities required to **DIRECT BOOK SERVICE, 33 GRAVEL HILL, MERLEY, WIMBORNE, DORSET, BH21 1RW** (mail order only).

Although books are normally sent within seven days of receipt of your order, please allow a maximum of 28 days for delivery. Overseas readers allow extra time for surface mail post.

Please check price and availability (see latest issue of **Everyday Electronics**) before ordering from old lists.

Note—our postage charge is the same for one book or one hundred books!

# PCB SERVICE

Printed circuit boards for certain constructional projects (up to two years old) are available from the PCB Service, see list. These are fabricated in glass fibre, and are fully drilled and roller tinned. All prices include VAT and postage and packing. Add £1 per board for overseas airmail. Remittances should be sent to: The PCB Service, *Everyday Electronics* Editorial Offices, 6 Church Street, Wimborne, Dorset BH21 1JH. Cheques should be crossed and made payable to *Everyday Electronics* (Payment in £ sterling only.)

Readers are advised to check with prices appearing in the current issue before ordering.

**NOTE:** Boards for older projects—not listed here—can often be obtained from Magenta Electronics, 135 Hunter St., Burton-on-Trent, Staffs DE14 2ST. Tel: 0283 65435 or Lake Electronics, 7 Middleton Close, Nuthall, Nottingham NG16 1BX. Tel: 0602 382509.

**NOTE:** please allow 28 days for delivery. We can only supply boards listed in the latest issue. Boards can only be supplied by mail order and on a payment with order basis.

PROJECT TITLE	Order Code	Cost
Light Rider—Lapel Badge - OCT '86 - —Disco Lights —Chaser Light	540 & 541	£2.97
	542	£5.12
	546	£4.04
Modem Tone Decoder - NOV '86 - 200MHz Digital Frequency Meter	547	£3.46
	548	£5.14
- DEC '86 - Dual Reading Thermometer Automatic Car Alarm BBC 16K Sideways RAM (Software Cassette)	549	£7.34
	550	£2.93
	551	£2.97
	551S	£3.88
Random Light Unit - JAN '87 -	552	£5.88
Car Voltage Monitor - FEB '87 - Mini Amp Video Guard Spectrum I/O Spectrum Speech Synthesiser	553	£2.48
	554 & 555	£5.68
	556	£3.80
	557	£4.35
558	£4.86	
- MAR - '87 Computer Buffer/Interface Infra Red Alarm : Sensor Head PSU/Relay Driver	560	£3.32
	561	£4.19
	562	£4.50
Alarm Thermometer - APR '87 - Experimental Speech Recognition Bulb Life Extender	559	£2.60
	563	£4.75
	564	£2.48
Fridge Alarm - MAY '87 - EE Equaliser—Ioniser	565	£2.40
	566	£4.10
Mini Disco Light - JUNE '87 - Visual Guitar/Instrument Tuner	567	£2.93
	568	£3.97
Ferrostat - JULY '87 - EE Buccaneer Metal Detector Monomix	569	£3.34
	570	£4.10
	571	£4.75
-AUG '87 - Super Sound Adaptor Main Board PSU Board Simple Shortwave Radio, Tuner Amplifier	572	£4.21
	573	£3.32
	575	£3.15
	576	£2.84
Noise Gate - SEPT '87 - Burst Fire Mains Controller Electronic Analogue/Digital Multimeter	577	£4.41
	578	£3.31
	579	£6.40
Transtest - OCT '87 - Video Controller	580	£3.32
	581	£4.83
Accented Metronome - NOV '87 - Acoustic Probe BBC Sideways RAM/ROM	582	£3.77
	584	£2.78
	585	£4.10
Pseudo Echo Unit - DEC '87 - Dual Mains Light Flasher Twinkling Star Audio Sine Wave Generator	586	£4.60
	587	£3.66
	588	£2.61
	589	£3.03
Capacitance Meter - JAN '88 - Bench Amplifier Transistor Curve Tracer	590	£4.10
	591	£5.51
	592	£2.84
- FEB '88 - Bench Power Supply Unit Game Timer	593	£4.01
	583	£3.55

Semiconductor Tester - MAR '88 - SOS Alert Guitar/Keyboard Envelope Shaper	594	£3.19
	595	£2.78
	596	£4.23
Stereo Noise Gate - APR '88 - Pipe & Cable Locator Inductive Proximity Detector	597	£6.65
	598	£2.72
	574	£2.97
- MAY '88 - Multi-Channel Remote Light Dimmer Transmitter Receiver Door Sentinel Function Generator—Main Board Function Generator—Power Supply Super Sound Effects Generator	599	£2.78
	600	£3.07
	605	£2.60
	606	£5.91
	607	£4.19
	608	£4.78
- JUNE '88 - Multi-Channel Remote Light Dimmer Relay/Decoder Dimmer Board Power Supply Mother Board Headlight Reminder	601	£4.86
	602	£3.07
	603	£2.72
	604	£7.76
	611	£2.78
Video Wiper - JULY '88 - Isolink	612	£6.75
	613	£4.21
Tea Tune - AUG '88 - Time Switch Suntan Timer Car Alarm	609	£2.56
	614	£4.84
	610	£3.07
	615	£3.12
Doorbell Delay - SEPT '88 - Breaking Glass Alarm Amstrad PIO	616	£3.55
	617	£4.27
	618	£6.77
- OCT '88 -		
Eprom Eraser	620	£4.07
Doorbell Delay - NOV '88 - Micro Alarm	616	£3.56
	621	£3.12
Infra-Red Object Counter Transmitter Receiver Display Seashell Sea Synthesiser	622	£4.61
	623	£3.23
	624	£3.05
	625	£4.84
Reaction Timer - DEC '88 - Main Board Display board Downbeat Metronome EPROM Programmer (On Spec) Phasor	626	£3.46
	627	£2.67
	629	£4.84
	630	£8.29
	631	£5.64
- JAN '89 -		
Monkey/Hunter Game	634	£3.36
Continuity Tester - FEB '89 - 4-Channel Light Dimmer Mini PSU	619	£2.67
	635	£7.67
	636	£3.23
Sound-to-Light Interface Midi Pedal -MAR '89- Midi Merge Audio Lead Tester	637	£6.24
	639	£7.00
	640	£2.78
	641	£5.77

Please note that when ordering it is important to give project title as well as order code. Please print name and address in Block Caps. Do not send any other correspondence with your order.

EE PRINTED CIRCUIT BOARD SERVICE  
Please send me the following p.c.b.s.  
Make cheques/PO payable to: **Everyday Electronics**  
(payment in £ sterling only)

Order Code    Project    Quantity    Price

.....

.....

.....

I enclose cheque/PO for £.....

Name.....

Address.....

.....

Please allow 28 days for delivery

BLOCK CAPITALS PLEASE

# A BETTER WAY TO CHARGE YOUR NICADS

With Cirklits' new automatic Ni-Cad Cycler/Charger.

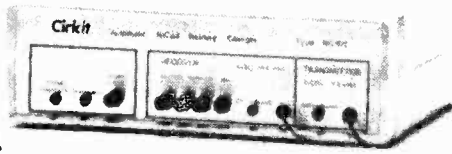

Designed for radio control applications, the charger features:

- Independent Discharge/Charge circuits for 4 cell (4.8V), 8 cell (9.6V) NiCad Packs used in TX/RX Applications
- RX Battery Selector 225, 500, 600 & 1200 mA Packs.
- Discharge/Charge Cycle typical 6 hrs.
- Audible warning of reverse polarity connection to unit.
- LED Status Indicators for Discharge, Charge & Cycle complete operations.
- Correct Discharge/Charge can add 20% better life to your NiCad Packs.

Built Unit	<b>£49.95</b> inc VAT	Stock No.	41-03422
PCB Assembly Kit	<b>£27.10</b> inc VAT		41-03420
Hardware Kit	<b>£12.50</b> inc VAT		41-03421

**TRADE ENQUIRIES WELCOME**

# Cirkit



**Cirkit Distribution Ltd.**

Park Lane, Broxbourne, Herts EN10 7NQ.  
Telephone (0992) 444111.

**EDU-SCOPE** Build your own solid state oscilloscope - complete kit of parts excluding case ..... £29.99  
**EDU-SCOPE CASE KIT** . . . £10.95  
**LOW COST LEAD/PROBE** .£3.95



- BUG-89** Micro sized surveillance transmitter - can be received by any FM/VHS radio or our MICRO-FM - PCB size only 50x20mm .... £4.99  
**MICRO-FM** A micro miniature personal FM receiver - High quality IC design (no alignment problems) - Great for surveillance work or for just listening to your favourite radio shows! (cased) ..... £7.99  
**ROBO-VOX** Instantly transforms your voice into into Dalek/Robot type - also amazing feedback sound effects possible (cased) ..... £9.95  
**ROBOT CIRCULAR** Unique radio controlled robot - can also be converted to control via computer ..... £16.95  
**THERAMIN MUSIC GENERATOR** An electronic device based on an ancient legendary mystical instrument (cased) ..... £12.75  
**SOLARTRONICS-88** Enter the exciting world of Solar Electronics with our Solar Designer's experimenter kit ..... £7.75  
**SUPER SOUND-FX MICROCOMPUTER** An easy to use and program single chip sound effects Micro completely self contained - Incredible sound routines already masked programmed into the device - this is our most popular kit at present ..... £9.95  
**SOUND-FX PRO CONSOLE CASE KIT** ..... £3.99

Please add 15% VAT and £0.95 per order for P&P. For FREE Datapack on all our Kits/ Products send SAE. - Allow up to 14 days for delivery - Make Cheques/Po's payable to :- ITRON U.K.

Castle Mill, Lower Kings Road  
**BERKHAMSTED**  
Hertfordshire HP4 2AD

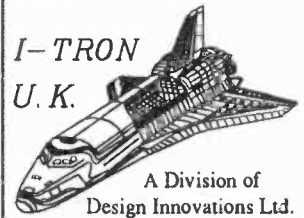

# ANDOR ELECTRONICS



I.C.'s 74 LS		I.C.'s 74 HC	
74LS00	20p	74HC00	27p
74LS02	20p	74HC02	27p
74LS04	20p	74HC04	27p
74LS08	20p	74HC08	27p
74LS10	20p	74HC10	27p
74LS13	30p	74HC14	60p
74LS14	35p	74HC20	27p
74LS20	20p	74HC27	27p
74LS27	20p	74HC30	27p
74LS32	20p	74HC32	27p
74LS42	45p	74HC42	50p
74LS74	25p	74HC74	48p
74LS75	35p	74HC75	48p
74LS86	28p	74HC123	55p
74LS90	38p	74HC125	60p
74LS93	38p	74HC138	60p
74LS95	55p	74HC151	60p
74LS125	30p	74HC157	60p
74LS138	40p	74HC163	80p
74LS155	45p	74HC175	60p
74LS157	45p	74HC193	70p
74LS161	50p	74HC195	65p
74LS164	55p	74HC240	90p
74LS175	50p	74HC242	95p
74LS193	60p	74HC244	95p
74LS240	70p	74HC257	60p
74LS244	70p	74HC366	75p
74LS257	48p	74HC390	95p
74LS373	60p	74HC393	95p
74LS390	60p	74HC4016	110p
74LS393	60p	74HC4040	75p
		74HC4051	90p
		74HC4066	110p

L.E.D's	
3mm & 5mm	
Red	10p
Green	14p
Yellow	16p
ZENNER DIODES	
BZX55 500mW	10p
BZX85 1.3W	20p
C3V3 C7V5	
C3V6 C9V1	
C4V7 C12	
C5V1 C15	
C5V6 C24	
C6V2 C36	

DIODES	
1N4148 10 for	30p

RESISTORS	
Carbon film 5%	
1 ohm - 1 Meg	
E12 range	
1	2p
10	17p
100	150p
Metal film 1%	
1 ohm - 1 Meg	
E24 range	
1	4p
10	35p
100	300p

Prices for same value not mixed

I.C.'s 74F	
74F00	32p
74F02	32p
74F04	32p
74F08	32p
74F10	32p
74F20	32p
74F74	45p
74F86	45p
74F157	65p
74F161	140p
74F164	140p
74F175	90p
74F240	100p
74F244	100p
74F257	65p
74F373	100p

IC SOCKETS	
Low Profile	
6 Way	5p
8 Way	5p
14 Way	7p
16 Way	9p
18 Way	11p
20 Way	12p
24 Way	14p
28 Way	17p
40 Way	22p

NUTS & BOLTS	
All steel & zinc plated	
Cheese Head Bolts	
6 BA 1/2in.	15p
6 BA 3/4in.	20p
4 BA 1/2in.	25p
4 BA 1in.	30p
Countersunk	
6 BA 1/2in.	15p
6 BA 3/4in.	25p
4 BA 1/2in.	25p
4 BA 1in.	30p
FULL NUTS	
6 BA	12p
4 BA	15p
Price for pack of 10	

CAPACITORS	
Radial lead	
0.1 63V	10p
10uF 16V	10p
100uF 16V	10p

SOLDER 60/40	
5 Metre 22 swg	95p
3 Metre 18 swg	95p
2 Metre 16 swg	95p

**STOCK ITEMS BY RETURN. ADD 75p P&P.**  
All prices include VAT. Send cheque or P.O. to  
**ANDOR ELECTRONICS, DEPT EE,**  
**112 VICTORIA HOUSE, HANLEY,**  
**STOKE-ON-TRENT ST1 3SD**

# b...Beeb...Beeb...Beeb...Beeb

## ...Filters...Tracking Filter...Filters...Tracking Filter...Filters...

IN LAST month's *Beeb Micro* article the concept of using a circuit based on a voltage controlled filter (v.c.f.) as a tracking filter using a simple negative feedback process was discussed. We follow on this month with a suitable circuit for a Tracking Filter, which appears in Fig. 1. This is very much along the lines of the system described in last month's article, and it is based on operational transconductance amplifiers (IC1 and IC2).

### Current Control

Strictly speaking these are current controlled filters (c.c.f.s), since transconductance amplifiers are current rather than voltage controlled. They differ from conventional operational amplifiers in that they respond to the differential input current and not the voltage difference across the inverting and non-inverting inputs.

Virtually all practical applications of these amplifiers make use of a third input, and one which is again current controlled. This input has no equivalent in conventional operational amplifiers.

The output current of the device is a function of the differential input current and the control current fed to the additional input (sometimes called the "amplifier bias" input). In effect, the gain

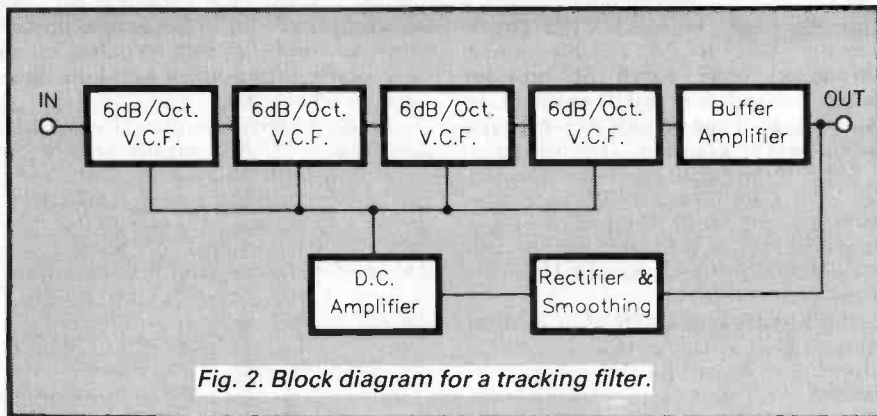

Fig. 2. Block diagram for a tracking filter.

of the device is controlled via the current fed to this third input, and is proportional to this current.

In most practical circuits, including this one, series resistors are added at all three inputs. The input current is then roughly proportional to the applied input voltage, and the device is effectively converted from current to normal voltage operation. Similarly, a load resistor connected at the output gives an output voltage that is proportional to the output current, and provides the required current to voltage conversion.

In this case the output resistors are replaced by filter capacitors (C3 to C6), and the transconductance amplifiers operate as what could be regarded as voltage controlled resistances. The LM13600N is a dual device, and so only two of them are required in order to provide the four filter stages.

In the block diagram shown last month (and repeated in Fig. 2) the filters were shown as four 6dB per octave types. Strictly speaking the filters are grouped as two 12dB per octave active filters, but the

Fig. 1. Complete circuit diagram for the Tracking Filter.

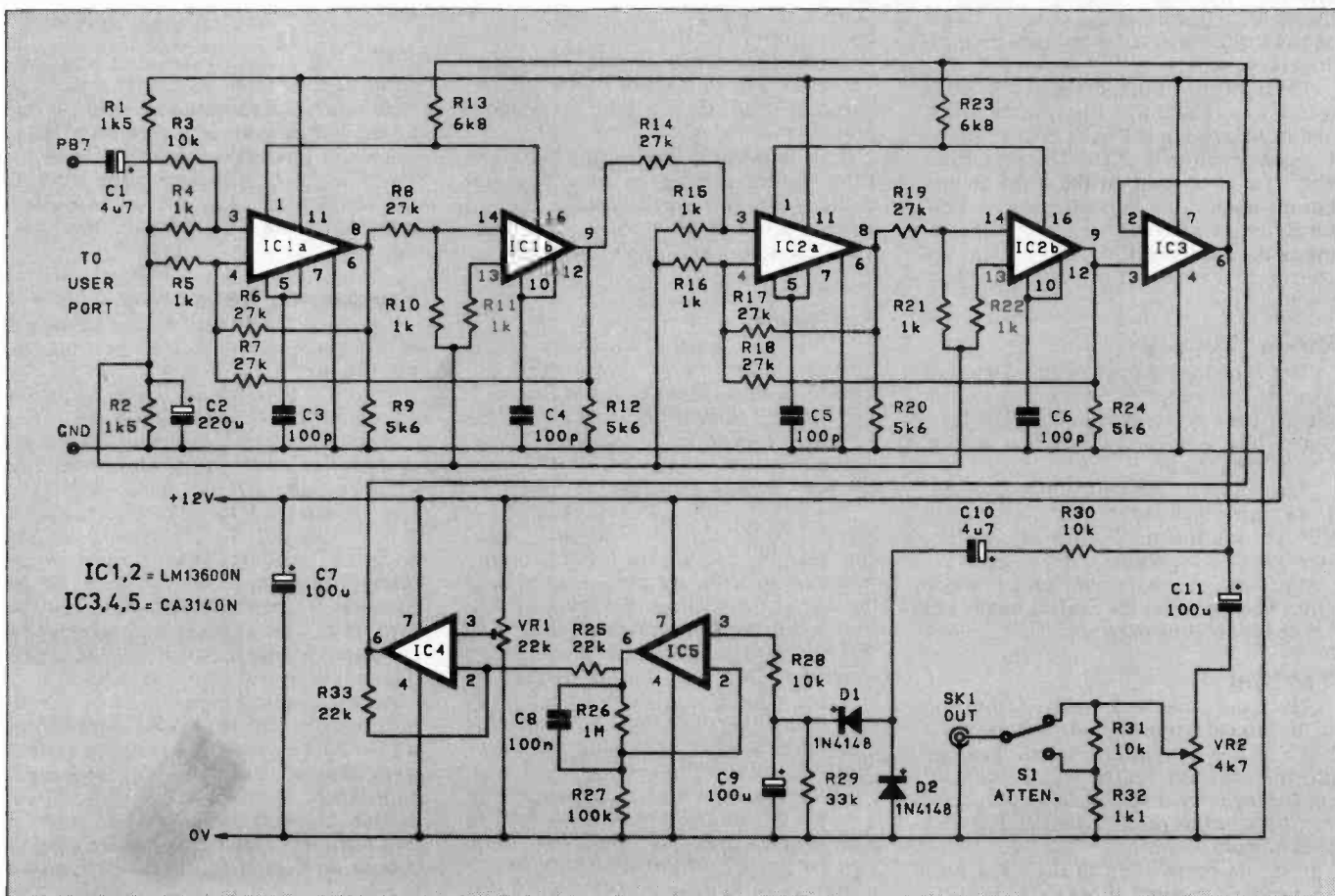

overall effect is much the same with a combined attenuation rate 24dB per octave.

The LM13600N includes two Darlington pairs wired as emitter follower buffer stages, and these are used at the outputs of the transconductance amplifiers. Low loading on the outputs of these amplifiers is especially important in a filter application. Any load on the output is effectively wired in parallel with the filter capacitor, and will reduce the attenuation rate at low frequencies.

Additional buffering at the output of the final filter stage is provided by IC3. Potentiometer VR2 is the variable output attenuator, while switch S1 provides switched attenuations of 0dB and 20dB. In other words, it can be used to reduce the output level by a factor of ten if desired.

Some of the output signal is coupled by resistor R30 and capacitor C10 to a rectifier and smoothing circuit. This produces a d.c. output signal that is roughly proportional to the strength of the output signal from the filter.

This signal is amplified by IC5, and then inverted by IC4. This gives a signal that is strongly positive with little or no output signal, but which drops rapidly to zero volts if there is even a moderately strong output signal from the filter. This signal is used to drive the control inputs of the filter via series resistors R13 and R23. This gives the required negative feedback action, with a strong output initially, but with the circuit then stabilising with a much more modest (and heavily lowpass filtered) output signal of about two volts peak-to-peak.

### Frequency Range

Obviously there are limits to the frequency range that the unit can handle without either giving inadequate filtering or letting the output signal wander from its normal output level by a significant amount. However, it seems to work quite well over the audio frequency range. In fact it seems to work quite well at frequencies of up to 200kHz or so.

The purity of the output signal does seem to fall away slightly at frequencies below about 50Hz, but is still quite respectable at frequencies down to 20Hz. This is presumably due to loading on the transconductance amplifiers by the buffer stages. Performance seems to vary somewhat depending on the particular LM13600Ns used, but any two devices should give acceptable performance.

### Power Supply

The Tracking Filter circuit operates from a single 12V supply, and this can be provided by the power port of the BBC computer. The current consumption is only about 20 milliamps.

Alternatively, the unit can be powered from a fairly high capacity battery such as a PP9 or equivalent. The circuit actually requires dual supply rails, but resistors R1 and R2 are used as a supply splitter which effectively provides the central supply rail needed for biasing purposes.

### Testing

The input of the unit is driven from one of the ground terminals of the user port and line PB7. As a point of interest, it can be driven from any source that provides a squarewave signal having an amplitude of between one volt peak-to-peak and 10 volts peak-to-peak.

It should be possible to drive the unit from some computers other than the BBC

machines (the Commodore VIC-20 and 64 machines being likely contenders). Note that the input must be a squarewave though, and not a short pulse signal.

Only one adjustment is needed before the unit is ready for use, and this is to set up preset VR1 correctly. This controls the bias level for the inverting amplifier, and it must be given a setting that provides an output voltage range that is suitable to drive the v.c.f.s.

Initially this should be set at a roughly mid-way setting, and the unit might work perfectly well with it in this position. If there are problems with no output, or an excessively strong output with little filtering, try other settings.

On the prototype the preset had to be set with its wiper offset slightly towards the "earth" end of its track in order to give satisfactory results. There should be a fairly broad range of settings that give acceptable results, and adjustment of this component does not seem to be too critical.

Note that the circuit is a form of automatic gain control, and that as such it requires a certain amount of time to adjust to changes in the input frequency. The amount of time taken to readjust depends on the change in input frequency.

If a series of frequencies are sent out from the computer, with small increments from one to the next, the unit will adjust to each new frequency in just a small fraction of a second. On the other hand, adjusting to suit a jump in frequency by a factor of (say) a thousand could take a couple of seconds. This is something that must sometimes be borne in mind when writing applications programs for the unit.

If in doubt about the length of time to allow before moving on to a new frequency, try a few experiments to discover acceptable times. If in doubt, always use long delays rather than short ones.

### Software

In previous articles the basics of the timer/counters have been covered, together with details of how to set up timer 1 to output a squarewave on PB7. We will not go over this ground again here, but the simple program in Listing 1 should prove useful when testing the unit.

It also enables the system to operate as a simple manually controlled signal generator. You supply the required output frequency in hertz—the program works out the correct timer values, displays them on-screen, and then writes them to timer 1 so that the appropriate output frequency is produced. Of course, not all frequencies can be produced precisely, and the program then selects the counter value that gives the nearest achievable frequency below the specified frequency.

As explained in a previous article, the duration of one cycle on PB7 is equal to  $2 \times (N+2)$  microseconds, where "N" is the value in timer 1. This is not a very convenient way of looking at things when you

wish to know the correct values for the two bytes of timer 1 for a given output frequency.

A better way of looking at things is to first divide 1,000,000 by the required output frequency (in hertz). Then half this figure and deduct 2.

This is the method used in the signal generator program at lines 60 and 70. Note that the answer is stored in an integer variable so that unwanted decimal points are avoided.

This gives you the total value to send to timer 1, but not the value required for each byte. If the number is less than 256, simply write that value to the low byte and 0 to the high byte. For values of 256 and upwards the BBC BASIC MOD and DIV functions when used with a divisor of 256 will furnish the low and high byte values respectively.

Line 100 ensures that excessively low frequencies are not accepted by the program. Line 80 performs a similar function with frequencies that are too high. In both cases when an out of range value is detected the program is looped back to line 50 where another input frequency is requested.

#### Listing 1: Test/Signal Generator Program

```
10 REM SIGNAL GENERATOR PROGRAM
20 MODE 7
30 ?&FE6B = 192
40 CLS
50 INPUT "INPUT FREQUENCY IN HERTZ ", FREQ
60 XX = 1000000/FREQ
70 X% = (X%/2) - 2
80 IF X% < 0 THEN GOTO 50
90 HIGH = X% DIV 256
100 IF HIGH > 255 THEN GOTO 50
110 LOW = X% MOD 256
120 ?&FE66 = LOW
130 ?&FE65 = HIGH
140 PRINT X%,HIGH,LOW
150 PRINT " "
160 GOTO 50
```

Line 140 prints on the screen the total value sent to timer 1's counter, the high byte value, and the low byte value, in that order. The program is therefore useful as a calculator for obtaining timer 1 values for given frequencies, perhaps when working out counter values for use in other programs which use the sinewave filter interface.

### Frequency Response

As pointed out in previous articles, a unit of this type is ideal as the basis of automatic test equipment. It provides a good basis for a system to produce automatic frequency response plots for audio equipment.

Basically this just involves setting the sinewave generator for a series of test frequencies, and reading the output level from the circuit under test using an a.c. millivolt meter interface connected to the computer's analogue port. Results can be displayed in simple numeric form, or the computer's graphics capability can be exploited. If the system is equipped with a dot matrix printer it is even possible to produce either type of output as hard-copy.

An a.c. millivolt meter interface is basically just a precision rectifier and smoothing circuit, preceded by an amplifier which gives the required sensitivity and input impedance. Next month's article will include the circuit for a suitable interface, plus software to enable the system to function as an automatic frequency response tester.

# EVERYDAY ELECTRONICS

CLASSIFIED

Reach effectively and economically today's enthusiasts anxious to know of your products and services through our semi-display and classified pages. The prepaid rate for semi-display spaces is £8.00 (plus VAT) per single column centimetre (minimum 2.5 cm). The prepaid rate for classified advertisements is 30 pence (plus VAT) per word (minimum 12 words).

All cheques, postal orders, etc., to be made payable to Everyday Electronics. VAT must be added. Advertisements, together with remittance, should be sent to the Classified Advertisement Dept., Everyday Electronics, 6 Church Street, Wimborne, Dorset BH21 1JH. Tel: (0202) 881749.

## Electronic Components

### A & G ELECTRONICS LTD.

If you are buying Electronic Components elsewhere you are almost certainly paying too much! Write to us for a free 1988 catalogue and start saving money. (Please send two 19p stamps towards postage.)  
P.O. Box 443. London E15 6JU Tel: 01-519 6149

### WALTONS OF WOLVERHAMPTON

Established since 1947 - offering a complete range - I.C.s, transformers, switches, pots, capacitors, resistors, kits, speakers, test equipment, books and lots, lots more!

COME AND SEE US AT: MON-SAT 9-6.00 pm  
55A WORCESTER STREET,  
WOLVERHAMPTON TEL: 0902 22039

### ELECTRONIC COMPONENTS

EVERYTHING FOR YOUR NEXT PROJECT

THE BIGGEST DISPLAY IN THE SOUTH IS AT

### FRASER ELECTRONICS

42 ELM GROVE ★ SOUTHSEA ★  
HANTS

Telephone 0705-815584

### RC3 VARIABLE VOLTAGE D.C. BENCH POWER SUPPLY

1 to 24 volts up to 1/2 amp. 1 to 20 volts up to 1 amp. 1 to 16 volts up to 1 1/2 amps A.C. Fully stabilised. Twin panel meters for instant voltage and current readings. Overload protection.

Fully variable.  
Operates from  
240V A.C.  
Compact Unit.  
size 9 x 5 1/2 x 3in.



£39 inc. VAT  
+ Post £2

### RADIO COMPONENT SPECIALISTS

337 WHITEHORSE ROAD, CROYDON  
SURREY, U.K. Tel: 01-684 1665

List. Large SAE. Delivery 7 days. Callers welcome. Closed Wednesday

## WANTED

Constructional Projects for publication to Electronic Enthusiasts, good rates.

Contact: Bill Williams  
Telephone: 01-444 6706

### \*\*\*RESISTOR PACKS\*\*\*

1/2W 5% CARBON FILM  
10 of each E12 value 10R to 10M  
Total 730 resistors

£8.00 UK only

RMOS P.O. BOX 3  
USK GWENT NP5 2YF

## Miscellaneous

**NEW VHF MICROTRANSMITTER KIT**  
tunable 88-115 MHz, 500 metre range, sensitive electret microphone, high quality p.c.b. SPECIAL OFFER complete kit ONLY £5 POST FREE. Access orders telephone 021-411 1821 (24 hrs).

Cheques/P.O.s payable to:  
**QUANTEK ELECTRONICS LTD.**  
(Dept. EE), 45a Station Road, Northfield, Birmingham B31 3TE

## REPAIR YOUR OWN HI-FI SPEAKERS

send large stamped addressed envelope for catalogue of replacement drive units from stock to:

### RTVCLTD.

21 High Street, Acton, London W3 6NG  
Tel: 01-992 8430 and 323 Edgware Road, London W2. Tel: 01-723 8432

**PRINTED CIRCUIT BOARDS** made to own requirements. For details send s.a.e. to Mr. B. M. Ansbro, 38 Poynings Drive, Hove, Sussex BN3 8GR.

**K.I.A. CATALOGUE** giftpack £1.00. 8 Cunliffe Road, Ilkley, LS29. 100 Watt poweramps £7.00 T03 heatsink.

**TRANSMITTER CIRCUIT DIAGRAMS;** medium, shortwave, f.m. C.B., minimum 17. Cheque £4.25 to D. Davies, (Dept. EE) 33 Gwalodrygarth, Merthyr Tydfil, CF47 8YU.

**OSCILLOSCOPE MANUALS** £4 each: OS300, OS255, OS245A, OS1420, OS3000A, OS3500, 4035, 4050, 4035, write to Mr Ben, 50 Harpourt Road, Barking, Essex.

## USE THIS SPACE TO SELL YOUR PRODUCTS

IT ONLY COSTS  
(see above for details) **£28** +VAT

Design and make your own PCBs using inexpensive equipment with the



### PRINTED CIRCUIT BOARD MANUAL

86 pages A4 illustrated  
Track layout design (without computer aid) & photoetching process fully explained by

**Dr. M. G. STANTON**  
Chartered Electrical Engineer  
Send cwo £9.75+75p P&P to

**Frank Stanton Ltd.**  
(ESTD 1936)

DEPT. D1, 9 PRIESTDEN PARK  
ST. ANDREWS, FIFE KY16 8DL

**TECHNICAL INFO SERVICES (EE)**  
76 Church St., Larkhall, Lanarkshire ML9 1HE  
Phone 0638-884585 Mon-Fri. 9-5.  
Any other time 0638-883334, FOR FAST QUOTES  
WORLD'S LARGEST COLLECTION SERVICE MANUALS - Most unobtainable elsewhere. Prices range from only £4.50 - large s.a.e. any quotation, no obligation to buy.  
WORLD'S SOLE Suppliers of TV & Video Repair manuals, etc. from TV TECHNIC, also such publishers as Henemann, Newsday, TV Technic, Thorn etc. Every published service sheet in stock, supplied full size, not bits & pieces. CTV's or any combination £3.50 plus Lsae; any other single item £2.50 plus Lsae. Complete Circuit Sets for most Videorecorders only £7 set (no serv shis made).  
LSAE for QUOTATIONS plus GIANT CATALOGUE - NEWSLETTERS - BARGAINS - FREE S'OSH as available.  
Comprehensive TV Repair Manual £9.50. Complete Radio Service and Repair Course £9.50. Complete Repair & Service Manuals - Mono TV £12.50; CTV £17.00; Video £19.50. Complete Repair Data with circuit - Mono TV £9.50; CTV £12.50; Video £10.50.  
**£3.00 plus LSAE BRINGS THE ONLY COMPREHENSIVE SERVICE SHEETS & MANUALS, CATALOGUES plus FREE CHASSIS GUIDE and £4.00 OF VOUCHERS**

## USE THIS SPACE TO SELL YOUR PRODUCTS

IT ONLY COSTS  
(see above for details) **£28** +VAT

**POWER SUPPLY:** 15 volts at 1 amp; 8 volts at 1.2 amps 40W. £18.00. Tel. 0993 775677.

**ARCADE VIDEO** game p.c.b.s. Working with information. Many useful parts. Various types from £20. J. L. Chambers, 11 Cooper Street, Nuneaton, Warks CV11 4BP.

**TURN YOUR** Spectrum with an a.d.c. into an oscilloscope for just £9.95. Timebase 100µs/pixel and triggering. Program supplied on tape. Mr. J. R. Curtis, 45 Kingsway, Dunstable, Beds LU5 4HE.

## Kits

**INTRODUCING DIGITAL ELECTRONICS.** Kit for first six parts E.E. series. Includes alkaline battery £12 (+70p, p&p). GCSE Technology, Electronics Kits. Includes study notes, project ideas, £10.50 (+70p, p&p) for all ten different kits (or s.a.e. for details). Sir-Kit Electronics, 70 Oxford Road, Clacton-on-Sea, CO15 3TE.

**KITS. MINIATURE V.H.F.** transmitter with microphone, size approx. 1 1/4in. x 1/2in., £3.99. Telephone transmitter, v.h.f. uses no batteries! £4.75. Automatic telephone recording switch, £8.99. Prices include P&P. Access cardholders telephone 05438 71902 (24 hr). S.A.E. catalogue. Cheque/P.O. to A.C. Electronics, Dept. EE, 99 Greenheath, Hednesford, Staffs.

**POWER SUPPLY MODULES:** High accuracy, high stability modules, 6-way switched or continuously variable. 2 amps, totally short-proof. Require only transformer, case and terminals to build a high quality PSU. Use two or more for multi-rail supplies. £11.95 each with full instructions. Custom Power Supplies, PO Box 558, Bristol BS99 1PN.

**F.M. MICRO TRANSMITTER** kit 20mm x 28mm. Long range, £3.99 inc. P&P. Cheques/P.O. to Minral, R/O 25 Orrell Road, Orrell, Wigan WN5 8EY.



★ LEARN BY BUILDING ★ ENJOY BY USING ★

# PROJECT KITS

★ BE CREATIVE ★ RAISE YOUR SKILLS ★ GET KITTED! ★

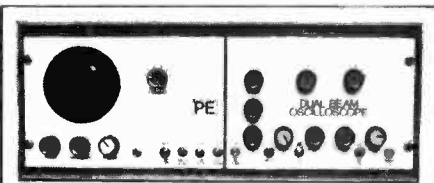

## DUAL BEAM OSCILLOSCOPE

2Y amps, 6 ranges, variable level, DC to over 1MHz 4 modes: Y1, Y2, Y1 & Y2, Y1 & Y2 to X Time base variable from 0.05Hz to 20KHz Variable sync level, polarity and source. Separate bright line, brilliance and focus controls. Independent trace deflection controls. Details in catalogue

## BURGLAR ALARM CONTROLLERS

### MULTIZONE CONTROL

**SET280 £22.77**  
Two entry zones, anti tamper loop, personal attack entry exit timing, timed duration, automatic resetting, latching LED monitors.

### SINGLE ZONE CONTROL

**SET279 £9.32**  
With timed duration control and latching LED monitor. Both units can be used with any standard detection devices, such as contact or magnetic switches, pressure pads, tremblers, ultrasonics, infrared etc. and will activate standard bells, strobes or sirens.

## COMPUTER KITS

The software listings published with the computer kit projects are for use with C64, PET and BBC computers.

**CHIP TESTER SET258F £39.30**

Computer controlled logic and chip analyser

**EPROM PROGRAMMER SET277 £25.25**

Computer controlled unit for 4K Eproms

**MICRO-CHAT SET276 £64.50**

Computer controlled speech synthesiser

**MICRO-SCOPE SET247 £44.50**

Turns a computer into an oscilloscope

**MICRO-TUNER SET257 £55.32**

Computer controlled, tuning aid and freq counter

**MORSE DECODER SET269 £22.16**

Computer controlled morse code-decoder

SEND 9"x4" S.A.E. FOR CATALOGUE AND WITH ALL ENQUIRIES (OVERSEAS SEND £1.00)

## VARIOUS

**VOICE SCRAMBLER SET287 £42.22**  
32 switchable channels to keep your communications confidential

**STORMS! £29.50 each unit**

Raw nature under panel control! Wind & Rain SET250W

Thunder & Lightning SET250T

**DISCO-LIGHTS SET245F £62.50**

3 chan sound to light, chasers, auto level

**EVENT COUNTER SET278 £31.50**

4-digit display counting for any logic source.

## ASTRONOMY



### SIDEREAL CLOCK

**SET295 £49.50**

Dual purpose star-time and solar-time digital clock with alarm

## ENVIRONMENT

### WEATHER CENTRE

Keep the Met Office in check and monitor the wind speed and direction, rain, temperature, soil moisture and sunny days

Six detector circuits - KIT 275.1 **£18.07**

Automatic metered control monitor circuit - KIT 275.2 **£40.95**

Optional computer control circuit - KIT 275.3 **£14.20**

### ELECTRONIC BAROMETER

**SET285 £35.55**

Computer controlled unit for monitoring atmospheric pressure

**GEIGER COUNTER SET264 £59.50**

A nuclear radiation detector for environmental and geological monitoring. With built in speaker, meter and digital output. This project was demonstrated on BBC TV.

## ORDERING

Send 9"x4" SAE for detailed catalogue, and with all enquiries (overseas send £1.00 or 5 I.R.C.'s). Add 15% VAT. Add P&P - Sets over £5 add £2.50. Others add £1.50. Overseas P&P in catalogue. Text photocopies - Geiger 264 and Weather 275 £1.50, others 50p, plus 50p post or large SAE. Insurance 50p per £50. MAIL ORDER, CWO, CHQ, PO, ACCESS VISA. Telephone orders: Mon-Fri, 9am - 6pm. 0689 37821. (Usually answering machine).

PHONOSONICS, DEPT PE92, 8 FINUCANE DRIVE, ORPINGTON, KENT, BR5 4ED.

MAIL ORDER

THE UNDISPUTED PACK KING FOR OVER 20 YEARS, we offer you the very best in Electronic Components and Semiconductors that your money can buy. Look at our lists and prices, they are unbeatable in value and quantity and you always have our "Satisfaction or money back guarantee". For 1989 we offer more and more Super Value Packs. All goods advertised in stock at time of going to press. This is just a small part of our stocks. Send a stamped SAE for our FREE CATALOGUE. PLEASE note our new mail order address: BI-PAK, PO BOX 33, ROYSTON, HERTS SG8 5DH. Telephone 0763 248851.

### RESISTORS

Pack No. Qty	Description	Price
VP1	300 Assorted Resistors, mixed values and types	£1.00
VP2	300 Carbon Resistors, 1/4, 1/2 watt, pre-formed, mixed	£1.00
VP4	200 1/2, 1 watt Resistors, mixed values and types	£1.00
VP16	50 Wirewound Resistors, mixed watt values	£1.00
VP140	50 Precision Resistors, 1% tolerance	£1.00
VP181	100 1 and 2 watt Resistors, assorted values	£1.00
VP287	100 Close Tolerance Resistors, 0.5-2% 10-910ohms mixed	£1.50
VP289	100 Metal oxide high stability Resistors, 1/4w 2%, mixed values	£1.50

**MINIATURE CARBON FILM RESISTORS 1/4 & 1/2 WATT 5%**

Resistance values from 1 ohm-10 meg ohms. Available in lots of 100 pieces per value. To order state R100 1/4w or R200 1/2w, plus resistance require

eg. R100 1K = 100 1K

BI-PAK PRICE PER 100 PIECES R100 £1.00 per pkt. R200 £1.30 per pkt.

### CAPACITORS

Pack No. Qty	Description	Price
VP5	200 Assorted Capacitors, all types	£1.00
VP6	200 Ceramic Capacitors, miniature, mixed values	£1.00
VP10	100 Assorted polyester/polystyrene capacitors	£1.00
VP9	60 C280 Capacitors, metal foil, mixed values	£1.00
VP11	50 Electrolytics, all types	£1.00
VP12	40 Electrolytics, 47mf-150mf, mixed volts	£1.00
VP13	30 Electrolytics, 150mf-1000mf, mixed volts	£1.00
VP14	50 Silver Mica Capacitors, mixed values	£1.00
VP15	25 01250v Miniature layer metal Capacitors	£1.00
VP180	25 Tantalum Bead Capacitors, assorted values	£1.00
VP182	4 1000uF 50v Electrolytics	£1.00
VP192	30 Min. Electrolytics, mixed values, 47mf-1000mf, 6-16v	£1.00
VP193	6 Sub Min. Electrolytics, 2 x 1000/2000/3000ml 10/16v	£1.00
VP530	20 High Voltage Electrolytics 47-470mf, 100-500 volts	£2.00
VP531	10 High Voltage Electrolytics 100-330mf, 100-350 volts	£2.00
VP532	20 Electrolytics, assorted, 2.2-470mf, 40-63 volts	£1.50
VP533	8 Electrolytics, 2 x 1000/2200/3300/4700mf, 10-16 volts	£2.00
VP534	5 Axial Electrolytics 1000mf 16 volts	£1.00
VP535	4 Radial Electrolytics 2200mf 16 volts	£1.00
VP536	3 Axial Electrolytics 4700mf 10 volts	£1.00
VP537	4 Axial Electrolytics 10000mf 6.3 volts	£1.50

### OPTOS

Pack No. Qty	Description	Price
VP24	10 .125" LEDs clear showing red	£1.00
VP25	10 Mixed shape and colour LEDs	£1.00
VP26	15 Small .125" red LEDs	£1.00
VP27	15 Large 2" red LEDs	£1.00
VP28	10 Rectangular 2" red LEDs	£1.00
VP57	25 Opto Special Pack, Assorted Super Value	£3.00
VP130	6 RED 7 Seg. CA 3x14mm x 7.5mm RDP FHD353 LED Display	£2.00
VP131	4 GREEN 7 Seg. CA 5 LDP XAN6520 LED Display	£2.00
VP133	6 RED Overflow, 6 3 x CA 3 x CC 5630/50 LED Display	£2.00
VP134	5 GREEN Overflow, 5 CA XAN6530 LED Display	£2.00
VP138	20 Assorted LED Displays, opt. mix, with data	£5.00

### RESISTORS

Pack No. Qty	Description	Price
VP147	1 Pair Opto Coupled Modifiers, with data	£3.00
VP199	4 DL707R LED Display	£1.00
VP203	15 Triangular shape LEDs, mixed colours	£1.00
VP204	10 Large 5mm green LEDs	£1.00
VP205	10 Small 3mm green LEDs	£1.00
VP206	10 Large 5mm yellow LEDs	£1.00
VP207	10 Small 3mm yellow LEDs	£1.00
VP208	10 Large 2" LEDs clear showing red	£1.00

Pack No. Qty	Description	Price
VP241	2 DIP-12 Light Dependant Resistors	£1.50
VP242	1 Tri-colour LEDs, 5mm, red, green, yellow	£1.00
VP243	3 Tri-colour LEDs, rectangular, 5mm, red, green, yellow	£1.00
VP266	10 Large 5mm orange LEDs	£1.00
VP267	8 Stackable LEDs, rectangular, mixed colours, r.g.y	£1.00
VP268	2 LED panel mounting clips, metal & plastic, 3-5mm	£1.00
VP269	2 Large 5mm red Flashing LEDs	£1.00
VP276	8 Stackable LEDs, rectangular, mixed colours, r.g.y	£1.00
VP268	10 LED panel mounting clips, metal & plastic, 3-5mm	£1.00
VP276	2 Large 5mm red Flashing LEDs	£1.00
VP279	10 OC71 Photo Germanium Transistor, PNP	£1.00
VP284	2 Opto-isolator IL74-4N27, single	£1.00
VP285	1 Dual Opto-isolator ILD74	£1.00

### TRANSISTORS

Pack No. Qty	Description	Price
VP38	100 Silicon Transistors, NPN plastic, coded with data	£3.00
VP39	100 Silicon Transistors, PNP plastic, coded with data	£3.00
VP45	40 NPN Transistors like BC107B, all good, TO18	£1.00
VP46	40 PNP Transistors like BC177B, all good, TO18	£1.00
VP47	10 Sil. Power Transistors, similar 2N3055, uncoded	£1.00
VP48	5 Pairs NPN/PNP plastic Power Transistors, 4A, with data	£1.00
VP60	60 NPN Sil. Switching Trans, TO18 and TO92	£1.00
VP51	20 PNP Sil. Switching Trans, TO18 and TO92	£1.00
VP60	100 Assorted Transistors, NPN/PNP	£1.00
VP150	20 BC183B Sil. Trans, NPN 30V 200mA Hfe240 + TO92	£1.00
VP151	25 BC171B Sil. Trans, NPN 40V 200mA Hfe240 + TO92	£1.00
VP152	15 T890 Sil. Trans, NPN 40V 200mA Hfe100 + TO92	£1.00
VP153	15 T891 Sil. Trans, PNP 40V 400mA Hfe100 + TO92	£1.00
VP154	15 MPSA56 Sil. Trans, PNP 80V 400mA Hfe50 + TO92	£1.00
VP155	20 BF95 Sil. Trans, NPN eqvt BF184 H.F. TO92	£1.00
VP156	20 BF495 Sil. Trans, NPN eqvt BF173 H.F. TO92	£1.00
VP157	15 2N4500 series Sil. Trans, PNP plastic	£1.00
VP158	15 2N1107 Sil. Trans, NPN eqvt BC107 plastic	£1.00
VP159	15 2N1108 Sil. Trans, NPN eqvt BC108 plastic	£1.00
VP161	25 BC183L Sil. Trans, NPN 30V 200mA TO92	£1.00
VP162	5 SJE451 Sil. Power Trans, NPN 80V 4A Hfe20 +	£1.00
VP163	2 NPN/PNP pairs Sil. Power Trans, like SJE451	£1.00
VP164	4 2N6289 Sil. Power Trans, NPN 40V 40W 7A Hfe30 +	£1.00
VP165	6 BF733 NPN Sil. Trans, 80V 5A Hfe50-2000 TO39	£1.00
VP166	5 BF734 NPN Sil. Trans, 100V 5A Hfe50-200 TO39	£1.00
VP167	1 BU769C NPN Trans, TO3 VCB 50V, 10A, 100W, Hfe15+	£1.00
VP168	10 BC478 eqvt BCY71 PNP Sil. Trans, TO18	£1.00
VP169	10 BX521 eqvt BC934 NPN Sil. Trans, 80V 50mA TO18	£1.00
VP170	10 Assorted Power Trans, NPN, coded and data	£1.00
VP171	10 BF355 NPN TO39 Sil. Trans, eqvt BF258 225V 100mA	£1.00
VP172	10 SM1502 PNP TO39 Sil. Trans, 100V 100mA Hfe100 +	£1.00
VP200	30 OC71 type germanium AF Transistors, uncoded	£1.00
VP201	20 OC45 germanium RF Transistors, uncoded	£1.00
VP261	4 Programmable Unijunction Transistor, MEL22, full data	£1.00
VP270	10 FET's UHF/MHF Amplifiers, switching and choppers, with data	£1.00
VP271	10 FET's general purpose, like 2N3819-2N5457, with data	£1.00
VP272	10 MOS-FET's Synthesizer, SO34, with data	£1.00
VP280	12 2T300 NPN Silicon Transistors	£1.00
VP290	15 MPSA06 Sil. Transistors, NPN 80V 500mA Hfe50 + TO92	£1.00
VP428	10 AC128K PNP germanium Transistors, 1A 32v	£1.00
VP429	10 AC178K PNP germanium Transistors, 1A 32v	£1.00
VP430	4 2N3055 Sil. Power Transistors, full spec	£2.00
VP431	25 PNP Sil. Transistors, TO39 like 2N2305A	£1.00
VP451	20 NPN Transistors, like BFY5051, all good, TO39	£1.00
VP452	5 PNP Power Transistors, BD244AX eqvt TP2955	£1.00

Pack No. Qty	Description	Price
VP453	10 BC109 Transistors, brand new, NPN TO18	£1.00
VP454	10 BC109 Transistors, brand new, NPN TO18	£1.00
VP455	10 BC109 Transistors, brand new, NPN TO18	£1.00
VP456	10 BC107 Assorted gain group Transistors, A, B and C	£1.00
VP457	10 BC108 Assorted gain group Transistors, A, B, and C	£1.00
VP458	10 BC109 Assorted gain group Transistors, B and C	£1.00
VP459	10 BC177/89 mixed Transistors, PNP, TO18	£1.00

### I.C.S.

Pack No. Qty	Description	Price
VP40	40 TTL I.C.s. all new gates - Flip Flop - MSI data	£4.00
VP59	20 Assorted I.C.s. like new, all coded	£2.00
VP209	12 74LS00	£2.00
VP210	12 74LS74	£2.00
VP211	10 CD4001B	£2.00
VP212	10 CD4001B	£2.00
VP214	10 CD4098B	£2.00
VP215	10 7419 8 pin	£2.00
VP216	10 555 Timer 8 pin	£2.00
VP282	1 Prog. Sound Gen. Chip, AY-3-8912, G.1 28 pin I.C.	£3.00
VP291	1 Z80A CPU Microprocessor, 40 pin DIL	£2.00
VP292	1 Z80A PIO Parallel Interface Controller, 40 pin DIL	£2.00
VP293	1 Z80A CTC Counter/Timer Circuit, 28 pin DIL	£2.00
VP294	1 2732E 32K Eprom	£3.00
VP295	1 6821F Peripheral Interface Adaptor (PIA)	£1.50
VP296	6 LM324 14 pin DIL Quad Op-Amp	£2.00
VP297	3 CA3130E MOS-FET UP, CMOS OP Op-Amp	£2.00
VP298	3 MC1310P Stereo Decoder, 14 pin DIL	£2.00
VP299	3 CA3085 Pos. Volt. Reg. 1.7v-45v, 8 pin TO5	£2.00
VP401	2 LM317T Adjust. Voltage Regulator 1.5A	£1.00
VP402	1 2114 4K Static Ram	£2.00
VP403	1 TA7201 Audio Amp. I.C. 4.2w, 13v, 2-4 ohms	£1.00
VP404	1 TBAA61 Audio Power Amp. 4w	£1.50
VP432	8 CD4018B	£2.00
VP433	6 CD4017B	£2.00
VP434	10 CD4021B	£2.00
VP435	10 CD4023B	£2.00
VP436	8 CD4081B	£2.00
VP461	1 LM380 Audio Amp 14 pin, DIL, 2.5w I.C.	£1.00
VP462	1 LM384 Audio Amp 14 pin, DIL, 5w I.C.	£1.00
VP463	1 LM339N Quad Voltage Comparator I.C.	£1.00
VP476	10 8 pin I.C. Sockets	£3.00
VP477	10 14 pin I.C. Sockets	£3.75
VP478	10 16 pin I.C. Sockets	£3.85
VP479	1 Pack of 5 each, 18-20-22 pin I.C. Sockets	£1.50
VP480	1 Pack of 5 each, 24-28 pin I.C. Sockets	£1.50
VP481	5 40 pin I.C. Sockets	£1.00

### 74 SERIES SALE "ROCK BOTTOM" PRICES

VP223	50 Asst 74 TTL I.C.s. All Gates new & coded our me. 7400-7453	£5.00
VP224	100 Asst 74 TTL I.C.s. All Gates new & coded our me. 7400-7453	

# TRANSFORMERS

## MAINS ISOLATORS

Pri 120V x2 or 220/240V or 415/440V, Sec 440 or 240V or 110V Centre Tapped Secs

VA	£	P&P
20	8.33	2.51
60	13.60	2.70
100	15.87	2.92
200	22.49	3.52
250	29.20	3.62
500	41.91	4.24
1000	76.01	5.33
1500	98.04	5.54
2000	117.96	5.74
3000	165.41	O/A
6000	353.43	O/A

50/25V or 25-0-25V  
2x25V Tapped Secs  
Volts available: 5, 7, 8, 10, 13, 17, 20, 25, 33, 40, 50V or 20-0-20V or 25-0-25V

50V	25V	£	P&P
0.5	1	5.91	2.09
1	2	7.19	2.21
2	A	12.81	2.75
3	M	14.82	2.92
4	P	20.30	3.24
6	S	25.81	3.41
8		36.52	4.12
10		43.34	4.41
12		51.87	5.22

**INVERTERS**  
12/24V DC to 240V AC  
Sine-Wave or Square Wave  
Outputs from 60VA

**TRANSFORMER WINDING SERVICE**  
3VA to 18KVA

**CONSTANT VOLTAGE TRANSFORMERS**  
For Spike-free Stable Mains  
Also Valve Mains Output & Matching Transformers

UNIT 211  
STRATFORD WORKSHOPS,  
BURFORD ROAD  
LONDON E15 2SP

## EX STOCK

24/12V or 12-0-12V  
2x12V Secs Pri 240V

24V	12V	£	P&P
0.15	0.03	3.44	1.87
0.25	0.5	3.64	1.90
0.5	1	4.36	1.98
1	2	6.08	2.09
2	A	7.01	2.20
4	P	12.08	2.36
6	S	15.62	2.64
8		18.59	3.08
10		25.02	3.52
15		31.10	3.63
20		44.40	4.12
30		63.75	4.89
41	83	73.41	6.32

**AUTOS**  
105, 115, 220, 230, 240V  
for step-up or down

VA	£	P&P
80	6.91	1.92
150	10.03	2.09
250	12.25	2.31
350	14.05	2.64
500	19.05	3.08
1000	34.03	3.68
1500	40.40	4.18
2000	60.41	5.11
3000	102.72	6.32
4000	133.35	O/A
5000	155.28	O/A
7500	239.70	O/A
10kVA	283.23	O/A

**CASED AUTOS**  
240V Cable Input  
3-pin 115V USA Skt Outlets

VA	£	P&P
20	9.85	2.03
80	13.38	2.14
150	17.34	2.53
250	21.13	2.57
500	34.66	3.90
1000	48.66	4.90
2000	86.70	6.16
3000	124.46	O/A

110V to 240V Cased Autos  
now available  
USA 3-pin plug input: 13A  
Socket Output  
AVOs & MEGGERS  
Full Range Available

**STAND-BY LIGHTING OR POWER SYSTEMS, PLUS UPS SYSTEMS**

PE OSCILLOSCOPE  
TRANSFORMER Y1  
£14.10 Inclusive

## TOROIDALS

Batches Wound to order  
Send Stamp for Lists  
Stock items by return  
Please add 15% to all items after P&P

**BARRIE ELECTRONICS LTD**  
Tel: 01-555 0228 (3 lines)

# SHERWOOD ELECTRONIC COMPONENTS

45 Rutland St., Mansfield  
Notts. NG18 4AP

## RESISTOR PACKS

0.25W C.Film 10 each (610) 425p  
0.25W C.Film 5 each (305) 265p  
0.25W C.Film Popular (1000) 600p  
0.25W Metal Glaze 2% (250) 150p  
Min. Hor. Presets 5 ea (65) 385p  
Min. Vert. Presets 5 ea (65) 385p

## 3mm LEDs

Red 12p  
Green 15p  
Yellow 15p  
Clip 3p

## 5mm LEDs

Red 9p  
Green 10p  
Yellow 12p  
Amber 12p  
Clip 4p

12x5mm Red or Green LED,s 100p  
12x5mm Clips 40p

## Diodes

1N4001 5p  
1N4002 5p  
1N4003 5p  
1N4004 6p  
1N4005 6p  
1N4006 7p  
1N4007 8p  
1N4148 3p

## Zener Diodes

BZY88 400 mW  
2V7 to 36V  
all at 10p each

## Voltage Regulators

100mA	1A	
78L05	7805	35p
78L12	7812	35p
78L15	7815	36p
79L05	7905	36p
79L12	7912	38p
79L15	7915	38p

## Low Profile DIL Sockets

8 Pin 8p, 10 off 75p  
14 pin 9p, 10 off 85p  
16 pin 10p, 10 off 95p  
24 pin 20p, 10 off 180p

## CMOS

4000	25p	4073	27p
4001	25p	4075	27p
4011	25p	4077	30p
4013	38p	4081	27p
4017	55p	4093	35p
4023	30p	4510	65p
4025	25p	4511	65p
4027	50p	4514	125p
4047	65p	4515	130p
4070	27p	4516	65p
4071	27p	4528	70p
4072	27p		

## I.C.s

555 22p, 5 off 100p  
741 22p, 5 off 100p  
CA3140E 45p  
CA3240E 125p  
TL071 60p  
TL072 80p  
TL081 40p  
TL082 55p

Cheque or P.O. to:

**SHERWOOD ELECTRONIC COMPONENTS**  
Please add £1 P&P  
NO VAT

Carbon Film resistors 1/4W 5% E24 series 0.51R to 10M0 ..... 1p  
100 off per value—75p, even hundreds per value totalling 1000 ..... £6.00p  
Metal Film resistors 1/4W 10R to 1M0 5% E12 series—2p, 1% E24 series ..... 3p  
Mixed metal/carbon film resistors 1/2W E24 series 1R0 to 10M0 ..... 11/2p  
1 watt mixed metal/Carbon Film 5% E12 series 4R7 to 10 Megohms ..... 5p  
Linear Carbon pre-sets 100mW and 1/4W 100R to 4M7 E6 series ..... 7p

**Miniature polyester capacitors 250V working for vertical mounting**  
015, .022, .033, .047, .068-4p. 0.1-5p. 0.15, 0.22-6p. 0.47—8p  
**Mylar (polyester) capacitors 100V working E12 series vertical mounting**  
1000p to 8200p - 3p. .01 to .068 - 4p. 0.1 - 5p. 0.12, 0.15, 0.22-6p. 0.47/50V-8p  
**Submin ceramic plate capacitors 100V wkg vertical mountings. E12 series**  
2% 1.8pf to 47pf - 3p. 2% 56pf to 330pf - 4p. 10% 390p - 4700p ..... 4p  
Disc/plate ceramics 50V E12 series 1P0 to 1000P, E6 Series 1500P to 47000P ..... 2p

**Polystyrene capacitors 63V working E12 series long axial wires**  
10pf to 820pf - 3p. 1000 pf to 10,000pf - 4p. 12,000 pf ..... 5p  
741 Op Amp - 20p. 555 Timer ..... 22p  
cmos 4001 - 20p. 4011 - 22p. 4017 ..... 40p

**ALUMINIUM ELECTROLYTICS (Mfids/Volts)**  
1/50, 2/250, 4/750, 10/25, 10/50 ..... 5p  
22/16, 22/25, 22/50, 47/16, 47/25, 47/50 ..... 6p  
100/16, 100/25 7p; 100/50 12p; 100/100 ..... 14p  
220/16 8p; 220/25, 220/50 10p; 470/16, 470/25 ..... 11p  
1000/25 25p; 1000/35, 2200/25 35p; 4700/25 ..... 70p

**Submin, tantalum bead electrolytics (Mfids/Volts)**  
0.1/35, 0.22/35, 0.47/35, 1.0/35, 3.3/16, 4.7/16 ..... 14p  
2.2/35, 4.7/25, 4.7/35, 6.8/16 15p; 10/16, 22/6 ..... 20p  
33/10, 47/6, 22/16 30p; 47/10 35p; 47/16 60p; 47/35 ..... 80p

**VOLTAGE REGULATORS**  
1A + or - 5V, 8V, 12V, 15V, 18V & 24V ..... 55p

**DIODES (piv/amps)**  
75/25mA 1N4148 2p. 800/1A 1N4006 6p. 400/3A 1N5404 14p. 115/15mA OA91 ..... 6p  
100/1A 1N4002 4p. 1000/1A 1N4007 7p. 60/1.5A S1M1 5p. 100/1A bridge ..... 25p  
400/1A 1N 4004 5p. 1250/1A BY127 10p. 30/15A OA47 ..... 8p  
Zener diodes E24 series 3V3 to 33V 400 mW - 8p. 1 watt ..... 12p  
Battery snaps for PP3 - 6p for PP9 ..... 12p  
L.E.D.'s 3mm, & 5mm. Red, Green, Yellow - 10p. Grommets 3mm - 2p, 5mm ..... 2p  
Red flashing L.E.D.'s require 5V supply only ..... 50p  
Mains indicator neons with 220k resistor ..... 10p  
20mm fuses 100mA to 5A Q/blow 5p. A/surge 8p. Holders pc or chassis ..... 5p  
High speed pc drill 0.8, 1.0, 1.3, 1.5, 2.0m - 30p. Machines 12V dc ..... £6.50p  
HELPING HANDS 6 ball joints and 2 croc clips to hold awkward jobs ..... £3.50p  
AA/HP7 Nicad rechargeable cells 80p each. Universal charger unit ..... £6.50p  
Glass reed switches with single pole make contacts - 8p. Magnets ..... 12p

**TRANSISTORS**  
BC547/8-9-8p, BC557/8-9-8p, BC182L/4L-10p, BC183, 183L-10p, BC212, 212L-10p, BC337, 337L-12p, BC27/737-12p, BD135/6/7/8/9-25p, BCY70-15p, BFY50, 52-20p, BFX88-15p, 2N3055-50p, TIP31, 32-30p, TIP41, 42-40p, BU208A-E1.20, BF195, 197-12p  
All prices are inclusive of VAT. Postage 25p (free over £5). Lists Free.

**THE CR SUPPLY CO**  
127 Chesterfield Rd, Sheffield S8 0RN  
Return posting

## Need an extra pair of hands?

It's often the case that conventional methods just won't do. Fortunately there is now an alternative with the

## MULTI-PURPOSE JIG

It will hold a circuit board steady for assembly and wiring—  
It can hold things while glue sets—  
It can hold models for painting and repair—  
All its interchangeable heads rotate through 360 degrees so you can position your workpiece to best advantage—no need to take it out to turn it over either—just rotate it to where you want it.  
Precision spring loaded head for holding pressures of up to 5.5lbs.

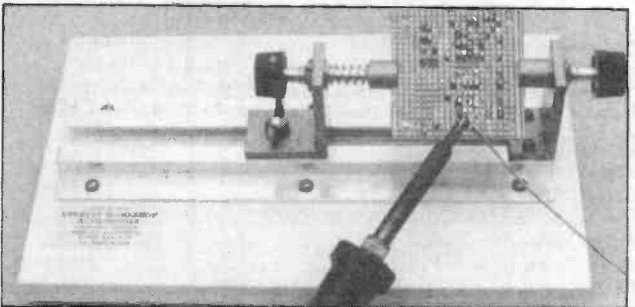

Each jig is hand built for a lifetime of use.

Due to improved production techniques we have also been able to reduce the prices!

Standard jig takes items up to 310 x 145mm **£19.50**  
Mini jig takes items up to 148 x 85mm **£16.50**  
inc. VAT and carriage

**EVERETT WORKSHOP ACCESSORIES**  
5 Railway Terrace, Henllan, Llandysul,  
Dyfed SA44 5TH



# BARGAIN £1 COMPONENT PACKS

100 polyester Capacitors, Assorted values 10nF to 680nF.  
2 Etch Resist Pens for making printed boards.  
100 Silicon Diodes equivalent to 1N4148.  
1 Surplus equipment panel containing lots of bits.  
20 x 270 ohm Horiz Sub-miniature Preset Pots.

Order all 5 packs for £5 plus £1 p/p and receive  
a FREE mystery pack.

## FULL WORKSHOP SERVICE MANUALS SUPPLIED

Any Video recorder—£12 inclusive.  
Any Colour TV, Audio, Test, Amateur Radio, Vintage etc.  
£6.00 inclusive.

FREE catalogue with all orders or LSAE for your copy.

## MAURITRON ELECTRONICS LTD. (EE)

8 Cherrytree Road, Chinnor, Oxon OX9 4QY  
(0844) 51694

## AUDIOKITS PRECISION COMPONENTS

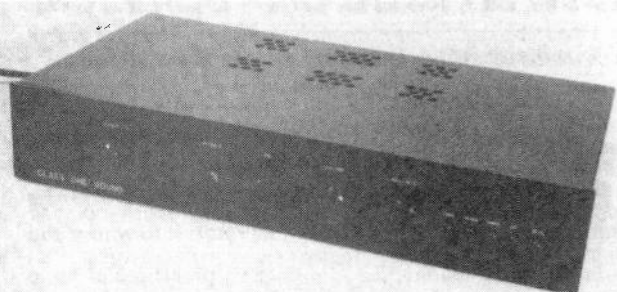

### CLASS ONE SOUND

The Class One Sound DM20 is the very latest amplifier kit from Audiokits. It is very easy to build (full instructions in *Everyday Electronics* Jan/Feb '89 issue) yet its sound quality is really good. And you can build it complete for under £100.

#### DM20 PRICES

Resistor Component Pack .....	£7.50
Capacitor Component Pack .....	£11.00
Semiconductor Component Pack .....	£9.00
PCB Only .....	£12.50
PCB Component Pack .....	£55.00
PCB Component Board built and tested .....	£90.00
COMPLETE KIT (including P&P) .....	£99.50
COMPLETE AMPLIFIER (built and tested) .....	£149.50

All parts available separately—send SAE for list  
Send cheque/PO or Access No. (phone orders accepted)  
to place your order

Delivery 2 to 3 weeks, but some metal parts may have longer  
delivery time if demand exceeds prediction

FOR DETAILS OF ALL AUDIOKITS AUDIOPHILE  
COMPONENTS AND KITS, PLEASE SEND LARGE 9 x 4in.  
SAE (Overseas, 3 IRCs) to:

6 MILL CLOSE, BORROWASH, DERBY DE7 3GU. Tel: 0332 674929

# PROFESSIONAL SURVEILLANCE EQUIPMENT KITS

A RANGE OF HIGH QUALITY KITS AS  
SUPPLIED TO LEADING UK SECURITY  
COMPANIES. ALL KITS COME FULLY  
DOCUMENTED WITH CONCISE  
ASSEMBLY AND SETTING-UP DETAILS,  
FIBRE GLASS PCB AND ALL  
COMPONENTS. PLEASE ADD £1.50 TO  
COVER P&P. ALL UNITS AVAILABLE  
READY BUILT. DETAILS IN CATALOGUE.

**VT600** High power version of the MTX with  
on-board PA stage providing 250mW  
of RF. Measures just 20mm x 40mm,  
power requirements 9-15V. Excellent  
sensitivity and stability. Fully tuneable  
over FM band. Ranges over 3000m can  
be expected £12.95

**CTX900** Sub-carrier scrambled transmitter. Audio is double modulated providing very secure  
transmissions. Any unauthorised listener will not be able to demodulate signal without  
DSX900 Decoder unit. Fully tuneable output covering FM band. 9V operation. Range up  
to 1000m. Measures 30mm x 40mm £18.95

**DSX 900** Decoder unit for CTX900. Connects to earphone output of receiver to descramble signal  
from CTX900 output to headphones. 9-12V operation. Measures 35mm x 50mm £17.95

**TLX700** Micro size telephone transmitter. Connects onto line at any point and requires no  
batteries. Clearly transmits both sides of conversations on both incoming and outgoing  
calls. Undetectable by phone users. Fully tuneable output covering FM band. Range up  
to 1000. Measures just 20mm x 20mm £9.95

**ATR2** Micro size telephone recording unit. Connects onto line at any point and connects into  
ANY normal cassette recorder having MIC and REM sockets. Requires no batteries.  
Switches recorder on silently when phone is used for incoming or outgoing calls.  
Switches off when phone replaced. Clearly records both sides of conversations.  
Undetectable by phone user. Measures 10mm x 35mm £10.95

**XML900** RF Bug Detector/Locator. Wide band input circuitry  
detects presence of RF field and triggers flashing LED and  
piezo bleeper. Variable sensitivity  
enables source of transmission to be pinpointed to within  
6 inches. Max sensitivity will detect MTX or similar  
transmitter at around 15-20 feet. 9V operation. Measures  
55mm x 55mm £21.95

Send 28p stamp for new 1989 Catalogue including crystal transmitters,  
mains transmitters, surveillance receivers etc.  
PHONE ORDERS ON ACCESS OR AMEX ACCEPTED. Tel 0827 714476

**MTX** Micro-miniature VHF transmitter. The  
smallest kit on the market measuring  
an incredible 17mm x 17mm including  
on-board mic. Super sensitive. Fully  
tuneable over FM band. 9V operation  
with range up to 1000m £10.95

**VOX7B** Voice-activated transmitter. Variable  
sensitivity trigger level switches  
transmitter on when sounds are  
detected. Stays on for time delay  
variable between 1-20 sec. Fully  
tuneable output covers all FM band.  
Very sensitive and low standby current  
through CMOS circuitry. 9V operation.  
Range up to 1000m. Measures  
30mm x 40mm £15.95

**SUMA DESIGNS  
(Dept. EE),  
THE WORKSHOPS  
95 MAIN ROAD,  
BAXTERLEY,  
Nr ATHERSTONE,  
WARCS CV9 2LE.  
TEL 0827 714476**

### OSCILLOSCOPES

TELEQUIPMENT D83. Dual trace 50MHz Delay sweep large tube with manual .....	£360
COSSOR OSCILLOSCOPE CDU150. Dual trace 35MHz delay sweep, solid state. Portable 8x10cm display. With Manual. NOW ONLY £108 each	
Optional front Protection cover containing 2 Probes and Viewing Hood .....	£10
S.E. LABS SM111 Dual trace 18MHz Solid State portable AC or external DC operation 8x10cm display with Manual .....	£150
ADVANCE OS250TV. Dual Trace 10MHz. With Manual .....	£150
SCOPEX 4D 10A. Dual trace 10MHz with manual	£150
TELEQUIPMENT S54A. Single Trace 10MHz. Solid State with manual .....	£90

TRIO OSCILLOSCOPES	
CS2150 4 Trace 150MHz Delay Sweep .....	£1000
CS1100 Dual Trace 100MHz Delay Sweep .....	£700
CS1066 3 Trace 60MHz Delay Sweep .....	£550

### MULTIMETERS

AVO 8 complete with Batteries and Leads From	£50
AVO8 MKV Complete with Batteries and Leads .....	£90
AVO TEST SET NO. 1 (Military version of AVO8) Complete with batteries and leads .....	£65
TEST LEADS suitable for AVOMETERS. Red and Black with 2 Croc. Clips and 2 Prods (P&P £3) .....	£5
BLACK 'EVER READY' CASES for AVOs, unused .....	£15 + P&P £4

LABGEAR CROSSHATCH GENERATOR CM6038 D8 Crosshatch/Grey scale/blank raster. Mains or Battery (P&P £3) .....	Unused £18 Used £12
LABGEAR Colour Bar Generator KG1 8 Test Patterns (P&P £4) .....	ONLY £40 each

### ISOLATING TRANSFORMERS

240V out 500VA £15 (p&p £5); 100VA £6 (p&p £3); 24V out 500VA £6 (p&p £5); 200VA £4 (p&p £4)	
---	--

### STEPPING MOTORS

Type 1. 200 Steps per rev. 4 Phase (5 wire) 12/24V. Torque 25 oz inch, will run on 5V with reduced torque .....	£15 each
Type 2. 612 Steps per rev. 3 Phase, 12/24V (will work on 5V) .....	£2 each
5 off .....	£6
Type 3. NORTH AMERICAN PHILIPS 24 Steps per rev. 4 wire 5V 3.3 Amps 0.250rpm 0-200PPS .....	£8 each
Type 4. 200 Steps per rev. 120V (3 wire) Torque 25 oz inch .....	£4 each
Type 7. WARNER 24 Steps per rev. 3 Phase (6 wire), 28V, Holding Torque 45 oz inch .....	£5 each

Used equipment—with 30 days guarantee. Manuals supplied if possible.  
This is a VERY SMALL SAMPLE OF STOCK. SAE or Telephone for Lists. Please check availability before  
ordering. CARRIAGE all units £16. VAT to be added to Total of Goods & Carriage

### STEWART OF READING

110 WYKHAM ROAD, READING, BERKS RG6 1PL  
Tel: 0734 68041 (Fax 351696) Callers welcome 9a.m.—5.30p.m. Mon—Fri (8p.m. Thurs)

### SPECIAL OFFER AT ONLY £300 each

TELEQUIPMENT D755 (NATO Approved version of D75) Dual Trace Delay Sweep 50MHz	
TRIO RF SIGNAL GENERATOR type SG402 100kHz— 30MHz. Unused .....	ONLY £75 (P&P £7)
COLOUR BAR GENERATOR type PAL MC-101. 8 pat- terns pocket size. Rechargeable batteries. Complete with battery charger/mains adaptor. Unused .....	ONLY £75 (P&P £4)
COLOUR BAR GENERATOR PAL MC321. 8 patterns video/sound output. Unused .....	ONLY £125 (P&P £7)

AVO VALVE TESTER CT 160. Suitcase style. 22 Bases. Unused .....	ONLY £25 each (P&P £7)
AVO TRANSISTOR ANALYSER MK2 (CT446). Suitcase style. Complete with batteries and operating instruc- tions .....	ONLY £25 each (P&P £7)

DISK DRIVE PSU 240V in 5V 1.6A & 12V 1.5A out. Size W125mm, H75mm, D180mm case, unused FARNELL SWITCHED MODE PSU	
5V 40A +/- 12V 5A .....	£30 each. P&P £4
OTHER SWITCHED MODE PSU available, please enquire.	

MARCONI AF POWER METER TF83A 20Hz-35Hz. 20uW-10W. With Manual (P&P £7) .....	ONLY £25
MARCONI RF POWER METER TF1152A/1 DC-500MHz. 0.5 to 25 Watts 50 Ohm. With Manual (P&P £7) .....	ONLY £46
MARCONI ATTENUATOR TF2162. DC 1MHz 600 ohm, 0-111dB in 0.1dB Steps (P&P £7) .....	£35
HATFIELD ATTENUATOR DC 250MHz 50 ohm 0-100dB (P&P £4) .....	£80

### NEW EQUIPMENT

HAMEG OSCILLOSCOPE 604. Dual trace 60MHz Delay Sweep. Component Tester and 2 Probes £575	
HAMEG OSCILLOSCOPE 203.6 Dual Trace 20MHz. Component Tester and 2 Probes .....	£314
All Other Models Available	
BLACK STAR FREQUENCY COUNTERS (P&P £4)	
Meteor 100—100MHz .....	£39
Meteor 600—600MHz .....	£129
Meteor 1000—1GHz .....	£178
BLACK STAR, JUPITOR 500 FUNCTION GENERATOR. Sine/Square/Triangle. 0.1Hz-500kHz. (P&P £4) £110	
BLACK STAR ORION. PAL TV/VIDEO COLOUR PATTERN GENERATOR .....	£209
HUNG CHANG DMM 7030 3 1/2 digit. Hand held 28 ranges including 10 amp AC/DC 0.1%. Complete with batteries and leads. (P&P £4) .....	£38.50
AS ABOVE. DMM 8010. 0.25% .....	£33.50
CARRYING CASE FOR ABOVE .....	£3
OSCILLOSCOPE PROBES. Switched x1; x10 (P&P £3) .....	£11

# PCB DESIGNER

FOR THE 48K ZX SPECTRUM

Now you can produce high quality printed circuit boards/circuit diagrams/component layouts on your 48K ZX Spectrum. If you don't own one it's worth getting one just for this suite of programs! Comprehensive manual included with getting started tutorial.

FULL SUITE FOR ONLY £30.00 INC.

## PCB LAYOUT:

Produce quality printed circuits directly from your EPSON RX/FX or compatible dot matrix printer using a dense 1:1 printout on positive photoresist coated board. Or super quality using x2 printout and photoreduction. Many features such as 15 track widths; 15 pad sizes; 16 transistor/ic/corners; 20 connectors; large multiscreen WYSIWYG display gives a clear uncluttered view of pads, tracks and drill holes; 0.1in. grid on/off; Block move; copy; mirror; rotate; erase; area fill (ideal for earth plane); preview; undo; dimensionally accurate printer routine with quick print; 1:1 or 2:1 dumps. Custom pad design and library. Available separately for £20.00 inc.

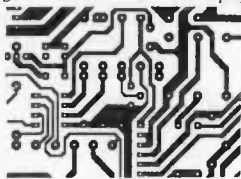

## COMPONENT LAYOUT

Draw component layouts directly or from existing pcb layouts using a unique track reducing facility. The following components are provided: resistors, capacitors, ics, diodes, transistors, line drawing, printout and block commands as above. Not available separately.

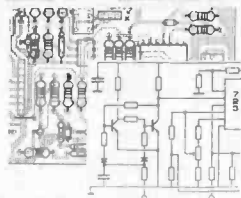

## CIRCUIT DIAGRAMS

Features similar to the above programs with a library of electronic symbols including resistors, capacitors, diodes, transistors, fets, op amp, switches, inductors, logic gates. Not available separately.

Version now available for EE Centronics Interface—see Jan issue State version required from: Disciple/+D; Discovery; +3; Microdrive & Tape. Important! Tape and Microdrive users please state Centronics interface in use or send £1 for details.

**KEMSOFT** THE WOODLANDS, KEMPSEY, WORCESTER WR5 3NB. Tel. 0905 821088 after 6 p.m., or see us on A.I.X-386 BULLETIN BOARD 0905 52536/754127 on any computer with modem.

## ADVERTISERS INDEX

AUDIOKITS .....	215
BARRIE ELECTRONICS .....	214
BICC-VERO ELECTRONICS .....	151
BI-PAK .....	213
B K ELECTRONICS ... Cover (iii)	
BULL, J. N. .... Cover (ii)	
CIRKIT DISTRIBUTION .....	209
CRICKLEWOOD ELECTRONICS .....	191
CROTECH INSTRUMENTS .....	150
CR SUPPLY CO. ....	214
ELTRAC ELECTRONICS .....	191
EVERETT WORKSHOP ACCESS .....	214
GREENWELD ELECTRONICS .....	149
HART ELECTRONIC KITS ...	199
HIGHGRADE COMPONENTS .....	148
ICS .....	216
I-TRON UK .....	209
JAYTEE ELEC. SERVICES ...	149
KEMSOFT .....	216
LONDON ELECTRONICS COLLEGE .....	216
MAGENTA ELECTRONICS .....	146
MAPLIN ELECTRONICS .....	Cover (iv)
MARCO TRADING .....	150
MAURITRON .....	215
NATIONAL COMPONENT CLUB .....	199
OMNI ELECTRONICS .....	216
PHONOSONICS .....	213
RISCOMP .....	157
RUGGED DISPLAYS .....	216
SHERWOOD ELECTRICAL COMPONENTS .....	214
SPECIALIST SEMICONDUCTORS .....	203
STEWART OF READING .....	215
SUMA DESIGNS .....	215
TANDY .....	171
TK ELECTRONICS .....	152
ZENITH ELECTRONICS .....	199

## ELECTRONICS TECHNICIAN FULL-TIME TRAINING

(FULL TIME COURSES APPROVED BY THE BUSINESS & TECHNICIAN EDUCATION COUNCIL)

### 2 YEAR

**BTEC National Diploma (OND) ELECTRONIC & COMMUNICATIONS ENGINEERING**  
(Electronics, Computing, Television, Video, Testing & Fault Diagnosis)

### 1 YEAR

**BTEC National Certificate (ONC) ELECTRONIC ENGINEERING**  
1—INFORMATION TECHNOLOGY  
(Electronics, Satellite TV, CD, Networks, Telecomms)

2—ELECTRONIC EQUIPMENT SERVICING  
(Electronics, Television, Video Cassette Recorders, CCTV, Testing and Fault Diagnosis)

3—SOFTWARE ENGINEERING  
(Electronics, Assembler, BASIC, PASCAL, CAD/CAM)

4—COMPUTING TECHNOLOGY  
(Electronics, Computing Software/Hardware, Microelectronic Testing Methods)

### 10 MONTHS

**BTEC Higher National Certificate (HNC) COMPUTING TECHNOLOGY & ROBOTICS**  
(Microprocessor Based Systems, Fault Diagnosis, ATE, Robotics)  
(Those eligible can apply for E.T. grant support)

These courses include a high percentage of college based practical work to enhance future employment prospects  
No additional fees for overseas students  
Shortened courses of from 3 to 6 months can be arranged for applicants with previous electronics knowledge

O.N.C. Monday 24th April 1989

FULL PROSPECTUS FROM

**LONDON ELECTRONICS COLLEGE**  
(Dept. EE), 20 PENYVERN ROAD  
EARLS COURT, LONDON SW5 9SU  
Tel: 01-373 8721

## MAKE YOUR INTERESTS PAY!

More than 8 million students throughout the world have found it worth their while! An ICS home-study course can help you get a better job, make more money and have more fun out of life! ICS has over 90 years experience in home-study courses and is the largest correspondence school in the world. You learn at your own pace, when and where you want under the guidance of expert 'personal' tutors. Find out how we can help YOU. Post or phone today for your FREE INFORMATION PACK on the course of your choice. (Tick one box only!)

Electronics <input type="checkbox"/>	Radio, Audio and TV Servicing <input type="checkbox"/>
Basic Electronic Engineering (City & Guilds) <input type="checkbox"/>	Radio Amateur Licence Exam (City & Guilds) <input type="checkbox"/>
Electrical Engineering <input type="checkbox"/>	Car Mechanics <input type="checkbox"/>
Electrical Contracting/Installation <input type="checkbox"/>	Computer Programming <input type="checkbox"/>
GCE over 40 'O' and 'A' level subjects <input type="checkbox"/>	

Name \_\_\_\_\_  
Address \_\_\_\_\_  
International Correspondence Schools, Dept ECS39 312/314 High St. Sutton, Surrey SM1 1PR. Tel: 01-643 95689 or 01-221 2926 (24 hrs.)

# OMNI ELECTRONICS

174 Dalkeith Road, Edinburgh EH16 5DX - 031 667 2611

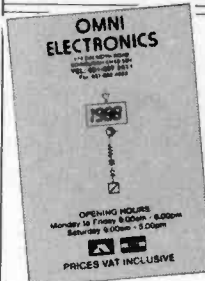

Have you sent for your copy of our catalogue yet?

If not, simply send 2x 19p stamps for a copy by return.

A COMPREHENSIVE RANGE WITH SERVICE SECOND TO NONE

Open: Monday-Friday 9.00-6.00  
Saturday 9.00-5.00



# RUGGED

LCD MULTIMETER PROJECT

- \* Full application notes
- \* Resolution 100 micro volts
- \* Minimum add on components

ONLY £16.04 inc VAT + p/p £1.25



**RUGGED DISPLAYS LIMITED**  
1 Mars House, Calleva Park, Aldermaston, Berks. RG7 4QW

LCD CLOCK PROJECT

- \* Full application notes and novel circuit ideas
- \* 12/24 Hour
- \* Snooze and alarm functions
- \* Tape counter/control timer

ONLY £10.34 inc VAT + p/p £1.25

Why not call us now



Mail-Order Tel: (07356) 79521



**POWER AMPLIFIER MODULES-TURNABLES-DIMMERS-LOUDSPEAKERS-19 INCH STEREO RACK AMPLIFIERS**

**OMP POWER AMPLIFIER MODULES**

Supplied ready built and tested.

**OMP POWER AMPLIFIER MODULES**

Now enjoy a world-wide reputation for quality, reliability and performance at a realistic price. Four models available to suit the needs of the professional and hobby market. i.e. Industry, Leisure, Instrumental and Hi-Fi etc. When comparing prices. NOTE all models include Toroidal power supply, Integral heat sink, Glass fibre P.C.B. and Drive circuits to power compatible Vu meter. Open and short circuit proof.

**THOUSANDS OF MODULES PURCHASED BY PROFESSIONAL USERS**



**OMP100 Mk 11 Bi-Polar Output power 110 watts R.M.S. into 4 ohms, Frequency Response 15Hz - 30KHz - 3dB, T.H.D. 0.01%, S.N.R. - 118dB, Sens. for Max. output 500mV at 10K, Size 355 x 115x65mm. PRICE £33.99 + £3.00 P&P.**

**NEW SERIES II MOS-FET MODULES**



**OMP/MF 100 Mos-Fet Output power 110 watts R.M.S. into 4 ohms, Frequency Response 1Hz - 100KHz - 3dB, Damping Factor, >300, Slew Rate 45V/uS, T.H.D. Typical 0.002%, Input Sensitivity 500mV, S.N.R. - 125dB, Size 300 x 123 x 60mm. PRICE £39.99 + £3.00 P&P.**



**OMP/MF200 Mos-Fet Output power 200 watts R.M.S. into 4 ohms, Frequency Response 1Hz - 100KHz - 3dB, Damping Factor >300, Slew Rate 50V/uS, T.H.D. Typical 0.001%, Input Sensitivity 500mV, S.N.R. - 130dB, Size 300 x 155 x 100mm. PRICE £62.99 + £3.50 P&P.**



**OMP/MF300 Mos-Fet Output power 300 watts R.M.S. into 4 ohms, Frequency Response 1Hz - 100KHz - 3dB, Damping Factor >300, Slew Rate 60V/uS, T.H.D. Typical 0.0008%, Input Sensitivity 500mV, S.N.R. - 130dB, Size 330 x 175 x 100mm. PRICE £79.99 + £4.50 P&P.**

NOTE:— MOS-FET MODULES ARE AVAILABLE IN TWO VERSIONS, STANDARD — INPUT SENS. 500mV BAND WIDTH 100KHZ, PEC (PROFESSIONAL EQUIPMENT COMPATIBLE) — INPUT SENS. 775mV, BAND WIDTH 50KHZ, ORDER STANDARD OR PEC

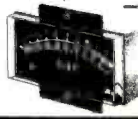

**Vu METER** Compatible with our four amplifiers detailed above. A very accurate visual display employing 11 L.E.D. diodes (7 green, 4 red) plus an additional on/off indicator. Sophisticated logic control circuits for very fast rise and decay times. Tough moulded plastic case, with tinted acrylic front. Size 84 x 27 x 45mm. PRICE £8.50 + 50p P&P.

**LOUDSPEAKERS**



**LARGE SELECTION OF SPECIALIST LOUDSPEAKERS AVAILABLE, INCLUDING CABINET FITTINGS, SPEAKER GRILLES, CROSS-OVERS AND HIGH POWER, HIGH FREQUENCY BULLETS AND HORNS, LARGE S.A.E. (30p STAMPED) FOR COMPLETE LIST.**

**McKENZIE:— INSTRUMENTS, P.A., DISCO, ETC.**

**ALL MCKENZIE UNITS 8 OHMS IMPEDANCE**

- 8" 100 WATT C8100GPM GEN. PURPOSE, LEAD GUITAR, EXCELLENT MID. DISCO. RES. FREQ. 80Hz FREQ. RESP. TO 14KHz SENS. 99dB. PRICE £28.59 + £2.00 P&P.
- 10" 100 WATT C10100GP GUITAR, VOICE, ORGAN, KEYBOARD, DISCO, EXCELLENT MID. RES. FREQ. 70Hz FREQ. RESP. TO 6KHz SENS. 100dB. PRICE £34.70 + £2.50 P&P.
- 10" 200 WATT C10200GP GUITAR, KEYBOARD, DISCO, EXCELLENT HIGH POWER MID. RES. FREQ. 45Hz FREQ. RESP. TO 7KHz SENS. 103dB. PRICE £47.48 + £2.50 P&P.
- 12" 100 WATT C12100GP HIGH POWER GEN. PURPOSE, LEAD GUITAR, DISCO. RES. FREQ. 45Hz FREQ. RESP. TO 7KHz SENS. 98dB. PRICE £36.66 + £3.50 P&P.
- 12" 100 WATT C12100TC TWIN CONE HIGH POWER WIDE RESPONSE. P.A., VOICE, DISCO. RES. FREQ. 45Hz FREQ. RESP. TO 14KHz SENS. 100dB. PRICE £37.63 + £3.50 P&P.
- 12" 200 WATT C12200B HIGH POWER BASS, KEYBOARDS, DISCO, P.A. RES. FREQ. 40Hz FREQ. RESP. TO 7KHz SENS. 100dB. PRICE £64.17 + £3.50 P&P.
- 12" 300 WATT C12300GP HIGH POWER BASS LEAD GUITAR, KEYBOARDS, DISCO, ETC. RES. FREQ. 45Hz FREQ. RESP. TO 5KHz SENS. 100dB. PRICE £85.79 + £3.50 P&P.
- 15" 100 WATT C15100BS BASS GUITAR, LOW FREQUENCY, P.A., DISCO. RES. FREQ. 40Hz FREQ. RESP. TO 5KHz SENS. 98dB. PRICE £53.70 + £4.00 P&P.
- 15" 200 WATT C15200BS VERY HIGH POWER BASS. RES. FREQ. 40Hz FREQ. RESP. TO 4KHz SENS. 99dB. PRICE £73.26 + £4.00 P&P.
- 15" 250 WATT C15250BS VERY HIGH POWER BASS. RES. FREQ. 40Hz FREQ. RESP. TO 4KHz SENS. 99dB. PRICE £80.53 + £4.50 P&P.
- 15" 400 WATT C15400BS VERY HIGH POWER, LOW FREQUENCY BASS. RES. FREQ. 40Hz FREQ. RESP. TO 4KHz SENS. 102dB. PRICE £94.12 + £4.50 P&P.
- 18" 400 WATT C18404BS EXTREMELY HIGH POWER, LOW FREQUENCY BASS. RES. FREQ. 27Hz FREQ. RESP. TO 3KHz SENS. 99dB. PRICE £167.85 + £5.00 P&P.

**EARBENDERS:— HI-FI, STUDIO, IN-CAR, ETC.**

**ALL EARBENDER UNITS 8 OHMS EXCEPT EB8-50 AND EB10-50 DUAL 4 AND 8 OHM. BASS, SINGLE CONE, HIGH COMPLIANCE, ROLLED FOAM SURROUND**

- 8" 50 WATT EB8-50 DUAL IMPEDANCE, TAPPED 4/8 OHM BASS, HI-FI, IN-CAR. RES. FREQ. 40Hz FREQ. RESP. TO 7KHz SENS. 97dB. PRICE £8.90 + £2.00 P&P.
- 10" 50 WATT EB10-50 DUAL IMPEDANCE, TAPPED 4/8 OHM BASS, HI-FI, IN-CAR. RES. FREQ. 40Hz FREQ. RESP. TO 5KHz SENS. 99dB. PRICE £12.00 + £2.50 P&P.
- 10" 100 WATT EB10-100 BASS, HI-FI, STUDIO. RES. FREQ. 35Hz FREQ. RESP. TO 3KHz SENS. 96dB. PRICE £27.50 + £3.50 P&P.
- 12" 60 WATT EB12-60 BASS, HI-FI, STUDIO. RES. FREQ. 28Hz FREQ. RESP. TO 3KHz SENS. 92dB. PRICE £21.00 + £3.00 P&P.
- 12" 100 WATT EB12-100 BASS, STUDIO, HI-FI, EXCELLENT DISCO. RES. FREQ. 26Hz FREQ. RESP. TO 3KHz SENS. 93dB. PRICE £32.00 + £3.50 P&P.
- FULL RANGE TWIN CONE, HIGH COMPLIANCE, ROLLED SURROUND**
- 5 1/2" 60 WATT EB5-60TC (TWIN CONE) HI-FI, MULTI-ARRAY DISCO ETC. RES. FREQ. 63Hz FREQ. RESP. TO 20KHz SENS. 92dB. PRICE £9.99 + £1.50 P&P.
- 6 1/2" 60 WATT EB6-60TC (TWIN CONE) HI-FI, MULTI-ARRAY DISCO ETC. RES. FREQ. 38Hz FREQ. RESP. TO 20KHz SENS. 94dB. PRICE £10.99 + £1.50 P&P.
- 8" 60 WATT EB8-60TC (TWIN CONE) HI-FI, MULTI-ARRAY DISCO ETC. RES. FREQ. 40Hz FREQ. RESP. TO 18KHz SENS. 89dB. PRICE £12.99 + £1.50 P&P.
- 10" 60 WATT EB10-60TC (TWIN CONE) HI-FI, MULTI-ARRAY DISCO ETC. RES. FREQ. 35Hz FREQ. RESP. TO 12KHz SENS. 86dB. PRICE £16.49 + £2.00 P&P.

**TRANSMITTER HOBBY KITS**

PROVEN TRANSMITTER DESIGNS INCLUDING GLASS FIBRE PRINTED CIRCUIT BOARD AND HIGH QUALITY COMPONENTS COMPLETE WITH CIRCUIT AND INSTRUCTIONS

3W FM TRANSMITTER 80-108MHz, VARICAP CONTROLLED PROFESSIONAL PERFORMANCE, RANGE UP TO 3 MILES, SIZE 38 x 123mm, SUPPLY 12V @ 0.5AMP. PRICE £14.99 + £1.00 P&P

FM MICRO TRANSMITTER (8UG) 100-108MHz VARICAP TUNED COMPLETE WITH VERY SENS FET MIC, RANGE 100-300m, SIZE 36 x 46mm, SUPPLY 9V BATT. PRICE £8.82 + £1.00 P&P

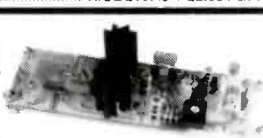

3 watt FM Transmitter



POSTAL CHARGES PER ORDER £1.00 MINIMUM. OFFICIAL ORDERS WELCOME FROM SCHOOLS, COLLEGES, GOVT. BODIES, ETC. PRICES INCLUSIVE OF V.A.T. SALES COUNTER. VISA ACCESS ACCEPTED BY POST, PHONE OR FAX.



\* PRICES INCLUDE V.A.T. \* PROMPT DELIVERIES \* FRIENDLY SERVICE \* LARGE S.A.E., 30p STAMPED FOR CURRENT LIST.

**OMP VARISPEED TURNTABLE CHASSIS**



★ MANUAL ARM ★ STEEL CHASSIS ★ ELECTRONIC SPEED CONTROL 33 & 45 ★ VARI PITCH CONTROLS ★ HIGH TORQUE SERVO DRIVEN DC MOTOR ★ TRANSIT SCREWS ★ 12 DIE CAST PLATTER ★ NEON STROBE ★ CALIBRATED BAL WEIGHT ★ REMOVABLE HEAD SHELL ★ CARTRIDGE FIXINGS ★ CUE LEVER ★ POWER 220 24V 50 60Hz ★ 390x305mm ★ SUPPLIED WITH MOUNTING CUT-OUT TEMPLATE.

PRICE £59.99 + £3.50 P&P.

**OPTIONAL MAGNETIC CARTRIDGES**

STANTON AL500  
PRICE £16.99 + 50p P&P

GOLDRING G850  
PRICE £6.99 + 50p P&P

**OMP MOS-FET POWER AMPLIFIERS, HIGH POWER, TWO CHANNEL 19 INCH RACK**

THOUSANDS PURCHASED BY PROFESSIONAL USERS



**NEW MXF SERIES OF POWER AMPLIFIERS**

THREE MODELS:— MXF200 (100w + 100w) MXF400 (200w + 200w) MXF600 (300w + 300w)

All power ratings R.M.S. into 4 ohms.

FEATURES: ★ Independent power supplies with two Toroidal Transformers ★ Twin L.E.D. Vu meters ★ Rotary indexed level controls ★ Illuminated on off switch ★ XLR connectors ★ Standard 775mV inputs ★ Open and short circuit proof ★ Latest Mos-Fets for stress free power delivery into virtually any load ★ High slew rate ★ Very low distortion ★ Aluminium cases ★ MXF600 Fan cooled with D.C. loudspeaker and thermal protection.

USED THE WORLD OVER IN CLUBS, PUBS, CINEMAS, DISCOS ETC.

SIZES:— MXF 200 W19" x H3 1/2" (2U) x D11  
MXF 400 W19" x H5 1/4" (3U) x D12  
MXF 600 W19" x H5 1/4" (3U) x D13

MXF200 £171.35  
MXF400 £228.85  
MXF600 £322.00

SECURICOR DELIVERY £12.00 EACH



**OMP LINNET LOUDSPEAKERS**

THE VERY BEST IN QUALITY AND VALUE



MADE ESPECIALLY TO SUIT TODAY'S NEED FOR COMPACTNESS WITH HIGH OUTPUT SOUND LEVELS, FINISHED IN HARDWEARING BLACK VYNIIDE WITH PROTECTIVE CORNERS, GRILLE AND CARRYING HANDLE. INCORPORATES 12 DRIVER PLUS HIGH FREQ. HORN FOR FULL FREQ. RANGE. 45Hz-20KHz BOTH MODELS 8 OHM, SIZE H18" x W15" x D12"

CHOICE OF TWO MODELS

POWER RATINGS QUOTED IN WATTS RMS FOR EACH CABINET

OMP 12-100 (100W 100dB) PRICE £159.99 PER PAIR  
OMP 12-200 (200W 102dB) PRICE £209.99 PER PAIR

SECURICOR DEL.:— £12.00 PER PAIR

**OMP SLIDE DIMMER 1K WATT & 2.5K WATT**

CONTROLS LOADS UP TO 1KW & 2.5KW. SUITABLE FOR RESISTIVE AND INDUCTIVE LOADS. BLACK ANODISED CASE. READY TO FLUSH MOUNTED THROUGH PANEL. CABINET CUT-OUTS. ADVANCED FEATURES INCLUDE:—

- ★ FULL 65mm SLIDE TRAVEL
- ★ NEON MONITOR INDICATOR
- ★ FLASH OVERRIDE BUTTON
- ★ HIGH & LOW LEVEL PRESETS
- ★ FULLY SUPPRESSED TO BS 800

SIZES:— 1KW H128 x W40 x D55mm  
2.5KW H128 x W76 x D73mm

PRICES:— 1K WATT £15.99  
2.5K WATT £24.99 + 60p P&P



**PIEZO ELECTRIC TWEETERS—MOTOROLA**

**PIEZO ELECTRIC TWEETERS — MOTOROLA**

Join the Piezo revolution. The low dynamic mass (no voice coil) of a Piezo tweeter produces an improved transient response with a lower distortion level than ordinary dynamic tweeters. As a crossover is not required these units can be added to existing speaker systems of up to 100 watts (more if 2 put in series) FREE EXPLANATORY LEAFLETS SUPPLIED WITH EACH TWEETER.

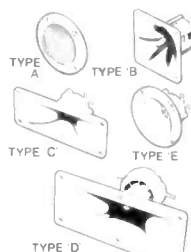

TYPE 'A' (KSN2036A) 3" round with protective wire mesh, ideal for bookshelf and medium sized Hi-fi speakers. Price £4.90 each + 50p P&P  
TYPE 'B' (KSN1005a) 3 1/2" super horn. For general purpose speakers, disco and P.A. systems etc. Price £5.00 each + 50p P&P  
TYPE 'C' (KSN6016A) 2" x 5" wide dispersion horn. For quality Hi-fi systems and quality discos etc. Price £6.99 each + 50p P&P  
TYPE 'D' (KSN1025A) 2" x 6" wide dispersion horn. Upper frequency response retained extending down to mid range (2KHz). Suitable for high quality Hi-fi systems and quality discos. Price £9.99 each + 50p P&P  
TYPE 'E' (KSN1038A) 3 1/2" horn tweeter with attractive silver finish trim. Suitable for Hi-fi monitor systems etc. Price £5.99 each + 50p P&P  
LEVEL CONTROL. Combines on a recessed mounting plate, level control and cabinet input jack socket. 85x85mm. Price £3.99 + 50p P&P

**STEREO DISCO MIXER**

STEREO DISCO MIXER with 2 x 5 band L & R graphic equalisers and twin 10 segment L.E.D. Vu Meters. Many outstanding features 5 inputs with individual faders providing a useful combination of the following:—  
3 Turntables (Mag). 3 Mics. 4 Line including CD plus Mic with talk over switch Headphone Monitor. Pan Pot L & R. Master Output controls. Output 775mV. Size 360x280x90mm. Supply 220-240v.  
PRICE £134.99 — £4.00 P&P

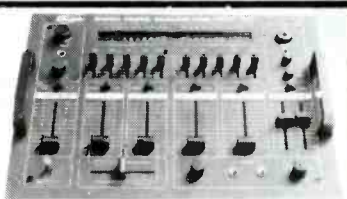

**B. K. ELECTRONICS** Dept EE  
UNIT 5, COMET WAY, SOUTHEND-ON-SEA, ESSEX. SS2 6TR  
TEL: 0702-527572 FAX: 0702-420243

# THE NEW MAPLIN CATALOGUE IT'S OUT OF THIS WORLD SEND FOR YOUR COPY TODAY

**ORDER  
OF THE NEW MAPLIN  
CATALOGUE ON SALE NOW**

Pick up a copy from any W.H. Smith for just £1.95 or post this coupon now to receive your copy by post for just £1.95 + 50p p & p. If you live outside the U.K. send £3.40 or 15 International Reply Coupons. I enclose £2.45.

Name \_\_\_\_\_  
Address \_\_\_\_\_  
Post Code \_\_\_\_\_  
Send to Maplin Electronics, P.O. Box 3, Rayleigh, Essex S56 8LR.

**AVAILABLE FROM 11th NOVEMBER 1988 IN ALL W.H. SMITH STORES**

EE 99



Evening on the planet Oldana, as the Maplin Juggernaut thunders along the highway; captured on canvas by galaxy famous artist Lionel Jeans and featured on the cover of the new Maplin Catalogue.