

EVERYDAY ELECTRONICS and computer PROJECTS

JUNE 1983

85p

TRS-80 and GENIE EPROM PROGRAMMER

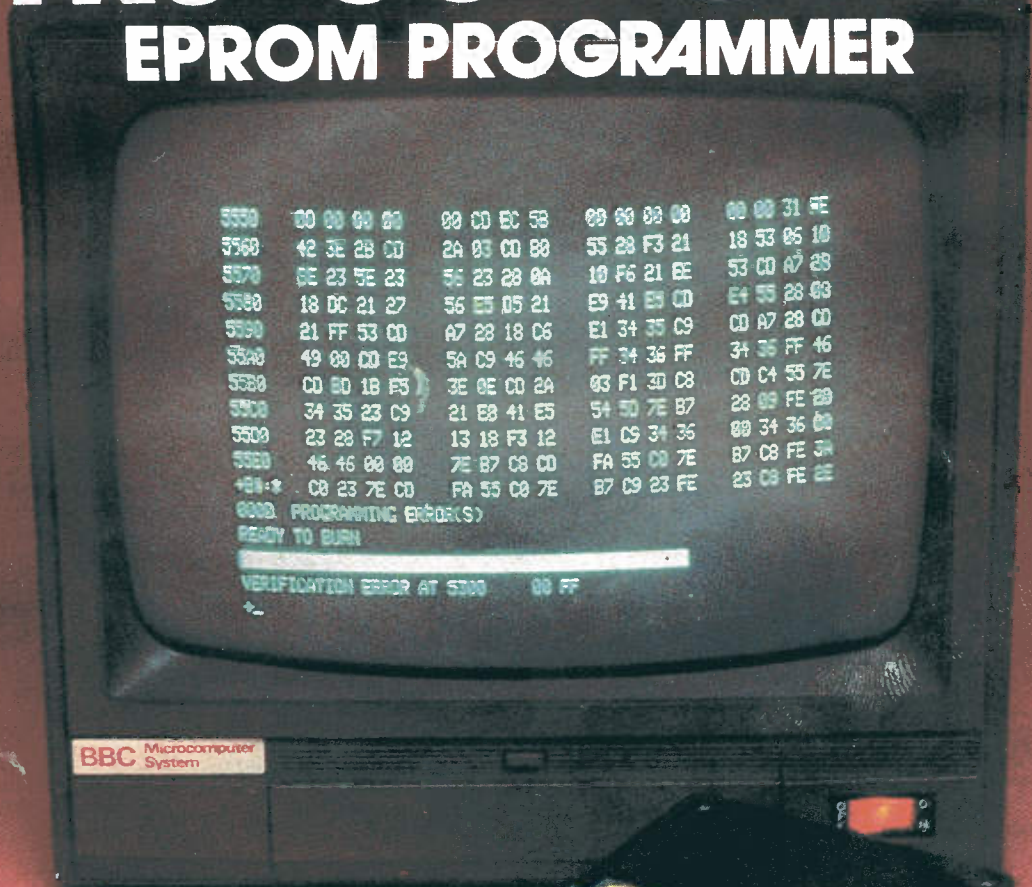

**CARAVAN
POWER SUPPLY**

**CARAVAN
FRIDGE ALARM**

**ENVELOPE SHAPER
FOR BASS GUITAR**



**BARGAIN OFFER
SMOKE
DETECTOR**

SAVE ON THE PRICE OF YOUR COLOUR PRINTS!

NOW ONLY 12p EACH

with the Everyday Electronics Colour Print Service

While prices go up elsewhere, Everyday Electronics makes a bargain offer in its Colour Print Service. Now you can have as many films printed as you like, including Giant Superprints, at only 12p a print. There is no developing charge and just 25p towards postage and packing.

At this new price, the magazine Colour Print Service, already used by hundreds of thousands of readers, is as fast and efficient as ever. Here's all you have to do to enjoy its advantages.

Send any make of colour print film, including disc film, inside the envelope enclosed with this issue. Or fill in the coupon below and send with your colour print film in a strong envelope to:

Everyday Electronics Colour Print Service, FREEPOST, READING RG1 1BR. No stamp is required.

SEND NO MONEY

We are so confident in the reliability of our service and the quality of our prints (each one date-stamped with the month and year of developing) that you don't pay until you've seen them.

LUXURY COLOUR PRINTS

You will be amazed at the beautiful colours and sheen finish of these prints. They have elegant rounded corners and are borderless to give you maximum picture area. And with the Giant Superprints, you get 30 per cent more picture area than the standard enprints *at no extra cost!*

Offer excludes Black & White, transparency, sub-miniature, C22 & Agfa CNS film. Superprints can only be produced from Kodacolor II, C41 cassette, cartridge and disc film not half frame. Prices correct at time of going to press.

UNBEATABLE VALUE

All you pay for the Colour Print Service is 12p for each good print received plus 25p towards postage and packing. The most you would pay us for processing and printing a 24-exposure film for example is £3.13. Compare that with the price you would pay in the shops.

FREE ALBUM PAGES

With each film we process, you receive an album page voucher. Collect and return three vouchers, and you receive a set of FREE album pages to fit into our specially designed album for any size of print up to 4in. by 6in.

HOW YOU BENEFIT

You benefit in three ways. Firstly, you pay nothing for the actual processing — only for prints and postage and packing. Secondly, you enjoy a personal service with every care taken over each individual order. And thirdly, you pay only for what you get — with no credit vouchers as with many other companies. An invoice comes with your prints, so it is a straight business transaction.

48 HOURS IN-LAB SERVICE

Your films will be processed within 48 hours* of receipt, but please allow for postal delays.

The price of this offer is limited to the U.K.

*C41 Process cassette and cartridge film only.



FILMS AT REDUCED PRICES

Always keep your camera action-ready. Order replacement films at our specially reduced prices: 110/24, 126/24 or 35/24 at £1.20 a roll, or three for £3; disc/15, £1.30 each (no quantity discount).

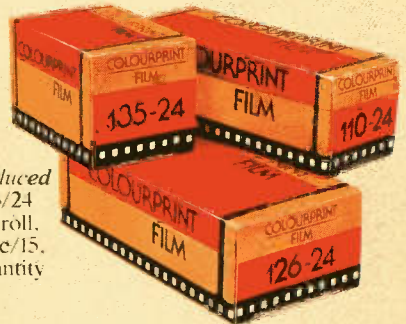

If you have any queries, contact our Customer Service on Reading (0734) 597332.

Use this label if you have no envelope, or pass it to a friend. It is used to pack your prints.

To: Everyday Electronics Colour Print Service
FREEPOST, Reading RG1 1BR

- Please print my film Superprint size
- Standard Enprint size

If film is being ordered ● Please send me
of 110/24 of 126/24 of 35/24 of disc 15

● Tick box(es) as required.

From: Everyday Electronics Colour Print Service
FREEPOST, READING RG1 1BR

Mr Ms _____

Address _____

Postcode _____

EVERYDAY ELECTRONICS and computer PROJECTS

VOL. 12 NO. 6 JUNE 1983

PROJECTS . . . THEORY . . . NEWS . . .
COMMENT . . . POPULAR FEATURES . . .

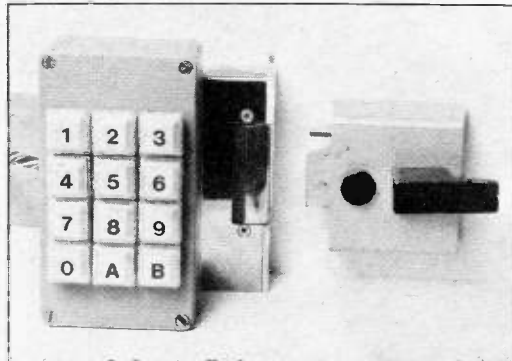
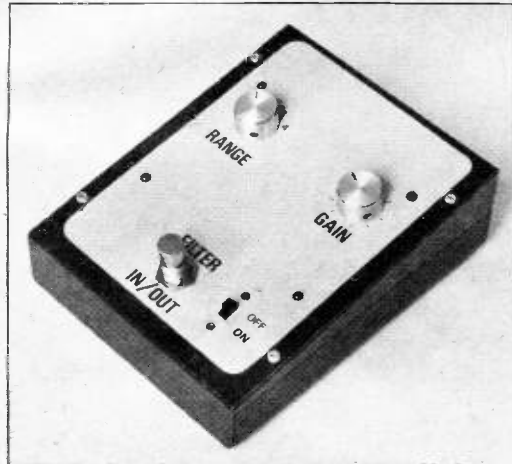
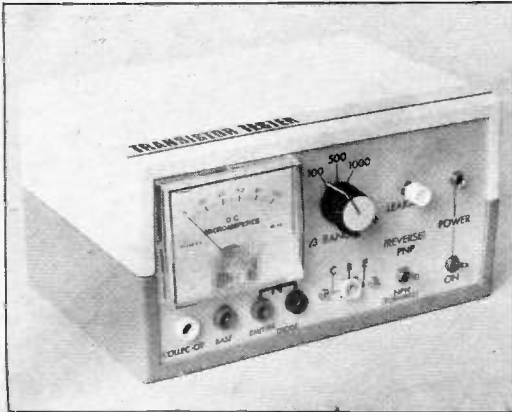

© IPC Magazines Limited 1983. Copyright in all drawings, photographs and articles published in EVERYDAY ELECTRONICS is fully protected, and reproduction or imitations in whole or in part are expressly forbidden.

PROJECTS

- EPROM PROGRAMMER** by B. W. Terrell and J. W. Terrell **338**
For TRS-80 and Genie. A useful tool for micro-based project development
- PUSH BUTTON COMBINATION LOCK** by J. Hadley **352**
Improved security for your home
- CARAVAN POWER SUPPLY** by T. R. de Vaux-Balbirnie **362**
Auxiliary 12V supply for amenity equipment
- CARAVAN FRIDGE ALARM** by T. R. de Vaux-Balbirnie **366**
Early warning of failure
- TEST GEAR 83—TRANSISTOR TESTER**
by J. R. W. Barnes **370**
For gain and leakage measurements
- ENVELOPE SHAPER FOR BASS GUITAR** by A. Niemiro **378**
Provides colourful sounds for soul and funk music

SERIES

- ELECTRONICS AND THE ELECTRON** by J. B. Dance **356**
Part 2: Conduction in Various Materials

FEATURES

- EDITORIAL** **337**
Holiday Trail
- JACK PLUG AND FAMILY** by Doug Baker **348**
Cartoon
- LOGIC SYMBOLS** **349**
A change in style—basic gates and truth tables
- SPECIAL REPORT** by J. W. Terrell **350**
Sinclair ZX Spectrum
- CIRCUIT EXCHANGE** **358, 384**
A forum for readers' letters
- BARGAIN OFFER** **359**
Smoke Detector Fire Alarm
- FOR YOUR ENTERTAINMENT** by Barry Fox **361**
Computer Forecast; Video In A Spin; Hospital Radio
- SHOP TALK** by Dave Barrington **369**
Product news and component buying
- BOOK REVIEWS** **376**
A selection of recent releases
- COUNTER INTELLIGENCE** by Paul Young **376**
A retailer comments
- RADIO WORLD** by Pat Hawker G3VA **382**
SW Broadcasting; Sporting Ploy; Teletext 10
- NEW PRODUCTS** **385**
Facts and photos of instruments, equipments and tools
- READERS' LETTERS** **387**
Your news and views

Our July 1983 issue will be published on Friday, June 17. See page 360 for details.

Readers' Services • Editorial and Advertisement Departments

337

electronize

AUTO-ELECTRONIC PRODUCTS

KITS OR READY BUILT

TOTAL ENERGY DISCHARGE ELECTRONIC IGNITION



IS YOUR CAR AS GOOD AS IT COULD BE ?

- ★ Is it **EASY TO START** in the cold and the damp? Total Energy Discharge will give the most powerful spark and maintain full output even with a near flat battery.
- ★ Is it **ECONOMICAL** or does it "go off" between services as the ignition performance deteriorates? Total Energy Discharge gives much more output and maintains it from service to service.
- ★ Has it **PEAK PERFORMANCE** or is it flat at high and low revs. where the ignition output is marginal? Total Energy Discharge gives a more powerful spark from idle to the engines maximum (even with bad leads).
- ★ **PERFORMANCE SMOOTH:** The more powerful spark of Total Energy Discharge eliminates the "miss" misfire whilst an electronic filter smooths out the effects of contact bounce etc.
- ★ Do the **PLUGS** and **POINTS** always need changing to bring the engine back to its best? Total Energy Discharge eliminates contact arcing and erosion by removing the heavy electrical load. The timing stays "spot on" and the contact condition doesn't affect the performance either. Larger plug gaps can be used, even wet or badly fouled plugs can be fired with this system.
- ★ **TOTAL ENERGY DISCHARGE** is a unique system and the most powerful on the market - 3 1/2 times the power of inductive systems - 3 1/2 times the energy and 3 times the duration of ordinary capacitive systems. These are the facts:
Performance at only 6 volts (max. supply 16 volts)
 SPARK POWER — 140W, SPARK ENERGY — 36mJ
 SPARK DURATION — 500µS, STORED ENERGY — 135mJ
 LOADED OUTPUT VOLTAGE
 50pF load — 38kV, 50pF + 500k — 26kV
 We challenge any manufacturer to publish better performance figures. Before you buy any other make, ask for the facts, its probably only an inductive system. But if an inductive system is what you really want, we'll still give you a good deal.
- ★ All **ELECTRONIZE** electronic ignitions feature:
EASY FITTING, STANDARD/ELECTRONIC CHANGEOVER SWITCH, STATIC TIMING LIGHT and DESIGNED IN RELIABILITY (14 years experience and a 3 year guarantee).
- ★ **IN KIT FORM** it provides a top performance system at less than half the price of comparable ready built units. The kit includes: pre-drilled fibreglass PCB, pre-wound and varnished ferrite transformer, high quality 2µF discharge capacitor, case, easy to follow instructions, solder and everything needed to build and fit to your car. All you need is a soldering iron and a few basic tools.

Most **NEW CARS** already have electronic ignition. Update **YOUR CAR**

PROTECT YOUR CAR WITH AN ELECTRONIZE ELECTRONIC ALARM



- ★ **2000 COMBINATIONS** provided by an electronic key - a miniature jack plug containing components which must match each individual alarm system. (Not limited to a few hundred keys or a four bit code).
- ★ **60 SECOND ALARM PERIOD** flashes headlights and sounds horn, then resets ready to operate again if needed.
- ★ **10 SECOND ENTRY DELAY** allows owner to dis-arm the system, by inserting the key plug into a dashboard mounted socket, before the alarm sounds. (No holes in external bodywork, fiddly code systems or hidden switches). Re-closing the door will not cancel the alarm, before or after it sounds, the key plug must be used.
- ★ **INSTANT ALARM OPERATION** triggered by accessories or bonnet/boot opening.
- ★ **30 SECOND DELAY** when system is armed allows owner to lock doors etc.
- ★ **DISABLES IGNITION SYSTEM** when alarm is armed.
- ★ **IN KIT FORM** it provides a high level of protection at a really low cost. The kit includes everything needed, the case, fibreglass PCB, CMOS IC's, random selection resistors to set the combination, in fact everything down to the last nut and washer plus easy to follow instructions.

**FITS ALL 12 VOLT NEGATIVE EARTH VEHICLES.
SUPPLIED COMPLETE WITH ALL NECESSARY LEADS
AND CONNECTORS PLUS TWO KEY PLUGS**

Don't Wait Until Its too Late ~
Fit one **NOW!**

fill in the coupon and send to:

ELECTRONIZE DESIGN Dept C · Magnus Rd · Wilnecote · Tamworth · B77 5BY · tel 0827 281000

TOTAL ENERGY DISCHARGE (6 or 12 volt negative earth)

- Assembled ready to fit £26.70 £19.95
 D.I.Y. parts kit £15.90 £14.95

TWIN OUTPUT for cars and motor cycles with dual ignition

- Twin, Assembled ready to fit £36.45 £29.95
 Twin, D.I.Y. parts kit £24.55 £22.95

INDUCTIVE DISCHARGE (12 volt only)

- Assembled ready to fit £15.95 £12.75



Prices Include VAT.

P+P £1-00 (UK)

CAR ALARM

- Assembled ready to fit £37.95
 D.I.Y. parts kit £24.95

I enclose cheque/postal order OR debit my Access/Visa card

Name _____

Address _____

_____ Code _____

ELECTRONI-KIT

FX-COMPUTER

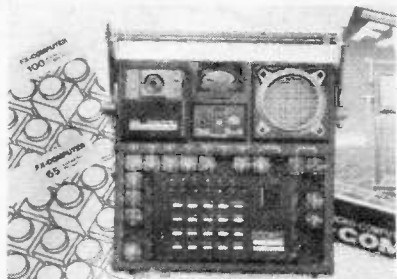

Teach-Yourself Computer and Electronics Construction Kit

A complete introduction to the "How, Why and What" of Computers and Electronics in the most practical way ever devised

THE KIT IS BATTERY-OPERATED AND COMPLETELY SELF-CONTAINED. NO TELEVISION OR OTHER EQUIPMENT IS REQUIRED. VERY EXTENSIVE MANUALS ARE INCLUDED

Ministry of Science and Technology, Japan — Prize Winning Product

The **FX-COMPUTER** is the ideal introduction to the study and understanding of computers and electronics. The kit offers remarkable versatility because the components are interchangeable and circuits are constructed by simply plugging specified components into the board provided in accordance with the instruction manuals. You quickly understand the principles involved and new circuits can be easily devised, built and dismantled. No soldering or wiring is involved, no tools are required; the components themselves complete the circuits.

No previous knowledge is required — very extensive educational manuals have been provided by English experts in computers and electronics. Working through the manuals you will soon be able to write programmes and "run" them and understand how computers work.

The following are just a few of the programmes in the Computer Manual (there are too many to list here) and also a few of the projects in the Electronics Manual:

How to Instruct the Computer and Store Information into Memories. Use of different instructions and Programming Techniques. Adding, subtracting, multiplying, dividing, averaging, counting up, counting down, etc. — in Decimal and Hexadecimal. Converting Hexadecimal to Decimal, storing Random Numbers. Games: Tennis, Catch-the-Rat, Gun Fight, Slot Machine, etc. Using the Computer as a Musical Organ, storing and playing-back tunes, etc. **OVER 100 PROGRAMMES SHOWN IN THE COMPUTER MANUAL PLUS EXPLANATIONS AND DEMONSTRATIONS OF ALL TECHNICAL TERMINOLOGY.**

Electronic Components and How they Work — batteries, conductors, resistors, capacitors, diodes, transistors, lamps, photo-electric devices (CdS cell is included in the kit), oscillators, burglar alarms, control systems, organ, lie detector, etc., etc. **OVER 65 PRACTICAL WORKING PROJECTS SHOWN IN THE ELECTRONICS MANUAL**

All this is in ONE kit, costing about the same as the cheapest "Basic" ordinary Computer

The price is only £69.95 plus £3.00 P&P (overseas rates quoted on request)

Delivery within 21 days

TRADE & EDUCATIONAL ENQUIRIES WELCOMED

Send cheque/PO/Access/Barclaycard to
DEPT. EEFX. Electroni-Kit Ltd

It's not JUST a computer!

**ELECTRONI-KIT LTD.
388 ST. JOHN STREET
LONDON, EC1V 4NN (01-278 0109)**

circuit board components

**Castle House, 1 Castle Lane, Bedford
MK40 3QE**

Telephone 0234 214219

Please note our new address

All components brand new — Please add 35p P & P plus 15% VAT. Please send cheque or P.O. with your order. Official orders are welcome from educational establishments, Government bodies and public companies. Credit accounts are available. Please ask for details.

LOW PROFILE SOCKETS

8 Pin	9p	22 Pin	22p	ORDER 12 OR MORE OF ANY ONE TYPE AND WE WILL SUPPLY 13.
14 Pin	10p	24 Pin	24p	
16 Pin	11p	28 Pin	26p	
18 Pin	16p	40 Pin	30p	
20 Pin	18p			

"A BAKERS DOZEN"

SPECIAL FOR JUNE-JULY '83

MEMBRANE KEYPADS. By F.S.T.

Multi-choice Graphics Keypad, 57 standard characters to choose from.

Blue or white as standard graphic options keypad complete with flexible backing with Berg connector.

PANEL DIMENSIONS

3 x 4 — 78 x 98 mm	£5.98
4 x 4 — 97 x 98 mm	£6.69
5 x 4 — 116 x 98 mm	£7.41

TTL

7400	11p	7427	18p	7474	19p
7401	11p	7428	25p	7475	26p
7402	11p	7430	13p	7476	25p
7403	12p	7432	20p	7480	45p
7404	12p	7433	20p	7482	65p
7405	14p	7437	23p	7483	30p
7406	19p	7438	24p	7485	60p
7407	19p	7440	14p	7486	19p
7408	13p	7442	30p	7489	180p
7409	13p	7444	85p	7490	19p
7410	13p	7446	58p	7491	34p
7411	15p	7447	36p	7492	24p
7412	17p	7448	43p	7493	24p
7413	17p	7450	14p	7494	33p
7414	23p	7451	14p	7495	33p
7416	19p	7453	14p	7496	38p
7417	19p	7454	14p	7497	86p
7420	14p	7460	14p	74100	78p
7421	19p	7472	22p	74107	22p
7422	19p	7473	24p	74109	24p

CMOS

4000	10p	4020	42p	4042	38p
4001	10p	4021	40p	4043	40p
4002	12p	4022	45p	4044	40p
4006	50p	4023	16p	4046	40p
4007	14p	4024	33p	4047	35p
4008	36p	4025	12p	4048	38p
4009	24p	4026	75p	4049	21p
4010	24p	4027	20p	4050	21p
4011	10p	4028	40p	4051	42p
4012	15p	4029	45p	4052	48p
4013	20p	4030	14p	4053	48p
4014	45p	4031	125p	4054	78p
4015	40p	4034	140p	4055	80p
4016	20p	4036	249p	4059	430p
4017	30p	4039	280p	4060	42p
4018	45p	4040	40p	4063	80p
4019	25p	4041	40p	4066	22p

Free — Satin Gold Biro

With all orders over £3.00 in "June and July" '83

XK113 MW RADIO KIT

Based on ZN414 IC, kit includes PCB, wound aerial and crystal earpiece and all components to make a sensitive miniature radio. Size: 5.5 x 2.7 x 2cms. Requires PP3 9V battery. IDEAL FOR BEGINNERS. **£5.00**

HOME LIGHTING KITS

These kits contain all necessary components and full instructions & are designed to replace a standard wall switch and control up to 300W of lighting.

TDR300K Remote Control Dimmer £14.30

MK6 Transmitter for above £4.20

TD300K Touchdimmer £7.00

TDEK Extension kit for 2-way switching for TD300K £2.00

LD300K Rotary Controlled Dimmer £3.50

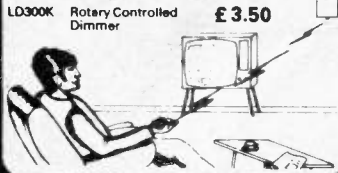

NOW available in stock

THE JUPITER ACE MICROCOMPUTER

uses FORTH which executes about 10 times faster and requires less program memory than a comparable program using basic. Features 8K ROM, 3K RAM, built in speaker, 40 key keyboard and a 32 x 24 line-flicker free display on TV. Comes supplied complete with leads, mains adaptor, a comprehensive easy-to-follow manual on Forth programming + FREE cassette containing 5 sample programs. **ONLY £75.00** (+ £2.00 carriage + VAT)

JUPITER ACE SOFTWARE

J3 SPACE INVADERS £3.90

J4 SWAMP MONSTERS £3.90

J5 DOT MAN

J7 ZAP 'EM (ASTEROIDS) DUCK

SHOOT & MINEFIELD (3 programs) £5.20

COMPONENT PACKS

- PACK 1 650 Resistors 47 ohm to 10 Mohm — 10 per value **£4.00**
- PACK 2 40 x 16V Electrolytic Capacitors 10µF to 1000µF — 5 per value **£3.25**
- PACK 3 60 Polyester Capacitors 0.01 to 1µF/250V — 5 per value **£5.55**
- PACK 4 45 Sub-miniature Presets 100 ohm to 1 Mohm — 5 per value **£2.90**
- PACK 5 30 Low Profile IC Sockets 8, 14 and 16 — pin — 10 of each **£2.40**
- PACK 6 25 Red LEDs (5mm dia.) **£1.25**

3-NOTE DOOR CHIME

Based on the SAB0600 IC the kit is supplied with all components, including loudspeaker, printed circuit board, a pre-drilled box (95 x 71 x 35mm) and full instructions. Requires only a PP3 9V battery and push-switch to complete. AN IDEAL PROJECT FOR BEGINNERS. Order as XK102 **£5.00**

LCD 3 1/2 DIGIT MULTIMETER

16 ranges including DC voltage (200 mv-1000 v) and AC voltage, DC current (200 mA-10 A) and resistance (0-2 M) + NPN & PNP transistor gain and diode check. Input impedance 10M. Size 155x88x31 mm. Requires PP3 9v battery. Test leads included **ONLY £29.00**

ELECTRONIC LOCK KIT XK101

This KIT contains a purpose designed lock IC, 10-way keyboard, PCBs and all components to construct a Digital Lock, requiring a 4-key sequence to open and providing over 5000 different combinations. The open sequence may be easily changed by means of a pre-wired plug. Size: 7 x 6 x 3 cms. Supply: 5V to 15V d.c. at 40µA. Output: 750mA max. Hundreds of uses for doors and garages, car anti-theft device, electronic equipment, etc. Will drive most relays direct. Full instructions supplied. **ONLY £10.50**

Electric lock mechanisms for use with latch locks and above kit **£13.50**

DISCO LIGHTING KITS

DL1000K
This value-for-money kit features a bi-directional sequence, speed of sequence and frequency of direction change, being variable by means of potentiometers and incorporates a master dimming control. **£14.60**

DL2100K
A lower cost version of the above, featuring unidirectional channel sequence with speed variable by means of a pre-set pot. Outputs switched only at mains zero crossing points to reduce radio interference to a minimum. **Only £8.00**

Optional opto input DLA1
Allowing audio ("beat")
—light response. **60p**

DL3000K
This 3 channel sound to light kit features zero voltage switching, automatic level control & built in mic. No connections to speaker or amp required. No knobs to adjust — simply connect to mains supply & lamps. (1Kw/Channel) **Only £11.95**

DVM/ULTRA SENSITIVE THERMOMETER KIT

This new design is based on the ICL7126 (a lower power version of the ICL7106 chip) and a 3 1/2 digit liquid crystal display. This kit will form the basis of a digital multimeter (only a few additional resistors and switches are required—details supplied), or a sensitive digital thermometer (-50°C to +150°C) reading to 0.1°C. The basic kit has a sensitivity of 200mV for a full scale reading, automatic polarity indication and an ultra low power requirement—giving a 2 year typical battery life from a standard 9V PP3 when used 8 hours a day, 7 days a week.



Price £15.50

Have you got our **FREE ORANGE CATALOGUE** yet?

NO!! Send S.A.E. 6" x 9" TODAY!!

It's packed with details of all our KITS plus large range of SEMICONDUCTORS including CMOS, LS TTL, linear, microprocessors and memories; full range of LEDs, capacitors, resistors, hardware, relays, switches etc. We also stock VERO and Antex products as well as books from Texas Instruments, Babani and Elektor.

ALL AT VERY COMPETITIVE PRICES.

ORDERING IS EVEN EASIER — JUST RING THE NUMBER YOU CAN'T FORGET FOR PRICES YOU CAN'T RESIST.

5-6-7 8-9-10

and give us your Access or Barclaycard No. or write enclosing cheque or postal order. Official orders accepted from schools, etc. **Answering service evngs & weekends**

FAST SERVICE · TOP QUALITY · LOW LOW PRICES

No circuit is complete without a call to



ELECTRONICS

11 Boston Road
London W7 3SJ



Add 65p postage & packing +15% VAT to total Overseas Customers; Add £2.50 (Europe), £6.00 (elsewhere) for p&p Send S.A.E. for further STOCK DETAILS. Goods by return subject to availability.

OPEN 9am to 5pm (Mon to Fri)
10am to 4pm (Sat)

ALL PRICES EXCLUDE VAT

TEL: 01-567 8910 ORDERS
01-579 9794 ENQUIRIES
01-579 2842 TECHNICAL AFTER 3PM

SPECTRUM

- 24 LINE INPUT/OUTPUT PORT £18.95 (motherboard not required)
- MOTHERBOARD — SIX SLOTS £26.50
- MOTHERBOARD PCB ONLY £6.50
- SPECTRUM 28-WAY CONNECTOR £3.25
- MALE CONNECTOR £1.90
- 34-WAY RIBBON CABLE per metre £1.80

ZX81

- 40-KEY KEYBOARD £20.00
- SPARE KEYS each £0.30
- MOTHERBOARD — TWO SLOTS £15.00
- 24-LINE INPUT/OUTPUT PORT £18.95
- 16K RAM PACK £22.95
- MUSIC BOARD £18.95
- 23-WAY FEMALE CONNECTOR £2.50
- MALE CONNECTOR £1.60
- 24-WAY RIBBON CABLE per metre £1.40
- GETTING ACQUAINTED WITH YOUR ZX81 £5.95
- PROGRAMMING FOR REAL APPLICATIONS £6.95
- REAL APPLICATIONS TAPE £11.44
- MASTERING MACHINE CODE £7.50

Prices are for built items, Postage 40p under £4.00.
Export postage (surface) £1.80. Send SAE for full catalogue.
Cash with order or Access

REDDITCH ELECTRONICS

DEPT. EE5
21 FERNEY HILL AVENUE
REDDITCH, WORCS B97 4RU

TECHNICAL TRAINING IN ELECTRONICS, TELEVISION AND AUDIO

IN YOUR OWN HOME — AT YOUR PACE

ICS can provide the technical knowledge that is so essential to your success, knowledge that will enable you to take advantage of the many opportunities open to the trained man. You study in your own home, in your own time and at your own pace and if you are studying for an examination ICS guarantee coaching until you are successful.

City & Guilds Certificates

Radio Amateurs Basic Electronic Engineering (Joint C&G/ICS)

Certificate Courses

TV and Audio Servicing Radio & Amplifier Construction Electronic Engineering* and Maintenance Computer Engineering* and Programming TV, Radio and Audio Engineering Electrical Engineering,* Installation and Contracting *Quality for IET Associate Membership

CACC Approved by CACC **Member of ABCC**

POST OR PHONE TODAY FOR FREE BOOKLET

Please send me your FREE School of Electronics Prospectus.
Subject of Interest _____
Name _____
Address _____



Post to: Dept H268
ICS School of Electronics
160 Stewarts Road
London SW8 4UJ

01-622 9911
(All Hours)

ELECTRONIC KITS

ALL NEW
to the
VELLEMAN
RANGE

Velleman electronic kits have gained respect for their high quality and the varied range which covers many applications in the vast field of electronics. All kits are designed and developed using the latest technology, giving them appeal, not only to the hobbyist and enthusiast but also to the experienced engineer.

The fully illustrated Velleman Kit Journal is available free of charge upon request and has full technical specification on each kit in the range. All kits are graded by difficulty from 1 to 3 and can be purchased direct or from the stockists listed below.

... and remember, we have a 'rescue service' for instances where enthusiasm exceeds ability!



K2584 - Precision timer
(timing from 1 sec
to 99 mins 99 secs.)
Actual size: 235 x 110mm

K2586 - Serial Controller/ Emulator
(designed primarily for use with
K2578 Velleman Eprom programmer)
Actual size: 100 x 160mm.

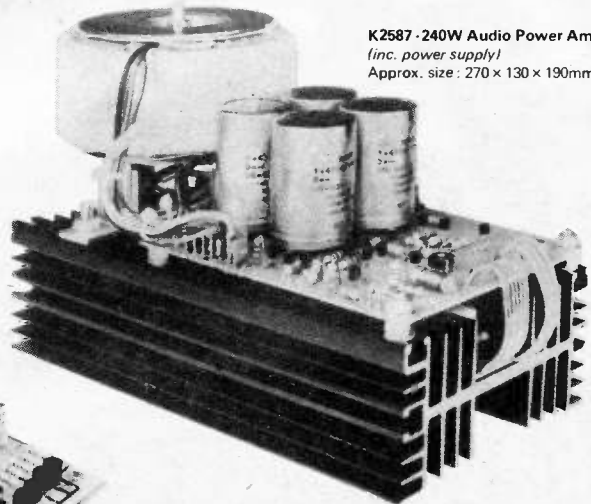
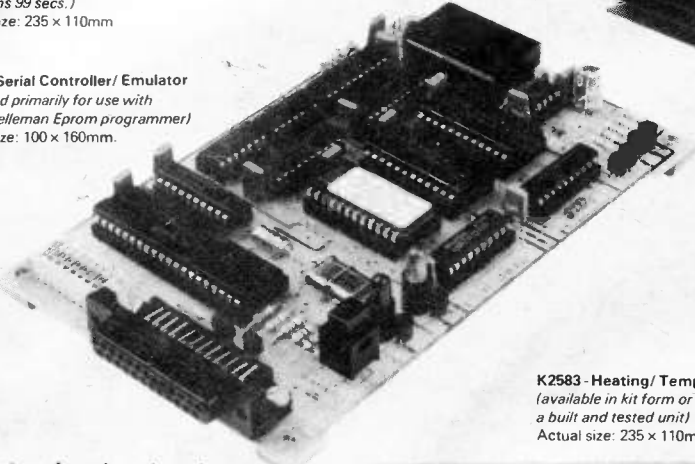

K2587 - 240W Audio Power Amplifier
(inc. power supply)
Approx. size: 270 x 130 x 190mm high

K2583 - Heating/ Temperature Controller
(available in kit form or as
a built and tested unit)
Actual size: 235 x 110mm

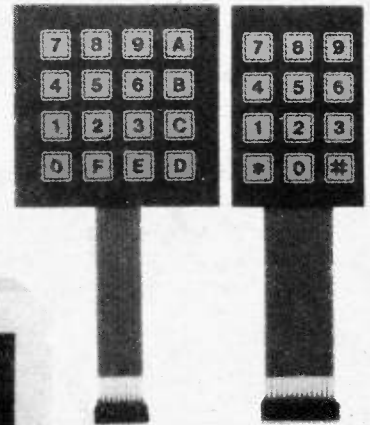

KBS16 and KBS12 - Membrane Keypads
(available with
or without legend)
Actual size:
65 x 100mm
100 x 100mm

**OTHER NEW KITS
recently introduced**

- K2580 Electronic powerswitch dimmer
- K2581 Stereo volume and tone control
- K2582 Stereo audio input selector
- K2585 Codeclock
- K2588 3 Channel sound to light unit

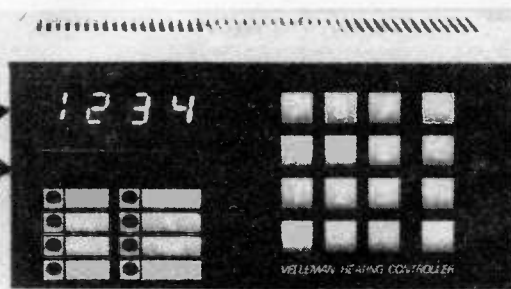

VELLEMAN UK. Ltd

P.O. Box 30, St. Leonards-on-Sea,
East Sussex TN37 7NL, England.

Telephone: (0424) 753246



VELLEMAN STOCKISTS

Baxol Tele Exports Ltd., Ballinaclesh, Post Rathdrum,
Co. Wicklow, Rep. of Ireland.
Bradley Marshall Ltd., 325 Edgware Road, London W2 1BN.
S & R Brewster Ltd., 86-88 Union Street, Plymouth, Devon.
Marshalls Electronics, 85 West Regent Street, Glasgow, Scotland.
Retail outlets are required in most major towns and cities.
Write for full details, including retail discounts.

FREE

SOLDERING IRON
with orders of
£25.00 and over
when accompanied
by this
voucher

Please send me your free catalogue of Velleman electronic kits:

Name:

Address:

EE

EE

T.V. SOUND TUNER BUILT AND TESTED



£24.95 + £2.00 p&p.

In the cut-throat world of consumer electronics, one of the questions designers apparently ponder over is "Will anyone notice if we save money by chopping this out?" In the domestic TV set, one of the first casualties seems to be the sound quality. Small speakers and no tone controls are common and all this is really quite sad, as the TV companies do their best to transmit the highest quality sound. Given this background a compact and independent TV tuner that connects direct to your Hi-Fi is a must for quality reproduction. The unit is mains operated.

This TV SOUND TUNER offers full UHF coverage with 5 pre-selected tuning controls. It can also be used in conjunction with your video recorder. Dimensions: 11½" x 8½" x 3¼". E.T.I. kit version of above without chassis, case and hardware. £12.95 plus £1.50 p&p.

PRACTICAL ELECTRONICS STEREO CASSETTE RECORDER KIT

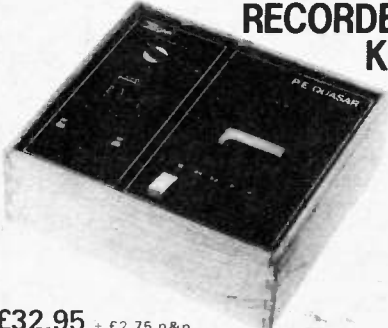

£32.95 + £2.75 p&p

• NOISE REDUCTION SYSTEM • AUTO STOP • TAPE COUNTER • SWITCHABLE E.O. • INDEPENDENT LEVEL CONTROLS • TWIN V.U. METER • WOW & FLUTTER 0.1% • RECORD PLAYBACK I.C. WITH ELECTRONIC SWITCHING • FULLY VARIABLE RECORDING BIAS FOR ACCURATE MATCHING OF ALL TAPES.

Kit includes tape transport mechanism, ready punched and back printed quality circuit board and all electronic parts, i.e. semiconductors, resistors capacitors, hardware - top cover, printed scale and mains transformer. You only supply solder and hook-up wire.

Featured in April issue P.E. Reprint 50p. Free with kit. Self assembly simulated wood sleeve - £4.50 + £1.50 p&p.

SPECIAL OFFER!
£31.00 plus £2.75 p&p
Complete with case.

BSR RECORD DECK

Manual single play record deck with auto return and cueing lever. Fitted with stereo ceramic cartridge 2 speeds with 45 rpm spindle adaptor ideally suited for home or disco.



13" x 11" approx. **£12.95** + £1.75 p&p.

SPECIAL OFFER! Replacement stereo cassette tape heads - £1.80 ea. Mono £1.50 ea. Erase 70p ea. Add 50p p&p to order.

STEREO CARTRIDGES



PHILIPS
Magnetic cartridge with diamond stylus. Model No. GP-397 III. Output: 2mV. Separation 22dB. Stylus 0.6mm diameter. **£3.95** each plus 60p P&P.

GARRARD

Sonotone Garrard Ceramic cartridge. 75mV. With turnover Sapphire stylus. **£2.95** plus 60p p&p.



HI-FI TWEETER BARGAIN

GOODMANS TWEETERS
8 ohm soft dome radiator tweeter (3¼" sq.) for use in up to 40W systems, with 2 element crossover. **£3.95** each (p&p £1) or **£6.95** pair (p&p £1.50)

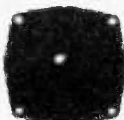

PERSONAL LS AMP KIT

Amplifier for your personal stereo cassette player as featured in January issue of Everyday Electronics. Turn your personal stereo into a mains powered home unit.



Parts: Stereo power amp PCB with all components, **£3.50** + 75p p&p. Power supply unit, **£1.95** + £1.50 p&p. Pair of 4½" elliptical speakers, **£1.50** the pair, + £1.00 p&p. Input & output sockets & plugs, **£1.50**. Recommended case (for the power supply and amp only), **£2.95** + 80p p&p. P&P inclusive price of **£1.75** for two or more articles.

VHF STEREO TUNER KIT



This easy to build 3 band stereo AM/FM tuner kit is designed in conjunction with Practical Electronics (July '81 issue). For ease of construction and alignment it incorporates three Mullard modules and an I.C. IF. System.

FEATURES: VHF, MW, LW Bands, interstation muting and AFC on VHF. Tuning meter. Two back printed PCB's. Ready made chassis and scale. Aerial: AM - ferrite rod, FM - 75 or 300 ohms. Stabilised power supply with 'C' core mains transformer. All components supplied are to strict P.E. specification. Front scale size: 10½" x 2½" approx. Complete with diagram and instructions.

*** SPECIAL OFFER! *** Self assembly simulated wood cabinet sleeve to suit tuner only. **£13.95** (w/out case) Finish size: 11½" x 8½" x 3¼". Plus £2.50 p&p. **£3.50** Plus £1.50 p&p.

SPEAKER KIT

2 WAY 10 WATT
8" bass/mid range and 3¼" tweeter. Complete with screws, wire, crossover components and cabinet. Cabinet comes in flat pre-mitred D.I.Y. form. Finish - chipboard covered wood simulate. size 14½" x 8½" x 4". **PAIR for ONLY £12.50** plus £1.75 p&p.



MONO MIXER AMP

Ideal for Church halls & Clubhouses. **£45.00** + £2.00 p&p.

50 WATT Six individually mixed inputs for two pick ups (Cer. or mag.), two moving coil microphones and two auxiliary for tape tuner, organs, etc. Eight slider controls - six for level and two for master bass and treble, four extra treble controls for mic. and aux. inputs. Size: 13½" x 6½" x 3¼" app. Power output 50 watts R.M.S. (cont.) for use with 4 to 8 ohm speakers. Attractive black vinyl case with matching fascia and knobs. Ready to use.

125W HIGH POWER AMP MODULES

£10.50 + £1.15 p&p (KIT)
£14.25 + £1.15 p&p (BUILT)

The power amp kit is a module for high power applications - disco units, guitar amplifiers, public address systems and even high power domestic systems. The unit is protected against short circuiting of the load and is safe in an open circuit condition. A large safety margin exists by use of generously rated components, result, a high powered rugged unit. The PC board is back printed, etched and ready to drill for ease of construction and the aluminium chassis is performed and ready to use.

Supplied with all parts, circuit diagrams and instructions. **ACCESSORY:** Stereo/mono mains power supply kit with transformer. **£10.50** plus £2.00 p&p.

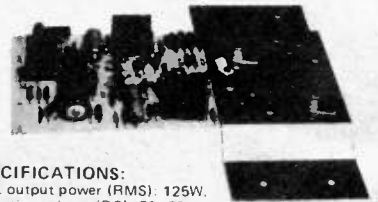

SPECIFICATIONS:

Max. output power (RMS). 125W.
Operating voltage (DC): 50 - 80 max.
Loads: 4 - 16 ohms.
Frequency response measured @ 100 watts: 25Hz - 20KHz.
Sensitivity for 100 watts: 400mV @ 47K.
Typical T.H.D. @ 50 watts, 4 ohms: 0.1%.
Dimensions: 205 x 90 and 190 x 36 mm.

STEREO CASSETTE DECK

Stereo cassette tape deck transport with electronics. Manufacturer's surplus - brand new and operational - sold without warranty.

£11.95 plus £2.50 p&p.

Just requires mains transformer and input/output sockets and a volume control to complete.

Supplied with full connection details.

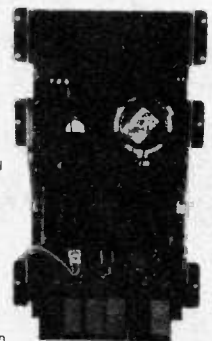

Matching AKG Microphone to suit (with speech and music filter). Complete with lead. **ONLY £9.95** plus 75p p&p.

All mail to:
21A HIGH STREET, ACTON W3 6NG.
Note: Goods despatched to U.K. postal addresses only. All items subject to availability. Prices correct at 30/5/83 and subject to change without notice. Please allow 14 working days from receipt of order for despatch. RTVC Limited reserve the right to up-

date their products without notice. All enquiries send S.A.E.

ALL CALLERS TO: 323 EDGWARE ROAD, LONDON W2. Telephone: 01-723 8432. (5 minutes walk from Edgware Road Tube Station) Now open 6 days a week 9 - 6. Prices include VAT.

Telephone or mail orders by ACCESS welcome.



EVERYDAY ELECTRONICS and computer PROJECTS

VOL. 12 NO. 6 JUNE 1983

Editor

F. E. BENNETT

Assistant Editor

B. W. TERRELL B.Sc.

Production and News Editor

D. G. BARRINGTON

Projects Editor

G. P. HODGSON

Technical Sub-Editor

R. A. HOOPER

Art Editor

R. F. PALMER

Assistant Art Editor

P. A. LOATES

Technical Illustrator

D. J. GOODING Tech. (CEI)

Secretary

JACQUELINE DOIDGE

Editorial Offices

KING'S REACH TOWER
STAMFORD STREET
LONDON SE1 9LS
Phone: 01-261 6873

Advertisement Manager

R. SMITH
Phone: 01-261 6671

Representative

R. WILLETT
Phone: 01-261 6865

Classified Supervisor

B. BLAKE
Phone: 01-261 5897

Make-Up and Copy Department

Phone: 01-261 6615

Advertisement Offices

KING'S REACH TOWER
STAMFORD STREET
LONDON SE1 9LS

HOLIDAY TRAIL

THOUGHTS of summer and holidays to come have prompted two projects for caravan users and campers which are featured this month.

In the months ahead we can confidently expect car-caravan combinations to become increasingly commonplace on our roads as motorists and their families feel the urge to get away from it all and explore remote off-beat places. It is one of life's little oddities that such intrepid travellers usually like to bring along with them some of the amenities of civilised life. This is not difficult in fact, since there are many examples of portable electrical and electronic equipment suitable for such trips and capable of being powered from a 12-volt supply.

It is not wise of course to impose excessive additional load on the car battery and the best course is to use a separate car battery installed inside the caravan to power equipment such as interior lights, refrigerators, cassette players, radios, TV sets or personal computers during overnight stops. (This arrangement is not suitable for long stays at holiday sites.) The extra battery can be recharged from the car generator whilst travelling. Circuitry to permit this kind of operation without any harm to the car's normal electrical system is described in the article *Caravan Power Supply*.

Many caravanners as well as tent campers take with them a small absorption-type refrigerator powered from a gas cylinder. There is always the possibility of the gas supply becoming exhausted unexpectedly or some other fault developing with the resultant loss of foodstuff. A simple warning device powered by its own 9V battery will eliminate this danger. The *Caravan Fridge Alarm* may be built with either a visual or audible alarm and is operative when touring or at a fixed site.

Security is a matter for concern the whole year round, and electronic devices are being resorted to more and more in order to frustrate attempts at unauthorised entry. The *Push Button Combination Lock* described in this issue, when used with the recommended electrically operated lock release, will provide alternative means to unlock a cylinder-type lock whilst retaining the normal key operation. It will meet various needs, for example where a number of persons require access to premises but the issuing of keys to all individuals is not practical nor desirable. Being battery operated, the combination lock and associated release mechanism are immune from mains failures.

A word about next month's EVERYDAY ELECTRONICS. Our new series *Microcomputer Interfacing Techniques* will be a must for all computer enthusiasts. This important series will explain how to get the most from your computer by linking it to the outside world. Appropriate electronic hardware will be described in each part. As each part will be vital to the whole do make sure of your copy every month by placing an order with your newsagent.

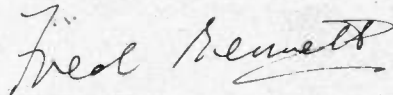

Readers' Enquiries

We cannot undertake to answer readers' letters requesting modifications, designs or information on commercial equipment or subjects not published by us. All letters requiring a personal reply should be accompanied by a stamped self-addressed envelope.

We cannot undertake to engage in discussions on the telephone.

Component Supplies

Readers should note that we do not supply electronic components for building the projects featured in EVERYDAY ELECTRONICS, but these requirements can be met by our advertisers.

All reasonable precautions are taken to ensure that the advice and data given to readers are reliable. We cannot, however, guarantee it and we cannot accept legal responsibility for it. Prices quoted are those current as we go to press.

Back Issues

Certain back issues of EVERYDAY ELECTRONICS are available worldwide price £1.00 inclusive of postage and packing per copy. Enquiries with remittance should be sent to Post Sales Department, IPC Magazines Ltd., Lavington House, 25 Lavington Street, London SE1 0PF. In the event of non-availability remittances will be returned.

Binders

Binders to hold one volume (12 issues) are available from the above address for £4.60 inclusive of postage and packing worldwide. Please state which Volume.

Subscriptions

Annual subscription for delivery direct to any address in the UK: £12.00. Overseas: £13.00. Cheques should be made payable to IPC Magazines Ltd., and sent to Room 2613, King's Reach Tower, Stamford Street, London SE1 9LS.

EPROM PROGRAMMER TRS-80 & GENIE

A PORT-BASED SYSTEM DESIGNED FOR USE WITH A HOST COMPUTER TO PROGRAM +5V RAIL 1K, 2K AND 4K BYTE EPROMS



BY B.W. TERRELL B.S.c. & J.W. TERRELL M.S.c.

THE EE124 Eprom Programmer has been designed to be used with a host computer to program single supply rail EPROMS. Two versions are described in this article (i) for use with the TRS-80 Model 1 Level II microcomputer (ii) for use with the Video Genie, Genie I and II microcomputers. The construction of the units has been tailored to allow them to be easily connected to the computer using the system bus expansion cable. The prepared software is suitable only for these machines.

Although specifically designed for use with these models, the hardware may be used with other computers providing certain system signals are accessible and that suitable software is developed. It is expected that the only hardware modification needed for use with other Z80 based computers is to configure the finger sets, by means of an adaptor or a custom built cable/connector to align with the configuration of the system bus of the chosen computer. The signals that need to be accessible are: D0 to D7, A0 to A7, 0V, IN, OUT for use with the TRS-80 version. If IN and OUT are not available, but IORQ, RD, WR are, then the Genie version can be used. Users will of course have to develop their own software.

The EE124 plus TRS-80 or Genie can program the EPROMS listed in Table 1 which also gives the required setting of the MODE switch.

The pinning details for the EPROMS in Table 1 are given in Fig. 1.

SYSTEM DESCRIPTION

The EE Eprom Programmer comprises:

- (i) Programmer Logic Unit (PLU)
- (ii) EE124 Software cassette (T004)

Programmer Logic Unit

Access to the PLU is through a double sided p.c.b. connector set projecting through a slot in the front panel. The 20 + 20 (TRS-80) and 25 + 25 (Genie) fingers allow direct connection to these computers using the system bus expansion cable.

The PLU is equipped with the following facilities:

(a) A 24-pin Zero Insertion Force socket. This allows an EPROM to be inserted or removed from the socket without applying any pressure to the pins. The EPROM should be placed in the socket with the lever in the vertical position. Moving the lever to the horizontal position causes the socket contacts to securely grip the EPROM pins and make good electrical contact with all pins. To remove an EPROM, return the lever to the vertical position. It may then be easily lifted out of the socket.

(b) An EPROM power supply isolating switch. This is labelled HOT-SAFE. When in the SAFE position the 0V, +5V and +25V supply lines to the socket are interrupted to allow the EPROM to be safely removed or inserted. If an EPROM is removed from, or inserted into, a HOT

socket, it may become permanently damaged.

(c) A two position MODE switch. When programming or reading EPROMs, the MODE switch must be set to A or B according to the EPROM type, see Table 1.

SOFTWARE

The EE124 Software is written in Z80 machine code and is suitable for use on the TRS-80 Model I Level II and Video Genie, Genie I and II microcomputers. It has many powerful features. Editing is particularly easy, with 256-byte page display, single interpage keystroke and full cursor control. The software is compatible with EDTASM so that object code prepared by EDTASM can be loaded and programmed quickly.

The commands provided are:

BURN COPY EXIT FILL LOAD MEMORY
NEW PAGE READ SAVE TEST ZERO

PRINCIPLE OF OPERATION

A block diagram illustrating the principle of operation of the EE124 Eprom Programmer is shown in Fig. 2.

It can be seen that the system is port based and has three latched OUT ports (252, 253 and 254) and one IN port (253). Once the MODE has been manually selected, the system is completely under software control. The mode referred to above has no connection with the two EPROM modes of operation described below.

Read Mode

In the read mode, the address and control data are clocked into the appropriate latches via the host computer data bus. Latch 253 output is disabled by a control line from latch 252.

When an IN signal is generated (active low), the IN port is enabled and the corresponding EPROM data read into the host computer. Successive EPROM locations are read until halted by software.

Program Mode

In the program mode, both the EPROM address and the data to be programmed reach the EE124 via the host computer data bus. The low order address, high order address plus control data, and program data are sequentially clocked into the port latches.

A number of control cycles are then executed in which control data is sequentially clocked into port latch 252 to produce the following order of events:

- (1) +25V to V_{pp}
- (2) PGM pin to appropriate program level
- (3) maintain this level for 50ms
- (4) return PGM pin to previous level
- (5) remove +25V from V_{pp}
- (6) read and verify

The above steps are repeated until either the last location is programmed or a verification error occurs, whereupon the system returns to command mode.

The assignment of the bits for each port are detailed in Table 2.

CIRCUIT DESCRIPTION

The complete circuit diagram of the Programmer for use with the TRS-80 computer is shown in Fig. 3b. The signals from the computer expansion slot reach the circuitry via the 40-way expansion cable.

The TRS-80 (and Genie) employs the Z80 microprocessor. Besides being able to address up to 64K memory locations, the Z80 also produces control signals and addresses to service up to 256 8-bit wide I/O ports.

The four Z80 signals for providing these and other control signals are MREQ (memory request), IORQ (input/output request), RD (read) and WR (write). Only four combinations of these outputs are allowed:

\overline{RD} \overline{MREQ} \overline{WR} } **READ** from memory
WRITE to memory

\overline{RD} \overline{IORQ} \overline{WR} } read from port \overline{IN}
write to port \overline{OUT}

It is the latter, \overline{IN} and \overline{OUT} which are used in this design. In the TRS-80, these two signals are generated on board and made available at the expansion slot. These signals are active low (indicated by

Table 1. Eproms accommodated by the EE124 Eprom Programmer

Type No.	Manufacturer	Organisation	Mode
TMS2758-0 TMS2508 2758	Texas Texas Intel	1K x 8	A A A
TMS2516 2716 S4716 2716 MB8516 HN462716 MK2716 MCM2716 MM2716 uPD2716 2716 SY2716 TMM323 M5L2716	Texas Intel AMI AMD Fujitsu Hitachi Mostek Motorola National NEC Signetics Synertek Toshiba Mitsubishi	2K x 8	A A A A A A A A A A A A A A
TMS2532 TMS25L32 HN462532 MCM2532	Texas Texas Hitachi Motorola	4K x 8	A A A A
2732 HN462732 M5L2732 MB8532	Intel Hitachi Mitsubishi Fujitsu	4K x 8	B B B B

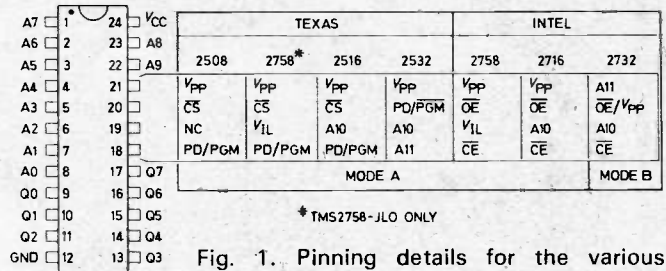

Fig. 1. Pinning details for the various EPROMs accommodated by the Programmer.

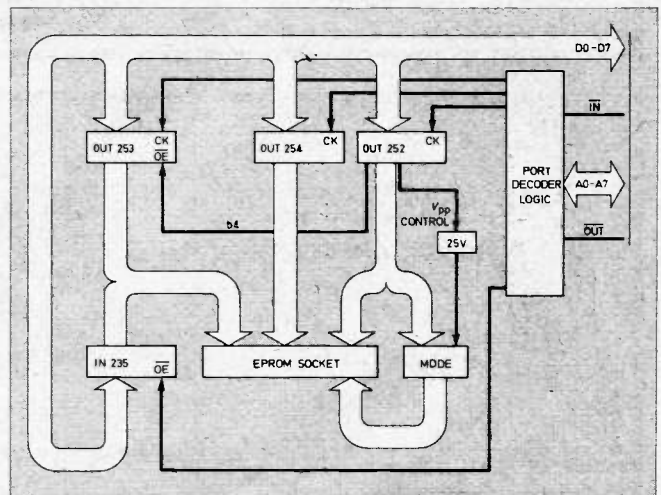

Fig. 2. Block diagram showing system operation.

Table 2. Selecting ports

Address bus during I/O cycle			Port Selected
A0	A1	A2 to A7	
0	0		252
0	1		253
1	0		254
1	1		255

Table 3. Truth table for 74LS139 (IC2)

Select inputs		Output control (OE)	$\overline{Q0}$	Outputs		
A	B			Q1	Q2	Q3
X	X	1				
0	0	0	0	1	1	
0	1	0	1	0	1	
1	0	0	1	1	0	
1	1	0	1	1	0	

X means don't care.

the "bar"), which means that when they are selected they are set to logic 0. Every time a port is selected, either **IN** or **OUT** goes to logic 0 (depending on direction of data transfer). At all other times they are at logic 1.

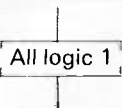
During an \overline{IN} and \overline{OUT} , the port address is placed on the lower half of the address bus (A0 to A7) and data read from or written to the port via the data bus in the usual way.

The ports chosen for this design are 252, 253 and 254 which allows a very simple and unique decoding to be implemented, and these are of course not in use by the TRS-80 or Genie systems.

When ports 252 to 255 are addressed, bits A2 to A7 are at logic 1. These six signals reach the inputs of IC1, an 8-input NAND gate. Only when all inputs are at logic 1 does the output go to logic 0. For all other combinations the output remains at logic 1. IC1 output is used as a control signal for IC2.

The precise port being addressed in this range is determined by the levels on A0 and A1, see Table 2. These address lines reach the select inputs of IC2, a 2-to-4-line decoder. This chip has 3-state outputs: the two logic levels 1 and 0 and a third high impedance (Hi-Z) state which produces the same effect as physically disconnecting the outputs (Q0 to Q3) from the circuitry.

IC2 outputs are in the Hi-Z state when its \overline{OE} control is at logic 1. Taking this pin to logic 0 allows the outputs to assume the logic levels selected by A0 and A1. The truth table for IC2 is given in Table 3. Port 255 (Q3) is not used.

The three outputs from IC2 reach inputs of NOR gates (IC3); **IN** and **OUT** also reach the appropriate IC3 gates. The outputs from IC3 provide the control signals for the following latches and buffer (IC5 to IC7 and IC8).

IC5, 6 and 7 are octal D-type latches. The information reaching the eight inputs is transferred and latched into the eight outputs by a positive going (low-to-high) pulse edge to the clock (CK) input. All inputs receive information from the data bus.

Suppose for example the CPU is **OUT**-putting to port 252. The port address appears on the lower half of the address bus with data to be sent out on the data bus. As A0 and A1 are at logic 0, output Q0 is selected. A2 to A7 are all at logic 1 so IC1 output drops to logic 0 and this enables the outputs of IC2. **OUT** goes low later in the output cycle after time has been allowed for the data and address buses to stabilise. So initially a logic 0 reaches IC3a pin 12 and a logic 1 is on pin 11. Consequently the output of IC3a is at logic 0.

When \overline{OUT} goes low, the output of

IC3a then goes high. This reaches the CK input of IC5 and the data bus information is clocked through and latched into the outputs of IC5. IC6 and IC7 operate in a similar manner.

Port 253 is wired as a bi-directional port, that is to say the CPU is able to read from (**IN**) and write to (**OUT**) this port address. The **OUT** section is IC7 with decoded control, and IC8 provides the **IN**. IC7 and IC8 are wired in anti-parallel.

Fig. 3a. Expansion bus contacts and additional circuitry (IC10) required by the Genie microcomputer.

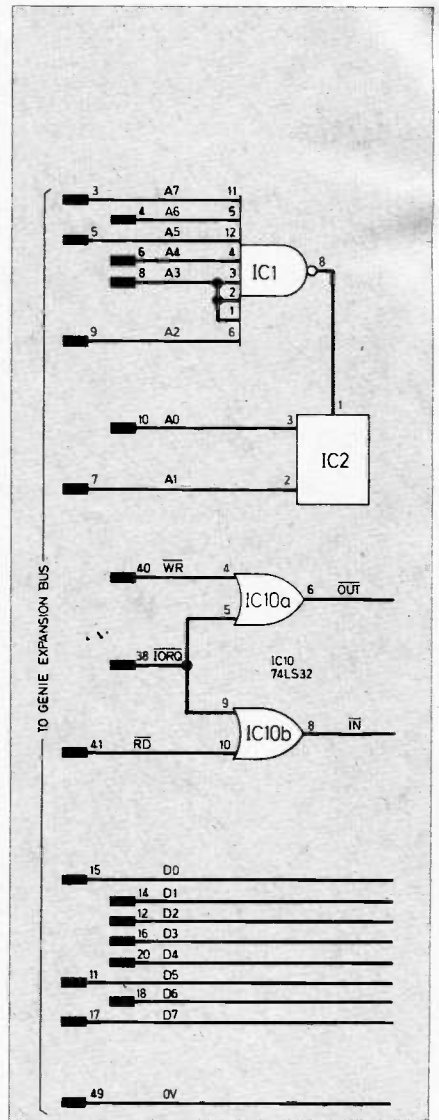

Table 4. Assignment of the ports

Host Computer Data Bus	Port 253 Data (IN & OUT)	Port 254 Low order address (OUT)	Port 252 (OUT) High order address and control			
			Mode A		Mode B	
			1K x 8	2K x 8	4K x 8	4K x 8
bit 0	D0 (9)	A0 (1)	A8 (23)	A8 (23)	A8 (23)	A8 (23)
bit 1	D1 (10)	A1 (2)	A9 (22)	A9 (22)	A9 (22)	A9 (22)
bit 2	D2 (11)	A2 (3)	VOL (19)	A10 (19)	A10 (19)	A10 (19)
bit 3	D3 (13)	A3 (4)	PGM (18)	PGM (18)	A11 (18)	A11 (21)
bit 4	D4 (14)	A4* (5)				
bit 5	D5 (15)	A5** (6)				
bit 6	D6 (16)	A6 (7)	CS (20)	CS (20)	PGM (20)	CE (18)
bit 7	D7 (17)	A7 (8)	V _{pp} (21)	V _{pp} (21)	V _{pp} (21)	V _{pp} /OE (20)
			Texas 2532	Intel 2732		

Notes

Numbers in parentheses are EPROM socket pin positions.

** Not used * Controls OE of OUT PORT 253.

VOL represents logic 0.

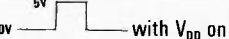
PGM 50 millisecond high pulse,  with V_{pp} on

PGM 50 millisecond low pulse,  with V_{pp} on

V_{pp} 25V supply: 0 — off, 1 — on

IC8 is connected as an octal buffer with tri-state outputs. Its outputs are enabled by providing a logic 0 to its OE pins (1 and 19). Similar circuitry to the OUT ports is employed but here the decoded address signal and \overline{IN} reach NOR gate IC3d. What is really required here is an OR gate to give a logic 0 to pins 1 and 19 when IN253 is requested. To make convenient use of the local "spare" NOR gate in the IC3 package, an inverter is used to follow IC3d to construct the required OR function. Thus when the decoded address control signal goes to logic 0 and \overline{IN} falls to logic 0, IC8 is enabled and connects the EPROM data outputs to the computer data bus.

To program (burn) an EPROM location, the address of the location and the data to be burned must be presented to the appropriate EPROM address and data pins. Next +25V needs to be connected to the V_{pp} pin and then a 50 millisecond pulse of the correct polarity fed to the programming pin.

Bit 7 of port 252 controls the +25V supply line, a logic 1 turns it on, a logic 0

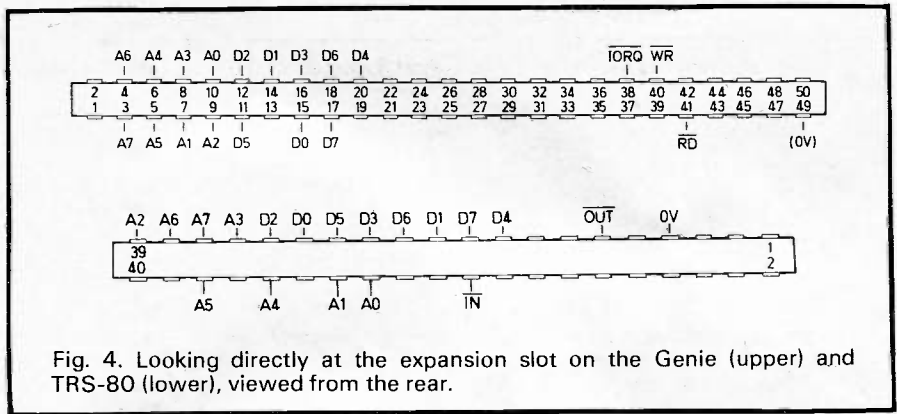

Fig. 4. Looking directly at the expansion slot on the Genie (upper) and TRS-80 (lower), viewed from the rear.

turns it off. The address is sent to the EPROM via IC6 (A0 to A7), and IC5 (A8 to A11). The data is sent via IC7. Control signals to present the 25V and programming pulse are sent via IC5 upper half.

The control signals for the EPROMs listed in Table 1 vary in several respects as can be seen in Fig. 1. To accommodate the different organisations and memory

size it was found necessary to include a manually operated MODE switch, S1, in the design. The position of S1 in conjunction with software produces the required result.

To read an EPROM location and IC5 and IC6 provide the address and control information and IC8 provides the link to the data bus.

Fig. 3b. Circuit diagram of the TRS-80 version of the Programmer.

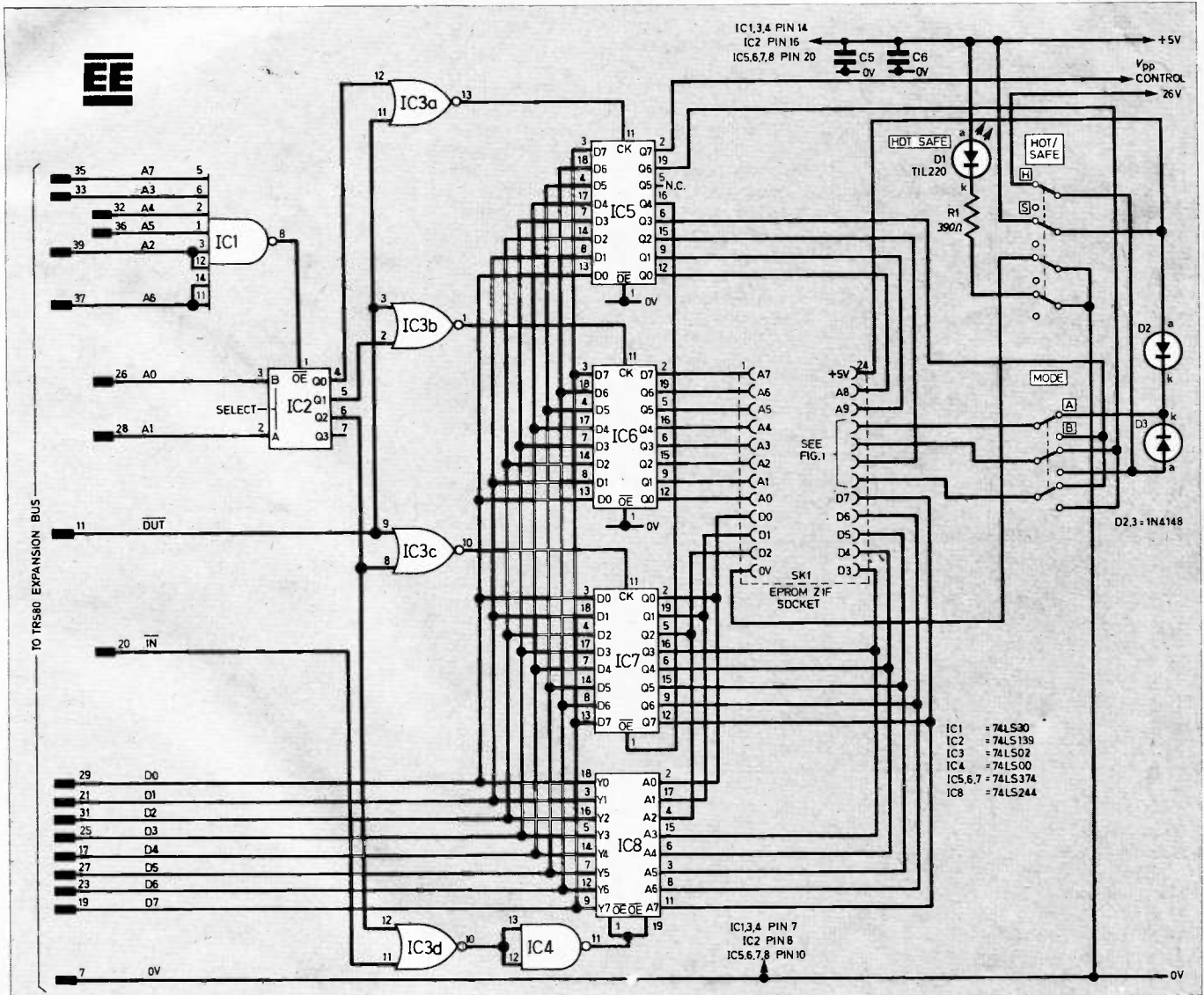

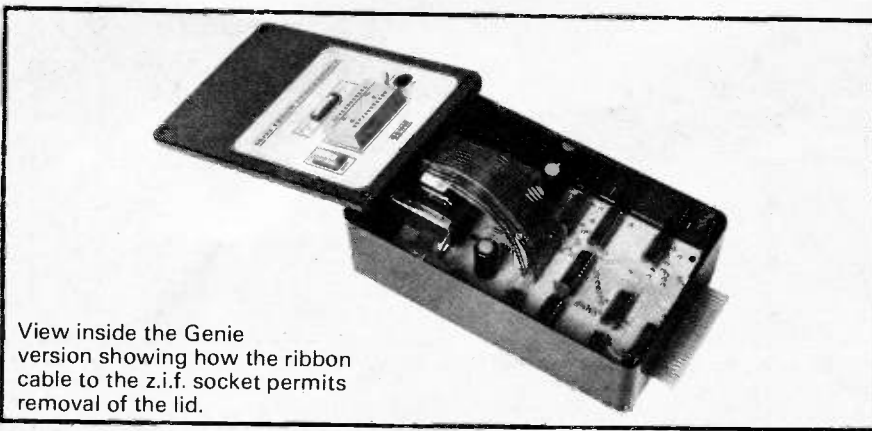

View inside the Genie version showing how the ribbon cable to the z.i.f. socket permits removal of the lid.

An EPROM should not be removed from or inserted into a powered up socket (hot socket). S2 functions as a HOT-SAFE switch. In the SAFE position the 0V, 5V and 25V supply lines to the socket are interrupted. Light emitting diode D3, lit when the socket is HOT, provides an immediate visual indication of the switch position.

The Genie microcomputers (Video Genie, Genie I and II) do not provide IN and OUT at their expansion slots. They do provide the CPU signals, IORQ, RD and WR which allows IN and OUT to be derived. The circuitry for doing this is given in Fig. 3a. The IN and OUT outputs are to connect to the IN and OUT inputs in the main circuit diagram, Fig. 3a, to produce the complete circuit diagram for use with the Genie microcomputers.

The edge contacts for the two computer types are given in Fig. 4.

POWER SUPPLY

The power supply section of the Programmer is shown in Fig. 5. It

produces +5V and +26V and is mains powered.

The 240V a.c. mains voltage enters the unit and appears across T1 primary. There are two secondary windings, each rated at 9.5V 320mA. One voltage winding is half-wave rectified by D8 and then smoothed by C5. This provides a raw d.c. input to monolithic voltage regulator, IC9. The output from this device is a stabilised +5V with in-built short circuit protection.

The other secondary winding feeds a voltage doubling and smoothing circuit composed of D6, D7, C3 and C4. This produces a raw d.c. level of about 30V at maximum V_{pp} load. This is applied to the collector of TR1 and feeds Zener diode D4 (27V) through its series resistor R3. The base emitter drops approximately 0.7V to give about 26V at its emitter. This is the supply to V_{pp} through S2 and S1.

This output stage is turned on (supplying 26V) or turned off (output is 0V) by the electronic switch composed of TR2 and TR3 and local components. The control signal for the switch comes from the software via bit 7 of IC5. A logic 1 to V_{pp}

CONTROL turns on TR3 and its collector drops to near 0V. TR2 is therefore off and is effectively disconnected from D4.

If now a logic 0 is presented, then TR3 is turned off. TR2 is now free to turn on via base bias resistor R4 and TR2 collector falls to near 0V. D4 is thus shunted and TR1 is held off so there is no voltage at TR1 emitter. R2 straps TR1 emitter to 0V in this condition.

HARDWARE

Both versions of the Programmer described here are constructed using two printed circuit boards. The larger board in each case is a double-sided type, that is to say, there is a track pattern on each side of the board. Interconnections are required between the two sides at numerous places. Track pins are made specially for such a connection and their use is strongly recommended for this project. These pins are tapered with heads. The board should be drilled 1mm diameter at these positions for the specified pin.

The through-the-board connections are at each of the pad positions seen on the board topside. Track pins are used in all but four places, where the component lead is used instead. These are the decoupling capacitors C1 and C2 which of course must be soldered on both sides of the board.

The p.c.b.s, supports and components have been tailored to suit the inexpensive but robust Vero General Purpose Plastic Box size 180 x 110 x 55mm.

The board is supported on snap-fixing 6mm long plastic stand-off pillars fitted to the base of the case. These require a 3.8mm diameter hole drilled in the board and a 5mm diameter hole drilled in the case.

A slot is required in the front end of the case to accommodate the protruding finger set. A shaped hole is needed in the rear end to allow the mains cable to pass to the board via a strain relief bush. This securely grips the cable and prevents any strain being exerted at the soldered connection to the board.

The second smaller p.c.b. is a single-sided board. It holds the two switches and the z.i.f. socket and local components and is screwed to the underside of the lid using four 6BA fixings. Three rectangular cut-outs are required in the lid to suit the z.i.f. socket and the switches. A hole is also required to accommodate the panel mounted l.e.d.

Begin construction by preparing the case. Full details are given in Figs. 6 to 8. The plastic is very easy to cut and file.

PRINTED CIRCUIT BOARDS

It is assumed that the drilled printed circuit boards have been obtained from the *EE Printed Circuit Board Service* with all holes drilled to suit the specified components.

Remove the two top corner cut-outs using a small hack-saw and then file smooth up to the border line so as to just remove it. Position the board (right-way

Fig. 5. Circuit diagram of the mains derived power supply of the Programmer.

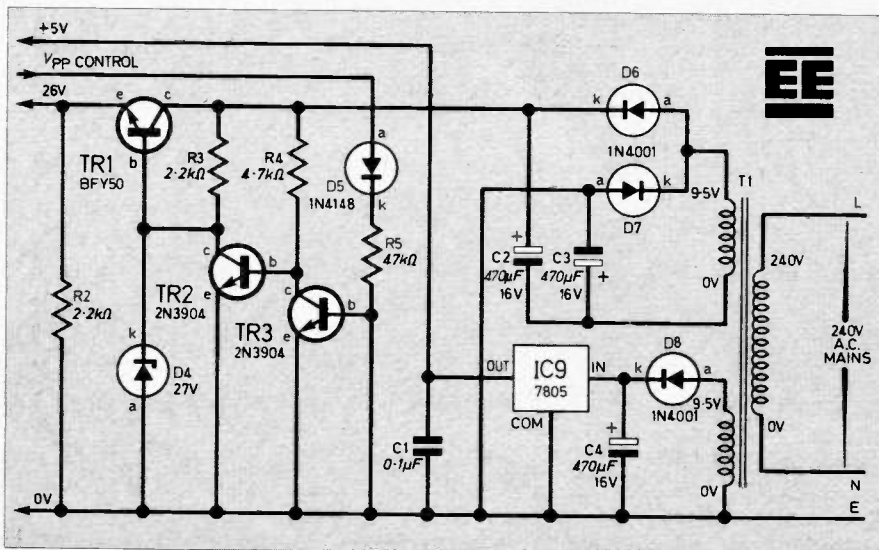

up) on the underside of the case and use the four board fixing holes to drill pilot holes in the case for the corresponding base fixing holes. Enlarge the case holes to 5mm diameter. Slightly countersink both sides of these four holes.

Push the plastic pillars into the case holes and then check that the board fits onto the pillars and the finger set protrudes through and clears the slot. If all is well remove the board and make ready for assembly.

ASSEMBLY

All components are fitted to the board topside as can be seen in the layout diagrams, Fig. 9 (for TRS-80 version) and Fig. 10 (for Genie version). Begin by inserting all the track pins. You will find it easier to push these in from the topside as all topside pad positions are through-the-board interconnection points.

Remember to leave the four holes for C1 and C2, to be fitted later. Push the pins firmly into the board. Solder all pin topsides, turn over and solder all pin undersides. A small diameter bit is recommended for most of the soldering on this board, about 1.5mm diameter.

Next insert the i.c. sockets and solder. Check for solder bridges as you proceed. An eye glass will be especially useful for this purpose.

Now position and solder all other low profile components: resistors, diodes and IC9 followed by the transistors and decoupling capacitors, C1, C2 and C6. Remember to solder C1 and C2 to top and underside. The electrolytic capacitors may next be inserted paying attention to polarity and finally fit and solder in T1. Prepare a length of mains cable 3-core and connect to the board according to layout diagram.

POWER SUPPLY CHECK

The assembly should now be thoroughly inspected, checking for possible solder bridges, unsoldered pins, correct orientation of diodes, transistors and capacitors. When you are satisfied, the power supply section should be checked. It is a good idea while testing to sit the board in its case with finger set protruding through the slot. This lessens the possibility of inadvertently touching the p.c.b. underside tracks carrying mains voltage.

Plug in and switch on at the mains. Identify the 0V and +5V rails and check that the voltage is at or very close to +5V.

Attach a short length of fine wire to your voltmeter probes and check that there is 5V between each V_{cc} and GND pin position at each socket. Too stout a wire has been found to excessively open the socket contact such that it is unable to make contact with the i.c. pin when inserted.

You should measure about 30V or more between 0V and TR1 collector. There should be no output at TR1 emitter. A lead connected between the free

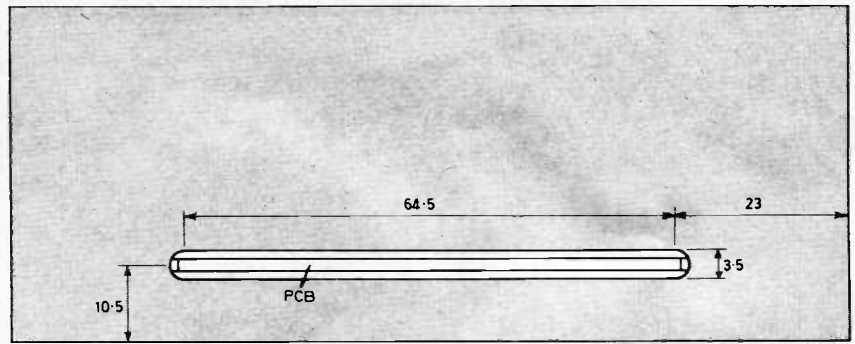

Fig. 6. Slot to be cut in the case front panel to suit the Genie version p.c.b. (830602).

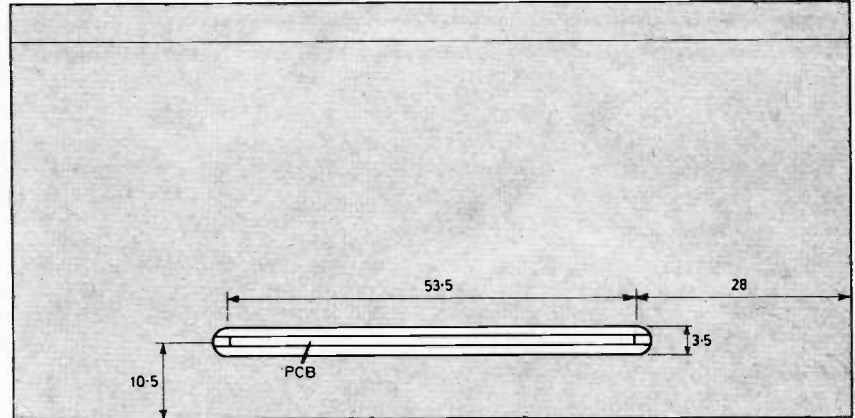

Fig. 7. Slot to be cut in the case front panel to suit the TRS-80 version p.c.b. (830601).

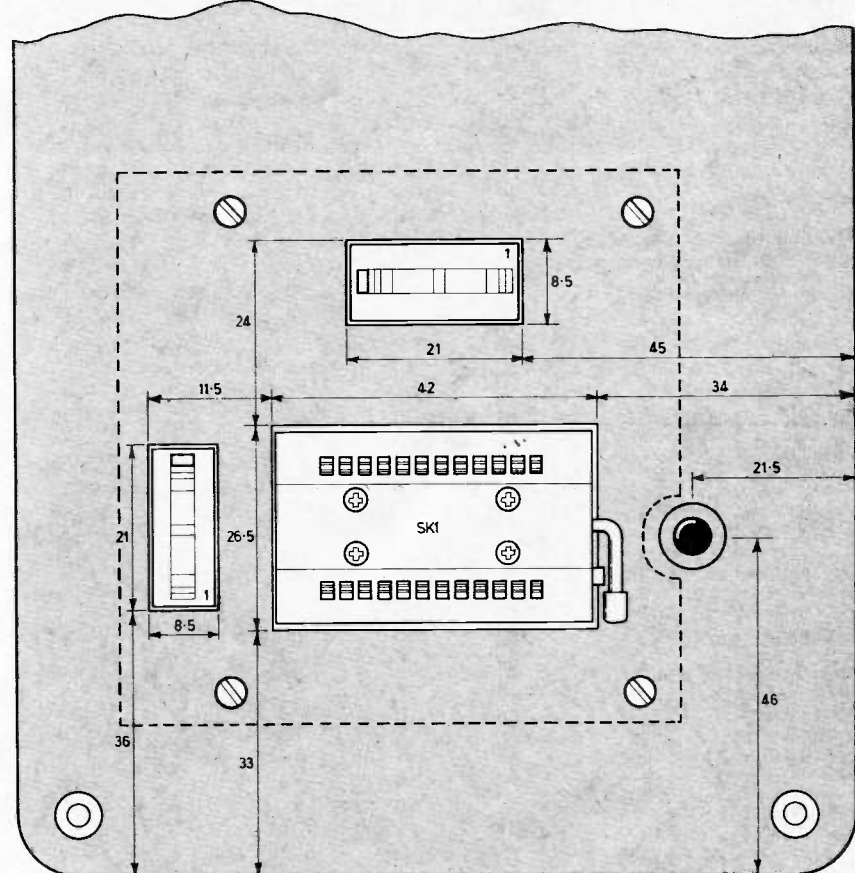
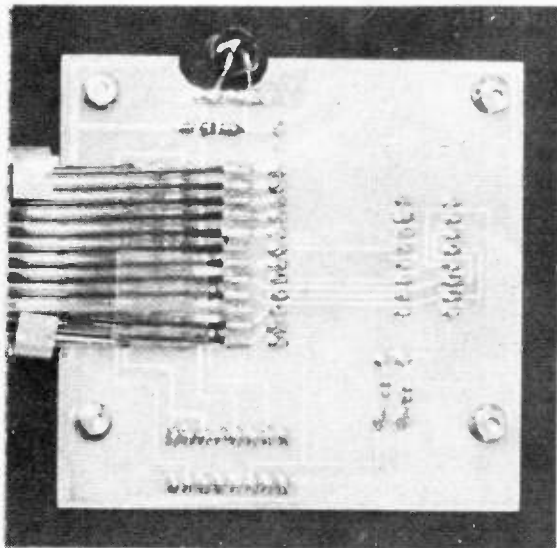

Fig. 8. Cut-out dimensions of the case lid to suit the p.c.b. (830603) and specified components. Note the orientation of the switches.

TRS-80 EPROM PROGRAMMER



The fitted top board fully populated showing ribbon cable running to lower board through a cable gripper.

COMPONENTS

Resistors

R1	390Ω
R2	2.2kΩ
R3	2.2kΩ ½W
R4, R5	47kΩ (2 off)
All ½W carbon ±5% except where stated otherwise	

Capacitors

C1	0.01μF ceramic
C2-C4	470μF 16V elect. radial (3 off)
C5, C6	0.1μF plastic or ceramic (2 off)

Semiconductors

D1, D2	1N4148 small signal silicon (2 off)
D3	TIL220 red l.e.d.
D4	BZY88C27 27V 400mW Zener diode
D6-D8	1N4001 1A 50V rectifier (3 off)
D5	1N4148 small signal silicon

TR2, TR3	2N3904 silicon <i>npn</i> (2 off)
TR1	BFY50 silicon <i>npn</i>
IC1	74LS30 TTL 8-input NAND gate
IC2	74LS139 TTL Dual 2-to-4 line decoder (3-state)
IC3	74LS02 TTL Quad 2-input NOR gates
IC4	74LS00 TTL Quad 2-input NAND gates
IC5-IC7	74LS374 TTL Octal D-type flip-flops (3-state) (3 off)
IC8	74LS244 TTL Octal buffers (3-state)
IC9	7805 5V 1A monolithic voltage regulator TO-220 package
IC10	74LS32 TTL Quad 2-input OR gates (Genie only)

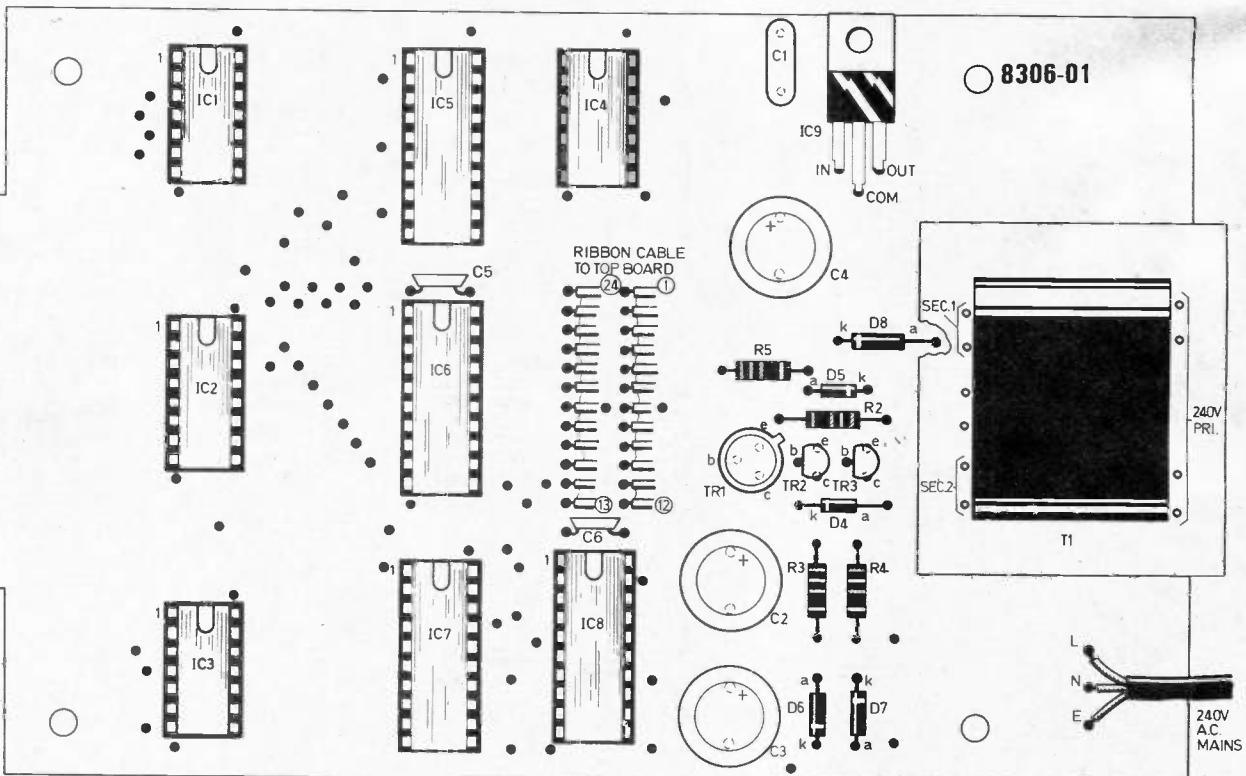

Fig. 9. Layout of the components of the topside of the TRS-80 version p.c.b. The black "dots" indicate the positions of the track pins to be soldered to both sides. Note that C5 and C6 are to be soldered top and underside.

GENIE EPROM PROGRAMMER

Miscellaneous

- S1, S2 4-pole 2-way d.i.l. switches (type DS16A 4-2) (2 off)
 SK1 24-pin d.i.l. Zero Insertion Force Socket (type W3924-10)
 T1 Mains primary/0-9.5V, 0-9.5V 320mA secondaries (type P0609)

Printed circuit boards: double-sided size 180 x 104mm Order Code: 8306-01 (TRS-80), 8306-02 (Genie); single-sided size 89 x 89mm Order Code: 8306-03; d.i.l. sockets: 20-pin (4 off), 16-pin (1 off), 14-pin (3 off, TRS-80), (4 off, Genie); plastics case Vero type 202-21391A; 1mm track pins (66 off, TRS-80), (79 off, Genie); 6mm long plastic stand-off pillars (Verospeed type 226-22549H) (4 off); self-adhesive rubber feet (4 off); mains cable strain relief bush; 6BA countersunk screws and

nuts, washers (4 sets); 3-core mains cable, 1m; 10-way flexible jumper link cable, 3 x 6 inch lengths (Verospeed type 226-22549H).

Software

T004 cassette: EE124 Eprom Programmer (TRS-80 & Genie)

COMPONENTS
 approximate
 cost **£35** excluding software

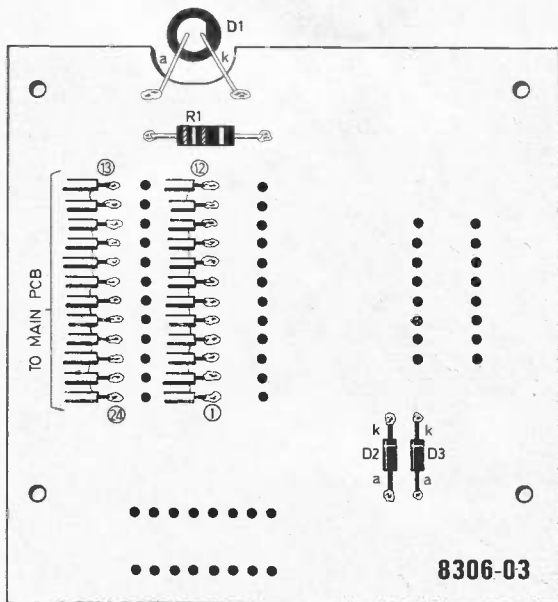

Fig. 11. Shows the components soldered to the "underside" of the top p.c.b. and ribbon cable connection points. For TRS-80 and Genie versions.

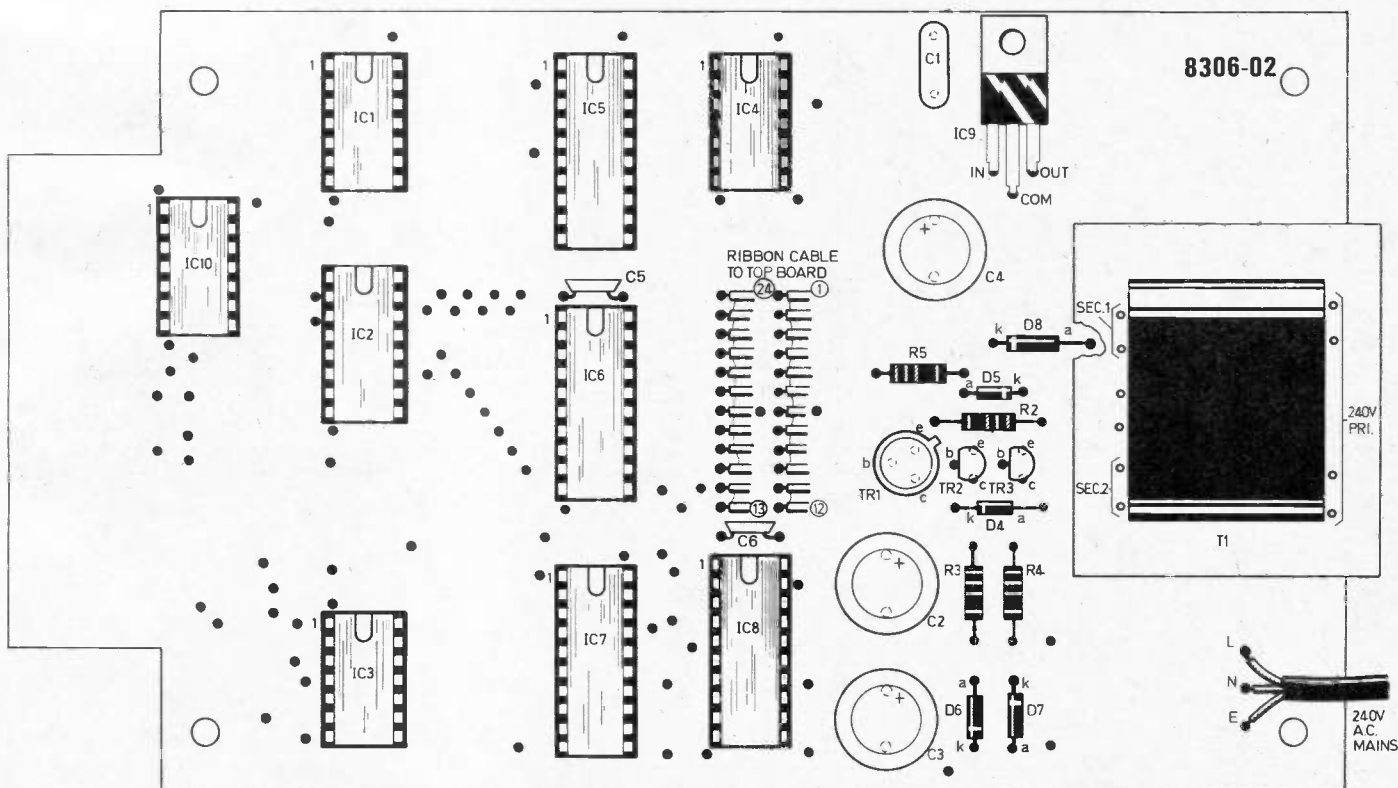

Fig. 10. Layout of the components on the topside of the Genie version p.c.b. The black "dots" indicate the positions of the track pins to be soldered to both sides. Note that C5 and C6 are to be soldered top and underside.

end of R5 and +5V should cause TR1 emitter voltage to become about 26V. If the above results are not obtained, switch off, investigate and remedy before proceeding.

If all is satisfactory, unplug the unit from the mains and connect the inter-board wiring cable. In the prototype, webbed 0.1 inch pitch ready-stripped and tinned cable was used. This is normally available in 10-wide lengths, and is very flexible. The two additional pairs were cut from a third length. Trim off excess from board underside.

The i.c.s may now be inserted. They all face the same way. Fit rubber feet at each corner of the case and push the board firmly onto its supports. Feed the mains cable through its exit hole, but do not fit the strain relief bush yet.

Prepare the case lid to accept the top panel components, see Fig. 8. Use a round file to remove the section of the board to clear the l.e.d. when fitted.

Components are to be mounted on both sides of the upper board. Fit S1, S2 and the z.i.f. socket on the top (uncoppered) side. Position the board so that the components fit into their apertures and then use the board fixing holes as a template to drill the fixing holes in the lid. Countersink the lid holes.

Use countersunk screws, nuts and washers to fix the board secure. A dab of paint on the thread of the screw will prevent the fixing working loose in use. A label to identify the functions may now be attached. This will also conceal the fixing screws. Fit the l.e.d. clip. Insert the l.e.d. and bend its leads carefully using a pair of pliers so that the leads make contact with the rectangular pads on the p.c.b. (Fig. 11). Check polarity before soldering.

Solder D1, D2 and R1 to the board, feeding the shortened leads into the pad holes. Attach the self-adhesive flat cable gripper to the lid immediately in front of the board as seen in the photograph.

It only remains for the 2 x 12-way flat cables to be soldered to the appropriate rectangular pads adjacent to the z.i.f. pins. Trim the tinned leads to about 3mm before soldering. Double-sided tape will be found useful when carrying out this. Stick a short length of the tape onto the board immediately in front of each line of pads. Press each 12-wide cable in turn and solder. Ensure that there are no "shorts". A small screwdriver blade was used to hold the wire in contact with its pad during soldering to give a good joint. A third hand would be useful at this stage. When both cables have been soldered close the cable-gripper arms to hold secure.

Manipulate the cables to run away from the transformer and screw down the lid.

TESTING

Plug into the mains. The panel l.e.d. should be lit when S2 is in the HOT position and go out when set to SAFE. Set in HOT position. Check that the voltage between pin 12 of the socket (GND) and pin 24 (V_{cc}) is +5V. With S1 set to MODE A, pin 21 (V_{pp}) will read either 4.5V or about 25V depending on whether IC5 bit 7 has initialised at turn on to logic 1 or logic 0. In MODE B V_{pp} will read about 26V or 0V depending on bit 7 state. This unknown state of bit 7 (IC5) clearly illustrates the danger of powering up the Programmer with an EPROM in the

socket. When certain conditions exist with 25V applied to V_{pp} the EPROM will be destroyed.

In normal use, this condition will not exist since the software correctly initialises the system before instructing the user to insert the EPROM. Full details later.

Connect the Programmer to the computer using the appropriate expansion cable. Do not apply power to the Programmer. Turn on the computer. It should function normally. Turn off the computer. Turn on the Programmer and then the computer. Again the computer should function normally. If not turn off both units, investigate and remedy.

If results are satisfactory, run through the "Setting-Up Procedure" but do not insert an EPROM when instructed to. Set to MODE A and type 4 in response to the prompt at instruction No. 9. You are now at No. 12.

Type P# <ENTER>

Move the cursor to 00F0 and type in AA Press <BREAK>

Type B0000:00FF <ENTER>

Check that the voltage at pin 21 is approximately 5V. Set your voltmeter to read 30V d.c. f.s.d. and connect across pin 12 and 21. Observe the meter and type <ENTER>. The needle should deflect to 25V for about 12 seconds and then fall back to its previous reading.

Check now that:

A0 to A3, A8 to A11, read logic 0

A4 to A7, read logic 1

D0, D2, D4, D6, read logic 0

D1, D3, D5, D7, read logic 1

Repeat the whole of this test procedure but this time set MODE B. V_{pp} is now on pin 20. Before a "burn" takes place, this

TRS-80 EPROM PROGRAMMER

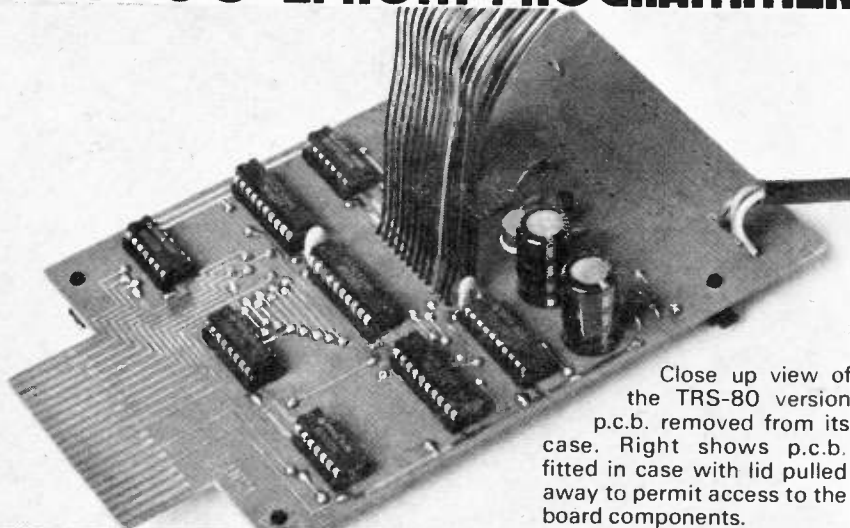

Close up view of the TRS-80 version p.c.b. removed from its case. Right shows p.c.b. fitted in case with lid pulled away to permit access to the board components.

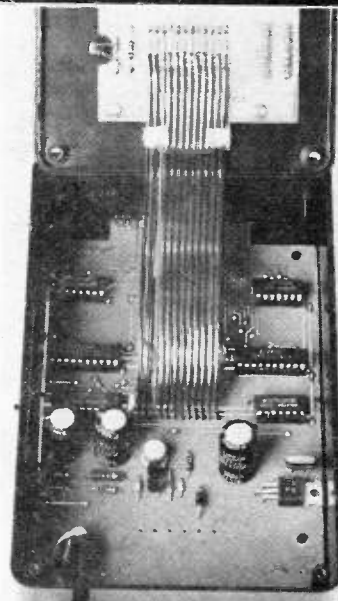

pin should read 0V, and during the burn it should read 26V approx. and return to 0V after about 12 seconds. Check all data and address pins to read the same logic levels as before. If so the unit is functioning normally and is ready for use.

SETTING-UP PROCEDURE

Users are advised to read all of this section before attempting to use the system.

The EPROM socket should be empty and all equipment should be "off" before commencing the setting-up procedure which should then be carried out in the following sequence.

1. Connect the PLU to the computer using the system bus expansion cable.
2. Set the HOT-SAFE switch to SAFE.
3. Connect the PLU to a 240V a.c. mains supply and switch on.
4. Switch on the TRS-80/Genie and enter BASIC in the usual way by pressing the <ENTER> key.
5. EE124 is a machine code program which can only be loaded via the SYSTEM command. Type SYSTEM <ENTER> and the SYSTEM prompt `*?_` will be displayed.
6. Depress the play button on the cassette recorder and check that the volume control is set between 5 and 6. Type the filename EE124 <ENTER>
The cassette motor will start and the program will load in the usual way.

7. Once the load is complete, the SYSTEM command prompt will again be displayed. This time type /<ENTER>
The following message will be displayed

EE124 SOFTWARE 1.1
COPYRIGHT EVERYDAY
ELECTRONICS 1983
SELECT MODE SWITCH_

8. Refer to Table 1 and identify the MODE (A or B) for the EPROM which is to be programmed. Set the MODE switch accordingly and type <ENTER>
The following message will be displayed
`SELECT 1, 2 OR 4 ?_`
9. The same EPROM socket is used to program three different sizes of EPROM. They are 1K x 8, 2K x 8 and 4K x 8. Thus, type
1 <ENTER> for 1K x 8
2 <ENTER> for 2K x 8
4 <ENTER> for 4K x 8
The following message will be displayed
`INSERT EPROM_`
10. Move the socket lever to the vertical position and insert the EPROM paying particular attention to polarity. Lock the EPROM into position.
11. Set the HOT-SAFE switch to HOT.
12. Type <ENTER>
and the system is ready for use. The command prompt `+_` will be displayed and any of the commands on page 348 will be accepted.



The Eprom Programmer in use with the Genie II microcomputer. The screen shows that a 4K-byte EPROM has just been successfully "burned".

To remove an EPROM from a powered up Programmer

- A. Set the HOT-SAFE switch to SAFE.
 - B. Move the socket lever to the vertical position and lift out the EPROM.
- At the end of a programming session, do not turn off any mains supply without having first removed the EPROM. Follow steps A and B with:
- C. Switch off Programmer.
 - D. Switch off computer.

GENIE EPROM PROGRAMMER

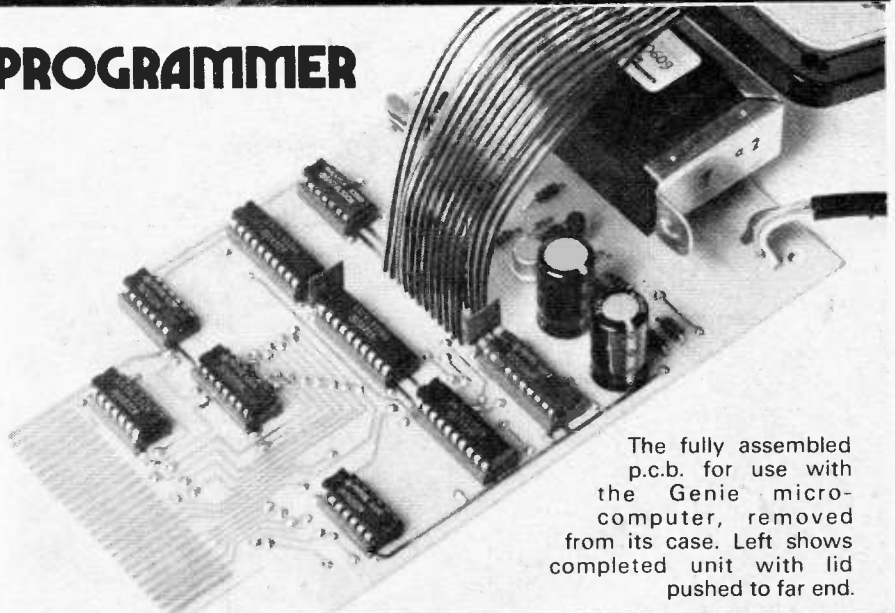
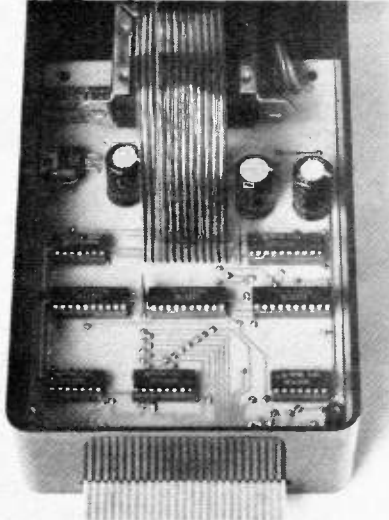

The fully assembled p.c.b. for use with the Genie micro-computer, removed from its case. Left shows completed unit with lid pushed to far end.

COMMANDS

All items appearing in ruled boxes are automatically displayed on the screen.

All commands are vetted by the syntax analyser. This is a routine which checks the structure of commands. If the structure of a command is incorrect, a **SYNTAX ERROR** message will be displayed.

Commands are of a particularly simple form and are checked against the following production rules:

```
<Command>      <Command letter> <Parameters>
<Command letter> B|C|F|L|M|N|P|R|S|T|X|Z
<Parameters>   <Address>|<Address>:<Address>|
                <Null string>

<Address>      #|*|.|<HHHH>
<H>            0|1|2|3|4|5|6|7|8|9|A|B|C|D|E|F
```

* and . are shorthand notations for first, last and current address, respectively. Spaces are ignored by the syntax analyser.

Example

(a) #* (b) * (c) . (d) 2410:* (e) .* (f) 2410:2490

The above parameters are not considered by the analyser to be syntactically incorrect but may be described as **BAD PARAMETERS** when used with certain commands. The following are considered to be syntactically incorrect:

(a) #* (b) 2410.2490 (c) :2490 (d) 2410. (e) .:

All commands must start with a bona fide command letter otherwise an **ILLEGAL COMMAND** message will be displayed. If the syntax of a command is correct, the legality of any parameters will be determined by the nature of the command.

A complete explanation of the commands and examples of their use will accompany the T004 software cassette available from the EE Software Service.

ENHANCING THE SOFTWARE

The authors feel that the set of 12 commands is sufficient for most needs but that there may be some users who wish to enhance the software by adding extra commands. This can easily be done.

The command table is situated from 5318 to 533B; each command cell of 3 bytes consists of

COMMAND LETTER | LSB | MSB

Space for four extra commands has been left from 533C to 5347. Simply type

in the three elements of a new command cell. The syntax of the new command will automatically be checked and on jumping to the command address, the top of the stack will hold the **BAD PARAMETER(S)** address.

CALL 58DO returns HL, DE with command parameters.

CALL 5AIC returns HL, DE with buffer addresses, i.e. command addresses which have been adjusted for origin of EPROM and position of

Table 5. Summary of commands

Command	Description
B	Burns bytes from the buffer to the EPROM
C	Copies bytes from the EPROM to the buffer
F	Fills buffer locations with FF
L	Loads SYSTEM tape into the buffer
M	Memory sets origin
N	New executes a cold restart
P	Page displays 256 bytes from the buffer
R	Read displays 256 bytes from the EPROM
S	Saves contents of buffer locations
T	Tests EPROM locations for FF
X	Exits to Basic
Z	Zeros buffer locations



Using the 25 + 25 ribbon cable (Lowe Electronics) to connect the Programer to the Genie.

buffer. (4300<HL & DL<52FF.)

COPYING SYSTEM TAPES

SYSTEM tapes can be easily copied, edited and created using the M, L, P and S commands. However, it must be remembered that although programs appear to be in main memory, they are actually stored in the buffer. They can only be run by first saving them onto cassette using the S command and then by loading them into main store from Basic using the SYSTEM command. □

JACK PLUG & FAMILY...

BY DOUG BAKER



Logic Symbols

YOU will have noticed this month that we are using a different set of symbols in circuit diagrams to represent logic gates. These changes have been made to agree with those symbols found in manufacturers logic i.c. data books and application notes, as well as logic and microprocessor books (especially those titles from America) and other journals.

The symbols for the gates need no qualifying letter inside the symbol outline, it is the shape of the symbol which conveys its logic function. In Fig. 1 you can see the "old" symbol followed by its logic description and the "new" symbol for each of the different types of gate. These apply to both TTL and CMOS families.

All gates with the exception of the Buffer and Inverter types, are shown as 2-input gates. For example, the first one in the list is fully described as a 2-input AND gate. AND gates with more inputs would be represented by drawing the elongated "D" with a number of lines equal to the number of inputs, into the flat of the "D"; Fig. 2 shows a 3-input AND gate. Other 3-input gate types are drawn similarly.

For a large number of inputs, the symbol is not made larger, but its input face is, see Fig. 3, which shows an 8-input NAND gate and an 8-input OR gate.

The difference between AND and NAND, and OR and NOR symbols is the small circle at the output. This is a negating sign. A logic 1 produced on the gate-side of the circle becomes a logic 0 at the other side. Similarly a logic 0 becomes logic 1. This can be seen in the truth tables.

Fast acting "Schmitt" versions of the NAND and INVERTING gates are also available and these are identified by a "hysteresis loop" symbol. Fig. 4 shows a Schmitt INVERTER and NAND gate. They obey the truth tables for the INVERTER and NAND gates, respectively.

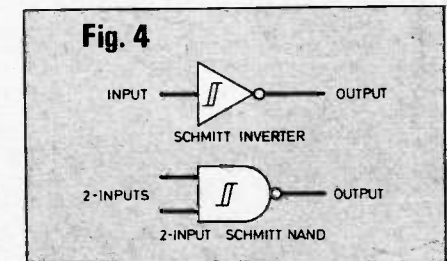
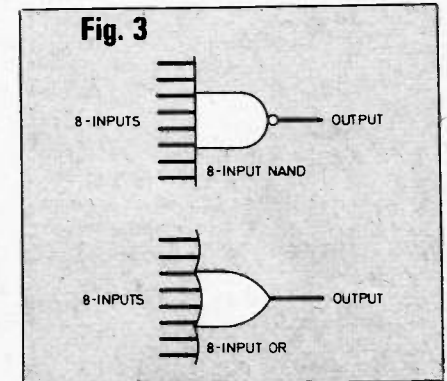
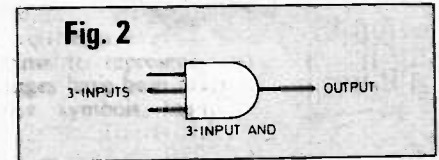
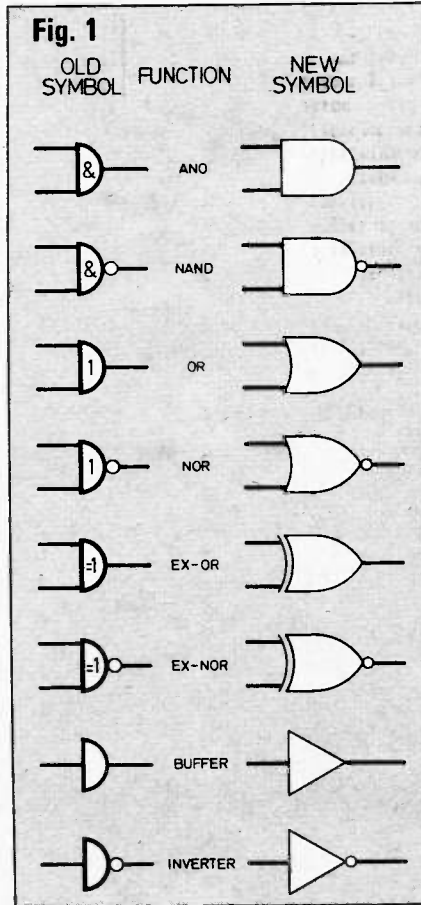

TRUTH TABLES

AND

Inputs		Output
A	B	C
0	0	0
0	1	0
1	0	0
1	1	1

OR

Inputs		Output
A	B	C
0	0	0
0	1	1
1	0	1
1	1	1

EX-OR

Inputs		Output
A	B	C
0	0	0
0	1	1
1	0	1
1	1	0

NAND

Inputs		Output
A	B	C
0	0	1
0	1	1
1	0	1
2	1	0

NOR

Inputs		Output
A	B	C
0	0	1
0	1	0
1	0	0
1	1	0

EX-NOR

Inputs		Output
A	B	C
0	0	1
0	1	0
1	0	0
1	1	1

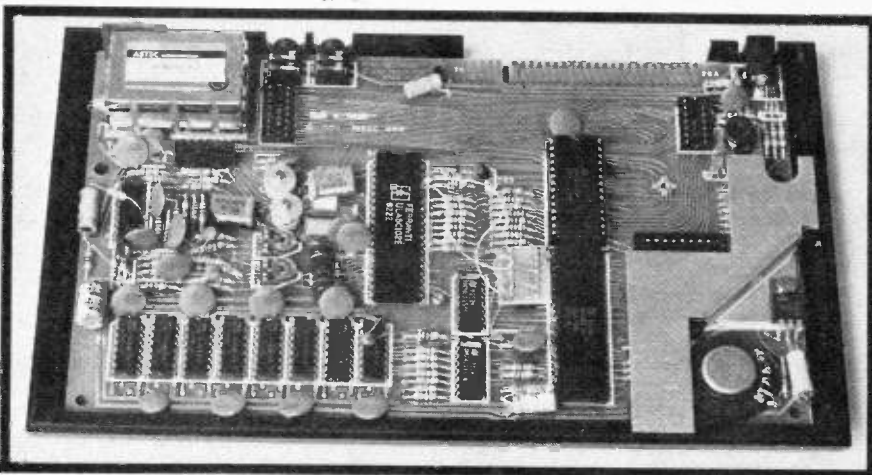

(Top) The Sinclair ZX Spectrum is supplied complete with 1.2A mains adaptor, manual, and all the necessary leads to connect it to a TV and cassette player. (Above) The printed circuit board assembly showing the edge finger set at the rear which provides access to the control, data and address buses for expansion purposes.

THE ZX Spectrum package comprises the computer, a 1.2A mains adaptor, a TV aerial lead, two cassette recorder leads, an introductory booklet and a comprehensive user's manual.

The computer is housed in an attractive plastic case, slightly longer than the ZX81 and measures 233mm wide by 144mm deep by 30mm high. A 29-way double-sided finger set is situated at the back from which full data, address and control busses can be accessed, and the system is controlled by the Z80A microprocessor, a faster version of the well-known Z80 μ P.

The mains adaptor connects to the Spectrum via a female cassette power connector, which is an improvement on the male miniature jack plug used on the ZX81. The adaptor is sufficiently powerful to run the ZX printer, unlike the standard 0.7A adaptor which accompanies the ZX81. However, the printer also comes with a 1.2A adaptor, and ZX Spectrum owners who buy the printer will have paid for a spare 1.2A adaptor!

KEYBOARD

The keyboard is made up of 40 "moving" keys with full upper and lower case, and is a significant improvement on the ZX81's touch-sensitive keyboard. All keys are at normal typewriter pitch, but the keyboard is not suitable for touch typing. For a non-ZX81 user who is used to single character entry on a full-size QWERTY keyboard, the Spectrum keyboard will take some getting used to.

There are many good points, however. All keys have auto-repeat which makes input and editing so much easier than the ZX81. If the cursor is positioned at the end of a long program line, for example, it can quickly and painlessly be moved back to the beginning of the line simply by holding down the CAPS SHIFT and \blacktriangleleft key. Every time a key is pressed, a click (albeit barely audible) can be heard from the internal loudspeaker.

All BASIC words can be obtained by pressing a single key, as with the ZX81. However, accessing the set below the keys requires practice. For example, to access the keyword CIRCLE, both shift keys, CAPS SHIFT and SYMBOL SHIFT, need to be pressed to change the K cursor to the E cursor. Then the SYMBOL SHIFT and the H key need to be

SPECIAL REPORT

SINCLAIR ZX

pressed for the word CIRCLE to appear. This sounds a rather long and complicated process, and indeed the number of keystrokes required to access some words is more than the number of characters in the word itself! Nevertheless, this is something that can be easily mastered.

DISPLAY

Users with black and white only TV's could be excused at times from thinking that the ZX Spectrum is just a ZX81 in a different case, for the screen format is identical to the ZX81. The main display, excluding the border which is unused on the ZX81, is split up into 24 rows of 32 columns. The bottom two rows (at least) are reserved for all program and run-time input. While this is fine for the beginner, it can be a limitation and a source of irritation to the more advanced programmer.

The main display of 22 lines of 32 characters is made up of 176 by 256 dots (called pixels), each of which can be controlled individually. The trade off between resolution and memory is a difficult one but one which the Spectrum designers seem to have got right.

Eight colours are available and are good on the whole, although certain combinations of colours in adjacent character positions give rise to blurring and instability along vertical boundaries. The colours have been sensibly arranged so that users with black and white televisions see ordered shades of grey ranging from white (colour code 0) to black (colour code 7). Pixels within each character position (and there are 64 of them arranged on an 8-by-8 grid) can only be one of two of the eight available colours and are aptly named PAPER (background) and INK (foreground). This could be considered a limitation, but is another instance where extra memory would be required to store the colour attributes of the pixels if more than two colours per character position were allowed. Again, they have got it right.

Furthermore, each character position can be set to flash and/or to be extra bright using the FLASH and BRIGHT commands. Together with BORDER, which sets the border colour, INVERSE which gives inverse video (that is PAPER colour becomes INK colour and vice-versa) and OVER which superimposes any printing or plotting that is already on

the screen, these all add up to a comprehensive and impressive range of colour graphics.

BASIC

The Spectrum uses what is essentially a super-set of ZX81 BASIC. The interpreter and operating system are stored in 16K of ROM and the system runs at the speed of the ZX81 in FAST mode with the steady non-flicker display of the '81 in SLOW mode.

The instruction words READ and DATA, which were missing from the ZX81, have been included together with the very useful RESTORE n, which restores the data pointer to program line n. Dummy reads of data are no longer necessary to reposition the data pointer.

The instruction IN and OUT are very useful additions so that port boards and other devices can be controlled directly from BASIC without recourse to machine code. A powerful feature of the Spectrum BASIC is the ability for users to define their own functions using the DEF FN instruction.

For example, DEF FN L\$(a\$,n) = a\$(TO n) returns the first n characters of a\$ so that L\$("PUTTY",3) = "PUT". Those of you familiar with Microsoft BASIC will recognise that this function is equivalent to LEFT\$. Functions may use up to 26 numeric and 26 string arguments and can be mixed, as in the above.

Another powerful and unusual feature of Spectrum BASIC is the full expression evaluator which is called during program execution whenever an expression, constant or variable, is encountered.

Graphics commands are comprehensive. PLOT controls the INK of a pixel and DRAW draws lines as well as parts of circles if an additional parameter is supplied.

SOUND

Tucked away inside the bottom right-hand corner of the Spectrum is a small loudspeaker. Under command of the instruction BEEP, notes of varying pitch and duration can be generated. Unfortunately, the sound is barely audible, which is a pity. BEEP also ties up the CPU for the duration of the tone and it is not possible to break into the system at this time. [An amplifier to increase the

volume of BEEP and other sounds was featured in the April '83 issue of EE. Full constructional details were given.]

TAPE STORAGE

The ZX81 cassette interface, as many users will know, is very unreliable. How many times have users waited for several minutes to load a long program only to find at the end, for some unexplained reason, that the data has not been accepted? These problems are well-known to ZX81 users, and so it comes as no surprise to find that a new cassette interface has been designed for the Spectrum. It is very reliable and fast. The Baud rate (number of bits transferred per second) has been increased six-fold to 1500 and a 16K program now takes only 100 seconds to load.

Not only is the system more reliable, but a VERIFY command has also been included so that a saved program can be compared with what the computer intended to be saved. Also, two programs, one stored in memory and the other on tape, can be combined using MERGE.

There are a number of other features which enable data files, other than programs, to be stored on tape. Blocks of machine code can be saved and loaded from BASIC and arrays can be transferred and merged individually. The contents of the entire screen can be stored using a single command and loading is equally as simple.

CONCLUSIONS

The 16K version is priced at £125 and the 48K version at £175. Undeniably, both represent superb value for money. Each microdrive will sell for under £50 and the RS232 for about £20.

Readers seriously considering buying a computer for the first time would not go far wrong if they bought the ZX Spectrum. The machine is not only a good one but it is well supported by software houses and add-on manufacturers, which is a very important point for a potential buyer to consider.

Early supply and production difficulties brought Sinclair Research much criticism from the computing press, but these problems are now behind them and the ZX Spectrum looks set to be an even bigger winner than the ZX81. □

ZX SPECTRUM

BY J.W. TERRELL M.Sc.

PUSH BUTTON COMBINATION LOCK

BY J. HADLEY

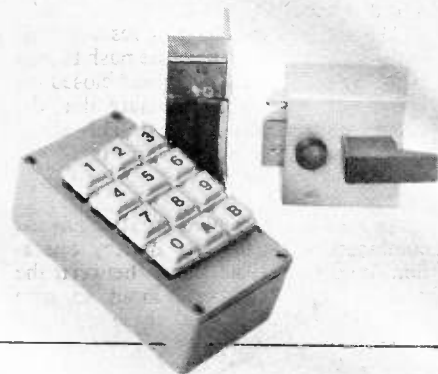

THE Push Button Combination Lock provides a convenient alternative to a key operated lock, especially when a number of people use the same door. This system is designed to use a lock release mechanism which can easily be fitted in place of the door frame mounted part of a cylinder lock, and which allows the lock to be used with a key, if required.

The circuit is battery powered, making for simpler installation and allowing operation during mains failure. Provision is made in the design to cater for the situation when the battery voltage eventually falls to a level at which the lock release fails to operate.

PRINCIPLE OF OPERATION

A number of designs for push button locks have been published which rely on relatively complex digital circuitry. The design to be described here makes use of the principle of transferred charge using the basic concept shown in Fig. 1.

When switch S1 is momentarily closed, capacitor C1 is charged to the supply

voltage. When switch S2 is momentarily closed, the charge on C1 is shared between C1 and C2. Similarly switch S3 transfers charge to C3; this stored charge is used to operate the lock release circuit by momentarily closing switch S4.

Switches S1, S2, S3, and S4 are selected from a keyboard of twelve or sixteen keys to provide the sequence of numbers required. Unused switches are connected through a common line, such that, if any incorrect key is pressed all charged capacitors are discharged via diodes D1, D2, and D3, and the sequence will then have to be restarted.

The simple arrangement of Fig. 1 has two disadvantages. The first is that the voltage falls at each transfer. If the values of the capacitors are equal the voltage is halved at each transfer and the voltage on C3 is only a quarter of the supply voltage. Secondly, the switching arrangement precludes the use of commercially available keyboards which usually have a common connection to one side of the switches.

THE CIRCUIT

The circuit shown in Fig. 2 overcomes these disadvantages by using CMOS NAND gates, as buffer stages, between each capacitor. This allows almost the full supply voltage to be transferred between each capacitor.

The operation of the circuit is as follows: when switch S1 is closed, C1 is charged through R1 and when released the voltage on C1 decays exponentially. Providing that this voltage is still greater than half the supply voltage, closing switch S2 will cause the output of gate IC1a to go low, which in turn causes the output of gate IC1b to go high.

C2 then charges through D3 and R4. The second pair of NAND gates (IC1c and IC1d) perform the same function by charging C3 when switch S3 is closed. The lock release is operated when switch S4 is closed, causing the output of gate IC2a to go low, switching on transistor TR3 which provides sufficient base current to cause TR4 to go into saturation.

LOCK RELEASE

The lock release coil is connected between the positive supply and the collector of TR4 via a 2.2 ohm resistor. This resistor limits the coil current when the battery voltage is high.

When the battery voltage has fallen to a level where the lock release fails to operate, the 2.2 ohm resistor can be bypassed by closing switch S5 at the same time as S4 is closed. The output of gate IC2d goes low when S5 is closed and this switches on TR1 and TR2. Since the collector of TR2 is connected directly to the coil, the full supply voltage, less the saturation voltage of TR2, appears across the coil.

The normal sequence of operation is to momentarily close S1, then S2, then S3 and finally S4 to operate the lock release. When the lock fails to operate, because the battery voltage is too low, the sequence is repeated but S4 and S5 are closed simultaneously.

This will allow the door to be opened in spite of the low battery voltage, but is also an indication that the batteries should be replaced before their voltage falls to a level at which the lock release

Fig. 1. Circuit of the transfer charge principle used in the Push Button Combination Lock.

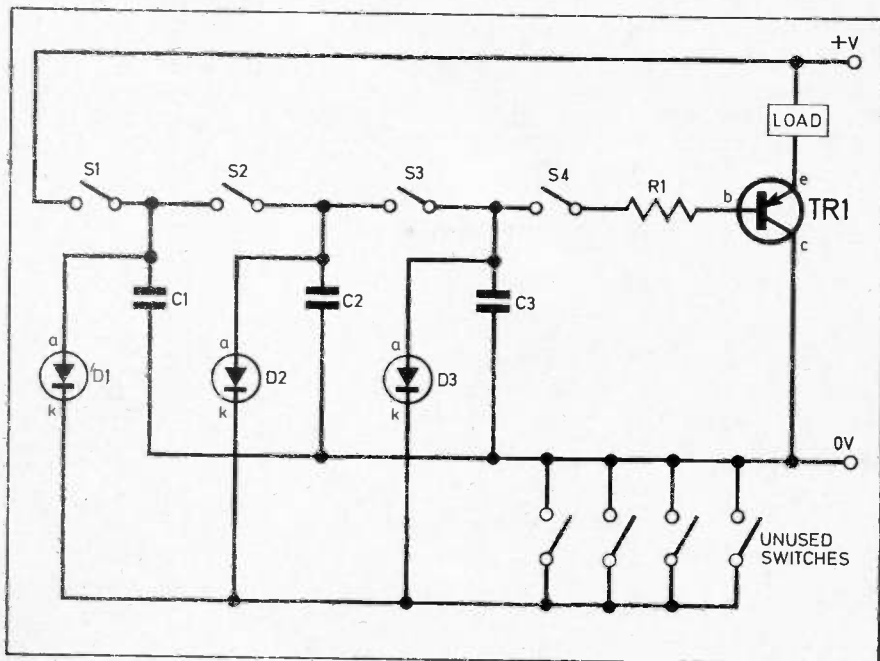

will fail to operate even when the override switch is used.

The value of the charging resistor used in the circuit requires that the push button switches S1, S2 and S3 are held closed for about half a second to ensure that the capacitors are fully charged. This slows down the maximum keying rate and provides added security against random keying.

Any switch not used in the selected combination, or for low battery operation, is connected as shown between the positive supply and the input to gate IC2b. Operating any of these switches causes the output of IC2b to go low and

as the door is opened. As can be seen from the graph in Fig. 3, the battery voltage on load has fallen to 6.2V after 4000 operations and that a further 200 operations are possible using the override switch, before the battery voltage has fallen to 5.2V.

Knowing the average daily use will enable the battery life to be estimated. Over an extended period there will be an additional loss of capacity due to storage effect which can amount to about 10 per cent per annum. For this reason it is not economical to use the higher powered HP2 cells, which have twice the capacity of HP11s, unless justified by frequent use.

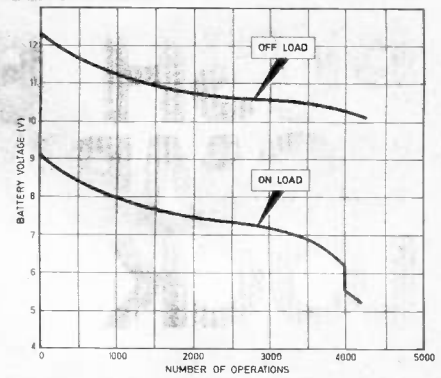

Fig. 3. Battery deterioration graph of voltage against number of operations.

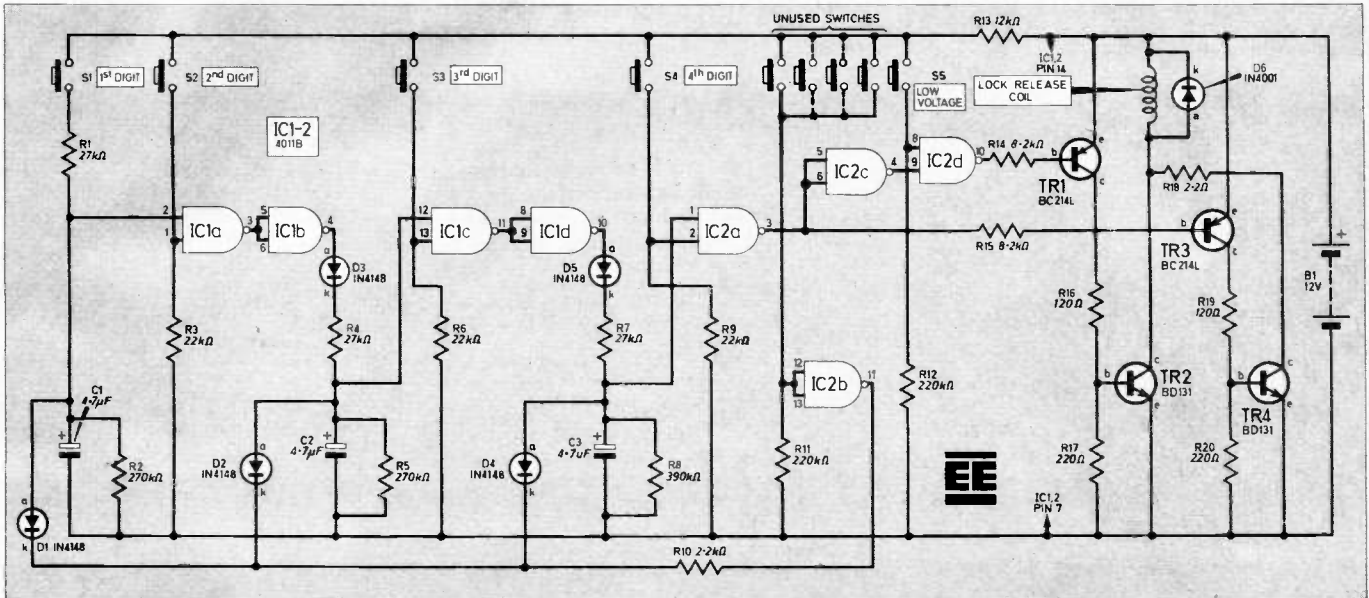

Fig. 2. Complete circuit diagram for the Push Button Combination Lock. The push switches S1 to S5 and the unused switches make up the keyboard and are housed in a separate case.

this discharges any of the capacitors (C1, C2 and C3) which have a charge. Pushing any wrong button therefore requires the correct sequence to be restarted at S1.

CHOICE OF BATTERIES

The lock release is designed to operate on a nominal 12V, but will operate down to about 4V, providing that pressure is not applied to the release, by pushing against the door, until the lock release has been activated.

With the 2.2 ohm resistor, the circuit and lock release will operate down to 6V or less. Using eight 1½V cells to provide an initial voltage of 12V allows a long battery life to be realised. Current drain is negligible on standby and 800mA when the lock is operated. HP11 batteries are capable of supplying this current and to check that a reasonable life can be expected, the manufacturers data has been supplemented by an accelerated life test.

The test used a time switch to operate the circuit for two seconds every 15 minutes. Two seconds is typical of the time for which the peak current is drawn

Foreground shows the keyboard housing, lock release mechanism and a typical cylinder lock. The control unit is partially obscured by the keyboard case.

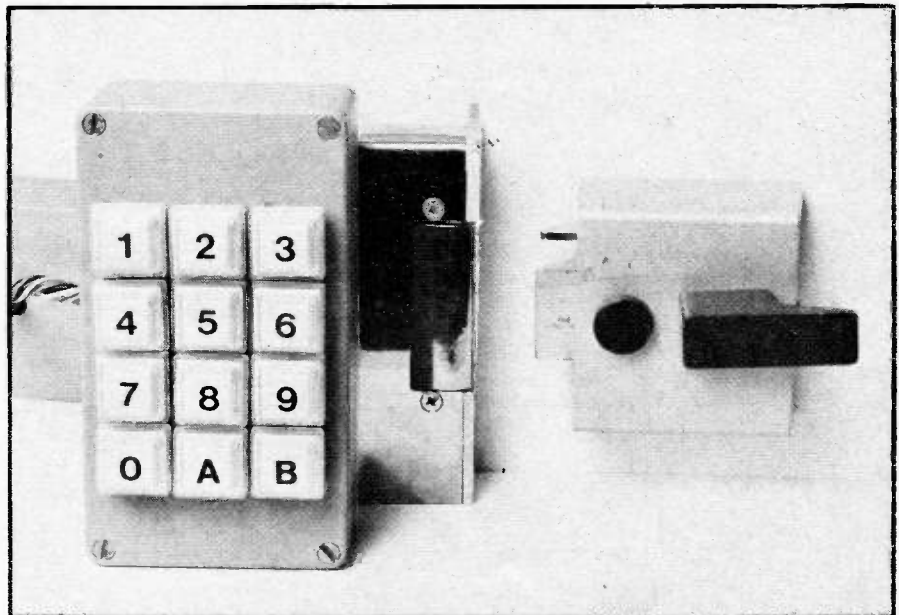

COMPONENTS

Resistors

R1,4,7	27kΩ (3 off)
R2,5	270kΩ (2 off)
R3,6,9	22kΩ (2 off)
R8	390kΩ
R10	2.2kΩ
R11,12	220kΩ (2 off)
R13	12kΩ
R14,15	8.2kΩ (2 off)
R16,19	120Ω (2 off)
R17,20	220Ω (2 off)
R18	2.2Ω 3W wire wound ±5%
All 1/4W carbon film ±5% unless otherwise stated	

See
**Shop
Talk**
page 369

Capacitors

C1,2,3	4.7μF 25V tantalum (3 off)
--------	----------------------------

Semiconductors

D1-5	1N4148 silicon (5 off)
D6	1N4001 silicon
TR1,3	BC214L <i>npn</i> silicon (2 off)
TR2,4	BD131 <i>npn</i> silicon (2 off)
IC1,2	4011B CMOS quad 2-input NAND gate

Miscellaneous

S1-12	12-way (or 16-way) keyboard with common connection (not matrix type)
B1-8	HP11 1.5V battery (8 off)
Diecast or plastic case, 112 x 62 x 31mm (for main circuit); plastic case 190 x 110 x 60mm (for batteries); 0.1in matrix strip-board, 19 strips by 41 holes; surface mounted electric lock release; battery holder for 4 x HP11 (2 off); 14-pin i.c. holder; Veropins; 7/0.2mm wire; 2-core mains cable; mounting hardware.	

Approx. cost
Guidance only

£10

excluding
lock & cases.

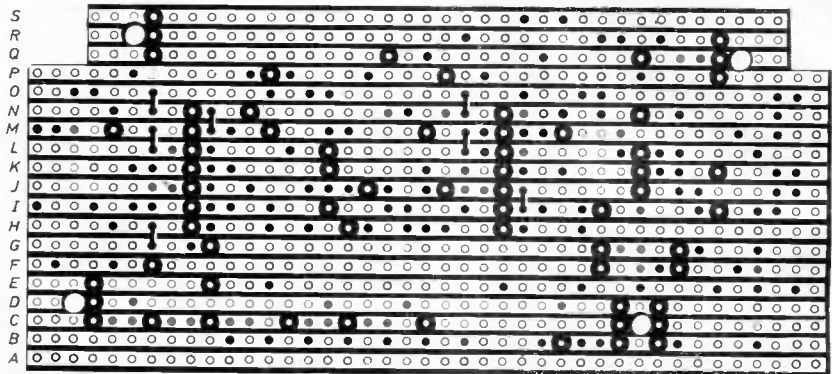
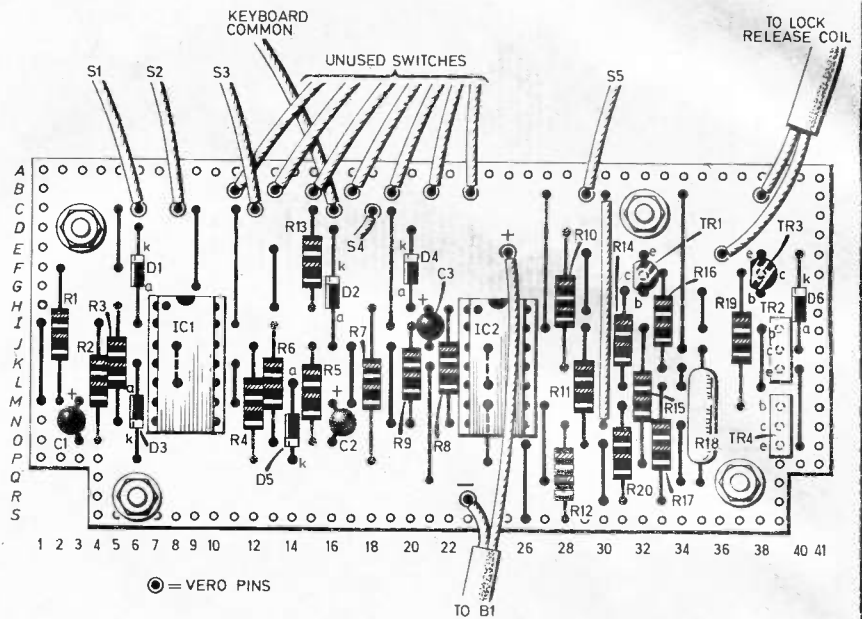
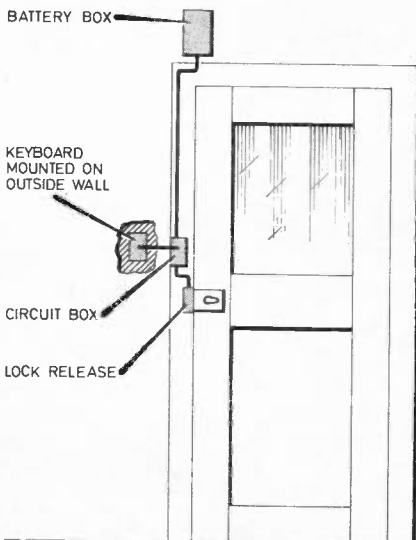

Fig. 4. Component layout, underside showing breaks in the copper and interwiring cables of the main lock control board. Pay special attention to the small links on the underside of the board.

Fig. 5 (Right). Wiring to the individual push-switches which make up a 12-way keyboard unit. The combination shown is 1740 with 6 as the low voltage key.

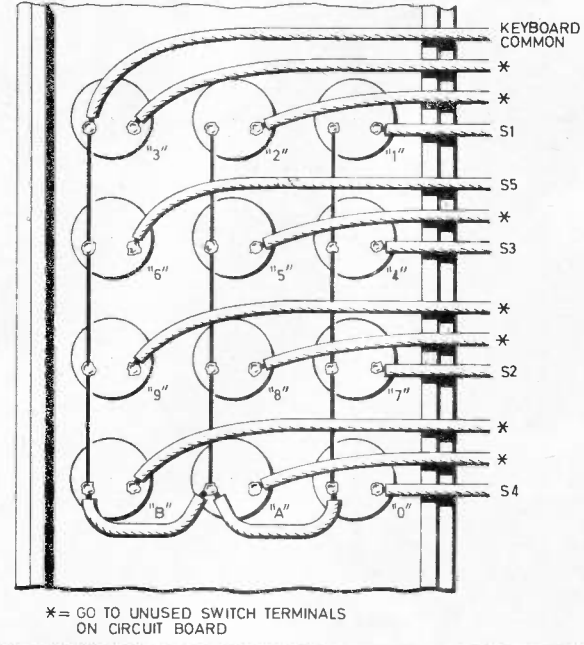
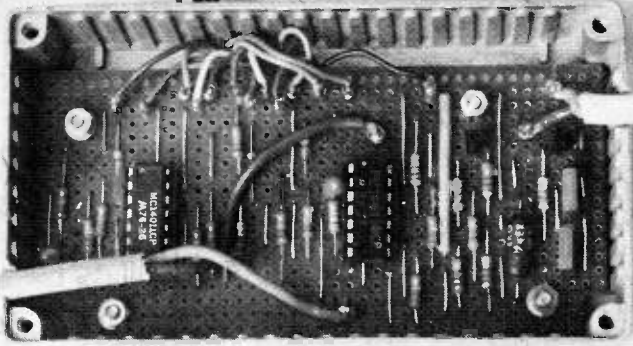
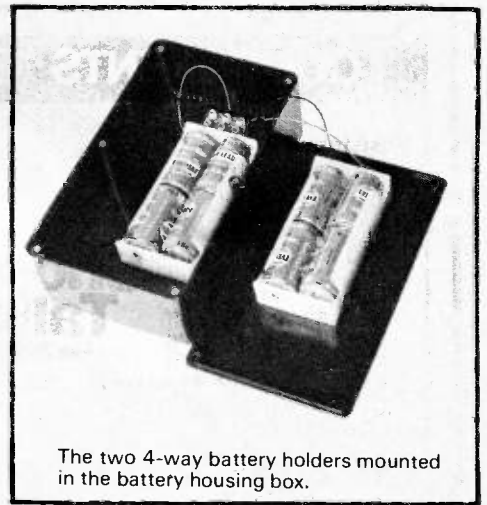

Fig. 6 (Left). Suggested mounting arrangement of the various units around the door and door frame.

* = GO TO UNUSED SWITCH TERMINALS ON CIRCUIT BOARD



The main lock circuit board mounted in the control unit.



The two 4-way battery holders mounted in the battery housing box.

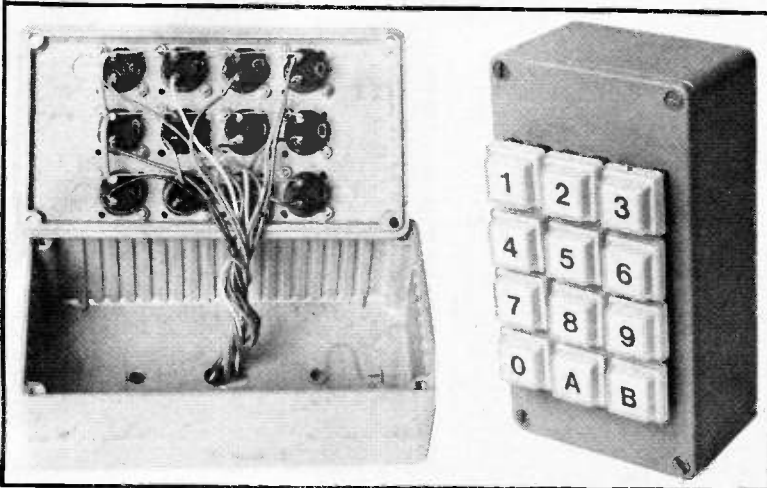

Wiring to the push button combination switches and the exterior of the keyboard box showing "coding" of the push switches.

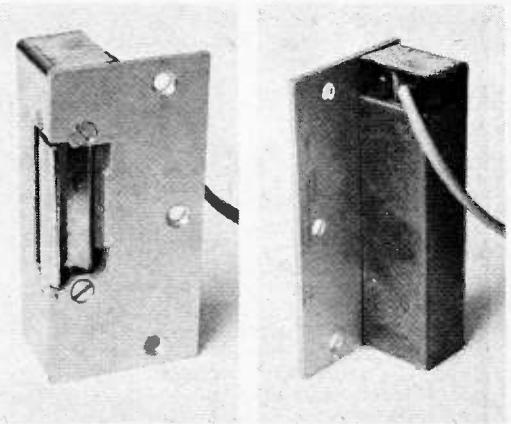

Front and rear views of the lock mechanism. The lock "solenoid" coil is shown on the right.

KEYBOARD

Keyboards are available commercially with 12 or 16 buttons and the single pole, not the matrix version, is required in this application. Alternatively, one can be made up from the wide selection of momentary action push button switches available from suppliers.

The circuit does not allow the use of repeated numbers so that the sequence 8593, for example, can be used but 8595 cannot. Because one button is used for low battery voltage, a 12-way keyboard will have $11 \times 10 \times 9 \times 8$ combinations and a 16-way keyboard will have $15 \times 14 \times 13 \times 12$ combinations.

These are equal to 7920 and 32,760, respectively. To anyone trying to operate the lock by pushing buttons at random, the chance of success at the first attempt is 1 in 20,736 (that is 1 in 12^4) for the 12-way keyboard, and 1 in 65,536 (1 in 16^4) for the 16-way keyboard.

CIRCUIT BOARD

The main lock circuit was built on a piece of 0.1in matrix stripboard, 19 strips by 41 holes and this is shown in Fig. 4. All wired connections to the keyboard must be made to Veropins as this facilitates the changing of the combination at a later date.

The usual care should be taken when inserting polarised components (tantalum capacitors and diodes) and to note the orientation of the semiconductors.

The layout requires a number of links, some of which are beneath the i.c. holders and also on the trackside of the board. These latter links are shown on the trackside view in Fig. 4.

The finished board is housed in a plastic or diecast box, $112 \times 62 \times 31$ mm.

The wiring of a keyboard made from individual switches (a 12-way is shown) is given in Fig. 5. This is made from 12 momentary action key switches in a plastic or diecast box, $120 \times 65 \times 40$ mm. Alternatively, a proprietary keypad can be used and this will have one side of the switches already commoned up.

INSTALLATION

The actual positioning of the units around the door will be determined by the available space. It is probably more convenient to install the batteries in a separate box and one arrangement is shown in Fig. 6.

An alternative would be to fit the keyboard and circuit box on the door and feed the lock release with a cable to the hinge side of the door and around the door frame.

The HP11 batteries are housed in a plastic case, size $190 \times 110 \times 60$ mm, using two, 4-way battery holders, one screwed to the base and the other to the lid of the box. Connections from the batteries and to the lock release should be made with 2-way mains cable.

SETTING THE COMBINATION

A wire from each switch, together with the common switch connection, is brought through the wall or door to the circuit box. The required sequence of digits is selected from the 12 or 16 switches of the keyboard and the wire from the first switch is wired to the pin marked S1. Similarly the second, third and fourth selected switches are wired to the pins marked S2, S3 and S4.

A fifth switch is selected to function as the low battery voltage switch and this is connected to the pin marked S5 on the circuit board layout. All switches not used in the sequence are connected to the row of pins marked. There are sufficient pins shown for a 12-way keyboard. If a 16-way keyboard is used four more pins can be added or two wires can be connected to a single pin. Finally the common lead is connected to the pin shown. □

ELECTRONICS and the ELECTRON

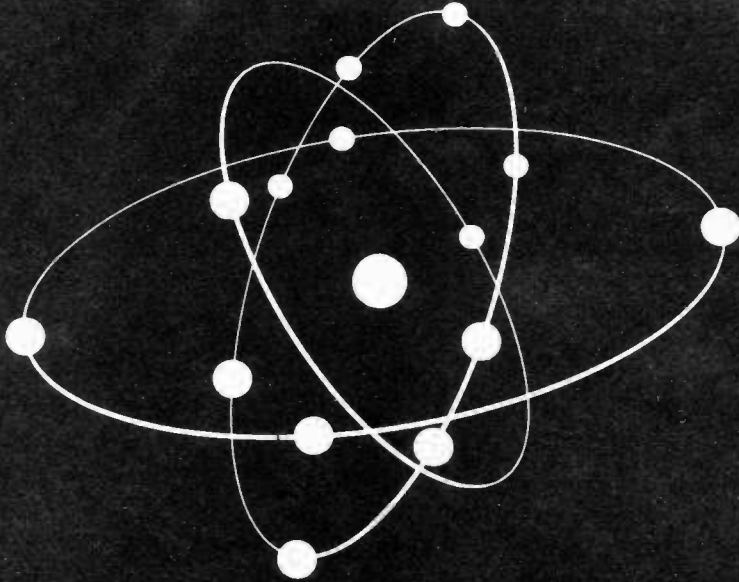

Part 2 CONDUCTION IN VARIOUS MATERIALS BY J. B. DANCE

CONDUCTION is the flow of an electric current through a material; it can occur in solids, liquids and gases. Indeed, an electric current can even flow through a vacuum.

CURRENT FLOW

The flow of an electric current involves the movement of electric charge. The charges which move may be positive charges, negative charges or both types, depending on the material through which the current is flowing. The term "electric charge" signifies the amount of electricity present or the amount flowing per unit time.

In order to understand electric currents, we must look at matter on the atomic scale. We then find that the flow of an electric current consists of the flow of extremely minute charged particles. In a metal these charged particles are electrons, but in liquids and gases positive ions can also contribute to the flow of current. If all the charged particles in a material are held firmly in position, no current can flow.

Charged particles are known as ions. Electrons are a rather special form of charged particle and one does not usually apply the term ion to an electron. If a neutral atom containing a positive nucleus and a number of electrons loses one of these electrons, we have a positive ion. Similarly if a neutral atom gains an electron, it becomes a negative ion.

In order to cause a steady electric current to flow through a material an electric voltage or e.m.f. (electromotive force) must be applied across the material concerned. In general the greater this voltage, the greater the current which will flow through a given piece of the material.

The voltage may be regarded as the driving force which causes the current to flow through the material. It may be compared with the water pressure between two points in a water system which causes water to flow through the system.

OHM'S LAW

Ohm's Law states that the voltage across a conductor is directly proportional to the current passing through it.

That is:

$$V \propto I$$

In general we do not like proportional signs, so we change the proportional sign to an equals sign and introduce a constant, R :

$$V = IR$$

This quantity R is the resistance of the material through which the current is flowing in ohms.

Most metals obey Ohm's Law; that is, the voltage across a given piece of the metal is proportional to the current flowing through it. However, there are many materials which do not obey this law. For example, in many semiconductor devices the current is not proportional to the voltage across the device.

Instead of saying that such materials do not obey Ohm's Law, one can say that the resistance of the material varies with the applied voltage.

CONVENTIONAL CURRENT

If one connects a battery to a small lamp, as in Fig. 2.1, current is said to flow from the positive terminal of the battery (which is known as the anode) through the bulb to the negative terminal (which is known as the cathode). In any external circuit which a battery feeds, current is said to flow from the positive to the negative electrode.

However, inside the battery the current must flow from the cathode to the anode in order to be able to continue flowing around the circuit. This matter concerning the direction of current flow can be quite confusing, so inexperienced readers should always be careful to give it an adequate amount of thought.

When the battery is being charged (Fig. 2.2), however, the current flows from the positive connection of the charger into the battery and through the battery to the cathode from where it returns to the charger. Thus it flows through the battery in the opposite direction to that shown in Fig. 2.1.

The battery charger in Fig. 2.2 must provide a voltage which exceeds the battery voltage by a small amount so that it can force the current through the battery against the e.m.f. of the battery.

Fig. 2.1. The direction of the conventional current flow from a battery through a lamp bulb.

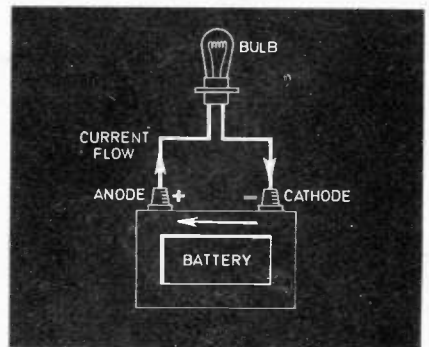

The direction of current flow to which we have been referring is known as the conventional current, since it is the direction of current flow accepted by most people. In actual fact the particles which carry the electric charge in any metallic wire are electrons. Electrons carry a negative charge and therefore flow from the negative to the positive electrode in the circuit external to the battery. It can be seen from Fig. 2.3 that the direction of the electron flow is opposite to that of the conventional current flow.

AN HISTORICAL MATTER

If the flow of electrons is from the negative to the positive electrode, why do we have a conventional current flowing in the opposite direction? This is essentially an historical matter.

When the terms "positive" and "negative" were given to the two types of electric charge and voltage a very long time ago, there was no particular reason why these terms should be allocated in one of the two possible ways and very little was known about electricity at the time. The electron had not been discovered.

It so happens that the anode of a battery was allocated the "positive" sign and the cathode the "negative" sign. When, much later, electrons were discovered, it followed that they had a negative charge on this convention. Hence these negatively charged particles flow towards a part of the circuit which is at a more positive potential, whilst current was assumed to flow from the positive through the external circuit to the negative connection of the battery.

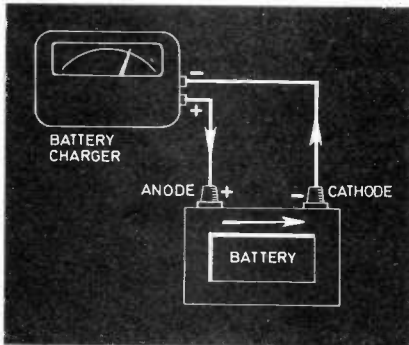
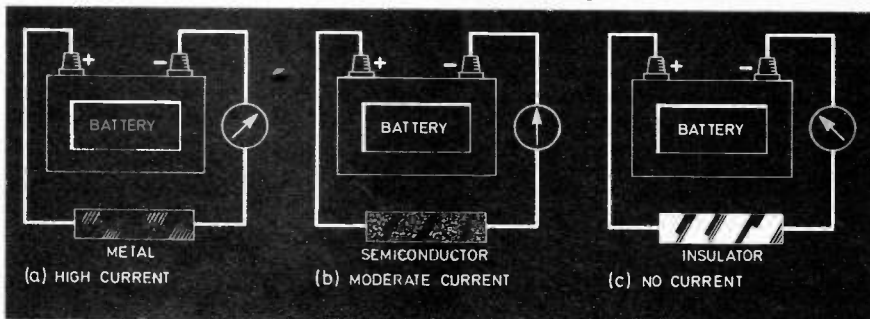

Fig. 2.2. The current flow from a charger through a battery; note that the current flows in the opposite direction through the battery to the current in Fig. 2.1.



From time to time authorities have suggested that we change the direction in which we consider a conventional current to flow so that it would become the same as the direction of the electron flow. However, if this change were made now, it would cause enormous confusion; for example, the arrow in all circuit diagrams containing diode or transistor symbols would have to be reversed in direction. When using a circuit one would have to think whether it had been published before or after the change.

In any case, positive ions flow in the same direction as our present conventional current. If we changed the conventional direction of current flow, we should meet the same problem with positive ion movement as we now have with electrons. One may note that the flow of current in the "metal" of antimatter, if it exists, is in the same direction as our conventional current, since charge carriers are positive positrons (the antiparticles of the electron).

Thus it appears we shall continue to regard conventional current as flowing from positive to negative electrodes in the external circuit of a battery.

MATERIALS

In some substances, such as metals, only a small voltage is required across a length of the material to produce a substantial current in it. Such materials are known as "good conductors".

In other materials, such as glass, the application of even a very high voltage across a thin layer of the material will produce only a very small current. Bad conductors are known as insulators.

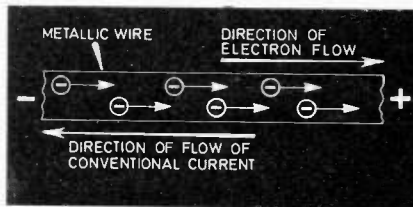

Fig. 2.3 (above). In a metallic wire the current is carried by the minute electrons which move towards the positive side. However, the conventionally accepted direction of current flow is opposite to movement of the electrons.

Fig. 2.4 (below). A battery will produce (a) a high current in a metal bar (b) a moderate current in a bar of a semiconductor and (c) no detectable current in an insulating bar.

In addition to the good conductors and insulators, there is a third class of materials known as "semi-conductors" which pass only a small current when a moderate voltage is applied across a thin slice of the material. It is this class of materials which makes modern electronics possible, since the flow of current through the material can be controlled by small input signals.

For completeness we will mention that a fourth class of materials can exist at very low temperatures which are known as "super-conductors". The resistance in a superconductor is almost zero, but the property of super-conduction disappears as the material is warmed only by a relatively small amount above the absolute zero of temperature.

METALLIC CONDUCTION

An atom consists of a central positively charged nucleus with electrons situated near to it. In a metal the inner electrons (those near to the nucleus) are fixed firmly in position, since the attraction between their negative charge and the positively charged nucleus prevents them from breaking away from the latter.

However, the outer electrons in a metal are free to move anywhere within that piece of metal. If a voltage is applied across the metal, electrons will flow towards the positive side and other electrons will enter the metal at the negative side. The battery which drives the electrons through the metal can be regarded as a pump which pumps electrons out of its cathode and receives a corresponding number back at its anode.

Thus it is the availability of huge numbers of electrons which are free to move in the metal which renders it a good conductor.

INSULATORS

In the case of insulators, the electrons are all fixed in positions by the electrical forces. The chemical bonds which hold electrons in position are electrical forces. A relatively large amount of energy is required to enable one of these electrons to break free and this amount of energy is not normally available for any one electron at room temperature. Thus there is nothing in an insulator which can carry an electric charge and any flow of current is extremely small.

In all solid materials the positively charged nuclei are held firmly in position by electrical forces and cannot contribute to conduction. It is only the movement of electrons which can make an appreciable contribution to the conductivity of any solid.

It is interesting to note that insulators will become conductors if their temperature is raised by an adequate amount. For example, if one applies a potential of about 200V across a glass rod about 20cm long by winding copper wires around each end and then heats the centre of the rod, a large current will pass when the temperature approaches red

heat and this current will be adequate to maintain the temperature of the rod.

The increase of conductivity is partly due to the heat energy enabling electrons in the glass to escape from the atoms to which they are normally fixed and partly due to the high temperature softening the glass so that ions can start to move as one approaches the liquid state.

SEMICONDUCTORS

In semiconductor materials there are a limited number of free electrons able to move in the material. This number is extremely small when compared with the number of free electrons in a metal. Thus the current which flows when a small voltage is applied across a semiconductor material is very much smaller than that which flows when a similar potential is

applied across a piece of metal of similar dimensions.

A semiconductor material is rather like an insulator, but the amount of energy required to release some of the electrons is far smaller. A few of the electrons acquire enough energy from the heat in the material for them to break away from the atoms to which they are normally attached and they can then contribute to conduction.

If the temperature of a semiconductor material is raised, the extra heat energy enables a much greater proportion of the electrons in the material to move. Thus the conductivity of a semiconductor material increases greatly with increasing temperature. The silicon semiconductor material used in most modern semiconductor devices cannot be used as a semiconductor above a temperature of

about 200 degrees C, since the number of mobile electrons is then too great for it to be regarded as a semiconductor material.

Modern semiconductor devices are made using extremely pure silicon to which certain elements have been added, but the early transistors were made using germanium. Silicon and germanium are elements, but certain compounds are also semiconductors; for example, cadmium sulphide is used in photoconductive cells, gallium phosphide in light emitting diodes and gallium arsenide in infra-red detectors and lasers.

Semiconductor products are often known as "solid-state devices" since the materials in them are solids, unlike the earlier radio valves in which electrons flow in an evacuated enclosure.

Next month we shall continue our discussion on conduction in various materials.

CIRCUIT EXCHANGE

This is the spot where readers pass on to fellow enthusiasts useful and interesting circuits they have themselves devised.

Payment is made for all circuits published in this feature.

Contributions should be accompanied by a letter stating that the circuit idea offered is wholly or in significant part the original work of the sender and that it has not been offered for publication elsewhere.

PROBELESS CONTINUITY TESTER

Continuity testers usually have two test probes. But in the present model, there is only one "touch point" instead of the probes. The device to be tested is held by one of its leads in one hand and the tester is held in the other. The other lead of the device is touched against the "touch point" (some metallic object about the size of a coin or even smaller. This is fixed on an insulated panel to isolate it from the tester case which is metallic.) The current flows from the metal body of the tester, through your body, the device and into the "touch point". This current is detected by the IC1 lighting up D1.

The "touch point" can be the head of a drawing pin. It should be insulated from the metal case, while mounting

J. Sreekumar,
Cochin,
India.

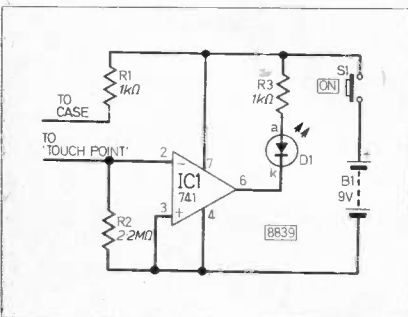

SIMPLE REACTION METER

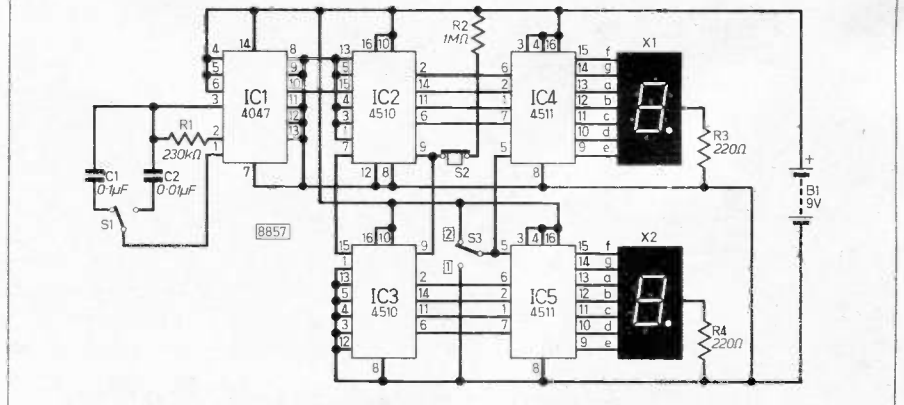

This is based on the 4047B multi-vibrator IC1 connected as an astable. S1 controls the frequency. When S1 is switched to C1 (0.1μF) the frequency is 10Hz. At C2 (0.01μF) the frequency is 100Hz. Resistor R1 is 230k (220k and 10k in series). This value is required in order to obtain fair accuracy. The pulse is fed into the 4510B BCD counter. This feeds binary into the 4511B which decodes it to drive a seven-segment common cathode display. The first 4510B (IC2) feeds a pulse which has been divided by 10 into the second counter stage IC3, IC5, which operates in the same way. S2 is push-to-break and resets both digits to 0.

S3 is the latch which when in position 1 (connected to negative) allows the 4511B to display the pulses being coun-

ted. When S3 is positive (position 2) the 4511B displays the number which was being counted at the exact moment the switch was turned to positive.

How to time a person's speed: The subject undergoing test holds S3 (which is in position 1). Another person holds S2 pressed so the digits are at 0. As soon as S2 is released the digits start counting the pulses, and when the person being timed sees the digits counting, he switches S3 to position 2, this latches the 4511B so the time is displayed. To reset, S3 is returned to position 1 and S2 pressed. Timing can be accurate to 1/10 of a second or 1/100 of a second depending on what range S1 is set to.

Z. Karim,
London
E13.



A Bargain Offer

To Everyday Electronics Readers

GAMMA F227

Ionization Type Smoke Detector



FIRE ALARM

**ONLY
£4.45**
INCLUSIVE OF
POST & PACKING
AND V.A.T.
TWO FOR £7.75 inc.

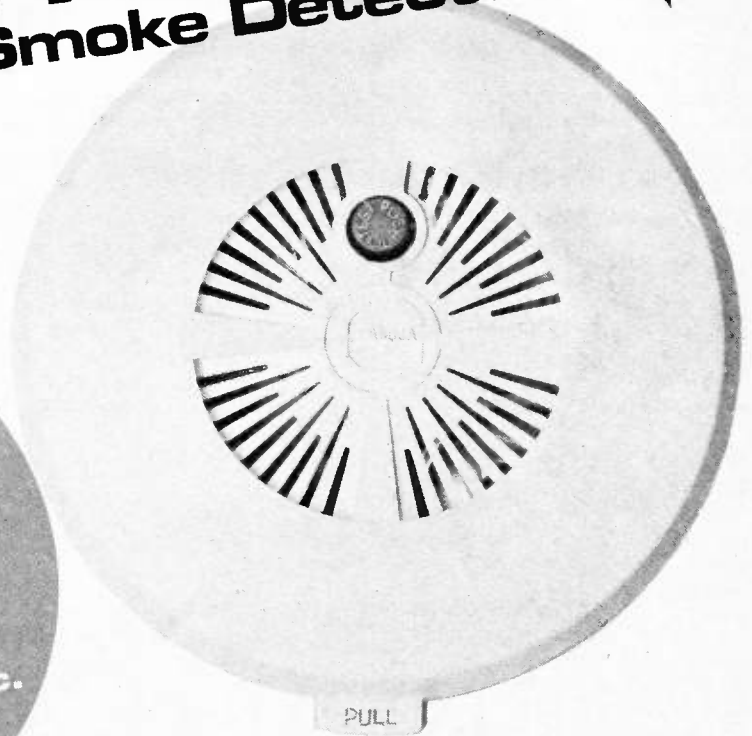

Responds to the initial stages of combustion and gives the earliest possible warning of a fire.

Self contained, operates from small 9V battery. Housed in white plastics case. Easily fitted to ceiling.

For further details see New Products (Page 385).

Half of Normal Retail Price!!

Please allow 14 days for delivery (from receipt of order). This offer is for UK addresses only. **OFFER CLOSES—July 20, 1983.**

Please complete both parts of the coupon in **BLOCK CAPITALS.**

To: RTVC Limited, 21A High Street, Acton, London W3 6NG.

GAMMA F227 Smoke Detector Fire Alarm
Mail Order Only

Please send me at *£4.45 each incl.

I enclose PO/Cheque No Value

(Payable to RTVC Ltd.)

Name

Address

* Including VAT and postage.

From: RTVC Limited, (E.E. Offer), 21A High Street, Acton, London W3 6NG.

Name

Address

Post Code

JULY ISSUE

PLANT CULTIVATION

AUTOMATIC GREENHOUSE WATERING SYSTEM

SUITABLE FOR GREENHOUSE OR CONSERVATORY THIS SYSTEM ENSURES ADEQUATE WATERING OF PLANTS AND ENABLES THEM TO BE LEFT FOR LONG PERIODS WITHOUT PERSONAL ATTENTION. A BOON FOR HOLIDAY TIMES.



NEW SERIES

Microcomputer Interfacing Techniques

PERIPHERAL CIRCUITS & SOFTWARE

THIS IS THE FIRST OF A SERIES OF ARTICLES TO HELP THE ELECTRONICS EXPERIMENTER BUILD AND USE A RANGE OF SIMPLE PERIPHERAL UNITS WHICH CAN BE INTERFACED WITH 6502-BASED MICROCOMPUTERS. EACH PART WILL INCLUDE A CONSTRUCTIONAL PROJECT.

TRI BOOST

A tone correction unit for the guitarist to boost the treble, mid-range or bass sections of the audio spectrum. Footswitch operation.

DIGI ALARM

Using an electret microphone insert and a.f. amplifier, this will boost sound from any wrist-watch alarm making it suitable for bedside use.

EVERYDAY
ELECTRONICS
and computer PROJECTS

JULY 1983 ISSUE ON SALE FRIDAY, JUNE 17

FOR YOUR ENTERTAINMENT

BY BARRY FOX

Computer Forecast

I've been doing some long overdue donkey work on computing. I wonder how many readers are in the same boat as I am? Too busy earning a living at work that doesn't involve computers to spend the time necessary to get to grips with computing.

With this in mind I'll make a public bet. I bet that within a couple of years there are word processors, and computer filing systems, on the market that require absolutely no knowledge of computing. You'll use them as easily as you use a typewriter. The software program will be in a dedicated chip inside the keyboard so that it's ready for action the moment you switch it on.

I'll also bet that the machines that make a killing on this market come from Japan. It will be the video boom all over again. While Western companies are still trying to sell equipment that requires the proud purchaser to make all manner of compromises, the Japanese will have quietly designed a range of computer equipment that is tailor-made for people who don't want to know anything about computers. Mark my words!

Medical Cure

Meanwhile, anyone who wants to use a computer as a working tool (for instance, I wanted to use one for indexing my files on audio and video topics) has got no choice. They have to learn a bit about computing or do without.

As a mixed blessing I ended up in hospital and convalescing for a couple of weeks. So I spent the time learning something about computers.

I'm not recommending that people who need to learn the rudiments get themselves into hospital, but if you are in the same unfortunate position I strongly suggest that you turn it to your advantage. Even if you aren't very interested in computing, it's better than watching someone else's choice of TV programme on the ward set.

To my surprise I found that modern hospitals now have mains power points by each bed. If you get on the right side of the ward nursing staff, they will let you bring in a small computing system, like a Sinclair, and run it on the bedside table.

I was lucky in finding a couple of doctors on the ward round who were both computer buffs. They encouraged me to bring in a computer and the ward sister said: "All right, provided it doesn't make any noise".

Other hospitals, and other wards, may have a different policy. But all is not lost. Your answer here is to use a pocket computer, like the Sharp PC 1211. The same model is also sold by Tandy.

The cost is well under £100 and although these units look like calculators, they are in fact full-blown computers, albeit with fairly limited memory. With a cassette interface you can write programs, dump them onto tape and load them again the next day.

The instruction book that comes with the Sharp is pretty clumsily written, and the Tandy version is much better. But with either, and some hard work, you can do some very useful ground work on basic computing and BASIC program language.

Bear this in mind if you have advance warning that you are likely to be laid up, in hospital or in bed, for a couple of weeks. It's a good opportunity to turn a stroke of bad luck to your advantage.

Hospital Radio

Here's another tip for anyone facing a stint in hospital. Unless you are very ill, you'll soon get bored. Even if you are learning computing, you'll want to listen to the

radio as well. But the radio systems in even modern hospitals leave a lot to be desired.

They use acoustic stethoscopes, like those in long-haul airlines, and you can only listen to a limited choice of channels piped through to your bed by the hospital distribution system. It's also likely to be in mono only.

The answer is to take along a personal stereo cassette player, or radio with headphones. However, do check that a tape player produces good sound while it is being shaken around, as well as while it is laying stationary on a shop counter.

Some of the cheaper models produce awful wow and flutter as soon as you use them on the move. It won't matter in hospital, but it will drive you crazy if you later try and use the player while you are walking or jogging.

By the way, if you are visiting someone in hospital and you can afford an expensive present, a personal cassette player or radio will probably be far more welcome than flowers or fruit.

Video In A Spin

The video games boom is levelling off. Atari in America has laid off a quarter of its workforce.

Personally, I'm not surprised, and I'm certainly not sorry, that the public is fast growing tired of blasting blips off a TV screen. The games manufacturers are trying to counter the loss of interest with ever more exotic cartridges.

One trend is to sell games that are "spin-offs" from feature films, like *Tron*, *Star Wars* and *Raiders of the Lost Ark*. Another trend is towards semi-sadistic games, like guiding chickens across a busy road. And in America, there are now pornographic games, from strip poker to all manner of unmentionables.

All the signs are that all these are the desperate efforts of a dying industry. But there is growth in games programs for micros. Businessmen and householders are buying small computers because they think they ought to use them for accounting, calculation or word processing. As often as not the only programs they end up running are games programs.

Joystick

Accessory firms are also making money out of video games. For a little over £10 each you can buy exotic joystick controls to replace those that come as standard with TV games.

Most hand controllers for home TV games use a separate joystick and firing button to steer and blast blips on the screen. Usually, only one shot is fired for each press of the button.

New add-on controls from American manufacturers Spectravision and DiscWasher do better than that. They come with a standard 9-pin D-plug which fits straight into the control socket of an Atari game or Commodore computer. The firing button is on top of the joystick, under the player's thumb.

The makers reckon that this brings consistently higher scores. It also means that right and left handed users can for the first time compete on equal terms.

For really high scores you have to pay an extra £8 and plug in a DiscWasher Constant Fire adaptor between the joystick plug and circuit. This contains an integrated circuit which is powered by spare d.c. from the games unit and generates a constant pulse fire cycle every time the thumb button is pressed. So on the screen there is a machine-gun effect.

Gadgets like these are selling well, partly because people just love to buy extra add-on gadgets. But it's also partly because the hand controllers with TV games get very hard use, wear out and need replacing with new ones fairly frequently.

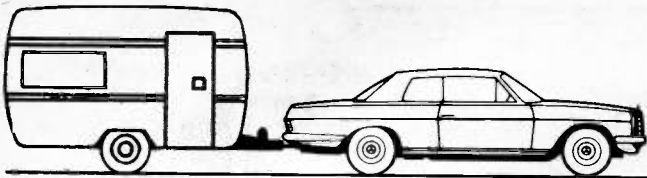

CARAVAN POWER SUPPLY

BY T. R. de Vaux-Balbirnie

THE author is one who believes that caravanning can be made more pleasurable by the benefits of electronics. Fluorescent lights, electric water pumps, extractor fans and cooker hoods are convenient, while cassette recorders, television and, perhaps, a video game or personal computer, can be useful on wet days and in making a true home-from-home.

POWER SUPPLY

The battery in the towing vehicle may be used to power any 12V equipment but this ties up the car since it must be parked nearby. Some members of the family might wish to use it leaving the others behind. So there is much to be said in favour of a separate battery for the caravan. This is useful, even at home,

since the interior light may be used without having to couple up the car.

It will be noted that an auxiliary battery is only used for the interior equipment, the exterior lights on the caravan receive their power from the car system in the usual way.

CHARGER

Assuming the auxiliary battery to be fully charged before setting out on a trip, it could only be expected to give a short period of service without being recharged. The present system has been designed to keep the battery topped up with charge, at a rate of about 2A on touring holidays. It is not designed for use on long-stay holidays at a fixed location. Since charging is effected by the generator in the car, the project is best

where stops are for a few days at a time, followed by periods of towing.

Readers wishing to keep a battery charged on fixed-site holidays would be advised to buy a commercial unit offering mains facilities and to choose a site with mains outlets.

The project described is for a *negative-earth* car. It is equally suitable for *positive-earth* systems and the simple modifications required are described later.

RESISTANCE

When driving along there will normally be about 14V available from the car charging system. This will exist at the accessory pin on the drawbar socket. From here, current is directed through existing wiring to the caravan and used to charge the auxiliary battery.

Fig. 1. Complete circuit diagram of the Caravan Power Supply.

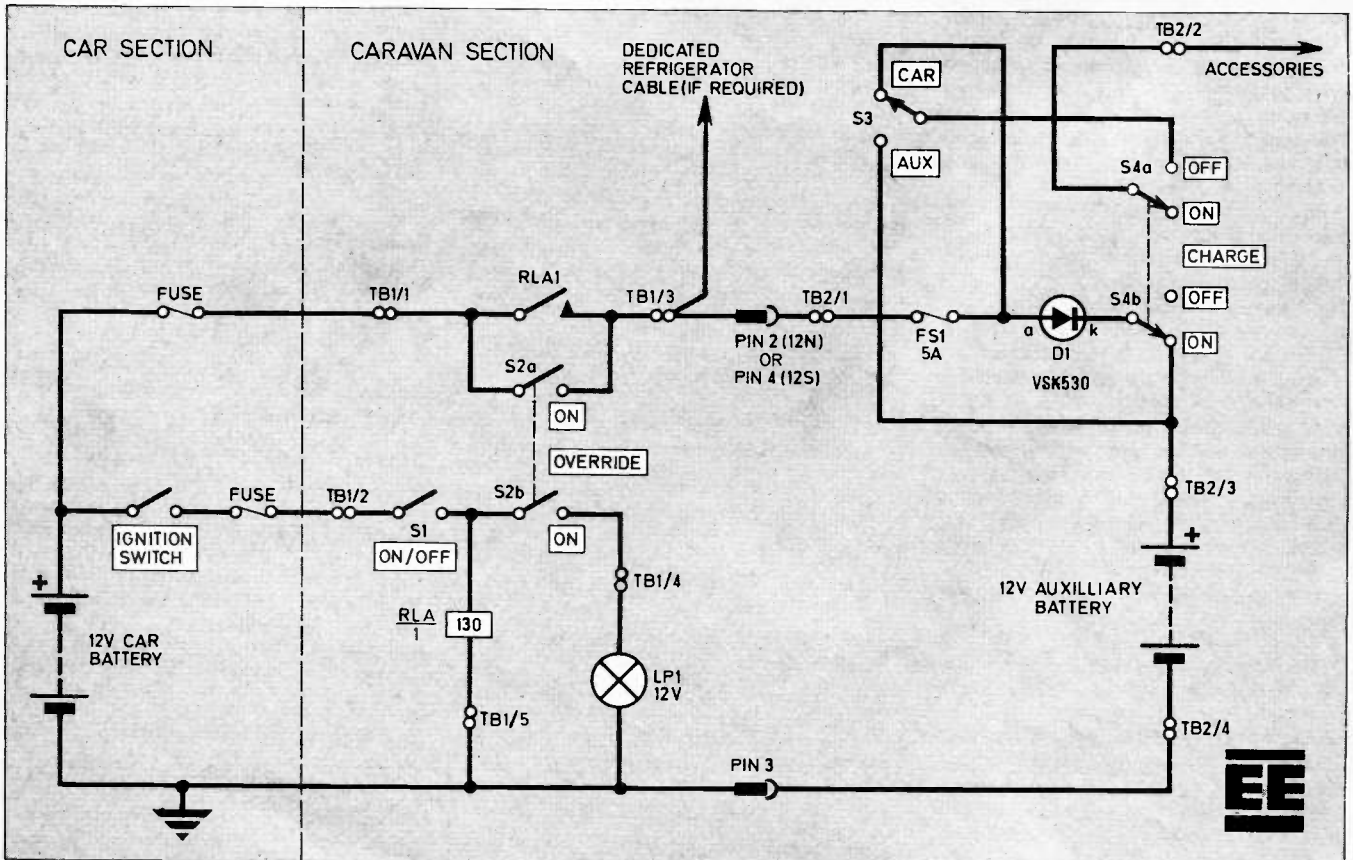

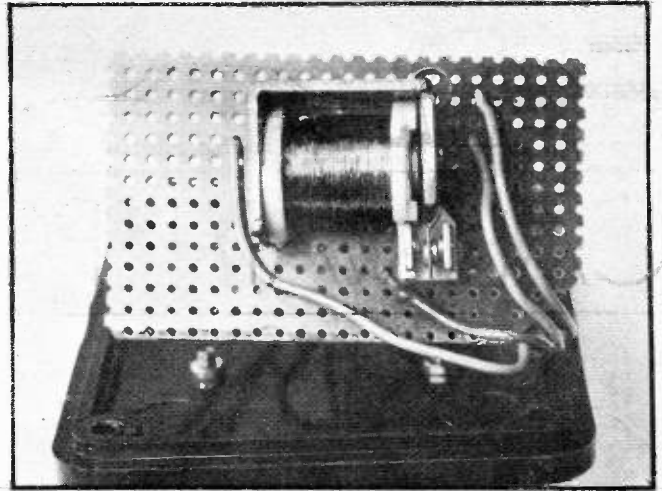
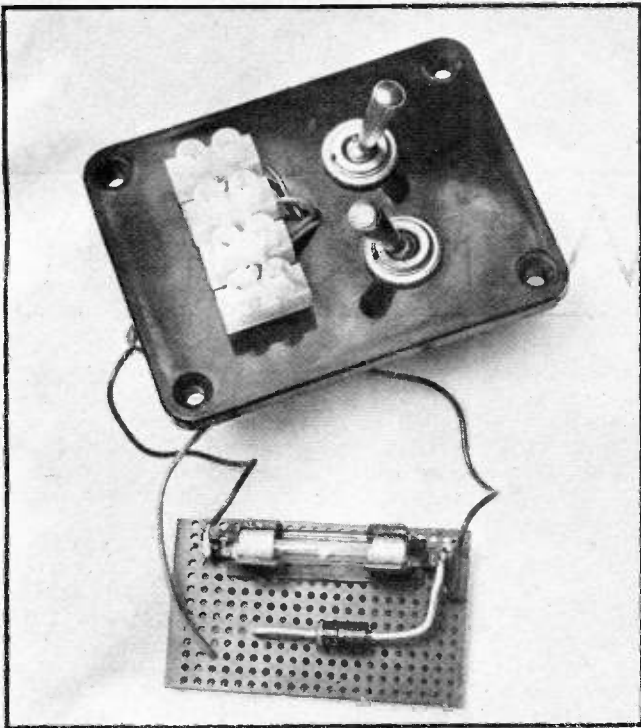

Above—The matrix board mounted relay in the car section. The two switches and 5-way terminal block (not shown in this view) are mounted on the lid.

Left—The caravan mounted section of the Power Supply, showing the diode and fuse constructed on a piece of plain matrix board. Switches and terminal block are again assembled on the case lid.

Since the caravan battery is nominally 12V, there will only be about 2V available to drive current through the circuit. For charging at 2A, using Ohm's law, we get:

$$R = \frac{V}{I} = \frac{2}{2} = 1 \text{ ohm}$$

From this it is clear that the resistance of all wiring must be kept low or a poor charge rate is to be expected. If a refrigerator is powered through the accessory cable, there is likely to be an excessive voltage drop due to the high current flowing. It is always much better to supply a refrigerator through a *dedicated* run of cable. This is difficult where the car is fitted with a single socket (the 12N (Normal) system), because there is no spare connection.

On recent outfits (both cars and caravans manufactured since October 1979) there is a second socket fitted to the drawbar, the 12S (Supplementary) socket. The 12S socket has pin 6 reserved for refrigerators. When a refrigerator is fitted in an older outfit, it would still be wise to fit a 12S socket. This is available from caravan accessory shops.

An alternative to fitting a 12S socket would be to tape a supplementary wire to the 7-core cable and use a weatherproof connector for powering the refrigerator.

HOUSING

The Caravan Power Supply is built into two similar plastic boxes, each fitted with two switches. One part is located in the boot of the towing car and the other in a front locker of the caravan adjacent to the auxiliary battery. The circuit diagram of the entire system is shown in Fig. 1.

The car mounted case contains a relay, RLA1. This permits charging of the caravan battery only whilst the ignition of the car is on. This is necessary as there will be no chance of a well-charged car battery draining into a poorly-charged auxiliary battery.

The first switch, S1, switches off the system. This is useful to avoid mechanical wear on the relay during long non-towing periods. The second switch, S2, over-rides the relay for a reason to be explained later. When over-ridden, a warning light illuminates on the dashboard when the ignition is next switched on.

CARAVAN SECTION

The caravan section of the project carries a fuse, FS1, and diode D1. The diode directs current to the caravan system and, under no circumstances, the other way. An ordinary *p-n* junction diode would lead to a voltage drop of up to 1V and a poor rate of charge. Instead, a *Schottky barrier* diode is used. This is more expensive than the conventional type but gives a more acceptable voltage drop of about 0.2V.

Switch S4 on the caravan section selects either ON CHARGE (when driving along) or OFF CHARGE (when parked). When OFF CHARGE the caravan equipment may be used. S3 is labelled CAR/AUX. This selects the battery from which current is to be drawn. When the car is available there seems no point in draining the auxiliary battery.

To enable the car battery to power accessories it will be necessary to set S2 to OVER-RIDE, hence the purpose of this switch.

CONSTRUCTION

COMPONENT BOARD

The circuits for each panel are illustrated in Fig. 2 and Fig. 3. The diagrams should make the connections clear. Note that the specified relay is fitted with change-over contacts but only the "energise-to-make" (or normally open) contacts are used. The diode is secured by passing its negative connection through a hole in the panel and bending it. The polarity of the diode is important and the white band shows the cathode.

COMPONENTS

Semiconductors

D1 VSK530
5A Schottky
barrier rectifier

See
**Shop
Talk**

page 369

Miscellaneous

S1,2,3,4 d.p.d.t. toggle (4 off)
RLA miniature relay, 12V,
130Ω coil with 30A
rated contacts
LP1 12V, 2-2W panel lamp
FS1 5A fuse
0.1 inch plain matrix board, 12
strips by 21 holes (2 off); plastic
case, 76 × 56 × 35mm (ABS
case type MB1) (2 off); terminal
block 6-way (2 off).

Approx. cost
Guidance only

£12

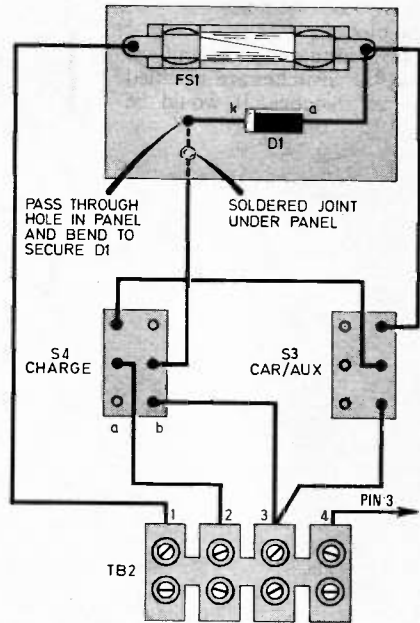
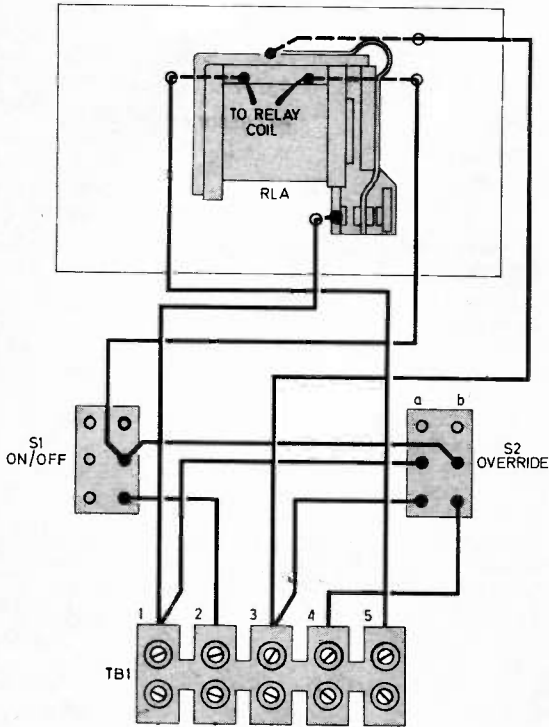
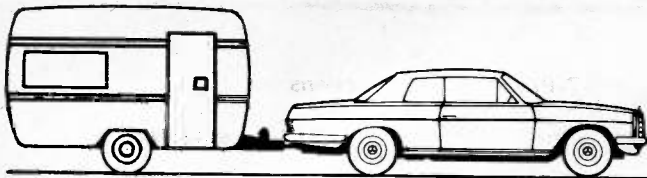

Fig. 2 (left). Diagram showing wiring details of the car section, consisting of a relay RLA1 and switches, S1 and S2.

Fig. 3 (above). Wiring details of switches, S3 and S4 in the caravan section, showing diode and fuse connections.

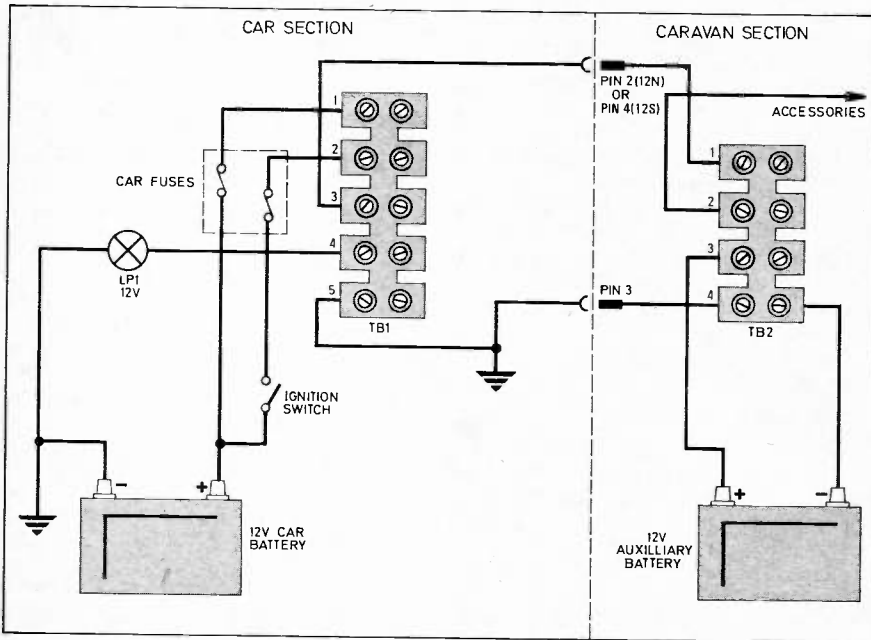

Fig. 4. Interwiring details for the car and caravan sections, note that the connections between the two sections are made via the 7-pin (12N or 12S) socket. See Table 1.

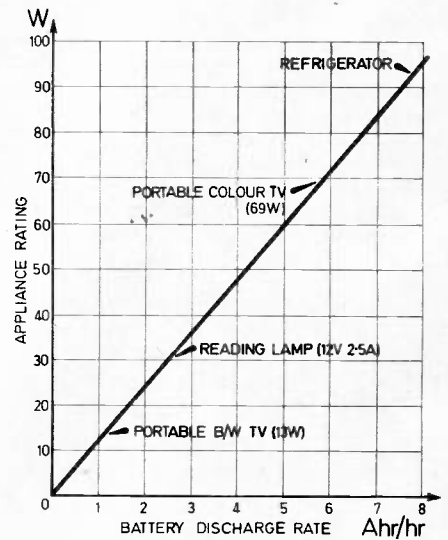

Fig. 5. Graph showing the typical discharge rate for the caravan auxiliary battery, for various electrical appliances.

Solder 100mm long wires to the components as indicated in the diagrams for connection to the terminal blocks. Drill the boxes for the switches and terminal strip fixings. Drill a small hole near each terminal strip to accept the wires from the circuit panels. Attach the switches and terminal blocks. Insert the circuit panels, pass the wires through the holes and wire up the terminal blocks.

For ease of ordering and uniformity of appearance, all four switches are specified as d.p.d.t. toggle switches. It would be possible, although hardly worthwhile, to make a small saving by using simpler switches for S1, S2 and S3. The switches must be of at least 3A rating. Small brackets may be attached to the boxes to enable them to be fitted in position.

INTERWIRING

Refer to Fig. 4 for wiring details. Choose a convenient place in the rear for the car section. This should be close to the existing wiring to the 7-pin drawbar socket. Remember that access is required to operate the switches.

Locate the wire which leads to the accessory pin on the drawbar socket. (See Table 1.) Break this wire and extend the free ends using "bullet" connectors. The end leading to the 7-pin socket should be connected to TB1/3 and the other end to TB1/1. Two runs of light-duty auto-type wire should be made to TB1/2 and TB1/4. The former connects to a fuse which is live only when the ignition is switched on and the latter to one terminal of the warning light positioned on the dashboard of the car. The remaining connection, TB1/5 is earthed by being connected to the metal body of the car. The unused terminal of the warning light is also earthed.

The caravan section may now be wired up. The locker chosen for the box and auxiliary battery should be as close as possible to the inlet connections from the 7-pin plug. These are often located in the locker itself or under the caravan. The wire leading to the accessories should be found, removed from its terminal, and connected to TB2/2.

The free terminal should be connected through a short length of wire to TB2/1. TB2/3 and TB2/4 are respectively the positive and negative connection for the auxiliary battery. TB2/4 is earthed by connecting it to the wire which leads to pin 3 on the 7-pin plug. Proper connectors should be used for the auxiliary battery, do not rely on crocodile clips or other make-shift methods. (Note previous comment about refrigerators.) On no account may one be powered through the caravan section of the unit.

POSITIVE EARTH

For *positive-earth* cars, reverse the connections to the diode and the auxiliary battery.

TESTING

Note that all tests must be made with the caravan stationary as the law does

TABLE 1
7-Pin Socket Connections

Pin No	12N (Normal)	12S (Supplementary)
1	Left indicator	Reversing light and catch if fitted
2	Foglight (accessories if no 12S fitted)	Battery charging
3	Earth	Earth
4	Right indicator	Accessories
5	Right sidelights and number plate	Warning lights
6	Stop lights	Refrigerator
7	Left-hand sidelights/ number plate	Spare

Looking at sockets from the plug side, pins are numbered clockwise with No. 1 at the top. Pin 7 is in the centre.

not permit riding in a caravan. Satisfactory testing can only be carried out using a 0-5A ammeter. First switch off all accessories and disconnect the wire from the positive terminal of the auxiliary battery. Connect the positive terminal of the meter to the free wire and the negative terminal to the battery terminal. Now set the switches in the following way:

Car Section:

S1 (ON-OFF switch) ON
S2 (OVER-RIDE switch) OFF

Caravan Section:

S3 (CAR/AUX switch) TO EITHER POSITION
S4 (CHARGE switch) ON

The ammeter should give no reading. Switch the ignition on but do not start the engine yet. A click may be heard as the relay operates and a small reading may be observed on the ammeter. Run the engine at a fast idle. The ammeter should indicate a current depending on the state of charge of the auxiliary battery. It may be expected to be 2A or so and higher for a very poorly charged battery.

Now check the circuit in the discharge mode. Remove the ammeter and reconnect the battery wire. Set the switches as follows and switch a caravan light on:

Car Section:

S1 (ON-OFF switch) ON
S2 (OVER-RIDE switch) ON

Caravan Section:

S3 (CAR/AUX switch) AUX
S4 (CHARGE switch) OFF

Assuming the auxiliary battery is charged, then the caravan light should be on. Now set the CAR/AUX switch to CAR. The caravan light should stay on. This time it receives current from the car battery. Remember that the relay must be over-ridden, using S2, before the car battery can supply current. Test by switching S2 OFF—the interior light should now go off. Test the warning light by setting the OVER-RIDE switch to ON with the ignition on.

AUXILIARY BATTERY

Any 12V car battery will serve for the auxiliary supply. It is always wise to choose a battery of the same size and having the same fittings as the car battery. It may then be used as a spare battery in an emergency. Budget batteries are quite suitable and will have a long life since the auxiliary supply is only intended for light-duty use. Even a battery from a breaker's yard may be satisfactory but reject one if it shows signs of neglect or if it has been left in a discharged state for a long time.

During long periods of non-use the battery should be charged periodically to keep it in good condition. Alternatively it may be exchanged with the car battery from time to time. Always keep the terminals clean and tight and remember to charge it fully before setting out on holiday.

SWITCH FUNCTIONS

S1 To cancel the system for the winter months. When ON, the relay operates each time the ignition is switched on whether towing or not. This is not harmful but causes unnecessary mechanical wear.

S2 To over-ride the relay. This is only needed when parked and the car battery is required to power caravan accessories.

S3 CAR/AUX—with S4 OFF set S3 to AUX to operate equipment from the caravan supply. Set to CAR (with S2 ON) to operate equipment from car battery.

S4 CHARGE switch. Set to ON when driving along to keep auxiliary battery charged. Set to OFF when parked. When S4 is ON, S3 may be set in either position.

The warning light comes on if S2 is left at OVER-RIDE and the ignition is switched on. It would be bad practice to leave it this way. □

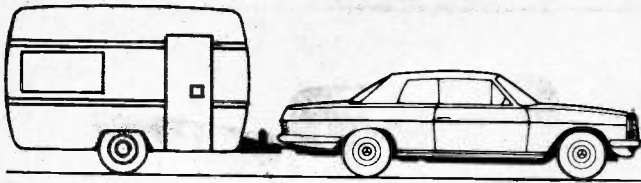

CARAVAN FRIDGE ALARM

BY T. R. de Vaux-Balbirnie

A REFRIGERATOR is regarded as an essential piece of caravanning equipment and can certainly simplify a holiday. Tent campers are also seeing the benefit of a well-stocked fridge. Unfortunately, refrigerators are prone to failure for the simplest reasons, a gas bottle running out or a poor electrical connection and this causes great inconvenience unless discovered in time.

This project is an alarm which will provide early warning of fridge failure. It gives a signal by means of either a lamp or a buzzer. The audible signal is useful when at a fixed site. The visible signal is more appropriate when towing.

In this case, the unit is placed in the front window of the caravan and the lamp observed through a car rear-view mirror. It would be a simple matter to construct the project for buzzer-only warning if preferred.

PLASTIC BOX

The project appears as a small plastic box with two switches mounted on top. The first is simply an on-off switch. The second is used to select either lamp or buzzer warning. A terminal block is used

to connect the unit to the sensor on the fridge.

The box contains its own battery. One reason for this is because the most common cause of failure while towing is failure of the electrical supply. The alarm would also fail to work if it received current from the same source as the fridge.

Although the internal 9V battery is small, excellent service may be expected even where the unit is switched on continuously for long periods. This is because the standby current requirement of the circuit is extremely low, about 15 microamps. When the alarm is actually operating the current rises to about 15mA (buzzer) or 60mA (lamp).

The Caravan Fridge Alarm was designed for use with *absorption* fridges of the type used in caravans and for camping. It may be used with certain *compressor* fridges of the household type but readers would need to make their own tests to find out if this is possible.

OPERATION

Previous designs have relied on the rise in temperature inside the fridge when it

fails. Unfortunately, there may be difficulty inserting the sensor into the cabinet without disturbing the thermal insulation. This project, by contrast, works by sensing the fall in temperature of an easily-accessible part behind the fridge.

A small boiler is an essential component of an absorption fridge. This is maintained at a high temperature by means of either a gas flame or an electric heater. The sensor is applied close to this and if the electric or gas supply fails then the boiler will cool and the alarm trigger. An adjustment on the circuit panels allows this to happen at a suitable preset temperature.

Although nearly fool-proof, this method of detecting failure is not quite so. If the refrigerant itself were to fail then the boiler would stay hot but the fridge would not work. Circumstances like this are thought very unlikely.

CIRCUIT DESCRIPTION

The circuit for the Caravan Fridge Alarm is shown in Fig. 1. The sensor detecting the fall in temperature is a suitably protected bead thermistor, RTH1. VR1, R1, RTH1 and R2 form a potential divider across the battery. When the unit is switched on at S2, a small current will flow continuously. This is too low to cause serious battery drain on account of the very high resistance involved.

When RTH1 is hot and the refrigerator operating normally, its resistance will be comparatively low and the voltage at point A less than the 0.7V needed to turn on TR1. When RTH1 cools, its resistance rises and the voltage at point A will rise above 0.7V so TR1, TR2 and TR3 will turn on.

These three transistors are connected in a very high gain arrangement called a "Darlington triple". The base current entering TR1 in order to operate the alarm at the end of the chain is exceptionally low. This leads to a very sharp response. The two-way switch, S1, allows current to flow to either the lamp, LP1, or the buzzer, WD1.

Switches S1 and S2 are specified as d.p.d.t. types since these are readily available. It would be possible to use a s.p.d.t. for S1 and a s.p.s.t. for S2 with a slight saving in cost.

VR1 is the adjustment whereby the alarm operates at a preset temperature within its range.

Fig. 1. Main circuit diagram of the Caravan Fridge Alarm.

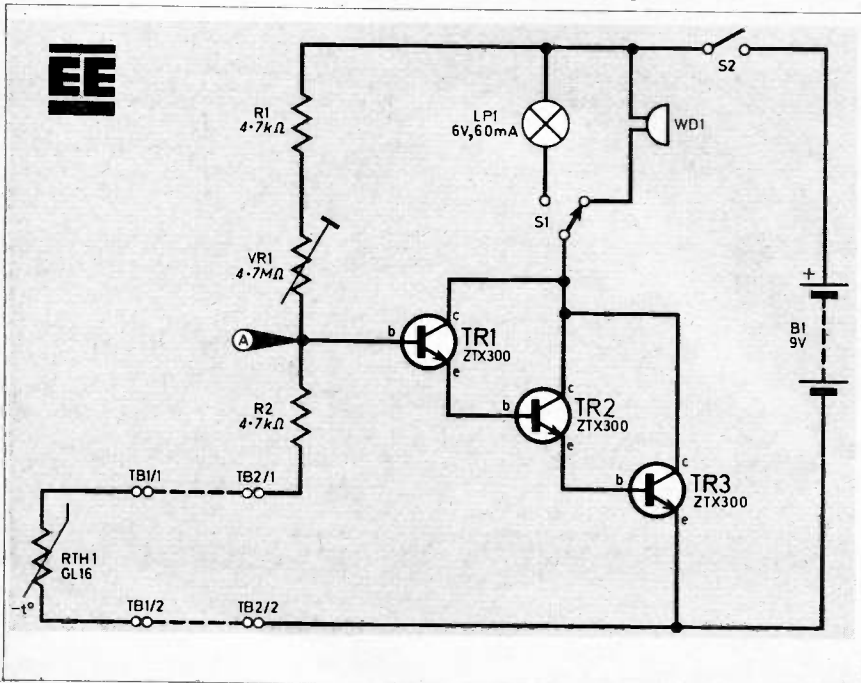

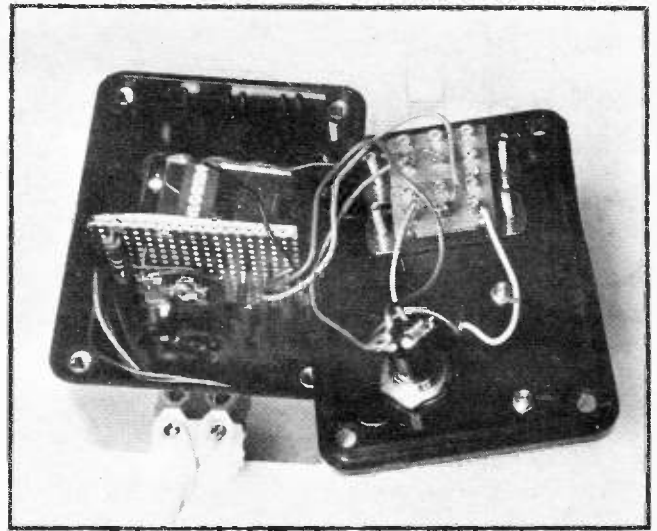
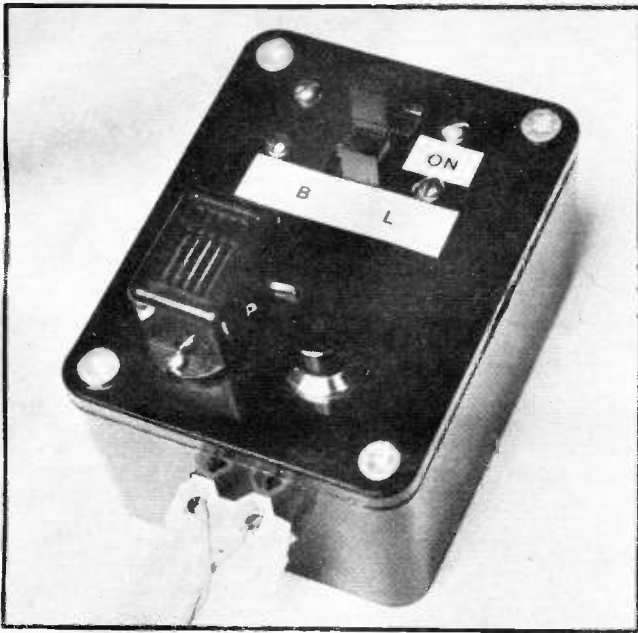

(Above). Prototype with the lid removed showing the internal layout and use of moulded guides to mount the circuit board.

(Left). The completed prototype Caravan Fridge Alarm showing the case mounted components.

CONSTRUCTION

COMPONENT BOARD

The circuit panel is constructed on a piece of 0.1 inch matrix stripboard 12 strips by 21 holes in size. Refer to Fig. 2 and solder all components into position. Any breaks in the stripboard should be made prior to inserting components. Check carefully that no solder bridges have been left between adjacent copper tracks. End by soldering connecting leads to Veropins as shown in Fig. 2.

COMPONENTS

Resistors

R1,2 4.7k Ω (2 off)

Semiconductors

TR1,2,3 ZTX300 npn silicon (3 off)

Miscellaneous

S1,2 d.p.d.t. slide (2 off)
 VR1 4.7M Ω horizontal skeleton preset
 RTH1 GL16 glass bead thermistor
 B1 9V PP3
 WD1 6V buzzer
 LP1 6V, 60mA indicating lamp

0.1 inch matrix stripboard, 12 strips by 21 holes; plastic case, 76 x 56 x 35mm (ABS case type MB1); terminal block 2-way (2 off); metal spring clip.

Approx. cost
 Guidance only **£9.00**

TESTING

A test may now be made on the circuit panel before fitting it into its case. Set VR1 to about mid-position and connect the thermistor as shown in Fig. 2. Connect the 6V bulb and then connect up the battery terminals. The lamp will probably light.

With the help of an assistant, warm RTH1 by holding a lighted match 50mm below it for a few seconds. The lamp should go off and re-light when the thermistor cools. If this does not happen then some adjustment to VR1 is required. The final setting for VR1 can only be found at the end when the sensor is in position on the fridge.

CASE

Prepare the case by drilling holes for the switches, lampholder, the buzzer and terminal block fixings. A suitable layout is shown in the photograph. Drill a small hole next to the terminal block position for the wires which will pass through from the component panel. Drill a similar hole for the buzzer wires to pass through. Attach all remaining components and complete the wiring (Fig.3).

SENSOR

It is essential to use a thermistor of the same type as specified in the components list. Suggested positions for the sensor are shown in the photographs, these cover the

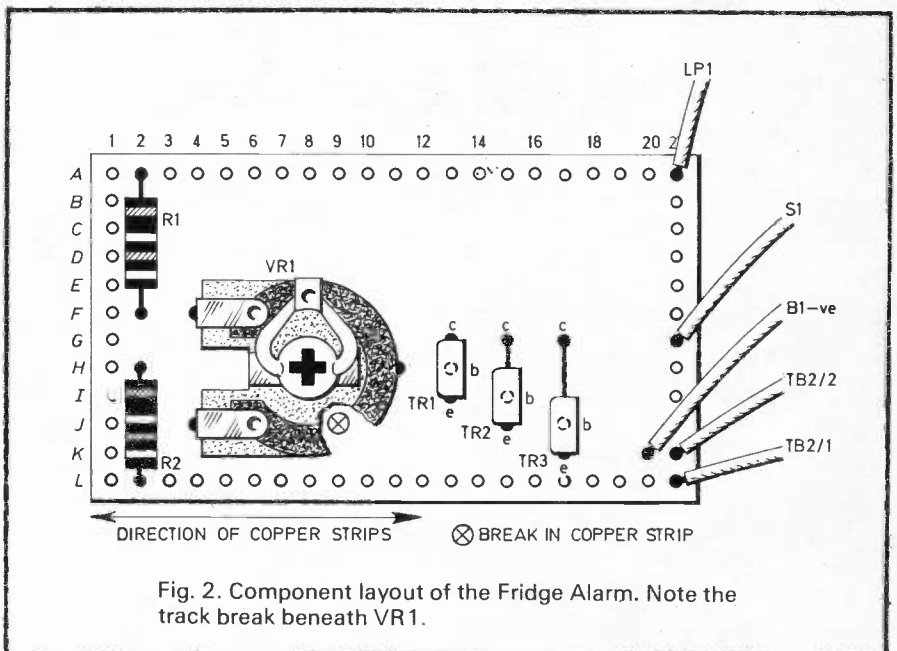
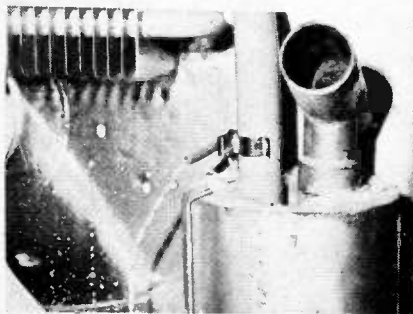
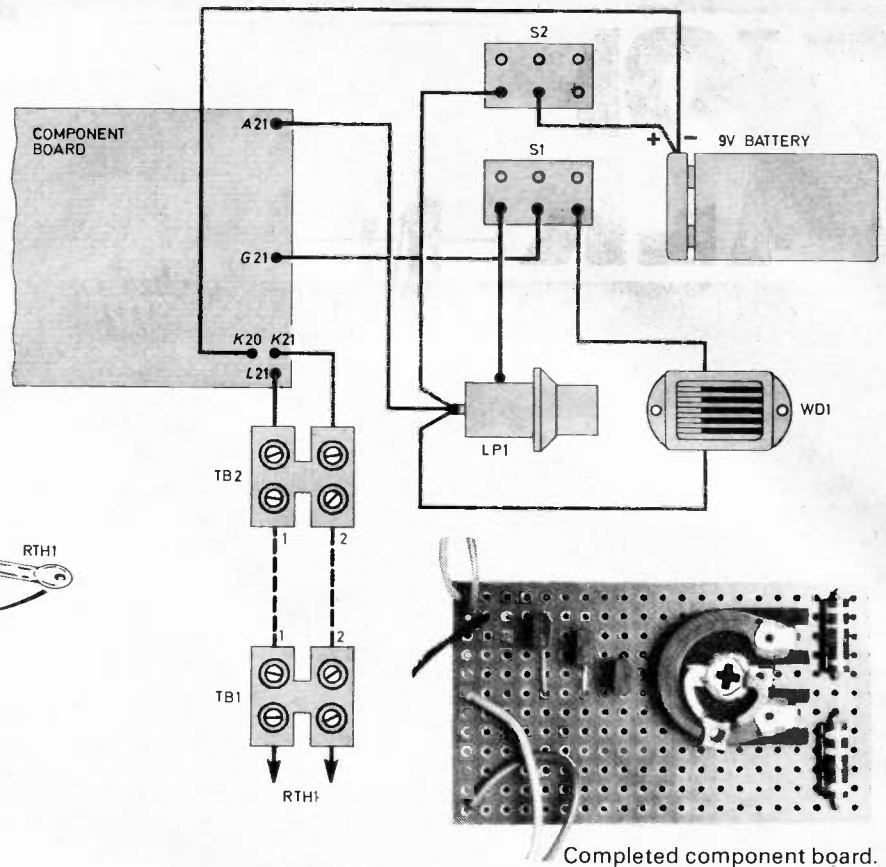
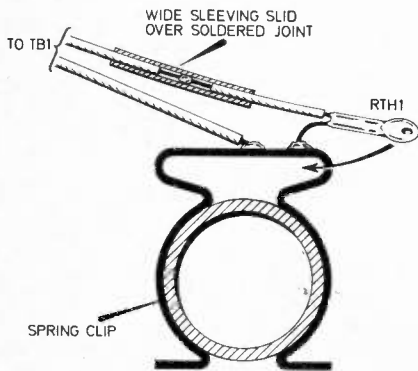

Fig. 2. Component layout of the Fridge Alarm. Note the track break beneath VR1.

Fig. 3 (right). Diagram showing offboard wiring details. Note that TB1 and RTH1 are remotely mounted via a twin covered cable on a suitably positioned pipe (see text and photographs).

Fig. 4 (below). Diagram showing mounting details for the temperature sensor. Note that when soldering to a plated spring clip, the plating must be removed and the use of an additional flux may be required. To make good thermal contact ensure that the bead is located in the bend of the clip using epoxy resin.



Temperature sensor shown mounted on the Electrolux Fridge.

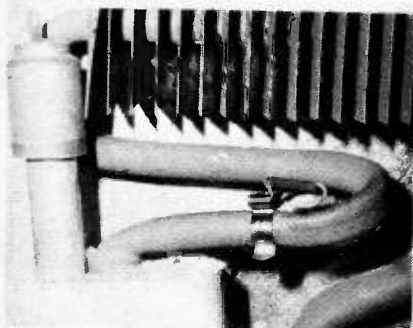

Temperature sensor shown mounted on the Camping Gaz Fridge.

Electrolux and Camping Gaz type refrigerators. Readers with other fridges should have no difficulty finding a suitable place.

The chosen position must feel very hot when the unit is at full operating temperature but warm enough to hold comfortably by hand about 15 minutes after switching off. On no account may the sensor be placed where it could disturb thermal insulation or interfere with the combustion of gas (inside the flue, for example).

The thermistor is very delicate and some protection is required. The method tried with the prototype is shown in Fig. 4. Alternatively, the thermistor may be secured to a small piece of thin sheet copper and this wired into position. Whatever method is used, it is essential that the sensor makes good thermal contact with the refrigerator.

Make sure that the thermistor leads cannot short circuit or the project will not work. The two thermistor leads are extended to reach TB1 which is attached to a convenient mounting point behind the fridge. Make certain that the wires are kept clear of all hot parts.

SETTING UP

Link TB1 at the refrigerator to TB2 at the unit using light-duty twin stranded wire. Run the fridge to operating tem-

perature. Switch the unit on at S2 and set S1 to LAMP. If the lamp comes on, adjust VR1 until it goes off. Allow the fridge to cool down. If the lamp comes on, re-adjust VR1 to keep it off. When the sensor feels just warm rather than hot, adjust VR1 so that the lamp is just on.

Check that the system works with the buzzer as well as the lamp. If the alarm operates continuously, suspect a break in the wire between the sensor and the unit. Note that it is normal for the warning, whether by lamp or buzzer, to begin gradually rather than suddenly.

When in position, the battery could cause short circuits to the copper strips of the circuit panel. To prevent this, place a piece of cardboard between the battery and panel. Use a little foam plastic to prevent the battery from moving around inside the case.

It is most important to allow for as large a drop in temperature as convenient to trigger the alarm. If this precaution is not observed the standby current consumption of the circuit will be higher than need be and the life of the battery reduced.

If a multimeter is available then this current may be checked with the sensor at full operating temperature. It should be about 15–20 microamps. When doing this, it is essential not to allow the alarm to operate since the increased current would damage the meter. □

SHOP TALK

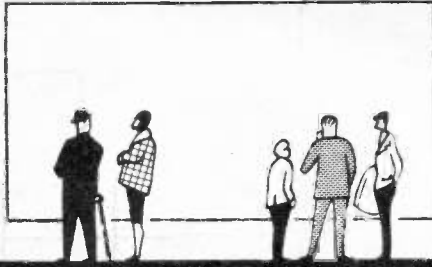

BY DAVE BARRINGTON

Catalogues

We have received just two catalogues this month. The first is the lavishly printed 48-page "Instruments for Testing and Design" from **Global Specialties Corporation**.

This catalogue covers digital logic probes and meters to function generators and a new oscilloscope multiplexer. The new 8-channel scope multiplexer, type 8001, extends the versatility of any single or dual channel scope by permitting viewing and comparison of eight channel analog or digital display.

For the constructor, there is a range of solderless breadboarding systems.

Copies of the "Instruments for Testing and Design" catalogue may be obtained from: **Global Specialties Corporation, Dept EE, Shire Hill Industrial Estate, Saffron Walden, Essex CB11 3AQ.**

For the Sinclair ZX81 and Spectrum home computer users, **Redditch Electronics** have just re-issued their accessories pamphlet.

This 16-page pamphlet lists such items as a add-on keyboard, input/output port boards and a music board. Also listed are a range of multi-pin connectors and a small range of books and tapes covering programming and using ZX81 and Spectrum machines.

Copies of the Redditch ZX81 and Spectrum Accessories pamphlet may be obtained from: **Redditch Electronics, Dept EE, 21 Ferney Hill Avenue, Redditch, Worcs. B97 4RU.**

Self-Service Multimeter

The latest addition to the range of multimeters and component test equipment stocked by **Alcon Instruments** is the Miselco T50 Super Multimeter. It has an input sensitivity of 50k Ω /V, large mirrored scale, switched ranges (39 in all) to measure resistance, d.c. and a.c. voltages and current, dB range and is fully protected against overload.

The p.c.b. and meter movement are factory calibrated such that any board will match any movement and maintain calibration. In this way the user is relieved of the worries of any repair or re-calibration problems.

The overall accuracy of the T50 Super is 2.5 per cent on all d.c. ranges and 3 per cent on a.c. The 16 μ A 100 degree movement incorporates an anti-parallax mirror.

The T50 SUPER Multimeter, housed in a two-tone brown plastics case, costs £52.35 plus VAT, without batteries. Included with the meter are a set of test probes/leads, instructions, circuit diagram and spare fuse.

Further information of the complete range of test meters may be obtained from: **Alcon Instruments Ltd., Dept EE, 19 Mulberry Walk, London SW3 6DZ.**

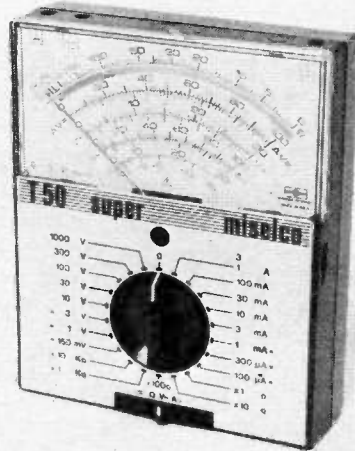

CONSTRUCTIONAL PROJECTS

Caravan Power Supply & Fridge Alarm

The heavy duty relay used in the *Caravan Power Supply* should be rated at least 3A contacts. The type used in the author's model was a 12V d.c. 30A automobile type. This is stocked by Maplin and listed as: YX99H (12V 30A Relay).

The 5A Schottky barrier diode D1, type VSK 530, should be ordered through a RS Components supplier. This carries the RS code 262-466.

The thermistor GL16 used in the *Caravan Fridge Alarm* is sometimes listed as G16 and TH-B11 types. These devices have a resistance of 1M Ω at 20°C.

The wiring for both models should be rated at approximately 5A.

Combination Lock

The only source for the lock release mechanism for the Combination Lock we have been able to locate is: **Altype Security Systems, Dept EE, 310 High Street, Watford, Herts.** This is known as type 203 and costs £11 (including postage) plus VAT. If any readers know of a similar device we would be pleased to hear from them.

We do not envisage any component purchasing problems for the *Transistor Tester* or the *Envelope Shaper for Bass Guitar*.

Eprom Programmer

The Eprom Programmer p.c.b. has been designed to accept the P0609 (and C0609) transformer from **Ambit**. The top board (8306-03) has been laid-out to accept the Erg D16A4-2 d.i.l. switches; these are stocked by RS Components (337-510). The z.i.f. socket is manufactured by Wimslow and is also stocked by RS (402-232). RS Components only supply to account customers and not to the general public. You will have to order through your local electrical/electronic dealer. Verospeed supply the "webbed" ribbon cable (226-22549H).

EE PRINTED CIRCUIT BOARD SERVICE

The printed circuit boards (drilled and roller tinned) for the Eprom Programmer may be obtained from **Everyday Electronics: 8306-01 (TRS-80 version) £6.95; 8306-02 (Genie version) £6.95; 8306-03 £1.50.** All prices include VAT and postage and packing. Remittances should be sent to **Everyday Electronics PCB Service, Everyday Electronics, Editorial Offices, King's Reach Tower, Stamford Street, London SE1 9LS.** Cheques should be crossed and made payable to **IPC Magazines Ltd.**

Printed Circuit Master Copies

For those constructors who wish to make their own Eprom Programmer p.c.b.s, photostat copies of the printed circuit masters may be obtained by sending a stamped SAE (A4 size) to the address above.

EVERYDAY ELECTRONICS SOFTWARE SERVICE

The EE Software Service provides an easy and reliable means of program entry for our computer-based projects. All programs have been tested by us and consist of two good quality copies of the working program on cassette tape. Certain program listings are also available.

All prices include VAT, postage and packing. Remittances should be sent to **Everyday Electronics Software Service, Editorial Offices, King's Reach Tower, Stamford Street, London SE1 9LS.** Cheques should be crossed and made payable to **IPC Magazines Ltd.**

PROJECT TITLE	CASSETTE CODE	CASSETTE COST	LISTING CODE	LISTING COST
ZX81 SPEED COMPUTING SYSTEM (Feb 83)	T001	£2.95	L001	£2.95
REAL-TIME CLOCK (Apple) (May 83)	T002	£2.95	L002	£2.95
REAL-TIME CLOCK (BBC) (May 83)	T003	£2.95	L003	£2.95
EPROM PROGRAMMER (TRS-80 & GENIE) (June 83)*	T004	£3.95	N/A	—

* Includes Command List with examples.

THE TEST GEAR 83 SERIES CONSISTS OF:

- DUAL POWER SUPPLY ● FUNCTION GENERATOR ● TRANSISTOR TESTER
 PULSE GENERATOR ● LABORATORY AMPLIFIER ● FREQUENCY METER

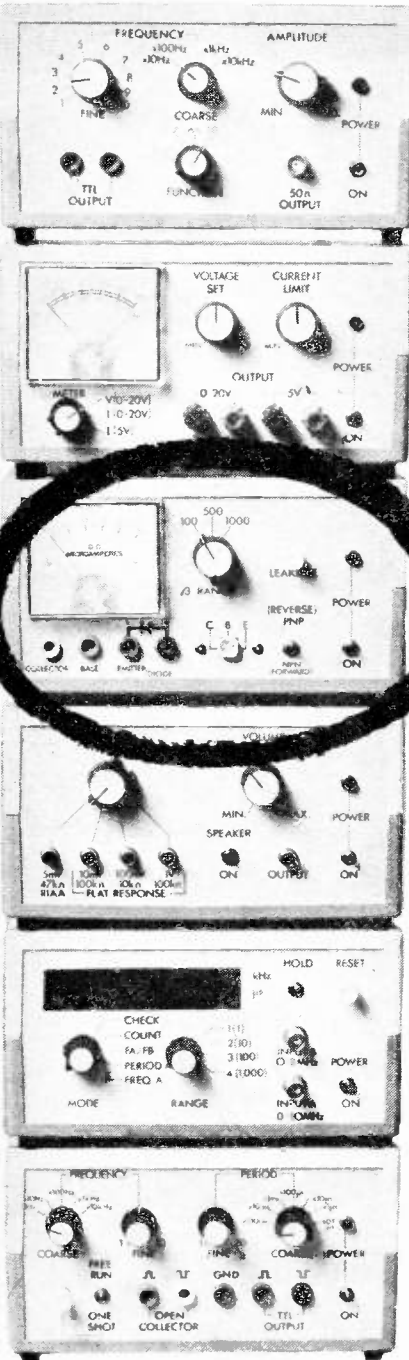

THE ADVENT of solderless breadboard systems has made it possible to re-use electronic components many times. The circuit can be breadboarded and the final version is built with the same components.

It is inevitable, however, that some transistors may be destroyed by incorrect connections or a design error. So some form of quickly testing transistors (and diodes) is desirable to ensure that the final circuit functions as the prototype did.

SPECIFICATIONS

A second reason for making a Transistor Tester a useful piece of laboratory equipment is to check the specification of a particular device against that given in the transistor data book.

The current gain (h_{fe}) of a transistor is usually given as a typical value or specified as being between an upper and a lower limit. As this parameter is one of the most important design considerations, an accurate reading is desirable.

Bargain packs are a useful source of cheap transistors and the Transistor Tester will sort them into good/bad, *npn/pnp* and identify the leads of unknown types.

TRANSISTOR PRINCIPLES

Transistors have two major roles in electronic circuits; as switches (digital applications) and amplifiers (analogue electronics). In both of these spheres, the transistor is a current controlled and current controlling device. The voltages in

a circuit are determined by resistors using the Ohms law relationship.

The most frequently used connection for a transistor is the common emitter configuration, and it is this method of connection that is used by the Transistor Tester. (See Fig. 1a and 1b.)

The collector current (I_C) of the transistor is given by:

$$I_C = h_{FE} \times I_B$$

where I_B is the base current and h_{FE} is the large signal (or static) current gain. In order to distinguish between the large signal current gain and the small signal (or dynamic) current gain, the former uses capital letters for the "FE" suffix on the notation.

The small signal current gain, h_{fe} (note the use of lower-case letters for "fe"), is given by:

$$h_{fe} = \frac{\text{change in collector current}}{\text{change in base current}}$$

$$h_{fe} = \frac{\delta i_c}{\delta i_b} \quad (\delta \text{ meaning "change in"})$$

As this is a ratio of two currents, it has no units. It is sometimes known as the forward current transfer ratio. Note also the use of lower-case letters indicating that i_c and i_b are small signal values.

CHARACTERISTIC CURVES

The transistor characteristics can be plotted graphically as shown in Fig. 2. If the base current (I_B) is fixed and the collector-emitter voltage (V_{CE}) is varied, the collector current (I_C) can be measured

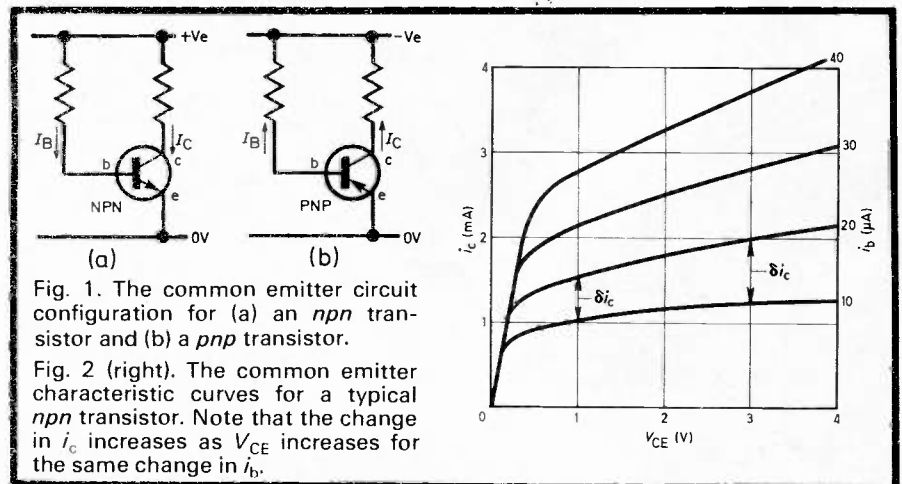

Fig. 1. The common emitter circuit configuration for (a) an *nnp* transistor and (b) a *pnp* transistor.

Fig. 2 (right). The common emitter characteristic curves for a typical *nnp* transistor. Note that the change in i_c increases as V_{CE} increases for the same change in i_b .

SPECIFICATIONS

Functions: measures the current gain (h_{FE}) of *npn* and *pnp* transistors. Tests diodes. Determines leakage current.

Gain ranges: 0-100
0-500
0-1000

Conditions: $V_{CE} = 3-5V$
 $I_b = 100\mu A, 20\mu A,$
 $10\mu A$ respectively

Leakage: 0-100 μA

Power: 9V PP6 battery

and plotted as in the diagram. This is done for a number of values of I_B to produce a series of curves.

It can be seen that the change in I_C compared with the change in I_B varies slightly as V_{CE} increases. Therefore the gain is not constant throughout and this implies that h_{FE} is not equal to h_{fe} (as h_{fe} is constant).

However, for most purposes, this difference is too small to be of any consequence and in most applications they can be assumed to be equal. The Transistor Tester measures gain by fixing the base current and measuring the collector current.

CIRCUIT DESCRIPTION

Unlike all other units in the *Test Gear 83* series, the Transistor Tester is battery powered since the current consumption is low and its use intermittent.

The Test Gear 83 Transistor Tester unit.

The actual current consumption is about 5mA with no transistor connected and rises to around 15mA dependent upon the gain of the transistor under test.

The use of an i.e.d. continually on to indicate power would be wasteful as the current consumption of the i.e.d. would be greater than that of the Tester!

Therefore, a small relaxation oscillator built around TR1 and TR2 pulses the i.e.d. about 90 times a minute thus reducing the average consumption to 0.9mA. This was found to be particularly effective in indicating that the unit was on.

The constructor may replace the battery with a mains power supply unit in which case the flasher circuit would not be required. For this modification, it is recommended that R9 is increased to 820 ohms and TR1, TR2, R6, R7, R8 and C3 are omitted. The collector and emitter pads of TR2 will need to be linked if the original p.c.b. layout is retained.

REGULATOR

The voltage regulator, IC2, provides a current limited supply of 5V. The low

Fig. 3. The complete circuit diagram for the Test Gear 83 Transistor Tester.

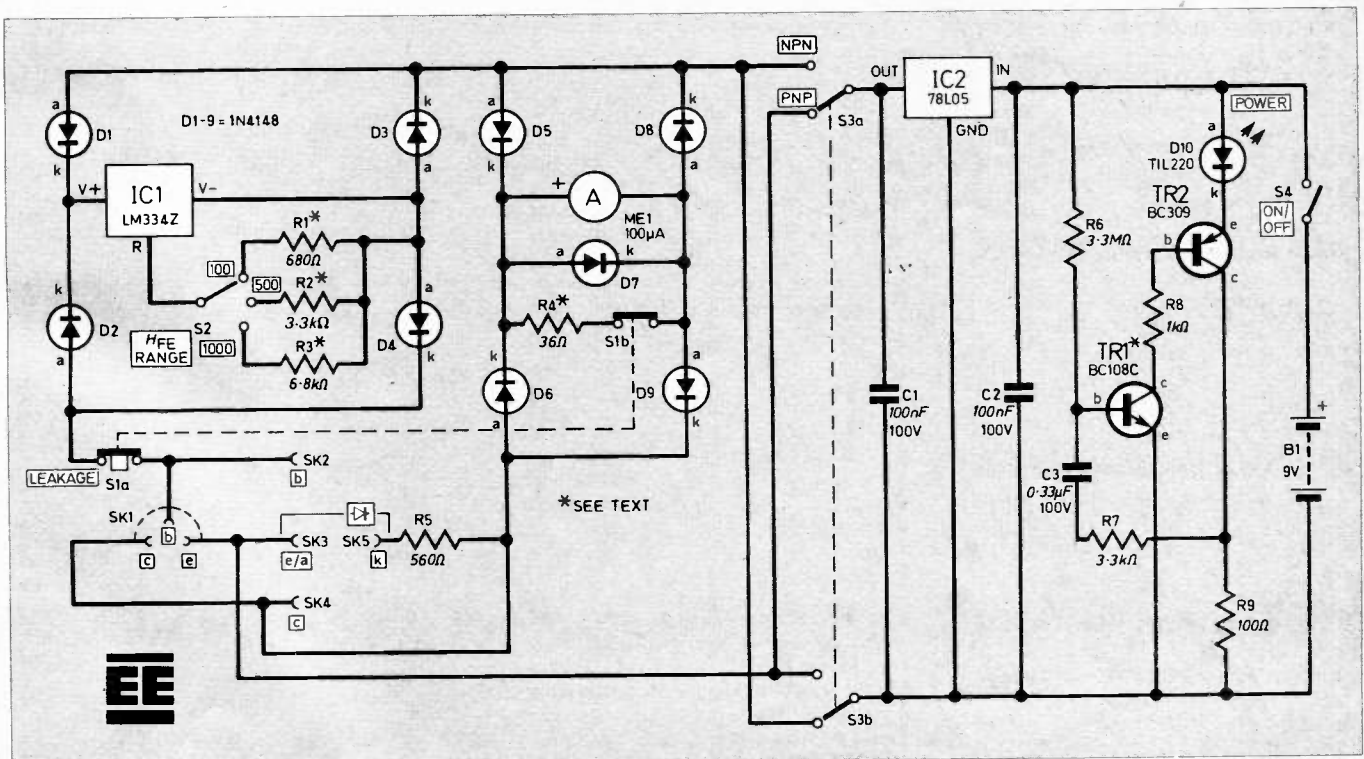

voltage will prevent damage to the transistor under test if the polarity switch (NPN/PNP) is incorrectly set. The current being limited to 100mA will protect the meter in the event of a short circuited transistor being placed in the test socket.

The capacitors C1 and C2 ensure the high frequency stability of the supply.

The polarity of the transistor under test is set by S3. This simply reverses the polarity of the power supply. In order to keep this switching arrangement uncomplicated, two bridge rectifiers are employed. The first, D1 to D4, ensures that the constant current generator (IC1) is always connected to the correct polarity power supply.

The second bridge, D5, D7, D8 and D9, avoids the necessity of having to switch the polarity of the meter, ME1.

Resistors R1, R2 and R3 are used to set the base current (I_B) of the transistor under test. R4 is a meter shunt resistor to set the meter sensitivity to 10mA full-scale deflection.

For the purposes of measuring leakage current, the base current is removed and the shunt resistor (R4) open circuited to return the meter sensitivity to 100 μ A f.s.d. This is done by depressing switch S2.

Note that most silicon transistors, including power types, should register very little leakage current and anything over 10 μ A should be regarded with suspicion. Germanium transistors will have a slightly higher leakage current.

CIRCUIT OPTIONS

Depending on the degree of accuracy the constructor requires, there are two options for the values of resistors R1 to R4. Should the high accuracy be chosen, then a fixed value resistor is used in series with a preset (in parallel with a preset in the case of R4). The values are shown in Table 1.

TABLE 1		
	High accuracy	Low accuracy
T1	620 Ω in series with 100 Ω preset.	680 Ω \pm 2%
R2	3k Ω in series with 470 Ω preset.	3.3k Ω \pm 2%
R3	6.2k Ω in series with 1k Ω preset.	6.8k Ω \pm 2%
R4	39 Ω in parallel with 1k Ω preset.	36 Ω \pm 2%

Provision is made on the p.c.b. layout for the presets. If however, an accuracy of around 10 per cent (worst case) is sufficient, then the fixed value resistors also listed in Table 1 can be used without the presets. Three links will be required on the p.c.b.

If the high accuracy version is selected, then a digital multimeter with a 200 μ A range will be needed to calibrate the base current.

COMPONENTS

Resistors

(High accuracy version)

R1	620 Ω
R2	3k Ω
R3	6.2k Ω
R4	39 Ω
All metal film \pm 2%	

VR1	100 Ω miniature horizontal preset
VR2	470 Ω miniature horizontal preset
VR3	1k Ω miniature horizontal preset
VR4	1k Ω miniature horizontal preset

(Low accuracy version)

R1	680 Ω
R2	3.3k Ω
R3	6.8k Ω
R4	36 Ω
All metal film \pm 2%	

(All versions)

R5	560 Ω
R6	3.3M Ω
R7	3.3k Ω
R8	1k Ω
R9	100 Ω
All carbon film \pm 5%	

Capacitors

C1,2	100nF, 100V Siemens type polyester (2 off)
C3	0.33 μ F, 100V Siemens type polyester

Semiconductors

D1-9	1N4148 silicon (9 off)
D10	TIL220 0.2in red l.e.d.
TR1	BC108C npn silicon
TR2	BC309B pnp silicon
IC1	LM334Z adjustable current source
IC2	78L05 5V, 100mA regulator

Miscellaneous

S1	d.p.d.t. non-latching push button
S2	1-pole, 12-way midget rotary (with stop set at 3-ways)
S3	d.p.d.t. miniature toggle
S4	s.p.s.t. miniature toggle
SK1	T05 pin circle transistor socket
SK2-5	4mm banana socket (4 off) colours to suit
ME1	100 μ A f.s.d. panel meter with 1.4k Ω coil (type ML52)
B1	9V PP6 battery
Verocase type 202-21036C; single-sided p.c.b. 155 x 57mm; battery clip; chrome l.e.d. mounting bezel; control knob; 7/0.2mm wire; Veropins.	

See
**Shop
Talk**
page 369

COMPONENTS
approximate
cost **£21**

CONSTRUCTION

CIRCUIT BOARD

A single p.c.b. is used, and it is designed to be attached to the terminals on the back of the panel meter. If a different meter is used, the spacing of the mounting holes may need to be modified. It is wise to check this before etching the p.c.b.

Alternatively, the p.c.b. assembly can be mounted on the base of the Verocase.

The layout and full-size track artwork are given in Fig. 4. Solder all components to the board in the normal order, taking all usual precautions with the polarity of the diodes and the orientation of the semiconductors. Veropins should always be used for the flying leads.

If the preset resistors are not used, the wire links drawn as dotted lines on Fig. 4 must be fitted adjacent to R1, R2 and R3. Note that R4 does not require a link to be fitted in place of the preset as this is in parallel with R4.

FRONT PANEL

The front panel is drilled to suit the controls and meter as shown in Fig. 5. The large hole for the meter can be made by drilling a series of small holes and cutting out the connecting pieces. The rough edge is then finished with a half-round file.

The dimensions of this cut-out and all mounting holes should ideally be checked against the actual components to be used as some variation does occur between different manufacturers.

The transistor socket, SK1 (T05 pin circle), is first mounted onto a piece of plastic or p.c.b. material and then fixed to the front panel from the reverse side with two screws.

Constructors may wish to fit other types of transistor sockets but in practice, the T05 type is suitable for most popular transistors.

The four 4mm sockets are for use in testing diodes and larger transistors via flying leads.

The wiring is carried out with a flexible 7/0.2mm equipment wire and the recommended length for each is about 150mm.

TRANSISTOR TESTER

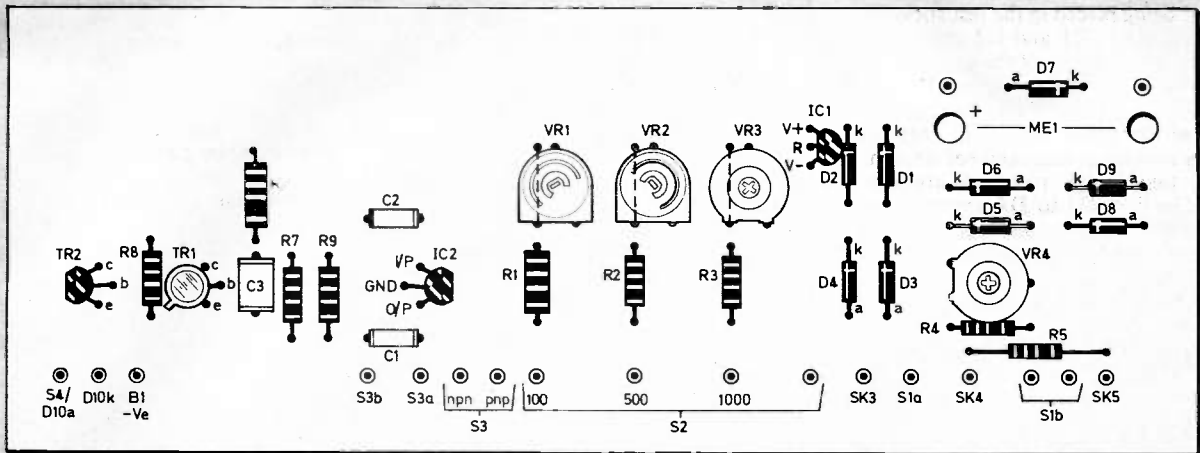
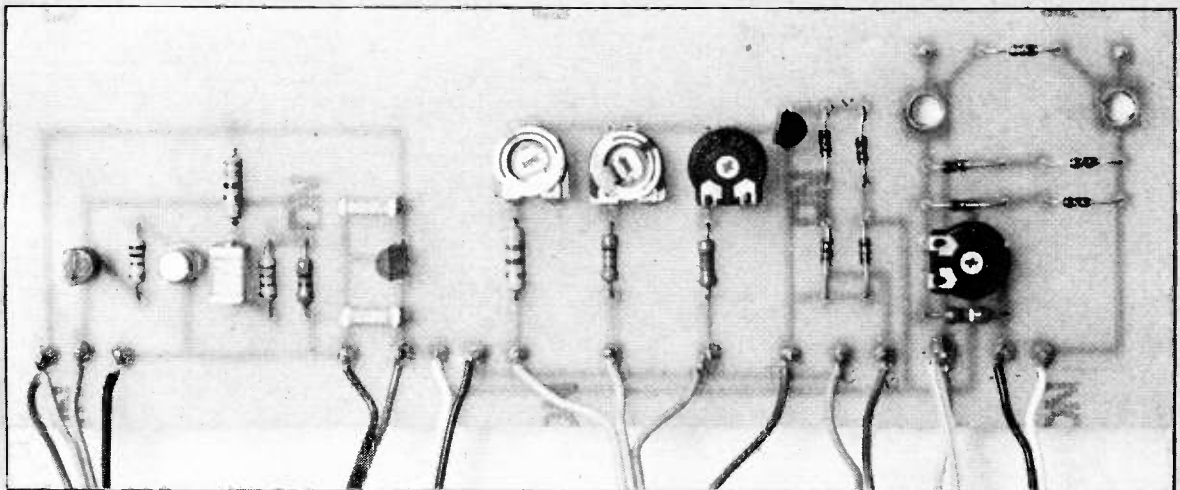
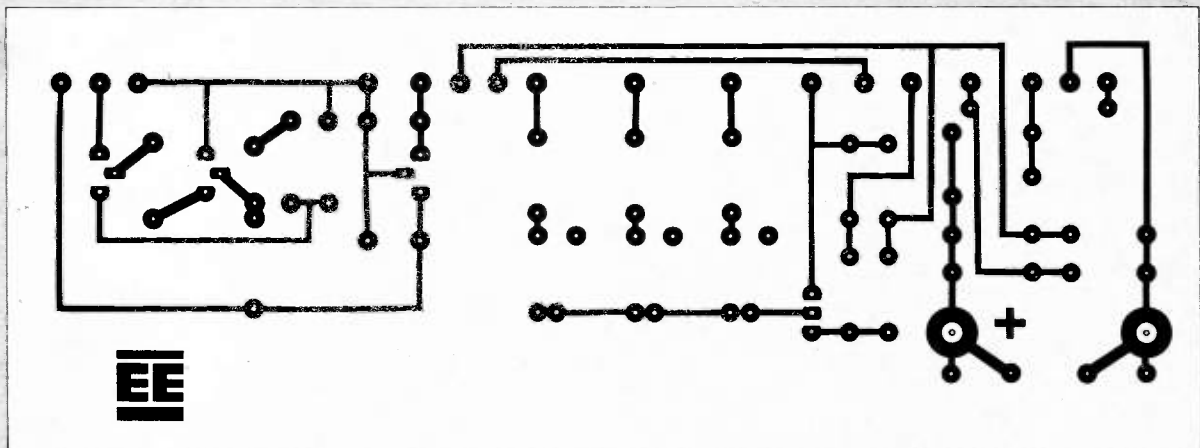

Fig. 4. Full-size p.c.b. artwork and component layout. Note that the three wire links shown as dotted lines below VR1, VR2 and VR3 are only required if the low accuracy version is built and the presets are omitted. No link is required in place of VR4. The board is mounted directly onto the meter terminals and it is advisable to check the pitch of these terminals before etching and drilling.



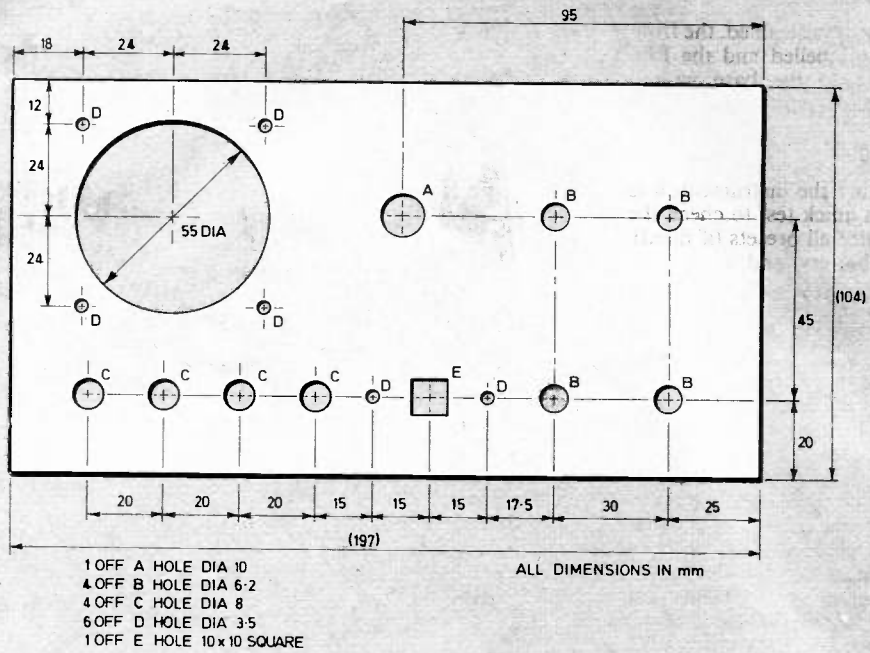

Fig. 5. Front panel drilling details. Note that the meter cut-out may vary for different panel meters.

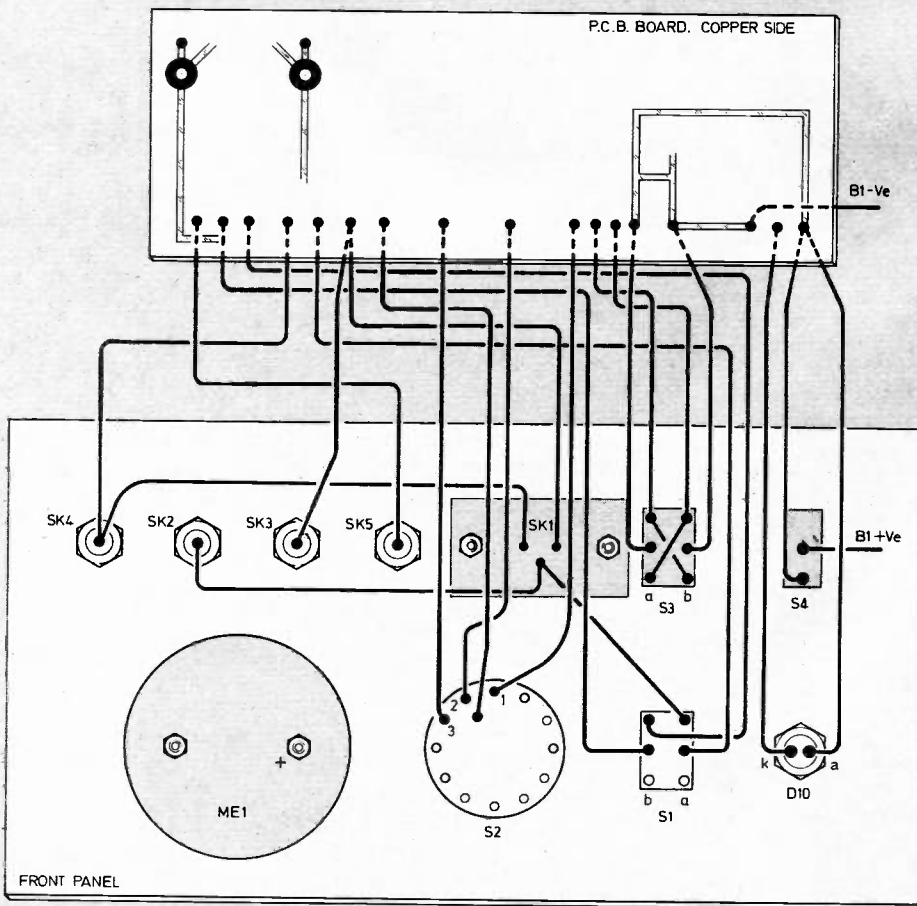

Fig. 6. Interwiring diagram with the p.c.b. shown from the trackside and folded down. All connections to the board are made on the component side.

The wiring diagram in Fig. 6 shows all interconnections but note that the p.c.b. is shown removed from the meter terminals for clarity.

Finally, the case is assembled, the front panel controls are labelled and the PP6 battery is secured to the base with a double-sided adhesive tab.

CALIBRATION

Before calibrating the instrument, it is advisable to run a quick test to check the basic circuit. Centre all presets (if fitted), connect the 9V battery and switch on. The l.e.d. should flash about 90 times a minute (three times in two seconds).

The voltage across C1 should be 5V. If so, a transistor of known polarity can be inserted into the test socket and the polarity switch set to the correct position. The meter should register a reading indicating that the circuit is functioning.

To set the base current, a digital microammeter is connected between the base and emitter sockets on the Transistor Tester, the positive lead to the base socket with the polarity switch set to NPN.

The RANGE switch is set to the first position, labelled 100 on the front panel, and the preset resistor in series with R1

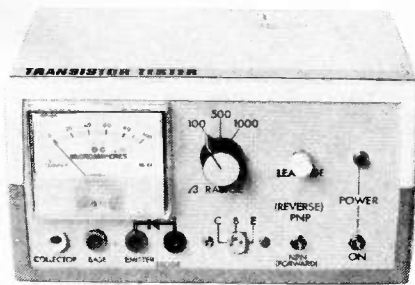

Front view of the prototype model showing the control labelling. Note that the meter full-scale deflection reading depends upon the position of the Range switch.

(marked VR1 on Fig. 4) is adjusted to read $100\mu\text{A}$ on the microammeter.

The RANGE switch is then set to the second position, labelled 500 on the front panel, and the preset in series with R2 (marked VR2 on Fig. 4) is adjusted to read $20\mu\text{A}$ on the microammeter.

With the RANGE switch in the third position, labelled 1000 on the front panel, the preset in series with R3 (marked VR3 on Fig. 4) is adjusted to read $10\mu\text{A}$ on the microammeter.

The fourth and final calibration is to set the full-scale deflection of the panel meter, ME1, to 10mA by adjusting the shunt resistor, R4. A one kilohm potentiometer is required and this is connected in series with a digital milliammeter between the collector and emitter sockets of the Tester. The positive probe to the collector with the polarity switch in the NPN position.

Adjust the one kilohm potentiometer for a reading of 10mA on the milliammeter and then adjust the preset in

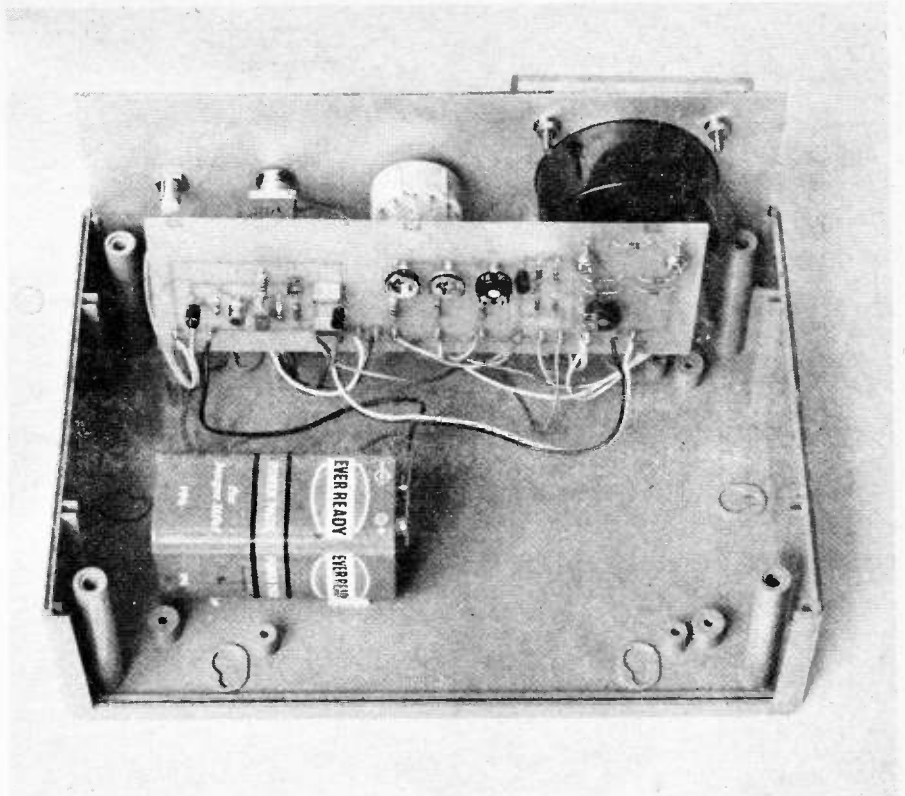

The front panel assembly viewed from the rear with the top and back panel removed. The battery is secured with double-sided adhesive foam tabs.

parallel with R4 (marked VR4 on Fig. 4) until the panel meter, ME1, reads full-scale deflection. Calibration is complete.

Using the Transistor Tester to measure the gain of a transistor is fairly straightforward. The device is inserted into the test socket and the polarity switch set to the correct setting (if known).

The meter will give a reading of static gain (h_{FE}). According to the position of the range switch, S2, the meter reading is multiplied by 1 (for the 100 setting), 5 (for 500) and 10 (for 1000).

The leakage current of a transistor is measured by depressing the LEAKAGE switch, S1, and the meter will give a reading in microamps (μA).

Diodes are connected as indicated on the front panel, that is anode (a) to the diode socket and cathode (k) to the emitter socket, and a meter reading should register with the polarity switch in the NPN (FORWARD) position. The reading is unimportant, it just shows that a current is flowing.

When the polarity switch is changed to the PNP (REVERSE) position, all current flow should cease, indicated by no move-

ment of the panel meter. Any other result indicates a faulty diode.

To ascertain the reverse biased leakage current of a diode, the LEAKAGE switch, S1, is depressed and the meter will give a reading in microamps (μA). □



PRACTICAL ELECTRONICS

PROGRAM CONDITIONER
—for reliable cassette storage and cassette to cassette copying

ROCKTONE
—for setting up pop group gear

PERCUSSION MICROSYNTH
—an inexpensive versatile dual drum synthesiser

FUSION
—learn about a £500 million giant in Oxfordshire

Plus all the regulars; including Ingenuity Unlimited, Microfile, Semiconductor Circuits and Microprompt.

It's ALL in
PRACTICAL ELECTRONICS
June issue on sale NOW!

BOOK REVIEWS

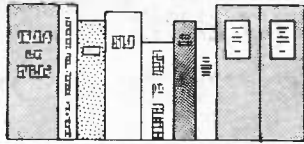

TOWERS' INTERNATIONAL DIGITAL I.C. SELECTOR

Author T. D. Towers, MBE, MA, BSc, C.Eng, MIERE
Price £9.95 limp edition
Size 248 × 174mm. 256 pages
Publisher W. Foulsham & Co Ltd
ISBN 0-572-01179-2

FOR THOSE readers unfamiliar with Towers' previous semiconductor guides, including Transistors, Linear i.c.s and Microprocessors, they are comprehensive and painstakingly researched data tables listing all currently available type numbers. The Digital Integrated Circuit Selector is no different and gives electrical and mechanical data on over 13,000 American, European, British and Japanese devices.

The data is listed under type numbers in alphanumerical order and gives details on logic family (CMOS, TTL and so on), application, description, packaging, some important specifications and a suitable substitute (should one exist). Perhaps the most useful information for day-to-day use is the pin-out diagrams for the dual-in-line versions of all the digital i.c.s listed.

As digital electronics is becoming increasingly important with the advent of the cheap microprocessor, a guide of this nature is invaluable to the hobbyist, teacher, engineer and buyer alike and in many cases will invalidate the need for numerous manufacturers' data books. G.P.H.

ELECTRONICS POCKET BOOK

Author E. A. Parr, BSc, C.Eng, MIEE
Price £6.40 limp edition
Size 185 × 120mm. 350 pages
Publisher Butterworth & Co Ltd
ISBN 0-408-00481-9

NOT A NEW book as the first edition was published twenty years ago, but still as useful today. Now in its fourth edition, the completely new Electronics Pocket Book has been fully updated and now includes sections on digital techniques, computers, opto-devices and all the usual branches of electronic design.

For the student and hobbyist, this handy reference work is an ideal source of readily available, and perhaps more importantly understandable, information. G.P.H.

HOW TO USE OP-AMPS

Author E. A. Parr, BSc, C.Eng, MIEE
Price £2.25 limp edition
Size 175 × 110mm. 154 pages
Publisher Bernard Babani Ltd
ISBN 0-85934-063-5

ONE PART of my technical education that was sadly lacking was that of the use of the op-amp. These eight-legged little creatures had always eluded me so it was a pleasant surprise to find this book most readable and obviously written by a man who has a great deal of respect for what is probably the most versatile i.c. available to the engineer.

The text starts with first principles and continues in as non-mathematical fashion as is possible to explain design techniques using op-amps in applications as diversified as audio circuits and industrial control.

As an op-amp i.c. can now be purchased for little more than the price of a simple transistor and yet still give high gain and predictable performance, an understanding of their function is essential for cost-effective design. G.P.H.

COUNTER INTELLIGENCE

BY PAUL YOUNG

Changing Times

A short while ago, I read about an American, he was driving over the Hudson when he noticed that his watch had stopped. He opened his window, tossed it into the river and took a new one out of the glove pocket. In the USA electronic watches can be purchased for about three dollars, at that price it is not even worthwhile changing the battery!

I recently made a purchase which makes me think we may have already reached that stage in this country. My wife's watch stopped and our local horologist having closed down, I decided to buy her a digital one to tide her over. I bought her a dainty wrist-watch, quartz controlled with the time and date functions. It was elegant to look at had a stainless steel bracelet and a twelve month's guarantee. All fairly routine, but the price, believe it or not was £2.95 including VAT!

This set me thinking. If you take off the VAT and assume that it must have passed through at least one pair of hands before it reaches the shop, what does the actual manufacturer receive for it, and equally important, what is the worker who assembles it paid?

The Government of the day is always urging manufacturers to be more competitive, but how do they compete with that? Robots? Yes, possibly, but there is one big drawback to replacing your workforce with Robots. Robots don't have wage packets, and taken to its ultimate conclusion, the manufacturer finishes up with no customers.

Fascinating Gift

I believe it was Einstein who came up with the theory, "That when sitting on a red hot stove, a few seconds would seem like half an hour, and conversely, when sitting next to a beautiful girl, half an hour would seem like a few seconds". Naturally whimsical Young wants to know how the time would compare between sitting next to a beautiful stove and sitting on a hot girl?

While pondering on these profound theories, I came up with one which is equally true, and which in the fullness of time you will be able to test out for yourself. It is this, as you get older, you will find that time passes more quickly. When you reach the status of senior citizen you will find it is whizzing by.

All of which brings me to a case in point. Earlier in the year I had been sent an amusing Christmas story by my brother, which I fully intended to pass on to you. Before I could sort it out and type it, we have arrived at the June issue. Here is his story, later than planned but blame it on Anno Domini (see above).

"Are children starting earlier these days? I am old enough to remember when little girls (that is under 10 years old) asked Father Christmas for things like dolls and prams. Apparently all that is changing. My boss's daughter just five years old and already getting to grips with computer programming decided she would like an electronic construction kit for Christmas.

We found a kit comprising of 150 different projects with a well produced 200-page construction manual. At £12 it was excellent value, but the real point was this.

On getting the kit home, my boss who is a top flight electronic and computer boffin, decided to try out some of the experiments (after the children were packed off to bed). He admitted next day, that he found making up the circuits with discrete components, so fascinating that he was up 'till the small hours experimenting. I gather that the kit has proved so successful it has actually stopped young Hannah from chattering for hours on end. Almost a miracle I understand."

Well I don't know if any moral can be drawn, but at least it is a useful tip to Mums and Dads as to what to buy their children—of either sex.

Do you think that designing and understanding electronic circuits is beyond you?

The summer edition of Electronics Digest, *Gateway To Circuit Design*, provides a step-by-step introduction for the newcomer to the art of circuit design. Firstly, you'll be introduced to the commoner electronic components — but not in a passive way. Electronics is a practical subject, so *Gateway To Circuit Design* will enable you to build simple circuits for yourself, and take measurements on them (along the way learning how to use a multimeter). Once these introductions are over, *Gateway To Circuit Design* shows you what goes into the design of a wide range of electronic equipment — for audio, computing and electronic music, for instance.

Gateway To Electronics is an occasional popular series in Electronics Digest, published by Argus Specialist Publications. Previous issues in the series have concentrated on projects; now we'd like you to design your own!

At all good newsagents now or available by post from Electronics Digest, 513 London Road, Thornton Heath, Surrey.

We'd like to show you that you're wrong

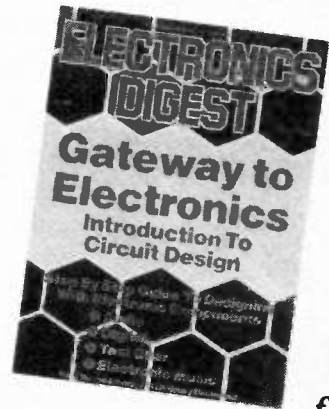

£1.85

The 2001 sweeps the board at only £110*

Get all the waveforms you need — 1 Hz to 1 MHz in five overlapping ranges: stable, low-distortion sine waves, fast rise/fall-time square waves, high linearity triangle waves — even a separate TTL square wave output. Plus high- and low-level main outputs.

An applied DC Voltage at the Sweep input can shift the 2001's frequency: or sweep up to 100:1 with an AC signal. A pushbutton activates the DC Offset control, which shifts the output waveform up or down on command.

For value for money the 2001 sweeps the rest off the board.

For immediate action — The G.S.C. 24 hour, 5 day a week service
Tel: (0799) 21682 and give us your Access, American Express, Barclaycard number and your order will be in the post immediately or just clip out the coupon.
Goods despatched within 48 hours.



*price excluding P&P and 15% VAT

GLOBAL SPECIALTIES CORPORATION



G.S.C. (U.K.) Limited, Dept. 4HH
Unit 1, Shire Hill Industrial Estate,
Saffron Walden, Essex CB11 3AQ
Tel: Saffron Walden (0799) 21682 Telex: 817477

Global Specialties Corporation (UK) Limited Dept 4HH
Unit 1, Shire Hill Industrial Estate, Saffron Walden, Essex CB11 3AQ

Model 2001 Sweepable
Function Generator

£129.95 (inc. P&P
and 15% VAT)

Qty
Reqd

For FREE catalogue
tick box

Name

Address

I enclose PO/Cheque for £
Barclaycard/Access/American Express No

or debit my
exp date

ENVELOPE SHAPER for BASS GUITAR

BY A. NIEMIRO

THE Envelope Shaper is not the most common of guitar effect pedals, but nonetheless produces a distinctive and useful sound. Operating by varying the tone of the instrument in sympathy with the signal level, the shaper produces a sound reminiscent of a "Wah-Wah" unit, but does away with the need for a mechanical pedal, so leaving the musician free to concentrate on playing his instrument.

The prototype was designed specifically for use with electric bass guitar which, when used with the shaper, gives a colourful and prominent sound especially appropriate in Soul and Funk music. However, the addition of a range switch increases the versatility considerably and allows the unit to be used equally well with lead and rhythm guitar and electric piano.

The unit is built into a small case and foot-operated so that the musician may switch the effect in and out whilst playing.

FILTER DESIGN

The actual sound effect is obtained by feeding the instrument signal through a bandpass or resonant filter. Such filters give a frequency response as shown in Fig. 1.

It was decided to achieve this response by employing a multiple feedback circuit;

the basic form of which is shown in Fig. 2. If R_{IN} is much greater than R_A then the centre or resonant frequency of the filter is given by:

$$f_0 = \frac{1}{2\pi \times C \times \sqrt{R_A \times R_B}}$$

HOW IT WORKS

The input signal from an electric musical instrument is split up and fed through two separate paths in the Envelope Shaper.

The control signal passes through an active rectifier which converts the a.c. input signal (A) into a chopped d.c. signal as shown in B. This is then smoothed and filtered by a resistor-capacitor network which removes the high-frequency components to give a d.c. voltage that is the envelope or "outline" of the original signal (C). This voltage is then amplified to a suitable level to drive an l.e.d. The brightness of this l.e.d. is, therefore, dependent only upon the amplitude of the input signal.

The input signal also passes through a band-pass filter. This section only allows through a narrow band of frequencies close to the filter's resonant frequency which is determined by the resistance of the photocell. Since the photocell is placed opposite the l.e.d. the resonant peak of the filter varies in sympathy with the changing signal level (D).

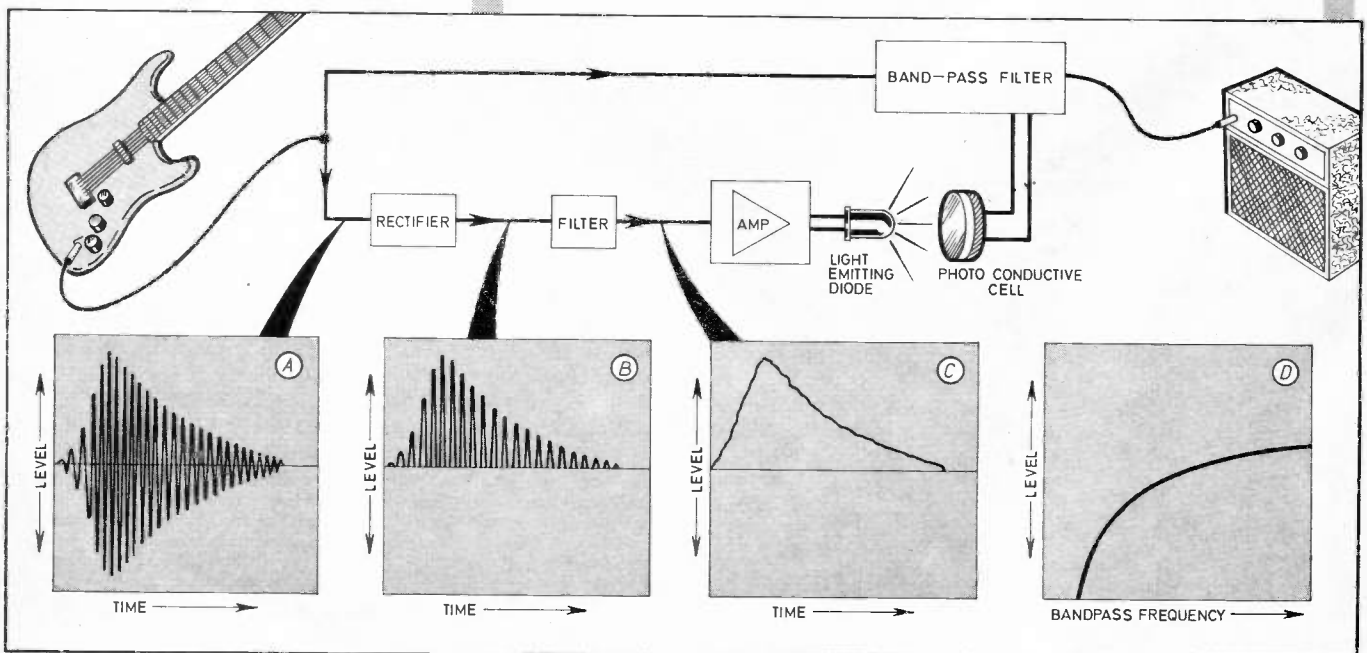

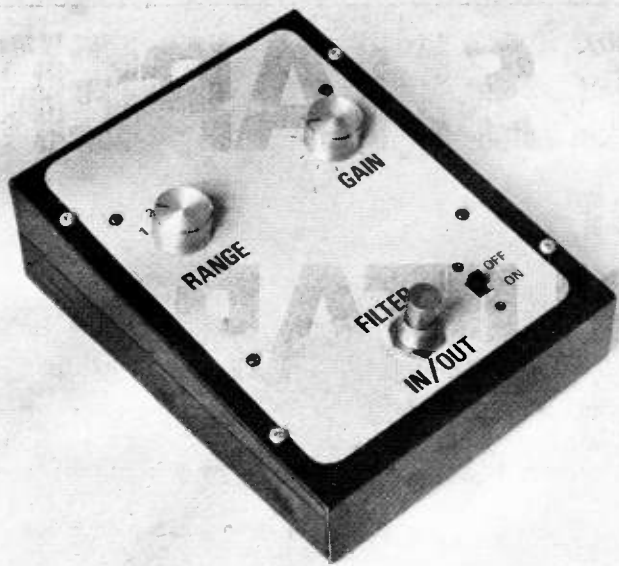

The completed sound effects pedal showing the layout of the front panel.

Therefore, by varying R_A , the centre frequency can be swept across the audio spectrum. In the final design, R_A is replaced by a light dependent resistor illuminated by an l.e.d. placed next to it.

Since f_o is also inversely proportional to C we can alter the frequency range swept by allowing different values of capacitance to be switched in. This not only changes the frequency but also affects the sharpness or Q (magnification factor) of the peak, thus allowing a greater variety of sounds to be produced.

CIRCUIT DESCRIPTION

The complete circuit diagram of the Envelope Shaper is given in Fig. 3. From the d.c. blocking capacitor C_1 , the signal is split and fed to $IC1a$ and $IC2$ via R_1 and R_4 , respectively.

Fig. 1. Frequency response of a resonant filter.

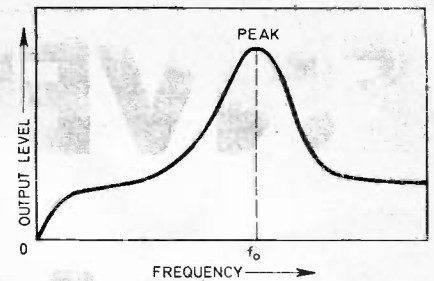
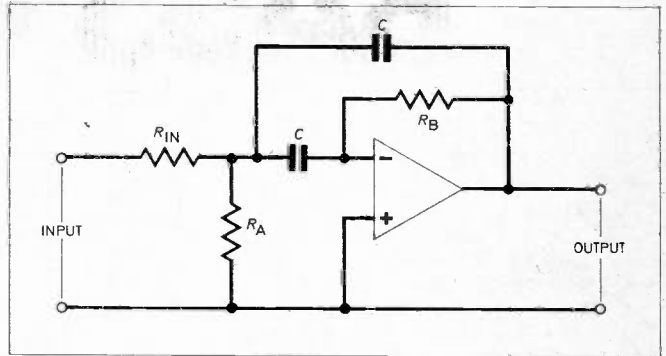

Fig. 2 (below). Diagram showing basic multiple feedback circuit.



$IC1a$ gives some gain and also performs a half-wave rectification. Placing the rectifying elements D_1 and D_2 , in the feedback path of $IC1a$ allows rectification of very small signals well below the diode's normal forward voltage of 600mV.

Capacitor C_2 is charged via R_3 to the instantaneous peak negative voltage at the input and this is amplified by $IC1b$. VR_1 controls the unit's sensitivity by varying the gain of $IC1b$.

The l.e.d. D_3 is driven from the output of $IC1b$ via current-limiting resistor R_8 .

It is seen that the brightness of this l.e.d. varies with the envelope of the input.

The input signal is also taken, by R_4 , to $IC2$. The band-pass filter is built around $IC2$ which is wired in a multiple feedback configuration. Light dependent resistor $PCC1$ determines the filter's resonant frequency and is arranged so that it is only illuminated by the light from D_3 .

Switch S_2 selects the value of capacitance in the feedback path of $IC2$ and thus alters the frequency range swept.

Fig. 3. Complete circuit diagram of the Envelope Shaper.

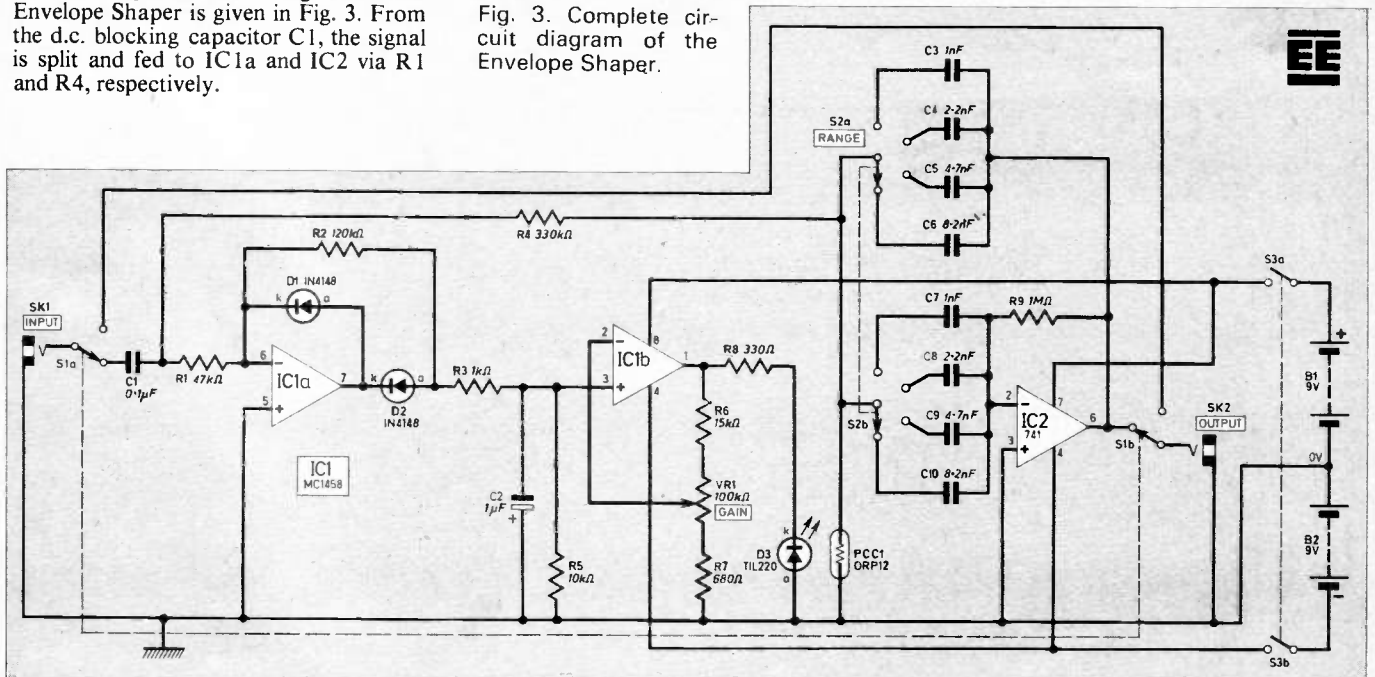

ENVELOPE SHAPER for BASS GUITAR

COMPONENTS

Resistors

R1	47k Ω
R2	120k Ω
R3	1k Ω
R4	330k Ω
R5	10k Ω
R6	15k Ω
R7	680 Ω
R8	330 Ω
R9	1M Ω

All $\frac{1}{4}$ W carbon $\pm 5\%$

Capacitors

C1	0.1 μ F polyester
C2	1 μ F polyester
C3,7	1nF polycarbonate (2 off)
C4,8	2.2nF polycarbonate (2 off)
C5,9	4.7nF polycarbonate (2 off)
C6,10	8.2nF polycarbonate (2 off)

Semiconductors

D1,2	1N4148 silicon (2 off)
D3	TIL220 0.2in red l.e.d.
IC1	MC1458 dual op-amp
IC2	741 op-amp

Miscellaneous

VR1	100k Ω lin carbon potentiometer
PCC1	ORP12 light dependent resistor
S1	d.p.d.t. foot switch
S2	2-pole, 6-way rotary
S3	d.p.d.t. miniature slide
SK1,2	0.25in mono jack (2 off)
B1,2	9V PP3 (2 off)

Single-sided printed circuit board, 95 x 78mm; aluminium case 150 x 120 x 50mm; 6BA fixings; 8-pin d.i.l. socket (2 off); rubber feet.

Approx. cost
Guidance only

£10.00

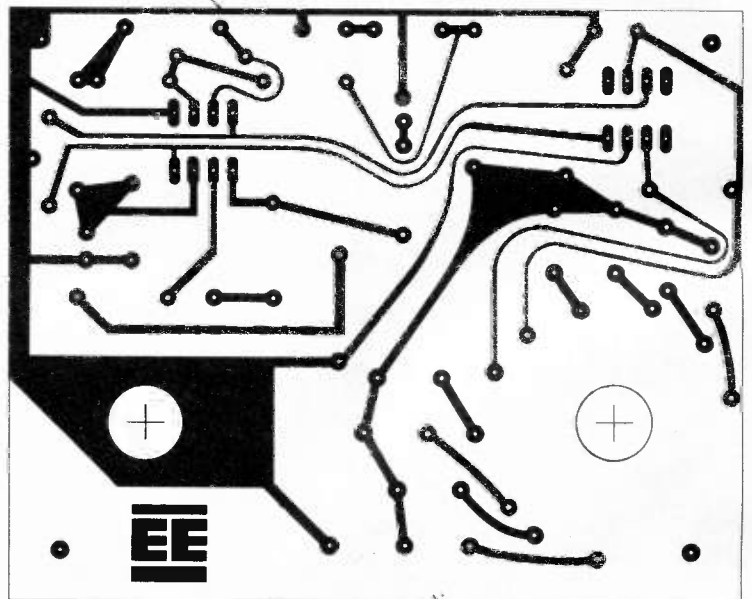
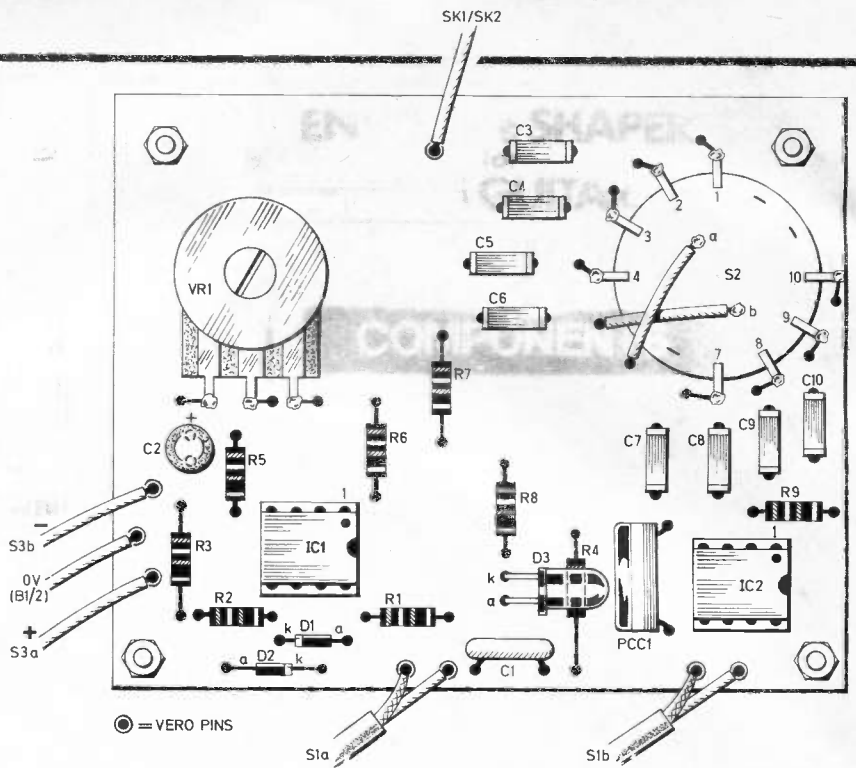
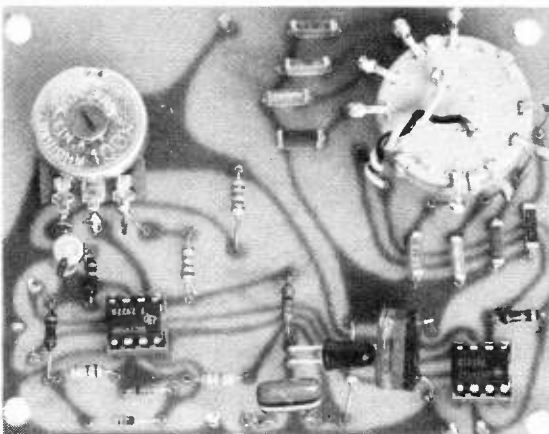
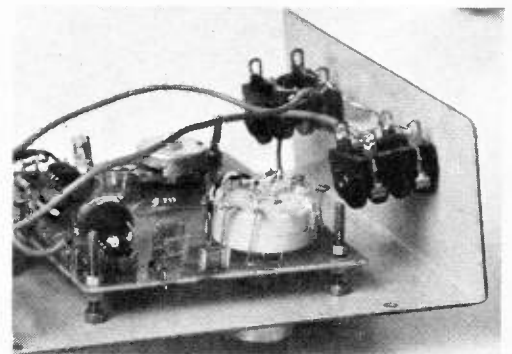

Fig. 4. Component layout and full size printed circuit board master for the Envelope Shaper.



(Left). Picture showing the components mounted on the printed circuit board.

(Right). Wiring details of front panel mounted components.



CASE

The selection of a case to house the Envelope Shaper is largely a matter of personal choice, but a metal case is preferable as this will prevent excessive hum pickup. Any case which measures about 150 x 120 x 50mm should be suitable. Whatever housing is selected it must be completely light-proof or the circuit will not function properly.

COMPONENT BOARD

Construction is quite straightforward as most of the components are mounted directly on the printed circuit board. Etch and drill this in the normal way and then use the board as a template to mark out the mounting and control holes in the case (see accompanying photographs).

Next, solder the components to the board, paying particular attention to the orientation of the diodes, i.c.s, and electrolytic capacitor. VR1 and S2 should be mounted last as shown in Fig. 4. Note that D3 and PCC1 are mounted so that the l.e.d. shines directly on the sensitive face of the photoresistor.

Remember also, that the use of i.c. sockets lessens the risk of damaging the devices through overheating during soldering. The use of Veropins is recommended for connection to the p.c.b. since they ensure a reliable contact. Crop the leads on the back (solder side) of the p.c.b. as short as possible to prevent them shorting out to the case.

Finally, mount the switches and jack sockets in the case and finish the wiring between them as shown in Fig. 5. Note that the screened lead used for these interconnections need only be earthed at one end. The batteries should now be clipped in place and the case assembled leaving the unit ready for use.

IN USE

In operation, best results are obtained with the guitar bass, treble, and volume controls, all set at maximum. The range switch setting should be chosen by experimentation; noting that each range requires a different sensitivity. The optimum sensitivity is found by turning the control clockwise from minimum until the most pleasing effect is achieved.

Note that at some settings it will be necessary to turn down the guitar volume when the effect is switched out.

Since the quiescent and peak currents are quite high it is recommended that high-power batteries are used and the unit is always switched off when not in use. Alternatively, any mains power pack supplying between $\pm 7V$ and $\pm 15V$ may be substituted. □

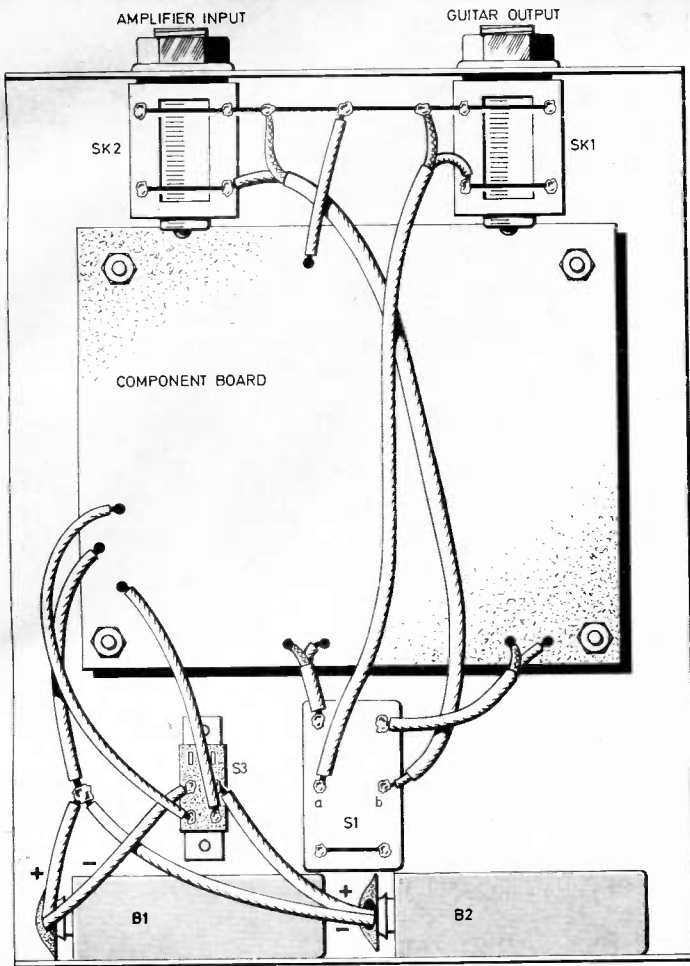
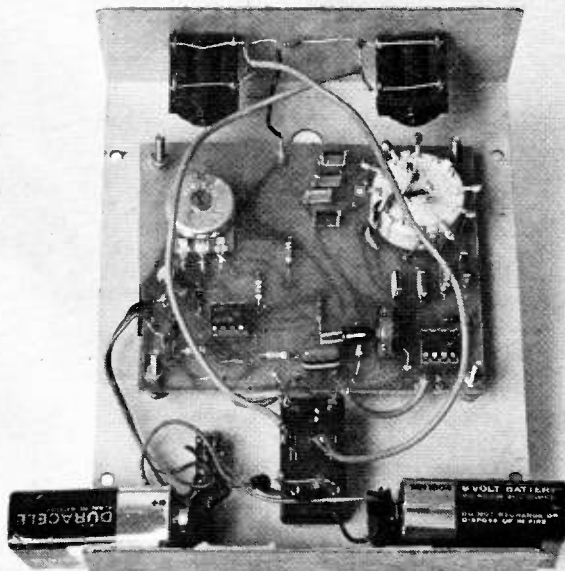
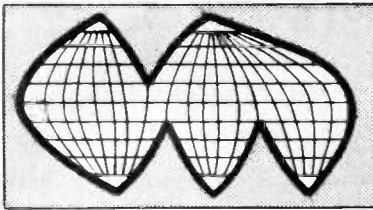

Fig. 5. Complete offboard interwiring details.

Picture showing the wiring details inside the case.



RADIO WORLD



BY PAT HAWKER G3VA

Short-Wave Broadcasting

For more than 50 years, most major countries have broadcast radio programmes on short-waves (h.f.) originally directed at expatriate audiences but more recently in the hope of influencing foreign citizens, either by crude propaganda or more subtly by presenting a favourable view of the local way-of-life. Such operations are not cheap—the British Government's "Grant-in-aid" to the BBC is heading towards £80 million per annum. The USSR not only spends money on external broadcasting but also incurs the expense of its large network of "jamming" stations.

There is little doubt that some of the overseas m.f. relays serve large audiences, and that in some parts of the world listeners still depend on h.f. But in countries such as the UK the number of listeners who seriously listen to programmes on h.f. (excluding the DX enthusiasts who seek to log rare or distant transmitters) must be very small indeed.

It is sometimes said the h.f. broadcasting is really "governments speaking to governments". One notes that the BBC is currently seeking £13-million to add some new satellite "ears" to its Government-paid-for listening post at Caversham Park near Reading.

I recall industry's efforts to interest British listeners in "all-wave" sets back in the 1930s. Even today, from time to time, one reads of new receiver designs that will bring a boom in short-wave listening. But it never happens.

There are a number of reasons why listening to h.f. broadcasting continues to be a tiny, minority taste. Receivers that are easy to tune to a given frequency are available, but inevitably cost a lot more than medium and long-wave sets.

But the main deterrent is never likely to be overcome: the need for the listener to have access to a large amount of data on transmission schedules and frequencies and to understand the many variables that determine whether a given station will be heard at a given time in a given month on a given frequency. The h.f. broadcasters, including the BBC, do their best to advise listeners, through publications or programmes such as the World Service "Waveguide", which replaced the long-running "World Radio Club" a couple of years ago.

It is usually only the DX enthusiast, or those interested in amateur radio as a hobby, who are prepared to absorb all the information needed to achieve consistent reception of a daily or weekly programme. This is assuming that they have a set that can be tuned to a given frequency, and they know the frequency they want.

The logical answer to world broadcasting

is not h.f. but space satellites in the form of Direct Satellite Broadcasting (DBS), though so far all attempts to establish DBS radio services on 26MHz or on microwaves during the past 15 years have floundered. The multi-channel digital sound systems to be used with television DBS are not a solution, as these will have "footprints" too limited for true intercontinental world coverage.

So it looks as though vast amounts of money will continue to be spent to broadcast, with limited success, on the 3.9, 6, 7, 9.5, 11.8, 15.3, 17.8 and 21.5MHz bands. And listeners will still need an up-to-date copy of *World Radio TV Handbook* to make sense of it all!

Teletext 10

With some one-million television sets containing teletext decoders installed in British homes, the Oracle and Ceefax services are now accepted as useful and well-established additions to television broadcasting.

It is surprising, even to those of us who were involved with the system in its early, experimental and "struggling" days, to recall that it is now over ten years since the

Sporting Ploy?

The use of two-way radio communications for sporting events is becoming ever more sophisticated and devious. This Year's British challenger for the America's Cup yachting event is even adopting military techniques to reduce the chances of giving away useful information to its American rivals.

The 12-metre yacht "Victory 83" and possibly other British entries will carry Racal-Tacticom's Clansman-type military equipment rather than standard marine equipment. Clansman is a frequency-synthesised system that can operate on virtually any frequency, and radio operators with military experience will be aboard.

However, they do not disclose whether high-speed "burst" data transmissions will be used to further confound eavesdroppers, nor whether the equipment will be authorised to use non-standard marine frequencies! But the Royal Burnham Yacht Club's "Victory Syndicate" are convinced that last summer their transmissions were constantly monitored by their rivals, who succeeded in obtaining vital performance intelligence.

first transmissions were made during broadcast hours, with "live" computer editing. These were based on the original Oracle system, and went out from the IBA's Crystal Palace transmitter to one or two prototype receivers!

The system, like the original Ceefax system, was indeed crude when compared to what became in 1974 the unified British teletext standard with its much higher data rate and far greater number of "pages". It was not until the beginning of 1977 that the first decoders reached the market in the form of a Labgear adaptor costing almost £400.

Teletext was basically what is called an engineer-led rather than a market-led development and it proved difficult for several years to interest the public in this new form of broadcasting cum information technology. Yet recent BREMA figures show that deliveries of teletext sets during 1982 reached 571,000 compared with 213,000 in 1981, about 80,000 in 1980, about 28,000 in 1979 and just 7,000 in 1978—an impressive growth rate for a British developed technology.

But, the most impressive industry figures are still those for video recorders, over 2.2 million deliveries in 1982 and 1 million in 1981. More videos sold or rented in the UK than even in the USA.

Technology For Change

The progress of telecommunications from its earliest days of the pre-Morse electric telegraph, line telegraphy and telephony to the later development of radio communications, broadcasting and television and the latest data transmission and optical fibre systems already spans some 150 years. A new permanent exhibition at the Science Museum in South Kensington, London, opened on March 15, 1983 by Prince Charles, emphasises that this is "a technology for change" and successfully brings together in lively displays an absorbing selection of "historic" components, equipments, publications.

In this case "historic" does not exclude many items that will be familiar to most readers and some which are likely to recall vivid personal memories. For instance, it even includes a display of current amateur radio and citizens' band transceivers, though my eye was caught more by one of the wartime National HRO communications receivers on which I spent many hours listening and the firm's National One-Ten receiver which was a pioneering super-regenerative design with plug-in coils covering 1 to 10 metres (30 to 300MHz), popular in the 1930s with amateurs using the old 56MHz and 112MHz bands.

Substantial financial support for the new gallery has come from STC, a firm which this year marks the centenary of the setting up in London of the first office of Western Electric, the original parent company of STC, in 1883. But this does not imply that many of the exhibits are STC company-oriented—in fact they are drawn from many British and foreign firms.

Any reader of EVERYDAY ELECTRONICS should regard a visit to the new gallery as a must if they live near or visit London. It is by no means "dead" history. There are buttons to press and even a chance to test your Morse-copying ability at speeds from very slow to very fast. And some fascinating photographs of the early days of the telephone with all those thousands of overhead wires converging on the first telephone exchanges.

PREVIOUSLY ADVERTISED STILL AVAILABLE

Tape punch and reader	£22.50
4 x 13 amp socket outlet	£4.95
Bench isolating transformer 250 watt	£7.75
BOAC in-flight stereo unit	£11.50
Drill assortment 4 each 25 sizes between .25mm & 2.5mm	£11.50
Flood lamp waterproof GEC	£9.90
Battery condition tester, less box	£1.75
Nicad chargers, mains	£0.75
Flourescent inventor 13 watt from 12v	£3.50
Cassette mechanism with heads	£4.50
Ten digit stitch pad-pb phone etc.	£1.95
Uniselector 2 pole 25 way	£4.60
Water valve mains operated	£2.50
Luminous switch mains up to 20 amp.	£1.15
Counter 6 digit mains operated	£1.15
ditto 12v resettable	£3.45
Double glazing clear PVC sheet, 23 1/2" wide-per running ft.	£0.15
Locking mechanism with 2 keys	£1.15
Magnetic Clutch	£4.50
Mouth operated suck or blow switch	£2.30
Fire alarm break glass switch	£3.75
Solenoid with slug 8-12v battery op	£1.82
ditto 230v mains	£2.30
Jug heater 250w at 230v	£7.50
Quick cuppa 250w heater, mains	£3.95
ditto, 100w 12v	£3.95
Timer Omron STP NH 110v AC Coil	£6.90
Key switch with 2 keys dp mains	£1.75
Air valve mains operated	£3.75
Latching relay mains operated	£3.50
Dry film lubricant aerosol can	£0.65
Coin op switch, cased with coin tray	£4.60
Auto transformer 1000 watts (plus postage for transformer)	£19.50
	£3.00



8 POWERFUL MODEL MOTORS
(all different)
for robots, meccanos, drills, remote control planes, boats, etc. £2.95.

MAINS POWERED UNIT

6 - 12 v with reversing and speed control totally enclosed - £4.60

12 volt MOTOR BY SMITHS

Made for use in cars, etc. these are series wound and they become more powerful as load increases. Size 3 1/2" long by 3" dia. They have a good length of 1/4" spindle - Price £3.45.
Ditto, but double ended £4.25.
Ditto, but permanent magnet £3.75.

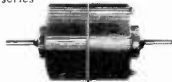

EXTRA POWERFUL 12v MOTOR

Made to work battery lawnmower, this probably develops up to 1/4 h.p., so it could be used to power a go-kart or to drive a compressor, etc. etc. £7.95 + £1.50 post.
(This is easily reversible with our reversing switch - Price £1.15).

BUILD A PASSENGER LOCO

Set of four 12 volt motors to drive passenger locomotive - £29.50
With address where to buy other parts.

THERMOSTAT ASSORTMENT

10 different thermostats. 7 bi-metal types and 3 liquid types. There are the current stats which will open the switch to protect devices against overload, short circuits, etc., or when fitted say in front of the element of a blow heater, the heat would trip the stat if the blower fuses; appliance stats, one for high temperatures, others adjustable over a range of temperatures which could include 0 - 100°C. There is also a thermostat pod which can be immersed, an oven stat, a calibrated boiler stat, finally an ice stat which, fitted to our waterproof heater element, up in the loft could protect your pipes from freezing. Separately, these thermostats could cost around £15.00 - however, you can have the parcel for £2.50.

LAST MONTH'S SNIP - STILL AVAILABLE

The AMSTRAD Stereo Tuner.

This ready assembled unit is the ideal tuner for a music centre or an amplifier, it can also be quickly made into a personal stereo radio - easy to carry about and which will give you superb reception.

Other uses are a "get you to sleep radio", you could even take it with you to use in the lounge when the rest of the family want to view programmes in which you are not interested. You can listen to some music instead.

Some of the features are: long wave band 115 - 270 KHz, medium wave band 525 - 1650KHz, FM band 87 - 108MHz, mono, stereo switch, AFC switch, tuning meter to give you spot on stereo tuning, optional LED wave band indicator, fully assembled and fully aligned. Full wiring up data showing you how to connect to amplifier or headphones and details of suitable FM aerial (note ferrite rod aerial is included for medium and long wave bands. All made up on very compact board.

Offered at a fraction of its cost: **only £6.00**
+ £1.50 post + insurance.

THIS MONTH'S SNIP

DISCO PANEL

Make your party or disco more thrilling - add to your record player or amp, a multi-coloured, sound-enhanced lighting display. Made for Amstrad their ref. No. RP10. Mains operated stereo or mono controlled - has 48 coloured lamps (plus 4 spares) and light level control. Brand new and unused - offered at a never to be repeated price of **£5.75 plus £2.00 post.**

SUPER HI-FI SPEAKER CABINETS

Made for an expensive Hi-Fi outfit - will suit any decor. Resonance free. Cut-outs for 8" woofer and 4" tweeter. The front material is Dacron. The completed unit is most pleasing. Supplied in pairs, price **£6.90** per pair (this is probably less than the original cost of one cabinet) carriage £3.00 the pair.

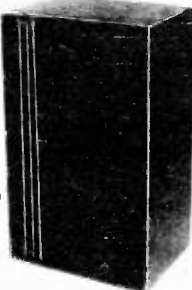

GOODMANS SPEAKERS

6 1/2" 8 ohm 25 watt **£4.50**. 2 1/2" 8 ohm tweeter. **£2.50**. No extra for postage if ordered with cabinets. Xover **£1.50**.
DITTO but for 8" speaker and 4" tweeter. **£7.50 + £3.50**.

2-WAY CROSSOVER NETWORK

4 or 8 ohm impedance - power input up to 25W, crossover frequency 2KHz with wiring diagram. **87p** each.

3-WAY CROSSOVER NETWORK

4 or 8 ohm impedance - power input up to 60W, crossovers at 700kHz and 3500kHz with wiring diagram. **£1.15**.

TELEPHONE ITEMS:

Pick-up coil - sucker attached	£1.15
Phone plug - 4 pin GPO type	£0.85
Modern desk telephone - GPO type	£7.50
Heavy black old type GPO phone	£5.50
GPO outside bell unit	£6.50

QUANTITY BUYERS - Please phone for our Bulk Buyers List - discount prices will amaze you e.g. 12v 1/2a. and 6v 1a @ 50p each!



VENNER TIME SWITCH

Mains operated with 20 amp switch, one on and one off per 24 hrs. repeats daily automatically correcting for the lengthening or shortening day. An expensive time switch but you can have it for only **£2.95**. These are without case but we can supply a plastic base £1.75 or metal case **£2.95**. Also available is adaptor kit to convert this into a normal 24 hr. time switch but with the added advantage of up to 12 on/off per 24 hrs. This makes an ideal controller for the immersion heater. Price of adaptor kit is **£2.30**.

50 THINGS YOU CAN MAKE

Things you can make include Multi range meter, Low ohms tester, A.C. amps meter, Alarm clock, Soldering iron mender, Two way telephone, Memory jogger, Live line tester, Continuity checker, etc. etc., and you will still have hundreds of parts for future projects. Our 10Kg parcel contains not less than 1,000 items - panel meters, timers, thermal trips, relays, switches, motors, drills, taps, and dies, tools, thermostats, coils, condensers, resistors, neons, earphone/microphones, nicad charger, power unit, multi-turn pots and data on the 50 projects.

YOURS FOR ONLY £11.50 plus £3.00 post.

MINI-MULTI TESTER

Deluxe pocket size precision moving coil instrument, jewelled bearings - 2000 o.p.v. mirrored scale. 11 instant range measures:

DC volts	10, 50, 250, 1000.
AC volts	10, 50, 250, 1000.
DC amps	0 - 100 mA.



Continuity and resistance 0 - 1 meg ohms in two ranges. Complete with test leads and instruction book showing how to measure capacity and inductance as well. Unbelievable value at only **£6.75 + 60p** post and insurance.

FREE Amps range kit to enable you to read DC current from 0 - 10 amps, directly on the 0 - 10 scale. It's free if you purchase quickly, but if you already own a Mini-Tester and would like one, send **£2.50**.

J. BULL (Electrical) Ltd.

(Dept. EE), 34 - 36 AMERICA LANE, ESTABLISHED 30 YEARS
HAYWARDS HEATH, SUSSEX RH16 3QU.

MAIL ORDER TERMS: Cash, P.O. or cheque with order. Orders under £10 add 60p service charge. Monthly account orders accepted from schools and public companies. Access & B/card orders accepted day or night. Haywards Heath (0444) 454563. Bulk orders: write for quote. Delivery by return. Shop open 9.00 - 5.30, Mon to Fri, not Saturday.

3 CHANNEL SOUND TO LIGHT

Now supplied with fully prepared metal work and p.c.b. You'll have it going in an evening.

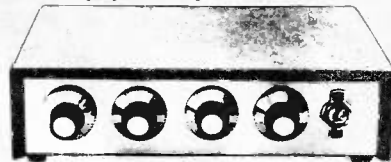

Complete kit of parts for a three channel sound to light unit controlling over 2000 watts of lighting. Use this at home if you wish but it is plenty rugged enough for disco work. The unit is housed in an attractive two tone metal case and has controls for each channel, and a master on/off. The audio input and output are by 1/4" sockets and three panel mounting fuse holders provide thyristor protection. A four pin plug and socket facilitate ease of connecting lamps. Special price is **£14.95** in kit form or **£25.00** assembled and tested. Case & metal Chassis No. Fully punched and prepared.

EXTRACTOR FANS

Mains operated - ex-company.

Woods extractor	5" - £5.75, Post £1.25
	6" - £6.95, Post £1.25
5" Plainair extractor	£5.50, Post £1.25.
4" x 4" Muffin 115v.	£4.50, Post 75p.
4" x 4" Muffin 230v.	£5.75, Post 75p.
10" American made	£11.50, post £2.00.
12 volt 6 1/2" extractor	£6.90, post £1.50.

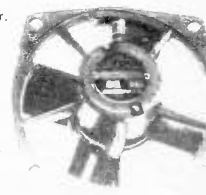

MILLIONS OF HOMES WILL BE BURGLED

Don't let yours be one of them. Install our burglar alarm. Install our burglar alarm. Complete kit includes 6" external alarm bell, mains power unit, control box with key switch, 10 window/door switches, 100 yards of wire. With instructions **£29.50**.

COMPUTER DESK

Size approx 4' x 2' x 26" high. These were made for hard work, the top being formica covered. Suitable for housing instruments or for use as office desks. Beautifully made, these cost over £100 each, our price only **£11.50** each, however, you must arrange to collect.



MINI MONO AMP on p.c.b. size 4" x 2"

approx. Fitted volume control and a hole for a tone control should you require it. The amplifier has three transistors and we estimate the output to be 3W rms. More technical data will be included with the amplifier. Brand new, perfect condition, offered at the very low price of **£1.15** each, or 10 for **£10.00**.

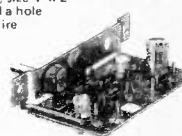

OTHER POPULAR PROJECTS

3 Channel sound to Light - with fully prepared metal case	£14.95
Ditto - made up	£25.00
Big Ear, listen through walls	£9.50
Robot controller - receiver/transmitter	£7.50
Ignition kit - helps starting, saves petrol, improves performance	£13.95
Silent sentinel Ultra Sonic Transmitter and receiver	£9.50
Car Light 'left on' alarm	£3.50
Secret switch - fools friends and enemies alike	£1.95
3 - 30v Variable Power Supply	£13.80
2 Short & Medium Wave Crystal Radio	£3.99
3v to 16v Mains Power Supply Kit	£1.95
Light Chaser - three modes	£17.50
Mullard Unilex Hi Fi stereo amplifier with speakers.	£16.75
Radio stethoscope - fault finding aid	£4.80
Mug Stop - emits piercing squawk	£2.50
Morse Trainer - complete with key	£2.99
Drill control kit	£3.95
Drill control kit made up	£6.95
Interrupted beam Kit	£2.50
Transmitter Surveillance Kit	£2.30
Radio Mike	£6.90
FM receiver kit - for surveillance or normal FM transmissions	£3.50
Seat Belt Reminder	£3.00
Car Starter Charger Kit	£14.00
Soil heater for plants or seeds	£16.50
Insulation Tester - electronic megger	£7.95
Battery Shaver or Fluorescent from 12v	£6.90
Matchbox Radio - receives Medium Wave	£2.95
Mixer Pre-amp - disco special with case	£16.00
Aerial Rotator - mains operated	£29.50
Aerial direction indicator	£5.50
40 watt amp - hi-fi - 20hz - 20KHz	£9.50
Microvolt multiplier - measure very low currents with ordinary multimeter	£3.95
Pure Sine Wave Generator	£5.75
Linear Power output meter	£11.50
115 Watt Amplifier 5hz - 25KHz	£13.50
Power Supply for one or two 115 watt amps	£17.50
Stereo Bass Booster, most items	£8.95

CIRCUIT EXCHANGE

This is the spot where readers pass on to fellow enthusiasts useful and interesting circuits they have themselves devised. Payment is made for all circuits published in this feature. Contributions should be accompanied by a letter stating that the circuit idea offered is wholly or in significant part the original work of the sender and that it has not been offered for publication elsewhere.

STABILISER FOR USE WITH LOW COST BATTERY ELIMINATORS

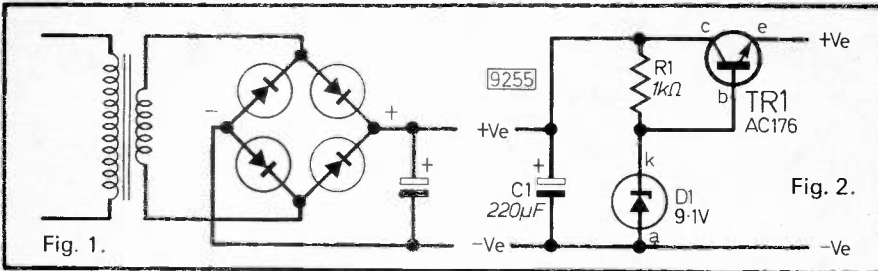

Fig. 1.

MAJNS 9V battery eliminators are on sale for use with a wide range of electronic equipment. Although these devices are described as "9 volts" they are unstabilised usually consisting of simply a mains transformer, rectifiers and

electrolytic smoothing capacitor as shown in Fig. 1. With a simple circuit such as this the voltage varies with current drawn, at low currents the voltage can rise to 12 volts.

The circuit described and shown in

Fig. 2 can be used between the power supply and a 9V circuit. It was designed for use with circuits normally powered by a PP3 size battery. The transistor AC176 is a low cost germanium *n*p*n* type (a BFY51 could be substituted).

If working with experimental circuits a 100 ohm resistor should be connected between the output of the stabiliser and the circuit to limit the current in the event of a short circuit. The stabiliser is suitable for low current only.

R. Soar,
Denaby Main,
Doncaster,
Yorkshire.

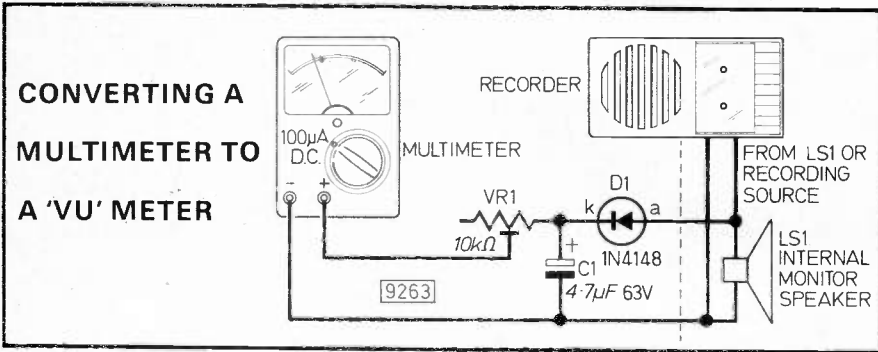

STRENGTH METER

THE circuit to be described can be used for comparing the strength of different persons; or rather as a "strength meter". Two hand grips (metallic rods) are held in the contestant's hands. As he squeezes the hand grips the l.e.d.s light up in sequence. The strength of the contestant is measured by the maximum number of l.e.d.s he can light up this way.

The hand grips are made of brass or aluminium tubes; 10cm long and 2cm diameter.

VR1 is adjusted with the hand grips gently placed in the contestant's hands until D1 is just "off". The strength at which each l.e.d. is lit up can be individually controlled using VR2, VR3, VR4 and VR5. These preset potentiometers should be adjusted so that D1 is

more expensive audio devices, there may be a VU meter included in the unit. This can be very useful for recording to tell whether there is any overload.

In most portable, mono cassette recorders there is no such meter and as a simple alternative you can use your multimeter, set at the 100µA (d.c.) range for recording. The diagram shows how it is set up, using just one diode, capacitor and potentiometer. The latter is adjusted to give f.s.d. at just below distortion.

Alex Clark,
Lichfield, Staffs.

the first to light and D4 the last.

The circuit connections for IC2 through to IC5 are similar and more stages can be added in a similar manner. Although the i.c.s are marked 741 in the circuit, IC2, IC3, IC4 and IC5 can be replaced by a quad-op-amp i.c.

J. Sreekumar,
Cochin,
India.

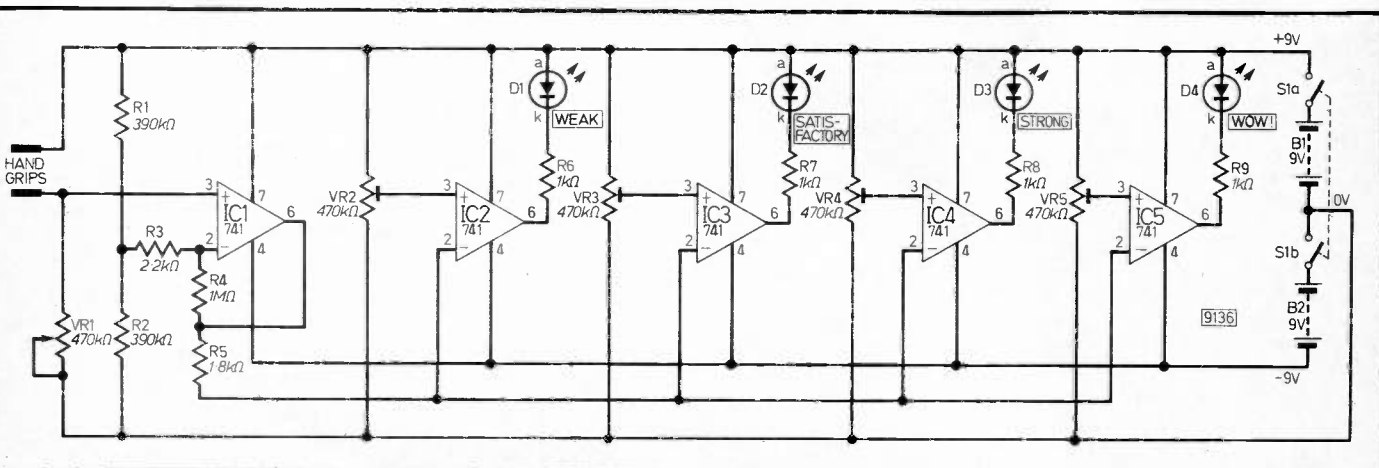

NEW · NEW · NEW · NEW
PRODUCTS
 NEW · NEW · NEW · NEW

VHS RE-RECORD TABS

WITH the increasing sales of video cassettes Bib Audio/Video Products have developed re-record tabs for use on VHS cassettes.

Some readers may not be aware that each video cassette has a safety tab, positioned at the rear of the cassette, which can be snapped out to avoid further recordings being made. This is a useful facility, particularly when precious recordings might be lent to friends, who may inadvertently erase the recording.



The Bib re-record tab enables further recordings to be made by taking up the space where the original tab was positioned. The new tab is re-usable and is removed by the use of a small screwdriver, or similar instrument.

The tabs are supplied in packs of 20, with fitting details printed on the pack. The recommended retail price of the Bib VHS Cassette Re-Record Tabs is £1.47, including VAT.

*Bib Audio/Video Products Ltd.,
 Dept EE, Kelsey House,
 Wood Lane End,
 Hemel Hempstead,
 Herts HP2 4RQ.*

PACKAGE DEAL

A NEW pack is being manufactured by **Cartados Packaging**, which has been specially designed to give protection to a wide range of electronic components during transit.

The pack consists of a white corrugated-board hinged carton, with profile foam on the inside of the lid and base. When the lid is closed and fastened into position, the foam sandwiches and holds the component firmly and accommodates all shapes and sizes of components.

This makes the cartons ideal for use as postal packs.

For more details and prices contact:

*Cartados Packaging Ltd.,
 Dept EE, King's Lane,
 Englefield Green,
 Surrey TW20 0TZ.*

AUTORANGING CAPACITANCE METER

A HAND-HELD autoranging capacitance meter which features a degree of precision, range and flexibility normally associated with benchtop instruments, is now being marketed by **Global Specialties**.

The new meter, type Model 3002, which incorporates a 3½-digit liquid-crystal display and measures only 193 × 95 × 44mm, provides direct readings of capacitance from 1pF to 19,990µF. Eight automatically selected ranges remove the need for manual switching, and a dual-threshold measuring technique ensures a claimed accuracy within 0.2 per cent (± one count) from 1pF to 199µF and 1 per cent (± one count) between 200µF and 19.99mF.

The dual-threshold measurement technique is claimed to eliminate reading errors caused by dielectric absorption, and the use of d.c. charging characteristics to determine true capacitance means that the instrument can be used for measurements on cables, switches and other components as well as on capacitors.

The Model 3002 operates from six AA nickel-cadmium or

alkaline batteries, and the maximum current consumption of 75mA ensures a long battery life. An optional a.c. adaptor/charger can also be used.

*Global Specialties Corporation,
 Dept EE, Shire Hill Industrial
 Estate, Saffron Walden,
 Essex CB11 3AQ.*



TALKING BOOKS

THE company that first put speech into learning aids with "Speak and Spell" have just introduced books that talk. Called the Texas "Magic Wand Speaking Reader" the system uses bar codes coupled with speech synthesis microchips to produce an audible commentary.

Aimed at 4 year-olds and upwards, it's a true learning aid, adding excitement to a child's early attempts at reading. It guides the child's reading asking and answering questions prompted by coloured picture books.

As well as a story, books containing puzzles with multiple choice answers, simple spelling tests and early arithmetic are available. Sound effects and simple tunes are also included in the books.

A bar code reader or "wand" is connected to a lightweight

"talking computer" by means of a coiled flexi-cable. The wand is simply scanned across the bar codes and the computer proceeds to tell the story or ask questions.

The Texas Instruments "Magic Wand Speaking Reader" is ex-

pected to sell in the UK at around £39.95, books about £7.95 each, and more details can be obtained from:

*Texas Instruments Ltd.,
 Dept EE, Manton Lane,
 Bedford, MK41 7PA.*



DIGITAL COUNTER

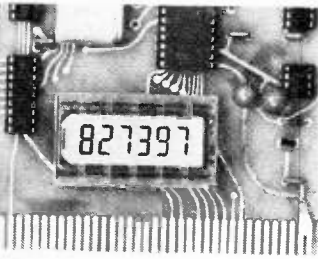

To meet the need of designers for a counter which can be mounted in a confined space, Eurovector have marketed the Sub-Cub digital counter.

The Sub-Cub comprises a 6-digit (500kHz) l.s.i. counter chip, oscillator, Schmitt trigger and l.c.d. readout in a single dual-in-line type package that can be directly mounted on a printed circuit board. A supply voltage of 2 to 6V d.c. is required to power the unit, with supply current typically 15µA at a counting rate of 10kHz.

The display can be frozen at any time whilst the counter continues accumulating counts or is reset to zero in preparation for a new counting cycle. This allows it to be used as a frequency meter, tachometer and for period and pulse-width measurement.

Two modules are currently available; Sub-Cub I with 5mm

high digits and Sub-Cub II with 9mm digits. An optional bezel kit provides for panel mounting if required.

For further information contact:

*Eurovector Ltd.,
Dept EE, Wessex House,
Silchester Road, Tadley,
Basingstoke, RG26 6PX.*

ZX81 INPUT/OUTPUT PORT BOARD KIT

THE RE98 I/O Port designed and available from Redditch Electronics provides bidirectional access for the ZX81 to the outside world. It thus provides a facility for monitoring and control of external equipment under software/keyboard control.

The unit is available in kit form and comes with full step-by-step

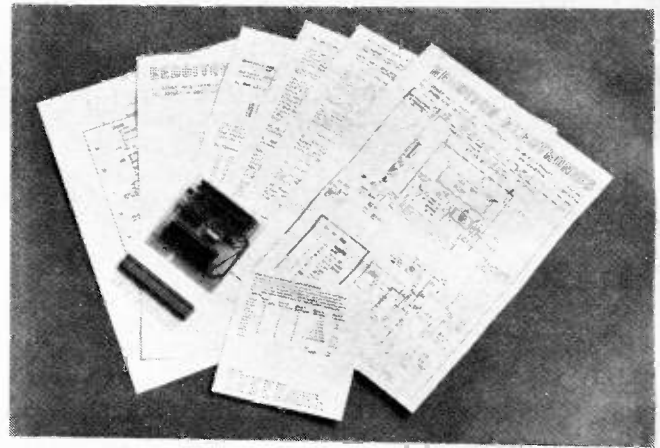

assembly instructions, test procedures and software test routines. Ideas for interfacing are also provided, such as using optoisolators to receive information, filament lamp and relay driver circuitry and others. We are presently building the unit and

plan to publish a technical report and suggest some application circuit ideas. For further information contact:

*Redditch Electronics, Dept. EE,
21 Ferney Hill Avenue, Redditch,
Worcs. B97 4RU.*

INSTRUMENT CASE

THE range of all metal instrument cases produced by Boss Industrial Mouldings has been increased with the introduction of another size model in their Bim 3000 Series.

Available in two sizes of 250 x 167.5 x 68.5mm high and 250 x 187.5 x 78.5mm high, they incorporate a rigid matt black stove

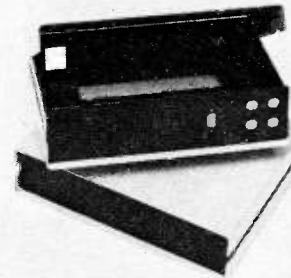

enamelled 18 s.w.g. chassis to which red, grey or orange stove

enamelled 14 s.w.g. top and bottom covers are independently attached.

The chassis design includes integral brackets for supporting components, p.c.b.s and other assemblies and can be supplied with special ventilation slots, cut-outs and punchings to individual customer requirements.

For more details and prices enquiries should be made to:

*Boss Industrial Mouldings Ltd.,
Dept EE, James Carter Road,
Mildenhall, Suffolk IP28 7DE.*

F227 SMOKE DETECTOR FIRE ALARM

THE F227 Ionisation Smoke Detector Fire Alarm is a highly sensitive instrument designed to sense the visible and invisible combustion of a fire. This type of detector gives the earliest possible warning of a fire, responding to the initial stages of combustion; and thus before visible-smoke or heat detectors. The extra seconds gained can be vital in allowing persons to escape from a developing fire.

The sensor utilises a tiny, harmless amount of radioactive material of 0.7µCi which complies to international standards. The detector is powered by a single 9V alkaline battery which can last for more than a year. When the battery runs low, the detector will emit a bleeping signal to indicate that the battery needs replacing. A test button is provided. Actuation of this button will cause the alarm to sound,

thus checking all electronic circuitry, the sensor, the horn and the battery. A weekly test is recommended by N.F.P.A.

The detector is housed in a circular white plastic case. The cover is hinged and can be easily released, giving access to all parts, also to the keyhole slots provided for the fixing screws. Since heat rises, the aerosol products of combustions are always carried towards the ceiling. The detector should therefore be located on the ceiling as close to the centre of the room or hallway as possible.

Advice concerning the location of one or more smoke detectors in domestic premises is included in the owner's manual supplied with each instrument.

The F227 Smoke Detector Fire Alarm is manufactured by Gamma Electronic PTe. Ltd., Singapore, and is available (UK only) from:

*R.T.V.C. Ltd., Dept EE,
21A High Street, Acton,
London W3 6NG.*

See Bargain Offer to EE readers on page 359 of this issue.

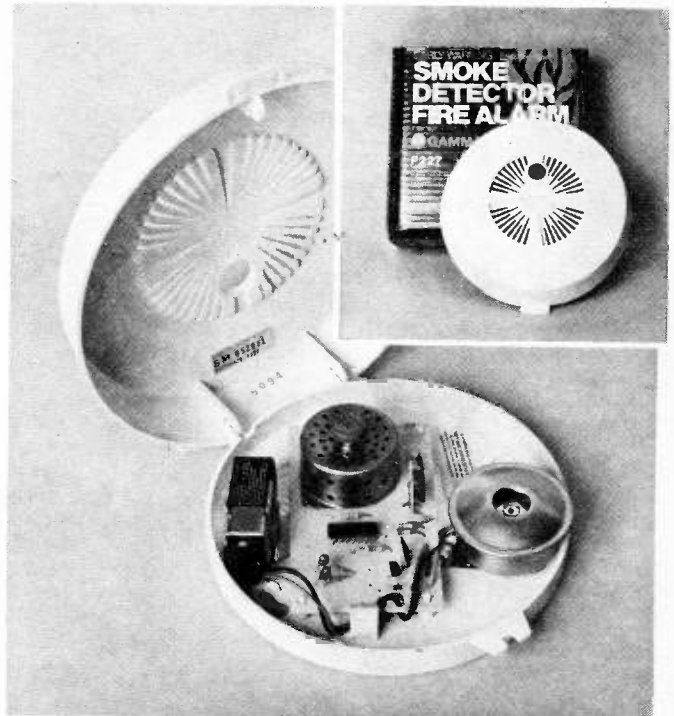

LETTERS

Pen Pal

Sir—I am thirteen years old, I am interested in electronics and computing and I collect electronic valves, and I am looking for a penfriend. My address is:

Shaun Gander,
6 Delaware Road,
Winterbourne,
Lewes,
Sussex
BN7 1LD.

Test Gear 83

Sir—I am building all the *Test Gear '83* projects in EVERYDAY ELECTRONICS. Unfortunately I cannot get hold of some of the components for the Power Supply. Please could you tell me where I can get them and how much they will cost?

The components are: KBL02 4A, 200V bridge rectifier (2 off); 0.47Ω, 3W wirewound resistor (2 off); 470Ω, 3W wirewound resistor (1 off); 0.1μF, 160V Siemens type capacitor, (3 off); 2-pole, 6-way midget rotary with adjustable stop and the 1mA f.s.d. panel meter with 120Ω coil type ML52.

P. Greenfield,
Taverham,
Norwich.

In reverse order, the ML52 panel meter is available from **Ambit International** for £5.98 and the stock number is 37 00521. They can also supply the midget rotary switch (stock number 53 21025) for 54p and the 0.1μF Siemens capacitors (stock number 04 10407) at 13p each. Prices are exclusive of VAT and please add 60p for postage.

Maplin also stock a suitable panel meter, order reference RW94C (2in Pan Meter 1mA), for £6.45 but this meter will require a slightly different cut-out in the front panel. The Maplin order reference for the switch is FF74R (Rotary Sw6B) at 70p, and the capacitors are ordered as WW41U (Carbonate 0.1μF) for 11p each. They also stock the 3W wirewound resistors as W0.47Ω (W/W Min 0.47Ω) and W470Ω (W/W Min 470Ω) at 29p each.

These prices are inclusive of VAT and orders over £5 are postage free. Orders under £5 require an additional 50p for postage.

The KBL02 bridge rectifier has been a little harder to locate. **RS Components** stock a suitable 4A, 200V "in-line" device which is equivalent to the KBL02 and the stock number is 262-113. However, RS do not sell directly to the public as they only supply to account customers. But most component shops will have an account with RS and can obtain this item on your behalf if you quote the stock number and the price should be in the region of £2 again.

Ambit International are at 200 North Service Road, Brentwood, Essex CM14 4SG (telephone 0277 230909) and **Maplin Electronic Supplies Ltd** address is P.O. Box 3, Rayleigh, Essex SS6 8LR (telephone 0702 552911).

Pin Function Generator

Sir—Your help please! Could you advise me of the pin-out of a 14-pin d.i.l. LM318N (IC3, *Function Generator*, April 1983).

The major suppliers do not seem to stock the LM318 and although the circuit simply specifies an LM318, I am advised that there is an "H" and "N" version.

I was told that the N version was the correct one, but when supplied, turns out to be a 14-pin d.i.l. I have searched literally hundreds of other circuits and magazines but cannot find a single design that uses an LM318 (98 per cent use the 741) and suppliers seem reluctant to answer such queries by telephone, hence the request.

Please note that Fig. 6 (calibration scale) is also missing from the article. I still hope to finish this unit and eventually the future units in the *Test Gear 83* series.

R. S. Bareham,
Tunbridge Wells,
Kent.

Dealing with your last point first, Fig. 6, the calibration scale, was omitted from the text due to a lack of space and unfortunately the reference to it was left in. However, from the photographs showing the front of the Function Generator unit it can be seen that the scale runs from 1 to 10 around the travel of the potentiometer in an almost linear fashion.

It is not truly linear as the points are closer together at the beginning and end of the scale than they are in the middle but as it was not deemed to be important to achieve very accurate calibration, an estimation based on the photographs of the prototype model will be sufficient. We hope this has not inconvenienced any readers.

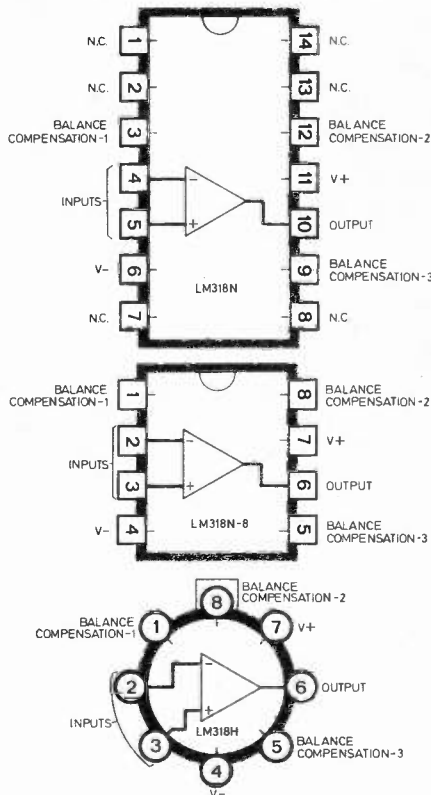

As far as the LM318 goes, it is available in many versions. The **LM318N** is the 14-pin d.i.l. plastic packaged type (a "J" in place of the "N" indicates that it is a 14-pin ceramic pack) and the **LM318H** is an 8-pin

TO5 metal can. The 8-pin d.i.l. variant is denoted the **LM318N-8** (again, a "J" signifies ceramic package). This suffix "8" was inadvertently omitted from the components' list.

The pin-out diagrams given below show the pin functions of the three basic package types. Note that if pins 1, 2, 7, 8, 13 and 14 are ignored on the 14-pin version, the relative positions of all functions are identical to those on the 8-pin d.i.l. type.

It can also be seen that the pin numbers for both the 8-pin d.i.l. device and the 8-pin metal can are identical so that the LM318H could be preformed to the d.i.l. format to fit the p.c.b. layout.

Greenhouse Monitor

Sir—The article on the *Beehive Temperature Meter* (February '83) prompted me to make up the project and adapt it to monitor my greenhouse, frames, compost heap and solar heater. The *Shop Talk* feature suggested Maplin for the parts, but the Digitron meter (ME1) is not in their catalogue and nor can I find a local (Glasgow) supplier.

I made up the project on a breadboard and have got it working in the meantime with a digital multimeter in place of ME1. I had some bother as the millivolt readings were too high and I found the current through the LM335Z temperature sensor also too high until I altered the circuit more in line with the drawing given in the Maplin catalogue. This meant putting a 2.85 kilohm resistor between the positive supply rail and the positive terminal of the LM335Z. The schematic diagram (see also Fig. 2, page 83) of this modification is shown below.

If you can get me the address of the manufacturer of the Digitron meter I should be most grateful. I have taken your paper now for some five years.

G. S. Wilton,
Clarkston,
Glasgow.

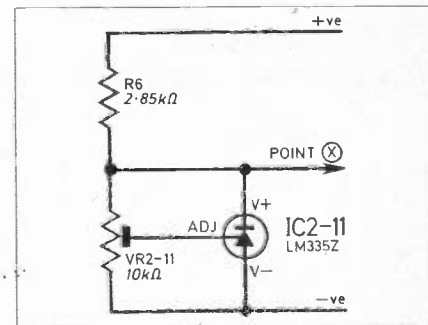

The Digitron 8000 meter is manufactured by **Digitron Instruments Ltd., Merchant Drive, Mead Lane Industrial Estate, Hertford SG13 7BH**. They can supply the meter used on the prototype Beehive Temperature Meter for £34.25 plus VAT plus £3.50 postage and packing (total £42.90). Please supply payment with order and specify that it is the Digitron 8000-01 digital voltmeter with 999mV full scale deflection that is required.

However, as this is an expensive component, a suitable alternative is to fit a pair of sockets in place of the meter and use a portable digital multimeter when measurements are required. The 2V range found on most d.v.m.s is ideal, remembering that 10mV is equivalent to one degree Celsius. Therefore a reading of 270mV (or 0.27V) is equal to a temperature of 27°C.

Sinclair ZX Spect

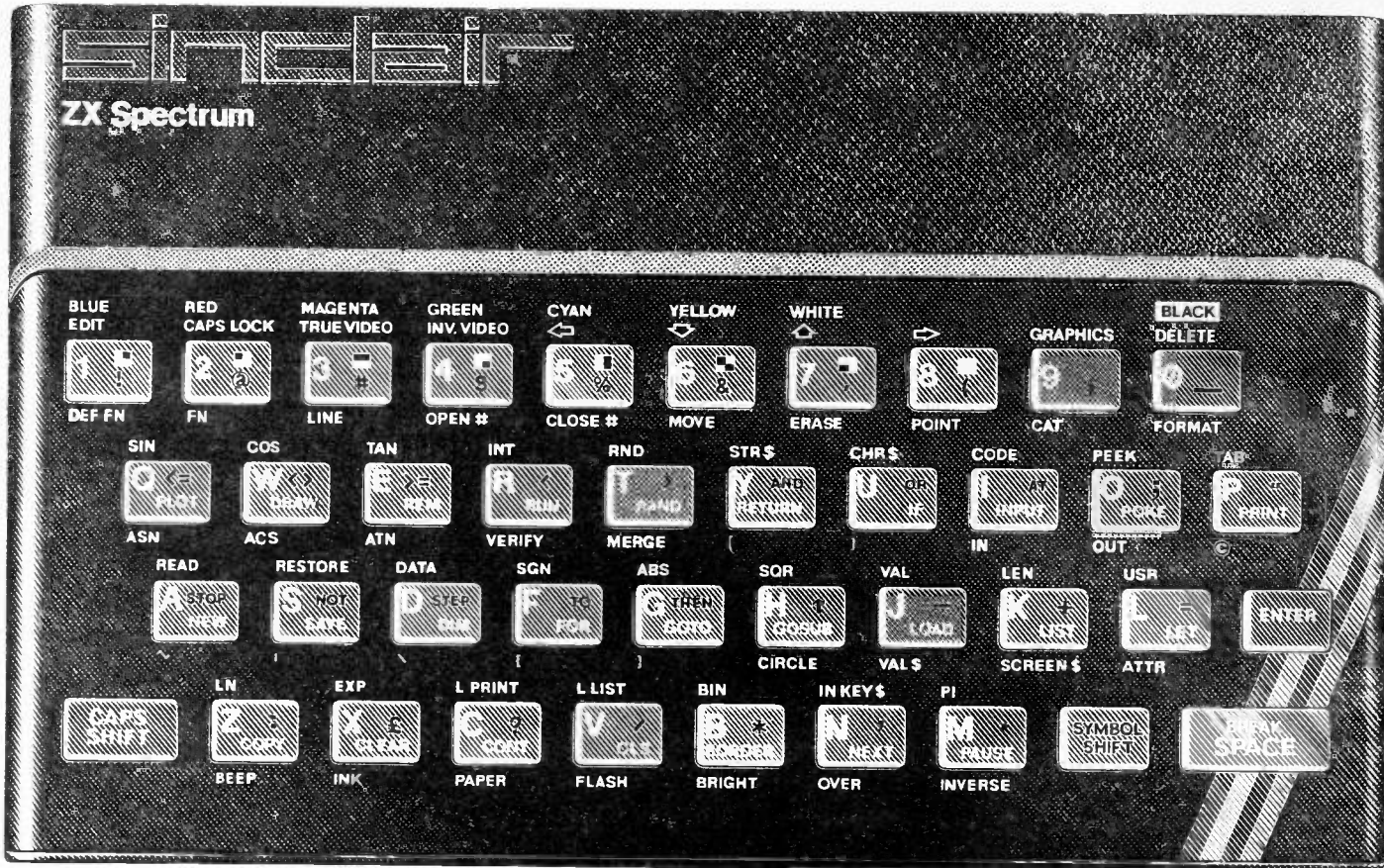

The growing range of Spectrum Software



You'll know already that the Spectrum has generated an enormous range of peripherals and independent software. Our own range is growing very fast and is shown in the Sinclair Software Catalogue - free with every ZX Spectrum.

rum - news!

**16K now
£99⁻⁹⁵**

Previously £125.

**48K now
£129⁻⁹⁵**

Previously £175.

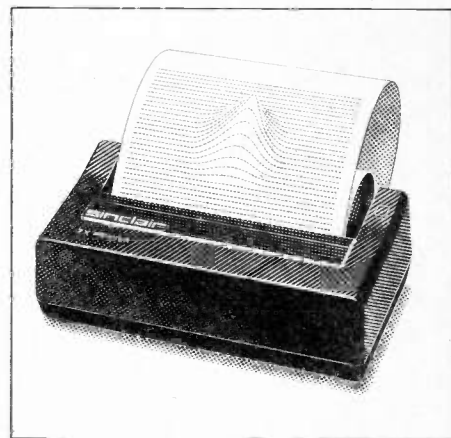

**ZX Printer now
£39.95**

Previously £59.95

How to order your ZX Spectrum
Access, Barclaycard or Trustcard holders
- call 01-200 0200 24 hours a day, every
day. By FREEPOST - use the coupon
below. Please allow up to 28 days for
delivery. 14-day money-back option.

**sinclair
ZX Spectrum**

Sinclair Research Ltd., Stanhope Road,
Camberley, Surrey, GU15 3PS.
Tel: 0276 685311. Reg no. 1135105

At last, a 16K colour computer
with graphics for under £100!

Why have we done it?

Partly because the sheer
volume of Spectrums sold (over
300,000 so far) has brought
down unit production costs.

And partly, of course,
because we hope you'll buy a
Sinclair computer - and not
some competitor's promise!
We've all heard about colour
computers breaking the £100
barrier. Here's the computer
that's done it. A colour computer
with advanced graphics that's
fully supported, and widely
available.

Right now, you can order a
Sinclair Spectrum at these
prices direct from Sinclair on
the order form below. And to
make it even easier to handle
high-level computing at the

lowest possible price, we've
cut the cost of the printer, too.
At £39.95, it's almost
unbelievable!

At prices like these, there's
really no reason to wait.

To: Sinclair Research, FREEPOST, Camberley, Surrey, GU15 3BR.

Qty	Item	Code	Item Price £	Order Total £
	Sinclair ZX Spectrum - 16K RAM version	3000	99.95	
	Sinclair ZX Spectrum - 48K RAM version	3002	129.95	
	Sinclair ZX Printer	1014	39.95	
	Printer paper (pack of 5 rolls)	1008	11.95	
	Postage and packing: orders under £90	0028	2.95	
	orders over £90	0029	4.95	
				Total £ _____

Please tick if you require a VAT receipt

*I enclose a cheque/postal order payable to Sinclair Research Ltd for £ _____

*Please charge to my Access/Barclaycard/Trustcard account no. _____

*Please delete/complete as applicable. _____

Signature _____

PLEASE PRINT

Name: Mr/Mrs/Miss _____

Address _____

LEVE 906

FREEPOST - no stamp needed.

Prices apply to UK only.

Export prices on application.

E.E. PROJECT KITS

I.C.s
TRANSISTORS
CAPACITORS

TOOLS
RESISTORS
HARDWARE

CASES
KITS

MAGENTA

Make us your No. 1 SUPPLIER OF KITS and COMPONENTS for E.E. Projects. We supply carefully selected sets of parts to enable you to construct E.E. projects. Kits include ALL THE ELECTRONICS AND HARDWARE NEEDED. Printed circuit boards (fully etched, drilled and roller finished) or Veroboard are, of course, included as specified in the original article, we even include nuts, screws and I.C. sockets. PRICES INCLUDE CASES unless otherwise stated. BATTERIES ARE NOT INCLUDED. COMPONENT SHEET INCLUDED. If you do not have the issue of E.E. which includes the project—you will need to order the instruction reprint at an extra 45p each. Reprints available separately 45p each + p. & p. 45p.

- MODEL TRAIN CONTROLLER May 83 £25.17
GUITAR HEADPHONE AMPLIFIER May 83 £27.20
MW PERSONAL RADIO less case, May 83 £6.93
LABORATORY AMPLIFIER May 83 £30.98
MOISTURE DETECTOR May 83 £4.97
CAR RADIO POWER BOOSTER April 83 £10.98
FUNCTION GENERATOR April 83 £21.98
FLANGER SOUND EFFECTS April 83 £21.98
NOVELTY EGG TIMER April 83 less case £4.98
ZX SPECTRUM AMPLIFIER April 83 £8.98
DUAL POWER SUPPLY March 83 £53.98
MULTISTATION INTERCOM March 83 master + 1 slave £43.02
Extra slave £5.46
BUZZ OFF March 83 £4.10
CAR THERMOMETER March 83 £29.98
SPEECH PROCESSOR Feb. 83 £10.66
PUSH BIKE ALARM Feb. 83 £11.32
MOTOR BIKE ALARM Feb. 83 £14.46
DOUBLE DICE Jan. 83 £10.82
ELECTRONIC V/I METER Dec. 82 £11.38
ZX TAPE CONTROL Nov. 82 £6.48
PHOTO FINISH Nov. 82 £5.89
SINE WAVE GEN Oct. 82 £14.65
G. P. PRE-AMP Oct. 82 £5.64
LIGHTS ON ALERT Oct. 82 £4.25
CONTINUITY CHECKER Sept. 82 £4.97
SOUND SPLITTER Sept. 82 £15.77
SOUND RECOMBINER Sept. 82 £3.70
SCREEN WASHING Sept. 82 £4.48
INSTRUMENT PRE-AMP Aug. 82 £7.82
TWO TONE DOORBELL ALARM Aug. 82, less case and bell transformer £8.82
CB ROGER BLEEPER Aug. 82 £8.47
2-WAY INTERCOM July 82 no case £4.11
ELECTRONIC PITCH PIPE July 82 £4.99
REFLEX TESTER July 82 £7.07
SEAT BELT REMINDER June 82 £3.73
EGG TIMER June 82 £4.95
TWO TONE TRAIN HORN WITH REMOTE TRIGGER OPTION May 82 £11.26
CAR LED VOLTMETER less case, May 82 £2.99
LIGHTNING CHESS BUZZER, May 82 £6.00
V.C.O. SOUND EFFECTS UNIT Apr 82 £11.56
CAMERA OR FLASH GUN TRIGGER Mar 82, £12.41 less tripod bushes.
POCKET TIMER Mar 82, £3.74
GUITAR TUNER Mar 82, £15.63
SIMPLE STABILISED POWER SUPPLY, Jan. 82, £24.58
MINI EGG TIMER, Jan. 82, £3.94
BIREN MODULE, Jan. 82, less speaker, £3.57
MODEL TRAIN CHUFFER, Jan. 82, £8.27
GUITAR ADAPTOR, Dec. 81, £3.76
ELECTRONIC IGNITION, Nov. 81, £25.98
BIMPLE INFRA RED REMOTE CONTROL, Nov. 81, £16.98
PRESSURE MAT TRIGGER ALARM, Nov. 81, £8.27 less mats.
EXPERIMENTER CRYSTAL SET, Nov. 81, less aerial, £5.99.
Headphones, £2.98 extra.
CAPACITANCE METER, Oct. 81, £23.51.
SUSTAIN UNIT, Oct. 81, £12.76.
"POPULAR DESIGNS", Oct. 81.
TAPE NOISE LIMITOR, £4.57.
HEADS AND TAILS GAME, £2.52.
CONTINUITY TESTER, £3.95.
PHOTO FLASH SLAVE, £3.46.
FUZZ BOX, £7.29.
OPTO ALARM, £6.78.
BOIL MOISTURE UNIT, £5.81.
ICE ALARM, £7.89.
0-12V POWER SUPPLY, Sept. 81, £17.98
CMOB CAR SECURITY ALARM, Sept. 81, £9.68
CMOS DIE, Sept. 81, £7.99
CMOB METRONOME, Aug. 81, £8.23.
COMBINATION LOCK, July 81, Less case, £19.58.
BURGLAR ALARM SYSTEM, June 81 less bell, loop & Mic's, £40.98.
LIGHTS REMINDER AND IGNITION LOCATOR E.E., May 81, £5.66
SOIL MOISTURE INDICATOR E.E., May 81, £4.09.
GUITAR HEADPHONE AMPLIFIER E.E., May 81, £4.23.
PHONE BELL, REPEATER / BABY ALARM E.E., May 81, £5.66.

- INTERCOM, April 81, £22.23.
SIMPLE TRANSISTOR & DIODE TESTERS, Mar. 81, Ohm meter version £2.02, Led version £2.73
MINI SIREN, Mar. 81, £8.04.
LED DICE, Mar. 81, £8.44.
LED FLASHER, Mar. 81, £4.29.
MODULATED TONE DOORBELL, Mar. 81, £6.64.
POWER SUPPLY Mar. 81, £53.47.
THREE CHANNEL STEREO MIXER, Feb. 81, £18.69.
SIGNAL TRACER, Feb. 81, £8.17 less probe.
Ni-Cd BATTERY CHARGER, Feb. 81, £13.61.
ULTRASONIC INTRUDER DETECTOR, Jan. 81 less case, £53.47.
2 NOTE DOOR CHIME, Dec. 80, £10.32.
LIVE WIRE GAME, Dec. 80, £11.70.
GUITAR PRACTICE AMPLIFIER, Nov. 80, £12.82 less case, Standard case £3.88, High quality case £8.33.
SOUND TO LIGHT, Nov. 80, 3 channel, £21.34.
TRANSISTOR TESTER, Nov. 80, £11.65 inc. test leads.
AUDIO EFFECTS UNIT FOR WEIRD SOUNDS, Oct. 80, £13.11.
BICYCLE ALARM, Oct. 80, £10.35 less mounting brackets.
IRON HEAT CONTROL, Oct. 80, £5.85.
TTL LOGIC PROBE, Sept. 80, £5.18.
ZENER DIODE TESTER, June 80, £8.66.
4 STATION RADIO, May 80, £16.29 less case.
LIGHTS WARNING SYSTEM, May 80, £4.88.
BATTERY VOLTAGE MONITOR, May 80, £11.56.
CABLE & PIPE LOCATOR, Mar. 80, £4.11 less coil former.
KITCHEN TIMER, Mar. 80, £14.85.
STEREO HEADPHONE AMPLIFIER, Mar. 80, £18.15.
MICRO MUSIC BOX, Feb. 80, £16.26. Grey Case £3.99 extra.
SIMPLE SHORT WAVE RECEIVER, Feb. 80, £25.86. Headphones £2.86.
SLIDE/TAPE SYNCHRONISER, Feb. 80, £12.30.
MORSE PRACTICE OSCILLATOR, Feb. 80, £4.62.
SPRING LINE REVERB. UNIT, Jan. 80, £25.86.
UNIBOARD BURGLAR ALARM, Dec. 79, £8.03.
BABY ALARM, Nov. 79, £9.60.
CHASER LIGHTS, Sept. 79, £23.40.
SIMPLE TRANSISTOR TESTER, Sept. 79, £7.30.
DARKROOM TIMER, July 79, £2.89.
ELECTRONIC CANARY, June 79, £5.88.
MICROCHIME DOORBELL, Feb. 79, £15.85.
THYRISTOR TESTER, Feb. 79, £3.78.
FUSE CHECKER, Oct. 78, £2.31.
SOUND TO LIGHT, Sept. 78, £8.42.
CAR BATTERY STATE INDICATOR, Sept. 78, Less case, £2.09.
R.F. SIGNAL GENERATOR, Sept. 78, £26.72.
IN SITU TRANSISTOR TESTER, June 78, £6.77.
WEIRD SOUND EFFECTS GENERATOR, Mar. 78, £5.59.
AUDIO VISUAL METRONOME, Jan. 78, £5.98.
ELECTRONIC TOUCH SWITCH, Jan. 78, £2.73 less case.
RAPID DIODE CHECK, Jan. 78, £2.74.
PHONE/DOORBELL REPEATER, July 77, £7.46.
ELECTRONIC DICE, Mar. 77, £5.68.

SOLDERING/TOOLS

- ANTEX X5 SOLDERING IRON 25W £5.48
SOLDERING IRON STAND £1.98
SPARE BITS, Small, standard, large, 65p each. For X5 + X25
SOLDER, Handy size 99p
SOLDER CARTON £1.84
DESOLDER BRAID 69p
HEAT SINK TWEEZERS 29p
DESOLDER PUMP £6.48
HOW TO SOLDER LEAFLET 12p
LOW COST CUTTERS £1.69
LOW COST LONG NOSE PLIERS £1.68
WIRE STRIPPERS & CUTTERS £2.69
PRECISION PETITE 12V P.C.B. Drill £11.67
Drill Stand £7.98
Grinding stone 50p
Grinding wheel 50p
Saw blade 85p. Brass wire brush 50p. Burr 50p.
VERO SPOT FACE CUTTER £1.49
PIN INSERTION TOOL £1.98
VEROPINS (pk of 100) 0.1" 52p
MULTIMETER TYPE 1 (1,000 opv) £5.48
SET, 10 leads with 20 clips 99p
RESISTOR COLOUR CODE CALCULATOR 21p
CONNECTING WIRE PACK TYPE ED, 11 colours 49p



MULTIMETER TYPE 2. (YN360TR) 20K o.p.v. with transistor tester £14.75

- ILLUMINATED MAGNIFIERS
Small 2" dia. (5x mag.) £1.14
Large 3" dia. (4x mag.) £2.40
CAST IRON VICE £2.98
SCREWDRIVER SET £1.98
POCKET TOOL SET £3.98
DENTISTS INSPECTION MIRROR £2.85
JEWELLERS EYEGLASS £1.50
PLASTIC TWEEZERS 69p
PAIR OF PROBES WITH LEADS (cc) 77p



HELPING HANDS JIG E630
Heavy base. Six ball and socket joints allow infinite variation of clips through 360°. Has 2 1/2" diameter (2.5 magnifier attached), used and recommended by our staff.
Speakers min 8ohm 64ohm 89p
Crystal earpiece 65p

- Mono headphones £2.98
Telephone pick up coil 72p
Min. buzzers 6V 50p
12V 65p
Magnetic earpiece 15p
Stereo headphones £4.35
Euro breadboard £6.40
S. Dec. breadboard £3.98
Bimboard breadboard £6.98
Verobloc breadboard £4.20

TEACH-IN 82

All top quality components as specified by E.E. FREE COMPONENT IDENTIFICATION SHEET. Follow this educational series and learn about electronics.
List 1 & 2 £27.98. List 3 £5.98.
ALL 3 TOGETHER £33.48.
WOODEN CASE KIT £11.98.

INTRODUCING ELECTRONICS

INTRODUCING ELECTRONICS 6 part series E.E. Oct. 82-Mar. 83. No soldering. Connections via screw terminal blocks. Very clear drawings showing how to connect components. Covers the basis of electronics. Components (less batteries) parts 1-6 £6.98. Reprints 45p each extra.

BOOKS

- SEMICONDUCTOR DATA BOOK Nov. 82 £5.90
ELECTRONIC PROJECTS FOR HOME SECURITY £3.35
ELECT. PROJECTS IN PHOTOGRAPHY £3.35
110 ELECT. ALARM PROJECTS £5.35
MODEL RAILWAY PROJECTS £1.95
BASIC ELECTRONICS. Theory and practice £7.98
BEGINNERS GUIDE TO BUILDING ELECT. PROJECTS £1.50

ADVENTURES WITH MICROELECTRONICS

Similar to 'Electronics' below. Uses I.C.s. Includes dice, electronic organ, doorbell, reaction timer, radio etc. Based on Bimboard 1 bread board. Adventures with Microelectronics £2.98
Component pack £29.64 less battery.

ADVENTURES WITH ELECTRONICS

by Tom Duncan

An easy to follow book suitable for all ages. Ideal for beginners. No soldering, uses an S-Dec breadboard. Gives clear instructions with lots of pictures. 16 projects—including three radios, siren, metronome, organ, intercom, timer, etc. Helps you learn about electronic components and how circuits work. Component pack includes an S-Dec breadboard and all the components for the projects.
Adventures with Electronics £2.85. Component pack £18.98 less battery.

MAGENTA gives you FAST DELIVERY OF QUALITY COMPONENTS & KITS. All products are stock lines and are new & full specification. We give personal service & quality products to all our customers—HAVE YOU TRIED US?

MAGENTA ELECTRONICS LTD.

EL51, 135 HUNTER ST. BURTON-ON-TRENT, STAFFS.
DE14 2ST. 0283 65435. MON.-FRI. 9-5. MAIL ORDER ONLY.
ADD 45p P. & P. TO ALL ORDERS. PRICES INC. VAT



Normal despatch by return of post. OFFICIAL ORDERS WELCOME. OVERSEAS: Payment must be in sterling. IRISH REPUBLIC and BFPO. UK PRICES. EUROPE: UK PRICES plus 10%. ELSEWHERE: Write for quote.

MORE KITS AND COMPONENTS IN OUR LISTS

FREE PRICE LIST
Price list included with orders or send see (9 x 4) CONTAINS LOTS MORE KITS, PCBs & COMPONENTS

ELECTRONICS CATALOGUE

Illustrations, product descriptions, circuits all included. Up-to-date price list enclosed. All products are stock lines for fast delivery. Send 80p in stamps or add 80p to order.

MORE E.E. KITS PLUS H.E. and E.T. PROJECT KITS IN THE PRICE LIST.

NEW

30 SOLDERLESS BREADBOARD PROJECTS

NEW

Book 1 by R. A. Penfold
Clear verobloc layouts and circuit diagrams. Includes fuzz box, radio, metronomes, timers, transistor checker, switches etc.
Introduction gives basic information on components including resistors, capacitors, I.C.s, transistors, photocells etc. Ideal for beginners as well as those with some experience.
Complete kit including verobloc, book and components (less batteries) £24.75
Less book £22.50. less verobloc £20.25. Book only £2.25.

CALL IN AND SEE FOR YOURSELF

AUDIO ELECTRONICS

ALL PRICES INCLUDE VAT

TEST EQUIPMENT CENTRES ALL MODELS ON DISPLAY OPEN SIX DAYS A WEEK

RETAIL • MAIL ORDER • EXPORT • INDUSTRIAL • EDUCATIONAL

DIGITAL MULTIMETERS (UK C/P Free)



ALL MODELS 3 1/2 DIGIT UNLESS STATED



HAND HELD ■ With free carry case
K025C 13 range 0.2A DC 2 meg ohm £24.95
K030S 16 range 10A DC 2 meg ohm £29.95
K030C 26 range 1A AC/DC 20 meg ohm £34.95
K055C 28 range 10A AC/DC 20 meg ohm £39.95
6010+ 28 range 10A AC/DC 20 meg ohm £34.40
7030+ As 6010 but 0.1% basic £41.30
K0615M 6 range 10A DC 2 meg plus Hfe tester £39.95
1B9M 30 range 10A AC/DC 20 meg plus Hfe tester £69.95
HAND HELD AUTO RANGE
DM2350 21 range 10A AC/DC 20 meg ohm (Miniature) £49.95
H030 16 range 0.2A AC/DC 2 meg ohm £41.95
H030/B As above plus cont. buzzer £44.50
H031 22 range 10A AC/DC 2 meg ohms plus cont. buzzer £58.95
 +Optional carry case £2.95

BENCH MODELS
TM353 27 range LCO 2A AC/DC £86.25
TM355 29 range LEO 10A AC/DC £86.25
TM351+ 29 range LCO 10A AC/DC £113.85
2001 28 range LCO 10A AC/DC plus 5 range Cap. Meter with case £108.00
TM451 4 1/2 digit LCO every facility [0.02%] £171.00
1503a 4 1/2 digit LCO every facility [0.05%] £171.00
 1503Ha 0.03% basic version of above £189.00
 *Optional carry case £6.84

BECKMAN HAND HELD
T100 34 range 10A AC/DC 20 meg ohm £56.35
T110 As above plus Cont. test etc. £67.85

FREQUENCY COUNTERS

PFM200A 200 MHz hand held pocket 8 digit LEO £67.50
8110A 8 digit LEO bench 2 ranges 100 MHz £77.00
8610B 9 digit LEO bench 2 ranges 600 MHz £113.85
8000B 9 digit LEO 3 ranges 1 GHz £178.00
TF040 8 digit LCO 40 MHz £126.50
TF200 8 digit LCO 200 MHz £166.75
 +Optional carry case £6.84
Prescalers - Extended range of most counters
TP600 600 MHz £43.00
TP1000 1 GHz £74.00

SIGNAL GENERATORS (220/240v AC)

FUNCTION: All sine/square/triangle/TTL etc
TG100 1 Hz - 100 KHz £90.00
TG102 0.2 Hz - 2 MHz £166.75
PULSE
TG105 Various facilities 5 Hz - 5 MHz £97.75
AUDIO: Multiband Sine/Square
LAG27 10 Hz to 1 MHz £90.85
AG202A 20 Hz to 200 KHz (List £94.50) £83.50
RF
SG402 100 KHz to 30 MHz (List £79.50) £69.50
LSG17 100 KHz to 150 MHz £79.35

ELECTRONIC INSULATION TESTER

YF 501 500 V/0-100m with carry case £63.00

MULTIMETERS (UK C/P 65p)

KRT 100 1K/V 12 range pocket £5.95
HM102Z 20 K/V 22 range & cont buzzer £14.95
ETC5000/5001 21 ranges 50K/V. Range doubler. 10A DC £18.95
TMK500 23 ranges 30K/V. 12A DC plus cont. buzzer £24.75
NM56R 20K/V. 22 range pocket £10.95
ETU 102 14 range 2K/V pocket £6.50
830A 26 range 30K/V. 10A AC/DC overload protection, etc. £23.95
360TR 23 range 100K/V. Large scale 10A AC/DC plus Hfe £39.95
AT1020 18 range 20K/V. Deluxe plus Hfe tester £18.95
YN 360TR 19 range 20K/V plus Hfe tester £15.95

AUDIO • RF • FUNCTION • PULSE OSCILLOSCOPES

Full specification any model on request. SAE by post
HM Series HAMEG: SC THANDAR: CS TRIO: 3' CROTECH DT' Salfgan
SINGLE TRACE UK C/P £3.00
3030 15 MHz 5mV. 95mm tube plus component tester C/P £3.00 £177.10
SC110A Miniature 10 MHz battery portable Post free £171.00
HM103 15 MHz 2mV 6 x 7 display plus component tester C/P £3.00 £181.70
 +Optional carry case £6.84 AC adaptor E6 69 Nicoids E12.50
DUAL TRACE (UK C/P £4.00)
DT 520 Dual 20 MHz £241.50
HM203/4 Dual 20 MHz plus component tester £287.50
CS1562A Dual 10 MHz (List £321.00) £269.50
3131 Dual 15 MHz - component tester £276.00
CS1566A Dual 20 MHz All facilities (List £401.35) £349.50
HM204 Dual 20 MHz plus component tester sweep delay £419.75
CS1820 Dual 20 MHz with extra facilities
OPTIONAL PROBE KITS (List £508.30) £485.00
X1 £7.95 **X11** £10.50 **X10** £9.45 **X100** £16.95

VARIABLE POWER SUPPLIES (UK C/P £1.00)

PP241 0/12/24V 0/1A £35.00
PP243 3 amp version £59.95
PS 1307S 8/15V 7 amp twin meter £24.95

DIGITAL THERMOMETER

TH301 LCO 50 C to +750 with thermocouple £68.43

AC CLAMP METER

ST300 0/300A 0/600 VAC. 0/1 Kohm 9 ranges With carry case (UK C/P 65p) £28.50

LOGIC PROBES

LP10 10 MHz £28.50
LDP076 50 MHz with carry case and accessories £71.30

HIGH VOLTAGE METER

Direct reading 0/40 KV 20K/Volt (UK C/P 65p) £23.00

DIGITAL CAPACITANCE METER

0.1 pF to 2000 mid LCO 8 ranges **DM6013** £52.75 (Carry case £2.95)

TRANSISTOR TESTER

Direct reading PNP, NPN, etc. **TC1** (UK C/P 65p) £21.95

FREE CATALOGUE! SEND LARGE SAE (UK 20p) ALL PRICES INCLUDE VAT

Order by Post with CHEQUES/ACCESS VISA or you can telephone your orders All orders despatched within 5 days unless advised

AUDIO ELECTRONICS

301 EDGWARE ROAD, LONDON W2 1BN. TEL: 01-724 3564
 ALSO AT HENRY'S RADIO, 404/406 EDGWARE ROAD, LONDON W2. TEL: 01-723 1008

TWO FABULOUS OFFERS FROM

ALCON

SUPER 20
 20kΩ/V a.c. & d.c.

A SUPER PROTECTED UNIVERSAL MULTIMETER

Undestructible, with automatic protection on all ranges but 10A.

ONLY £33.50

inc. VAT, P&P, complete with carrying case, leads and instructions.



This special offer is a wonderful opportunity to acquire an essential piece of test gear with a saving of nearly £20.00.

Accuracy: d.c. ranges and Ω 2% a.c. 3% (of f.s.d.)
39 ranges: d.c. V 100mV, 1.0V, 3.0V, 10V, 30V, 100V, 300V, 1000V.
 d.c. I 50μA, 100μA, 300μA, 1.0μA, 3mA, 10mA, 30mA, 100mA, 1A, 10A
 a.c. V 10V, 30V, 100V, 300V, 1000V.
 a.c. I 3mA, 10mA, 30mA, 100mA, 1.0A, 10A.
 Ω 0-5.0kΩ, 0-50kΩ, 0-500kΩ, 5MΩ, 50MΩ.
 dB from -10 to +61 in 5 ranges.

Dimensions: 105 x 130 x 40mm.

TESTER 50 39 ranges

50kΩ V a.c. and d.c.
 With protective diodes and quick-acting 1.25A fuse.

THE PROFESSIONAL SOLUTION TO GENERAL MEASUREMENT PROBLEMS

ONLY £36.30

incl. VAT, P&P, complete with carrying case, leads and instructions. Goods normally by return of post.

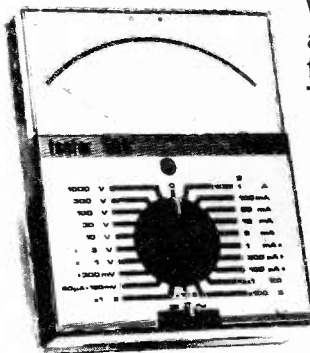

The best instrument for the workshop, school, toolbox, TV shop and anywhere accurate measurement is needed quickly and simply.

Accuracy: d.c. ranges and Ω 2% a.c. 3% (off.s.d.)
39 ranges: d.c. V 150mV, 1V, 3V, 10V, 30V, 100V, 300V, 1000V;
 d.c. I 20μA, 100μA, 300μA, 1.0mA, 3mA, 10mA, 30mA, 100mA, 1A, 3A.
 a.c. V 10V, 30V, 100V, 300V, 1000V;
 a.c. I 3mA, 10mA, 30mA, 100mA, 1A, 3A.
 Ohms 5kΩ, 50kΩ, 500kΩ, 5MΩ, 50MΩ.
 dB from -10 to +61 in 5 ranges.

Dimensions: 105 x 130 x 40mm.

For details of these and the many other instruments in the Alcon range, including multimeters, components measuring, automotive and electronic instruments, please write or telephone:

ALCON Instruments Ltd.

19 MULBERRY WALK LONDON SW3 6DZ TEL: 01-352 1897 TELEX: 918867

**HOBBY HERALD
HAS ALL THE
LATEST NEWS
FOR THE
ELECTRONICS
HOBBYIST**

When you need to update yourself with all that is available in the "Do-it-yourself" market, then you need the Hobby Herald.

Packed with product information essential to the electronics enthusiast, this new electronics catalogue lists over 60 exciting products ranging from All Purpose Cutters to Verobloc, the solderless breadboard. All products are available throughout the U.K. from over 200 stockists.

**HOBBY
HERALD**

Alternatively ordering products through the Herald is simplicity itself, and you can pay by either cheque, Barclaycard or Access. So make sure you get your copy of Hobby Herald by ringing

(04215) 62829.



BICC-Vero Electronics Ltd.,
Industrial Estate,
Chandlers Ford, Hampshire,
SO5 3ZR.



METERS: 110 x 82 x 35mm
30 μ A, 50 μ A, 100 μ A. **£6.75.** Post 50p.

METERS: 45 x 50 x 34mm
50 μ A, 100 μ A, 1mA, 5mA, 10mA, 25v, 1A, 2A, 5A 25V. **£3.54.** Post 30p.

METERS: 60 x 47 x 33mm
50 μ A, 100 μ A, 1mA, 5mA, 10mA, 100mA, 1A, 2A, 25v, 50v, 50-0-50 μ A, 100-0-100 μ A. **£5.87.**
VU meters **£5.87.**
Post on above meters 30p.

Silicone grease 50g £1.32.
Post 16p.

NI-CAD BATTERY CHARGER

Led indicators charge-test switch. For PP3, HP7, HP11 & HP2 size betteries.
Price **£5.85.** Post 94p.

MULTI-METER 7N 360TR
20,000 ohm/volt
DC Volts: 0.1, 0.5, 2.5, 10-150-250-1,000v.
AC Volts: 10-50, 250-1,000
RESISTANCE RANGES X1, X10, X1K, X10K
£15.20
P.&P. 94p.



TRANSFORMERS 240v Primary

3-0-3v	100mA	82p
6-0-6v	100mA	87p
6-0-6v	250mA	£1.21
12-0-12v	50mA	87p
12-0-12v	100mA	97p
9-0-9v	75mA	87p
9-0-9v	250mA	£1.33
Post on above transformers 48p.		
9-0-9v	1A	£2.00
12-0-12v	1A	£2.50
15-0-15c	1A	£2.95
6.3v	1½A	£2.00
6-0-6v	1½A	£2.20

Post on above transformers 94p.

All above prices include V.A.T. Send 80p for fully illustrated catalogue with 1983 price list. S.A.E. with all enquiries. Special prices for quantity quoted on request. For a new price list only send large s.a.e.

All goods despatched within 3 days from receipt of the order.

M. DZIUBAS

**158 Bradshawgate, Bolton,
Lancs. BL2 1BA.**

WHY USE STRIPBOARD?

Make your own PCB. It's easy:

"GET YOU STARTED" KIT

12V Mini Drill (takes ½A),
1mm Bit.
25 sq ins Copper Clad.
PCB Etchant for ½ ltr.
Tweezers and Dish.
Fine Etch Resist Pen.
Instructions. Only **£6.00.**
"SUPER" KIT. As above with: 3 Pens, Fine-Medium-Thick.
75 sq ins Copper Clad.
3 Sheet Transfers - Etch Resist.
Only **£8.50.**

SIMPLE PCB DRILL.

12V Motor with chuck attached with 3 collets 0.8 to 2.0mm **£4.50.**

PCB ETCHANT

Double strength to make ½ ltr solution. **£0.90.**

ETCH RESIST PENS

Set of 3, Fine-Medium-Thick **£1.80.**

Cheques & P.O.'s payable to POPS Components. Callers welcome to our new shop extension. Five times the size.

RESISTOR FILE

Std E12 VALUES ¼w CARBON FILM 10 Ω to 10M Ω

73 PRINTED ENVELOPES EACH CONTAINING 10 FULL SPEC, 5% RESISTORS COVERING THE E12 SERIES FROM 10 Ω TO 10M Ω IN A SMART FLIP-TOP FILE FOR YOUR WORK BENCH **£8.50**

CHEQUES & P.O.'s
PAYABLE TO: POPS
COMPONENTS.
PRICES ARE INCLUSIVE
BUT ADD 60p P&P TO
EACH ORDER

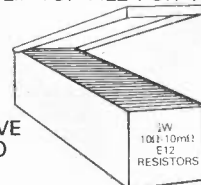

SUPER FILE. AS ABOVE BUT WITH 100 RESISTORS IN EACH ENVELOPE £55.00

REFILL ENVELOPES CONTAINING 10x¼w RESISTORS ANY E12 VALUE FROM 10 Ω TO 10MEG Ω 15p EACH CONTAINING 100x¼ RESISTORS ANY E12 £1.20 EACH

Please allow 28 Days Delivery

POPS COMPONENTS
CALLERS WELCOME @

38/40 LOWER ADDISCOMBE RD,
CROYDON, SURREY CR0 6AA
TEL: 688 2950

Step-by-step fully illustrated assembly and fitting instructions are included together with circuit descriptions. Highest quality components are used throughout.

Sparkrite

BRANDEADING ELECTRONICS
NOW AVAILABLE IN KIT FORM

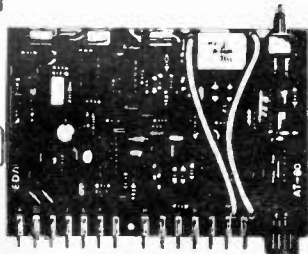
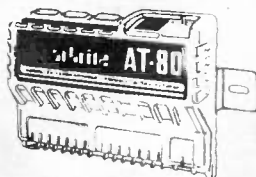

AT-80 Electronic Car Security System

- Arms doors, boot, bonnet and has security loop to protect fog/spot lamps, radio/tape, CB equipment
- Programmable personal code entry system
- Armed and disarmed from outside vehicle using a special magnetic key fob against a windscreen sensor pad adhered to the inside of the screen
- Fits all 12V neg earth vehicles
- Over 250 components to assemble

VOYAGER Car Drive Computer

- A most sophisticated accessory
- Utilises a single chip mask programmed microprocessor incorporating a unique programme designed by EDA Sparkrite Ltd
- Affords 12 functions centred on Fuel, Speed, Distance and Time
- Visual and Audible alarms warning of Excess Speed, Frost/Ice, Lights-left-on
- Facility to operate LOG and TRIP functions independently or synchronously
- Large 10mm high 400ft-L fluorescent display with auto intensity
- Unique speed and fuel transducers giving a programmed accuracy of + or - 1%
- Large LOG & TRIP memories 2,000 miles 180 gallons 100 hours
- Full Imperial and Metric calibrations
- Over 300 components to assemble
- A real challenge for the electronics enthusiasts!

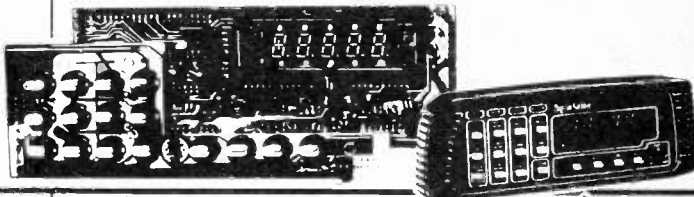

SX1000 Electronic Ignition

- Inductive Discharge
- Extended coil energy storage circuit
- Contact breaker driven
- Three position changeover switch
- Over 65 components to assemble
- Patented clip-to-coil fitting
- Fits all 12v neg. earth vehicles

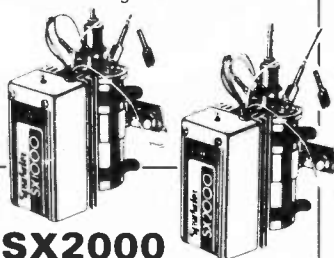

TX1002 Electronic Ignition

- Contactless or contact triggered
- Extended coil energy storage circuit
- Inductive Discharge
- Three position changeover switch
- Distributor triggerhead adaptors included
- Die cast weatherproof case
- Clip-to-coil or remote mounting facility
- Fits majority of 4 & 6 cyl. 12V. neg. earth vehicles
- Over 145 components to assemble.



SX2000 Electronic Ignition

- The brandleading system on the market today
- Unique Reactive Discharge
- Combined Inductive and Capacitive Discharge
- Contact breaker driven
- Three position changeover switch
- Over 130 components to assemble
- Patented clip-to-coil fitting
- Fits all 12v neg. earth vehicles

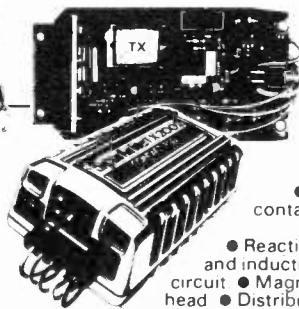
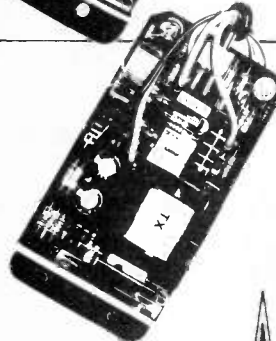

TX2002 Electronic Ignition

- The ultimate system
- Switchable contactless
- Three position switch with Auxiliary back-up inductive circuit
- Reactive Discharge
- Combined capacitive and inductive
- Extended coil energy storage circuit
- Magnetic contactless distributor triggerhead
- Distributor triggerhead adaptors included
- Can also be triggered by existing contact breakers
- Die cast waterproof case with clip-to-coil fitting
- Fits majority of 4 and 6 cylinder 12v neg. earth vehicles
- Over 150 components to assemble

All SPARKRITE products and designs are fully covered by one or more World Patents

SPECIAL OFFER
"FREE" MAGIDICE KIT WITH ALL ORDERS OVER £45.00

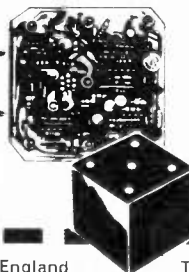

MAGIDICE Electronic Dice

- Not an auto-tem but great fun for the family
- Total random selection
- Triggered by waving of hand over dice
- Bleeps and flashes during a 4 second tumble sequence
- Throw displayed for 10 seconds
- Auto display of last throw 1 second in 5
- Muting and Off switch on base
- Hours of continuous use from PP7 battery
- Over 100 components to assemble

Sparkrite, 82 Bath Street, Walsall, West Midlands

SPARKRITE 82 Bath Street, Walsall, West Midlands, WS1 3DE England

Tel: (0922) 614791 Allow 28 days for delivery

NAME _____ EE/5/82
ADDRESS _____

I ENCLOSE CHEQUE(S)/POSTAL ORDERS FOR

£ _____ KIT REF _____

CHEQUE NO _____

	SELF ASSEMBLY KIT
SX 1000	£12.95
SX 2000	£19.95
TX 1002	£22.95
TX 2002	£32.95
AT 80	£32.95
VOYAGER	£64.95
MAGIDICE	£9.95

PRICES INC VAT POSTAGE & PACKING

PHONE YOUR ORDER WITH
SEND ONLY SAE IF BROCHURE IS REQUIRED



BRANDEADING BRITISH ELECTRONICS
CUT OUT THE COUPON NOW!



ROBOTICS FANS LOOK

ONLY
£4.95

"BIG TRAK" MOTORIZED GEARBOX

These units are as used in the "Big Trak" computerized vehicle, and offer the experimenter in robotics the opportunity to purchase the electro-mechanical parts required in building remote controlled vehicles. The unit comprises:
(a) 2 x 3V motors, linked by a magnetic clutch, thus enabling turning of the vehicle;
(b) A gearbox contained within the black ABS housing reducing the final drive speed to approx. 50rpm.

Data is supplied with the unit showing various options on driving the motors, as well as a direction controller circuit, enabling the unit to turn right, left or go straight ahead.

2N3055 SCOOP!!

Made by Texas - full spec devices 60p each; 10 for £4; 25 for £9; 100 for £34; 250 for £75; 1000 for £265.

"COMPUTER BATTLESHIPS"

Probably one of the most popular electronic games on the market. Unfortunately the design makes it impractical to test the PCB as a working model, although it may well function perfectly. Instead we have tested the sound chip, and sell the board for its component value only (PCB may be chipped or cracked). SN76477 sound IC; TMS1000 u-processor; batt clips, R's, C's, etc. Size 160 x 140mm. Only £1.50. Instruction book and circuit 30p extra.

SIMON GAME

...is back again. Another supply of ready built PCB's for this flashing light/pulsating tone computerised game is now with us. Supplied tested and working with speaker & instructions. £4.95.

REED RELAYS

Manufacturers rejects - DIL and other PCB mounting types. SP, DP and 4P - make, break & c/o contacts. Not tested, may be only partially working or o/c etc, so very low price - pack of 10 assorted £1; 25 £2.00; 100 £7.00.



**NOW
REDUCED
TO £ 3.95**

ELECTRO-DIAL

Electrical combination lock for maximum security - pick proof. 1 million combinations!! Dial is turned to the right to one number, left to a second number, then right again to a third number. Only when this has been completed in the correct sequence will the electrical contacts close. These can be used to operate a relay or solenoid. Overall dia 65mm x 60mm deep. Only £3.95.

STABILIZED PSU PANEL

A199 A versatile stabilized power supply with both voltage (0-30V) and current (20mA-2A) fully variable. Many uses inc. bench PSU. Ni-cad charger, gen. purpose testing Panel ready built, tested and calibrated. £7.75. Suitable transformer and pots, £6.00. Full data supplied.

IN4006 DIODES

Special purchase of 1A rects, Russian made. Packed in boxes of 300, £8.50 per box; 4 boxes £30; 10 boxes £75.

GOODS NORMALLY DESPATCHED BY RETURN OF POST

GREENWELD

443D MILLBROOK ROAD, SOUTHAMPTON SO1 0HX
All prices include VAT - just add 50p post. Tel. (0703) 772501

TALK TO THE WHOLE WORLD

Study now for the RADIO AMATEUR'S EXAMINATION

We have had 40 years successful experience in training men and women for the G.P.O. Transmitting licence.



FREE R.A.E. brochure without obligation from:-

British National Radio & Electronics School
READING, BERKS. RG1 1BR

Name

Address

EE/6/517

BLOCK CAPS PLEASE

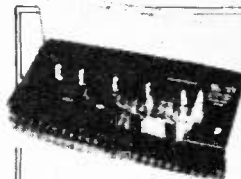

Universal Ni-CAD, battery charger. All plastic case with lift up lid. Charge/Test switch. LED indicators at each of the five charging points.

Charges:- PP3 (9V), U12 (1.5V penlite), U11 (1.5V "C"), U2 (1.5V "D"). Power:- 220-240V AC. Dims:- 210 x 100 x 50mm. Knock down price only while stocks last.

Only **£5.00**

Order No. MW 398

Multimeter & Transistor Tester

DC volts 0-1v-5v-2.5v 10v-50v-250v-1000v ±3%

AC volts 0-10v-50v-250v-1000v ±3%

DC current 0-50uA-2.5mA-25mA-0.25A ±3%

Resistance:

Minimum 0.2-2-200-200k ohms

Midscale 20-200-20k-200k ohms

Maximum 2k-20k-2m 20m ohms

As a transistor tester

Leakage current 0-150uA at Z1k range

0-15mA at X10 range

0-150mA at X1 range

PLEASE ADD 15% VAT & £1 P&P

Only **£11.95**

Order No

HT 320



**ENFIELD
ELECTRONICS**

Please allow 10 days delivery

208 BAKER ST. ENFIELD
MIDDX. Tel: 01-366 1873



SWITCH ON TO

JUNE 1983

NOW ON SALE 90p

TELEVISION

SERVICING-VIDEO-CONSTRUCTION-DEVELOPMENTS

If you have trouble understanding chopper circuits and protection arrangements, want to know about flywheel line sync, are deeply interested in all things from pattern generators to satellite TV receiving techniques—well, have we got the magazine for you!

What would you say to a unique specialist magazine which offers guidance to enthusiasts as well as electronics technicians on all aspects of TV and Video, including servicing, news and developments?...it's well worth a closer look...
*June project: In situ transistor SCR and diode tester—simple and inexpensive—uses i.e.d.s to indicate polarity and device condition.

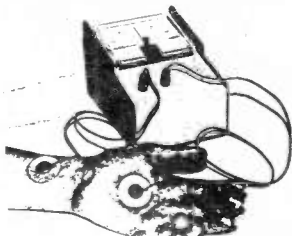

LIE DETECTOR

Not a toy, this precision instrument was originally part of an "Open University" course, used to measure the change in emotional balance, or as a lie detector. Full details of how to use it are given, and a circuit diagram. Supplied complete with probes, leads and conductive jelly. Needs 2 4V batts. Overall size 155 x 100 x 100mm. Only £9.95—worth that for the case and meter alone!!

AA NI-CADS — 10 for £9.95

Brand new nickel cadmium batteries by GE - standard 1.2V @ 450mA/H. Professional quality with solder tags both ends. Special price, £1.40 ea; 10 for £9.95; Box of 80 £65.
Ni-cad Charger: Charges up to 4 AA, C or D cells + PP3. Only £7.95

1000 RESISTORS £2.50

We've just purchased another 5 million pre-formed resistors, and can make a similar offer to that made two years ago, at the same price!! K523-1000 mixed 1 to 1W 5% carbon film resistors, pre-formed for PCB mntg. Enormous range of preferred values. 1000 for £2.50; 5000 £10; 20k £36.

BI-PAK

CATALOGUE

BI-PAKS NEW 1983 CATALOGUE IS OUT!

"IRRESISTABLE RESISTOR BARGAINS"

Pak No.	Qty*	Description	Price
SX10	400	Mixed "All Type" Resistors	£1
SX11	400	Pre-formed 1/4 watt Carbon Resistors	£1
SX12	200	1/4 watt Carbon Resistors	£1
SX13	200	1/4 watt Carbon Resistors	£1
SX14	150	1/2 watt Resistors 22 ohm 2m2 Mixed	£1
SX15	100	1 and 2 watt Resistors 22 ohm-2m2 Mixed	£1

Paks SX12-15 contain a range of Carbon Film Resistors of assorted values from 22 ohms to 2.2 meg. Save pounds on these resistor paks and have a full range to cover your projects.

*Quantities approximate, count by weight

"CAPABLE CAPACITOR PAKS"

Pak No.	Qty*	Description	Price
SX16	250	Capacitors Mixed Types	£1
SX17	200	Ceramic Capacitors Miniature Mixed	£1
SX18	100	Mixed Ceramics 1pf-56pf	£1
SX19	100	Mixed Ceramics 680pf-0.5mf	£1
SX20	100	Assorted Polyester/Polystyrene Capacitors	£1
SX21	60	Mixed C280 type capacitors metal foil	£1
SX22	100	Electrolytics, all sorts	£1
SX23	50	Quality Electrolytics 50-1000mf	£1
SX24	20	Tantalum Beads mixed	£1

*Quantities approximate, count by weight

BARGAINS

SX42	20 small 125 Red LED's	£1
SX43	10 Rectangular Green LED's 2	£1
SX46	30 Assorted Zener Diodes 250mw-2 watt mixed voltages all coded New	£1
SX47	4 Black Instrument Knobs—winged with pointer 1/4" Standard screw. Fit size 29 x 20mm	50p
SX49	20 Assorted Slider Knobs, Black/Chrome, etc.	£1
SX80	12 Neons and Filament Lamps. Low voltage and mains—various types and colours—some panel mounting	£1

SX52
6 Black Heatsink will fit TO 3 and TO 220 Ready drilled. Half price value. **£1**

SX53
1 Power Finned Heatsink. This heatsink gives the greatest possible heat dissipation in the smallest space owing to its unique staggered fin design—pre drilled TO 3 Size 45mm square, 20mm high. **40p**

SX54
10-66 size 35mm x 30mm x 12mm. **35p**

SX55
1 Heat Efficiency Power Finned Heatsink 90mm x 80mm x 30mm High. Drilled to take up to 4 x TO 3 devices. **£1.50 each**

SEMICONDUCTORS FROM AROUND THE WORLD

100 A Collection of Transistors, Diodes, Rectifiers, Bridges, SGR's, Triacs, IC's both Logic and Linear plus Opto's all of which are current everyday usable devices **100**

Guaranteed Value over £10 at Normal Retail Price

your's for only **£4.00** Data etc. in every pak. Order No. SX56



BI-PAK'S OPTO BARGAIN OF THE YEAR!

Valued at over £10—Normal Retail—we offer you a pack of 25 Opto devices to include LED's Large and Small in Red Green Yellow and Clear. 7 Segment Displays both Common Cathode and Common Anode PLUS bubble type displays—like DL 33. Photo Transistors—similar to OCP71 Photo Detectors—like MEL11-12. This whole pack of 25 devices will cost you just

25 £4.00 25

AND we guarantee your money back if you are not completely satisfied. FULL data etc. included. **Order No. SX57.**



TECASBOTY

The Electronic Components and Semiconductor Bargain of the Year. A host of Electronic components including potentiometers—rotary and slider, presets—horizontal and vertical Resistors of mixed values 22ohms to 2M2—1 to 2 Watt. A comprehensive range of capacitors including electrolytic and polyester types plus disc ceramics etcetera. Audio plugs and sockets of various types plus switches, fuses, heatsinks, wire, nuts, bolts, gromets, cable clips and ties, knobs and P.C. Board. Then add to that 100 Semiconductors to include transistors, diodes, SGR's opto's, all of which are current everyday usable devices in all a Fantastic Parcel. No rubbish all identifiable and valued in current catalogues as well.

over £25.00. Our Fight Against Inflation. Price—**JUST £6.50.** O/no SX85
—Beat the Budget
—Down with Depression



Send your orders to Dept EE6, BI-PAK PO BOX 6, WARE, HERTS. SHOP AT 3 BALDOCK ST, WARE, HERTS.



Use your credit card. Ring us on Ware 3182 NOW and get your order even faster. Goods normally sent 2nd Class Mail. Remember you must add VAT at 15% to your order. Total Postage add 75p per Total order.

Presented with a Professional Approach and Appeal to ALL who require Quality Electronic Components, Semiconductors and other Accessories ALL at realistic prices.

There are no wasted pages of useless information so often included in Catalogues published nowadays. Just solid facts i.e. price, description and individual features of what we have available. But remember, BI-PAK's policy has always been to sell quality components at competitive prices and THAT WE STILL DO.

We hold vast Stocks "in stock" for fast immediate delivery, all items in our Catalogue are available ex stock.

The Catalogue is designed for use with our 24 hours "ansaphone" service and the Visa/Access credit cards, which we accept over the telephone.

To receive your NEW 1983 BI-PAK Catalogue, send 75p PLUS 25p p&p to:-



BI-PAK (Catalogues) PO Box 6 WARE, Herts. SG12 9AD. Access & VISA accepted Ring 0920 3182 for immediate despatch

SOUND with SINCLAIR

MAKE AMAZING SOUND EFFECTS WITH YOUR ZX 81, TIMEX Sinclair 1000 or SPECTRUM

THE ZON X 81
£25.95
incl p&p & VAT



- The ZON SOUND UNIT is completely self-contained and especially designed for use with the ZX 81, TIMEX Sinclair 1000 and Spectrum Computers. It just plugs in—no dismantling or soldering.
- No power pack, batteries, leads or other extras.
- Manual Volume Control on panel—ample volume from built-in loud-speaker.
- Standard Sinclair—16K Rampack or printer can be plugged into ZON X Sound Unit without affecting normal computer operation.
- Huge range of possible sounds for Games, Music, Helicopters, Sci-Fi, Space Invaders, Explosions, Gun-shots, Drums, Planes, Lasers, Organs, Bells, Tunes, Chords, etc., or whatever you desire!
- 8 full octaves. Uses 3-Channel sound chip giving programme control of pitch, volume of tones and noise all with envelope control.
- Easily added to existing games or programmes using a few simple "BASIC" lines or machine code.
- No memory addresses used—10 mapped.

FULL instructions with many examples of how to obtain effects and the programmes, supplied. Fully guaranteed. British Made.

*Except with Spectrum, you need the Spectrum Extension Board Order No. SE1—PRICE £6.80 inc. VAT.

Payment may be made by Cheque, P.O. Giro No. 388 7006. Postal Order or Credit Card.

Export orders:- Bank Cheque, International Money Order, U.S. ★ or £ Sterling

BI-PAK Dept EE6 P.O. Box 6 63A, High Street, Ware, Herts. Access & VISA accepted Ring 0920 3182 for immediate despatch

The Big Event for '83

Sponsored by Everyday Electronics, Practical Electronics and Practical Wireless

The first Electronic Hobbies Fair in 1982 immediately established itself as the foremost consumer electronics exhibition-the biggest attendance and the largest number of exhibitors.

The 1983 Fair will build on the success and the experience of the first year. It will be 1983's largest and most influential

shop window for the whole range of electronic equipment and components for the electronics hobby enthusiast-constructural projects, home computers, amateur radio, video games, musical instruments and peripheral equipment-whether for the beginner, the specialist or the all-round enthusiast.

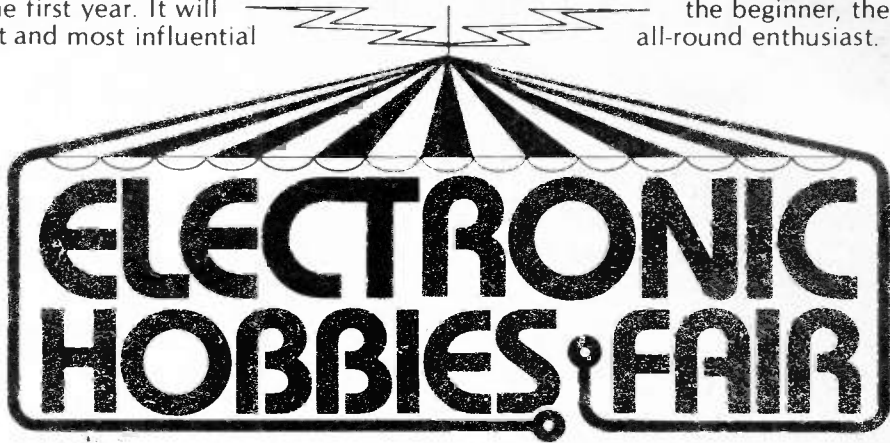

ELECTRONIC HOBBIES FAIR

Alexandra Palace, London - October 27-30, 1983

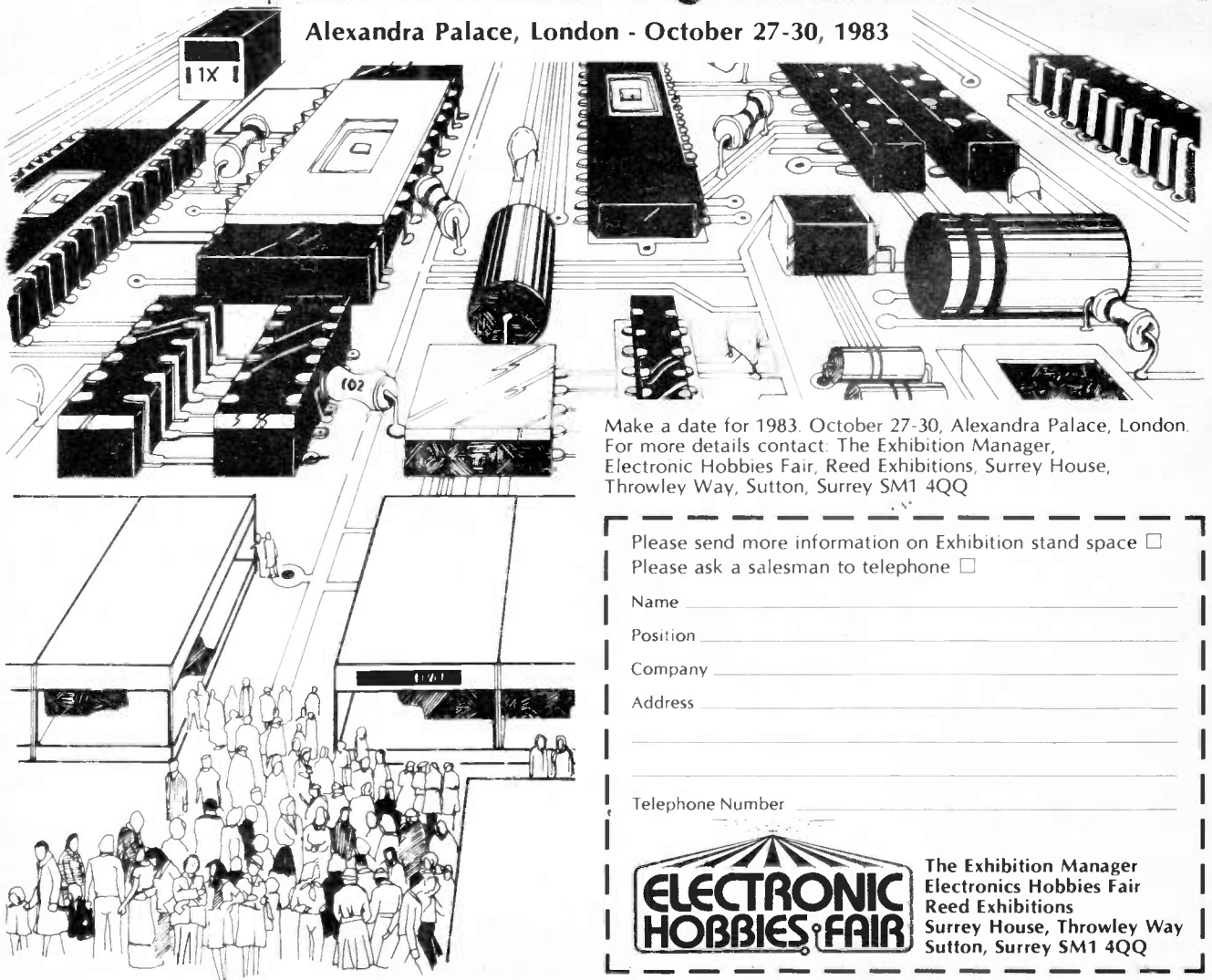

Make a date for 1983. October 27-30, Alexandra Palace, London. For more details contact: The Exhibition Manager, Electronic Hobbies Fair, Reed Exhibitions, Surrey House, Throwley Way, Sutton, Surrey SM1 4QQ

Please send more information on Exhibition stand space

Please ask a salesman to telephone

Name _____

Position _____

Company _____

Address _____

Telephone Number _____



ELECTRONIC HOBBIES FAIR

The Exhibition Manager
Electronics Hobbies Fair
Reed Exhibitions
Surrey House, Throwley Way
Sutton, Surrey SM1 4QQ

MASTER ELECTRONICS NOW!

The PRACTICAL way!

This new style course will enable anyone to have a real understanding of electronics by a modern, practical and visual method. No previous knowledge is required, no maths, and an absolute minimum of theory.

You learn the practical way in easy steps mastering all the essentials of your hobby or to start or further a career in electronics or as a self-employed servicing engineer.

All the training can be carried out in the comfort of your own home and at your own pace. A tutor is available to whom you can write personally at any time, for advice or help during your work. A Certificate is given at the end of every course.

You will do the following:

- Build a modern oscilloscope
- Recognise and handle current electronic components
- Read, draw and understand circuit diagrams
- Carry out 40 experiments on basic electronic circuits used in modern equipment
- Build and use digital electronic circuits and current solid state 'chips'
- Learn how to test and service every type of electronic device used in industry and commerce today. Servicing of radio, T.V., Hi-Fi and microprocessor/computer equipment.

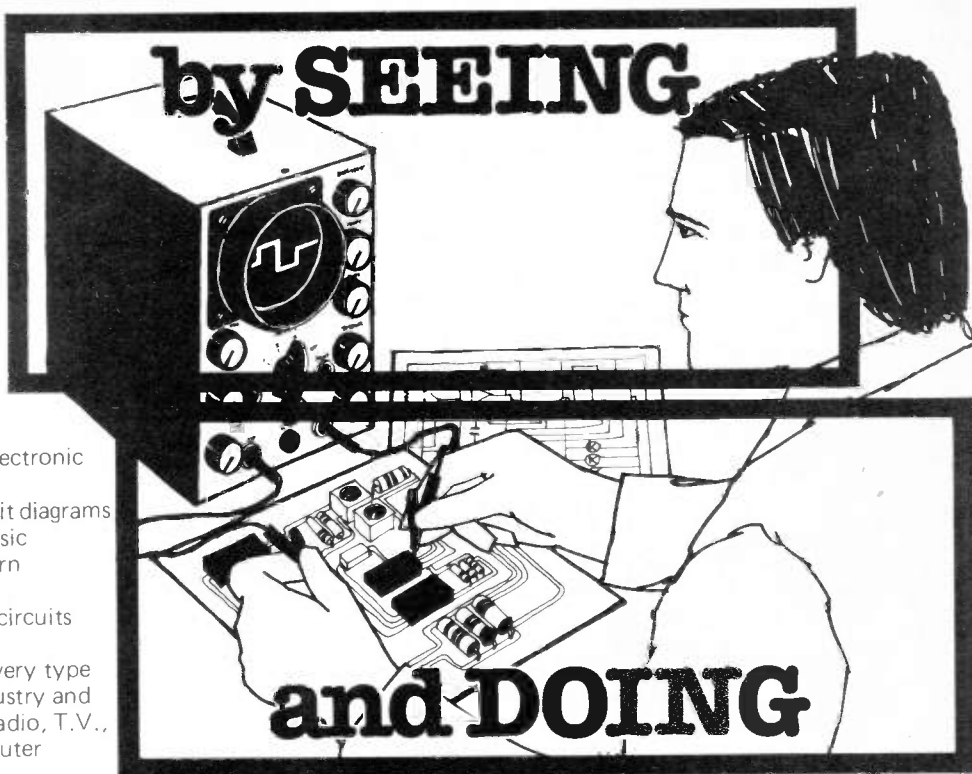

New Job? New Career? New Hobby? Get into **Electronics** Now!

FREE!

COLOUR BROCHURE



Please send your brochure without any obligation to

I am interested in:

NAME _____

- COURSE IN ELECTRONICS as described above
- RADIO AMATEUR LICENCE
- MICROPROCESSORS
- LOGIC COURSE

ADDRESS _____

OTHER SUBJECTS _____

POST NOW TO:

BLOCK CAPS PLEASE

EE/6/821

British National Radio & Electronics School Reading, Berks. RG1 1BR.

Receivers & Components

AERIAL BOOSTERS trebles incoming signal, price £7.00. SAE leaflets. **VELCO ELECTRONICS**, Ramsbottom, Lancashire BL0 9AG

BUMPER BOX OF BITS

WOW!!! We've got so many components in stock, we can't possibly list them all!!! - So buy a box, in it you'll find resistors, capacitors, displays, switches, panels with transistors, diodes, IC's etc, coils, pots ... and so on. All modern parts - guaranteed at least 1000 items, minimum weight 10lbs. ONLY £8.50 inc.

"JUST OUT! 40 page catalogue ONLY 50p."

ELECTRONICS WORLD

1d Dewes Road, Salisbury, Wilts, SP2 7SN
(Prop: Westbrough Ltd)

TURN YOUR SURPLUS capacitors, transistors etc., into cash. Contact Coles Harding & Co., 103 South Brink Wisbech, Cambs. 0945-584188. Immediate settlement.

NEW COMPONENTS DIL SOCKETS 8 pin 8p, 14/16 pin 9p, 1W Resistors 1p, 5mm LEDs Red 8p, yell/green 9p, Clips 2p, 400MW Zeners 7p, 1N4148 2p, 1N4001/2/3/4 4p, 1N4007 6p, BC109C 10p, 2N3055 40p, 555 16p, 741 15p, 4001B 10p, 4011B 10p, plus 30p post to: G. Stone, 22 Mailers Lane, Manuden, Bishop's Stortford, CM23 1DP.

PCB's

I AM PREPARED to manufacture PCB's for the hobbyist and enthusiast on a one off basis, from your own actual size artwork, at very attractive rates. Interested? Then send S.A.E. for details and prices.

ROBINSON PCB'S,

62 Moor Road,
Orrell, Wigan, Lancs WN5 8RR.

ELECTRONIC COMPONENTS MERSEYSIDE, Myca Electronics, 2 Victoria Place, Seasombe Ferry, Wallasey, L44 6NR. Mail order. Send 50p for price list refundable off first order. 051-638 8647.

Miscellaneous

BAFFLE YOUR FRIENDS with a Proximity Switch. Far more sensitive than Touch Switches, Triggers from a distance, no contact required. Switches mains at 480W. Can be used in many fun projects for the Hobbist. £9.95 + £1.50 p&p, make cheques & PO payable to: Tout and Castle Components, 17 Rowallan Close, Caversham Park, Reading, Berkshire (Prop. P. S. Castle).

THE SCIENTIFIC WIRE COMPANY

PO Box 30, London E.4. 01 531 1568

ENAMELLED COPPER WIRE

SWG	1 lb	8 oz	4 oz	2 oz
8 to 34	3.30	1.90	1.00	0.80
35 to 39	3.52	2.10	1.15	0.85
40 to 43	4.87	2.65	2.05	1.46
44 to 47	8.37	5.32	3.19	2.50
48 to 49	15.96	9.58	6.38	3.69

SILVER PLATED COPPER WIRE

14 to 30	7.09	4.20	2.43	1.72
----------	------	------	------	------

TINNED COPPER WIRE

14 to 30	3.97	2.41	1.39	0.94
----------	------	------	------	------

FLUXCORE
SOLDER 5.75 3.16 1.73 0.96
Prices include P & P vat. Orders under £2 add 20p. SAE for list of copper and resistance wire. Dealer enquiries welcome.

DIGITAL WATCH REPLACEMENT PARTS. Batteries, displays, backlights, etc. Also reports, publications, charts. SAE for full list. **PROFORDS**, Copners Drive, Holmer Green, Bucks HP15 6SGA.

LEARN ELECTRONICS WITHOUT SOLDER

Build electronic circuits without solder on a Roden S-Dec.

This has built-in contacts and holes into which you plug your components. Suitable for all ages. Can be used time after time. Ideal gift for students or experimenters. Full instructions and 2 circuit diagrams with each S-Dec.

Send cheque or P.O. to:

Roden Products, Dep EE
High March, Daventry,
Northants, NN11 4DE

£4.99 including p & p

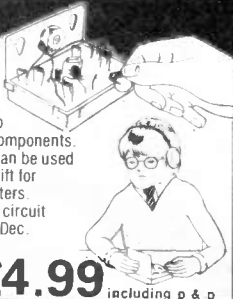

EVERYDAY ELECTRONICS and computer PROJECTS

Reach effectively and economically to-days enthusiasts anxious to know of your products and services through our semi-display and classified pages. Semi-display spaces may be booked at £7.24 per single column centimetre (minimum 2.5cm). The prepaid rate for classified advertisements is 31 pence per word (minimum 12 words), box number 60p extra. All cheques, postal orders, etc., to be made payable to

Service Sheets

ANY PUBLISHED, FULL-SIZE SERVICE SHEET by return £2 + LSAE. CTV/music centres £3. Repair data with all circuits, layouts, etc. your named TV or Video £8.50. Free 50p mag. All orders, queries—T.I.S. (E.E.), 76 Churches, Larkhall, Lanarkshire.

BELL'S TELEVISION SERVICE for service sheets on Radio, TV etc. £1.25 plus SAE. Colour TV Service Manuals on request. SAE with enquiries to BTS, 190 King's Rd., Harrogate, N. Yorkshire. Tel: 0423 55885.

Situations Vacant

Design Engineers

Satellite Communications

Major expansion of our Space Division has created numerous opportunities for engineers to be involved in some of the most technologically challenging work on meteorological and communications satellites.

Qualified Hardware and Software Design Engineers of various levels of experience are required for posts which vary from Engineering Manager/Group Leader to membership of a Design Team. Disciplines include:

Spacecraft Systems

Communications Systems

Microwave Systems and Equipment

Radar and Signal Processing

Electronic Circuit Design

Mechanical, Thermal and Dynamics Design

Power Supplies Switch-Mode

Salaries and benefits will reflect the importance we attach to the positions and relocation assistance is available if required.

Please write or telephone stating your qualifications, recent experience and area of interest to **Jack Burnie, Marconi Space & Defence Systems Limited, Browns Lane, The Airport, Portsmouth, Hants. Tel (0705) 674019 Ref: BL 34.**

(All posts are open to men and women)

Marconi
Space & Defence Systems



AT YOUR SERVICE

Everyday Electronics and Computer Projects and crossed "Lloyds Bank Ltd." Treasury notes should always be sent registered post. Advertisements, together with remittance, should be sent to the Classified Advertisement Department, Everyday Electronics and Computer Projects, Room 2612, IPC Magazines Limited, King's Reach Tower, Stamford St, London SE1 9LS. (Telephone 01-261 5942).

Security

ALARMS

FREE CATALOGUE!

OUR GREAT NEW ILLUSTRATED CATALOGUE IS PACKED WITH INFORMATION ON SUPERB QUALITY, PROFESSIONAL BURGLAR ALARM EQUIPMENT

AT UNBEATABLE PRICES!

SEND SAE OR PHONE NOW FOR YOUR COPY

A D ELECTRONICS
DEPT EE
217 WARBECK MOOR
AINTREE LIVERPOOL
19 OHU/051 523 8440

THIEFCHECK BURGLAR ALARM D-I-Y SYSTEM
MAIN DISTRIBUTOR

FREE CATALOGUE OF BURGLAR ALARM EQUIPMENT

TOP QUALITY D.I.Y. SYSTEMS AND PARTS AT TRADE PRICES

SEND S.A.E. OR PHONE:
**C-TEC SECURITY, Dept. EE,
60, MARKET ST, WIGAN
(0942) 42444**

BURGLAR ALARM EQUIPMENT. Free catalogue. C.W.A.S. Ltd., 0274-308920, showrooms open 9-5. Mon-Sat.

Courses

CONQUER THE CHIP—master modern electronics the practical way by seeing and doing in your own home. Write for your free colour brochure now to **BRITISH NATIONAL RADIO & ELECTRONICS SCHOOL**, Dept C3, Reading, Berks RG1 1BR.

ORDER FORM PLEASE WRITE IN BLOCK CAPITALS

Please insert the advertisement below in the next available issue of **Everyday Electronics** for Insertions. I enclose Cheque/P.O. for £.....
(Cheques and Postal Orders should be crossed Lloyds Bank Ltd. and made payable to Everyday Electronics)

NAME.....	EVERYDAY ELECTRONICS
ADDRESS.....	Classified Advertisement Dept., Room 2612, King's Reach Tower, Stamford Street, London SE1 9LS Telephone 01-261 5942
Rate:	31p per word, minimum 12 words. Box No. 60p extra.

Company registered in England. Registered No: 53626 Registered Office: King's Reach Tower, Stamford Street, London SE1 9LS

6/83

★ BAKER ★

GROUP P.A. DISCO AMPLIFIERS post £2

150 watt Output, 4 input Mixer illustrated	£99
150 watt Output, Slave 500 mv. Input	£80
150w+150w Stereo Slave 500 mv. Inputs	£125
150w P.A. Vocal, 8 inputs, High-Low Mixer	£129
100 watt Valve Model, 4 inputs	£125
60 watt Valve Model, 4 inputs	£59

DRILL SPEED CONTROLLER LIGHT DIMMER KIT
Easy to build kit. Control up to 800 watts AC mains with plastic case 4 x 3 x 1 1/2 in £5 less case £4.

STEREO PRE-AMP KIT. All parts to build this pre-amp, 3 inputs for high, medium or low gain per channel, with volume control and P.C. Board. Can be ganged to make multi-way stereo mixers £3.50. Post 65p.

SOUND TO LIGHT CONTROL KIT MK II

Complete kit of parts, printed circuit. Mains transformer, 3 channels. Up to 1,000 watts each. Will operate from 200MV to 100 watts signal. Suitable for home Hi-Fi or Disco. £19. Post £1.
OR COMPLETELY READY BUILT IN CABINET £27.

200 Watt Rear Reflecting White Light Bulbs. Ideal for Disco Lights. Edison Screw 75p each or 6 for £4 or 12 for £7.50. Post £1.50 per six.

MAINS TRANSFORMERS Primary 240V A.C.	Post
250-0-250V 80mA, 6.3V 3.5A 1A	£6.00 £2
350-0-350V 250A, 6.3V 6 Amp CT	£12.00 £2
220V 25ma 6V 1A £2, 220V 45ma 6V 2A	£4.00 £1
250V 60ma 6.3V 2A	£4.75 £1

General purpose tapped outputs voltages available:	
2 amps 3.4, 5.6, 8, 9, 10, 12, 15, 18, 25 and 30V	£6.00 £2
1 amp 6.8, 10, 12, 16, 18, 20, 24, 30, 36, 40, 48, 60	£6.00 £2
2 amp 6.8, 10, 12, 16, 18, 20, 24, 30, 36, 40, 48, 60	£10.50 £2
3 amp 6.8, 10, 12, 16, 18, 20, 24, 30, 36, 40, 48, 60	£12.50 £2
5 amp 6.8, 10, 12, 16, 18, 20, 24, 30, 36, 40, 48, 60	£16.00 £2
5-8-10-16V 1a	£3.00 £1
6V 1a	£2.00 £1
6-0-6V 1a	£3.50 £1
9V 250ma	£1.50 £1
9V 3a	£4.00 £1
9-0-9V 50ma	£1.50 £1
10-0-10V 2a	£4.00 £1
10-30-40 2a	£4.50 £1
12V 100ma	£1.50 £1
12V 750ma	£2.50 £1
12V 3a	£4.50 £1
12V 7a	£4.00 £1
TOROIDAL 30-0-30V 4 Amp +20-0-20V 4 Amp	£10.00 £2
CHARGER TRANSFORMERS RECTIFIERS	
6-12V 3a	£4.00 £2
6-12V 4a	£6.50 £2

LOUDSPEAKER BARGAINS. MANY OTHERS

4 ohm 6 x 4in, 7 x 4in £2.50, 8 x 5in 6in £3, 6in, 10in £7.50, 8in, £4.50, 10in, £5, 8 ohm, 2 1/2, 2 1/2in, £2, 3in, 5 x 3in, £2.50, 8in, £4.50, 10in, £5, 12in, £6, 16 ohm 3 1/2in, 6 x 4in, £2.50, 8in, £4.50, 10 x 6in, £4, 25 ohm, 3in, 35 ohm, 3in, £2.50, Many others in stock. Speaker Covering Material Samples 32p, Stamps.

R.C.S. LOW VOLTAGE STABILIZED POWER PACK KITS 90-100 mA Post 75p **£3.95**

All parts and instructions with Zener diode printed circuit, rectifiers and double wound mains transformer input 200-240 a.c. Output voltages available 6 or 7.5 or 9 or 12V d.c. up to 100mA. State voltage required.

PP BATTERY ELIMINATOR BRITISH MADE Post £1 **£5**
Mains Transformer Rectifier 9 volt 400mA. Stabilised, with overload cutout. Plastic case size 5 x 5 1/2 x 2 1/2 Suitable Radio/Cassettes. Fully Isolated and Smoothed.

THE "INSTANT" BULK TAPE ERASER Suitable for cassettes and all size of tape reels A.C. 200/240V (120V to order) **£9.50**

Ideal Computer Recorder Post £1
Tapes, Discs, Cassettes.
HEAD DEMAGNETISER PROBE £5.00

A.C. Electric Motors Post 95p
2 Pole, 240V, 0.2 Amp, Spindle-1 43 x 0.2 12in. £1.75, 2 Pole, 240V, 0.15 Amp Double spindle-1 75 x 0.16in. Each £1.7
2 Pole, 120V, 5 Amp Spindle-0 15 x 0.2 in. Two in series-240V, 50p each.
Brush Motor From a Food Mixer 240V, 3 Amp High Speed and Powerful Spindle-0 5 x 0.25in. £2.95. Good selection of B.S.R. Motors £4. Garrard Motors £5.

ALUMINIUM CHASSIS 18 s.w.g. Un-drilled, 4 sides, riveted corners: 6 x 4 x 2 1/2in. £1.75, 8 x 6 x 2 1/2in. £2.20, 10 x 7 x 2 1/2in. £2.75, 14 x 9 x 2 1/2in. £3.60, 16 x 6 x 2 1/2in. £2.50, 12 x 3 x 2 1/2in. £1.80, 12 x 8 x 2 1/2in. £3.70, 16 x 10 x 2 1/2in. £3.80.

ALL ANGLE BRACKET 6 x 3 x 4in 30p
ALUMINIUM PANELS 18 s.w.g. 12 x 12in. £1.80, 14 x 9in. £1.75, 6 x 4in. 55p, 12 x 8in. £1.30, 10 x 7in. 96p, 8 x 6in. 90p, 14 x 3in 72p, 12 x 5in. 90p, 16 x 10in. £2.10, 16 x 6in. £1.30 up.
ALUMINIUM BOXES, MANY OTHER SIZES IN STOCK. 4 x 2 1/2 x 2in. £1.00, 3 x 2 x 1in. 80p, 6 x 4 x 2in. £1.60, 8 x 6 x 3 in. £2.50, 12 x 5 x 3in. £2.75, 6 x 4 x 3in. £1.80, 10 x 7 x 3in. £3.

HIGH VOLTAGE ELECTROLYTICS	32 + 32/350V	50p
8/450V	45p	50/450V 95p
32/350V	45p	8+16/450V 75p
32/500V	95p	16+16/350V 75p

SINGLE PLAY Turntables Large 240 volt AC. Post £2

Make	Model	Drive	Cartridge	Price
BSR	P170	Rim	Ceramic	£20
BSR	P232	Rim	Ceramic	£24
GARRARD	6200	Rim	Ceramic	£22
HSR	P232	12 volt	Magnetic	£24

AUTOCHANGERS 240 VOLT				
BSR	Budget	Rim	Ceramic	£16
BSR	Deluxe	Rim	Ceramic	£18
HSR	C142	Rim	Magnetic	£26

RADIO COMPONENT SPECIALISTS

Dept 4, 337, WHITEHORSE ROAD, CROYDON SURREY, U.K. TEL: 01-684 1665

Post 65p Minimum. Callers Welcome.
Closed Wed. Same day despatch
Access-Barclay-Visa. Lists 32p

INTERNATIONAL

THE MOST COMPREHENSIVE RANGE OF COMPONENTS, KITS AND MODULES IN THE WORLD & THERE'S ONLY ROOM FOR A FRACTION HERE, GET THE CATALOGUE AND FIND THE REST. ALWAYS USE STOCK CODE WHEN ORDERING PLEASE.

4000 CMOS

Type	Stock No.	Price	Type	Stock No.	Price
4000B	21 0420 0.11	14C170	40152L	29 7920 1.55	
4001	21 0400 0.11	14C171	40153M	29 7920 1.55	
4002	21 0400 0.12	14C172	40154M	29 7920 1.55	
4003	21 0400 0.13	14C173	40155M	29 7920 1.55	
4008	21 0400 0.50	14C174	40156M	29 7920 1.55	
4010	21 0400 1.00	14C175	40157M	29 7920 1.55	
4011	21 0400 1.50	14C176	40158M	29 7920 1.55	
4012	21 0400 2.00	14C177	40159M	29 7920 1.55	
4013	21 0400 2.50	14C178	40160M	29 7920 1.55	
4014	21 0400 3.00	14C179	40161M	29 7920 1.55	
4015	21 0400 3.50	14C180	40162M	29 7920 1.55	
4016	21 0400 4.00	14C181	40163M	29 7920 1.55	
4017	21 0400 4.50	14C182	40164M	29 7920 1.55	
4018	21 0400 5.00	14C183	40165M	29 7920 1.55	
4019	21 0400 5.50	14C184	40166M	29 7920 1.55	
4020	21 0400 6.00	14C185	40167M	29 7920 1.55	
4021	21 0400 6.50	14C186	40168M	29 7920 1.55	
4022	21 0400 7.00	14C187	40169M	29 7920 1.55	
4023	21 0400 7.50	14C188	40170M	29 7920 1.55	
4024	21 0400 8.00	14C189	40171M	29 7920 1.55	
4025	21 0400 8.50	14C190	40172M	29 7920 1.55	
4026	21 0400 9.00	14C191	40173M	29 7920 1.55	
4027	21 0400 9.50	14C192	40174M	29 7920 1.55	
4028	21 0400 10.00	14C193	40175M	29 7920 1.55	
4029	21 0400 10.50	14C194	40176M	29 7920 1.55	
4030	21 0400 11.00	14C195	40177M	29 7920 1.55	
4031	21 0400 11.50	14C196	40178M	29 7920 1.55	
4032	21 0400 12.00	14C197	40179M	29 7920 1.55	
4033	21 0400 12.50	14C198	40180M	29 7920 1.55	
4034	21 0400 13.00	14C199	40181M	29 7920 1.55	
4035	21 0400 13.50	14C200	40182M	29 7920 1.55	
4036	21 0400 14.00	14C201	40183M	29 7920 1.55	
4037	21 0400 14.50	14C202	40184M	29 7920 1.55	
4038	21 0400 15.00	14C203	40185M	29 7920 1.55	
4039	21 0400 15.50	14C204	40186M	29 7920 1.55	
4040	21 0400 16.00	14C205	40187M	29 7920 1.55	
4041	21 0400 16.50	14C206	40188M	29 7920 1.55	
4042	21 0400 17.00	14C207	40189M	29 7920 1.55	
4043	21 0400 17.50	14C208	40190M	29 7920 1.55	
4044	21 0400 18.00	14C209	40191M	29 7920 1.55	
4045	21 0400 18.50	14C210	40192M	29 7920 1.55	
4046	21 0400 19.00	14C211	40193M	29 7920 1.55	
4047	21 0400 19.50	14C212	40194M	29 7920 1.55	
4048	21 0400 20.00	14C213	40195M	29 7920 1.55	
4049	21 0400 20.50	14C214	40196M	29 7920 1.55	
4050	21 0400 21.00	14C215	40197M	29 7920 1.55	
4051	21 0400 21.50	14C216	40198M	29 7920 1.55	
4052	21 0400 22.00	14C217	40199M	29 7920 1.55	
4053	21 0400 22.50	14C218	40200M	29 7920 1.55	
4054	21 0400 23.00	14C219	40201M	29 7920 1.55	
4055	21 0400 23.50	14C220	40202M	29 7920 1.55	
4056	21 0400 24.00	14C221	40203M	29 7920 1.55	
4057	21 0400 24.50	14C222	40204M	29 7920 1.55	
4058	21 0400 25.00	14C223	40205M	29 7920 1.55	
4059	21 0400 25.50	14C224	40206M	29 7920 1.55	
4060	21 0400 26.00	14C225	40207M	29 7920 1.55	
4061	21 0400 26.50	14C226	40208M	29 7920 1.55	
4062	21 0400 27.00	14C227	40209M	29 7920 1.55	
4063	21 0400 27.50	14C228	40210M	29 7920 1.55	
4064	21 0400 28.00	14C229	40211M	29 7920 1.55	
4065	21 0400 28.50	14C230	40212M	29 7920 1.55	
4066	21 0400 29.00	14C231	40213M	29 7920 1.55	
4067	21 0400 29.50	14C232	40214M	29 7920 1.55	
4068	21 0400 30.00	14C233	40215M	29 7920 1.55	
4069	21 0400 30.50	14C234	40216M	29 7920 1.55	
4070	21 0400 31.00	14C235	40217M	29 7920 1.55	
4071	21 0400 31.50	14C236	40218M	29 7920 1.55	
4072	21 0400 32.00	14C237	40219M	29 7920 1.55	
4073	21 0400 32.50	14C238	40220M	29 7920 1.55	
4074	21 0400 33.00	14C239	40221M	29 7920 1.55	
4075	21 0400 33.50	14C240	40222M	29 7920 1.55	
4076	21 0400 34.00	14C241	40223M	29 7920 1.55	
4077	21 0400 34.50	14C242	40224M	29 7920 1.55	
4078	21 0400 35.00	14C243	40225M	29 7920 1.55	
4079	21 0400 35.50	14C244	40226M	29 7920 1.55	
4080	21 0400 36.00	14C245	40227M	29 7920 1.55	
4081	21 0400 36.50	14C246	40228M	29 7920 1.55	
4082	21 0400 37.00	14C247	40229M	29 7920 1.55	
4083	21 0400 37.50	14C248	40230M	29 7920 1.55	
4084	21 0400 38.00	14C249	40231M	29 7920 1.55	
4085	21 0400 38.50	14C250	40232M	29 7920 1.55	
4086	21 0400 39.00	14C251	40233M	29 7920 1.55	
4087	21 0400 39.50	14C252	40234M	29 7920 1.55	
4088	21 0400 40.00	14C253	40235M	29 7920 1.55	
4089	21 0400 40.50	14C254	40236M	29 7920 1.55	
4090	21 0400 41.00	14C255	40237M	29 7920 1.55	
4091	21 0400 41.50	14C256	40238M	29 7920 1.55	
4092	21 0400 42.00	14C257	40239M	29 7920 1.55	
4093	21 0400 42.50	14C258	40240M	29 7920 1.55	
4094	21 0400 43.00	14C259	40241M	29 7920 1.55	
4095	21 0400 43.50	14C260	40242M	29 7920 1.55	
4096	21 0400 44.00	14C261	40243M	29 7920 1.55	
4097	21 0400 44.50	14C262	40244M	29 7920 1.55	
4098	21 0400 45.00	14C263	40245M	29 7920 1.55	
4099	21 0400 45.50	14C264	40246M	29 7920 1.55	
4100	21 0400 46.00	14C265	40247M	29 7920 1.55	

RF POWER

Type	Stock No.	Price	Type	Stock No.	Price
RF100A	58 0076 0.85	RF200A	58 0077 0.85	RF300A	58 0078 0.85
RF120A	58 0079 0.85	RF150A	58 0080 0.85	RF180A	58 0081 0.85
RF210A	58 0082 0.85	RF240A	58 0083 0.85	RF270A	58 0084 0.85
RF310A	58 0085 0.85	RF340A	58 0086 0.85	RF370A	58 0087 0.85
RF410A	58 0088 0.85	RF440A	58 0089 0.85	RF470A	58 0090 0.85
RF510A	58 0091 0.85	RF540A	58 0092 0.85	RF570A	58 0093 0.85
RF610A	58 0094 0.85	RF640A	58 0095 0.85	RF670A	58 0096 0.85
RF710A	58 0097 0.85	RF740A	58 0098 0.85	RF770A	58 0099 0.85
RF810A	58 0100 0.85	RF840A	58 0101 0.85	RF870A	58 0102 0.85
RF910A	58 0103 0.85	RF940A	58 0104 0.85	RF970A	58 0105 0.85
RF1010A	58 0106 0.85	RF1040A	58 0107 0.85	RF1070A	58 0108 0.85
RF1110A	58 0110 0.85	RF1140A	58 0111 0.85	RF1170A	58 0112 0.85
RF1210A	58 0113 0.85	RF1240A	58 0114 0.85	RF1270A	58 0115 0.85
RF1310A	58 0116 0.85	RF1340A	58 0117 0.85	RF1370A	58 0118 0.85
RF1410A	58 0120 0.85	RF1440A	58 0121 0.85	RF1470A	58 0122 0.85
RF1510A	58 0123 0.85	RF1540A	58 0124 0.85	RF1570A	58 0125 0.85
RF1610A	58 0126 0.85	RF1640A	58 0127 0.85	RF1670A	58 0128 0.85
RF1710A	58 0130 0.85	RF1740A	58 0131 0.85	RF1770A	58 0132 0.85
RF1810A	58 0133 0.85	RF1840A	58 0134 0.85	RF1870A	58 0135 0.85
RF1910A	58 0136 0.85	RF1940A	58 0137 0.85	RF1970A	58 0138 0.85
RF2010A	58 0140 0.85	RF2040A	58 0141 0.85	RF2070A	58 0142 0.85
RF2110A	58 0143 0.85	RF2140A	58 0144 0.85	RF2170A	58 0145 0.85
RF2210A	58 0146 0.85	RF2240A	58 0147 0.85	RF2270A	58 0148 0.85
RF2310A	58 0150 0.85	RF2340A	58 0151 0.85	RF2370A	58 0152 0.85
RF2410A	58 0153 0.85	RF2440A	58 0154 0.85	RF2470A	58 0155 0.85
RF2510A	58 0156 0.85	RF2540A	58 0157 0.85	RF2570A	58 0158 0.85
RF2610A	58 0160 0.85	RF2640A	58 0161 0.85	RF2670A	58 0162 0.85
RF2710A	58 0163 0.85	RF2740A	58 0164 0.85	RF2770A	58 0165 0.85
RF2810A	58 0166 0.85	RF2840A	58 0167 0.85	RF2870A	58 0168 0.85
RF2910A	58 0170 0.85	RF2940A	58 0171 0.85	RF2970A	58 0172 0.85
RF3010A	58 0173 0.85	RF3040A	58 0174 0.85	RF3070A	58 0175 0.85
RF3110A	58 0176 0.85	RF3140A	58 0177 0.85	RF3170A	58 0178 0.85
RF3210A	58 0180 0.85	RF3240A	58 0181 0.85	RF3270A	58 0182 0.85
RF3310A	58 0183 0.85	RF3340A	58 0184 0.85	RF3370A	58 0185 0.85
RF3410A	58 0186 0.85	RF3440A	58 0187 0.85	RF3470A	58 0188 0.85
RF3510A	58 0190 0.85	RF3540A	58 0191 0.85	RF3570A	58 0192 0.85
RF3610A	58 0193 0.85	RF3640A	58 0194 0.85	RF3670A	58 0195 0.85
RF3710A	58 0196 0.85	RF3740A	58 0197 0.85	RF3770A	58 0198 0.85
RF3810A	58 0200 0.85	RF3840A	58 0201 0.85	RF3870A	58 0202 0.85
RF3910A	58 0203 0.85	RF3940A	58 0204 0.85	RF3970A	58 0205 0.85
RF4010A	58 0206 0.85	RF4040A	58 0207 0.85	RF4070A	58 0208 0.85
RF4110A	58 0210 0.85	RF4140A	58 0211 0.85	RF4170A	58 0212 0.85
RF4210A	58 0213 0.85	RF4240A	58 0214 0.85	RF4270A	58 0215 0.85
RF4310A	58 0216 0.85	RF4340A	58 0217 0.85	RF4370A	58 0218 0.85
RF4410A	58 0220 0.85	RF4440A	58 0221 0.85	RF4470A	58 0222 0.85
RF4510A	58 0223 0.85	RF4540A	58 0224 0.85	RF4570A	58 0225 0.85
RF4610A	58 0226 0.85	RF4640A	58 0227 0.85	RF4670A	58 0228 0.85
RF4710A	58 0230 0.85	RF4740A	58 0231 0.85	RF4770A	58 0232 0.85
RF4810A	58 0233 0.85	RF4840A	58 0234 0.85	RF4870A	58 0235 0.85
RF4910A	58 0236 0.85	RF4940A	58 0237 0.85	RF4970A	58 0238 0.85
RF5010A	58 0240 0.85	RF5040A	58 0241 0.85	RF5070A	58 0242 0.85
RF5110A	58 0243 0.85	RF5140A	58 0244 0.85	RF5170A	58 0245 0.85
RF5210A	58 0246 0.85	RF5240A	58 0247 0.85	RF5270A	58 0248 0.85
RF5310A	58 0250 0.85	RF5340A	58 0251 0.85	RF5370A	58 0252 0.85
RF5410A	58 0253 0.85	RF5440A	58 0254 0.85	RF5470A	58 0255 0.85
RF5510A	58 0256 0.85				



MULLARD SPEAKER KITS

Purposefully designed 40 watt R.M.S. and 30 watt R.M.S. 8 ohm speaker systems recently developed by MULLARD'S specialist team in Belgium. Kits comprise Mullard woofer (8" or 5") with foam surround and aluminium voice coil. Mullard 3" high power domed tweeter. B.K.E. built and tested crossover based on Mullard circuit, combining low loss components, glass fibre board and recessed loudspeaker terminals.

SUPERB SOUNDS AT LOW COST. Kits supplied in polystyrene packs complete with instructions.

8" 40W system - recommended cabinet size 240 x 216 x 445mm
 Price £14.90 each + £2.00 P & P.

5" 30W system - recommended cabinet size 160 x 175 x 295mm
 Price £13.90 each + £1.50 P & P.

Designer approved flat pack cabinet kits, including grill fabric. Can be finished with iron on veneer or self adhesive vinyl etc.

8" system cabinet kit £8.00 each + £2.50 P & P.
 5" system cabinet kit £7.00 each + £2.00 P & P.

STEREO CASSETTE TAPE DECK MODULE.

Comprising of a top panel and tape mechanism coupled to a record play back printed board assembly. Supplied as one complete unit for horizontal installation into cabinet or console of own choice. These units are brand new, ready built and tested.

Features: Three digit tape counter. Autostop. Six piano type keys, record, rewind, fast forward, play, stop and eject. Automatic record level control. Main inputs plus secondary inputs for stereo microphones. **Input Sensitivity:** 100mV to 2V. **Input Impedance:** 68K. **Output level:** 400mV to both left and right hand channels. **Output Impedance:** 10K. **Signal to noise ratio:** 45dB. **Wow and flutter:** 0.1%. **Power Supply requirements:** 18V DC at 300mA. **Connections:** The left and right hand stereo inputs and outputs are via individual screened leads, all terminated with phono plugs (phono sockets provided). **Dimensions:** Top panel 5 1/2" x 11 1/2". **Clearance required under top panel:** 2 1/2". Supplied complete with circuit diagram and connecting diagram. Attractive black and silver finish.

Price £26.70 + £2.50 postage and packing.
 Supplementary parts for 18V D.C. power supply (transformer, bridge rectifier and smoothing capacitor) £3.50.

LOUDSPEAKERS

15" 100 watt R.M.S. (HI-FI, P.A., DISCO, BASS GUITAR) Die cast chassis, 2" aluminium voice coil, white cone with aluminium centre dome, 8 ohm imp., Res. Freq. 20Hz., Freq. Resp. to 2.5KHz., Sens. 97dB (As photograph). Price: £32.00 + £3 carriage.

12" 100 watt R.M.S. (HI-FI) Die cast chassis, 2" aluminium voice coil. Black cone, 8 ohm imp., Res. Freq. 20Hz., Freq. Resp. to 4.5KHz. Sens. 95dB. (As photograph). Price: £23.50 + £3 carriage.

8" 50 watt R.M.S. (HI-FI, P.A.) 1 1/2" aluminium voice coil. White cone, 8 ohm imp. Res. Freq. 40Hz., Freq. Resp. to 6KHz. Sens. 92dB. Also available with black cone fitted with black metal protective grille. (As photograph). Price: White cone £8.90, Black cone/grille £9.50 P&P £1.25.

12" 85 watt R.M.S. McKENZIE C1285GP (LEAD GUITAR, KEYBOARD, DISCO) 2" aluminium voice coil, aluminium centre dome, 8 ohm imp., Res. Freq. 45Hz., Freq. Resp. to 6.5KHz., Sens. 98dB. Price: £22.00 + £3 carriage.

12" 85 watt R.M.S. McKENZIE C1285TC (P.A., DISCO) 2" aluminium voice coil. Twin cone, 8 ohm imp., Res. Freq. 45Hz., Freq. Resp. to 14KHz. Price £22 + £3 carriage.

15" 150 watt R.M.S. McKENZIE C15 (BASS GUITAR, P.A.) 3" aluminium voice coil. Die cast chassis, 8 ohm imp., Res. Freq. 40Hz., Freq. Resp. to 4KHz. Price: £47 + £4 carriage.

PIEZO ELECTRIC TWEETERS MOTOROLA

Join the Piezo revolution. The low dynamic mass (no voice coil) of a Piezo tweeter produces an improved transient response with a lower distortion level than ordinary dynamic tweeters. As a crossover is not required these units can be added to existing speaker systems of up to 100 watts (more if 2 put in series). **FREE EXPLANATORY LEAFLETS SUPPLIED WITH EACH TWEETER.**

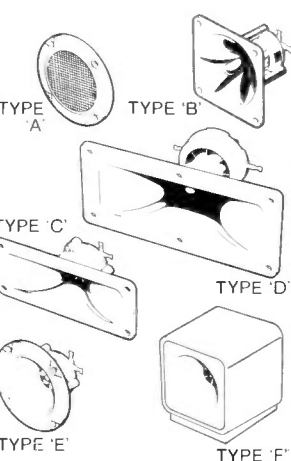

TYPE 'A' (KSN2036A) 3" round with protective wire mesh, ideal for bookshelf and medium sized Hi-fi speakers. Price £4.29 each.

TYPE 'B' (KSN1005A) 3 1/2" super horn. For general purpose speakers, disco and P.A. systems etc. Price £4.99 each.

TYPE 'C' (KSN016A) 2" x 5" wide dispersion horn. For quality Hi-fi systems and quality discos etc. Price £5.99 each.

TYPE 'D' (KSN1025A) 2" x 6" wide dispersion horn. Upper frequency response retained extending down to mid range (2KHz). Suitable for high quality Hi-fi systems and quality discos. Price £7.99 each.

TYPE 'E' (KSN1038A) 3 3/4" horn tweeter with attractive silver finish trim. Suitable for Hi-fi monitor systems etc. Price £4.99 each.

TYPE 'F' (KSN1057A) Cased version of type 'E'. Free standing satellite tweeter. Perfect add on tweeter for conventional loudspeaker systems. Price £10.75 each.

P&P 20p ea. (or SAE for Piezo leaflets).



OMP 80 LOUDSPEAKER

The very best in quality and value. Ported tuned cabinet in hardwearing black vinylite with protective corners and carry handle. Built and tested, employing 10in British driver and Piezo tweeter. Spec: 80 watts RMS; 8 ohms; 45Hz-20KHz; Size: 20in x 15in x 12in; Weight: 30 pounds.

Price: £49.00 each, £90 per pair
 Carriage: £5 each, £7 per pair

1K.WATT SLIDE DIMMER

- Controls loads up to 1KW
 - Compact size
 - 4 3/4" x 13" x 2 1/2"
 - Easy snap in fixing through panel/cabinet cut out
 - Insulated plastic case
 - Full wave control using 8amp triac
 - Conforms to BS800
 - Suitable for both resistance and inductive loads
- Innumerable applications in industry, the home, and discos/theatres etc.



Price: £11.70 each + 50p P&P (Any quantity)

BSR P256 TURNTABLE

- P256 turntable chassis
 - S shaped tone arm
 - Belt driven
 - Aluminium platter
 - Precision calibrated counter balance
 - Anti-skate (bias device)
 - Damped cueing lever
 - 240 volt AC operation (Hz)
 - Cut out template supplied
 - Completely manual arm
- This deck has a completely manual arm and is designed primarily for disco and studio use where all the advantages of a manual arm are required.

Price: £31.35 + £2.50 P&P

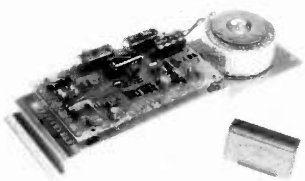

BK ELECTRONICS

Prompt Deliveries
 VAT inclusive prices
 Audio Equipment
 Test Equipment
 by
 Thandar and Leader

KEYBOARDS



MEMBRANE KEYBOARDS

manufactured from a tough polycarbonate film mounted on 1mm glass fibre printed circuit board assembly incorporating silver plated contacts.

16 way numeric keyboard
 Standard keyboard providing 0-9 and A-F functions.
 Size: 100mm x 100mm x 2mm. Price: £5.99 + 35p p&p

Alpha Numeric Keyboard Full size 55 key non encoded keyboard with the commonly required functions in a Qwerty array. Matrix output via a 16 pin DIL socket.
 Size: 350mm x 100mm x 2mm. Price: £13.99 + 50p p&p

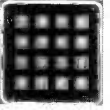

NEW OMP100 Mk.II POWER AMPLIFIER MODULE

Power Amplifier Module complete with integral heat sink, toroidal transformer power supply and glass fibre p.c.b. assembly. Incorporates drive circuit to power a compatible LED Vu meter. New improved specification makes this amplifier ideal for P.A., Instrumental and Hi-Fi applications.

SPECIFICATION:
 Output Power: 110 watts R.M.S.
 Loads: Open and short circuit proof 4/16 ohms.
 Frequency Response: 15Hz - 30KHz - 3dB.
 T.H.D: 0.01%
 S.N.R. (Unweighted): -118dB ± 3.5dB.
 Sensitivity for Max Output: 500mV @ 10K.
 Price: £31.99 + £2.00 P & P.
 Vu Meter Price: £7.50 + 50p. P + P.

Matching 3-way loudspeakers and crossover

Build a quality 60watt RMS system 8ohms
 Build a quality 60 watt R.M.S. system

- ★ 10" Woofer 35Hz-4.5KHz
- ★ 3" Tweeter 2.5KHz-19KHz
- ★ 5" Mid Range 600Hz-8KHz
- ★ 3-way crossover 6dB/oct 1.3 and 6KHz

Recommended Cab-size 26" x 13" x 13"
 Fitted with attractive cast aluminium fixing es-cutcheons and mesh protective grills which are removable enabling a unique choice of cabinet styling. Can be mounted directly on to baffle with or without conventional speaker fabrics. All three units have aluminium centre domes and rolled foam surround. Crossover combines spring loaded loudspeaker terminals and recessed mounting panel.
 Price £22.00 per kit + £2.50 postage and packing. Available separately, prices on request

12" 80 watt R.M.S. loudspeaker.
 A superb general purpose twin cone loudspeaker. 50 oz magnet. 2 aluminium voice coil. Rolled surround. Resonant frequency 25Hz. Frequency response to 13KHz. Sensitivity 95dB. Impedance 8ohm. Attractive blue cone with aluminium centre dome.
 Price £18.49 each + £3.00 P&P.

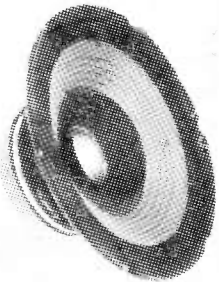
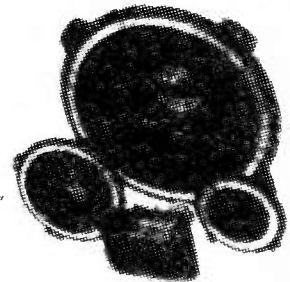

B.K. ELECTRONICS

Unit 5, Comet Way, Southend-on-Sea, Essex, SS2 6TR.

★ SAE for current lists. ★ Official orders welcome. ★ All prices include VAT. ★ Mail order only. ★ All items packed (where applicable) in special energy absorbing PU foam. Callers welcome by prior appointment, please phone 0702-527572



Send now for an application form — then buy it with MAPCARD.

MAPCARD gives you real spending power — up to 24 times your monthly payments — instantly!

Maplin News

MAPCARD
MAPLIN privileged account holder
56790013
M SMITH
Expiry Date NOV 79

Sole UK Agents for Heathkit

NOW THE world-famous Heathkit range of superb electronic kits is available from Maplin — the newly appointed exclusive UK distributor. Kits range from a simple clock for beginners to a unique Robot (see pic) with which you can learn about robotics.

There is a range of training courses covering electronics and computing topics, many containing constructional projects. For full details, pick up a copy of the latest Maplin magazine or write for a free copy of our Heathkit catalogue. Order As XH62S.



GREAT PROJECTS FROM E&M



OUR NEW book "Best of E&M Projects Vol. 1" brings together 21 fascinating and novel projects from E&M's first year.

Projects include Harmony Generator, Guitar Tuner, Hexadrum, Syntom, Auto Swell, Partylite, Car Aerial Booster, MOS-FET Amp and other musical, hi-fi and car projects. ORDER AS XH61R. PRICE £1.

Computer Shopping Arrives

AS FROM June 1st you can place orders directly with our computer from your personal computer. The computer shopping revolution has arrived! To communicate, you'll need a modem (our RS232C compatible modem kit is LW99H price £39.95) and an interface (our ZX81 interface LK08J price £24.95 is available already with many more for most popular micros coming soon).

Just dial us up on 0702 552941 and you'll be able to interrogate our stock file then place your order, type in your credit card number and a few minutes after you hang up your order will print out in our warehouse ready for packing. And all without saying a word.

Try out the future way of shopping now! You'll see immediately what stock we've got available and you'll discover how easy it is to ensure your order is exactly right. And you'll see precisely what the current price is for each item and what total amount will be charged to your credit card. It all helps to make buying easier. So give us a ring now!

Maplin's Fantastic Projects

FULL DETAILS in our project books. Price 70p each.

In Book 1 (XA01B) 120W rms MOSFET Combo-Amplifier • Universal Timer with 18 program times and 4 outputs • Temperature Gauge • Six Vero Projects.

In Book 2 (XA02C) Home Security System • Train Controller for 14 trains on one circuit • Stopwatch with multiple modes • Miles-per-Gallon Meter.

In Book 3 (XA03D) ZX81 Keyboard with electronics • Stereo 25W MOSFET Amplifier • Doppler Radar Intruder Detector • Remote Control for Train Controller.

In Book 4 (XA04E) Telephone Exchange for 16 extensions • Frequency Counter 10Hz to

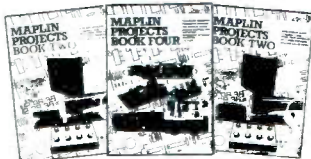

600MHz • Ultrasonic Intruder Detector • I/O Port for ZX81 • Car Burglar Alarm • Remote Control for 25W Stereo Amp.

In Book 5 (XA05F) Modem to European standard • 100W 240V AC Inverter • Sounds Generator for ZX81 • Central Heating Controller • Panic Button for Home Security System • Model Train Projects • Timer for External Sounder.

In Book 6 (XA06G) Speech Synthesiser for ZX81 & VIC 20 •

Module to Bridge two of our MOSFET Amps to make a 350W Amp • ZX81 Sound on your TV • Scratch Filter • Damp Meter • Four Simple Projects.

In Book 7 (XA07H) *Modem Interface for ZX81/VIC20 • Digital Enlarger Timer/Controller • DXers Audio Processor • Sweep Oscillator • Minilab Power Supply • Electronic Lock • and others.

*Projects for Book 7 were in an advanced state at the time of writing, but contents may change prior to publication (due 14th May 1983).

25W Stereo MOSFET Amplifier



- Over 26W/channel into 8Ω at 1kHz both channels driven.
- Frequency response 20Hz to 40kHz ± 1dB.
- Low distortion, low noise and high reliability power MOSFET output stage.
- Extremely easy to build. Almost everything fits on main pcb, cutting interwiring to just 7

wires (plus toroidal transformer and mains lead terminations).
*Complete kit contains everything you need including pre-drilled and printed chassis and wooden cabinet.

Full details in Projects Book 3. Price 70p (XA03D). Complete kit only £55.20 incl. VAT and carriage (LW71N).

MATINEE ORGAN

EASY-TO-BUILD, superb specification. Comparable with organs selling for up to £1000.

Full construction details in our book (XH55K). Price £2.50. Complete kits available. Electronics (XY91Y) £299.95*. Cabinet (XY93B) £99.50*. Demo cassette (XX43W) £1.99. *Carriage extra



Maplin's New 1983 Catalogue

Over 390 pages packed with data and pictures and all completely revised and including over 1000 new items.

On sale in all branches of WH SMITH. Price £1.25.



MAPLIN ELECTRONIC SUPPLIES LIMITED, P.O. Box 3, Rayleigh, Essex SS6 8LR. Telephone: Sales (0702) 552911 General (0702) 554155.

Shops at: 159 King St., Hammersmith, London W6. Tel: 01-748 0926. 284 London Rd., Westcliff-on-Sea, Essex. Tel: (0702) 554000. Lynton Square, Perry Barr, Birmingham. Tel: (021) 356 7292.

Shops closed Mondays.

All prices include VAT & carriage. Please add 50p handling charge to orders under £5 total value.

POST THIS COUPON NOW!

Please send me a copy of your 1983 catalogue. I enclose £1.50 (inc. P&P). If I am not completely satisfied I may return the catalogue to you and have my money refunded. If you live outside the UK send £1.90 or 10 International Reply Coupons.

Name

Address

Post Code

EE 683