

Easy to build projects for everyone

Everyday ELECTRONICS

JUNE 78

40p

61 1/2
202
571



100 W
POWER SLAVE

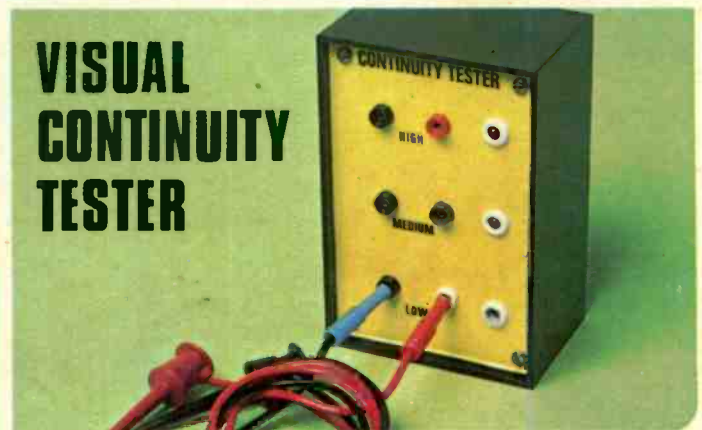

You need never buy a colour film again!

thanks to the Everyday Electronics Colour Print Service

FREE Kodak colour film

for every one of yours we process

SEND NO MONEY

see your prints
before you pay

RELIABLE
film service

LUXURY colour prints
with a borderless
hi-definition
sheen finish

So it can now cost you less to take photographs and, thanks to our reliable developing and printing service, you don't send your money until you've actually seen your pictures.

Hundreds of thousands of magazine readers are delighted with this outstanding Colour Print service. So why don't you give it a try?

HERE'S WHAT YOU DO

Send us any make of colour print film inside the envelope enclosed in this issue. Or fill in the double coupon below and send it with your film in a strong envelope to: The Everyday Electronics Colour Print Service, FREEPOST, Teddington, Middlesex, TW11 1BR. No stamp is required.

FREE KODAK COLOUR FILM

In return you will receive a free Kodak colour film worth over £1, the same size as the one you sent us for developing. Meanwhile we produce your prints, every one of which will be checked by professionals at our laboratories before being sent to you.

You'll love the quality - all crisp, sharp, hi-definition sheen prints, and borderless to give you maximum picture area.

UNBEATABLE FOR QUALITY AND VALUE

What about our prices? Certainly much less than you pay in most shops, and remember you get another film FREE. With our Colour Print service, you only pay 14p for each print, plus 85p towards developing, postage and packing. The minimum charge is 85p (assuming no prints can be made) inc. VAT. The offer is limited to UK, Eire, CI and BFPO.

A SERVICE TO BENEFIT YOU

You benefit in two additional ways. Firstly, you enjoy a personal service, with every care taken over each individual order. And secondly, you pay only for what you get - with no credit vouchers like many other companies. An invoice comes with your prints, so it's a straight business transaction.

Use these labels if you haven't got an envelope, or pass them to a friend who might like to take advantage of our offer.



Films accepted on Standard Terms of Business (available on request).

From: Everyday Electronics Colour Print Service,
FreePost, Teddington, Middlesex TW11 1BR

Mr/Ms _____

Address _____

Postcode _____

PLEASE FILL IN BOTH LABELS

This label
used to
send your
prints

This label
used to
send your
free film

From: Everyday Electronics Colour Print Service,
FreePost, Teddington, Middlesex TW11 1BR

Mr/Ms _____

Address _____

Postcode _____

TUNE IN TO THE WORLD OF MICROPROCESSORS



Greenisleeves • God Save the Queen • Rule Britannia
Land of Hope and Glory • O Come All Ye Faithful
Oranges and Lemons • Westminster Chimes • Sailor's Hornpipe
Beethoven's 'Fate Knocking' • The Marseillaise • Mozart
Wedding March • Cook House Door • Star Spangled Banner
Beethoven's Ode to Joy • William Tell Overture
Soldier's Chorus • Twinkle, Twinkle Little Star
Great Gate of Kiev • Maryland • Deutschland über Alles
Bach • Colonel Bogie • The Lorraine

Build this
24 Tune Electronic
Door Chime for
only £18*

- Handsome purpose built ABS cabinet
- Easy to build and install
- Uses Texas Instruments TMS1000 microcomputer
- Absolutely all parts supplied including I.C. socket
- Ready drilled and legended PCB included
- Comprehensive kit manual with full circuit details
- No previous microcomputer experience necessary
- All programming permanently retained in on chip ROM
- Can be built in about 3 hours!
- Runs off 2 PP3 type batteries.
- Fully Guaranteed

DUE TO THE FANTASTIC SUCCESS OF CHROMA-CHIME NOW ONLY £16.50
PRICE INCLUDES V.P. VAT

Here's the Chroma-Chime—a perfect example of British scientific achievement brought right to your own front door. Now—you can be among the first enthusiasts in the world to build your own electronic musical door chime—a door chime with no moving parts. There are 24 of the world's favourite and best known tunes pre-programmed onto the microcomputer chip so that all you have to do is to set the Chroma-Chime's built-in selector switches to a code to index the "tune of the day" from the repertoire.

Since everything is done by precise mathematics, it cannot play the notes out of tune.

The unit has comprehensive built-in controls so that you can not only select the "tune of the day" but the volume, tempo and envelope decay rate to change the sound according to taste.

Not only visitors to the front door will be amazed, if you like you can connect an additional push button for a back door which plays a different tune!

This kit has been carefully prepared so that practically anyone capable of neat soldering will have complete success in building it. The kit manual contains step-by-step constructional details together with a fault finding guide, circuit description, installation details and operational instructions all well illustrated with numerous figures and diagrams.

The CHROMA-CHIME is exclusively designed by
CHROMATRONICS

River Way, Harlow, Essex.

To CHROMATRONICS, River Way, Harlow, Essex, U.K.

Please send Chroma-Chime Kits at ~~£18.00~~ **£16.50** each including VAT and post and packing

PLEASE USE BLOCK CAPITALS

Name _____

Address _____

I enclose cheque/PO value £ _____

or debit my ACCESS/BARCLAYCARD account No. _____

Signature _____

N.B. The CHROMA-CHIME is also available, fully assembled, price £ 19.95 inc VAT and post and packing.

EE 6/78

ELECTRONI-KIT

"EDUCATIONAL KITS OF EXCEPTIONAL QUALITY"

(AUDIO magazine)

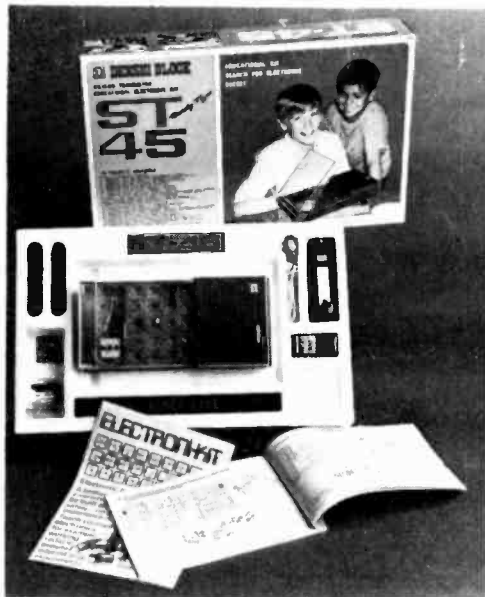

Special offer to Readers of
Everyday Electronics only.

DENSHI KITS AT 20% DISCOUNT

This is a genuine offer of the ST-45 or SR-1A kits at this bargain price for a limited period only.

ST-45 Send £15.50 only, to include VAT p&p, educational manual, batteries and everything necessary to build 45 different actual working projects and learn electronics at the same time:

You build: Radio receivers and transmitters, signal tracers and signal injectors, morse code amplifiers and voice amplifiers, electronic birds, guns, metronomes, and all types of oscillators, metal detectors, radio gilded detectors, etc., etc., etc. **ALL IN ONE FABULOUS KIT.**

SR-1A Send £9.50 only, to include VAT, p&p, educational manual, batteries and everything necessary to build 16 different actual working projects and learn electronics at the same time:

You build: Radio receivers and transmitters, amplifiers, morse code trainers, water level warning devices, signal tracers and injectors, etc., etc.

You can design and build your own circuits too with these kits. No previous experience of electronics is required, but you certainly learn all about the subject in **practice** with these tremendous kits, which are completely safe for **anyone** to use.

All kits are guaranteed. Add-on sets (to increase the number of projects) are available, plus spares and accessories as required.

We guarantee **complete satisfaction** with either of these kits.

Special Offer applies to U.K. customers only. Callers at 20 Bride Lane will be very welcome (please bring this advertisement).

Cheque/P.O./Barclaycard/Access No. (or 11p for illustrated literature) to **Dept. EE**

ELECTRONI-KIT
20 BRIDE LANE, LUDGATE CIRCUS,
LONDON, EC4Y 8DX (01-353 6430)

SINCLAIR PRODUCTS*
PDM35 digital multimeter £25.95.
Mains adaptor £3.24. Deluxe padded carry case £3.25. 38kV probe £18.36.
New DM235 digital meter P.O.A. Cambridge scientific programmable calculator £13.15. Prog. library £4.85. Mains adaptor £3.20. Microvision TV £200.

CUT PRICE TELETEXT
Texas Instruments XM11 tifax module £120. Labgear 7025 ready to use, attractively cased, complete unit. Plugs into TV aerial socket. Full colour. Remote control page select £355.

TV GAMES KITS
Send s.a.e. for free data. Tank Battle chip AY-3-8710 plus economy kit £17.95. Stunt motor cycle chip AY-3-8760-1 plus economy kit £17.95. 10 game paddle 2 chip AY-3-8800 plus economy kit £14.70. AY-3-8500 chip plus economy kit £8.95. Modified shoot kit £4.95. Rifle kit £4.95. Colour Generator kit £7.50. Joystick controls £1.90. 4.43MHz pal crystals 90p.

ASSEMBLED TV GAMES
All attractively cased. 4-game black and white model (tennis, football, squash and pelote) £11.95. 5-game colour model with pistol attachment £21.95. Tank battle game £39.95. Stunt motor cycle game £39.95. Stabilized mains adaptor for all games £3.10.

MAINS TRANSFORMERS
6-0-6V 100ma 75p. 1½a £2.35. 6-3V 1½a £1.89. 9-0-9V 75ma 75p. 1a £1.99. 2a £2.50. 12-0-12V 50ma 75p. 100ma 90p. 1a £2.49. 13V ½a 95p. 15-0-15V 1a £2.79. 30-0-30V 1a £3.59.

JC12, JC20 AND JC40 AMPLIFIERS
A range of integrated circuit audio amplifiers supplied with free data and printed circuits. JC12 5 watts £1.50. JC20 10 watts £2.95. JC40 20 watts £4.20. Send s.a.e. for free data on our range of matching power and pre-amp kits.

FERRANTI ZN414
IC radio chip £1.05. Extra parts and pcb for radio £3.85. Case £1. Send s.a.e. for free data.

PRINTED CIRCUIT MATERIALS
PC Etching kits: Economy £1.70. Standard £3.82. 50 sq ins pcb 40p. 1 lb FeCl £1.05. Etch resist pens: Economy 45p. Dalo 73p. Small drill bit 20p. Etching dish 88p. Laminating cutter 75p.

BATTERY ELIMINATOR BARGAINS
TV games power unit stabilized 7-7V 100ma £3.10. 3-way models with switched output and 4-way multi-tap: 3/4/6V 100ma £2.92. 6/7/9V 300ma £3.30. 100ma radio models same size as a PPD battery with press stud connectors. 9V £2.85. 6V £2.85. 4½V £2.85. 9V+9V £4.50. 6V+6V £4.50. 4½V+4½V £4.50. Cassette recorder mains unit 7½V 100ma with 5 pin din plug £2.85. Fully stabilized model switched output 3/6/7/9V 400 ma £6.40. Car converters 12V dc input. Output 9V 300ma £1.50. Output 7½V 300ma £1.50.

BATTERY ELIMINATOR KITS
Send s.a.e. for free leaflet on range. 100ma radio types with press stud connectors. 4½V £1.80. 6V £1.80. 9V £1.80. 4½+4½V £2.50. 6+6V £2.50. 9+9V £2.50. Cassette type 7½V 100ma with din plug £1.80. Translator stabilized 8-way types for low hum 3/4/6/7/9/12/15/18V. 100ma £3.20 1Amp £6.40. Heavy duty 13 way types 4½/6/7/8/11/13/14/17/21/25/28/34/42V. 1Amp £4.65. 2Amp £7.25. Car converter kit input 12V dc. Output 6/7/9V 1A stabilized. Stabilized power kits 3-18V 100ma £3.80. 3-30V 1A £9.95. 3-30V 2A £14.95.

S-DECS AND T-DECS*
S-DEC £3.39. T-DEC £4.44. u-DeCA £4.52. u-DeCB £6.67. 16 dll or 10T05 adaptors: with socket £2.14. New S-de-kit £4.95.

CONTINENTAL SPECIALITIES PRODUCTS*
EXP300 £6.21. EXP350 £3.40. EXP600 £6.80. EXP650 £3.89. EXP48 £2.48. PB8 £9.94. PB100 £12.74. LM1 £30.99. LP1 £33.48. LP2 £19.44.

BI-PAK AUDIO MODULES
Send s.a.e. for data. S450 tuner £23.31. AL60 £4.88. PA100 £18.71. SPM80 £4.47. BMT80 £5.95. MK80 £36.74. Stereo 30 £20.12.

COMPONENTS
Resistors: 5% carbon E12 10 to 10M. 1W ½p. 1W 2p. Polyester capacitors 250V E6 .01 to .068mf 3½p. .01mf 2p. .1mf 5p. .22mf 4p. .33. .47mf 6p. Polystyrene capacitors E12 63V 15pf to 6800pf 2½p. Ceramic capacitors 50V E12 22pf to 1000pf 2½p. E6 1500pf to 47000pf 2½p.

SWANLEY ELECTRONICS

DEPT. EE, PO Box 68, 32 Goldsel Rd., Swanley, Kent BR8 8TG
Mail order only. Please add 30p to the total cost of order for postage. Prices include VAT. Overseas customers deduct 7% on items marked * and 11% on others. Official credit orders welcome.

DORAM

Quality Range of Products
from The Doram Catalogue include:

Single Semiconductors

Wide range of single diodes, zener diodes, rectifiers and general purpose transistors.

Integrated Circuits

Quality linear and digital IC's, regulators etc.

Mains Transformers

Comprehensive top quality selection of low voltage transformers.

Switches

A switch for most applications.

Hand Tools

We stock a large range of tools for most electronic projects.

Books

We can supply a wide range of books from simple projects to detailed text books.

Wire & Cable

Small or large quantities from a metre upwards.

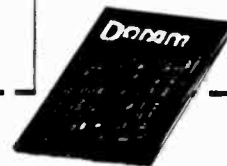

To avoid disappointment send now for the current Doram catalogue (edition 4) enclose 20p to cover post and packing.

Name

Address

DORAM Doram Electronics Ltd PO Box TR8
Wellington Road Estate
Wellington Bridge Leeds LS12 2UF

LOOK! Here's how you master electronics.

...the practical way.

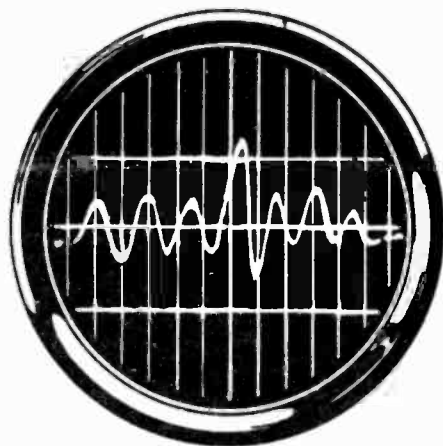

This new style course will enable anyone to have a real understanding of electronics by a modern, practical and visual method. No previous knowledge is required, no maths, and an absolute minimum of theory.

You learn the practical way in easy steps mastering all the essentials of your hobby or to further your career in electronics or as a self-employed electronics engineer.

All the training can be carried out in the comfort of your own home and at your own pace. A tutor is available to whom you can write, at any time, for advice or help during your work. A Certificate is given at the end of every course.

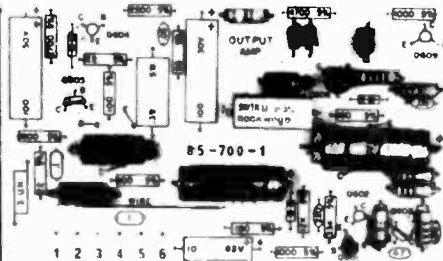
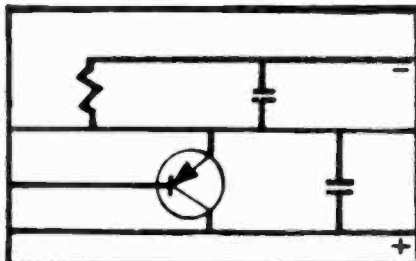
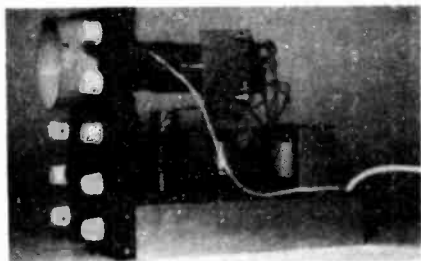

1 Build an oscilloscope.

As the first stage of your training, you actually build your own Cathode ray oscilloscope! This is no toy, but a test instrument that you will need not only for the course's practical experiments, but also later if you decide to develop your knowledge and enter the profession. It remains your property and represents a very large saving over buying a similar piece of essential equipment.

2 Read, draw and understand circuit diagrams.

In a short time you will be able to read and draw circuit diagrams, understand the very fundamentals of television, radio, computers and countless other electronic devices and their servicing procedures.

3 Carry out over 40 experiments on basic circuits.

We show you how to conduct experiments on a wide variety of different circuits and turn the information gained into a working knowledge of testing, servicing and maintaining all types of electronic equipment, radio, t.v etc.

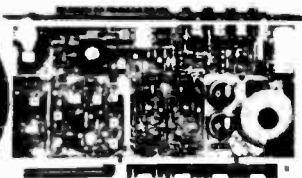

All students enrolling in our courses receive a free circuit board originating from a computer and containing many different components that can be used in experiments and provide an excellent example of current electronic practice.

Free!

To find out more about how to learn electronics in a new, exciting and absorbing way, just clip the coupon for a free colour brochure and full details of enrolment.

British National Radio & Electronic School

P.O. Box 156, Jersey, Channel Islands.

NAME _____

ADDRESS _____

EE B6 Block caps please

SEMICONDUCTORS

COMPONENTS

CERAMIC PAK

Containing range of first quality miniature ceramic capacitors.
 16160—24—3 of each value—22pf, 27pf, 33pf, 39pf, 47pf, 68pf, 82pf. 60p*
 16161—24—3 of each value—100pf, 120pf, 150pf, 180pf, 220pf, 270pf, 330pf, 390pf. 60p*
 16162—24—3 of each value—470pf, 560pf, 680pf, 820pf, 1000pf, 15000pf, 2200pf, 33000pf. 60p*
 16163—21—3 of each value—4700pf, 6800pf, 01uf, 015uf, 022uf, 033uf, 047uf. 60p*

ELECTROLYTIC PAKS

A range of paks each containing 18 first quality, mixed value miniature electrolytics.
 16201—values from 47mFD—10mFD 60p*
 16202—values from 10mFD—100mFD 60p*
 16203—values from 100mFD—680mFD 60p*

CARBON RESISTOR PAKS

These paks contain a range of Carbon Resistors assorted into the following groups.
 16213—60 mixed $\frac{1}{4}$ W 100ohms—820ohms 60p*
 16214—60 mixed $\frac{1}{4}$ W 1Kohms—8.2Kohms 60p*
 16215—60 mixed $\frac{1}{4}$ W 10Kohms—83Kohms 60p*
 16216—60 mixed $\frac{1}{4}$ W 100Kohms—820Kohms 60p*
 16217—40 mixed $\frac{1}{4}$ W 100ohms—820ohms 60p*
 16218—40 mixed $\frac{1}{4}$ W 1Kohms—8.2Kohms 60p*
 16219—40 mixed $\frac{1}{4}$ W 10Kohms—82Kohms 60p*
 16220—40 mixed $\frac{1}{4}$ W 100Kohms—820Kohms 60p*
 16230—40 mixed $\frac{1}{4}$ W 1Meg—10 Meg ohms 60p*
 16231—40 mixed $\frac{1}{4}$ W 1Meg—10 Meg ohms 60p*

COMPONENT PAKS

16164—200 Resistor mixed value approx. (Count by weight) 60p*
 16165—150 Capacitors mixed value approx. (Count by weight) 60p*
 16166—50 Precision resistors. Mixed values 60p*
 16167— $\frac{1}{4}$ W resistors mixed values 60p*
 16168—5 pieces assorted ferrite rods 60p*
 16169—2 Tuning gangs MW/LW VHF 60p*
 16170—1 Pack wire 50 metres assorted colours single strand 60p*
 16171—10 Reed switches 60p*
 16172—3 Micro switches 60p*
 16173—15 Assorted pots 60p*
 16174—5 Metal jack sockets 3 x 3.5mm 2 x standard 2 switch types 60p*
 16175—30 Paper condensers—mixed values 60p*
 16176—20 Electrolytics trans. types 60p*
 16177—1 Pack assorted hardware—Nuts/bolts, gromets etc. 60p*
 16178—5 Mains slide switches assorted 60p*
 16179—20 Assorted tag strips and panels 60p*
 16180—15 Assorted control knobs 60p*
 16181—3 Rotary wave change switches 60p*
 16182—2 Relays 6—24v operating 60p*
 16183—1 Pak, copper laminate approx. 200 sq. inches 60p*
 16184—15 Assorted fuses 100mA—5amp 60p*
 16185—50 Metres PVC sleeving assorted size and colours 60p*
 16186—60 $\frac{1}{4}$ W resistors mixed values 60p*
 16187—25 Presets assorted types and value 60p*
 16188—30 Metres stranded wire assorted 60p*

TRANSISTORS

BRAND NEW — FULLY GUARANTEED

Type	Price	Type	Price	Type	Price	Type	Price	Type	Price
AC126	£0 18	BC109C	£0 08	BC550	*£0 14	BFY52	£0 16	TIP3055	£0 50
AC127	£0 18	BC147	*£0 08	BC556	*£0 14	8IP19	£0 24	2N3708A	£0 07
AC128	£0 18	BC148	*£0 08	BC557	*£0 13	BIP20	£0 38	2N3709	*£0 07
AC128K	£0 26	BC149	*£0 08	BC558	*£0 13	BIP19	£0 38	2N3710	*£0 07
AC132	£0 20	BC157	*£0 10	BC559	*£0 14	20MP	£0 80	ZTX107	*£0 10
AC134	£0 20	BC158	*£0 10	BD115	£0 50	BRY39	£0 45	ZTX108	£0 10
AC137	£0 20	BC159	*£0 10	BD116	£0 80	BU105	£1 40	ZTX109	*£0 10
AC141	£0 22	BC167	*£0 12	BD121	£0 65	BU105/02	£1 95	ZTX300	*£0 12
AC141K	£0 30	BC168	*£0 12	BD124	£0 70	BU204	£1 70	ZTX500	*£0 14
AC142	£0 20	BC169	*£0 12	BD131	£0 38	BU205	£1 70	2N1813	£0 20
AC176	£0 26	BC170	*£0 10	BD132	£0 40	BU208	£2 25	2N1814	£0 20
AC178	£0 25	BC171	*£0 10	BD131P	£0 85	BU208.02	£2 95	2N1889	£0 45
AC179	£0 25	BC172	*£0 10	BD135	£0 40	E1222	£0 38	2N1890	£0 45
AC180	£0 20	BC173	*£0 12	BD136	£0 35	MJE2955	£0 98	2N1891	£0 30
AC180K	£0 28	BC177	*£0 16	BD136P	£0 35	MJE3055	£0 60	2N2147	£0 75
AC181	£0 20	BC178	*£0 16	BD137	£0 35	MJE3440	£0 52	2N2148	£0 70
AC181K	£0 28	BC179	*£0 16	BD138	£0 40	MP1102	£0 35	2N2160	£1 00
AC187	£0 18	BC180	*£0 25	BD139	£0 40	MPF104	£0 38	2N2193	£0 38
AC187K	£0 20	BC181	*£0 25	BD140	£0 36	MPF105	£0 38	2N2194	£0 38
AC188	£0 18	BC182L	*£0 10	BD139P	£0 80	MPSA05	*£0 30	2N2217	£0 22
AC188K	£0 20	BC183	*£0 10	140MP	£0 80	MPSA06	*£0 30	2N2218	£0 22
AD140	£0 60	BC183L	*£0 10	BD155	£0 80	MPSA55	*£0 28	2N2218A	£0 20
AD142	£0 85	BC184	*£0 10	BD175	£0 60	MPSA56	*£0 28	2N2219	£0 20
AD143	£0 75	BC184L	*£0 10	BD176	£0 60	OC22	£1 50	2N2219A	£0 24
AD149	£0 60	BC207	*£0 11	BD177	£0 68	OC23	£1 50	2N2904	£0 18
AD161	£0 42	BC208	*£0 11	BD178	£0 68	OC24	£1 35	2N2904A	£0 21
AD162	£0 42	BC209	*£0 12	BD179	£0 75	OC25	£1 00	2N2905	£0 18
AD161/161MP	£0 35	BC212	*£0 11	BD201	£1 70	OC26	£1 00	2N2905A	£0 20
AF114	£0 21	BC213	*£0 11	202MP	£1 70	OC28	£0 80	2N2906	£0 16
AF115	£0 21	BC213L	*£0 11	BD203	£0 80	OC29	£0 95	2N2906A	£0 19
AF116	£0 21	BC214	*£0 12	BD204	£0 80	OC35	£0 90	2N2907	£0 20
AF117	£0 21	BC214L	*£0 12	BD203P	£0 80	OC36	£0 90	2N2907A	£0 22
AF118	£0 40	BC237	*£0 16	BDY20	£0 80	OC70	£0 24	2N2966	£0 09
AF124	£0 30	BC238	*£0 16	BDX77	£0 90	TIC44	*£0 29	2N2966*	£0 08
AF125	£0 30	BC251	*£0 15	BF457	£0 37	TIC45	*£0 35	2N2966*	£0 08
AF126	£0 30	BC251A	*£0 16	BF598	£0 37	TIP29A	£0 40	2N2966*	£0 08
AF127	£0 32	BC301	£0 28	BF599	£0 30	TIP29B	£0 52	2N3053	£0 16
AF139	£0 35	BC302	£0 28	BF594	*£0 30	TIP29C	£0 50	2N3054	£0 40
AF180	£0 40	BC303	£0 28	BF596	*£0 28	TIP30A	£0 50	2N3055	£0 40
AF181	£0 60	BC304	£0 38	BF839	£0 24	TIP30B	£0 60	2N3414	*£0 16
AF186	£0 58	BC327	*£0 16	BF840	*£0 25	TIP30C	£0 60	2N3415	*£0 16
AF239	£0 50	BC328	*£0 15	BF879	*£0 28	TIP31A	£0 45	2N3416	*£0 29
AL102	£0 38	BC337	*£0 15	BF880	*£0 28	TIP31B	£0 47	2N3417	*£0 29
AL103	£1 20	BC338	*£0 15	BF829	£0 22	TIP31C	£0 49	2N3614	£1 00
ALU04	£1 18	BC440	£0 30	BF830	£0 24	TIP32A	£0 49	2N3615	£1 05
AU110	£1 00	BC441	£0 30	BF844	£0 34	TIP32B	£0 51	2N3616	£1 05
AU113	£1 00	BC460	£0 38	BF845	£0 24	TIP32C	£0 53	2N3646	£0 09
BC107A	£0 08	BC461	£0 38	BF885	£0 24	TIP41A	£0 49	2N3702	*£0 08
BC107B	£0 08	BC477	£0 20	BF886	£0 24	TIP41B	£0 51	2N3703	*£0 08
BC107C	£0 08	BC478	£0 20	BF887	£0 22	TIP41C	£0 53	2N3704	*£0 07
BC108A	£0 08	BC479	£0 20	BF888	£0 22	TIP42A	£0 53	2N3705	*£0 07
BC108B	£0 08	BC547	*£0 12	BF890	*£6 55	TIP42B	£0 55	2N3706	*£0 08
BC108C	£0 08	BC548	*£0 12	BFY50	£0 16	TIP42C	£0 57	2N3707	*£0 08
BC109B	£0 08	BC549	*£0 12	BFY51	£0 16	TIP2955	£0 65	2N3708	*£0 07

MIDGET WAFER SWITCHES

1965—1 pole 12 way 48p*
 1966—2 pole 6 way 48p*
 1967—3 pole 4 way 48p*
 1968—4 pole 3 way 48p*

IC PAKS

Manufacturers "Fall-outs" which include functional Units. These are classed as 'out-of-spec' from the maker's very rigid specifications, but are ideal for learning about I.C.'s and experimental work.
 16224—100 Gates assorted 7400-01-04-10-50-60 etc. £1 20
 16226—30 MSI Assorted types 7441-47-90-154 etc. £1 20
 16227—30 Assorted Linear Types 709-741-747-748-710-588 etc. £1 50*
 16228—8 Assorted types 5L403 76013, 76003 etc. £1 00*
 16229—5 I.C.'s 76110 Ekv. to MC1310P-MA767 £1 50*

MAMMOTH I.C. PAK

16223—Approx. 200 pieces Assorted fall-out integrated circuits, including: Logic, 74 series, Linear, Audio, and D.T.L. Mandy coded devices, but some unmarked— you to identify £1 20

UNTESTED SEMICONDUCTOR PAKS

16130—100 Germ. gold bonded OA47 diodes 60p*
 16131—150 Germ. point contact 100mA OA70/81 diode 60p*
 16132—100 Silicon diodes 200mA OA200 60p*
 16133—150 Silicon fast switch diode 75mA 1N4148 60p*
 16134—50 Silicon rectifiers top hat 750mA 60p*
 16135—20 Silicon rectifiers stud type 3Amp 60p*
 16136—50 400mW zeners D07 case 60p*
 16137—30 NPN transistors BC107/8 plastic 60p*
 16138—30 PNP transistors BC177/178 plastic 60p*
 16139—25 NPN TO39 2N697/2N1711 silicon 60p*
 16140—25 PNP TO39 2N2905 silicon 60p*
 16141—30 NPN TO18 2N706 silicon, switching 60p*
 16142—25 NPN BFY50/51 60p*
 16143—30 NPN plastic 2N3906 silicon 60p*
 16144—30 PNP plastic 2N3905 silicon 60p*
 16145—30 Germ. OC71 PNP 60p*
 16146—15 plastic power 2N3055 NPN TO220 case £1 20
 16147—10 TO3 metal 2N3055 NPN £1 20
 16148—20 Unijunction transistors T1543 60p*
 16149—10 lamp SCR TO39 £1 20
 16150—8 3amp 5CR TO66 case £1 20

74 SERIES TTL IC'S

BI-PAK STILL LOWEST IN PRICE. FULL SPECIFICATION GUARANTEED

Type	Price	Type	Price	Type	Price	Type	Price	Type	Price
7400	£0 14	7409	£0 15	7441	£0 65	7482	£0 85	7493	£0 40
7401	£0 14	7410	£0 15	7442	£0 64	7483	£0 79	7494	£0 38
7402	£0 15	7411	£0 23	7445	£0 90	7484	£0 98	7495	£0 70
7403	£0 15	7412	£0 23	7446	£0 90	7485	£1 00	7496	£0 80
7404	£0 15	7413	£0 27	7447	£0 78	7486	£0 30	74100	£1 00
7405	£0 15	7414	£0 28	7448	£0 80	7489	£2 50	74110	£0 50
7406	£0 30	7416	£0 28	7475	£0 48	7490	£0 42	74118	£0 90
7407	£0 30	7417	£0 28	7480	£0 50	7491	£0 75	74119	£1 85
7408	£0 15	7440	£0 15	7481	£0 95	7492	£0 45	74121	£0 30

CMOS IC'S

Type	Price	Type	Price	Type	Price	Type	Price	Type	Price
CD4000	£0 15	CD4012	£0 20	CD4022	£0 90	CD4031	£2 20	CD4046	£1 30
CD4001	£0 18	CD4013	£0 52	CD4023	£0 20	CD4035	£1 30	CD4047	£1 10
CD4002	£0 18	CD4015	£0 98	CD4024	£0 80	CD4037	£0 95	CD4049	£0 55
CD4006	£0 98	CD4016	£0 50	CD4025	£0 20	CD4040	£0 95	CD4050	£0 55
CD4007	£0 18	CD4017	£0 98	CD4026	£1 70	CD4041	£0 82	CD4054	£1 10
CD4008	£0 98	CD4018	£1 00	CD4027	£0 60	CD4042	£0 82	CD4055	£1 30
CD4009	£0 98	CD4019	£0 85	CD4028	£0 90	CD4043	£0 98	CD4056	£1 45
CD4010	£0 20	CD4020	£1 10	CD4029	£1 15	CD4044	£0 94	CD4059	£0 40
CD4011	£0 20	CD4021	£0 98	CD4030	£0 55	CD4045	£1 40	CD4520	£1 25

LINEAR IC'S

Type	Price	Type	Price	Type	Price	Type	Price	Type	Price
CA3011*	£1 05	LM320-15v	£1 50	MC1456G	£				



**ALL THE PARTS YOU
NEED TO BUILD THE
STUNT CYCLE PROJECT
THE MOST COMPULSIVE TV GAME
EVER MADE**

★ Realistic stunt-cycle sounds come directly from the TV ★ Realistic crash effects and penalty points. ★ Four competitive games with amateur and professional modes.
★ On-screen scoring ★ Up to 36 buses can be jumped. ★ Throttle has the 'feel' of a motorbike: too much and you will skid and crash, too little and you will not get over the buses or obstacles.

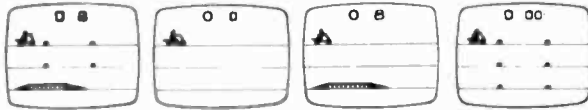

Super Stunt Cycle Drag Race Stunt Cycle Motorcross

AY-3-8760-1 £11 90

P.C.B. (EE Project copyright Teleplay) £2 50

STYLISH CASE £2 50

SOUND & VISION MODULATORS £4 90

100uH CHOKE 0 45p

BASIC KIT (All PCB Components) £18 90

COMPLETE KIT (No Extras needed) £25 90

VERY
EASY
ASSEMBLY
SUITABLE
FOR FIRST
TIMERS



+ FREE
MAINS ADAPTOR

All prices include VAT. For orders under £10 add 20p p&p. Cheques and postal orders to be made payable to TELEPLAY; send your order (no stamp needed) to: Teleplay, Freepost, Barnet, EN5 2BR, or telephone your order quoting your Barclaycard or Access number.



SHOP OPEN 10 a.m.-7 p.m., Monday to Saturday
CLOSE TO NEW BARNET BR STATION—
MOORGATE LINE. Trade enquiries welcome.



41 STATION ROAD,
NEW BARNET, HERTS.
EN5 1QW
Tel: 01-440 7033/01-441 2922

teleplay

**TECHNICAL TRAINING
IN ELECTRONICS AND
TELECOMMUNICATIONS**

ICS can provide the technical knowledge that is so essential to your success: knowledge that will enable you to take advantage of the many opportunities open to you. Study in your own home, in your own time and at your own pace and if you are studying for an examination ICS guarantee coaching until you are successful.

City and Guilds Certificates:
Telecommunications Technicians
Radio, TV, Electronics Technicians
Technical Communications
Radio Servicing Theory
Radio Amateurs
Electrical Installation Work
MPT Radio Communications Certificate

Diploma Courses:
Colour TV Servicing
Electronic Engineering and Maintenance
Computer Engineering and Programming
Radio, TV, Audio Engineering and Servicing
Electrical Engineering, Installation
and Contracting

POST OR PHONE TODAY FOR FREE BOOKLET

**ICS To: International Correspondence
Schools**

Dept 268V Intertext House, London
SW8 4UJ or telephone 622 9911

Subject of Interest

Name

Address

Tel: Age:

ANNOUNCING

**THE NEW
EUROBREADBOARD**

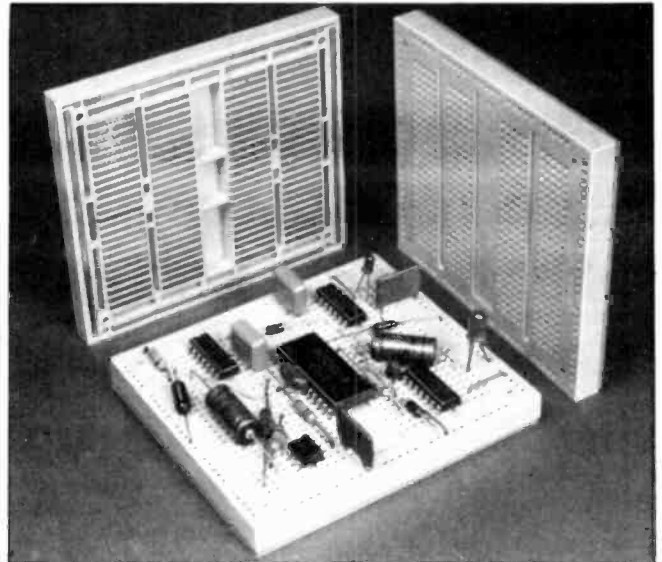

Logically laid out to accept both 0.3" and 0.6" pitch DIL packages as well as Capacitors, Resistors, LED's, Transistors and components with leads up to .85mm dia.

500 individual connections in the central breadboarding area, spaced to accept all sizes of DIL package without running out of connection points.

4 Integral Power Bus Strips around all edges for minimum inter-connection lengths.

Double-sided, nickel silver contacts for long life (10K insertions) and low contact resistance (< 10m.ohms)

Easily removable, non-slip rubber backing allows damaged contacts to be rapidly replaced.

What other breadboarding system has as many individual contacts, offers all these features and only costs £5.80 inclusive of VAT and P.P. — NONE.

At £5.80 each The EuroBreadBoard is unique value for money. At £11.80 for 2 The EuroBreadBoard is an indispensable design aid. Snip out and Post

David George Sales, r/o 74 Crayford High St., Crayford, Kent, DA1 4EF

David George Sales
r/o 74 Crayford High Street,
Crayford, Kent, DA1 4EF.

Please send me 1 EuroBreadBoard @ £5.80 Please
or 2 EuroBreadBoards @ £11.00 Tick

(All prices include VAT and P.P., but add 15% for overseas orders).

Name

Company

Address

Tel. No.

Please make cheque/P.O.'s payable to David George Sales

EDITOR

F. E. BENNETT

ASSISTANT EDITOR

B. W. TERRELL B.Sc.

PRODUCTION EDITOR

D. BARRINGTON

TECHNICAL SUB-EDITOR

T. J. JOHNSON G8MGS

ART EDITOR

R. PALMER

TECHNICAL ILLUSTRATORSP. A. LOATES
D. J. GOODING**EDITORIAL OFFICES**Kings Reach Tower,
Stamford Street,
London SE1 9LS
Phone: 01-261 6873**ADVERTISEMENT MANAGER**V. PIERI
Phone: 01-261 6727**REPRESENTATIVE**P. J. MEW
Phone: 01-261 6676**CLASSIFIED MANAGER**C. R. BROWN
Phone: 01-261 5762**MAKE-UP AND COPY
DEPARTMENT**

Phone 01-261 6035

ADVERTISEMENT OFFICESKings Reach Tower
Stamford Street,
London SE1 9LS

Projects... Theory...

and Popular Features...

Our *Tele-Bell* should be very popular. Telephone subscribers will find this device a boon. With the summer ahead, and all those long hours likely to be spent in the garden, now is a particularly good time to build this unit. One can then concentrate on weeding the flower beds or hoeing the rows of vegetables, or just indulge in a quiet siesta on the patio or lawn knowing that the outside extension bell will be heard when the telephone rings.

The remote or extension bell can of course be installed anywhere within the house, in the garage or garden shed, to meet the special requirements of a household.

And this is not all. The remote indicator may be a lamp, rather than a bell or buzzer. This would be more appropriate if installed, for example, in the TV lounge.

Being essentially a sound-operated relay, the *Tele-Bell* has other useful applications; such as a Baby Alarm, or a remote indicator of a caller at the front door.

In the latter or in the phone application, the aged, handicapped, or hard of hearing will find the facilities offered by the *Tele-Bell* of genuine practical assistance.

We can leave it to our readers to make good use of this project,

whether in their own home or in that of a friend or neighbour.

A 100 watts of audio! My, the mind boggles. Yet this is nowadays the accepted norm in the pop world. Powers of 200 watts and even higher are not unusual either.

It seems that stimulus via the ear is but a secondary consideration. Pop music relies chiefly upon the sensual effect of low frequency sound waves impinging upon the diaphragm and abdomen. Thus the incessant demand for watts and more watts.

To help satisfy (albeit in part only) this demand for 100's of watts we offer this month the *EE Power Slave*. The cool 100 watts of audio delivered by this excellent portable equipment should help meet the requirements of pop groups, and will certainly adequately cover the needs for public address systems in medium or large size halls.



Our July issue will be published on Friday, June 16. See page 503 for details.

Readers' Enquiries

We cannot undertake to answer readers' letters requesting modifications, designs or information on commercial equipment or subjects not published by us. All letters requiring a personal reply should be accompanied by a stamped self-addressed envelope.

Telephone enquiries should be limited to those requiring only a brief reply. We cannot undertake to engage in discussions on the telephone, technical or otherwise.

Component Supplies

Readers should note that we do not supply electronic components for building the projects featured in **EVERYDAY ELECTRONICS**, but these requirements can be met by our advertisers.



Everyday **ELECTRONICS**

VOL. 7 NO. 10

JUNE 1978

CONSTRUCTIONAL PROJECTS

- TELE-BELL** *A sound-operated monitoring device for the home* by F. G. Rayer 480
- IN-SITU TRANSISTOR TESTER** *Carry out in-circuit spot-checks with this unit* by R. A. Penfold 486
- EE 100W POWER SLAVE** *Plug-in to "big sound" with this 100W power amplifier* by E. M. Lyndsell 504
- VISUAL CONTINUITY TESTER** *Narrows down the ohmic value of circuit under test* by A. Sproxtton 516

GENERAL FEATURES

- EDITORIAL** 478
- CROSSWORD No. 4** by D. P. Newton 484
- SHOP TALK** *New products and component buying for constructional projects* by Dave Barrington 485
- BRIGHT IDEAS** *Reader's hints and tips* 490
- FOR YOUR ENTERTAINMENT** *Video at the summit, compatibility check* by Adrian Hope 491
- CLUB CORNER** *News from amateur organisations* 491
- BRAIN ON A GRAIN—2** *The impact microprocessors are having on everyday living* by S. McClelland 492
- JACK PLUG AND FAMILY** *Cartoon* by Doug Baker 495
- TEACH-IN 78** *Part 9. Radio, Modulation, Receivers* by George Hylton 496
- READERS' LETTERS** *Your news and views* 513
- EVERYDAY NEWS** *What's happening in the world of electronics* 514
- PROFESSOR ERNEST EVERSURE** *The Extraordinary Experiments of.* by Anthony J. Bassett 520

Back issues of EVERYDAY ELECTRONICS (June 1977 onwards—October, November, December 1977 and January 1978 NOT available) are available worldwide at a cost of 60p per copy inclusive of postage and packing. Orders and remittance should be sent to: Post Sales Department, IPC Magazines Ltd., Lavington House, 25 Lavington Street, London SE1 0PF.

Binders for Volumes 1 to 7 (state which) are available from the above address for £2.85 inclusive of postage and packing.

© IPC Magazines Limited 1978. Copyright in all drawings, photographs and articles published in EVERYDAY ELECTRONICS is fully protected, and reproductions or imitations in whole or in part are expressly forbidden.

All reasonable precautions are taken to ensure that the advice and data given to readers are reliable. We cannot however guarantee it, and we cannot accept legal responsibility for it. Prices quoted are those current as we go to press.



**EE makes it
all so EASY!**

TELE-BELL

By F. G. Rayer



A low cost remote monitor. Ideal for the housewife—in the kitchen. The handyman—in the workshop or greenhouse. Also an invaluable aid for the aged or disabled.

This device will control a signal lamp, bell or buzzer either locking on or giving intermittent warning. It is sound triggered and so can be used to alert one to the ringing of a telephone bell, doorbell or some other sound source for positions remote from the sound source.

As a sound triggered telephone bell warning (expected to be its primary application), it can control a signal lamp or bell located in a kitchen or television room, or elsewhere in circumstances where the telephone may not be readily heard. For a doorbell extension, it can operate in a similar way, though an indicator lamp will be chosen when ringing of a doorbell is to be signalled to a deaf person. It could also serve as a baby-cry alarm.

Although the unit is shown as mains powered, it can easily be adapted for battery operation by simply omitting the power supply section. This modification however removes the intermittent facility.

CIRCUIT DESCRIPTION

The complete circuit diagram of the Tele-Bell is shown in Fig. 1. An inexpensive crystal microphone insert is used as the sound pick-up device. The signal originating in

the microphone is passed to an audio amplifier composed of IC1 and associated components. This i.c. is the well known 741 differential operational amplifier tailored for audio signals and provides a gain of 100.

The output of IC1 is fed via a d.c. blocking capacitor to the base of TR1. The collector current in TR1 is negligible until an audio signal is present in the system resulting in the potential on the collector being close to ground.

NEGATIVE DRIVE

When a signal is present at the output of IC1, it passes through C2 and is then rectified by diode D1 to provide a negative drive bias for TR1 base. Collector current flows and therefore causes a voltage drop across VR1. In other words the collector potential rises; the amount of rise is controlled by the effective value of VR1 and can be adjusted to suit the sensitivity required.

The collector potential is directly coupled to the gate of CSR1 and when sufficiently high causes CSR1 to switch on. This places 12 volts d.c. at the output (extension) sockets SK1 and SK2, which is indicated by LP1 illuminating.

This lamp will be found particularly useful when setting the sensitivity when the extension bell or buzzer is not connected. Diode D2 is included to suppress back e.m.f. generated when the extension bell or buzzer is operated.

To maintain current through CSR1 when the alarm trembler contacts are open, should the lamp fail, resistor R7 is included.

MODES OF OPERATION

Mode of operation is controlled by the 3-way switch S1. If S1 is at Lock CSR1 receives current rectified by D3 and smoothed by C4. The thyristor thus remains in the avalanche or conducting state, even if the sound operating the device is only momentary. Turning this switch to MUTE interrupts current so that the thyristor returns



to the non-conducting condition. Should S1 be at NON LOCK then the thyristor receives current directly from the transformer, so remains in conduction only while sound is present (since it turns off on every negative excursion of the a.c. secondary voltage). Therefore an indicator lamp or extension bell will only operate while the phone bell is actually ringing.

Switch section S1b removes supply voltage from IC1 and TR1, so that there is a slight delay when switching to LOCK ON or NON LOCK positions. This avoids having to switch off with the mains switch S2, wait a short interval, then switch on again.

If the unit is always to be used with an indicator lamp only, D2 and R7 can be omitted.

CIRCUIT ACTION

Mains voltage enters the unit via S2 and FS1 and appears across the primary of T1. This is stepped down to 9 volt a.c. which appears across the secondary of T1. Half wave rectification is achieved by D3 and smoothing accomplished by reservoir capacitor C4.

HOW IT WORKS ...

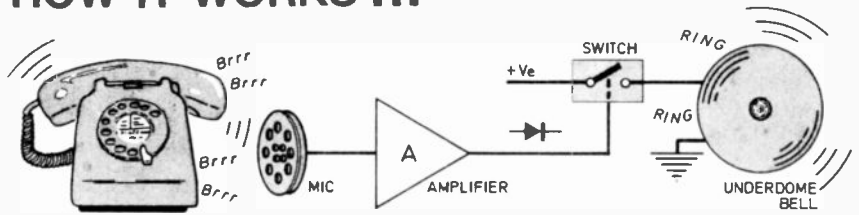

Sound from a remote source, such as a telephone, is picked up by the microphone and amplified to a suitable level by the amplifier. The amplifier has a sensitivity control to allow different sound levels to operate the unit correctly. The output from the amplifier is rectified to produce a "voltage spike" which is used to operate the switch.

The switch itself is of the electronic variety and is arranged to have a "latching" action. This means that once the switch is operated, it remains operated. The output from the switch is used to control an external warning device such as a bell or buzzer. The warning device can be placed at any remote point, thereby giving a warning that the telephone has been ringing.

Supply voltages for IC1 and TR1 are derived from the 12 volt level by R6 and C3 and these components introduce a short delay in operation of these stages to avoid triggering the unit at switch on.

A d.c. level of 12 volts is available for the remainder of the

circuitry. Capacitors C5 and C6 are included to help suppress triggering by noise or transients on the mains supply.

The prototype unit employed a thyristor rated at 3 amps when a 1 amp type would be sufficient under normal operating conditions

Fig. 1. Complete circuit diagram for the Tele-Bell.

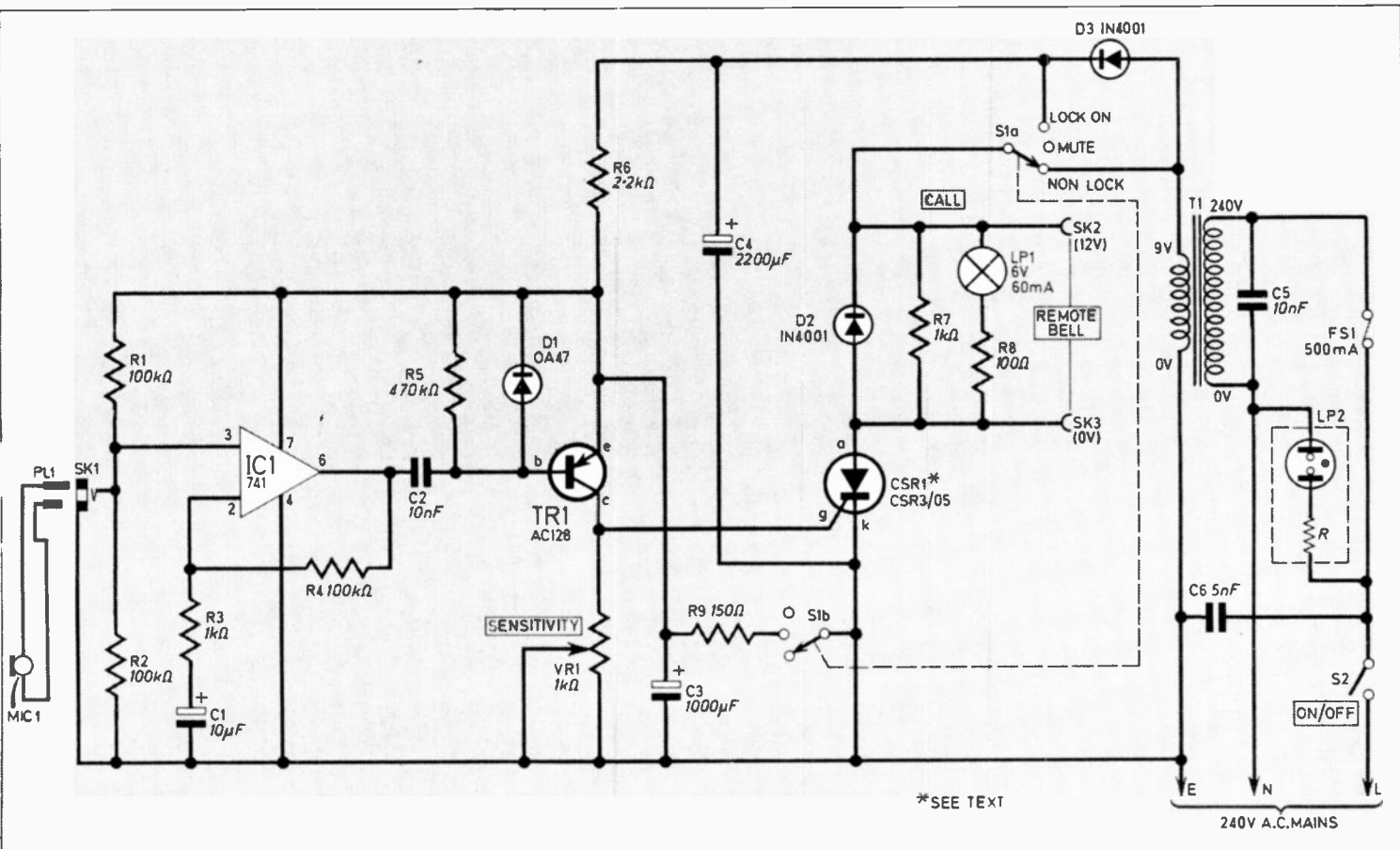

*SEE TEXT

with the specified transformer. However, this was chosen so as not to require any heatsink.

If a thyristor rated at 1 amp is used, it will probably not be in the same case style as that shown in Fig. 3 and connection details will need to be investigated. It may then be necessary for this device to be fitted with a heatsink.



COMPONENT ASSEMBLY

All of the components are mounted on the rear face of the front panel, and most of the components are assembled on a piece of 0.15 inch matrix perforated board size 28 x 24 holes as shown in Fig. 3 and 4. The board is secured to the front panel by means of a metal bracket bolted to the board and sandwiched between the front panel and VR1.

Begin construction by cutting the board to size and drilling to suit CSR1, SK1 and the bracket fixing bolts and then assemble the components as shown in Fig. 3. In most places the wire ends of the resistors and capacitors will be long enough to reach the connecting points. If not, some tinned copper wire will be required. When assembling IC1, note that pin 8 is closest to the tag on the body, see Fig. 3.

The next stage is to prepare the front panel to accept the panel mounted components. With these secured in position, using counter-sunk bolts for the transformer and lampholder fixings, the board can be secured in place on its mounting bracket and then wired up to the rest of the components according to Figs. 2 and 4.

CASE

The prototype unit was housed in a home-made wooden case, and dimensions of this are given in Fig. 5 for those wishing to make a similar housing. Each side is rebated along its sloping edge to

accommodate the front panel. The upper and lower edges of the front panel are chamfered as necessary to obtain a good fit, and is then secured with two small wood screws.

EXTENSION CIRCUIT

Current drawn by IC1, TR1 and LP1 should be no more than about 70 milliamps therefore with the specified transformer a bell or buzzer with a current rating of up to 1 amp can be used, or a 12 volt lamp of up to 12 watts rating. A 3 watt lamp should be adequate for most applications.

Several lamps can be fitted in parallel and located in different rooms for instance, but observe the maximum wattage rating. If two bulbs are used, these must each be rated at 6 watts or less, or if 4 lamps are required these must be rated at 3 watts or less. Remember that the total wattage of a parallel lamp system is ob-



tained by adding the individual wattage ratings of the lamps.

The extension cable can be of any length, except that very long thin leads will reduce the voltage to the bell or buzzer or lamp if heavy currents are flowing.

A bell or buzzer can be anywhere in the room, but a lamp should be placed where it will be readily seen (for example, in a small fitting on top of a television set if used in the lounge).

COMPONENTS

Resistors

R1 100k Ω	R4 100k Ω	R7 1k Ω
R2 100k Ω	R5 470k Ω	R8 100 Ω $\frac{1}{2}$ W
R3 1k Ω	R6 2.2k Ω	R9 150 Ω

All $\frac{1}{2}$ W carbon $\pm 5\%$ except where otherwise stated

Potentiometer

VR1 1k Ω lin. carbon

Capacitors

C1 10 μ F 10V elect.	C4 2200 μ F 16V elect.
C2 10nF plastic or ceramic	C5 10nF 400V a.c.
C3 1000 μ F 16V elect.	C6 5nF 400V a.c.

Semiconductors

D1 OA47 or similar germanium diode
D2 1N4001 or similar 1A silicon diode
D3 1N4001 or similar 1A silicon diode
TR1 AC128 germanium <i>pnp</i>
CSR1 CRS3/05 or similar 3A thyristor (see text)
IC1 741 differential operational amplifier TO-5 style case

Miscellaneous

LP1 6V 60mA	SK1 3.5mm jack socket
LP2 mains panel neon	SK2, 3 4mm sockets (2 off)
S1 2-pole 3-way rotary	PL1 3.5mm jack plug
S2 on/off mains toggle single pole	MIC1 crystal microphone insert
T1 mains primary/9 volt 1 amp secondary	FS1 500mA 20mm fuse

Perforated s.r.b.p. 0.15 inch matrix size 28 x 24 holes; 20mm panel mounting fuseholder; holder and lens for LP1; screened lead; mains cable; plastic knobs (2 off); solder tags (2 off); mains cable retaining clip; grommet to suit mains cable; 6BA fixings; materials for case; aluminium for component board mounting bracket.

See
**Shop
Talk**
page 485

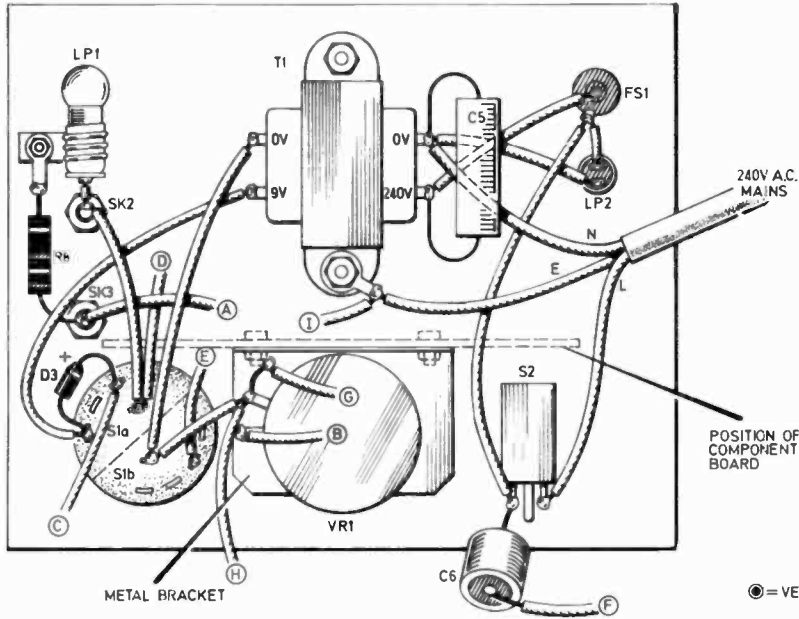
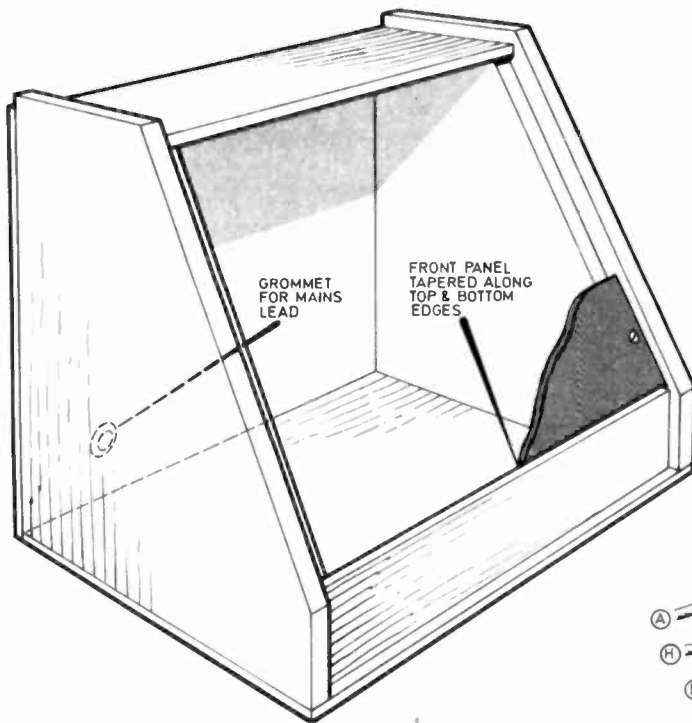

Fig. 2. Layout of components on the front panel and inter-wiring.



OVERALL DIMENSIONS OF CASE
 HEIGHT 140mm
 WIDTH 165mm
 DEPTH 127mm

Fig. 5. Suggested arrangement and main dimensions for the case.

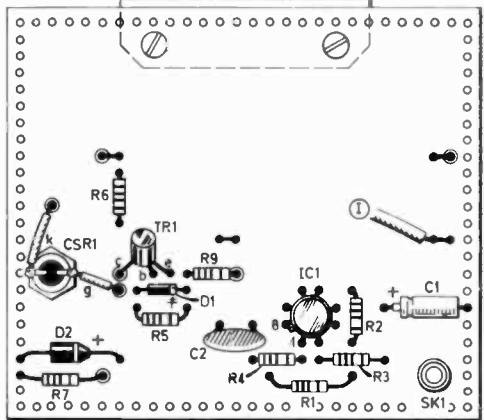
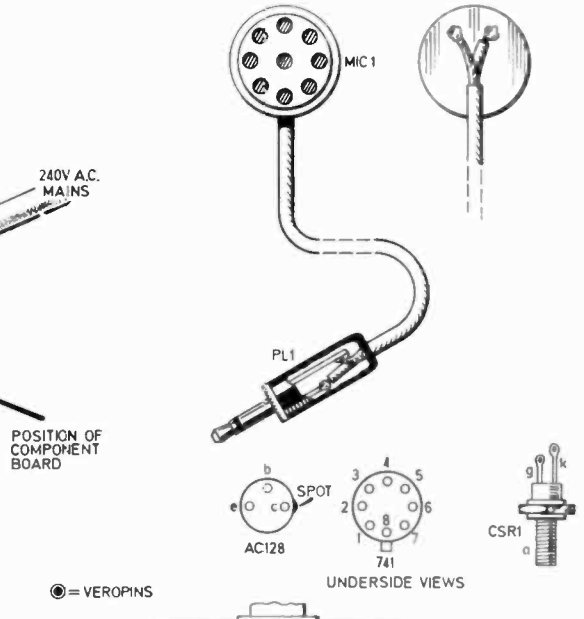

Fig. 3. Component layout for the topside of the circuit board and connections for TR1, IC1 and CSR1.

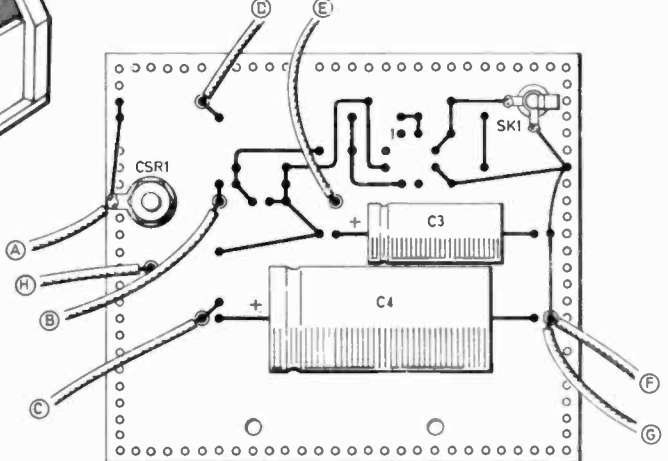
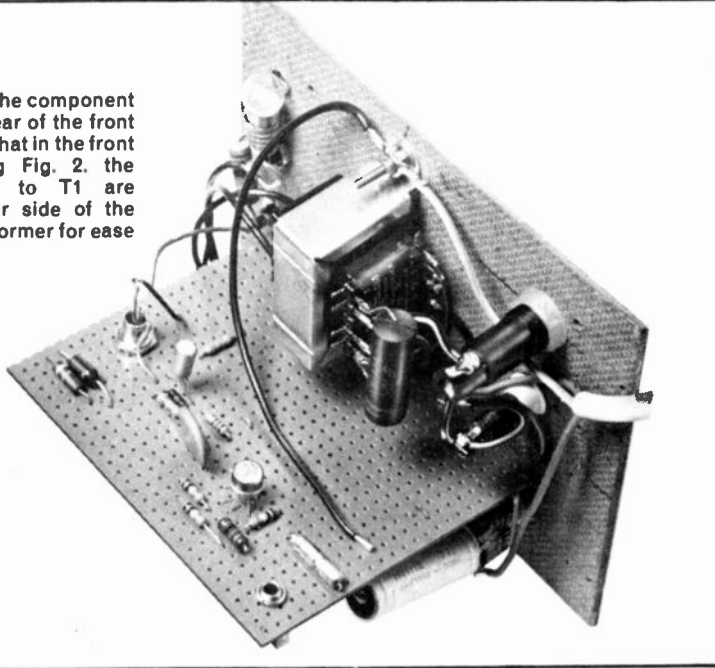

Fig. 4. Underside wiring of the component board. The MIC jack socket SK1 was mounted on the component board in the prototype, but should be mounted on the case back panel and wires taken from the board to SK1 solder tags.

Top view of the component board and rear of the front panel. Note that in the front panel wiring Fig. 2, the connections to T1 are shown either side of the mains transformer for ease of wiring.



a long way from the telephone (or door bell), with sensitivity set high. But with sensitivity reduced by VR1, and the microphone reasonably near the phone or other sound source, unwanted triggering of the circuit will be avoided.

Once the unit has been triggered in the LOCK position, it will be necessary to turn switch S1 to MUTE to cancel the extension bell or lamp.

BATTERY OPERATION

For a battery operated Tele-Bell omit S2, D3, C5, C6, R9 and the transformer. As the power is now d.c. only, no NON LOCK position is available. The thyristor can be restored to its non-conducting condition by opening the switch in one battery lead, but a small delay must be left before returning the switch to the on position, or the thyristor will again be triggered.

A 9 or 12 volt supply would be satisfactory. The non-operational current will be only about 1 milli-amp, so the unit can be left on for long periods. To conserve battery current, a relatively small buzzer, bell or lamp should be used with the extension circuit. ☐

ADJUSTMENT

It was found that the maximum sensitivity which is available is virtually unusable in the LOCK position. It is practicable to set VR1 for greater sensitivity when using the NON LOCK position. With the switch at LOCK turn VR1 clockwise

until the lamp LP1 is lit when snapping the fingers a foot or two from the microphone. Later, VR1 should be set to suit conditions.

Too great a sensitivity will cause the circuit to be triggered by low level sounds. Unwanted operation of the circuit in this way is very probable if the microphone is



CROSSWORD NO. 4

BY D.P. NEWTON

ACROSS

- 1 A solicitous cartridge?
- 6 A TV hideout?
- 7 A watery way of making inroads into a coil.
- 9 A means of embedding information in the carrier wave.
- 10 Millicent gives us a thousandth but not in the hundred part.
- 11 Exist.
- 12 Half, often associated with conductors.
- 13 The brown one is this on the fence.
- 14 Just a few volts, initially.
- 15 CR circuits may be used for this minute device.
- 16 Perforated sheet, found in some valves.
- 18 Change.
- 20 Could a sloop turn about in these?
- 21 England, Ireland, Scotland and Wales.
- 22 Power divided amongst voltage is extant.
- 23 News travels fast on this.
- 24 To indicate position.
- 25 What we might expect on a well-tuned TV.
- 27 Useless shortly.
- 28 This gate we would find prohibitive.

- 29 The telly would not be the same without it.
- 30 To transmit information.

DOWN

- 2 The fashion in headgear for some valves.

- 3 The spouse in the push circuit?
- 4 There are ratlets about in high level communications. (anag.)
- 5 Resistance movement on Her Majesty's Service.
- 6 A small flash of light produced by a phosphor.
- 8 No ham could be without one.(1,3)
- 9 Take a tip for this signal-sorting-circuit.
- 10 Send the signals in and they may come out with these feelings.
- 12 A coil core of gardening notoriety.
- 17 An LCR circuit gives this response.
- 18 A one-way street for electrons.
- 19 An eggy link from core to core.
- 20 Some spots do this in lasting.
- 21 Loosen.
- 24 Unattended operation.
- 26 The signs of high voltage discharge.
- 28 Layers of a semiconductor.

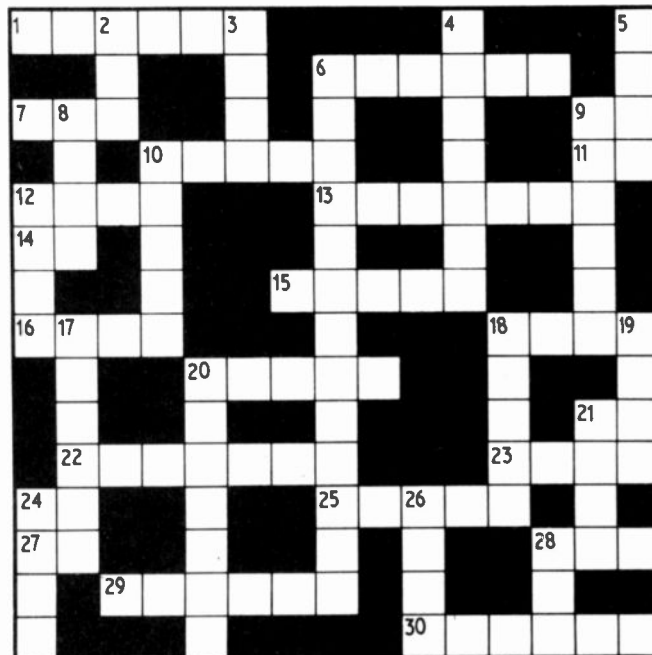

Solution on page 513



By Dave Barrington

New products and component buying for constructional projects.

This month we seem to have quite a mixed bag of products to bring to your attention.

Stickies

In a recent issue we mentioned the novel but most practical idea of self-adhesive labels for identifying pin functions for a range of some of the most popular 14 and 16-pin 74 Series of TTL integrated circuits.

In view of the low operating currents (typically 100µA) and ease in which CMOS integrated circuits can be damaged, it becomes even more important to know the pin functions of these devices. With this in mind it was only a matter of time before the producers of these labels, Concept Electronics, were to market a range of the popular 4000 Series of CMOS i.c.s.

Specially for the constructor, Concept Electronics are making available 120-label sets of STICKIES for both TTL and CMOS integrated circuits. The CMOS range is made up from 65 of the most popular 4000 Series.

Costing 80p per set (120 labels), each set of STICKIES are packed in a plastic wallet with a data card and instructions. Sets of 480 labels are available and for further details readers should contact Concept Electronics, Dept EE, 8 Bayham Road, Sevenoaks, Kent.

Drill Stand

On the subject of printed circuit boards and of particular interest to those readers who make their own boards, Mega Electronics Ltd., have just introduced a p.c.b. drill stand for use with the low voltage hand-held drill units.

Designated the Photolab PLST-12A, the drill stand has been specifically introduced to meet requirements in the production of prototype printed circuit boards. It is constructed with a strong base of machined cast iron supporting precision steel guides for raising and lowering the drill.

Boards of up to 254mm x 229mm will be accepted by the drill stand.

The Mega Photolab PLST-12A drill stand costs £14.50, plus VAT, and is available from Mega Electronics Ltd., Dept E.E., 9 Radwinter Road, Saffron Walden, Essex CB11 3HU.

Special Offer

Some good news for readers from one of our advertisers this month. Electroni-Kit Ltd., distributors of the excellent Denshi educational kits, have just introduced a new range they call Denshi EX kits.

To make way for these new kits and to clear existing stocks they are offering readers of EE a special 20 per cent discount on their SR-1A and ST-45 kits.

The SR-1A contains 16 different projects ranging from simple radio receivers to morse code amplifier. The ST-45 contains 45 projects ranging from metronomes to metal detectors.

This offer is only while present stocks last and readers are directed to the Electroni-Kit advertisement.

Logic Monitor

Finally, for those readers who are keen on logic circuits and would like to "see" those mysterious integrated circuits functioning then the LM-1 Logic Monitor from A. Marshall's should be a sound investment at £30.99 including VAT.

Suitable for all dual-in-line (up to 16 pin) logic i.c.s., the monitor simultaneously displays the static and dynamic logic states of DTL, TTL, HTL or CMOS on a 16 l.e.d. display; one for each i.c. pin.

The LM-1 is simply clipped over the i.c. and the l.e.d.s give an instant logic indication; high (1)-l.e.d. on, low (0)-l.e.d. off.

For further particulars write to A. Marshall (London) Ltd., Dept E.E., 40-42 Cricklewood Broadway, NW2 3ET.

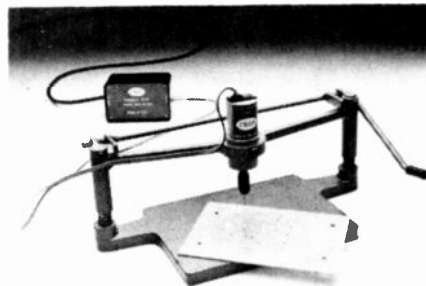

Printed circuit drill stand from Mega Electronics.

TV Stunt Cycle

One of the items called for in the *TV Stunt Cycle* game we published last month was a 9V d.c. power supply.

The estimated cost of the design we published was just over £3. Since then however, we have found that one of our advertisers, J. Bull (Electrical) Ltd, is able to supply a suitable ready-built power pack for £2.53. Built in a small plastic case, the unit is listed as a PP3/PP9 Replacement and is suitable for loading up to 100mA.

If you prefer to build your own power supply they are able to supply another build-it-yourself kit, which gives voltages of 6, 9 and 12V for loads up to 500mA. This kit is listed as a Mains Transistor Pack and sells for just £2.

Constructional Projects

There are only a few points to mention regarding the constructional projects this month.

We cannot foresee any problems with the *In-Situ Transistor Tester*. If readers do not wish to use the tester for in-situ checkouts, then the DIN socket can be dispensed with and three miniature crocodile clips used to hold the transistors under test.

This is not a new idea and all you need to do is fasten the emitter, base and collector wires that would normally be connected to the DIN socket pins to each crocodile clip. The clips can then be stuck, with impact adhesive, to the front panel to form a connecting block.

There should be no difficulty in obtaining parts for the *Visual Continuity Tester* or the *Tele-Bell*.

Judging from readers correspondence, the *100W Power Slave* amplifier this month is quite an ambitious project that should prove very popular. Provided the instructions are followed carefully there should be no problems with the circuit construction as the design uses a printed circuit board.

Some of the components are "specials" and not generally available, but it is strongly recommended that readers use only those items specified in the article and components box.

The mains transformer, type 9010 (9011—8ohms version), is the most expensive item and was designed specifically for the job. This is available from Zeta Windings, 26 All Saints Road, London, W1, at a cost of £16.36 including VAT and post/packing.

All the transistors and the diode D6, which is a special forward bias reference type, are available with most other components from A. Marshall (London) Ltd., Dept EE, 40-42 Cricklewood Broadway, London, NW2 3ET.

Finally, if like me you are not a dab hand at woodworking, readers will be pleased to know that a completed wooden surround for the amplifier is available from P. Daly, 13 Cherston Road, Loughton, Essex, price £13.60 including postage and packing.

IN-SITU TRANSISTOR TESTER

By R. A. Penfold

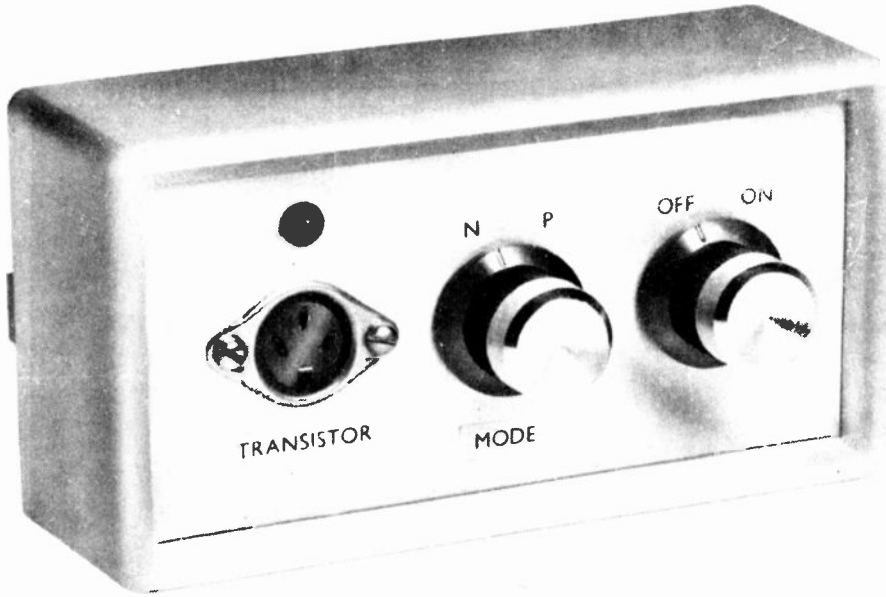

WITH transistors featuring prominently in most electronic designs for the home constructor it is not surprising that transistor testers are very popular constructional projects with numerous designs having been published in the past.

Most transistor tester circuits are for simple leakage and gain tests or for comprehensive transistor analysers. In either of these cases the units are intended to check a transistor which is not connected into circuit.

IN CIRCUIT TESTING

The transistor checker described here is a little unusual in that it can be used to check a transistor while it is in or out of circuit.

It must be emphasised that the unit provides only a very rough check of the device under test and although in most cases it will provide reliable results, under certain circumstances it can provide

erroneous results, as will be explained more fully later on.

Despite this, provided the unit is used sensibly with its limitations being borne in mind, it can prove to be invaluable for rapid checks on batches of untested transistors or faulty transistorised equipment.

OPERATING PRINCIPLE

The basic way in which the unit tests an *npn* transistor is illustrated in Fig. 1a.

A transistor will not normally conduct between its collector and emitter terminals unless a suitable bias current is applied to its base connection. With the circuit in the state shown the base of the device under test is short circuited to the emitter, and so no collector/emitter current should flow through the device. An l.e.d. indicator is used to monitor the collector current, and so this should not light up at present.

However, if the switch is set to the other setting a base bias current will be supplied to the device via the appropriate resistor, and a collector current will flow which will cause the l.e.d. indicator to come on.

The test circuit for a *pnp* transistor is shown in Fig. 1b, and is the same as for a *npn* device except that the supply rails and l.e.d. polarity must be reversed.

CIRCUIT DESCRIPTION

The final circuit diagram of the In-Situ Transistor Tester based on this idea is shown in Fig. 2.

The manual switching arrangement of the basic circuit is replaced here by an electronic switch which "cycles" at a rate of approximately 1Hz. Thus, when the circuit is connected to a serviceable transistor the l.e.d. indicator should flash on and off about once per second.

An NE555 timer i.c. in the astable mode is used to generate the 1Hz switching signal. Resistors R1, R2, and capacitor C1 set the frequency of oscillation and also determine the mark to space ratio

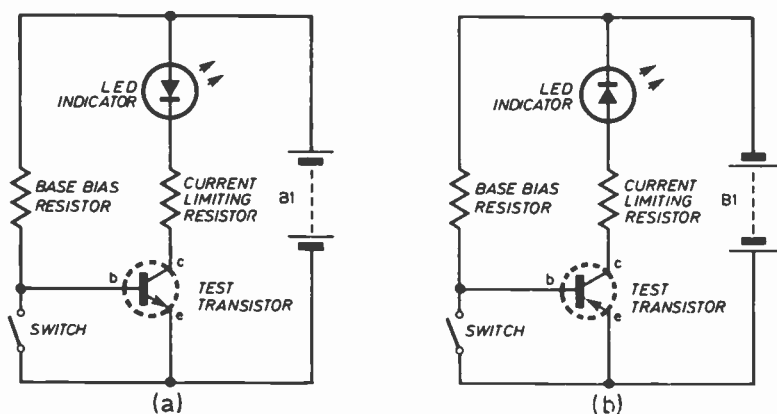

Fig. 1. (a) Testing an *npn* transistor (b) Testing a *pnp* device.

of the output waveform. In this case the ratio is roughly one to one (i.e. the on and off times of the l.e.d. will be approximately equal).

PNP MODE

If we consider the circuit in the *pnp* mode, the output of IC1 is connected to the base of TR1 via the potential divider which consists of R3 and R5. Transistor TR1 will therefore be switched hard on when the output of IC1 is low, and cut off when this output goes high.

When in the high state the output of the i.c. is about 1 to 2 volts below the positive supply rail potential, which normally would be sufficient to turn TR1 on if its base was simply fed via a series current limiting resistor, rather than by way of the potential divider network. Resistor R6 is the base bias resistor for the transistor under test.

The emitter of the test transistor is connected to the positive supply rail through S1d, and the collector is connected to the negative supply rail through D1 and current limiting resistor R8. The base terminal connects to TR1 collector through S1a, and so the device under test will be biased by R6 when TR1 is cut off, and it will be cut off when TR1 is switched on and effectively short circuits the base emitter terminals of the test transistor.

HOW IT WORKS ...

Basically the unit consists of a low frequency oscillator operating an electronic SWITCH. When the SWITCH is closed the base and emitter terminals of the test transistor are shorted together. Thus the transistor is turned off.

When the SWITCH is turned on, by the pulses from the oscillator, the base/emitter is disconnected. Instead the base is connected to a BIAS RESISTOR which turns the transistor *on*. Thus the indicator illuminates. The final result is that the l.e.d. indicator flashes on and off when a good transistor is connected.

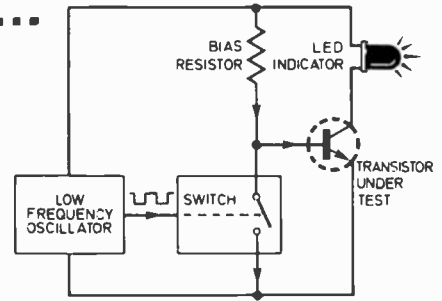

NPN MODE

In the *nnp* mode the base of the test transistor is connected to the junction of TR2 collector and R7. It is then TR2 which short circuits the base of the device under test, and R7 which provides the base bias. Transistor TR2 is switched on when the output of the i.c. goes high and switched off when it goes low. In the low state the output of the NE555 is only a fraction of a volt, and so TR1 can have its base fed from the output of IC1 via only a current limiting resistor rather than a potential divider, as in the case of TR1.



ESTIMATED COST OF COMPONENTS

£3.50

excluding case

Fig. 2. The complete circuit diagram for the In-Situ Transistor Tester.

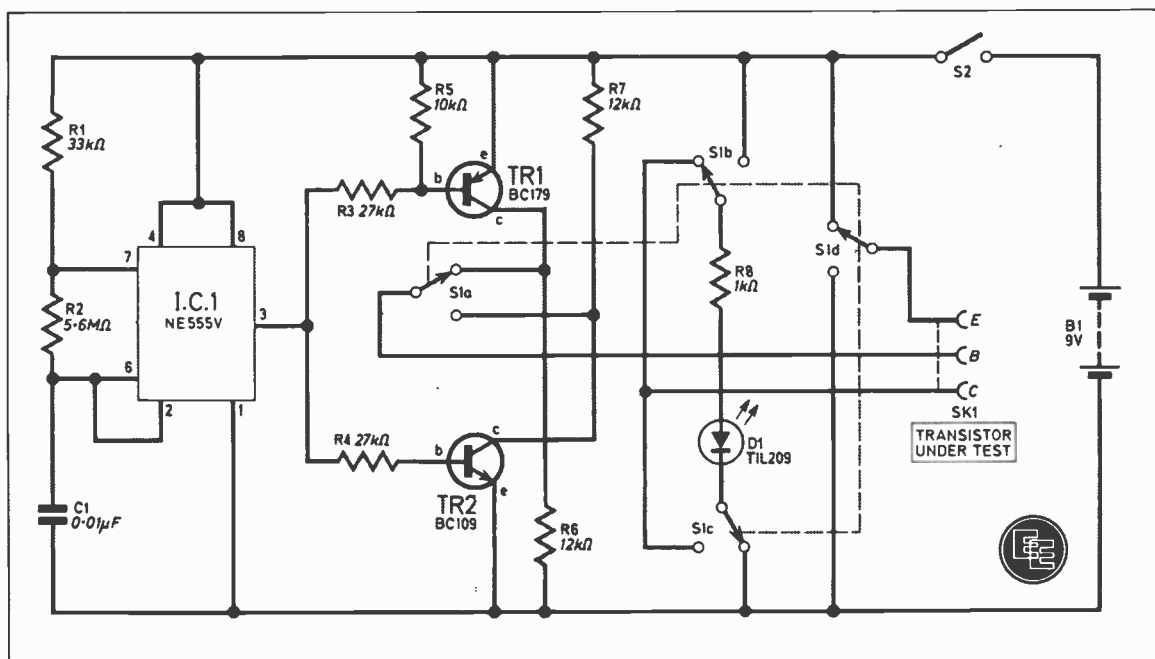

In the *npn* mode S1d connects the emitter of the test transistor to the negative supply rail, and S1b and S1c connect the collector to the positive supply rail via R8 and D1. These two poles of the mode switch also ensure that the polarity of D1 is appropriate.

Switch S2 is the on/off switch. The quiescent current consumption of the circuit is about 5mA, this rising to about 10mA when the device is connected to an operative transistor.

**START
HERE FOR
CONSTRUCTION**

CASE

A Verobox type 65-3851A makes an excellent housing for the project, but any case of a similar size, 120×65×40mm, should also be suitable. The general layout of the front panel can be seen from the photographs, but this is not critical and any layout can be used.

TEST LEAD

The connections to the test transistor are brought out to a 3-way DIN socket. Most transistors will plug direct into this socket, but for those which will not, or when testing in-situ devices, it is necessary to connect suitable test prods to the unit via a 3-way DIN plug.

It is advisable to use clip-on type test prods or sub-miniature crocodile clips as it would be extremely difficult to hold three test prods in position simultaneously.

The DIN socket requires a central mounting hole 16mm in diameter and this can be made using a chassis punch. The positions of the two 3mm diameter mounting holes are then found using the socket as a template. Short 6BA mounting screws are used.

CIRCUIT BOARD

Most of the components are assembled on a 0.1 inch matrix stripboard panel which has 14 holes by 18 strips. Details of the



Completed tester showing front panel layout.

component panel and other wiring of the unit are shown in Fig. 3.

Make the four breaks in the copper strips and drill the two 3mm diameter mounting holes in the panel, then solder in all the components and link wires, leaving the transistor and i.c. until last. Next wire in R8 and the battery clip, and complete all the point to point wiring using thin multistrand p.v.c. covered wire, using reasonably long leads between the component panel and the components on the front panel.

BOARD MOUNTING

When all the wiring has been completed the component panel is mounted on the rear panel of the case behind diode D1 and the DIN socket. It is mounted using two short 6BA bolts, and an extra nut is used over each bolt, between the panel and the case, so that the panel is just slightly spaced off the

Completed transistor tester with front panel removed showing mounting of the circuit board.

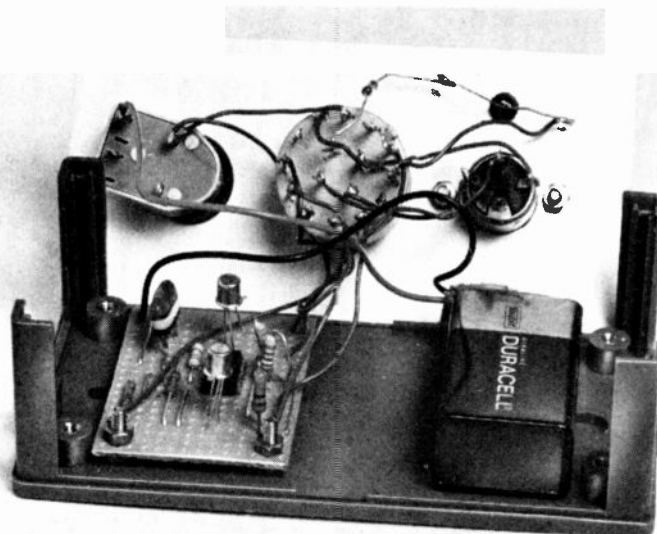

case. If this is not done it is possible that the panel would be damaged when the mountings were tightened. The PP3 battery can be fitted into the space below the two switches, or behind S2.

USING THE UNIT

As was pointed out earlier, the unit needs to be used sensibly if it is to be of maximum worth, and it is not simply a matter of setting S1 to the correct mode, connecting the tester to the transistor, and seeing if the l.e.d. flashes on and off.

The following points should be noted:

With germanium transistors it is quite in order for a small amount of current to flow through the device even when the base and emitter terminals are shorted together. This current is known as the "leakage current" and will cause the l.e.d. to glow (but comparatively dimly) when it should be switched off.

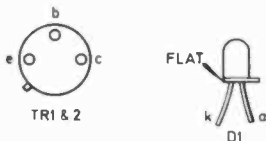
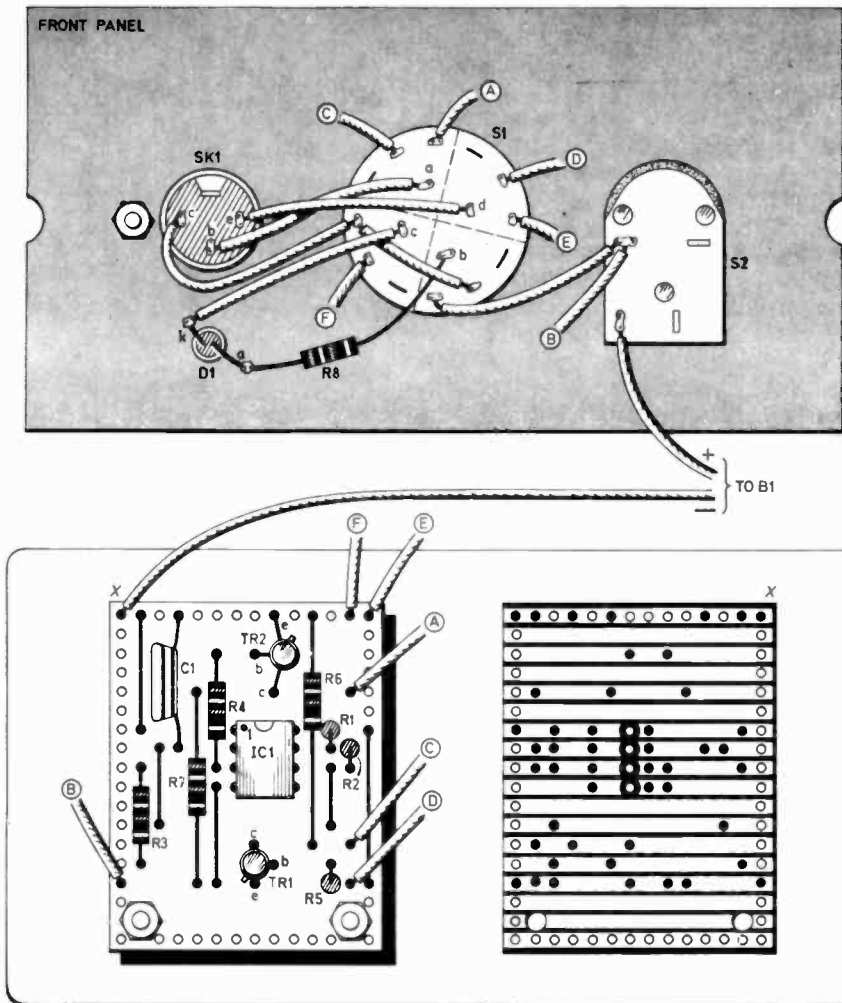

Fig. 3. Interwiring details for the front panel, circuit board component layout and underside of the stripboard showing breaks in the copper tracks.

IN-SITU TRANSISTOR TESTER

COMPONENTS

Resistors

R1	33k Ω	R5	10k Ω
R2	5.6M Ω	R6	12k Ω
R3	27k Ω	R7	12k Ω
R4	27k Ω	R8	1k Ω

All are $\frac{1}{4}$ W carbon $\pm 5\%$

Capacitors

C1 0.01 μ F plastic or ceramic

Semiconductors

IC1 NE555V timer i.c.
 TR1 BC179 silicon *pnp*
 TR2 BC109 silicon *nnp*
 D1 TIL209 red light emitting diode

Miscellaneous

S1 4-pole 2-way rotary switch.
 S2 rotary double pole switch (mains type)
 B1 PP3 9V battery
 SK1 3-pin DIN socket
 Stripboard 0.1 inch matrix 18 strips by 14 holes; Verocase type 65-3851 A or similar size, 120 x 65 x 40mm; battery connector; mounting clip for D1; i.c. socket; two small round knobs; connecting wire; solder; 6BA hardware; additional components for test lead if required: 3-pin DIN plug; flexible stranded wire; three small crocodile clips.

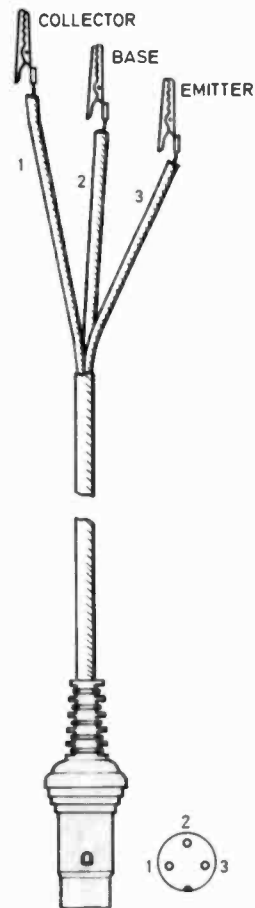

Fig. 4. Test lead for in-situ testing using three-core cable, subminiature crocodile clips and a three-pin DIN plug.

See
**Shop
 Talk**
 page 485

IN-SITU TESTING

A similar problem exists when testing any device in-situ. In virtually all instances there will be components in the circuit which will provide leakage paths and will cause the l.e.d. to glow dimly when it should be turned off. If the device under test is serviceable there will nearly always be a significant change in the brightness of the l.e.d. as the tester switches from one state to the other. If the l.e.d. comes on continuously at full brightness this probably means the device has gone short circuit.

Failure of the l.e.d. to come on, or only a continuous dim glow probably means the test transistor has become open circuit.

However, before removing and discarding a device which has produced such results it would be prudent to check the circuit diagram to see if the circuit around the transistor contains any low resistance paths which could upset the operation of the tester. These would normally only occur in stages handling fairly high powers,

such as a.f. output stages, and the unit is not recommended for this type of test.

Reference to Fig. 1 will show that misleading results could be obtained if there was a short circuit between the collector and base terminals of the test transistor. This would cause the l.e.d. to come on when the switch was in the position shown as the circuit would be completed through the switch and the collector-base terminals of the transistor.

This path would be broken when the switch position was changed, possibly causing the l.e.d. to be switched off. It is therefore advisable to test the transistor with the emitter test prod disconnected. This should result in the l.e.d. failing to come on except on in-situ tests where it will probably light up rather dimly.

DIODE CHECKING

The unit can also be used to provide a quick check on diodes and rectifiers. With a diode or rectifier connected across the emitter and collector test prods, with the

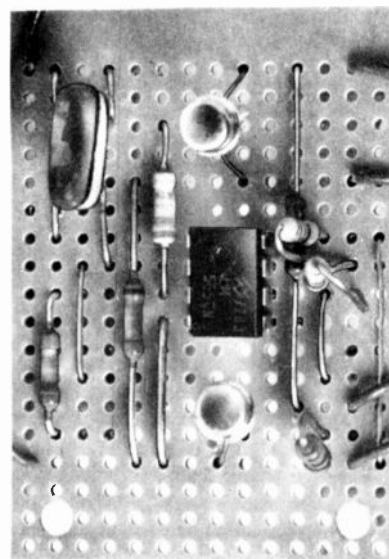

Layout of components on the circuit board.

cathode connected to the emitter prod, the l.e.d. should light up when S1 is in the *npn* mode, and extinguish when it is switched to the *pnp* mode. ☒



Readers' Bright Ideas; any idea that is published will be awarded payment according to its merit. The ideas have not been proved by us.

TOUCH SWITCH

While reading an article in the January issue of *EVERYDAY ELECTRONICS* about an electronic touch switch, it occurred to me that a suitable set of touch contacts could be made from a phono or similar plug.

The protruding centre-pin is cut to the same level as the outer cylinder, then smoothed with a file or emery paper. The phono plug is then glued into a suitable hole drilled in the project case.

It is then a simple matter to switch the circuit on and off.

N. Sutcliffe,
Manchester

LOCATOR CASE

In the *Treasure Locator* project (October '77), I have mounted all the components on a piece of hard-board and fitted an ordinary seed tray on to this. The trays without the drainage holes should be used. These are readily available and cost only 20 pence or so. The external controls are simply mounted at one end of the tray.

A second improvement I have made is using a plastic dinner plate for mounting the search coil, as this gives a neater finish. Mounted on the plate are three bolts which connect to the search coil. The three wires from the circuit are terminated in spade tags which fit over the bolts. This will prove useful when dismantling.

G. Prynne,
Plymouth,
Devon.

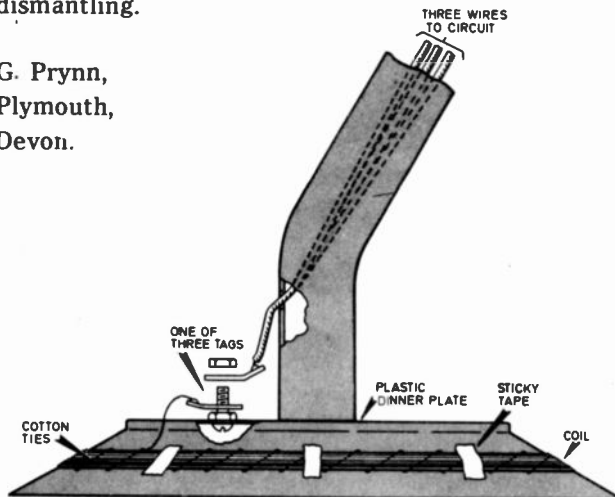

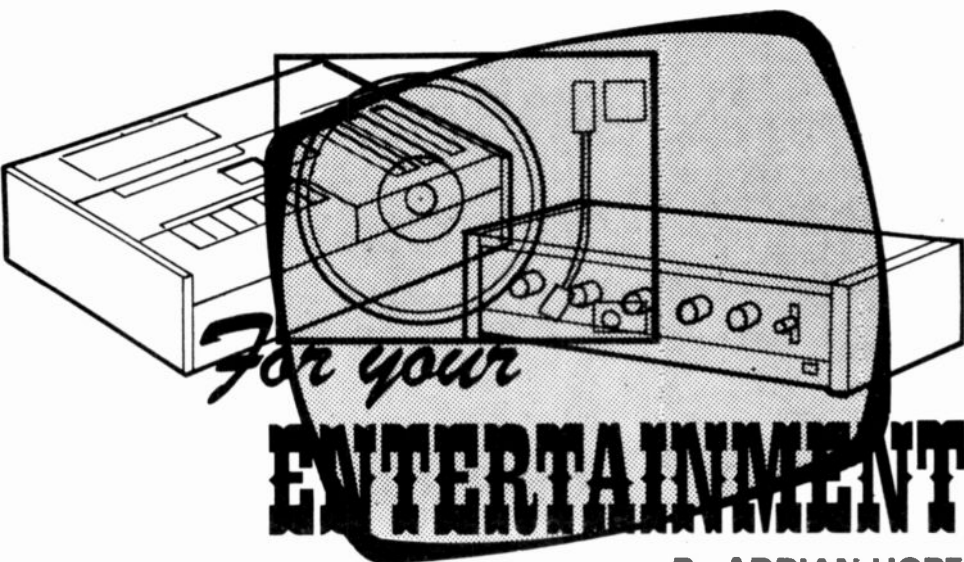

By ADRIAN HOPE

Video at the Summit

Recently there was some publicity on how the BBC had started using electronic newsgathering techniques for television news. In other words, instead of using 16mm film cameras, the BBC is now using video cameras and portable videotape decks.

The first electronic news item was of Mrs Thatcher. But, seeing their first efforts, I think the BBC engineers should take a close look at a remarkable Japanese-Canadian film called *The Man Who Ski-ed Down Everest*.

This film was made a couple of years ago, but has only just recently reached these shores. It records the extraordinarily bizarre Japanese expedition in 1970, led by Yuichiro Miura, to Mount Everest.

Eight hundred porters hauled 27 tons of equipment up the early slopes of Everest (at a rate of \$1 a day for a 30-kilo load!) and seven men went with Miura and two tons of equipment up to the top of the glacier just below the summit. It was Miura's ambition to ski down that glacier and, although he very nearly killed himself in the process this he actually accomplished.

It's all there in the wide screen colour film, shot with massive Panavision cameras that must have made up a fair fraction of the 27 tons. But what made the trip electronically fascinating was the fact that Miura also took up a full complement of Akai video equipment.

He knew that the 6,600ft long glacier would provide a frighteningly fast run on skis (well over 100m.p.h.) and send him plunging down a ravine at the end unless he could stop in time. So Miura planned to use a parachute trailing out behind him, to slow his ski speed down a little.

The problem was that parachutes are not designed to operate at the altitude of Everest which is around 30,000ft, where the air is very thin. So

Miura and his colleagues tried some short, experimental runs with the parachute, filmed them with the video camera, and then sat down to watch what must have been the highest altitude video playback ever.

They didn't waste the video equipment in between ski runs, as amongst the porters' baggage was a canister of pre-recorded video tapes. For most of the Sherpas it was the first time they had ever seen television. And the programmes? Several episodes of the TV series *Bonanza* and a full length version of *The Seven Samurai*. Surely that belongs in the Guinness Book of Records.

Compatibility Check

To run a calculator or TV game or small cassette recorder on batteries is often a very expensive business. A full set of cells can easily cost £1. It makes far more sense to use a d.c. supply or "battery eliminator". These cost less than a fiver and will very soon repay the original outlay.

But, beware problems of polarity. Recently I noticed that two items of battery equipment, one a calculator and the other a TV game, both plugged neatly into the same battery eliminator. But one worked and the other didn't. The reason; each needed an opposite polarity d.c. supply.

Because so much electronic equipment now comes in from the East, with double Dutch or inadequate instructions (or none at all) there may be no way of knowing which side of the d.c. input socket is positive or negative. So try swapping polarity of the d.c. supply if a gadget works on batteries but not on an eliminator.

Bear this in mind when buying (or making) an eliminator. You will need a polarity reversal switch to avoid fiddly and time consuming re-wiring.

My impression is that calculators may tend to have one polarity and recorders and TV games the opposite. But is this a standard? If it is, no-one seems to refer to it. Possibly it's just a matter of 50-50 chance which polarity a piece of equipment needs.

A couple more, equally irritating, non-standard situations are arising. There are now several miniature tape recorders on the market which rely on miniature audio cassettes. These cassettes all superficially resemble minaturised versions of the well known Philips audio cassette but, and it's a big but, they aren't all the same. In fact, there are now three or four slightly different miniature cassettes which fit only the machines for which they were designed.

So be warned. Although two miniature cassettes and recorders may look compatible, there is a good chance that the cassette for one won't quite fit the machine for another and so on.

Likewise, be warned when buying microphones for ordinary audio cassette recorders. Some of these come with DIN plugs and present no problem. But others have a double miniature jack on the end, one half of the jack carrying the audio signal and the other serving the remote on-off switch on the microphone.

The snag is that the spacing between the two halves of the plug may be such that a microphone for one machine won't fit another even though their sockets look exactly the same. So be very careful about buying such microphones by mail order or without the machine itself to hand, so that you can check for an easy fit before purchase.

CLUB CORNER

THE BRITISH AMATEUR ELECTRONICS CLUB

Special facilities are now offered by BAEC to its novice members. A "clearing house" has been established, through which beginners can request information and advice, and receive appropriate help and even practical assistance in the form of kits, components and books. The BAEC Newsletter will contain a new series aimed at the beginner.

Secretary: J. G. Margetts, 42 Old Vicarage Green, Keynsham, Bristol.

WALLINGFORD ELECTRONICS CLUB

Formed in September 1977, The Wallingford Electronics Club is a non-profit making organisation for the pursuance of electronics as a hobby. The Club exists to provide mutual exchange of knowledge and experience in the fields of radio, electronics, electrical engineering and related sciences and technology. The club also provides education and encouragement to younger members who wish to make electronics their hobby or their career.

Secretary: J. Gilpin, 27 Clapcot Way, Wallingford, Oxon OX10 8HS.

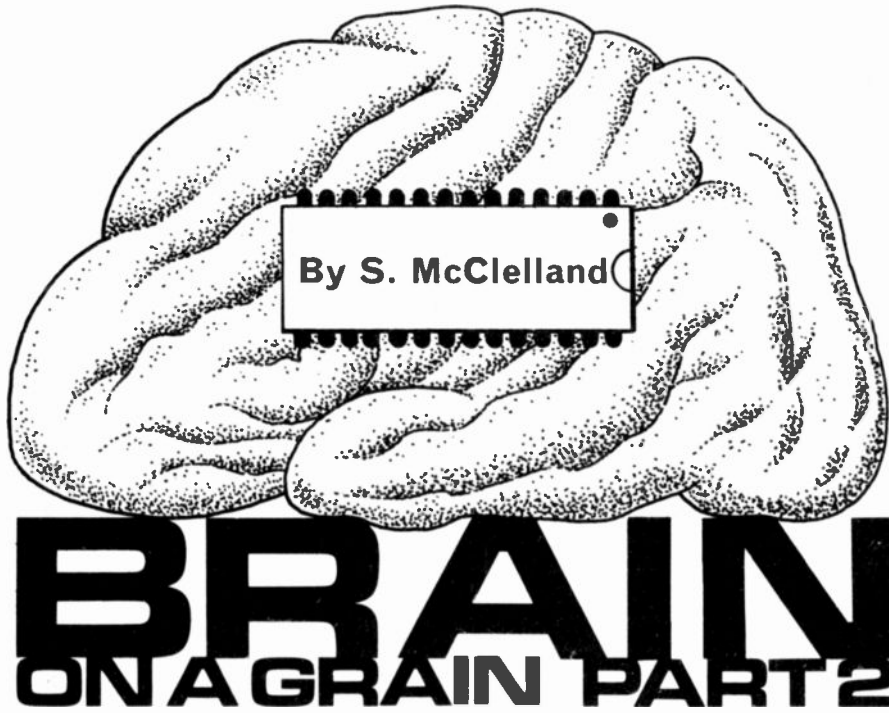

By S. McClelland

BRAIN ON A GRAIN PART 2

LAST MONTH we saw how information in a microcomputer is conveyed in bytes (groups of 8 bits). Let us now discover how this information is shunted around a microcomputer to enable it to do exactly what the human user intends.

Remember the MPU chip is only part of the complete microcomputer system; it can do nothing by itself because it needs two sorts of information:

- (1) A complete list of instructions called a *program* that actually tell the MPU what to do (add, subtract, multiply or divide, for example).
- (2) *Data* or "numbers" on which to perform these instructions.

These two kinds of information are stored in two kinds of memory—we are going to call these just program memory and data memory respectively for the moment (see Glossary). These memories are usually contained in separate chips—referred to as "peripherals".

BUSES OR HIGHWAYS

When instructed by the MPU itself, either of these memories can unload bytes of information. They communicate with the MPU by means of *buses* or highways which transfer information and control signals from one part of the system to another. There are

commonly three main buses in a microcomputer system:

- (1) Data bus.
- (2) Control bus.
- (3) Address bus.

The term data bus may confuse—it not only transfers data but also instructions! It's a two-way (bi-directional, in the trade jargon) bus, that is, by crafty design, we can use the same signal lines to put information into and take information out from, the MPU.

The control bus as its name implies switches the peripheral chips to the MPU on and off in sequence to ensure for example that more

than one memory doesn't use the same bus at the same time. Understandably, this would cause the MPU some confusion!

But all this wouldn't be much use if the MPU didn't know where the information it wanted was located in the memories. And this is where the address bus comes in. Each byte in each memory is assigned a unique label or *address* which performs exactly the same function as our own house addresses—they tell people where we are..

When the MPU outputs the binary address of a memory location it uses the address bus to activate the right one and discharge its contents on the data bus.

For an 8-bit MPU the address bus is usually of 16-bit capacity, i.e. it can address up to 2^{16} or 65,536 separate locations.

You can visualise the memories as stacks of "pigeon holes" in which each instruction is stored neatly next to the following one. This makes for a logical program read-out when the contents of each are examined in turn by the MPU.

INSIDE THE M.P.U.

Fig. 2 shows schematically the important parts of the MPU itself.

Again note that nearly all the internal components have access to one or other of the main external buses. The MPU also possesses its own small storage registers, the most important of which is the 8-bit *accumulator*, the main store of the MPU where data is arithmetically manipulated (for example, added together) to produce results.

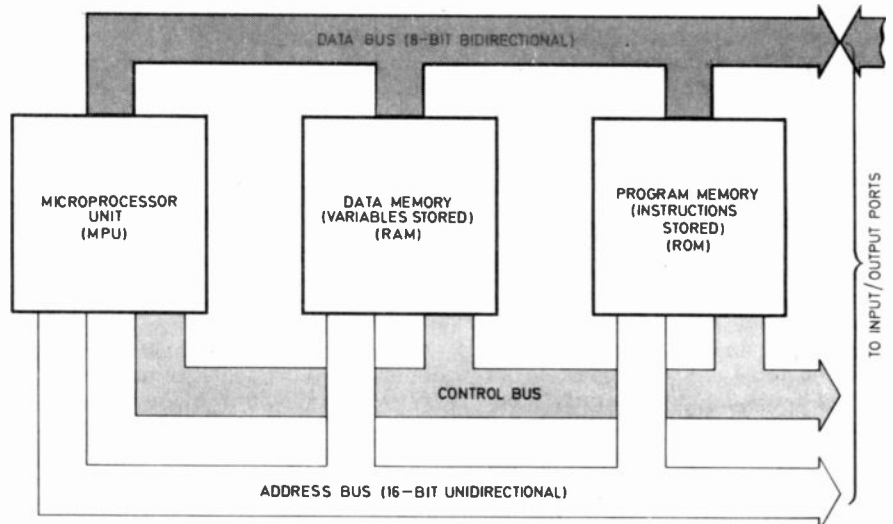

Fig. 1. A basic microcomputer system, including MPU and memories.

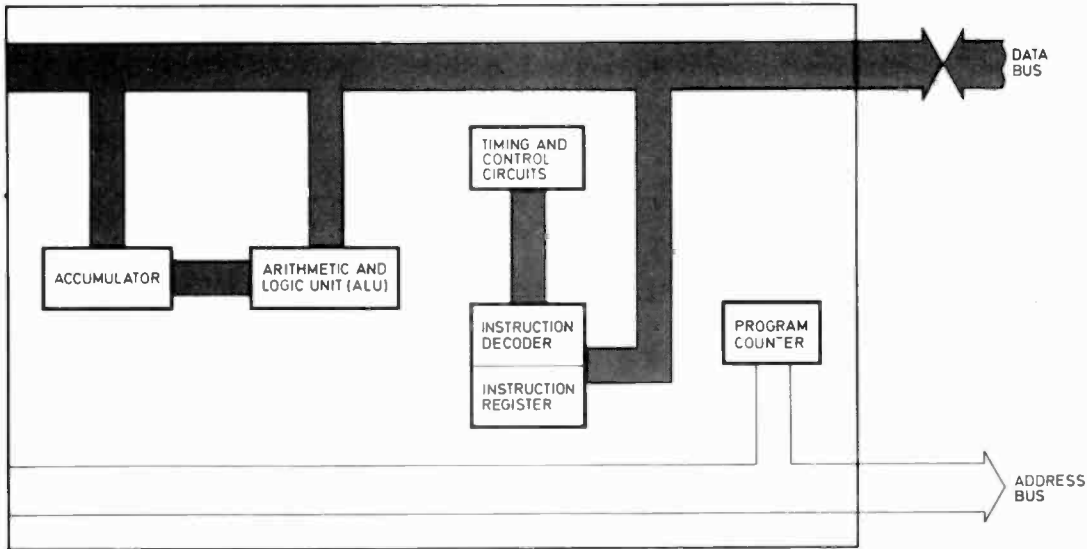

Fig. 2. A schematic diagram of the inside of a microprocessor.

The 16-bit *program counter* holds the address of the next instruction to be drawn from the (program) memory. After each instruction is completed it is automatically incremented by 1 and so keeps track of the progress of the program.

Other major components include the *arithmetic and logic unit* (ALU) which actually performs the additions (etc) and logical operations on the incoming data; and the *instruction decoder* which actually interprets the meaning of an 8-byte instruction for the rest of the MPU.

There are also other miscellaneous registers concerned with

instructions and addressing and timing circuits which properly sequence the operations of the processor.

PROGRAMMING EXAMPLE

We can now follow the operation of a microcomputer in action. It is important to realise that even the simplest calculations as far as humans are concerned (for example, a simple addition such as $2+3=5$) involve the microprocessor in many separate steps. But we can summarise its basic operation as being one of fetching bytes of data (in this case the numbers 2,3) from the data memory, adding them together in the accumulator

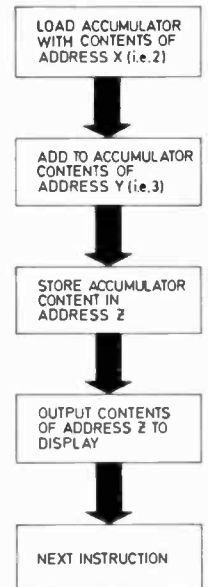

Fig. 3. Flow diagram of MPU operations for simple addition $2 + 3 = 5$. The number 2 is stored in data memory address X. The number 3 is stored in data memory address Y. The result is to be stored in data memory address Z. (X, Y, and Z can be any locations in memory).

(the "add" instruction is of course signified by the "+") and then storing the result in another memory location for future reference, for example, display.

This is summarised in Fig. 3, a *flow diagram* which is a common means for breaking down programs into their essentials.

OPERATION SUMMARY

Describing the full operation of a microcomputer system, i.e. what happens instruction by instruction, is a very long-winded procedure.

GLOSSARY

ACCUMULATOR. The main register or store in the microprocessor chip.

ADDRESS. The particular location of a data element in a memory store.

ARITHMETIC AND LOGIC UNIT (ALU). The component in the microprocessor chip which performs the arithmetic (e.g addition and subtraction) and logical (AND, OR) functions on data.

BUS. A data highway to which several components or peripherals have access.

HARDWARE. The physical construction of the computer; i.c.s, memories, displays, etc.

HEXADECIMAL. A number system with base 16, effectively a shorthand form of standard binary much used by programmers. Decimal and hexadecimal nomenclature is the same for 0 to 9, but decimal 10 to 15 becomes hex A to F.

HIGH LEVEL LANGUAGE. A computer language so highly developed that programs can be written almost in English using it.

MACHINE CODE. Basic microprocessor language, straight binary.

MICROCOMPUTER. A general term referring to a system containing a microprocessor and support i.c.s such as memories.

MICROPROCESSOR (MPU). The "brain" of a microcomputer, a circuit capable of highly advanced calculation ability.

PROGRAM. A complete list of instructions that tells the MPU what to do with its data.

RANDOM ACCESS MEMORY (RAM). A type of memory usually used for implementing *data memory* i.e. the MPU can read information in it.

READ ONLY MEMORY (ROM). Implements *program memory*. Information once stored in it cannot usually be altered by the MPU.

SOFTWARE. A general term for computer programs (as opposed to the computer's physical construction, *hardware*).

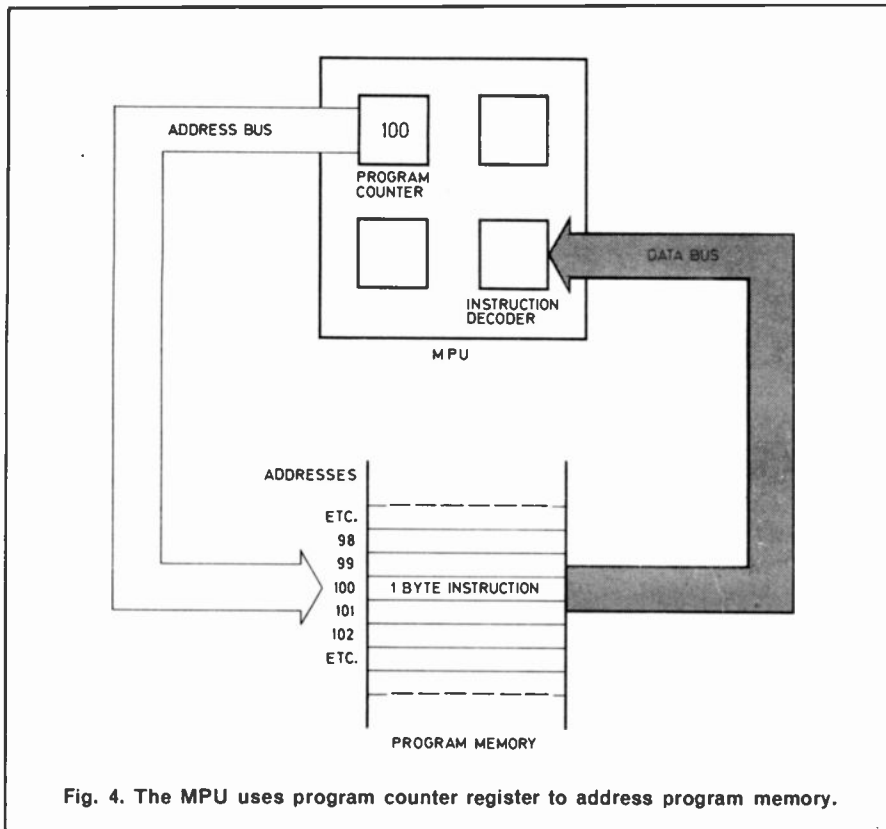

Fig. 4. The MPU uses program counter register to address program memory.

What basically takes place however is relatively straightforward. The MPU fetches instructions from its program memory, interprets them in its instruction decoder and then executes them. The number of permissible instructions for a modern microprocessor is in the range 70-100, quite large enough for all the possible data manipulations that can take place.

This "fetch-execute" cycle can be broken down into sub-operations. The MPU in fact accesses instructions in the program memory by addressing them, location by location in turn via its program counter.

Only when each instruction has been acted on by the MPU is the program counter incremented by 1 to address the next location (Fig. 4). The program memory also contains the addresses in the data memory of the data, i.e. "numbers" on which these instructions have to be performed.

INTERRUPTS

We extend the data and address buses through "input/output ports" to the outside world, so with the right devices (for example tele-typewriters) we can

"talk" to the MPU and it can communicate with, and even control, external equipment.

A particularly important feature of this communication is the provision for interrupt signals. The MPU can after all carry out instructions in mere microseconds but the outside devices it is dealing with, for example teleprinters, are relatively slow by comparison.

So we can squeeze the most usage out of the MPU (and this is the important thing in any computer system) if we operate two or more of these peripheral equipments seemingly simultaneously, but in fact by fast switching, one at a time.

We can even run the MPU normally through a main program and only break off what it is doing when a peripheral device signals "interrupt". When the MPU has dealt with the peripheral in question it can rejoin the main program again exactly where it left off.

Fig. 5 and Fig. 6 show how future in-car and domestic microprocessor systems may be able to multiplex themselves to give a great range of "simultaneous" facilities, with such techniques.

WHAT'S IN IT FOR US?

"Big deal," you may say. "We can add two numbers together by microcomputer. But we can add them with a simple logic circuit, too. What have we gained?"

Apart from the small size and power consumption of the MPU and the fact that we could probably do upwards of a hundred-thousand of these additions every second, what we've really gained (as we hope you've realised) is versatility. A dedicated binary adder is an adder all of its days, but give a different program to a microcomputer and it can do a different job entirely.

We may find the same microprocessor chip in a counter/timer, a sewing machine, a piece of test gear, a robot-controlled car or in a calculator. The functions of these equipments are all different but the principles of their operation are basically the same.

"ISN'T PROGRAMMING TOO COMPLICATED FOR MOST PEOPLE?"

The programming in machine code can be a long and tedious

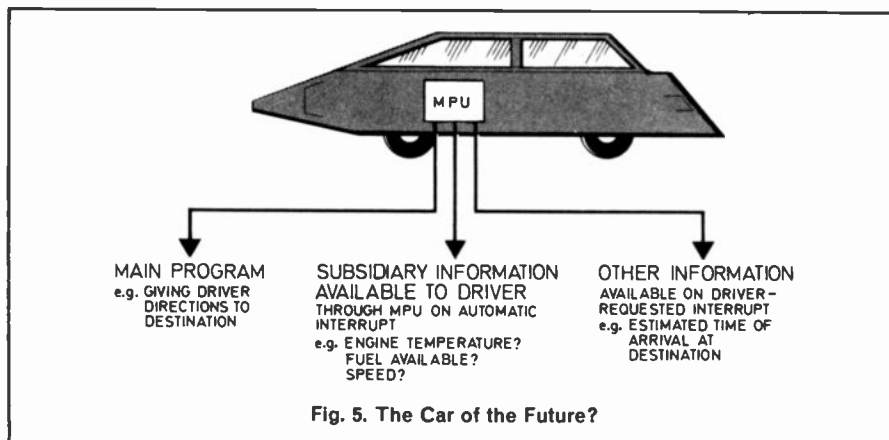
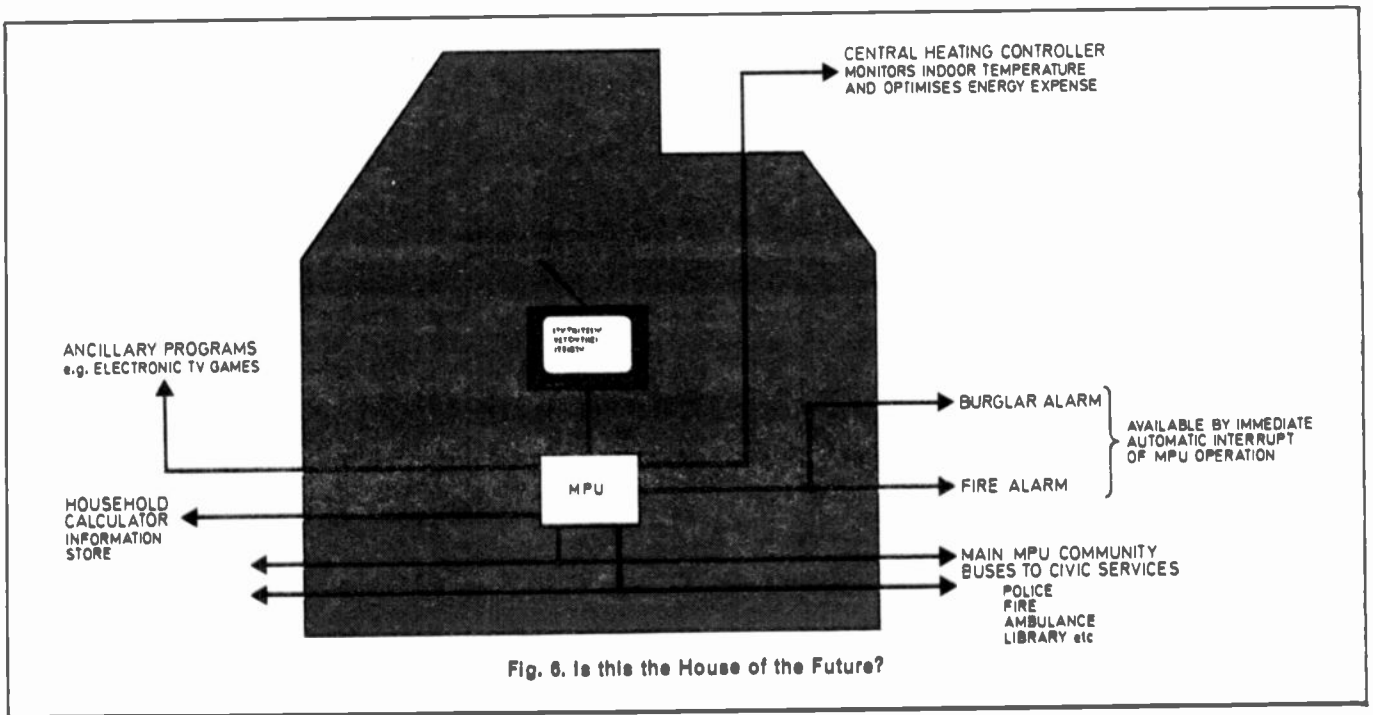

Fig. 5. The Car of the Future?



business and it won't make micro-computers many friends.

However computer engineers—fiendishly clever as they are—have simplified it enormously. We can “talk” to the processor in mnemonic words rather than exclusively binary. These mnemonic words are translated into machine code by the computer system for the MPU.

If you have a large computer handy you can even use a really sophisticated language like FORTRAN or BASIC in your programs. It will translate the high level language into MPU type machine code.

“WHAT DO I NEED TO SET UP A MICRO-COMPUTER SYSTEM?”

Most manufacturers market their own MPU “low cost development kits” aimed at getting the small user interested. They contain all the essentials needed to get a basic microcomputer functioning—typically the MPU chip itself plus memory and interface i.c.s and all the terminal equipment necessary to enter the display data.

It's this equipment which can become the most expensive part of the whole system. The ideal input/output or terminal devices are probably the teletypewriter or

visual display unit (VDU) but these are probably too costly for most people (although building a VDU is now certainly within scope of the home enthusiast).

Fortunately the manufacturers have got round this to some extent at least by supplying calculator-type keyboards and displays to enter and display programs. In the cheaper type of development kit banks of switches and l.e.d.s perform the same function.

So if your pocket stretches to it—or if you can club together with a few friends at school or college why not take the plunge and set up your own computing system? ☒

JACK PLUG & FAMILY...

BY DOUG BAKER

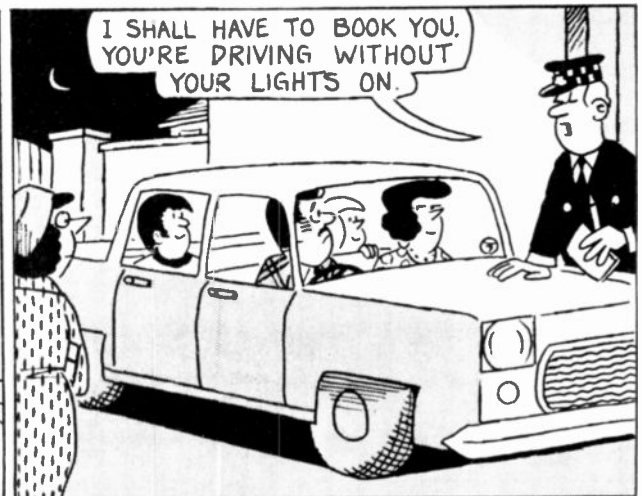

TEA

CH-

in

78

Part 9

BY
GEORGE
HYLTON

RADIO—MODULATION—RECEIVERS

THIS month we continue with the subject of Radio.

RADIO WAVES

The possibility of radio waves was glimpsed by Michael Faraday, worked out theoretically by his younger contemporary, James Maxwell, and later demonstrated by Heinrich Hertz.

Faraday said nothing about his ideas except that he wrote a mysterious note which said, in effect, "I've got an idea that electromagnetic fields could be used for communication, but I haven't time to investigate this now." He never did.

According to one of his biographers Faraday probably visualised the field of a magnet Fig. 9.1, as lines of force curving outwards into space like some invisible, weightless array of wires. The array extended to infinity.

If a line of force could be plucked like a harp string the vibration would travel out into space along the line. An observer at some distant point along the line could, in principle, detect the vibration. The vibrations could therefore be used to transmit information.

To transmit electrical energy required changes of both voltage and current. As we have seen, current is always associated with a magnetic field. Voltage is associated with an electric field. Both kinds of field can extend into space. If both are varied, in sympathy, power is transmitted. This is what happens in radio transmission.

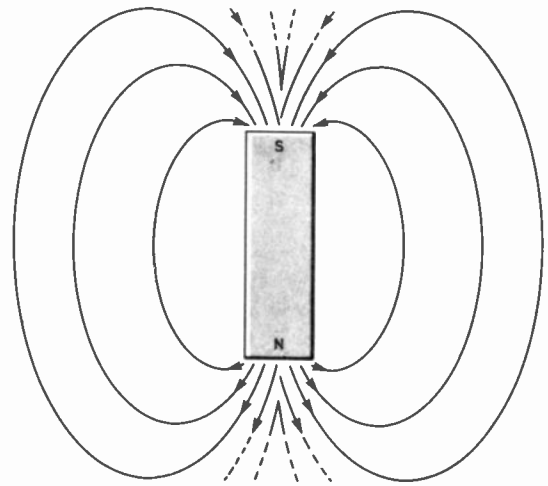

Fig. 9.1. The field of a bar magnet is represented here by the contour lines of ever-widening diameter.

ELECTRIC FIELDS

At the receiver you can pick up either the magnetic part or the electric part or both. The coil on your ferrite rod responds to the magnetic field, which induces a voltage. An aerial wire responds to the electric field. In effect, the aerial joins together points in space where the voltages are different, so that a current flows in the wire.

The electric field and the magnetic field are always at right angles to each other. If you could see these fields with your eyes and you looked at a radio transmitter with a vertical aerial the electric field would be vertical and the magnetic field horizontal. Such a transmission is said to be **vertically polarized**, the direction of the electric field shows the polarization.

Radio waves travel through empty space at the speed of light. This is not surprising because light is just a very short-wavelength (around half a millionth of a metre), electromagnetic wave.

The speed in air is only very slightly less. In more solid media it may be much less. Although the speed of electromagnetic waves is high, 300 million metres per second, their passage can be timed by fast electronic timing methods. Time intervals down to about a thousand-millionth of a second are fairly easy to measure nowadays.

A wave travels about 300mm in a nanosecond.

To return to your radio receiver, Fig. 7.12. It is of a kind which used to be called an O-V-1. That means there is no (O) amplification of the incoming radio frequencies, one detector stage (V) and one audio amplifier stage (1).

You will have realised, no doubt, that the ferrite-cored aerial coil and its capacitor, CT form a parallel-tuned LC circuit which gives selectivity. You may well also have realised that the selectivity is not very good.

If you remove the tuned circuit and just connect an aerial Fig. 9.2, and a resistor to discourage mains hum you will be able to see what happens when there

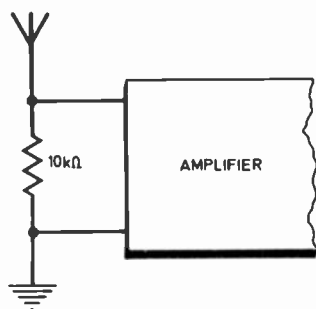

Fig. 9.2. By connecting just an aerial to the input of an amplifier, interesting results can be obtained.

is no selectivity at all. You can use as long an aerial as you like for this experiment.

One thing you are likely to pick up is the local TV signal. You may also hear short wave signals.

SUPERHETERODYNE RECEIVERS

Great selectivity is needed to pick out weak stations from among strong ones on frequencies close by.

For many years the standard way of improving selectivity has been to make use of the fact that it is easy to change one frequency into another. The strategy is to change the frequency of the wanted signal to a standard frequency called the **intermediate frequency**. The receiver has highly selective filters set to pick out the intermediate frequency.

The method of changing the frequency makes use of an effect called **intermodulation**. When two frequencies are fed to a device such as a diode or transistor, which does not obey Ohm's Law, two more frequencies are generated. These are the sum of the two original frequencies and their difference.

Thus if the two original frequencies are 10kHz and 11kHz the new frequencies are 21kHz and 1kHz. The human ear does the same thing. This is why, when you hear two loud sustained musical notes close to one another in frequency you also hear a third note.

This is a low frequency throbbing noise, the difference between the two notes. It is called a beat note or beat tone.

An a.m. transmitter modulated with a single pure note shows this intermodulation effect. In addition to the nominal frequency, called the **carrier frequency**, **sum** and **difference** frequencies are generated. If the carrier frequency is 1000kHz and the modulating frequency is 1kHz the sum and difference frequencies are 999kHz and 1001kHz.

These fall symmetrically on each side of the carrier and are called side frequencies. When the carrier is modulated by speech and music, which consist not of single frequencies but mixtures of frequencies a whole series of side frequencies is generated on either side of the carrier. These side frequencies are known collectively as **sidebands**.

DETECTION

The process of detection is also an intermodulation process. When applied to the detector, the carrier and side frequencies give rise to different frequencies.

In the example quoted each side frequency beats with the carrier to produce a side frequency of 1kHz. This of course is the original audio frequency, which is thereby recovered by the detection process. When intermodulation takes place the strongest signal is dominant. In amplitude modulated signals the carrier is always at least twice as powerful as the sidebands. So the sidebands beat with the carrier, not with one another.

To change the frequency of an incoming transmission to the intermediate frequency the usual type of receiver uses a local oscillator. Its output is fed to the intermodulation generator called the frequency changer along with the incoming station Fig. 9.3.

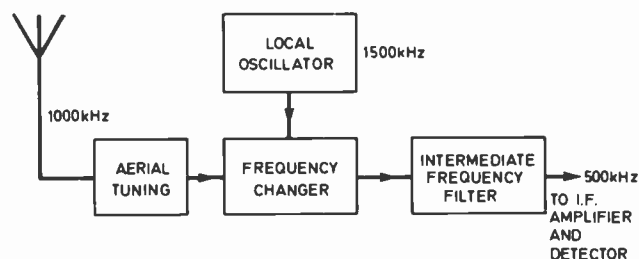

Fig. 9.3. Simple block diagram of a superhet receiver. The important section to note is the frequency changer.

IMAGE FREQUENCIES

One snag about the system is that there are always two signal frequencies which can beat with the local oscillation to yield the wanted i.f. In the example given, this other signal frequency is 2000kHz Fig. 9.4.

The aerial tuning circuit has to be selective enough to eliminate this unwanted other frequency called the **image frequency** or **second-channel frequency**.

This is not very difficult for the frequencies shown.

Other signal frequencies near the wanted frequency also beat with the local oscillator to produce difference frequencies.

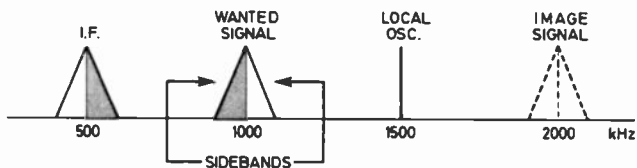

Fig. 9.4. Illustrating how image signals or second channel frequencies can be produced.

These fall on either side of the chosen i.f. and are rejected by the i.f. filter. Sum frequencies are also generated and similarly rejected.

This kind of receiver is called a superhet, which is short for "supersonic heterodyne". Here heterodyne means beat frequency and supersonic means too high-pitched to be audible.

Your kind of receiver, with tuning only at the incoming radio frequency is called a tuned radio frequency receiver. Practical t.r.f. receivers usually incorporate positive feedback to improve selectivity.

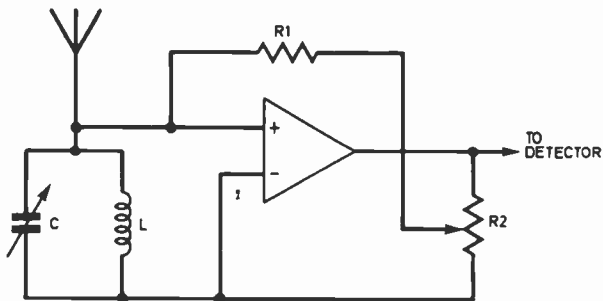

Fig. 9.5. The principal of a t.r.f. receiver. This circuit is essentially the same as an LC oscillator.

The principle Fig. 9.5, is essentially the same as in an LC oscillator, but the feedback is adjustable. To maximise selectivity the receiver operator sets the feedback control so that the circuit just fails to oscillate. Since the LC aerial circuit has an impedance which is highest at the tuned frequency, the feedback via R1 is greatest at this frequency, which is emphasised most.

The general effect is shown by the dotted curve in Fig. 9.6. The feedback, usually called reaction or regeneration increases gain as well as selectivity.

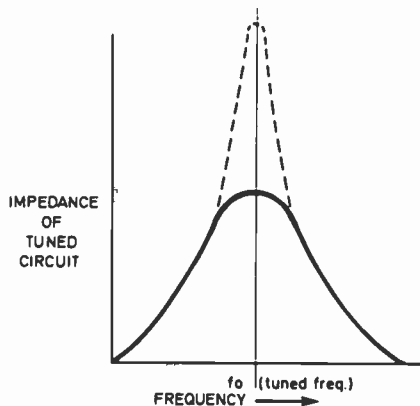

Fig. 9.6. Graph showing how the impedance of a tuned circuit varies with frequency.

MODULATION

A radio transmitter sending out a steady frequency is not a very effective communicator. You might say that the only information it is sending out is that it is switched on! This is true in spite of the fact that lots of change is in progress, the waves emitted go through their regular cycles of positive and negative.

However, all these cycles are identical. Looked at in terms of Francis Bacon's code, if you call a positive half cycle A and a negative half cycle B then the transmission is an endless alternation of A's and B's.

No matter how you divide this up into groups of fives (or any other number for that matter) it just goes on repeating the same code.

To convey more information it is necessary to vary the signal in some way. The simplest is to switch the transmitter on for A and off for B. Thus the transmission pattern for A B B A A would have a short "on" period, a double-length "off" period then a double-length "on" period. Fig. 9.7.

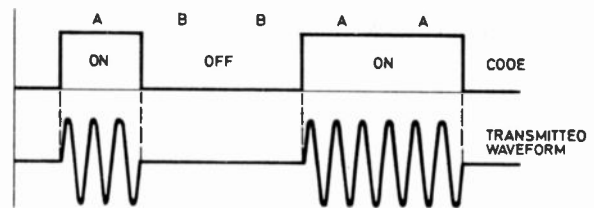

Fig. 9.7. Switching a transmitter on and off for certain periods, a code such as A B B A A can be sent. In this waveform the code is sent as a series of waves.

This sort of code involves precise timing. It is not too bad for teleprinters, where the timing depends on the design of the machine. Even then, however, it is usually necessary to transmit an extra A at the beginning of the sequence to mark the start of a symbol and an extra one to mark the end.

CW TRANSMISSION

Human beings are not at all good at reading this sort of code and they hate having to work at an absolutely steady, machine-like pace. So, in the Morse code, which was designed for human operators, the task of distinguishing between time intervals is made easy. There are short intervals, dots and long ones, dashes.

The transmitter is turned on for both dots and dashes. So the international distress code, the SOS signal, consists of three dots, three dashes, and three dots. Fig. 9.8.

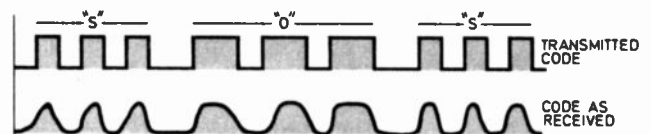

Fig. 9.8. The top waveform is a perfectly transmitted morse code signal. The bottom waveform is the shape sometimes received on a distant receiver.

So long as the human recipient of the message can distinguish between dots and dashes, and also recognise the complete sequence as one meaningful code the desired information is successfully received.

Also, it does not matter if the on pulses are rather rounded, the lower pattern is still quite recognisable.

This kind of Morse transmission is usually called **carrier wave** transmission. The carrier wave is the nominal frequency of the transmitter. Strictly speaking, of course, a broken up or pulsed transmission is not a pure carrier wave at all. It should be given some other name such as pulsed carrier wave, or interrupted carrier wave.

The basic characteristic, however, is that the strength of the transmitter is varied according to the signals transmitted. In a Morse transmission the transmitter is just turned hard on or hard off. You cannot get a bigger variation in strength than that. Morse code does not have to transmit signals of varying strength, it is a binary system in that respect.

Speech and music are very different. Their strength varies all the time, and of course their frequency varies too.

AMPLITUDE MODULATION

To transmit sound by making the strength of the transmitted waveform vary in sympathy needs the sort of waveforms shown in Fig. 9.9. The transmitter is turned on all the time, even during silent periods.

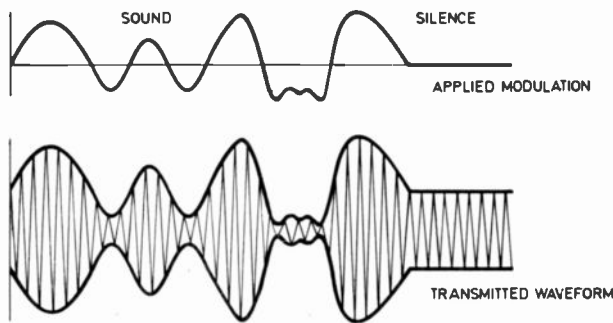

Fig. 9.9. An audio waveform as depicted by the upper curve is applied to a carrier as in the lower curve. As can be seen the audio is "carried" both by the negative and positive sides of the carrier.

The sounds make the strength of the carrier increase or decrease. This enforced variation is called **modulation**, and the strength, in engineering terms, is **amplitude**. So we end up with **amplitude modulation**.

SIDEBANDS

If a complex sound signal is analysed it is found to consist of mixtures of sine waves of different frequencies, which add or subtract to produce the complex wave. Each of these sine waves, when it modulates the carrier wave, produces two new frequencies, one above and one below the original frequency.

A 1kHz sine wave signal modulating a 100kHz carrier creates frequencies of 99kHz and 101kHz as well. Note that these new side frequencies differ from the carrier by the audio frequency. To transmit a 10kHz audio frequency, additional frequencies of 90kHz and 110kHz are generated. To transmit all frequencies up to 10kHz fills the band between 90 and 110kHz. This **bandwidth** is 20kHz, just **twice** the bandwidth of the audio signals.

This is wasteful. In effect, the audio is transmitted in duplicate, once above the carrier frequency and once below it. Also, the carrier itself, as we saw earlier, conveys no information.

If the carrier and one sideband are removed, and only the other sideband is transmitted, we have a single sideband signal, s.s.b. In the example above, the s.s.b. signal for 1kHz modulation on a carrier of 100kHz is 99kHz (lower sideband) or 101kHz (upper sideband).

SINGLE SIDEBAND

Single sideband is used a great deal for commercial purposes and by radio amateurs but not for sound broadcasting. The reasons for this become clear when you examine the receiving end of a communications system. To illustrate the point we shall use an amplitude-modulated signal. Fig. 9.10.

Here the audio is a sine wave shown dotted, and the carrier frequency is the waveform inside the audio envelope.

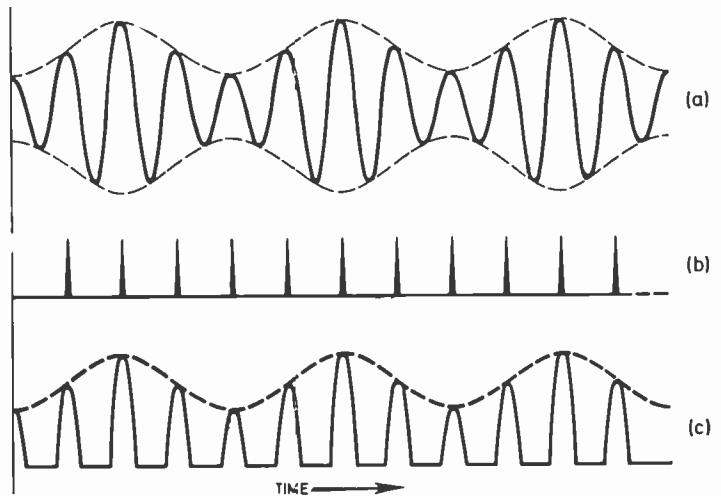

Fig. 9.10. A modulated carrier is shown at (a). To recover the audio from this, samples are taken at regular intervals as shown by (b). The samples thus produced d.c. pulses, which can then be "filled" in to form the audio.

To recover the audio from the a.m. signal you have to sample it at each, say, positive peak, this is represented by the second graph. The samples are then d.c. pulses as shown by the third graph. Their heights follow the shape of the audio wave. It is very easy to fill in the gaps between samples.

The usual way is to use an RC time constant. If the sample pulses are pulses of current these can be used to charge a capacitor. A resistor discharges it, slowly enough to retain most of the charge from one sample to the next, but quickly enough to allow the stored voltage to follow the audio variations.

Normally, the carrier frequency is much higher than the audio, so there is no difficulty in finding a time constant which can fill in the gaps without affecting the audio.

FREQUENCY MODULATION

There is another common method of impressing information onto a carrier, that is used widely in v.h.f. and u.h.f. systems, including TV sound.

This is called frequency modulation or f.m. for short. Unfortunately we do not have the space to discuss this particular method in the present series.

BEAT FREQUENCIES

By now, many of you will be wondering why all this fuss is being made about sampling. Surely, you are asking, all you need to do, to get the audio back, is rectify the transmitted signal? If half wave rectification is used the output is as shown in the last graph. This is obviously a mixture of d.c., audio, and the carrier frequency.

With ordinary a.m. signals like this it is easy. But what about single sideband, signals? In s.s.b., a steady modulation at a fixed audio frequency produces a pair of steady side frequencies, each unvarying in amplitude. Rectifying one of these, Fig. 9.11, produces d.c. only, and no audio.

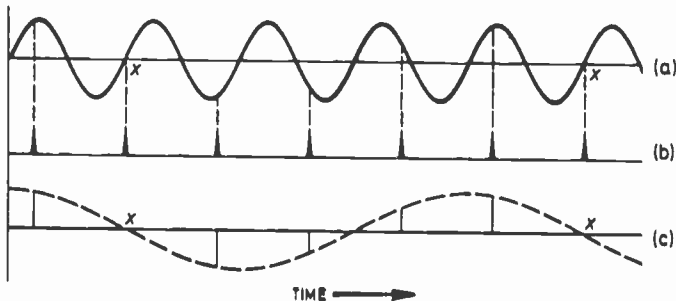

Fig. 9.11. For recovering the audio from s.s.b. signals (a), samples must be taken at different intervals as in (b). The output samples now go both positive and negative to produce a low frequency sine wave.

To produce audio, you have to sample at a different rate, as in the second graph (b). The output samples now rise and fall and go positive and negative (c), and clearly have a low frequency sine wave in them. What frequency?

Well, this obviously depends on the difference between the side frequency and the sampling frequency. The bigger the difference the faster the sampling times go in and out of phase with the s.s.b. signal and the higher the output frequency. What is happening is the production of a beat frequency between signal and sampling frequencies.

We need a beat frequency which is equal to the original audio frequency at the transmitter. If you think about it, you will find that to remake the original audio, the sampling frequency must be the original carrier frequency. This is the *one* sampling frequency which produces the correct audio frequency from *any* side frequency.

You can now see the virtue of transmitting the carrier frequency of an a.m. signal. When the complete a.m. signal is rectified the carrier makes the rectifier conduct at just the right instants; the peaks.

For s.s.b. reception a frequency equal to the original carrier must be generated at the receiver and used to control the sampling process. This is known as "re-inserting the carrier". How exact need the reinserted carrier frequency be?

Suppose, as is commonly the case, the original sound is not a pure tone but also contains harmonics. Say 300Hz with a second harmonic at 600Hz and a third at 900Hz. If the locally generated carrier is in error by 50Hz, the effect is to change each of these frequencies by 50Hz.

So instead of producing 300, 600 and 900Hz you get, 350, 650 and 950Hz. These false frequencies are no longer harmonically related. The true harmonics

of 350Hz are 700 and 1050Hz. The effect of this is to make the sounds of speech and music take on a peculiar croaky quality and become less intelligible.

To keep the frequency correct calls for a very stable local oscillator. If the true carrier frequency is 10MHz and the permissible error is 10Hz then this requires a frequency accurate within 1 part per million (1Hz in 1MHz). This is a very stringent requirement, difficult to meet. A possible way out is to transmit, along with the s.s.b. signal, a carrier small in amplitude, often called a **pilot carrier**. This can be picked out and amplified and used to reconstitute the missing carrier.

PRACTICAL RECEIVER

It is all very well discussing the theory of modulation etc, but the best idea is to actually hear the different types. To do this some type of receiver is necessary. A suitable design is shown in Fig. 9.12. This receiver covers part of the medium wave band but goes on to cover the lower short wave bands as used by shipping, commercial users, and radio amateurs etc. This part of the frequency spectrum is often called the Trawler Band. The exact coverage obtained depends on the coil and tuning capacitor. Basically however we want you to use the receiver to experiment.

CONSTRUCTION

The covercard required for the receiver module is shown in Fig. 9.13. No problems should be encountered in construction, however a few points need to be observed.

The coil is homewound on a large insulated former, in our model we found a cylindrical container which once contained pills. If no container of suitable size can be found then a substitute can be made by rolling several layers of paper together to make a stiff former. The former is about 38mm in diameter and about 90mm in length, the actual length is not too critical.

The larger coil, L1, has 45 turns of ordinary insulated wire, and the coupling coil L2 has 5 turns of the same wire wound about 20mm from the one end of L1, see Fig. 9.13.

Capacitor C2 need only be a few picofarads in value and we make it ourselves, by connecting short lengths of stiff insulated wire to the top of L1 and TR2 collector then twisting them together as shown on the layout diagram.

The two conductors are plates, and the insulation is the dielectric. The more twists the greater the capacitance.

As will be mentioned later the two coils, L1 and L2 and capacitor C2 may need slight adjustment to obtain a satisfactory coverage. It is advisable therefore to wind a few extra turns on both coils, so that later separate windings can be easily removed. It is far easier to remove turns than to add extra!

Once constructed and, as always, checked for any mistakes, a battery may be connected. The audio output from this simple circuit is not really large enough to drive a loudspeaker direct, so take the output to the input of the **POWER AMPLIFIER**.

SHORT WAVE RECEIVER

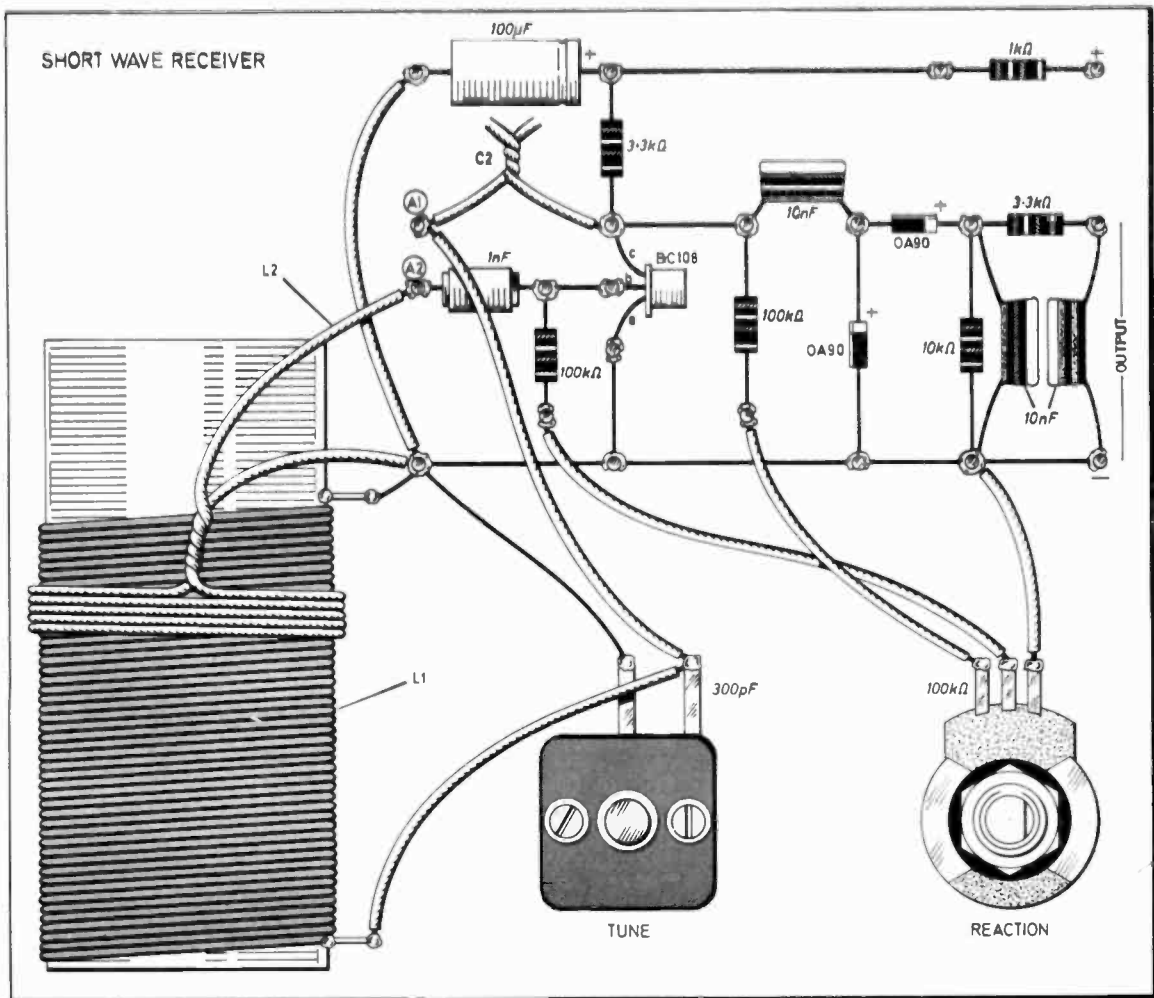
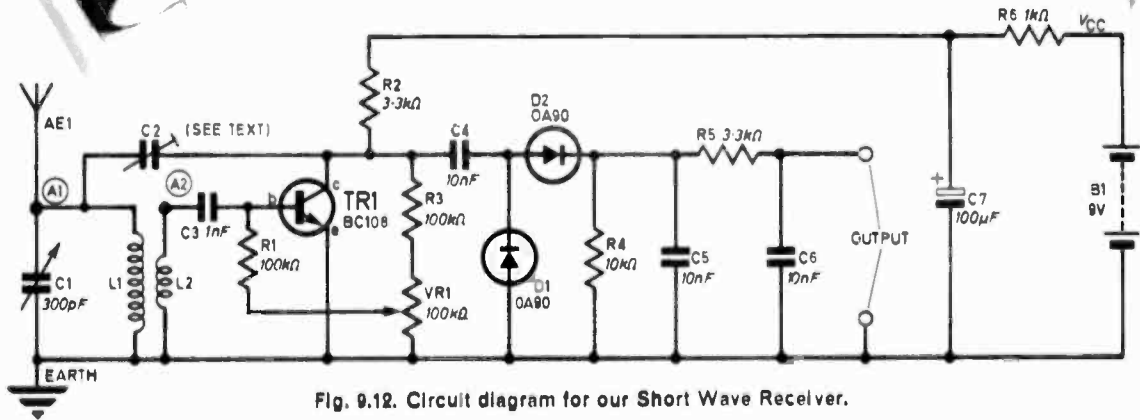

OPERATION

Since the receiver relies on positive feedback it needs careful adjustment. Positive feedback (reaction or regeneration) exaggerates differences between transistors, battery voltage, etc. The circuit consists of a radio frequency amplifier, TR1 followed by a diode detector D1 and D2.

Positive feedback is controlled in two ways. First, C2 is a preset reaction control which feeds part of the signal back from the collector of TR1 to the tuned circuit C1, L1. The two coils L1, L2 form a transformer and by connecting the right end of L2 via C3 to the base of TR1, positive feedback is obtained.

The other reaction control is VR1, which supplies base bias current to TR1. Reaction is usually most effective at the high frequency end of the tuning range and least effective at the low frequency end.

To adjust C2, turn VR1 fully clockwise and adjust C2 so that the circuit just oscillates. This is heard in the loudspeaker as a whistle which varies in pitch as a station is tuned in. If you get a steady whistle all the time it means you have too much reaction.

The adjustment of C2 is made with an aerial and earth connected. A short vertical aerial (half a metre of wire) can be connected to point A1. If you live in a steel-framed building or other difficult location you may have to use a longer aerial connected to point A2.

The earth connection should ideally be buried in the ground but a water pipe, radiator or any large metal object in the house is better than nothing.

REGENERATION

A good regenerative receiver works without "backlash". That is, it should be possible to turn up the reaction control so that the circuit slides gently and imperceptibly into oscillation. A bad circuit will suddenly burst into uncontrollable oscillation and you have to turn down the reaction control a long way to stop it.

Your receiver should behave itself if C2 is set correctly. If it does not, but gives the sort of behaviour just described, remove a few turns from L2 and readjust C2. If you still cannot get any oscillation at all but still pick up a few stations it probably means that L2 needs its connections reversed.

If there is a fault somewhere, check with your VOLTAGE INDICATOR. The collector should be at almost V_{CC} when the slider of VR1 is anticlockwise, falling to above 2V when it is clockwise.

The two diodes conduct alternately to form a sort of full wave rectifier.

The components R5, C5 and C6 form a storage and smoothing circuit to remove the radio frequency ripple.

Diode detectors must have a d.c. load, which here is R4. Resistor R6 and C7 are not strictly necessary. They form a decoupling circuit to prevent feedback from the power amplifier, which can upset the reaction, especially when the battery is old and tired.

You can add or remove turns on L1 to adjust the tuning range, C2 must be readjusted after any major change. When all is correct you will find yourself in the fascinating world of shortwave reception, a world

full of whistles, buzzes, clicks, Donald Duck speech noises, and foreign programmes.

If you use an outside aerial, earth the downlead (the connection to the set), outside the house in thundery weather for safety.

ZERO BEAT

One effect worth looking for is **synchronisation** of a weak oscillation in your receiver with an incoming carrier. If you tune in very slowly the beat frequency suddenly drops to zero. This is a tiny "dead zone", or **null** in which you can change the tuning without producing a beat. In this zone the incoming carrier takes charge.

Another phenomenon is "hand effect". Putting your hand anywhere near the circuit when it is in a sensitive condition has an audible effect. This is proof that electric fields extend into the air, but otherwise it is just a nuisance.

Bringing a piece of metal, for example, a coin, near the coil when the set is oscillating has an effect on the frequency, audible as a change in a beat note. This is used in one kind of metal detector to reveal buried metal. You will find that the detection range is very short. This is because the magnetic field of the coil diminishes rapidly as you go further away.

Next month we shall introduce the subject of Logic.

QUESTIONS

- 9.1. A superhet receiver tuned to 2.7MHz experiences "image" interference from a second transmission on 1.3MHz. The receiver's intermediate frequency is;
a. 465kHz
b. 700kHz
c. 1.4MHz
- 9.2. In C.W. transmission the carrier wave is;
a. the frequency of the transmission
b. the code transmitted
c. the sidebands
- 9.3. An a.m. transmitter sending on 800kHz is modulated by a steady 1kHz signal. The frequencies transmitted are;
a. 800kHz only
b. 799kHz and 800kHz
c. 799, 800 and 801kHz
- 9.4. An s.s.b. transmitter on 3MHz sends the lower sidebands. When modulated by a steady 2kHz signal the frequencies emitted are;
a. 3MHz and 2.998MHz
b. 2.998, 3.0 and 3.002MHz
c. 2.998MHz
- 9.5. Which frequency is supersonic (ultrasonic);
a. 30kHz
b. 3kHz
c. 30Hz

ANSWERS

(To part 8)

- | | |
|---------------|----------------|
| 8.1. 40W (c) | 8.4. 200mA (b) |
| 8.2. 20V (b) | 8.5. 140V (a) |
| 8.3. 180° (a) | |



next month

LDR CONTROLLED NIGHTLIGHT

Completely automatic low-powered lamp. Switches on at dusk. Switches off at dawn. Ideal for child's bedroom. Has many other useful applications.

LOGIC PROBE

Using one i.c. and associated components, this pocket-size instrument can be useful for tracing faults in projects, and for testing ex-computer i.c.s.

SHORT WAVE RADIO

Tuning from around 3MHz to 16MHz, this simple t.r.f. receiver offers the constructor an introduction into the fascinating world of short wave radio.

QUAGMIRE

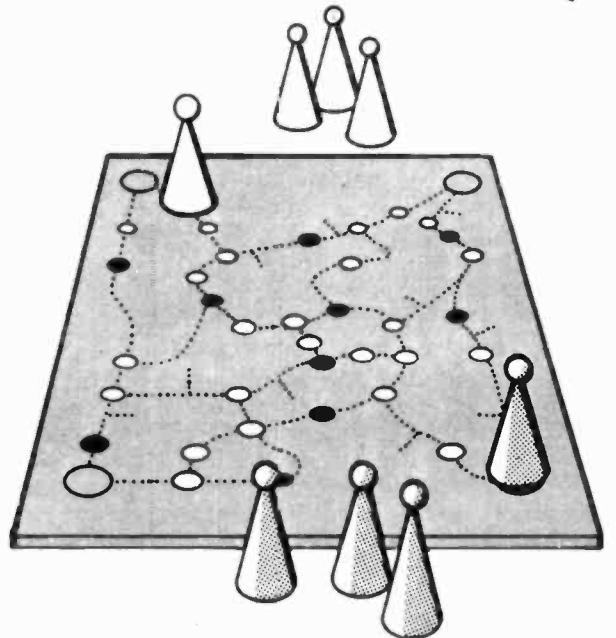

An absorbing and exciting electronic board game combining skill and chance. The object for the game is to travel from base to diagonally opposite side of the "quagmire", contending with changing hazards on route. Suitable for up to four players.

IT'S A FACT!

This Grand Selection of Projects leaves no doubt about it at all. EVERYDAY ELECTRONICS HAS SOMETHING FOR EVERYONE! There will be a great demand for our July issue so be wise and ensure your copy well in advance.—See your newsagent NOW!

Everyday ELECTRONICS

JULY
ISSUE ON SALE
FRIDAY, JUNE 16

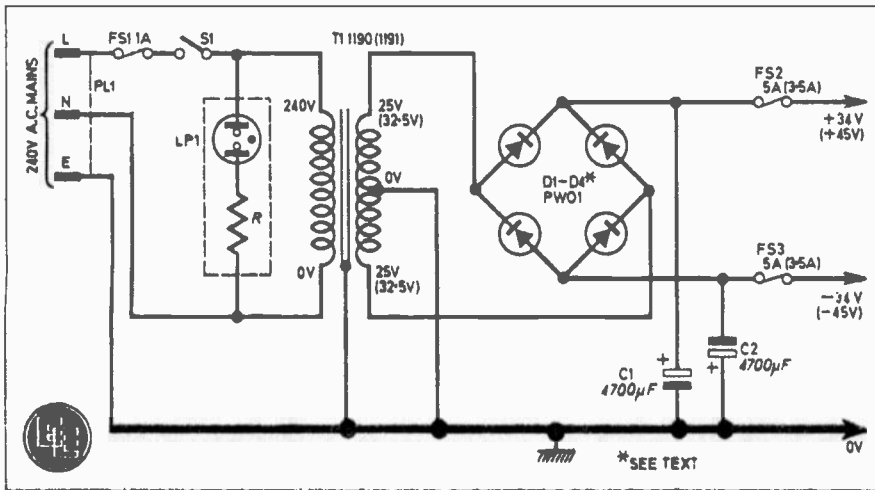

Fig. 1a. The circuit diagram of the power supply section of the 100W Power Slave.

shown in Fig. 1b which is seen to be a full complementary direct coupled amplifier with output short circuit protection.

Input to the amplifier is at SK1 and the input signal appears across VR1 which acts as a volume control. A second socket SK2 is wired in parallel with SK1. This is not intended as a second input, although it could be used as such, but is a means of linking to another power slave input.

The wiper of VR1 is coupled to the base of TR1a via d.c. blocking capacitor C4. TR1 is arranged to

form a differential amplifier which is a convenient means of setting the d.c. voltage level at the output to 0V, enabling the amplifier to be directly coupled to the loudspeaker. D.C. stability is accomplished by means of 100 per cent feedback from the output to the input by resistor R6.

The ratio of R6 to R5 governs the closed loop a.c. voltage gain. Zener diode D5 is used to set the d.c. current through the differential amplifier and provide a.c. hum rejection from the negative power supply line.

Transistor TR5 serves as a constant current source for the d.c. bias current which flows through TR3 and the dual bias diode D6. This diode has been selected to drop the precise amount of voltage (between the bases of TR6 and TR8) to bias the output stage to the verge of conduction.

The resulting output from the differential connected pair (collector 1) is directly coupled to the base of TR3 connected as a high gain common emitter amplifier which feeds the two compound pairs in the output stage, TR6/7 and TR8/9. As can be seen these function as emitter followers which provide high current gain with unity voltage gain. Therefore, TR3 must be capable of handling the full load voltage swing (peak-to-peak).

The positive portions of the signal are handled by TR6 and TR7 with the negative excursions being dealt with by TR8 and TR9.

The amplified signal is fed to the output sockets SK3 and SK4 wired in parallel through emitter resistors R15 and R16 and a choke L1.

The latter is incorporated in the circuit together with resistor R30 to dampen the output response when feeding highly capacitive loads (e.g. hi fi speakers incorporating cross-over networks).

Fig. 1b. The circuit diagram of the audio amplifier section of the 100W Power Slave incorporating electronic short-circuit protection.

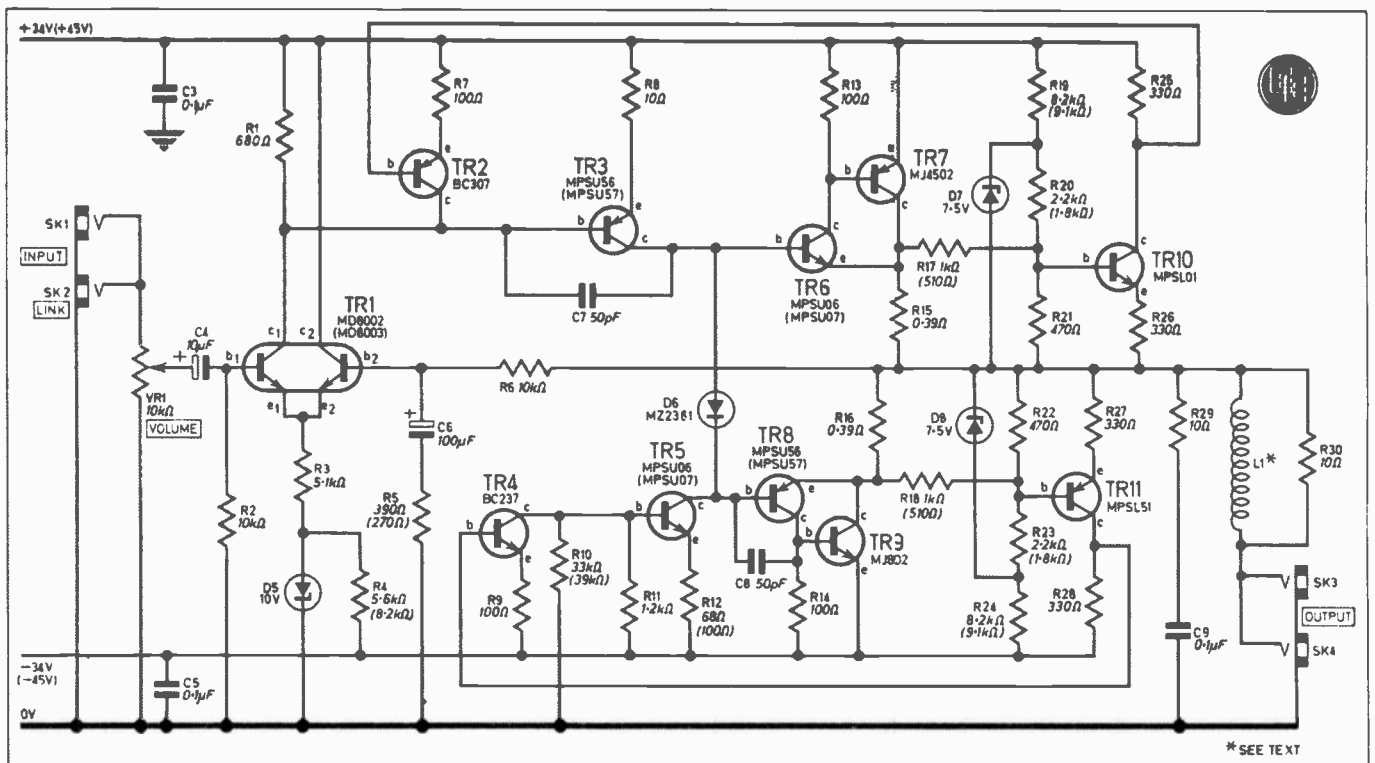

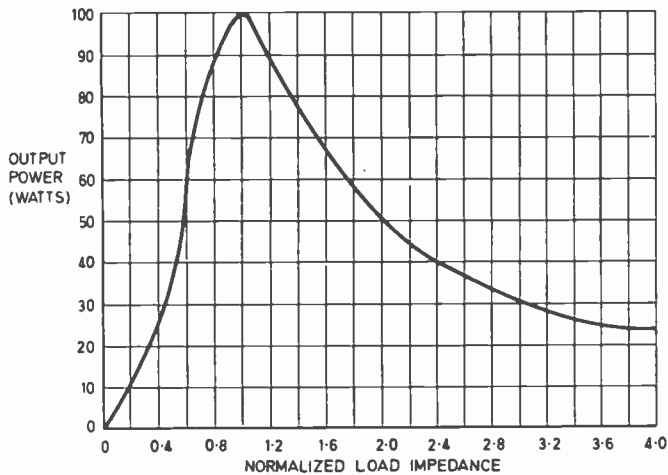

Fig. 2. Maximum obtainable output power as a function of load impedance. The normalised load is obtained by dividing the speaker impedance by the nominal load, 4 or 8 ohms. (Motorola).

A Sobel network composed of R29 and C9 are included for reasons of stability when feeding reactive loads.

SHORT CIRCUIT PROTECTION

The short-circuit protection network active components comprise TR10, TR2 and D7 for positive portions of the output signal and TR11, TR4 and D8 for negative portions. The protection network has been designed so as not to interfere with a "normal load" under worst case conditions which occurs when there is phase shift of 60 degrees between voltage and current. This is particularly the case in hi fi speaker systems where the load can appear highly capacitive or inductive as well as resistive.

For positive half cycles of the signal, resistors R17, R19, R20 and R21 form a voltage summing network. The voltage appearing at the base of TR10 is determined by the voltage drop across R15 (which is

proportional to the current flowing in TR7 and therefore into the load) and the voltage between the positive supply rail and the output. Since this arrangement detects both current and voltage, it effectively senses the peak power dissipated in TR7.

The values of the components in the summing network have been calculated with the worst case conditions mentioned above taken into consideration to cause TR10 to turn on when the peak power dissipation in TR7 ($\frac{1}{2} \times$ positive rail voltage \times maximum power current flow) is exceeded. When TR10 conducts, its collector moves towards 0V and turns on TR2 which steals the drive current from the base of TR3 and hence limits the power dissipated in TR7.

Similarly for negative excursions exceeding the predetermined level, TR11 conducts which in turn causes TR4 to conduct. This shuts down TR5, the constant current source, thereby limiting the dissipation in TR9.

Zener diode D7 is included to

prevent TR10 from conducting under normal load conditions when the output swings negative; D8 has similar action on positive output swings.

The protection network will also operate if the nominal supply line voltages are exceeded by 10 per cent or more.

OUTPUT PERFORMANCE

The circuit has been designed to operate under any load conditions including a short circuit, but maximum output will only be obtained for a precise load, in this case 4 or 8 ohms according to the version built. The graph of Fig. 2 shows the output power as a function of the impedance of the load as a result of the inclusion of the protection network. A power-bandwidth graph is shown in Fig. 3.

CONSTRUCTION

The majority of the components are mounted on a printed circuit board. In the prototype fibreglass board was used but this is not essential.

The pattern to be etched is shown full size in Fig. 4a.

A 1mm drill will be suitable for most of the holes but those allocated to resistors R15, R16, R29 and R30 may need to be enlarged as these leads can be quite thick. Use is made of Veropins as these make wiring up much easier as will be seen later. The board fixing should be drilled for 4BA clearance.

Begin by assembling the resistors and capacitors according to Fig 4b. Inductor L1 is made by

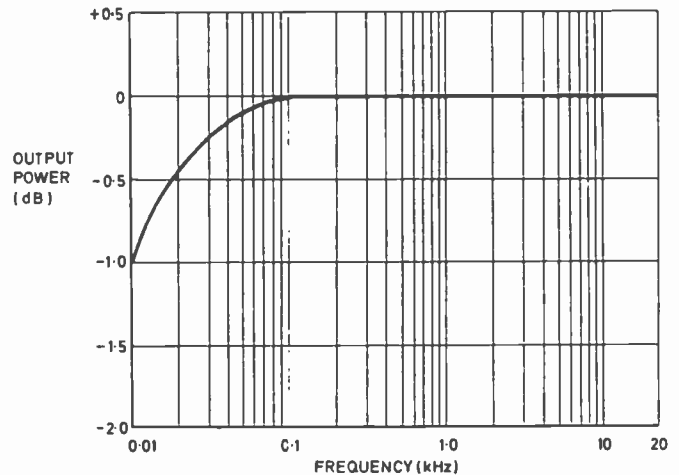

Fig. 3. The output power as a function of signal frequency into a resistive load; 0dB represents 100 watts r.m.s. (Motorola).

TYPICAL PERFORMANCE FIGURES

- Output Power**
100 watts r.m.s. into 4 ohms or 8 ohms (dependent on version built)
- Input Sensitivity**
775mV into 10 kilohms for full output
- Frequency Response**
Less than 3dB roll-off from 10Hz to 100kHz referenced to 1kHz
- Power Bandwidth**
100 watts r.m.s. ± 0.5 from 20Hz to 20kHz
- Total Harmonic Distortion**
Less than 0.2% at any power level between 100mV and 100W at any frequency between 20Hz and 20kHz
- Intermodulation Distortion**
Less than 0.2% at any power level from 100mV to 100W (60Hz and 7kHz mixed 4 to 1)
- Damping Factor**
Greater than 150 at any frequency from 20Hz to 20kHz

(Motorola)

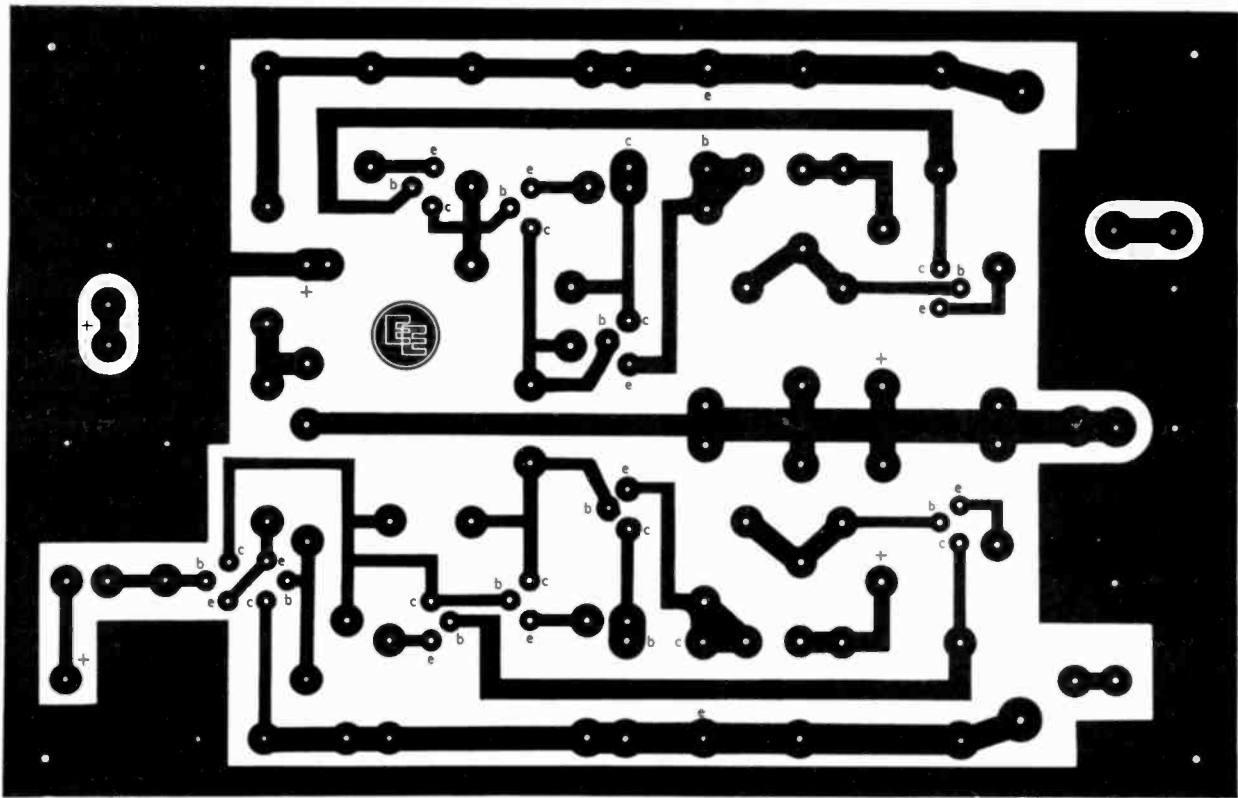

Fig. 4a. The underside of the printed circuit board shown full-size. The black areas are the regions of copper to remain after etching.

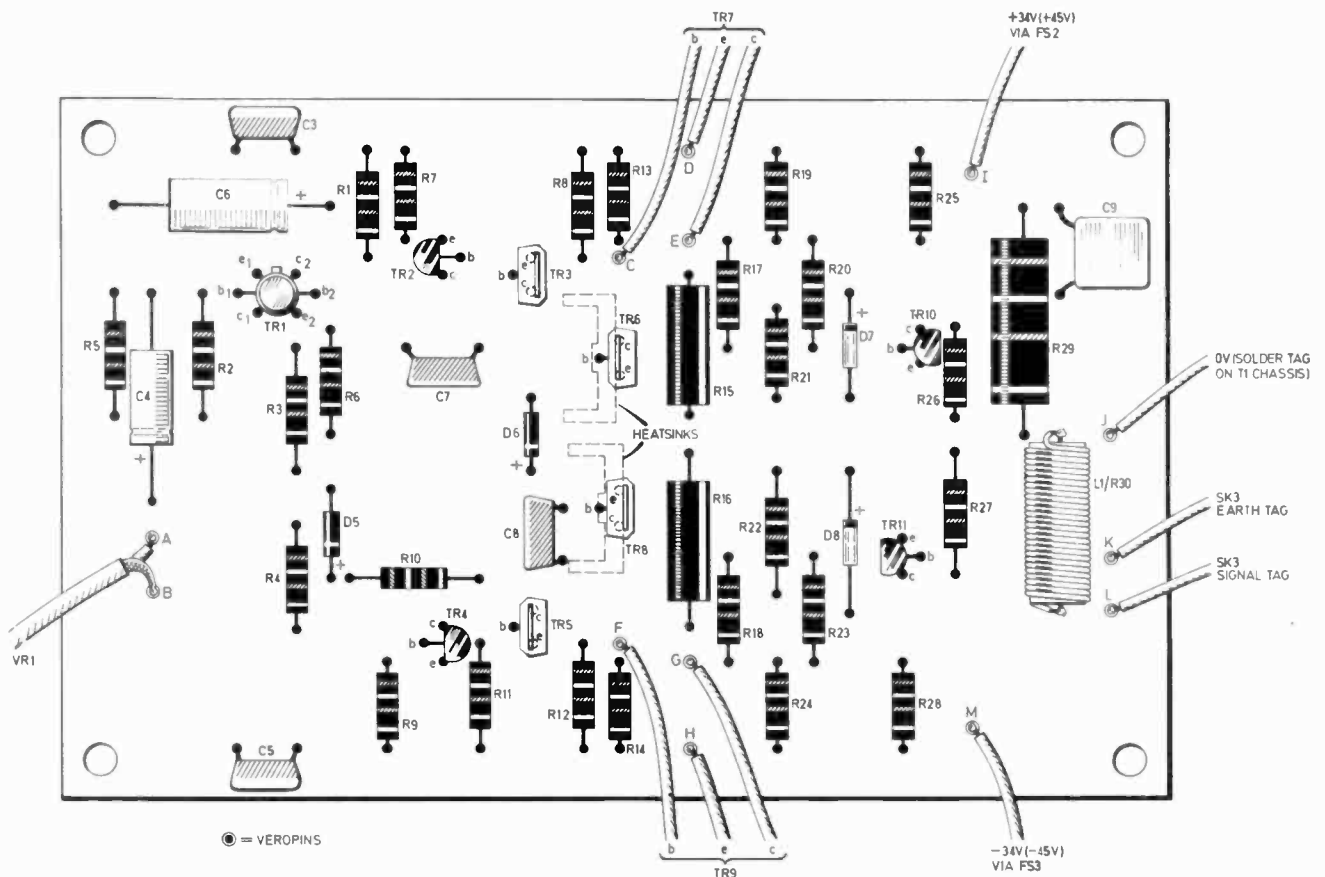

Fig. 4b. The layout of the components on the topside of the p.c.b. together with wiring information to other components.

winding 20 s.w.g. enamelled copper wire the full length of resistor R30 and soldering the ends to the resistor leads close to the body. Next insert and solder in position the Veropins.

Finally position and solder the semiconductors paying special attention to polarity and connection details, see Fig. 5.

Close inspection of some of the transistor cases will reveal that the lead connections are printed on the body. This is not so with the MD8001 (MD8002) and this must be orientated with reference to the tag on the body. It is wise to use a heatsink on the leads of this semiconductor to prevent thermal damage.

The author found that the leads on the Uniwatt transistors (MPSU06, MPSU07, MPSU56 and MPSU57) have very thin leads and are easily sheared, so be careful to bend the leads correctly first time. The driver transistors TR6 and TR8 require heatsinks. It is best to position these on the board and then secure the heatsinks before soldering. A layer of heatsink compound between the tab and heatsink will produce a more efficient thermal contact. Mica washers and insulating bushes are not required for mounting TR6 and TR8 as long as separate heatsinks—not in contact, are used as in the prototype.

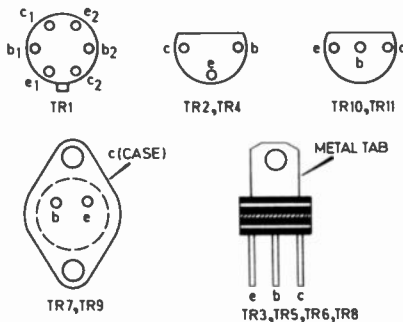

Fig. 5. Shows lead-out details of the semiconductors specified. All are viewed from below with the exception of the Uniwatt devices which are seen facing the coloured bands on the body.

POWER HEATSINKS

The power output stage heatsinks should next be drilled to accommodate TR7 and TR9. Also drill the heatsinks for mounting to the chassis with 2BA clearance holes.

It is imperative that the output transistors be mounted using a mica washer and insulating bushes, see Fig. 6. The collector

COMPONENTS

Resistors

R1	680Ω	R11	1.2kΩ	R21	470Ω
R2	10kΩ	R12	68 (100Ω)	R22	470Ω
R3	5.1kΩ	R13	100Ω	R23	2.2kΩ (1.8kΩ)
R4	5.6kΩ (8.2kΩ)	R14	100Ω	R24	8.2kΩ (9.1kΩ)
R5	390Ω (270Ω)	R15	0.39Ω 5W *	R25	330Ω
R6	10kΩ	R16	0.39Ω 5W *	R26	330Ω
R7	100Ω	R17	1kΩ (510Ω)	R27	330Ω
R8	10Ω	R18	1kΩ (510Ω)	R28	330Ω
R9	100Ω	R19	8.2kΩ (9.1kΩ)	R29	10Ω 2W
R10	33kΩ (39kΩ)	R20	2.2kΩ (1.8kΩ)	R30	10Ω 2W

All $\frac{1}{2}$ watt carbon film or metal oxide $\pm 5\%$ except where stated otherwise. (*wirewound)

Capacitors

C1	4700μF 50V elect. radial tag	C6	100μF 10V elect.
C2	4700μF 50V elect. radial tag	C7	50pF ceramic
C3	0.1μF plastic or ceramic	C8	50pF ceramic
C4	10μF 6V elect.	C9	0.1μF plastic or ceramic
C5	0.1μF plastic or ceramic		

Semiconductors

TR1	MD8002 (MD8003) dual transistor silicon <i>nnp</i>
TR2	BC307 silicon <i>pnp</i>
TR3	MPSU56 (MPSU57) silicon <i>pnp</i>
TR4	BC237 silicon <i>nnp</i>
TR5	MPSU06 (MPSU07) silicon <i>nnp</i>
TR6	MPSU06 (MPSU07) silicon <i>nnp</i>
TR7	MJ4502 silicon <i>pnp</i>
TR8	MPSU56 (MPSU57) silicon <i>pnp</i>
TR9	MJ802 silicon <i>nnp</i>
TR10	MPSL01 silicon <i>nnp</i>
TR11	MPSL51 silicon <i>pnp</i>
D1-D4	PW01 6A 100V bridge rectifier
D5	400mW 10V Zener
D6	MZ2361 silicon forward reference diode
D7	7.5V 400mW Zener
D8	7.5V 400mW Zener

Miscellaneous

VR1	10kΩ log. carbon
T1	9010 (9011) mains primary/50V 5A (65V 3.5A) centre-tapped
S1	mains on/off toggle [secondary]
SK1, 2, 3, 4	standard jack socket (4 off)
LP1	mains panel mounting neon
FS1	1A 20mm
FS2, 3	5A (3.5A) 20mm (2 off)
PL1	panel mounting 3-pin mains plug

Printed circuit board size 160 × 102mm; 20mm panel fuseholder for FS1; 20mm chassis fuseholders for FS2, 3 (2 off); heatsinks: Redpoint type 4W and CH77 (2 off each); TO-3 mica washers and insulating bushes (2 sets); vertical mounting capacitor clips for C1 and C2; 5A connecting wire; screened cable; 18 s.w.g. aluminium for chassis; rubber grommets (4 off); 4BA threaded spacers 25mm long for p.c.b. mounting (4 off); 2BA nuts, bolts and washers (10 sets); 4BA fixings: bolts, washers (16 off), nuts (8 off), solder tag; 6BA nuts, bolts and washers (6 off each); 6BA solder tags (2 off); materials for front and rear panels (metal), base panel and case; Veropins.

See
**Shop
Talk**
page 485

Values and type numbers
in parenthesis refer to the
8 ohm version only

connections to each output transistor is at the case and this is made via a solder tag under one of the transistor fixing nuts.

Attach ample lengths of heavy duty insulated wiring to each transistor connection. A mechanical joint prior to soldering is advised. Use different colours for each of

the six leads for easy identification when wiring to the p.c.b.

Dimensions, drilling details and shape of the main chassis are shown in Fig. 6; 18 s.w.g. aluminium was found to be suitable. Three sets of wires will be fed through this chassis and each feed hole should be fitted with a rubber grommet.

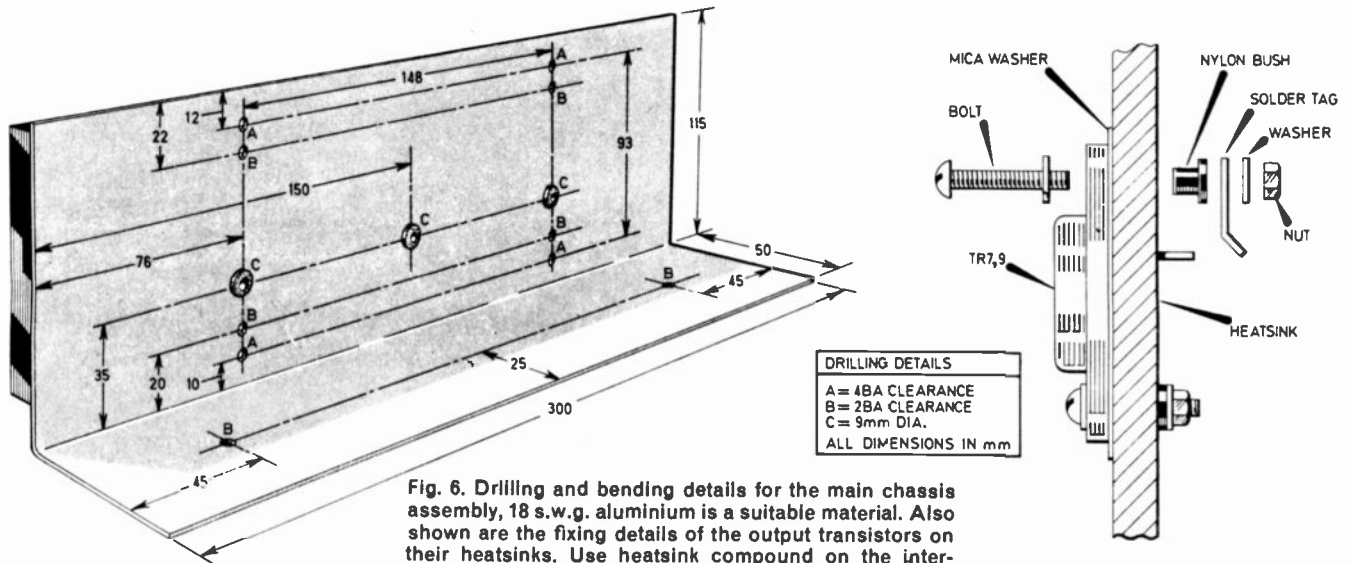

Fig. 6. Drilling and bending details for the main chassis assembly, 18 s.w.g. aluminium is a suitable material. Also shown are the fixing details of the output transistors on their heatsinks. Use heatsink compound on the interfaces for good thermal contact.

Feed the wires from each transistor through to their appropriate hole and bolt each heatsink to the chassis. Now secure the p.c.b. to the chassis using 4BA bolt/washers and threaded spaces and then wire up the output transistors to the board at the Veropin anchor points. Make mechanical joints prior to soldering. This applies to all other Veropin connections. This assembly, to be called the main chassis assembly is complete and can be put aside until later.

POWER SUPPLY

Details of the power supply chassis are shown in Fig. 7 and is again made from 18 s.w.g. aluminium. This also acts as a heat-sink for the bridge rectifier. Mount the capacitors in their clips and secure to the chassis using 4BA nuts, bolts and shakeproof washers. Do likewise with the bridge rectifier and fuseholders and wire up according to Fig. 7 using heavy duty insulated wiring. The supply line wiring is passed through a feed hole in the chassis which must be fitted with a rubber grommet. Do not insert the fuses into their holders at this stage.

FRONT PANEL

Drilling details for the front panel are included in Fig. 8. In the prototype this was made from 4mm plywood and after the fixing rail had been fitted using counter-sunk screws, was covered in black Formica to produce a hard glossy finish. Self-adhesive labels with

Fig. 7. Dimensions and drilling details for the power supply chassis with complete wiring up details. This has been drawn "flat" for reasons of clarity. This chassis is held in place on the base panel by four self-tapping screws.

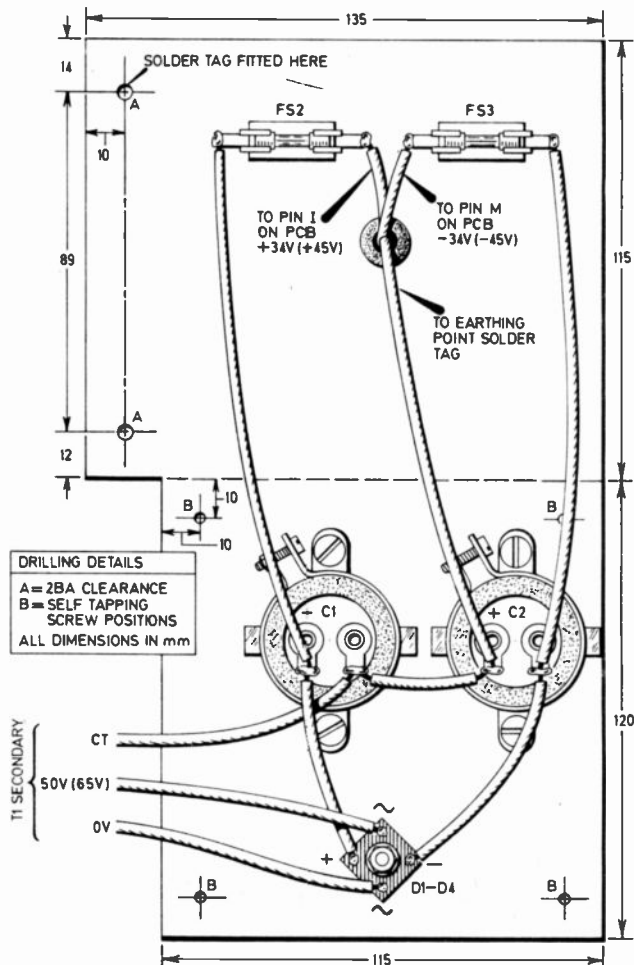

power supply output voltage levels at the input sides of FS2 and FS3 with respect to earth. On FS2 the voltage reading should be +34V (+45V) and that on FS3, -34V (-45V) or up to 10 per cent more.

If all is well, the amplifier should be switched off and FS2 and FS3 inserted. Care should be exercised here as the smoothing capacitors will be charged up, and could give a nasty shock if touched. It may be as well to discharge them first using a resistor of about 200 ohms.

With the fuses connected, no input signal, and no speakers or other load connected, switch on and measure the voltage at the output socket. It should read 0V or very close to this. If all is well a speaker load can now be connected. Do this with the amplifier switched off. With power back on the voltage across the speaker should still read 0V. A signal fed into SK1 should be heard in the speaker and become louder as VR1 is advanced.

It only remains to check the short circuit protection. This can be done by wiring a heavy duty on/off switch in parallel with the speaker load. With a signal passing through the system operate this switch. The sound from the speaker will of course disappear but sound should return when the switch is turned off.

Space does not allow details of the case to be given, but a photograph of the prototype case is shown above. This may of course

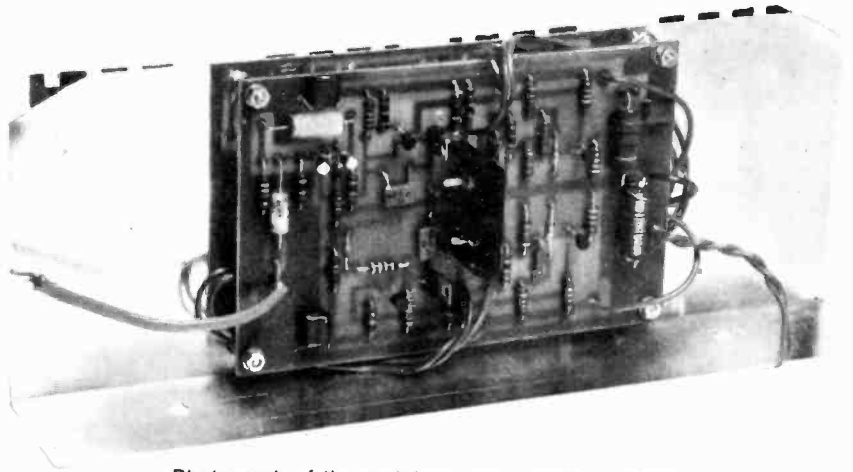

Photograph of the prototype main chassis assembly completed and ready for installation on the base panel. Observant readers will note that TR1 has been replaced by two TO-18 type transistors, BC109's in fact, as these were to hand at the time of construction. This substitution was found to have no adverse effect on performance.

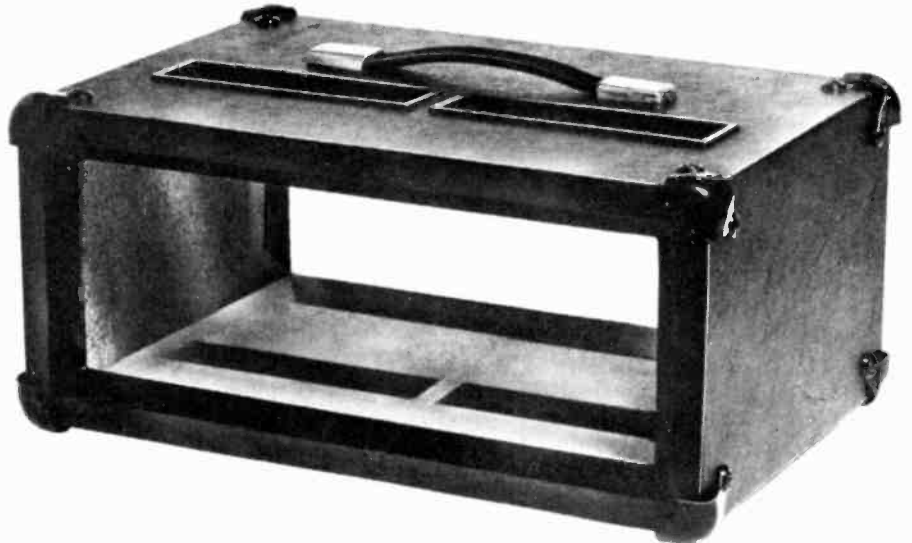

Photograph of the prototype sleeve-type cabinet. This was constructed from 13mm chipboard with triangular batten forming the front lip. The finished amplifier is fed in from the rear and held in place by the cabinet feet fixings. This cabinet is available ready built as shown, see *Shop Talk* for details.

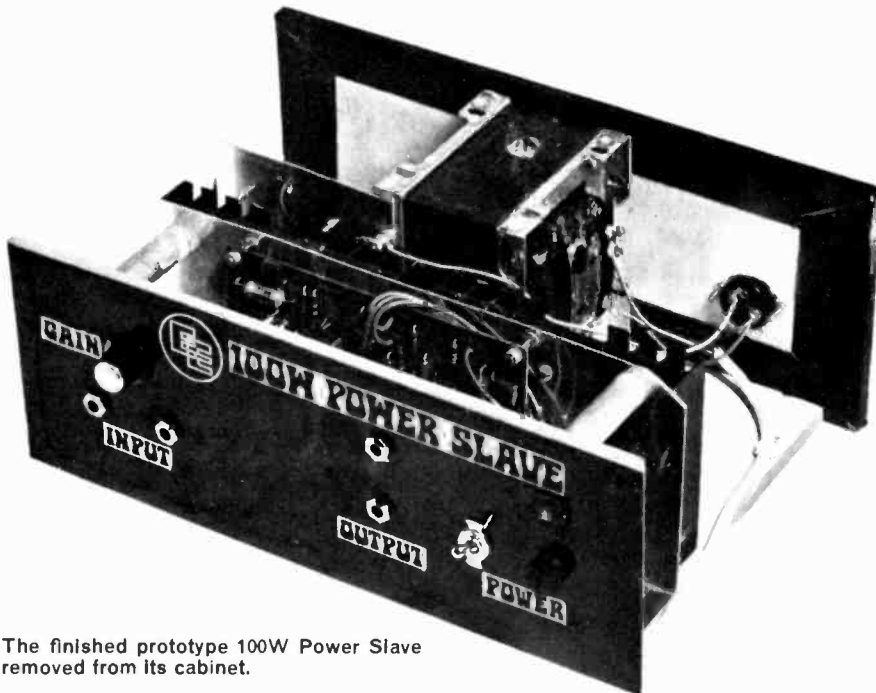

The finished prototype 100W Power Slave removed from its cabinet.

be changed to suit individual tastes but it is important that ventilation grills be included in the design and for these to be sited directly above and below the output transistor heatsinks.

Also the cabinet base must be raised to provide an air passage to the lower grill. This is accomplished by using about 25mm high plastic feet on the base. The fixings for the feet in the prototype were long enough to also serve as the base panel fixing screws. ☐

Next month we shall be taking a look at pop, disco PA and hi fi systems using a 100 Watt Power Slave.

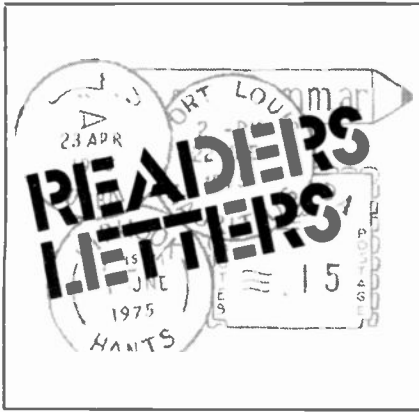

Encapsulation

I have recently encapsulated a small radio in Plasticraft liquid plus hardener. I thought this would be an ideal way to stop components from coming adrift.

However the radio after a time ceases to work. Could this be due to some type of screening effect? Incidentally only the components, not the aerial, were encapsulated.

I would be interested in your comments or if anyone else has tried this. If in fact it does work, there must be possibilities if vibration is likely to occur in the use of any project.

P. G. Sherwood,
Manchester.

The idea of sealing electronic circuits is of course well known in the professional areas, but is not used widely in the amateur area.

We see no reason why the radio should not work because of any screening effect. Only metal would completely screen any radio waves. It is possible then that the sealant has caused some damage to the components themselves.

Have any readers any ideas on this? Any ideas will be welcome and be considered for publication.

Light Display

I have just built the *Chaser Light Display* in the February issue, and have found the following modifications very worthwhile.

By adding four single-pole switches in series with the wipers of S4 and the junctions of the l.e.d.s and base resistors, a more versatile display is achieved. Instead of the basic two patterns, we have four.

H. Bowker,
Sandy,
Beds.



Photograph of the RTV31 taken at Erith, by Mr. Cooper.

Photoflash Socket

In the *Photoflash Slave Unit* in the December '77 issue, a flash socket was required. It was said in Shop Talk that these are not generally available, however I have found at my local shop, a socket manufactured by Kaiser Foto Technik.

Their part number is 1327, and the price was £1.02. This could be cheaper than buying the extension lead from Dixons as suggested.

N. Mortimer,
Milnthorpe,
Cumbria.

Clunk-Click Trip

I should like to draw readers' attention to an improvement to the "Clunk Click Jogger", circuit No. 13 in the *Popular Circuits* feature.

Some readers may experience difficulty in preventing spurious firing of CSR1 when the car engine is running. All seems well until the engine is started whereupon the device would fire spontaneously.

Although my prototype did not suffer from this defect and was tried on a few vehicles, it seems that some cars tend to produce excessive noise from the charging circuit and the spikes tend to fire the CSR through capacitor C1.

This defect was corrected by reducing the value of C1 to 0.01µF instead of 0.1µF. This, of course, would also occur in cases where C1 was on the high side of its tolerance.

T. R. de Vaux-Balbirnie,
Huntingdon.

Loudspeakers

First may I compliment Mr. J. Smith on his excellent article on loudspeaker enclosures in the February '78 issue.

However, I am surprised that no mention has been made concerning the "phasing" of the speakers. This means that the cones of all three speakers move in the same direction at the same time. And not "one in-one out" so to speak. As this was not mentioned, the project may be a disappointment to the beginner.

It is a good idea to mark all one's speakers with the correct polarity for future reference. A simple way of doing this is to use a 1½ volt battery, connected across the speaker coil. If the cone moves out, then the positive of the battery is connected to the positive of the speaker.

Finally I would like to say that the author is quite right when he implies that the quality will be unexpectedly good.

J. W. Robson,
Newcastle upon Tyne.

Cranfield Place. The Continuing Story . . .

I must agree with Mr. U. F. Wood that Tracked Hovercraft Ltd., was not at Cranfield, see letter in the February issue.

The Institution of Mechanical Engineers, Railway Division, paid an official visit to the site and installation of T. H. Ltd., at Erith, Cambridge in April 1972 at which I was privileged to be present.

Enclosed is a copy of the Institution notice and the notes, handed out at the time, about T. H. Ltd., together with a couple of not very good photographs of the experimental vehicle taken on the day, which you will note is identified RTV31 and not TSR2.

P. C. Cooper,
Derby

Mr. Hope replies . . .

I enclose a strip of negative film (see photographs—Ed.) showing on the same strip two shots I took at Cranfield, one of the tracked hovercraft and one shot of the Good-year airship.

The fact that both shots are on the same strip surely proves that I haven't taken leave of my senses. I really did see both the airship and the tracked hovercraft at Cranfield on the same day!—Were there two RTV31's?

By the way the TSR2 (unless I mis-remember the code word title) was a very fast low flying aircraft.

Crossword No. 4—Solution



Mr. Hope's photographs, showing on the left the RTV31 at Cranfield. On the right the Good-year airship—also at Cranfield!

Everyday News

A NEW TESTIMONY BY ELECTRONICS

It is not often that an electronics magazine is invited to a film premier, but this is what happened when the film, *The Silent Witness*, produced and directed by David W. Rolfe for Screenpro Films, was first shown in London recently.

The film traces and investigates the amazing history of the Holy Shroud of Turin, which millions believe was used to cover Jesus after the crucifixion.

Displayed to the public only three times in the last hundred years, the 14ft long and 3ft wide Shroud is kept behind bars in Turin Cathedral. Recently, however, leading international scientists and scholars were allowed to examine the Shroud for the first time and *The Silent Witness* presents, exclusively, the results of their research.

Some of the questions facing the investigators were as mysterious as the cloth itself. Why is the image a photographic negative? Why does it possess anatomical and medical detail centuries ahead of its time? This is where electronics plays an important part in the investigators' findings.

For an analysis of the medical evidence on the Shroud, the film crew travelled to Los Angeles where they have the busiest and most modern forensic medical centre in the world. The chief forensic medical examiner, Dr. R. Bucklin, at Austin, Texas, reconstructed the exact manner of death of the man on the Shroud.

A team of American scientists from the Atomic Weapons Research Laboratory and the US Air Force Academy also produced dramatic discoveries using electronics.

On one research project US Air Force physicists found that the image is encoded with 3-dimensional information that can recreate a perfect 3D picture on a computer screen—no other painting or photograph, it is claimed, in the world possesses this quality! The supervisor of image enhancement at the Jet Propulsion Laboratory and responsible for the analysis of the pictures sent back on the Mars *Mariner* space mission, Dr. D. Lynn, subjected the image on the Shroud to a frequency analysis to detect any form

of "directionality" or hand painting — results show, graphically, that it cannot be the product of a human hand!

Together the scientists conclude that the only cause of the image that will fit the new data on the Shroud is a micro-second burst of intense radiation.

We found the film a very personal and moving experience and all credit to its producers in that it leaves the audience to form their own verdict. Unfortunately, at the time of going to press, the film is to finish its run in

London and although it is hoped to move it to another cinema no definite date has been finalised. Also, it is hoped to show *The Silent Witness* in other parts of the country.

★ The latest information we have is that the film is being put on to 16mm and will be available for hire to any interested parties. Details can be obtained from the distributors, Namara Entertainment Ltd., 18b Wellington Court, Knightsbridge, London SW1.



PARIS COMPONENTS SHOW

The 21st Salon International Des Composants Electroniques was held in Paris from 3 to 8 April.

This year special emphasis was given to quality of products, and prototypes of components having obtained the CECC (CENELEC Electronic Components Committee) certificate were on display in a special stand.

The CECC includes representation from 11 European countries, and is responsible for establishing norms, specifications and procedures with which the certified components must comply.

The French equivalent of "Viewdata" known as *ANTIOPE* (*Acquisition Numeriques et Televisualisation d'Informations Organisees en Pages d' Ecriture*) was in operation and attracted much interest.

Thirty different nations were represented amongst the total of 1,200 firms exhibiting. The UK had the 4th largest contingent, with 87 participants. These included all the big names in the UK semiconductor industry, and a variety of firms in the passive component, solder, materials and hardware business.

Kits for home constructors were displayed by several French distributors. Also on show with its French name *Dis-cosonn*, was the Chroma-Chime microprocessor-based door chimes.

After successfully launching hobby computers in the USA last year, Heathkit have introduced them to the UK market.

Name Dropping

A link with the past was broken when the name Elliott was dropped from Marconi-Elliott Avionic Systems Ltd. The company is now to be known as Marconi Avionics Ltd. and its American associate as Marconi Avionics Inc.

The name of Elliott has been in the title since 1969 when Elliott Flight Automation and Elliott Automation Radar Systems came into the Group. Marconi Avionics has now grown to 9,000 people employed, with

equipment used in some 150 different types of civil and military aircraft.

Transatlantic Date

The Post Office transatlantic Packet Switching Service is due to start on July 1. It enables computer data to be transmitted both ways between the USA and the UK in "packets", providing substantial cost savings.

Tornado Radar

The air interception radar to be fitted to the air defence variant of the Tornado aircraft now being built for the Royal Air Force will have a target detection range of 100 miles. Its Skyflash missiles can be engaged on targets at a range of 24 miles.



... from the World of Electronics

Engineers' Salaries

The average chartered electrical engineer's salary, according to a survey carried out by the Institution of Electrical Engineers, increased by only 5 per cent last year, well below the national average. This represents an increase from £5,890 to £6,210 p.a.

An interesting statistic emerging from the survey is that the predominant field of employment for IEE Fellows, Members and Associates is now electronic or telecommunications equipment development or manufacture and not, as one might have assumed in the IEE, in heavy electrical engineering or electricity generation and distribution.

Military Order

In conjunction with Cincinnati Electronics Inc of the USA, Marconi Space and Defence Systems has won a development contract for the US Army SINGARS-V (Single Channel Ground/Air Radio Systems VHF).

This is the first time a British company has been able to compete on level terms with US contractors. The development contract is worth \$6 million and it is said that if successful the follow-on production orders may amount to as much as 250,000 equipments.

The 19-member Arab League is spending about £10 million in consultancy fees to Comsat General Corporation to advise on a communications satellite system for Arab States. The system will be called Arabsat.



The Impact of Electronics

The keynote address to the London conference, The Impact of Electronics, by Jack Akerman, Managing Director, Mullard Ltd., has been reprinted in an attractive brochure with illustrations of historical interest. The story concludes with a happy prospect for blind persons, who may be able to see with the aid of synthetic eyesight by the year 2000. This kind of achievement makes electronics truly the great servant of man.

Copies of this booklet are available from Central Enquiry Handling Unit, Mullard Ltd., New Road, Mitcham, Surrey.



A new department has been set up by Post Office Telecommunications to accelerate the development of System X, the all-British electronic exchange equipment that, it is claimed, will revolutionise the nation's phone system.

—ANALYSIS—

MOST SECRET

Secret written codes are known to have existed for over 2,000 years but it wasn't until the invention of the telephone and, later, the radiotelephone, that systems had to be invented to make voice communications secret because telephone lines can be tapped and radio transmissions monitored. Speech scramblers, as such systems are popularly known, have been mainly used by governments, security services and armed forces but, today, industrial espionage has reached such proportions that many business firms are now using similar equipment.

In fact, what used to be a comparatively small esoteric hush-hush back-room activity has now blossomed into an industry in its own right called Communications Security, covering not only voice but data communications and facsimile.

So, over the years, there has been a build-up of move and counter-move. On the one side, big spending on increasingly sophisticated message encryption systems, on the other equally big spending on means of defeating the systems, generally by using huge number-crunching code-breaking computers.

The big advances of recent years are entirely due to electronics, in particular digital electronics and large scale integration (LSI) which have enabled very complex systems to be built in quite small packages and at reasonable cost. One commercially available equipment, for example, is built into an ordinary document case. With it you can go into a public telephone call-box and providing the person you are calling has decoding equipment you can have a conversation secure from eavesdropping.

The same firm makes a tiny encoder which can be clipped on to a military manpack radio so that even a platoon sergeant in the front line of battle can report back to his commanders with freedom from intelligible reception by enemy monitoring stations.

Brian G. Peck

TOMORROW'S BROADCASTING

A few points from a lecture by Dr. Boris Townsend, of the Independent Broadcasting Authority, delivered at the IBA last February.

MECHANISMS INTO MICROCIRCUITS

"Mechanisms grow more and more expensive to produce, while electronics become cheaper and cheaper. Compare the £70 monochrome television receiver, of dubious performance, which sold in 1938, with its contemporary £100 small motor car: and then take today's large, bright, reliable monochrome television receiver, still at £70, and its contemporary £2,000 Mini. So whenever we can replace mechanisms by electronics we shall."

NEW STUDIOS

"In the future, real background scenery will be unnecessary, although super-stars will probably insist on having it. Toy scenery and chroma-key techniques will do, with computer control of the scenery camera, which looks into the miniature stage through a periscope, keeping the perspective of the background correct as the foreground camera is crabbled. After a few years, even the toy scenery will disappear. The

scenery camera will look at a flatly lit photograph of the required background and the graphics computer will adjust a perspective and the shadows of the transmitted image as required."

TOMORROW'S TELEVISION SET

"By the 1980s we can also expect the domestic television receiver to be as much a computer visual display unit as it is a television set and television will face more competition than does radio. Microprocessors will turn this colour VDU into an indoor games centre."

WHAT IS POSSIBLE?

"Our technology has reached a rather exciting stage—a very democratic stage—an open stage. Television research engineers have some powerful technologies at their disposal and organisational methods which enable them to move fast in meeting a demand. The question is no longer 'What is possible?' We have to decide between a bewildering array of possibilities."

ENERGY SAVING

"Perhaps the most significant technical development in television has already been made—in ten years we have reduced the power consumption of domestic receivers by two-thirds; this saves, every night 700 megawatts, or enough electricity to rescue 100,000 old people from hypothermia."

"It is no longer a question of what can the engineers do? It is a case of what will the programme makers of the 1980s want? What will the Governments of the 1980s permit? What will the public of the 1980s pay for? Who will tell us?"

VISUAL

CONTINUITY TESTER

By A. Sproxton



IT is often required to be able to do a quick continuity test, usually a simple battery and bulb combination will suffice. It is however, limited to a circuit with a resistance not exceeding 100 ohms resistance or thereabouts.

It is with this idea in mind that this circuit was formulated. The basic idea is that the tester can differentiate between various types of resistive circuits.

CIRCUIT DESCRIPTION

The circuit of the Continuity Tester appears in Fig. 1, and as

can be seen is very simple. Three indicating devices are provided, the first, LP1 is connected in series with a resistor of 22 ohms.

This part of the circuit is able to provide an indication of the continuity in circuits where the "continuity resistance" is less than 100 ohms (LOW).

The second indicator D1 is a light emitting diode with its series limiting resistor and can just be seen to illuminate when only 0.2 milliamps flows, therefore being able to indicate when the "continuity resistance" is any value up to about 39 kilohms (MEDIUM).

For continuity through higher valued resistances an amplification stage is required, and this is accomplished by means of TR1 which is loaded with the third indicator D2 (HIGH), a similar light emitting diode to D1. The "continuity resistance" forms the base resistor in series with R3.

GAIN

According to manufacturers data, the minimum gain of a BC108 transistor is 120. Now the current required for the l.e.d. to be illuminated is, as we have seen earlier,

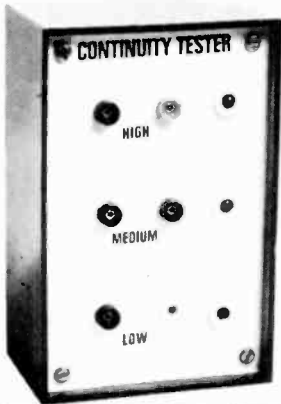

COMPONENTS

Resistors

- R1 22Ω
- R2 560Ω
- R3 270kΩ
- All 1/2W carbon ±10%

See
**Shop
Talk**
page 485

Semiconductors

- TR1 BC108 silicon *npn*
- D1 TIL209 green light emitting diode
- D2 TIL209 red light emitting diode

Miscellaneous

- LP1 6.5V 0.06A i.e.s. bulb
 - PL1, 2 2mm plugs (1 red, 1 black)
 - B1 PP3 9V battery
 - SK1 to 6 2mm sockets, black (3 off), red, green, white (1 off each)
- Plastic case, size approximately 115 x 75 x 50mm; battery clip to suit B1; flexible wire for test leads; two crocodile or other clips; connecting wire; mounting hardware for i.e.d.s and LP1; 6BA solder tag.

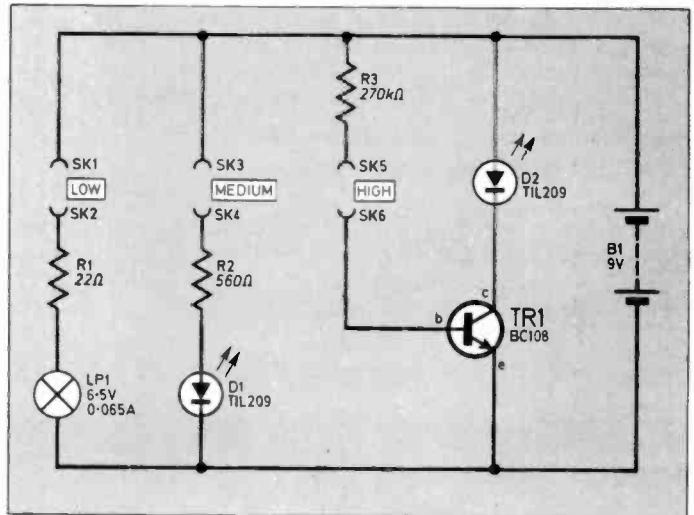
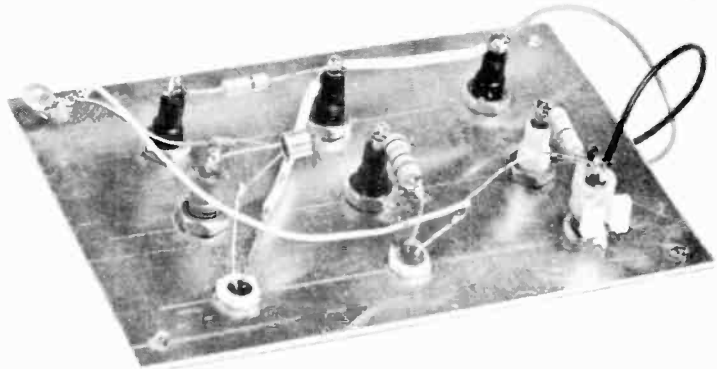
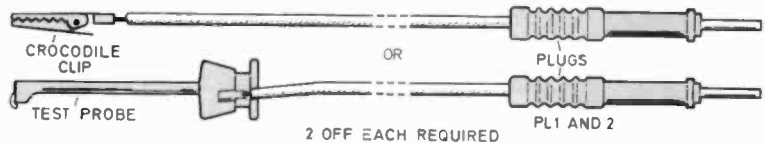

Fig. 1. Complete circuit diagram for the Visual Continuity Tester.



Showing how all components are mounted and interwired on the front panel.



FOR GUIDANCE ONLY

**ESTIMATED COST
OF COMPONENTS**

£2.00

excluding case

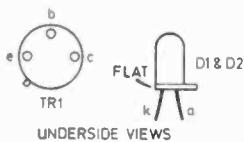
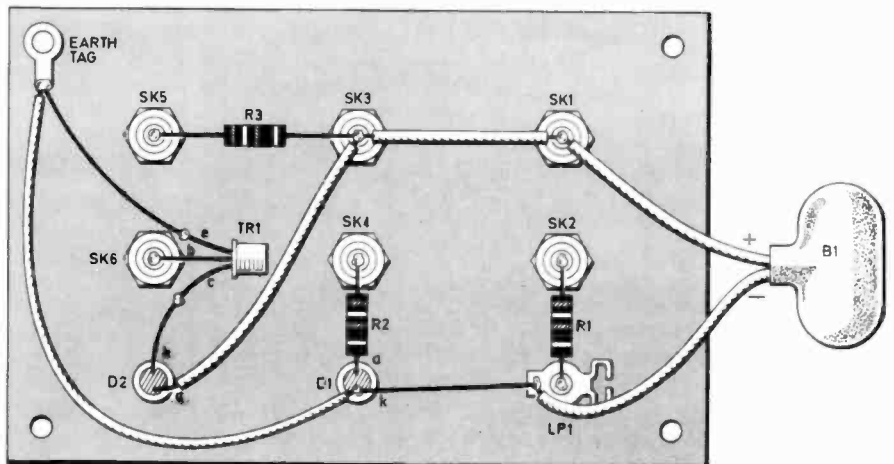

Fig. 2. Wiring details for the unit. Note the earth tag which is trapped under the front panel when this is fully assembled. If a panel other than metal is used be sure to provide an extra wire from the emitter of TR1 to the negative of the battery.

about 0.2 milliamps. The base current required to cause this collector current to flow is 1.6 microamps $\left(\frac{0.2\text{mA}}{120}\right)$

Therefore the maximum value of the base resistor from Ohm's law is $\left(\frac{8.4\text{V}}{1.6\mu\text{A}}\right) = 5.25$ megohms. From this we must subtract the fixed base resistor of 270 kilohms to obtain the upper limit of the HIGH range which is seen to be about 5 megohms.

START HERE FOR CONSTRUCTION

CONSTRUCTION

The construction is quite straightforward, all the details are shown in Fig. 2. Nothing is particularly critical about the layout, and can be varied to suit the case used.

The only points to watch for are the correct orientation of the l.e.d. and the transistor.

Two test leads are made up using 2mm plugs and test clips (or crocodile clips). In the prototype, flexible multistranded leads were used and found most convenient.

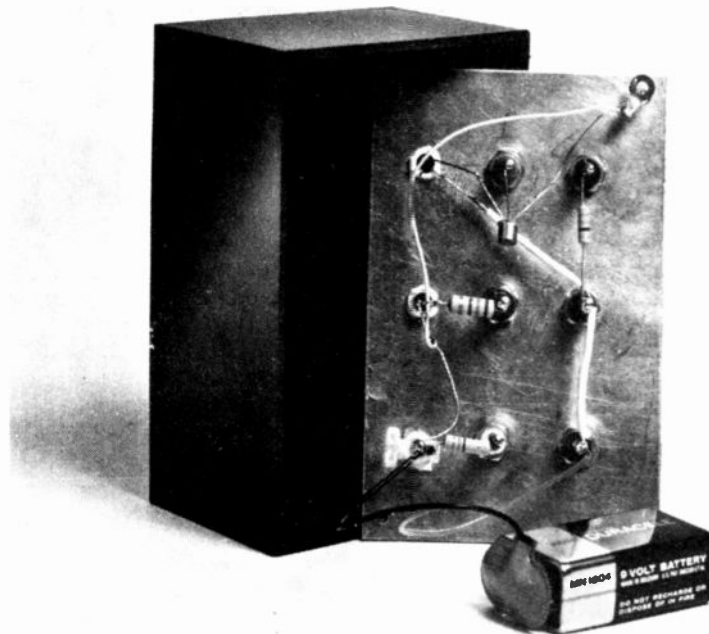

The completed Visual Continuity Tester prior to mounting in the case.

TESTING AND USE

Once constructed and the circuit checked for any errors the battery can be connected. It was not thought necessary to provide an on/off switch as the current drain is negligible.

In use the test leads are connected to the appropriate range and then clipped to the circuit under test. For example, if the resistance of the circuit is unknown first try the MEDIUM range. If there is no light then it can mean that the circuit is either open circuit or the resistance is greater than 39 kilohms.

Now try the HIGH range, if the resistance is not greater than 5 megohms the l.e.d. will light.

If when the MEDIUM range is tried and the l.e.d. lights up this means there is continuity but the resistance could be between near zero and 39 kilohms. To find out in what range it could be, the LOW range is used. This will then tell you where the resistance of the circuit lies. That is, between 0 and 100 ohms or 100 ohms to 39 kilohms.

The brilliance of bulbs and l.e.d.s will be seen easily if they are shielded from extraneous light. □

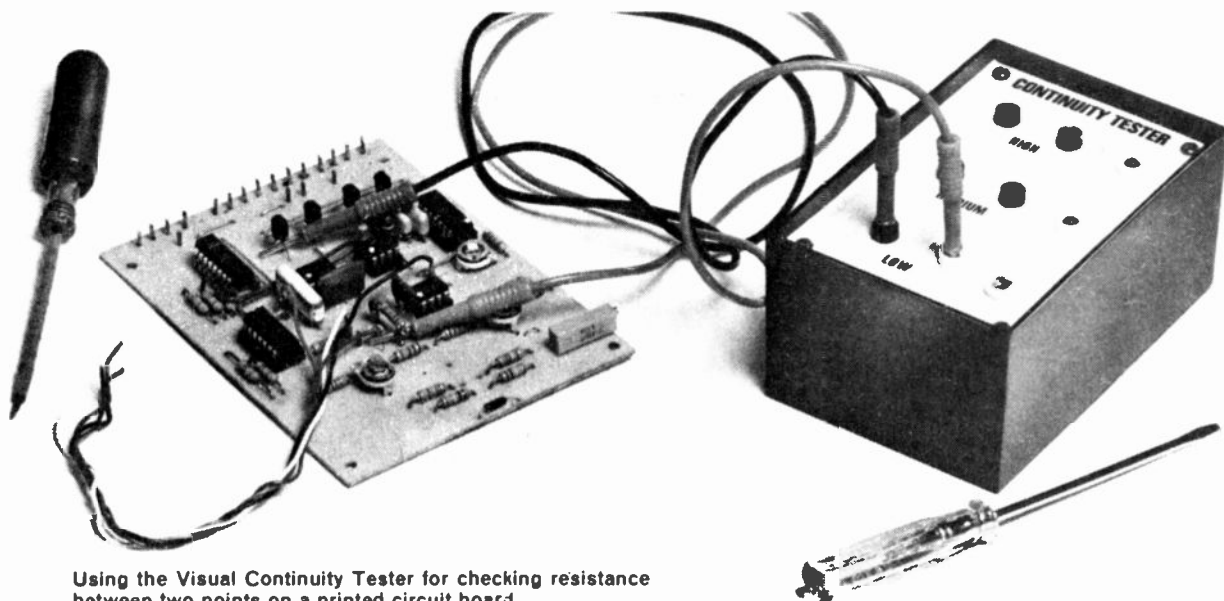

Using the Visual Continuity Tester for checking resistance between two points on a printed circuit board.

The Extraordinary Experiments of Professor Ernest Eversure

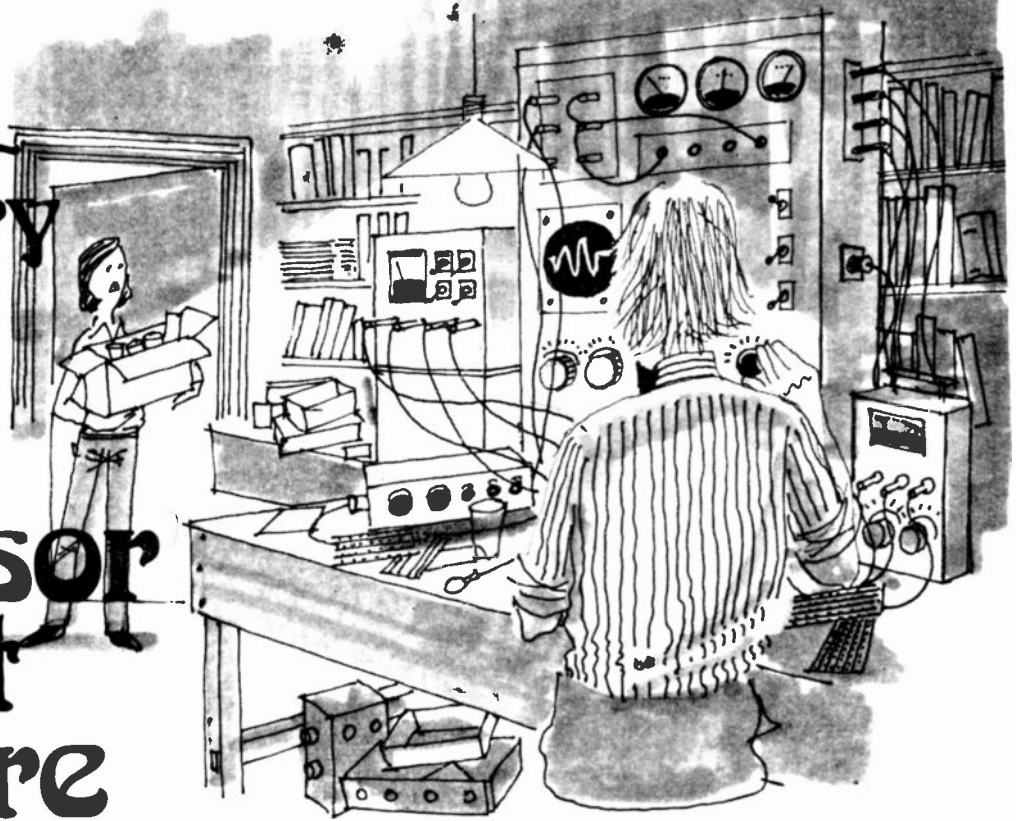

by Anthony John Bassett

"HELLO there, Bob!" the Prof's voice came from a small loud-speaker concealed in a nearby armchair. "Caught you again; do sit down!"

"Oh peanuts!" Bob was frustrated again, "Prof., I never do manage to spy on the secret experiments you carry out when there's no-one else in the laboratory."

He sat in the armchair, which was one item of the Prof's collection of experimental remote-controlled mobile furniture. With a gentle whirr it lifted slightly to hover a few centimetres above the floor then whisked Bob along the corridor to arrive once again in the presence of the Prof. in his laboratory.

Bob knew there was a lot he could learn from the Prof. and often tried to get to know more about some of his most advanced experiments.

But the Prof. wisely insisted that Bob should learn more of the basics first.

VALVE AMPLIFIER

"Prof., I was fascinated by your use of transistors as interface devices between circuits which operate from different supply-voltage levels, and I have noticed

that recently some of my friends are beginning to show a lot of interest in thermionic valves and valve-operated equipment.

I would like to know a lot more about valves, but first I would like to ask your advice on a specific problem: can valves also be used as interface devices in conjunction with transistors, in order to operate at even higher voltages? One of my friends is in a small band which uses a lot of electronic equipment and effects and he has a Vox AC-30 amplifier.

Unfortunately the gain of the amplifier, which is an older model and is his favourite, is too low to give adequate volume with his new guitar, so he uses a small transistorised preamplifier. Occasionally the battery in the preamplifier unit runs out at the most inconvenient times; usually at night, on stage in the middle of a booking, his guitar sound fades and becomes distorted. He would like to have a preamplifier built into one of the input-channels to provide gain, especially at high frequencies as he also wants some treble-boost.

I seem to remember you mentioning to me a circuit where one of the valves acts as an element in the power supply for a transistor preamplifier, and at the same time

amplifies the output of the pre-amplifier further, and this saves the expense and complication of an extra mains power supply for the preamplifier.

This sounds like a very interesting circuit and I wonder whether you could tell me about it so I could use it in this amplifier?"

Suddenly Bob spotted, on a nearby workbench, the old but cherished Vox AC-30 amplifier which belonged to his friend.

"What! How did that get here?" he exclaimed.

"Because you mentioned to your friend that you were coming to consult me, Bob, and he decided to call round and leave the amplifier at the laboratory. So now we can not only discuss possible solutions to his problems, but also put them to use for your friend! However, he has mentioned that the amplifier has developed a fault which seems to be getting worse. At first there was a crackling and some distortion when he played loudly.

OUTPUT TRANSFORMER

Now the distortion has become worse, and commences at a much lower volume, but only after he has played a few notes, some of

15-240 Watts!

HY5 Preamplifier

The HY5 is a mono hybrid amplifier ideally suited for all applications. All common input functions (mag Cartridge, tuner, etc) are catered for internally. The desired function is achieved either by a multi-way switch or direct connection to the appropriate pins. The internal volume and tone circuits merely require connecting to external potentiometers (not included). The HY5 is compatible with all I.L.P. power amplifiers and power supplies. To ease construction and mounting a P.C. connector is supplied with each pre-amplifier.

FEATURES: Complete pre-amplifier in single pack—Multi-function equalization—Low noise—Low distortion—High overload—Two simply combined for stereo.

APPLICATIONS: Hi-Fi—Mixers—Disco—Guitar and Organ—Public address

SPECIFICATIONS:
INPUTS: Magnetic Pick-up 3mV; Ceramic Pick-up 30mV; Tuner 100mV Microphone 10mV; Auxiliary 3-100mV; Input impedance 4.7k Ω at 1kHz.
OUTPUTS: Tape 100mV; Main output 500mV R.M.S.
ACTIVE TONE CONTROLS: Treble \pm 12dB at 10kHz; Bass \pm at 100Hz.
DISTORTION: 0.1% at 1kHz. Signal/Noise Ratio 88dB.
OVERLOAD: 38dB on Magnetic Pick-up. **SUPPLY VOLTAGE** \pm 18-90V.
Price £5.22 + 65p VAT P&P free.

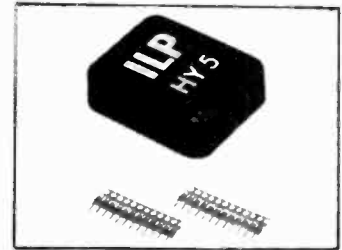

HY30 15 Watts into 8 Ω

The HY30 is an exciting New kit from I.L.P. It features a virtually indestructible I.C. with short circuit and thermal protection. The kit consists of I.C., heatsink, P.C. board, 4 resistors, 6 capacitors, mounting kit, together with easy to follow construction and operating instructions. This amplifier is ideally suited to the beginner in audio who wishes to use the most up-to-date technology available.

FEATURES: Complete Kit—Low Distortion—Short, Open and Thermal Protection—Easy to Build.

APPLICATIONS: Updating audio equipment—Guitar practice amplifier—Test amplifier—audio oscillator.

SPECIFICATIONS:
OUTPUT POWER 15W R.M.S. into 8 Ω ; **DISTORTION** 0.1% at 1.5W.
INPUT SENSITIVITY 500mV. **FREQUENCY RESPONSE** 10Hz-15kHz—3dB.
SUPPLY VOLTAGE \pm 18V.
Price £5.22 + 65p VAT P&P free.

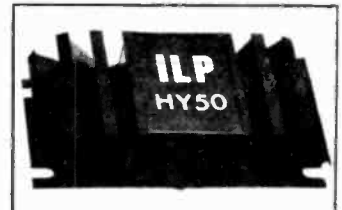

HY50 25 Watts into 8 Ω

The HY50 leads I.L.P.'s total integration approach to power amplifier design. The amplifier features an integral heatsink together with the simplicity of no external components. During the past three years the amplifier has been refined to the extent that it must be one of the most reliable and robust High Fidelity modules in the World.

FEATURES: Low Distortion—Integral Heatsink—Only five connections—7 amp output transistors—No external components

APPLICATIONS: Medium Power Hi-Fi systems—Low power disco—Guitar amplifier

SPECIFICATIONS: **INPUT SENSITIVITY** 500mV
OUTPUT POWER 25W RMS into 8 Ω **LOAD IMPEDANCE** 4-16 Ω **DISTORTION** 0.04% at 25W at 1kHz
SIGNAL/NOISE RATIO 75dB **FREQUENCY RESPONSE** 10Hz-45kHz—3dB
SUPPLY VOLTAGE \pm 25V **SIZE** 105 50 25mm
Price £6.82 + 65p VAT P&P free

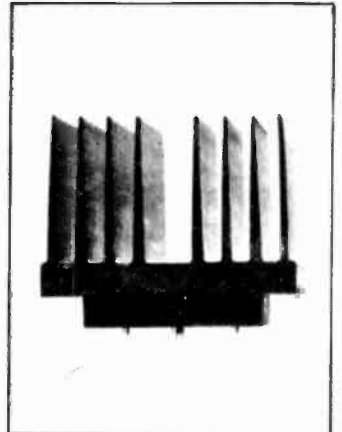

HY120 60 Watts into 8 Ω

The HY120 is the baby of I.L.P.'s new high power range. Designed to meet the most exacting requirements including load line and thermal protection this amplifier sets a new standard in modular design.

FEATURES: Very low distortion—Integral heatsink—Load line protection—Thermal protection—Five connections—No external components

APPLICATIONS: Hi-Fi—High quality disco—Public address—Monitor amplifier—Guitar and organ

SPECIFICATIONS: **INPUT SENSITIVITY** 500mV.
OUTPUT POWER 60W RMS into 8 Ω **LOAD IMPEDANCE** 4-16 Ω **DISTORTION** 0.04% at 60W at 1kHz
SIGNAL/NOISE RATIO 90dB **FREQUENCY RESPONSE** 10Hz-45kHz—3dB **SUPPLY VOLTAGE** \pm 25V
SIZE 114 50 85mm
Price £18.84 + £1.27 VAT P&P free.

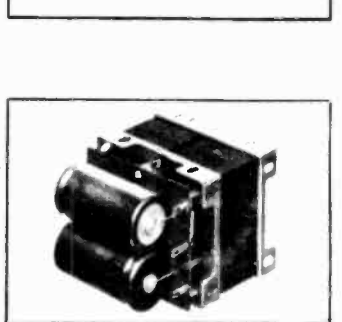

HY200 120 Watts into 8 Ω

The HY200 now improved to give an output of 120 Watts has been designed to stand the most rugged conditions such as disco or group while still retaining true Hi-Fi performance.

FEATURES: Thermal shutdown—Very low distortion—Load line protection—Integral heatsink—No external components

APPLICATIONS: Hi-Fi—Disco—Monitor—Power slave—Industrial—Public Address

SPECIFICATIONS: **INPUT SENSITIVITY** 800mV
OUTPUT POWER 120W RMS into 8 Ω **LOAD IMPEDANCE** 4-16 Ω **DISTORTION** 0.05% at 100W at 1kHz.
SIGNAL/NOISE RATIO 96dB **FREQUENCY RESPONSE** 10Hz-45kHz—3dB **SUPPLY VOLTAGE** \pm 45V
SIZE 114 50 85mm
Price £23.32 + £1.87 VAT P&P free.

HY400 240 Watts into 4 Ω

The HY400 is I.L.P.'s "Big Daddy" of the range producing 240W into 4 Ω ! It has been designed for high power disco address applications. If the amplifier is to be used at continuous high power levels a cooling fan is recommended. The amplifier includes all the qualities of the rest of the family to lead the market as a true high power hi-fidelity power module.

FEATURES: Thermal shutdown—Very low distortion—Load line protection—No external components.

APPLICATIONS: Public address—Disco—Power slave—Industrial

SPECIFICATIONS: **OUTPUT POWER** 240W RMS into 4 Ω **LOAD IMPEDANCE** 4-16 Ω **DISTORTION** 0.1% at 240W at 1kHz
SIGNAL NOISE RATIO 94dB **FREQUENCY RESPONSE** 10Hz-45kHz—3dB **SUPPLY VOLTAGE** \pm 45V
INPUT SENSITIVITY 500mV **SIZE** 114 100 85mm
Price £32.17 + £2.57 VAT P&P free.

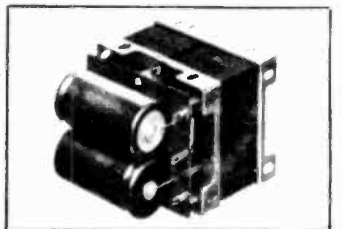

POWER SUPPLIES

PSU36 suitable for two HY30's £5.22 plus 65p VAT. P/P free.
 PSU50 suitable for two HY50's £6.82 plus 65p VAT. P/P free.
 PSU70 suitable for two HY120's £13.75 plus £1.10 VAT. P/P free.
 PSU90 suitable for one HY200 £12.65 plus £1.01 VAT. P/P free.
 PSU180 £23.10 + £1.85 VAT.
 B1 £0.48 + £0.06 VAT.

TWO YEARS' GUARANTEE ON ALL OUR PRODUCTS

I.L.P. ELECTRONICS LTD., CROSSLAND HOUSE, NACKINGTON, CANTERBURY, KENT, CT4 7AD.

I.L.P. ELECTRONICS LTD.,
CROSSLAND HOUSE, NACKINGTON,
CANTERBURY, KENT, CT4 7AD.

Please Supply _____
 Total Purchase Price _____
 I Enclose Cheque Postal Orders Money Order
 Please debit my Access account Barclaycard account
 Account number _____
 Name and Address _____
 Signature _____

You'll learn a lot from the free Heathkit catalogue.

The Heathkit catalogue is packed with scores of top quality electronic kits. Educational, practical and fascinating items which you can build yourself.



Send for the catalogue now.

To Heath (Gloucester) Limited,
Department , Bristol Road,
Gloucester, GL2 6EE.

Name

Address

EE 68

Please tick the literature you want and enclose the appropriate amount in postage stamps.
Heathkit catalogue only (enclose 11p to cover postage) 16 page computer brochure only (enclose 20p to cover postage and part costs). N.B. If you are already on the Heathkit mailing list you will automatically receive a copy of the latest catalogue without having to use this coupon.

Soldering
iron offer
FREE

When you receive your catalogue you'll get details of this free offer worth approx mately £4.75

HEATH
Schlumberger
The world's
biggest producers
of electronic kits.

ACCESS AND
BARCLAYCARD
WELCOMED

There are Heathkit Electronics Centres at 233 Tottenham Court Road, London (01-636 7349) and at Bristol Road, Gloucester (Gloucester 29451).



New Computer systems
Send for a special 16 page brochure



NEW Bi-directional
RF Wattmeter



NEW De-luxe Coin-tracking Metal Locator



NEW De-luxe
12" CRT Ignition Analyser

CRESCENT RADIO LTD.

MAIL ORDER DEPT. 1 St Michaels Terrace, Wood Green
London N22 4SJ Phone 888-4474

MULTIMETER BARGAINS

A special bulk purchase of Eagle Multimeters enables us to offer two from their range at up to 15% off Eagle's own recommended retail price.

EP20KN

20,000 opv multimeter with anti-parallax mirror, 'off' damping. DC volts: 0 to 0.25, 5, 25, 125, 500, 1,000 (20,000 opv). AC volts: 0 to 10, 50, 250, 1,000 (10,000 opv). DC current: 0 to 50 uA, 2.5 mA, 250 mA. Resistance: 0 to 60K, 600K, 6 Meg. Decibels: -20 to +22 dB. Dimensions: 118 x 86 x 34 mm. PRICE £16.16 + 8% VAT.



POWER SUPPLY UNIT TYPE 'PPI'

Switched 3, 4, 6, 7, 9 and 12 volts at 500mA. With on/off switch and pilot light. Size: 130mm x 55mm x 75mm approx. OUR PRICE: Only £6.00 + 8% VAT

C1095 20,000 opv multimeter with hinged 4-position scale for easy-reading bench use. Anti-parallax mirror, 3-colour scale, overload protection. Ranges: DC volts: 5, 25, 50, 250, 500, 2,500 (20,000 opv). AC volts: 10, 50, 100, 500, 1,000 (10,000 opv). DC current: 50 uA, 2.5 mA, 250 mA. Resistance: 50 K, 5 meg. Decibels: -20 to +22 dB. Dimensions: 140 x 85 x 35 mm. PRICE: £14.31 + 8% VAT

ABS PLASTIC BOXES

Handy boxes for construction projects. Moulded extrusion rails for P.C. or chassis panels. Fitted with 1mm Front Panels. 1005 = 105 x 73 x 45mm = 85p
1006 = 150 x 74 x 47mm = £1.05
1022 = 107 x 85 x 45mm = 80p (sloping front) Plus 8% VAT.

POPULAR DUAL IMPEDANCE MICROPHONE

Uni-Directional Cardioid Dynamic Microphone. Type No. UD 130. Freq. Response: 80-14,000 Hz. Impedance: Dual—600 ohm or 50k ohm. On-off Slide Switch. Supplied with Mic. Holder (1/8" thread) and approx. 17ft of cable with microphone connector and Jack plug attached. PRICE: £10.00 + 12 1/2% VAT.



BARGAIN PROJECT BOX

A Plastic Box with moulded extrusion rails for P.C. or chassis panels with metal front plate fitted with four screws (all supplied). Size: (Internal): 81 x 51 x 28mm. PRICE: 60p + 8% VAT.

FERRIC CHLORIDE

Anhydrous Ferric Chloride in double sealed one pound 'Polypaks'. PRICE: £1.15 per lb + 8% VAT.

'BARGAIN TRANSFORMER'

240v PRIMARY 12-0-12v, 500mA SEC. Approx. size: 60 x 40 x 50mm. Fixing centres: 75mm. PRICE: £1.80 + 8% VAT.

ACCESS AND BARCLAYCARD ACCEPTED—PHONE ORDERS WELCOMED. ALL PRICES INCLUDE POSTAGE—PLEASE ADD VAT AS SHOWN—S.A.E. WITH ALL ENQUIRIES PLEASE. Personal Callers Welcome at: 21 Green Lanes, Palmers Green London, N.13. Phone: 888-3206 and 13 SOUTH MALL, EDMONTON, N.9. Phone: 803-1685.

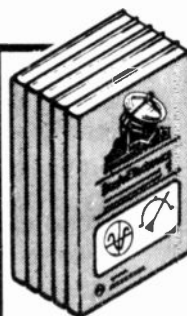

ANNOUNCING A NEW SET OF BASIC ELECTRONICS

This 5 volume set contains over 500 pages. Bound in stiff linen. Cover size 8 1/2" x 5 1/2". Price £7.50 per set (we pay the postage).

- Book 1. Introducing Electronics Book 4. Meters/Voltage-dividers
Book 2. Resistors/Capacitors Book 5. Transistor Project Circuitry
Book 3. Inductors/Diodes

The manuals are unquestionably the finest and most up-to-date available and represent exceptional value.

This series has been written in a fascinating, absorbing and exciting way, providing an approach to acquiring knowledge that is a very enjoyable experience. Suitable for industrial trainees, City and Guilds students, DIY enthusiasts and readers of electronic journals.

Each part explains electronics in an easy-to-follow way, and contains numerous diagrams and half tone blocks with construction details and circuit diagrams for making the following transistor projects: Lamp Flasher, Metronome, Wailer, Photographic/Monostable Timer, Metal Locator, Geiger Counter, Radio Receiver, Intercom., Intruder Alarm, Electronic Organ, Battery Eliminator, Anemometer, Sound Switch, Light and Water-operated Switches, Pressure-operated Switches, Light meter, Radio Thermometer, Ice Alarm.

Order now:
Salray Book Company
60 Hayes Hill
Bromley
BR2 7HP

OUR 100% GUARANTEE
Should you decide to return the set after 10 days examination, your money will be refunded by return of post.

Amount enclosed: £

Name:

Address:

EE 6

which are loud, and clear of the distortion which he complains of. This leads me to suspect that the fault may be in the primary of the output transformer, although intermittent faults with crackling and distortion can easily occur elsewhere in the circuit due to vibration from the loudspeakers and from the frequent transport which these amplifiers are usually subject to."

"Why do you suspect the output transformer, Prof?"

"Because this component is subject to particularly high voltage surges when a loud note is played, especially if the input is a square wave. Then the inductance of the primary winding causes voltage spikes at the leading and trailing edges of the square-wave."

INSULATION BREAKDOWN

These high voltages sometimes result in a breakdown of the insulation between adjacent windings or between nearby turns of the same winding, and I think that this may be the problem with this amplifier. When the insulation breaks down between adjacent turns of the same winding, a partially conducting track of carbon forms between the nearby turns. This absorbs power when the player strums loudly, but much less when he plays quietly, as there is then very little induced voltage between the turns.

When he plays loudly, the power absorbed by the conducting carbon track causes it to raise in temperature. This produces more carbon from nearby insulating material and the fault worsens, until, as I suspect in this case, more power is absorbed in the carbon than is delivered to the loudspeakers.

This results in a low-volume, distorted output from the amplifier, and if he continues to try to play loudly, the rise in temperature within the transformer may cause it to produce smoke and fail more catastrophically.

VALVE BASES

Another component where carbon tracks can be formed with similar results is the valve base in which each output valve is held. Each of the output-valve bases is subject, along with the valve itself, to the same high-voltage spikes produced by the output transformer, and a track of hot carbon is formed, spreading until it may reach a point of low potential and cause the valve base to catch fire.

"What I usually recommend in such cases is replacement of the plastic valve-bases with ceramic ones. Although these are more expensive and may have to be ordered specially, it is impossible for them to carbonise, and so it is worth the trouble of obtaining them."

The Prof. finished unscrewing the back of the amplifier. He slid it out of its cabinet and fitted an extension to the loudspeaker terminals, as he knew that it is, for the most part, unwise to operate a valve audio power amplifier without a proper load on the speaker terminals. He then removed the base of the amplifier to reveal the connections to the primary of the output transformer.

NEON TEST

"Now," he told Bob, "I am going to show you a simple test which will often reveal the presence of shorted turns in an audio output transformer of a valve amplifier. Here is a neon indicator lamp with symmetrical electrodes, and it is also fitted with a 270 kilohm series limiting resistor."

Bob could see the small neon bulb contained two parallel wire electrodes. The Prof. soldered the

leads of the neon indicator, together with its 270 kilohm limiting series resistor, to the opposite ends of the primary winding of the output transformer. Then he plugged the amplifier into the mains supply and switched on. Plugging the output of an audio signal generator into one of the inputs, he told Bob:

"When I turn the volume up, both electrodes of the neon should glow with equal intensity if the transformer is satisfactory and the signal I am injecting is symmetrical."

However, even at maximum volume the sound from the speakers was very weak and distorted, and neither electrode of the neon lamp glowed.

SHORTED TURNS

"It seems to me that we have here a very severe example of shorted turns in the output transformer. Usually even if it is faulty, at least one electrode of the neon will light as the fault usually occurs in one half of the primary of a push-pull transformer, and despite the damping effects of this, the other half will usually produce sufficient voltage surge to light one electrode of the neon."

The Prof. switched off the amplifier and unplugged it from the mains supply socket. Then he used a multimeter to ensure that the high voltage from the h.t. supply had drained away, before working on it. He removed the faulty transformer and, with a few instructions in a strange robotic language, handed it to his experimental robotic assistant.

"Now whilst the Robot rewinds this transformer using new copper wire and insulation I will draw the circuit diagram of the output, and will discuss what went wrong and how to prevent it, as rewinding or replacement of these transformers can sometimes be expensive, not to mention the embarrassment of having equipment fail before an audience. This, incidentally, is a rare occurrence with the Vox AC-30, which is a very popular amplifier and this one probably failed from sheer old age and very heavy use!"

Deftly the Prof. began to draw out the circuit diagram of the four-valve output stages of the amplifier.

To be continued



THE DYNAMIC DUO



The C15/15 is a unique Power Amplifier providing Stereo 15 watts per channel or 30 watts Mono and can be used with any car radio/tape unit. It is simply wired in series with the existing speaking leads and in conjunction with our speakers S15 produces a system of incredible performance.

A novel feature is that the amplifier is automatically switched on or off by sensing the power line of the radio/tape unit, hence alleviating the need for an on/off switch.

The amplifier is sealed into an integral heatsink and is terminated by screw connectors making installation a very easy process.

The S15 has been specially designed for car use and produces performance equal to domestic speakers yet retaining high power handling and compact size.

C15/15

15 watts per channel into 4Ω
Distortion 0.2% at 1 kHz at 15 watts
Frequency Response 50Hz-30kHz
Input Impedance 8Ω nominal
Input Sensitivity 2 volts R.M.S. for 15 watts output
Power Line 10-18 volts
Open and Short Circuit Protection
Thermal Protection
Size 4 × 4 × 1 inches
C15/15 Price £17.74 + £2.21 VAT P&P free

Data on S15

6" Diameter
5½" Air Suspension
2" Active Tweeter
20oz Ceramic Magnet
15 watts R.M.S. Handling
50Hz-15kHz Frequency Response
4Ω Impedance
S15 Price per pair £17.74 + £2.21 VAT P&P free

TWO YEARS GUARANTEE ON ALL OF OUR PRODUCTS

Please supply
Total Purchase Price
I enclose cheque Postal Order Money Order
Please debit my Access Account Barclaycard Account
Account Number
Name & Address
Signature.....

Reg. No. 202141535



Crookland House,
Nackington,
Canterbury, Kent
Tel (0227) 63218

ELECTROVALUE

All the many types of components we supply are BRAND NEW and guaranteed and only from manufacturers direct or approved suppliers. (No surplus, no seconds)

CMOS—buffered and protected (BE)

4000	23p	4013	51p	4023	23p	4043	1.00	4081	23p
4001	23p	4014	1.04	4024	1.04	4044	94p	4082	26p
4002	23p	4015	1.14	4025	23p	4046	1.40	4510	1.42
4006	1.14	4016	51p	4026	1.75	4049	54p	4511	1.50
4007	23p	4017	1.14	4027	60p	4050	53p	4514	3.30
4008	99p	4018	1.32	4028	95p	4060	1.40	4516	1.44
4009	62p	4019	62p	4029	1.23	4069	30p	4518	1.26
4010	63p	4020	1.32	4030	51p	4070	50p	4520	1.26
4011	23p	4021	1.14	4041	84p	4071	26p	4543	1.30
4012	23p	4022	1.13	4042	96p	4072	26p	4583	1.45

OUR COMPUTER TAKES GOOD CARE OF YOUR ORDERS

SIEMENS CAPACITORS ●

World-famous for quality and dependability—exceptionally large stocks held.
PCB TYPES—7.5mm PCM 0-001 to 0-01 5p each: 0-015 to 0-047 6p each: 0-068, 0-1 7p each.

CERAMIC—2.5mm PCM 0-01, 0-022 4p: 0-033, 0-047 5p each: 0-068 6p each: 0-1 7p.

ELECTROLYTICS—1/100, 10/25, 10/63, 100/25, etc. etc.
For full range see our current lists.

RESISTORS

½, 1, 2 watts 2p ● each: metal film, metal oxide and 1 watt carbon 5p ● each: Good quantity discounts. Magnetic field dependent from £1.50. Hall effect from £1.23.

SIEMENS TRANSISTORS

Silicon npn and pnp from 8p each: LEDs, red 19p: yellow or green 23p (3 or 5mm): Photo transistors from 76p.

KEEN PRICES ● GOOD SERVICE ● WIDE RANGES

DISCOUNTS

5% if list value of order over £10
10% if list value of order over £25
—where cash (P.O. or cheque) is sent with order.

V.A.T.—Add 8% to value of order or 12½% with items marked. (No V.A.T. on overseas orders). Goods sent post free on C.W.O. orders in U.K. over £5 list value. If under, add 27p per order.

MONTHLY BARGAIN LISTS S.A.E. brings monthly list of bargains. Also current quick reference price list of all ranges.

Cash with order (P.O. or cheque payable to Electrovalue Ltd) or your Access or Barclaycard number.

TRADE AND INDUSTRIAL ENQUIRIES INVITED

For all round satisfaction—be safe—buy it from ELECTROVALUE

ELECTROVALUE LTD

Dept E.E.7, 24 St. Judes Rd, Englefield Green, Egham, Surrey TW20 0HB.
Phone Egham 3603. Telex 264475.
Northern Branch (Personal shoppers only), 680 Burnage Lane, Burnage, Manchester M19 1NA. Phone (061) 432 4945.

HAVE YOU DONE IT LATELY!

Fit a new tape head and transform the performance of your tape recorder

MONOLITH
THE MONOLITH ELECTRONICS CO LTD

QUALITY
REEL TO REEL
AND CASSETTE TAPE HEADS



Please enclose

Full Catalogue 25p

20p P&P with order

B24—RP stereo cassette glass/ferrite record/playback £9.84
B12—01 mono cass. playbk. £1.60 B24—01 stereo cass. playbk. £2.80
A28—05 stereo 8tk cartridge £1.80 E12—09 stereo/mono cass. erase £1.80

5/7 Church St, Crewkerne, Som. Tel. (0460) 74321

4-STATION INTERCOM



£19.95
- V.A.T. £1.80

Solve your communication problems with this 4-station Transistor Intercom system (1 master and 3 Subs), in robust plastic cabinets for desk or wall mounting. Call/talk/listen from Master to Subs and Subs to Master. Ideally suitable for Business, Surgery, Schools, Hospitals and Office. Operates on one 9V battery. On/off switch. Volume control. Complete with 3 connecting wires each 6ft. A Battery and other accessories. Adaptable for mains. Battery eliminator £8.18 (optional) P & P. 99p.

MAINS INTERCOM



ONLY
£15.95
+ V.A.T. £1.28

Latest transistorised Telephone Amplifier with detached plug-in speaker. Placing the receiver on to the cradle activates a switch for immediate two-way conversion without holding the handset. Many people can listen at a time. Increase efficiency in office shop, workshop. Perfect for "conference" calls; leaves the user's hands free to make notes, consult files. No long waiting, saves time with long-distance calls. On/off switch, volume control, conversation recording model at £18.95 + VAT £1.52. P. & P. 89p.

10-day price refund guarantee on all items.
WEST LONDON DIRECT SUPPLIES (EE8) 169 KENINGTON HIGH STREET, LONDON, W8 01-837 6648

ROOM THERMOSTAT

Famous Salchwell, elegant design, intended for wall mounting. Will switch up to 20 amps at mains voltage, covers the range 0.30 C. Special snip this month £3.00.

ROD THERMOSTAT—£3.00.

WINDSCREEN WIPER CONTROL

Vary speed of your wiper to suit conditions. All parts and instructions to make £3.75.

MICRO SWITCH BARGAINS

Rated at 5 amps 250V, ideal to make a switch panel for a calculator and for dozens of other applications. Parcel of 10 (two types) for £1.

RADIO STETHOSCOPE

Easiest way to fault find, traces signal from aerial to speaker when signal stops you've found the fault. Use it on Radio, TV, amplifier, anything. Kit comprises transistors and parts including probe tube, twin stetho-set. £3.95.

MULTISPEED MOTORS

Six speeds are available 500, 850 and 1,000 r.p.m. and 7,000, 9,000 and 11,000 r.p.m. Shaft is 1/8 in diameter and approximately 1 in. long. 230/240V. Its speed may be further controlled with the use of our Thyristor controller. Very powerful and useful motor. Size approx. 2 in. dia. x 5 in. long. Price £2.

12V MINIATURE RELAY

dc operated with two sets of change over contacts. The unique feature of this relay is its heavy lead out wires; these provide adequate support and therefore the relay needs no fixing; on the other hand there is a fixing bolt protruding through one side so if you wish you can fix the relay and use its very strong lead outs to secure circuit components—an expensive relay; but we are offering it for only 87p each. Don't miss this exceptional bargain!

EXTRACTOR FAN

Extractors—made by Woods of Colchester. Ideal for fixing through panel—reasonably quiet running—very powerful 2500 rpm. Choice of two sizes 5" or 6 1/2" dia. £4.43.

MAINS RELAYS

With triple 10 amp changeover contacts—operating coil wound for 230V a.c. Chassis mounting one screw fixing. Price £1.75.

MICRO AMPLIFIER

Excite behind the ear hearing aid—complete with volume control. £2.16. Case not supplied.

MERCURY BATTERIES

Bank of 7 Mercury cells type 625 which are approx. 3/16 in. diameter by 3/16 in. thick in plastic tube giving a total of 10.7V. Being in a plastic tube it is very easy to break up the battery into separate cells and use these for radio control and similar equipment. Carton of 25 batteries £1.60.

PP3/PP9 REPLACEMENT

Japanese made in plastic container with leads size 2in. x 1 1/2in. x 1 1/2in. this is ideal to power a calculator or radio, it has a full wave rectifier and smoothed output of 9V suitable for loading of up to 100mA. £2.33.

SWITCH TRIGGER MATS

So thin is undetectable under carpet but will switch on with slightest pressure. For burglar alarms, shop doors, etc. 24in. x 18in. £2.50. 13in. x 10in. £1.95.

MAINS TRANSISTOR PACK

Designed to operate transistor sets and amplifiers. Adjustable output 6V, 9V, 12V for up to 500mA (class D working). Takes the place of any of the following batteries: PP1, PP3, PP4, PP6, PP7, PP9 and others. Kit comprises: main transformer rectifier, smoothing and load resistor condensers and instructions. Real snip at only £2.00.

CONTROL DRILL SPEEDS

DRILL CONTROLLER

Electronically changes speed from approximately 10 revs to maximum. Full power at all speeds by finger-clip control. Kit includes all parts, case, everything and full instructions. £3.45. Made-up model £1 extra.

8 POWERFUL BATTERY MOTORS

For models, Meccanos, drills, remote control planes, boats, etc. £2.

ROTARY PUMP

Self priming, portable, fits drill or electric motor, pumps up to 200 gallons per hour depending upon revs. Virtually uncorrodible, use to such water, oil, petrol, fertiliser, chemicals, anything liquid. Hose connectors each end. £2.

SHORTWAVE CRYSTAL SET

Although this uses no battery it gives really amazing results. You will receive an amazing assortment of stations over the 19, 25, 29, 31 metre bands. Kit contains chassis front panel and all the parts £1.94—crystal earphone 55p including VAT and postage.

MULLARD UNILEX

A mains operated 4 + 4 stereo system. Rated one of the finest performers in the stereo field this would make a wonderful gift for almost anyone in easy-to-assemble modular form and complete with a pair of Plessey speakers this should sell at about £30—but due to a special bulk buy and as an incentive for you to buy this month we offer the system complete at only £15.00 including VAT and postage.

HUMIDITY SWITCH

American made by Ranco, their type No J11. The action of this device depends upon the dampness causing a membrane to stretch and trigger a sensitive micro-switch adjustable by a screw, quite sensitive—breathing on it for instance will switch it on. Micro 3 amp at 250V a.c. Overall size of the device approx. 3 1/2 in. long, 1 in. wide and 1 1/2 in. deep. 75p.

DELAY SWITCH

Mains operated—delay can be accurately set with pointers knob for periods of up to 2 1/2 hrs. 2 contacts suitable to switch 10 amps—second contact opens few minutes after 1st contact 95p.

25A ELECTRIC PROGRAMMER

Learn in your sleep. Have radio playing and kettle boiling as you wake—switch on lights to ward off intruders—have a warm house to come home to. All these and many other things you can do if you invest in an electrical programmer. Clock by famous maker with 15 amp on/off switch. Switch-on time can be set anywhere to stay on up to 6 hours independent 60 minute memory jogger. A beautiful unit.

MULLARD AUDIO AMPLIFIERS

All in module form, each ready built complete with heat sinks and connection tags, data supplied. Model 1153 500mW power, output £1.69. Model 1172—10 watts power output £3.94. Model 1172 1W, power output £2.25. Model EP9000 4 watt power output £2.90. EP 9001 twin channel or stereo pre-amp £2.90.

PRINTED CIRCUIT KIT PROJECTS

CONTENTS: (1) 2 Copper Laminate Boards 4 1/2 in. x 2 1/2 in. (2) 1 Board for Marchbox Radio. (3) 1 Board for Wristwatch Radio, etc. (4) Resist. (5) Resist Solvent. (6) Etchant. (7) Cleanser/Degreaser. (8) 16-page Booklet Printed Circuits for Amateurs (9) 2 Miniature Radio Dials SW/MW/LW. Also free with each kit. (10) Essential Design Data Circuits, Chassis Plans, etc for PROJECTS. £1.90.

SOUND TO LIGHT UNIT

Add colour or white light to your amplifier. Will operate 1, 2 or 3 lamps (maximum 450W). Unit in box all ready to work. £9.95.

MINI-MULTI TESTER

Amazing, deluxe pocket size precision moving coil instrument—jewelled bearings—1000 opv—mirrored scale. 11 instant ranges measure: DC volts 10, 50, 250, 1000 AC volts 10, 50, 250, 1000 DC amps 0-1 mA and 0-100 mA Continuity and resistance 0-150K ohms. Complete with insulated probes, leads, battery, circuit diagram and instructions.

Unbelievable value only £5.50p + 50p post and insurance. FREE Amps ranges kit enable you to read DC current from 0-10 amps, directly on the 0-10 scale. It's free if you purchase quickly but if you already own a mini tester and would like one send £1.50p.

TERMS: Cash with order—but orders under £6 must add 50p to offset packing etc. BULK ENQUIRIES INVITED. PHONE: 01-688 1833

J. BULL (ELECTRICAL) LTD
(Dept. EE), 103 TAMWORTH RD.
CROYDON CR9 1SG

IT'S FREE

Our monthly Advance Advertising Bargains List gives details of bargains arriving or just arrived—often bargains which sell out before our advertisement can appear—it's an interesting list and it's free—just send S.A.E. Below are a few of the Bargains still available from previous issues.

MAINS TRANSFORMERS

All these have 230/240v 50Hz Primary

VOLTAGE	CURRENT	REF.	PRICE
1v	2 amp	TM 1	£1.94
2.4v	5 amp	TM 2	£1.62
4v	7 amp	TM 32	£2.70
6v	2 amp	TM 4	£0.85
6.5v	1 amp	TM 37	£0.85
6.5v	200 mA	TM 21	£1.62
6.5v-0-6.5v	100 mA	TM 21	£1.62
6.5v-0-6.5v	750 mA	TM 7	£2.16
6.5v-0-6.5v	100 mA	TM 33	£1.62
6.3v	2 amp	TM 4	£1.89
8.5v	1 amp	TM 12	£1.62
8.5v + 8.5v sep winding	1 amp	TM 12	£1.62
9v	1 amp	TM 5	£1.62
9v	1 amp 'c' core	TM 6	£1.80
9v	3 1/2 amp	TM 11	£2.70
9v	5 amp	TM 38	£3.24
10v	25 amp	TM 4	£1.89
10v-0-10v	12 1/2 amp	TM 15	£4.86
12v-0-12v	4 amp	TM 27	£4.32
12v	1 amp	TM 9	£1.05
13v	1 amp	TM 7	£2.16
12v-0-12v	1 amp	TM 10	£1.89
12v-0-12v	50mA	TM 19	£1.62
15v tapped 9v	1 amp	TM 41	£3.24
15v	2 amp	TM 11	£2.70
15v	7 amp	TM 27	£4.32
15v-0-15v	3 1/2 amp	TM 27	£4.32
15v-0-15v	3 1/2 amp	TM 35	£4.86
17v	1 amp	TM 12	£1.62
18v	1 amp	TM 13	£1.90
20v	1 amp	TM 14	£1.62
20v	5 amp	TM 27	£4.32
20v	12 1/2 amp	TM 15	£4.86
20v-0-20v	6 amp	TM 15	£4.86
20v	100 mA	TM 21	£1.62
24v	1 1/2 amp	TM 12	£1.62
24v	2 amp	TM 17	£2.70
24v + 2v 7 amp	2 amp	TM 39	£2.97
24v	4 amp	TM 40	£3.78
25v	1 1/2 amp	TM 18	£2.43
25v	3 1/2 amp	TM 39	£2.97
30v tapped 24, 20, 15 & 12	3 1/2 amp	TM 27	£4.32
30v	8 amp	TM 15	£4.86
37v	37 amps	TM 34	£31.86
40v tapped " 30v, 20v & 10v	6 amp	TM 15	£4.86
50v-2 amp with 6.3v shrouded	8 amp	TM 22	£4.86
60v	5 amp	TM 29	£11.85
75v-3 amp with 6.3v shrouded	5 amp	TM 24	£7.02
75v	4 1/2 amp	TM 23	£8.10
80v tapped 40v & 75v	4 amp	TM 24	£7.02
100v	1 amp	TM 25	£7.02
100v-0-100v	1 amp	TM 25	£7.02
130v tapped 120v	1 amp	TM 28	£3.78
200v	3 1/2 amp	TM 25	£7.02
250v-0-250v with 6.3v 2A	50 mA	TM 36	£3.78
250v	100 mA	TM 36	£3.78
500v	50mA	TM 36	£3.78

Add 25% to transformer prices to cover postage etc.

350mA 6 VOLTS MAINS UNIT

Ideal for power 6 volt equipment, cassettes, tape recorder or amplifier or other appliances requiring more than the average amount of current. This is a really well made unit in plastic case made for Crown Radio intended originally to clip into position, this has external battery type contacts but it is a simple matter to solder leads straight on to these contacts and this unit employs full wave rectification and is recommended in every way. Price £4.30.

CALCULATORS

By famous makers like Texas, intended originally to be sold at quite high prices new and unused. Type 1. Basic functions—add, subtract, multiply, divide etc. Price £5.15. Type 2—again basic functions but with rechargeable nicad batteries. Price £7.02p. Battery chargers for same £2.70. Type 3—basic functions but with memory and rechargeable batteries. Price £11.34p + 84p.

AM/FM RADIO

Complete chassis, has turning scale with pointer volume control, on/off etc. Controls have edgewise knobs. These radios can be mounted on or just inside extension speaker, then you have a first class "music while you work" receiver. Reception on both AM-FM is better than average and even in areas where FM is notoriously bad, good results have been obtained. The output also is above average, the speaker power is probably around 1 1/2 - 2 watts. They can be powered by 6v batteries or 6v power supply. In fact the Crown Radio One mentioned above is ideal, would no doubt function as an AM/FM Tuner—real bargain - £5.50 + 69p.

UV TUBES (PHILLIPS ATINIC)

Useful for bringing out water marks in stamps and special colours in rocks, similar specimens. We have these in two sizes 9" 6v price £1.50 + 12p. Post 50p + 4p. 2ft 20 watt £2.00 + 16p. post 75p + 6p.

POLE 10 WAY SWITCH

For digital displays the 10 positions being evenly spaced through the 360 turn, and there is no stop. Silver plated contacts are rated " 5 amps, normally an expensive switch but offered " 86p each.

TERMINALS

Very good quality, British made, screw down type, top accepts a 4mm plug. The screw down section also has a hole through which solid wire may be passed, with insulators for metal panel mounting, 5 popular colours. Price 16p each, Ref. TS1, or 10 in a bag for £1.30. Ref. TS1/10.

SKELTON PRE-SET

Miniature size 2-2k, 10 for £1.00 + 12p.

RELAY BASE

14 pin standard for many plug in relays 50p + 4p.

SPRING TRIGGER TERMINALS

Red and black terminals mounted on insulated panel, approximate size 2 1/2" x 1". These terminals grip like a vice but connection in the first place is quick and simple. Hold back the trigger—push in wire—let go of trigger, definitely a time saver. Price 54p the pair.

VOLTAGE	CURRENT	REF.	PRICE
260v	60mA	TM 26	£3.24
1Kv	1mA	TM 44	Please apply
2Kv	1mA	TM 44	
5Kv	5mA	TM 30	£7.02
8.5Kv	10mA	TM 31	£10.26

Quantity prices available. Please, unless you are calling, add 25% to your order to cover the cost of carriage. Also if you want to collect, telephone the day before.



SMALL ADS

The prepaid rate for classified advertisements is 16 pence per word (minimum 12 words), box number 60p extra. Semi-display setting £4.00 per single column centimetre. All cheques, postal orders, etc., to be made payable to Everyday Electronics and crossed "Lloyds Bank Ltd." Treasury notes should always be sent registered post. Advertisements, together with remittance, should be sent to the Classified Advertisement Manager, Everyday Electronics, Room 2337, IPC Magazines Limited, King's Reach Tower, Stamford St., London, SE1 9LS. (Telephone 01-261 5918).

CONDITIONS OF ACCEPTANCE OF CLASSIFIED ADVERTISEMENTS

1. Advertisements are accepted subject to the conditions appearing on our current advertisement rate card and on the express understanding that the Advertiser warrants that the advertisement does not contravene any Act of Parliament nor is it an infringement of the British Code of Advertising Practice.
2. The publishers reserve the right to refuse or withdraw any advertisement.
3. Although every care is taken, the Publishers shall not be liable for clerical or printers' errors or their consequences.

Books and Publications

WHAT'S THE SECRET OF MAKING MONEY? The Knowledge, and ability, that very few people possess, to undertake work in a specialised field that is crammed with opportunities. We are supplying a MANUAL that will enable you, in your own home, WITH NO PREVIOUS EXPERIENCE, to repair VACUUM CLEANERS, DRILLS, and PORTABLE TOOLS, by showing in easy, step by step stages, how to diagnose faults, rewind ARMATURES and FIELDS and make up test equipment. 13 chapters covering test procedures, apparatus required, test charts, where to obtain materials and where to find work. Packed with diagrams and information. Get your copy now. Only £4 plus 30p P&P. CWO. COPPER SUPPLIES, 102 Parrswood Road, Withington, Manchester 20, Dept. EE1.

RADIO BOOK SERVICE

WORLD RADIO TV HANDBOOK 1978 Edition £8-25
 10 CMOS IC Projects (R. A. Penfold) £1-05
 A Practical Introduction to Digital IC's £1-05
 28 Tested Transistor Projects (R. Torrano) £1-05
 10 Projects using Relays, SCR's & TRIAC's (F. G. Rayer) £1-20
 How to build your own Metal & Treasure Locators (F. G. Rayer) £0-95
 Practical Repair & Restoration of Colour TV's (C. P. Miller) £1-05
 Fun & Games with your Electronic Calculator (I. Vines) £0-85
 How to build Advanced Short Wave Receivers (R. A. Penfold) £1-30
 Radio Antenna M'Book for Long Distance Reception £0-95
 50 (Foot) Field Effect Transistor Projects (F. G. Rayer) £1-35
 Servicing Transistor Radio Receivers £0-95
 Solid State Short Wave Receivers for Beginners £1-05
PRICES INCLUDE POSTAGE & PACKING... S.A.E. FOR FULL LIST

4 CHILCHESTER COURT, WICKHAM RD, BECKENHAM KENT BR3 2QW

SIMPLIFIED TV REPAIRS. Full repair instructions individual British sets £4.50, request free circuit diagram. Stamp brings details unique TV publications. Ausec, 76 Church Street, Larkhall, Lanarkshire.

For Sale

FOR QUICK SALE, quantity of Sin C.R.T. 5U1. As used in the Heathkit 10-18 Oscilloscope at £25 each (includes VAT, postage and packing). Brand new, in manufacturer's original boxes. Send Cash with Order to: HEATH (GLOUCESTER) LTD, Bristol Road, Gloucester.

LOGIC PROBE, suitable TTL/CMOS 5-15V indicates Logic States and Trigger Pulses. £12 inc. C. MARSHALL, 22 Oakfield Road, Croydon, Surrey, CR0 2UA.

NEW BACK ISSUES of "EVERYDAY ELECTRONICS". Available 60p each Post Free, open PO/Cheque returned if not in stock. BELL'S TELEVISION SERVICES 190 Kings Road, Harrogate, Yorkshire. Tel: (0423) 55885.

TRANSISTORS, Thyristors, Diodes, Led, Zeners, Voltage Regulators, Tracs, Bridge Rectifiers, Plugs, Sockets ALL NEW. Cheap E.G. 2N3773 2 15p, BFY90 95p, BD 131 45p. SAE list. JAI Electronics, 39 Balvernie Gro, London SW18 5RR.

Miscellaneous

ARMATURES, Armatures B and D, Wolf, Bridges Makita etc. Exchange armatures and fields for most power tools obsolete models covered. S.A.E. for quotation or ring 061-799 0624. INTER-C-CONTROL, 26 Broadway, Worsley, Manchester.

EVERYDAY ELECTRONICS PCB's

In top quality glass fibre tinned and drilled. For full list and current boards please send SAE also produced from customers own masters please send for quote.

PROTO DESIGN, 4 Highcliff Way, Wickford, Essex SS11 8LA.

DISCOVER THE PLEASURE of Electronic Games, including TV Football, Tennis, Squash, Practice; TV Tank Game; Battleships; Noughts & Crosses; Roulette. Cheap and easy to build (TV Football less than £10). Eight circuits, plans for only £1.85. Orders to: RIDLEY PHOTO/ELECTRONICS, Box 62, Uckfield, Sussex (reg. office, Wall-send House, Pevensey Bay, Sussex).

100 RESISTORS 75p
 1W 5% c/FILM 2-RΩ-2-2MΩ (E12)
 10 each of any value
 Send stamped envelope for free sample

C60 CASSETTES 30p	All Cassettes in Plastic Case with Index and Screwed Assembly.
600 CASSETTES 48p	

All prices include VAT. Add Postage 10p in £1
 Quantity Discounts **SALOP ELECTRONICS,**
 10 Units 5% **23 WYLE COP,**
 60 Units 7% **SHREWSBURY**
 100 Units 10% **TEL. 03286 URV.**

METAL DETECTOR KIT type "MD1" (Home Office approved). Supersensitive. Operates with Transistor radio, only £3.75. **VOX KIT "AO3-VR"** High performance. Relay output module £9.75. Other easy-buildkits available. 16p stamps for illustrated catalogue. **WELLEX Co.,** 9 Sirdar Strand, GRAVESEND, KENT.

RECHARGEABLE BATTERIES

'AA' pencil (HP7) £1.32; Sub 'C' £1.64; 'C' (HP11) £2.43; 'D' (HP2) £3.56; PP3 £4.98. Matching chargers £6.98 each except PP3 charger £5.82. Charging holders for 2, 3, 4, 5 or 6 pencils 50p. 'C' & 'D' size holders, 4 cells only 80p. Prices include VAT. Add 10% post package and insurance orders under £20. 5% over £20. SAE for full details plus 75p for 'Nickel Cadmium Power' booklet. Mail orders to **SANDWELL PLANT LTD.,** Dept. EE, 201 Monmouth Drive, Sutton Coldfield, West Midlands. Tel: 021 354 9764. Callers to T.L.C., 32 Craven Street, Charing Cross, London W.C.2.
 "250/12 Volt Inverters now available"

LIST No. 28 NOW READY. Styli illustrated equivalents also cartridges, leads, etc. Free for long SAE. **FELSTEAD ELECTRONICS (EE),** Longley Lane, Gatley, Cheshire, Cheshire.

ENAMELLED COPPER WIRE				
swg	1 lb	8 oz	4 oz	2 oz
14-19	2.40	1.20	.69	.50
20-29	2.45	1.60	.82	.59
30-34	2.60	1.70	.89	.64
35-40	2.85	1.90	1.04	.75

Inclusive of p&p and VAT. SAE brings Catalogue of copper and resistance wires in all coverings. **THE SCIENTIFIC WIRE COMPANY**
 PO Box 30, London E4 9BW
 Reg. Office: 22 Coningsby Gardens

Amateur Clubs

THE BRITISH AMATEUR ELECTRONICS CLUB can help you learn more about electronics. Special concessions, practical help and new series for beginners in the B.A.E.C. Newsletter, sent to members quarterly. All four Newsletters for year from January 1st sent to new members. Annual subscription: U.K. £3.50. Overseas £4.50 surface or £5.50 airmail, payable in sterling. SAE for details to the Hon. Sec. J. G. MARGETTS, 42 Old Vicarage, Green, Keynham, Bristol.

Receivers and Components

COMPUTER MODEL KITS. Suitable beginners or as introduction to computer circuits. Transistor and IC types available. Prices from £7.50. SAE details. **TRANTRER,** The Orchards, Buttgate, Grainthorpe, Lincolnshire.

NO LICENCE EXAMS NEEDED

To operate this miniature, solid-state Transmitter-Receiver Kit. Only £9.75 plus 25p P&P. 'Brain-Freeze' 'em with a MINI STROBE Kit, pocket-sized 'lightning flashes', vari-speed, for discos and parties. A mere £4.10 plus 20p P&P. Experiment with a psychedelic DREAM LAB, or pick up faint speech/sounds with the BIG EAR sound-catcher; ready-made multi-function modules. £5.00 each plus 20p P&P.
LOTS MORE! Send 20p for lists. Prices include VAT. (Mail order U.K. only).

BOFFIN PROJECTS

4 CUNLIFFE ROAD, STONELEIGH EWELL, SURREY. (E.E.)

DISCOVER ELECTRONICS. Build forty easy projects including: Metal Detector; Wireless Transmitter; Breathalyser; Radios; Stethoscope; Lie Detector; Touch time-switches; Burglar Alarms, etc. Circuits, plans all for £1.29 including FREE circuit board. Mail only. **RIDLEY PHOTO/ELECTRONICS,** Box 62, 111 Rockspark Road, Uckfield, Sussex.

Electronic Timers 48p	15 Watt Miniature 250V Soldering Irons £3 87
Mini Electronic Buzzers 6/9/12 Volt DC 38p	Stabilised Power Supply 9 Volt 120mA £1.85
Mini Buzzer 12V AC 58p	Mains Motor 250 RPM 250V AC 48p Trimphone Warbler Unit 85p
80Ω Mini Speaker 48p	Calculator Keyboard 50p
Loud Sirens 5 Volt DC £1.38 ea. Buzzer Alarms 11 Volt DC 65p	240V Solenoid £1.50
Key Switch + Key £1.12	Pots 10K 1M Lin 16p
Small Reed Switch 16p	Component Panel 16p
Large Reed Switch 12p	Croc. Clips Red/Black 7p
Reed Magnets 6p & 12p	40 Assortment Pak 46p
Large Circular 16p	25 Assort. Capacitors 50p
Reed Relay 3-12V DC 46p	30 Untested QA91 28p
8Ω Earphone & Plug 18p	20 Untested AC128 28p
Enamelled Copper Wire 32, 34, 36, 40 SWG 1p ft	25 Untested IC's 36p
Large Red/Clear LEDs 20p	30 Transistors 36p
BC107/8/9 12p ORP12 75p	50 Assort. Resistors 36p

Resistors 1W 5% 10 ohms-10 Meg 2p ea.
 Prices include V.A.T. Add 16p Postage.

GRIMSBY ELECTRONICS

64 Tenyson Rd., CLETHORPES, HUMBERSIDE
 Callers to our Lambert Rd., Grimsby Shop. 1000 of Bargains-Components, Cases, Pots, Vars, Relays, etc. Open Tues., Wed., Fri., Sat. 10-5.30 p.m. List No. 14 18p. ADVERTS from DEC. 1977 STILL VALID

71b ASSORTED COMPONENTS £2.95. Small Audio Amplifiers, 3 transistors equivalent to AC128, OC72, with circuit. 3 for £1. 300 small components, Transistors, Diodes £1.30. No Postage, list 15p refundable. Insurance add 15p. J.W.B. Radio, 2 Barnfield Crescent, Sale, Cheshire M33 1NL.

COMPONENTS FOR E.E. PROJECTS.

Component lists with prices available for all E.E. projects from October 1977 onwards, including Teach-In 78. Send S.A.E. stating project and month of publication (maximum 4 projects per S.A.E.). List sent by return together with ACE order form/catalogue.

ACE MAILTRONIX, Tootal Street, Wakefield, W. Yorks. WF1 5JR.

Educational

HOLIDAY FOR BOYS, 14-16 years. JULY/AUGUST 1978. Tuition and practical work in Engineering (Karting), Electronics Radio Production and Tape Recording and Photography. Nine days in Norfolk. £34. Write for free brochure. INTER SCHOOL CHRISTIAN FELLOWSHIP, c/o Ashcroft, Old Bolingbroke, Nr. Spilshy, Lincs.

Service Sheets

BELL'S TELEVISION SERVICE for service sheets of Radio, TV etc. 75p plus SAE. Colour TV Service Manuals on request. SAE with enquiries to BTS, 190 King's Road, Harrogate, N. Yorkshire. Tel: 0423 55885.

SERVICE SHEETS for Radio, Television, Tape Recorders, Stereo, etc. With free fault-finding guide, from 50p and a.s.e. Catalogue 25p and s.a.e. Hamilton Radio, 47 Bohemia Road, St. Leonards, Sussex.

PLEASE
MENTION
EVERYDAY
ELECTRONICS
WHEN
REPLYING
TO
ADVERTISEMENTS

DENCO (CLACTON) LIMITED

Dept. E.E.

357-8-9 OLD ROAD
CLACTON-ON-SEA
ESSEX CO15 3RH

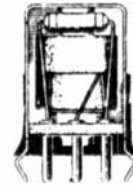

Our components are chosen by technical authors and constructors throughout the world for their performance and reliability, every coil being inspected twice plus a final test and near spot-on alignment. General Catalogue showing full product range 36p. Overseas Customers 70p, Air-Mail Post Paid.

U.K. & OVERSEAS MANUFACTURERS/STOCKISTS ENQUIRIES WELCOME

Australian Readers Please Note—Our Complete Range of Coils are available from Watkin Wynne Pty. Ltd., 32, Falcon Street, CROWS NEST, 2065, AUSTRALIA. P.O. Box 392.



TUAC

TRANSISTOR UNIVERSAL AMPLIFICATION CO. LTD.
PHONE 01-672 3137/672 9080
MANUFACTURERS OF QUALITY AMPLIFICATION AND LIGHTING CONTROL SYSTEMS

NEW FROM TUAC

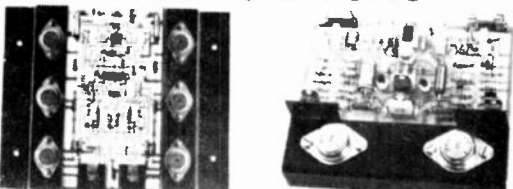

ULTRA QUALITY HIGH POWER New D.C. Coupled Design AMPLIFIERS

Featuring
Electronic Short Open and Thermal Overload Protection.
Brief Spec.
Input Sensitivity 0.775 v. R.M.S. (O.D.B.) at 25K Ohms.
Frequency Response 20 Hz - 20KHz.
Hum and Noise—100 dB Relative full output.
T.H.D. at full power 0.1%.

T.D. 500 300W into 2 Ohms 220W into 4 Ohms	£45 00
Size 7" x 9" x 1 1/2" 140W into 8 Ohms	£28 50
Power supply P.S. 300	
T.D. 150 150W into 4 Ohms	£26 25
5" x 5" x 2" 100W into 8 Ohms	£16 25
Power supply P.S. 150	
T.D. 150	
60 Version 80W into 8 Ohms	£17 75
5" x 5" x 2" 40W into 15 Ohms	£15 25
Power supplies P.S. 60	

Note—P.S. 300 will drive 2 T.D. 150 amplifiers.
All output ratings are R.M.S. continuous sine wave output.

TO ORDER BY POST
Make cheques/P.O.s payable to TUAC LTD., (EE68) or quote Access/Barclay Card No. (We accept holders phone orders 01-672 9080).
Post to—
TUAC LTD., (EE68), 119 CHARLTON ROAD, LONDON SW.17 9AB.
Send stamp for our free 28 page catalogue of LIGHTING & AMPLIFIER MODULES, etc.

E.E. PROJECTS

CHASER LIGHT DISPLAY. Feb. 78. £19.56 inc. p.c.b. Case £3.47.
A.C. METER CONVERTER. Feb. 78. £4.25 inc. case.
AUDIOTEST. March 78. £19.91 less case. Front Panel 66p.
CATCH A LIGHT. March 78. £4.32. Case £1.32. Switch cases 55p each.
C/R SUBSTITUTION BOX £6.20. Case £0.97 (1/2W Resistors).
WEIRD SOUND EFFECTS GENERATOR. March 78. £3.63 inc. case.
ELECTRONIC TOUCHSWITCH Jan 78. £1.44.
AUTOMATIC PHASE BOX. Oct. 77. £8.80 inc. p.c.b. and case.
CAR SYSTEM ALARM. Feb. 78. £3.68 inc. case.
AUDIO VISUAL METRONOME. Jan. £3.99 inc. case.

POCKET TIMER April, 78. £4.09 inc. case.
TRANSISTOR TESTER. Oct. 77. £6.40, case extra £2.98.
PHOTOFLASH SLAVE. Dec. £3.68 inc. case. Less lead.
VHF RADIO. Nov. £10.20 inc. case.
TREASURE LOCATOR. Oct. £7.98. Case £2.49.
SHORT WAVE RECEIVER. Aug. £9.38. Case £1.55.
DICE. March. £4.24 inc. case.
SOIL MOISTURE. June. £2.95 inc. case and probe.
PHONE/DOORBELL REPEATER. July. £4.70 inc. case.
RAPID DIODE CHECK. Jan. £2.12 inc. case.
FUZZTONE UNIT. July. £5.75 exc. case.
ADD ON CAPACITANCE UNIT. Sept. £4.50 inc. case.
CONSTRUCTIONAL ARTICLES 29p each.

1978 COMPONENTS CATALOGUE • MAGENTA •

Magenta gives you a wide range of the things you need—components—tools—hardware—and lots more. First-class delivery. NO minimum order. Inclusive prices. All products stock lines. Illustrated catalogue with data. Send 2 x 9p stamps.

This Catalogue is a MUST for constructors. Write Today!

AMPLIFIER MODULE—STEREO 1 1/2 + 1 1/2W. 8 ohms. Tone/Vol. controls plus Fascia 9V D.C. £4.90.
SIGNAL INJECTOR AF/RF probe and leads £4.98.
MULTIMETER, TYPE 1, 1,000 o.p.v. with probes. 2" x 3 1/2" x 1 1/2" £5.95.
MULTIMETER, TYPE 2, 20,000 o.p.v. with case and probes 5" x 3 1/2" x 1 1/2" £10.95.
ANTEX ST3 £1.55.
DESOLDER BRAID. 62p.
HEAT SINK TWEEZERS 12 1/2p.
DRILL, 12 VOLT, 10,000 r.p.m. Hand or stand use £10.05.
DRILL STAND. Adjustable height. 75 5/8".
TRANSFORMER for 12V drill £8.37.
BUZZER. 6V. 74p.
INTERCOM. 2 station desk model. Cable and battery £5.95.
HEADPHONES, STEREO. 8 ohm. 13-15 KHz. Padded £3.85.

HEADPHONES, MONO. 2K ohms. Sensitive. £2.50.
PHONE PICK-UP COIL. 3.5mm plug. 65p.
EYEGLASS. Jewellers magnification x 3. 93p.
TRIPLE MAGNIFIER. Each lens x 5 magnification. £1.15.
DENTISTS MIRROR. Adjustable £1.70.
SCREWDRIVER SET. 6 miniature jewellers type, in case. £2.40.
SPEAKERS. Miniature 8 ohm 59p. 64 ohm 85p. 80 ohm £1.15.
EARPIECES. Crystal 38p. magnetic 15p.
F.M. INDOOR AERIAL 49p.
S-DEC £2.20.
T-DEC £3.98.
U-DEC £7.58.
TELESCOPIC AERIAL. 6 section. 70cm. 95p.

MAGENTA ELECTRONICS LTD., EES, 61 Newton Leys, Burton-on-Trent, Staffs. DE15 0DW. 0283-65435.

TEACH-IN 78 COMPLETE KIT £13.95

The latest kit innovation!

from Sparkrite

the quickest fitting
CLIP ON
 capacitive discharge
 electronic ignition
 in KIT FORM

Introductory
SPECIAL OFFER
£2 OFF



- Smoother running
- Instant all-weather starting
- Continual peak performance
- Longer coil/battery/plug life
- Improved acceleration/top speeds
- Optimum fuel consumption

Sparkrite X4 is a high performance, high quality capacitive discharge, electronic ignition system in kit form. Tried, tested, proven, reliable and complete. It can be assembled in two or three hours and fitted in 1/3 mins. Because of the superb design of the Sparkrite circuit it completely eliminates problems of the contact breaker. There is no misfire due to contact breaker bounce which is eliminated electronically by a pulse suppression circuit which prevents the unit firing if the points bounce open at high R.P.M. Contact breaker burn is eliminated by reducing the current to about 1/50th of the norm. It will perform equally well with new, old, or even badly pitted points and is not dependent upon the dwell time of the contact breakers for recharging the system. Sparkrite incorporates a short circuit protected inverter which eliminates the problems of SCR lock on and, therefore, eliminates the possibility of blowing the transistors or the SCR. (Most capacitive discharge ignitions are not completely foolproof in this respect). The circuit incorporates a voltage regulated output for greatly improved cold starting. The circuit includes built in static timing light, systems function light, and security changeover switch. All kits fit vehicles with coil/distributor ignition up to 8 cylinders.

THE KIT COMPRISES EVERYTHING NEEDED

Die pressed epoxy coated case. Ready drilled, aluminium extruded base and heat sink, coil mounting clips, and accessories. Top quality 5 year guaranteed transformer and components, cables, connectors, P.C.B., nuts, bolts and silicon grease. Full instructions to assemble kit neg. or pos. earth and fully illustrated installation instructions.

NOTE— Vehicles with current impulse tachometers (Smiths code on dial RV1) will require a tachometer pulse slave unit. Price £3.35 inc. VAT, post & packing. 82 Bath Street Walsall WS1 3DE

Electronics Design Associates, Dept. EE6
 82 Bath Street, Walsall, WS1 3DE. Phone: (0922) 614791

Name
 Address

Phone your order with Access or Barclaycard

Inc. V.A.T. and P.P.

QUANTITY REQ'D.

X4 KIT	£14.95	£12.95	
ACCESS/BARCLAYCARD No.			
TACHS PULSE SLAVE UNIT	£3.35		

I enclose cheque/PO's for

£

Cheque No.

Send SAE if brochure only required.

THIS is the Catalogue you need to solve your component buying problems!



- The finest components catalogue yet published.
- Over 200 A-4-size pages.
- About 5,000 items clearly listed and indexed.
- Nearly 2,000 illustrations.
- Bargain List sent free.
- At £1.40, incl. p. & p., the catalogue is a bargain.

Send the coupon below now.

HOME RADIO (Components) LTD.,
 Dept. EE., 234-240 London Road,
 Mitcham, Surrey CR4 3HD

POST THIS COUPON
 with cheque or P.O. for £1.40

Please write your Name and Address in block capitals

NAME

ADDRESS



HOME RADIO (Components) LTD., Dept. EE (Regn No
 234-240 London Road, Mitcham, Surrey CR4 3HD London 912986)



Become a radio amateur.

Learn how to become a radio-amateur in contact with the whole world. We give skilled preparation for the G.P.O. licence.

Free! Brochure, without obligation to: WAA
EE K6

BRITISH NATIONAL RADIO & ELECTRONICS SCHOOL,
 P.O.Box 156, Jersey, Channel Islands.

NAME

ADDRESS (Block caps please)

Marshall's

Come and get a great deal

Call in and see us 9-5.30 Mon-Fri 9-5.00 Sat
Express Mail Order Tel orders on credit cards £10 min.
Trade and export enquiries welcome

A. Marshall (London) Ltd, Dept: EE London: 40-42 Cricklewood Broadway, NW2 3ET Tel 01-452 0161/2 Telex: 21492 & 325 Edgware Rd, W2 Tel 01-723 4242 Glasgow: 85 West Regent St, G2 2QD Tel: 041-332 4133 Bristol: 1 Straits Parade, Fishponds Rd, BS16 2LX Tel: 0272 654201

PLEASE NOTE ALL OUR PRICES NOW INCLUDE VAT

TRANSISTORS

2N3390	0 50	2N3391	0 40	2N3392	0 18	2N5086	0 30	2N5107	0 45	AD161	1 00	BC168B	0 13	BC184LC	0 15	BC303	0 54	BD139	0 43	BD530	0 55
2N696	0 39	2N2195A	0 40	2N3391A	0 45	2N4651	0 18	2N5087	0 30	2N6108	0 55	AD162	1 00	BC168C	0 13	BC212	0 15	BC307	0 16	BD140	0 43
2N697	0 31	2N2217	0 50	2N3392	0 17	2N4652	0 18	2N5088	0 30	2N6109	0 55	AF106	0 60	BC169B	0 13	BC212A	0 15	BC307A	0 16	BD181	1 90
2N698	0 49	2N2218	0 35	2N3393	0 17	2N4653	0 72	2N5190	0 65	2N6121	0 41	BC107	0 52	BC169C	0 13	BC212B	0 15	BC307B	0 16	BD182	2 20
2N699	0 58	2N2218A	0 38	2N3394	0 17	2N4657	0 60	2N5191	0 75	2N6122	0 44	BC107A	0 16	BC177A	0 22	BC212LA	0 18	BC308B	0 16	BD183	2 35
2N706	0 30	2N2219	0 38	2N3395	0 19	2N4658	0 22	2N5192	0 80	2N6123	0 48	BC107B	0 16	BC177B	0 25	BC212LB	0 18	BC309A	0 16	BD235	0 46
2N707	0 30	2N2219A	0 39	2N3396	0 19	2N4659	0 22	2N5193	0 75	2N6124	0 45	BC108	0 16	BC178	0 22	BC213	0 15	BC309B	0 16	BD236	0 44
2N708	0 30	2N2220	0 39	2N3397	0 19	2N4660	0 22	2N5194	0 80	2N6125	0 47	BC108A	0 16	BC178A	0 25	BC213A	0 15	BC309C	0 16	BD237	0 44
2N718	0 30	2N2221	0 25	2N3436	0 85	2N4661	0 22	2N5195	0 97	40361	0 55	BC108B	0 16	BC178B	0 25	BC213B	0 15	BC327	0 22	BD238	0 44
2N718A	0 54	2N2221A	0 25	2N3440	0 75	2N4662	0 22	2N5245	0 37	40362	0 59	BC108C	0 17	BC179	0 25	BC213C	0 15	BC328	0 20	BD239A	0 44
2N720A	0 85	2N2222	0 25	2N3441	0 92	2N4664	1 35	2N5246	0 38	40363	1 45	BC109	0 16	BC179A	0 25	BC213LA	0 17	BC329	0 20	BD239B	0 44
2N722	0 45	2N2222A	0 25	2N3442	1 45	2N4674	2 65	2N5247	0 44	40408	0 82	BC109B	0 17	BC179B	0 25	BC213LB	0 17	BC357	0 13	BD240A	0 49
2N727	0 50	2N2369	0 27	2N3638	0 17	2N4121	0 27	2N5248	0 44	40409	0 82	BC109C	0 18	BC179C	0 26	BC213LB	0 17	BC357A	0 13	BD240C	0 59
2N914	0 38	2N2369A	0 27	2N3638A	0 17	2N4122	0 27	2N5249	0 44	40410	0 82	BC140	0 30	BC182	0 12	BC213LC	0 17	BC547A	0 13	BD241A	0 49
2N916	0 33	2N2646	0 80	2N3702	0 14	2N4123	0 19	2N5295	0 44	40411	3 10	BC141	0 32	BC182A	0 12	BC214	0 17	BC547B	0 13	BD241C	0 55
2N917	0 38	2N2647	1 55	2N3703	0 14	2N4124	0 19	2N5296	0 44	40594	0 87	BC147	0 13	BC182B	0 13	BC214B	0 17	BC548	0 13	BD242A	0 65
2N918	0 418	2N2648	1 55	2N3704	0 14	2N4125	0 19	2N5297	0 44	40595	0 98	BC147B	0 13	BC182C	0 15	BC214C	0 17	BC549	0 14	BD242C	0 65
2N929	0 37	2N2904	0 31	2N3705	0 14	2N4126	0 19	2N5298	0 44	40596	0 98	BC148	0 13	BC182LA	0 15	BC214L	0 17	BC549B	0 14	BD243A	0 65
2N929A	0 37	2N2904A	0 31	2N3706	0 14	2N4127	0 19	2N5299	0 44	40597	0 98	BC148B	0 13	BC182LB	0 15	BC214LB	0 17	BC550	0 14	BD243B	0 65
2N930	0 37	2N2905	0 31	2N3707	0 14	2N4128	0 22	2N5449	0 20	AC126	0 48	BC148C	0 13	BC183	0 12	BC214C	0 17	BC551	0 14	BD244	0 65
2N930A	0 95	2N2905A	0 31	2N3708	0 12	2N4129	0 22	2N5457	0 38	AC127	0 48	BC149	0 15	BC183A	0 12	BC237B	0 18	BC558	0 13	BD244C	0 65
2N171	0 30	2N2906	0 25	2N3709	0 12	2N4228	0 22	2N5458	0 35	AC128	0 48	BC149C	0 15	BC183B	0 13	BC238A	0 13	BC559	0 15	BD245A	0 69
2N188	0 30	2N2906A	0 25	2N3710	0 12	2N4229	0 22	2N5459	0 32	AC129	0 48	BC150	0 15	BC183C	0 13	BC238B	0 13	BC570	0 21	BD245C	0 69
2N189	0 30	2N2907	0 25	2N3711	0 12	2N4230	0 22	2N5460	0 65	AC130	0 54	BC150A	0 15	BC183LA	0 15	BC238C	0 13	BC571	0 26	BD246A	0 73
2N193	0 50	2N2907A	0 25	2N3712	0 12	2N4231	0 22	2N5461	0 37	AC131	0 59	BC150B	0 15	BC183LB	0 15	BC238C	0 13	BC572	0 18	BD246C	0 73
2N192	0 58	2N2923	0 17	2N3819	0 36	2N4518	0 65	2N5485	0 40	AC133K	0 59	BC150C	0 15	BC183LC	0 15	BC257A	0 18	BD131	0 55	BD43	0 46
2N192	0 58	2N2924	0 17	2N3820	0 39	2N4519	0 70	2N5486	0 40	AC176	0 70	BC159B	0 17	BC183LC	0 15	BC257A	0 18	BD131	0 55	BD43	0 46
2N193	0 50	2N2925	0 19	2N3821	0 96	2N4520	0 83	2N5490	0 54	AC176	0 70	BC160	0 38	BC184	0 12	BC258B	0 19	BD132	0 75	BD43	0 46
2N193A	0 52	2N2926	0 17	2N3900	0 28	2N4521	0 54	2N5492	0 64	AC187	0 59	BC161	0 38	BC184B	0 13	BC259B	0 19	BD133	0 40	BD43	0 46
2N194	0 42	2N3053	0 25	2N3901	0 30	2N4522	0 60	2N5494	0 65	AC187K	0 65	BC167	0 13	BC184C	0 13	BC300	0 43	BD136	0 40	BD437	0 55
2N194A	0 42	2N3054	0 72	2N3902	0 20	2N4523	0 75	2N5496	0 67	AC188	0 54	BC167B	0 13	BC184L	0 15	BC301	0 43	BD137	0 41	BD438	0 55
2N195	0 40	2N3055	0 75	2N3903	0 18	2N4524	1 15	2N5904	0 64	AC188K	0 65	BC168A	0 13	BC184LB	0 15	BC302	0 37	BD138	0 41	BD529	0 49

LINEAR CIRCUITS

CA3018	0 75	LM378N	2 40	LM324	0 75	TBA120	0 80
CA3018A	1 10	LM379S	4 25	LM3785K	1 75	TBA150Q	2 24
CA3020	2 20	LM380N	0 96	LM78L1202	0 30	TBA500Q	2 34
CA3020A	2 50	LM380N14	0 98	LM78L1202	0 30	TBA500Q	2 35
CA3028A	0 90	LM381AN2	2 70	LM78L15C2	0 30	TBA500Q	2 35
CA3028B	1 25	LM381N	1 69	MM5314	4 60	TBA500Q	2 35
CA3030	1 50	LM382N	1 32	MM5316	4 60	TBA500Q	2 35
CA3030A	2 20	LM384N	1 55	NE555	0 33	TBA500Q	2 35
CA3038	2 90	LM386N	0 88	NE556	0 85	TBA500Q	2 35
CA3038A	4 10	LM387N	1 10	NE558N	1 98	TBA500Q	2 35
CA3045	1 55	LM388N	1 00	NE560	4 50	TBA500Q	2 35
CA3046	0 77	LM389N	1 00	NE561	4 50	TBA500Q	2 35
CA3048	2 45	LM702C	0 81	NE562	4 50	TBA500Q	2 35
CA3052	1 78	LM709	0 70	NE565	1 39	TBA500Q	2 35
CA3080	0 85	LM7098	0 50	NE566	1 75	TBA500Q	2 35
CA3080A	2 10	LM70914	0 49	NE567	1 90	TBA500Q	2 35
CA3086	0 50	LM710	0 67	NE568	1 39	TBA500Q	2 35
CA3086B	1 87	LM71014	0 64	NE569	1 75	TBA500Q	2 35
CA3089B	2 90	LM710CN	0 72	NE571	1 90	TBA500Q	2 35
CA3090A	4 40	LM723C	0 75	NE571N	1 98	TBA500Q	2 35
CA3130	1 06	LM723C140	45	SAS60	2 70	TBA500Q	2 35
CA3140	1 04	LM726	5 80	SAS70	2 70	TBA500Q	2 35
LM301	0 30	LM741C	0 70	SAJ110	2 10	TBA500Q	2 35
LM307N	0 50	LM741C8	0 30	SO41P	1 35	TBA500Q	2 35
LM308P	0 50	LM741C10	0 30	TA4522	2 10	TBA500Q	2 35
LM309KC	1 95	LM747CN	0 99	TA4600	3 00	TBA500Q	2 35
LM317K	3 35	LM7488	0 50	TA4603N2	38	TBA500Q	2 35
LM318N	2 45	LM74814	0 99	TA4603N1	30	TBA500Q	2 35
LM32015	2 16	LM1303N	1 15	TA4603N1	30	TBA500Q	2 35
LM320112	2 15	LM1304N	1 52	TA4603N2	35	TBA500Q	2 35
LM320115	2 15	LM1305N	1 52	TA4603N3	35	TBA500Q	2 35
LM320124	2 15	LM1307N	2 20	TA4630	3 70	TBA500Q	2 35
LM320P5	1 15	LM1310N	1 10	TA4630A	3 70	TBA500Q	2 35
LM320P121	1 15	LM1315N	1 30	TA4630A	3 70	TBA500Q	2 35
LM320P215	1 15	LM1458N	0 45	TAA350A	3 00	TBA500Q	2 35
LM320P241	1 15	LM1496N	0 97	TAA521	1 10	TBA500Q	2 35
LM323K	6 95	LM1808N	2 10	TAA521	1 10	TBA500Q	2 35
LM339N	0 60	LM1812N	6 20	TAA550	0 48	TBA500Q	2 35
LM34015	0 88	LM1820N	1 16	TAA550	0 48	TBA500Q	2 35
LM34015A	0 88	LM1828N	1 90	TAA550	0 48	TBA500Q	2 35
LM340124	0 88	LM1830N	1 90	TAA570	2 20	TBA500Q	2 35
LM3401P5	0 80	LM1841N	1 90	TAA370A	1 25	TBA500Q	2 35
LM341P120	0 80	LM1845N	1 50	TAE630	1 10	TBA500Q	2 35
LM341P15	0 80	LM1848N	1 98	TA4630	2 10	TBA500Q	2 35
LM341P240	0 80	LM1850N	1 90	TA4630	2 10	TBA500Q	2 35
LM348N	0 95	LM1889N	1 40	TA4970	2 40	TBA500Q	2 35
LM358N	0 60	LM1330N	0 60	TAA611B2	50	TBA500Q	2 35
LM360N	3 30	LM3302N	0 55	TAA621	2 50	TBA500Q	2 35
LM370N	3 00	LM3401N	0 55	TAA661A	1 65	TBA500Q	2 35
LM371H	2 35	LM3900N	0 68	TAA661B	1 45	TBA500Q	2 35
LM350K	6 45	LM3909N	1 15	TA4600	3 70	TBA500Q	2 35
LM373N	3 35	LM3909N	0 78	TA4600	3 70	TBA500Q	2 35
LM374N	3 36	LM3911N	1 75	TAA930A1	45	TBA500Q	2 35
LM377N	1 80	LM7805K	1 75	TAA930B1	45	TBA500Q	2 35

SPECIALIST CONSUMER NEW CATALOGUE

Stocking Distributors Officially Appointed

- NATIONAL VERO
- TEXAS ANTEX
- MULLARD ELECTROLUBE
- SIEMENS SIFAM
- SESCOSE ARROW HART

MAPLIN

everything for the modern D.I.Y. electronics enthusiast and more.

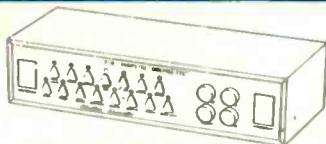

THE 'DRUMSETTE' RHYTHM GENERATOR

Organists, pianists, guitarists... an automatic drum set to accompany you! Nine highly realistic instruments play fifteen different rhythms. Fifteen rhythm-select touch switches and a touch plate for stop/start without rhythm change gives absolute ease of operation. Build it yourself for under £65 including smart teak-effect cabinet. See it and hear it in our shop! Send for full construction details now: MES49 price 25p. (All prices include V.A.T. and p & p).

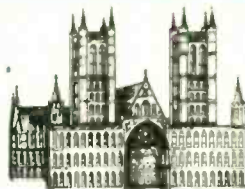

REVERBERATION SYSTEMS

High quality spring line driver module uses 4 integrated circuits and two transistors. Built and tested circuit board with wiring instructions for spring line. XB85G, price £6.00. Power supply to suit driver module costs around £2.50 and construction details are in catalogue, or ask for leaflet MES24. Mechanical spring lines: Short line (XL08J) £4.49; Long line (XB84F) £10.39. (All prices include V.A.T. and p & p).

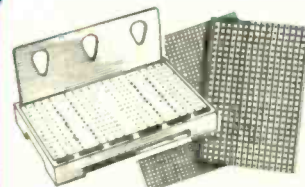

BOARDS AND PCB'S

Pages 59 to 61 of our catalogue show you our range of Veroboards and S-Decs or if you prefer to make your own pcb's a range of etching systems including the novel etch-in-a-bag system, plus printed circuit transfers for the professional finish to your boards.



9-CHANNEL RADIO CONTROL SYSTEM

A comprehensive model control system, featuring nine independent fully proportional channels achieved by a design using very few components thus keeping the cost to a minimum. Full construction details in our booklet (XF03D)

price £1.20. (All prices include V.A.T. and p & p).

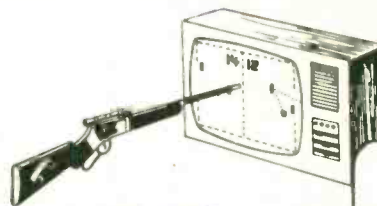

T.V. GAME

A fascinating TV game kit that plays football, tennis, squash and practice for only £21.59. Reprint of construction details 25p. Add on rifle kit only £10.60. (All prices include V.A.T. and p&p).



MASSIVE RANGE OF COMPONENTS

For instance the capacitor section in our catalogue includes non-polarised electrolytics and our resistor section includes even 1% tolerance types. Get our fascinating catalogue now—you won't regret it.



AUDIO MIXER

A superb stereo audio mixer. It can be equipped with up to 16 input modules of your choice and its performance matches that of the very best tape-recorders and hi-fi equipment. It meets the requirements of professional recording studios, FM radio stations, concert halls and theatres. Full construction details in our catalogue. A component schedule is available on request.



ELECTRONIC ORGAN

The only organ you can build in stages and tailor to your requirements as you go along—and at each stage you'll have a fully working instrument. We haven't got the gimmicks yet—(they're coming soon) but we have got the most beautiful sounds—you won't find them on any organ less than twice our price. So get our MES50 series leaflets now! 65p buys the three available so far.



MICROPROCESSOR

Build a mini-computer with our microprocessor kit. Features: 48 different instruction types; 256 bytes of read/write memory (more are easily added) microprocessor can address up to 65,536 8 bit-bytes. Complete kit for use with teletype etc. (XB91Y) £74.10.

20-key keyboard for use with above (in place of teletype) (XB92A) £71.11. Both kits with detailed instruction books. See our newsletters for details of additional RAM's, tri-state interfacing chips, number-cruncher and standard cassette tape-recorder interface to store your programmes. (All prices include V.A.T. and p&p)



Our bi-monthly newsletter keeps you up to date with latest guaranteed prices - our latest special offers - details of new projects and new lines. Send 30p for the next six issues (5p discount voucher with each copy).

IT'S A FANTASTIC BESTSELLER!

216 big (11" x 8") pages! Over a thousand illustrations! Over 30 pages of complete projects to build! Thousands and thousands of useful components described and illustrated!

No wonder it's a bestseller!

DON'T MISS OUT! SEND 60p NOW!

MAPLIN ELECTRONIC SUPPLIES

P.O. BOX 3 RAYLEIGH ESSEX SS6 8LR

Telephone: Southend (0702) 715155

Shop: 284, London Road, Westcliff-on-Sea, Essex

(Closed on Monday) Telephone: Southend (0702) 715157



POST THIS COUPON NOW FOR YOUR COPY OF OUR CATALOGUE PRICE 60p

Please rush me a copy of your 216 page catalogue I enclose 60p, but understand that if I am not completely satisfied I may return the catalogue to you within 14 days and have my 60p refunded immediately.

NAME _____

ADDRESS _____