

Easy to build projects for everyone

Everyday ELECTRONICS

MAR. 78
40p

FREE
TOOL RACK

EVERYDAY ELECTRONICS TOOL RACK



CATCH-A-LIGHT



C/R SUBSTITUTION BOX

ALSO THE AUDIO TEST

LOOK! Here's how you master electronics.

...the practical way.

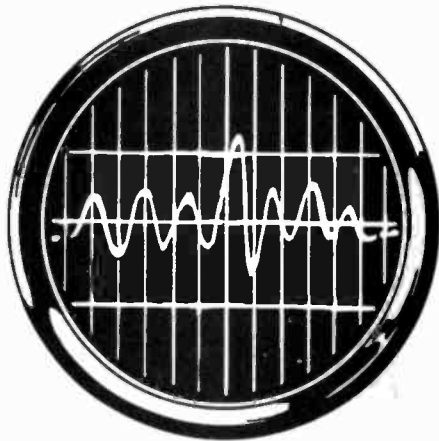

This new style course will enable anyone to have a real understanding of electronics by a modern, practical and visual method. No previous knowledge is required, no maths, and an absolute minimum of theory.

You learn the practical way in easy steps mastering all the essentials of your hobby or to further your career in electronics or as a self-employed electronics engineer.

All the training can be carried out in the comfort of your own home and at your own pace. A tutor is available to whom you can write, at any time, for advice or help during your work. A Certificate is given at the end of every course.

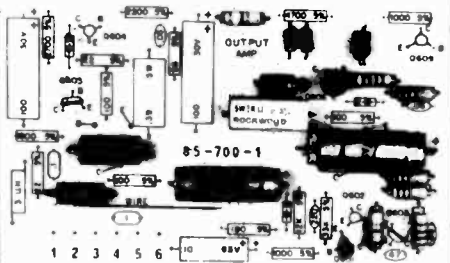
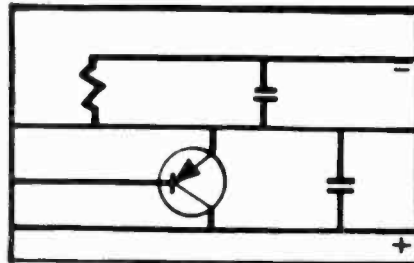
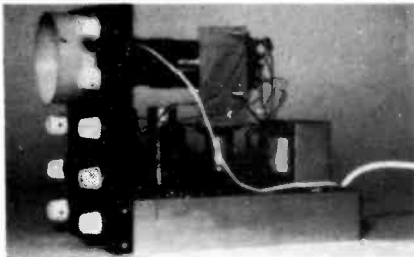

1 Build an oscilloscope.

As the first stage of your training, you actually build your own Cathode ray oscilloscope! This is no toy, but a test instrument that you will need not only for the course's practical experiments, but also later if you decide to develop your knowledge and enter the profession. It remains your property and represents a very large saving over buying a similar piece of essential equipment.

2 Read, draw and understand circuit diagrams.

In a short time you will be able to read and draw circuit diagrams, understand the very fundamentals of television, radio, computers and countless other electronic devices and their servicing procedures.

3 Carry out over 40 experiments on basic circuits.

We show you how to conduct experiments on a wide variety of different circuits and turn the information gained into a working knowledge of testing, servicing and maintaining all types of electronic equipment, radio, t.v etc.

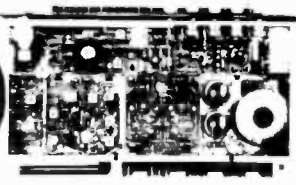

All students enrolling in our courses receive a free circuit board originating from a computer and containing many different components that can be used in experiments and provide an excellent example of current electronic practice.

Free!

To find out more about how to learn electronics in a new, exciting and absorbing way, just clip the coupon for a free colour brochure and full details of enrolment.

British National Radio & Electronic School

P.O. Box 156, Jersey, Channel Islands.

NAME _____

ADDRESS _____

Block caps please

ROOM THERMOSTAT

Famous Salchow, elegant design, intended for wall mounting. Will switch up to 20 amps at mains voltage, covers the range 0.30 C. Special snip this month £3.00.

WINDSCREEN WIPER CONTROL

Vary speed of your wiper to suit conditions. All parts and instructions to make £3.75.



MICRO SWITCH BARGAINS

Rated at 5 amps 250V. Ideal to make a switch panel for a calculator and for dozens of other applications. Parcel of 10 (two types) for £1.



RADIO STETHOSCOPE

Easiest way to fault find, traces signal from aerial to speaker when signal stops you've found the fault. Use it on Radio, TV, amplifier, anything. Kit comprises transistors and parts including probe tube, twin stetho-set. £3.95.

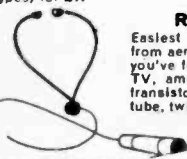

MULTISPEED MOTORS

Six speeds are available 500, 850 and 1,000 r.p.m. and 7,000, 9,000 and 11,000 r.p.m. Shaft is 1/4 in diameter and approximately 1 in. long. 230/240V. Its speed may be further controlled with the use of our Thyristor controller. Very powerful and useful motor size approx. 2 in. dia. x 5 in. long. Price £2.



THIS MONTH'S SNIP

is a miniature sealed relay 12v dc operated with two sets of change over contacts. The unique feature of this relay is its heavy lead out wires; these provide adequate support and therefore the relay needs no fixing; on the other hand there is a fixing bolt protruding through one side so if you wish you can fix the relay and use its very strong lead outs to secure circuit components—an expensive relay; but we are offering it for only 87p each. Don't miss this exceptional bargain!

EXTRACTOR FAN

Ex computers—made by Woods of Colchester. Ideal for fixing through panel—reasonably quiet running—very powerful 2500 rpm. Choice of two sizes 5" or 6 1/2" dia. £4.43.

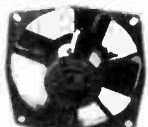

MAINS RELAYS

With triple 10 amp changeover contacts—operating coil wound for 230V a.c. Chassis mounting one screw fixing, ex unused equipment 80p each, post and VAT paid.



MICRO AMPLIFIER

Es. behind the ear hearing aids complete with volume control. £2.16. Case not supplied.

MERCURY BATTERIES

Bank of 7 Mercury cells type 625 which are approx 1/4 in. diameter by 1/2 in. thick in plastic tube giving a total of 10.7V. Being in a plastic tube it is very easy to break up the battery into separate cells and use these for radio control and similar equipment. Carton of 25 batteries £1.00.



PP3/PP9 REPLACEMENT

Japanese made in plastic container with leads size 2in. x 1 1/4in. x 1 1/4in. This is ideal to power a calculator or radio, it has a full wave rectifier and smoothed output of 9V suitable for loading of up to 100mA. £2.53.



SWITCH TRIGGER MATS

So thin is undetectable under carpet but will switch on with slightest pressure. For burglar alarms, shop doors, etc. 24in. x 18in. £2.50. 13in. x 10in. £1.95.



MAINS TRANSISTOR PACK

Designed to operate transistor sets and amplifiers. Adjustable output 6V, 9V, 12V for up to 500mA (class D working). Takes the place of any of the following batteries: PP1, PP3, PP4, PP6, PP7, PP9 and others. Kit comprises, main transformer rectifier, smoothing and load resistor, condensers and instructions. Real snip at only £2.00.

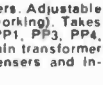

CONTROL DRILL SPEEDS

DRILL CONTROLLER

Electronically changes speed from approximately 10 revs to maximum. Full power at all speeds by finger-tip control. Kit includes all parts, case, everything and full instructions. £3.45. Made-up model £1 extra.



8 POWERFUL BATTERY MOTORS

For models, Meccanos, drills, remote control planes, boats, etc. £2.



ROTARY PUMP

Self priming, portable, fits drill or electric motor, pumps up to 200 gallons per hour depending upon revs. Virtually uncorrodable, use to suck water, oil, petrol, fertiliser, chemicals, anything liquid. Hose connectors each end. £2.



TANGENTIAL HEATER UNIT



A most efficient and quiet running blower-heater by Solotron—same type as is fitted to many famous name heaters—Comprises mains induction motor—long turbo fan—split 2 kw heating element and thermostatic safety trip—simply connect to the

mains for immediate heat—mount in a simple wooden or metal case or mount direct onto base of say kitchen unit—price £4.95 post £1.50 control switch to give 2kw, 1kw, cold blow or off available 60p extra. 3kw Model £5.95 + £1.50 P. A. P.

MULLARD UNILEX

A mains operated 4 + 4 stereo system. Rated one of the finest performers in the stereo field this would make a wonderful gift for almost anyone in easy-to-assemble modular form and complete with a pair of Plessey speakers this should sell at about £30—but due to a special bulk buy and as an incentive for you to buy this month we offer the system complete at only £15.00 including VAT and postage.



HUMIDITY SWITCH

American made by Ranco, their type No. J11. The action of this device depends upon the dampness causing a membrane to stretch and trigger a sensitive micro-switch adjustable by 2 screws, quite sensitive—breathing on it for instance will switch it on Micro 3 amp at 250V a.c. Overall size of the device approx. 3 1/2 in. long, 1 in. wide and 1 1/2 in. deep. 75p.



DELAY SWITCH

Mains operated—delay can be accurately set with pointers knob for periods of up to 2 1/2 hrs. 2 contacts suitable to switch 10 watts—second contact opens few minutes after 1st contact 85p.

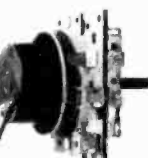

CENTRAL HEATING HEARTS

Randal (illustrated) replacement in 3060 etc. £8.75. HORTSMAN £8.30. SMITHS Controller 10/100 complete in wall mounting case £7.50.



TEACH IN '78

Start right away. Order the part for this series—send £3 deposit and £2 monthly for 5 months or £12 cash. Past lessons available.

PRINTED CIRCUIT KIT PROJECTS

CONTENTS: (1) 2 Copper Laminate Boards 4 1/2 in. x 2 1/2 in. (2) 1 Board for Matchbox Radio. (3) 1 Board for Wristwatch Radio, etc. (4) Resist. (5) Resist Solvent. (6) Etchant. (7) Cleanser/Degreaser. (8) 16-page Booklet Printed Circuits for Amateurs. (9) 2 Miniature Radio Diode SWM/WLW. Also free with each kit. (10) Essential Design, Data Circuits, Chassis Plans, etc. for PROJECTS. £1.50.

SOUND TO LIGHT UNIT

Add colour or white light to your amplifier. Will operate 1, 2 or 3 lamps (maximum 450W). Unit in box all ready to work. £9.95.



MINI-MULTI TESTER

Amazing, deluxe pocket size precision moving coil instrument—jewelled bearings—1000 opv—mirrored scale. 11 instant ranges measure:—DC volts 10, 50, 250, 1000 AC volts 10, 50, 250, 1000 DC amps 0-1 mA and 0-100 mA Continuity and resistance 0-150K ohms. Complete with insulated probes, leads, battery, circuit diagram and instructions.



Unbelievable value only £5.50 + 50p post and insurance.

FREE Amps ranges kit enable you to read AC current from 0-10 amps, directly on the 0-10 scale. It's free if you purchase quickly but if you already own a mini tester and would like one send £1.50p.

TERMS: Cash with order—but orders under £8 must add 50p to offset packing etc. BULK ENQUIRIES INVITED. PHONE: 01-688 1833

IT'S FREE

Our monthly Advance Advertising Bargains List gives details of bargains arriving or just arrived—often bargains which sell out before our advertisement can appear—it's an interesting list and it's free—just send S.A.E. Below are a few of the Bargains still available from previous lines.

Special Snip. Japanese made FM Tuner and a matching decoder. We are offering the pair at less than the price most firms are asking for a similar tuner only, namely £11.20. If you wish you can buy the items separately, a brief description is as follows:

FM Tuner (A 1005S), the tuner is very compact but has quite a smart dial with cord drive and pointer. It covers the range 88-108 mhz, has an input sensitivity of 10uV, uses 6 transistors and 3 diodes and needs a 9 volt 9mA power supply. It is an excellent performer and when tested here has results quite equal to a tuner costing over £40. Price only £7.32.

Decoder 1005MS. This uses 5 transistors and 6 diodes, has provision for stereo indicator lamp, we can supply this as an extra at 50p with wiring instructions, needs 9v power supply or battery and is partner to the above tuner, price £7.50 + 94p.

Rigonda Boishoi. This is a multi band radio, stereo amplifier and record player, an impressive console having many features not found in the average radio. This originally sold for well over £100. The radio side has motorized auto tuning, 4 short wave bands, long, medium and short wave for playing records at 33, 45 or 78, and facilities for tape recording, tape playing back, microphone amplification through stereo amplifier which has a peak output of 10 watts per channel. The equipment weighs approximately 150lbs and is in a console type cabinet size approximately 3 7/8" wide, 2 5/8" x 14" deep on 11" legs. We have only a few of these left as new but may be slightly second for some reason or other. We offer these to callers only, you must attend here, test the equipment and satisfy yourself that you are getting an acceptable bargain because we would sell as seen and accepted but without guarantee because the price we are asking, namely £35 is a giveaway. VAT of course at 12 1/2% must be added to this price.

Still Available the Rigonda Calypso 10 + 10 stereo record players. Price £12.00 (note these are repairable items).

Multi Tester Bargain. An instrument you will be proud to own, not a pocket model, it measures 6" x 4 1/2" x 2" and it has many features which make it very desirable so if you are contemplating buying a multi-tester you must consider this one. Japanese made this has a large clear scale with mirror reflector. It has a total of 24 ranges (26 if you count the two extra ranges which we added to it by our free gift) as follows: AC volts:—0 to 6, 30, 120, 300, 600, 1200 DC volts:—0 to 6, 30, 120, 600, 1200, 3000, 6000 DC current:—0 to 60 ua, 6 ma, 60 ma, 600 ma Resistance:—0 to 6K, 600K, 6 meg, 30 meg, 60 meg Decibels:—20 db to +63 db. Size:—6" x 4 1/2" x 2" Price of this £18.75. Special offer—with this instrument we will give free of charge our shunt kit enabling you to measure DC amps in 2 ranges 0-5 amps, 0-15 amps.

Fluorescent Tube Inverter. For camping—car repairing—emergency lighting from a 12v battery you can't beat fluorescent lighting. It will offer plenty of well distributed light and is economical. We offer inverter for 21" 13 watt miniature tube for only £3.75 with tube and tube holders as well.

4 Changeover 12 volt Relay. This may be just what you are looking for, for your complicated circuit the changeover contacts are 10 amp rated, limited quantity only £1.82.

Mains Operated 3 Changeover (10 amp) type Relay. This is single screw fixing type very reliable and popular ex equipment but guaranteed ok. Price 86p.

Ditto but new in maker's box £1.40.

Relays, plug in types with two 10 amp changeover contacts all with dust covers and available in the following coil voltages 6, 12, 50, 110 volts. All priced 86p each, octal base to suit these 27p each.

3 Changeover 10 amp Contacts plug in type available with the following coil voltages: 6, 12, 24, 48, 115 volts AC and 110 volts DC, all £1.08 each. 11 pin base 8p.

Soil Heating. We do not have to stress the advantage you get from soil warming but where there is the slightest chance of damage by cultivation tools then low voltage must be used. Our very efficient 250w mains transformer will operate 100 metres of soil warming cable very effectively. The price is £6.28 for the transformer and £6.00 for the warming cable.

Bench Warming for fast germination, mist propagation, etc. The warming cables are buried in sand on the bench so mains voltage cables may be used. We can supply a 6000 watt "big" power pack which will warm 200ft of 3ft wide bench at a concentration of 10w per square foot, price is £24.00. This big grower pack contains 3 x 100 metres twin warming cables and 3 connection boxes. Medium growers pack 1200 watts.

Neon Novelties. One of the most versatile of electronic devices is the neon, you can make it do all sorts of things to regulate voltage, imitate "Ernie" by lighting numbers at random, etc. etc. We have miniature neons at 20p each also neon valves 4 pin type, 10 for £1.95 + 8p. Post 50p + 4p.

Ex-G.P.O. Telephones. Normal desk type with internal bell and dial, and handset of course. Tested, with diagram showing how to connect as extensions or in pairs or multiway circuits, price £4.30.

Ditto but less dial £2.95.

Accessories for Telephones. Extra earphones. Very useful in noisy situations or for old people who suffer with deafness, price 81p. Extension bells (in wall box) often save you missing vital calls, price £3 + 25p Wall-type phones, no dials or bells but hook switch £2.75.

Dim, full and off Switch. This is a 4 pole changeover switch each of 10 amp 230v rating, panel mounting toggle operation. Useful where 2 similar lamps or banks of lamps, heaters, motors, etc. are required to be run in series or parallel. Especially useful in photographic studios when setting up, saves expensive lamps. Supplied complete with circuit diagram. Price £1.00 + 8p.

J. BULL (ELECTRAL) LTD
(Dept. EE), 103 TAMWORTH RD.
CROYDON CR9 1SG

CRESCENT RADIO LTD.

MAIL ORDER DEPT. 1 St Michaels Terrace, Wood Green
London N22 4SJ Phone 888-4474

MULTIMETER BARGAINS

A special bulk purchase of Eagle Multimeters enables us to offer three from their range at up to 15% off Eagle's own recommended retail price.

KEW 7

1,000 opv pocket multi-meter with 'off' damp-ing.

All basic ranges included. Leads, battery and instructions supplied.

Spec. as follows:—
DC volts: 0 to 10, 50, 250, 1,000 volts. AC volts: 0 to 10, 50, 250, 1,000 volts. DC current: 0 to 100 mA. Resistance: 0 to 150 K ohms (mid-scale); 3 K ohms. Decibels: —10 to +22dB. Dimensions: 90×60×27 mm. PRICE: £5.97+8% VAT



POWER SUPPLY UNIT TYPE 'PPI'

Switched 3, 4½, 6, 7½, 9 and 12 volts at 500mA. With on/off switch and pilot light.

Size: 130mm × 55mm × 75mm approx.
OUR PRICE:
Only £6.00 + 8% VAT

CI095 20,000 opv multimeter with hinged 4-position scale for easy-reading bench use. Anti-parallax mirror, 3-colour scale, overload protection.

Ranges: DC volts: 5, 25, 50, 250, 500, 2,500 (20,000 opv). AC volts: 10, 50, 100, 500, 1,000 (10,000 opv). DC current: 50 uA, 2.5 mA, 250 mA. Resistance: 50 K, 5 meg. Decibels: —20 to +22 dB. Dimensions: 140 × 85 × 35 mm.
PRICE: £14.31 + 8% VAT

EM1200

100,000 opv multimeter. Comprehensive meter with 3-colour scale, anti-parallax mirror, taut band movement, electronic protection, reversible polarity, 15 amps AC current range. Supplied with leather carrying case, shoulder strap and probes.

DC Voltage: 0-0.15, 0.5, 1.5, 5, 15, 50, 150, 500, 1500 volts (100,000 opv). AC voltage: 0-1.5, 5, 15, 50, 150, 500, 1500 volts (30,000 opv). DC current: 10 uA, 15 uA, 500 uA, 15 mA, 500 mA, 1.5 amps, 15 amps. AC Current: 15 amps. Resistance: 0-20 K ohms, 200 K ohms, 2 megohms, 20 megohms, 200 megohms. (Mid-scale): 100 ohms, 1 K ohm, 10 K ohms, 100 K ohms, 1 megohm. Accuracy: DC-2%, AC-3%. Dimensions (inc. case): 210 × 178 × 80 mm.
PRICE: £40.23 + 8% VAT.

H2009 STEREO HEADPHONES

Eagle headphones available at new reduced price.

Spec. — Frequency range: 20-20,000 Hz ±5 dB. Second harmonic distortion: 0.7% maximum. Third harmonic distortion: 1.0% maximum. Matching impedance: 8-16 ohms. Weight: 360 gm. Switching: +5 dB @ 100 Hz (Popular), Flat @ 100 Hz (Classical), -5 dB @ 100 Hz (Vocal). These headphones have a bass cut/filter control on each earpiece
PRICE: £15.50 + 12½% VAT.

'BARGAIN TRANSFORMERS'

240v PRIMARY 12-0-12v, 500mA/SEC. Approx. size: 60 × 40 × 50mm. Fixing centres: 75mm.

PRICE: £1.80 + 8% VAT.
Also available MAINS TRANSFORMER with 18v 500mA SEC. Price and size same as above.

ACCESS AND BARCLAYCARD ACCEPTED—PHONE ORDERS WELCOMED, ALL PRICES INCLUDE POSTAGE—PLEASE ADD VAT AS SHOWN—S.A.E. WITH ALL ENQUIRIES PLEASE.

Personal Callers Welcome at: 21 Green Lanes, Palmers Green London, N. 13. Phone: 888-3206 and 13 SOUTH MALL, EDMONTON, N9. Phone: 803-1685.

THE IDEAL ANYTIME PRESENT

S · R · B

**MINIATURE
SOLDERING IRON**
for HOBBY or TRADE

MAIL ORDER PRICES:
(including VAT and P and P)

Irons £3.70 each
Bits 41p each

Stands **£3.90 each**
Solder **28p.56.**

18 watts of power
at 240 v. straight to the bit

BIT SIZES:
19 (1.5 mm) 20 (3.0 mm)
21 (4.5 mm) 22 (6.0 mm)

Trade Enquiries Welcome

From your Local Dealer or Direct from the Manufacturers:
S. & R. BREWSTER Ltd.
86-88 UNION ST · PLYMOUTH Tel 0752-65011

Over 200 kits in the free Heathkit Catalogue



NEW 4 Function
Solid State Multimeter
— One of a whole range
of test equipment



NEW Digital Clock —
with repeater alarm

Freezer Alarm — Gives audible signal
if freezer temperature rises to -6 C
for any reason

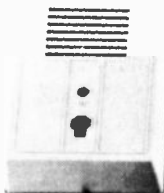

Car Intrusion Alarm
— Gives a distinctive
yelping sound-signal
the moment your car
is tampered with



NEW Electronic
Chess Game

The Heathkit catalogue is
packed with top quality kits
— hundreds of practical and
fascinating items which you
can build yourself.



**Send for
your copy now!**

To Heath (Gloucester) Ltd.

Department EE-38.

Bristol Road, Gloucester, GL2 6EE.

Please send a copy of the Heathkit Catalogue.
I enclose 11p in stamps to cover postage only.

Name _____

Address _____

**Soldering
iron offer
FREE**

When you receive
your catalogue
you'll get details of
this free offer worth
approximately £4.75.

HEATH
Schlumberger
The world's
biggest producers
of electronic kits.

**ACCESS AND
BARCLAYCARD
WELCOMED**

There are Heathkit Electronics Centres at 233 Tottenham Court Road,
London (01-636 7349) and at Bristol Road, Gloucester (Gloucester 29451).

The latest kit innovation!

from **Sparkrite**

the quickest fitting
CLIP ON
capacitive discharge
electronic ignition
in KIT FORM

Introductory
SPECIAL OFFER
£2 OFF Kit or
Ready Built Unit



- Smoother running
- Instant all-weather starting
- Continual peak performance
- Longer coil/battery/plug life
- Improved acceleration/top speeds
- Optimum fuel consumption

Sparkrite X4 is a high performance, high quality capacitive discharge, electronic ignition system in kit form. Tried, tested, proven, reliable and complete. It can be assembled in two or three hours and fitted in 15-30 mins. Because of the superb design of the Sparkrite circuit it completely eliminates problems of the contact breaker. There is no misfire due to contact breaker bounce which is eliminated electronically by a pulse suppression circuit which prevents the unit firing if the points bounce open at high R.P.M. Contact breaker burn is eliminated by reducing the current to about 1/50th of the norm. It will perform equally well with new, old, or even badly pitted points and is not dependent upon the dwell time of the contact breakers for recharging the system. Sparkrite incorporates a short circuit protected inverter which eliminates the problems of SCR lock on and, therefore, eliminates the possibility of blowing the transistors or the SCR. (Most capacitive discharge ignitions are not completely foolproof in this respect). The circuit incorporates a voltage regulated output for greatly improved cold starting. The circuit includes built in static timing light, systems function light, and security changeover switch. All kits fit vehicles with coil/distributor ignition up to 8 cylinders.

THE KIT COMPRISES EVERYTHING NEEDED

Die pressed epoxy coated case. Ready drilled, aluminium extruded base and heat sink, coil mounting clips, and accessories. Top quality 5 year guaranteed transformer and components, cables, connectors, P.C.B., nuts, bolts and silicon grease. Full instructions to assemble kit neg. or pos. earth and fully illustrated installation instructions.

NOTE - Vehicles with current impulse tachometers (Smiths code on dial RW1) will require a tachometer pulse slave unit. Price £3.35 inc. VAT, post & packing. 82 Bath Street Walsall WS1 3DS

Electronics Design Associates, Dept. EE3
82 Bath Street, Walsall, WS1 3DE. Phone: (0922) 33852

Name
Address

Phone your order with Access or Barclaycard

Inc. V.A.T. and P.P.

QUANTITY REQ'D

X4 KIT £14.95	£12.95	
X4 READY BUILT £24.95	£22.95	
TACHS PULSE SLAVE UNIT £3.35		

I enclose cheque/PO's for

£
Cheque No.

Send SAE if brochure only required.

E.E. PROJECTS

AUDIO VISUAL METRONOME, Jan. £3.95 inc. case.
PHOTOFLASH SLAVE, Dec. £3.68 inc. case. Less lead.
VHF RADIO, Nov. £10.20 inc. case.
TREASURE LOCATOR, Oct. £7.87. Case £2.24.
TRANSISTOR TESTER, Oct. £6.40. Case £2.98.
SHORT WAVE RECEIVER, Aug. £8.65 Case £1.45.
DICE, March. £4.24 inc. case.
METRONOME, May. £3.80 inc. case.

Prices include. Articles extra 25p. Projects not listed, please write.
SOIL MOISTURE, June. £2.95 inc. case and probe.
PHONE/DOORBELL REPEATER, July. £4.70 inc. case.
RAPID DIODE CHECK, Jan. £2.12 inc. case.
FUZZTONE UNIT, July. £5.75 exc. case.
ADD ON CAPACITANCE UNIT, Sept. £4.50 inc. case.

Prices include. Articles extra 25p each.

1978 COMPONENTS CATALOGUE • MAGENTA •

Magenta gives you a wide range of the things you need—components—tools—hardware—and lots more. First-class delivery. NO minimum order. Inclusive prices. All products stock lines. Illustrated catalogue with data. New products. Send 2 x 9p stamps. This Catalogue is a MUST for constructors. Write Today!

AMPLIFIER MODULE—STEREO 1½ + 1½W. 8 ohms. Tone/Vol. controls plus Fascia 9V D.C. £4.90.
PRE-AMP—STEREO. Matches Magnetic cartridge to above amplifier. 9V D.C. £6.45.
CAPACITANCE SUB. BOX. 9 valves 1000pF to .22µF £2.95.
DIODE TESTER. With leads £1.68.
SIGNAL INJECTOR AF/RF probe and leads £4.98.
MULTIMETER, TYPE 1. 1,000 o.p.v. with probes. 2" x 3¼" x 1" £5.95
MULTIMETER, TYPE 2. 20,000 o.p.v. with case and probes 5" x 3½" x 1½" £10.95.
ANTEX X25 SOLDERING IRON 25W. Ideal for electronics £3.68.
SOLDERING IRON STAND. ANTEX ST3 £1.55.
DESOLDER BRAID. 62p.
HEAT SINK TWEEZERS 12½p.
DRILL. 12 VOLT. 10,000 r.p.m. Hand or stand use £10.05.
DRILL STAND. Adjustable height. £5.91.
TRANSFORMER for 12V drill £9.37.
POWER SUPPLY. Safe, economical plug type 6, 7.5, 9V D.C. 300mA, with lead £3.98.
NIGHT LIGHT. Safe. Built in 13A plug. Very cheap to run £1.18.
MORSE KEY. Use with 6V buzzer for practice set. Code included. £1.18.
BUZZER. 6V. 74p.

INTERCOM. 2 station desk model. Cable and battery £5.95.
HEADPHONES. STEREO. 8 ohm. 13-15 KHz. Padded £3.85.
HEADPHONES. MONO. 2K ohms. Sensitive. £2.50.
PANEL METERS. Nominal 2" matt black Fascia. 0-50µA, 0-100µA, 0-1mA £4.12.
LEVEL METER 0-200µA, 1200 ohms £1.10.
PHONE PICK-UP COIL. 3.5mm plug. 65p.
EYEGLASS. Jewellers magnification x3. 93p.
TRIPLE MAGNIFIER. Each lens x5 magnification. £1.15.
DENTISTS MIRROR. Adjustable £1.70.
SCREWDRIVER SET. 6 miniature jewellers type, in case. £2.48.
NEEDLE FILES. 3mm square and round. 68p.
AERIAL. 6 section telescopic. 70cm. 95p.
SPEAKERS. Miniature 8 ohm 59p. 64 ohm 85p. 80 ohm £1.15.
EARPIECES. Crystal 30p. magnetic 15p.
Also capacitors, resistors, semi-conductors, knobs, connectors, p.c.b. materials, potentiometers, variable capacitors, switches, cases, transformers, etc., etc.
All prices include VAT and FIRST CLASS POST. Orders under £5.00 please add 15p.

MAGENTA ELECTRONICS LTD., EB2, 61 Newton Leys, Burton-on-Trent, Staffs. DE15 0DW. 0283-65435.

TEACH-IN '78 COMPLETE KIT £13.95

TRAIN AT HOME

Be an ELECTRONIC ENGINEER

Do something PRACTICAL about your future. Firms all over Britain are crying out for qualified people. With the right training, you could take your pick of these jobs.

Now, the British Institute of Engineering Technology will train you in your spare time to be an Electrical Engineer.

You risk nothing! We promise to get you through your chosen course—or refund your fee!

So, join the thousands who have built a new future through home study Engineering courses.

Courses in
C & G Elect. Technicians
C & G Elect. Installations
Telecomms. Technicians Exams
Television Servicing
Radio Maint. & Repairs (BIET)
Pract. Radio & Electronics
Plus over 60 other home study courses.

POST COUPON FOR FREE 44 PAGE GUIDE

BRITISH INSTITUTE OF ENGINEERING TECHNOLOGY

Aldermaston Court, Dept. TEB 31 Reading RG7 4PF.

NAME (Block capitals please)

ADDRESS

POSTCODE

Other Subjects AGE

Accredited by CACC Member of ABCC

AUDIO MODULES - ALL REDUCED! TRANSISTOR PRICES SLASHED! MANY PAKS 33% OFF

BI-PAK GREAT SPACE

WE NEED THE SPACE-

SPECIAL OFFER!

THYRISTORS

No. THY1A/50	1Amp. 50 volt	TO5	18p
No. THY1A/400	1Amp. 400 volt	TO5	32p
No. THY3A/50	3Amp. 50 volt	TO64	25p
No. THY3A/200	3Amp. 200 volt	TO64	32p
No. THY3A/400	3Amp. 400 volt	TO64	40p
No. THY5A/50	5Amp. 50 volt	TO66	25p
No. THY5A/400	5Amp. 400 volt	TO66	40p
No. THY5A/600	5Amp. 600 volt	TO66	50p
No. C106/4	6Amp. 400 volt	TO220	42p

TRIAC

584	8Amp. 400 volt	TO220 Plastic (Non Isolated Tab)	80p
-----	----------------	----------------------------------	-----

DIACS

BR100	15p
D32	15p

SWITCHES

No. 16178	5 x Mains Slide Switches	40p*
No. S17	5 x Miniature Slide Switches	40p*
No. S18	4 x Standard Slide Switches	40p*
No. S19	4 x Miniature Push to Make single hole mounting	40p*
No. S20	3 x Miniature Push to Break single hole mounting	40p*
No. S21	Push button Switch Pak 4 x Assorted types multi bank and singles Latching and non-latching	£1.00*

CAPACITOR PAKS

16201	18 Electrolytics	4.7µF-10µF	18p
16202	18 Electrolytics	10µF-100µF	18p
16203	18 Electrolytics	100µF-680µF	18p
ALL 3 AT Special Price of £1.20*			
16160	24 Ceramic Caps	22pF-82pF	24p
16161	24 Ceramic Caps	100pF-390pF	24p
16162	24 Ceramic Caps	470pF-3300pF	24p
16163	21 Ceramic Caps	4700pF-0.047µF	21p
ALL 4 AT Special Price of £1.60*			

RESISTOR PAKS

Order No.	60 1W	100ohm-820ohm	60p
16213	60 1W	1K-8.2K	60p
16214	60 1W	10K-82K	60p
16215	60 1W	100K-820K	60p
16216	60 1W	100ohm-820ohm	60p
ALL 4 AT Special Price of £1.60*			
16217	40 1W	100ohm-820ohm	40p
16218	40 1W	1K-8.2K	40p
16219	40 1W	10K-82K	40p
16220	40 1W	100K-820K	40p
ALL 4 AT Special Price of £1.60*			

TRANSISTOR FALL-OUT PACK GERM, SILICON, POWER, NPN, PNP. ALL MIXED, YOURS TO SORT AND TEST. APPROX. 500 PIECES. Order No S23 £1.25 per pack

POSITIVE			
No. MVR7805	µA7805	TO220	85p
No. MVR7812	µA7812	TO220	85p
No. MVR7815	µA7815	TO220	85p
No. MVR7818	µA7818	TO220	85p
No. MVR7824	µA7824	TO220	85p
NEGATIVE			
No. MVR7905	µA7905	TO220	£1.10
No. MVR7912	µA7912	TO220	£1.10
No. MVR7915	µA7915	TO220	£1.10
No. MVR7918	µA7918	TO220	£1.10
No. MVR7924	µA7924	TO220	£1.10
µA723C TO99	38p	72723 14 pin DIL	38p
LM309K	TO3	£1.20	

MICROPHONES

DYNAMIC DUAL IMPEDANCE UNIT DIRECTIONAL CARDIOID MICROPHONE Impedance 600ohms. and 50K. Response 50-14,000 Hz. Sensitivity 54db. at 50K. Size 1 1/2" Dia x 6 1/2" Long Order No. 1328 £7.50*			
DYNAMIC CASSETTE MIC. Fitted with On/Off switch. 1 meter of tough lead with floating 2.5 and 3.5 mm plugs. Impedance 200 ohms. Sensitivity 90db. Frequency 90-10,000 Hz. Size 20mm Dia x 120mm long. Order No. 1326 £1.15*			

LOGIC PROBE

A pocket size instrument capable of detecting T.T.L., D.T.L., Flip Flop and other pulse circuits. It is easy to use and operates from the 5V. D.C. supply of the circuit under test. The logic levels are indicated by 2 red L.E.D.'s one for High and the other for Low. There is also a green L.E.D. for the Pulse Mode of the unit. No. S59 Our Special Price £15.95

TRANSISTORS

BRAND NEW-FULLY GUARANTEED

TYPE	PRICE	TYPE	PRICE	TYPE	PRICE	TYPE	PRICE	TYPE	PRICE
AC107	25p	BC177	12p	BF194	9p	TIP32C	36p	2N1711	15p
AC126	14p	BC178	12p	BF195	9p	TIP41A	34p	2N1893	28p
AC127	16p	BC179	12p	BF196	12p	TIP41B	35p	2N2218	15p
AC128	16p	BC182	9p	BF197	12p	TIP41C	36p	2N2218A	18p
AC128K	24p	BC182L	9p	BF200	25p	TIP42A	36p	2N2219	15p
AC176	16p	BC183	9p	BF209	22p	TIP42B	37p	2N2219A	18p
AC176K	24p	BC183L	9p	BF284	18p	TIP42C	38p	2N2221	15p
AC187	16p	BC184	9p	BFY50	12p	TIP295S	65p	2N2221A	16p
AC187K	26p	BC184L	9p	BFY51	12p	TIP305S	42p	2N2222	15p
AC188	16p	BC212	10p	BFY52	12p	ZTX107	6p	2N2222A	16p
AC188K	26p	BC212L	10p	MPSA05	22p	ZTX108	6p	2N2369	10p
AD1611	16p	BC213	10p	MPSA06	22p	ZTX109	7p	2N2904	14p
I62 MF	80p	BC213L	10p	MPSA55	22p	ZTX300	7p	2N2904A	15p
AF139	30p	BC214	10p	MPSA56	22p	ZTX301	7p	2N2905	14p
AF239	30p	BC214L	10p	OC44	12p	ZTX500	8p	2N2905A	15p
BC107	6p	BC251	10p	OC45	12p	ZTX506	12p	2N2906	12p
BC108	6p	BCY70	12p	OC71	9p	ZTX501	10p	2N2906A	14p
BC109	6p	BCY71	12p	OC72	10p	ZTX502	12p	2N2907	12p
BC118	6p	BCY72	12p	OC73	10p	2N696	10p	2N2907A	13p
BC147	8p	BD115	40p	OC81	14p	2N697	10p	2N2926G	9p
BC148	8p	BD131	35p	TIP29A	35p	2N706	7p	2N2926J	9p
BC149	8p	BD132	37p	TIP29B	36p	2N706A	8p	2N3053	12p
BC154	16p	BD115	17p	TIP29C	38p	2N708	9p	2N3055	12p
BC137	9p	BF167	19p	TIP30A	36p	2N1302	12p	2N3702	7p
BC158	9p	BF173	20p	TIP30B	37p	2N1303	13p	2N3703	7p
BC159	9p	BF180	25p	TIP30C	38p	2N1304	15p	2N3704	6p
BC169C	10p	BF181	25p	TIP31A	32p	2N1307	18p	2N3903	11p
BC170	6p	BF182	25p	TIP31B	33p	2N1308	22p	2N3904	11p
BC171	6p	BF183	25p	TIP31C	34p	2N1309	22p	2N3905	11p
BC172	6p	BF184	25p	TIP32A	34p	2N1613	15p	2N3906	11p
BC173	7p	BF185	25p	TIP32B	35p				

DIODES

TYPE	PRICE	TYPE	PRICE	TYPE	PRICE	TYPE	PRICE
AA119	3p	BAX16/	3p	BYZ16	30p	OA85	7p
AZ13	4p	OA202	5p	BYZ17	28p	OA90	6p
BA100	10p	BY100	15p	BYZ18	28p	OA91	7p
BA115	5p	BY127	10p	BYZ19	28p	OA95	7p
BA144	3p	BYZ10	32p	OA47	5p	IN34	5p
BA148	10p	BYZ11	32p	OA70	5p	IN60	6p
BA173	10p	BYZ12	32p	OA79	7p	IN914	4p
BAX13/	10p	BYZ13	30p	OA81	7p	IN4148	4p
OA200	5p						

LINEAR IC's

TBA800	12 pin QIL	75p*	UA703	TO99(Plastic)	20p	72558	(Dual 748)	45p
TBA810	12 pin QIL	£1.00*	741P	8 pin DIL	18p	TO99		
TBA820	14 pin QIL	80p*	72741	14 pin DIL	20p	MC1310P	14pin DIL	£1.25*
LM380	14 pin DIL	80p*	UA741C	TO99	20p	76115	14 pin QIL	£1.25*
LM381	14 pin DIL	£1.35*	72747	14 pin DIL	35p	NE555	8 pin DIL	32p
72709	14 pin DIL	28p	748P	8 pin DIL	35p	NE556	14 pin DIL	60p
UA709	TO99	28p	UA748	TO99	28p	SL414A	10 pin	£1.00*
UA711C	TO99	28p						

NEW CONSIGNMENT ZN414 RADIO CHIP 75p*

OPTOELECTRONICS

DISPLAYS			
No. 1510	707 LED Display	70p each	
No. 1511	747 LED Display	£1.50 each	
553 DL33	Triple 7 segment, LED Display. Character height - 1"		
Common cathode	12 pin DIL	30p each	
2nd QUALITY LED PAKS 75p			
1507	10 x LED's Assorted		
LED CLIPS			
1508/125	.125	5 for 12p	
1508/2	.2	5 for 15p	

SPECIAL REDUCTIONS

1514	NORP 12	45p each
CP71	5 for £1.00	
583	5 NIXIE Tubes IIT 5870 ST.	£2.00
(Including Data)		
577	Neon Indicator Lamps	
230 V. A.C.		
State Colour (Red, Amber and Green)		25p each

D.I.Y. PRINTED CIRCUIT KIT

Contains 6 pieces of copper laminate board, box of etchant powder, measure, tweezers, marker pen, high quality pump drill, Stanley knife and blades and 6 in. metal rule. Full easy to follow instructions. Order No. S64 SALE PRICE £5.50

P.C.B. BOARDS

S61	8 pieces 8" x 3 1/2" (Approx). single sided paper	50p
S62	4 pieces 8" x 3 1/2" (Approx). single sided fibreglass	50p
S63	3 pieces 7" x 3 1/2" (Approx). double sided fibreglass	50p

ETCH RESIST PENS

Order No. 1609 50p each

SOLDER

5 m. of 18 sw. Multi-core Solder Order No. S60 50p

I.C. INSERTION EXTRACTION TOOL

Order No. 2015 30p

MAMMOTH I.C. PAK

Approx. 200 pieces. Assorted fall-out integrated circuits, including Logic, 74 series, Linear, Audio and D.T.L. Many coded devices, but some unmarked—you to identify. Order No. 16223 £1.00

POWER SUPPLY STABILIZER BOARD

Unused ex-equipment stabilizer board, input 30 V. D.C. output 20 V. Complete with circuit diagram. Order No. S81 £1.25

P.O. RELAYS

S85 2 Off Post Office relays 40p

BATTERY HOLDERS

to take 6 x HP7's Order No. 202 10p each

EX. G.P.O. MICROSWITCHES

Order No. S84A 4 For 50p

CABLE CLIPS

S65 50 2.5 mm round single pin fixing 30p

UNTESTED SEMICONDUCTOR PAKS

Code No's shown below are given as a guide to the type of device. The devices themselves are normally unmarked.

No. 16130	100 Germ. Gold bonded diodes like OA47	40p
No. 16131	150 Germ. Point contact diodes like OA70/81	40p
No. 16132	100 200mA Sil. diodes like OA200	40p
No. 16133	150 75mA Sil. Fast switching diode like IN4148	40p
No. 16134	50 750mA Sil. top hat Rects.	40p
No. 16135	20 3amp. Sil. stud Rect.	40p
No. 16136	50 400mw. Zeners D.O.7 case	40p
No. 16137	30 NPN Plastic trans. like BC107/8	40p*
No. 16138	30 PNP Plastic trans. like BC177/8	40p*
No. 16139	25 NPN Trans. like 2N697/2N1711 TO 39	40p
No. 16140	25 PNP Trans. like 2N2905 TO 39	40p
No. 16141	30 NPN Trans. like 2N706 TO 18	40p
No. 16143	30 NPN Plastic trans. like 2N3906	40p*
No. 16144	30 PNP Plastic trans. like 2N3905	40p*
No. 16145	30 PNP Germ. trans. like OC71	40p
No. 16147	10 NPN TO3 Power trans. like 2N3055	80p

IC SOCKET PAKS

No. S66	11 x 8 pin D.I.L. Sockets	£1.00
No. S67	10 x 14 pin D.I.L. Sockets	£1.00
No. S68	9 x 16 pin D.I.L. Sockets	£1.00
No. S69	4 x 24 pin D.I.L. Sockets	£1.00
No. S70	3 x 28 pin D.I.L. Sockets	£1.00

TRANSISTOR SOCKETS

No. S71	15 x TO18 Sockets	£1.00
No. S72	10 x TO5 Sockets	£1.00

MOUNTING PADS

No. S73 50 Mixed Transistor Pads TO18 and TO5 40p

Transistor Heatsink Pak

20 Assorted types TO1, TO5, TO18, TO92 Our Mix. Order No. S75 60p

Transistor Insulating Kits

Mica washers and bushes assorted types, i.e. TO220, TO66, TO3 etc. Approx 100 pieces (Approx 40 sets) Order No. S74 50p

Darlington Power Trans.

70 watt 8 amp. NPN and PNP in plastic case 199 High Voltage (Typ. 80V) High gain. 10 pieces 5 NPN and 5 PNP Data Sheet supplied. Order No. S78 £1.00 per Pak

MATCHED PAIRS OF GERMANIUM MED. POWER TRANS.

2 amp. 750 mW			
VCE VCB HFE			
NKT301	40	60	30-100 35p per pair
NKT302	40	60	50-150 35p per pair
NKT303	20	30	30-100 25p per pair
NKT304	20	30	50-150 25p per pair

ZENER PAKS

No. S55	20 mixed values 400m
---------	----------------------

SAVING SALE BI-PAK

YOU MAKE THE SAVING!

OPT FOR OPTOELECTRONICS! PRINTED CIRCUIT KITS, BOARDS & PENS.

SILICON RECTIFIERS
SIMILAR IN4000 SERIES G.E. 1 Amp.

No. 541	25 Like IN4001 (1A/50V)	60p
No. 542	20 Like IN4002 (1A/100V)	60p
No. 543	18 Like IN4003 (1A/200V)	60p
No. 544	15 Like IN4004 (1A/400V)	60p

SILICON RECTIFIERS—1 Amp. G.E.

No. 548	40 x 50 V.	60p
No. 549	30 x 200 V.	60p
No. 550	20 x 700 V.	60p

G.E. HIGH VOLTAGE SILICON RECTIFIERS

GR559	10mA 14 KV (14,000 V)	20p each
GA432	1 AMP. 2 KV (2,000 V)	20p each
FD2'S	2.5 KV. Voltage Doubler	20p each

POTENTIOMETERS

Slider 40 mm. TRAVEL

Order No.	Value	Order No.	Value
16191	6 x 470 Ohm LIN Single	40p*	
S24	6 x 1K LIN Single	40p*	
S25	6 x 5K LIN Single	40p*	
16192	6 x 10K LIN Single	40p*	
S26	6 x 10K LOG Single	40p*	
16193	6 x 22K LIN Single	40p*	
16195	6 x 47K LOG Single	40p*	
16194	6 x 47K LIN Single	40p*	
S27	6 x 100K LIN Single	40p*	
S28	6 x 100K LOG Single	40p*	
S29	6 x 500K LOG Single	40p*	

60 mm. TRAVEL

S30	6 x 2.5K LOG Single	40p*
S31	6 x 10K LIN Single	40p*
S32	6 x 50K LIN Single	40p*
S33	6 x 250K LOG Single	40p*
S34	4 x 5K LOG Dual	40p*
S35	4 x 10K LIN Dual	40p*
S36	4 x 100K LOG Dual	40p*
S37	4 x 1-3 MEG LOG Dual	40p*
S38	20 MIXED SLIDER POTS. VARIOUS VALUES & SIZES—OUR MIX 20 FOR ONLY £1.00*	
S39	6 x CHROME SLIDER KNOBS	40p*

WIREWOUND

A range of wirewound single gang pots. with linear tracks of 1 watt rating.

Order No.	Value	Order No.	Value
1891	10 ohms	1896	470 ohms
1893	47 ohms	1897	1 K
1894	100 ohms	1898	2K2
1895	220 ohms	1899	4K7

NOW ONLY 35p* each

16173 15 Rotary Potentiometers. Assorted values and types 40p*

16186 25 Pre-sets Assorted Values and types SALE PRICE 40p*

MULTI-TURN PRE-SETS

S40	3 x 100 K LIN	ONLY 50p*
-----	---------------	-----------

AUDIO PLUG AND SOCKET PAKS

Order No.	Description	Price
S1	5 x 3.5mm. Plastic Jack Plugs	40p*
S2	5 x 2.5mm. Plastic Jack Plugs	40p*
S3	4 x Std. Plastic Jack Plugs	50p*
S4	2 x Stereo Jack Plugs	30p*
S5	5 x 5 Pin 180° Din. Plugs	50p*
S6	8 x 2 Pin Loudspeaker Plugs	50p*
S7	6 x Phono Plugs Plastic	50p*
S8	5 x 3.5mm. Chassis Sockets (Switched)	25p*
S9	5 x 2.5mm. Chassis Sockets (Switched)	25p*
S10	4 x Metal Std. Chassis Switched Jack Sockets	50p*
S11	2 x Stereo Jack Sockets with instruction leaflet for H/Phone connection	50p*
S12	5 x 5 Pin 180° Din. Chassis Sockets	40p*
S13	8 x 2 Pin. Din. Chassis Sockets	50p*
S14	6 x Single Phono Sockets	40p*

AUDIO LEADS

Order No.	Description	Price
117	A.C. Mains Connecting Lead for Cassette Recorders and Radios: Telefunken Type	45p*
118	5 pin Din Headphone Plug to Stereo Socket	78p*
119	2 x 2 pin Plug to Inline Stereo Socket for Headphones	60p*
123	20ft. of Coiled Guitar Lead	£1.15*
124	3 Pin to 3 Pin Din Plug	50p*
125	Audio Lead 5 Pin Plug to 5 Pin Din Plug	50p*
126	Audio Lead 5 Pin Din Plug to Tinned open Ends	50p*
127	Audio Lead 5 Pin Din Plug to 4 Phono Plugs	90p*
129	Audio Lead 5 Pin Plug to 5 Pin Din Plug—Mirror Image	70p*
130	5 Meter Lead 2 Pin Din Plug to 2 Pin Din Inline Socket	45p*
132	10 Meter Lead 2 Pin Din Plug	65p*

HEAVY GAUGE BLACK PLASTIC BOX
WITH ALUMINIUM LID
and FIXING SCREWS Size 6½" x 3½" x 2"
Order No. S16 ONLY 75p

74 SERIES TTL ICs

Type	Quantity	Type	Quantity	Type	Quantity
	100		100		100
	£ p	£ p	£ p	£ p	£ p
7400	0-09 0-08	7448	0-70 0-68	74122	0-45 0-42
7401	0-11 0-10	7450	0-12 0-10	74123	0-65 0-62
7402	0-11 0-10	7451	0-12 0-10	74141	0-68 0-65
7403	0-11 0-10	7453	0-12 0-10	74145	0-75 0-72
7404	0-11 0-10	7454	0-12 0-10	74150	1-10 1-05
7405	0-11 0-10	7460	0-12 0-10	74151	0-65 0-60
7406	0-28 0-25	7470	0-24 0-23	74153	0-70 0-68
7407	0-28 0-25	7472	0-20 0-19	74154	1-20 1-10
7408	0-12 0-11	7473	0-26 0-22	74155	0-70 0-68
7409	0-12 0-11	7474	0-24 0-23	74156	0-70 0-68
7410	0-09 0-08	7475	0-44 0-40	74157	0-70 0-68
7411	0-22 0-20	7476	0-26 0-25	74160	0-95 0-85
7412	0-22 0-20	7480	0-45 0-42	74161	0-95 0-85
7413	0-26 0-25	7481	0-90 0-88	74162	0-95 0-85
7416	0-28 0-25	7482	0-75 0-73	74163	0-95 0-85
7417	0-26 0-25	7483	0-88 0-82	74164	1-20 1-10
7420	0-11 0-10	7484	0-85 0-80	74165	1-20 1-10
7422	0-19 0-18	7485	1-10 1-10	74166	1-20 1-10
7423	0-21 0-20	7486	0-28 0-26	74174	1-10 1-08
7425	0-25 0-23	7489	2-70 2-50	74175	0-85 0-82
7426	0-25 0-23	7490	0-38 0-32	74176	1-10 1-00
7427	0-25 0-23	7491	0-65 0-62	74177	1-10 1-00
7428	0-36 0-34	7492	0-43 0-35	74180	1-10 1-00
7430	0-12 0-10	7493	0-38 0-35	74181	1-90 1-80
7432	0-20 0-19	7494	0-70 0-68	74182	0-80 0-78
7433	0-38 0-36	7495	0-60 0-58	74184	1-50 1-40
7437	0-26 0-25	7496	0-70 0-68	74190	1-40 1-38
7438	0-26 0-25	74100	0-95 0-90	74191	1-40 1-30
7440	0-12 0-10	74104	0-40 0-35	74192	1-10 1-00
7441	0-60 0-57	74105	0-30 0-25	74193	1-05 1-00
7442	0-80 0-70	74107	0-30 0-23	74194	1-05 1-00
7443	0-95 0-90	74110	0-48 0-45	74195	0-80 0-75
7444	0-95 0-90	74111	0-75 0-72	74196	0-90 0-85
7445	0-80 0-75	74118	0-85 0-82	74197	0-90 0-85
7446	0-80 0-75	74119	1-30 1-20	74198	1-90 1-80
7447	0-70 0-68	74121	0-28 0-26	74199	1-80 1-70

Devices may be mixed to qualify for quantity price. Data is available for the above series of IC's in booklet form Price 35p

CMOS ICs

Type	Price	Type	Price	Type	Price
CD4000	£0.14	CD4022	£0.80	CD4046	£0.95
CD4001	£0.16	CD4023	£0.18	CD4047	£0.75
CD4002	£0.16	CD4024	£0.64	CD4049	£0.46
CD4006	£0.80	CD4025	£1.40	CD4050	£0.46
CD4007	£0.17	CD4026	£1.85	CD4054	£0.95
CD4008	£0.80	CD4027	£0.48	CD4055	£1.60
CD4009	£0.50	CD4028	£0.80	CD4056	£1.15
CD4010	£0.50	CD4029	£0.95	CD4069	£0.32
CD4011	£0.18	CD4030	£0.46	CD4070	£0.32
CD4012	£0.17	CD4031	£1.80	CD4071	£0.20
CD4013	£0.25	CD4032	£1.40	CD4072	£0.30
CD4015	£0.80	CD4037	£0.78	CD4081	£0.20
CD4016	£0.42	CD4040	£0.78	CD4082	£0.20
CD4017	£0.80	CD4041	£0.68	CD4510	£1.10
CD4018	£0.85	CD4042	£0.68	CD4511	£1.25
CD4019	£0.45	CD4043	£0.78	CD4516	£1.10
CD4020	£0.95	CD4044	£0.78	CD4518	£1.10
CD4021	£0.85	CD4045	£1.15	CD4520	£1.10

AUDIO MODULE SALE

Type	Description	Normal Price	Sale Price
AL30A	10W RMS Power AMP	£3.65*	£2.95*
AL60	25W RMS Power AMP	£4.35*	£3.55*
AL80	35W RMS Power AMP	£6.95*	£5.95*
AL250	125W RMS Power AMP	£15.95*	£14.45*
SPM80	35V Power Supply	£3.7*	£3.10*
PS12	20-30V Power Supply for AL30A	£1.10*	£1.15*
PA12	Stereo Pre-Amp for AL30A	£6.70*	£5.95*
PA100	Stereo Pre-Amp for AL60/AL80	£13.75*	£12.45*
S450	Stereo F.M. Tuner	£20.45*	£18.65*
MPA30	Magnetic-Ceramic Pre-Amp	£2.85*	£2.55*
Stereo 30	Complete Audio Chassis 7W+7W RMS	£16.25*	£14.95*

LOOK & LISTEN!

GE 100 NINE CHANNEL MONO-GRAPHIC EQUALIZER MODULE

The GE100 has nine 1 octave adjustments using integrated circuit active filters. Boost and Cut limits are ±12db. Max. Voltage handling 2 V RMS, T.H.D., 0.05%, input impedance 100 K, Output impedance less than 10 K, Frequency response 20 Hz-20 KHz (3DB). The nine gain controls are centred at 50, 100, 200, 400, 800, 1,600, 3,200, 6,400 and 12,800 Hz. The suggested gain controls are 10 K LIN sliders. (Not supplied with the module). See Paks S31 and 16192.

ONLY £19.50

SG30 POWER SUPPLY BOARD FOR GE100
15-0-15 Volt.

ONLY £4.50

SEND S.A.E. FOR TECHNICAL DATA ON ANY OF THE AUDIO MODULES

POSTAGE AND PACKING
Add 25p for postage and packing unless otherwise shown. Add extra for airmail. Min. order £1.

SPECIAL OFFER!
COMPONENT PAKS

Order No.	Quantity	Price
16164	200 approx. Resistors, mixed values (count by weight)	40p*
16165	150 approx. Capacitors, mixed values (count by weight)	40p*
16167	80 ½W. Resistors, mixed values	40p*
16168	5 pieces Assorted Ferrite rods	40p*
16169	2 pieces Tuning gangs MW/LW	40p*
16170	50 metres Single strand wire assorted wire	40p*
16171	10 Reed switches	40p*
16172	3 Micro switches	40p*
16176	20 Assorted electrolytics Trans type	40p*
16177	1 pack Assorted hardware nuts/bolts, etc.	40p*
16179	20 Assorted tag strips and panels	40p*
16180	15 Assorted control knobs	40p*
16184	15 Assorted Fuses 100mA-5 amp.	40p*
16188	60 ½W. resistors, mixed values	40p*
16187	30 metres stranded wire assorted colours	40p*

½ PRICE BARGAIN!
£4 worth (Min. Value) of Electronic Project Books, Technical, Semiconductor Data and Equiv.—Books of Assorted Titles.

OUR CLEARANCE PRICE—
Order No. S80 **£2† per bundle**

SUPER SOUND SAVING!

C60 METRO SOUND LOW NOISE CASSETTES

Order No. S53A **10 for £2.50***

BIB GROOVE-CLEAN

Model 60 Chrome Finish Plastic
Order No. 829 **£1.40***



HOT OFFER

ANTEX SOLDERING IRONS

ORDER No. 1931 X25 25 WATT LOW LEAKAGE
Usually £2.40 **NOW ONLY £2.95**
PLUS FREE Heatshunt
1948 Model C 15 watt General Purpose
Usually £3.40 **SALE PRICE £2.95**
PLUS FREE Heatshunt

Order No. 1939 ST3 Soldering Iron Stand suitable for either Iron £1.20

NEW Siren Alarm Module

American Police Screamer powered from any 12 volt supply into 4 or 8 ohm speaker. Ideal for car burglar alarm, Freezer breakdown, and other security purposes.

Order No. S15 **ONLY £3.50**

AVDEL BOND

Cyanocrylate adhesive Bonds—plastic, rubber, Transistors, Components in Seconds.
Order No. 143 **35p per 2gm. phial**

ORDERING

PLEASE WORD YOUR ORDERS EXACTLY AS PRINTED, NOT FORGETTING TO INCLUDE OUR PART NUMBER.

VAT

ADD 12½% TO PRICES MARKED*. ADD 8% TO OTHERS EXCEPTING THOSE MARKED†. THESE ARE ZERO RATED

Postage & Packing add 25p. Add extra for air mail

BI-PAK

Dept. P.W.3, P.O. Box 6, Ware, Herts.
COMPONENTS SHOP: 18 BALDOCK STREET, WARE, HERTS.

FOR RELIABLE JOINTS—ANTEX IRONS!

EDITOR

F. E. BENNETT

ASSISTANT EDITOR

B. W. TERRELL B.Sc.

PRODUCTION EDITOR

D. BARRINGTON

TECHNICAL SUB-EDITOR

T. J. JOHNSON G8MGS

ART EDITOR

R. PALMER

TECHNICAL ILLUSTRATORSP. A. LOATES
D. J. GOODING**EDITORIAL OFFICES**Kings Reach Tower,
Stamford Street,
London SE1 9LS
Phone: 01-261 6873**ADVERTISEMENT MANAGER**D. W. B. TILLEARD
Phone: 01-261 6676**REPRESENTATIVE**P. J. MEW
Phone: 01-261 6676**CLASSIFIED MANAGER**C. R. BROWN
Phone: 01-261 5762**MAKE-UP AND COPY
DEPARTMENT**

Phone 01-261 6035

ADVERTISEMENT OFFICESKings Reach Tower,
Stamford Street,
London SE1 9LS

Projects... Theory...

and Popular Features ...

The electronics enthusiast seldom sticks just to constructing. A natural extension of one's hobby leads quite easily to the checking and repairing of sundry domestic electronic equipment like radios and audio systems.

Many an enthusiast has been propelled along this path by requests, if not demands, from friends or neighbours. It's a fact, once you're known to be interested in electronics, it won't be long before you will be approached to help out in a variety of ways, from fixing a plug on a smoothing iron to having a look at the "telly".

Having warned you, there are two choices. Be self-depreciating, and gently but firmly close the front door. Or, let your ego be flattered by the first approach and decide to make a name for yourself as the friendly neighbourhood repairman.

We don't encourage you to adopt the latter course without careful thought however.

Forgetting all about reputations to be made (or lost) in your neighbourhood, there remains the possibility of confining your servicing expertise to a smaller circle, within the home.

To help equip you for a start in this direction we offer this month the *Audiotest*. The purpose of this equipment will be evident from its title.

A never-failing source of interest and amusement is the electronic sound generator.

Things have moved far since those days when radio receivers were notorious for the unwanted grunts, howls and shrieks they emitted as the tuning and reaction controls were juggled with desperately in attempts to pick up the wanted station. A whole new art has been created, based on the employment of electronic sound producing and processing techniques.

No self-respecting TV cops and robbers drama dares to be presented without some electronic sound backing. And we all know how indispensable electronic effects are to science fiction films like *Star Wars*.

Those with only modest means can get into the act without much difficulty. For many intriguing sounds can be produced with a quite simple oscillating circuit. Apart from an amusement, this month's *Weird Sound Effects Generator* will be a useful instrument for the creative tape recording enthusiast, for with its aid not only effects but electronic music can be produced.



Our April issue will be published on Friday, March 17. See page 341 for details.

Readers' Enquiries

We cannot undertake to answer readers' letters requesting modifications, designs or information on commercial equipment or subjects not published by us. All letters requiring a personal reply should be accompanied by a stamped self-addressed envelope.

Telephone enquiries should be limited to those requiring only a brief reply. We cannot undertake to engage in discussions on the telephone, technical or otherwise.

Component Supplies

Readers should note that we do not supply electronic components for building the projects featured in *EVERYDAY ELECTRONICS*, but these requirements can be met by our advertisers.



Everyday ELECTRONICS

VOL. 7 NO. 7

MARCH 1978

CONSTRUCTIONAL PROJECTS

- THE AUDIOTEST** *A workshop aid for testing radio receivers and audio gear. Also includes a m.w. l.w. tuner*
by D. W. Easterling **312**
- C-R SUBSTITUTION BOX** *Gives switched selection of resistors (10Ω–10MΩ) and capacitors (3·3pF–1000μF)*
by P. G. O'Neil **320**
- CATCH-A-LIGHT** *A reaction game with a difference* by R.A. Penfold **332**
- WEIRD SOUND EFFECTS GENERATOR** *Create your own "Star Wars" with this simple project and a tape recorder* by D. Edwards **438**

GENERAL FEATURES

- EDITORIAL** **310**
- TEACH-IN 78** *Part 6. Conductance, matching, gain* by George Hylton **324**
- FOR YOUR ENTERTAINMENT** *Pioneers in audio* by Adrian Hope **331**
- EVERYDAY NEWS** *What's happening in the world of electronics* **338**
- SQUARE ONE** *Choosing a case* **340**
- SHOP TALK** *New products and component buying for constructional projects* by Brian Terrell **342**
- EE CROSSWORD No. 1** by D. P. Newton **343**
- AIRPORT RADAR** *A look at ASMI the latest high speed radar* by G.A.G. Brooke **344**
- READERS' LETTERS** *Your news and views* **347**
- BRIGHT IDEAS** *Readers' hints and tips* **351**
- JACK PLUG AND FAMILY** by Doug Baker **351**
- PROFESSOR ERNEST EVERSURE** *The Extraordinary Experiments of.* by Anthony J. Bassett **352**
- DOWN TO EARTH** *Measuring low resistance* by George Hylton **354**

- ★ **FREE GIFT** *(Mounted on front cover)*
TOOL RACK **337**

Back issues of EVERYDAY ELECTRONICS (June 1977 onwards—October, November, December 1977 and January 1978 NOT available) are available worldwide at a cost of 60p per copy inclusive of postage and packing. Orders and remittance should be sent to: Post Sales Department, IPC Magazines Ltd., Lavington House, 25 Lavington Street, London SE1 0PF.

Binders for Volumes 1 to 7 (state which) are available from the above address for £2·85 inclusive of postage and packing.

© IPC Magazines Limited 1978. Copyright in all drawings, photographs and articles published in EVERYDAY ELECTRONICS is fully protected, and reproductions or imitations in whole or in part are expressly forbidden.

All reasonable precautions are taken to ensure that the advice and data given to readers are reliable. We cannot however guarantee it, and we cannot accept legal responsibility for it. Prices quoted are those current as we go to press.

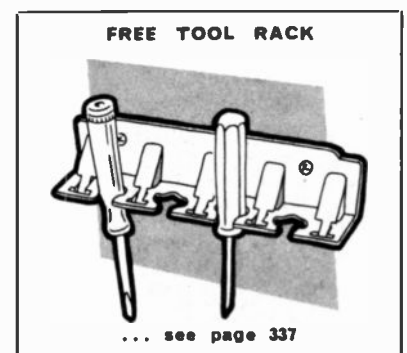

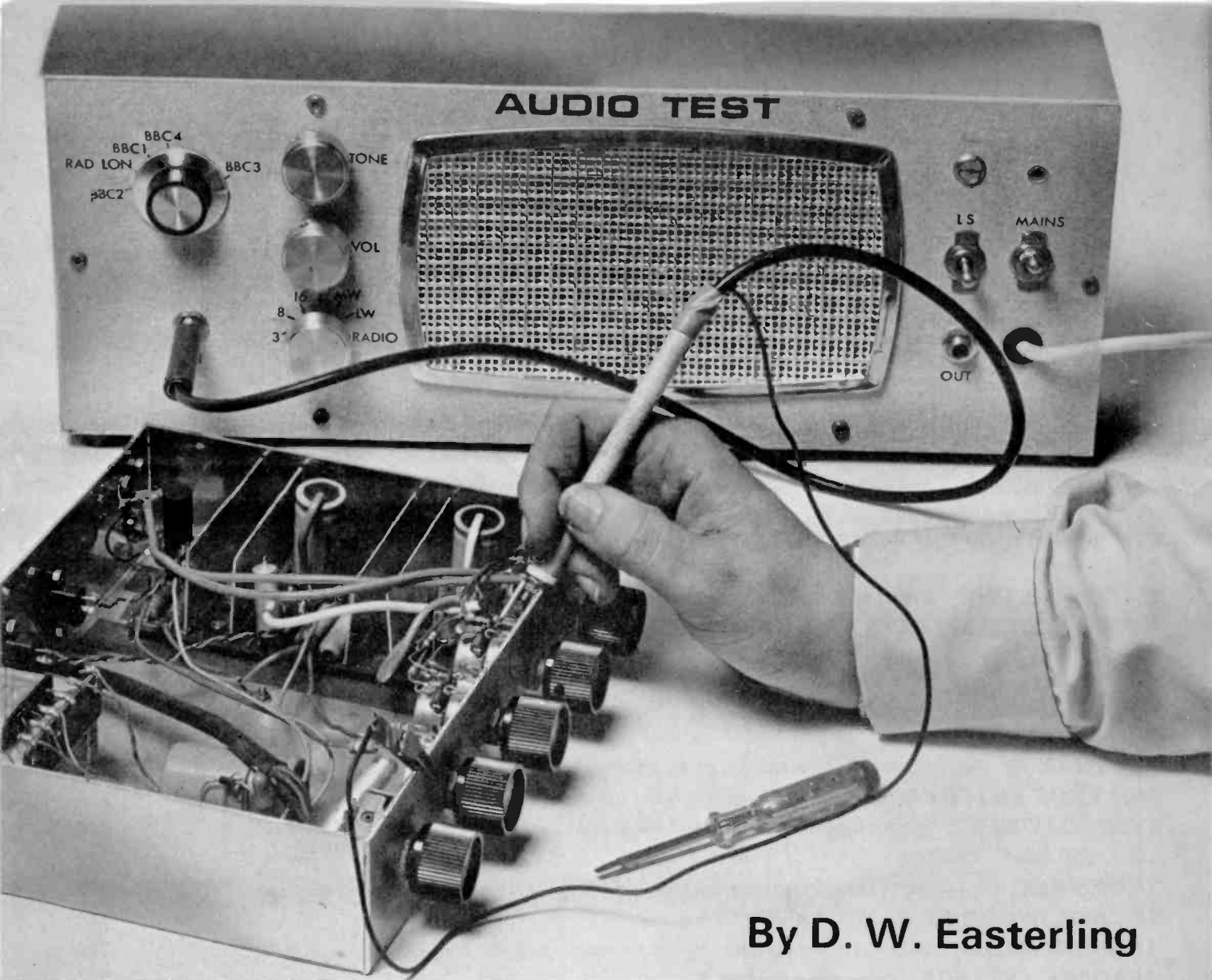

By D. W. Easterling

THE AUDIOTEST

A useful piece of audio test gear for the workshop incorporating a radio tuner

THE main purpose of the unit to be described is to provide a loudspeaker and loudspeaker amplifier stage for testing radio receivers, record players, tape recorders, pre-amplifiers and similar equipment having an output power not exceeding 10 watts. A simple radio tuner is incorporated as a speech and music source, and to provide entertainment in the workshop.

Since one side of the input and output connections are connected to earth, the unit is generally unsuitable for testing equipment hav-

ing a transformerless mains-driven power supply, such as that typically used with domestic television sets.

FACILITIES

The facilities provided by the unit are best explained by reference to the front panel layout as shown in the photograph above. A single input jack socket is mounted below the tuning control. Load resistors across the input may be selected by the function switch to simulate various loudspeaker im-

pedances ranging from 3 to 16 ohms.

A high input impedance is provided by a further position of the switch, and two more positions activate the radio tuner on either the medium or long waveband.

The output jack socket is at low impedance and is suitable for driving small loudspeakers and headphones as well as high impedance devices such as amplifiers and tape recorders. Provision is made to mute the built-in loudspeaker independently of the signal at the output socket.

COMPONENTS

Resistors

- R1 4.7k Ω
- R2 1k Ω
- R3 680 Ω
- R4 100k Ω
- R5 1M Ω
- R6 470 Ω
- R7 10k Ω
- R8 4.7k Ω
- R9 10k Ω
- R10 3.3 Ω 10W
- R11 8.2 Ω 10W
- R12 4.7 Ω 10W
- R13 10k Ω
- R14 390 Ω
- R15 110 Ω
- R16 1.8k Ω
- R17 47 Ω
- All $\frac{1}{4}$ W carbon \pm 5%

Potentiometers

- VR1 2.2M Ω carbon log.
- VR2 2.2M Ω carbon lin.

Capacitors

- C1 22 μ F 10V elect.
- C2 350pF Jackson type 01
- C3 0.1 μ F polyester
- C4 0.022 μ F polyester
- C5 10 μ F 25V elect.
- C6 0.1 μ F polyester
- C7 22 μ F 10V elect.
- C8 0.01 μ F polyester
- C9 1 μ F polyester
- C10 2200pF plastic or ceramic
- C11 180pF ceramic
- C12 100pF ceramic
- C13 0.1 μ F polyester
- C14 470 μ F 25V elect.
- C15 4700 μ F 25V elect.
- C16 47pF polystyrene

Semiconductors

- D1, 2, 3, 4 1N914 or similar silicon type (4 off)
- D5 TIL209 light emitting diode
- D6, 7 1N4001 or similar 1A silicon rectifier (2 off)
- D8 OA91 germanium
- TR1 BC108 silicon *n*p*n*
- IC1 ZN414 radio receiver i.c.
- IC2 LM380 2 watt audio amplifier i.c. 14 pin d.i.l.

Switches

- S1 2-pole 6-way rotary
- S2 single pole on/off toggle
- S3 d.p.s.t. mains toggle

Miscellaneous

- T1 mains primary/12.0-12V 100mA secondary
- SK1 standard jack socket with one break contact
- SK2 standard jack socket
- LS1 8 ohm elliptical (5x3in.) moving coil speaker
- PL1 standard jack plug
- Stripboard: 0.1 inch matrix 34 strips \times 39 holes; plain matrix board: 0.1 inch matrix 35 \times 24 holes; rubber grommets (4 off); mains cable approximately 1 metre; screened cable; connecting wire; aluminium for front panel; case materials; control knob (4 off); speaker grille to suit LS1; ferrite beads (3 off); co-ax. cable; material for probe; 14 pin d.i.l. socket.

See
**Shop
Talk**
page 342



**START
HERE FOR
CONSTRUCTION**

PROTOTYPE CASE

The cabinet assembly can be seen in the photographs, and employs an aluminium front panel fitted to a simple wooden frame which becomes the sides, top and base. Pegboard was used for the back panel. A metal front panel is convenient for mounting the controls and jack sockets, and provides partial screening. Full screening could not be used because of the built-in ferrite-rod aerial, therefore a metal box is ruled out. Plastic types are suitable if available in this size.

FRONT PANEL

The first step is to mark out and drill the front panel. The loudspeaker aperture is best traced out using the loudspeaker chassis as a guide, and then redrawing it to allow a 6mm margin for the mounting flange. The panel size is 400 x 150mm.

The method of cutting out the aperture depends on the tools available. Usually the simplest way is to drill a series of holes just inside the cut-out mark, and link them with cuts made by a small cold chisel. The edge may then be cleaned to the line with a half-round file. A metalised plastic grill was used to cover the aperture, and this is secured to the front panel by four pillars slotting into push-fit holes. Again, the component was used as a template to arrive at the correct hole location.

In the prototype the frame was made from 80 x 13mm planed timber with the joints mitred, glued and pinned, but the front panel is fixed with six small wood screws and glued before the joints become firm. Once the glue is dry, pin-holes, grain and cracks can be filled, and the whole assembly rubbed down ready for painting.



The completed Audiotest showing front panel control layout

The front panel was covered with Contact self-adhesive vinyl which forms an ideal background for dry-transfer lettering. For permanency, the lettering should be coated with a clear varnish; nail varnish was found to be ideal.

MAIN COMPONENT BOARD

Most of the components are mounted on a piece of 0.1 inch matrix stripboard size 34 strips x

39 holes. The layout of the components on the topside of the board is shown in Fig. 3 together with the underside of the board showing the breaks to be made along the copper tracks. Begin by making the breaks and then positioning and soldering in place the Veropins, link wires, resistors and capacitors. In the prototype, sockets were used for mounting the i.c. and the transistors, but this is not essential although the i.c.

HOW IT WORKS

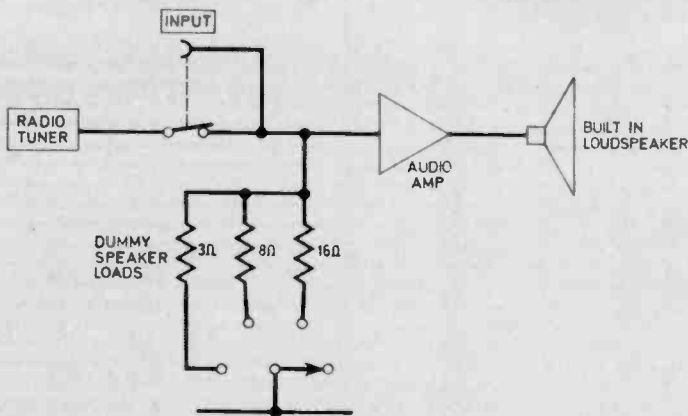

The Audio Test consists of two completely separate units. The first is a simple radio tuner, and the second an audio amplifier. An i.c., the ZN414, is used as the radio together with coils for both medium and long wave bands. This section provides an audio source for testing amplifiers, as well as providing music for the workshop.

The amplifier is slightly unusual in that it has fixed resistors which are selected by a switch to replace the loudspeaker in the external equipment. Using this arrangement tests on an amplifier can be made, taking the output direct from the loudspeaker.

Other facilities exist that make the Audio Test most valuable in the testing of radios and amplifiers.

socket is recommended. When soldering the transistors and diodes, be sure to use a heatsunt on the legs being soldered so as to eliminate possible damage from the hot soldering iron. The connection between the board and other components are made at the board end to Veropins thus enabling the flying leads to be attached to the board after it has been fitted in the case.

FERRITE AERIAL WINDINGS

The ferrite rod aerial used in the prototype unit used a rod with dimensions 100 x 10mm. The medium wave winding, L2 is about 20mm long and consists of a single layer of 30 turns of 42 s.w.g cotton covered wire. The longwave coil, L1 is made with the same wire but has 200 turns pile wound over about 10mm. The aerial is secured to the main component board by nylon thread, rubber grommets being slipped over the core to give support, see Fig. 3. Connection of the coils to the equipment board are made to Veropins.

POWER SUPPLY BOARD

The power supply is constructed on a small piece of plain matrix board size 0.1 inch pitch 35 x 24 holes. The layout of the components on this board is shown in Fig. 4 together with interconnection details on the underside. The transformer is bolted to the board using 4BA nuts, bolts and shake-proof washers, and when this assembly is complete is fitted to the case frame using three wood screws with rubber grommets between board and frame, Fig. 2.

The transformer used in the prototype had short stiff leads emerging from the underside forming the secondary winding. This is not essential as other types with flying leads can be employed and the leads fed to the appropriate connection points.

WIRING UP AND CHECKING

Care should be taken when connecting the mains cable to S3 and the transformer to ensure that there is no possibility of it shorting to the low voltage part of the circuit. A cleat fitted inside the cabinet will prevent strain on the electrical connections.

THE AUDIOTEST

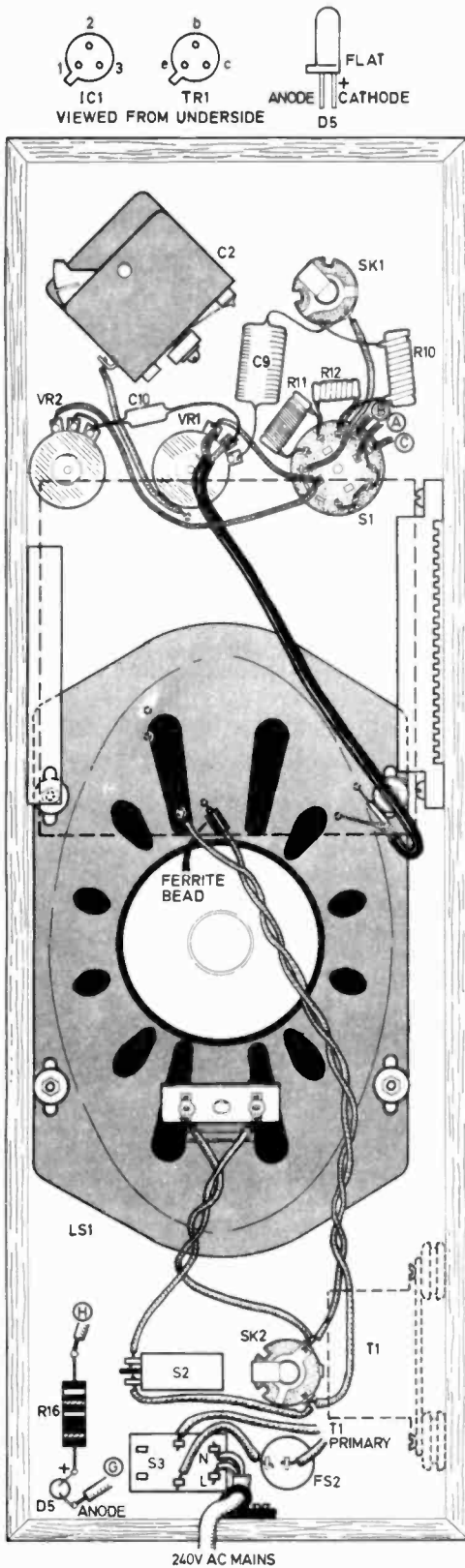

Fig. 2. Front Panel assembly, viewed from rear.

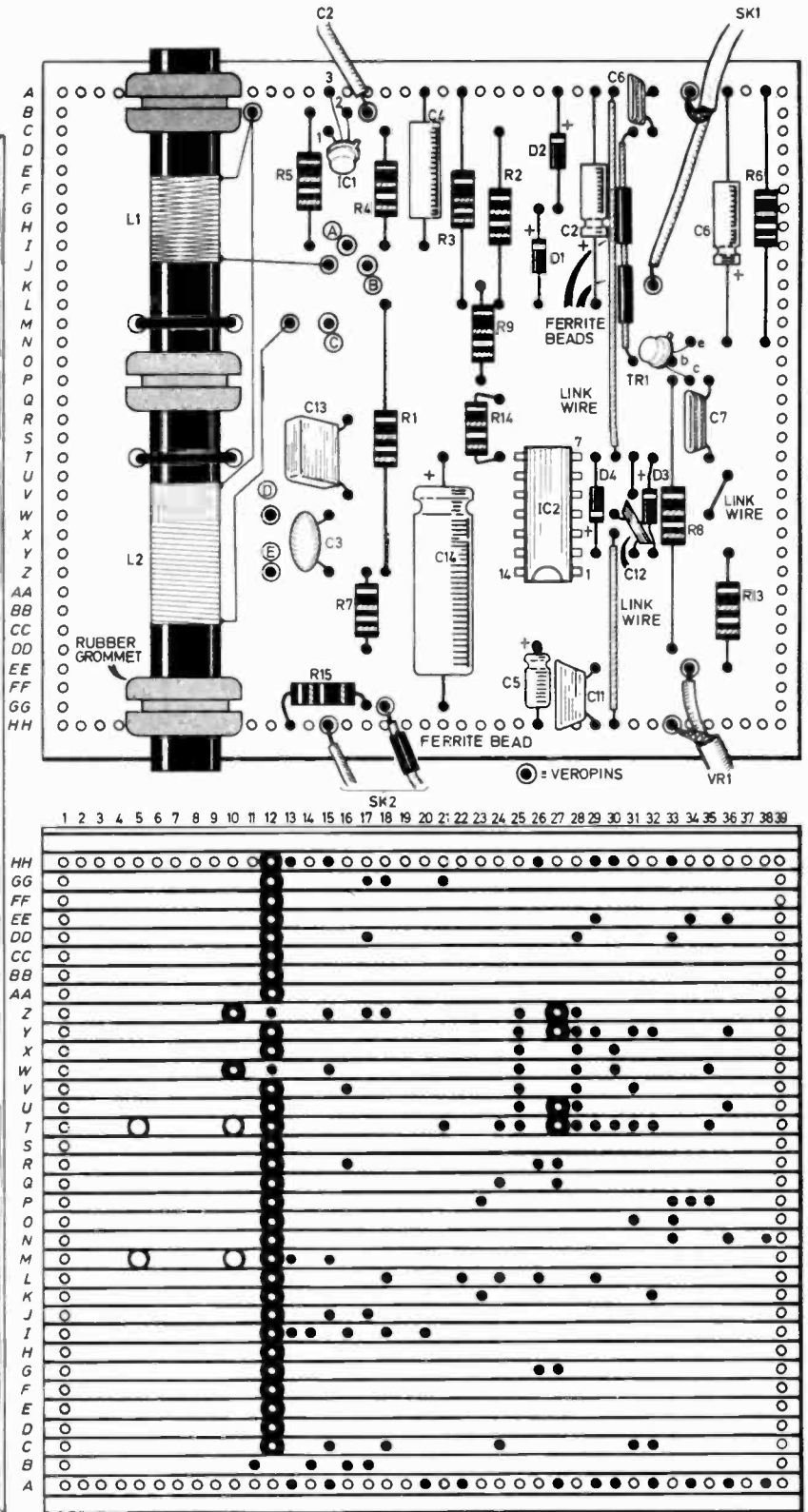

Fig. 3. Main component board layout, underside detail showing breaks in copper strips and interwiring to controls.

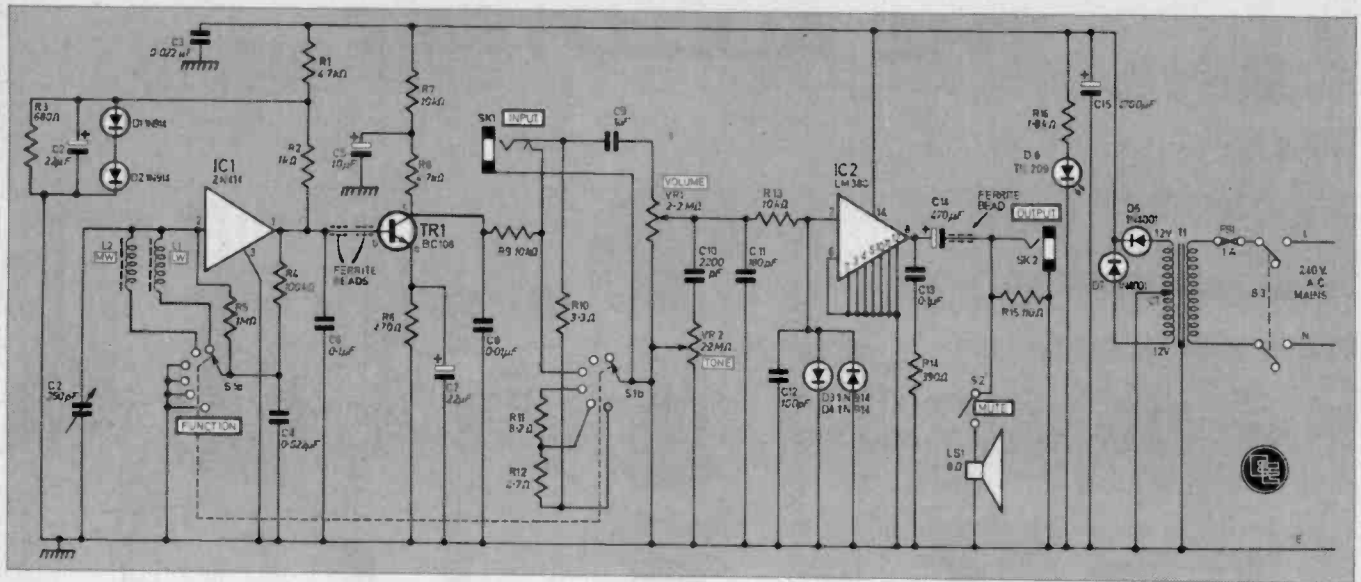

Fig.1. Complete circuit diagram, including power supply, for the Audiotest.

CIRCUIT DESCRIPTION

The complete circuit diagram is shown in Fig. 1.

Integrated circuit IC1 is the well known Ferranti ZN414 t.r.f. receiver i.c. and is tuned by the variable capacitor C2 and the ferrite-rod aerial winding L1 or L2, depending on the waveband selected by switch S1a.

Resistor R5 across the tuned circuit widens the bandwidth slightly, thus improving the sound quality. In difficult reception areas when sharper selectivity is required, it may be omitted.

Network R1, R3, D1, D2 and decoupling capacitor C1 reduce the supply to IC1 to the required 1.2 volts, using the forward-voltage threshold of the diodes to provide regulation.

The output from IC1 is fed to the base of TR1, a voltage amplifier, r.f. being removed by the inclusion of C6 and the inductance of the ferrite beads. This amplifier stage is connected in the common-emitter mode with decoupling networks R7, C5 and R6, C7 establishing the correct d.c. working conditions.

Output from the collector is passed via R9, filter C8, and a screened lead, to the input jack

socket, SK1. This arrangement automatically disconnects the radio tuner whenever the jack-plug is inserted.

DUMMY LEADS

Switch S1b applies the appropriate load resistance across the input when the amplifier circuit is being used to simulate a loudspeaker. This avoids having to use a specially wound transformer and facilitates control of the signal level to the built-in loudspeaker. The main purpose of R9 is to attenuate the radio signal whenever the tuner is not selected.

The input via SK1 is fed via d.c. blocking capacitor C10 to the volume-control and tone-control network VR1, VR2, C10. The tone control acts as a simple top-cut filter. The signal is then fed to the input of the power amplifier integrated circuit IC2, which has a fixed gain of 50.

The network C11, R13, C12 provides further r.f. and noise filtering, and diodes D3 and D4 protect IC2 against input overload. Attempts to over-drive the amplifier will produce distortion but should not damage the i.c. which has thermal protection.

The output of IC2 is coupled to the output jack, SK2, by C14, and via S2 to the built-in loudspeaker.

Network C13, R14 and a ferrite bead on the output line discourage parasitic oscillation which may occur when long external output leads are used. The output voltage and power delivered by IC2 will depend on the external load. Although the circuit will operate over a wide range of load resistance 4 ohms should be considered a minimum. Care should be taken, however, to ensure that no potential exceeding ± 5 volts is fed from the load back to the amplifier. If necessary, an external non-electrolytic capacitor of appropriate working voltage and capacitance should be used.

POWER SUPPLY

The power supply circuit is a conventional double-diode full-wave rectifier driven by a step down mains transformer having a centre-tapped secondary winding. Smoothing is by electrolytic capacitor C15. The 4700 microfarad quoted is rather high and holds the unit operational for a second or so after it has been switched off. It could be reduced to 1000 microfarads with a slight increase in hum level. The light-emitting diode D5 and current limiting resistor R16 are included to indicate that power is being applied to the unit.

THE AUDIOTEST-POWER SUPPLY

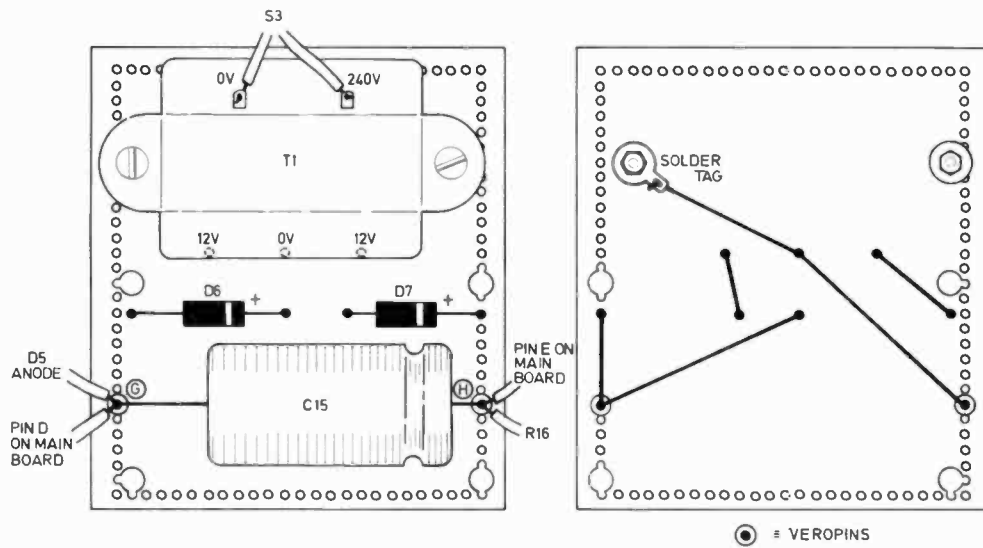

Fig. 4. Power supply board component layout and underside wiring details.

THE AUDIOTEST-PROBE

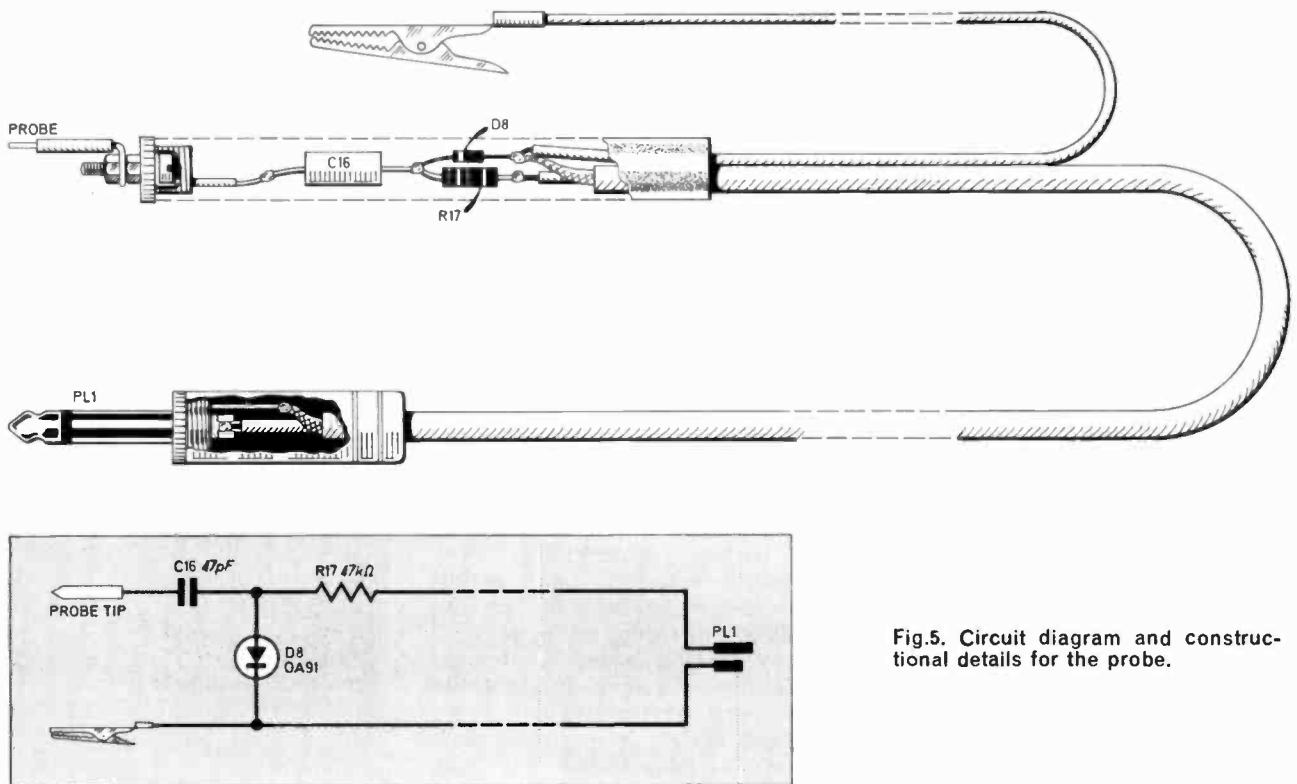
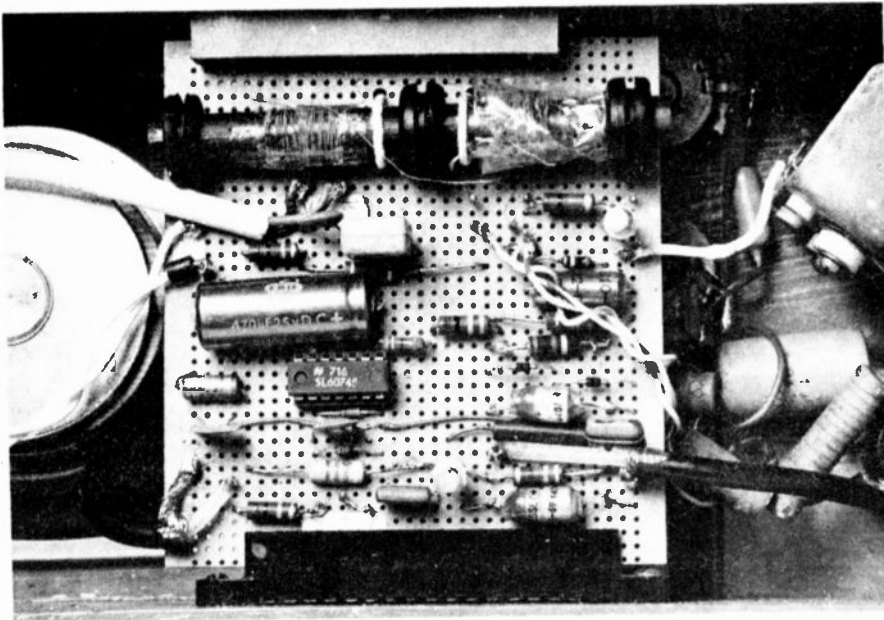

Fig. 5. Circuit diagram and constructional details for the probe.



Close-up of the circuit board showing the mounting of the ferrite aerial.

With the front panel drilled to accept all the panel-mounted components these and the power supply board should be secured in place and interwiring carried out as in Fig. 2 and Fig. 4, with leads that are to connect to the board, of sufficient length to reach the latter when fitted in the case.

In the prototype, the board was held in position by means of p.c.b. slots that were taken from an old computer panel, but an alternative would be to use suitable hardwood mouldings obtainable from many timber merchants and d.i.y. stores.

It is a good idea to check the power supply and l.e.d. indicator before making connections to the circuit board. The smoothed output voltage should be in the order of 18 volts, and the l.e.d. should be at satisfactory brilliance.

If all is well, the main component board should be fitted in place and wired up according to Fig. 3.

The audio amplifier circuit can be checked by connecting, via SK1, a suitable test oscillator, or the phones output socket of a transistor radio, for example. The in-built radio should operate at the appropriate switch position. Unwanted oscillation may be cured by reversing the connections to the tuning coils, L1 and L2.

SIGNAL TRACING WITH THE UNIT

The unit is an ideal signal tracer especially when used with the probe shown in Fig. 5. The probe

enables the r.f. and i.f. stages of a radio tuner to be checked (long, medium and short waves—not f.m.) as well as being suitable for low level audio stages. The small coupling capacitor restricts the low frequencies and makes the sound appear rather "toppy" but has the advantage of reducing mains hum which could be overwhelming under certain test conditions. The final assessment of a.f. signals should be made with the test point connected to the audio-test by a screened lead and not via the probe.

PROBE CONSTRUCTION

The probe consists of a small coupling capacitor, diode detector and filter resistor directly wired to the end of a length of screened aerial feeder. The whole assembly being subsequently slipped into a length of plastic tubing with a wire tip brought out through the end cap. The tube should be long enough to accommodate about two inches of screened cable in order to give it a place where it can be held without introducing stray pick-up. A separate earth return wire is also required. Construction details will be found in Fig. 5.

Signal tracing is simply a matter of working progressively along the signal path of the system under test from aerial, gramophone pick-up or recorder head to loudspeaker, with the object of locating

the point where the normal signal is no longer detected and hence the faulty stage. A similar method can be used to trace distortion.

VOLTAGE CHECKS

Before attempting to signal trace it is wise to make voltage checks to ensure that power supplies are normal and metallic surfaces are either fully isolated or at earth potential. It is also a good idea at this time to visually inspect the system for signs of overheating or other damage. Finally, before using the probe, the earth return lead should be connected to the common or earthy line of the system under test—**NEVER TO THE MAINS LIVE OR NEUTRAL LINES.**

SUBSTITUTION

Once the faulty part of a sound system has been detected a further check can be made by substituting the Audiotest. The unit tuned to a suitable radio programme can be used as a signal source in place of the original tuner, record deck or recorder. The amplifier and loudspeaker can be similarly substituted.

Suppose that a faulty loudspeaker is suspected, replace it with the Audiotest and switch in the appropriate load resistor which should be a similar value to the impedance specified for the system loudspeaker. If distortion is still present try a higher load resistor, and if this is beneficial suspect the loudspeaker coupling capacitor.

Table 1: Approximate signal levels for various sources.

Source	Output
Probe at r.f. stage	1mV
Probe at i.f. stage	5mV
Magnetic pick-up	
Recorder tape head	50mV
Crystal microphone	
Ceramic pick-up	100mV
Crystal pick-up	500mV
Radio tuner	
Preamp tone control	
8 ohm loudspeaker at 0.5 watt	2V

Table 2: Audiotest input sensitivity and output voltage levels using the loudspeaker as the measuring device.

Sound level (Audiotest L/S)	Input sensitivity (VR1 at maximum)	Signal source output voltage
Just discernable	1mV	less than 10mV
Slightly louder	5mV	50mV
Comfortable	50mV	500mV
Loud	reduce VR1 as necessary	2V

Signal tracing can sometimes be applied to diagnose the cause of a low stage gain. A disconnected or unserviceable by-pass capacitor may introduce unwanted negative feedback. Decoupling circuits should be checked to ensure that no signal is detected at their junctions.

VOLUME

At all times the volume control of the Audiotest should be set to provide adequate signal level without overloading either the test set or the equipment under test. Tables 1 and 2 give some idea of the signal levels to be expected. ☒

Sometimes it is difficult to identify the connections to a DIN plug or socket. Standards are specified but not always adopted by the equipment manufacturer. In any case there may be a fault con-

dition or some confusion over the switching arrangements. The connections can be quickly traced using the signal tracing and signal source facilities of the Audiotest.

SOLD OUT

OCT - NOV - DEC - JAN

**New Year Resolution
HAVE YOU KEPT YOURS ?...**

**if not—fill in the
coupon below
without delay!**



To..... NAME.....
 (Name of Newsagent) ADDRESS.....
 Please reserve/deliver the APRIL issue of EVERY-
 DAY ELECTRONICS (40p) ON SALE MARCH 17th,
 and continue every month until further notice.



C-R

SUBSTITUTION BOX

By P. C. O'Neil

START
HERE FOR
CONSTRUCTION

INTRODUCTION

WHEN one is starting to equip a workshop with test equipment one of the first items to be purchased is a multimeter. The next likely item could either be an a.f. generator or power supply.

If all this expensive equipment is bought it is so easy to forget the usefulness of really simple equipment. One such item is the resistance/capacitance substitution box to be described here.

A substitution box is basically a selection of different standard value resistors and capacitors which can be connected into an external circuit and be used to replace that component of its entire function.

Typical examples are;

1. Finding the value of a damaged component in a circuit.
2. Finding the correct bias resistor for a transistor.
3. By using both the resistors and capacitors, the required period in a timing circuit may be found.

There are other uses of course but the three mentioned are the most popular. It can of course be very valuable to the professional circuit designer.

RATINGS

In such a design as this the voltage ratings and tolerances of the components become a slight problem. On one hand high tolerance and high voltage components could be selected, thus increasing the finished size and more important increasing the cost. On the other hand one can select standard components thus producing an inexpensive design and cutting down on the size.

It is the last method which is adopted in this design. Standard capacitors with a reasonable voltage rating have been used, and resistors with the maximum tolerance required in most circuits. After all it is no good using 1 percent resistors when experimenting with a circuit and then using standard 10 percent types in the final



C-R SUBSTITUTION BOX

FOR GUIDANCE ONLY

ESTIMATED COST
OF COMPONENTS

£3.75
excluding
case

Resistors

R1 10 Ω	R7 2.2k Ω	R13 22k Ω	R19 820k Ω
R2 47 Ω	R8 3.3k Ω	R14 39k Ω	R20 1M Ω
R3 100 Ω	R9 5.6k Ω	R15 56k Ω	R21 3.3M Ω
R4 220 Ω	R10 8.2k Ω	R16 100k Ω	R22 10M Ω
R5 560 Ω	R11 10k Ω	R17 220 Ω k	
R6 1k Ω	R12 15k Ω	R18 560k Ω	

All resistors are $\frac{1}{4}$ W carbon $\pm 5\%$

Capacitors

C1 3.3pF silver mica	C9 22nF polyester	C17 33 μ F 40V elect.
C2 10pF silver mica	C10 47nF polyester	C18 47 μ F 40V elect.
C3 100pF silver mica	C11 100nF polyester	C19 100 μ F 40V elect.
C4 470pF polystyrene	C12 1 μ F 35V tant.	C20 220 μ F 40V elect.
C5 1nF polystyrene	C13 2.2 μ F 35V tant.	C21 470 μ F 25V elect.
C6 2.2nF polystyrene	C14 4.7F 35V tant.	C22 100 μ F 16V elect.
C7 4.7nF polystyrene	C15 10 μ F 63V elect.	
C8 10nF polyester	C16 22 μ F 63V elect.	

Miscellaneous

S1, 2, 3, 4 1-pole 12-way rotary wafer switch (4 off)
S5, 6 2-pole 2-way miniature slide switch (2 off)
Aluminium case, 105mm \times 105mm \times 40mm or similar; four crocodile clips (3 off black, 1 off red); white card for front panel; four large round knobs; two grommets; connecting wire; solder.

See
**Shop
Talk**
page 342

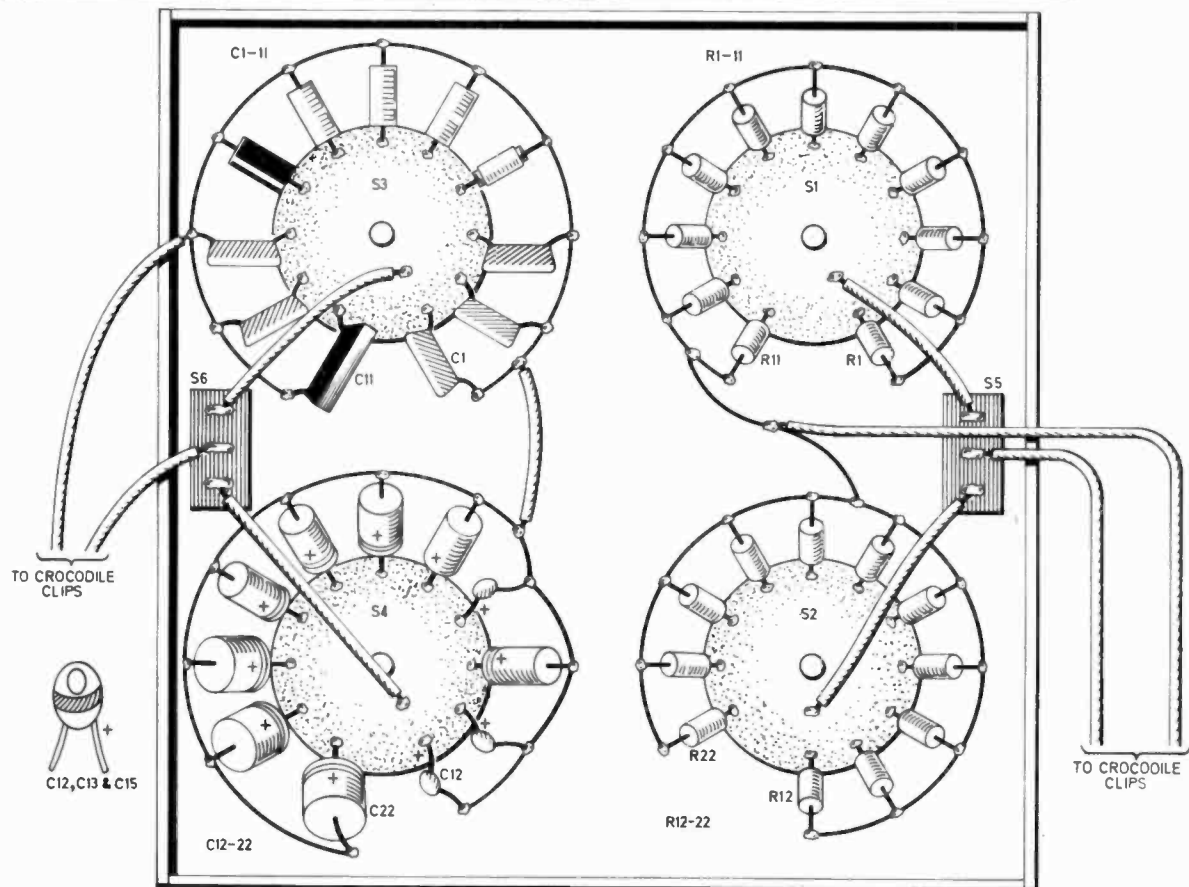

Fig. 2. Component layout and wiring for the C-R Substitution Box. Note that the components have not been drawn to size to make wiring easier to follow.

CIRCUIT DESCRIPTION

The complete circuit is shown in Fig. 1. It may be considered as two separate sections; resistors and capacitors. Each section consists of two 1-pole 12-way switches, each with one spare position which is used as the OFF position.

Each rotary switch may be selected by a single pole slide switch, which selects either HIGH or LOW values as required. These ranges are set out in Table 1.

The output from either switch is applied via crocodile clips to the external circuit. It is important to note that only one value component is selected at any one time, unlike some boxes which are called "decade" boxes.

When using the capacitor section the polarity of the electrolytic capacitors should be observed. With this particular unit both the resistors and the capacitors can be selected at the same time.

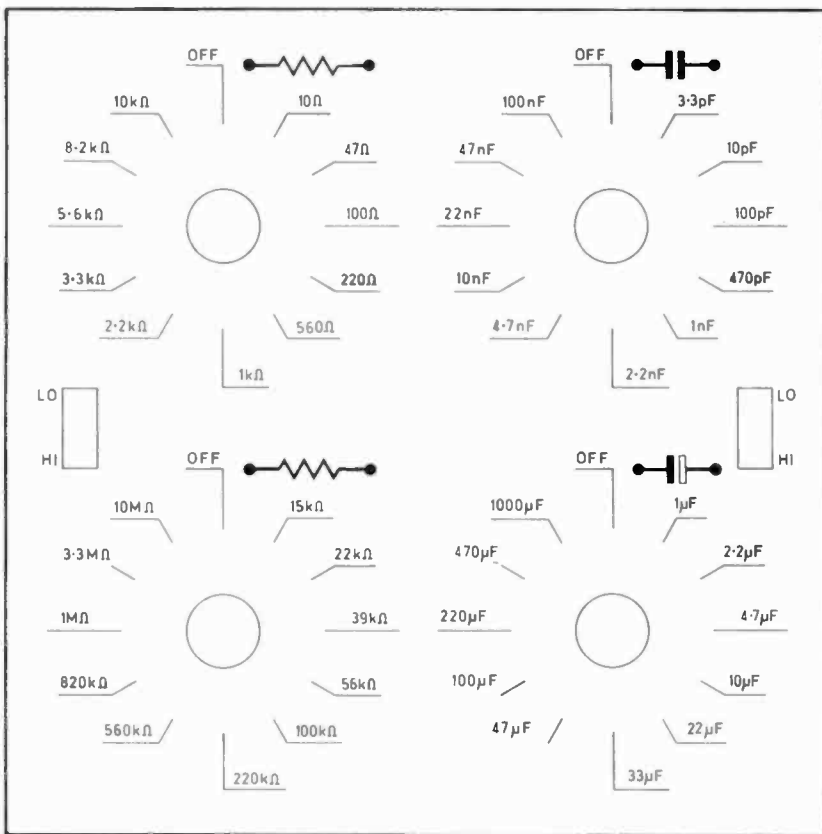

Fig. 3 Front panel layout shown full size.

design. The results will not be the same!

Follow the diagram in Fig. 2 and wire up the resistors first then the capacitors next. Be sure to identify the correct positions of

each, mistakes at this stage could be confusing when the unit is used. The remaining wires can then be soldered, leaving a generous length for connecting to the crocodile clips.

Once wiring has been completed the front panel may be traced or redrawn on stiff white card using the layout in Fig. 3. The general arrangement can be seen from the photographs.

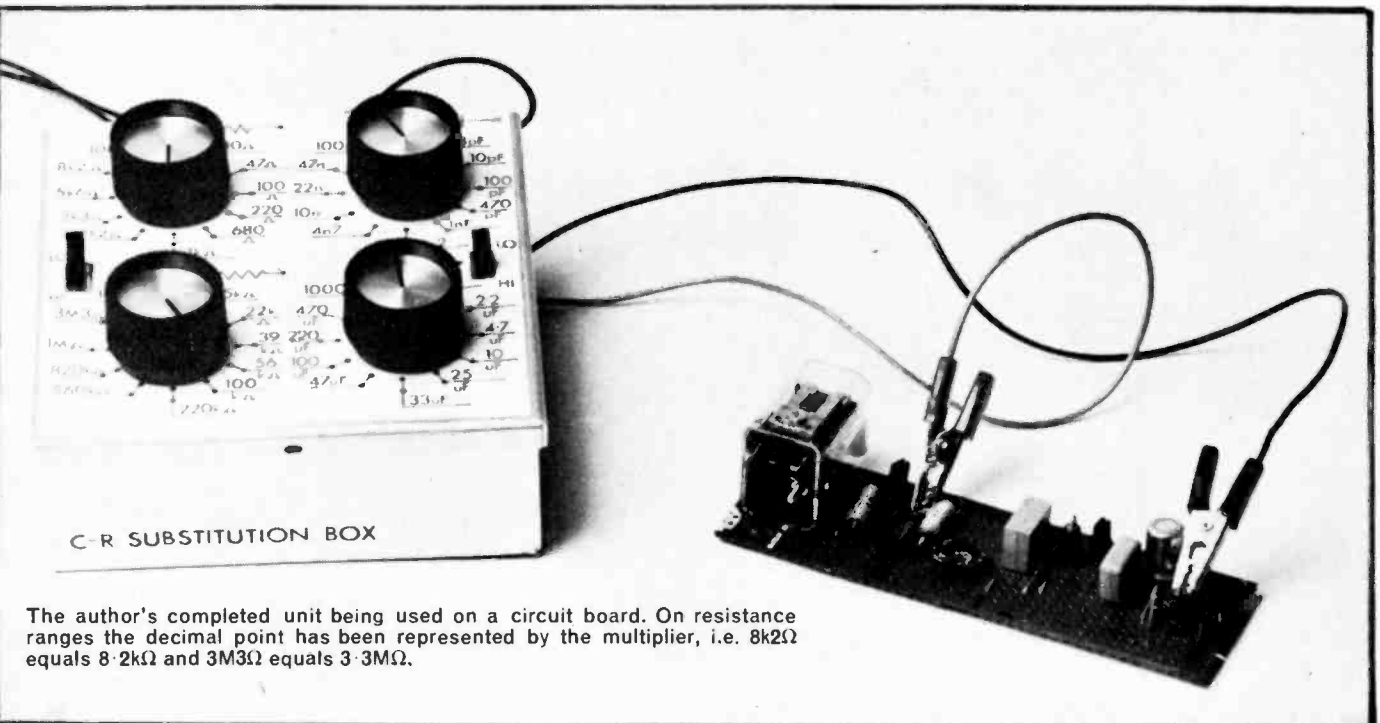

The author's completed unit being used on a circuit board. On resistance ranges the decimal point has been represented by the multiplier, i.e. 8k2Ω equals 8.2kΩ and 3M3Ω equals 3.3MΩ.

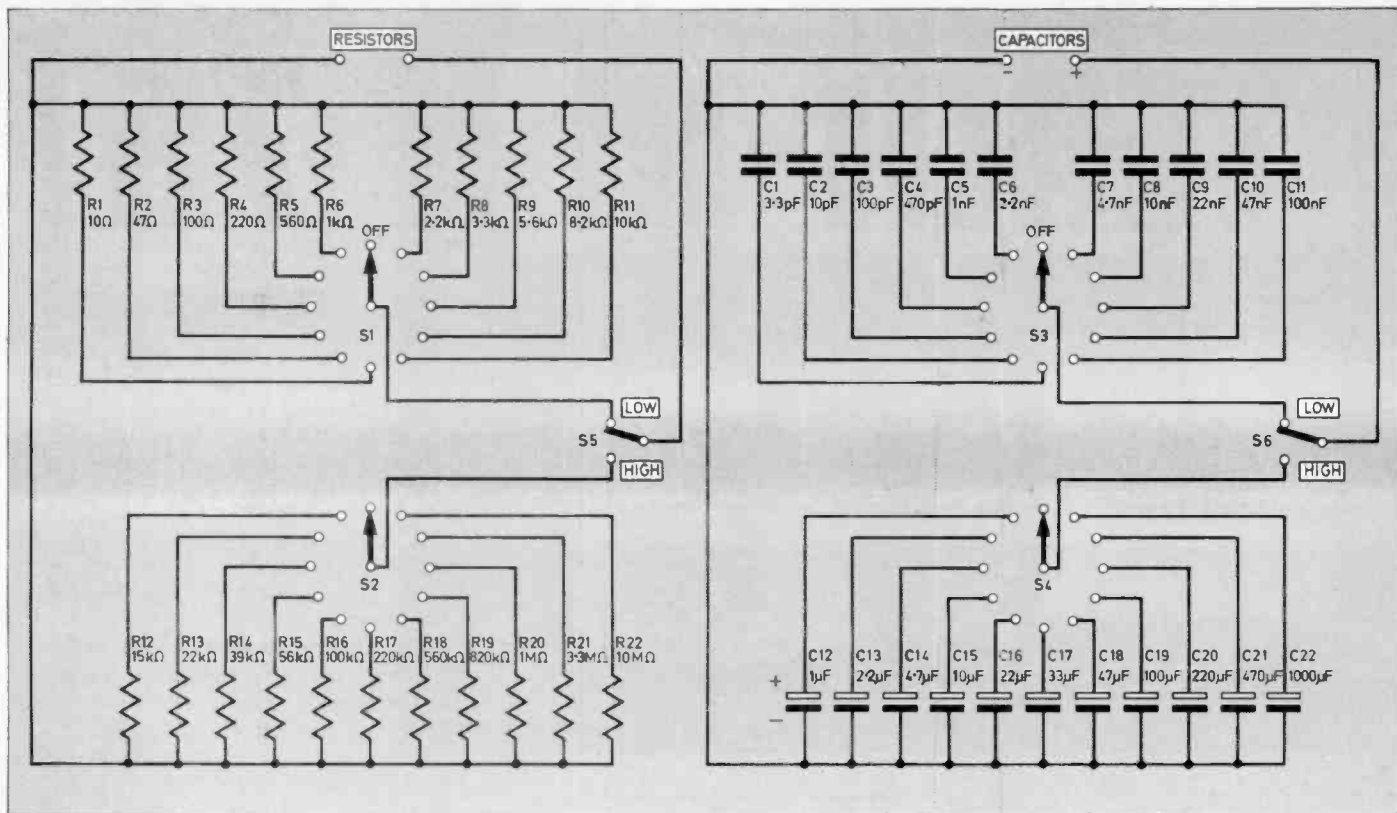

Fig. 1. Circuit diagram of the C-R Substitution Box.

Back of front panel showing wiring to range switches. Due to the size of some of the components it may be necessary to tilt them at an angle to fit into the area of the case.

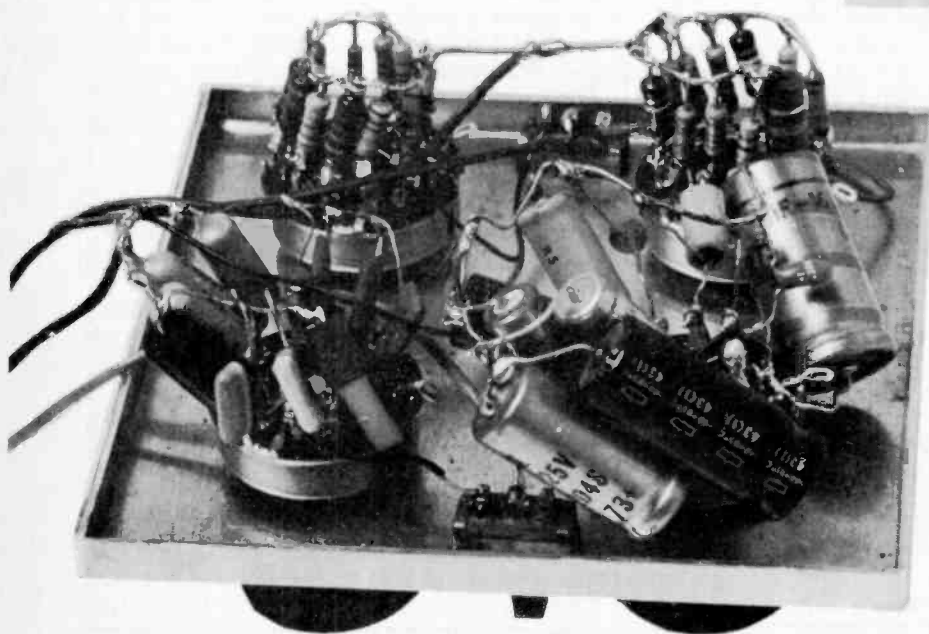

Table 1. R/C Ranges

	Resistors	Capacitors
Low	10Ω to 10kΩ	3.3pF to 100nF
High	15kΩ to 10MΩ	1μF to 1000μF

Ratings; Resistance— $\frac{1}{2}$ W \pm 5%
Capacitance—35 to 250V

OPERATION

The major uses have already been mentioned no doubt other uses could be found in time. Two important points should be noted. First the power rating, half a watt, of the resistors should not be exceeded. Secondly the voltage rating of the capacitors must be observed. In fact these two points should not cause any worry, since most of the circuits will probably be low voltage anyway.

Using the substitution box is very easy, just connect the clips into the circuit at the required point and set the switches to the required value, switch on the circuit and you're away! ☞

TEACH-IN

78

BY
GEORGE
HYLTON

Part
6

AMPLIFIERS — CONDUCTANCE — GAIN

AT THE end of last month the amplifier was introduced. So far in talking about amplifiers only *input impedance* has been discussed. This as you have found is most important when using amplifiers, so much so that the *matching* of one stage to another is very important.

These two qualities are of course very useful, but mean nothing if the gain is not known.

This then is our subject for this month, to measure the gain of a practical amplifier which can be built using various modules.

MATCHING

When people talk of *matching* a signal source to an amplifier they usually mean making the input impedance of the amplifier high enough, so that sufficient signal voltage is actually delivered to the amplifier by the source. Practical transistor amplifiers of the usual kind in which the emitter is earthed have input impedances from a few kilohms to a few hundred kilohms.

An alternative transistor connection in which the emitter is not earthed directly can have an input

impedance of several megohms, but no voltage gain. A field effect transistor, is one example.

Signal sources with very low internal impedances can be something of a problem, not because they are hard to match but because they usually deliver very small voltages. Transistors themselves generate small voltages in the form of electrical *noise* and these tend to interfere with small signal voltages. A typical example would be a microphone with an internal impedance of 30 ohms.

This might deliver only a few tens of microvolts. Fortunately the transformer comes to the rescue here. Remember that the voltage on the secondary can be different from the voltage on the primary. The two voltages are in fact in proportion to the number of turns. If the secondary has ten times the turns of the primary then the secondary voltage is ten times as great.

So 10 μ V from the microphone can in principle be increased to 100 μ V at the secondary Fig. 6.1. There is no need to stop at tenfold increase. In principle, any turns ratio can be used and therefore any voltage increase obtained.

Looking back from the amplifier into the secondary, the impedance seen is not 30 Ω of the microphone but something much greater. It is in fact 30 Ω times the turns ratio times the turns ratio again. So if a turns

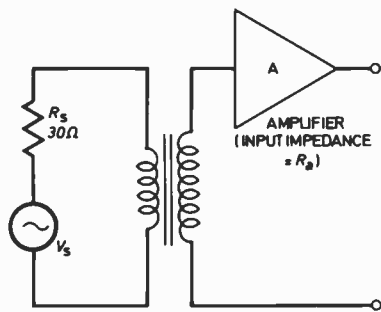

Fig. 6.1. Using a transformer, the output of a microphone, represented here by the generator symbol and internal resistance R_s , may be increased to a level dependent on the turns ratio of the transformer.

ratio of 10 is used to increase the signal voltage ten times the impedance is increased to $30 \times 10 \times 10 = 3000\Omega$. If the turns ratio were 100 the impedance would be increased $100 \times 100 = 10,000$ times.

It is this increased impedance which must be small compared to R_a . So there is a limit to the amount of step-up of voltage which can be used.

Similar considerations apply to the output end of an amplifier. There is a limit to the current and voltage which any particular amplifier can deliver. This determines the lowest load resistance which can safely be connected to the output. We shall look into this in more detail when we consider power amplifiers, but it is worth a quick look now.

VOLTAGE AMPLIFIERS

A common arrangement in voltage amplifiers Fig. 6.2a is to connect a d.c. load resistance R_1 through which the collector current passes. This current increases or decreases in sympathy with the signals being amplified. These variations in current produce a varying voltage drop in R_1 . In a.c. amplifiers such as audio amplifiers these voltage variations are the output signal. They are often separated from the steady d.c. voltage at the collector by a coupling capacitor C which allows a.c. signals to pass but blocks d.c.

The capacitor transfers the output voltage to some kind of d.c. load impedance, R_2 .

If R_2 is zero, there can be no voltage across it. If it is infinite, the voltage at the upper end must be the same as the voltage at the collector when there is no R_2 there. But what about real values of R_2 , in

between zero and infinity? To tackle this problem you need the right tools. In this case the tools are two ideas.

The first idea is about mixtures of d.c. and a.c. An amplifier, as we mentioned before, works by using the power of its battery to make enlarged copies of its input signal. The battery supplies d.c. The input signal is usually a.c. It is inevitable that d.c. and a.c. get mixed up in the process of amplification. But you are at the moment not interested in the d.c., but only in the a.c.

IDEAS

The idea you need to tackle this problem is that when mixed a.c. and d.c. flow in circuits which contain only resistance, inductance and capacitance the a.c. and d.c. have no effect on one another.

So you can forget about the d.c. and think only of the a.c.

The second tool is the knowledge that in a.c., which is periodically reversing its direction, the forward flowing bits contain the same average energy as the reverse flowing bits. What is true of the forward flowing bits, called positive half cycles, is equally true of the backward flowing negative half cycles, except that the direction of flow and polarity of voltage is reversed.

For the purpose of thinking about a.c. circuits you can concentrate on one half cycle, when the voltages, are positive, and think about the circuit in terms of d.c. polarities instead of reversing polarities. In effect you take a short exposure snapshot of the a.c., freezing its motion.

This may sound rather difficult, but you will see it is really quite easy when we apply these ideas to our circuit. We shall consider the transistor as a source of a.c. which flows out of the collector, through the circuit and back to the emitter. The directions of current and polarities of voltage are then as marked in the diagram

The current being a.c. can in effect pass through C so one path is via C and R_2 and so back to the emitter. The other is through R_1 . If it goes through R_1 it must still somehow find its way back to the emitter.

There is, in fact, an easy path via a component not shown on the diagram, the battery. Of course, the current has to flow backwards through the battery, but remember we are talking about a.c., not d.c. The battery offers such a low impedance to the a.c. signals

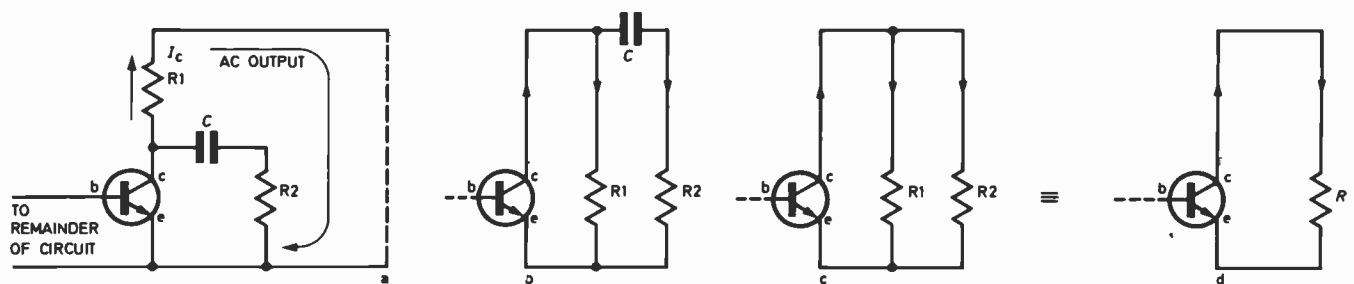

Fig. 6.2. The output from an amplifier is developed across resistor R_1 as in (a). Because the battery has a low impedance to a.c. the two resistors can effectively be connected together as in (b). Now as C is effectively a short to a.c. the circuit can be simplified as shown in (c). We now have the situation where R_1 and R_2 are in parallel at a.c. and the conductances add together.

that for practical purposes it is a short circuit, as shown by the dotted line. This connects the top of R1 to the bottom of R2.

So as far as a.c. signals concerned we can redraw the circuit as in Fig. 6.2b, but even this can be simplified. If C has a very low a.c. impedance it too can be effectively a short circuit to a.c. So we end up with Fig. 6.2c.

This last circuit is a great help to understanding. The transistor can be regarded as a device which pumps out a current. It is clear that this current must divide between R1 and R2. If R2 is small, most of the current goes through it, but the voltage across it is low. If R2 is large, most of the current goes through R1 and the voltage is something close to what it would be if R2 were not there at all.

If we are stuck with particular values of R1 and R2, and we need to know the output voltage we have to know something about combinations of resistances connected together at both ends, like these. These are called parallel connections, for the obvious reason that the current divides and follows parallel paths, one through R1 and the other through R2.

Earlier in the series it became clear from measurements in your RESISTOR CHAIN that resistances in series

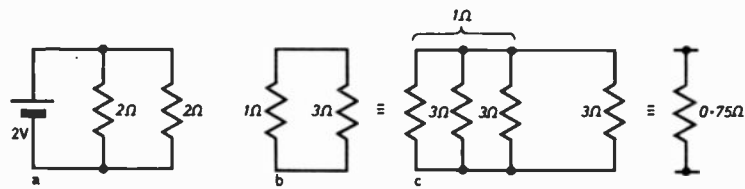

Fig. 6.3a. Two 2Ω resistors are in parallel, their total resistance is 1 ohm. Different values as in (b) can be thought of four resistors of the same value in parallel (c) giving the result as 0.75Ω.

just add together. This can not be true of resistances in parallel because by allowing more paths for the current to follow it can flow more easily. So the effect of connecting a resistance in parallel with another must be to *reduce* the resistance of the circuit as a whole.

CONDUCTANCE

Fortunately, though resistances in parallel do not add together, something else does. You can think of a resistance as something which conducts a current. A low resistance conducts current more readily than a high resistance.

If two resistances are connected in parallel then the conducting ability of the second is added to the conducting ability of the first.

The standard name for this conducting ability is **conductance**. So if you know the conductances of R1 and R2 you can add them to obtain the overall conductance of the combination. That is you can get a single quantity which takes both R1 and R2 into account. If this can be turned back into an equivalent resistance you are home and dry.

You can replace R1 and R2 by a single resistance R Fig. 6.2d, and Ohm's Law will then tell you what voltage is dropped across it by the current from the transistor. This must be the output voltage, since it appears at the right place in the circuit.

PARALLEL RESISTANCE

It turns out that the conductance of a resistance is just 1 divided by the resistance itself. The usual symbol for conductance is G. We can not use C because it is already used for capacitance. So in mathematical notation:

$$G = 1 \div R$$

If we have two resistances, R1 and R2,

$$G = 1 \div R1 + 1 \div R2$$

In fact you can have as many resistances in parallel as you like and add up all their conductances. To turn the total value of conductance back into its corresponding resistance you divide 1 by the conductance. That is:

$$R = 1 \div G$$

To take a simple example; what is the effective resistance of 10, 100 and 1000 ohms, all in parallel? The corresponding conductances are 0.1, 0.01, and 0.001 which add up to 0.111. If this is now divided into 1 it comes to 9, as near as makes no difference. So the net resistance is 9 ohms. Practical resistance values are often less easy to turn into conductances. If you have a calculator it is simple. If not you can use a parallel resistance chart.

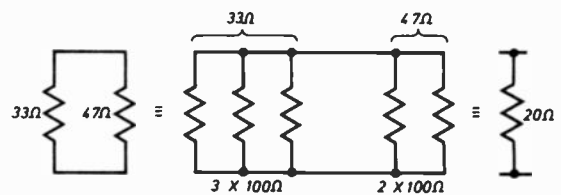

Fig. 6.4. Using an extension of the idea that odd values can be broken down into resistors of equal value. Here 33Ω and 47Ω resistors are connected in parallel. Each can be considered as so many 100Ω resistors. Using the method as found in Fig. 6.3c the answer is simply $100 \div 5$.

EQUAL RESISTORS

Fortunately it is often possible to find the equivalent of two resistances in parallel by a simple trick. The basis of it is the fact that if *equal* resistances are connected in parallel their equivalent resistance is very easy to find. Take a look at Fig. 6.3a.

Here a 2V cell is connected to two resistances each of 2Ω. The voltage across each resistance is 2V, so the current in each resistance is $2V \div 2\Omega = 1A$. The total is therefore 2A. If you apply 2V to a single resistance and 2A flows then Ohm's Law, which says that; Resistance = Voltage/Current, shows that the resistance must be 1Ω.

Evidently, since the voltage and current is the same in each case, your two 2Ω resistors in parallel are equivalent to one 1Ω resistor.

In the same way you can show that *three* equal resistances in parallel are the same as a single resistance of one-third the value of one of the individual resistances. Similarly four in parallel are one quarter, five one-fifth, and so on. So ten 100Ω in parallel are the same as one 100Ω divided by ten, i.e. 10Ω.

To use this to work out resistances in parallel, you mentally turn the lower resistances into parallel combinations of the higher ones. What is the equivalent

of 1Ω and 3Ω resistors in parallel? Fig. 6.3b. The 1Ω resistor can be thought of as three 3Ω resistors in parallel. The original 3Ω resistor thus makes up the fourth. So the circuit is equivalent to four 3Ω in parallel, which is $3\Omega \div 4$ or 0.75Ω .

This trick cannot *always* be used, because sometimes the resistance comes in odd values which do not lend themselves to simple arithmetic. But it works in most cases, especially if an approximate answer is acceptable.

For example, what is the equivalent of a 33Ω resistor and a 47Ω resistor in parallel? Fig. 6.4. These values look very awkward. But 47Ω is not far from 50Ω , and 50Ω is the equivalent of two parallel 100Ω resistors. Also, 33Ω is very nearly the equivalent of three parallel 100Ω . So altogether the circuit is the equivalent of five parallel 100Ω which is of course the same as one 20Ω resistor.

PRACTICAL AMPLIFIERS

Let us get back to amplifiers. Consider the simple practical amplifier circuit of Fig. 6.5. This is for a.c. voltages and uses one transistor, two capacitors, and two resistors. The capacitors are to block d.c. while

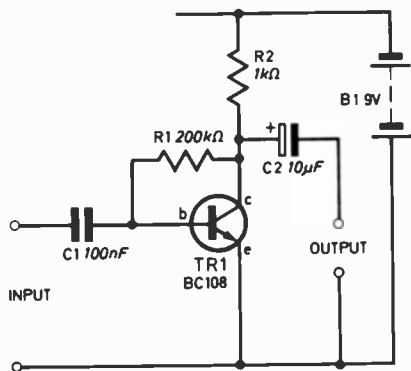

Fig. 6.5. A simple and practical amplifier circuit. This may be built using either of the NPN modules and the additional components shown.

allowing a.c. to pass. The transistor is turned on by a small current through the base, which flows via R1, often called the base bias resistor. It might seem more sensible to connect the top end of R1 to battery positive rather than to the collector.

However, the connection shown here has an advantage. The more base current flows, the more collector current flows. But the collector current flows through R2 and as it does so it produces a voltage drop. Because of this the collector voltage is less than 9V. So the voltage available for driving base current through R1 is less than 9V.

If for some reason the collector current increases the collector voltage falls, and this further reduces the voltage available to provide base bias current. The collector current therefore tends to stay put at something near its original value. The arrangement is in fact a form of negative feedback and tends to stabilise the collector current.

This is useful in counteracting the effects of temperature changes. More important, it helps the designer to get more consistent performance from transistors with different current amplifications.

At present, it is not possible to control the current amplification closely when transistors are manu-

factured. This is why your BC108 can have a current amplification of about 100 to 800. Some manufacturers restrict the "spread" of current amplification to some lesser range such as 120 to 450, and some divide their BC108 into three groups identified by letters A, B, and C. A usually signifies a current amplification of 125 to 260; B, 240 to 500; and C, 450 to 900.

The designer must take this variation into account. The bias system used here is a crude but useful way of reducing its effects.

A useful "rule of thumb" is to make R1 greater than R2 by the current amplification. For an amplification factor of 200, if R2 is $1k\Omega$ then R1 should be $200k\Omega$. This has the effect of making the collector voltage set itself to about half the battery voltage. So R2 drops about half the battery voltage. It follows that the collector current must be half the battery voltage divided by R2. With our values this means a collector current of $4.5mA$.

CALCULATIONS

In engineering shorthand the battery voltage is written as V_{cc} , the collector current as I_c and the current amplification as h_{FE} . So in shorthand form the rule of thumb can be written;

$$R2 = h_{FE} \times R1$$

$$I_c = V_{cc} \div 2R2$$

CALCULATING R1

Now build up the circuit of Fig. 6.5 using either of the two NPN modules. At this stage it does not matter which. Make temporary connections to R1. Short lengths of connecting wire with crocodile clips attached at each end will do.

For voltage amplification a collector current of about half a milliamp is suitable. The required value for R2 is then given by: $4.5V \div 0.5 = 9k\Omega$. The nearest preferred value is $10k\Omega$.

If the value of h_{FE} is 100 to 800, then R1 must be in the range $1M\Omega$ to $8M\Omega$. A reasonable compromise is $3.3M\Omega$, but with the aid of your VOLTAGE INDICATOR and RESISTANCE SUBSTITUTION BOX you can find a value which fixes V_{CE} as near as $4.5V$ as possible.

At the same time this enables you to deduce the h_{FE} value which is roughly $R1 \div R2$, if V_{CE} is $V_{cc} \div 2$. This is unlikely to give quite the same value as you measured in Part Four, but should be reasonably close.

Now repeat the experiment with the other NPN module. You will probably find that entirely different values are required for each module. In fact we found that we had to use a value for R1 of $1M\Omega$ for one of the modules, and $3.3M\Omega$ for the other, in order to get V_{CE} near to $4.5V$.

These values for R1 imply that the h_{FE} in each case is 100 and 300 respectively.

If you can not get close to $4.5V$ because one resistance in your RESISTANCE BOX is too high and the other too low, then use the lower resistance. Once the values for both modules have been found solder actual resistors in place on top of the modules.

A single stage amplifier like this will give a voltage gain of about 200. Quite a high gain but not enough for our purposes. What we are going to do is experiment with using loudspeakers and earphones in reverse, as microphones.

LOUDSPEAKER DESIGN

A loudspeaker such as your 80Ω one is an electro-magnetic device Fig. 6.6. A coil of very fine wire is attached to the back of the cone or diaphragm. This coil sits in the field of a powerful magnet. When a current is passed through the coil it sets up a magnetic field in the usual way. This field either assists or opposes the field of the permanent magnet, depending on which way the current is flowing.

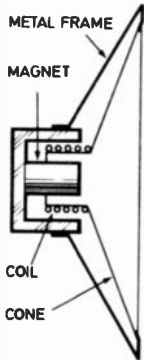

Fig. 6.6. Internal constructional details of a typical loudspeaker. Essentially a powerful magnet and a coil is used to reproduce electrical currents as sound waves.

The result is that the cone is pushed outwards for one direction of current and pulled inwards for the other. If the current is audio frequency a.c. the cone vibrates in sympathy with the current, and the resulting pressure on the air in contact with the cone is the beginning of a sound wave.

The device can also be worked backwards. That is, when a sound wave makes the cone vibrate, a voltage is induced in the coil.

If the loudspeaker is used as a microphone something else must be used to listen with. A crystal earphone could be used here.

If you connect the loudspeaker to the input and an earphone to the output of your single stage amplifier you should be able to hear something if a loud noise is made near the microphone e.g. by tapping it.

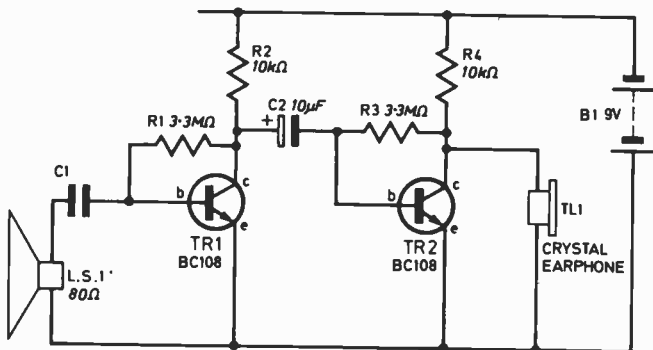

Fig. 6.7. In this circuit an extra stage is added to give more gain. This can be constructed using the two NPN modules. The resistors in the previous experiment being omitted.

Evidently more amplification is needed. This can be obtained by adding another stage of amplification Fig. 6.7. Since C2 blocks d.c. from the first stage it is not necessary to use a second capacitor for the other position. As a matter of fact it is not necessary to use an output capacitor for the last stage either. A crystal earphone does not allow d.c. to flow through. It is a capacitor itself.

So connecting it between the collector of TR2 and earth does not upset the d.c. conditions. A loudspeaker or a magnetic earphone would pass d.c. and rob the transistor of collector voltage. If you use a magnetic earphone it must either be connected between collector and battery positive or an output capacitor must be used. But only a high impedance earphone will be of any use.

The usual 8 ohm types supplied with the transistor radios are no good. Large old fashioned ones from headphones are generally satisfactory.

Make the two stage circuit of Fig. 6.7 and experiment with it. You will probably notice a number of things. First, the amplification is much greater. Secondly, you hear a buzz, especially if you touch the wires of C1. Thirdly, the quality of the sound is poor. Fourthly, after a sudden loud noise the amplifier goes silent for a while.

MAINS HUM

The buzz is "mains hum". You might think that the mains has no place in a battery operated amplifier. However, minute mains frequency currents flow all over the house. When you touch the input terminal of the amplifier, mains hum is induced into your body and flows to earth.

On its way via your finger to earth it passes through the input of the amplifier, setting up a small voltage which thereby gets amplified to produce the hum.

It sounds more like a real humming noise in amplifiers whose speakers can reproduce very low frequencies. What you hear from your amplifier is mostly "harmonics", that is multiples of the mains frequency which get manufactured accidentally in various ways.

The distortion arises partly from the fact that neither your microphone nor your earphone is hi-fi. Each reproduce some frequencies better than others. Speech and music, which are mixtures of frequencies, do not sound natural. Undue emphasis of particular frequencies is called *colouration* of the sound.

WAVEFORMS

The jangly quality of loud sounds is also due to distortion of quite a different kind. The amplification is now so great that the a.c. from TR1 passing into the base of TR2 is greater than the d.c. base bias current in TR2. Fig. 6.8.

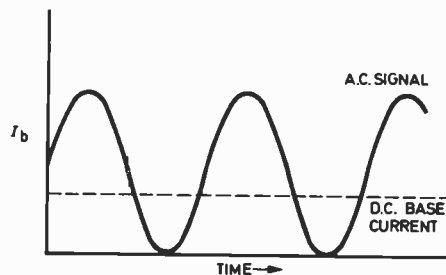

Fig. 6.8. Waveform obtained from the collector of TR1. Here the amplification is so great that it is larger than the base bias on TR2.

During one half cycle, say the positive half cycle, the a.c. and d.c. combine to make TR2 pass more collector current. But during negative half cycles a point is reached at which the a.c. just cancels the d.c. Fig. 6.9.

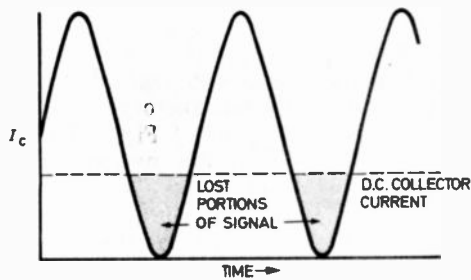

Fig. 6.9. We now have a situation where the a.c. collector current of TR2 is so large that any further increase is just cancelled out by the d.c. collector current.

At this instant the base current is zero so the collector current is zero. Any further negative swing of the a.c. can have no further effect. You cannot reduce the collector current to less than zero. The result is that the tips of the negative half cycles do not get reproduced at all. They just get flattened. This kind of distortion, called **peak clipping** is an example of **overloading**. The amplifier is being fed signals too big for it to handle.

On tests carried out with the amplifier, an oscilloscope was connected to the output. The resultant waveform which appeared on the screen was not a sine wave, or even clipped sine wave as shown in Fig. 6.9 but a *symmetrically* clipped sine wave: Fig. 6.10.

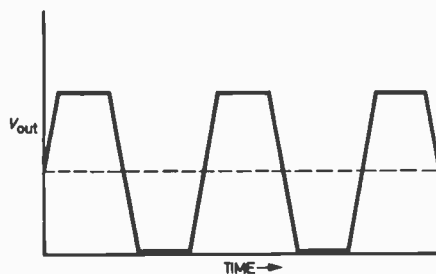

Fig. 6.10. The idea of overloading can be extended further when both positive and negative peaks are clipped resulting in the waveform shown here.

Why is this? Well, the overloading can only explain the cutting-off of collector current by the tips of negative half cycles of base signal current. Positive tips merely make the collector current increase. The solution to the problem lies in following this through to its logical conclusion. The current increases. What happens to the collector *voltage* when it increases?

If the collector current increases, the voltage drop in the $10k\Omega$ collector load resistance increases. More of the battery voltage is used up in the $10k\Omega$ resistor. The collector voltage *falls*. Now, the circuit is set up so that with no signals the collector sits at half the supply voltage, that is, 4.5V. The voltages can only

fall to zero. Any further attempt to increase the collector current can have no effect on the collector voltage. Once all the battery voltage is used up in the resistor the collector can only remain at 0V.

We are in a familiar situation, peak clipping occurs. Only this time it is on the other peaks, so, we end up with double peak clipping.

OVERLOADING

Overloading is also the explanation of the silent periods which follow sudden large input signals. There is evidently a **time constant** at work somewhere and one component likely to be associated with it is the $10\mu F$ capacitor. If this somehow gets charged up by a strong signal so that its negative plate makes TR2 base so negative that TR2 is cut off, the amplifier stops working. When the $10\mu F$ discharges sufficiently, TR2 comes on again and the amplifier works once again.

The fact is that $10\mu F$ is too large a capacitance, if you change it to $100nF$ ($0.1\mu F$) you will find that the silent intervals disappear.

MEASUREMENT OF GAIN

Just how much voltage gain does the two stage amplifier provide? You can make an estimate by exploiting positive feedback. An amplifier like this with two stages each of which has its emitter earthed is non-inverting. Feedback from output to input is positive. If the amplifier has a voltage gain of 1000, then feeding back 1/1000 of the output will just make it oscillate.

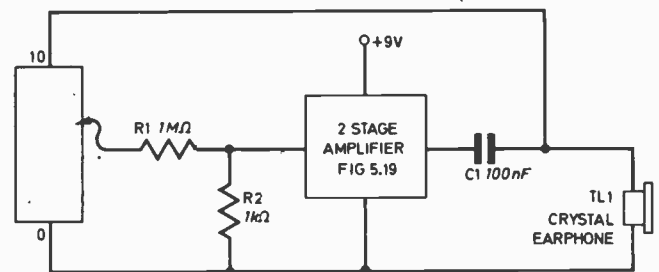

Fig. 6.11. Using the amplifier of Fig. 6.7 and the RESISTOR CHAIN, the gain can be measured by utilising ratios.

If you feed back the output of your amplifier through a voltage divider, and set the division ratio so that the circuit just oscillates then the ratio gives the gain.

A double divider Fig. 6.11 enables the ratio to be varied in a known way. The overall division is the product of the two divisions, that is the first one times the second, the second gives a ratio of about 1000.

The RESISTOR CHAIN gives ratios from 1 to 10. So, overall, ratios of 1000 to 10,000 are obtainable. Our amplifier oscillated (producing a rasping noise) with the RESISTOR CHAIN tapped at points 2 and above, but not on point 1. This indicates that the gain is over 5000 (tap 2 gives a division ratio of 5) but under



10,000 (tap 1 is 10). This was with a crystal earphone. If you use a magnetic earphone it may greatly reduce the effective load on TR2 and so reduce the gain.

You can connect it between the top of the $10k\Omega$ and battery positive to avoid this. The amplifier gives quite a respectable gain, but should it not be higher? We said that a *single* stage amplifier should have a gain around 200. On this basis two similar stages should give $200 \times 200 = 40,000$, which is a lot more than the measured gain.

UNKNOWN IMPEDANCES

What has gone wrong? A careful inspection of the circuit shows us that there are several examples in it of impedances which are in parallel in just the right way to reduce the gain. First the RESISTOR CHAIN, which has an impedance of $10k\Omega$, is in parallel with the $10k\Omega$ load of TR2 Fig. 6.11. This reduces the effective load to $10k\Omega/2 = 5k\Omega$ and halves the output voltage.

The part of the RESISTOR CHAIN between the tap and earth is "shunted" by the $1M\Omega + 1k\Omega$ divider. The input impedance of TR1 (i.e. between input and earth) is in parallel with the $1k\Omega$ resistor, reducing its effective resistance and therefore increasing the division ratio to something over 1000. The input impedance of TR2 is in parallel with the $10k\Omega$ load of TR1.

Since we do not know the input impedances of the transistors we cannot estimate their effect on gain. One thing we do know about (the values of the RESISTOR CHAIN resistances and the $1M\Omega$ and $1k\Omega$ resistors) should tell you, without bothering to do any sums, that the effect of the $1M\Omega + 1k\Omega$ on the RESISTOR CHAIN ratio is negligible, because very little current will be taken from the RESISTOR CHAIN by the $1M\Omega$ resistor. If our original guesstimate of 40,000 was

right, then the effect of the RESISTOR CHAIN across the $10k\Omega$ load brings down the gain to 20,000 and the other factors must reduce it to less than half this.

Later, when we explore the characteristics of transistors in more detail, you will be in a better position to estimate the effects of their input impedances. Let us leave it for now, and do some more experiments. First, substitute your $100k\Omega$ POT for the two voltage dividers, R1 and R2 and see how the frequency of oscillation varies as the knob is turned.

Disconnect the POT and connect the amplifier input terminal to the positive of the battery.

Do you hear anything? Can you think why the circuit is behaving as it does?

Next month we shall continue with amplifiers and discuss some of the more important parameters to be considered when designing amplifiers.

QUESTIONS

- 6.1. A transistor collector load resistor drops 3 volts. The voltage gain of the transistor is about;
 - a. 30
 - b. 120
 - c. 300
- 6.2. A transistor has an h_{FE} of 100, and an I_c of $100\mu A$. Its a.c. input resistance is approximately;
 - a. $25k\Omega$
 - b. $10k\Omega$
 - c. 250Ω
- 6.3. Noise is thermally generated in;
 - a. inductors
 - b. resistors
 - c. capacitors
- 6.4. A gramophone pickup delivers $10mV$ to a pre-amplifier which then drives a power amplifier. If the power amplifier needs $300mV$ to produce full output, the gain required in the pre-amplifier is;
 - a. 10
 - b. 30
 - c. 300
- 6.5. A TV film crew is filming a speaker at a conference from the back of the hall. The sound recordist combats the noise of the audience by;
 - a. using a directional microphone
 - b. increasing the amplifier gain
 - c. inserting a sharply tuned filter

ANSWERS (To part five)

1. positive (a)
2. a voltage or e.m.f. (b)
3. L and C in series (b)
4. all the field of one passes through the other (c)
5. very low (a)
6. 1.33Ω (c)
7. 220 (a)
8. 48Ω (c)

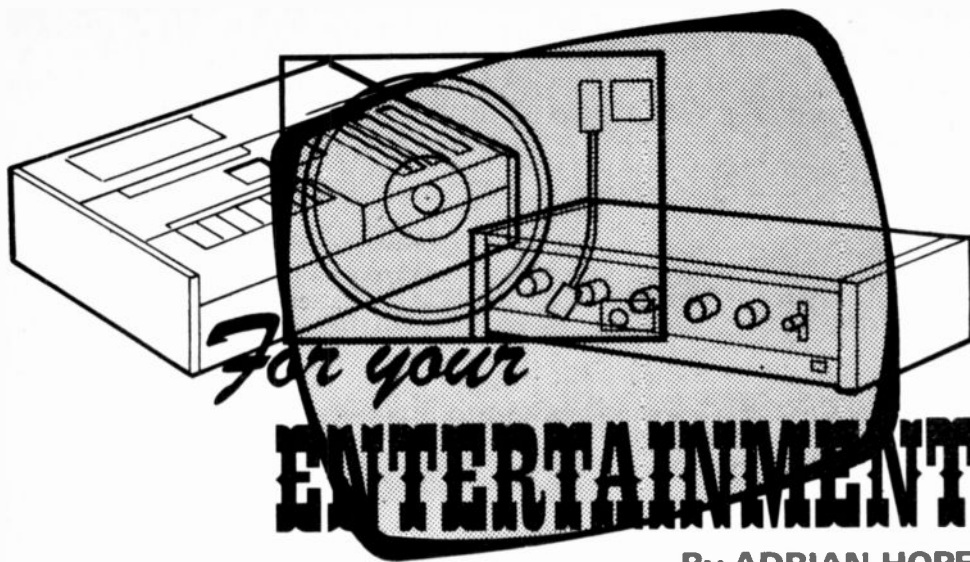

By ADRIAN HOPE

Pioneers

IN THE field of audio electronics the work of two pioneers has quite shamefully been underestimated, misunderstood and misinterpreted.

It was in 1933 that Major Edwin Armstrong of Columbia University invented and patented the principles of modern f.m. radio. He demonstrated multi-channel multiplexing just a year later. But it wasn't until the early Sixties, some five years after Armstrong's suicide, that f.m. and stereo multiplexing was authorised in the U.S.A.

Likewise, EMI engineer Alan Blumlein never really saw the fruits of his 128 patents in action. Whereas Armstrong died of frustration, in 1954, Blumlein was killed by an accident in 1942. The Halifax bomber in which he was testing the H2S radar system that helped win the War crashed in the Wye Valley and all on board were killed.

Armstrong's life and work is publicised by the Armstrong Memorial Research Foundation at Columbia University in New York City. But no such "official" body has ever sought recognition for Blumlein in the U.K.

Blue Plaque

The situation has, however, changed recently for the better, due mainly to the enthusiasm of Blumlein's official biographer, F. P. Thompson, who encouraged the Greater London Council to commemorate Blumlein's last London home at No. 37 The Ridings, Ealing, with a traditional blue plaque. The official unveiling was followed by a ceremony sponsored by Blumlein's original employers, EMI.

The ceremony took place almost to the day 35 years after his death, and ten years after the publication in the June 1967 issue of *Electronics and Power* of an article by engineer, B. J. Benzimra. This article meticulously

researched and tabulated all 128 of Blumlein's patents, and probably triggered all the current interest.

Stereo Quad

Of these, British Patent No. 394 325, which was filed in 1931, is perhaps the most significant, for it laid the foundation to all modern stereo sound. Every stereo record in the shops today has its left and right channels cut in the single groove as suggested by Blumlein.

In January 1934 the invention was put into practice at EMI's Abbey Road studios when Sir Thomas Beecham took time out of a mono recording session to let the young Blumlein make a test version of some sections in stereo. Sadly, these historic recordings have never been issued or made public, although some are now in the hands of the British Institute of Recorded Sound in London, who may well play some at public demonstrations.

It's fascinating to see how even now, despite the flurry of interest that came with the unveiling of the Blumlein plaque in the centenary year of recorded sound, the man's work still continues to be underestimated and misinterpreted. In April the *Telegraph Magazine* was censured by the Press Council for belittling Blumlein by suggesting that his work was so secret that no one had ever heard of him and that there was thus comedy in the idea of erecting a blue plaque to such a man.

Then, in his speech at the official unveiling of the plaque, Sir Alan Hodgkin perpetuated an erroneous myth which has passed into audio folklore. Referring to the recent quadrasonic broadcasts made by the BBC, Sir Alan spoke of Blumlein's original stereo work and suggested that "Not only did his patent specification

refer to the invention of stereo: it also included an outline of quadrasonic and ambisonic techniques."

In fact, although Blumlein paved the way to such modern techniques as the NRDC's Ambisonics surround sound system, by describing sum and difference techniques of signal handling, Blumlein did *not* specifically invent and describe "quad". But with the text of the speech released by EMI and quoted *verbatim* by newspapers round the world, Blumlein is now assured a place in history as the inventor of quad.

It's ironical, because it's probably one of the few aspects of modern audio that Blumlein didn't invent.

Television Games

The price of television tennis, football, shooting and race games is now dropping like a stone, just as the price of calculators plummeted once the basic chips had been developed and put on the market for manufacturers to incorporate in their own brand name machines.

In a previous column we warned about the risk of buying too early and thus spending too much on a t.v. game, and personally I have no doubt that the price of games will drop further as more and more new chips and games are developed. Already programmable games are on sale, which makes the basic style seem very tame.

Another development soon will be devices which connect with an audio tape recorder, (cassette or reel-to-reel) and enable you to take part in pre-taped sports, such as racing and target shooting, complete with a soundtrack of advice, sound effects and music.

But, sorry to be a wet blanket, here's another word of warning. Do beware of tube burn. I have talked with several t.v. engineers and without doubt there is a risk of damaging the cathode ray tube of a t.v. set if a game puts a fixed field pattern on the screen for hours on end at high brilliance and contrast. And, of course, this is just what might happen during the school holidays.

Because the beam current of a colour set is fairly low, there is less risk likely with a colour t.v. than with a black-and-white set. And there is least risk of all with a colour game that puts a single colour field pattern on a colour t.v. screen, because this way the beam current is reduced even further.

But if you use a black-and-white game with a black-and-white set, don't play on the same static field pattern for too long. Change for instance from ping-pong to football and back again every quarter hour. And reduce brilliance and contrast, using the set controls.



Do you think you have fast reactions?

Test yours against opponents with this easy to build reaction game.

By R.A. Penfold

CATCH A LIGHT

INTRODUCTION

MODERN electronics readily lends itself to the production of simple but amusing games, many of which could not be accomplished using more traditional materials. The electronic game described below is for two players and is a competitive test of their reaction speeds.

GAME BASICS

A set of six lights forms the basis of the game. These are arranged in the pattern shown in Fig. 1, and have been numbered in the diagram for the convenience of this explanation.

The game begins by one player throwing a switch, which causes lights 3 and 4 to blink on and off at a rate of several times per second. As one light turns on, the

other switches off. After a few seconds this process ceases with one light remaining on and the other turned off.

Each player has two push button switches, one player's switches operating lights 1 and 2, and the other player's switches operating

lights 5 and 6. If, for instance, light 4 remains on at the end of the blinking process, the two players must try to switch on whichever of their lights is nearest to light 4 by depressing the appropriate push buttons.

If the player operating the upper set of lights manages to get lamp 2 on first, he is the winner of that round. There can be no argument as to who is the winner, as once a player turns a light on, the light at the other end of the row is blocked and cannot be switched on until the winning light is extinguished.

There is obviously no effective way of cheating at this game, since to do so it would be necessary to anticipate both the end of the blinking period and the random matter of whether light 3 or 4 is the one which will remain on at the end. The game is thus purely a test of the skill and reaction speeds of the two players.

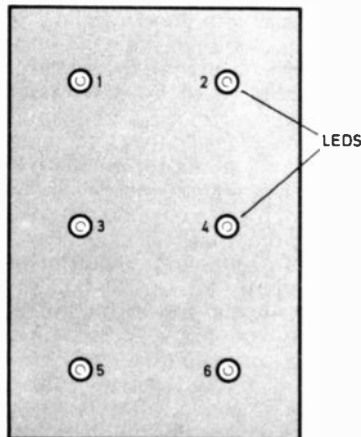

Fig. 1. Layout of the light emitting diodes on the front panel.

MULTIVIBRATORS

The winking light part of the circuit is based on two forms of multivibrator circuit, the astable and bistable types. The basic circuit diagrams of these two types of multivibrator are shown in Figs. 2a and 2b respectively.

ASTABLE

An astable circuit operates in the following manner. When the supply is initially connected both transistors will receive base currents and will begin to turn on. Due to inevitable circuit imbalances, one transistor will begin to turn on faster than the other. For the sake of this explanation we will assume that TRa turns on faster than TRb. As TRa turns on, a negative signal will be fed via C_a to the base of TRb. This will hold TRb in the off state while base current via R_b turns TRa hard on.

When TRa is turned fully on, no further signal will be developed at its collector and transmitted to TRb base via C_a . The charge across C_a will quickly die away and as TRb now starts to receive base current via R_c , it begins to turn on. As it does so, a negative signal is fed via C_b to the base of TRa, thus turning TRa off. This sends a positive pulse to the base of TRb by way of C_a , quickly turning TRb hard on in the process. As a result of this regenerative action TRa now becomes turned off and TRb becomes turned on.

The charge across C_b then quickly dies away and this process continues with both transistors continuously changing state.

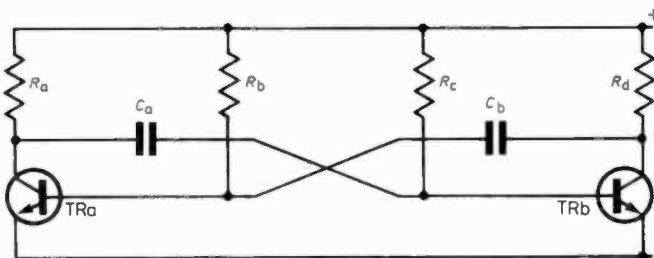

Fig. 2a. Basic astable multivibrator circuit.

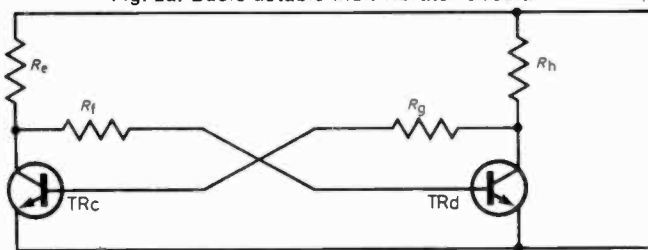
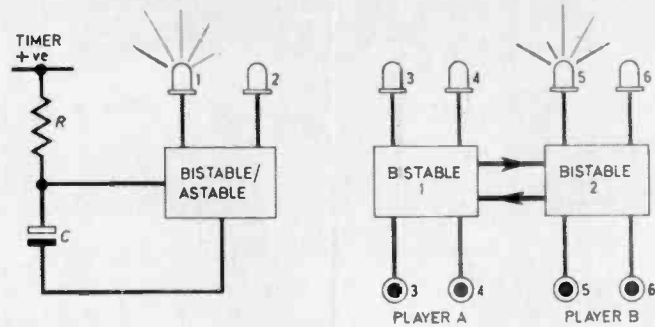

Fig. 2b. Basic bistable multivibrator circuit.

HOW IT WORKS



A simple timing circuit consisting of R and C provides a variable timing period to the combined bistable/astable. This part of the circuit produces random flashing of two l.e.d.s. At the end of each period this circuit will stop and only one l.e.d. will remain illuminated. Whatever l.e.d. remains on, either 1 or 2, the players press their switches corresponding to that l.e.d. In the case shown this is 3 or 5.

As one switch is pressed, say 5, the associated l.e.d. illuminates, at the same time the bistable "latches" on in one state thus preventing the other l.e.d. from turning on. Due to the "cross coupling" between the two bistables, the other bistable is prevented from turning on.

Thus the circuit indicates which player has "caught the light" first.

BISTABLE

A bistable operates in a similar manner, except that as it is d.c. coupled it latches with one transistor turned off and the other turned on. Referring to Fig. 2b, when the supply is initially connected both transistors will begin to turn on, and again one will turn on faster than the other at the outset. If, for example, TRc begins to turn

on faster than TRd, TRd will be starved of base current as the collector potential of TRc quickly falls. TRc on the other hand, will be able to draw plenty of base current from the collector of TRd and in consequence it will quickly turn hard on. In doing so it completely starves TRc of base current, and the circuit will rest with TRc turned on and TRd turned off.

The completed Catch-A-Light reaction tester.

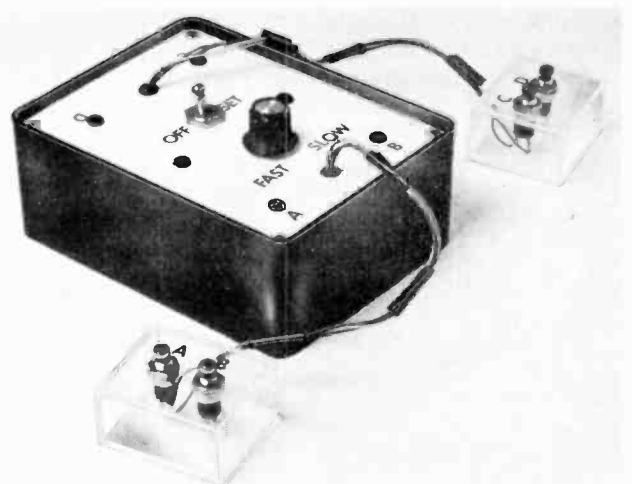

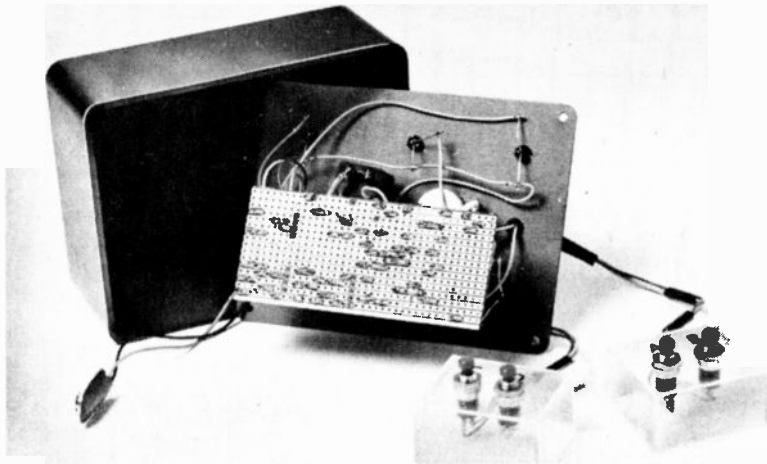

Rear view showing the circuit board mounted on the front panel.

WIRING

The final wiring of the unit is also shown in Fig. 4. The component panel is positioned behind D2, D5 and D6, with its component side facing the front panel. Thick insulated single strand wire (about 16 to 18 s.w.g.) is used to connect the panel to VR1 and S1, and provided these leads are kept as short as possible they will provide a firm mounting for the panel. The rest of the circuit can then be wired up according to Fig. 4.

To avoid mistakes, use a different colour connecting wire for each switch when wiring in S3 and S5, and also when connecting S2 and S4. These are connected to the main unit by leads about 20cm long. It is advisable to fit the front panel holes for these leads with grommets if a metal panel is used.

The battery fits beneath D1 and D3, and some foam rubber can be used to hold it in place more firmly if it is found to be at all loose.

START HERE FOR CONSTRUCTION

Begin construction by cutting a 16 strip width of 0.1 inch matrix Veroboard from a 3.75 inch length of board, using a hacksaw. Then referring to Fig. 4, make the 14 cuts in the copper strips, and solder in all the components, leaving the transistors until last. The components are fairly closely spaced and care must be taken to avoid short circuiting adjacent copper strips with blobs of excess solder.

With the exceptions of the push button switches and battery, the remaining components are mounted on the front panel of the case. The author used an inexpensive plastic case having a steel front panel, but any case of a similar size (130×100×50mm) should be suitable.

Two small cases are used to house the push button switches, one box for each player's switches. A couple of commercially made plastic boxes are used on the prototype, but if suitable ready made boxes cannot be obtained, suitable containers can be made

from wood or aluminum. The containers do not even have to have a full six sides, and can be very basic.

Components

Resistors

R1	10kΩ	R10	27kΩ
R2	4.7kΩ	R11	2.7kΩ
R3	2.7kΩ	R12	2.7kΩ
R4	68kΩ	R13	27kΩ
R5	68kΩ	R14	27kΩ
R6	68kΩ	R15	2.7kΩ
R7	68kΩ	R16	2.7kΩ
R8	2.7kΩ	R17	27kΩ
R9	10Ω		

All resistors are carbon $\frac{1}{4}$ W \pm 5%

Potentiometer

VR1 100kΩ Lin.

Capacitors

C1 100μF 10V elect.
C2 2.2μF 10V elect.
C3 2.2μF 10V elect.

Semiconductors

TR1, 2, 3, BC109 silicon *npn* (3 off)
TR4, 5, 6, 7 BC108 silicon *npn* (4 off)
D1 to 6 TIL209 red light emitting diode (6 off)

Miscellaneous

S1 d.p.d.t. standard toggle switch
S2 to 5 push to make, release to break push switches (4 off)
B1 PP3 9V battery
Stripboard 0.1 inch matrix 37 holes by 16 strips; battery clip; case type M3 or similar size, 130mm×100mm×50mm; two small boxes to suit S2 to S5; small round knob; grommets as required; connecting wire; mounting clips for l.e.d.s (if not supplied); solder.

See
**Shop
Talk**
page 342

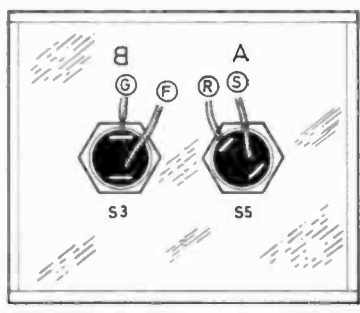
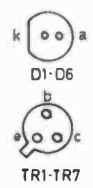
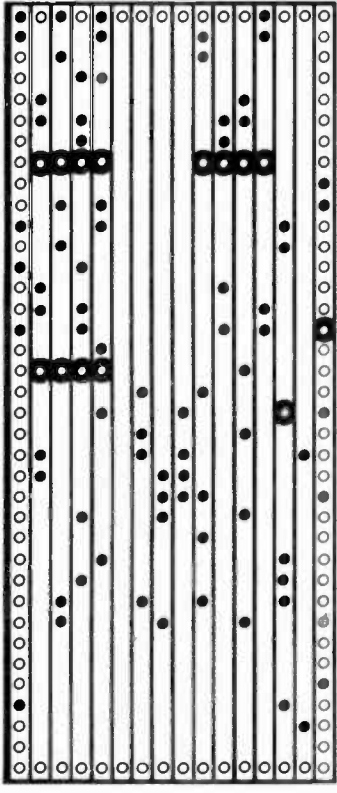
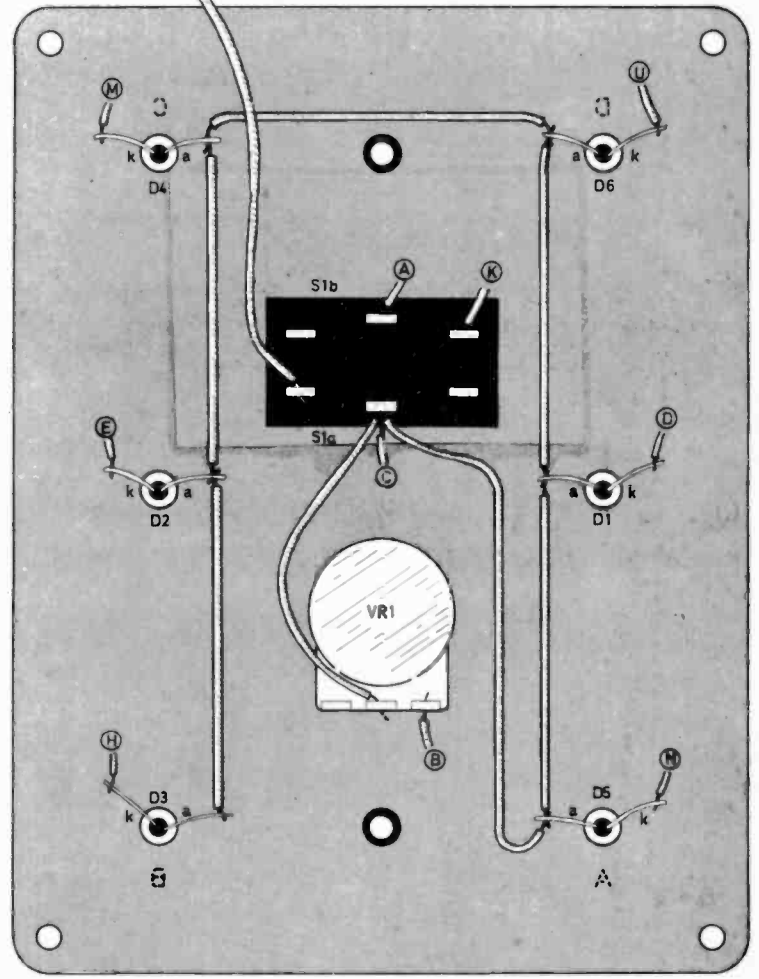
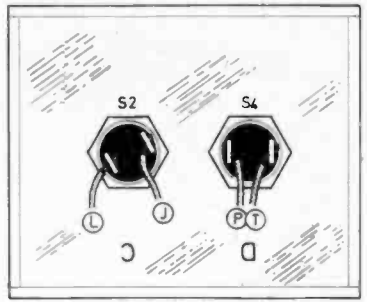
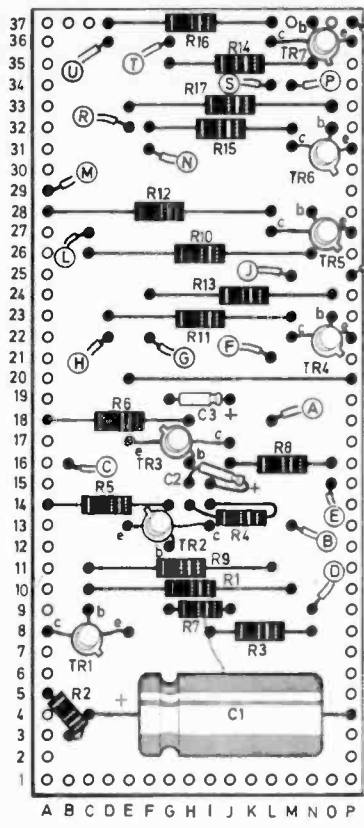

Fig. 4. Interwiring details, component layout and underside of the stripboard showing breaks in the copper tracks. Wires from the reaction switches and front panel mounted components should be connected to their corresponding letters on the circuit board.

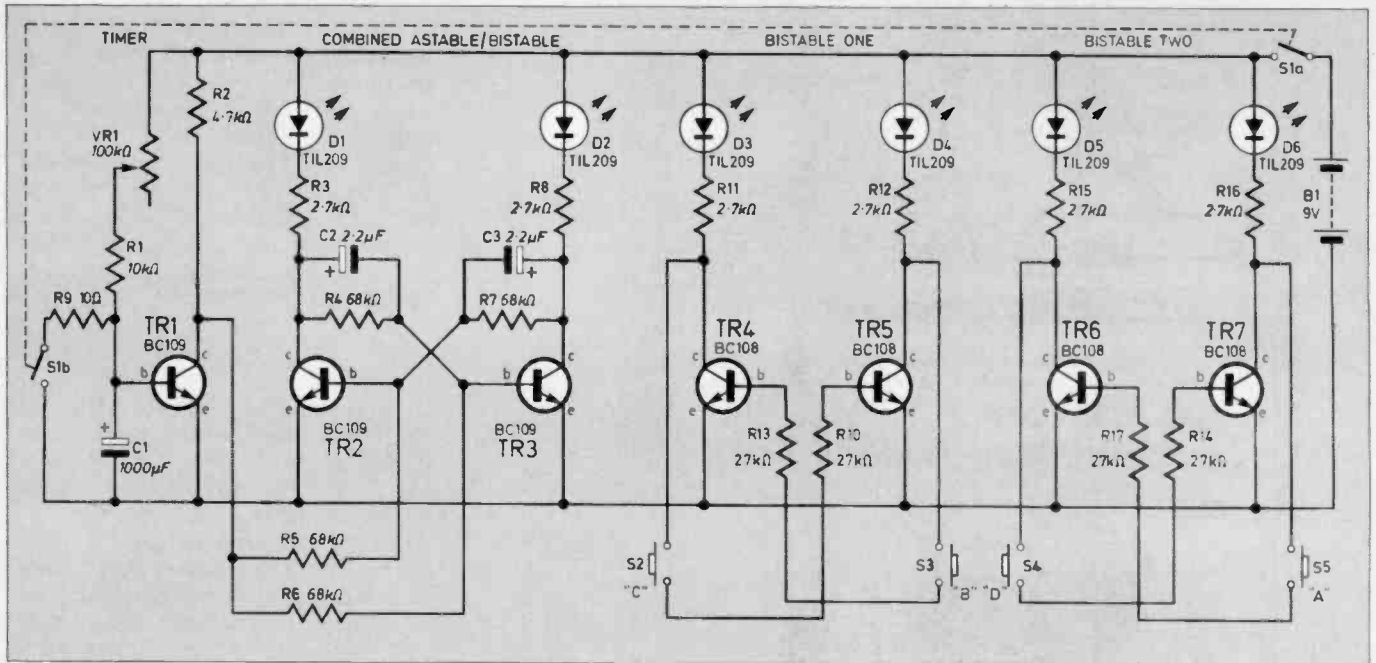

Fig. 3. The complete circuit diagram for the Catch-A-Light.

CIRCUIT DESCRIPTION

The complete circuit diagram of the reaction game appears in Fig. 3.

Transistor TR1 is used as a time switch, and when the supply is connected C1 charges via R1 and VR1. Normally there is virtually the full supply voltage at TR1 collector, but when about 0.6 volts is developed across C1, TR1 will turn on and its collector voltage will fall to almost zero.

BIAS

For the period that TR1 collector is high, TR2 and TR3 will operate as an astable multivibrator with base bias current being provided via R2, R5, and R6. Resistors R4 and R7 have no significant effect on the circuit yet.

As TR2 and TR3 repetitively turn on and off, their l.e.d. loads, D1 and D2, will flash on and off. When TR1 turns on, the base bias via R2 is cut off and the circuit will no longer operate in the astable mode. It will, instead, operate as a bistable multivibrator with R4 and R7 providing the cross

coupling. These cause the circuit to latch in whichever state it was in when the bias was removed.

For instance, if TR2 is on and TR3 is off when the bias is removed, bias current flowing through R7 will hold TR2 in the on state while TR3 will be unable to receive any base current from TR2 collector and so remains off.

Thus, when the supply is turned on, D1 and D2 will flash on and off for a few seconds until TR1 turns on, whereupon the oscillation ceases with one of the l.e.d.s remaining on.

TIMING

The timing period can be varied from about 2 to 12 seconds using VR1. It is largely a matter of chance whether it is D1 or D2 which remains on at the end of the timing period, but with VR1 at any given setting the circuit is likely to be imbalanced in favour of one or other of these. Altering the timing period at the end of each

round using VR1 helps to iron out this imbalance, as well as making it more difficult to estimate and anticipate the end of the period.

PRECEDENCE CIRCUIT

Two identical bistable circuits form the remainder of the unit. These ensure that only one winning light can come on at one time, and one bistable is used for each row of lights.

In practice, D3 and D4 are mounted at opposite ends of the display (positions 1 and 5 in Fig. 1), and one player has S2 while the other has S3. If S2 is pressed, base current will flow from the positive supply to TR5 via D3, R11, and R10. Transistor TR5 will turn on and D4 will light. If S3 is now depressed, as TR5 collector is at almost the same potential as the negative supply rail, TR4 can receive no significant base current via R13 and D3 will not light. The circuit is extremely fast in operation, and the moment one push button is depressed the other is blocked.

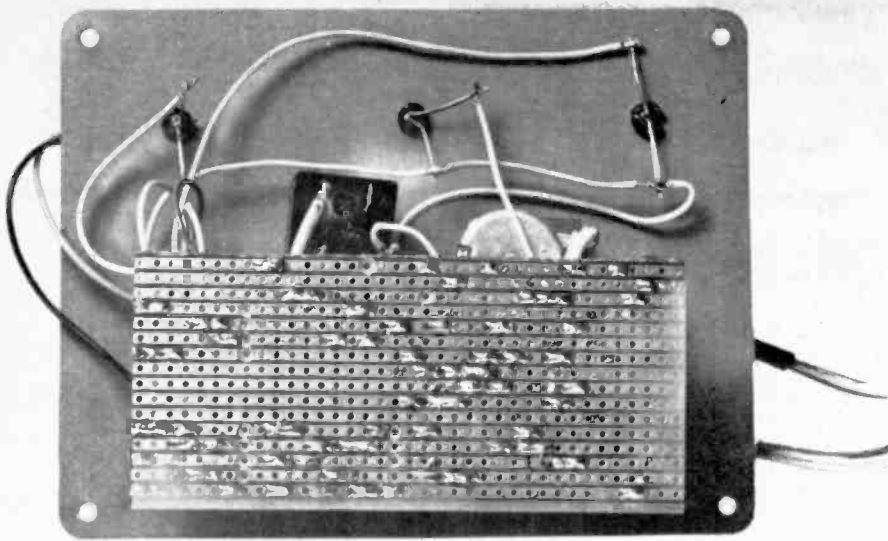

Close-up of the rear of the front panel.

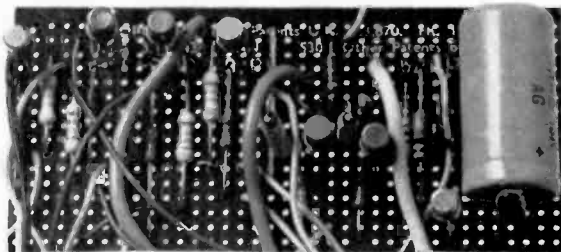

Top view of the circuit board showing component layout.

IN USE

To start the unit it is merely necessary to switch S1 into the *on* position. At the end of the round S1 is put back in the off position, and C1 will then almost instantaneously discharge through S1b and current limiting resistor, R9. After the setting of VR1 has been altered, the unit is then ready to be turned on again and another round played.

A simple method of playing a game using the unit is to have the first player to score 10 points as the winner. One point is scored for each round that is won, and a point is deducted in the event that a player either pushes the wrong button or pushes both at once.

An element of luck can be introduced into the game by having additional points scored by players betting on which light they think will remain on at the end of each round.

The precedence switch part of the circuit could be used as a quiz monitor, and the other part of the circuit a sort of electronic heads or tails, and could possibly have uses in other games. □

YOUR FREE TOOL RACK

Presented Free with this issue is a very useful item to have in the workshop. How many times after you have finished working on your latest project, put your tools down and walked away, only to discover that when you return the tools have grown legs and vanished. A tool rack solves this problem, by having the tools mounted in an easy to see quick to find position.

As received the EVERYDAY ELECTRONICS Tool Rack is flat, before using therefore it must be folded to the correct shape.

With the Tool Rack on a flat surface and the lettering facing you, bend up at an approximate angle of 45 degrees, the five locating strips. Next bend up the bottom half to meet the strips, at the same time pushing the lugs on the strips into the slots provided and lock them in position by pushing the lugs back.

Do this operation with all five strips, and your tool rack is then ready for use. The photographs should make this clear.

It can be mounted in any convenient position using small screws. A half-inch number 8 wood screw would be ideal. Once the tool rack is mounted the tools can be put in, and is then ready for use.

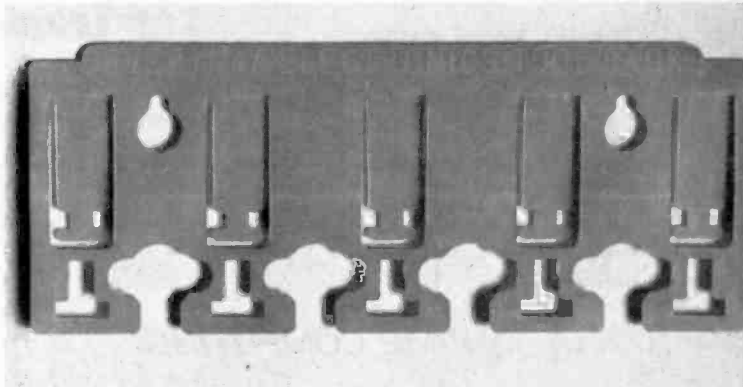

Everyday News

EXPLORE THE WORLD OF SCIENCE

To those familiar with the layout of the Science Museum in London, there have been a few changes just recently. The latest being the conversion of the ground floor Electric Power Gallery into an Exploration exhibition illustrating some of the ways in which scientific and technical skills are being used to explore the world and beyond.

The exhibits include the actual *Apollo 10* spacecraft that completed a moon orbit in 1969, a full size reconstruction of the *Apollo 11* moonbase (with additional "Keep off the MOON" signs so necessary to stop children of all ages from 'stepping boldly'), a lifesize model of a manned submersible and an EMI brain scanner in simulated working operation.

Electronics play such a vital part in the modern world it is good to see this exhibition, which is on for at least three years, depicting so clearly the use to which it can be put, from remote sensing where we can look at familiar objects at wavelengths outside the range of our own eyes and truly see the world in a new light, to earth-based radio telescopes and orbiting observatories.

Each section has its own story to tell, and audio visual aids are everywhere including several video-taped displays. The museum staff are to be congratulated on this exciting and well presented exhibition which is proving so popular.

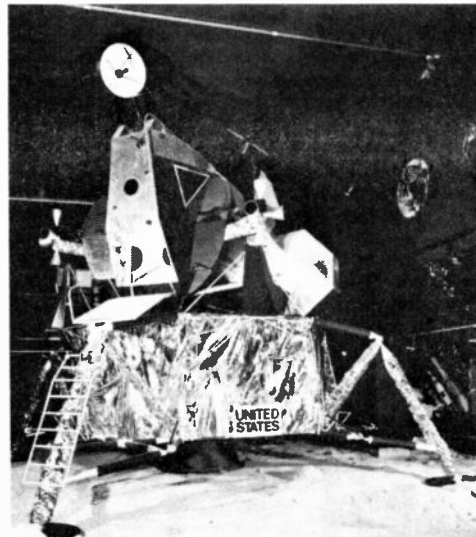

Full scale model of Apollo Moon Lander, on display in the Exploration Gallery. (Science Museum Photo.)

Britain's largest computer company, ICL, is now gaining more than half its revenue from exports. Total turnover is now running at over £400 million a year, a 45 per cent increase over the previous year and pre-tax profit is up 31 per cent. All this despite restriction on output through labour disputes.

HOME COMPUTING

The popularity and some idea of the tremendous growth of home computing was demonstrated at a recent seminar in London.

The seminar, entitled "Home Computing", was organised by Lynx Electronics Ltd and was a complete sell out. Such was the popularity that they had to expand the accommodation to take 550 people who turned up on the day.

The final line-up of specialist guests who agreed to speak set a standard that would be very hard to better, be it hobbyist or professional. In order of appearance the guests were: Gary Tysoe of Mostek; Jim Ayres

The 240Hz "song" of the early Marconi rotary spark gap transmitter was heard once again on the air waves during a week of commemoration of the first two-way transatlantic radio messages achieved by Marconi and his assistants in 1903.

of Harrow College of Technology; Phil Pittman of Zilog; Phil Cooke of Sussex University and Tony Rundle of Compeda.

The seminar was given to commemorate the launching of the Nascom 1 Microcomputer Kit. This kit is built around the Mostek Z80 CPU and includes a full keyboard, 1K EPROM which provides eight basic operator commands including single step and a 2K RAM.

The kit has interfaces for connecting to a domestic TV as a monitor, a domestic cassette recorder for data storage and a teletype. The price of the kit is £197.50 (excluding VAT).

Transatlantic Radio Messages

Amateur stations on the original sites at Poldhu, Cornwall, and Cape Cod, Massachusetts, gave thousands of amateurs throughout the world the opportunity of "working" the historic sites. The control operator at Cape Cod, Robert J. Doherty, re-

ceived special permission to reproduce by audio means the famous Marconi sound on his c.w. transmissions.

The amateur stations also operated on single sideband R/T, radio teletype and slow-scan t.v., all unknown techniques 75 years ago.

Signing Off

Over 50 million QSL cards (exchanged by radio amateurs to confirm contact) have been handled during the 38 years Arthur Milne, G2MI, and his wife have been running the QSL bureau for the Radio Society of Great Britain (RSGB) which currently has 20,000 members.

Arthur Milne has now retired and the new manager of the QSL Bureau is E. G. Allen, G3DRN, 30 Bodnant Gardens, London SW20 0UD.

Marine Call

Radiotelephone calls through the Post Office v.h.f. maritime radio service have increased more than tenfold in ten years. Annual calls are now 200,000 a year compared with 17,000 ten years ago.

In the same period the number of small coastal craft fitted with R/T has risen from 1,500 to 8,000, much of the increase being attributed to safety-conscious leisure yachtsmen and boat-owners.



—ANALYSIS—

MICROS AND JOBS

MICROELECTRONICS in general and microprocessors in particular are putting employment at risk. Today's electronics revolution, so technologically sweet, can be socially very sour indeed.

This was one of the messages emerging from the Impact of Electronics conference organised recently by our contemporary, "Electronics Weekly".

The consumer benefits are plain to see. Jack Akerman, managing director of Mullard, reminds us that the domestic radio set of 1936 cost about £13 when a Morris Minor car cost about £100. Today the equivalent radio still costs £13 while the cost of a Mini is about £2,000. Electronics has never been better value.

The Social cost, however, is highlighted by Kenneth Corfield, chairman and managing director of STC. Modern techniques like l.s.i. and p.c.m. have reduced equipment switching size in telephone exchanges by a factor of 15.

This means smaller buildings, less work for the building industry as well as those manufacturing exchange equipment. The present generation of electronic exchanges has reduced direct operatives in manufacture by a factor of 2.6 and the next generation will reduce labour by a further factor of 10:1.

The vice-president of Siemens, W. Germany, Dr. Alfred Prommer, reinforces the argument by pointing out that modern technology has reduced the cost of producing a single component in an integrated circuit by a thousandfold with a corresponding decrease in manpower required for its production.

And Alex d'Agapayeff, chairman of Computer Analysts and Programmers, referring to the broader impact in commerce and industry, suggests that it is inevitable that 2½ million people will endure substantial changes in their jobs and that 1½ million jobs may actually be lost through the application of microelectronics.

Have we, then created a technological monster which threatens to destroy our society? Not at all, provided we all recognise the challenge and abandon complacency.

Electronics has and can enrich our lives. But clearly we shall have to accept and adapt to change in work habits and attitudes if we are to continue to enjoy the riches yet to come.

Brian G. Peck.

The 13th Appleton Lecture delivered in the IEE lecture theatre had the title 'Solid-state devices and the age of indolence'.

Olympics TAMED

The new television centre in Moscow, now under construction for world coverage of the 1980 Olympic Games, will be equipped with Marconi Instruments Television Automatic Monitoring Equipment (TAME).

TAME will monitor all incoming signals from the competition areas and all twenty outgoing programme channels. Picture quality is continuously checked on 24 parameters.

AWARD

The 1977 Royal Television Society Southern Centre Award has been won by Mr. P. A. Crozier-Cole for his contribution to the development of the Independent Broadcasting Authority's Regional Operations Centres. For four years he has been project manager leading the team of engineers whose work is recognised by this award.

The RTS Southern Centre Award is given annually for the most significant contribution to television during the year in the Southern Centre area. It is not confined to the engineering field.

COMPETITION

The "Young Engineer for Britain 1978" competition has now been launched and is organised by PETT (Project-Engineers and Technologists for Tomorrow).

Regional competitions are scheduled for August, followed by the national final. This year's prizes include Concorde flights to the USA and visits to American engineering projects and a spacecraft centre.

One of last year's winners was 14-year-old electronic hobbyist Matthew Tonks with an ingenious integrated circuit test set.

Details of this year's competition can be obtained from the Secretary, PETT, Department of Industry, Room 114, Abell House, John Islip Street, London SW1P 4LN.

The US-based company, Teradyne, has sold \$25 million worth of laser-trimming equipment to thick-film microcircuit manufacturers in the past six years.

The recently appointed Assistant Managing Director, Post Office Telecommunications, John Harper, builds radio equipment as a spare time occupation. In his new job he has special responsibilities for business planning and system efficiency.

Farnborough Air Show

The giant Farnborough Air Show, a shop window for avionics, is already fully booked by exhibitors. The exhibition areas have been re-designed for the 1978 show and will be larger and higher, allowing complete aircraft and space vehicles to be displayed under cover.

A quarter of a million visitors are expected to visit Farnborough International '78 which runs from September 3-10. The general public will be admitted only on the three public days September 8-10 when a full flying programme will also be staged.

Deer Wins First Prize

The ninth Scotch Wildlife Sound Recording Contest attracted over three hundred entrants with top prize and Sound Recordist of the Year title (plus equipment worth £500) going to Keith Biggadyke, seen below, for his chance recording of "Muntjac Deer and Nightingale".

He and other winners were recently presented with their prizes by Lord Alec-Douglas Home in the plush surroundings of the Hilton Hotel, London.

The annual competition is open to amateur tape recordists whose task it is to capture on tape cassette or spool, the sounds of British Wildlife. Entry forms for this year's contest, with first prize valued at £1,000 are available from Scotch tape retail outlets.



SQUARE

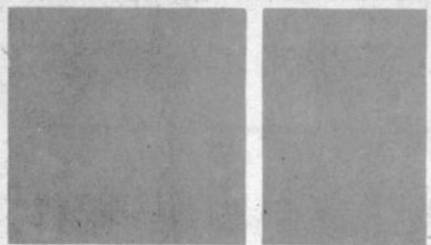

ONE

...FOR BEGINNERS

WE ARE HERE TO HELP YOU -

**NO MATTER HOW NON-TECHNICAL
YOU MAY BE, JUST READ ON!**

THE HOUSING SITUATION

Thanks to miniature components and low power requirements, many electronic projects can be accommodated in quite small cases or housings.

Constructors have always been enterprising when it comes to providing a suitable case for some project. Tobacco and mustard tins, even baking tins, have all been pressed into service over the years! More recently, the large variety of cast-off plastic receptacles for all kinds of products have been seized upon by constructors and put to good use.

CUSTOM BUILT

While not decrying these inspired efforts at improvisation, we recommend the use of "custom-made" cases wherever possible. This implies, generally, commercial products, yet does not exclude home-made cases in metal or even wood.

No matter how simple the project, it is possible to finish it off in style. Metal and plastic containers designed expressly to house electronic equipment are available in considerable variety—and even in a choice of colours. So every home-built unit can have a professional look.

Our constructional articles show and specify all the mechanical details, including recommended cabinets or cases, where applicable.

We say "where applicable" because certain projects intended to be used in association with other equipment or apparatus can usually be installed within that equipment without any special housing for the unit itself. For example, the *Electronic Touch Switch* (January '78).

Where projects are designed for incorporation within other equipment,

obviously we cannot provide exact details regarding the installation, the interwiring and the drilling of holes for controls and so on. The builder has to think this out for himself.

The greater majority of projects are, however, entirely enclosed within their own box or case. This is generally desirable. It is mandatory for portable or hand-held units—and is necessary also for safety reasons in many instances where the electronic unit is permanently installed in position. Electronic projects for motor cars, for example.

PLASTIC OR METAL

Plastic cases are a boon to the amateur constructor since they can be obtained in a variety of styles, sizes and even colours. They enhance the appearance of the finished project. Plastic cases are generally tough enough for the environmental hazards we normally have to take into account.

For exceptionally hazardous situations a metal housing might be better.

Burglar Alarms and power controllers are examples where the greater security afforded by a sheet aluminium or a die-cast box might be beneficial.

Great ruggedness, rigidity, and resistance to fire are not the only advantages offered by metal housings. There is the important consideration of electro-magnetic screening.

Some electronic circuits *must* be enclosed within a metal container in order to prevent either the radiation or the pick-up of electro-magnetic signals. Such extraneous signals may affect the proper operation of electronic equipment or cause interference on radio, TV, or audio equipment.

HOME-MADE CASES

With the wide selection of plastic and metal cases to choose from, the incentive to build one's own case has largely vanished. But for those who like working with metal or wood, the opportunities are still there.

The construction of metal cases requires certain skills and tools—and will appeal to a specialist minority.

Wood is a more commonly handled material. In fact wood was one time extensively used for home-made cases and cabinets. Modern timber materials with or without some plastic cladding are readily available in variety, and offer a solution for anyone proficient in woodworking.

Examples of projects using wooden cases are not very common nowadays, but as it happens one does appear this month, see the *Audiotest*.

CHOOSE WITH CARE

EVERYDAY ELECTRONICS projects are presented in full detail, right through to the housing stage. Suitable cases are specified in the articles, but the individual can use his own initiative and employ something different of course if he wishes.

However, if a metal case is specified there will be a good reason for this, and a plastic (or wooden) case should not be used as a substitute without due regard to the possible consequences.

Conversely, should a metal box be contemplated in place of a specified plastic (or wooden) case, remember that proper electrical isolation of all circuit components and wiring from the metal case is vital.

If in doubt, always stick to the kind of case specified in the articles.

NEXT MONTH

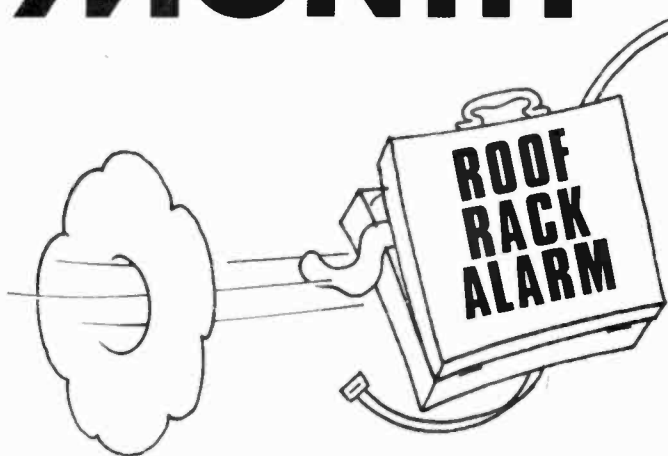

Have you ever been frightened at the state of the load on your car roof rack? If so set your mind at rest with our simple design.

MAINS DELAY SWITCH

This timing circuit can be used with TV's, radios, tape recorders etc. With the option of a remote control the uses are endless.

POCKET TIMER

A portable unit for indicating elapsed time from a few seconds to several hours. Ideal for use in games, the kitchen and as a parking meter reminder.

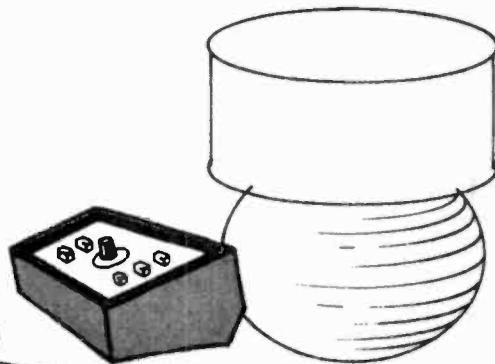

*Special Feature
Popular Circuits*

A selection of proven designs of varied application. Something for everybody!

Everyday ELECTRONICS

APRIL
ISSUE ON SALE
FRIDAY, MARCH 17



By Brian Terrell

New products and component buying for constructional projects.

Printed Circuit Boards

In last month's issue of *EVERYDAY ELECTRONICS* you will have noticed that two of our constructional projects, *Chaser Light Display* and *Stereo/Mono Lead Tester* use printed circuit boards as the basis of construction as was the case with the *Automatic Phase Box* in the December issue.

Although details of fabricating home-made p.c.b.s were included in each of these issues it is felt that certain constructors may not wish to get involved in this and may prefer to obtain the p.c.b.s ready etched and drilled. The use of p.c.b.s in constructional projects is known to be in the minority as opposed to stripboard and other general purpose boards, but it is surprising to find no firms advertising such a service to readers. So advertisers (or would-be-advertisers) how about it? We feel sure it will be well received by our readers.

The two sizes of Flip-Top Box from Vero.

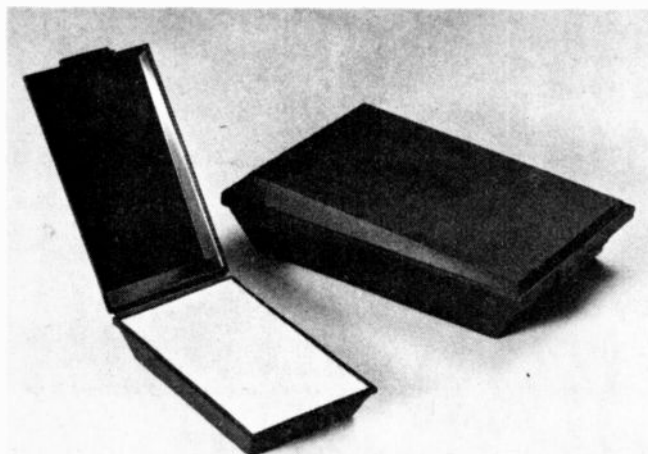

New From Vero

A new addition to the Verobox range of small plastic enclosures has recently become available. Known as the Flip-Top Box, it has a unique flip-over hinged cover to protect panel mounted items.

The cover, hinge and base are moulded in one piece of polypropylene and has a textured matt exterior. An aluminium alloy panel is supplied with the enclosure which clips in and requires no fixing bolts or screws. The inside of the enclosure contains pillars, integrally moulded to facilitate horizontally mounted components boards. Six self-tapping screws are supplied for this purpose.

The boxes are available in two sizes, 130 x 75mm (pocket size) and 196 x 127mm and there is a colour choice in both sizes—black or yellow.

The cases will find many uses and are ideal for keyboard units, field test equipment etc. Across the counter prices are £1.92 and £2.50 excluding VAT and are available from the usual Vero stockists.

Ultrasonic Transducers

As constructors will no doubt have found, there are very few suppliers to the amateur market of ultrasonic transducers. We are pleased to inform readers that Ace Mailtronix, Tootal Street, Wakefield, West Yorkshire can supply a pair of ultrasonic transducers at a cost of £4.00 including VAT and post and packing. This is a very good price and we believe it to be the lowest.

The transducers known as type 7505 are a suitable replacement for the RL400P as used in the *Ultrasonic Remote Control System* featured in the November and December 1977 issues of *EVERYDAY ELECTRONICS* (all issues sold). Ace Mailtronix tell us that they can supply a set of electronic components to build this project and can supply a priced component list for this project on the receipt of a stamped self-addressed envelope. Also they can supply a photostat copy of the article at a cost of 25p per part.

The company extends this service to all other constructional projects featured in *EVERYDAY ELECTRONICS* from the October 1977 issue onwards, see their advertisement in this issue. For components they are unable to supply, they will advise constructors of competitive sources of supply. An invaluable service to the constructor—especially the beginner!

Logic I.C. Stickers

Users and designers of circuits embodying πL integrated circuits will be pleased to hear of an ingenious aid, called *STICKIES*. These are self-adhesive printed labels—same size as i.c.s—and show pin-outs for 61 of the most popular 74 series of integrated circuits, both 14 and 16 pin.

The labels are peeled from a master sheet and then positioned on the upper body of the i.c. thereby giving instant recognition of pin function, see photograph. They can be used for constructing and de-bugging prototypes, and useful in fault location. Another application is evident when designing printed circuit and other component board layouts.

These *STICKIES* are available in sets of 450 and come complete with comprehensive instructions. The cost is £2.80 for one sheet containing 450 labels with discounts on quantities, and can be obtained from Concept Electronics, (Dept. EE.), 8 Bayham Road, Sevenoaks, Kent, Tel: Sevenoaks 514110.

Constructional Projects This Month

No buying problems should be experienced when getting together the components for the *C-R Substitution Box*. The types of capacitors specified are those that appeared in the author's model, but these are not critical and can be of any composition that may be available. Attention should be paid to the working voltages however, since these will limit its application. The

A *STICKIE* in position on an integrated circuit.

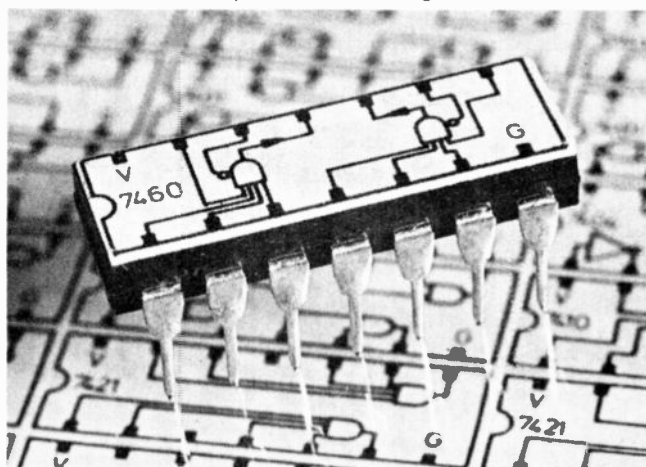

voltage ratings should, if necessary, be raised to be compatible with the voltage levels in the equipment likely to be used with the unit.

A d.p.d.t. slide switch is specified although only a s.p.d.t. version is called for as the latter type is unavailable.

All the components for the *Weird Sound Effects Generator* are available from a number of sources and should present no problems. The silicon *pnp*

transistors specified may be unfamiliar to some readers and were chosen since they are complements to the BC108. However, any silicon *pnp* type may be substituted if more readily available. A suitable replacement is the 2N3702, but remember that this has a different pin configuration to the BC178.

The "heavyweight" project this month is the *Audiotest* and a few components may prove difficult to

locate. These are the 10 watt resistors, the 350pF variable capacitor, and the ferrite beads. All of these components are listed in the Maplin catalogue. Also, the 10 watt resistors are stocked by Marshall's. Both of these suppliers' addresses can be found in the advertisement pages of *EVERYDAY ELECTRONICS*.

All components required to build the *Catch-A-Light* are available from a number of sources and should present no buying problems.



CROSSWORD NO1

BY D.P. NEWTON

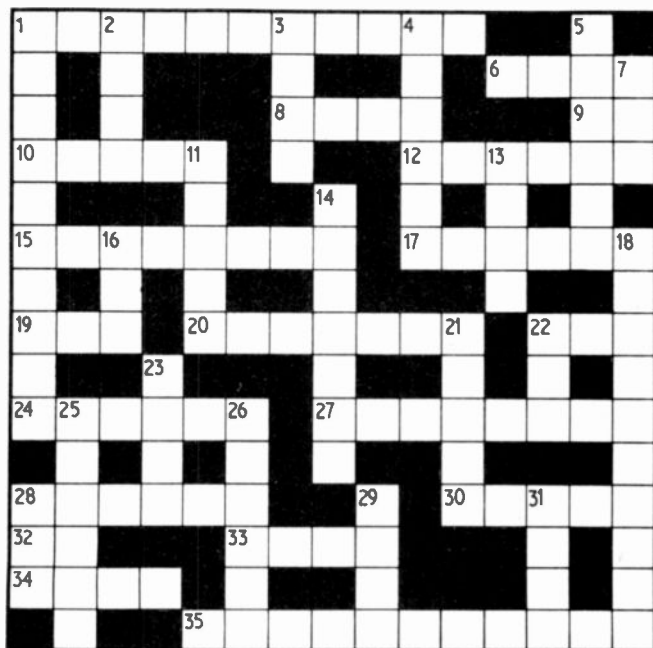

ACROSS

- 1 A bet on a battery?
- 6 Stand open for an old capacitor.
- 8 Pure and tidy.
- 9 Frequency modulation.
- 10 Entrance terminal.
- 12 Guiding lights.
- 15 Send across.
- 17 Musical devices for selection.
- 19 Useful for fishy work.
- 20 Grounded.
- 22 A small item of computer information.
- 24 Mistakes
- 27 A device of usefully low conductivity.
- 28 Pert. to the stars.

- 30 There's a stoat about for a drink. (Anag.)
- 32 A small piece of a circuit.
- 33 Reflect to give a t.v. ghost.
- 34 A light switch with watery connections.
- 35 Diminution of a signal.

DOWN

- 1 Impedance reciprocates to allow entry.
- 2 A semiconductor found on some shoulders.
- 3 If this is missing it can cause some trouble.
- 4 Delivery terminal.
- 5 Roof beam.

- 7 Take arms in part to give the equivalent D.C.
- 11 A sense from a state. (Anag.)
- 13 A wire along which signals are sent.
- 14 The fixed plates of a capacitor also found in some motors.
- 16 With tar about we don't get science. (Anag.)
- 18 The above and beyond state when nothing extra is to be gained.
- 21 Electronic wandering.
- 22 To offer money against a chance of gain.
- 23 Not a gate.
- 25 Not quite a blank screen.
- 26 To choose in a tuned circuit.
- 28 The dielectric for some capacitors.
- 29 A cornucopia of a loudspeaker.
- 31 Against.

Solution to Crossword on page 351



"This computer my wife constructed tends to be a bit garrulous"



AIRPORT RADAR

BY G. A. G. BROOKE

EVERYONE appreciates the need for airport radars that keep Air Traffic Controllers (A.T.C.) "in the picture" as to where all arriving and departing aircraft are at any one moment. But most people would be surprised to know that, at major airports anyway, exact knowledge of aircraft on the ground (on runways and taxiways) is likely to become of even greater importance.

BLIND LANDING

What really makes this ground knowledge so vital are the increasing pressures on A.T.C. staff. These condense to more aircraft leading to tighter schedules (there can be eighty movements an hour), larger airports with 4km runways making visual checks difficult or impossible, and the introduction of blind landings in fog.

Blind landings whatever the cloud height and with runway visibility at only 50m will soon be used by British Airways at Heathrow and any other airport fitted with the necessary equipment. Gatwick and eight other British airports can handle landings with a ceiling of 30 feet and runway visibility of 400m.

It is the Civil Aviation Authority's aim to bring all major airports up to Gatwick standard as soon as possible. So, where previously fog meant a rest for A.T.C. staff it now means even greater pressure and necessity to know where everyone is on the ground.

AIRFIELD SURFACE MOVEMENT INDICATION

How in fact do they do it at all? Well at Heathrow, Paris (Orly) and Rome (Fiumicino) and shortly

at Milan and Turin they rely on the ASMI (Airfield Surface Movement Indication) radar. To anyone familiar with ordinary radar the problems would seem immense.

The surface of an airport, not unlike a small town, with its control buildings, hangars, stores, car parks and so on would normally provide a radar picture that was an indiscriminate jumble of echoes at best. ASMI is not, however, a normal radar; it was purpose designed, in collaboration with the Civil Air Authority, for this one airport job.

Radar does not pass through solids like radio, so that a target in front of another will throw a "shadow" on the display in the form of a blank space. So the first requirement was to give the radar

Heading photo via *Flight International*.

a high viewpoint, obviously the top of the control tower.

This has the advantage that it has the same view as the Controller a few feet below, but it also has a disadvantage in that the weight of the aerial (and its turning mechanism) restricts aerial size, with an important result as we shall see. At Heathrow and other places the control tower is suitably central, but at Rome it is not, needing a second ASMI to cover the outlying area, its radar data being transmitted back by microwave link.

PERFORMANCE

The next question was how to give ASMI an unheard of radar performance in all parameters except range, which needs in most cases to be not more than 4,500m. Arriving at the eventual specification was an interesting exercise in juggling the various characteristics involved so that they "meshed" suitably for the ASMI requirement.

Radar design is no different to that of ships, cars or in fact any complex system in that it is a compromise. In this case tremendous resolution was vital, but range, as we have seen, unimportant. The designers started with two other variables fixed, or at least limited, one of them unusual to the point of it being unique.

AERIAL ROTATION

This was the necessity for a very high aerial rotation rate. Aerials of ordinary radars revolve at from 24 to 60 r.p.m., which means that the synchronised trace in the display crosses the target, renewing echo brightness, every one to two seconds. This is good enough for slow moving targets (or even fast targets) at long range, but if you consider an aircraft only 800m away taking off at 120 knots across the front of the observer, it will travel 60 yards between each passage of the trace and thus appear to be leaping forward in disconnected jerks.

With the unique rotation rate of 750 r.p.m. however, targets are "repainted" 12 times a second and the aircraft will only advance a few yards between renewals; in practice it is seen to proceed smoothly but in a slight blur.

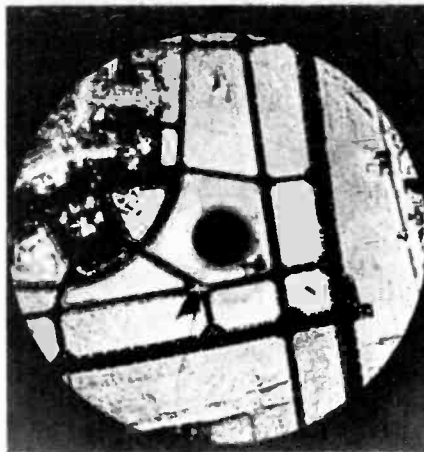

An aircraft on a taxiway at Fiumicino (Rome) airport as seen by the Dacca Airfield Surface Movement Indication (ASMI) radar. The aerial is on the control tower, centre circle, hence the "shadow" thrown by the aircraft's echo.

Another advantage of the high rotation rate and only slightly secondary in importance is that the resulting picture is virtually steady and flicker-free, much easier on the eyes of Control Officers who may have to watch it for long periods, than the usual bright trace circling round a dark display.

The other limited variable was size of aerial. Mounted on top of a tower, the weight of the aerial and its turning mechanism limited size to 6ft and it will soon be seen how this influenced other factors. It is actually encased in a radome to reduce wind resistance and so the power and size of turning motor required.

RESOLUTION

With a steady picture providing smooth motion we are already some way towards that "unheard of radar performance." Providing very high resolution takes us the rest of the way.

In broad terms resolution means the ability to see the shape of a target and is therefore divisible into definition (accurate delineation of the extremities of the target) and discrimination (ability to separate adjacent echoes). To do these two things well you have to measure the target in range; front to back, and in azimuth; from side to side.

The keys to these measurements are pulse length and aerial beamwidth (pulse repetition frequency also comes into it, but only to the extent that at the high aerial rotation rate used here, a high p.r.f. is necessary in order to record the target at all). The shorter the pulse length the better for purposes of range discrimination; short pulse represents a shorter distance over the ground so that two close objects are more easily resolved than with a long pulse. ASMI pulse length is 0.03 microseconds, resulting in a range discrimination of 13.8m as observed on the Plan Position Indicator (P.P.I.) at 1,800m.

BEAMWIDTH

Good bearing discrimination comes from narrow beamwidth (obviously a broad beam is not so



A view of the Heathrow control tower. Top right is ASMI, encased in a "radome".

accurate). Beamwidth depends on the size of the aerial; the longer the aerial the more concentrated the beam and the narrower the beamwidth.

Using the standard radar X-band frequency (about 9.4MHz) an aerial of about 25ft (as employed in major harbour surveillance systems) would be necessary to provide the beamwidth required by ASMI, i.e. 0.4 degrees. We have seen that a large aerial is ruled out for practical reasons and so recourse has to be had to very high frequency in order to permit the use of a 6ft aerial. The frequency chosen is Q-band (35MHz).

INCANDESCENT MAP

The end result is startling, more like an incandescent map than a radar picture; grass is reproduced as a bright, speckled expanse, flat concrete as jet black, so the runways and taxiways of airports are distinctly drawn. Resolution is such that dead hares, six inch

countersunk runway lights and puddles of paint only half an inch thick show up.

With ordinary radars an aircraft shows up as a blob, but ASMI "draws" its shape, faithfully enough for seasoned operators to be able to recognise different

One of four Decca ASMI Bright Displays in the visual control room at Heathrow. Any particular section of the radar coverage can be displayed, enlarged as required.

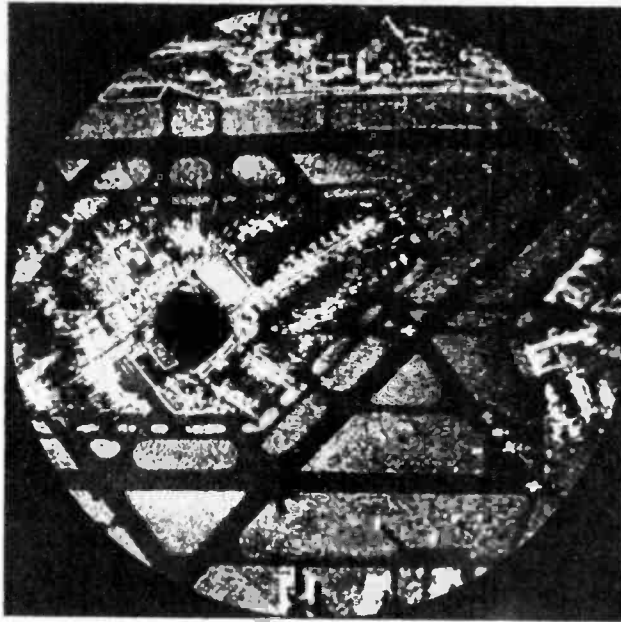

A radar picture of Heathrow airport showing control tower and runways. A Jumbo jet is waiting to take off.

types: and of course a Jumbo stands out a mile. Due to an effect already mentioned, aircraft just off the ground throw a "shadow" on the grass and the exact moment of take-off or touch-down can be told by the behaviour of this shadow. Though they can see directly whenever the visibility is good, many A.T.C. officers have come to rely on ASMI all the time.

BRIGHT DISPLAY

A problem common to all radars but particularly applicable to those in the Visual Control Room of an airport control tower, is that the radar screen is difficult to see in bright light. This has been over-

come in recent years by the provision of Bright Display, which employs a television technique.

The Visual Control Room at Heathrow has just been completely redesigned, the opportunity being taken to fit four ASMI Bright Displays; one for the western and one for the eastern facing control consoles, one for the Ground Controller and one for the Lighting Controller. The aerial itself is in a radome conspicuously mounted above and a little to one side, at the top of the Control Tower).

The radar in the form of azimuth, video and trigger signals is fed to a P.P.I. display employing a small (11cm) but high resolution cathode ray tube. The P.P.I. picture is optically coupled to a vidicon camera channel employing a storage vidicon pick-up tube. The camera channel will operate on various scanning standards with 2:1 interlace, and may be internally or externally driven.

The camera channel output can be fed to any desired number of t.v. displays either directly or via a t.v. distribution system or a t.v. link. The P.P.I. and camera channel are specially compensated to ensure a substantially uniform video signal over the total t.v. field area.

The P.P.I. is provided with four range scales and an off-centring facility, both of which can be remotely controlled if necessary, for example at the t.v. viewing



position. Thus, by off-centring in the desired direction and switching to the shortest range (to give the largest scale) the whole display can be filled with a fairly small section of the original total coverage. A useful facility when, for instance, there has been an "incident", such as a crashed aircraft.

OTHER TASKS

This leads to the fact that there are, indeed, several subsidiary uses for ASMI itself, in addition to the general surveillance role. It can be used, in conjunction with the runway lighting, to assist pilots to leave the runway at the designated point, more quickly and without fear of collision with other aircraft, thus speeding up operations generally. It can ensure that aircraft and vehicles (both being fitted with v.h.f. communication) do not encroach on the instrument landing system restricted area, as their presence can cause distortion to the glide path and localiser beams.

As we have seen, fire engines, ambulances and other emergency vehicles can be directed to the

scene of an accident, which might be just outside the airport. This is important in foggy weather; there have been instances of precious time being lost by such vehicles being unable to find the spot.

Lastly, and this was probably not in the manufacturer's mind when an ASMI was first installed at Heathrow ten years ago, is its undoubted value to security. If hares show up, a gentleman with a bazooka will be only too apparent!

What of the famous hare? Bits drop off aircraft, believe it or not, usually inspection plates and so on, and when the ASMI detects one of these, a Land-Rover is sent out to recover the object before it obstructs an aircraft. On one occasion at Heathrow something was indicated on the runway and a Land-Rover despatched, only to find that it was a dead hare! Those with radar experience find such sensitivity hard to believe, but it is true.

A lot of people are already taking a second look at this unusual radar that does a specific job extremely well. □



The ASMI "radome" being lowered into place at Orly airport, France.



Wiper Mods

Having recently obtained my first car, I found it annoying to switch the windscreen wipers on and off during fine drizzle.

With that in mind, I decided to build an electronic slave to do the job for me. The sensor for this device comprised of a piece of stripboard wired in the form of "interlocking fingers", and was held in place on the radiator grille with the help of two elastic bands.

However, this did not prove satisfactory, as a droplet of water between two adjacent tracks on the stripboard, took an appreciable time to disperse.

This is where your colleague's idea, mentioned in *Shop Talk*, which was to paint a pattern of "interlocking fingers" on the windscreen using electrically conductive paint gave me the idea of writing to you.

Although I have not tried the paint, I feel sure it would work. For this reason I've enclosed the circuit diagram for my original idea, which although very simple I hope will be of interest to your readers.

It is at this point I feel I should point out the need for two models, i.e. one for positive and one for negative earth vehicles. Should a negative earth design be fitted to a positive earth car, in heavy rain, a virtual short circuit across the battery would be inevitable. A model of the correct polarity could not let more than a current of 1.2mA ($R1=10k\Omega$) drain to earth.

J. M. Hayes,
Keighley,
Yorks.

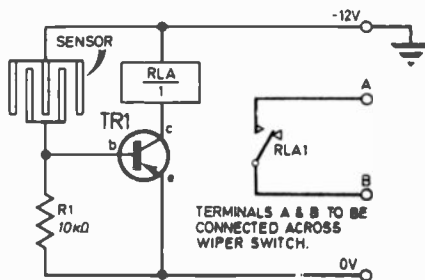

Fig.1. Circuit diagram for a negative earth vehicle wiper delay. The terminals A & B are connected across the car wiper switch. For positive earth vehicles TR1 should be any medium power npn switching transistor.

Thyristor

In the February issue of *EVERYDAY ELECTRONICS* a design for a *Windscreen Wiper* was published.

So far I have been unable to obtain the specified thyristor. I would be grateful if you could list a supplier or an alternative.

G. L. Clifford,
Warwickshire.

A suitable alternative for the thyristor is the C126M available from Maplin Electronics, PO Box 3, Rayleigh, Essex. The latest price we have is £1.42. In fact any thyristor with a rating of 10A at 50V would suffice.

Triac

I am in the process of building the *Enlarger Timer* featured in the October '77 issue of *EVERYDAY ELECTRONICS*. One component I cannot seem to obtain is the 2N5756 triac.

I wonder if you could possibly advise me where to obtain this part.

B. Appleton
Bucks.

You can obtain the triac from Arrow Electronics, Leader House, Coptfold Road, Brentwood, Essex. The cost is £2.04 including VAT and post/packing.

WEIRD SOUND EFFECTS GENERATOR

By. D. Ewards

INTRODUCTION

THIS unit came about as a result of experiments in electronic music and musique concrète. While the unit's musical validity may be open to some question, tastefully used it can be put to good effect. For those who indulge in making tape plays, the Weird Sound Effects Generator can provide a whole host of futuristic sounds to rival even those heard in the film *Star Wars*. The circuit, in fact, was designed with the creative tape recording enthusiast in mind and the prototype, in extensive use, has proved its worth.

**START
HERE FOR
CONSTRUCTION**

The circuit is built on a piece of 0.15 inch matrix perforated board size 15×9 holes. The layout of the components on the topside of the board and the interwiring on the underside is shown in Fig. 1.

It is advisable to leave the component leads untrimmed as these can form the wiring for the underside connections. Leave the transistors until last. Unless you are an experienced constructor, able to carry out speedy soldering, a heat-shunt is recommended when soldering the transistors in place.

CASE

The next stage of construction concerns the case. In the prototype, a plastic hinged case measuring 90×90×30mm that was designed as a presentation case has been effectively utilised by the author. Make the cut-outs in any suitable case to suit the DIN socket and the three potentiometers, and then fix these in position. The layout of these components within the case is shown in Fig. 1, but this is not critical and may be changed to suit individual requirements. Attach a battery clip as shown and then wire up between board and case mounted components as detailed in Fig. 1.

One important point to be aware of when selecting a suitable case, is the overall depth of VR1/S1 body. The type used in the prototype was a "midget" type which just fitted in the case. If a larger potentiometer/switch assembly is obtained the height of the case will need to be increased.

HOW IT WORKS

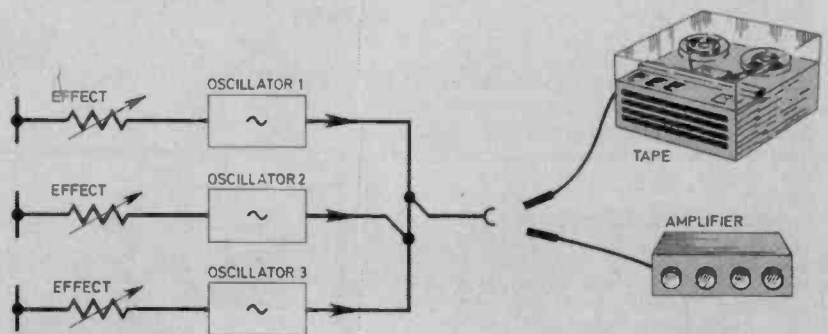

Three oscillators running at different frequencies have their outputs connected to form a composite output signal. The output signal of each oscillator when combined with the other two is both affected by and affects the other two outputs. No oscillator however is dominant and a strange mixture of electronic sounds appears at the unit output socket.

COMPONENTS

Resistors

- R1 39k Ω
- R2 1.5k Ω
- R3 39k Ω
- R4 1.5k Ω
- R5 39k Ω
- R6 1.5k Ω
- R7 1k Ω

All $\frac{1}{4}$ watt carbon $\pm 10\%$

Potentiometers

- VR1/S1 470k Ω lin. carbon with ganged on/off switch
- VR2 470k Ω lin. carbon
- VR3 470k Ω lin. carbon

Capacitors

- C1 0.047 μ F plastic or ceramic
- C2 0.1 μ F plastic or ceramic
- C3 0.01 μ F plastic or ceramic
- C4 0.1 μ F plastic or ceramic

Semiconductors

- TR1 BC178 silicon *pnp*
- TR2 BC108 silicon *nnp*
- TR3 BC178 silicon *pnp*
- TR4 BC108 silicon *nnp*
- TR5 BC178 silicon *pnp*
- TR6 BC108 silicon *nnp*

See
**Shop
Talk**
page 342

Miscellaneous

- B1 9V type PP3
 - SK1 5 pin 180° DIN socket
- 0.15 inch plain matrix board size 15 x 9 holes; battery connector to suit B1; plastic case approximate size 90 x 90 x 30 mm; control knobs (3 off); connecting wire.

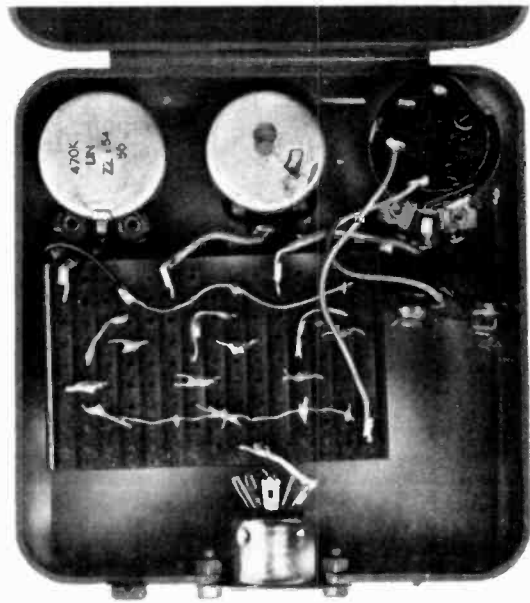

Components and circuit board mounted inside the case.

FOR GUIDANCE ONLY

ESTIMATED COST OF COMPONENTS

£3.00

excluding case

WEIRD SOUND EFFECTS GENERATOR

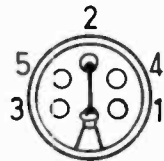

SK1 VIEWED
LOOKING AT
PINS

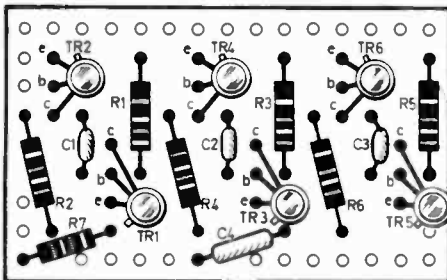

TR1-TR6
VIEWED FROM
UNDERSIDE

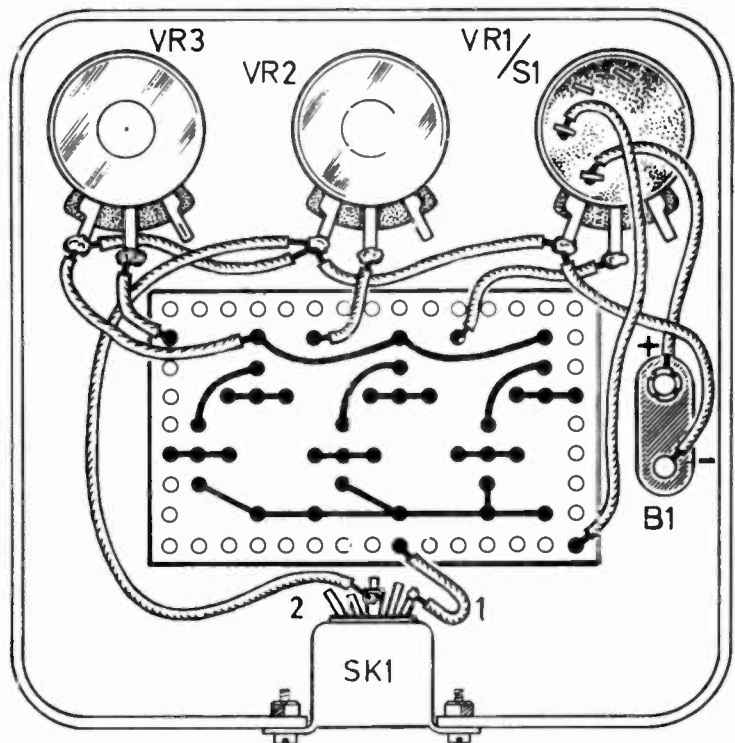

Fig.1. Component layout for the circuit board and interwiring to the controls and underside of board.

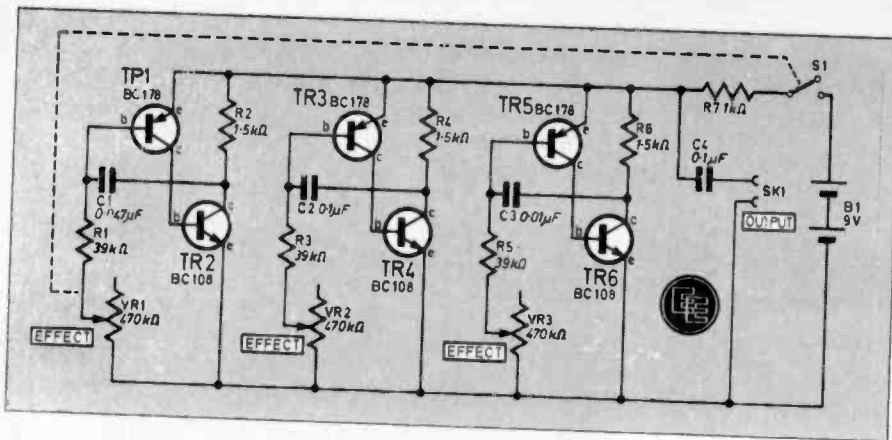

Fig.2. Circuit diagram of the Weird Sound Effects Generator

CIRCUIT DESCRIPTION

The complete circuit diagram of the Weird Sound Effects Generator is shown in Fig. 2 and can be seen to consist of three distinct, similar sections, each being an oscillator of different frequency from the complementary astable multivibrator family.

The operation of each of these oscillators is identical, so only the circuit action of that comprising TR1 and TR2 and associated components will be described.

When power is applied to the circuit, capacitor C1 initially uncharged begins to charge up via R7, R2, R1 and VR1 with TR1 and TR2 off (non-conducting). The capacitor continues to charge up until the voltage on the base of TR1 becomes negative with respect to its emitter. This causes TR1 to turn on (conduct) and at the same time the potential on TR2 collector, coupled to TR1 base rises and causes TR2 to be biased on (conducting).

Under these conditions the capacitor is presented with a discharge path through TR1 and continues to

discharge until the voltage on the base of TR1 becomes positive with respect to its emitter and turns off. The base bias of TR2 is thus removed and so TR2 turns off. The capacitor then starts to charge up again and the above cycle of events repeats, and continues for as long as power is applied to the circuit.

During each cycle, the voltage level on TR2 collector rises and falls and this is coupled to the output socket via d.c. blocking capacitor C4 from a split collector load R2, R7.

The frequency of oscillation, being the inverse of the charging time of C1, is therefore governed chiefly by the setting of VR1 with R1 (since their values are much greater than the combination R2, R7 which completes the charging route).

Since all the oscillators share a common load resistor R7, the output is a complex signal that is substantially changed by the operation of a single effect potentiometer.

switch on the unit. Rotating each control knob in turn should alter the sound heard. This condition will indicate that the unit is functioning satisfactorily and is ready for use.

IN USE

The Weird Sound Effects Generator consists of three separate oscillators but there is no reason why the number of oscillators cannot be increased to provide an even greater range of sounds.

Different values of tuning capacitors would, of course, be required for each of the additional oscillators.

Alternatively by using only two oscillators coupled together and giving the timing capacitor values of a few microfarads, the unit can be used as a simple rhythm generator. In this mode, of course, the remaining oscillator could be used to rigorously adhere to the values of the timing capacitors suggested, try any values from 0.001 microfarads to 10 microfarads (with electrolytics, the positive plate should be connected to the collector of the npn transistor at each oscillator). The higher the value, the lower the frequency of the oscillator.

Also, switches ganged with VR2 and VR3 to switch these oscillators in or out of circuit as desired could be incorporated for extending the number of effects.

The author has used the prototype generator to create electronic compositions in conjunction with a mixer, tape recorder, organ, fuzz box and waa-waa unit to produce "out of this world" sounds and effects.

The output level and the wiring of the output socket makes the generator compatible with most automatic recording level tape recorders (eg. Philips, as used by the author) although it should work equally well with other machines.

However, in the case of an amplifier or similar high input level equipment, a small booster amplifier should be added and the output for this could be wired to pin 3 of the DIN socket SK1. A separate lead should then be made up to allow this output to be fed to the high input level equipment, ie. DIN plug with connections at pin 3 and earth.

Although a DIN socket was used in the prototype, there is no reason why any other socket cannot be substituted to be compatible with the tape-recorder or other equipment that will be used with the Weird Sound Effects Generator. Finally connect the battery, fix three control knobs and the unit is ready for testing.

TESTING

Connect the unit via a suitably terminated lead to an amplifier or tape recorder set to record and



The Extraordinary Experiments of Professor Ernest Eversure

by Anthony John Bassett

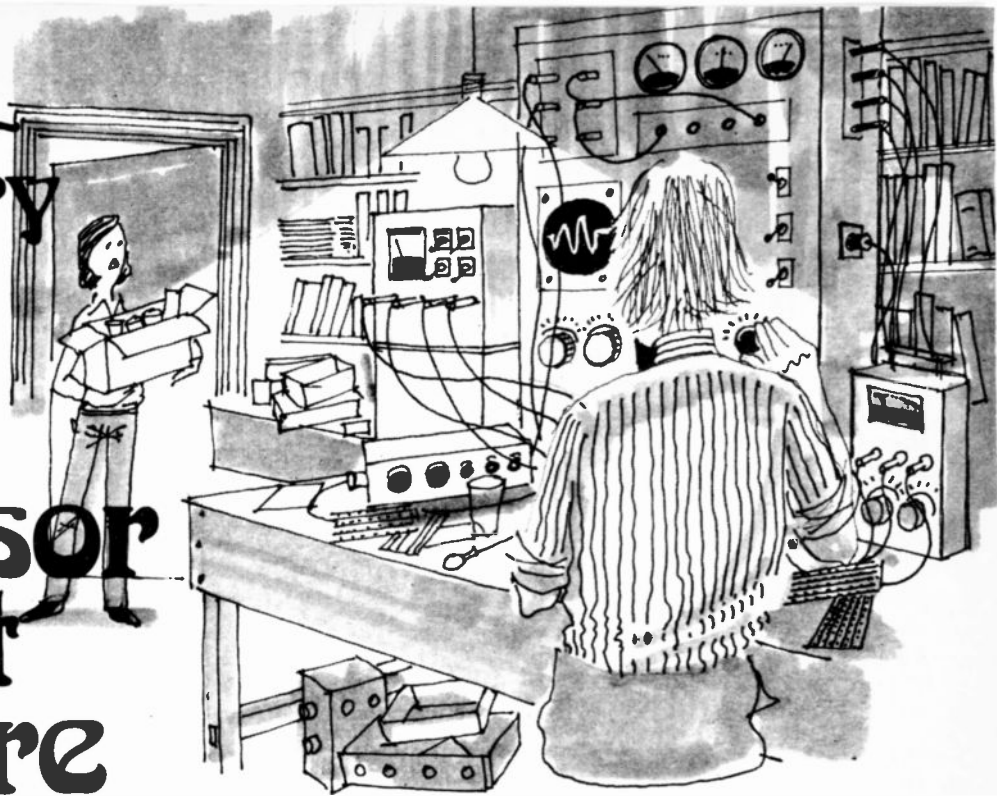

BOB has been assisting Miss Lilian Whiteley, in some "Extraordinary Experiments in Dowsing" in the presence of the Prof. and Dr. Angus R. Paterson, who is highly sceptical of the procedures of dowsing. Lily has been using a Radiesthetic Pre-amplifier to assist her in the identification of concealed substances, and Bob has queried the function of this pre-amplifier.

DISTURBING INFLUENCE

The Prof's experimental Robot soldered a small copper plate to each end of a length of copper wire of just over 1 metre, and acting on the Prof's instruction, has arranged this wire in place of the Radiesthetic Pre-amplifier with its copper input plate and output plate.

This is to test Bob's surmise that the influence which Lily picks up by dowsing will travel along a plain piece of wire without the assistance of the Radiesthetic Pre-amplifier.

Following the same procedure as before, Bob secretly placed a sample of one of the five substances onto the copper plate at one end of the wire, concealed from Lily by means of an opaque screen. The wire led past the screen to the plate at the other

end, over which Lily now swung her pendulum.

"It's no good, Bob", she announced, "I'm not getting any response at this end".

Bob was astounded. "I felt sure that it would work!" he said in puzzled disappointment.

"I thought that, if this influence would travel along a conducting wire with the assistance of the pre-amplifier, it should equally do so without one!"

"Actually I think you're right", Lily told him, "But there is a factor which you have not allowed for. It is the disturbing influence of the nearby samples in their containers. If you move the containers away to a distance of several metres I'll try again."

Bob placed the five sample containers on a small tray and removed them from the vicinity. A few moments later Lily was able to correctly identify the sample which was concealed from her by the opaque screen, but connected by a wire to the copper plate over which she swung her small perspex pendulum.

NEW ARRIVALS

However, this had been witnessed by an increased audience as the Prof. had meanwhile

admitted two more visitors to the laboratory; Tom and Maurice, who enthusiastically devoted most of their spare time to the running of events for their favourite charity organization.

Lily explained to the small assembly: "The influence of the sample on the plate at one end of the wire travels along the conductor to the plate at the other end and by dowsing at this end I am able to identify the sample at the other end. But this process is subject to a number of disturbing influences, such as the presence of a nearby sample of the same substance in a container. One of the functions of the Radiesthetic Pre-amplifier is to enable me to overcome disturbing influences such as these—and it helps me to obtain more accurate results."

DOWSING COMPETITION

Tom and Maurice were very interested. "We are running yet another Charity Fair", said Maurice, "Bob I wonder, Miss Whiteley, whether you might very kindly give a dowsing demonstration as one of the events there."

"That's a really good idea, Maurice", Tom chipped in enthusiastically, "Maybe you could also

help us to run a Dowsing Competition so that members of the Public could try their hand. We could easily fix up one or two tables with small opaque screens, and a wire leading to two copper plates just like you have here!"

"Maybe!" Angus thought out aloud, "Maybe the Prof. could construct a Dowsing Robot."

"Angus!" warned Lily, "For this Charity Fair, we're going to dress you up in a Robot suit made of sheets of cardboard covered in shiny aluminium foil, with flashing lights, electronic beepers and an electronic Cyberman voice projector". She turned to Tom and Maurice, "I'd be delighted to help at the Charity Fair, boys, maybe we could arrange details later as Angus and I must leave now. Thanks, Prof., and Bob for mending my preamplifier."

might be able to advise on how to connect them up electrically to operate various amusing gadgets or competitions".

Angus placed a coin in the slot, and, to his surprise the box began to rock and move, with a mysterious grinding noise. A flap opened and out slunk a green plastic hand which slowly approached the coin, grabbed it and suddenly slammed back into the box with a bang! "I think I'll be leaving now!" remarked Angus with mock horror, then, "Cherrio, everyone, Au Revoir". Angus and Lily left the Laboratory.

DRACULA'S BANK

The Prof. now picked up the small black plastic box. "So this is Dracula's Bank!!" he remarked, examining the writing on one side,

but is probably adequate for amusement purposes".

"Prof., we tried to look inside the box in order to see whether we could work anything out for ourselves, but the box is sealed with blobs of molten plastic which we could not cut away as the blade in our craft knife has been broken."

"Yes, Maurice, I can see them". The Prof. had removed the batteries and also unscrewed the bottom of the box. After tipping out a small heap of coins he could see that further access to the mechanism was sealed with a few small blobs of molten plastic.

"I will be able to remove those seals quite quickly, Prof." he offered. "Okay, Tom, and you can use some of my tools if you like, as some of the plastic which you must cut away is rather awkward to remove. Meanwhile I think Bob has something he wishes to ask me".

MORE INFO'

The Prof. had noticed that whilst he was discussing the mechanical money-box with Tom and Maurice, Bob had become increasingly agitated, and now looked about ready to burst! "Prof!" he said, "I must know more about the Radiesthetic Preamplifier! What circuit does it use? When I mended it I could see that it did not look very complicated, but I am really keen to know more about the circuit!"

To be continued

Fig. 1. Arrangement of equipment for the "dowsing" experiment without the inclusion of a preamplifier.

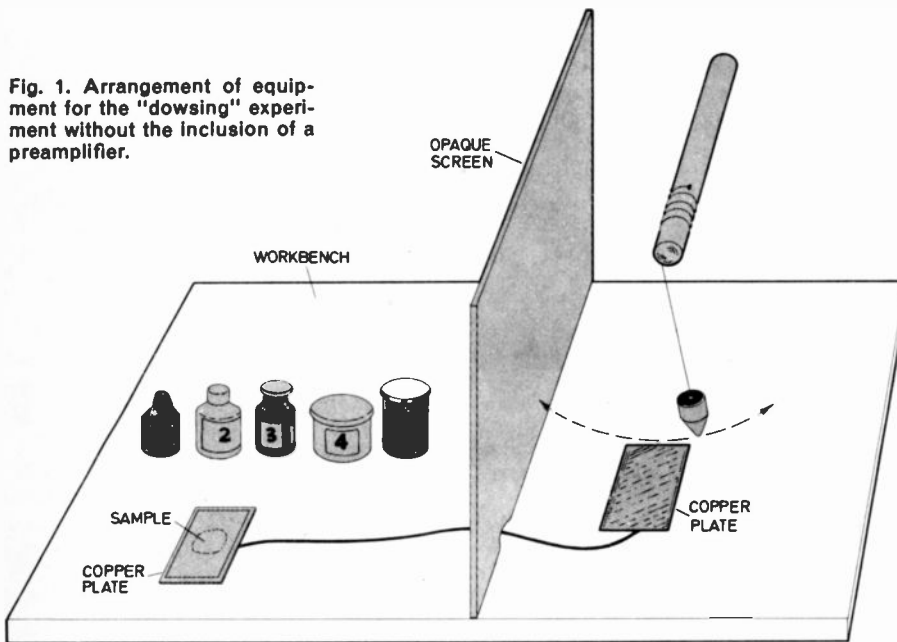

"It has been a most interesting visit", said Angus, then suddenly, "Hey! Whatever is that?" His eyes had fallen on a brightly coloured small box which Maurice had placed on one of the laboratory workbenches.

It was garishly labelled "The Thing—from the Crypt!" Maurice opened the packet and brought out a small box with a slot in the top. "This is what I have come to consult the Prof. about," he told Angus, "We are thinking of using several of these as coin collector mechanisms at the Charity Fair and I have the idea that the Prof.

"What a good idea of yours to convert it for the benefit of Charity.

From my initial observations it would seem that the mechanism in this box could be used for two chief functions when activated by the donation of a coin. One would be to initiate or enable an action or the start of a small game, display or competition sideshow.

The other function would be to act as a timing mechanism dependent upon the time taken from first placing the coin in the slot, until the coin is snatched away by "The Thing". Of course timing accuracy may not be very good,

TEACH-IN 78 REPRINTS

Owing to great demand the October and November issues of EVERYDAY ELECTRONICS have completely sold out. To help those readers who wish to follow the Teach-In 78 series but have missed parts 1 and 2 that appeared in these issues, reprints of Teach-In Part 1 and Part 2 are available at a cost of 35p each, inclusive of postage. Orders (specifying Part required) with remittances should be sent to: Post Sales Department, IPC Magazines Ltd., Lavington House, 25 Lavington Street, London SE10 6PF.

GEORGE HYLTON brings it down

Measuring Low Resistance

A READER, sent us a circuit for using an ordinary 1mA meter to measure low resistances. He has doubts about whether it's right.

First, the problem. The circuit (Fig. 1) is first set up without the unknown resistance R_x . The variable (potentiometer) R_s is adjusted so that the meter (whose resistance is R_m) reads some convenient value, such as exactly full scale.

When R_x is connected (by closing the switch), some of the current is diverted from the meter. The resistance R_x can then (according to our reader's source) be calculated by a formula which includes the two meter readings and R_m but not V or R_s .

When R_x is connected the resistance of the circuit as a whole must fall. So the current must increase. Doesn't this change of current affect the measurement?

Ohm's Law

When confronted with this sort of problem there are two ways of attack. One is to do a lot of algebra and get a thorough understanding.

The other method is to put some plausible circuit values on the diagram and see what happens using nothing more complicated than Ohm's Law. I've done this (bracketed values). If V is 1V, then to set the meter to 1mA (R_x out) it's necessary to have a total resistance of 1000 ohms ($1V/1mA = 1k\Omega$). The meter is 100Ω so R_s must supply 900Ω .

When R_x is connected across the meter there are two 100Ω in parallel, making 50Ω . With R_s the total is now 950Ω and the current is $1V/950\Omega = 1.052mA$. Half this goes through the meter, which then reads $0.526mA$. The question is, do these figures, inserted into the formula, provide

the correct value for R_x ? The formula is:

$$R_x = \frac{\text{(meter resist.)} \times \text{(2nd meter reading)}}{\text{(1st meter reading)} - \text{(2nd reading)}}$$

Without doing an exact calculation you can see that this gives the wrong answer. The right answer, we know, is 100Ω . But the formula says it is 100Ω times $0.526/0.474$. Since $0.526/0.474$ is greater than 1, the answer is greater than 100Ω (actually about 111Ω), so the system "reads high".

To produce the right answer, the currents at the top and bottom of the fraction must be equal. One can't avoid the suspicion that the formula "wants" them both to be $0.5mA$. To obtain this value the total current must not change when R_x is connected. This is impossible, but you can get as close to it as you like by making V and R_s large.

In this case, R_s "swamps" the effect. If $V = 10V$, then for $1mA$, the total resistance must be $10k$, of which R_s supplies 9900Ω and R_m 100Ω . Connecting R_x reduces the total resistance to $9900 + 50 = 9950\Omega$, which is low by only 0.5 per cent. The error is roughly twice this, or about 1 per cent, which is acceptable for most practical purposes.

Linear Scale

The circuit has one distinct advantage. It does not rely on the accuracy of the meter. So long as the meter is *linear*, the system works. Even if the meter calibration is "out" by quite a substantial amount it still works.

But there is also a *disadvantage*. If R_x is small compared with R_m , then on connecting R_x the reading falls to a very small value. This makes it hard to get an accurate reading.

For example, if R_x is $1/100$ of R_m then the reading falls from full-scale to less than 1 per cent of full scale. This is less than one small scale

division on most meters, and cannot be read accurately. In fact the system is most accurate when R_x is about equal to R_m .

Many of the cheaper multimeters have only a few current ranges, for the higher currents, together with a good selection of voltage ranges. In this case, a different approach to the problem of measuring low resistance is preferable.

Current/Voltage

If a known current is passed through a resistance (Fig.2) then the resulting voltage drop tells you what the resistance is. If, for instance, you pass $100mA$ through 1Ω , the voltage drop is $100mV$ ($0.1V$).

So, a multimeter can be used first to set the current then to measure the voltage drop. A meter which reads $100mA$ full scale is likely to have a low resistance, perhaps about 1Ω . If R_s is around 100Ω the meter resistance has little effect on the current. If V is $9V$, R_s must be 90Ω for $100mA$, enough for most purposes.

When the meter is switched to a *voltage* range and connected across R_x to measure the voltage drop, it will not seriously effect the accuracy so long as it takes only a small amount of the current. Most multimeters take $1mA$ or less for full-scale deflection. So if $90mA$ is flowing through R_x the accuracy of measurement won't be seriously impaired by the $1mA$ bled off by the meter.

To measure R_x , then, you use a current range to set a suitable current and a voltage range to measure the voltage drop. For a current of $100mA$ and voltage range of $100mV$ ($0.1V$) a resistance (R_x) of 1Ω gives full-scale deflection (f.s.d.).

Smaller resistances give proportionally less deflection: 50Ω gives a reading of $50mV$ ($0.05V$) for example.

This scheme has the disadvantage that any inaccuracy in meter calibration affects the result.

Fig. 1

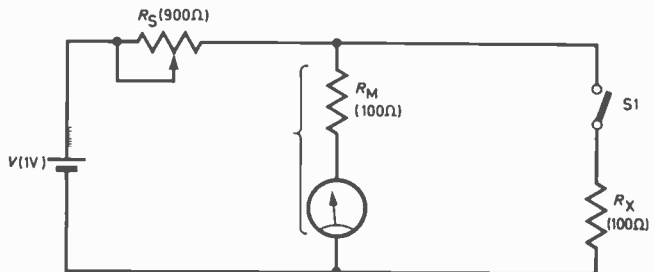
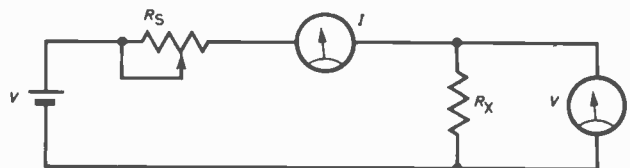

Fig. 2



to earth

TV GAMES
 AY-3-8800 £5-95.
 AY-3-8850 £9-95.
 AY-3-8900



£13-95. 4-43MHz crystals £1-95. Black and white TV games kits:—standard model £10-50. Economy model £5-95. Colour TV games kits:—standard £18-95. Economy £13-45. Colour generator kit adds colour to most black and white games £7-50. Rifle kit £4-95. Send sse for giant free data leaflet.

NEW COMPONENT SERVICE
 Resistors 5% carbon E12 10 to 10M. 1W 1/2. 1W 3p. Preset Pots subminiature 0-1W 100 to 4M7 5p. Potentiometers 1W 4K7 to 2M2 log or lin. Single 30p. Dual 50p. Polystyrene capacitors E12 83V 22pf to 8200pf 3p. Ceramic Capacitors 50V E8 22pf to 47000pf 3p. Polyester Capacitors 250V E8 0.1 to 1mf 5p. -15. -22. -33mf 7p. -47 11p. Electrolytics 50V 47. 1. 2mf 5p. 25V 5. 10mf 5p. 16V 22. 33. 47mf 6p. 100mf 7p. 220. 330 6p. 470 11p. 1000mf 18p. Zener Diodes 400mW E24. 3V3 to 33V 5p.

MAINS TRANSFORMERS
 6-0-6V 100ma 94p. 9-0-9V 75ma 94p. 12-0-12V 50ma 94p. 13V 1A £1-10. 0-3V 1A £1-80. 0-0-6V 1A £2-35. 9-0-9V 1A £1-90. 12-0-12V 1A £2-40. 15-0-15V 1A £2-70. 30-0-30V 1A £2-90. 9-0-9V 2A £2-90.

PRINTED CIRCUIT MATERIALS
 PC etching kits:—economy £1-70. Standard £3-80 ad tna pcb 40p. 1lb FeCl £1-95. Etch resist pens:—economy 45p. Dalo 83p. Small drill bit 20p. Laminate cutter 75p. Etching dish 65p.

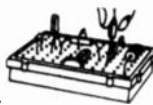

S-DECS AND T-DECS
 S-DeC £2-23.
 T-DeC £3-98.
 u-DeCA £3-97.
 u-DeCB £5-67.
 16 diff adaptors:—plain 90p. With socket £1-97.
 New S-De-Kit £4-95.
FERRANTI ZN414
 IC radio chip £1-44. Extra parts and pcb for radio £3-85. Cass £1. Send sse for free data.

SINCLAIR PRODUCTS*

Cambridge scientific programmable calculator £13-95. Prog library £4-95. Mains adaptor £3-99. Cambridge scientific £2-45. Oxford scientific £19-95. Enterprise £3-99. President £18-95. PDM35 digital multimeter £25-95. Adaptor £3-24.

BI-PAK AUDIO MODULES
 S450 tuner £21-95. AL80 £4-95. PA100 £14-95. MK80 audio kit £36-45. Stereo 30 £17-95. SPM80 £3-75. BMT80 £5-95. Send sse for free data.



JC12, JC20 AND JC40 AMPLIFIERS
 A range of integrated circuit audio amplifiers supplied with free data and printed circuits.
 JC12 6 Watts £1-95. JC20 10 Watts £2-95. JC40 20 Watts £4-29. Send sse for free data on all 3 models.

BATTERY ELIMINATOR BARGAINS
 TV games power unit stabilized 7-7V 100ma £3-25. 3-way models with switched output and 4-way multi-jack:—3/4/8V 100ma £2-92. 6/7/9V 150ma £2-50. 100ma radio models with press stud connectors. 9V £2-55. 6V £2-55. 4.5V £2-55. 6V+9V £4-50. 6V+6V £4-50. 4.5V+4.5V £4-50. Cassette recorder mains unit 7.5V 100ma with 5 pin din plug £2-85. Fully stabilized model switched output of 3/6/7.5/9V 400ma stabilized £2-40. Car converters 12V DC input. Output 9V 300ma £1-90. Output 7.5V 300ma £1-90.

BATTERY ELIMINATOR KITS
 Send sse for free leaflet on range. 100ma radio types with press stud battery terminals. 4.5V £1-90. 6V £1-90. 9V £1-90. 4.5V+4.5V £2-50. 6V+6V £2-50. 9V+9V £2-50. Cassette type 7.5V 100ma with din plug £1-90. Transistor stabilized 8-way type for low hum. 3/4/6/7.5/9/12/15/18V. 100ma £3-29. 1Amp £2-40. Heavy duty 12-way types 4.5/6/7.5/11/13/14/17/21/25/28/34/42V. Amp £4-85. 2 Amp £7-95. Car converter kit input 12V DC. Output 6/7/9V DC 1A. transistor stabilized £1-95. Stabilized power kits 3-15V 100ma £3-90. 3-30V 1A £9-95. 3-60V 1A £10-95. 3-80V 2A £13-95.

SWANLEY ELECTRONICS

DEPT. EE. PO Box 60, 32 Gosdel Rd., Swanley, Kent BR8 5TG

Mail order only. Please add 30p to total cost of order for postage. Prices include VAT. Overseas customers deduct 7% on items marked * and 11% on others. Official credit orders welcome.



Become a radio amateur.

Learn how to become a radio-amateur in contact with the whole world. We give skilled preparation for the G.P.O. licence.

Free! Brochure, without obligation to: WAA
EEK3

BRITISH NATIONAL RADIO & ELECTRONICS SCHOOL,
 P.O.Box 156, Jersey, Channel Islands.

NAME _____

ADDRESS _____ (Block caps please)

ITS EASY WHEN YOU KNOW!

To avoid missing your copy of EVERYDAY ELECTRONICS—simply complete this order form and hand it to your newsagent.

ORDER FORM

To..... (name of newsagent)

Address

Please reserve/deliver every month one copy of EVERYDAY ELECTRONICS until further notice.

My Name.....

Address

FREE CATALOGUE/ORDER FORM SEND S.A.E

800+ Top quality Transistors, I.C.'s, Resistors, Capacitors, Plugs/Sockets, Veroboard/cases, Indicators, Knobs, Switches, Wire and Books at prices you can afford.

741 ONLY 30p	555 ONLY 50p	TIL209 ONLY 15p	IN4001 ONLY 5p
--------------	--------------	-----------------	----------------

All prices include VAT. P&P FREE over £2.

Name _____

Address _____

Get an ACE up your sleeve!

ACE

ACE MANTRONIX LTD
 Dept. EE, Tontal Street
 Wakefield, W. Yorkshire WF1 5JR

For Semi-conductors
 Including

- Small Signal Transistors
- Power Semi-conductors
- TTL, CMOS, I.Cs
- Linear I.Cs
- Signal and Power Diodes
- Zener Diodes
- Magneto Resistors
- Magnetic Proximity Switches
- Opto-electronic devices

Go to **ELECTROVALUE** TO MAKE THE BEST OF

For passive components
 Including

- Plastic Film Capacitors
- Electrolytics
- Semi-precision capacitors
- Transformers
- Pot, R.M and Ring Cores etc.

E.E. TEACH-IN '78
 Complete Kit as specified £12.50

Go to **ELECTROVALUE** THE PROJECTS YOU BUILD

The Open Door to Quality

It's the Electrovalue Catalogue No. 8 (4th edition black and white cover) with completely up-dated prices. 144 pages, well illustrated and informative. 40p post free with 40p voucher usable on orders for £5 or more. Send for yours now and order in confidence.

GOODS SENT POST FREE IN U.K. FOR C.W.O. ORDERS. Keenly competitive prices plus **ATTRACTIVE DISCOUNTS** and only best quality goods.

ELECTROVALUE LTD

(Dept EE.178), 20 St. Jude's Rd., Englefield Green, Egham, Surrey TW20 0HB
 Phone Egham 3603. Telex 264475
 North—680 Burnage Lane, Burnage, Manchester. Phone (061) 432 4943.

All you need for listening!



Listen with the complete hi-fi magazine

PRACTICAL HI-FI & AUDIO

Every month 40p

GREENWELD

443 Millbrook Road Southampton
SO1 0HX Tel: (0703) 772501

BUY A COMPLETE RANGE OF COMPONENTS AND THESE PACKS WILL HELP YOU

- ★ **SAVE ON TIME**—No delays in waiting for parts to come or shops to open!
- ★ **SAVE ON MONEY**—Bulk buying means lowest prices—just compare with others!
- ★ **HAVE THE RIGHT PART**—No guesswork or substitution necessary!

ALL PACKS CONTAIN FULL SPEC. BRAND NEW, MARKED DEVICES — SENT BY RETURN OF POST. VAT INCLUSIVE PRICES.

K001 50V ceramic plate capacitors, 5%, 10 of each value 22pF to 1000pF. Total 210, £3.35.

K002 Extended range, 22pF to 0.1µF 330 values, £4.90.

K003 Polyester capacitors, 10 each of these values: 0.01, 0.015, 0.022, 0.033, 0.047, 0.068, 0.1, 0.15, 0.22, 0.33, 0.47µF. 110 altogether for £4.75.

K004 Mylar capacitors, min 100V type, 10 each of all values from 1000pF to 10,000pF. Total 130 for £3.75.

K005 Polystyrene capacitors, 10 each value from 10pF to 10,000pF, E12 series 5% 160V. Total 370 for £12.30.

K006 Tantalum bead capacitors, 10 each of the following: 0.1, 0.15, 0.22, 0.33, 0.47, 0.68, 1, 2.2, 3.3, 4.7, 6.8, all 35V; 10/25 15/16 22/16 33/10 47/6 100/3. Total 170 tants for £14.20.

K007 Electrolytic capacitors 25V working, small physical size, 10 each of these popular values: 1, 2.2, 4.7, 10, 22, 47, 100µF. Total 70 for £3.50.

K008 Extended range, as above, also including 220, 470 and 1000µF. Total 100 for £5.90.

K021 Miniature carbon film 5% resistors, CR25 or similar, 10 of each value from 10R to 1M, E12 series. Total 610 resistors, £6.00.

K022 Extended range, total 850 resistors from 1R to 10M £8.30.

K041 Zener diodes, 400mW 5%, BZY88 etc. 10 of each value from 27V to 36V, E24 series. Total 280 for £15.30.

K042 As above but 5 of each value £8.70.

TEACH-IN '78

Complete kit of parts for the New Series started in October. Everything for £13.50 including Post and VAT, Order Early!!

1977/78 CATALOGUE

Big new illustrated catalogue with 50p discount vouchers! Complete range of resistors, capacitors, semiconductors, knobs and boxes, etc., all at discount prices!! Only 30p + 15p post.

THIS is the Catalogue you need to solve your component buying problems!

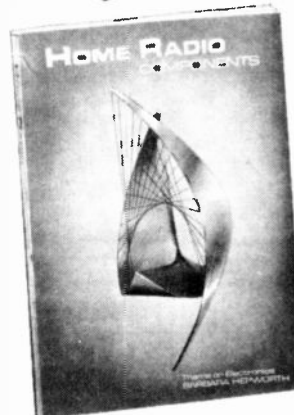

- The finest components catalogue yet published.
- Over 200 A-4-size pages.
- About 5,000 items clearly listed and indexed.
- Nearly 2,000 illustrations.
- Bargain List sent free.
- At £1.40, incl. p. & p., the catalogue is a bargain.

Send the coupon below now.
HOME RADIO (Components) LTD.,
Dept. EE., 234-240 London Road,
Mitcham, Surrey CR4 3HD

POST THIS COUPON with cheque or P.O. for £1.40

Please write your Name and Address in block capitals

NAME

ADDRESS



HOME RADIO (Components) LTD. Dept. EE (Regn No 234-240 London Road, Mitcham, Surrey CR4 3HD London 912986)

SMALL ADS

The prepaid rate for classified advertisements is 16 pence per word (minimum 12 words), box number 60p extra. Semi-display setting £4.00 per single column centimetre. All cheques, postal orders, etc., to be made payable to Everyday Electronics and crossed "Lloyds Bank Ltd." Treasury notes should always be sent registered post. Advertisements, together with remittance, should be sent to the Classified Advertisement Manager, Everyday Electronics, Room 2337, IPC Magazines Limited, King's Reach Tower, Stamford St., London, SE1 9LS. (Telephone 01-261 5918).

CONDITIONS OF ACCEPTANCE OF CLASSIFIED ADVERTISEMENTS

1. Advertisements are accepted subject to the conditions appearing on our current advertisement rate card and on the express understanding that the Advertiser warrants that the advertisement does not contravene any Act of Parliament nor is it an infringement of the British Code of Advertising Practice.
2. The publishers reserve the right to refuse or withdraw any advertisement.
3. Although every care is taken, the Publishers shall not be liable for clerical or printers' errors or their consequences.

Miscellaneous

TIMESWITCHES, cheap timeswitches, Sangamo 20 amp reconditioned, guaranteed for one year. Only £3.70. Also Electric Eyes. Write: J. DONOHUE, 1 Upper Norfolk Street, North Shields, Tyne & Wear.

100 RESISTORS 75p
1W 5% c/FILM 2-20-2.2MΩ (E19)
10 each of any value

Send stamped envelope for free sample

C90 CASSETTES 30p All Cassettes in Plastic Case
890 CASSETTES 45p with Index and Screwed Assembly.

All prices include VAT. Add Postage 10p in £1

Quantity Discounts: **25 WYLE ELECTRONICS,**
10 Units 5% **25 WYLE COP**
50 Units 7% **SHREWSBURY,**
190 Units 10% **TEL: 523266**

LIST No. 28 NOW READY. Styli illustrated equivalents also cartridges, leads, etc. Free for long SAE. **FELSTEAD ELECTRONICS (EE)**, Longley Lane, Gatley, Cheadle, Cheshire.

EVERYDAY ELECTRONICS PCB'S
IN GLASS FIBRE TINNED AND DRILLED

Oct 77 Auto phase box PCB £1-35
Component kit including case and battery £7-10
Feb 78 Chaser light display PCB £2-95

Please send payment with order.
For full list including Practical Electronics PCB's please send S.A.E.

PROTO DESIGN
4 Highlife Way, Wickford, Essex, SS11 9LA

BURGLAR ALARM GOODIES! 12V Siren £5-55, 240V Siren £9-61, plastic coated and lettered Bell Box £5-25. Flush Magnetic Contact 60p, Surface 65p. SAE for price list. C.W.A.S., 11 Denbrook Walk, Bradford BD4 0QS, Bradford 682674. All prices fully inclusive.

ENAMELLED COPPER WIRE

swg	1 lb	8 oz	4 oz	2 oz
14-19	2.40	1.20	.69	.50
20-29	2.45	1.60	.82	.59
30-34	2.60	1.70	.89	.64
35-40	2.85	1.90	1.04	.75

Inclusive of p&p and VAT.
SAE brings Catalogue of copper and resistance wires in all coverings.

THE SCIENTIFIC WIRE COMPANY
PO Box 30, London E4 9BW
Reg. office 22, Coningsby Gardens

Receivers and Components

I.C.s., TTL/C/Mos, Linear, Capacitors, Resistors (E19) 81L/Rectifiers, Diodes, LED, Thyristors, Zeners, Voltage Regs, DIL Sockets, Bridge Rectifiers, Potentiometers, Presets, Trimps, Diac, Plugs, Sockets, Cable, Vero. Carefully selected range, excellent despatch service. Same day turn round. S.A.E. List. Suppliers to A.E.R.E., U.K.A.S.A., Government Dept, Schools, Universities, Manufacturers. Accounts opened for trade and amateur. Join the professionals. Phone by 4 p.m. Goods out 1st class by 8 p.m. Try us and prove it!

ORCHARD ELECTRONICS

Plant House, High Street, Wallingford, Oxon.
Telephone 0461-358855

71b ASSORTED COMPONENTS £2.95. Small Audio Amplifiers, 3 transistors equivalent to AC128, OC72, with circuit. 3 for £1. 300 small components, Transistors, Diodes £1.30. No Postage, list 15p refundable. Insurance add 15p. J.W.B. Radio, 2 Barnfield Crescent, Sale, Cheshire M33 1NL.

NO LICENCE EXAMS NEEDED

To operate this miniature, solid-state Transmitter-Receiver Kit. Only £9.75 plus 25p P&P.

'Brain-Freeze' 'em with a MINI-STROBE Kit, pocket-sized 'lightning flashes', vari-speed, for discos and parties. A mere £4.10 plus 20p P&P. Experiment with a psychedelic DREAM LAB, or pick up faint speech/sounds with the BIG EAR sound-catcher; ready-made multi-function modules. £5.00 each plus 20p P&P.

LOTS MORE! Send 20p for lists. Prices include VAT. (Mail order U.K. only).

BOFFIN PROJECTS

4 Cunliffe Road, Stoneleigh Ewell, Surrey. (E.E.)

COMPONENTS FOR E.E. PROJECTS.

Component lists with prices available for all E.E. projects from October 1977 onwards, including Teach-In 78. Send S.A.E. stating project and month of publication (maximum 4 projects per S.A.E.). List sent by return together with ACE order form/catalogue.

ACE MAILTRONIX, Tootal Street, Wakefield, W. Yorks. WF1 5JR.

DISCOVER ELECTRONICS. Build forty easy projects including: Metal Detector, Wireless Transmitter, Breathalyser, Radios, Stethoscope, Lie detector, Touch time switches, Burglar Alarms, etc. Circuits, plans; all for £1.20 including FREE circuit board. Mail only. **RIDLEY Photo/electronics**, Box 62, 111 Rockpark Rd, Uckfield, Sussex.

Service Sheets

BELL'S TELEVISION SERVICE for service sheets of Radio, TV etc. 75p plus SAE. Colour TV Service Manuals on request. SAE with enquiries to **BTS**, 190 King's Road, Harrogate, N. Yorkshire. Tel: 0423 358855.

SERVICE SHEETS for Radio, Television, Tape Recorders, Stereo, etc. With free fault-finding guide, from 50p and s.a.e. Catalogue 25p and s.a.e. **Hamilton Radio**, 47 Bohemia Road, St. Leonards, Sussex.

A NEW SUPER DRILL

from

PRECISION PETITE

An extra powerful precision drill for Electronic Design and Development Engineers who need a small low voltage, precision drill with high capacity, and there's a new all metal stand for greater accuracy.

P2 Mk2 with detachable head (without case) £18.00 pp 86p

In storage case with room for Transformer

£19.50 pp 86p

In case with variable transformer

£20.00 pp 86p



P2 DRILL

S2 Drill stand (holds both drills)

£18.50 pp 106p

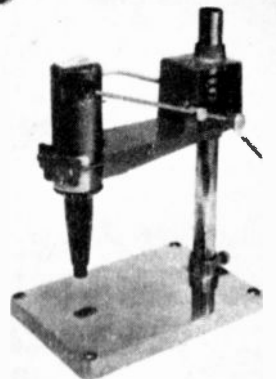

and the popular P1 DRILL

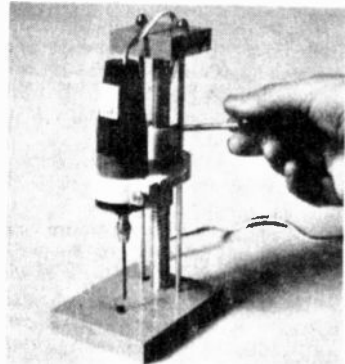

P1 Drill £9.67 p & p 30p

S1 Stand £5.15 p & p 30p

Accessories include drills, stones, burre, saw blades etc. Send 6" x 4" S.A.E. for full details and order form.



Sole UK Distributors

PRECISION PETITE LTD

119a HIGH STREET

TEDDINGTON MIDDLESEX TW11 8HG

TEL: 01-977 0878

Books and Publications

WHAT'S THE SECRET OF MAKING MONEY? The Knowledge, and ability, that very few people possess, to undertake work in a specialised field that is crammed with opportunities. We are supplying a **MANUAL** that will enable you, in your own home, **WITH NO PREVIOUS EXPERIENCE**, to repair **VACUUM CLEANERS, DRILLS, and PORTABLE TOOLS**, by showing in easy, step by step stages, how to diagnose faults, rewind **ARMATURES and FIELDS** and make up test equipment. 13 chapters covering test procedures, apparatus required, test charts, where to obtain materials and where to find work. Packed with diagrams and information. Get your copy now. Only £4 plus 30p P&P. **CWO. COPPER SUPPLIES**, 102 Parrswood Road, Withington, Manchester 20, Dept. EE1.

EVERYDAY ELECTRONICS KNOW-HOW made easy. 30-stage speedlearn program. Unique Timesaver breadboards, terminals, plans, and circuit Know-how. Ideal for beginners, students, clubs, schools, colleges. Special intro-offer £4.75. Money back if not delighted. **TECHNOCENTRE (EE)**, P.O. Box 33, 54 Adcott Road, Middlesbrough.

SIMPLIFIED TV REPAIRS. Full repair instructions individual British sets £4.50, request free circuit diagram. Stamp brings details unique TV publications. Ausee, 76 Church Street, Larkhall, Lanarkshire.

Wanted

SURPLUS?? Turn it into cash. Phone: 0491 35529 (Oxon).

WANTED E.E. December 75. **J. BIDDALL**, Caravan Park, Anderson Street, Partick, Glasgow G11.

Tape Exchanges

SPEAK to the world without licence! **WORLDWIDE TAPETALK**, 35 The Gardens, Harrow; Britain's largest Tape-x-change (cassette or reel).

NOTICE TO READERS

When replying to Classified Advertisements please ensure:

- (A) That you have clearly stated your requirements.
- (B) That you have enclosed the right remittance.
- (C) That your name and address is written in block capitals, and
- (D) That your letter is correctly addressed to the advertiser.

This will assist advertisers in processing and despatching orders with the minimum of delay.

DENCO (CLACTON) LIMITED

Dept. E.E.

357-8-9 OLD ROAD
CLACTON-ON-SEA
ESSEX CO15 3RH

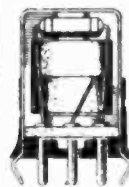

Our components are chosen by technical authors and constructors throughout the world for their performance and reliability, every coil being inspected twice plus a final test and near spot-on alignment.

General Catalogue showing full product range 34p. Overseas Customers 70p, Air-Mail Post Paid.

U.K. & OVERSEAS MANUFACTURERS/STOCKISTS ENQUIRIES WELCOME

Australian Readers Please Note—Our Complete Range of Coils are available from Watkin Wynne Pty. Ltd., 32, Falcon Street, CROWS NEST, 2065, AUSTRALIA. P.O. Box 392.

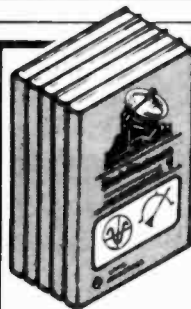

ANNOUNCING A NEW SET OF BASIC ELECTRONICS

This 5 volume set contains over 500 pages. Bound in stiff linen. Cover size 8½in x 5in. Price £7.50 per set (we pay the postage).

Book 1. Introducing Electronics **Book 4.** Meters/Voltage-dividers
Book 2. Resistors/Capacitors **Book 5.** Transistor Project Circuitry
Book 3. Inductors/Diodes

The manuals are unquestionably the finest and most up-to-date available and represent exceptional value.

This series has been written in a fascinating, absorbing and exciting way, providing an approach to acquiring knowledge that is a very enjoyable experience. Suitable for industrial trainees, City and Guilds students, DIY enthusiasts and readers of electronic journals.

Each part explains electronics in an easy-to-follow way, and contains numerous diagrams and half tone blocks with construction details and circuit diagrams for making the following transistor projects: Lamp Flasher, Metronome, Wailer, Photographic/Monostable Timer, Metal Locator, Geiger Counter, Radio Receiver, Intercom., Intruder Alarm, Electronic Organ, Battery Eliminator, Anemometer, Sound Switch, Light and Water-operated Switches, Pressure-operated Switches, Light meter, Radio Thermometer, Ice Alarm, Sound effects oscillator, Variable time-delay switch.

Order now:
Selray Book Company
60 Hayes Hill
Bromley
BR2 7HP

OUR 100% GUARANTEE
Should you decide to return the set after 10 days examination, your money will be refunded by return of post.

Amount enclosed: £

Name:

Address:

ET3

VERO

For the Professional Amateur

Vero can offer a complete package to help you build your product to a truly professional standard. Full range of veroboard, accessories and housings. Please send 10p plus S.A.E., size 7" x 9" for catalogue.

Vero Electronics Limited, Industrial Estate, Chandler's Ford, Eastleigh, Hampshire, SO5 3ZR.
Telephone: (04215) 2956 Telex 47551 VEROEL G
Available worldwide through 3 subsidiary Companies and 25 Agents.

Electronics. Make a job of it....

Enrol in the BNR & E School and you'll have an entertaining and fascinating hobby. Stick with it and the opportunities and the big money await you, if qualified, in every field of Electronics today. We offer the finest home study training for all subjects in radio, television, etc., especially for the CITY AND GUILDS EXAMS (Technicians' Certificates); the Grad. Brit. I.E.R. Exam; the RADIO AMATEUR'S LICENCE; P.M.G. Certificates; the R.T.E.B. Servicing Certificates; etc. Also courses in Television; Transistors; Radar; Computers; Servo-mechanisms; Mathematics and Practical Transistor Radio course with equipment. We have OVER 20 YEARS' experience in teaching radio subjects and an unbroken record of exam successes. We are the only privately run British home study College specialising in electronics subjects only. Full details will be gladly sent without any obligation.



Become a Radio Amateur.

Learn how to become a radio-amateur in contact with the whole world. We give skilled preparation for the G.P.O. licence.

Free!

Brochure without obligation to:

British National Radio & Electronic School

P.O. Box 156, Jersey, Channel Islands.

NAME _____

ADDRESS _____

EEL3 Block caps please

TECHNICAL TRAINING IN ELECTRONICS AND TELECOMMUNICATIONS

ICS can provide the technical knowledge that is so essential to your success: knowledge that will enable you to take advantage of the many opportunities open to you. Study in your own home, in your own time and at your own pace and if you are studying for an examination ICS guarantee coaching until you are successful.

City and Guilds Certificates:

- Telecommunications Technicians
- Radio, TV, Electronics Technicians
- Technical Communications
- Radio Servicing Theory
- Radio Amateurs
- Electrical Installation Work
- MPT Radio Communications Certificate

Diploma Courses:

- Colour TV Servicing
- Electronic Engineering and Maintenance
- Computer Engineering and Programming
- Radio, TV, Audio Engineering and Servicing
- Electrical Engineering, Installation and Contracting

POST OR PHONE TODAY FOR FREE BOOKLET

ICS To: International Correspondence Schools

Dept 7490 Intertext House, London SW8 4UJ or telephone 622 9911

Subject of Interest

Name

Address

Tel:

Age:

NEW BOOK

Op-Amps: Their principles and applications

J. Brian Dance

This book is intended for home constructors and other electronics enthusiasts who require information on operational amplifiers in order to use them in conventional circuits. The text is written in an easy-to-read, non mathematical style and is profusely illustrated with circuit diagrams. A useful glossary of terms is included.

- Contents:
- Introduction
 - Some basic 741 circuits
 - Further 741 circuits
 - Various integrated circuit amplifiers
 - FET input devices
 - Audio power circuits
 - Low noise audio preamplifiers
 - Appendix
 - Glossary of terms
 - Index

Early 1978

96 pages

£2.25 approx



Order now from your bookseller or from
Newnes Technical Books
Borough Green, Sevenoaks,
Kent TN15 8PH

Get a great deal from

Marshall's

A. MARSHALL (LONDON) LTD. DEPT. E.E.
 LONDON—40-42 Clicklewood Broadway, NW2 3ET
 Tel. 01-452 0161 Telex 21492Z
 LONDON—325 Edgware Road W2. Tel: 01-723 4242/3
 GLASGOW—85 West Regent Street, G2 2QD
 Tel. 041-332 4133
 BRISTOL—1 Stella Parade, Fishponds Rd. BS16 2LX
 Tel. 0272 654201

OUR NEW 40pp SPRING 1978
 CATALOGUE IS NOW
 AVAILABLE. PRICE 35p TO
 CALLERS, 45p POST PAID.

TOP 400 SEMICONDUCTORS FROM THE LARGEST RANGE IN THE U.K.

EXPRESS M.O. SERVICE BY RETURN POST—all

orders received despatched same day on stock items

2N696	35	2N3703	-15	2N6126	-45	BC159	-74	BD116	1-20	BFX84	-35
2N697	-50	2N3704	-15	40361	-55	BC160	-35	BD131	-51	BFX85	-35
2N698	-62	2N3705	-15	40362	-55	BC161	-35	BD132	-54	BFX87	-30
2N699	-55	2N3706	-16	40363	1-30	BC167	-12	BD135	-37	BFX88	-30
2N706	-28	2N3707	-18	40406	-60	BC168	-12	BD136	-37	BFX89	1-25
2N706A	28	2N3708	-13	40407	-52	BC169	-12	BD137	-38	BFY50	-25
2N708	28	2N3709	-15	40408	-75	BC170	-18	BD138	-38	BFY51	-25
2N709	-50	2N3710	-16	40409	-75	BC171	-18	BD139	-40	BFY52	-30
2N718	-27	2N3711	-11	40410	-75	BC172	-14	BD140	-40	BFY53	-34
2N718A	-50	2N3712	1-20	40411	2-85	BC177	-20	BD239	-40	BFY90	1-20
2N720A	-80	2N3713	2-30	40514	-80	BC178	-20	BD240	-45	BFY99	1-20
2N914	-35	2N3714	2-45	40595	-90	BC179	-23	BD241	-45	BSX20	-32
2N916	30	2N3715	2-55	40673	-75	BC182	-11	BD242	-50	BSX21	-32
2N918	38	2N3716	3-00	AC126	-45	BC182L	-14	BD243	-60	BO105	1-40
2N929	-25	2N3717	1-45	AC127	-45	BC183	-11	BD244	-65	BO205	2-20
2N930	28	2N3719	2-00	AC128	-45	BC183L	-14	BD245	-65	ME0402	-20
2N1131	-30	2N3720	2-90	AC151V	-40	BC184	-12	BD246	-66	ME0404	-15
2N1132	-37	2N3789	2-90	AC152V	-50	BC184L	-14	BD249	-45	ME0412	-20
2N1613	-30	2N3790	3-10	AC153	-55	BC207	-10	BD530	50	ME4102	-10
2N1711	-30	2N3791	3-10	AC153K	-55	BC208	-10	BDY20	1-00	ME4104	1-00
2N1893	-38	2N3792	3-50	AC176	-50	BC212	-14	BF115	-38	MJ481	1-55
2N1910	-88	2N3794	-20	AC176K	-85	BC212L	-17	BF121	-55	MJ490	1-35
2N2218	-33	2N4058	-38	AC187K	-45	BC213	-18	BF123	-55	MJ2955	-1-25
2N2218A	-37	2N4059	-38	AC188K	-60	BC213L	-18	BF125	-25	MJ2955	-1-25
2N2219	-35	2N4060	-40	AD161	1-00	BC214	-18	BF152	-25	MJ340	-58
2N2219A	-36	2N4061	-42	AD162	1-00	BC214L	-17	BF154	-25	MJ370	-58
2N2220	-25	2N4062	-22	AF106	-55	BC237	-14	BF159	35	MJ371	-60
2N2221	-25	2N4036	-87	AF109	-75	BC238	-12	BF160	30	MJ520	-45
2N2221A	-28	2N4037	-55	AF124	-65	BC239	-15	BF161	60	MJ581	-85
2N2222	-25	2N4058	-20	AF125	-65	BC251	-18	BF166	40	MJ2955	-50
2N2222A	-25	2N4059	-15	AF126	-65	BC252	-22	BF166	40	MJ3055	-85
2N2368	-25	2N4060	-20	AF139	-69	BC257A	-17	BF167	35	MP8111	-35
2N2369	-25	2N4061	-17	AF188	-50	BC258A	-17	BF173	35	MP8112	-40
2N2369A	-25	2N4062	-18	AF200	1-20	BC259B	-18	BF178	25	MP8113	-45
2N2648	-75	2N4126	-17	AF239	-65	BC261A	-24	BF179	30	MPF102	-30
2N1647	40	2N4209	-20	AF240	-60	BC262B	-24	BF180	35	MPSA05	-25
2N2904	-35	2N4919	-85	AF279	-80	BC263C	-24	BF180	35	MPSA06	-25
2N2904A	-37	2N4920	-75	AF280	-85	BC300	-40	BF181	-35	MPSA12	-40
2N2905	-37	2N4921	-50	BC107	-15	BC301	-40	BF182	-35	MPSA55	-25
2N2905A	-38	2N4922	-55	BC108	-15	BC303	-50	BF183	-40	MPSA56	-25
2N2906	-28	2N4923	-70	BC109	-15	BC307	-50	BF184	38	MPSU05	-50
2N2906A	-35	2N5190	-60	BC113	-20	BC308	-15	BF185	35	MPSU06	-58
2N2907	-25	2N5191	-70	BC115	-20	BC309C	-15	BF194	-15	MPSU55	-55
2N2907A	-25	2N5192	-75	BC116	-19	BC317	-14	BF195	-15	MPSU60	-60
2N2924	-15	2N5195	-90	BC116A	-20	BC318	-13	BF196	-15	TIP29A	45
2N2925	-17	2N5245	-34	BC117	-22	BC327	-20	BF197	-17	TIP29C	60
2N3019	-55	2N5294	-40	BC118	-20	BC328	-19	BF198	-18	TIP30A	-18
2N3053	-26	2N5295	-40	BC119	-30	BC329	-19	BF200	-35	TIP30C	85
2N3054	-60	2N5296	-40	BC121	-45	BC336	-21	BF203	-25	TIP31A	-50
2N3055	-70	2N5298	-40	BC122	-30	BC342	-12	BF244	35	TIP31C	35
2N3390	-20	2N5447	-15	BC134	-20	BC548	-12	BF245	-40	IP132A	-55
2N3391	-20	2N5448	-15	BC135	-20	BC549	-13	BF245	-40	IP132C	75
2N3391A	-20	2N5449	-19	BC136	-19	BC590	1-00	BF254	-24	TIP33A	80
2N3392	-10	2N5457	-32	BC137	-20	BCY31	1-00	BF255	-24	TIP33C	1-18
2N3393	-15	2N5458	-33	BC140	-35	BCY32	1-00	BF257	-37	TIP34A	-80
2N3394	-15	2N5459	-29	BC141	-40	BCY33	1-00	BF258	-45	TIP34C	1-20
2N3439	-59	2N5494	-34	BC142	-30	BCY34	1-00	BF259	-48	TIP35A	2-50
2N3440	-64	2N5496	-38	BC143	-30	BCY38	2-00	BF459	-50	TIP36A	2-80
2N3441	-81	2N6027	-60	BC147	-12	BCY42	-60	BF839	-28	TIP41A	-70
2N3442	1-35	2N6181	-45	BC148	-12	BCY58	-25	BF821A	2-60	TIP41C	-90
2N3638	-18	2N6107	-42	BC149	-14	BCY59	-25	BF828	1-38	TIP42A	-80
2N3638A	-18	2N6109	-50	BC153	-27	BCY70	-25	BF861	-30	TIP42C	1-00
2N3639	-30	2N6121	-38	BC154	-27	BCY71	-28	BF929	-37	TIP2955	-85
2N3641	-20	2N6122	-41	BC157	-14	BCY72	-24	BF929	-35	TIP3055	-55
2N3702	-13	2N6123	-43	BC158	-14	BD115	-80	BFX30	-35	TIS43	-43

INTEGRATED CIRCUITS

CA320	2-00	LM748-8	35	TAA5702	3-30
CA3020A	1-00	LM748N	35	TAA611B	1-85
CA3028B	1-20	LM1808	1-92	TAA621	2-15
CA3028A	1-20	LM1826	1-75	TAA661A	1-50
CA3030	1-35	LM3302N1	40	TAA661B	1-50
CA3030A	1-35	LM3401	70	TAA700	3-91
CA3045	1-40	LM3905	1-80	TAA930A	1-30
CA3046	1-80	MC1035	1-75	TAA930B	1-30
CA3048	2-23	MC1303	1-93	TAD100	1-95
CA3049	1-80	MC1304	1-40	TAD100	1-95
CA3050	2-42	MC1305	1-40	TBA120	75
CA3052	1-82	MC1310	1-91	TBA400	2-00
CA3080	1-75	MC1321	1-54	TBA500	2-21
CA3080A	1-88	MC1330	1-80	TBA500Q	2-30
CA3086	1-70	MC1351	1-20	TBA510	2-21
CA3088	1-70	MC1352	1-10	TBA510Q	2-21
CA3089	2-52	MC1458	1-91	TBA520	2-21
CA3090	1-35	NE555	-40	TBA520Q	2-21
CA3130	2-00	NE566	1-80	TBA570Q	2-21
CA3045	1-40	LM3909	68	TBA570Q	2-21
CA3048	2-23	MC1303	1-93	TBA570Q	2-21
CA3049	1-80	MC1304	1-40	TBA570Q	2-21
CA3050	2-42	MC1305	1-40	TBA570Q	2-21
CA3052	1-82	MC1310	1-91	TBA570Q	2-21
CA3080	1-75	MC1321	1-54	TBA570Q	2-21
CA3080A	1-88	MC1330	1-80	TBA570Q	2-21
CA3086	1-70	MC1351	1-20	TBA570Q	2-21
CA3088	1-70	MC1352	1-10	TBA570Q	2-21
CA3089	2-52	MC1458	1-91	TBA570Q	2-21
CA3090	1-35	NE555	-40	TBA570Q	2-21
CA3130	2-00	NE566	1-80	TBA570Q	2-21
LM301A	-67	NE565	1-30	TBA570Q	2-21
LM301N	-40	NE566	1-30	TBA570Q	2-21
LM304	2-45	NE567	1-80	TBA570Q	2-21
LM307N	-85	SA5560	2-50	TBA570Q	2-21
LM308C	1-82	SA5570	2-30	TBA570Q	2-21
LM308N	-85	SO42	1-25	TBA570Q	2-21
LM309K	1-85	SO401	1-30	TBA570Q	2-21
LM317K	3-00	76003N	2-20	TBA570Q	2-21
LM318N	2-26	76008K	1-50	TBA570Q	2-21
LM323K	6-46	76013N	1-50	TBA570Q	2-21
LM339N	1-40	76013ND	1-30	TBA570Q	2-21
LM348N	1-50	76018K	1-50	TBA570Q	2-21
LM350N	2-75	76023N	1-45	TBA570Q	2-21
LM370N	2-50	76023ND	1-26	TBA570Q	2-21
LM371N	1-70	76033N	1-20	TBA570Q	2-21
LM372N	1-70	76110N	1-18	TBA570Q	2-21
LM373N	2-00	76115N	1-51	TBA570Q	2-21
LM374N	3-10	76116N	1-66	TBA570Q	2-21
LM377N	1-75	76131N	1-20	TBA570Q	2-21
LM378N	1-45	76145N	1-56	TBA570Q	2-21
LM379S	3-95	76227N	1-20	TBA570Q	2-21
LM380-8	-90	76228N	1-45	TBA570Q	2-21
LM380N	4-00	76530N	75	TBA570Q	2-21
LM381A	2-45	76532N	1-40	TBA570Q	2-21
LM381N	1-60	76533N	1-20	TBA570Q	2-21
LM382N	1-25	76544N	1-44	TBA570Q	2-21
LM384N	1-45	76545N	1-45	TBA570Q	2-21
LM386N	1-05	76556N	1-44	TBA570Q	2-21
LM387N	1-05	76550N	35	TBA570Q	2-21
LM388N	90	76552N	52	TBA570Q	2-21
LM389N	1-00	76570N	1-85	TBA570Q	2-21
LM702C	-75	76582N	90	TBA570Q	2-21
LM709C	-85	76650N	1-10	TBA940	1-82
LM709N	-85	76650N	1-10	TCA150C	1-85
LM710C	-60	76666N	82	TCA160B	1-81
LM710N	-70	LM710N	-60	TAA320A	1-81
LM723C	-85	LM723C	-85	TAA350A	2-48
LM723N	-75	TAA521	1-90	TCA270A	2-25
LM741C	-85	TAA521	1-90	TCA280A	2-25
LM741N	-40	TAA550	6-00	TCA290A	2-33

MAPLIN

in a modern world of electronics

AUDIO MIXER

A superb stereo audio mixer. It can be equipped with up to 16 input modules of your choice and its performance matches that of the very best tape-recorders and hi-fi equipment. It meets the requirements of professional recording studios, FM radio stations, concert halls and theatres. Full construction details in our catalogue. A component schedule is available on request



PEDAL UNIT

A completely self-contained pedal unit. 13-note, 2-Octave range. 4 organ stops. It can be added to any organ. A really unusual extra is the bass guitar stop which uses four envelope shapers to give a real bass guitar sound. A must for the solo guitarist. Full construction details in our catalogue—post the coupon below now!

BOARDS AND PCB's
Pages 59 to 61 of our catalogue show you our range of Veroboards and S-Decs or if you prefer to make your own pcb's a range of etching systems including the novel etch-in-a-bag system plus printed circuit transfers for that professional finish to your boards.

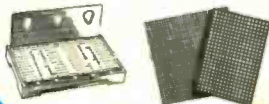

THE 'DRUMSETTE' RHYTHM GENERATOR

Organists, pianists, guitarists... an automatic drum set to accompany you! Nine highly realistic instruments play fifteen different rhythms. Fifteen rhythm-select touch switches and a touch plate for stop/start without rhythm change gives absolute ease of operation. Build it yourself for under £65 including smart teak-effect cabinet. See it and hear it in our shop! Send for full construction details now: MES 49 price 25p

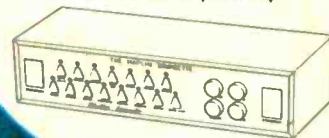

10 CHANNEL STEREO GRAPHIC EQUALISER

A new design with no difficult coils to wind, but a specification that puts it in the top-flight hi-fi class. All this for less than £70 including fully punched and printed metalwork and woodwork. Send for our component schedule now. Full construction details price 40p.



Who says the Maplin Catalogue's worth having?

- "In our 'musts' for readers-to-collect list"—P.E.
- "contains... just about everything the DIY electronics enthusiast requires"—P.W.
- "probably the most comprehensive catalogue we have ever come across"—E.E.
- "has been carefully prepared and is very well presented..."—R.E.C.
- "make the job of ordering components an easy, accurate and enjoyable pastime"—P.W.
- "Only one word describes the publication—superb!" E.T.I.

**OVER 60,000 COPIES SOLD DON'T MISS OUT!
SEND 60p NOW**

MAPLIN ELECTRONIC SUPPLIES
P.O. Box 3, RAYLEIGH, ESSEX S55 8LR
Telephone: Southend (0702) 715155

Shop: 284 London Road,
Westcliff-on-Sea, Essex.

(Closed on Monday)
Telephone: Southend
(0702) 715157

Our bi-monthly newsletter keeps you up to date with latest guaranteed prices—our latest special offers—details of new projects and new lines. Send 30p for the next six issues (5p discount voucher with each copy).

**POST THIS COUPON NOW
FOR YOUR COPY OF OUR
CATALOGUE PRICE 60p**

Please rush me a copy of your 216 page catalogue. I enclose 60p, but understand that if I am not completely satisfied I may return the catalogue to you within 14 days and have my 60p refunded immediately.

NAME 126

ADDRESS

.....

.....

.....

