

Practical projects to build at home

everyday electronics

SEPT. 76
30p



Winemakers'
**FERMENTATION
INDICATOR**

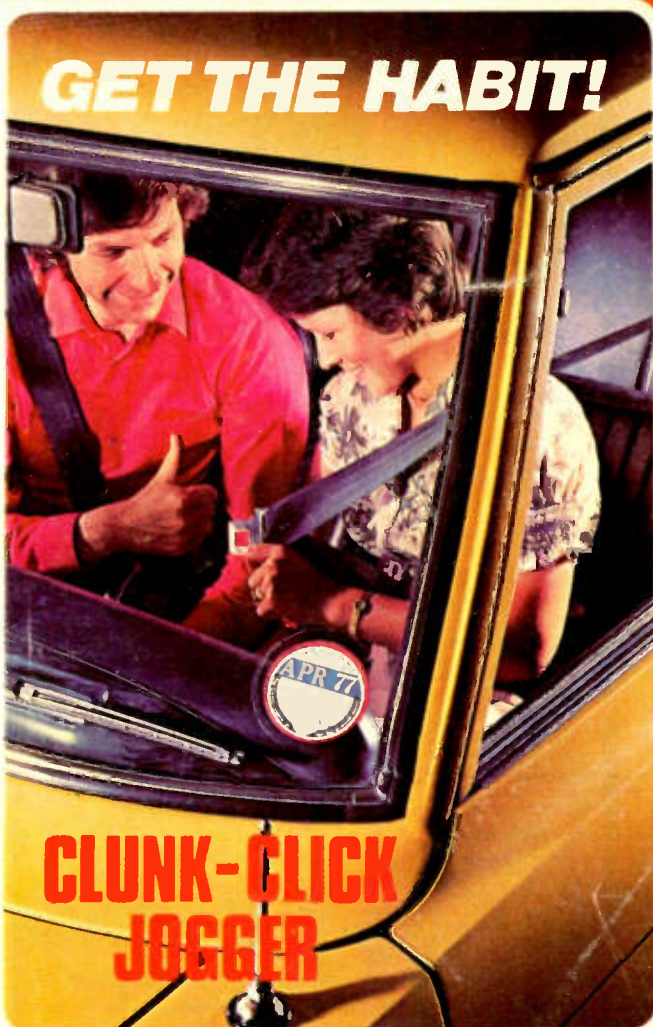

GET THE HABIT!

**CLUNK-CLICK
JOGGER**

ALSO INSIDE ...

- **ELECTRONIC THERMOMETER**
- **COMPONENT TESTER**

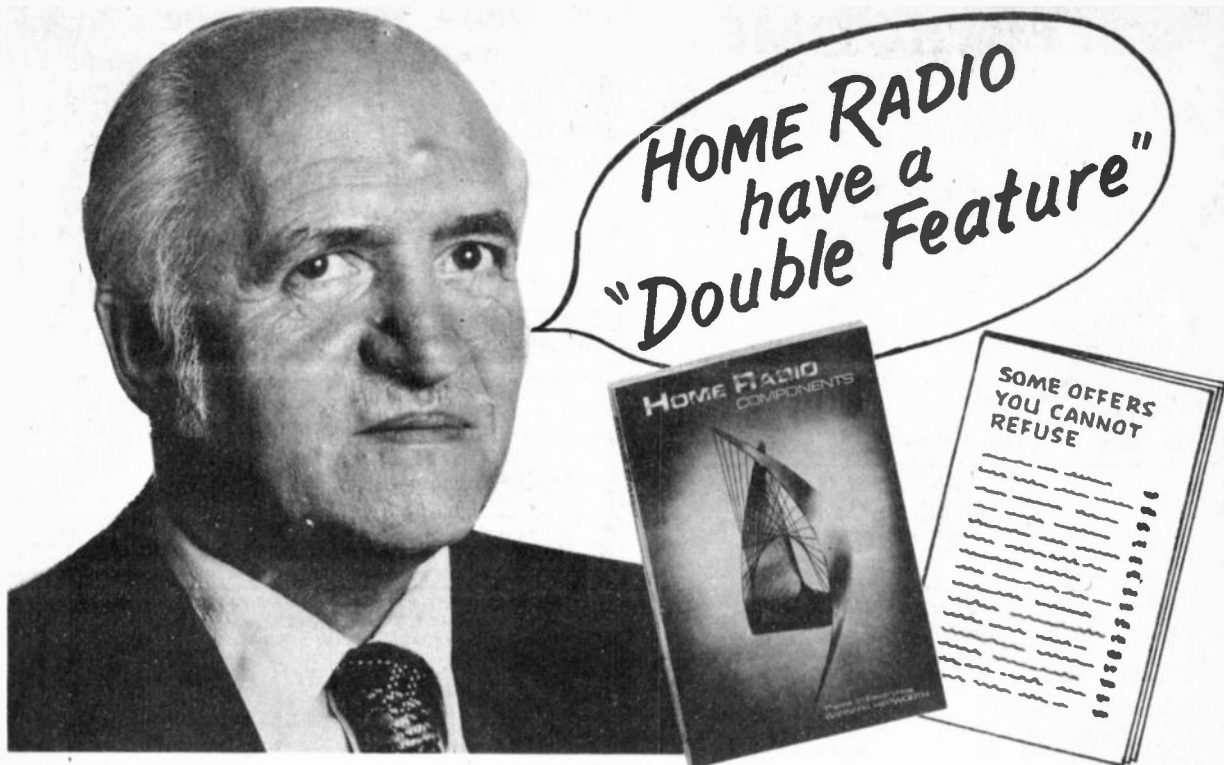

Perhaps you have to be of *my* vintage to know the phrase "a Double Feature", but up to a few years ago cinemas always ran a main film and a supplementary film. Perhaps they still do—I wouldn't know! However, that's by the way; it was just that I was reminded of it because with their new catalogue Home Radio Components are now giving away a supplementary catalogue of bargain lines.

It sounds to me like a very practical and sensible idea. After all, most electronic component firms are bound to accumulate surplus stocks of various items, and rather than dispose of them, why not offer them to their customers at really exceptionally low prices? I'm told that this bargain list will continue for several months and

be up-dated from time to time . . . with new items being added and others deleted. No constructor should be without the famous Home Radio Components Catalogue (it contains 5,000 items clearly listed and indexed plus about 2,000 illustrations) but now you have a *double* incentive for buying one. In addition to getting one of the finest component catalogues available, you also receive a list of bargains at unbelievably low prices. For example, Gemini Mains Transformers: normal price £11.48, bargain list price £5, saving £6.48! This means that with a single purchase from the bargain list you can save the price of your catalogue several times over!

Please write your Name and Address in block capitals

NAME

ADDRESS

HOME RADIO (Components) LTD., Dept. EE
234-240 London Road, Mitcham, Surrey CR4 3HD



(Regn. No
London 912966)



The price of £1.25 applies only to customers in the U.K. and to BFPO Addresses.

By the way, the price of the catalogue is 90p plus 35p for postage and packing. Without doubt it is "a jolly good buy". Why hesitate? Send off your cheque or Postal Order for £1.25 today, together with the coupon on the left.

HOME RADIO (Components) LTD, Dept EE, 234-240 London Road, Mitcham, CR4 3HD Phone 01-648 8422

ELECTROTIME

SPECIALISTS IN ELECTRONIC TIMEKEEPING

ELECTRONIC DIGITAL ALARM CLOCK MODEL EC 3

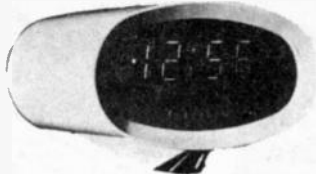

- ★ LARGE 4 DIGIT DISPLAY
- ★ AM/PM INDICATOR
- ★ FLASHING SECONDS INDICATOR
- ★ 5 MINUTE REPEATING SNOOZE ALARM
- ★ 24 HOUR ALARM
- ★ BRIGHTNESS CONTROL
- ★ ATTRACTIVE WHITE CASE

COMPLETE BUILT CLOCK PRICE **£14** inc. VAT

THE "MISTRAL" I DIGITAL CLOCK



- ★ PLEASANT GREEN DISPLAY
- ★ 12/24 HOUR READOUT
- ★ FULLY ELECTRONIC
- ★ PULSATING COLON
- ★ PUSH BUTTON SETTING
- ★ BUILDING TIME 1 HOUR

COMPLETE KIT PRICE **£11.07** inc. VAT

BUILT CLOCK PRICE **£14.95**

LCD MODEL TLC4

CONTINUOUS
READOUT
UTILISING
LIQUID CRYSTAL
DISPLAY

WITH BACKLIGHT
FOR NIGHT
READING

FEATURES—

- ★ HOURS
- ★ MINUTES
- ★ SECONDS
- ★ DATE

RHODIUM **£39.95**

GOLD **£41.50** inc. VAT



LED MODEL TLES

FEATURES—

- ★ HOURS
- ★ MINUTES
- ★ SECONDS
- ★ DATE
- ★ DAY OF WEEK

£29.50 inc. VAT

GOLD OR
RHODIUM PLATED



We are proud to announce the opening of our new Showroom in which you will find one of the Largest Ranges of Digital Electronic Clocks and Watches available in the UK so why not call in and see us! One year's guarantee with all models Electronic accuracy to within seconds per week

ELECTROTIME, DEPT. 4/8, 11, SHEPLEY'S YARD,
SHOPPING PRECINCT, TOWN CENTRE,
CHESTERFIELD, DERBYSHIRE. TEL (0246) 35804

PLEASE SUPPLY
I ENCLOSE CHEQUE/POSTAL ORDER

NAME

ADDRESS

QUALITY STEREO SOUND.

ALMOST **1/2 PRICE OFFER!** SOLENT AUDIO SYSTEM
£7.00
down

Solent Mark II Stereo Tuner Amplifier chassis with AM/FM radio covering long medium short and Stereo FM wavebands. Separate Base and Treble controls. 30 watts total power output (frequency response 25-20,000 Hz) AFC Switching Tape record and playback facilities. Dimensions 18 1/2" x 9" x 3 1/2". The very latest BSR automatic record deck with cue and pause control. Two matching elliptical speaker units.

Order early limited stocks available cash price **£89.95**.
Credit Sale **£7.00** deposit 9 monthly payments of **£8.00**
(Total Credit price **£79.50**). P. & P. **£4.00**. Send **£11.00**
today.

Chassis only available for cash at **£49.00** + p. & p. **£3.00**.

Full 12 months Guarantee.

CALLERS WELCOME.

Access and Barclaycard Orders Accepted by Telephone

FREE! Stereo headphones supplied with every complete order

LEWIS radio EE 9/76 100 CHASE SIDE SOUTHGATE
LONDON N14 6PL Telephone: 01-882-1644

express component service same day turn round

We offer

QUALITY—SERVICE
RELIABILITY—CARE
FULL SPEC DEVICES
COMPETITIVE PRICES

S.A.E. brings Stock

List and Freepost

Order Service plus

Special Offers of the month.



orchard
electronics

Flint House, High Street
Wallingford, Oxon

Tel: (0491) 35529. Telex: 4SP WALFRD 849349

MULLARD AUDIO AMPLIFIERS

All in module form, each ready built complete with heat sinks and connection tags, data supplied.
 Model 1153 600mW power output \$1-10 + 40p post & VAT.
 Model 1172 1W. power output \$1-35 + 45p post & VAT.
 Model EP9000 4 watt power output \$2-40 + 50p post & VAT.
 EP 9001 twin channel or stereo pre amp. \$3-50 + 50p post & VAT.



SOUND TO LIGHT UNIT

Add colour or white light to your amplifier. Will operate 1, 2 or 3 lamps (maximum 450w). Unit in Box all ready to work. \$7-95 plus 95p VAT and postage.



MAINS TRANSISTOR PACK

Designed to operate transistor sets and amplifiers. Adjustable output 6v., 9v., 12 volts for up to 500mA (class B working). Takes the place of any of the following batteries: PP1, FP3, FP4, FP6, FP7, FP9 and others. Kit comprises: main transformer rectifier, smoothing and load resistor condensers and instructions. Real snip at only \$1-50, VAT & Postage 60p.



MAINS MOTOR

Precision made—as used in record decks and tape recorders—ideal also for extractor fans, blower, heaters, etc. New and perfect. Snip at \$6p + VAT & Postage 25p.
 1" stackmotor \$1-50 + VAT & postage 25p. 1 1/2" stackmotor \$3 + VAT & Postage 40p.



AMMETERS

Ideal for chargers etc. 2" sq. full vision 0-8 amp \$6p. 1 1/2" round 0-2 amp \$5p. 0-3 amp \$6p. 0-4 amp 75p. Post & VAT 25p each.

RELAY BARGAIN

Type 600 relay, 2 changeover one open and one closed contact. Twin 500 ohm coils make this suitable or closing off DC 6v. DC 12v. DC 24v or AC mains using resistor and rectifier. 40p each. Resistor or rectifier 20p extra. Post & VAT 20p.

OVEN THERMOSTAT

Made by the famous Diamond H Company, this has a motor joined by a capillary to a variable control and when fitted with a knob is ideal for many ovens or processes. 60p each + post and VAT 15p.



SPIT MOTOR

200-250V Induction motor, driving a Carter gearbox with a 1 1/2" output drive shaft running at 8 revs p.m. for roasting chickens, also for driving models—windmills, coloured disc lighting effects, etc. \$2-95 plus 50p post and VAT.



RECORD PLAYBACK TAPE HEADS

Individual prices of these are:
 2 track record playback heads 75p each.
 4 track record playback heads \$1-10 each.
 Erase heads are also available separately—
 2 track \$6p—4 track \$8p.
 MV metal mounting shields 60p each.
 2 track heads already fixed on heavy mounting plate with shield \$1-85. ALL PLUS 25% VAT.

PRESSURE SWITCH

Containing a 15 amp change over switch operated by a diaphragm which in turn is operated by air pressure through a small metal tube. The operating pressure is adjustable and is set to operate in approx. 10in. These of water are quite low pressure devices and can in fact be operated simply by blowing into the inlet tube. Original use was for washing machine to turn off water when tub has reached applications \$2-10 each + 25p post & VAT.



MICRO SWITCH BARGAINS

Rated at 5 amps 250 volts. Ideal to make a switch panel for a calculator and for dozens of other applications. Parcel of 10 for \$1-00 VAT AND POST PAID.

HONEYWELL PUSH BUTTON PANEL MOUNTING MICRO SWITCH

1-2-3-Bank, each bank consisting of the changeover micro switch rated at 10 amps 250 volts. Through panel fixing by 2 lock nuts complete with black 1" diameter knob. Prices—
 1 bank 60p—2 bank \$6p—
 3 bank 70p.



MULLARD UNILEX

A mains operated 4 + 4 stereo system. Rated one of the finest performers in the stereo field this would make a wonderful gift for almost anyone in easy-to-assemble modular form and complete with a pair of Goodmans speakers this should sell at about \$38—but due to a special bulk buy and as an incentive for you to buy this month we offer the system complete at only \$14-00 including VAT and postage.



DISCO STROBE

Mains operated for speed strobe—kit comprises: motorised multi flasher, strobe flash rate switch, master switch, 'W' shaped tube, tube mounting clips, holders and ballast unit. Price \$2-50, VAT and post paid. Price \$4-50 each.

DISTRIBUTION PANELS

Just what you need for work bench or lab. 4 x 1 1/2 inch sockets in metal box with standard 1 1/2 amp fused plug and on/off switch with neon warning light. Supplied complete with 6 feet of flex cable. Wired up ready to work. \$3-75, VAT and postage 65p.



THIS MONTH'S SNIP

Smiths 24 hr. timer heart, really the "Autoset" without its plastic case. This is a 24 hr. twice on, twice off, clock switch which will repeat until re-programmed. Switches rated at 15 amps. Limited supplies—£4-50 VAT and post paid.

TWIN OUTPUT POWER PACKS



These have two separately R.C. smoothed outputs so can operate two battery radios on a stereo amp without cross modulation (they will of course operate one radio-tape-cassette-calculator in fact any battery appliance and will save their cost in a few months). Specs: Full wave rectification, double insulated mains transformer—total enclosed in a hard P.V.C. case—three core mains lead—terminal output—when ordering please state output voltage 4 1/2v, 6v, 7 1/2v, 9v, 12v or 24v. Price \$3-95. Post and VAT included.

ROOM THERMOSTAT

Famous Batchwell, elegant design, intended for wall mounting. Will switch up to 20 amps at mains voltage. covers the range 0-30°C. Special snip this month \$2-50, post and VAT paid.

LIGHT PIPE

A mains operated travelling light array 24ft. long it uses 130 miniature bulbs which flash in sequences to make bands of light move along the tube—The tube can be draped around a particular item or set and cannot fail to attract attention—complete kit consists of—24ft. of translucent tubing—140 miniature bulbs—8 yards multicore cable—motorised switch—tape for quick connections and full wiring instructions, \$10-00 for the complete kit. Post and VAT paid.



SECRET SWITCH/MICROWAVE ACTIVATED

Transmitting at very high frequency around 5000 Mhz, this device will stay dormant until the micro wave is reflected back by the passing of an object be it animal or mineral. Once reflected back a relay is triggered. The advantage of this over light switches or sound switches is that the beam is completely invisible and it is not affected by sunlight or by darkness. It can be used as an intruder alarm or to open gates, raise flaps, etc., and it will work ready to work regardless of daylight, sunlight or darkness. An extremely useful device employs a mains operated Kaytron microwave transmitter with associated receiver and tuned circuits, etc. Limited quantity only, price \$50 each, post and VAT paid.

**FERMENTATION INDICATOR—
 "CLUNK-CLICK" JOGGER—
 ELECTRONIC THERMOMETER—
 CAPACITY INDUCTANCE AND
 RESONANCE TESTER**

To receive parts for the projects featured this month, send the estimated price + 40p post. Any cash adjustment can be made later.

RADIO STETHOSCOPE

Easiest way to fault find, traces signal from aerial to speaker, when signal stops you've found the fault. Use it on Radio, TV, amplifier, anything. Complete kit comprises two special transistors and all parts including probe tube and crystal earpiece. \$2-95, twin stetho-set instead of earpiece \$8p, VAT and postage incl. in price.



TERMS: Where order is under 45 please add 30p surcharge to offset packing expenses. Send SAE for monthly list.

J. BULL (ELECTRICAL) LTD.
 (Dept. EE), 103 TAMWORTH RD.
 CROYDON CR9 1SG

ITS FREE!

Our monthly Advance Advertising Bargains List gives details of bargains arriving or just arrived—often bargains which sell out before our advertisement can appear—it's an interesting list and it's free—just send S.A.E. Below are a few of the Bargains still available from previous lists.

Power transformer with circuit for sound to light unit. It is a very simple circuit and all parts are readily obtainable from us or you may already have them in your junk box. Price of the transformer with circuit 74p, post and VAT paid.

ORP 12 light set. This device has been going for some years now but it has not been bettered and new applications keep being found for it. We have good stocks, price \$6p + 8p.

Throat mikes. These are an ex WD item as used by air crew on their intercom, but being electromagnetic they also serve as pick-ups on musical instruments, talking to passengers on motor bike and no doubt many other use. Price 60p a pair + 15p.

12 1/2 watt speaker bargain, 5" round mid-range, made for high price hi-fi outfit, a really super speaker. \$3 + 37p, post 60p + 18p.

O.C.P. photo transistor by Mullard, very popular for circuits such as infra-red burglar alarms, smoke detectors, etc. A big buy enables us to offer at the very favourable price of 25p each + 2p, or 5 for £1 + 8p.

Component boards, mainly ex computer, these contain many useful parts and represent fantastic value at 5 for £1 + 8p. We guarantee the 5 would be different. You would receive ICs etc., variable controls with long leads and so on easy to remove and re-use. Post 50p + 4p.

Ferrite pot core (Vinko) made by Mullard, maker's ref. No. LA 14107402K, circular, size approx. 1 1/2" x 7/8", a size which is the same as the one specified for the Scorpio car ignition system. Price only 60p + 4p per pair. Post 15p + 1p.

18v DC motor made by Smiths, powerful, ideal for car blower; motor size 4" long x 3" diameter, 1" spindle, 1 1/2" long. \$2 + 10p. Post 40p + 3p.

Thermostat with capillary with sensor joined by approx. 1 metre of capillary covering the temperature range 0-170°C capable of switching 16 amps at 250v. Made by the famous Ranco Company with screwed thread and spindle rather like a volume control—has dozens of applications. Offered at only 75p + 8p. Post 12p + 1p.

Aerials. For medium and long wave, wound and fitted on ferrite rod, 6" long by 1" diameter. Price 60p + 15p. Post 16p + 8p.

Dial Thermometer by Rototherm, indicates from 0°F to 250°F, dial size 3 1/2" chrome and glass front. 75p + 8p. Post 16p + 1p.

Instrument Mains Transformer, 6-3v at 1 amp and 115v at 100mA. This is an upright mounting open construction, small size (2 1/2" x 2 1/2"). Price £1-40 + postage and VAT 60p. DITTO. 6-3v at 1 amp and 160v at 200mA. This is a fully shrouded upright mounting transformer, size approx. 2 1/2" x 3" x 3". Price £1-95 + post and VAT 85p.

6 switch 5000 lamp controller. This is a motor driving a rotating drum made up of discs with cut-outs. As the cut-outs engage on the switch levers, contact is made via 10 amp switches. A large variety of lighting effects can be obtained. Ready for mains operation. A real bargain at \$2-75 + post & VAT 65p.

Clock switch for Tricity cooker, made by Smiths and probably a replacement in many other cookers. This has clock in the centre and the two control switches on the right-hand side. The top control switch sets the on-off times and is infinitely adjustable over the 12 hours; the lower switch selects manual or automatic. No glass front, but you could take this off your existing clock. Price £1-75 each + post & VAT 35p.

Photo Multiplier Tubes. U.S. made, R.C.A. type No. 4555. These tubes have a gain of a million or more—regular price around \$50 each, our price \$2-75 + 54p each. Brand new in original maker's cartons.

Audio Depth Alarm. Kit of parts for this project as featured in the August edition of "P.F.W.", price \$2-50, post and VAT paid.

Photo Electric Kit. Comprises electrophoto cell, relay and all the parts to make broken beam infra-red or light operated switch. The basis for an intruder alarm and for counting, door opening, etc. All parts with circuit £1-95 post and VAT paid.

Disco Dimmers made by Ultra Electronics, this is a variable controller which can be fitted behind a panel or into a standard switch box and it will control by 1250 watts along your similar non-inductive load. Very special price only \$3 + 24p + 30p + 3p.

Disco Black Light Lamp 175 watts—230/240v pear-shaped back outer glass which obscures all visible radiation but emits long wave near violet (black light). This lamp provides a convenient way of fluorescing a discotheque, club, dance hall, party etc., and being a direct plug-in replacement of a tungsten lamp it is very convenient for temporary use anywhere. Price \$6-50 + 50p. Post 50p + 4p.

Some more Relay bargains. Miniature plug-in type with persepex dust cover 700 ohm 13v DC working. 4 sets of gold-plated changeover contacts 1/3 amps. Normally an expensive relay. Our price £1 + 8p.

SINCLAIR IC20
IC20 10W+10W stereo IC amplifier kit with free booklet and printed circuit £4.95
PZ20 Power supply kit for the above £3.95.
VP20 Volume, tone-control and preamp kit £7.95.
Send sae for free leaflet.

JC12 AMPLIFIER

6W IC audio amp with free data and printed circuit £1.95*

DELUXE KIT FOR JC12

Contains extra parts for the pcb and volume and tone controls. Mono version £2.35. Stereo £4.95.

JC12 POWER KIT

Supplies 25V 1Amp £3.55.

JC12 PREAMP KITS

Type 1 for magnetic pickups, mics and tuners. Mono £1.50. Stereo £3.95. Type 2 for ceramic or crystal pickups. Mono 89p. Stereo £1.75.

Send sae for free leaflet.



S-DECS AND T-DECS*

S-Dec £2.34. T-Dec £4.95.

u-DeCA £4.45. u-DeCB £7.85

IC carriers:—

16 dil: plain £1.87.

with socket £2.21.

10T05: plain 99p. with socket £1.95.

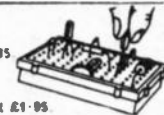

FERRANTI ZN414

IC radio chip £1.44. Extra parts and pcb for radio £3.95. Case 99p. Send sae for free data.

SINCLAIR PROJECT 80 AUDIO MODULES

FM tuner £13.25. Q16 £9.50. PZ5 £3.95. PZ6 £8.70. PZ8 N/A. Trans for PZ8 £5.90. Z40 £5.75. Stereo 80 £11.95. Project 8050 £18.95. Quad decoder £14.95.

SI-PAK AUDIO MODULES

S450 Tuner £18.95. AL60 £4.33. PA100 £13.45. MK80 audio kit £27.30. Teak 60 £9.95. Stereo 30 £15.95. TC30 £4.90. AL250 £18.15. Send sae for free data.

SAXON ENTERTAINMENTS AUDIO MODULES

SA1208 £18.95. SA1204 £13.30. SA808 £11.95. SA604 £18.30. PM1201/8 £11.45. PM1202/8 £14.95. PM1202/4 £14.95. PM1201/4 £11.45. PM601/8 £9.95. PM301/8 £9.70. Send sae for free leaflet.

SINCLAIR BLACK WATCH

Fully assembled with black strap £29.95*. Bracelet £2.90*



SINCLAIR CALCULATORS*

Scientific N/A. Cambridge % £7.35. Cambridge Scientific £11.45. Oxford 100 N/A. Oxford 300 £13.30. Programmable Scientific with free mains unit £24.95. Mains adaptors: For Oxtords £3.16. For Cambridge and Scientific £3.18.

CBM CALCULATORS*

7964D 8 digit/1/2% memory £5.99. 897D 8 digit/1/2% function memory £8.45. SR7910D 8 digit or 5+2/2 memory/trig/log/pi/powers £11.90. SR1800 10 digit scientific £29.55. SR4148R 14 digit rechargeable scientific £30.10. Mains adaptors £3.20.

CASIO CALCULATORS*

Personal Mini 6+6 digits/squares/powers/reciprocals £3.95. Pocket 8S 8 digits/1/2% const £8.95. Memory 8R 8 digit/1/2% memory/const. £8.95. Pocket Mini P-310 £3.95. FX20 £18.95. Mains adaptors £3.95.

NOVUS CALCULATORS*

750 8 digit £3.45. 835 8 digit/1/2% const/sq. root/4 function memory £7.99. 4525 10 digit programmable scientific £45.90. 4510 £13.20. 4515 £37.65. 4520 £22.65. Free charger with 4515. 4520 and 4525. Mains adaptors for other models £4.20.

MISTRAL 1 24HR DIGITAL CLOCK KITS*

Includes pcb, power supply, case, 1/2" display, chip and all parts. Kit £10.95. Built £12.50. Also Mistral 2, deluxe assembled version with alarm and tilt sleep-over facility £13.95.

NATIONAL M100MH DIGITAL CLOCK MODULE*

Complete module including 1/2" display and clock chip fully assembled on a 1 1/2" x 3" pcb. Just add a power supply, switches, etc. to produce a 24hr clock with alarm and auto-dim. £8.55.

SEND SAE FOR OUR DIGITAL CLOCK LEAFLET

PRINTED CIRCUIT KIT £3.95*

Make your own printed circuits. Contains etching dish, 100 sq ins of pc board, 1 lb ferric chloride, etch resist pan, small drill bit, laminate cutter.

BATTERY ELIMINATOR BARGAINS STABILIZED POWER UNITS*

Millenia series. Switched 1 to 30V in 0.1V steps. 1A output: Kit £11.45. Kit + case £14.40. Built £16.40. 2A output: Kit £13.95. Kit + case £16.90. Built £20.95.

6-WAY SPECIAL £5.20

Switched output of 3, 4, 6, 7, 9, 12V at 500mA

6-WAY DOUBLE RADIO MODEL £5.20

Switched output 3+3/4+4+7/8+7/8+7/8+9/12+12V at 250mA. Also 15/16/24V single. 3-WAY MODEL

3-WAY MODEL

Switched output of 8/7/8V at 250mA with 4-way multi-jack plug and free matching socket £2.95*

RADIO MODELS

50mA with press-stud battery connectors. 9V £3.25. 6V £3.45. 9+9V £4.45. 6+6V £4.65. 4+4+4V £4.45. Also 9V 300mA £3.95.

CASSETTE MAINS UNITS

74V output with 5 pin DIN plug. 50mA £3.45. 300mA £3.95.

CAR CONVERTERS

Input 12V DC. Output 8/7/8V OC 1A regulated £4.75*

BATTERY ELIMINATOR KITS

Send sae for free leaflets on range.

100mA radio type with press-stud battery terminals. 4 1/2V £1.95. 6V £1.95. 9V £1.95.

100mA double radio type with press-stud battery terminals 4 1/2V+4 1/2V £2.90. 6V+6V £2.90. 9V+9V £2.90

100mA cassette type with 5 pin DIN plug. 7 1/2V £1.95.

Stabilized 8-way type transistor stabilized to give low hum. 3/4/7/7/9/12/15/18V. 100mA £3.15. 300mA £4.65.

Heavy duty 13-way types 4 1/2/6/7/8 1/2/11/13/14/17/21/25/28/34/42V. 1 Amp Model £4.40. 2 Amp Model £6.95.

Car Converter kit Input 12V DC. Output 8/7/8V DC 1A regulated £1.95.

MAINS TRANSFORMERS

6-0-6V 100mA 95p. 9-0-9V 100mA 95p. 18V 1A £1.65.

0/12/15/20/24/30V 1A £3.60. 12-0-12V 100mA £1.95.

0/12/15/20/24/30V 2A £4.95. 20V 2 1/2A £2.25.

SWANLEY ELECTRONICS

Dept. EE, PO BOX 68, SWANLEY, KENT.

Post 30p on orders under £2, otherwise free. Prices include VAT. (Overseas customers deduct 7% on items marked*, otherwise 11%). Official orders welcome.



Become a radio amateur.

Learn how to become a radio-amateur in contact with the whole world. We give skilled preparation for the G.P.O. licence.

Free! (Black caps please)

Brochure, without obligation to: **BRITISH NATIONAL RADIO & ELECTRONICS SCHOOL,** P.O.Box 156, Jersey, Channel Islands.

NAME _____

ADDRESS _____

WAA EEK96

VALVE BARGAINS

Any 5 64p, 16 £1, 50 £4-50. Your choice from the following list:

- ECH84, ECC82, EF80, EF183, EF184, PC85, PC88, PCF30, PCF802, PCL82, PCL84, PCL85, PCL805, PFL200, PL36, PL504, PY61, PY800, PY88, EH90, 30PL14, 6F28.

Colour Valves 30p each PL508, PL 508, PY500/A. Price £3.60 each. Polyester Capacitors—250 v/w 25p per pack of 5—0.01µF, -0.015µF, -0.022µF, -0.033µF, -0.1µF, -0.15µF, -0.22µF, -0.33µF, -0.47µF, 1.5µF.

Prices include V.A.T. P. & P. under £1/15p, £1 to £3/25p above £3/35p. Overseas at cost. Money back guarantee on all orders.

ELECTRONIC MAIL ORDER

62 BRIDGE ST., RAMSBOTTOM, BURY, LANCs. Tel. Rams. 3036

AERIAL BOOSTERS

We make three types of Aerial Boosters all for set top fitting, with Co-ax Plugs and Sockets. B11—For Stereo and Standard VHF Radio.

B12—For the older VHF Television, please state BBC1 and ITV Channels.

B48—For mon. or colour this covers the complete UHF band.

All Boosters are complete with Battery and take only minutes to fit.

Price £3.60 each. 5—0.01µF, -0.015µF, -0.022µF, -0.033µF, -0.1µF, -0.15µF, -0.22µF, -0.33µF, -0.47µF, 1.5µF.

OVER 2,000 ELECTRONIC COMPONENTS IN A

BIG NEW FREE

100 PAGE CATALOGUE

YOURS BY POSTING TODAY

Please send me the 100 page Tandy catalogue

Name _____

Address _____

TANDY

Nationwide supermarket of sound!

Tandy Corporation (Branch UK), Bilton Road, Wednesbury, W. Midlands WS3 7JN.



40 PAGES IN COLOUR



Stirling Sound Products

FROM BI-PRE-PAK

UNIT 1 PRE-AMP/CONTROL

SUPERB VALUE AT

£7.80

WITH ACTIVE TONE CONTROL CIRCUITRY

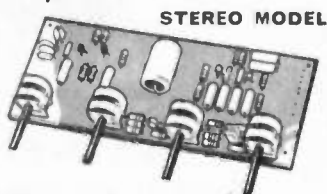

STEREO MODEL

UNIT 1, latest addition in the Stirling Sound range of realistically priced constructional modules is going to assure many more constructors of obtaining quality where price has prevented it before. UNIT 1 offers full stereo facilities, is guaranteed and easy to connect up.

- Input sensitivity—50 mV, adjustable
- Output—200 mV for 50 mV in
- Bass control—±15 dB at 30 Hz
- Treble control—±15 dB at 10 kHz
- Balance control; volume control; bushed spindles throughout.
- Operating voltage—10 to 16V

MADE IN OUR OWN FACTORY IN ESSEX

MORE POWER—LESS VAT

GREATER VALUE

SS.140 MK.3

POWER AMP.

Built for hard work

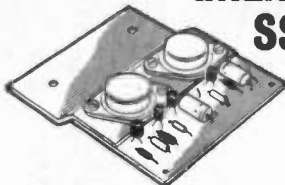

40 WATTS R.M.S.

INTO 4Ω

£3.95

+ 8% V.A.T.

Resulting from research and development, the Mk.3 version of this most popular power amp. now includes built-in output capacitor with improved stability under severest working conditions. Greatly used for P.A., disco and similar work, SS.140 offers fantastic value for the price.

Build and save with Stirling Sound

BASIC MODULES FOR BUILDING UP TO A STEREO TUNER-AMP

POWER AMPS

- | | | |
|----------|--|-------|
| SS.103 | 3W r.m.s. amplifier incorporating I.C./SL60745. With current, short-circuit and thermal protection | £1.75 |
| SL.103-3 | Stereo version of above | £3.25 |
| SS.105 | 5W amplifier to run from 12V (3½" x 2" x 1") | £2.25 |
| SS.110 | Mk. 3 Similar to SS.105 but more powerful giving 10W into 4 ohms, using 24 volts | £2.75 |
| SS.120 | Mk. 3 20W module when used with 34 volts into 4 ohms | £3.00 |

CONTROL

- | | | |
|--------|---|-------|
| SS.100 | Active tone control, stereo, ± 15dB cut and boost with suitable network | £1.60 |
| SS.101 | Pre-amp for ceramic p.u., radio & tape with passive tone control details | £1.60 |
| SS.102 | Stereo pre-amp with R.I.A.A. equalisation, mag., p.u., tape and radio in. | £2.25 |

POWER STABILISER

- | | | |
|--------|---|--------|
| SS.300 | Add this to your unstabilised supply to obtain a steady working voltage from 12 to 50V for your audio system, workbench etc. Money saving and very reliable | £3.25* |
|--------|---|--------|

F.M. TUNING

- | | | |
|--------|---|-------|
| SS.201 | Front end, geared drive capacitor tuning, 88-108 MHz. AFC facility | £5.00 |
| SS.202 | I.F. amp A meter and/or A.F.C. can be connected (size 3" x 2") | £2.85 |
| SS.203 | Stereo decoder
For use with Stirling Sound modules, or with any other good mono F.M. tuning section. A L.E.D. beacon can be added to indicate when a stereo signal is tuned in (3" x 2") | £3.85 |

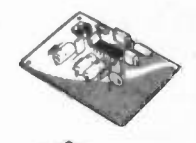
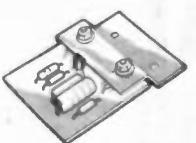
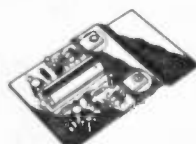

Stirling Sound

POWER PACKS

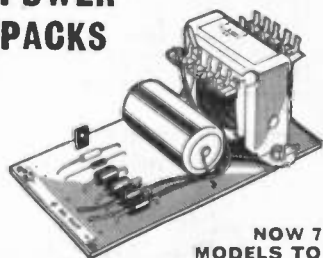

NOW 7 MODELS TO CHOOSE FROM

Not only do these excellent power packs stand up unflinchingly to hard work, inclusion of a take off point at around 13-15 V adds to their usefulness and once again price value is outstanding.

Add 50p for plp any model.

Made to serve for years

- | | | |
|--------|--------|--------|
| SS.312 | 12V/1A | £3.75* |
| SS.318 | 18V/1A | £4.15* |
| SS.324 | 24V/1A | £4.60* |
| SS.334 | 34V/2A | £5.20* |
| SS.345 | 45V/2A | £6.25* |
| SS.350 | 50V/2A | £6.75 |

SS310/50 STABILIZED VARIABLE OUTPUT POWER SUPPLY
Gives stabilized output as and when required at any voltage from 10 to 50V. With heat sink. Tested and guaranteed £11

TERMS OF BUSINESS:

NEW SHOWROOM

We have extended our premises and opened up a new demonstration showroom. All welcome.

VAT at 12½% must be added to total value of order except for items marked * or (8%) when VAT is to be added at 8%. No VAT on overseas orders. POST & PACKING add 30p for UK orders unless marked otherwise. Minimum mail order acceptable—£1 Overseas orders, add £1 for postage. Any difference will be credited or charged. PRICES subject to alteration without notice. AVAILABILITY All items available at time of going to press when every effort is made to ensure correctness of information.

TO STIRLING SOUND (BI-PRE-PAK LTD.), 220/222 WEST ROAD, WESTCLIFF-ON-SEA, ESSEX S50 9DF

Please send

..... for which I enclose £

Inc. V.A.T.

NAME

ADDRESS

EEC8

Order your Stirling Sound products from

BI-PRE-PAK LTD

Co Reg No 820919

222 224 WEST ROAD, WESTCLIFF-ON-SEA, ESSEX S50 9DF.

TELEPHONE: SOUTHERN (0702) 46344

CHEQUES/MONEY ORDERS PAYABLE TO BI-PRE-PAK LTD.

BI-PAK High quality audio

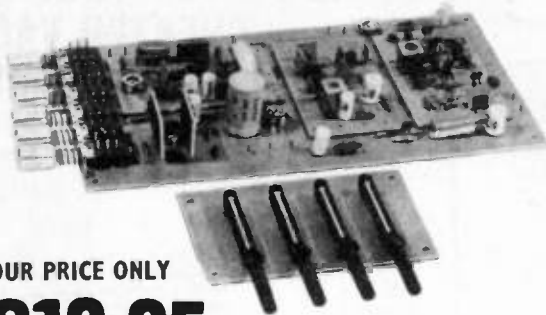

OUR PRICE ONLY

£19.95

The 450 Tuner provides instant programme selection at the touch of a button ensuring accurate tuning of 4 pre-selected stations, any of which may be altered as often as you choose, by simply changing the settings of the pre-set controls.

Used with your existing audio equipment or with the BI-KITS STEREO 30 or the MK60 Kit etc. Alternatively the PS12 can be used if no suitable supply is available, together with the Transformer T461.

The S450 is supplied fully built, tested and aligned. The unit is easily installed using the simple instructions supplied.



STEREO FM TUNER

Fitted with Phase Lock-loop Decoder

- ★ FET Input Stage
- ★ VARI-CAP diode tuning
- ★ Switched AFC
- ★ Multi turn pre-sets
- ★ LED Stereo Indicator

Typical Specification:
Sensitivity 3µ volts
Stereo separation 30db
Supply required 20-30v
at 90 Ma max.

STEREO PRE-AMPLIFIER PA 100



A top quality stereo pre-amplifier and tone control unit. The six push-button selector switch provides a choice of inputs together with two really effective filters for high and low frequencies, plus tape output.

Frequency Response + 1dB
20Hz-20KHz.

Sensitivity of inputs:

1. Tape Input 100mV into 100K ohms
2. Radio Tuner 100mV into 100K ohms
3. Magnetic P.U. 3mV into 50K ohms

P.U. Input equalises to R1AA curve within 1dB from 20Hz to 20KHz. Supply 20-35V at 20mA. Dimensions—290mm x 89mm x 35mm.

£13.50 P & P 45p

MK60 AUDIO KIT:

Comprising: 2 x AL60's 1 x SPM80, 1 x BTM80, 1 x PA100, 1 front panel and knobs. 1 Kit of parts to include on/off switch, neon indicator, stereo headphone sockets plus instruction booklet. **COMPLETE PRICE £27.55** plus 62p postage.

TEAK 60 AUDIO KIT:

Comprising: Teak veneered cabinet size 16 1/2" x 11 1/2" x 3 1/2", other parts include aluminium chassis, heatsink and front panel bracket plus back panel and appropriate sockets etc. **KIT PRICE £9.20** plus 62p postage.

AL 60

25 Watts (RMS)

VAT ADD 12 1/2%



- Max Heat Sink temp. 90C.
- Frequency response 20Hz.
- Distortion better than 0.1 at 1kHz.
- Supply voltage 15-50v.
- Thermal Feedback.
- Latest Design Improvements.
- Load—3,4,5, or 16ohms.
- Signal to noise ratio 80db.
- Overall size 63mm. 13mm.

Especially designed to a strict specification. Only the finest components have been used and the latest solid-state circuitry incorporated in this powerful little amplifier which should satisfy the most critical A.F. enthusiast.

ONLY £3.95

Stabilised Power Supply Type SPM80

SPM80 is especially designed to power 2 of the AL60 Amplifiers, up to 15 watts (r.m.s.) per channel simultaneously. With the addition of the Mains Transformer BMT80, the unit will provide outputs of up to 1.5A at 35V. Size: 63mm, 105mm, 30mm. Incorporating short circuit protection.

INPUT VOLTAGE 33-40V. A.C.
OUTPUT VOLTAGE 33V. D.C. Nominal
OUTPUT CURRENT 10mA-1.5 amps
OVERLEAD CURRENT 1.7 amps approx.
DIMENSIONS 105mm x 63mm x 30mm
TRANSFORMER BMT80 £2.60 + 62p. postage

£3.00

STEREO 30 COMPLETE AUDIO CHASSIS

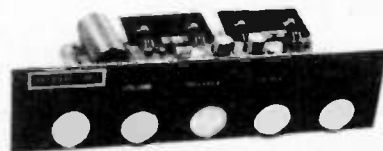

7 + 7 WATTS R.M.S.

The Stereo 30 comprises a complete stereo pre-amplifier, power amplifiers and power supply. This, with only the addition of a transformer or overwind will produce a high quality audio unit suitable for use with a wide range of inputs i.e. high quality ceramic pick-up, stereo tuner, stereo tape deck etc. Simple to install, capable of producing really first class results, this unit is supplied with full instructions, producing really first class results, this unit fuse and fuse holder and universal mounting brackets enabling it to be installed in a record plinth, cabinets of your own construction or the cabinet Hi-Fi performance with a minimum of installation difficulty (can be installed in 30 mins.).

TRANSFORMER £2.45 plus 62p p & p

TEAK CASE £3.65 plus 62p p & p.

£15.75 P & P 45p.

equipment mono and other modules for Stereo

NOW BI-PAK BRINGS YOU— The AL80

35^{RMS} w power Amp!

ONLY
£6.95

+ 8% VAT

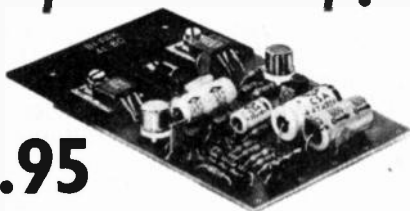

A High Fidelity Power Amplifier with a maximum Power Output of 35 watt R.M.S., which has a maximum operating voltage of 60v. A MUST for all HI-FI users.

Maximum supply voltage	15-60v
Power output for 2% THD	35 watts R.M.S.
Harmonic distortion	0.1%
Load impedance	3-8-16 ohm
Input impedance	50K ohm
Frequency response +3dB	20Hz-40KHz
Sensitivity for 25 watts O/P	280mV R.M.S.
Max. Heat sink temperature	90°C
Dimensions	102mm x 64mm x 15mm
Mounting	2, 4BA fixing holes in heat sink
Fuse requirements	1.5A

AND for those who need more P-O-W-E-R

AL250

125^{RMS} w

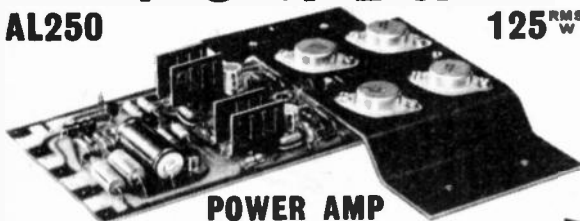

POWER AMP

Specially designed for use in—
Disco Units, P.A. Systems, high power
Hi-Fi, Sound reinforcement systems

SPECIFICATION:

Output Power: 125 watt RMS Continuous	Total harmonic distortion 50 watts into 4 ohms: 0.1%
Operating voltage: 50-80	50 watts into 8 ohms: 0.06%
Loads: 4-16 ohms	S/N ratio: better than 80dBs
Frequency response: 25Hz- 20kHz Measured at 100 watts	Damping factor, 8 ohms: 65
Sensitivity for 100 watts output at 1kHz: 450mV	Semiconductor complement: 13 transistors 5 diodes
Input impedance: 33K ohms	Overall size: Heatsink width 190mm, length 205mm, height 40mm

ONLY **£15.95** +8% VAT

MPA 30



Enjoy the quality of a magnetic cartridge with your existing ceramic equipment using the new Bi-Pak M.P.A. 30 which is a high quality pre-amplifier enabling magnetic cartridges to be used where facilities exist for the use of ceramic cartridges only. Used in conjunction are 4 low noise, high gain silicon transistors. It is provided with a standard DIN input socket for ease of connection. Supplied with full, easy-to-follow instructions.

£2.65

**VAT
ADD
12½%**

POSTAGE & PACKING

Postage & Packing add 25p unless otherwise shown. Add extra for airmail. Min. £1-00

AL 20-30 AUDIO AMPLIFIER MODULES

The AL20 and AL30 units are similar in their appearance and in their general specification. However, careful selection of the plastic power devices has resulted in a range of output powers from 5 to 10 watts R.M.S. The versatility of their design makes them ideal for use in record players, tape recorders, stereo amplifiers and cassette and cartridge tape players in the home. Harmonic Distortion Po = 3 watts f = 0.25% Load Impedance 8-16 ohm

Frequency response ± 3dB Po = 2 watts 50Hz-25KHz.
Sensitivity for Rated O/P—Vs = 25v. RL = 80 ohm.
f = 1kHz 75mV. RMS. Size: 78mm x 63mm x 28mm.

AL20 5w **£2.65** AL30 10w **£2.95**
R.M.S. R.M.S.

NEW
PA12
£6.50

NEW PA12 Stereo Pre-Amplifier completely redesigned for use with AL20-30 Amplifier Modules. Features include on/off volume, Balance, Bass and Treble controls. Complete with tape output.
Frequency Response 20Hz-20KHz (-3dB)
Bass and Treble range ± 12dB
Input Impedance 1 meg ohm
Input Sensitivity 300mV
Supply requirements 24V, 5mA
Size 132mm x 64mm x 33mm

PS12 Power supply for AL20-30, PA12, S450 etc. Input voltage 15-20v A.C. Output voltage 22-30v D.C. Output Current 800 mA Max. Size 60mm x 43mm x 26mm.
Transformer T338 **£2.30**
£1.20

BI-PAK

P.O. BOX 6, WARE, HERTS

everyday electronics

PROJECTS..
THEORY.....

TOGETHER WE'LL MAKE IT

Dear Reader,

Do you realise just how important you could be to the future of electronics? It never even occurred to you? Well we are perfectly serious. In your tens of thousands you regular readers of this magazine represent all shades of opinion, all trades and professions, and all ages. As good a cross-section of people as one is likely to get.

The fact that electronics is (in all probability) a hobby and rarely your main pursuit in life, makes you all the more important and valuable as contributors of ideas for future uses of simple electronic circuits.

Each individual has some pet subject (apart from electronics) which might well benefit from an electronic aid. By bringing such thoughts to our attention you could do maybe thousands of similarly minded folks a good service, apart from yourself.

Don't think for one moment that this is all far fetched stuff. Look, for example, at the wine-maker's *Fermentation Indicator*. This new and most useful device is one direct outcome of our original request to readers to send in their suggestions a few months ago. Who can doubt that thousands of amateur winemakers up and down the country will shortly be reaping the benefit of this clever design. In gratitude, they ought to raise their glasses to two individuals.

Our October Issue will be published on Friday, September 17
See page 465 for details.

To our contributor who was responsible for the technical design and who has shown considerable ingenuity in bringing electronics into this unsuspected field of application. And to our reader who indicated the need for such a device in the first place. He was the instigator of the whole operation and deserves full praise.

We shall be publishing other exciting and unusual designs which have been conceived and brought into practical form through such happy partnerships. The proposers of all new ideas that reach completion will receive honourable mention in our pages when the resulting article appears. They will also receive a small monetary reward. (By "new" we mean ideas that we on EVERYDAY ELECTRONICS had no previous knowledge or intimation of.)

So here's your chance to get involved. To make our use of electronics as widespread as possible we welcome everyone's thoughts concerning off-beat applications. Don't worry if they sound a trifle crazy—most new ideas do at first—but send them in. They all will receive careful consideration.

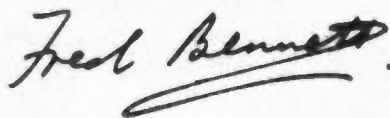

EDITOR F. E. Bennett ● ASSISTANT EDITOR M. Kenward ● TECHNICAL EDITOR B. W. Terrell B.Sc.
ART EDITOR J. D. Pountney ● P. A. Loates ● K. A. Woodruff
ADVERTISEMENT MANAGER D. W. B. Tilleard ● P. Mew

© IPC Magazines Limited 1976. Copyright in all drawings, photographs, and articles published in EVERYDAY ELECTRONICS is fully protected, and reproduction or imitations in whole or part are expressly forbidden.

All reasonable precautions are taken by EVERYDAY ELECTRONICS to ensure that the advice and data given to readers are reliable. We cannot, however, guarantee it, and we cannot accept legal responsibility for it. Prices quoted are those current as we go to press.

Editorial Department: Everyday Electronics, Fleetway House, Farringdon Street, London EC4 4AD. Phone 01-634 4452.

Advertisement Department: Everyday Electronics Advertisements, King's Reach Tower, Stamford Street, London SE1 9LS. Phone 01-261 5148.



..EASY TO CONSTRUCT
..SIMPLY EXPLAINED

VOL. 5 NO. 9

SEPTEMBER 1976

CONSTRUCTIONAL PROJECTS

FERMENTATION INDICATOR <i>A bubble watcher for winemakers</i> by S. R. Lewis	458
CLUNK-CLICK JOGGER <i>Get the seat belt habit now</i> by T. R. de Vaux Balbirnie	462
ELECTRONIC THERMOMETER <i>Fast acting analogue indicator</i> by R. A. Penfold	476
C-L RESONANCE TESTER <i>Simple tester for use with a signal generator</i> by P. H. Alley	480

GENERAL FEATURES

EDITORIAL	456
COUNTER INTELLIGENCE <i>A retailer's comments</i> by Paul Young	464
TEACH-IN 76 Part 12 <i>Filters, Rectification and Smoothing</i> by A. P. Stephenson	466
PHYSICS IS FUN <i>Readers' Favourite Experiments</i>	471
YOUR CAREER IN ELECTRONICS <i>The Plessey Company</i> by Peter Verwig	472
JACK PLUG AND FAMILY <i>Cartoon</i>	474
FOR YOUR ENTERTAINMENT <i>Japanese technology</i> by Adrian Hope	475
YOUNG CIRCUIT IDEAS	483
I.C.s EXPLAINED Part 5 by Brian Dance	484
PROFESSOR ERNEST EVERSURE <i>The Extraordinary Experiments of.</i> by Anthony J. Bassett	488
SHOP TALK <i>Component buying and new products</i> by Mike Kenward	491
DOWN TO EARTH <i>The Potential Divider</i> by George Hylton	492

BACK NUMBERS, LETTERS AND BINDERS

We are unable to supply back copies of *Everyday Electronics* or reprints of articles and cannot undertake to answer readers' letters requesting modifications, designs or information on commercial equipment or subjects not published by us. An s.a.e. should be enclosed for a personal reply. Letters concerning published articles should be addressed to: The Editor, those concerning advertisements to: The Advertisement Manager, at the addresses shown opposite.

Binders for volumes 1 to 5 (state which) are available for £2.10, including postage, from Post Sales Department, Lavington House, 25 Lavington St., London SE1 0PF

NEXT MONTH

A GIFT FOR YOU

see page 465.

Winemakers

Fermentation Indicator

By S.R. LEWIS B.Sc.

WHEN making wine, the fermentation process is taken to be complete when no more bubbles of gas are seen to pass through the airlock. Towards the end of fermentation, the bubbles appear only at long intervals and this makes it difficult to say exactly when the process is complete without constantly watching the airlock.

The Fermentation Indicator to be described overcomes this problem by acting as an electronic bubble watcher. When used to replace a conventional airlock, it will remain inert if no bubbles appear but will flash a red light as soon as one is detected.

Thus the winemaker simply switches on the Fermentation Indicator and leaves it knowing that even if he does not return for hours, the flashing red light will tell all.

SYSTEM DESIGN

The first requirement of the unit is compactness. It is not really sensible to have wires trailing from the fermentation jar, so the whole unit with its power supply should be mounted on the jar. In fact, the unit described is so small that it can be mounted on top of the airlock itself.

To achieve such compactness the power supply must be kept as small as possible, and since, in batteries, smallness implies

low capacity, the electronics must consume as little power as possible and work off a low voltage. These last two requirements exactly fit CMOS (complementary metal oxide semiconductor) logic integrated circuits.

Without going into the technology of these devices, suffice it to say that, in their steady state, typical CMOS logic i.c.s have input impedance of hundreds of megohms and consume in the order of a few microamps (see *I.C.s Explained*, page 484).

The maker's data on CMOS i.c.s indicate that they will work down to 3V supply voltage. Two hearing aid batteries in series give a voltage of 2.8V and, in fact, the i.c. in question was found to work well at this slightly reduced voltage.

A light emitting diode was selected as the indicator as this gives high light output with low current. It was decided to have the l.e.d. flashing as, not only is this more noticeable, but less power is required.

Fig. 1. The circuit diagram of the Fermentation Indicator.

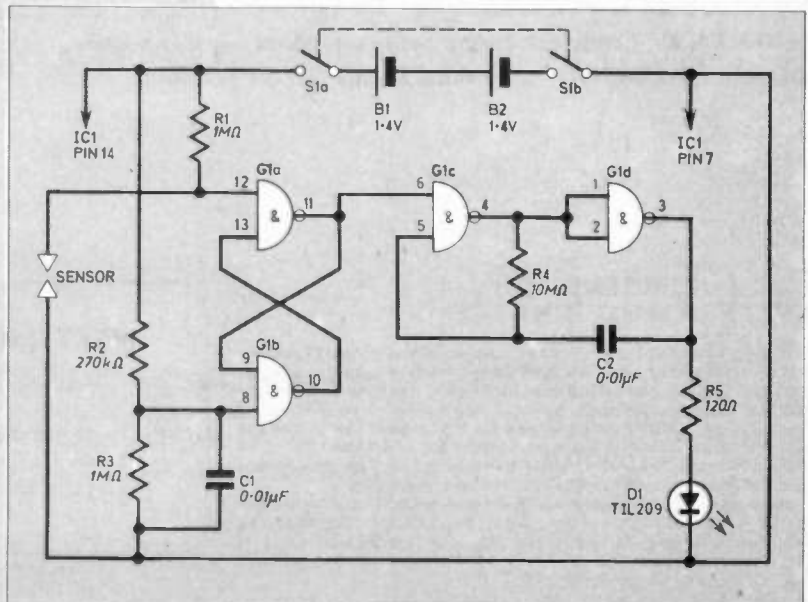

CIRCUIT



The complete circuit of the Fermentation Indicator is shown in Fig. 1.

A single CMOS integrated circuit consisting of four two-input NAND gates, see Fig. 2, is used both as the bubble detector and the l.e.d. flasher. A logic NAND gate is one whose output will only go low if both its inputs are high.

The bubble detector consists of two of the gates (G1a and G1b) cross-connected to form a bistable.

On connecting the power supply pin 12 of G1a will immediately go high since it is connected to the positive supply line via R1. Pin 8 of G1b however will take a short time to go high as C1 has to charge up via R2. This means that pin 8 will be held low for a short time which forces pin 10 high. Now both inputs of G1a are high so pin 11 goes low, holding the output of G1b high even after C1 has charged.

This circuitry is necessary to ensure that on switch-on the bistable will always be in its "reset" state, thus eliminating the need for a reset switch.

So far we have ignored the sensor probes connected to pin 12 and battery negative. Should a low resistance path of less than about 500 kilohms occur between the two probes then pin 12 will have a low input. This will cause pin 11 to go high and now both inputs to G1b are high (C1 being fully charged) and so pin 10 goes low thus keeping pin 11 high even when the low resistance path at pin 12 is removed. We say that the bistable acts as a "latch".

The low resistance path is formed by the water in the airlock which rises above its normal level and makes contact with the probes when a bubble passes through.

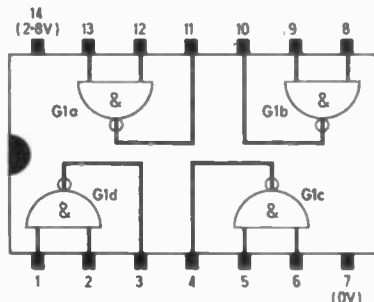

Fig. 2. Pin connections of the CD4011A IC.

The output of G1a is used to switch on an oscillator formed by G1c, G1d, R4 and C2. This oscillates at about 10Hz. The very high input impedances of CMOS gates are useful in that they enable a low frequency oscillator to be built using a small capacitor, since the timing resistor is very large (10M Ω).

The light emitting diode D1 is connected across the output of G1d in series with a resistor which helps limit current consumption. When the l.e.d. is flashing about 1mA is consumed.

To reset the unit back into its waiting state the supply voltage is removed using the specially constructed double-pole switch S1. Capacitor C1 discharges through R3 and, on reconnecting the supply, the bistable will be reset.

CONSTRUCTION



Airlocks come in various forms—some plastic and in two pieces, and some in a single glass unit. The two-piece plastic types are available in two sizes for large and small fermentation jars—both for just a few pence.

It was decided to use the smaller size as it would then be possible to build the electronics into the larger airlock if required.

A cross section of the airlock is shown in Fig. 3. The water levels are as they would be just before a bubble is formed. By

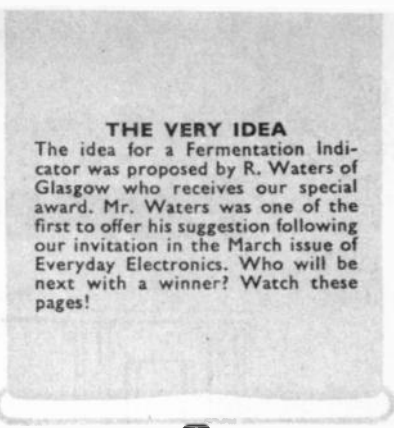

THE VERY IDEA

The idea for a Fermentation Indicator was proposed by R. Waters of Glasgow who receives our special award. Mr. Waters was one of the first to offer his suggestion following our invitation in the March issue of *Everyday Electronics*. Who will be next with a winner? Watch these pages!



placing one of the sensors always in the water and the other just above the "pre-bubble" level, the water carried with the bubble as it rises up will make contact with the top sensor, and so the bubble is detected.

The sensors consist of two strips of copper glued with plastic adhesive to the "cap" part of the airlock. These strips were, in fact, two strips removed carefully from a piece of stripboard. These are flexible and take solder easily.

Components



Resistors

R1	1M Ω
R2	270k Ω
R3	1M Ω
R4	10M Ω
R5	120 Ω
All $\frac{1}{4}$ W or $\frac{1}{2}$ W carbon $\pm 5\%$	

Capacitors

C1	0.01 μ F disc ceramic
C2	0.01 μ F disc ceramic

Semiconductors

IC1	CD4011 AE CMOS quad 2-input NAND gate (or MC14011)
D1	TIL209 or similar light emitting diode

Miscellaneous

B1, B2	RM675 batteries (2 off)
S1	see text
0.1in matrix Veroboard 10 holes \times 10 strips; plastic airlocks (2 off); hair-clip; 8BA bolts (2 off); connecting wire and solder.	

See
**Shop
Talk**

Fermentation Indicator

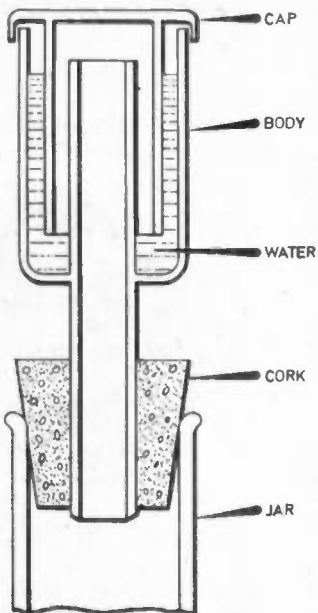
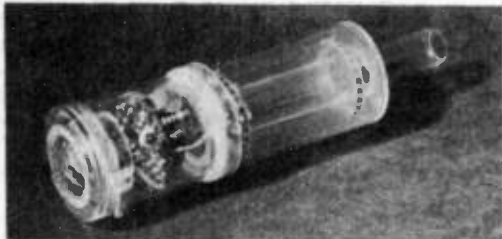

Fig. 3. Cross section of a plastic airlock of the type used in the prototype. The water levels are as they would be just before a bubble is formed.



Photograph of the completed prototype unit.

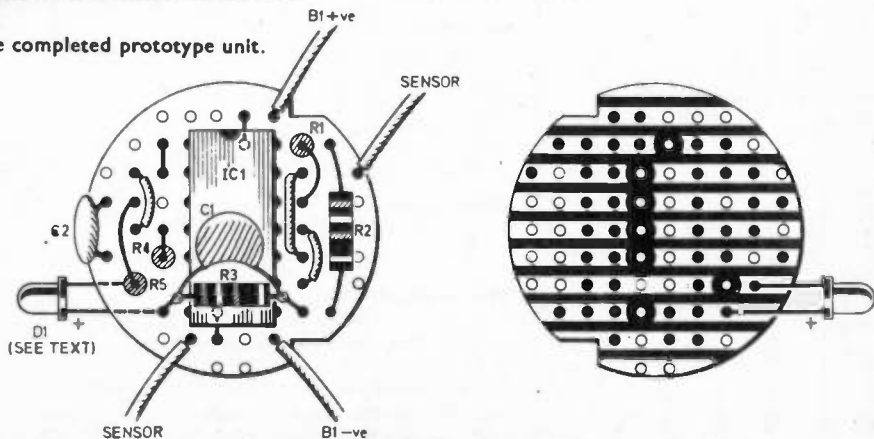

Fig. 4. Layout of the components on the circular piece of stripboard. Note the two wire links under the i.c. and that C1 and R3 are across the i.c. D1 should not be attached to the board before it is mounted on the airlock.

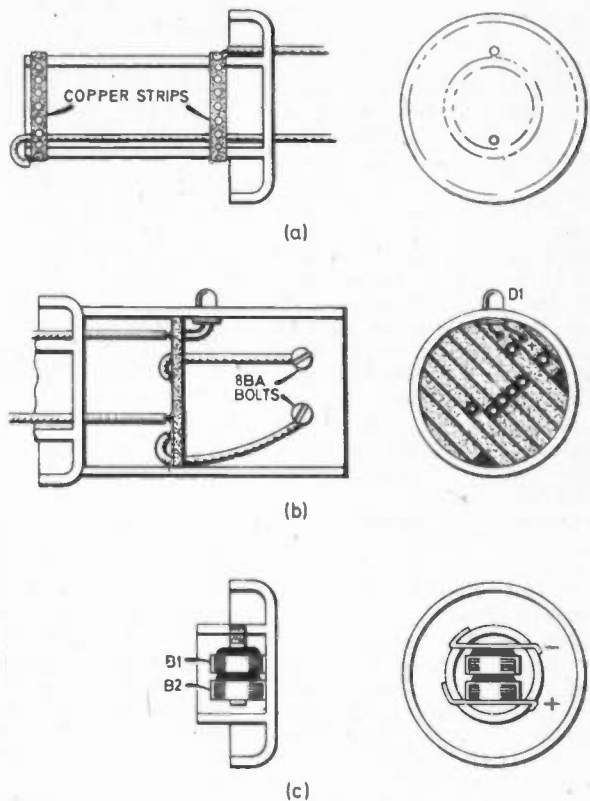

Fig. 5. (a) Shows the mounting of the two sensor strips on the airlock tube. (b) The mounting of the circular board inside the housing tube and the orientation of the i.e.d. D1. (c) The construction of the battery holder and switch contacts. The piece of tube sawn off is discarded.

Two 1.5mm holes are drilled in the cap to take the wires from the sensors to the electronics. The wire from the lower strip travels up the inside of the tube and that from the upper sensor on the outside (see Fig. 5a).

The wires should be soldered as quickly as possible using a small soldering iron otherwise the plastic will melt. About 20mm of wire should be left protruding through the top for connection to the component board. The holes through which the wires pass should be sealed with plastic glue.

FOR GUIDANCE ONLY



**ESTIMATED COST OF COMPONENTS *
excluding V.A.T.**

£1.50

The "electronics" are mounted on a small piece of circular strip-board as shown in Fig. 4. First cut a square of board 10 holes by 10 holes then cut off the corners and finally file to shape. Clean off any copper swarf which could cause shorts between the tracks.

File the two notches as shown. These are to allow the leads to the battery to pass round the board when it is mounted in the tube.

First make all the breaks in the strips as shown. Insert and solder all the wire links. Connect about 25mm of thin flexible wire to the battery lead holes and bend round through the notches.

Solder in the resistors (except R3), capacitors (except C1) and the integrated circuit. Mount R3 and C1 over IC1. Note that the leads of C1 are soldered to the leads of R3 for compactness.

HOUSING

The housing for the electronics is made from another airlock. About 30mm of the outer tube is

cut. A 3mm hole is drilled half way along it, see Fig. 5b. The l.e.d. is glued in this hole but first the anode and cathode must be identified. Different l.e.d.s use varying identification methods so it is best to make sure using a 9V battery and 10kilohm resistor. Paint a dot or file a notch to indicate the cathode.

Cut the l.e.d. leads to about 5mm and bend in half, then glue the l.e.d., correctly orientated, into the hole.

Next make sure that the circular piece of board slides freely into this tube. Note that the tube may taper slightly; the board should fit the smaller end. If it does not go in, file off any obstructions.

Mount the board, components down, on the cap of the airlock, soldering the two sensor wires in the holes shown. Make sure that the board sits centrally.

Now slide the tube with the l.e.d. over the board making sure that the l.e.d. is over the copper strips to which it is to be soldered as shown in Fig. 5.

The tube should sit closely on the cap and any projections such as the maker's name should be filed down. Solder the l.e.d. leads to the copper strips indicated and then glue the tube to the cap with plastic adhesive. Make sure the battery leads have been bent round the board before doing this.

BATTERY HOLDER AND SWITCH

The cap of the second airlock is used as a battery holder and switch. First the middle tube is sawn off leaving about 8mm in the cap. Now two saw cuts are made across the inner tube. Use a saw with a very thin blade.

Two aluminium strips from a hairclip are used to grip the two batteries. The strips are placed in the sawcuts see Fig. 5c. If the batteries are not held firmly the strips should be bent very slightly inwards.

The ends of the hairclip strips are bent so that when the cap is fitted over the tube surrounding the component board they just make contact with the walls. These strips are used to form a switch, making contact with two round headed bolts fixed inside the housing tube.

These two bolts are 8BA and

about 6mm in length. The distance between them should equal the distance between the ends of the battery holder clips. Drill two holes in the appropriate positions and then insert the bolts, heads innermost, wrapping the battery leads from the board around them to give a good connection.

FINAL ASSEMBLY AND USE

Insert the batteries into the holder making sure that they are the correct way round. It is advisable to paint one of the strips red to indicate positive. Note that the small batteries specified have the case as positive rather than the top as is usual with other types of battery.

Turn the cap until the two battery holder strips make contact with the bolt heads. The l.e.d. should not light. Next short out the sensor strips with a piece of wire—the l.e.d. should start flashing (and remain flashing when the shorting lead is removed).

If all is well proceed to testing the unit in situ. Enough water should be put in the airlock so that just before a bubble rises the water level is about 3mm below the upper sensor. An easy way to judge this is to put the unit on top of a washing up liquid bottle just holding it in place. Squeeze the bottle gently to simulate the pressure of the gas in the fermentation bottle. This must be done very slowly.

When the correct water level has been found remove the cap from the airlock and make some sort of mark on the outside of the tube to indicate where the water should come up to next time it is filled.

To use, the airlock is simply put in place of a conventional airlock. The cap is turned to connect the battery and the unit is then left for however long one desires.

CURRENT CONSUMED

In its quiescent state about one microamp is consumed so the unit can be left on for months without draining the batteries. In the flashing condition less than one milliamp is consumed—the batteries should last about ten full days in this state. ☐

...Get the habit!

CLUNK-CLICK JOGGER

says

T.R. de VAUX BALBIRNIE B.Sc.

A simple circuit to remind you to use car seat belts.

IT LOOKS as if the compulsory wearing of seat belts in cars will soon become law. We are told that the clunk of the door is supposed to remind us to belt up. If you are like the author, it is likely to remind you of nothing except, perhaps, that the door needs adjusting.

For the absent-minded, some sort of memory-jogger is necessary and the circuit to be described fulfils this need. It was decided not to make connections to the seat-belt mechanism itself — this could be dangerous and certainly rather difficult. Rather than this, a device which emits a high-pitched whistle when the ignition is switched on was constructed. This reminds you to attach your seat belt. The whistle is silenced by pressing a small button.

Of course, the device is a nuisance. In its present simple form it could hardly be otherwise. Perhaps it could be abandoned when it has established the habit. In any case, it seems a good idea to get into one before the law comes into being.

THYRISTOR

The most tricky part of the design is to prevent the switched-on ignition circuit from simply causing the device to operate again after the silencing button has been released. Silencing it

with a normal type of switch was thought to be out of the question as it could be inadvertently left in the 'off' position. A button was essential.

To overcome this problem a silicon controlled rectifier, often called a thyristor, was used. Although this looks like a transistor it behaves very differently. As it may be new to a number

of constructors some explanation of its action seems appropriate. The thyristor, unlike a transistor, is a four-layer device, pnpn.

Like a diode it will allow current to pass in one direction only. Unlike an ordinary diode, however, it will only do this if a positive pulse is applied to the "gate". In the absence of such a pulse, current will flow in neither

Fig. 1. Circuit diagram of the Clunk-Click Jogger. Connection is shown for negative earth, for positive earth cars live connection should go to chassis.

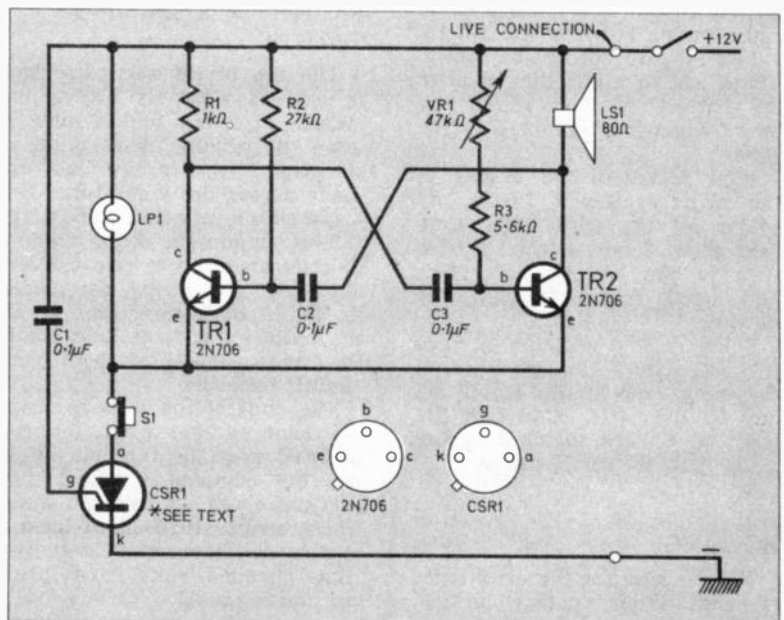

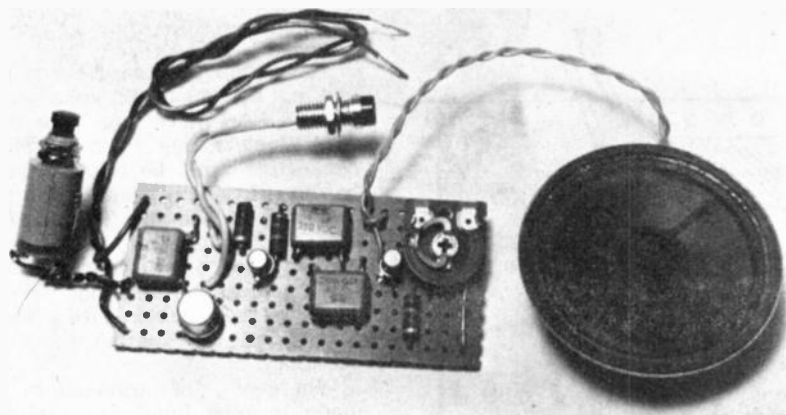

FOR
GUIDANCE
ONLY



ESTIMATED COST
OF COMPONENTS *
excluding V.A.T.

£2.50

direction. Once the pulse has been given the thyristor "fires" and after that the gate loses all control over its action. That is why only a short pulse is required. If the current passing through the device is stopped or allowed to fall below a certain threshold value, then the thyristor fails to conduct and another pulse will be necessary to make it work again. The pin connections are given in Fig. 1.

CIRCUIT



In the present circuit (Fig. 1) the pulse is given via capacitor C1. After the pulse capacitor will be kept charged and will not keep the thyristor conducting as it would if the gate were connected straight to the positive line. Pressing the push button S1 cuts the current through the device momentarily and, in the absence of a new pulse, the circuit remains switched off. It will, of course, trigger again if the ignition is switched off then on again. In fact, if this is done fairly quickly it is unlikely to start conduction as the charge on C1 will take several seconds to die away sufficiently.

The rest of the circuit is fairly straightforward. It consists of two transistors and other components connected as a multivibrator. This is a type of oscillator and will give a tone from the loudspeaker which depends on the setting of VR1. With the values given, the frequency in the prototype was that of a good high-pitched whistle. Resistor R3, placed in series with VR1, is to prevent excessive base current from destroying TR2 if VR1 is set to near-zero.

The transistors chosen were 2N706s because they are cheap but various types could be used with success. Again, the thyristor (CSR1) may be any small type with a working voltage of, say, 25 volts or more and a current carrying capacity of 1 amp. The author used one which could handle 3 amps because this happened to be to hand.

It will be noted that there is an indicator lamp LP1 in the circuit. This is so that the SCR will pass a reasonable current when it is conducting. If it did not—i.e. if all it had to do was pass the small current needed for the multivibrator section—then this would probably be below the threshold value of current mentioned earlier. This would mean that the SCR would fail to remain 'fired' after the gate pulse had stopped.

The loudspeaker needs special

mention. This should be a small type of approximately 60mm diameter. It must have a high-resistance coil—about 80 ohms.

CONSTRUCTION



The constructor may well wish to design his own way of building the project. For those wanting detailed plans to follow, a strip-board layout is given as used for the prototype. Be sure to cut away the copper strip at the places marked using a special cutter or a carefully used pen-knife.

Even though the loudspeaker is a small one it could make the front of the finished project rather clumsy-looking. The tone is loud enough to permit the speaker to be mounted on the bottom of any case employed, pointing downwards. In this way a small panel, with only the indi-

Components



See
**Shop
Talk**

Resistors

R1	1 k Ω
R2	27k Ω
R3	5-6k Ω
All $\pm 5\%$ $\frac{1}{4}$ W carbon	

Capacitors

C1	0.1 μ F	} plastic or ceramic
C2	0.1 μ F	
C3	0.1 μ F	

Semiconductors

CSR1	any small thyristor e.g. 50 p.i.v. 1A
TR1	2N706 npn silicon
TR2	2N706 npn silicon

Miscellaneous

S1	s.p.s.t. push to make button
LP1	12v 0.6A indicator lamp, and holder
VR1	47k Ω skelton preset potentiometer
LS1	miniature 80 Ω (approx.) loudspeaker
Stripboard (Verobard) 9 strips by 20 holes by 0.15 inch matrix, auto type connecting wire, earth tag.	

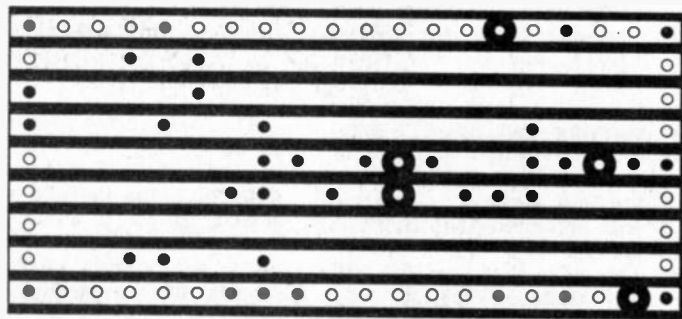
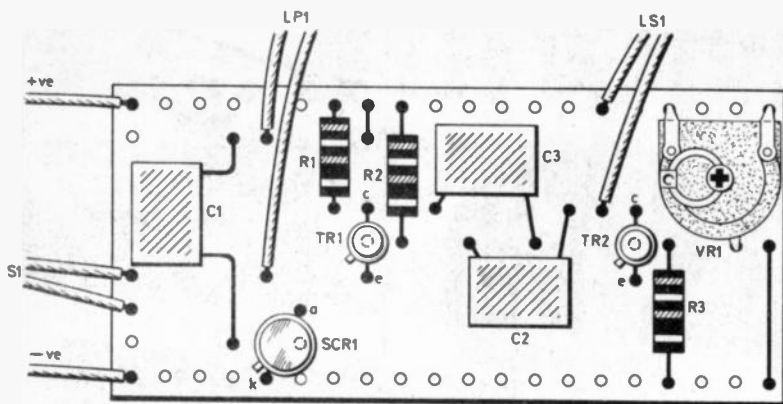

Fig. 2. Layout and wiring of the prototype unit.

indicator light and small push button showing can be used. The indicator light may be one which is

moulded complete with integral bulb or a 12 volt bulb in a sub-miniature holder.

INSTALLATION

The circuit may be checked by making up about 12 volts with batteries before fitting it to the car. When fitting it, a suitable connection must be found which becomes live only when the ignition is switched on. The wiring diagram for the car, or a little common sense will help. Either this connection may be taken direct to the fusebox or to a wire already in use for an existing accessory.

Wherever this connection is made it must be done properly using an appropriate connector and light-duty auto type wire. Never use single strand wire for this type of work or any of the ordinary wire used in general electronics work. Wires to be passed through metal must be protected with a grommet.

The only other connection to be made is an "earth". If a suitable earth point cannot be found, a small hole will need to be drilled through a metal part and a self-tapping screw fitted. The earth wire is secured to this by an earth tag.

Potentiometer VR1 should be finally adjusted so that the loud-speaker emits a really penetrating and annoying noise. It will get on your nerves but should keep you out of trouble. □

COUNTER INTELLIGENCE

By PAUL YOUNG

ONE of the disadvantages of being regarded as an oracle is that you get all sorts of questions thrown at you. The more successful you are at answering them, the more you receive.

A few years ago my friend, Mr. Rayer thought it might be fun to make a replica old fashioned crystal set. When it was almost finished he hit a stumbling block, "Where do you buy the old fashioned type crystal?"

I searched, and searched in vain. I telephoned all the firms that I remembered supplying them in the past, only to be greeted with derisive laughter. Well I hate to be beaten and, adopting a pose like Rodin's "Thinker", I thought really hard. Finally I remembered two

things, one, that it was sometimes called galena crystal, and two, that galena is a crude form of lead. The next question was "Who uses lead?" Answer "firms who make solder".

I wrote to ask one if they had any galena crystal, and it was then, that I had my first lucky break. The gentleman they passed my letter on to, was an old customer of ours. He wrote me a long and erudite letter on the subject, and explained, that although his firm used it, it was a low commercial grade and he considered it unsuitable.

Luckily he had a friend who sold samples of this kind. He put me in touch with his friend, who, when I explained that a large quantity might be required,

put me in touch with his supplier, and he was happy to let us have all that we needed. However, the story does not end there.

Spurred on by Mr. Rayer's success, I built a replica crystal set of a different pattern, which was published in this magazine a little later. This co-incided with some B.B.C. anniversary, and the *News of the World* wanted me to produce my set in kit form, so they could make it a special offer. The snag was, although they were vaguely talking about thousands of kits, I could not get a firm order.

It finally reached a stage where I was due to go on holiday and I had to make a decision about ordering all the parts. I decided to take a chance. I ordered all the parts, but I said to my partner, that if the order from *News of the World* did not arrive by the following Tuesday, he was to telephone round immediately and cancel the orders. It did not, so he did, and managed to cancel everything except the 2,000 pieces of white plastic tubing which had already been cut and were on the way to us. I told *News of the World* of our dilemma and they kindly paid for the tube, although they dropped the project. What did I do with 2,000 pieces of white plastic tubing? That's yet another story.

Next Month...

FREE PIECE OF VEROBOARD

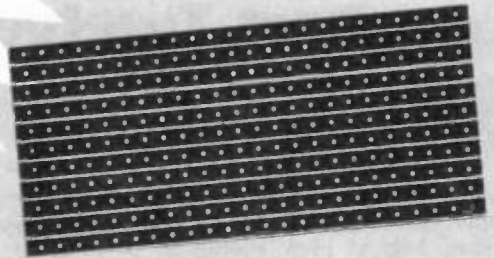

PLUS...

2 SPECIAL PROJECTS
for this board

**NEW SERIES...
DOING IT
DIGITALLY**

This series of articles introduces the reader to the use of TTL digital integrated circuits, and shows just how these inexpensive devices can be used in practical designs.

Also...

- BURGLAR ALARM
- ONE TRANSISTOR RADIO
- CAR REV. COUNTER

There is bound to be an extra heavy demand for this special issue so make sure of your copy by placing an order with your newsagent now.

everyday electronics

PRICE INCREASE. As from the October issue, the cover price of Everyday Electronics will be 35p. This increase is regretted, but rising production costs make this unavoidable.

The October issue will be on sale on Friday, September 17.

TEACH=IN 76

By A.P. STEPHENSON

Part Twelve

12.1 FILTERS

Speech, music and television signals are very complex waveforms but may be treated as if they were a mixed bag of pure sinewaves of different frequencies. In fact it was discovered many years ago by a Mr. Fourier that any waveform, whatever its shape, can be analysed into a pack of pure sine waves. It is frequently necessary to devise black-boxes which allow some frequencies to pass easily but hinder the passage of others. Such boxes are called **filters** and there are many species—in fact too many for us to cover completely so the following simple examples are chosen.

High Pass

The high-pass filter shown in Fig. 12.1a passes, with negligible loss, all frequencies above a certain limit called the **transition frequency**, (f_T). The so-called "pass band" is therefore all frequencies above f_T , and the "cut-off" band is all frequencies below f_T . Note the change from cut-off to pass band is rather gradual but nevertheless, the curve rapidly rolls off towards zero on the left of f_T ; a.c. theory will explain why the circuits behave in this manner.

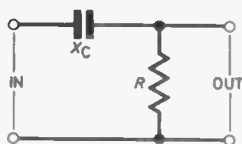
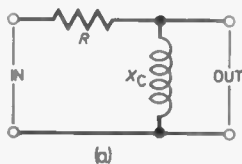
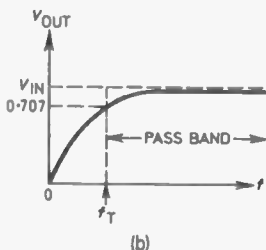

Fig. 12.1(a) High pass RC and RL filters (b) filter output.



Take for example the capacitor/resistor version which is a series impedance ($R - jX_C$) across the voltage V_{IN} . At low frequencies, X_C is very high, relative to R , and very little voltage appears across the output. As the frequency increases, X_C falls and the output receives a larger share of the input. The frequency f_T is defined as that frequency at which X_C equals R , which from our previous work is when

$$\frac{1}{2\pi f C} = R$$

which makes

$$f_T = \frac{1}{2\pi CR}$$

At this frequency (which is the transition between cut-off and pass-band) the filter output is 0.707 of the input voltage, see Fig. 12.1b.

Although the CR filter is the most popular variety, the LR filter in Fig. 12.1a is occasionally seen. The low frequencies see the coil as a low ohms "short-circuit" but higher frequencies are almost unaware of it and pass through. The equation for the transition frequency f_T is found by setting X_L equal to R so $2\pi f L$ equals R or

$$f_T = R/2\pi L$$

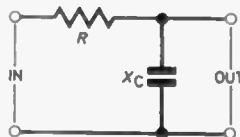
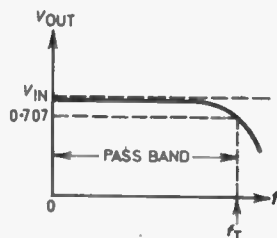
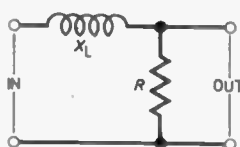

Fig. 12.1(c) Low pass RC and RL filters (d) filter output.



Low Pass

The CR version shown in Fig. 12.1c will pass low frequencies because the parallel X_C is a high resistance but high frequencies find it a "short-circuit". The transition frequency $f_T = 1/2\pi CR$.

The LR version has the same effect by causing

12.2 RESONANT CIRCUITS

Circuits containing inductance and capacity display startling behaviour at certain input frequencies. Because X_L rises and X_C falls with frequency, there must always be one particular frequency at which they meet each other, i.e. a condition when $X_L = X_C$. Suppose for example we have a series LCR circuit as in Fig. 12.2a and the frequency is adjusted until $X_L = X_C$.

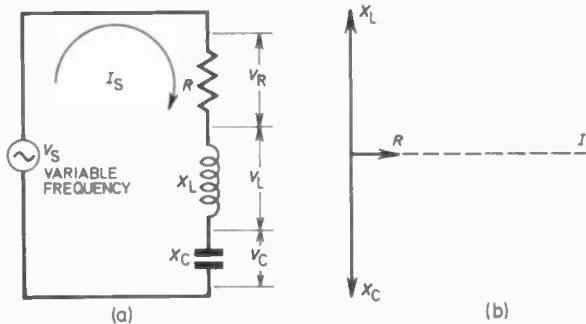

Fig. 12.2. (a) A series LCR circuit and (b) vector conditions at resonance.

The impedance in rectangular form is $Z = R + jX_L - jX_C$ but since $X_L = X_C$ then Z equals R .

This means that however high the separate values of X_L or X_C , they have cancelled each other and the only opposition left is that due to the resistance R ; Fig. 12.2b shows the vectors of this condition which is known as resonance.

The current $I_S = V_S/Z$, which in this case is V_S/R and this current must flow through all three components and will cause very high voltages to be dropped across X_L and X_C .

Example

Suppose resonant conditions are $R = 10$ ohms, $X_L = 100$ ohms and $X_C = 1000$ ohms, the supply voltage, V_S being 20 volts.

$Z = R = 10$ ohms, $I = V_S/Z = 20/10 = 2$ amps. Volts across X_L is $V_L = IX_L = 2 \times 100 = 200$ volts. Volts across X_C must be the same, so V_C is also equal to 2000 volts.

The circuit at resonance is therefore acting as a voltage magnifier of 100: 1, i.e. 20 volts supply is stepped up by 100 times to 2000 volts. The voltage magnification is called the Q factor and there are several equations for finding it:

12.3 PARALLEL RESONANCE

Parallel circuits, involving LCR, can also be handled by j , but require a little too much algebra for the space allowed in this series so we must settle for facts alone.

In Fig. 12.3a we see a parallel circuit which often appears in practice, i.e. a perfect capacitor in parallel

Everyday Electronics, September 1976

high frequencies to be blocked by the high X_L ohms. The equation here is $f_T = R/2\pi L$, the same as the equivalent high-pass version. The response curve is shown in Fig. 12.1d. The behaviour of the phase angles are exactly as described under "High-Pass".

$$Q = X_L/R \quad \text{or} \quad Q = X_C/R$$

$$\text{or} \quad Q = \frac{1}{R} \sqrt{\frac{L}{C}}$$

The frequency in a circuit which causes resonance is given by

$$f = 1/2\pi \sqrt{LC}$$

where L is in henries, C in farads and f in Hz, or L in mH, C in nF, f in MHz.

The proof is based on the definition: $X_L = X_C$, $2\pi fL = 1/2\pi fC$, therefore $f^2 = 1/(2\pi)^2(LC)$ or $f = 1/2\pi \sqrt{LC}$.

A series resonant circuit can be a very effective and sharp filter, i.e. high voltage across C or L at frequencies close to resonance but low voltages on both sides of these; Fig. 12.2c illustrates such a bandpass filter, which has enormous importance as a tuning device in all branches of electronics. By using a variable capacitor or inductance, we can select (tune) a narrow band of frequencies from many frequencies which arrive at the input.

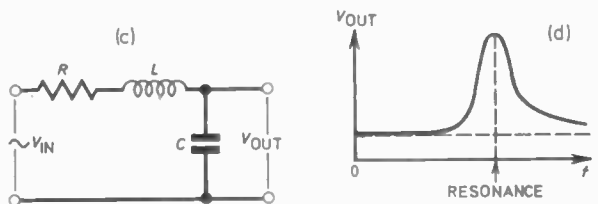

Fig. 12.2c. A simple band-pass filter and output details.

The higher the Q of the circuit, the narrower or "sharper" is the selected band. The bandwidth is therefore inversely proportional to Q ; in fact the equation is

$$\text{bandwidth} = \text{resonant frequency}/Q$$

with a coil of inductance L and resistance R . This behaves exactly opposite to the series resonant circuit. There is no voltage magnification but there is a current magnification at resonance, i.e. the circulating current I_{circ} is about Q times greater than the supply current I_S .

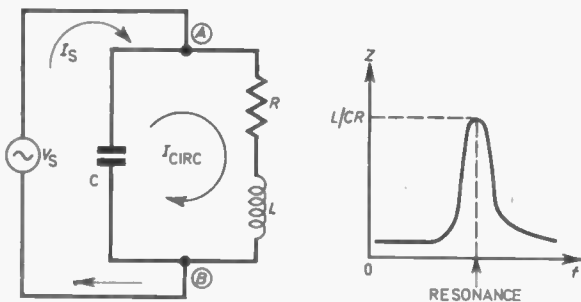

Fig. 12.3a. A parallel LCR circuit and output details.

The impedance, across AB, is very high at resonance and is called the dynamic impedance, Z_D and

the formula is

$$Z_D = L/CR \text{ ohms}$$

The Q factor is still X_L/R or X_C/R but the resonant frequency formula $f = 1/2\pi\sqrt{LC}$ is not quite accurate but good enough to be used in practice. The supply current is minimum at resonance because Z_D is maximum—this is opposite to the series resonant case.

12.4 RECTIFICATION

Half-wave rectification

Sometimes a sinewave voltage is available but, for some reason or other, we find one half of it is a nuisance. The diode provides a simple method of slicing off the offending half cycles; see Fig. 12.4a.

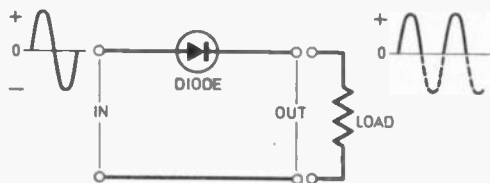

Fig. 12.4a. A simple arrangement for producing half-wave rectification.

The diode is a one-way path, allowing only the chosen half-cycle in this case only the positive halves. The output is said to be rectified. Reversing the diode would only allow the negative half-cycles to pass.

The rectified output has an average value in one direction but is very much lower than the peak voltage. We know from a.c. theory that the average value of half-a-sinewave is $2V_p/\pi$ but this is even lower because every other half cycle is completely missing, therefore the average voltage across the load is $V_{av} = V_p/\pi$ (about a third of the peak value). This is called half-wave rectification.

Full-wave rectification

Instead of wasting the other half cycles, we can turn 'em "upside down" by using more diodes; Fig. 12.4b shows a four diode arrangement called a bridge. During the positive half cycles of the input (Z positive to Y) current flows through the load via ABCDE. During the negative half cycles (Y positive to Z) the path is EBCDA. Both of these output halves are in the same positive direction.

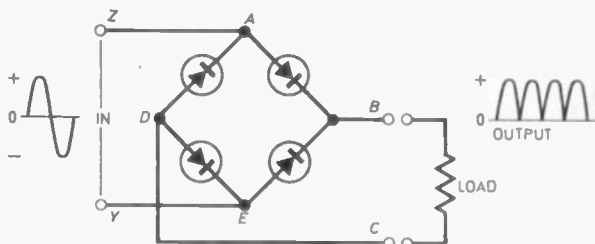

Fig. 12.4b. A diode bridge arrangement for producing full-wave rectification.

There are several advantages over the previous half wave system, some of which are (a) double the average voltage, i.e. $V_{av} = 2 V_p/\pi$ (b) the output frequency is double the input frequency because the definition of a cycle is "one complete sequence" and the output sequence is half the "length" (time wise).

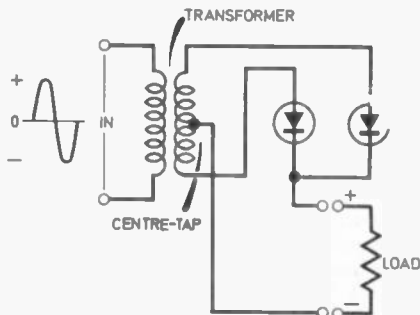

Fig. 12.4c. A centre tapped transformer needs only two diodes to produce full-wave rectification.

Shown in Fig. 12.4c is an alternative system using only two diodes but requiring a centre tapped transformer. Each half cycle is shared alternatively by the diode. Since diodes are cheap and transformers aren't, this is less popular.

12.5 A.C. MAINS POWER SUPPLIES

Batteries are convenient, portable and are capable of delivering a very smooth d.c. voltage. Unfortunately they decide to go "flat" at the most awkward times and they are horribly expensive if required to deliver

moderate or high powers. The domestic mains supply in spite of the present inflationary spiral, is a very cheap power source in comparison with batteries—in the order of a 1000 times cheaper per watt!

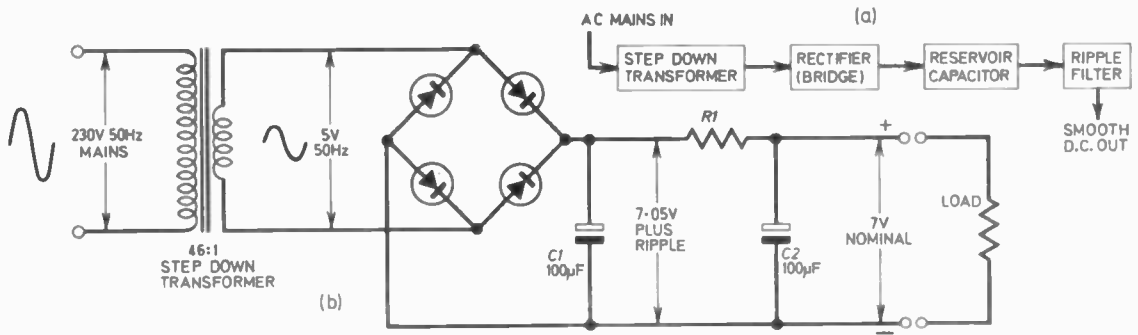

Fig. 12.5. (a) Block diagram and (b) circuit diagram for producing smooth d.c. voltage from the a.c. mains.

There are two things to be done to the mains before it can compete with a battery, (a) step down the 240 volts to the required voltage by using a transformer, (b) rectify the sinewave by half-wave or preferably full-wave methods and (c) filter out any remaining ripple which might adulterate the smooth d.c. output.

The block box representation of the system is shown in Fig. 12.5a and a detailed circuit producing a smooth d.c. voltage of about 7 volts is shown in Fig. 12.5b.

The Reservoir Capacitor (C1)

After the full-wave rectifier, the waveform across the rectifier (without the reservoir) would have the shape as shown in Fig. 12.4b. The average value would be about two thirds peak ($2V_p/\pi$) and the waveform would be difficult to smooth. The reservoir capacitance charges up to peak voltage and, providing it is large enough, tends to hold the voltage at this value. ("Large enough" means the time constant formed by C1 and the load resistor is long, relative to the period of the supply frequency). The reservoir may be thought of as the actual d.c. voltage supply which is kept "topped-up" by occasional pulses from the rectifier.

The Filter (C2/R1)

This is a low pass filter which reduces the slight ripple left after the reservoir; C2 must be large

because R1 is in series with the load and will drop some of the voltage. For example if the load is equivalent to a resistance of 1 kilohm then R1 should not exceed say 100 ohms; even this will cause about a 10 per cent loss of output voltage because of voltage divider action.

Load Regulation

Due to the internal series resistance of the power pack, the output voltage tends to fall if the load requires more current, a defect called **bad load regulation**. This can be improved by using a simple Zener diode stabiliser as in Fig. 12.5c.

Earlier in this series it was explained that a Zener diode maintains a constant voltage across it in spite of varying currents through it.

More sophisticated regulators, employing high gain amplifiers, are used if the power pack is to supply heavy current.

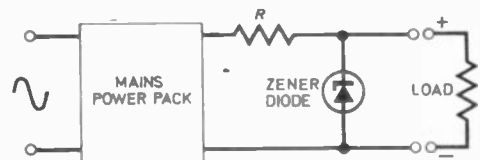

Fig. 12.5c. Use of a Zener diode to stabilize the output

TEACH-IN '76 EXPERIMENTS AND EXERCISES

EXPERIMENT 12A

To demonstrate full wave rectification and a stabilised power supply system.

PROCEDURE

Assemble the components on the Circuit Deck as shown in Fig. 12A.1 but leave out for the moment the two 1000µF capacitors C1 and C2 and the Zener diode D5; also unscrew the bulb. Switch on the mains.

2. Switch on S1 and measure the voltage across CD. Because of the full-wave bridge rectifier action, the average voltage should be $2V_p/\pi = 2 \times 1.41 \times 5/\pi = 4.49$ volts plus or minus the usual tolerance variations.

3. Screw in the 6 volt bulb and re-measure the voltage at points CD which because of the extra 40mA loading will reduce the previous reading by about 1 volt. (40 milliamps through 23.5 ohms drops 0.94

volts and the diodes will drop a fraction more). Unscrew the lamp again.

4. Connect the reservoir capacitor C1 and again measure the voltage across CD. The voltage should have risen to $V_p = 5 \times 1.41 = 7.07$ volts. Switch off S1 and confirm that this voltage only slowly leaks away. Switch on again.

5. Connect the smoothing capacitor C2 which in conjunction with R1 forms a low pass filter and removes most of the mains ripple which escapes the reservoir action. The voltage across CD can again be measured but should not have altered substantially from the previous reading.

6. Screw in the bulb again and measure the voltage across CD. The current of 40mA through R1 will drop about a volt which means you should be reading about 6 volts. Unscrew the bulb.

7. Connect the 4.7 volt Zener diode as shown and

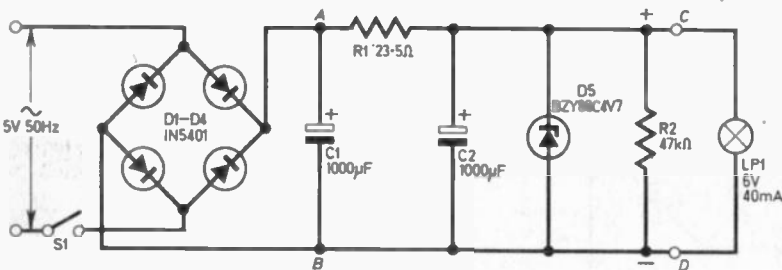

Fig. 12A.1. Theoretical circuit diagram and component layout on and around the Circuit Deck for experiment 12A.

check the voltage across *CD* is now pulled down to the nominal 4.7 volts plus or minus the usual tolerance. Screw in the bulb and check that the Zener is still stabilising the voltage. The voltage will drop a little of course because the Zener is not perfect but contrast the variation without the Zener.

8. Remove the lamp connections entirely but leave the remainder of the complete circuit for the next experiment.

The circuit of Fig. 12A.1 (without the lamp) can be reassembled into a small box to form a stabilised power supply for permanent use after the Teach-In series is completed. It should be capable of supplying about 50 milliamps at a nominal 5 volts although it would be wise to use a little higher wattage rating for the Zener diode—say a 1 watt type. If a nominal 9 volts is required, the only changes would be (a) use the 8 volts tapping on the transformer (b) change the Zener diode for a 9 volt 1 watt type.

EXPERIMENT 12B

To plot the load regulation curve of a stabilised power supply.

PROCEDURE

1. Assemble as shown in Fig. 12B.1 where it will be noticed that the regulator is supplying a "dummy" load consisting of a fixed 100 ohm resistor and a 1 kilohm variable resistor. The fixed 100 ohm is to protect the supply when the variable resistor is at the zero end, i.e. the maximum current load will be about 5 volts/100 ohms = 50 milliamps.

The 1 kilohm variable is linear so there is no need to actually measure the resistance because it can be estimated by noting the ratio of spindle movement at each setting. Start with VR1 at max. resistance and

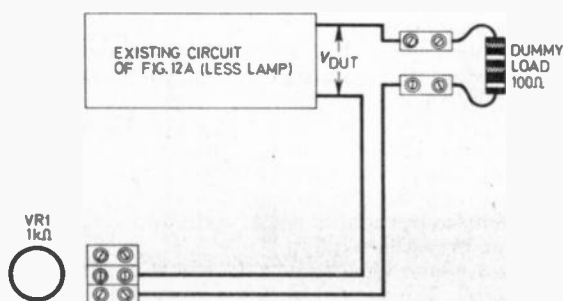
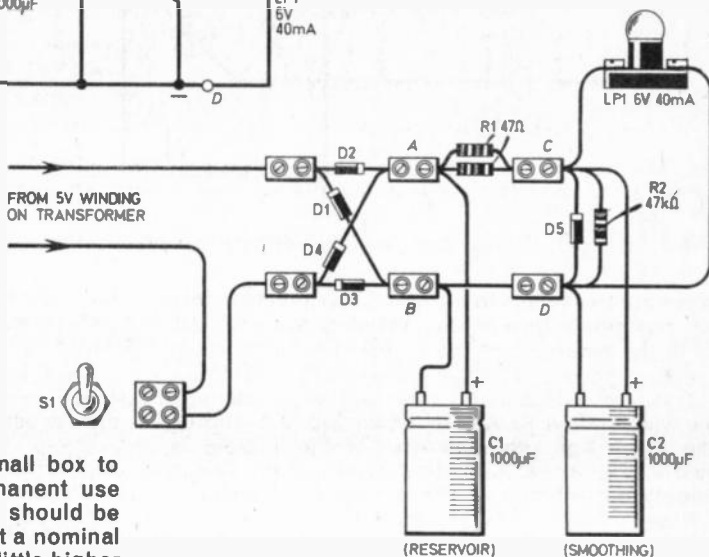

Fig. 12B1. Wiring up details for experiment 12B.



measure V_{out} . Reduce VR1 about 10 per cent and again measure V_{out} . Repeat this procedure in 10 per cent steps until VR1 is at the zero end. Plot your results on a graph.

CONCLUSIONS

You will find that the voltage falls as the load resistance is reduced, i.e. the actual behaviour is not ideal but nothing ever is.

EXERCISES

12.1 What is the resonant frequency of a 10 millihenry inductance and a 10 nanofarad capacitance?

12.2 A 20 volt sine wave is across a series impedance $Z = 100 + j500 - j500$. (a) Is the circuit at resonance? (b) Why? (c) What is the impedance modulus in ohms? (d) What is the supply current? (e) What is the voltage across the capacitor? (f) What is the "Q" factor.

12.3 In Fig. 12.5b if C2 became disconnected, the voltage out would be lower. Why?

If C2 became disconnected what would be the symptom?

Answers

12.1 16kHz. 12.2 (a) Yes (b) Because $X_L = X_C$ (c) 100 ohms (d) 0.2 amps (e) 100 volts (f) 5.1. 12.3 Because C2 is the reservoir trying to hold the peak voltage, in spite of the load draining off current. Mains hum of 100Hz due to the frequency doubling of full wave rectifier.

Physics is FUN!

THIS MONTH.... A selection of readers "Favourite Experiments"

Instead of the normal type of article this month we present some reader's favourite experiments received as a result of our request some months ago—more will follow later.

Balancing Act!

Insert a coin in the prongs of two forks, one at either side of the coin, so that the forks can swing or pivot to and fro on the coin. Do this to one side of the coin, (see Fig. 1), the other side of the coin can now be balanced on the edge of any suitable fulcrum. The principal of operation is that the handles of the forks, owing to their relatively large mass, alter the centre of gravity of the system, thus enabling the system to balance in what appears to be a very precarious manner. In fact, physically speaking, the system is very stable.

Care needs to be taken doing this, but it should be managed by a child of ten. People often accuse me of employing glue or magnets when doing this. Be cause of its simplicity, and apparent gravity defying performance, this little experiment will remain a firm favourite of mine for a long time.

W. J. Williamson
York

Good fun at party time, will keep everyone happy for hours

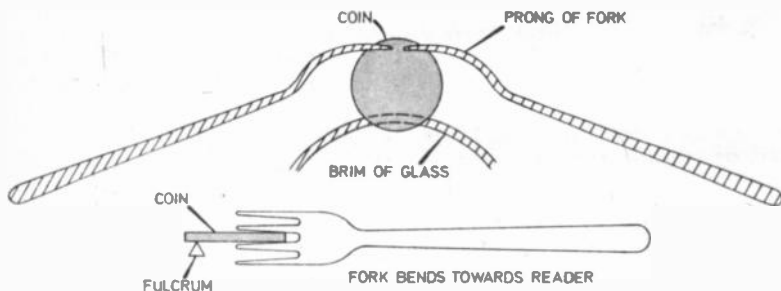

Fig. 1. Mounting the forks on a coin.

Silent Bell

My candidate for a simple but effective experiment concerns the transmission of sound waves. We all seem to take for granted the fact that we will hear the thunder some seconds after the lightning appears but what is not apparent is that if there was no transmission medium i.e., air, then no sound would be heard at all, and this is the reason why it sticks in my mind—it demonstrates a fact which we all take for granted, or else do not even think about!

The experiment consists of a glass jar fitted with an outlet tube and big enough to cover a source of sound, e.g., small battery operated bell. The outlet should be connected to a suction device which in a laboratory would be a Buchner type water suction pump, but at home could possibly be a bicycle pump with the leather washer inverted so that it sucks rather than blows.

The bell is started and covered by the jar which should have some grease around the rim to seal it to a flat surface. The sound of the bell will be heard through the glass. Now begin to extract the air from the jar and, depending on the efficiency of the suction device used, the sound will become fainter and fainter, and under good vacuum the sound will disappear almost completely. The sight of a bell vibrating with little or no sound will bring home to your audience the necessity of our oft forgotten atmosphere for sound transmission.

Tom Smales
Wrexham

A great "classic" experiment. Not easy to carry out in the home, but well worth doing. Just watch the expressions of disbelief on the faces round about you!

Frightfully Baffling

I have two experiments for you. One is the sticky balloon, the other is the crushed tin, experiment.

The sticky balloon is very simple; take an inflated balloon (red seems to be the best?) and rub it one way on a woollen jumper five or six times, then put it on a wall or ceiling, it should stick, I think it must be static electricity.

The crushed tin is far more dramatic and a little frightening. You need, an empty, washed, (with soapy hot water) 5 litre (1 gallon), oil tin with screw top. Put about 15mm boiling water in tin keep boiling for half a minute on gas jet (steaming freely from spout). Remove from heat and quickly screw on the cap; allow it to cool slowly.

The pressure slowly drops in the tin, and the pressure outside crushes the tin.

I like these experiments because the first baffles, the second frightens.

Clive G. Brierley
Oldham

A well-known party trick, Mr. Brierley, but thank you for all that. Again, demonstrating the attractive qualities of static electricity. At first sight, it seems unlikely that red should be more effective than any other colour, but who knows? There might be something in the dyes that would affect it.

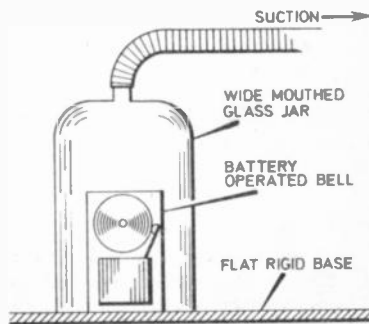

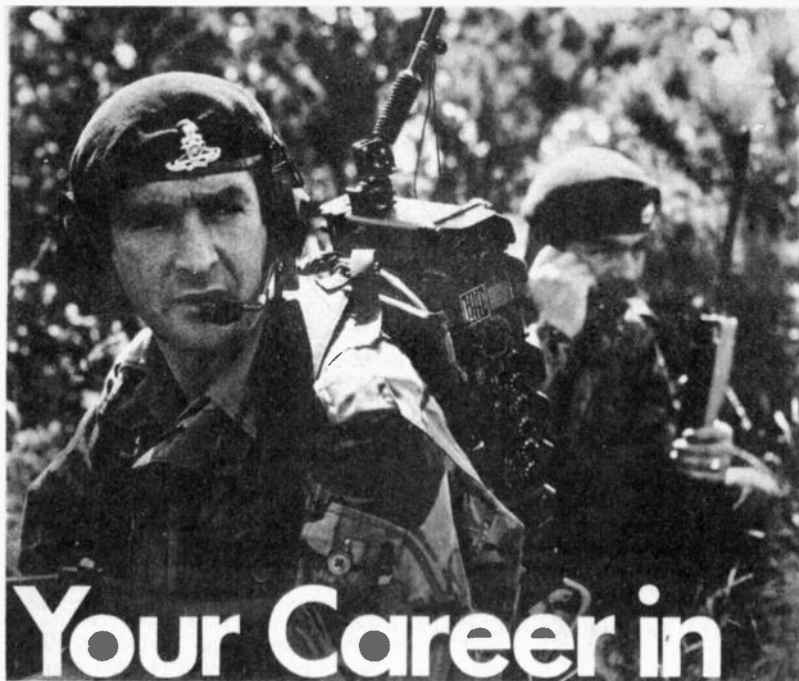

Your Career in Electronics

By Peter Verwig

WORKING WITH PLESSEY

IN PREVIOUS articles in this series I have selected careers in specific activities as my subject for discussion. For example, a career as a test engineer or technical author, or in instruments. And I have generally chosen one company as a practical example but also indicated other companies in which you might work in a similar capacity.

This month I am devoting my whole space to a single organisation, The Plessey Company Ltd, and its broad spread of activities. So broad in fact that it offers career opportunities for every imaginable speciality in mechanical, electrical and electronic engineering and is large enough to also provide good opportunities in non-engineering positions.

INSTRUCTIVE

But there is another reason for my choice. Plessey is involved in the whole of electronics from microcircuits to giant radars, from passive component manufacture through to great electronic systems, and the company is powerful in both consumer and

professional electronics at home and overseas. Thus, a study of Plessey is in many respects a study of the whole of the electronics industry as it is today.

What is happening at Plessey is also, to a greater or lesser degree, what is happening elsewhere in the industry and thus is instructive for those wishing to get a "feel" of the industry and its present trends.

The Plessey Company Limited is one of the world's great multinational companies with manufacturing units at nearly 30 locations in the UK, and subsidiary companies in the USA, South Africa, New Zealand, Australia, Lebanon, Brazil, Portugal and Switzerland. The company also has substantial investments in associated companies at home and overseas, the best known in the UK being International Computers Ltd, Goodman Loudspeakers Ltd and Technograph Ltd.

Plessey trades in over 130 countries and for the last trading year turned over £490.1 million with a pre-tax trading profit of £52.6 million.

In the UK, Plessey employs

some 50,000 people in a geographical spread of locations from Bathgate, West Lothian in the north to Cowes, Isle of Wight, in the south, and to the west there is a plant at Newport in Wales and another at Templecombe. The headquarters is at Ilford, Essex.

ORGANISATION

Plessey is organised in a number of "businesses" each operating independently in its own speciality, but also able to call on certain central services as required. The largest business is telecommunications, employing some 30,000 people. The next largest is radar with 4,000. All the other businesses have 2,500 or less. The largest businesses in terms of people, however, are not necessarily the best ones in terms of career opportunities for graduate or technician engineers.

With about half the total workforce in telecommunications, there are about 700 people involved in R and D. Yet, in Plessey Marine there are 600 people on R and D in a total of 1,800. Avionics and Communications has 2,500 people of whom 1,000 are engineering staff. Plessey Radar has 4,000 people of whom more than 900 are on R and D. The largest proportion of all is, of course, at the Allen Clark Research Centre, a world-class laboratory engaged on fundamental research for the whole of the group. Nearly 10 per cent of all Plessey people are engaged in R and D, as befits a company engaged in the design, development and production of high technology products.

RECESSION

Plessey was hit by the downturn in the demand for electronic components which started in mid-1974 and was further hit by the increase in VAT to 25 per cent on consumer products. The telecommunications business was also hit by cut-backs in Post Office orders and in this area a number of people were made redundant. Overseas, the North American business was affected by slackness in automotive products and semiconductor demand. But while these businesses were struggling for profit in a bad time, others were holding or improving their positions.



Technician training includes classroom teaching and practical instruction.

Heading photo shows the Plessey Clansman WF 55B manpack tactical radio in service with the British and overseas armies.

This is the advantage of having a wide range of businesses spread throughout the world. But in a total world recession, and that is what we have all just experienced, there tends to be a total cut-back in trade. In fact Plessey has done rather well in the circumstances and has shown great flexibility in meeting rapidly changing market conditions.

The Post Office cut-backs were the most serious because Post Office business accounts for about a quarter of the whole turnover. Plessey had no option but to reduce the workforce in the past financial year at a heavy cost in redundancy payments.

The worst is now over and with the revival in world trade Plessey is now fully embarked on an export-led recovery. The order book today stands at some £500 million, a figure regarded with sober satisfaction and with current rumours that the Post Office is returning to substantial profit there is a good possibility that the hard-pressed telecommunications business will benefit from a resurgence in home orders.

In this respect it should be noted that Plessey has already a fine reputation with the TXE2 electronic telephone exchange of which several hundred are already in service and has substantial interests in the larger TXE4 now going into production.

DEVELOPMENTS

Another great system is the Ptarmigan military mobile trunk radio system for which Plessey is the design authority and prime contractor and which was the subject of a number of papers presented at Communications '76 Conference at Brighton in June. This project is one that will last well into the 1980s, as will TXE4. There are other on-going projects like the Clansman tactical radio system for the British and overseas armies which will enjoy extensive "life".

Plessey Radar is reported as doing exceptionally well at the moment in both civil and defence fields. An example of Plessey ex-

pertise is the recently developed AR-3D three-dimensional long-range radar acknowledged to be a significant breakthrough in radar technology. The AR-3D, as a single unit, provides slant range, bearing and height simultaneously at ranges up to 300 miles.

The principle of operation was patented by Plessey in the early 1960s but a practical design had to await some new technology, one example being the application of surface acoustic wave equalisers developed at the Allen Clark Research Centre.

Plessey has substantial naval business with the Royal Navy and overseas navies and is the leading commercial design authority on sonar systems in the UK. The R and D establishment at Templecombe, Somerset, is the most closely guarded of all Plessey R and D establishments, the most secretive, and said to be the finest equipped and staffed laboratory in Europe for the study of underwater disciplines. The location has the advantage of having a near-by deep-water lake used for trials of new equipment.

RECRUITMENT

Plessey takes on about a hundred school leavers a year for technician apprentice training so that at any one time there are 400-500 apprentices working their way through the system. The normal entry requirement is at least four 'O' levels including mathematics, physics and English. Those accepted will normally be on the day release scheme hopefully working towards HNC.

Applicants with an 'A' level in mathematics or physics and with the appropriate 'O' levels (including English) may be selected for a three-year sandwich course leading to HND. Like most companies of similar status and size, Plessey retains some flexibility and it may be possible for young people who are showing particularly good aptitude to switch to a higher stream to get along faster or to a higher qualification.

It is interesting to note that the proportion of craft apprentices is dropping all the while as numerical control and other forms of automation supplant many of the old manual skills. On the other hand, the shift of emphasis has created a demand for more tech-



Part of the basic training includes practical instruction on machine tools.

nician engineers for skilled maintenance of complex machinery, process control and expanding areas such as planning.

In fact the range of careers open to technician engineers is broadening all the while to embrace tasks like estimating and value engineering. Plessey would appear to favour flexibility in technicians to undertake a variety of tasks whereas the graduate engineer, as he climbs the ladder, tends to become more and more a specialist in a narrow discipline.

As a high-technology company,

Plessey employs a very large number of graduates, not only in the traditional electronic and electrical engineering disciplines but also in physics, chemistry, mathematics, economics, computer science, business studies, operational research, and metallurgy.

There are two streams of entry, Science and Technology Entry. Even if you have your degree there must be a period of on-the-job training and for an engineering graduate this may be anything from a month to two years. Those

who already have appropriate practical experience may join by Direct Appointment. Undergraduates thinking about a career in industry and wanting to know what it's really like at Plessey can apply for Vacation Experience, a scheme in which undergraduates spend six or eight weeks (sometimes longer) in Plessey laboratories or engineering departments during the summer vacation.

EMPLOYEES

Plessey Chairman, Sir John Clark, says this of company employees: "They supply Plessey with skill, imagination, determination and effort, without which there would be no company. In return we provide jobs, job interest, career prospects, personal satisfaction and the income which supports personal needs and reflects the contribution which each is making to the success of the enterprise. We intend to continue to invest in people, in their training and development and in their pay and benefits—it is only by doing so that we will maintain our competitive position in the face of international competition, with all that this demands in terms of technical progress, marketing skills and productivity".

Plessey started in business in 1917 as a small jig and tool maker. Today, Plessey is a world-class organisation. This didn't happen by magic. It happened, and was made to happen, by people.



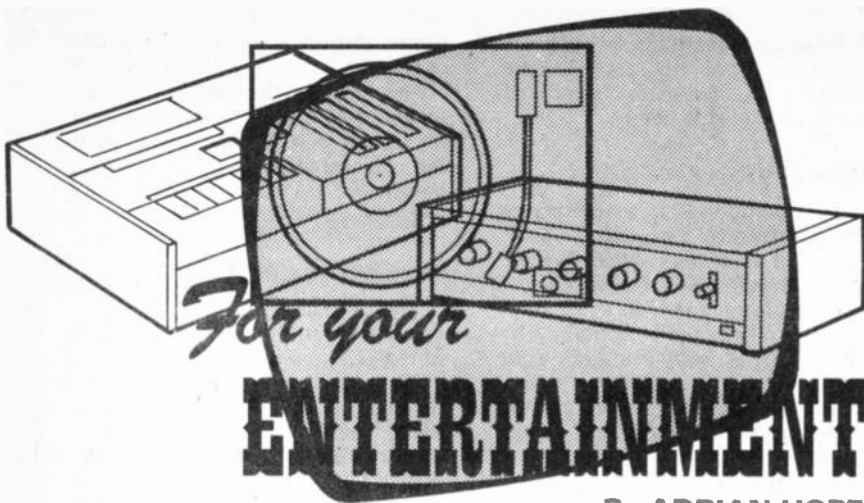

By ADRIAN HOPE

Video Recording

A FEW more of the electronic sights seen in Japan recently warrant at least brief mention as an indication of things likely to come here.

Microwave ovens have long been available, but there is mounting enthusiasm for induction stoves, which can boil a pan through the human hand. Although at first appearing magical, the stove simply uses a heavy duty transformer coil fed with an alternating current of super-sonic frequency. This produces an intense electromagnetic field which induces eddy currents in any electrically conductive cooking utensil that is held in the field.

Stoves of this type are dangerous when used with cooking utensils made of copper, because this metal reacts too efficiently to the field. Thus it is usually necessary to build a magnetic detector into the cooker which blocks current flow to the transformer coil unless a safe ferrous utensil is being used. Other "magical" electronic gadgetry seen included a silicon strain transducer with a dynamic range of 100dB, a modified cadmium sulphide photocell ten times as sensitive as the conventional type, and a cadmium sulphide solar battery with a conversion efficiency of nearly 10 per cent in sunlight.

A problem to date with video recording has been the need to duplicate tapes in "real time" because mass duplication at high speed (like audio-cassettes) pushes up the high frequencies to an unmanageable degree. The duplication of tape at ten times real time is however now fully automated using an anhyseretic process. A mirror image master tape is wound together with a blank tape, the sandwich briefly saturated in an intense magnetic field and then fast unwound at ten times normal running speed. The result is a copy with horizontal resolution better than 240 lines and signal-to-noise ratio of better than 40dB. A single master can produce 1,000 copies in this way without quality loss.

Obviously of potentially great significance to the slide-tape user is the

new technique which digitally encodes still colour TV pictures onto tiny 0.2mm wide tracks down the centre of an ordinary Philips compact audio cassette running at standard speed. Playback is via a special cassette machine with a video head set to read the centre tracks. This feeds a store which builds up the video information necessary for each still picture and displays a new image on a TV screen every few seconds. Incidentally I noticed only one move away from electronics as the answer to everything.

High intensity light is now being used to weld metal sheet, instead of electricity. The illumination from a xenon lamp is concentrated by a reflector to produce an illuminated intensity of 3,000 joules per centimetre square. This light is beamed onto the contact point of two metal pieces to be welded together, within a surrounding atmosphere of inert argon gas. The light is converted locally into heat and produces a seam weld which is uncontaminated because no electrodes are necessary.

Channels

Because few if any mains or telephone cables are buried in Japan, the skyline is a cobweb of high voltage cables feeding stepdown transformers mounted high on a pole outside every few houses. Not surprisingly, good quality off-air TV reception is difficult, and cable systems are used to supply the hotels.

The major cities have at least half a dozen different Japanese language channels to choose from, in addition to an English language channel directed at the specific area covered. This channel is, of course, intended mainly for foreign visitors in their hotel rooms, and carries valuable information on local facilities, train times and entertainments, interspersed by commercials for local restaurants and services.

In the United Kingdom, most

attempts at making local cablevision pay its way, even with advertisements, have failed. The Sheffield local Community Cablevision station recently closed down through lack of support.

With the benefit of a sight of the Japanese situation, it seems astonishing that in London there is no cable TV station directed at visitors from abroad staying in our many hotels.

Closed Circuit T.V.

Television plays an increasingly important part in Japanese life. Many large motor coaches now carry a video camera mounted on the roof at the rear, which is connected to a small video monitor on the coach dashboard. In this way the driver can get a clear, wide-angled view of the road behind him when he reverses.

In fact it is now law that every coach must either have a video eye at the rear or carry a human "guard" who goes to the rear of the coach and blows a whistle every time there is a need to reverse. What is more, engagement of reverse gear automatically sounds a warning horn at the coach rear, to alert pedestrians.

Security

Anyone snooping behind the scenes at Japanese airports will find video screens in use for a very different purpose. The Japanese have suffered badly through hijacking, and obviously intend never to let it happen again.

Every piece of hand baggage carried by a flight passenger is loaded onto a conveyor and passed through a cabinet looking rather like a laboratory fume cupboard. The cabinet is bathed in "soft" (low-level) X-ray radiation, and a bank of TV cameras provides an X-ray picture of each piece of luggage.

Because the conveyor is continually moving, each camera output is fed to a memory store, which provides a freeze X-ray frame picture of each item of luggage from several angles for the benefit of a security guard out of sight behind the system. The level of X-ray radiation is low enough to constitute no risk to film—certainly none of my 35mm film was fogged by two exposures to X-ray security at Tokyo.

I only saw one piece of unsuccessful technology; a smoke fire alarm which was thrown into total confusion by a Dutch journalist. The alarm was set to raise a warning signal whenever it detected excessive smoke. Its sensitivity was set to ignore cigarette smoke, and even pipe smoke, in the evening; but the one thing no one had bargained for was the Dutchman, who smoked a pipe before breakfast. As regular as clockwork, he was visited in his room by the hotel fireman each morning, within two minutes of lighting up.

I'll touch on some other areas of new Japanese technology next month.

There are many areas where electronics can be used for measurement. As well as electronic parameters a wide variety of measurements can be made by using the appropriate transducer. Electronic measuring gear often has distinct advantages over more conventional means.

This article describes a simple but accurate electronic thermometer which has a range of 50 to 100 degrees Fahrenheit (10 to 35 degrees Centigrade if preferred).

The unit consists of the main electronics including a moving coil meter on which the temperature is displayed and a thermistor probe which is the sensing element of the apparatus.

RANGE

The range covered makes the unit suitable for use in many household applications such as an aquarium thermometer, a temperature monitor for photographic solutions or simply as a room thermometer.

The most obvious advantages of this type of thermometer over an ordinary mercury or alcohol type is that it has a large, clear, and easy-to-read scale. This makes it eminently suitable for use in demonstrations of several heat experiments encountered in "O" level physics.

Another important advantage is that the sensor and the scale are not contained within a single unit. This makes it possible to have the sensor remotely situated from the main unit.

Thus, it is possible, for instance, to have the sensor inside a greenhouse and the main unit inside the house. There must be many similar applications where this feature would be useful.

Another advantage is that the unit responds to temperature changes much faster than conventional thermometers.

WHEATSTONE BRIDGE

In common with many pieces of electronic measuring gear, this unit is based on the Wheatstone Bridge. The circuit of the bridge is shown in Fig. 1.

The Wheatstone Bridge consists of a network of four resistors and is really two potential dividers connected across the input. A certain fraction of the input will therefore appear at each output terminal.

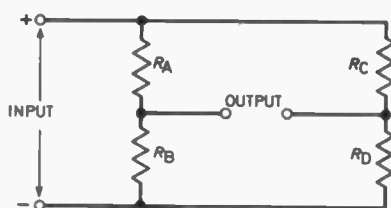

Fig. 1. A Wheatstone bridge arrangement.

If the ratio $R_A:R_B$ equals that of $R_C:R_D$ then obviously the same voltage will be present at each output terminal. If a meter were connected across the output it would read zero as the difference between the two outputs is zero. The bridge is said to be balanced when in this condition.

If the meter had its negative terminal connected to the junction of R_A and R_B and its positive terminal connected to the junction of R_C and R_D and the value of R_B was decreased, the bridge would become unbalanced and the voltage at R_A, R_B would be lower than that at R_C, R_D . A positive indication

would therefore be produced on the meter.

The lower the value R_B is made, the greater the voltage difference across the output and the greater the reading on the meter.

PRACTICAL CIRCUIT

The circuit diagram of the Electronic Thermometer is shown in Fig. 2.

One side of the bridge is formed by R_2 and R_{TH1} , these being the equivalent of R_A and R_B in Fig. 1. The top section of VR_2 and the bottom section of VR_2 plus R_3 from the other side, these being the equivalents of R_C and R_D .

The thermistor R_{TH1} has a negative temperature coefficient

FOR GUIDANCE ONLY



ESTIMATED COST OF COMPONENTS * excluding V.A.T.

£4.50
excluding case

Electronic THERMOMETER

By R.A. PENFOLD

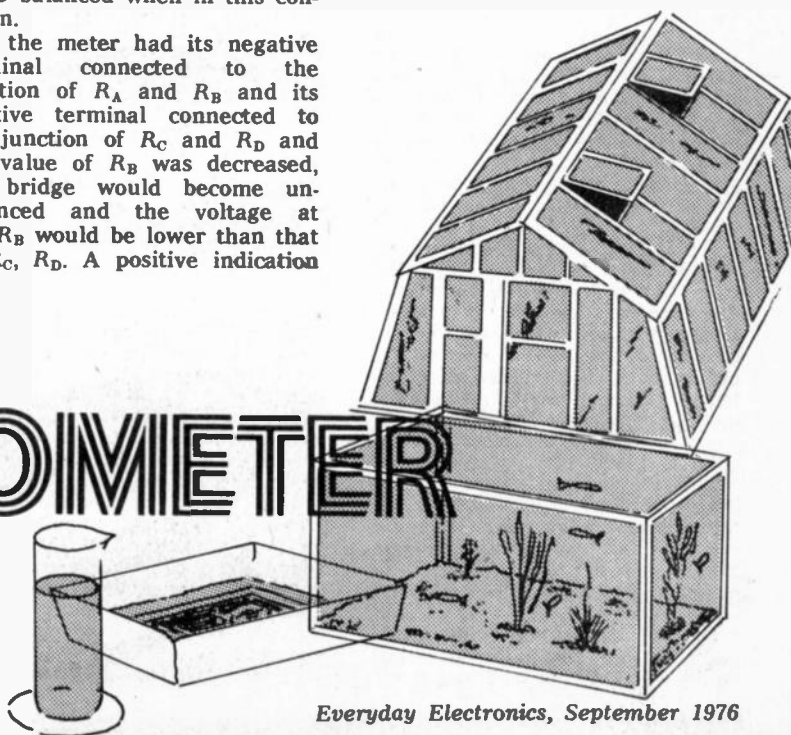

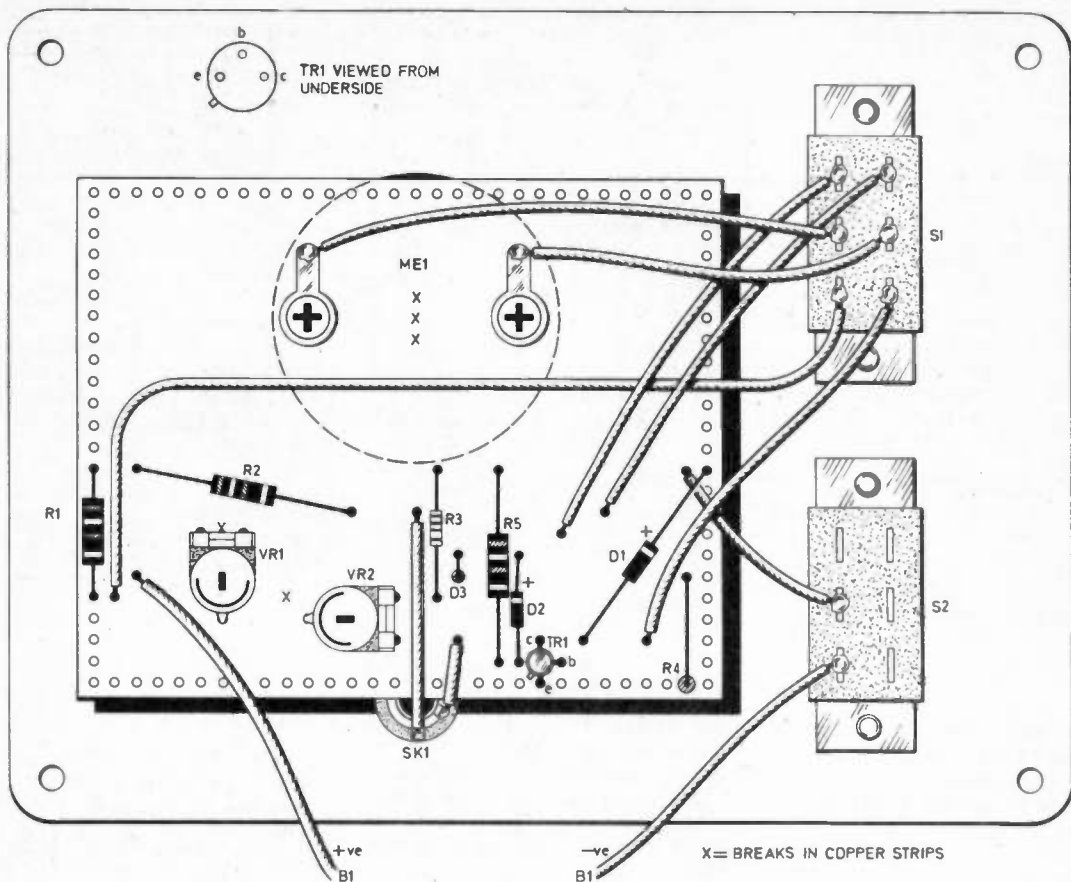
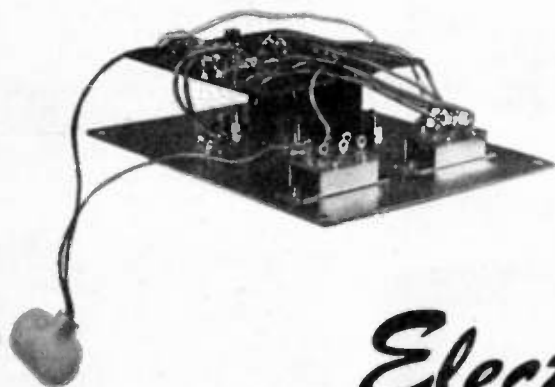

Fig. 3. The wiring up details and layout of the components in the prototype unit.



Photograph of the prototype unit removed from its case.

Electronic THERMOMETER

panel is mounted on the meter terminals so be careful to drill the holes in suitable positions if the meter employed is not the one specified.

CASE

The prototype is housed in a ready-made plastic case having an aluminium front panel. This has dimensions of 130 x 100 x 50mm, and any similar case can be used.

The general layout of the front panel can be seen in the photographs. The large cutout for the meter and the two rectangular cutouts for the switches can be cut using a fretsaw. It is advisable to cut just on the inside of the cutting line and then file out the holes to precisely the correct size and shape.

A 3.5mm jack socket SK1 is mounted beneath the meter and the thermistor lead plugs into this.

When all the components have been mounted, the unit is wired according to the wiring diagram shown in Fig. 3. There is a space for the battery on the left of the switches. Do not switch the unit on unless the probe is plugged into its socket.

PROBE

The probe can consist simply of a length of twin cable with

a 3.5mm jack plug connected at the end and the thermistor at the other.

The thermistor, its leadout wires and the soldered connections should be given several coats of paint or lacquer so that the leads cannot short together. This insulation is also necessary if the probe is to be used in a liquid. A thick piece of p.v.c. sleeving can be slid over the thermistor leadout wires and the soldered joints in order to give a neat appearance.

If the probe is likely to be used in chemicals which might attack the paint or where the paint might affect the chemicals, it would probably be better to embed the thermistor in epoxy resin, although this will result in a slower response to temperature changes.

ADJUSTMENTS

Before switching on the unit, set VR1 and VR2 at their midway settings. Ideally, when calibrating the unit, two dishes of water are required: one at 50 degrees Fahrenheit and one at 100 degrees Fahrenheit. Since, in practice, it is not possible to maintain these temperatures for any length of time without expensive equipment, one will probably have to settle for one dish in the fifties Fahrenheit and one in the nineties. A thermometer to calibrate the unit against is also required.

Place the probe and the

thermometer in the cooler dish and when they have both had time to assume the same temperature as the water adjust VR2 to give the same reading on the meter as appears on the thermometer.

Next place the probe and the thermometer in the warmer dish and when they have settled to the temperature of the water adjust VR1 to give the same reading on the meter as on the thermometer.

Replace the probe and the thermometer in the cooler dish and repeat the procedure several times until no further adjustment is needed in order to obtain the correct reading on the meter.

In order to obtain the best accuracy it is advisable to keep the bulb of the thermometer and the thermistor close together with neither touching the sides or bottom of the dish.

SCALE

As it stands, the scale of the meter reads from 0 to 50 instead of the required 50 to 100. It is therefore necessary to add 50 to the scale reading in order to arrive at the correct temperature.

Alternatively, the front of the meter can be unclipped, the scale carefully removed and the existing numbers carefully scraped or rubbed off using a sharp point or scouring powder. Transfers can then be used to add suitable scale markings.

With a new battery fitted to the unit, switch to the BATTERY CHECK facility and make a note of the reading on the meter.

It is advisable to check the battery before and after each use of the thermometer. As soon as a reading noticeably lower than the original is indicated it is time to change the battery.

CENTIGRADE VERSION

If built as a Centigrade thermometer, the unit can obviously be calibrated using much the same procedure as was described for the Fahrenheit version.

A 10 to 35 degree Centigrade scale does not convert quite so readily from the 0 to 50 meter scale and it is virtually a necessity to recalibrate the actual scale of the meter. ☐

Components

Resistors

R1	220k Ω
R2	12k Ω
R3	4.7k Ω
R4	220 Ω
R5	10k Ω
All $\frac{1}{4}$ W carbon $\pm 5\%$	

Semiconductors

TR1	BC108 silicon npn
D1	BZY88 C6V2 6.2V 400mW Zener
D2	1N914 silicon diode
D3	1N914 silicon diode

Miscellaneous

RTH1	VA1066S thermistor
ME1	50 μ A d.c. moving coil meter type 'T' 51mm or similar
S1	d.p.d.t. slide switch
S2	d.p.d.t. slide switch
VR1	47k Ω miniature horizontal preset
VR2	47k Ω miniature horizontal preset
SK1	3.5mm jack socket
PL1	3.5mm jack plug
B1	9V PP3 battery and connector
0.1in matrix stripboard 24 strips x 30 holes; case; connecting leads.	

See
**Shop
Talk**

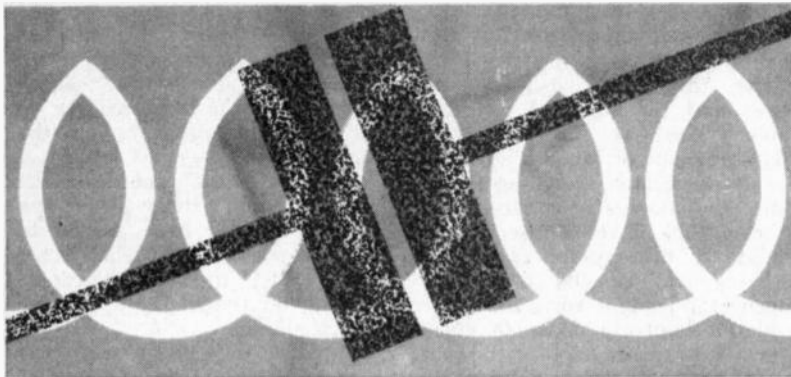

For measuring capacitance, inductance and resonant frequencies of tuned circuits.

C-L RESONANCE TESTER

By P. H. ALLEY

WHEN modifying a medium waveband radio to additionally receive long wave programmes, it was necessary to have an accurate way of measuring the values of capacitors and coils as well as tuned frequencies.

The normally accepted way of measuring tuned frequencies is to listen for beats between the tuned circuit and a reference frequency—a method known as heterodyning. This method is all very well for those versed in aural discrimination against sub-harmonics, but to the inexperienced (and that includes the author) this method can be very confusing. There is even greater difficulty when the method is applied to the mixer section of a radio receiver with its multiplicity of frequencies and sub-harmonics.

In an effort to provide both a visual and an aural indication of tuned frequency, devoid of ambiguity, the simple circuit of Fig. 1 was constructed. Used in conjunction with an r.f. signal generator (such as that described in the July 1976 issue of *EVERYDAY ELECTRONICS*), it has proven to be a most useful and versatile adjunct up to a frequency of approximately 30 to 35MHz.

The circuit can also be used to determine the frequency of tuned audio circuits if used in conjunction with an audio generator.

PRINCIPLES OF OPERATION

The principles of the circuit are based on the concept of interposing a parallel tuned circuit be-

tween the output of a signal generator and the base of an r.f. transistor (Fig. 1).

At frequencies outside the narrow tuned band, the parallel circuit offers relatively little impedance, so that, after r.f. amplification by transistor TR1, detection by D1 and d.c. amplification by TR2, the amplified signal is indicated on the meter.

If the r.f. signal generator is audio modulated, the amplified audio signal comes through the crystal earpiece loud and clear.

When the signal generator is tuned through the narrow resonance band of the tuned circuit, the impedance offered prevents all or most of the signal getting to the base of TR1. This is indicated by a gross meter dip and absence of audio signal through the earpiece. The appropriate frequency is then read off the signal generator scale. Additional dips at sub-harmonics are relatively small and cause no confusion.

CONSTRUCTION

The layout of the components is shown in Fig. 2.

Any small tin box or plastic case can be used as the housing. Two small crocodile clips are soldered to individual stand-off posts A and B. These are used for gripping capacitor or coil leads.

The variable capacitor C1 is from an old radio receiver and can be calibrated using a single one per cent capacitor.

Transistor TR1 is a germanium

m.a.d.t. (metal alloy diffused) transistor which operates admirably on low collector voltages of one to three volts. Any r.f. transistor can be substituted if a higher battery voltage is used.

Transistor TR2 is also a m.a.d.t. type but any low signal audio type transistor could be substituted. Diodes D1 and D2 are germanium point contact diodes. The purpose of D2 is to prevent meter overload since its forward voltage drop never allows more than 0.2 to 0.3V across the meter.

The meter is a 500 μ A indicator used in an old battery checker. This type is cheaper than conventionally scaled meters and perfectly adequate since no precise measurements can be made using the meter reading.

Transistor TR1 is biased so that its collector is at half the supply voltage and since transistor gains vary, this entails selection of R1. Start at 820k Ω and reduce if

FOR
GUIDANCE
ONLY

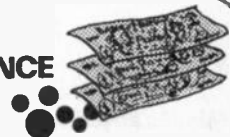

ESTIMATED COST
OF COMPONENTS *
excluding V.A.T.

£3.40
excluding case

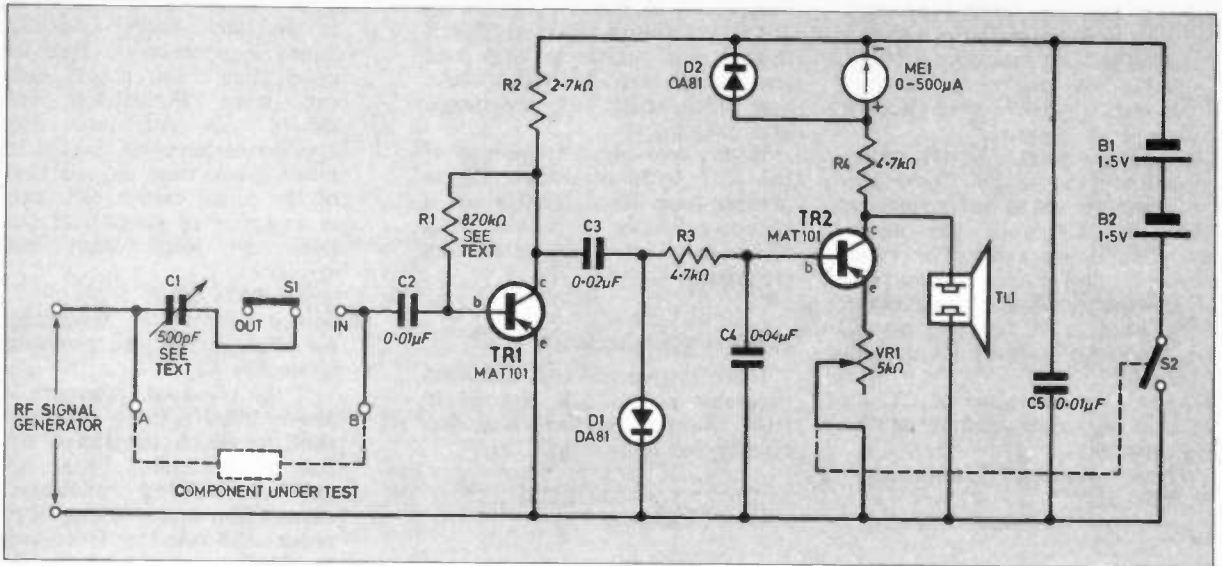

Fig. 1. The circuit diagram of the C-L Resonance Tester.

necessary; R1 gives some a.c. negative feedback which helps prevent oscillation.

CAPACITOR CALIBRATION

The variable capacitor C1 can be calibrated using a one per cent capacitor or a few five per cent

capacitors of the same value. The procedure is as follows:

- (1) Place the calibrating capacitor and an r.f. coil across A-B such that resonant frequency is less than 30MHz. The r.f. coil should have negligible self-capacitance.
- (2) Set switch S1 to OUT. Connect an r.f. signal generator and switch it on.

- (3) Switch the tester on and adjust VR1 so ME1 reads $\frac{3}{4}$ f.s.d.
- (4) Sweep through the frequency band until the meter dips to zero. (Unlike grid dip meters, the generator frequency control can be rotated quite rapidly.) There will be some minor dips but at the resonant frequency the meter will dip very close to zero.

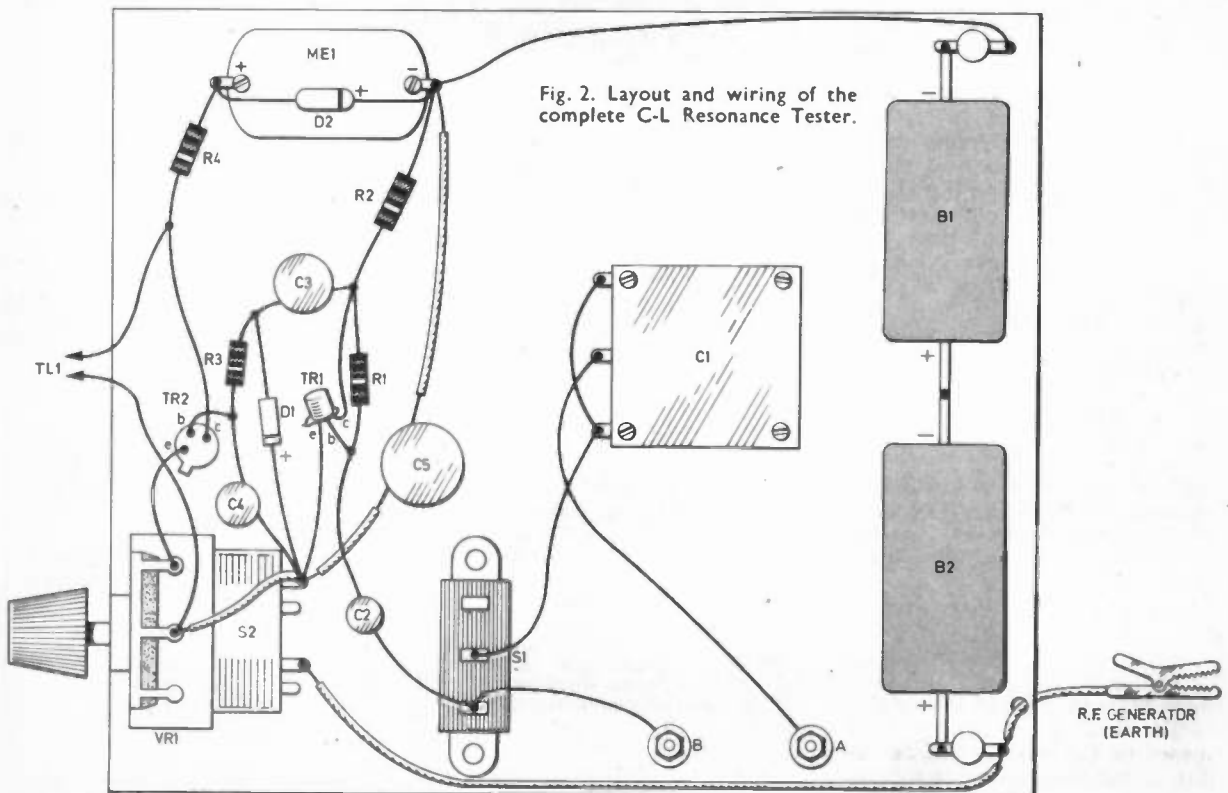

Fig. 2. Layout and wiring of the complete C-L Resonance Tester.

If five per cent capacitors are used repeat step 4 using each in turn and take a mean value of the resultant frequencies. Now remove the five per cent capacitor.

- (5) With the same r.f. coil across A-B, set S1 to IN. Leave the generator set to last frequency.
- (6) Rotate C1 until the meter again shows a dip. The value of C1 now equals the one per cent capacitor (or the average of the five per cent capacitors). Mark the scale of C1 accordingly.
- (7) The complete scale of C1 can now be constructed using the formula:

$$\frac{C_{\text{original}}}{C_{\text{unknown}}} \times \text{original frequency.}$$

For instance, if the calibration capacitor was 100pF which resonated with the r.f. coil at 6.1MHz, then 110pF on C1 scale will occur at a resonant frequency of

$$\frac{100}{110} \times 6.1\text{MHz} = 5.81\text{MHz.}$$

- (8) Set 5.81MHz on the signal generator and increase C1 for dip. Mark 110pF on C1 scale. Repeat similar operations until C1 scale is completed. Note: The most sensitive configuration giving most pronounced dip is with minimum setting of r.f. signal generator output consistent with minimum setting of VR1 and $\frac{3}{4}$ f.s.d. when off resonance. This is never critical but is worth remembering at high settings of C and high frequencies. Even so remember that the dip at resonance is always greater than those at subharmonics.

USING THE TESTER

Measuring Inductance

Place the coil across A-B. Set S1 to IN. Sweep the generator frequency and/or adjust C1 for meter dip. Read the value of C1 (=C).

$$L = \frac{25330}{f^2 C}$$

where L is in μH , f in MHz and C in pF.

Should the coil resonance be outside the range of the r.f. signal

generator minimum frequency and C1 minimum, the chances are that it is a relatively large coil and has a high self-capacitance. See "Measuring self-capacitance of a coil" later.

If the resonating frequency of the coil with maximum C1 is greater than about 30MHz add a known capacitor in parallel with C1 so as to lower the resonating frequency.

Measuring Capacitance

Place known coil and unknown capacitor across A-B. Set S1 to OUT. Sweep the generator frequency for meter dip. Use

$$C_{\text{unknown}} = \frac{25330}{f^2 L}$$

Alternatively, if coil inductance is unknown, remove C_{unknown} , and set S1 to IN. With original frequency found previously, set on signal generator, adjust C1 for dip. Then $C_{\text{unknown}} = C1$.

Checking Tuned Circuits

Note that no power is required to the tuned circuit which can also be checked in situ.

- (1) Connect one side of the tuned

circuit to A and the other to B (by two short crocodile leads if necessary). Bear in mind that these short leads can have inductance but should not introduce any appreciable errors if the inductance is less than ten per cent of the tuned circuit coil. This is a matter of judgement but keep the leads short and straight.

Set S1 to OUT.

- (2) Sweep generator frequency for dip. This is the resonant frequency f_r .

If the resonant frequency is above 25MHz it is still possible to check the tuned circuit by switching S1 to IN and introducing additional capacitance across C1 so as to reduce the resonant frequency to 25MHz. Call this setting of C1 'C1', and $f_1 = 25\text{MHz}$.

Now increase C1 slightly, say about 10pF and reduce the signal generator frequency for resonance. Call this setting of C1 'C2' and the frequency f_2 .

It can be shown that: Resonant frequency of original tuned circuit, f_r is given by

$$f_r = \frac{f_1^2 f_2^2 (C_2 - C_1)}{f_2^2 C_2 - f_1^2 C_1}$$

Components

See
**Shop
Talk**

Resistors

R1	820k Ω see text
R2	2.7k Ω
R3	4.7k Ω
R4	4.7k Ω
All $\pm 5\%$ $\frac{1}{4}$ W carbon	

Capacitors

C1	Any a.m. radio tuning capacitor about 500pF
C2	0.01 μF disc ceramic
C3	0.02 μF disc ceramic
C4	0.04 μF disc ceramic
C5	0.01 μF disc ceramic

Semiconductors

TR1	MAT101	} see text
TR2	MAT101	
D1	O A81 germanium diode	
D2	O A81 germanium diode	

Miscellaneous

ME1	500 μA edgewise meter (see text)
VR1	5k Ω potentiometer with switch (S2)
S1	S.p.d.t. slider switch
TL1	Crystal earpiece
B1, B2	1.5V batteries (2 off)

Case, crocodile clips (2 off), stand-off terminals (2 off)

e.g. A small v.h.f. coil and capacitor were placed across A-B. $C_1=110\text{pF}$, $f_1=25\text{MHz}$, $C_2=120\text{pF}$, $f_2=24\text{MHz}$.

$$f_r = \frac{25^2 \times 24^2 (120 - 110)}{(24^2 \times 120) - (25^2 - 110)} = 98.64 \text{ MHz}$$

As a check the coil and capacitor were measured independently. $L=0.3434\mu\text{H}$, $C=7.6\text{pF}$ (marked 8pF).

$$f_r = \frac{25330}{LC} = \frac{25330}{0.3434 \times 7.6} = 98.52\text{MHz}$$

It should be stressed that C_2 and C_1 be kept as low, as possible and a mean of several readings then taken. In practice, at such frequencies and above, a more satisfactory and inherently more accurate result is obtained by measuring the coil and capacitor separately.

It can also be proven that:

$$L = \frac{25330 (f_r^2 - f_1^2)}{f_r^2 f_1^2 C_1}$$

$$\text{or } \frac{25330 (f_r^2 - f_2^2)}{f_r^2 f_2^2 C_2}$$

This leads to a practical method of not only determining the resonant frequency of a tuned circuit, but also determining the values of L and C without separating or disturbing the tuned circuit. Thus so long as the tuned circuit leads are accessible (the tuned circuit could be a black box with the leads coming out) f_r , L and C can all be determined.

It follows that the method could similarly be used by heterodyning, but aural confusion could easily result. Also power would be required to the tuned circuit whereas none is required when using this test instrument and even a radio can be aligned without having to switch the radio on.

The method is as follows:

- As (1) and (2) above to find f_r .
- (3) Set S1 to IN, and introduce additional capacitance across C_1 to lower the resonant frequency which we shall call f_1 and $C_1=C_1$.

$$\text{Now } L = \frac{25330 (f_r^2 - f_1^2)}{f_r^2 f_1^2 C_1}$$

$$C = \frac{25330}{f_r^2 L}$$

With some tuned circuits using large coils, it may be found that C_1 as calculated above may not quite agree with that if the capacitance had been checked with another coil under "Measuring Capacitance". The difference is the self-capacitance of the large coil.

Measuring Self-Capacitance of a Coil

Self-capacitance can only be determined if the self-capacitance is more than 1 to 2pF and is therefore confined to coils in the order of those used for l.w. radio frequencies and below. These quite often self-resonate well below 30MHz and home-made l.w. coils 1MHz or less.

- (1) Connect coil across A-B. Set S1 to OUT. Sweep generator frequency for dip. This is the self-resonant frequency f_r .
- (2) Set S1 to IN, and introduce additional capacitance with C_1 (the smaller the additional capacitor the more accurate the result). Sweep the generator frequency for dip at frequency f_1 .

$$L = \frac{25330 (f_r^2 - f_1^2)}{f_r^2 f_1^2 C_1}$$

$$\text{Self-capacitance } C = \frac{25330}{f_r^2 L}$$

For example, a home-made l.w. coil was found to have a self-resonant frequency of 860kHz. With C_1 set at 20pF dip occurred at 390kHz.

Then $L =$

$$\frac{25330 (0.86^2 - 0.39^2)}{0.86^2 \times 0.39^2 \times 20} = 6614\mu\text{H}$$

Self-capacitance $C =$

$$\frac{25330}{0.86^2 \times 6614} = 5.18\text{pF}$$

Checking Crystals

- (1) Connect crystal across A-B. Set S1 to OUT. Sweep generator frequency control for sudden and dramatic rise in meter reading. This is the series resonant frequency of the crystal and is less than 0.1 per cent below the parallel resonant frequency, the latter not being easily discernible on the meter as a dip.

✧

YOUNG CIRCUIT IDEAS

I am enclosing a discovery which I have just made. I am 13 years old and my science master at Bishop Challoner School, Shortlands, Kent, thought you might like to publish it in some form or other.

David Rowlands

THE circuit shown here was designed to make the cathode of the neon tube light up in the normal fashion in addition to making the anode (the electrode that usually does not light up) flash quite fast. With a strobe wheel it is possible to observe that the cathode is flashing, but not with the naked eye, as it is too fast.

The buzzer used to power the neon is from G.E.C. It has two r.f. suppressing components: a small capacitor and a resistor. These must however be

removed as they decrease the voltage produced. A bell wired in series with the secondary coil of a mains to 12 volt transformer can be used instead of the buzzer. (The oscillator has to be joined to the primary.)

Circuit Operation

The buzzer produces spikes of high voltage, known as back e.m.f. Each high voltage peak makes the cathode flash orange. The capacitor is also

charged up. When the armature of the buzzer next touches the adjusting screw the electrons in the capacitor flow through the coil of the buzzer and make the anode of the neon tube flash yellow. It flashes yellow due to the large pulse of electrons which make two or more electrons ionise the neon. This is known as 2nd spark spectrum. If a spectroscope is available the colours from red to blue can be seen.

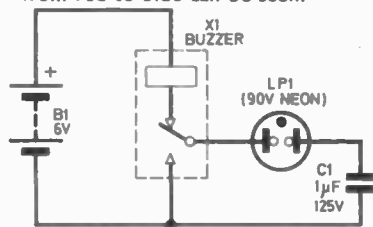



I.C.'s EXPLAINED

By BRIAN DANCE

PART
FIVE

ONE of the most important families of logic devices now available employs complementary p-channel and n-channel MOSFETs (Metal Oxide Silicon Field Effect Transistors) without any passive components. This type of COS/MOS or CMOS logic is not quite so fast as TTL, but it has many advantages.

Probably the most important advantage of COS/MOS techniques is the very low standby power required when the circuits are not being switched. Another important advantage is the very high packing density which can be achieved on the silicon chip and which enables very complex devices to be made.

COS/MOS devices can operate over a much wider range of supply voltages (normally 3V to 15V) than that which can be used with TTL, whilst they are also more immune to the effect of stray noise pulses.

RCA and SGS-ATES market this type of device under the name COS/MOS, whilst National Semiconductor and Motorola use the name CMOS. As in the case of TTL, many manufacturers offer similar devices under rather similar

type numbers. Some claim particular advantages, such as in the case of the Mullard/Philips LOC MOS devices.

Speeds of up to 200MHz have been obtained by RCA in the laboratory using silicon-on-sapphire COS/MOS techniques at low power, but this technology is still under development.

NAND GATE

COS/MOS NAND gate is shown in Fig. 5.1. It requires only 4 MOS transistors without passive components and may be compared with the TTL NAND gate of Fig. 3.2.

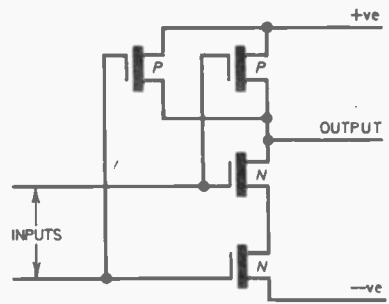

Fig. 5.1. Basic CMOS NAND gate which requires only four transistors.

TTL devices need regulated power supplies providing a moderately high current, but a simple power supply with a Zener diode across the output is adequate for most COS/MOS systems. In general one should use about 5V for slow COS/MOS applications and 10V to 15V for faster work.

A single COS/MOS NAND gate consumes only around 10nW (10⁻⁹W) in the quiescent state—about a million times less power than that required by a TTL NAND gate. Low power dissipation brings the advantage of low thermal stress and hence increased device reliability.

This low power consumption is possible because COS/MOS devices are MOS transistors which are normally biased into the off state. Only the leakage current flows when they are not being switched.

The low power enables extremely complex circuits to be made without the devices overheating. A typical TTL counter requires about 150 milliwatts, whilst a similar COS/MOS device requires a few microwatts.

As the switching speed of the COS/MOS circuit increases, the power required increases, since current is needed to switch the charge on the stray capacitance. Even at 100Hz the current required for the switching greatly exceeds the static current. At frequencies in the megahertz range, the power required may exceed that of TTL devices. The higher the supply voltage used with COS/MOS devices, the greater the current consumed.

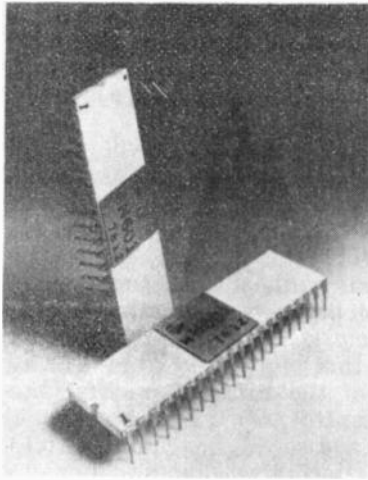

The mN601 microprocessor from Data General Corporation

One of the major disadvantages of COS/MOS logic is that the maximum operating speed is about two or three times less than that of TTL. However, a COS/MOS output can drive almost any number of other devices, whereas a standard type TTL output can drive up to about ten TTL inputs.

COS/MOS devices have fallen in price extremely quickly recently. They are now being used in much industrial and medical equipment, in portable instruments where their low power consumption is important, in the automobile field, etc.

Indeed, they are replacing TTL in most spheres, but they dominate the watch industry where their small size and low power consumption is vital.

TYPES

One of the best known series of COS/MOS devices is the RCA 4000 series which includes, as a simple example, the CD4012A dual 4-input NAND gate. This series was first introduced in 1968, but is now gaining wide acceptance.

Equivalent devices to the CD4012A are the Fairchild 34012, the SGS-ATES HBF 4012 AE, the Motorola MC14012A and the National Semiconductor CD4012C. However, similar COS/MOS devices from various manufacturers are not nearly so similar to one another as the TTL devices from various producers.

Another range of CMOS devices is produced by National Semiconductor which are similar to the "74" series of TTL devices; they have the same pin connections as the latter and similar type numbers. The MM74COO, for example, is a CMOS quad 2-input NAND gate functionally similar to the 7400. Designers familiar with TTL do not have to get used to a whole new range when using this series of CMOS devices.

However, the 4000 series has been specially

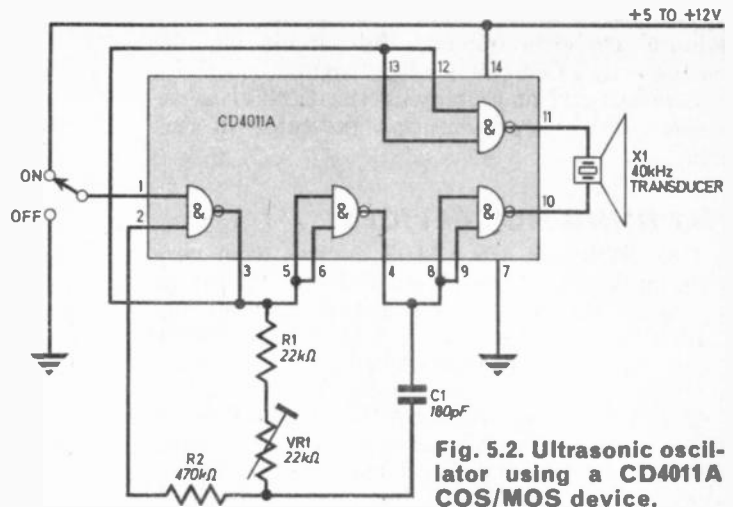

Fig. 5.2. Ultrasonic oscillator using a CD4011A COS/MOS device.

designed for COS/MOS techniques and incorporates more complex facilities on single chips than are possible with TTL. For example, the 4026 and the 4033 devices are decade counters which incorporate 7-segment decoders so that a separate decoder is not required.

SIMPLE OSCILLATORS

In case some readers feel COS/MOS devices are used only in complex circuits and are therefore of no interest to them, it is worth while discussing their use in very simple, economical oscillators.

A typical circuit is shown in Fig. 5.2 in which the CD4011A quad 2-input NAND gate is used, this device being available for less than 20 pence. The two NAND gates on the left hand side form a simple oscillator operating at about 40kHz. The frequency is determined by C1, R1 and VR1 and can be adjusted by the latter potentiometer.

When the potential at pins 3, 5 and 6 is high, the potential at pins 4 and 2 is low to the inverting property of the NAND gate; C1 charges through VR1 and R1 until the potential at pin 2 becomes so high that the output potential at pin 3 falls and that at pin 4 rises. After this switching has taken place, C1 charges with the opposite polarity.

Good square waves in push-pull can be obtained from pins 3 and 4, these waves having virtually the full amplitude of the supply voltage under no load conditions. In the circuit shown, the two NAND gates on the right form a buffer amplifier to drive an ultrasonic transducer.

This type of oscillator can also be used for other purposes at frequencies up to about 1MHz. The high input resistance of the gate enables relatively high values of timing resistors to be used and hence fairly small capacitors can be employed even when one requires very low frequencies.

The on/off switch shown passes only a very minute current. Indeed, the circuit can be switched by a COS/MOS output signal.

Another circuit employing the CD4011 is described in the *Fermentation Indicator* in this issue.

HANDLING MOS DEVICES

COS/MOS and other MOS devices have very high input impedances. If an electrostatic charge forms on the input electrodes, it can build up a high voltage which easily destroys the device. Such charges are readily picked up from a nylon shirt, for example, even without any contact.

The 4000 series of COS/MOS digital devices have input protection networks which prevent damage by normal electrostatic charges in almost all circumstances, but nevertheless it is wise to take the following precautions:

1. During storage the leads of the devices should be inserted into conductive plastic foam.
2. Devices should never be inserted into or removed from sockets with the power on, since this may generate high transient voltages.
3. Soldering iron tips and any tools should be grounded.
4. Signals should not be applied to the inputs unless the power supply is connected.
5. All unused inputs must be connected to a suitable point—normally the positive or negative supply lines according to the logic required.

The author and many of his colleagues have often ignored many of these recommendations when using cheap 4000 series devices and have never yet had a device fail. Nevertheless, when using the more expensive devices, it is wise to observe the above recommendations carefully.

When using MOS devices with unprotected inputs—such as some electronic watch chips—one should work on an earthed aluminium foil with one's sleeves rolled up and one's bare arms in good contact with the foils. All tools, etc. which touch the chip connections should be earthed. It may be possible to earth all of the contacts with very fine wire which can later be removed.

MICROPROCESSORS

During the past couple of years there have been great developments in the microprocessor field, but these products are so complex that it is not possible to give them the attention they deserve in this article. Indeed, almost all of the major semiconductor manufacturers have entered this field and produce weighty volumes about their products and organise seminars for prospective customers. The amount of information is quite bewildering.

The microprocessor (MPU or μ P) is often referred to as a "computer on a chip". Although they can perform an enormous amount of work with numbers, they still seem to fall short of

being a complete computer on a chip, since most of them require quite an array of additional equipment (such as external additional memories, input/output facilities, etc) which can be quite complex.

However, a microprocessor device will provide most of the central processor facilities of a digital computer together with its control circuitry, facilities such as interrupt flags, etc.

Currently microprocessors are used for specific applications rather than for general computing, partly because conventional computers are too complex for minor applications. It seems certain that microprocessors will be used in vehicles of the future for many purposes, for the control of traffic signals, in domestic washing and sewing machines, in telephone equipment (including domestic installations for re-routing calls, etc).

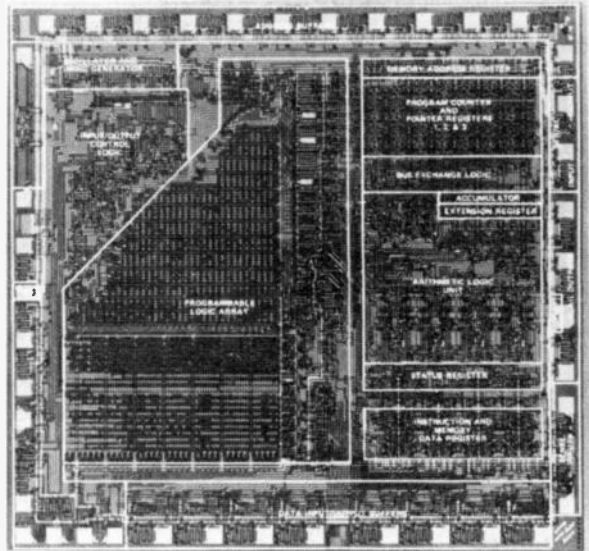

A magnified view of the National SC/MP microprocessor chip designed to sell for less than £5.

They will also be widely used in industrial control, at check-out points in stores apart from their obvious use in programmable calculators.

At the present time most microprocessors are priced at some tens of pounds. However, with increased volume of sales, their price should fall rapidly, since their manufacture should not cost much more than that of other complex chips. It is particularly important for manufacturers to develop devices which can be used for a wide variety of applications so as to achieve a high sales volume. Devices with 40 pins are common in the microprocessor field.

Present L.S.I. devices have over 10,000 transistors per chip, but it is strongly forecast that the early 1980's will see one million per chip in the most complex devices. One can only wonder what revolution this will bring in our standards of living. □

Bring 'scope' to your interest.

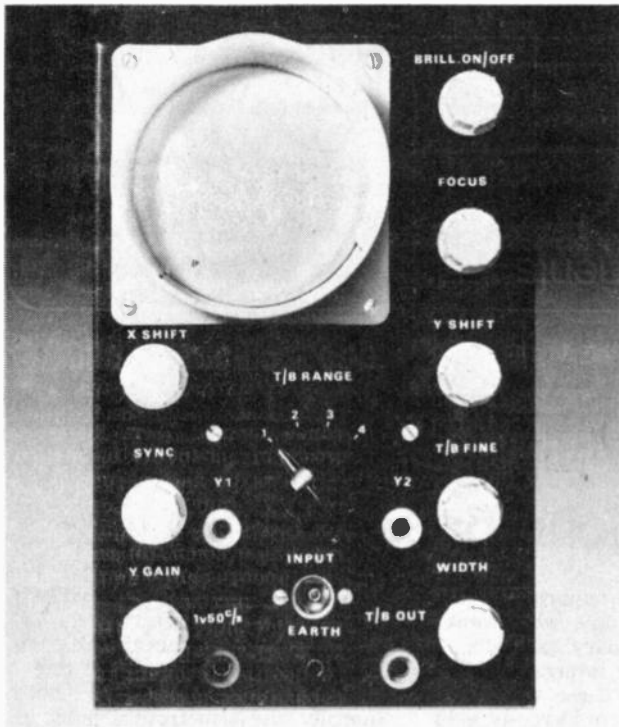

'There's only one way to master electronics... to see what is going on and learn by doing.'

This new style course will enable anyone to have a real understanding of electronics by a modern, practical and visual method. No previous knowledge is required, no maths, and an absolute minimum of theory.

You learn the practical way in easy steps mastering all the essentials of your hobby or to further your career in electronics or as a self-employed electronics engineer.

All the training can be carried out in the comfort of your own home and at your own pace. A tutor is available to whom you can write, at any time, for advice or help during your work. A Certificate is given at the end of every course.

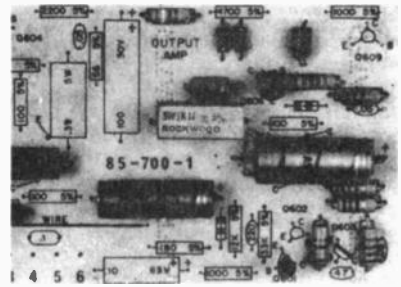
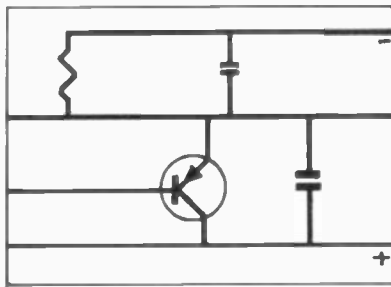
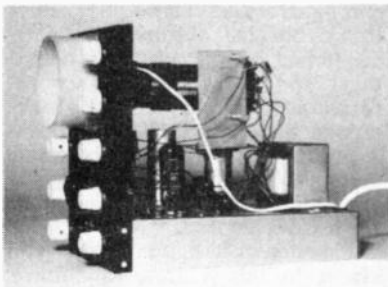

1 Build an oscilloscope.

As the first stage of your training, you actually build your own Cathode ray oscilloscope! This is no toy, but a test instrument that you will need not only for the course's practical experiments, but also later if you decide to develop your knowledge and enter the profession. It remains your property and represents a very large saving over buying a similar piece of essential equipment.

2 Read, draw and understand circuit diagrams.

In a short time you will be able to read and draw circuit diagrams, understand the very fundamentals of television, radio, computers and countless other electronic devices and their servicing procedures.

3 Carry out over 40 experiments on basic circuits.

We show you how to conduct experiments on a wide variety of different circuits and turn the information gained into a working knowledge of testing, servicing and maintaining all types of electronic equipment, radio, t.v. etc.



All students enrolling in our courses receive a free circuit board originating from a computer and containing many different components that can be used in experiments and provide an excellent example of current electronic practice.

To find out more about how to learn electronics in a new, exciting and absorbing way, just clip the coupon for a free colour brochure and full details of enrolment.

Write to:- British National Radio & Electronics School,
P.O. Box 156, Jersey, Channel Islands.

NAME _____
ADDRESS _____
EEB 96

The Extra-ordinary Experiments of Professor Ernest Eversure

by Anthony John Bassett



DR Paterson, the Prof's visitor, was having trouble getting his patients to perform therapeutic exercises, and he had come to ask the Prof's advice.

"These electronic games machines", the Prof. informed the Doctor, "can be used to relieve the boredom of tedious therapeutic exercises. By connecting the controls to the muscles which need exercise, by way of suitable arrangements of levers, pedals or joystick-type controls, these electronic games machines can be made to act as a positive form of motivational aid for the patient, and provide the correct amount of exercise in a proper manner.

If the patients' muscles are weak or slow, the weak movements can be amplified, both mechanically by means of the levers, and electronically by means of special positionally-compensated d.c. amplifiers, to give significant and psychologically rewarding movements of the figures on the screen. As the muscles grow stronger, the amplification may be reduced.

Also, a healthier 'opponent' may be given handicaps, such as a delayed-action circuit to slow down his responses.

This way opponents can be closely matched, and given a positive interest in performance of the necessary movements. It may

also be a great opportunity for enjoyment by people who cannot join in with ordinary games!"

"This is really interesting", he told the Prof., "these electronic games machines could really help in solving some of the motivational problems I have in trying to get my patients to perform tedious therapeutic exercises. Why, two patients could compete with one another in one of these electronic games, and they could each be exercising completely different sets of muscles! I will discuss this with my colleagues, and we will decide how many of these machines my department needs!" With that, the Doctor bade them farewell and departed from the laboratory.

INTRUDER

"Prof., you do have some fascinating visitors. Do please tell us about some of them!" Suzy asked.

"Today," began the Prof. "The Robot captured a chap who tried to get past my latest experimental electronic intruder-alarm. He did not have an appointment to see me, but insisted that he wanted to consult me to try to find a way of getting past the security system at the Bank of England, and he'd decided to try to sneak past my own security system as a test."

"Poor fellow! what did you do with him?" Suzy enquired.

"I asked him whether he'd be satisfied with a career of thieving" replied the Prof., "both morally and also from a point of view of his own personal safety and satisfaction. These days, electronic burglar alarms are being developed which are more tricky than the burglars, and some recent advances in electronic technology have resulted in not only a number of more sophisticated systems, but also some simpler ones which give more protection for less money.

I demonstrated my old burglar alarm to this visitor, as I have left it wired in as a standby, and he was quite shocked to discover the number of ways in which even my old system would have caught him out! Then I sent him on his way with the suggestion that he should seriously consider taking up a more philanthropic occupation!

Before, he went, however, I warned him about some of the latest computerised burglar-alarms which use ultra-sonic beams, microwaves and a variety of sophisticated sensors which it would be almost impossible to dodge."

"Aren't ultrasonic beams and microwaves dangerous, Prof.?" Bob enquired, "I have been told of people who became quite ill

Get a great deal from Marshall's

A. Marshall (London) Ltd Dept: EE

40/42 Cricklewood Broadway London NW23ET Tel: 01-452 0161/2 Telex: 21492
& 85 West Regent St Glasgow G2 2QD Tel: 041-332 4133
& 1 Straits Parade Fishponds Bristol BS16 2LX Tel: 0272-854201/2
& 27 Rue Danton Issy Les Moulineaux Paris 92

Call in and see us 9-5.30 Mon-Fri 9-5.00 Sat
Trade and export enquiries welcome

Catalogue price 40p
(30p to callers)

Our range covers over 7,000 items. The largest selection in Britain

Top 200 IC's TTL, CMOS & Linear

CA3020A	£1.45	CD4050	56p	NE556	£1.30	SN7448	85p	SN74157	68p
CA3028A	85p	CD4510	£1.54	NE560	£4.48	SN7450	16p	SN74160	£1.20
CA3035	£1.35	CD4511	£1.70	NE565	£1.30	SN7451	16p	SN74161	£1.20
CA3046	73p	CD4516	£1.94	SL414A	£2.35	SN7453	16p	SN74162	£1.20
CA3048	£1.35	CD4518	£1.38	SL610C	£2.35	SN7454	16p	SN74163	£1.20
CA3052	£1.62	CD4520	£1.38	SL611C	£2.35	SN7460	16p	SN74164	93p
CA3089E	£2.00	LM301AH	47p	SL612C	£2.35	SN7470	32p	SN74165	93p
CA3090Q	£4.23	LM308N	£1.17	SL620C	£3.50	SN7472	26p	SN74167	70p
CD4000	20p	LM309K	£1.80	SL621C	£3.50	SN7473	30p	SN74174	£1.06
CD4001	20p	LM380	99p	SL623C	£3.75	SN7474	30p	SN74175	94p
CD4002	20p	LM381AN	£2.07	SL640C	£4.06	SN7475	40p	SN74176	86p
CD4006	£1.16	LM702C	79p	SN7400	16p	SN7476	36p	SN74180	£1.23
CD4007	20p	LM709	SN7401	16p	SN7480	45p	SN74181	£2.58	
CD4008	97p	TO99	40p	SN7402	16p	SN7481	£1.10	SN74190	£1.33
CD4009	37p	BOIL	40p	SN7403	16p	SN7482	67p	SN74191	£1.33
CD4010	37p	140IL	40p	SN7404	16p	SN7483	92p	SN74192	£1.13
CD4011	20p	LM710	45p	SN7405	16p	SN7484	85p	SN74193	£1.13
CD4012	20p	LM723C	60p	SN7406	51p	SN7485	£1.23	SN74196	£1.81
CD4013	59p	LM741C	SN7407	18p	SN7486	29p	SN74197	£1.81	
CD4014	£1.01	TOS	38p	SN7408	18p	SN7490	43p	SN74198	£2.04
CD4015	£1.01	BD1	38p	SN7409	18p	SN7491	68p	SN74199	£2.04
CD4016	56p	140DL	40p	SN7410	16p	SN7492	43p	SN76003N	
CD4017	£1.01	LM747CN	78p	SN7412	25p	SN7493	43p	SN76013N	£2.36
CD4018	£1.01	LM748	SN7413	40p	SN7494	74p	SN76013N		
CD4019	57p	BD1	44p	SN7416	43p	SN7495	99p		£1.90
CD4020	£1.13	140ZL	41p	SN7417	43p	SN7496	78p	SN76023N	£1.90
CD4021	£1.01	LM3900N	55p	SN7420	£1.15	SN76033N	2.50		
CD4022	97p	LM7805P	£1.99	SN7423	26p	SN74107	30p	TAA263	£1.25
CD4023	20p	LM7812P	£1.99	SN7425	27p	SN74118	90p	TAA300	£2.47
CD4024	79p	LM7815P	£1.99	SN7427	27p	SN74119	£1.80	TAA350A	£2.68
CD4025	20p	LM7824P	£1.99	SN7430	16p	SN74121	34p	TAA550	40p
CD4027	56p	MC1303L	£1.44	SN7432	27p	SN74122	45p	TAA611C	£2.25
CD4028	£1.10	MC1310P	£1.91	SN7437	33p	SN74123	40p	TAA621	£2.15
CD4029	£1.17	MC1330P	35p	SN7438	35p	SN74141	72p	TAA661B	£1.32
CD4030	37p	MC1351P	87p	SN7440	74p	TBA641B	£2.50		
CD4031	£2.26	MC1455J	£4.07	SN7441	76p	SN74150	£1.20	TBA651	£1.80
CD4037	97p	MC1466L	£3.95	SN7442	35p	SN74151	77p	TBA800	£1.19
CD4041	83p	MC1469R	£2.50	SN7446	80p	SN74153	73p	TBA810	£1.28
CD4049	86p	NE555V	48p	SN7447	81p	SN74154	£1.29	TBA820	£1.02
								TBA920	£1.79

LONDON GLASGOW PARIS AND BRISTOL
IT'S OUR SERVICE THAT MAKES US GROW

POPULAR SEMICONDUCTORS

2N696	25p	2N3906	22p	AF139	69p	BD139	42p	MPSA56	20p
2N697	16p	2N4058	20p	AF239	74p	BF115	36p	OC28	£2.00
2N699	35p	2N4062	18p	AF279	80p	BF117	70p	OC42	50p
2N706	12p	2N4921	60p	AF280	85p	BF154	25p	TIP29A	50p
2N708	21p	2N4923	70p	AL102	£1.30	BF180	36p	TIP31A	62p
2N718	43p	2N5245	29p	BC107	14p	BF181	36p	TIP32A	75p
2N918	34p	2N5294	35p	BC109	15p	BF184	35p	TIP34A	£1.20
2N1302	37p	2N5296	36p	BC147B	10p	BF194	13p	TIP35A	£2.50
2N1306	45p	2N5458	26p	BC149B	13p	BF196	13p	TIP36A	£3.55
2N1308	60p	2N5459	29p	BC158A	12p	BF197	14p	TIP41A	70p
2N1711	27p	2N6027	45p	BC158A	11p	BF198	15p	TIP42A	70p
2N2102	60p	3N128	80p	BC167B	12p	BF244	35p	TIP2955	£1.00
2N2148	£1.63	3N140	£1.00	BC168B	12p	BF258	49p	TIP3055	50p
2N2184	47p	3N141	85p	BC169B	12p	BF259	49p	TIS43	30p
2N2219A	52p	3N200	£2.60	BC182	11p	BF598	27p	ZTX504	£2.50
2N2220	35p	40361	45p	BC182L	14p	BF39	24p	ZTX301	15p
2N2221	22p	40362	45p	BC183	11p	BF79	24p	ZTX301	15p
2N2222	25p	40406	48p	BC183L	14p	BFX29	36p	ZTX502	18p
2N2369	25p	40407	30p	BC184	12p	BFX84	38p	IN4194	7p
2N2646	55p	40408	50p	BC184L	14p	BFX85	41p	IN4007	18p
2N2905	37p	40409	55p	BC212	14p	BFX88	32p	IN4148	7p
2N2906	28p	40410	55p	BC212L	14p	BFY50	30p	IN4504	18p
2N2907	21p	40411	£2.30	BC213L	16p	BFY51	38p	IN4508	40p
2N2926G	13p	40594	75p	BC214L	19p	BFY52	36p	AA119	14p
2N3053	25p	40595	88p	BC237B	14p	BRX39	50p	BA105	15p
2N3054	50p	40636	£1.15	BC239C	16p	ME0412	20p	BA142	15p
2N3055	65p	40673	73p	BC257A	17p	ME4102	10p	BA155	12p
2N3391	27p	AC126	37p	BC259B	18p	ME480	£1.05	BB103B	20p
2N3393	15p	AC127	44p	BC301	45p	ME481	£1.30	BB103B	34p
2N3440	57p	AC128	37p	BC307B	20p	ME490	£1.05	BY126	70p
2N3442	£1.20	AC152	50p	BC309C	25p	ME491	£1.55	BY111	27p
2N3638	16p	AC153	40p	BC327	20p	ME2955	£1.00	BY122	70p
2N3702	17p	AC176	40p	BC328	19p	ME370	68p	OA47	10p
2N3703	15p	AC187K	40p	BCY70	25p	ME371	81p	OA90	6p
2N3706	14p	AC189K	45p	BCY72	24p	ME520	65p	OA91	6p
2N3708	46p	AD161	75p	OD102	£2.00	ME521	75p	OA200	8p
2N3716	£2.60	AD162	75p	BD124	£2.00	ME2955	£1.25	BY164	57p
2N3771	£1.60	AD166	45p	BO131	51p	ME3055	75p	ST2 diac	20p
2N3773	£2.65	AF109	45p	BD132	54p	MP8113	45p	40669	£1.00
2N3789	£2.60	AF115	65p	BD136	36p	MPSA05	20p	TIC44	29p
2N3819	26p	AF116	65p	BD137	36p	MPSA06	20p	C106D	65p
2N3904	21p	AF118	65p	BD138	39p	MPSA55	20p	ORP12	70p

PRICES CORRECT AT AUGUST 1976, BUT ALL EXCLUSIVE OF VAT. P. & P. 30p

TECHNICAL TRAINING IN ELECTRONICS AND TELECOMMUNICATIONS

ICS can provide the technical knowledge that is so essential to your success; knowledge that will enable you to take advantage of the many opportunities open to you. Study in your own home, in your own time and at your own pace and if you are studying for an examination ICS guarantee coaching until you are successful.

City & Guilds Certificates:
Telecommunications Technicians
Radio, TV, Electronics Technicians
Technical Communications
Radio Servicing Theory
Radio Amateurs
Electrical Installation Work
MPT Radio Communications Certificate

Diploma Courses:
Colour TV Servicing
Electronic Engineering and Maintenance
Computer Engineering and Programming
Radio, TV, Audio Engineering and Servicing
Electrical Engineering, Installation and Contracting

POST OR PHONE TODAY FOR FREE BOOKLET

ICS To: International Correspondence Schools

Dept. 710X Intertext House, London SW8 4UJ or telephone 622 9911

Subject of Interest

Name

Address

Tel:

G F MILWARD Phone --- 021-327-2339

369 ALUM ROCK ROAD, B'HAM. B8 3DR

SOLDERING IRONS PENCIL BIT 40 WATT £1.50	1N4005 600VOLT. ORIGINAL. 15 ---- £1
100 RESISTORS ASSORTED £1	1N4148 ORIGINAL 25 ---- £1
Volume Controls & Pre Sets 25p £1	BARGAIN BAGS RESISTORS CAPACITORS DIODES TRANSISTORS ELECTROLYTICS CONTROLS ETC. (MIXED) 4 lb £5
BC158 SILICON PNP ORIGINAL 8 ---- £1	11 Range MULTI METERS £4
BC148C HIGH GAIN SILICON PNP 8 ---- £1	100 GERMANIUM PNP TRANSISTORS (UNTESTED) £1
3watt Stereo Amps Ready built with independent Volume and Tone Controls £3.25	

ALL ABOVE PRICES INCLUDE POST & VAT

during the course of work with ultrasonics."

"Yes, Bob, they can both be dangerous. However, both ultrasonic vibrations, and microwaves, occur in nature. There is nothing intrinsically wrong in making use of them provided that the dangers are understood and the necessary precautions are taken in order to protect people, and the environment, from their effects. When they are used in burglar alarms the levels of radiation are kept low so that damage is unlikely to result; also the premises in which they are used are usually unoccupied.

A recent developed product, however, makes possible a fairly simple type of alarm which does not rely on any of these high-frequency radiations. It is a pressure-sensitive transistor, which can be used to make improvements to an older type of electric burglar alarm by application of modern electronic technology.

The building which is being protected is pressurised slightly by means of an electric fan. Provided there is not a lot of leakage through odd cracks and chinks, under doors and so on, this maintains the air in the building at a

pressure slightly higher than that outside, and this was previously detected by an aneroid barometer capsule. Changes in air pressure cause the aneroid barometer capsule to expand and contract, and these actions, are made to cause a lever to move.

If a door or window is opened, this causes the air pressure to fall nearly to the same as that outside the building, and the lever then moves over and touches a contact.

With a pressure sensitive transistor this mechanical arrangement can be replaced."

Continued next month.

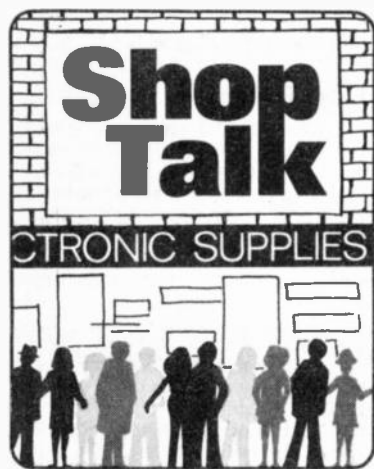

By Mike Kenward

New products and component buying for constructional projects.

A case of time

A new case designed especially for digital clocks has recently been introduced by West Hyde Developments, called the "Time Box" it is moulded in anti-static ABS, has a good tough finish with moulded feet at the front, and measures 131 by 71.5 by 56 mm. Available in red, white, orange and blue with a translucent red acrylic front window. Basic price is £1.79 each but West Hyde operate a minimum order charge of £2.

More details from West Hyde Developments, Ryefield Crescent, Northwood Hills, Middlesex HA6 1NN (Tel. Northwood 24941).

Clunk Click Jogger

Not many components are employed in the *Clunk Click Jogger*, none of them are particularly expensive and they should all be easy to obtain. The thyristor can be virtually any small

type, since it is used at low voltage and current, the ratings are not important but it would be pointless to go above about 300 p.i.v. at 3 amp since size and cost will then increase.

C-L Resonance Tester

The transistors specified for the *C-L Resonance Tester* are rather unusual, although alternatives can be used (see text) the MAT101's can be obtained from RST Valve Mail Order Co., Climax House, 156 Fallsbrook Road, London SW16 6ED. They cost 25p each plus 8 per cent plus 15p postage—69p?

When buying the tuning capacitor we suggest you get the cheapest available but remember it should be a reasonably compact type of around 500pF. All other components should be readily available.

Electronic Thermometer

No difficulties in buying parts for the *Electronic Thermometer* and most large

firms supplying catalogues should list most of the parts—see literature notes below.

Fermentation Indicator

The *Fermentation Indicator* is a first in more ways than one—it is the first time we have featured a project for wine-makers, it is the first of our "ideas from readers" (see this month's editorial) and it is the first project we have published employing a small CMOS i.c.

The i.c. is available for about 20p and is one of a fairly large number of CMOS devices that have been around, but little used, for some time. Incidentally there is no need to take precautions against static when using this device, such precautions may have put many constructors off using some of the older CMOS devices (see *I.C.s Explained* page 484).

All other components for this device should be readily available, the two air locks can be obtained from Boots.

Literature

Just released by Chromasonic Electronics is their Catalogue '76. Twenty pages packed with illustrations and details of a good range of components, amplifier modules, kits, cases, even an electronic ignition system. They stock an extensive range of i.c.s and other semiconductor devices and they should be able to supply all components for many of our projects. The catalogue costs 35p inclusive and includes three vouchers each worth 12p when used as directed against orders.

A 24 hour turnaround is operated where orders received by 3.00 p.m. are despatched the same day, and this we are sure will be very attractive to many readers who may have waited weeks for parts in the past.

For your catalogue write to Chromasonic Electronics, 56 Fortis Green Road, London N10 3HN. As we have said before it does help if you always mention *Everyday Electronics* when buying anything for any of our projects; and this includes catalogues. As they say, "just mention my name"—it probably won't mean anything to anyone—but mention it anyway!

Another catalogue worth investigating is the Maplin one and we now receive a regular two-monthly newsletter, from them which carries a price list and gives details of new items etc. We note with interest that they can now supply all components for the radio control system we published in our November 1975 and January 1976 issues. If you want to get the newsletter, it will only cost you 30p a year (refundable on purchases), write to Maplin—see their advertisement on the back page for details.

GEORGE HYLTON brings it down

Voltage Dividers

THE voltage divider (also known as the potential divider) is a handy piece of circuitry which readers may well need to use. It crops up all over the place, for example in transistor bias circuits. However, in this Down to Earth I shall concentrate on its use as an attenuator of signals.

A typical case is in audio test oscillators. An oscillator may have an output of 1V. If it is just fitted with a "pot" as its output level control, it will be easy to set the voltage to, say, 0.3V or even 0.1V. But suppose you need 3mV or 1mV; You just can't set up these small output voltages because they require turning the "pot" up from zero by very small amounts—as little as a thousandth part of its total travel. With the usual 270 degree travel, this means setting to 0.27 degree. Even if it can be done at all, this can't be done with ease and accuracy.

So the "pot" is usually followed by a voltage divider. This can be switched to give outputs which are 1/10, 1/100, or 1/1000 of the voltage which comes out of the "pot". So to set the output to 3mV you set the "pot" to 0.3V (=300mV) and the divider to 1/100.

Design

Readers may well wish to design their own voltage dividers. To illustrate the principles, let's look at a very simple one first (Fig 1). This has only two resistances, A and B, and divides by 10. The question is, what size should the resistances be?

It is clear that if 1V appears across B then the other 9V of the input must be lost across A. If the usual assumption is made that no current is drawn from the 1V "tap" (more about this later) then the same current I flows through A and B. The flow of I in A produces a voltage drop of 9V and in B of 1V. So A must have nine times the resistance of B.

The voltages across the resistance add up to the input voltage. This is a useful clue to the design of more

complicated dividers; Fig. 2 shows such a divider, preceded by a "pot" (VR1) connected to a source of 1V a.c. (such as an oscillator).

Looking at the voltages at the "taps", you can see that with 1V input 1mV appears across D, 9mV across C, 90mV across B and 900mV across A. (That is, each resistance drops the difference between the voltages at its upper and lower ends.) To produce these voltages the resistances must be in the same proportions.

If D is 1 ohm, C is 9 ohms, B is 90 ohms, and A is 900 ohms. But we could just as easily have made D=10 ohms in which case all the others would have had to be ten times as great. Similarly, we could have made D = 1 megohm, in which case the others would have worked out at 9, 90, and 900 megohms.

The Best Alternative

All these alternatives produce the correct outputs. So which is the best? The answer is that the resistance of the voltage divider as a whole (i.e. $A \times B \times C \times D$) should be high enough not to draw too much signal current. In practice this means that A (which accounts for the bulk of the divider resistance) should be about 10 times VR1. So A=9 kilohms (which is nine times VR1, or quite near enough to 10 times for our purpose).

If you can't get 9 kilohm resistors you can use two 18 kilohms in parallel. However, there's another alternative. If all the resistances are multiplied by 10/9, the required values become 10 kilohms, 1 kilohm, 100 ohms, and 11.1 ohms. The first three are quite standard and the last can be made up of 12 ohms and 150 ohms in parallel.

Source and Load Resistance

I've assumed that the internal resistance of the voltage source (R_s) is so small compared with VR1 that it can be neglected. If it isn't, then the

flow of current in it will reduce the available output voltage.

I've also assumed that any load resistance (R_L) connected at the divider output is so high that it draws negligible current. If it isn't, then the voltage is reduced. The reduction depends mainly on which "tap" is in use. It is usually greatest on the second "tap" (in this case the 100mV tap). Here, looking back from the output into the "tap", you "see" a resistance which is about equal to B.

In the example, $B=1$ kilohm. So if R_L is also 1 kilohm there is a 50 per cent reduction in voltage. On the 10mV "tap" the resistance is roughly C (100 ohms) and on D roughly 10 ohms. On "1000mV" the output resistance depends strongly on the setting of VR1.

If the slider is at the bottom it is zero. As the slider is moved up, the resistance first increases (to roughly $VR1/4$ or 250 ohms) then decreases to R_s at the top. For most purposes, the general rule is that reasonable accuracy of output voltage is obtained if R_L is at least as big as B.

Extra Ranges

Looking at the resistance values in the divider it is clear that extra low-voltage ranges can be added by replacing D with a chain of resistances, 10, 1, 0.1 ... etc, remembering that the last in the chain has to be one ninth of the last but one, e.g. 0.0111. Unfortunately this technique leads to awkward low-value resistances which can't be bought at the usual component suppliers.

An alternative tactic, which doubles the number of ranges, is to put a 1000 to 1 attenuator (Fig. 3) between the "pot" and the divider. This turns volts into millivolts or (in our case) millivolts into microvolts. The design criteria are simple: R_2 should be about 1/100 of A, and R_1 should be 999 times R_2 . In practice, use $R_1=1000$, R_2 , because you then get standard values and the error is negligible.

Fig. 1. Simple voltage divider.

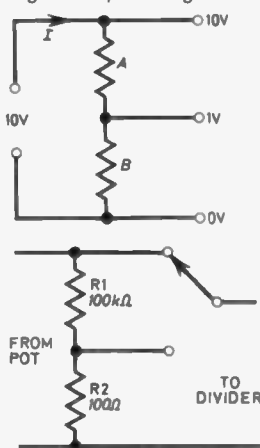
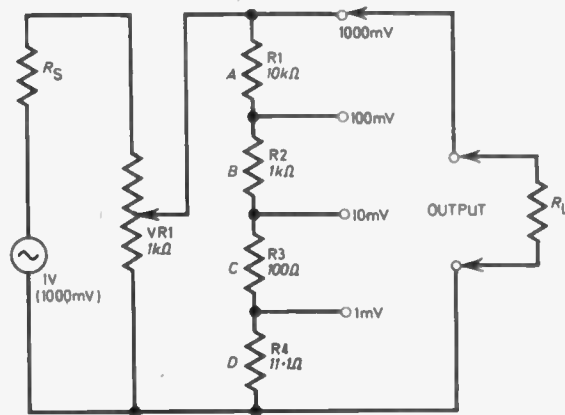

Fig. 3. 1000 to 1 attenuator.

Fig. 2. A voltage divider preceded by a potentiometer.



to earth

NEW KITS

EASY TO CONSTRUCT



**DORAM
KITS
CONTAIN
EVERYTHING
DOWN TO
THE LAST
NUT!**

AM-FM-MPX Stereo TUNER

£44.95 +H

★ Output 100mV ★ Compliments audio separates

CAR PUSH-BUTTON MW/LW RADIO

£16.95 +H

★ Output 4W
★ Dual Polarity
★ Short Circuit Proof

COMPLETE WITH FITTING KIT & SPEAKER

Available NOW!

POWER SUPPLY

0-30V and 0-1A with a variable current limit

£19.95 +S

SOIL MOISTURE METER

Indicates whether water is needed for plants and lawns

£2.00 +S

TRANSISTOR TESTER

Measures h_{FE} leakage for PNP or NPN transistor either silicon or germanium transistors - includes battery check facility

£9.95 +S

- ★ New 16-page brochure contains complete details of kit range.
- ★ Big range of kits to interest Radio, Electronic and Hi-Fi enthusiasts.
- ★ Kits sent by return-of-post.
- ★ Each kit designed by specialists - only highest quality and reliable components included.

SEND FOR YOUR NEW KIT BROCHURE TODAY only **25p** inc. post and packing.

S - 8% V.A.T.
H - 12½% V.A.T.

DORAM

DORAM ELECTRONICS LTD
P.O.Box TR8,
Leeds LS12 2UF.

I enclose 25p please send me by return my new Doram kit brochure. Overseas orders except for N.Ireland please add 10p for post and packing surface only.

CUSTOMERS WHO ORDER THIS KIT BROCHURE TOGETHER WITH DORAM'S NEW EDITION 3 COMPONENT CATALOGUE CAN SAVE 15p ON THE INDIVIDUAL PURCHASE PRICE FOR BOTH AND OBTAIN TWO 75p VOUCHERS

PLEASE PRINT BLOCK CAPITALS **EE8/76**

NAME _____
ADDRESS _____
POST CODE _____

An Electrocomponents Group Company

Everyday Electronics Classified Advertisements

RATES: 14p per word (minimum 12 words). Box No. 40p. extra. Semi-display—£9.00 per single column inch. Advertisements must be prepaid and addressed to GMG Classified Advertisement Department, "EVERYDAY ELECTRONICS," I.P.C. Magazines Ltd., Room 2337 King's Reach Tower, Stamford Street, London. SE1 9LS. (01-261 5918)

RECEIVERS and COMPONENTS

100 POLYESTER CAPACITORS £2.25
100 Fully guaranteed electrically tested polyester capacitors. No floor sweepings. All famous makes ITT, MULLARD, ERIE etc.
Mixed pack of **YOUR CHOICE** from the following values—mainly 250V. Prompt despatch.
-01 MF -047 MF -22 MF
-015 -068 -33
-022 -1 -47
-033 -15 Mail Order Only
£2.25 includes P&P.
B. Malloy, (E.E.), 66 Woodvale Avenue,
Belfast BT13 3EX, Northern Ireland

Toko I.F.s 7p. Disc Ceramics .01 .02 .04 3p. Polyester Caps C200 -1 250v 2p ea. 16p doz. Wave Change Switch 4 Pole 2 Way PCB 10p. Large Red L.E.D.s 25p. 5 for £1.00. Loudspeakers 8 ohm 2" 2 1/2" 2 1/4" 80 ohm 2 1/2" 75p ea. 3 Digit Counters 15p. Mains Relays treble pole c/o £1.10p. Small Mains Motor 250 rpm 45p. Siren 6v DC £1.28p. Burglar Alarms Best op 75p. Reed Switch Large/Small 10p. Miniature Push To Test Switch 20p. Croc Clips Red/Black 7p. 90v Neons 8p. Veroboard 4" x 3" 25p. 8Ω Earphone & Plug 10p. Capacitors or Resistors Assort Pack 35p. 100mA Mains Transformer 6-0-6v 90p. LT700 65p. Intercom Cases 35p. Enamelled Copper Wire 32, 34, 36 swg 1p ft. Tuning Capacitors 15pf 45p. 500-500 75p. Small Jap Radio Type 30p. Pots 25K, 1M Lin 15p. Assortment Bags 50p. Solder 5p yd. Ferrite Rods 4 1/2" x 4" 18p. BC 107/8/9 15p. Slide Switch DPDT 16p. Resistors 1W 2p ea. Prices include VAT. Add 15p post.

GRIMSBY ELECTRONICS
64, TENNYSON ROAD, CLEETHORPES, HUMBERSIDE.
100's of Bargains at our Lambert Road Components shop (open Saturdays). 1976 List 9p.

FLOATLESS SWITCH. Contains 2 CO relay, mains transformer, 24 and 8 volt, bridge rectifier, 2 transistor control circuit, neon, perspex cover, £2.25 (30p). **NEONS** 30-50p (20p). **COPPER CLAO P.C. BOARDS** 5 1/2" x 9 1/2" 6-50p. 10 1/2" x 9 1/2" 75p. 9 1/2" x 9 1/2" 3-21.38. All C.P. PANEL WITH 10 AMP SCR on heat sink. 11 silicon transistors BC108, BCY72 etc. panel neon, 2 trim pots etc. 80p (25p). **C200 POLYESTER CAPS 100-21 (20p).** List 15p refund on purchase. 7lbs assorted components £2-99 C.P.

JWB RADIO
2 Barnfield Crescent, Sale, Cheshire M33 1NL.
Postage in brackets Mail order only

VALVES
Radio-TV Industrial Transmitting
2,200 Types. 1930 to 1975, many obsolete. List 20p S.a.e. for quotation. Postal export service. We wish to purchase all types of new and boxed valves. Wholesalers, Dealers, etc. stocks purchased.

COX RADIO (SUSSEX) LTD.
The Parade, East Wittering, Sussex.
Tel: West Wittering 3822.

BOOKS and PUBLICATIONS

Start your own business printing pound notes

Printing pound notes? Well not quite—but "start your own business rewinding electric motors" could easily be your licence to make money in 1976.

Lavishly illustrated, this unique instruction manual shows step by step how to rewind motors working part or full time, without experience. Everything you need to know easily explained, including where to obtain materials, how to get all the work you need, etc. etc.

A goldmine of information and knowledge. Only £3.99 plus 26p P&P. From:—
Magnum Publications Dept. EES, Brinkway Trading Estate, Brinkway, Stockport SK3 0BZ

FOR SALE

EVERYDAY ELECTRONICS, No. 1—to date, also Demo-Deck. Complete. Assorted Electronic parts and multi-meter. Offers to **ABBOTT**, 10 Blakemore Road, Streatham, London, SW16 1NH.

AKG D150C MIKES. New and boxed £24. 'E' model £26 inc. VAT and postage. **J. J. FRANCIS (WOOD GREEN) LTD.**, Manwood House, Matching Green, Harlow, Essex. Tel: Matching 476.

WANTED

WANTED BACK ISSUES dated November, December 1971, January, March, May 1972, March, April, May 1973 and March 1976. Please write Box No. 6.

WANTED ELECTRONICS COURSE with Oscilloscope or Multimeter Mr. B. HARRIS, 586 Llanyfelaeh Road, Treboeth Swansea SA5 9EW.

EDUCATIONAL

TRAIN FOR SUCCESS

An ICS home study course will give you the qualifications to improve your career prospects in electronics.

C & G Exams

Course for Certificates in Telecoms Technicians, Electrical Installations, Radio, T.V. and Electronics Technicians & Radio Amateurs.

Practical Radio

Courses include FREE construction kits.

Colour TV Servicing

Covers principles, practice and alignment with numerous illustrations and diagrams. Other courses for Radio & Audio Servicing.

Technical Training

Courses include Electronic Technicians, Computer Technicians, Radio and Television Technicians and many more.

Write for full details TODAY.

ICS School of Electronics, Dept. 710X, Intertek House, London SW3 4UJ.
Telephone 01-422 9911 (all hours).

SERVICE SHEETS

SERVICE SHEETS for Radio, TV, Tape Recorders, Stereo, etc., with free fault-finding guide, 50p and SAE. Hamilton Radio, 47 Bohemia Road, St. Leonards, Sussex.

BELL'S TELEVISION SERVICES for service sheets on Radio, TV, etc. 75p plus s.a.e. Colour TV Service Manuals on request. S.a.e with enquiries to B.T.S., 190 Kings Road, Harrogate, N. Yorkshire. Tel: 0423 55885.

MISCELLANEOUS

SUPERB INSTRUMENT CASES by Bazelli, manufactured from heavy duty PVC faced steel. Hundreds of people and industrial users are choosing the cases they require from our vast range, competitive prices start at a low 75p. Over 400 Models to choose from. Prompt despatch, Free literature. (stamp would be appreciated) Bazelli, Department No. 24, St. Wilfreds, Foundry Lane, Halton, Lancaster LA2 6LT.

LOUDSPEAKERS

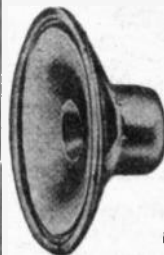

Speakers, kits and cabinets for D.I.Y., Hi Fi, P.A., Disco, etc. by EMI, Fane, Goodmans, Baker, Kef, Elac, Richard Allan, Wharfedale, etc. Send stamp for free booklet "Choosing a speaker"

WILMSLOW AUDIO

Dept. EE, Swan Works, Bank Square, Wilmslow, Cheshire SK9 1HF
Tel. Wilmslow 29599

STYLI & CARTRIDGES. For the best at keenest prices send SAE for free illus. list to **FELSTEAD ELECTRONICS (EE)**, Longley Lane, Gatley, Ches. SK8 4EE.

ENAMELLED COPPER WIRE

SWG	1lb	4oz	2oz
14-18	2-40	80	50
20-22	2-45	82	50
30-34	2-60	80	64
35-40	2-85	1-04	75

Inclusive of P. & P. and VAT

S.A.E. brings Catalogue of copper and resistance wires in all coverings.

THE SCIENTIFIC WIRE COMPANY
P.O. Box 36 London E4. 9BW.

LOWEST COST IC SOCKETS. Use Soldercon IC socket pins for 8 to 40 pin DIL's. 50p for strip of 100 pins, £1.50 for 3 strips of 100, £4 for 1000. 10p p&p for orders under £2. Add 8% VAT. Instructions supplied—send SAE for sample. **SINTEL**, 55e Aston Street, Oxford. Tel: 0865 43203.

HOME SCIENTISTS

Get the key to a FANTASTIC WORLD of previously UNHEARD-OF-PROJECTS. The NEW Boffin catalogue lists LOTS of HIGHLY UNUSUAL, LOW-COST BARGAINS, READY-BUILT MODULES. Here are just a few examples, there are stocks more!

Dazzling MINI-STROBE (pocket size) £3-50

PEOPLE DETECTOR £4-20

Big-Ear SOUND-CATCHER £4-20

Mini DREAM LABORATORY £4-20

Don't take our word for it thought GET A COPY & SEE! SEND ONLY 20p, and we'll RUSH YOU A COPY (YOU'LL GET THE GOODIES' JUST AS QUICKLY TOO!)

BOFFIN PROJECTS

4 Cunliffe Road, Stoneleigh, Ewell, Surrey
(Mail Order U.K. Only)

RECHARGEABLE NICAD BATTERIES
Pencell, AA—94p. Sub 'C'—£1.16. 'C'—£1.92. 'D'—£2.59. PP3—£4.48. Chargers £4.48, £4.48, £4.98, £4.98, £3.98, respectively. Others. All prices include VAT, add 10% post and package. S.a.e. for price list plus 25p for information booklet. SANDWELL PLANT LTD., 1 Denholm Road, Sutton Coldfield, West Midlands. 021-354 9764.

BUILD THE TREASURE TRACER MK III Metal Locator



- Varicap tuning
- Britain's best selling metal locator kit; 4,000 sold
- Weighs only 22oz. Fitted with Faraday shield
- Speaker and earphone operation
- Knocks down to only 17in
- Prebuilt search coil assembly
- Thoroughly professional finish
- As seen on BBC1 and BBC2 TV
- You only need soldering iron, screwdriver, pliers and snips
- Five transistor circuit

Send stamped addressed envelope for leaflet

Complete Kit **£12.50** Built & tested **£17.50**
Post 85p—£1.00 VAT (8%) Post 85p—£1.90 VAT (8%)

MINIKITS ELECTRONICS
5b CLEVELAND ROAD
LONDON, E15 2AN (Mail order only)

NOTICE TO READERS

Whilst prices of goods shown in classified advertisements are correct at the time of closing for press, readers are advised to check with the advertiser both prices and availability of goods before ordering from non-current issues of the magazine.



Please mention

Everyday Electronics

when replying to

advertisements.



ELECTRONI-KIT

BUILD, DISMANTLE AND REBUILD OVER 100 DIFFERENT PROJECTS AND DESIGN NEW CIRCUITS TOO

Radio Receivers and Transmitters, Telephone Amplifiers, Time Buzzers, Battery Checkers, Computer Circuits, Amplifiers, Directional Transmitters, Metal Detectors, Continuity Testers, Electronics Birds, Guns, Metronomes, Sirens, Roulette, Etc., Etc. **ALL IN ONE KIT**

"... educational kits of exceptional quality" (AUDIO mag.)

"... worthwhile ... good value for money" (EVERYDAY ELECTRONICS mag.)

Educational manuals included with each kit. No previous experience required. Suitable for beginners and experts too.

- 100 project kit **£19.00**
- 45 project kit **£15.00**
- 25 project kit **£12.10**

(Add-on kits available too)

Prices include Manuals, Batteries, VAT and p and p

Cheque/P.O. (or 11p for illustrated literature) to **DEPT. EE**

Satisfaction guaranteed
ELECTRONI-KIT LTD, 405 St. John's Street, London, EC1. (01-278 4579)

DENCO (CLACTION) LIMITED

Dept. E.E.

357-8-9 OLD RD.,
CLACTION-ON-SEA
ESSEX CO15 3RH

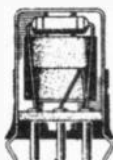

Our components are chosen by technical authors and constructors throughout the world for their performance and reliability, every coil being inspected twice plus a final test and near spot-on alignment.

General Catalogue showing full product range 32p. Overseas Customers 70p, Air-Mail Post Paid.

U.K. & OVERSEAS MANUFACTURERS/STOCKISTS ENQUIRIES WELCOME

Australian Readers Please Note—Our Complete Range of Coils are available from Hobipak, Box 224, South Carlton, 3053, Victoria, Australia and Watkin Wynne Pty. Ltd., 32, Falcon Street, CROWS NEST, 2065, AUSTRALIA. P.O. Box 392.

GF

GIRO NO. 331 7056. Access and Barclaycard accepted. C.W.O. only. Terms of business as in our catalogue. Export Order enquiries welcome (£5 min.)

Official Orders accepted from Educational & Government Departments

ALL PRICES INCLUDE VAT AS APPROPRIATE AT 2% and 12% AND P & P

E. & O.E. SHOP HOURS—9-12.30, 1.30-5 pm 5 DAYS CLOSED WEDNESDAY

66 Pages—3000 Items Fully Illustrated

★20p Credit Vouchers ★All New Stock

1976 Issue ★Satisfaction Guarantee

★Discounts ★New Price

20p Also 10p postage

TRONIC COMPONENTS catalogue 5

RESISTORS - CAPACITORS - SEMICONDUCTORS - BOXES - CASES - KITS - PC MATERIALS - TOOLS - TEST METERS - BOOKS - PETS - COILS - HARDWARE - AUDIO ACCESSORIES - CONNECTORS - VERBOARD TRANSFORMERS - SCREWS - KNOBS - CALCULATORS - AUDIO - MODULES - AUDIO LEADS - BATTERIES - MOUNTINGS - 5 Dec Storage Units etc. etc.

SPECIAL RESISTOR KITS (CARBON FILM 5%) (Prices include post & packing)

10E12 1/2W or 1/4W KIT: 10 of each E12 value, 22 ohms—1M, a total of 570 **£3.94 net**

25E12 1/2W or 1/4W KIT: 25 of each E12 value, 22 ohms—1M, a total of 1425 **£11.79 net**

SPECIAL CAPACITOR KITS

C200 Kit—PC Mounting polyester 250V 5 or each value: 0-01, 0-022, 0-047, 0-1, 0-22µF, 2 of 0-47, 1µF **£1.01 net**

C200 Kit—Tubular polyester, 400V 5 of each value: 0-02, 0-1, 0-22µF, 2 of 0-47µF **£2.45 net**

Ceramic Kit—square plaque 50V 5 of each value: 22, 33, 47, 100, 220, 330, 470, 1000pF, 2200, 4700pF, 0-1µF **£1.71 net**

250V Paper Kit—Tubular metal case 3 of each value: 0-02, 0-1, 0-22, 0-5, 1µF **£1.29 net**

500V Paper Kit—Tubular metal case 3 of each value: 0-025, 0-05, 0-1, 0-025, 0-5µF **£1.29 net**

1000V Paper Kit—Tubular metal case 3 of each value: 0-01, 0-025, 0-05, 0-1µF **£1.59 net**

B. H. COMPONENT FACTORS LTD.

MULTIMETER U4323
22 Ranges plus AF/IF Oscillator
20,000 Ω/Volt.
Vdc—0.5—1000V in 7 ranges.
Vac—2.5—1000V in 6 ranges.
Idc—0.05—500mA in 5 ranges.
Resistance—5 Ω—1M Ω in 4 ranges.
Accuracy—5% of F.S.O.
OSCILLATOR—1 KHz and 400KHz (A, M.) at approx. 1 Volt
Size—100 x 97 x 40mm.
Supplied complete with carrying case, test leads and battery.
PRICE £10.79 net



U4323

MULTIMETER U4324
34 Ranges, High Sensitivity.
20,000 Ω/Volt.
Vdc—0.5—1200V in 9 ranges.
Vac—3—200V in 6 ranges.
Idc—0.06—3A in 6 ranges.
Iac—0.3—3A in 5 ranges.
Resistance—25 Ω—2M Ω in 5 ranges.
Accuracy—dc and R—2% of F.S.O.
ac and db—1% of F.S.O.
Size—167 x 98 x 53mm.
Supplied complete with storage case, test leads, spare diode and battery.
PRICE £12.47 net



U4324

TEACH-IN SERIES COMPONENT KIT KIT No. T12

ALL COMPONENTS AS SPECIFIED BY E.E. FULLY GUARANTEED AND NEW STOCK (INCLUDES BATTERIES) £10.10 NET

WOOD KIT
Includes all wood as specified by E.E., cut to size, ready to assemble and includes adhesive and screws. (Not drilled)
£3.75 NET

FULL LIST AVAILABLE. S.A.E. PLEASE OR FREE WITH CATALOGUE

(E. E.) LEIGHTON ELECTRONICS CENTRE—59 NORTH STREET, LEIGHTON BUZZARD, LU7 7EG. Tel: Leighton Buzzard 2316 (Std. Code 06255).

B. BAMBER ELECTRONICS

Dept EE, 5 STATION ROAD, LITTLEPORT, CAMBS., CB6 1QE
Telephone: ELY (0353) 860185 (2 lines) Tuesday to Saturday

PLEASE ADD 8% VAT UNLESS OTHERWISE STATED

FREE WELER 25W (SP25) SOLDERING IRON (worth £3.24 inc. VAT) with all orders over £20 Limited period only. Send now.

VARIABLE STABILISED POWER SUPPLY, mains input, 0-24V output, stabilised and current limiting at 500mA + 32V at 50mA. Brand new by British manufacturer. Size approx. 7 1/2 x 2 1/2 x 4 in. complete with external 5A 1.3-turn pot for voltage control. Connection data supplied. £7.
50uA (25-0-25uA) EDGEWISE METERS, modern type by Sangamo Western, display area 1/2 x 1 1/2 in with 2 mounting lugs. (Can be zeroed left or right hand.) £1.50 each, while stocks last.

MAINS ISOLATION TRANSFORMERS, Tapped mains input, 240V at 3A + 12V at 500mA output. New, boxed, made by Gardners, £12.

FLEXIBLE HEATER STRIP, 240V a.c., 150W, approx. 1 metre long (insulated with fibreglass) with mains connector block. Many, many uses. 80p each.

HEAVY DUTY RELAYS, 24V d.c. operated (will work on 18V) 3 heavy duty make contacts (around 15A rating) + 4 change over contacts + 1 break contact. New, complete with mounting bracket (ideal for switching HT on Lines!) Many uses for this high quality unit. £1.50 each.
Good Quality Pressure Gauges, 2 1/2 in dia. flange mounting. 3 models avail. 0-60 lbs/ci. in. 0-100 lb sq. in. 0-200 lb sq. in. state which £1.25 each.
2N3055 type Transistors, O.K., but unmarked, 5 for £1.

110V NEONS, SCREW-IN-TYPE, 4 for 50p. Slow motion motors (suitable for programmers, displays, etc.) 230-240V a.c. 1/2 rev. rotation between 1 and 2 revs per minute. £1.25 each.

MINIATURE PLIERS High quality 'Crescent', made in USA. £4.35 + VAT (50p).

BITE CUTTERS, high quality 'Crescent', made in USA. £4.45 + VAT (50p).

MIXED COMPONENT PACKS, containing resistors, capacitors, switches, pots, etc. All new (random sample bag revealed approx. 700 items), £2 per pack, while stocks last.
TUNED COILS, 2 section coils around 1MHz, with a black enamel tuning knob, which moves an internal core to vary the inductance, many uses, easily re-wound, 3 for 50p.

HIGH QUALITY SPEAKERS, 8 1/2 in x 6 in elliptical, only 2 in deep, inverse magnet, 4 ohms, rated up to 10W. £1.50 each or 2 for £2.75 (qty. discount available + 12% VAT).

T03 transistor insulator sets, 10 for 50p.

MINIATURE 2 PIN PLUGS AND SOCKETS (fit into pin hole, pins enclosed, with covers for chassis mounting, or can be used for in-line connectors). Bargain pack of £3 plugs + 3 sockets + covers. 50p.

PROGRAMMERS (magnetic devices) Contain 9 microswitches (suitable for mains operation) with 9 rotating cams, all individually adjustable, ideal for switching disco lights, displays, etc., or industrial machine programming (Need slow motion motor to drive cams, not supplied) 3 switch version £1.50.
HEAVY DUTY HEATSINK BLOCKS, un drilled, base area 2 1/2 in x 2 in, with 8 fins, total height 2 1/2 in. 50p each.
RUBBER MAGNETS pin square, with mounting hole, 20 for 30p.

SPEERY 7 SEGMENT P.G.D. DISPLAYS, digit height 0.3 in red, with decimal points, 150V to 200V (nominal 180V) operation. These are high-volt industrial type and therefore brighter than normal displays. All brand new, AT THE BARGAIN PRICE OF 50p PER DIGIT. TYPE 332 (two digits in one mount) £1 each. TYPE 333 (three digits in one mount) £1.50. (Sorry, no single digit available.) Data Supplied.

BSX20 (VHF Osc/Mult), 3 for 50p.

BC108 (metal can), 4 for 50p.

PBC 108 (plastic BC108), 3 for 50p.

CC200 Transistors, 5 for 50p.

BF751 Transistors, 4 for 60p.

BCY72 Transistors, 4 for 50p.

PNP audio type T05 Transistors, 12 for 25p.

BF152 (UHF amp/mixer), 3 for 80p.

BA121 Varicap Diodes, 4 for 50p.

1N914 diodes, 10 for 25p.

SMALL MAINS SUPPRESSORS (small chokes, ideal for radio, Hi-Fi inputs, etc.) approx. pin x 1 1/2 in, 3 for 50p.

PERSPEX TUNER PANELS (for FM Band 2 tuners) marked 88-108 MHz and Channels 0-70, clear numbers, rest blacked out, smart modern appearance, size approx. 8 1/2 in x 1 1/2 in, 2 for 35p. Lead suppressors (10kohm) for mobile plug leads, 4 for 50p.

PLEASE ADD 8% VAT UNLESS OTHERWISE STATED

ALU-SOL ALUMINIUM SOLDER (made by Multi-core). Solders aluminium to itself or copper, brass, steel, nickel or tinplate. 16 s.w.g. with multicore flux, with instructions. Approx. 1 metre coil 30p pack. Large reel (approx. 12 metres) £2.75.

1 1/2 in polythene chassis mounting fuseholders, 6 for 30p.

Mullard Tubular ceramic trimmers, 1-180pF, 6 for 50p.

I.C.'s, some coded, 14 DIL type, untested, mixed, 20 for 25p.

Mobile Converters, 24V DC input, 13.8V at approx 3-4A DC output, fully stabilised. £3.50 each (ideal for running 12V car radio from 24V lorry battery).
R/S Midget 3 pole 4 way, rotary switches, 40p each.

We now stock Spritax Tools for the electronic enthusiast. Screwdrivers, Nut Spanners, BA and Metric sizes, pop rivet guns, etc. S.A.E. for list.

I.F. Cans, pin square, suitable for rewinding, 6 for 30p + 12% VAT.
Miniature earphones with min. jack plug, 2 for 50p + 12% VAT.

TWIN I.F. CANS, approx. 1 in x 1 in x 1 in high, around 3.5-5MHz, 2 separate transformers in 1 can. Internally screened, 5 for 50p + 12% VAT.

Dublier Electrolytics, 50uF, 450V, 2 for 50p.

Dublier Electrolytics, 100uF, 275V, 2 for 50p.

Plessey Electrolytics, 470uF, 63V, 3 for 50p.

TCC Electrolytics, 1000uF, 30V, 3 for 60p.

Plessey Electrolytics, 1000uF, 180V, 40p each (3 for £1).

Dublier Electrolytics, 5000uF, 35V, 50p each.

Dublier Electrolytics, 5000uF, 50V, 60p each.

ITT Electrolytics, 6800uF, 25V, high grade screw terminals, with mounting clips, 50p each.

Plessey Electrolytics, 10,000uF at 63V, 75p each.

Plessey Cathodray Capacitors, 0-0.4uF at 12.5kV DC. Screw terminals, £1.50 each.

PLEASE ADD 12% VAT TO ALL CAPACITORS

A LARGE RANGE OF CAPACITORS AVAILABLE AT BARGAIN PRICES. S.A.E. FOR LIST.

TV PLUGS AND SOCKETS
TV Plugs (metal type), 5 for 50p.
TV Sockets (metal type), 4 for 50p.
TV Line Connectors (back to back sockets), 4 for 50p. Please add 12% VAT.

PLUGS AND SOCKETS
N-Type Plugs 50 ohms, 50p each, 3 for £1.50.
N-Type Sockets (4-hole chassis mounting), 50 ohms (a small coax lead type), 50p each.
PL259 Plugs (PTFE), brand new, packed with reducers, 85p or 5 for £3.
SO239 Sockets (PTFE), brand new (4-hole flanging type), 50p each or 5 for £2.25.
25-way ISEP Plugs and Sockets, 40p set (1 plug + 1skt).

Plugs and sockets sold separately at 25p each. Bulgin Round Free Sks 3 pin, for mains input on test equipment, etc. 25p each.

WELER SOLDERING IRONS
EXPERT, Built-in spotlight illuminates work. Pistol grip with fingertip trigger. High efficiency copper soldering tip.
EXPERT SOLDER GUN KIT (spare bits case, etc.), £9.80 + VAT (75p)

SPARE BITS, PAIR, 30p + VAT (2p)

MARKSMAN SOLDERING IRONS
SP150 15W £3 + VAT (24p)

SP250 25W £3 + VAT (24p)

SP250K 25W + bits, etc. kit £3.85 + VAT (31p)

SP400 40W £3.44 + VAT (28p)

BENCH STAND with spring for Marksmen Irons, £2.22 + VAT (18p)

SPARE BITS
MT8 for 15W, 46p + VAT (4p).

MT4 for 25W, 36p + VAT (3p)

MT10 for 40W, 42p + VAT (3p)

TEMPERATURE CONTROLLED IRON, Temperature controlled iron & PSU, £20 + VAT (£1.80)

SPARE TIPS
Type CC single flat, Type K double flat fine tip.
Type P, very fine tip, £1 each + VAT (8p).

ALL SPARES AVAILABLE

MULTICORE SOLDER
Size 5 Savbit 18 s.w.g. in alloy dispenser, 32p + VAT (20p).
Size C15AV18 Savbit 18s w.g., 50p + VAT (4p).
Size 12 SAVBIT 18s w.g. on plastic reel £1.80 + VAT (15p)

Terms of Business: CASH WITH ORDER. MINIMUM ORDER £1. ALL PRICES INCLUDE POST & PACKING (UK ONLY). SAE with ALL ENQUIRIES Please. PLEASE ADD VAT AS SHOWN. ALL GOODS IN STOCK DESPATCHED BY RETURN. CALLERS SATURDAYS ONLY 9.30-12.00, 1.30-5.00.

1. Understand electronics.

Step by step, we take you through all the fundamentals of electronics and show you how easily the subject can be mastered using our unique Lerna-Kit course.

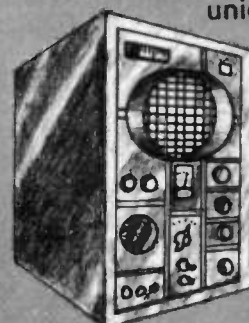

2. Become a radio amateur.

Learn how to become a radio amateur in contact with the whole world. We give skilled preparation for the G.P.O. licence.



- (1) Build an oscilloscope.
- (2) Read, draw and understand circuit diagrams.
- (3) Carry out over 40 experiments on basic electronic circuits and see how they work.

Free!

Brochure, without obligation to:

BRITISH NATIONAL RADIO & ELECTRONICS SCHOOL,
P.O. Box 156, Jersey, Channel Islands.

NAME _____

ADDRESS _____

Block caps please

EEC 96

Published approximately the third Friday of each month by IPC Magazines Ltd., Fleetway House, Farringdon St., London EC4 4AD. Printed in England by Index Printers Ltd., Dunstable, Beds. Sole Agents for Australia and New Zealand—Gordon and Gotch (A/81a) Ltd. South Africa—Central News Agency Ltd. Everyday Electronics is sold subject to the following conditions, namely that it shall not, without the written consent of the Publishers first given, be lent, resold, hired out or otherwise disposed of by way of Trade at more than the recommended selling price shown on cover, excluding Hire where the selling price is subject to V.A.T., and that it shall not be lent, resold, or hired out or otherwise disposed of in a mutilated condition or in any unauthorised cover by way of Trade, or affixed to or as part of any publication or advertising, literary or pictorial matter whatsoever.

constructors —guides—

This exciting new series provides clear and easily understood descriptions, advice and general help for amateur constructors, students and technicians aimed at breaking down the barriers that often deter beginners in electronics.

AVAILABLE NOW 

PROJECT PLANNING AND BUILDING

Morris A. Colwell

This guide will help the constructor to plan, design and lay out his electronic projects. The book explains planning, use of tools, component board layout, the design and layout of chassis and cases, and assembly and wiring.

There is also an extremely useful Appendix.

128 pages 216 x 138mm Illustrated
0 408 00229 B £1.95

SIMPLE CIRCUIT BUILDING P. C. Graham

This guide provides a logical introduction to general purpose circuits for the home constructor and to converting theoretical circuits into practical layouts. The book covers a wide range of easy to assemble circuits, including switching and logic circuits and their layouts, operational amplifiers, a.c. amplifiers and d.c. power supplies.

128 pages 216 x 138mm Illustrated
0 408 00230 1 £1.95

PRACTICAL ELECTRONIC PROJECT BUILDING

Alan Ainslie and Morris A. Colwell

A concise but informative guide to some of the current popular methods of construction and techniques employed in home construction. Contains hints on finishing and fault-finding methods.

128 pages 216 x 138mm Illustrated
0 408 00231 X £1.95

Other titles published in this series are: ELECTRONIC DIAGRAMS—0 408 00201 B—£1.80; PRINTED CIRCUIT ASSEMBLY—0 408 00203 4—£1.80; ELECTRONIC COMPONENTS—0 408 00202 6—£1.80

For details of all Newnes Technical Books please write for a free catalogue and watch for announcements in following issues of *Everyday Electronics*.

 **Newnes Technical Books**

NEWNES-BUTTERWORTHS

Borough Green, Sevenoaks, Kent TN15 8PH

Sparkrite Mk2

Capacitive discharge electronics ignition kit



- * Smoother running
- * Instant all-weather starting
- * Continual peak performance
- * Longer coil/battery/plug life
- * Improved acceleration/top speeds
- * Up to 20% better fuel consumption

Sparkrite Mk. 2 is a high performance, high quality capacitive discharge, electronic ignition system in kit form. Tried, tested, proven, reliable and complete. It can be assembled in two or three hours and fitted in 15/30 mins.

Because of the superb design of the Sparkrite circuit it completely eliminates problems of the contact breaker. There is no misfire due to contact breaker bounce which is eliminated electronically by a pulse suppression circuit which prevents the unit firing if the points bounce open at high R.P.M. Contact breaker burn is eliminated by reducing the current to about 1/50th of the norm. It will perform equally well with new, old, or even badly pitted points and is not dependent upon the dwell time of the contact breakers for recharging the system. Sparkrite incorporates a short circuit protected inverter which eliminates the problems of SCR lock on and, therefore, eliminates the possibility of blowing the transistors or the SCR. (Most capacitive discharge ignitions are not completely foolproof in this respect). All kits fit vehicles with coil/distributor ignition up to 8 cylinders.

THE KIT COMPRISES EVERYTHING NEEDED

Ready drilled pressed steel case coated in matt black epoxy resin, ready drilled base and heat sink, top quality 5 year guaranteed transformer and components, cables, coil connectors, printed circuit board, nuts, bolts, silicon grease, full instructions to make the kit negative or positive earth, and 10 page installation instructions.

OPTIONAL EXTRAS

Electronic/conventional ignition switch. Gives instant changeover from "Sparkrite" ignition to conventional ignition for performance comparisons, static timing etc., and will also switch the ignition off completely as a security device. Includes switch connectors, mounting bracket and instructions. Cables excluded. Also available RPM limiting control for dashboard mounting (fitted in case on ready built unit).

CALLERS WELCOME. For Crypton tuning and fitting service — phone (0922) 33008

PRICES INCLUDE VAT, POST AND PACKING.

Improve performance & economy NOW

POST TODAY!

Quick installation
No engine modification
required

Electronics Design Associates, DEPT EE/9
82 Bath Street, Walsall, WS1 3DE. Phone: (0922) 33652

Name
Address

Mk 2 DIY Ass. Kit @ £11.80	QUANTITY REQD.	I enclose cheque/PO's for £
Mk 2 Ready Built Negative Earth @ £14.97		
Mk 2 Ready Built Positive Earth @ £14.97		Cheque No.
Ignition Changeover switches @ £4.30		
R.P.M. Limit systems in above units @ £2.42		Send SAE if brochure only required.

md DiLworth

Make it with MAPLIN!

ELECTRONIC COMPONENTS

WIDE RANGE • HIGH QUALITY • FAST SERVICE

The 4600 SYNTHESISER



We stock all the parts for this brilliantly designed synthesiser, including all the PCB's, metalwork and a drilled and printed front panel, giving a superb professional finish. Opinions of authority agree the ETI International Synthesiser is technically superior to most of today's models. Complete construction details in our booklet now available price £1.50, or send SAE for specification.

ELECTRONIC ORGAN

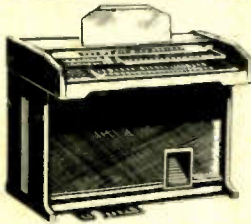

BUILD IT YOURSELF ... IN STAGES

Get started with a 49 note instrument - features tremulant and reverbation. Ideal to learn on. Leaflet MES 51. Price 15p gives full details to build this complete instrument.

Extend the range of MES 51 by adding another keyboard and several new tone colours. Leaflet MES 52. Price 15p also shows how to use 61 note keyboards.

Fully controllable attack and decay controls (normally found only on the most expensive organs), up to seven footages on each keyboard, up to 70 controls including drawbars, and a 13 note pedalboard, make up the additions described in the step-by-step 32 page instruction leaflet MES 53. Price 35p.

GRAPHIC EQUALIZER

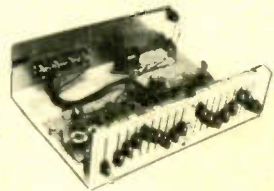

A really superior high-quality stereo graphic equalizer featuring 9 octaves per channel. We stock all the parts (except woodwork) including the metalwork drilled and printed. 15p brings you a reprint of the article.

DIGITAL CLOCK KITS

ONLY **£8.60** INC. VAT E/P/P



This is a fully constructed and tested electronic clock module as illustrated. Data sheet supplied. Simple to connect to alarm and your battery/mains radio. Smart case available. Data sheet available separately. Please send SAE.

- * Bright 4 Digit 0.5" Display
 - * Flashing Colon (1Hz)
 - * Switch for Display Seconds
 - * Alarm Set Indicator
 - * P.M. Indicator
 - * Power Failure Indicator
 - * Sleep Timer
 - * Snooze Timer
 - * Time can be set accurately to within one second
 - * Leading Zero Blanking
- SIMPLE ALARM KIT - £9.38 ALARM CLOCK KIT - £10.99
 ALARM CLOCK & RADIO CONTROLLER KIT - £11.51
 SMART PLASTIC CASE with fully punched chassis - £2.49
 Please send SAE for our Clock data sheet



100W PER CHANNEL STEREO DISCO

- * Automatic voice operated fader
- * Belt drive turntables
- * Monitor facilities (Headphones and VU meters)
- * Sound operated light show - plus many other advantages.

Full construction details to be published in Electronics Today International on sale August.

Send for our leaflet MES 41, giving full details for construction Price 20p. Soon you'll be the Deejay everyone wants at their party!

Get our FABULOUS NEW 1977/78 CATALOGUE

PUBLICATION DATE OCT. 28, 1976 ON APPROVAL

All new • Completely re-written • Hundreds of new lines.
 Lots of exciting new projects to build - PRICE 50p.
 SEND NO MONEY NOW. Overseas send 8 International reply coupons.

JOIN OUR MAILING LIST NOW!
 Published every two months our Newsletter gives full details of our latest guaranteed prices. Send just 30p and we'll send you the next six news letters as they are published.

- * SAVE 50% ON SPECIAL OFFERS!
- * DETAILS OF NEW PROJECTS AND NEW LINES

Please rush me a copy of your brand new 1977/78 catalogue the instant it is published (October 28th, 1976). Only if I am completely satisfied that it is worth every penny will I send 50p within 14 days of receipt. If I am not satisfied I may return the catalogue to you within 14 days without obligation. I understand that I need not purchase anything from your catalogue should I choose to keep it.

NAME _____

ADDRESS _____

If you do not wish to cut magazine write your request for catalogue on separate sheet
 1975 76 GREEN COVER CATALOGUE STILL AVAILABLE PRICE 40p



MAPLIN ELECTRONIC SUPPLIES
 All mail to: P.O. Box 3, Rayleigh, Essex S56 6LR.
 Shop: 284 London Road, Westcliff-on-Sea, Essex
 (Closed on Monday). Tel: Southend (0702) 44101